

KFAE Pullman, Wash. Page 37

AUGUST 1923

25 Cents

RADIO

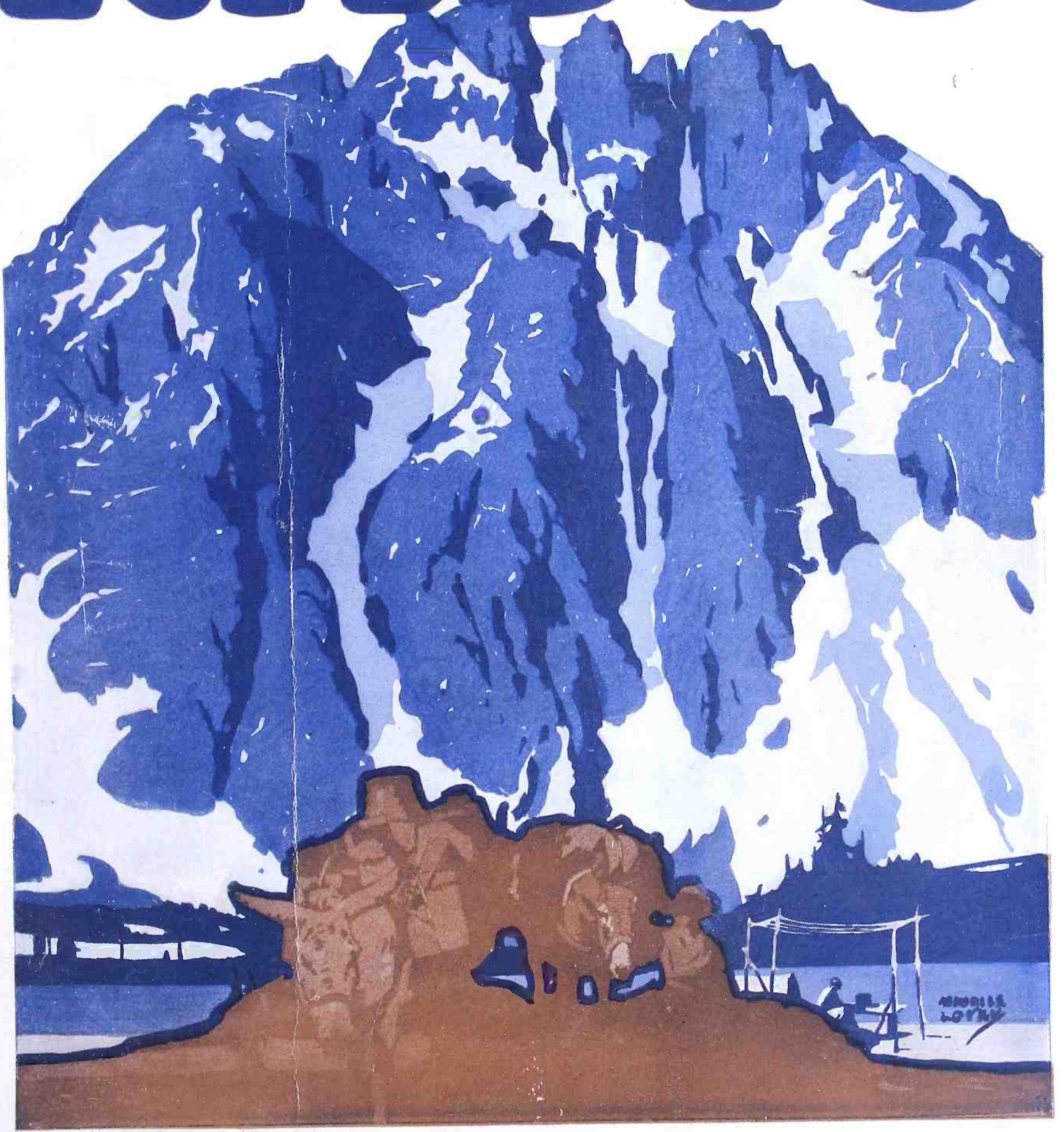

In this Issue:

Wonder One-Tube Portable with Loop.
A Simplified Reinartz Circuit by M. B. Sleeper.



The Ideal Tube For the Call of the Open

Are you spending your vacation in the North Woods—at the seashore—in one of our many great national parks, or are you motoring across country? In any event the new Cunningham dry battery detector and amplifier, type C-299, makes it possible for you to take a radio receiver, which will be light in weight, compact in design, and highly efficient in operation. It is the special filament in this tube, having a current so low that it may receive its supply from standard No. 6 dry batteries or even from ordinary flashlight batteries, that makes possible this new and interesting application of radio.

The receiving set you now have can be readily adjusted to use this new tube and be a source of use and pleasure on your vacation trip. In any event your dealer can give you useful suggestions for the purchase or construction of a highly efficient and practical portable set.

*A Specially
Designed Tube
For Every
Radio Use*

Patent Notice: *Cunningham tubes are covered by patents dated 11-7-05, 1-15-07, 2-18-08, and others issued and pending. Licensed for amateur, experimental and entertainment use in radio communication. Any other use will be an infringement.*

E. J. Cunningham Inc.

Home Office:
248 First Street
San Francisco, Calif.

154 West Lake Street
Chicago, Ill.

Room 519, 30 Church Street
New York City, N. Y.

RADIO

Established 1917 as Pacific Radio News

Volume V

for AUGUST, 1923

Number 8

CONTENTS for AUGUST, 1923

Radiatorial Comment	9
Interference	10
<i>By DONALD K. LIPPINCOTT</i>	
The Simplified Reinartz Set	11
<i>By M. B. SLEEPER</i>	
Universal Motion for Secondary and Tickler Coils	12
<i>By ARTHUR S. GORDON</i>	
An Exclusive Broadcast Receiver	13
<i>By SAMUEL G. MCMEEN</i>	
What Is It?	14
<i>By RUDOLPH W. VAN NORDEN</i>	
A Five-Watt Radiophone	15
<i>By STUART A. HENDRICK, 2BJG</i>	
A Wonder One-Tube Portable "Super"	17
<i>By T. N. SLOCUM</i>	
Fading	18
<i>By EDWARD T. JONES</i>	
Jimson's Coup	19
<i>By EARL ENNIS</i>	
Sparks Shows The Club a New Stunt	21
<i>By S. P. WRIGHT</i>	
Principles of Radio Telephony	22
<i>By A. Machson</i>	
General Design of a Receiving Set	25
<i>By FLORIAN J. FOX</i>	
Resonance Phenomena and The Distribution of Energy	27
<i>By BERNARD STEINMETZ</i>	
The Toth Circuit	29
<i>By BERT T. BONAVENTURE</i>	
Getting Ranker and Ranker	30
<i>By DAVID P. GIBBONS</i>	
Selectivity and Its Application To Reception	31
<i>By JEROME SNYDER</i>	
The Effect of Poor Insulation and Leakage	32
<i>By A. REISNER</i>	
An Exceptional Single Circuit Non-Regenerative Tube Set	33
<i>By JESSE MARSTEN</i>	
An Interesting Application of Radio Circuits	34
<i>By L. R. FELDER</i>	
Queries and Replies on C. W. Practice	35
<i>By GERALD M. BEST</i>	
News of The Broadcasters	37
Letters To The Editor	38
Mott's Signals Heard in Australia	39
<i>By L. A. LANE</i>	
Radio in Australia	39
With the Amateur Operators	40
New Apparatus and Supplies From the Radio Manufacturers	42

RADIO is Published Monthly by the Pacific Radio Publishing Co., Inc.,
Pacific Building, San Francisco, Calif.

ARTHUR H. HALLORAN	Editor
LAWRENCE MOTT	Associate Editor
LOUIS TREVISO	Art Editor
GERALD M. BEST	Technical Adviser
G. E. BURKS	Engineering Draughtsman
H. W. DICKOW	Advertising Manager

Branch Offices: 17 West 42nd St., New York City, Telephone Longacre 8248; 157E. Ontario St., Chicago; 761 Spitzer Bldg., Toledo, Ohio; 52 Irving Street, Boston, Telephone Copley 5107-R; 1102 Republic Bldg., Kansas City, Mo.; Suite 511, 456 So. Spring St., Los Angeles, Cal., Telephone 12050; 2218 Third W., Seattle, Wash., Telephone Elliot 1903.

European Representatives: Compagnie Universelle De Representation wt de Commerce. Rue des Fortifications, 69, Anvers, Belgium.

Advertising Forms Close on the First of the Month Preceding Date of Issue.

Issued Monthly, 25c a copy. Subscription price \$2.50 per year in the U. S., \$3.00 per year elsewhere. Instructions for change of address should be sent to the publisher two weeks before the date they are to go into effect. Both old and new addresses must always be given.

Entered as second-class matter at the Post Office at San Francisco, Calif., under the Act of March 3, 1879.

Copyright 1923, by the Pacific Radio Publishing Co., Inc.

Forecast of Contributions for September Issue

D. B. McGown, radio inspector at San Francisco, is a graduate electrical engineer who has designed and made many radio sets. For the readers of September RADIO he gives general advice on designing a receiver with specific details on the mechanical and electrical design of induction coils. This will be continued in the next issue with design data for transmitters and amplifiers.

K. Kenneth of Minneapolis in "Notes on the Beverage Antenna" treats of the theory, design, application and characteristics of this type of antenna which has been found to materially reduce interference.

Preston Allen, who runs a radio school and operates two broadcast stations at Oakland, Calif., has taken time to write "The Romance of The Radio Calls," a story that will interest the old-time "op" as well as the novice.

E. M. Sargent, whose design for a radio-frequency amplifier was the prize winner in these columns, tells how to design a long distance receiver that is extremely selective and sensitive for wavelengths from 180 to 750 meters. Full details are given so that any capable amateur can duplicate this set.

"Music from the Parlor Table" is the title of a description of a five-tube set with loop aerial built by L. W. Van Slyck of Ironwood, Wash.

Louis Falconi of Roswell, N. M., well and favorably known as 5ZA, gives full details of the 200-watt phone C. W., and I. C. W. transmitter which he has so successfully used for the past year.

"Handy Hints" is a new department which will be started with September RADIO with D. B. McGown as editor. He wrote the first lot himself, but will be glad to edit further contributions from our readers.

In his inimitable style David P. Gibbons, in "Loop versus Bloop," comes to the defense of the much-maligned single-circuit receiver and tells how to make a loop that will cut out the bloop from a "Gibbon's" hook-up.

The editor believes that an issue of RADIO without an article from Samuel G. McMeen falls short of the high standard which he is trying to maintain. Next time Mr. McMeen will tell about his idea for varying the selectivity of a receiver by means of a rotating tickler inside the secondary.

Jesse Marsten, whose past articles on the theory of radio have clarified the minds of many readers, has a contribution on "Electron Emission, Its Control, and Life of Tubes." His treatment assumes some knowledge of electricity and radio. Jay Emm has a good article on the design and use of wavemeters.

The beginner will be helped by an article on "Antenna Types" by Maurice Buchbinder. He shows the advantages and limitations of several kinds of antennas for broadcast reception.

A. Reisner follows up his article on the harmful effects of poor insulation with a discussion of the effects of over-insulation. B. Steinmetz likewise completes his article on series resonance, as printed in this issue, with a contribution on parallel resonance in the September number.

"Fame is the follower
of reality."
— Yu Tse.

the New
Grebe

Broadcast
Receiver
earns great fame
through superior
performance.
— Doctor Mu.

Seven Points
of Satisfaction.

1. Requires no outdoor antenna—no loop.
2. Uses all kinds of tubes (4 of them) in any desired combination.
3. Employs the perfect combination of Regeneration and Tuned Radio Frequency Amplification with only two tuning adjustments.
4. Receives all broadcasting.
5. Tuning Dial graduated in wavelengths.
6. May be set up immediately, and successfully operated—anywhere—by anyone.
7. Complete, self-contained Receiver, in attractively finished walnut cabinet, with compartments for A and B batteries.

Write for Booklet



Type CR-12

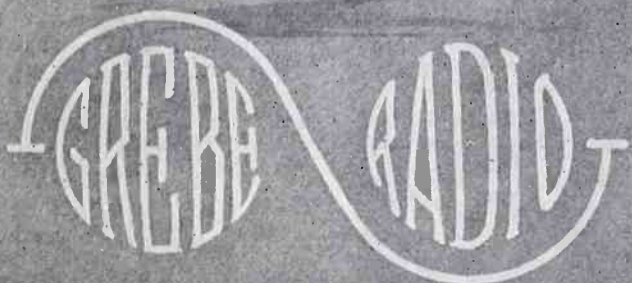

A. H. GREBE & COMPANY, Inc.
Richmond Hill, N.Y.
Western Branch, 451 East 3rd St., Los Angeles, Cal.

Licensed under Armstrong
U. S. Pat. No. 1,113,149

Tell them that you saw it in RADIO

ONLY A FEW LEFT

The Latest Edition of CITIZEN'S RADIO CALL BOOK

180 Pages. Only 50 Cents Per Copy

CITIZENS

RADIO

CALL BOOK

A

Complete Radio Encyclopedia and Directory

Telephone Broadcasting Stations
Radio Map and Full Operating Schedules
United States Amateurs
Canadian Amateurs

Naval Stations
Foreign Time and Press Schedules
World's High Power Transoceanic Stations

ARRL Section
"Hook Ups"

Formulae
Questions and Answers
RADIO LAWS

"How to Build Your Own"

Compiled from official records, Bureau of Standards and other sources

50 Cents U. S. A.

65 cents Canada and Foreign

"Why Pay More"

CONTENTS

The Nine Amateur Districts, Special Amateur and Experimental Stations. All practical wireless circuits. Schematic diagrams of these and a glossary or description of the working of the circuits. There are also full page graphic illustrations and photographs of the Flewelling circuit, the Reinartz and Armstrong double regenerative circuits.

A complete list of all Telephone Broadcasting Stations with their full operating schedules. These are also listed alphabetically by States. A complete 4 page American Radio Relay League section, containing a letter to the Citizen-Radio, by Mr. Kenneth B. Warner. A double page A. R. R. L. divisional map. A page giving the personnel of the Executive and Operation Divisions throughout the country.

A complete list of all Canadian Amateurs and Canadian Telephone Broadcasting Stations with their schedules.

A double page Radiophone Map of the United States, with all stations marked on the map, drawn to scale.

A double page map of the world, with all high powered stations marked. A Complete Schedule over 24 hours' time (Greenwich) of all high power stations, time they send, system they employ, wave length and character of the matter they send.

A Complete Federal Market Broadcasting schedule, by state, town and information on matter they broadcast.

International Continental Code and Conventional "Q" Signals.

Trap Circuits.

Up-to-date Radio laws, Amateur and Commercial.

Hook Ups.

Formulae for the Amateur and Experimenter. A wonderful Question and Answer Department, very complete.

The Circuit section contains both Receiving and Transmitting diagrams. The Transmitting end of this covers the best of the Amateur hook-ups on short wave transmission, C. W., I.C.W., and Voice.

The book contains 176 pages and cover printed in two colors.

Amateurs---Broadcast Listeners---you need this wonderful radio book. Send 50c. for your copy today. Supply almost exhausted!

DEALERS: Write for Trade Prices

CITIZENS RADIO SERVICE BUREAU,
Dept. R, 416 South Dearborn St.,
Chicago, Ills.

Herewith is 50 cents for which you will immediately send me the latest CITIZENS RADIO CALL BOOK.

Name.....

Address.....

Tell them that you saw it in RADIO

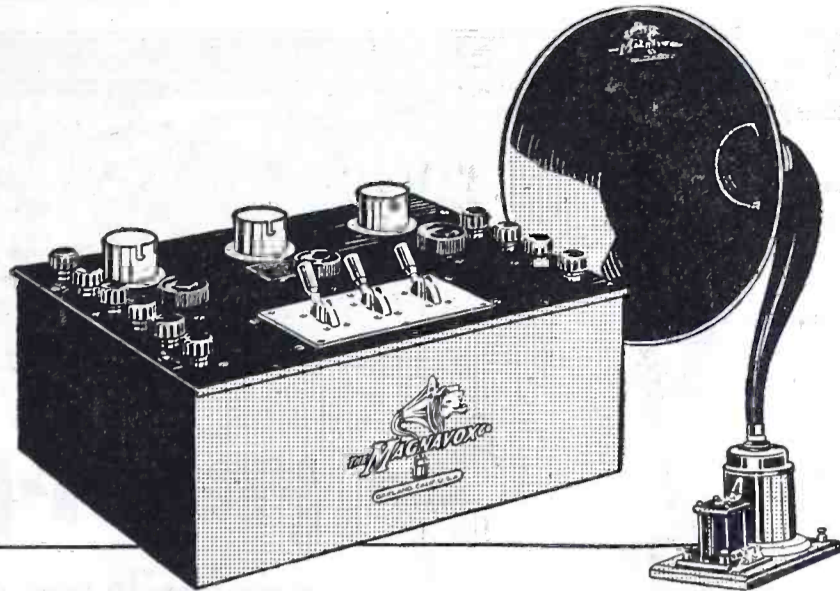

MAGNAVOX and FORMICA

THE radio engineers of the Magnavox Company have given their approval to Formica in the most sincere and convincing way — by using it exclusively in their apparatus for a long time.

Think over the list of great independent radio manufacturers whose standing and prestige in radio counts for something, and you will find almost every one among the regular users of Formica.

The only reason is that Formica is better looking, more uniform, more efficient than any other radio insulation of the kind. They have tested and tried them all and they *know*.

Your dealer will supply you promptly with a Formica panel in any of the standard sizes, or in any special sizes.

Dealers: Sell panels in the size your trade demands — not a few sizes that some one else wants you to carry. You will find Formica sales and advertising support and its wonderful nation-wide reputation a big help in building up your sales of panels and tubes.

THE FORMICA INSULATION COMPANY
4616 Spring Grove Ave., Cincinnati, Ohio

Sales Offices

50 Church St., New York, N. Y.
422 First Ave., Pittsburgh, Pa.
1042 Granite Bldg., Rochester, N. Y.
415 Ohio Bldg., Toledo, Ohio

1210 Arch St., Philadelphia, Pa.
1819 Lyndale Ave., S. Minneapolis, Minn.
Sheldon Bldg., San Francisco, California
Whitney Central Bldg., New Orleans

414 Finance Bldg., Cleveland, Ohio
9 S. Clinton St., Chicago, Ill.
313 Title Bldg., Baltimore, Md.
47 King St., Toronto, Ontario

FORMICA

Made from Anhydrous Redmanol Resins
SHEETS TUBES RODS

Tell them that you saw it in RADIO



No. 162
2000 ohm set
\$5⁰⁰

No. 163
3000 ohm set
\$6⁰⁰

Easily the most famous popular-priced head fones in the world. Built like a high-grade watch, yet sold at prices which offer you biggest value.

FROST-RADIO



FROST RADIO PLUGS
No. 139 Cord Tip Plug, shown here, is smallest, finest plug made. Price 60 cents.



FROST-RADIO JACKS
Millions have bought them because of their high quality. No. 131 Double Circuit Jack: 90 cents.



FROST-RADIO MULTI-PHONE PLUG
A convenient way to connect four or less pairs of Frost-Fones. Immensely popular. \$2.50.

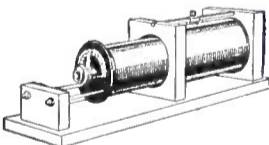

FROST-RADIO RECEIVING TRANSFORMER
Could hardly be made better if it cost twice as much. Extremely selective. 200-4000 meter range. \$8.50.

"The name FROST is your guarantee of quality"

HERBERT H. FROST, Inc.
154 WEST LAKE STREET
CHICAGO
30 Church Street, New York

FROST-FONES

are built up to an ideal
—not down to a price

IF Frost-Fones were built in small quantities, by hand, they could not be made more efficient, more sensitive, or of higher quality.

Because they are produced by precision methods in vast numbers every working day, by the most modern of automatic machines, they cost less than most other fones of similar quality.



Do not, however, judge Frost-Fones by their selling price. For we have built them up to an ideal, and not down to a price.

If you could see the care used in their manufacture—the countless tests during every stage of production—and could realize how jealously we safeguard Frost-Fone quality, you would feel that Frost-Fone prices were too low, or that most other head fones were overpriced.

But after all, the real test is on your radio receiving set. Get a set of Frost-Fones from your dealer today—try them on your set—note their wonderfully human tone—their clear reproduction—their light weight—their snug fit. *Convince yourself by this test that they are the finest head fones on the market at anywhere near their price.*



MAGNAVOX

Radio in Summer

THE man who purchases a Magnavox for its clearness of reproduction, finds additional advantages in its use which contribute greatly to his enjoyment of Radio.

For instance, due to its extreme sensitivity, the Magnavox can clearly reproduce signals which otherwise would be indistinguishable.

This means a great increase in distance range—more stations brought within the Magnavox owner's reach.

Magnavox Reproducers and Power Amplifiers can be used with any receiving set of good quality. Without Magnavox, no receiving set is complete.

Magnavox R2 Reproducer and 2 stage Power Amplifier (as illustrated)
\$115.00

R2 Magnavox Reproducer with 18-inch curvex horn: the utmost in amplifying power; requires only .6 of an ampere for the field \$60.00

R3 Magnavox Reproducer with 14-inch curvex horn: ideal for homes, offices, etc. . . . \$35.00

Model C Magnavox Power Amplifier insures getting the largest possible power input for your Magnavox Reproducer.

AC-2-C, 2-stage, \$55.00
AC-3-C, 3-stage, \$75.00



ANY GOOD RECEIVING SET



*A clearer Radio voice,
sounding above the
tumult of vacation time*

WHEN days are spent in summer's outdoor playgrounds, Magnavox needs only an instant's notice to supply dance music, sporting news or entertainment for all.

Open places test impartially the real quality of Radio reproduction—with Magnavox equipment your receiving set will give superbly adequate performances, indoors or out, the year 'round.

Magnavox products can be had of good dealers everywhere. Send for copy of unusual booklet.

The Magnavox Co., Oakland, California
New York: 370 Seventh Avenue

MAGNAVOX

Radio

The Reproducer Supreme

A Separate Filament Transformer for Radiotron Transmitting Tubes

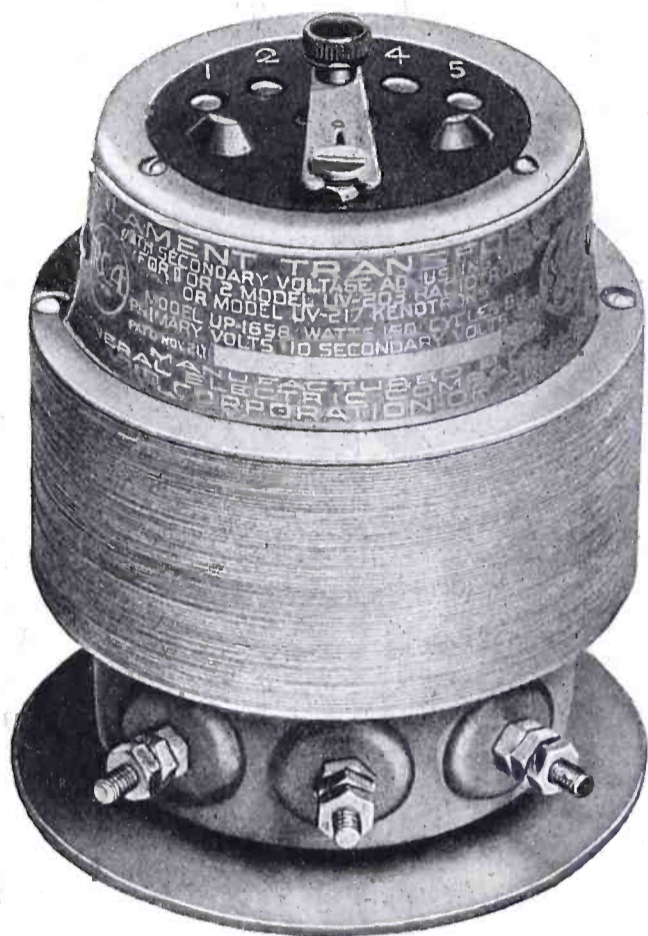

LEADING engineers have determined that alternating filament current means longer life for your tubes. The 110-volt current of the house lighting system is led to the Separate Filament Transformer, and then directly to the filaments. This means more service from your tubes. There are two models, one for 5-watt Radiotrons and 20-watt Kenotrons; the other for 50-watt Radiotrons and 150-watt Kenotrons — both made with the precision for which the symbol RCA is famous.

Model UP-1658

operates on a 60-cycle, 110-volt source and has an output of 150-watts, which will take care of either one or two UV-203 Radiotrons or UV-217 Kenotrons. The five taps in the PRIMARY circuit give secondary voltages of 9.7 to 10.8 on one tube and 9.2 to 10.3 on two tubes. A center tap is provided at one-half the secondary voltage. It is 3-19/32 inches in diameter, and 4-13/16 inches high.

\$11.50



This symbol of quality is your protection

Model UP-1656

is designed to operate on a 60-cycle, 110-volt source and has an output of 75 watts, which will take care of one to four UV-202 Radiotrons or UV-216 Kenotrons. It has five taps in the PRIMARY circuit, which give secondary voltages between 7.3 and 8.1 used with one tube, and 7.0 to 7.7 on four tubes. A center tap is provided at one-half the secondary voltage. It is 3-19/32 inches in diameter, and 4-1/16 inches high.

\$9.75

Radio  **Corporation**
of America

Sales Dept. Suite 2069
233 Broadway
New York

District Sales Offices
10 So. LaSalle Street
Chicago, Illinois

433 California Street
San Francisco, California

Tell them that you saw it in RADIO

August 1923

RADIO

Established 1917

Vol. 5, No. 8

Radiatorial Comment

ELSEWHERE in this issue is a statement as to certain changes in the regulations governing amateur licenses.

These changes are largely in accordance with the recommendations of the Second Radio Conference and presumably have been made after consultation with representatives of the A. R. R. L. In view of the several new restrictions placed upon amateur transmission to lessen interference with broadcasting, and especially in view of the voluntary cessation of amateur transmission during the early evening hours, it hardly seems fair to definitely prohibit transmission between the hours of 8:00 and 10:30 p.m.

While this will not greatly hinder the old-time dyed-in-the-wool amateur who goes to bed with the chickens so as to get up ahead of the first rooster, it certainly will deter many new hands at the game. When it is considered that little or no interference results from a C. W. set operating during broadcast hours, this prohibition seems at once arbitrary and unnecessary.

One beneficial effect of the new regulation will be to show that much of the so-called amateur interference originates from commercial stations. What with broadly-tuned sparks and harmonics from arc transmitters, especially along the coast line, most of the B.C.L. troubles will continue as in the past. It is certainly no more than just that equally stringent regulations be enforced as regards commercial operation, especially on the 450-meter wavelength.

Furthermore, with the amateurs off the air till 10:30 p.m., in all fairness, the broadcast stations should shut down at that time so as to give the amateurs a chance.

There is yet unpaid a great debt of gratitude to the radio amateur. Without his work in the past radio would not be where it is today. It is likely also that any cessation of amateur interest in the future will seriously cripple the advancement of the art. So it certainly is to the self interest of all concerned with the development of radio to see to it that the amateur has a square deal and is encouraged in his activities. This prohibition does not give such a square deal and it discourages the young man ready to take up C. W. transmission.

THE newest radio puzzle is how to unscramble the Catalina phone conversations. And take it from me, boys, some enterprising amateur is going to separate this hash into its component parts and reconstruct intelligible speech. How the sausage is made by the Bell engineers and how it is digested is being kept as secret as its resultant speech. But like the age-long battle between the code-makers and the code decipherers somebody, just for the fun of it, is going to again listen into "the key-hole of the Pacific." Not that it will do them any good or harm, for

all commercial traffic is being handled over the newly-laid cable from the island to the mainland and these fresh-egg messages do not have to be scrambled to disguise them.

CONSIDERABLE interest attaches to press reports of Marconi's successful experiments with directive transmission on short wavelengths. While complete reports are not yet available it is to be assumed that these experiments were with wavelengths of from ten to twenty meters. As is well known, these can be reflected without spreading out in all directions by means of a series of wires hung in the form of a parabolic cylinder. This is similar to the reflection of the much shorter wavelength of a beam of light by means of the parabolic reflector in a search light.

While this result is the direct antithesis of that secured and desired in ordinary broadcasting, it would be suitable when it was desired to confine the reception to a limited area or more especially for "point-to-point" communication when the message from one transmitting station is to be heard by but one receiving station. Most of the ship radio and transoceanic traffic is of this character. It must be remembered, however, that the method is not applicable to the lower frequencies, or longer wavelengths used in such service.

The secret of Marconi's success in long distance transmission with low power is that all of the energy is made available for transmission in one direction instead of in every direction, so that the strength of the received signal is many times greater. This result can be intensified by means of a similar parabolic reflector at the receiving end.

AS the result of the reception of code signals by amateurs in countries other than that from which the signals were transmitted, comes the question of distinguishing the nationalities of the amateurs. American amateurs have standardized on "de," the Latin word for "from," in their interstate work, and use "f m" and "a a" in communicating with Canadian amateurs. But in view of the confusion and difficulties which would arise if arbitrary letter combinations were adopted to designate the amateurs in the different countries over the globe, the A. R. R. L. has suggested that the initial of the country be used as a separation sign. This suggestion appears to be most sensible, but before adopting it the A. R. R. L. would be glad to receive the commendation of the plan from the amateurs.

This matter of the increasing range of radio is giving a greater impetus to the study of Esperanto, as some such universal language will have to be adopted as the power of the radiophone stations and the sensitivity of the receiving sets are increased. Through radio, the globe is shrinking in size every day.

Interference

By Donald K. Lippincott

Here are a few simple directions for making and using a wave-trap and an audio-frequency filter for eliminating extraneous noises from a radio receiver. They are intended for the guidance of the novice.

THE novice usually buys a radio receiver with the idea of listening to concerts. He soon finds that he is compelled to listen to noises whose existence he did not contemplate when he made the purchase. Although the definition is broader than the one generally used, I am going to group all these extraneous sounds together and define "interference" as any sound in the receivers not originating in the studio of the station to which the listener is tuned.

Such station interference as "commutator ripples" and "a.c. hum"—noises in the broadcasting of the station itself, are included in this definition. Their elimination is wholly dependent upon engineering work in the broadcasting station, and they are only mentioned here to point out the fact that they are avoidable, and that they so reduce the pleasure obtainable from radio reception that their presence should not be tolerated.

Of all types of interference the most difficult to deal with is "static," or "strays," or "atmospherics"—those hissing, crackling, rushing sounds that get more pronounced and difficult to ignore as the summer advances. We cannot legislate against static nor trap it out, and, of the hundreds of methods that have been devised to cope with it, none is sufficiently positive to have won general recognition.

Probably the best defense is a short, low antenna. It is true you will not get as great distance as with a larger structure, but if the static is bad, you will not get distance anyway, and the smaller the structure you use the lower will be the "static ratio," which is the relative intensity of the static as compared with the tuned signals. From this it follows that a small loop is freest of all from this annoyance, and, if you have the radio frequency amplifiers to bring the signals up to audibility with this type

of antenna, it is of course the thing to use at this time of year. Even the loop is not a cure, but merely a palliative measure.

The use of a small antenna is advisable even in static-free weather, with single circuit receivers, as it is also a defense against interference from other broadcasting stations. Under the new wavelength allocation there is no need for anyone to be troubled with interference of this character. The requisites are an antenna not over 100 feet long or 30 feet high, made from copper wire with carefully soldered joints, a good connection with moist ground, and the use of all the regeneration possible, *without causing oscillation*. The idea is to reduce the resistance of the circuit as much as possible, as resistance always decreases selectivity.

If you have a set using coupled circuits, you may use a big antenna and

Continued on page 69



Radio Equipment on S.S. "Leviathan," Comprising Four Independent Transmitting and Receiving Outfits. The Main Transmitter is Equipped with Two 10 K. W. Tubes

Radio Corporation of America.

The Simplified Reinartz Set

By M. B. Sleeper

Because of the excellent results that many amateurs have secured with the Reinartz circuit especial value attaches to this description of a simplified set employing such a circuit. The reputation of the author is sufficient guarantee that it will work.

EXPERIMENTS with the Reinartz circuit show that three of the controls ordinarily used can be eliminated by doing away with switches. This is in accord with a very definite tendency in the design of receiving equipment. In operating the Reinartz receiver, it will be found usually that, if the inductance is properly designed, the three switches connected with the plate, antenna and grid are seldom varied. It is awkward, often times, to tap the coils

inside. A variety of methods can be employed for mounting the binding posts which carry the battery terminals. A satisfactory method is to use a socket which can be mounted directly on the panel by means of bushings moulded into the base. Then a small Formica panel is fastened by means of machine screws to the under side of the socket and the binding posts put on the rear end.

A little careful planning of the in-

ductance will save considerable trouble in making connections. The coil can be seen clearly in the rear view. It is wound on a Formica tube $3\frac{1}{2}$ ins. in diameter by $3\frac{1}{2}$ ins. long with a $\frac{1}{8}$ -in. wall. The plate winding is started at the top, $\frac{1}{8}$ -in. down. There are 24 turns in the plate coil. The tuning inductance is started close to the other

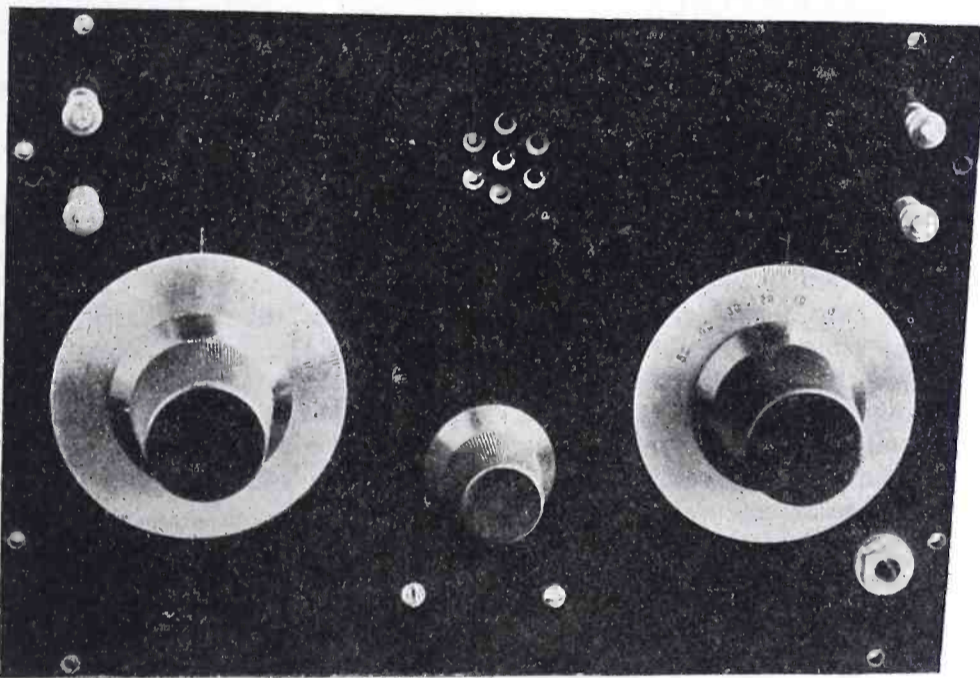

Fig. 1. Front View of Two-Control Reinartz Receiver

for the customary switches and to do the work of soldering the leads to the switch points. Also, the use of these switches somewhat complicates the mechanical design and adds a certain amount to the cost of parts necessary.

In Figs. 1 and 2 is illustrated the two-control Reinartz receiver, while in Fig. 3 a diagram of the conventional connections and of the two-control circuit are given. You will see, upon going over the two-control circuit, that the leads from the coil are taken off as if the switches in the other diagram were all set at maximum. Wavelength and regeneration are entirely controlled by the two condensers.

The construction of the set is quite simple, as it involves the use of a plain single layer coil, two 11-plate condensers, a jack, grid and condenser, and a support for the battery connections. It is very convenient to mount the coil on the rear plate of the left hand variable condenser. This is done by means of two short mounting pillars secured to the end plate by screws from underneath and to the coil by screws from the

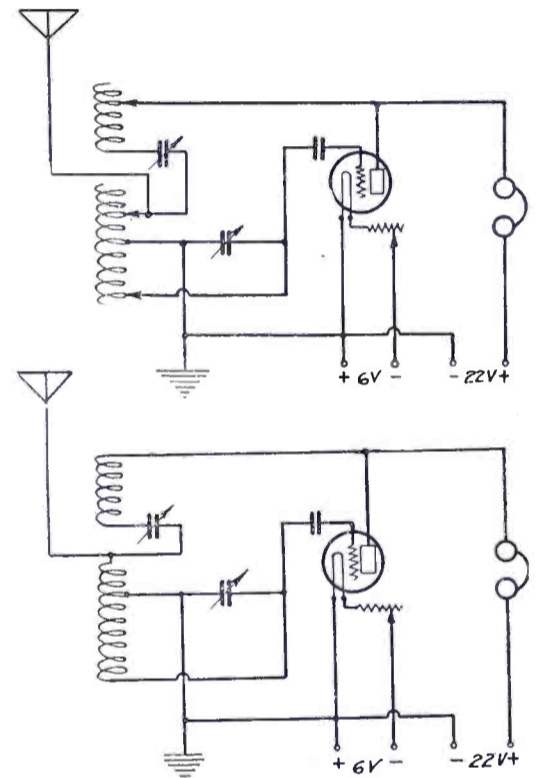

Fig. 3. Conventional (upper) and Simplified (lower) Reinartz Circuit

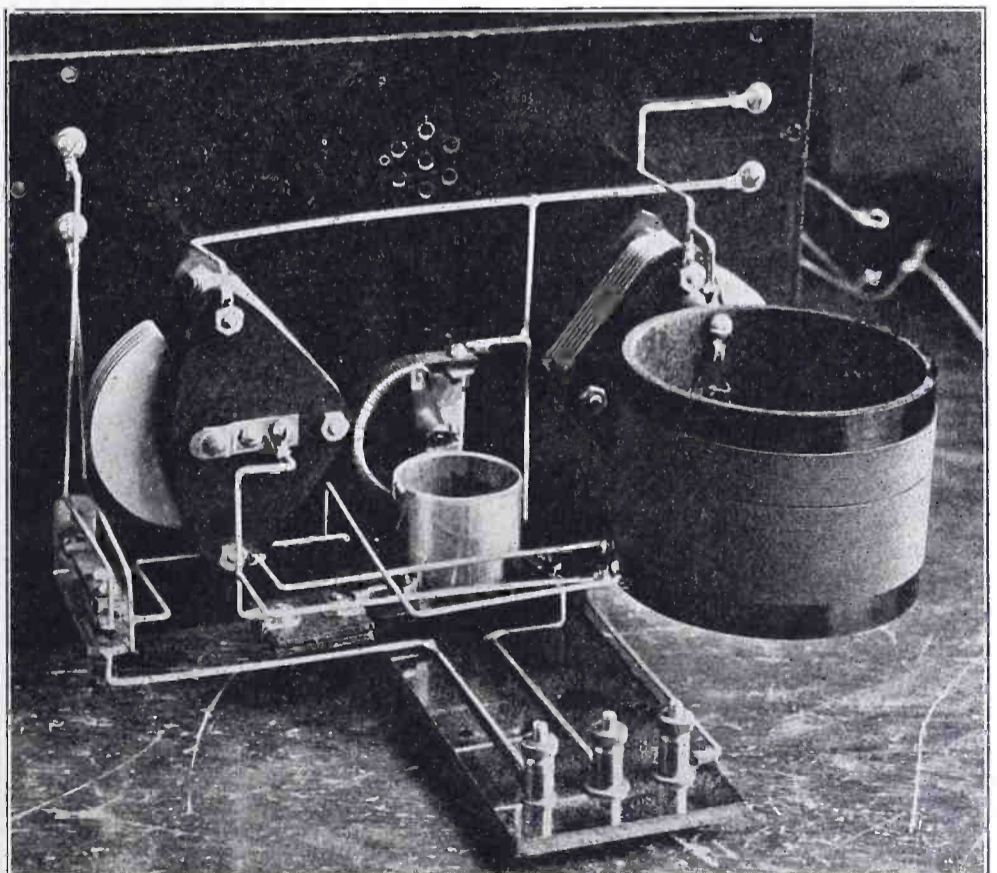

Fig. 2. Rear View of Two-Control Reinartz Receiver

winding. At the tenth turn a tap is taken off for connection to the ground. Then 35 more turns are wound on for the balance of the coil. No. 24 SSC wire is used for both windings. From the top of the coil a lead is run down to a machine screw and lug 90 degrees around from the mounting pillar. One-half inch toward the left, looking at the set from the front, there is a screw and lug connected to the bottom of the winding. Another 1/2 in. around is a terminal for the ground tap. A little farther to the left is a terminal for the lead to the antenna. The lower end of the plate inductance is connected by a lug and screw which holds the tube to the upper coil mounting pillar. By checking the foregoing against illustrations you will see that this arrangement works out to the best advantage in making the leads short and direct.

A plain Dubilier condenser was used in the grid circuit. There was a tendency on the part of the tube to block at first. This trouble was remedied by scratching the surface of the condenser clamping plate with a scribe and marking between the two terminals with a soft lead pencil. This gave quite as good results as when a regular grid leak was employed, and is an inexpensive way to get around the use of a separate grid leak. At the right hand side of the panel there is a double-circuit Pacent jack connected so that when the plug is not inserted the plate circuit goes to the two output binding posts in the upper right hand corner. No difficulty from squealing was experienced when the set, just as it is shown, was connected to an ordinary two-step amplifier. Some experimenters have found that by-pass condensers or radio frequency choke coils are necessary but that is not true in the case of this receiving set.

In operation the right hand condenser is adjusted for wavelength and the left hand condenser for regeneration. Four hundred meters is about the maximum wavelength to which the set will respond. If it is necessary to tune to higher wavelengths, the right hand condenser can be replaced with a 23 or even 43-plate type. Perhaps the easier method is to make the first part of the lower coil of two banks, starting the banking after the ground tap has been taken off. If the coil is banked for fifteen sections, the inductance will be increased sufficiently to tune up to 600 meters with an eleven-plate condenser.

The standard size of panel 7 in. by 10 in. was used to carry the receiving set. This is about as small a panel as can be used, although the height might be decreased if that appears necessary. Mahogany cabinets can be obtained at practically any of the radio stores for this size panel. Holes should be drilled at the rear so that the leads can be brought

in to the three binding posts which are connected with the filament and plate circuits.

In very thorough tests made on this receiving set no loss has been found because of the elimination of the three switches. For DX reception at 200 meters, this is a decided advantage, for a station can be tuned in very quickly. Any trouble experienced in adjusting the left hand condenser for maximum regeneration can be overcome by burning the filament at a little below normal brilliancy. If, then, the regeneration control is brought up nearly to the peak, the final adjustment can be obtained by increasing the filament brilliancy slightly.

UNIVERSAL MOTION FOR SECONDARY AND TICKLER COILS

By ARTHUR S. GORDON

It often happens that the hardest part of building a vario-coupler is to mount the coils so that they can be conveniently adjusted, one to the other. In a three-coil tuner, for example, one coil is mounted so that it will remain fixed, while the other two are arranged so that they are movable. In most cases, that movement is in one direction only; that is the movable coils either telescope toward and away from the stationary coil or swing in front of it like the pendulum of a clock.

Some radio amateurs prefer the first

way, others prefer the second, while still others are dissatisfied with both. They ask the fairly reasonable question: "Why only the single movement?" They feel that a movable unit in a tuning device of any efficiency should have complete freedom to move in one or several directions at the same time. One way in which such universal motion can be secured for the movable coils of a three-element tuner is described and illustrated in this article.

The vario-coupler shown in the sketch is of the spiderweb or "pancake" type, in which the tickler coil is stationary. Amateurs may balk at this freedom, but a moment's consideration will lead to the decision that it doesn't make any difference which one of the three coils is fixed so long as the other two can be placed in any comparative position relative to that coil. The direct reason for having the tickler stationary is because, having the most number of turns of wire, it is the heaviest of the three coils and therefore hardest to handle as a movable unit.

The primary and secondary coils are mounted between the tickler and the inside face of the panel. They are suspended from tubular shafts which fit over and slide upon brass rods. These rods are placed 2 1/2 in. apart and stretch from a little in front of the panel to the back of the cabinet, where they are bolted inside and out to keep them in

Continued on page 65

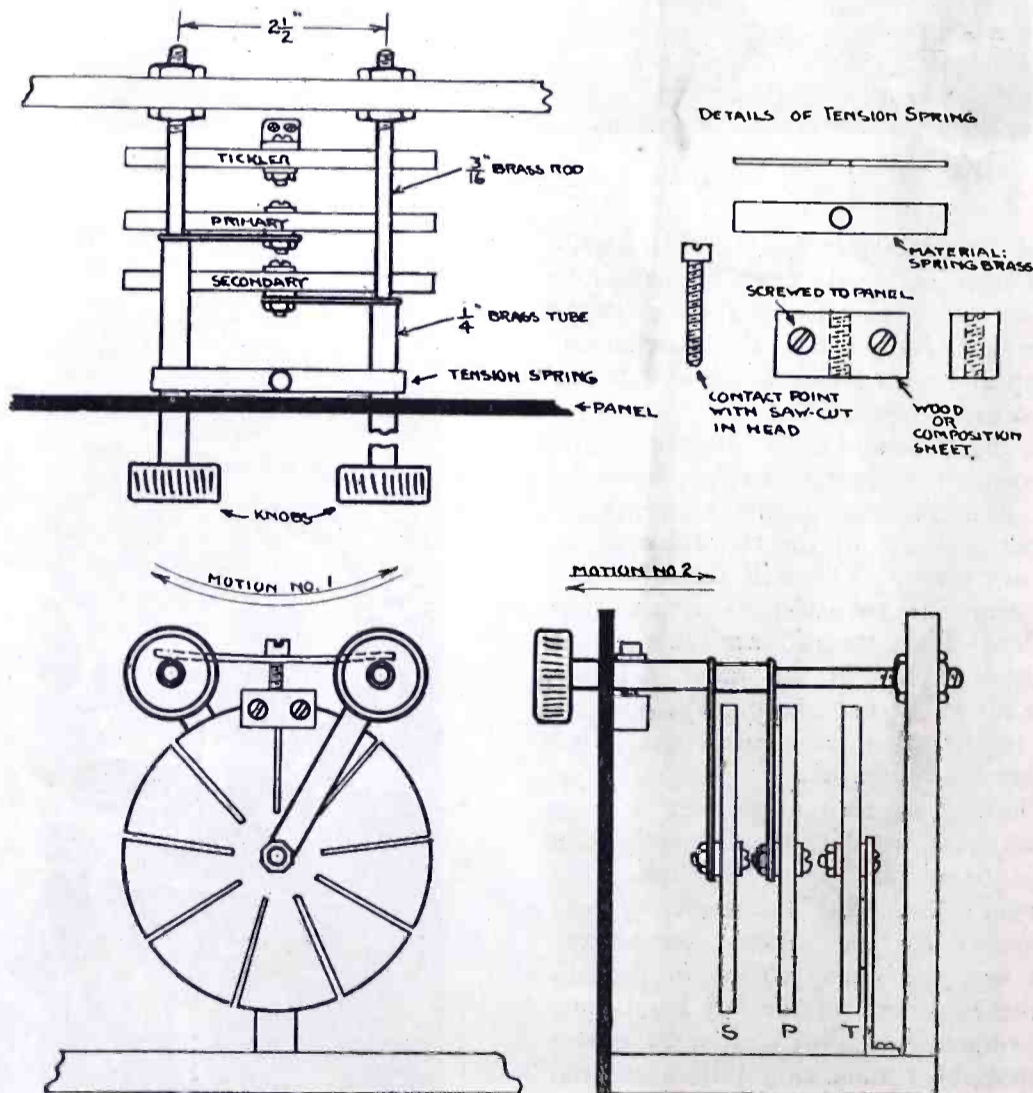

Details of 3-Coil Vario-coupler with Universal Motion

An Exclusive Broadcast Receiver

By Samuel G. McMeen

Here is a set which the amateur can build for a B. C. L. friend, if he has one, with a minimum of time and expense. With slight modification it can be made as "exclusive" for the amateur transmitting band.

THE receiving set here described is exclusive in the sense that it discriminates sharply between the wavelengths that are wanted and those that are not wanted, and also in the sense that it is designed specifically for broadcast reception and does not contain means for tuning to the wavelengths that lie very much above or below the broadcasting belt of 360 and 400 meters.

The reasons for bothering to build a receiver that is limited in its range of wavelengths are two, and they are both fairly good. One of them is that in all regenerative receivers of the type in which both the primary and secondary windings are tapped and equipped with tap-switches for the selection of portions, there are always unused end turns hanging on to the used portion whenever the set is tuned to a wavelength less than the maximum capacity of the windings. The other reason is that the omission of all tap-selecting switches lessens the cost of the set, and markedly saves time and work in assembling the elements.

Any arrangement that utilizes the incoming energy more fully has its usefulness in this art, and the omission of the dead-end turns seems to put this hook-up in that class. In this particular it is like the use of untapped honeycomb or spiderweb coils, but with results that are of a higher order than either, under the limitations of its range. What it can do in the reception of the more distant stations the writer unfortunately can not report, due to the present use of an aerial too well blanketed by a row of eucalyptus trees. But its reception of reasonably nearby stations leaves nothing to be desired, and in comparison with similar circuits earlier described and enthusiastically reported on as to DX work, we are supposing that it will give a good account of itself in this regard. We shall be glad to be told what success the fraternity meets with it. There is a definite thrill to be had from the letters of the workers, and we have enjoyed all of those that have arrived so far, with comment, question and suggestion. The pages of RADIO seem to be read in all the corners of the world.

The foundation of the tuner portion of the rig is a 4 3/4-in. tube. This carries the primary and secondary windings on the outside and the tickler on the inside. Neither the primary nor the secondary has any taps; the whole of each of these windings is in the circuit at all times. The primary is wound in two layers. This would be bad practice unless special methods were utilized,

which is the case. The two layers are separated by a strip of corrugated paper, such as is used in the packing of fragile articles. Its purpose is to space the layers apart with the greatest possible inclusion of air, as air has the lowest obtainable natural specific inductive capacity, and so helps in the need of limiting the capacitance between layers to the minimum. The two layers of the primary are both wound in the same direction—meaning, say, from left to right—so that the ends come out at opposite

tickler shaft. The size of the wire makes all this winding very easy, even if it has to be done in the hands and not in a lathe. Also, the robustness of the wire reduces the resistance of the whole device, which, though slight in its final effect, is in the right direction.

The rotor or tickler is of the wood or pasteboard or bakelite cored type, the best form being turned from wood with double curved faces—that is, to be a portion of a sphere—and this is wound with 50 turns of No. 28 wire. Such a

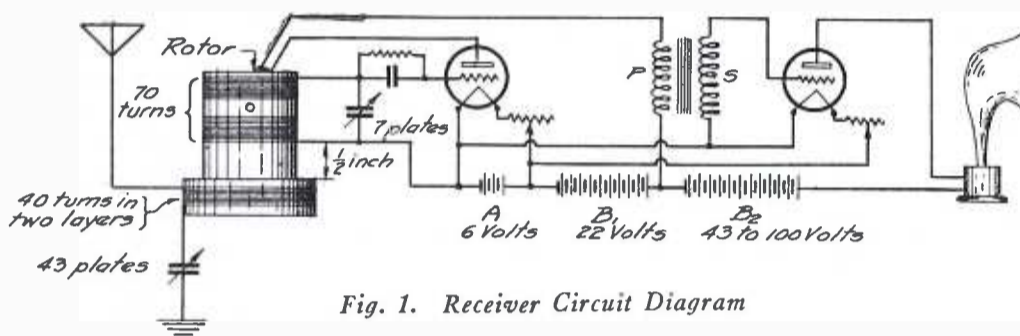

Fig. 1. Receiver Circuit Diagram

edges of the layers. The purpose of this detail is that the beginning and ending of the whole primary shall not be one over the other, as would be the case if the winding were first left to right and then right to left. The result of the preferred method is that the potential between layers is, at its maximum point, only half what it would be in the other case.

There are 40 turns in the primary, as shown in the figure, and both the primary and secondary, in the particular device under description, are wound with the special wire known to telephone engineers as switchboard wire. It is tinned copper wire, No. 22 gauge, and is insulated with two wrappings of silk and one of cotton over those two. Its virtue for this particular use is merely that it spaces the turns a little further apart than if single insulated, and is the more easy to wind because of its slightly greater diameter. However, as to results, there should be little difference if single cotton covered wire be used, and that difference, for all we know at this time of writing, may be in favor of the latter wire.

Whatever the insulation, the gauge shall be No. 22, and the secondary shall be a single layer, parted at the middle of the 70 turns to admit the rotor or

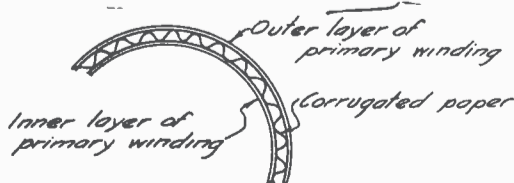

Fig. 2. Method of Winding Primary

number of turns will just fit the space if the rotor be made of three thicknesses of mahogany 3/8-in. thick, with allowance at the middle for a shaft 3/16-in. in diameter. That is, if the winding spaces on each side of the shaft be just a shade under half an inch wide.

The most workmanlike method to bring out the ends of the rotatable tickler winding is to use tubing for the shaft and to file or drill a hole in that tube within the opening inside the rotor, carrying the wires into this hole, through the bore of the shaft to the rear end, then attaching them to brass escutcheon pins in a small bakelite or rubber block attached to that end of the shaft. To these escutcheon pins in turn are soldered short lengths of tinsel cord, this being of a very flexible sort. The others ends of the tinsel cords lead to stationary pins or other terminals, and in this way the motion of the rotor is cared for without the slightest displacement of the ends of the rotor winding, and one of the annoyances and causes of trouble is permanently avoided.

The escutcheon pins referred to are of heavy gauge—they happen to be .082

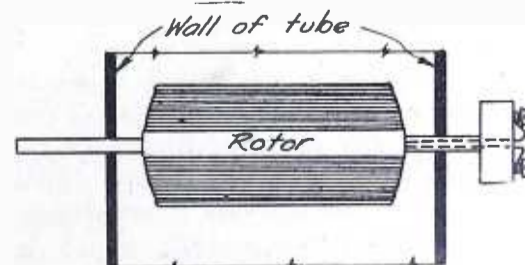

Fig. 3. Method of Bringing Out Rotor Winding Ends

in. in diameter—and make a snug fit in a No. 45 drill hole. They are better for all 'round uses as terminals than those of the more familiar type, a little larger than common pins. When used in strips of bakelite $\frac{3}{8}$ in. square they make excellent connecting racks for all hookups, and have the great advantage of keeping the wiring workmanlike and accessible for testing.

The circuit of the set is shown in Fig. 1, and is of the widely used and popular regenerative type. We show it as a two-tube arrangement, but the amplifying stage can be omitted if desired. In this case the telephones will go where the primary of the transformer is shown, and the latter and what follows it will be omitted. With the one step of amplification shown, the results will be of sufficient power to operate a loud-speaker, and somewhat louder speech will be secured if the amplifier be of the power or transmitting type.

It will be noted that the connections between the three batteries are such that their potentials are additive, and that the storage battery furnishes its small contribution to the effective *B* voltage.

With a separation of $\frac{1}{2}$ in. between the primary and secondary windings, the turns specified should give sharp separation between the two present standard broadcasting wavelengths. If for any local reason due to the worker's other equipment the secondary 7-plate condenser should not turn in far enough to satisfy the user that he is getting the desired variability, a few turns may be taken off the secondary winding. Fortunately the use of No. 22 wire makes such a change simple and free from danger of the whole winding getting away and making a hopeless snarl.

Here and there is to be found a novice BCL who has not found time, energy or space for a veritable aerial, and who has made or acquired a receiver. To such we recommend the expedient of wrapping seven feet of any wire larger than No. 24 around any electric light cord that happens to be handy and connected to a socket. It does not matter what it leads to. All we want is an exposure between the wrapped wire and one or both of the conductors within the cord. Connect one end of the wrapped wire to the antenna post of the set and the other leave free. The result is that you have inserted a small condenser between the cord and the set and will receive through it, the antenna being composed of the wiring outside and within the premises.

In such a case it is well to have ample capacity in the primary condenser of the set, and it is for this reason that we have specified 43 plates for that device. This works well with electric light aerials. With regular 100-ft. aerials, in which there is not the low series capacitance that exists in the electric light aerial, a

smaller condenser will serve. There is no particular advantage in the smaller condenser, but the builder of the set may have one at hand and not the larger.

As the whole of each winding is always used, it is not essential that the nearer ends of the windings go to grid and antenna respectively, as is the case when part of the turns are used on the shorter wavelengths of the total range.

The reason for winding the primary in layers is to bring its turns more fully into inductive relation with those of the secondary. The reason for not winding the secondary also in layers is to keep its turns spread out to approximately the width of the rotor, the diameter of the latter being in turn controlled by the diameter of the tube, and this again by the requirement of getting the necessary inductance in the windings.

Those who are familiar by experiment with the disadvantage of winding radio coils in layers, as compared with the results from single-layer and bank windings, will appreciate the usefulness of the air spaces given by the corrugated paper. The reason for the inclusion of air spaces, as earlier mentioned, is to keep down the capacitance between the turns of the layers. The proper place for capacitance in a receiving set is in the condensers and not in the coils. Whatever appears in the coils is an opportunity for losses. What exists in the condensers co-operates with the coils in establishing resonance, which is what is sought.

This set, with one slight change of connections, is of a type ready to operate with the simple radio frequency amplifier described in the March issue of RADIO. The change referred to is the placing of the primary condenser of the set as here described in parallel instead of in series with the primary winding. Referring to the sketch of the March article, it will be noticed that there are taps on both primary and secondary coils. Imagine the taps to be omitted, and the sketch will apply, though the size of wire and nature of winding the primary coil will be different.

WHAT IS IT?

By RUDOLPH W. VAN NORDEN

Considerable interest has been aroused by moving pictures showing an experimental apparatus, devised by French scientists to measure the strength of "personal magnetism." In its simplest form this apparatus consists of a cylinder, made of ordinary letter paper, about 2 in. in diameter and $2\frac{1}{2}$ in. long. Two small holes diametrically opposite and close to one end of the cylinder are made and there is inserted in these holes a straw, or toothpick, which acts as a cross member for a pivot support. A needle is pushed through the straw about $\frac{1}{4}$ in. into the cylinder coinciding

with its axis, thereby forming the pivot. The cylinder is placed over a small inverted glass pill bottle so that the point of the needle rests upon the upturned bottom of the bottle, thereby forming an almost frictionless bearing and allowing the cylinder to revolve freely.

The cupped hand of the demonstrator is then placed close to the cylinder, care being taken not to touch it. The cylinder will immediately commence to revolve in a counter-clockwise direction when the right hand is used and in the opposite direction with the left hand. If both hands are placed close to the cylinder the forces are neutralized and no movement results, but if one hand be reversed so that the fingers of both hands point in the same circular direction the moving torque appears to be increased and the cylinder will revolve at higher speed than when either one of the hands are used alone.



Measuring the Strength of "Personal Magnetism"

In order to demonstrate that neither air-currents, nor heat from the hand is the cause of the torque produced, a glass jar may be placed over the cylinder. When the hand is placed against the jar in the same relative position to the cylinder as without the jar, the cylinder revolves as before.

A number of variations from the cylinder can be made, as, for example, a frame made of two toothpicks in the form of a cross with the needle pivot at the center and at the four extremities may be fastened flat squares of paper. This fan-shaped model will revolve in the same manner as does the cylinder.

The word, "magnetism," is very much overworked and in lieu of some other word to express the existence of some unseen force which cannot be explained, is often intended to explain a cause for something with which magnetism in the strict meaning of the word has nothing to do. There is nothing magnetic about the apparatus described, for magnetic force acting in an uninterrupted field has no such selective power, i.e., to produce a continuous torque. It would appear as equally unreasonable to attribute this torque to any electrical phenomenon.

A Five-Watt Radiophone

By Stuart A. Hendrick, 2BJG

The author here describes the method whereby he constructed his own transmitter at 2BJG. By following his directions and drawings it should be possible for any amateur to readily duplicate this installation.

AN amateur usually spends more time in thought than in the actual building of his apparatus and with the wide diversity of articles on transmitters and claims of the work they will perform his thoughts are so divided between different types of sets that he sometimes gives up the task of building a set before he has actually started to invest money in parts for it. We will make no claims for this type of set except to say that once it is finished it will be ready to work day and night and is about the most simple set for anyone to construct. The range depends entirely upon local conditions, antenna, ground, etc.

Before a man starts anything he usually wants to know what the effect will be upon his pocketbook, and here we will say that the cost will depend upon whether he builds the parts or buys them ready-made. If he builds them, considerable money can be saved in the cost of constructing the set. We will describe the construction of as many of the parts of the set as possible so that they may be constructed by the builder. The following is a list of all the parts which it will be necessary to obtain, and from this list the approximate cost may be figured.

List of Materials

- | | |
|--|--|
| 2 1 mfd. W. E. Co. No. 21 AA condensers. | 1 L 200 honeycomb coil. |
| 1 Inductance. | 1 Rectifier. |
| 1 5-Watt tube. | 1 C. W. Transformer (Acme 50 Watt). |
| 1 Socket. | 1 Hand Microphone. |
| 1 Rheostat | 1 Inductance Switch and 10 points. |
| 1 8000 ohm grid leak. | 1 Key Switch (Federal Anti-Capacity). |
| 1 Antenna Condenser (.0015 mfd). | 1 Panel 12 in. x 12 in. x 3/16 in. (Bakelite). |
| 1 Grid Condenser (.0008 mfd). | 1 Shelf 6 in. x 6 in. x 3/16 in. |
| 1 Milliammeter (0-150). | 11 Binding Posts. |
| 1 Ammeter, Hot Wire (0-1). | |
| 2 150 Milliampere chokes (Acme). | |

The panel should be laid out carefully and drilled. The holes for the meters had better be done in a machine shop equipped for such work. After all the holes for the various parts are drilled the panel should be grained by rubbing down with fine emery cloth and oil. This will give it a finished appearance which is much superior to the shiny black when it comes from the factory.

After making the panel, obtain a base as shown in the picture and drawings and fasten the panel to it. Then start the brass framework, which is made of 3/32 in. x 1/2 in. brass strip. When this is finished the shelf should be made according to the drawings and drilled for the parts to be put upon it. Then fasten it in place by means of the 2 brass angle pieces. Before putting the shelf in place the transformer and choke coils should be fastened to the base by means

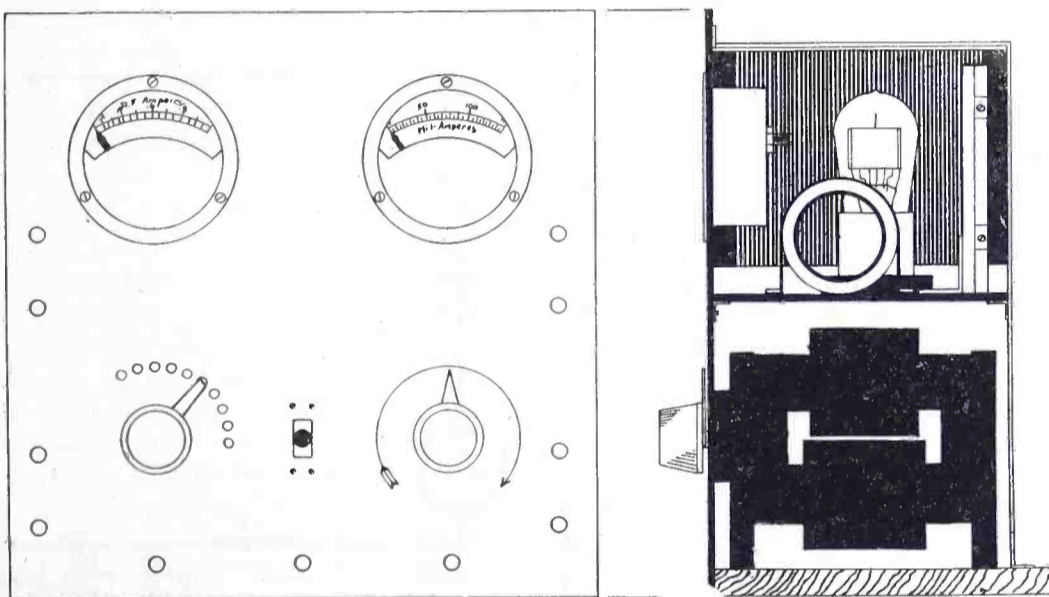

Plan and Section of Completed Set

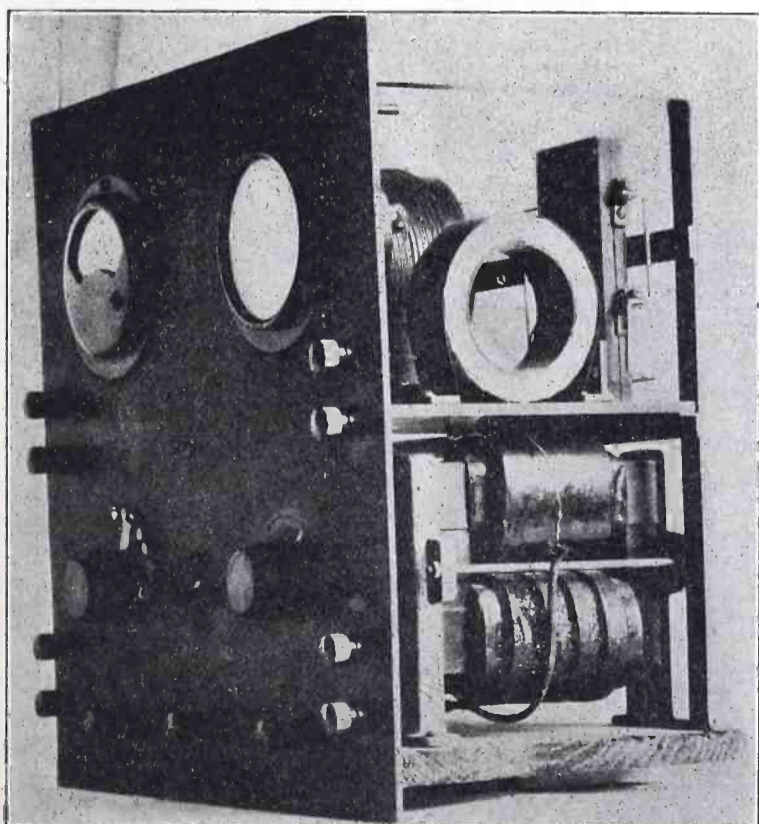

Front View of Five-Watt Radiophone

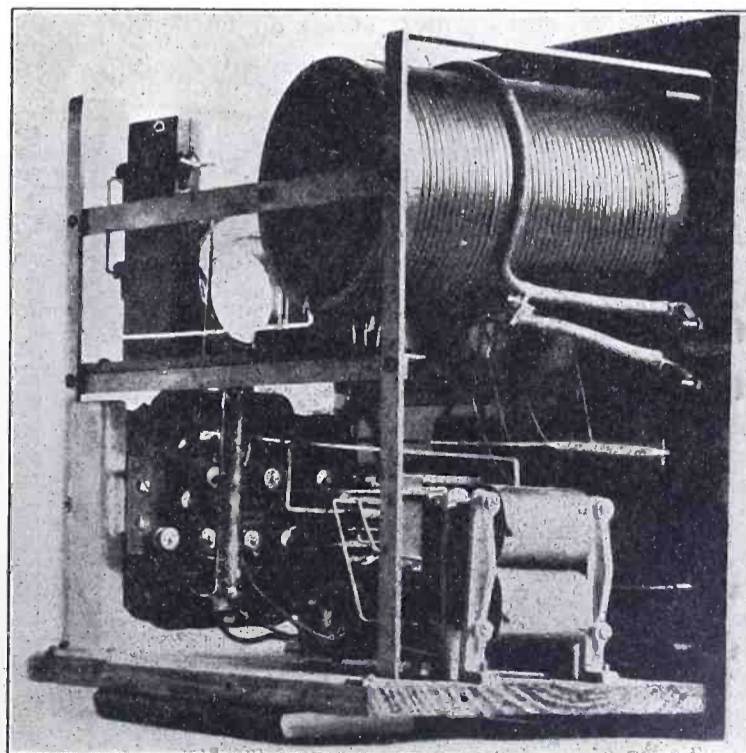

Rear View of Five-Watt Radiophone

of wood screws because after the shelf is in place it is impossible to get these parts fastened down. The inductance coil should then be placed and fastened by means of several small angle braces. Next the meters should be put on the panel followed by the key switch, rheostat switchpoints and binding posts. After these have been placed the parts to go on the shelf should be mounted, namely, the socket, condensers and the honeycomb coil.

If all the parts have been purchased, the set will be ready to wire, but if the parts are to be made, the necessary construction data may be obtained from the following:

The inductance L is wound upon a bakelite tube threaded to fit the wire. The tube can be threaded at any machine shop for a small sum. Another way to make the inductance is to use a cardboard tube, 4 in. in diameter and 6 in. long, which has been boiled in paraffine. It should be wound with heavy twine or fishline which will make a thread upon which the No. 14 copper wire may be wound. 40 turns are to be put on and should be tapped from one end at every other turn until the twentieth turn is reached, giving ten taps. These taps should be connected to the switch points on the panel by means of short lengths of No. 14 wire.

A honeycomb coil, shown in the wiring diagram as L_3 , is used as a radio-frequency choke. If the builder does not want to buy one, he may build a simple radio-frequency choke by winding 250 turns of No. 30 insulated wire on a tube $2\frac{1}{4}$ in. in diameter and 4 in. long. The inductance of such a coil is the same as a L200 honeycomb coil.

The transformer is the most difficult part to construct, and unless you have had a little experience with them it would be advisable to purchase one. The one used with this set is an Acme 50 Watt C. W. transformer. Data on a suitable transformer are as follows:

Core—6 in. long and 4 in. high with a cross-section of $1\frac{1}{4}$ square in. Primary—550 turns of No. 20 D. C. C. wire for use with 110 volts A. C. Filament Secondary—50 turns of No. 14 D. C. C. wire with center tap at 25th turn. This gives 10 volts. High Voltage Secondary—4000 turns of No. 32 D. C. C. wire tapped at 2000 turns. This gives 400 volts on both sides of the center tap. The core should be made of transformer iron, and if black sheet iron is used the cross-section should be doubled. The number of turns will remain the same. To make the windings use a block of wood slightly larger than the cross-section of the core and wind the wire upon this and when the coil is finished the wood should be taken

out and the coil shellacked and taped up before the core is put into it.

The rectifier is made up of 20 small jars $2\frac{1}{2}$ in. in diameter and 4 in. high. The elements consist of a strip of aluminum 3 in. x $\frac{3}{4}$ in. x $\frac{1}{16}$ in. bolted to a piece of lead of the same size. These two pieces are then bent into a U shape in order that the lead may fit into one jar and the aluminum into the next. After these are made up and inserted in the jars the solution which is to fill the jars should be mixed and poured into each jar, filling it to within $\frac{1}{2}$ in. of the top. A saturated solution of borax should be mixed in a jar large enough to hold as much as will be needed to fill all the small jars.

Continued on page 59

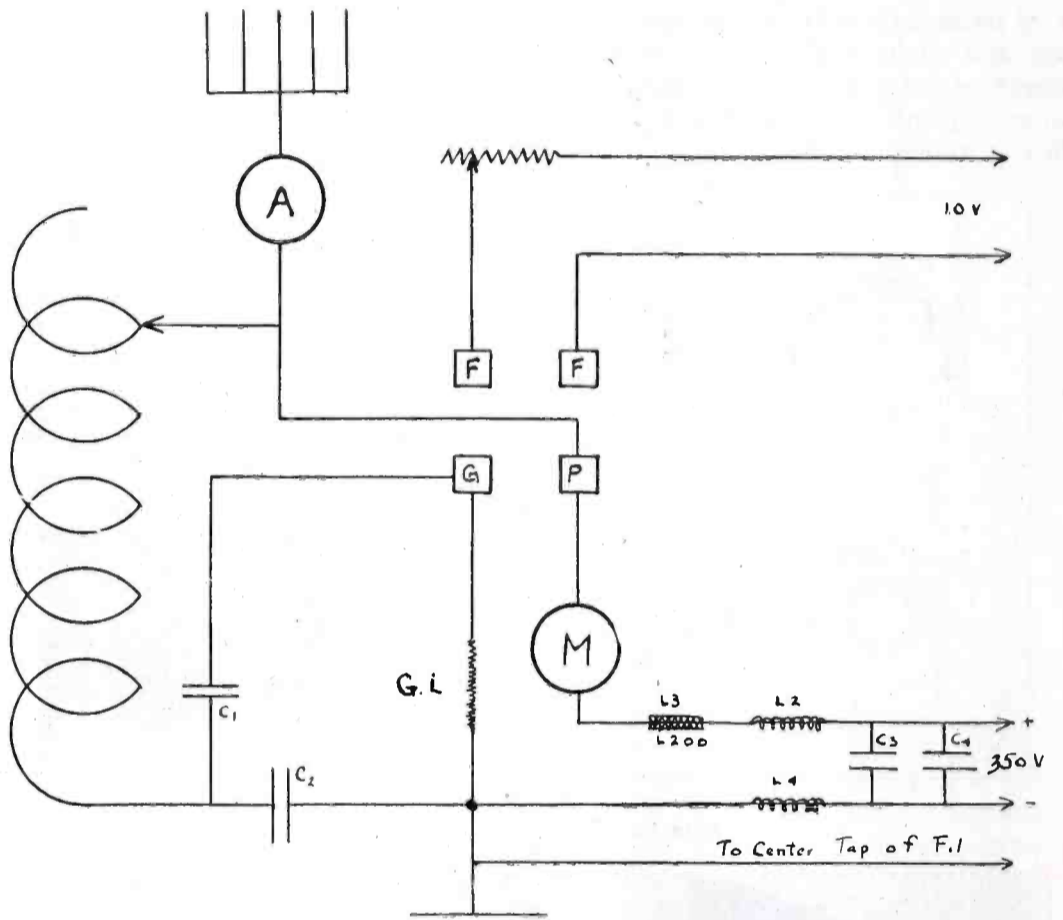

Wiring Diagram

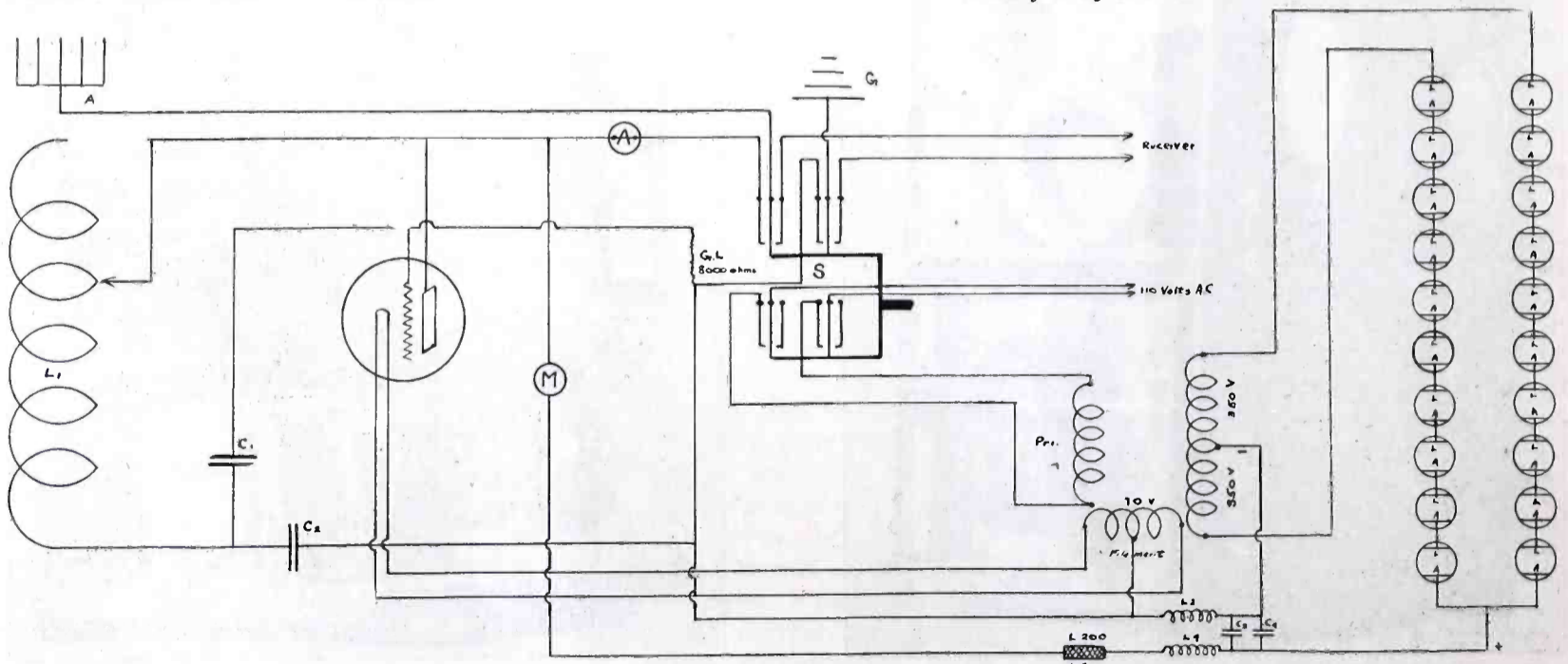

Schematic Hookup of Transmitter at 2BJG

A Wonder One-Tube Portable "Super"

By T. N. Slocum

This article gives the details for making a practical super-regenerative dry-battery portable that has clearly and consistently received complete programs on a small loop from stations 700 miles away. It is an ideal set for use in an auto, on a train, or in camp. Its total cost was less than \$20.

PERHAPS you shake your head and want to turn over the page when you note that this is another article on the Armstrong super-regenerative circuit. But first read it, see how simple it is, and ask yourself if you can't do as well as any other amateur constructor. The entire set is home-made, as also are many of the parts. But if you are not inclined to build your own parts you can buy them and then assemble into an equally compact form.

The construction of the set can best be understood by an examination of the pictures and the circuit diagram. It will be noticed that the loop is mounted on a hinged support on the cover when in use. Otherwise, it lies flat in the cover, where it may also be used, but with lower efficiency. The loop is 7 in. high and 14 in. wide, and consists of 42 turns of No. 28 D.C.C., magnet wire.

In the upper, left-hand side of the interior view will be seen the two inductance coils, L_3 and L_4 . L_3 is a 1250-turn R.G. or honeycomb coil, and L_4 a 1500-turn coil. These coils are inductively related and the distance between them should be variable. This may be permanently fixed after the correct adjustment has been determined. Immediately behind these inductances, are two .001 mfd. condensers, C_2 and C_3 . These condensers are of the home-made book type. While made variable, it is found that fixed condensers give as good results.

At the top center is the variometer, L_2 , and the tickler, L_1 . This is home-made also. The variometer stator is wound on $3\frac{1}{2}$ in. cardboard tubing, and the rotor on 3 in. tubing, both having been soaked in paraffin. Each is wound with 50 turns of No. 32 D.C.C. magnet wire. Coil L_1 , the tickler, should be $3\frac{1}{2}$ in. in diameter and wound with 25 turns of No. 32 D.C.C. magnet wire. This coil should be so arranged that the distance between it and the variometer can be varied. This combination of coils gives a range up to 600 meters. If the reader so desires, he may use a 100-turn R.G. or honeycomb coil in place of the variometer, and a 25-turn honeycomb in place of L_1 . A standard variometer with a 100-turn rotor, or spiderweb coils may also be used.

At the extreme right is shown a No. 6 dry A battery, used for lighting the filament of the WD-11 tube. Between coil L_1 and the battery is a variable con-

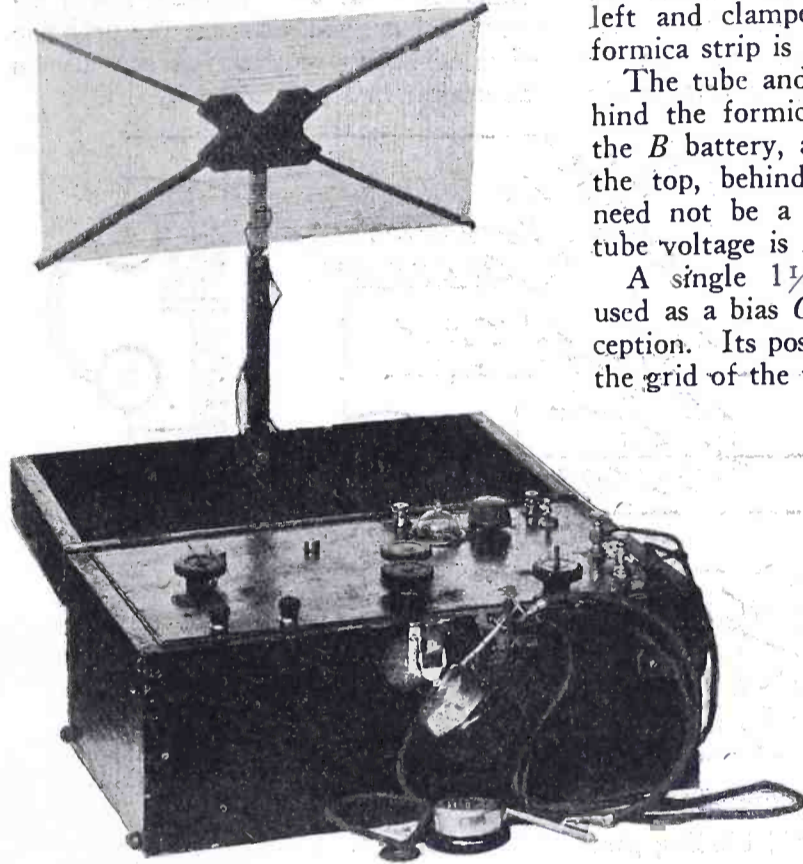

Complete One-Tube "Super" with Loop Aerial

denser, C_1 , of .00025 mfd. capacity, this also being of the home-made book type. The phone condenser, C_4 , .008 mfd., is mounted behind the A Battery, in this case being made up of .006 and .002 condensers connected in parallel. I believe that a .01 condenser would give better results.

Along the bottom of the set is a formica strip, on which is mounted a row of binding posts connected to the several coils and condensers. On the

left and clamped to the panel by the formica strip is the $22\frac{1}{2}$ -volt B battery.

The tube and socket may be seen behind the formica strip, to the right of the B battery, and the rheostat is near the top, behind the A battery. This need not be a vernier rheostat, as the tube voltage is not critical.

A single $1\frac{1}{2}$ -volt flashlight cell is used as a bias C battery to improve reception. Its positive side is connected to the grid of the tube, this being different from the usual practice of connecting the negative side to the grid.

Before assembling the parts on the panel, which by the way is made of quarter-inch board, it is better to connect the parts on a table so as to insure correct connections. All of the fixed condensers should be mica insulated, as the paper type puncture easily and cause trouble that is hard to find.

After the parts have been hooked up, first light the tube to full brilliancy and then bring coils L_3 and L_4 close together, so as to get a shrill whistle, something like that on a peanut roaster. If you do not get this whistle, reverse the connections of one of the coils and examine all other connections to see that they are correct. After getting the whistle, separate the coils as far apart as possible without losing the whistle, which will get weaker as the separation is increased,

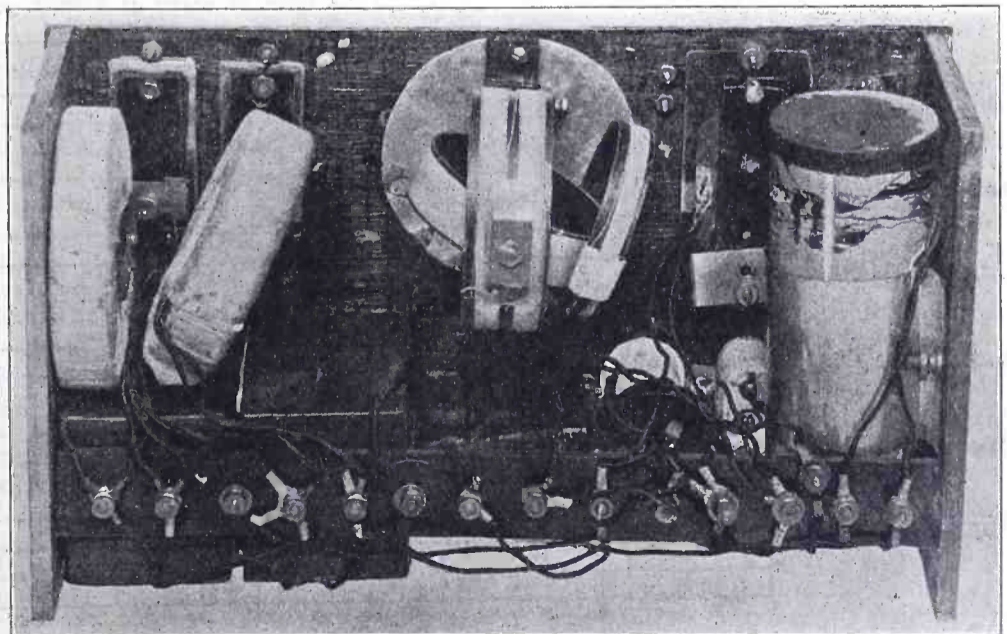

The "Insides" of the "Super"

until it is just audible. Then by adjusting the condenser C_1 , and bringing the coils L_1 and L_2 close together, you will get a loud roar. If this does not materialize, reverse one of the coils L_1 or L_2 . Coils L_3 and L_4 should now be moved to such position as to give a maximum roar, and then vary condenser C_1 until the roar gradually disappears. If coils L_1 and L_2 are too closely coupled, the roar will stop, but can be started again by slightly separating the

FADING

By EDWARD T. JONES, I. R. E.

I AM not going to breathe a word about the actual cause of fading because this is not going to be the type of article that encourages fantastic discussions about an effect not well enough understood by even the most enlightened members of the art. Instead, I will attempt to have you visualize the probable effect of fading so that you can discuss the subject in a practical way.

However distasteful the time-worn story about the effect produced when a stone is thrown into a pond of water may be, this subject has placed me in an unfortunate position and I must beg your pardon for bringing it to light

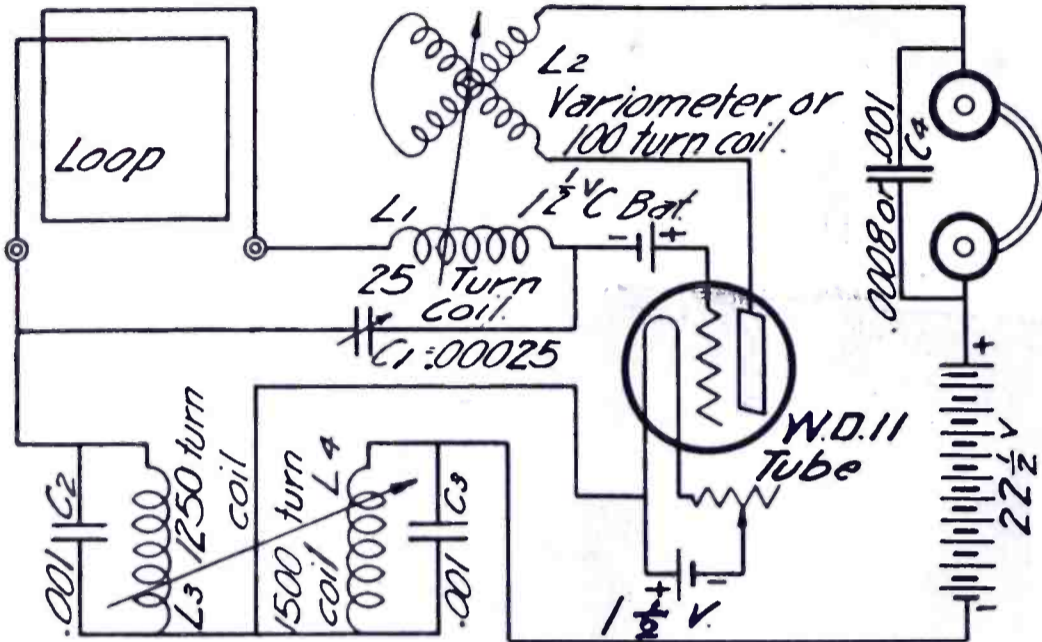

Circuit Diagram of Portable One-Tube "Super"

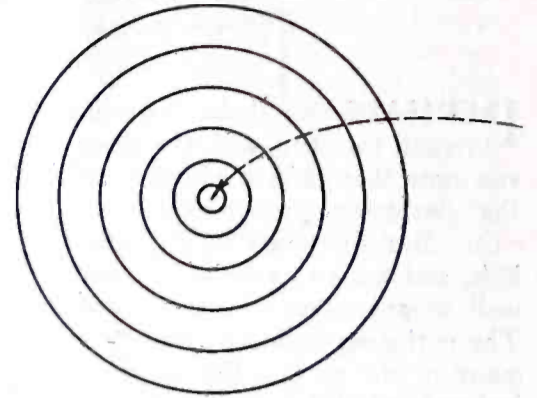

Fig. 1. Effect of a Stone Thrown into Water again. Hence, in Fig. 1 you will obtain a picture of what happens when a stone is thrown into a pond of water. Ever enlarging waves are created and they expand in circles from the source of disturbance. I want you to carry this picture in your mind throughout the article. Liken the water wave to the radio waves created at the sending station.

Wireless waves encounter numerous obstacles in their journey and therefore it can be said that the ever-expanding

Continued on page 74

coils and touching the grid binding post of the loop with your finger.

The signals should come in when the roar just stops. By varying the condenser C_1 and coils L_1 and L_2 , you can now tune in any of the stations within the range of your set.

On local stations the set should easily work a loud speaker. Signal strength can be increased by grounding the A battery side of the loop or by using a larger loop. This circuit will also work with any other dry battery tube. It has been in use for the past eight months throughout California and under the most unfavorable conditions has given remarkable results.

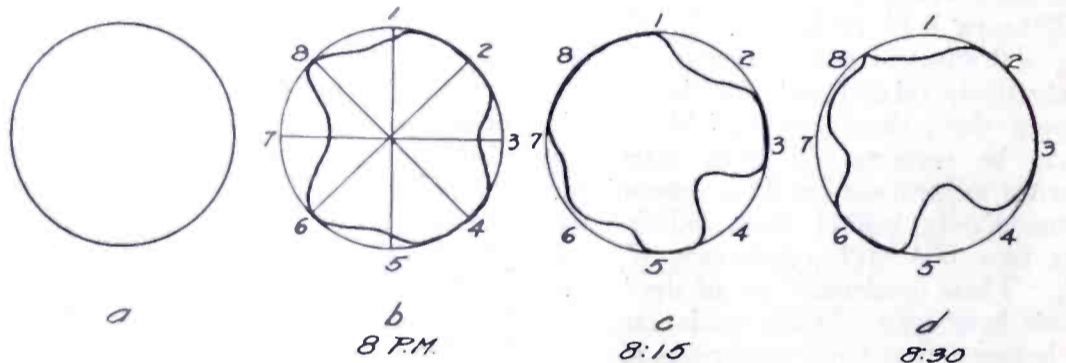

Fig. 2. Contour Changes Caused by Fading

- (a) Non-existent perfect wave form
- (b) True form of wave at 8:00 p. m.; 2, 4, 6, 8 receiving well, and 1, 3, 5 and 7 recording signal fading
- (c) True form of wave at 8:15 p. m.; 1, 3, 5, 8 receiving well and 2, 4, 6, 7 recording signal fading
- (d) True form of wave at 8:30 p. m.; 2, 3, 6 receiving well and 1, 4, 5, 7, 8 recording signal fading

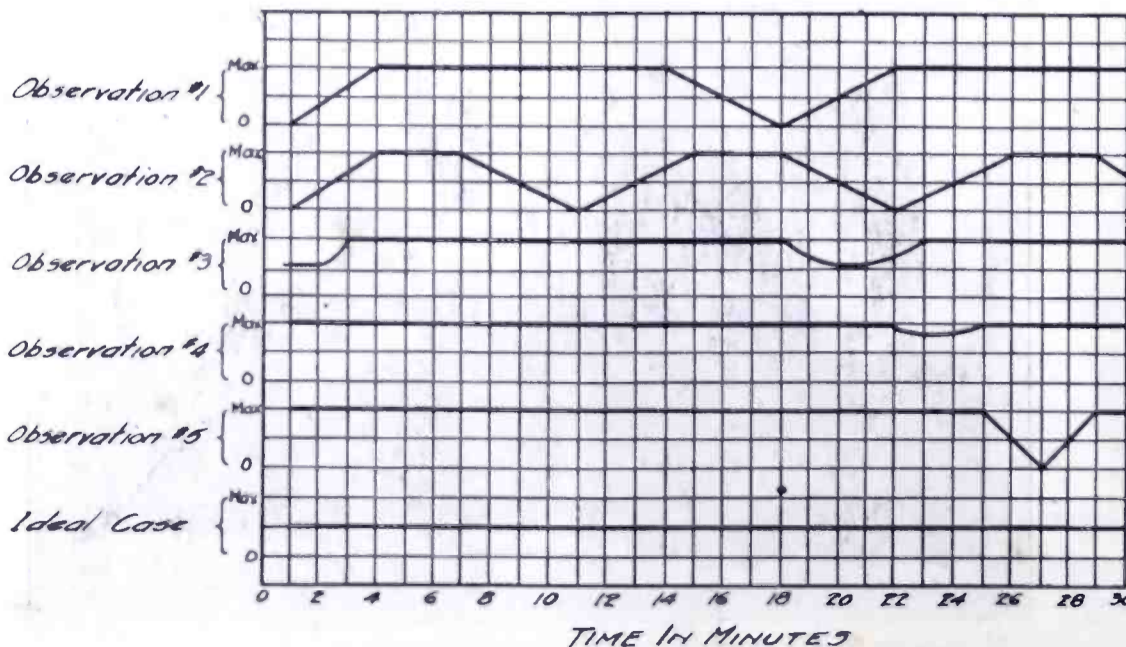

Fig. 3. Observations of Fading from Atlanta "Journal"

Max Signal duration	10 mins
Fading Period-	8 mins
Max Signal duration	3 mins
Fading Period-	8 mins
Max Signal duration	15 mins
Fading-Partial	5 mins
Max Signal duration	22 mins
Fading Slight-	3 mins
Max Signal duration	25 mins
Fading Period	4 mins
Unrecorded Fading-	

Jimson's Coup

By Earl Ennis

As a sequel to "Jimson The Great," this story illustrates that "a fool and his money are soon parted." The author puts in just enough radio to show that a little knowledge is a dangerous thing.

THE way me and Jimson gets mixed up with the Senorita de la Montanya is due to that dumbbell secret agent, Peri, gettin' confidential at the bar of the Useless S. Mahoney, en rooy to New York, although I doesn't tumble that he has got in his dirty work 'til Jimson comes to me, lookin' kind of mooney and says:

"Bud—it's a shame for a nice dame like the Senorita to be in the power o' them cattle," he says. "Anyway yuh look at it, I reckon we could do her a lot of good."

I hands over a reproachful look.

"Aint yuh the hombre that's always told me to cheesez la femme?" I demands.

"Yes," says he, "but this is different."

"Sure it is," says I.

"Fools rushes in where married hombres don't dast tread, every time," I says. "It's a rolling bimbo that don't gather no females."

Jimson shakes his head.

"Yore intentions does you credit," says he, "but when you got all the facks, you're gonna see things different."

"You mean when I gets talked into it?" I retorts, havin' had some little experience with Jimson's power of face.

"Lissen," he comes back. "S'pose you was a nice, refined lady that was held prisoner for tryin' to help yore country," he says. "An' s'pose the only way you could get out of the can was to marry a fat, wall-eyed greaser. What would you do?"

"Well," says I, "not bein' either refined or a lady, I can't suspect. But if I was plumb anxious to git away, I reckon I'd marry him. And if I was plumb anxious to git rid of him," I says, "I reckon I'd marry him. Because I can't think of no quicker way of doin' it," I says.

Jimson gives me a cross-cut look.

"You got the same feelin' in yore ornery system as a Piute Injun," he declares. "This here is a delicate female," he says, "and them kind suffers like hell."

"Yeah," says I, "all the delicate females I ever seen made their husbands suffer."

"You make me sick," Jimson says and walks off real huffy.

I tumbles how Peri has got him goin' so I hunts him up to get the low down, because every time Jimson gets the ijea he was special cut out by Providence to save females, we're due to meet up with trouble. It aint no trick to find Peri, seein' as he aint left the bar since he come aboard the boat. He's an undersized runt with a trick moustache and a dark look and don't resent my buttin' in none at all.

"Ah—salutay," says he, wavin' a glass. "You dreenk weeth me—si?"

I says yes, and we libates. Then I unlimbers.

"Tell me," says I, "how come this Senorita of yours gets in bad like my

all dose t'ings," says Peri, kissin' his fingers. "If you could see . . ."

Accordin' to Peri trouble starts in Mazatlan when one Valesquo Ruiz gets restless because he has to live in one spot. He decides he wants a change. There wasn't nothin' small about Ruiz. He opines as how Obregon's job would be about his style. So he gets brash and tells the world. Obregon hears about it and looks Ruiz over. He finds he is a soft pescado that will do anything for a woman. Weno! He asks the Senorita de la Montanya will she take a little pasear down to Maz and find out all about Ruiz' plans.

"Thee bee-oo-tiful, thee noble Senorita—she say ver' gladly for thee countr-r-y," says Peri, rollin' his r's and his eyes all to once.

"Sure she would," says I. "They always do."

Somebody in the palacio—one of the help probable-tips off Ruiz as to what's doin'. Jus' outside Mazatlan, the lady is kidnapped neat and nifty by a gang of bandits. Obregon suspects Ruiz of havin' a hand in it and he sends Peri to investigate. Peri, actin' plumb helpless, chases a bum clue down the coast, only to find out the lady's in Ruiz attic. He's beatin' it for Mazatlan on the Mahoney to save her—pronto.

"How come you figger the Senorita is a prisoner of this Ruiz person?" I asks.

"Undoubted," says Peri, ordering six more drinks. "From ver' good frien' I deescover el diablo Ruiz have gran' fiesta on Saturday because of marry to g-r-r-r-eat lady. Eh? Eet is the Senorita who is the g-r-r-r-eat lady. No? Because, what g-r-r-r-eat lady would marry weeth that dog of a Ruiz unless it is mos' necessar'? No, senor—Peri is not secret agent for nothing. If the diablo Ruiz hav' thee fiesta, then eet is because he have force the Senorita to marry weeth heem."

He is so overcome with these words that he busts into tears and we has a real damp time for awhile.

"Come on, hombre," says I. "Buck up. There's many a deck has a fifth ace in it. Tears aint never launched no ijeas yet. Why don't el administracion



"I shoves Mr. Colt's well known offspring under his nose."

frien' Jimson tells me." Peri sits down his glass, gets husky.

"Por dios," he says, wipin' his eye, "it is mos' sad—of a sureness. Thee heart, it is touch mos' deep with seempathy and thee mind is mos' unhappy to theenk." He snivles quiet some.

"I wouldn't strain myself none much thinkin'," says I. "S'pose you give me some inside dope, the which mebbe I can handle without gettin' no brain fever." Which he does.

Seems, the Senorita comes from a family, the which is so noble, they've plumb forgot who was hung last. Bein' a haughty filly from birth, she grows up proud and classy, with eyes for all an' malice towards none. Like her ol' man Don. Loego de la Montanya she's strong for whoever's in power, the same bein', at the moment, Kid Obregon.

"She is bee-ootiful, talent, wisdom—

get a couple of squads of soldados and gather in the Senorita?"

Peri holds up both hands, registerin' cold horror.

"Oh, no, no, no," says he. "El Presidente not know for a sureness—he only theenk. That is why he send me. If he make a mistake it is thee . . . thee . . ."

"Fox paw," says I. "Bum politics. I get yuh."

"So—I ask thee help of dos Americanos," says he. "I have hear they have save thee sister countree from a gran' revolution. If they would be the salvador for the poor Senorita . . ."

He waves both hands and waits for the answer, while I stands thinkin' of the mess we just got out of, which was spoilin' the plans of a lot of bum bozos who was dead set on upsettin' the government. We has one million pesos down in the steward's safe right now, as a good-bye gift for what we done. And here come another job, the which might be good pickin's.

"El administracion weel pay five hundred t'ousand pesos for to save the Senorita," whispers Peri in my off ear.

I perks up immejit.

"I'd rescue my grandmother for one-half of that and eighty-five cents extra," says I.

"A-h-h-h!" says Peri, lettin' out his breath. "Then we dreenk—yes."

"Well," says I, "we aint had more'n five or six hundred drinks, so I reckon we can have one more," I says.

I goes back to Jimson, feeling kinda sorry for the Senorita myself. When he finds I'm set on helpin' the lady, he chuckles to hissself in a way that's sassy and insultin'.

"Don't get escondido," says I. "It's a wise stone that changes its moss," says I. "Further," says I, "I got a question to ast."

"Shoot," says Jimson. "And make it intelligent."

"How come this Peri bird picks us for this job?" says I.

Jimson chuckles.

"He seen me spendin' a little time in the radio cabin," he says. "Me and the ops got quite chummy and I been learnin' what's what with a wireless set. Peri thinks I'm a regular Macaroni."

"What's that got to do with it?" I asts.

Jimson leads me off to one side where there aint nothin' listenin' but waves.

"Jes' this," he says. "Peri's got a nice little scheme for gettin' the Senorita out of hock, the which me and you is goin' to be part of. But we got to get the yacht first," he says.

"The yacht?" says I. "I aint heard anything about a yacht."

Jimson chuckles.

"I jus' bought it," he says. "For twenty-five thousand pesos. Peri can get it cheap," he says, "so I snaps it up. I aint gonna throw no fortune away for want of a boat."

"Huh," says I. "As thick as the plot is, I'm a heap thicker. What are we buyin' a boat for?"

"We aint," says Jimson. "But I am. If you wasn't so dumb a person has to talk to you on his fingers, you'd savvey we was goin' to use the yacht to rescue the Senorita," he says.

I gives him a sad stare.

"Lissen buddy," says I. "I've rescued dames before in my time, and I'm tellin' you a row boat's plenty good enough, especial if they is the quick-huggin' kind. Give 'em a pair of oars and let 'em pull. It keeps 'em from marryin'."

"Well," Jimson replies, "a row boat aint gonna be no good on this party. We've got to get away purty and pronto once we gets her safe. There'll probable be a couple of warships chasin' us at the time."

"From what I've saw of Mex warships," I says, "a sail boat would be plenty fast enough for a getaway. However, I aint gonna spoil yore pleasure. If you wants a yacht, I reckon I can stand it."

"You can," says Jimson. "And you're gonnabe right glad we got it, too. As the plan stands, we grabs the lady, beats it, throws her on the yacht, and starts up the coast. We delivers her to a government boat at the Port of Tiajuana," he says.

"Where does the wireless get in on this party?" I asks.

"The yacht stands off-shore," says Jimson, "with her wireless workin'. Peri's got a private station parked out ashore. When we get all set, I goes to the private station and gives the yacht a call, an' says where we'll be and when. The yacht slides in after dark and away we goes."

"And then what?" I asks. "Does we spend the rest of our lives sailin' around with this here Senorita? Because, if so, I aint aimin' to set foot on no yacht."

"We does not," says Jimson emphatic. "We hustles up the coast in the yacht and delivers the lady to a government tug at Tiajuana."

"Oh, no we doesn't" says I. "Tiajuana aint no port," I says. "It's inland where they sells snake skins to tourists."

"Well," says Jimson, "then we got to put rollers on the yacht, that's all."

Right there I sees he's made up his mind.

"How come we got to go so far for a government boat," says I, "with which to FOB the Senorita. Didn't you say somethin' about warships?"

"Say," says Jimson, "if you was Obregon would you trust the Senorita to any admiral you ever seen?"

That was that. I knew blamed well I wouldn't.

"We goes ashore tomorrow night," says Jimson, gettin' down to business.

"We parks at La Pierna hotel, which aint none for looks but same's got a couple of back doors what don't squeak. Peri scouts 'round and finds the dame. Then he sends a messenger and we're all set to go."

"An' while we're sittin' 'round, waitin' for Peri," says I, "this here delicate female maybe is bein' made to eat onions or other forms of cruelty," I says. "Why not lets go out and find her ourselves."

"We aint secret agents," says Jimson. "And furthermore, we doesn't speak the pat-wah of the alleys," he says. "An' we wouldn't get far. Nope. We lets Peri do the huntin'. We come in on the finish plenty strong—five hundred million pesos worth."

"Maybe," says I, as he walks off to start packin' the community tooth-brush. For I'm considerable like an old maid, bein' none too hopeful, no matter how cheerful thinks looks. And that was that.

TWO days later, we was stabled in La Pierna Hotel, like Jimson prognosticates, with a fine view of a dirty patio, and a landlady with a heavy moustache.

"I wonder has Peri found the Senorita yet?" remarks Jimson after we has talked up everything else.

"Undoubted," says I, quotin' the gent in question. "He's probable her husband anyhow."

"You got a low disposition," says Jimson, kinda shocked. "Yore ijeas is plumb putrid. A fine woman," says he, "like the Senorita aint gonna tie up with no skate like Peri."

"A marryin' female'll do anything," I replies, lookin' hard at him, and he lets it lay. Because we was both thinkin' of a certain blonde.

"Anyhow, we got nice comfortable quarters," says Jimson. "This here hospitalary has all the beauties and graces of Port Said—dirty squaws, high and low bozos and gallopin' chiggers. It has all the appointments," says he, "of a first class Chicago sewer."

"Well," I opines, "I've been locked in the stable with all kinds of sheep in my time, so one or two goats aint gonna bother me none."

This was early in the day. That afternoon, in busts an hombre with about the finest set of face curtains I've saw since I went to the Mormon picnic in Salt Lake.

"Senor Peri have sen' me," says the bandy legged runt, trailin' his weepin' willies on the floor.

"Lord Ostermoor to see you," says I to Jimson. "Git the asparagus."

"Shut up," says Jimson. "Don't kid the ambassador."

The maverick opens up and says Peri is waitin' for us at a little cantina about two plazas down from the cuartel.

Continued on page 46

Sparks Shows the Club a New Stunt

By Samuel Peaslee Wright

Here is an idea for the first radio club meeting after the summer vacation. It will arouse much interest and enthusiasm among the members.

"WHAT'LL we do now?" asked Bozo, restlessly. "Never saw such a short meeting of the Club, and it isn't time to go home yet!"

"Ever play Radio Tag?" Sparks queried. "It is rather a lot of fun for—at least, we used to think so! I used to enjoy it myself, 'way back before the war, when I was younger."

"Radio Tag? Never heard of it! How does it go? Where'd you learn it? Why didn't you ever tell us about it before?" came a shower of questions from the fellows within earshot.

Sparks grinned good-naturedly.

"Never asked me about it, I guess. We used to amuse ourselves with it quite a lot when we didn't have anything else to do, after Club meetings—that was at the old Club, that most of you fellows don't remember. It's great for field days, too—it's really an out-of-doors game, but as the gym ought to be available by now, I guess we can make it all right in there."

The Radio Club had an operating room in the "Y", and so it was only a matter of going down a couple of flights of stairs to land in the gym. Sparks and Bozo brought up the rear, carrying a storage battery between them. A key, a buzzer and some wire bulged Sparks' pockets, and speculation was rife as to just what could be the nature of the new game.

"Now listen closely, fellows, and I'll give you the dope on this stunt. First thing, how many of you haven't calls?"

Some six or eight hands shot up, and Sparks proceeded to "issue" their owners calls, jotting down the calls after their names on a long slip of paper.

"All right, every one has a call now. When I send a call signal on the buzzer here, the person who is called is IT, and will try to tag some other player. The tagged player then becomes IT, but as a rule I will keep the calls coming so rapidly that there will be few taggings. The idea is to keep as far away from every other fellow as possible, for anyone is liable to be the next one made IT. You want to memorize the calls of everybody, as only the calls will be sent, and if you don't know whose call has been sent, you won't know who is IT."

Sparks seated himself behind the key, and adjusted the buzzer to a loud, sharp note that could be heard easily all over the room.

"Scatter!" he cried, and the crowd spread itself over the gym floor. "No going out of bounds!" cautioned Sparks.

RULES FOR RADIO TAG

1. Player whose call is sent is IT until some other call is sent, or until he tags some one.
2. A "tag" consists of a touch on any part of the person.
3. Every player must be careful not to divulge the identity of the one who is IT by words, looks or signs. Each player should discover who is IT for himself.
4. The man at the key should be careful to send the call letters of each man as nearly as possible an equal number of times during the course of the play, but not in the same order, of course.
5. When one man is tagged five times, the game is over, and those who have not been tagged at all decide upon the forfeit he is to pay. This rule is flexible, and may be changed in any way.
6. In all cases of dispute, the decision of the man at the key shall be taken as final.

"Ready?" he asked. A chorus of assent answered him.

The buzzer burred a rapid call—Wildcat's, and two or three fellows near him, recognizing it, edged rapidly away from him, one of them almost jostling a fellow player named "Red," this being a delicate reference to the tint of his hair. On the instant Red's call shrilled through the air, and that quick-witted individual swung like a flash and tagged his jostler. The latter grinned, realizing how Sparks, at the key, had played a trick on him, and made across the floor in a wild effort to tag a suddenly retiring friend.

Inside of three minutes the gym was bedlam itself; every once in a while some unfamiliar call-letter, such as one of those "issued" by Sparks would fool the whole bunch, each one being suspicious of the rest, until the elected party suddenly dashed up to some victim and revealed the identity of IT. If the fellow who was IT seemed a little slow, it was easy enough to elect some one else by merely a quick tapping of the key; Sparks kept his eyes closely on the game, and his quick wit made the situations doubly interesting and amusing.

Sometimes he would rattle off two or three calls at a clip; sometimes they would be slow, and sometimes fast; once he merely sent a call twice, and fooled them all.

Each time a fellow was tagged, Sparks made a note of the fact, and the first man to be tagged five times was duly appointed the Grand Dubb, and all those who had not been tagged at all had the privilege of deciding upon his penalty. The horrible details we will not go into at this time, but they involved a strip of adhesive tape applied while warm to the hairy portion of the forearm, and then the removal of that

tape. If you've ever had it happen to you, you'll get the general idea. This, however, is not in the Book of Hoyle that governs Radio Tag, and any penalty desired may be substituted.

"Gee!" exclaimed Bozo, brushing back his shock of black hair which hung in clammy locks upon his perspiring forehead, "That's SOME game, ain't it?"

"Not so bad," admitted Sparks, "especially when you play it out-of-doors, with a Ford horn instead of a buzzer. It helps get a bunch of fellows acquainted awful quick, and I'll bet you learned more local calls, and who they belonged to tonight than you ever did in six months before."

"I'll say I did! And not only that; the thing's mighty good practice in picking out signals, do you know it?"

"There's a lot of good points about Radio Tag that make it appeal to hams, especially the younger variety, although I've seen men with families dashing around as excited as a ham with a 'super' that works. When the crowd is very large, and the gang isn't very well acquainted, each player has to call out his signal when he tags anyone, which aids the other players in identifying him the next time; when the crowd is very small, a set of fictitious calls are assigned, mixing up the numerals and everything. This makes a very exciting game, I'll tell the world!"

Wildcat came up just in time to catch this last remark. His shirt was sticking to his back from perspiration, and tiny rivulets of sweat were still coursing down his flushed face. He was one of the few who hadn't been tagged at all, and he had worked hard for the honor.

"Sparks," said he solemnly, in a weak, exhausted voice, "when you say this game is exciting, you haven't *begun* to describe it! No sir, you haven't even begun to get ready to start commencing!"

MONITOR CONTROL

Monitor control is a system employed by the Navy at San Francisco, San Diego and Washington to minimize interference in receiving. The receiving operators at each district headquarters are connected by wire to the receiving set which is located at a distant place free from electrical disturbances than is the headquarters. An expert radio man at the distant station tunes the receiving set and keeps it operating properly, thus acting as the "monitor," so that the operator merely receives and transcribes the message.

Principles of Radio Telephony

By A. Machson

Herewith is presented an exceptionally clear explanation of what is meant by the modulation of a transmitting station, with a detailed consideration of the Heising system. It concludes with an analysis of why relatively broad tuning gives distortionless reception.

THE problem of radio telephony differs from that of telegraphy in one very important particular. In the case of radio telegraphy in order that the receiver be actuated so that the ear can hear the signal it is only necessary that the transmitted radio waves be interrupted at an audible rate, say 500 to 1000 times per second. In the case of telephony, however, the transmitted radio waves must be moulded to conform to the actual speech waves in order that the ear shall hear the signal as recognizable speech. It is at once clear that the problem of telephony is ever so much more complex than that of telegraphy. In Fig. 1 are represented the



Fig. 1. C. W. Telegraph Wave

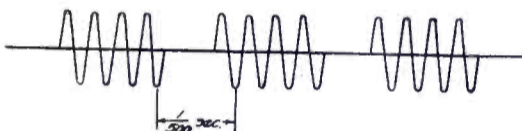

Fig. 2. Interrupted C. W. Telegraph Wave

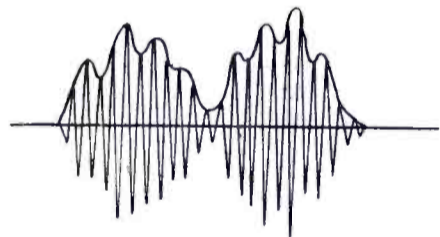

Fig. 3. Speech Modulated C. W. Wave

radio waves as emitted by a wireless transmitter. For telegraphy these waves need only be interrupted periodically as shown in Fig. 2, to be heard at the receiver. But for telephony these waves must be shaped according to the complex speech waves shown in Fig. 3 in order to be heard as articulate and recognizable speech.

The modification of the emitted radio waves according to speech is called "modulation." The methods by which this modulation is effected are numerous. But since the ultimate result is the same regardless of which system of modulation is employed, we will, in outlining the fundamental principles of radio telephony, consider the simplest system of modulation. Later in the discussion we will take up in detail one of the most important systems.

For the present, therefore, we will consider the microphone transmitter placed directly in the antenna, as in Fig. 4. The action of the transmitter in this case may be described as follows: The

diaphragm of the microphone, when no speech is transmitted, is motionless. In this condition the microphone has its normal resistance and the antenna current will therefore have a definite normal value. Now assume that the micro-

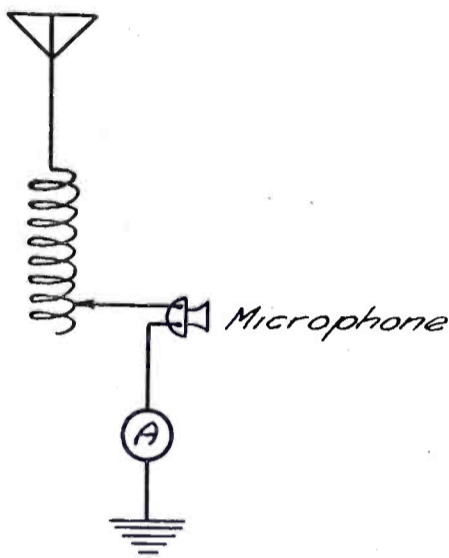

Fig. 4. Simple Microphone Transmitter

phone is spoken into. The microphone diaphragm upon which the speech waves are impressed follows every variation of speech and moves back and forth in unison with the speech waves. In this way a variation of the resistance of the microphone is effected, this variation being in accordance with the speech. Since the microphone resistance is in the antenna, variations in the resistance will produce corresponding variations in the antenna current. That is, a rise in the microphone resistance will produce a fall in the antenna current amplitude, and a fall in the microphone resistance will produce a rise in the amplitude of antenna current. In other words a speech wave of the form of Fig. 5a will result in corresponding movements of the microphone diaphragm, which results in corresponding variations in antenna resistance producing a radiated current of the form of Fig. 5b. This radiated current has a varying amplitude conforming identically with the speech wave of Fig. 5a. In this manner the modification or modulation of the r. f. wave in accordance with speech is effected.

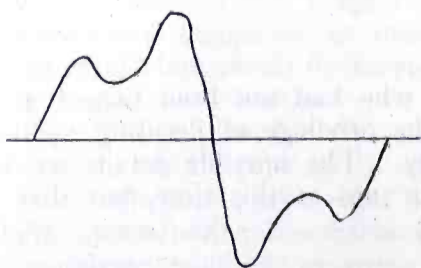

Fig. 5a. Form of Speech Wave

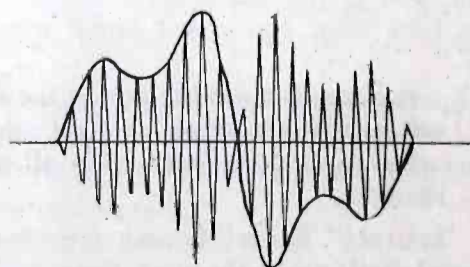

Fig. 5b. Corresponding Form of C. W. Wave

Since modulation is effected by varying the amplitude of the radiated wave the greatest or best effect will be obtained when a given speech intensity produces the maximum change in the amplitude of the radiated current. When this maximum change in amplitude is obtained we say that we have *complete modulation*. This is the aim of all systems of radio telephony.

Let us see what change in antenna current amplitude is required for complete modulation. In the first place what must be the value of the microphone resistance to secure most favorable output? This can be demonstrated in a simple and elementary manner as follows: Suppose the antenna resistance is 12 ohms total, including inductance coils. Suppose the microphone resistance is only 1 ohm, normally. Then normally the total antenna resistance will be the sum of these two, or 13 ohms. Now assume that the microphone resistance varies the maximum possible, namely from 1 to zero. It cannot ever become lower than zero. Hence the antenna resistance varies from 13 ohms to 12 ohms, thus producing only about 8% variation in the resistance. Hence the antenna current amplitude will also only vary by 8%, which is very small variation. Hence we see that if the microphone resistance is very low compared to the antenna resistance there will be hardly any variation in the current amplitude and hence there will be very small modulation. On the other hand suppose the microphone resistance is 48 ohms, normally, thus making a total resistance in the antenna of 60 ohms. In this case most of the antenna energy will be consumed by the microphone as heat, leaving only a very small percentage to be radiated. Thus if the antenna resistance is very small compared to the microphone resistance, even if complete modulation is had, there will be so little energy left for radiation since the high resistance microphone absorbs most of it, that very little effect will be produced. Thus we see that the microphone resistance must not be too low or too high

compared to the antenna resistance. Now experiment and mathematical analysis show that maximum results will be obtained if the microphone had a normal resistance equal to that of the antenna.

In discussing the question of what change is required in antenna current amplitude for maximum or complete modulation, we will therefore assume that the microphone resistance equals the antenna resistance and call the resistance R . The total antenna resistance is therefore $2R$, and the antenna current will be some value i , when the set is not modulating. Assume now that the set is modulating. Complete modulation requires maximum possible change in antenna current and this can only be accomplished if a maximum change takes place in the microphone resistance R . For maximum change the microphone resistance R at the most can decrease to zero and increase to infinity. In the first case when the microphone resistance decreases from R to zero, the total antenna resistance will decrease from $2R$ to R , hence the antenna current will rise to twice its normal value, namely from i to $2i$. In the second case when the microphone resistance increases from R to infinity the antenna current must decrease to zero. For complete modulation, then, the amplitude of the antenna current must drop to zero from its normal value and rise to twice its normal value, as in Fig. 6.

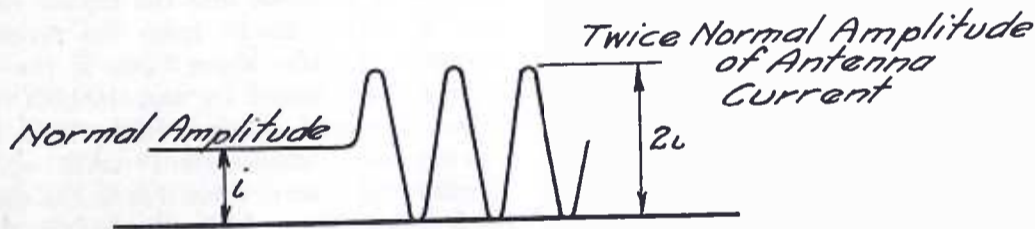

Fig. 6. Variation of Antenna Current Amplitude with Change in Microphone Resistance

It is obvious that this change in microphone resistance to zero and infinity, to secure complete modulation, is not possible. The best that can happen is that the resistance of the microphone alternates between some value less than R , but not zero, and some value greater than R , but not infinity. Hence modulation with this system can never be complete. In general practice engineers are content to secure, with the system, a percentage of modulation between 50% and 75%. Naturally, for a given power of the radio frequency transmitter complete modulation will result in a much greater range than incomplete modulation. Consequently other methods of modulation have been developed which are capable of giving complete modulation. Regardless of what the system of modulation is, the principle of radio telephony is always the same. Namely, speech is transmitted by the radiophone by modifying or varying the amplitude of the radiated wave in such manner that the amplitude variations coincide

and are proportional to the speech variations.

There are two serious disadvantages in any system of radio telephony which modulates incompletely. The first is that since the variations in antenna current amplitude is not its maximum, the possible available full power of the set is not utilized, resulting in diminished

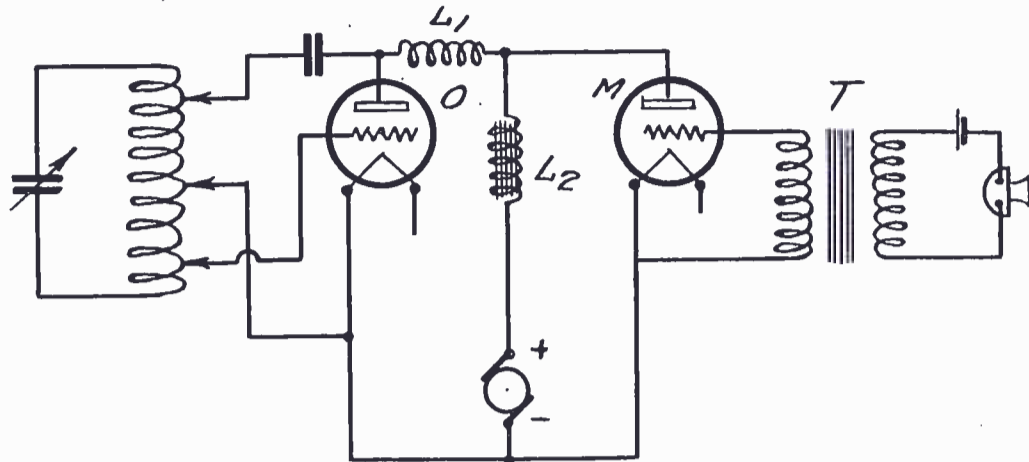

Fig. 7. Heising Modulation System

transmission range. The second disadvantage is that if there is any distortion of speech in the set this distortion will be comparatively greater when modulation is incomplete than when it is complete. The desirability, therefore, of systems which modulate completely becomes evident.

One of the best circuits in this connection is the Heising modulation system. This is probably the most used circuit of all. Its operation is therefore

well worth mastering and we will consider it in detail. The circuit connections for this system are shown in Fig. 7. The circuit applies solely to tube sets, and requires an oscillator tube O , and a modulator tube M , both tubes being of equal power. If there are more oscillator tubes in parallel, then an equal number of modulator tubes must be supplied.

It will be immediately noted that the modulator and oscillator tube are fed by the same generator through two choke coils L_1 and L_2 . L_1 is a radio frequency choke coil and L_2 is an audio frequency choke coil, both of very high inductances. Since the radio frequency choke coil is connected between the plate of the oscillator valve and the plate of the modulator valve, it will be understood that no radio frequency currents from the oscillator circuit can pass over into the modulator circuit due to the choking action of L_1 , which is used precisely for this purpose. The reactance of this choke coil is generally very much higher

than the resistance of the plate circuit of the modulator tube.

The function of the audio frequency choke coil L_2 is to assist in the modulation action of the system. This is accomplished in the following way: When the microphone is spoken into, the speech voltage generated across the secondary of the telephone transformer T is im-

pressed on the grid of the modulator tube. Since this voltage is alternating, the resistance of the plate circuit of the modulator tube will vary correspondingly. Thus when the voltage is positive the resistance decreases, and when negative it increases. Consequently the plate current into the modulator tube will vary. However the presence of the high reactance choke coil L_2 prevents much change in the total plate current supply. Hence any variation in the modulator plate current must be accompanied by an opposite variation in the plate current of the oscillator tube. Thus suppose the speech voltage makes the grid of the modulator highly positive. As a result the modulator plate circuit resistance decreases and the plate current into the modulator tube must increase. Since the total plate current supply is kept approximately constant by the choke coils, this increase in modulator plate current must be accompanied by an equivalent decrease in the oscillator plate current. The opposite takes place when the modulator grid becomes highly negative. Experiment shows that there is a slight variation in the plate current supply when speech is applied. This small audio frequency variation when it takes place in the audio choke coil L_2 results in the generation of a very high audio frequency potential across the terminals of L_2 , corresponding to the speech. The speech voltage generated in the plate circuit across L_2 is equal to

$$\text{Voltage} = 6.28 \times fL \times i$$

where f is the frequency of the speech, and L the inductance of L_2 , and i the variation of current through L_2 . Hence we see that even though i , the current variation, may be very small, by making the inductance of L_2 very high, the audio voltage generated across L_2 may be made very high. This audio voltage across

the choke coil L_2 is impressed on the plate of the oscillator tube, i.e. superimposed on the d.c. voltage on the oscillator tube. Hence the resultant voltage on the oscillator plate will vary with the speech voltage. But the output of the oscillator tube is proportional to the voltage on the oscillator plate. Hence the output will be proportional to the speech voltage and a wave modulated according to the original impressed speech will be radiated.

This modulation system is capable of giving complete modulation, which requires that maximum change take place in the antenna current amplitude. In

to transmit via radio frequency waves the true form of speech waves with all its inflections, variations and complexities. It is not only important that speech should be capable of transmission with a minimum of distortion, but the received speech must likewise be undistorted and received exactly as transmitted. Certain fundamental principles must therefore be considered in the design of the receiving system.

Mathematical analysis of the form of the received wave shows that the modulated current is composed of three components, one having a frequency of f of the unmodulated radio frequency, the

In other words in order that the received current be identical with the transmitted speech, the receiver must tune equally well to the lowest and highest frequencies of the modulated wavelength band, in the above cases to 99,000 and 101,000 cycles per second, and thus the most important principle, that for radiophone receivers tuning must be relatively broad.

It is obvious that the higher the audio frequency the broader the receiver tuning will have to be. For in the above case, audio frequency being 1000 cycles, the difference between lowest and highest frequencies is only 2000 cycles, or only 2% of the unmodulated radio frequency. Suppose we consider the case where the high musical tones are transmitted, where the frequency of speech is say 3000 cycles per second. Then

$$f-F=97,000 \text{ cycles and} \\ f+F=103,000 \text{ cycles.}$$

Thus in this case there is a difference between lowest and highest frequencies of 6000 cycles, which means a percentage deviation from the unmodulated radio frequency of 6%, which obviously requires much broader tuning to get this band of wavelengths in equally well. It is for this reason that the speech of many receivers is drummy and sounds low. For due to the fact that receiver is sharply tuned to the unmodulated radio frequency, it eliminates those frequencies resulting from modulation by the higher speech frequencies, and the higher tones are therefore absent from the received speech. In the above case, if the receiver were tuned to, say, 100,000 cycles, it would receive fairly well the frequencies which were 1000 cycles higher and lower. But due to the sharp tuning qualities of the receiver it does not receive equally well the frequencies 2000 cycles or more higher or lower than 100,000 cycles, and therefore the speech sounds drummy.

The receiver which is used for damped wave telegraphy will be capable of receiving speech. For although the speech waves are continuous, unlike damped waves which are not, the speech modulated waves have varying amplitudes which actuate the telephone receiver, after being properly rectified by the detector, be it crystal or tube. The difference between the telegraph receiver and the speech receiver is that the telegraph receiver is generally made very selective, whereas, as explained above, the speech receiver requires to be broadly tuned. Hence, contrary to the accepted method of making radio telegraph receivers, the radiophone receiver is better made a high resistance, high decrement receiver. Although the speech intensity might be less than on the other highly selective type of receiver, the quality of the speech on the broadly tuned receiver will be better, clearer and more intelligible.

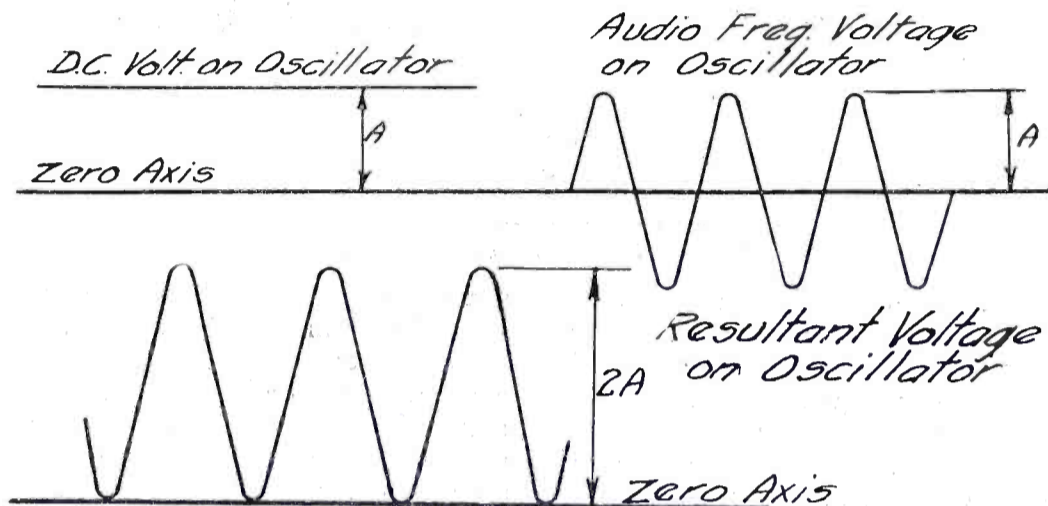

Fig. 8. Voltage Relations of Heising System

order to accomplish this, the normal antenna current amplitude must be reduced to zero. This means that the plate voltage must drop from normal to zero. Hence the maximum amplitude of the speech voltage applied to the oscillator plate must be equal to the plate d.c. voltage supplied by the generator to the oscillator valve. When this is the case, shown in Fig. 8, the plate voltage on the oscillator tube is reduced to zero on the negative cycle of the speech wave, since the resultant plate voltage equals the sum of the d.c. plus the a.c. speech voltages. On the positive cycle the plate voltage rises to twice the d.c. value of voltage for complete modulation. This speech voltage can be secured by properly designing the telephone transformer T , Fig. 7, so that enough voltage is applied to the modulator grid to produce sufficient change in the plate resistance of the modulator valve, and by designing the choke L_2 so that the resultant change in current through it will produce the necessary audio frequency voltage amplitude across L_2 . In other words, unlike the system of the microphone in the antenna, there is nothing inherent in this system which prevents complete modulation from being obtained.

We thus far have considered the radiophone transmitter and the modulation of the emitted waves. The radiophone set is, however, not complete without its receiving system, which will now be given its due consideration. We have seen how, by modulation, it is possible

second having a frequency of $f+F$, the sum of the radio and audio frequencies, and the third having a frequency of $f-F$ the difference of the radio and audio frequencies. Thus the radiated modulated wave has not a single frequency, but is a band of frequencies ranging from $f-F$ to $f+F$. This has important consequences in the design of radiophone receivers. One of the most important is that the radiophone receiver must not be a highly selective receiver. Let us see why.

Speech frequency ranges from 300 cycles to 3000 cycles per second and in order that the received speech be a faithful copy of the transmitted speech the receiver must not destroy any of the frequencies in this range. Suppose the radio frequency is 100,000 cycles per second. That is the transmitted unmodulated wavelength is 3000 meters..... $f=100,000$ cycles per second. Suppose we assume that the speech frequency averages 1000 cycles per second. $F=1000$ cycles per second. Then, from the foregoing discussion the modulated current will range in frequency from $f-F$ 99,000 cycles per second to $f+F$ 101,000 cycles per second. If the receiver is highly selective and tunes very sharply, say to 100,000 cycles per second, then the components of the received wave having a frequency of 99,000 and 101,000 cycles per second will be eliminated by the sharp tuning, with the result that the received current will not be a faithful copy of the transmitted speech, and distortion results.

General Design of a Receiving Set

By Florian J. Fox

These general suggestions for planning the layout of a radio receiving set and for completing its construction might well be followed by anyone who intends to build any of the sets described in these columns from time to time. It includes specific directions for making a two-stage a.f. amplifier.

MANY radio enthusiasts who would like to build sets designed by themselves rather than to use standard blue-prints, hesitate because the problem seems too large. If you go about it in a systematic way it is really very simple. The necessary tools can be found around the average work bench.

In the first place the builder must make up his mind as to what he wants to build, and exactly what instruments

When the builder has pictured to himself a satisfactory arrangement, measure the layout and then he will obtain some idea as to the size panel required. It is always well to make a couple of inches allowance to avoid a crowded appearance, and in order to be able to shift things around slightly so as to make a more symmetrical appearance.

At this stage, the builder will know

has found through considerable experience that plans and designs of any kind can be quickly and accurately laid out on cross-section paper. A pad of cross-section paper is a handy thing to have around a station; it is generally used for plotting data, making calibration charts for meters, wave meter charts, etc. If used for the panel layout it will do away with the necessity of drawing instruments, and enable a great saving of time and patience. Let one division equal any convenient unit—say $\frac{1}{2}$ in., or whatever is necessary to enable the complete panel to be drawn to scale on the paper. Then with a soft pencil indicate roughly where the different parts are to be mounted. Now indicate more carefully the centers of the dials and controls, and draw the general shape of the various parts to scale. Squares representing the parts will suffice, the object is to make sure that there will be room enough for all the parts. If this is not done, the builder may find in assembling that a certain part will not fit in where intended and a patch job will result. If the layout does not appear symmetrical and pleasing to the eye, the misplaced part may be erased and redrawn as before.

Now we assume that everything is satisfactory. The beauty of the use of cross-section paper will now become ap-

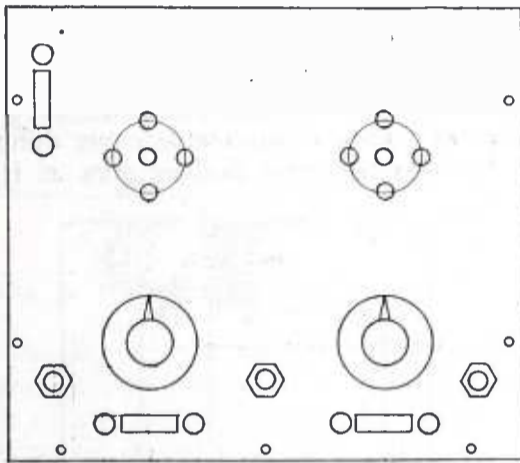
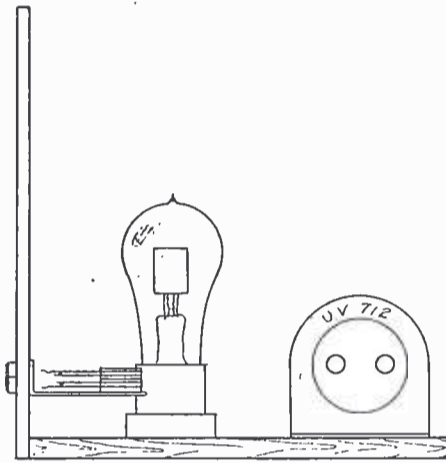

Fig. 1. Rough Preliminary Sketch



he is going to use. Current literature is full of such information, and all reliable dealers will give all necessary information. The parts may be either home-made or bought. The latter are usually of better workmanship and appearance, and the difference in price is usually not great. The results will usually be better because all parts are pretty well standardized nowadays. All the parts that are to be used should be now at hand ready for the next step.

Now the actual designing begins. One should try to form some idea as to how he would like his instrument to look; long or short, high or low, square, etc. This will serve as an end towards which to work.

Considerable thought must be given to accessibility and convenience. Those parts which are to be used the most should be located in the most convenient places. Crowding of such controls is to be avoided. For instance it would be poor judgment to place the tickler and condenser controls near the top of a panel, and have three or four rheostat controls near the bottom. Lay the parts on the table in front of you and imagine them to be in a panel and see if the tuning would be convenient. If not, rearrange the material. Two other things should also be remembered, symmetry and convenience in wiring, although these are not so important as is convenience in the handling of the finished instrument.

the size of his panel and this panel should be obtained. A cabinet can now be made, if desired, and the panel carefully fitted to it.

Planning the panel lay-out is now in order. First it is recommended that several rough sketches be drawn to serve as a guide for the next step. The writer

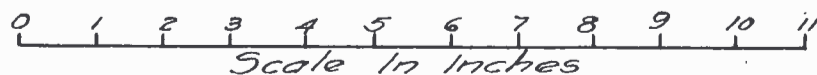
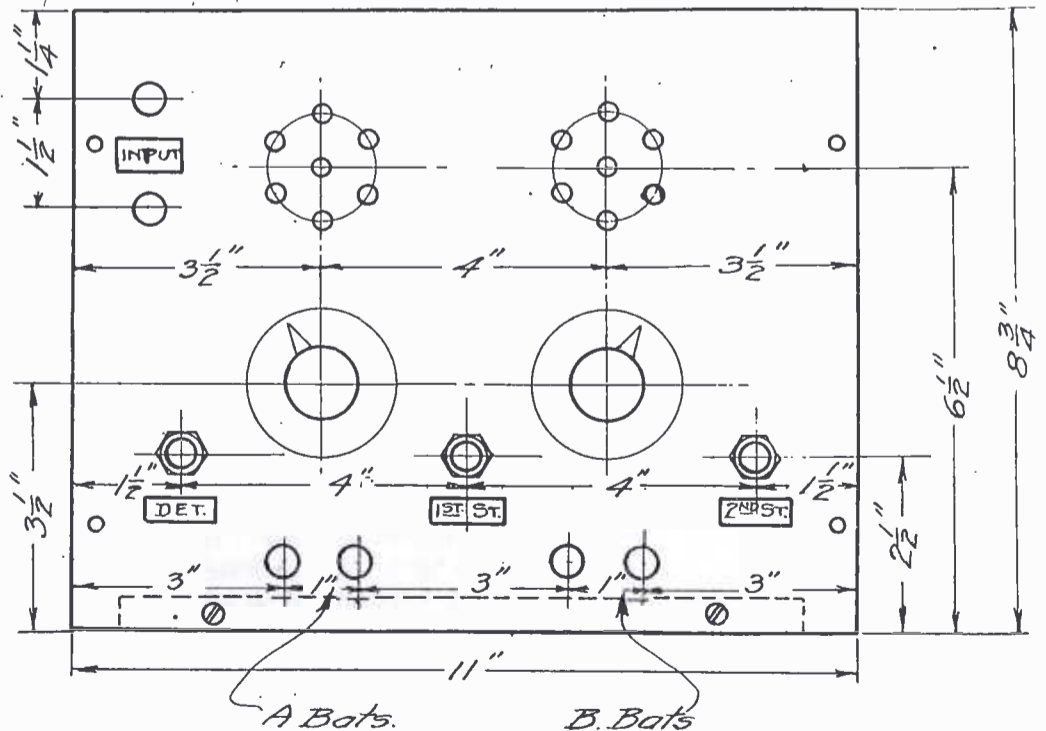

Fig. 2. Actual Layout Based on Sketch

parent. To dimension the drawing it is only necessary to count off the number of units to any particular point, and the dimension is known. For example, say the distance between two centers is 8 units, scale 1 unit equal $\frac{1}{2}$ in., then the dimension or distance is 4 in. The writer generally uses cross-section paper with centimeter and millimeter divisions and uses a scale of 1 cm=1 in., in this way the dimensions may be read directly in inches. If the paper has $\frac{1}{4}$ in. rulings, a scale of 1 unit=1 in., or 2 units=1 in., will be found convenient, depending on the size of the panel and of the paper. In any event this method will be found to be useful in laying out plans for almost any purpose, where extreme accuracy is not required.

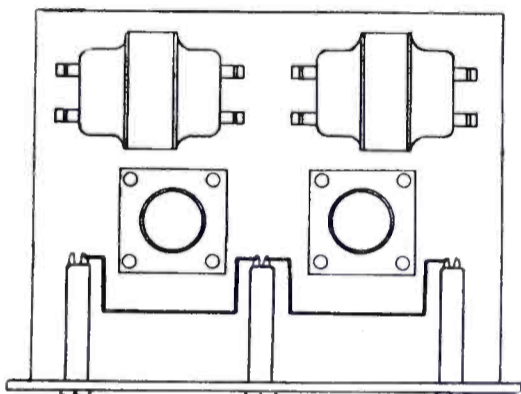

Fig. 3. Top View for Planning Inside Arrangement

Usually one side of a panel will have a better finish than the other. The better side is used for the front. Now place the panel, good side down, on a table and lay off the dimensions by means of a scale and make marks (either crosses or points) where holes are to be drilled. Please remember that you are working now on the *reverse* side of the panel and that the drawing is for the *right* side. This means that all dimensions must be marked in the reverse order from those on the drawing. In other words simply imagine that the drawing is the panel, turn it over (as you did the panel for marking) and hold it up to the light, and you will see how the marks are to be made on the back of the panel. Indeed, if you are afraid that you will make a mistake, you can stick the drawing to a window pane, reverse side facing you, and lay off on panel as it then appears. If you will simply remember this fact, you won't make a mistake in any event.

After marking, the panel is ready for drilling and assembling. If proper care has been used in making measurements, the parts will be found to fit into their respective places very nicely, and the panel will have a "factory-like" appearance. For mounting condensers and similar things where more than one screw hole is required, little paper templates will help to locate the holes accurately.

We are now ready to consider the last but not least important stage; namely, the wiring. For a real fine appearing

job, hard drawn copper wire is recommended, and wherever a wire changes direction, a sharp right angled bend should be made. This is commonly spoken of as "bus wiring." The wires should not be run here and there at all angles, but rather run them all either horizontally or vertically, or combine the two in order to reach a certain point. A glance at the wiring of most modern sets will serve as an example. Go to your dealer and look at a Grebe set, or turn to the advertising section of this magazine and you will see how this is done. The results in appearance are really astonishing. To further improve appearances the writer uses varnished cambric tubing. Copper wire will turn black due to corrosion, in time, and the tubing will hide this; furthermore, in case any of the wires should ever touch, short circuits will be prevented. All connections should be carefully soldered. Clean joints are essential to good soldering.

The writer uses No. 14 hard-drawn

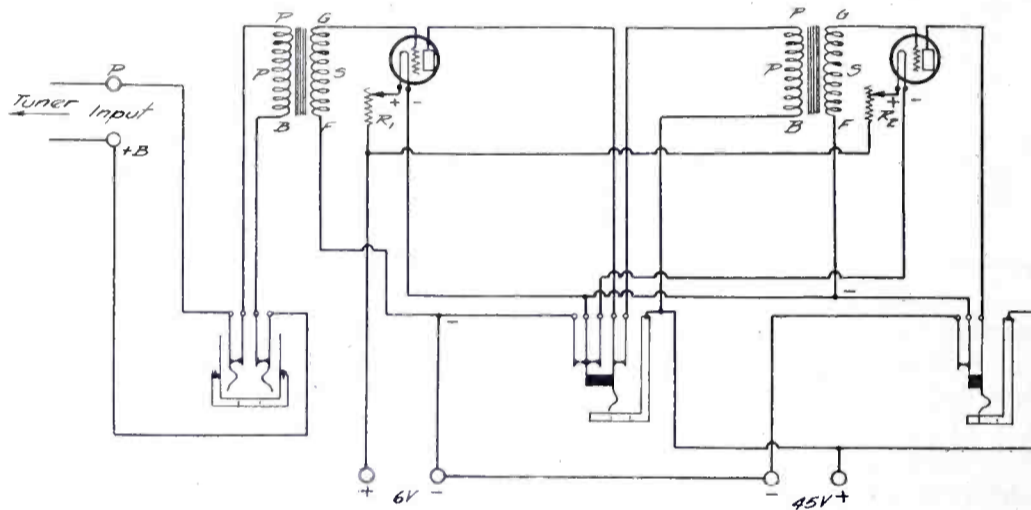

Fig. 4. Connection Diagram for 2-stage A. F. Amplifier

copper wire for all wiring. This wire is nice and stiff and once bent to shape will stay that way. Annealed copper wire is bad because the wire soon gets out of shape due to jarring or handling, and the job soon looks sloppy.

As an example of the method outlined above, suppose we wished to build a two-stage amplifier, and we wanted three jacks (detector, first stage and second stage). We would first get our material together.

- | | |
|---------------------------------------|------------------|
| 3 jacks. | 2 amplifying |
| 2 sockets. | transformers. |
| 2 rheostats. | 6 binding posts. |
| Name plates, screws, wire, etc., etc. | |

Suppose further that the amplifier is to match a set whose panel is $8\frac{3}{4}$ in. high. This will at once fix one dimension. The other dimension will be determined by the amount of space required for the transformers, sockets, rheostats and jacks. After making several rough sketches and after arranging the parts on the table, we arrive at a dimension of say 11 in. We now lay a panel $8\frac{3}{4}$ in. x 11 in. off on our cross-section paper and indicate roughly where the parts are to go. This is done

very lightly, and now the parts may be shifted slightly to give a symmetrical appearance. See Fig. 1. Next the centers are located with reasonable accuracy and the sizes of the parts indicated. It is found there is plenty of room. Fig. 2. The drawing is then dimensioned as described above.

Often, to improve appearances and avoid crowding of the interior, it is well to lay out the parts there also. This was done. In order to allow for the size of the other set, the size of the amplifier cabinet, etc., we assume that we are allowed a depth of 8 in. Fig. 3 shows the result. Such a plan will tell us if there is room for the sockets and transformers and the jacks which protrude considerably.

With the above example as an illustration the writer believes that anyone should understand the method of attack set down in the first part of this article. It will be seen that the design of a set or of a piece of apparatus is not difficult if the prospective builder goes at it in

the right way and if he has a little creative imagination.

For the benefit of those who do not care to design their own equipment and who like the design of the above amplifier, we shall include the wiring diagram. The above amplifier was actually designed and built by the writer for a friend of his, so no mistake will be made by copying it.

SWEDEN TO HAVE LIBERAL RADIO LAWS

The proposed Swedish law for regulating radio telephony recognizes the principle of free competition, with regard to the manufacture of radio apparatus. It will permit amateurs to build their own sets, requiring only that these shall be constructed in accordance with regulations. The Department does not contemplate limiting within narrow margins the wavelengths on which amateurs may receive. In accordance with the proposed law, the government is to erect the broadcasting stations and rent them to the Radio Telephony Company, which in turn will receive a rental from receiving stations.

Resonance Phenomena and the Distribution of Energy

By Bernard Steinmetz

In simple language here is told the effect and result produced by connecting a condenser and an inductance coil in series in a radio circuit. A future article by the same author will tell how parallel connection is applied to eliminate interference.

WITHOUT doubt resonance is the phenomenon that plays the major role in radio. We are always tuning circuits so that they will be in resonance with other circuits. Amplifier output circuits are designed so that they resonate with the signal to be amplified. Filter circuits are designed on the basis of resonance, and so on. Due to the fundamental part which resonance plays in the radio art a clear un-

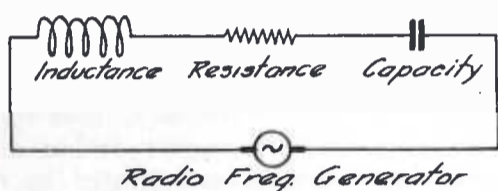

Fig. 1. Typical Series Radio Circuit

quency of the voltage, meanwhile keeping the value of the voltage the same, and measure the current flowing through the circuit at each different frequency. If we draw a curve which shows the value of the current through the circuit for each value of the corresponding frequency, we will have a curve such as that in Fig. 2.

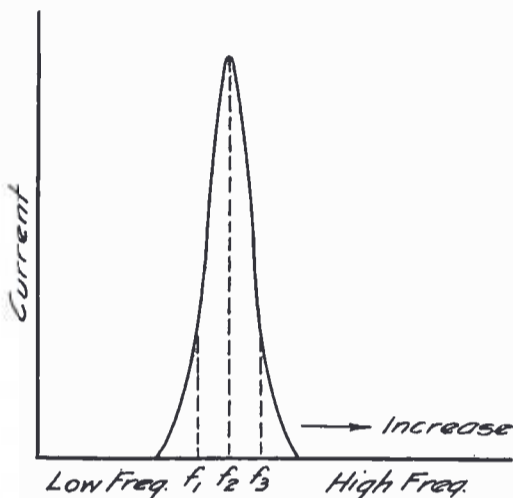

Fig. 2. Resonance Curve of Circuit with Low Resistance

This curve gives us the clue to the whole problem of resonance. We see that the current in the circuit is not constant in spite of the fact that the voltage value is constant and the inductance, capacity and resistance values are the same. The current, then, does depend upon the frequency. We see that as we increase the frequency from very low values to higher ones the current gradually increases. At a certain intermediate frequency we see that the current reaches its very highest value. If the frequency is further increased the current begins to decline in value. Now what is this particular frequency, f_2 , at which the current in the circuit reaches such a maximum value? Obviously it must have some connection with the circuit, since the voltage has been kept constant throughout the experiment. If a calculation is made of the frequency of the circuit it will be discovered that *the frequency of the circuit coincides exactly with the frequency of the applied voltage at which maximum current was obtained.* This equality of frequencies is evidently the condition for maximum current in the circuit, and is called "resonance." No matter what kind of circuit is used or what applied voltage is used, if the frequency of the circuit is the same as that of the applied voltage, namely if resonance exists, the current in the circuit will be a maximum.

The reader will immediately understand why he tunes his different circuits to the same wavelength or frequency. By so doing he secures maximum current in his set, and hence maximum results, either in loudness of signal or magnitude of antenna current.

Let us see just why maximum current should be obtained when the frequency of the circuit is the same as the frequency of the applied voltage. In ordinary electrical circuits the value of current depends upon the voltage and the resistance. If the voltage is constant the current depends solely upon the resistance, or opposition which the circuit offers to the flow of current. The same applies to alternating currents and to radio currents, with one important difference. In radio currents we not only have the resistance of the circuit to take into account but also the opposition which both the inductance and capacity offer to the flow of current.

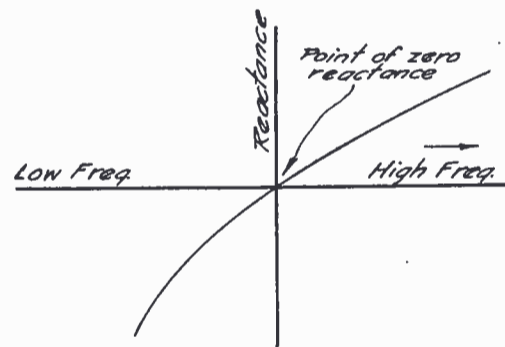

Fig. 3. Variation of Reactance with Frequency

derstanding of the phenomenon, what it accomplishes, and how it accomplishes it is of the utmost importance to one who would understand radio. It is not sufficient to state that two circuits are in resonance when they are tuned to the same wavelength. While this statement is true, it conveys no idea as to the effects produced by this state of resonance and why it is important that circuits be in resonance. It will be the purpose of this article to explain simply, yet accurately, what is involved in the phenomenon of resonance.

Resonance can take place only in circuits which have inductance and capacity, as it is a phenomenon dependent upon the frequency and wavelength of a circuit, and a circuit will have a frequency and wavelength only if it has inductance and capacity. Almost all radio circuits have some inductance and capacity and so resonance may occur in almost every circuit in radio.

If we have a circuit containing an inductance, capacity and resistance—we include resistance because every inductance coil must possess some resistance—and we apply a radio frequency voltage of constant amplitude to it in the manner of Fig. 1, how much current will flow through this circuit as measured by an ammeter? The answer to this question depends upon a number of different factors: Two of them, strength of the driving voltage and opposition the circuit offers, may be assumed to be constant. When this is the case both theory and experiment show that the current flowing through the circuit depends primarily on the frequency of the applied voltage. Suppose we vary the fre-

This opposition which they offer is called *reactance*. The total opposition which a radio circuit offers to the flow of current is a combination of resistance and reactance and is called *impedance*. Although the resistance of the circuit is, to all intents and purposes, practically constant, the same cannot be said of the reactance of inductance and condenser. These, it is found, vary with the frequency. As a result the total opposition which the circuit offers to the flow of current, namely the impedance, also varies with the frequency. And the important feature about this is that this variation takes place in such a way that the above condition of resonance is secured, namely maximum current is obtained at a certain definite frequency.

Both theory and experiment agree as to the particular manner in which the reactance of a radio circuit, such as Fig. 1, varies with the frequency. If we calculate or measure the reactance of such

a circuit at different frequencies, and draw a curve which shows the value of the reactance corresponding to each frequency, the curve will look like Fig. 3. This curve shows us that for low values of the frequency the reactance of the circuit is very high, but as we increase the frequency the reactance gradually diminishes until it becomes zero at a particular frequency. If we increase the frequency still more the reactance begins to increase again. The important point here is that the reactance is nothing at one frequency, namely the inductance and capacity do not oppose the flow of current at this frequency. Hence the total opposition offered the flow of current is a minimum. Again, as above, if we calculate the frequency of the circuit, we find that *its frequency coincides with the frequency at which the reactance of the circuit is zero*. But we found above that when this equality of frequencies occurs we have the condition of resonance. From this we immediately draw the important conclusion that *when resonance exists the reactance of a circuit is zero, and the impedance of the circuit is a minimum*. In this conclusion we have the secret of the phenomenon of resonance, why the current is always a maximum in the resonant condition. It is: The current is always the greatest at resonance because the impedance, or opposition of the circuit to the flow of a radio frequency current, is a minimum at resonance.

The reason why the reactance of such a circuit as Fig. 1 is zero at resonance is to be found in the action of the inductance and the condenser. These two elements of the radio circuit behave in exactly opposite ways, where one pushes the other pulls. The reactance of the inductance alone gets larger as the frequency increases, while the reactance of the condenser gets smaller as the frequency increases. Furthermore these reactances act in opposite directions. As a result at a certain frequency the reactance of the condenser is equal but opposite to that of the inductance, like an equal push and pull, and hence they just neutralize each other. This occurs at the resonant frequency of the circuit.

We see, thus far, that when a circuit is in the resonant condition the current through it is a maximum. We have considered the case where a single circuit is in resonance with the frequency of an applied voltage. However, two or more circuits may be in resonance with each other, which happens when the frequency of one circuit is the same as the others. The important factor is that the frequencies must be the same. It will therefore be apparent that tuning the secondary circuit of a receiver to the primary is equivalent to placing them in the resonant condition, since when their wavelengths are the same their frequencies are the same. The ob-

ject of tuning secondary to primary is to obtain maximum current in the secondary and thus secure maximum signal, and this is obtained in the resonant condition. The method of tuning is to vary the condenser. By doing this we are varying the reactance of the condenser so that it will just neutralize the reactance of the inductance, giving us the condition of zero reactance at resonance, hence maximum current. Thus it is seen that an understanding of what resonance means enables one to explain intelligently each operation in the adjustment of his set.

We can learn much more from an understanding of resonance. The curve derived in Fig. 2, which shows the current in a circuit for different frequencies, is called a "resonance curve," since it shows the effect of resonance on the current. Now all resonance curves show the same effect, namely a maximum current at a certain frequency. However the exact shape of the curve depends upon the circuit and is an indication of whether the circuit is poorly designed or not. To show this suppose we obtain, by experiment, the resonance curve of a circuit having a certain inductance, certain capacity, and a certain low resistance. If its resistance is very low the curve will appear as in Fig. 2. Suppose now we add some more resistance to the circuit and again obtain the resonance curve, leaving the other factors the same as before. The curve will now appear as in Fig. 4. If we add

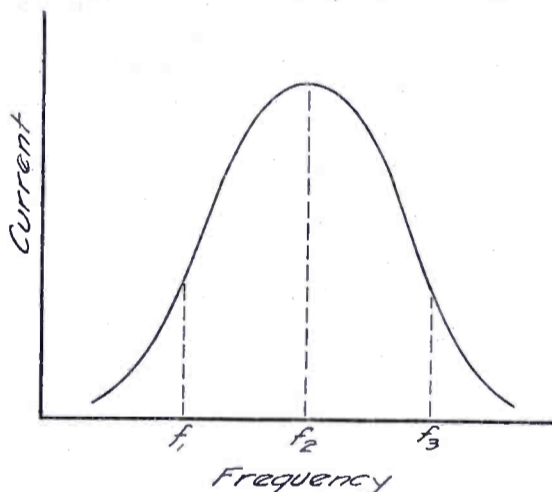

Fig. 4. Resonance Curve with Medium Resistance

still more resistance making the resistance very high and again obtain the resonance curve, it will appear as in Fig. 5. There is much to be learned from these curves.

The first obvious feature we note is that when the resistance is low the total current flowing in the circuit at any given frequency and voltage is greater than when it is high. Thus a receiver will give a louder signal in the telephones when its coils have low resistance than otherwise. From this viewpoint alone it is desirable therefore that all circuits be designed to have as low a resistance as possible.

The second, and equally important

feature to note, is the manner in which the shape of the resonance curve varies with the resistance. It will be seen that when the resistance is very low, as in Fig. 2, the curve rises to a very sharp peak, whereas when the resistance is very

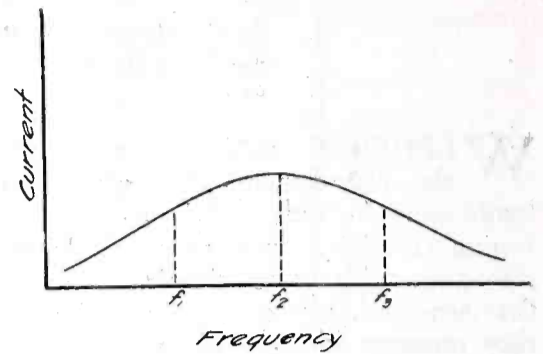

Fig. 5. Resonance Curve with High Resistance

high the curve, Fig. 5, is very flat or broad. What does this indicate? Suppose we have a high resistance circuit giving a resonance curve as Fig. 5, and that a number of voltages are applied to this circuit simultaneously, these voltages being equal in magnitude but different in frequency, as indicated by f_1, f_2, f_3 in Fig. 5. The effects which these voltages would have on the circuit are represented by the corresponding points on the curve, and it is seen that the currents due to each of these voltages are almost alike. Hence if they affected a telephone the signals produced by each of these different frequencies would conflict seriously with each other. The application to a radio receiver will at once be apparent. If instead of ordinary voltages from a generator we have different received signals applied to a receiver circuit having a high frequency, it will be seen that each of these different signals, f_1, f_2, f_3 , will influence the receiver almost equally with the result that considerable interference is produced and the desired signal is not heard clearly. On the other hand if we have a circuit having a very low resistance which gives a resonance curve such as Fig. 2, the effects produced are entirely different. Here we see that the current effect produced by voltages of frequencies f_1, f_2, f_3 are very different, f_2 producing a great effect, while other frequencies produce a very small effect. In other words little interference would be produced in such a low resistance circuit.

A low resistance circuit having a well defined peak results therefore in less interference between signals while the high resistance circuit with the broad curve results in considerable interference. The former is said to have a "sharp resonance curve," and is sharply tuned, while the latter is said to have a "broad resonance curve" and is broadly tuned. We are thus able to tell by the amount of interference present in a receiver whether it is a sharply tuned circuit or not, hence whether it is well designed or not.

Continued on page 60

The Toth Circuit

By Bert T. Bonaventure

With due deference to the energy and ability of the devisers of new wonder-making circuits this satirical account of another miracle carries a moral which the cautious amateur will appreciate. The lack of the customary circuit diagram is obvious. Full many a truth is spoken from the chest.

YOU have a head without a head-set if you have not marvelled at the many and diversified "circuits" which have appeared of late in our sacred domains. Take for instance the Super, which impressed us quite a bit. Then we laughed up our sleeve at the Flewelling and took our hats off to the long known and justly famous Reinartz. But suddenly we were catapulted out of our sedentary repose by the militant hosts of what followed. Shades of Hertz and Maxwell guide us!

In blazoned hieroglyphics our various sources of information printed elucidating articles on the Buy-one-circuit, the Cain Alligator circuit, the Fowl of Noon circuit, the Uniped Perfect, not to mention all the other lesser circuits. Here, indeed, was a Conglomeration of worthy and trick circuits, each of which was Better than the Rest and each the Best of them All. Each and every inventor of one was given a Flood-lighted niche in the Hall of Fame and had a Bronze Bust cast by the people of his Tribe. His mail was laden with fat and bounteous Checks, those haughty implements of Modern Barter.

What fed these lean and hungry Artists of the Tube and Tuner that they had grown so Big? What Nectar trickled down their Thirsty Throats and washed their moorings loose to produce such Wisdom? Ay, indeed, how came they to sow Dissension in our Peaceful Community? Where before our mighty County lay like a Lily in its Tranquility, here came these Kapacity Koupling Krusaders, Active Twenty Gaelics, and these other sons of men to cast our commonwealth into a most Hideous Uproar. There resounded day and night the Brazen Trumpets of the Multitude who had become Attached each to their individual Honeyed Circuit. Our heretofore Peaceful Citizens battled on the Highways to prove at the Shrine of the Artists of the Tube and Tuner, that their Gods were Unassailable in their Perfection. We looked on and pondered, pondered, Pondered.

We too, decided to join the Artists. We too, must have a Deceiving Likeness cast for us. We too must have our Disciples, hair-brained and Senseless though they be. We too, could Juggle and make Potent Magic to turn out The Peer of them All, by far the most Wonderful Circuit in the Creation of men and mortals.

Our friend Toth, who Pretends to be wise in the ways of Electrons and

Vacuums, had to listen one whole Night to our pleadings for the Conception of The Peer of them All. Entreaty was in vain. Heart's Blood could not move that Block of Petrified Calculus. Ay, even our Fair and Beauteous Sister could not lay low his Detested Reluctance. "Alas!" we cried, "Is the Birth of the Peer of them All to be delayed for the lack of Energy?" Nay!

At a great and Stupendous Expense we Imported Sixteen Ounces of an age-old Elixir, which was found Buried in the Tomb of Toot-anhk-omin before the days of the Great Catastrophe. Toot-anhk-omin was a famous Restaurant, it will be remembered by our Aged Citizens, which Flourished in the Mighty City of New York before the draught. Fair means or Fowl; the Peer of them All must be Evolved and the only Living Being to do it was Toth, and he Disdained to aid us.

Ah, my Friends, Potent indeed is the Drink of Toot-anhk-omin. If we could but induce him to Drink of it. Cautiously and with great trepidation, we showed him the precious Gold Grain enamelled Brazier that contained the Great Happiness. He Gazed at It dully, that Mass of picayune mental Innocuousness Concealed in his skull seemed to Fail to grasp the Value of the Sacrifice we were making. His lower jaw Drooped and his eyes Gaped. Surely a Fit was coming o'er him. And Then, with a Fearful Shriek, like a Tortured Soul in the Land of the Gilded Vacuum, he leaped for our Outstretched Hand, clawing and clutching for the Great Happiness as tho he were Mad. Frightful beyond Words were the Antics that possessed our Friend.

With an all too familiar Pop and a Soul-Tearing Gurgle, we saw the Great Happiness diminish in Volume according to some Unknown Law, and at last the Precious Fluid was No More.

"Friend," quoth Toth, "You have furnished me Untold Happiness. Demand what you Will, and Forthwith it shall be yours."

We perceived that the Great Happiness had begun to influence him and Boldly made answer.

"Whereas the World is now Suffering from a Malady caused by the Unknown Station Signing Off and,

"Whereas it is Necessary to Cure Humanity from the Curse of Evil Circuits and their Attendant Unholy Intricacies,

"Be it Known therefore that you are

to Give us This Day the Peer of them All that we may Confound our Enemies and Relieve the Suffering of Them who have been Bitten by this Insidious Insect."

"Thy Wish is Granted," came in Staggered Phrases from him Possessed of the Great Happiness, "Here is what you Seek. Thereupon he handed us a Magnificently engraved Scroll of Parchment, whereon in Radiant Characters was drawn the Circuit, the Peer of them All. In the lower Corner, all the Necessary Data were inscribed. With a Heart Overflowing with Joy, we took the Noble Document from his Unsteady Hand.

Most Gentle of Readers, if you have ever been Deceived before, come now to this Haven of Refuge. We are about to unveil a living prototype of this Ancient Scroll, so that You may benefit thereby. Gather 'round while we press the Key that will Disclose to Posterity the Great Revelation.

And ah, Gaze on the Artists of the Tube and Tuner. See how they Shiver in their Gaudy Garments. See how their Circuits Crumble to Ruin before their very Eyes. See their Apostles flee before them as if from the Very Pestilence itself. Ye, they Tremble before the coming Truth.

Friends, You are about to Behold the Last Work of the Immortal Toth, Sage and Savant of All Time—the Long Looked For Peer of them All. Gentlemen, below is printed the Toth Circuit, the Peer of them All, Bar None. Let Its Marvelous Simplicity, attainable by the Fourth Dimensional Controls, impress you with its Diabolic Wonder. The very Antipodes have been Heard in the Broad Light of High Noon, using but one Tube. Even a Child of Earth can Operate it. Oh, Great Toth, Manifold indeed are the Fruits of the Blessing you have Bequeathed to Mankind. Lo, gaze and Behold!.....

Editor's Note:

We are extremely regretful that, due to the gross negligence of the head office boy, the precious scroll, while on its way to the printer, was lost during transit in the subway. Our efforts to locate this invaluable document have been in vain; the scroll has vanished from the face of this earth.

Our only hope is that Sir Conan Doyle—and he has assured us of his utmost endeavors, will be able to duplicate the circuit by calling on the spirit of the Honorable Toth, who, as we have recently learned with deep sorrow, had liked the glimpse of heaven which he received so well that he has left this world forever.

We beg the indulgence of our readers and again express our regrets.

GETTING RANKER AND RANKER

By DAVID P. GIBBONS

To Editor RADIO

(magazine which outranks many such)

Esteemed Sir:

It are, mightbe, possible that as member of great working class which are so common, you must retire yourself hayward before the very small hours of the a.m. come along. If so you are not aware yet that my Cousin Scratchi are now fully fledge komrade of that kurius kollection of knuts which are known as the "Knitely Disorder of Kwak-Kwaks," and which hold its sittings on the air at the time you are catching muchly-needed beauty sleep.

Since this are very private and exclusive klub and are only open to person of certain mentally kwalities you are kwite korrekt in guessing that Scratchi had very slite trouble in entering into it. About a weak back or more he come home and say towards me "Handshake me, Cousin Nogo! I have just post-marked my blank application for up-joining most uneek society and hope to be taken in by the home coop of the order at irregular meeting which will break out at 1 G.M. next week."

I refrain myself, Mr. Editor, from making gratulating or asparaging remarks at Scratchi until some later-on time when I learn something about this latest bunch of straw on the ham's back, altho I have sneaky suspicion that he are going to be taken in P.D.Q.

For two or four nights following this my cousin make many try-again tempts at record cracking receiving with same unusual as always,—to wiz., none. He read about one truthful gent in South Africa who can pick up all sixth dis-

trict hamburgers and hot doggies on one single tube and with aerial lying on the snow, so Scratchi go out and prostrate our 150 foot amplifying wire across back fences. When he fail most utterly to catch even broadest broadcaster on earth who are located on the roof top of neighborly dryware palace, he conclude to himself that further testings along this line must postpone until heavy snowburst arrive around here. He then elevate back into place our foster-bronze, enamel-welded, softened copper conductor and resume listening.

When night of grand event at last come round my Cousin have all parts of set in very top-tip shape. He have added a verinear condenser button which move dial so slitley as to be unseen by the naked vision, and a verinear reestat which curb the juicy flow by millionths of one degree. He put fresh bait in wave trap for KPH, which consist of few messages of jap ten letter code and some limo ship calls, and he remove away some verinear dead B batteries which he have just received by male man from distant bargain house.

To sure himself that everything are now jimmy-dandy we listen for about three hours or less to sparkling ray of musicky stars who strew the heaven with songs and words. In compliants with the governor's relations we observe the customers two minute comma and listen to gent telling pilot boat of last weeks ships positions in voice of slow-motion phonograph.

When silents finally fall down Scratchi tune around and find on one sector of dial large patch of mushy noise like ark chopper warming itself up or some stake-meat getting fried out on stove-top. In the center of this he hear delik-it voice say that "This are station Beeah Ceeah Deeah", with super-refined accent on all letters, and he know that meeting are now being called to disorder.

For next following 58 mins. we absorb overdose of wit and humor—only the wit are the kind given off by pool-table gumeaters, and the humor not quite so fresh and clean as in Sunday comic sector. Wise chicken crackles mingle abundantly with barred boot-leggy gags and with occasional gentlemanly kick-in-the-shinbone to some personal victim who are too far absent to deliver snappy nose-punch to speaker. This splendid sample of grand new lift-up force of radio also include singings and recitings by vocal comets who save most special numbers for aerial output due to QRM from police people if tried before the feetlights. During last few moments the sweetly-speaking announcer gent rattle off longish list of candied dates who are terrible anxious to become members of such noble band, and to hear their names rattled out by above - said sweetly - speaking Grand Kwak.

Among those are my Cousin, and after his name come thru the jumble of many such like others, his interest in the Knitely Kwak Kwaks fades out like shorted B battery.

For 10 or 8 mins. he impress to me highly charged opinions on abusings of glorious radio game by peanuttty group of smart alexanders, and he prejects that Hon. Govt. Inspec. are soon about to take quicksteps to tone (up, down, or out) the yellow wave which such stations spread fourth.

I warn my cousin that his combustion language would get him remoted to rear rank or mightbe repelled all-to-gather if evedropped by someone or another, but he bark back at me

"No can do, little brite eye! Since 11 mins. passed ago I am resign".

Hoping you are likewise, Mr. Editor,
I am,

Yours very fletearnally,
HILOLI NOGO.

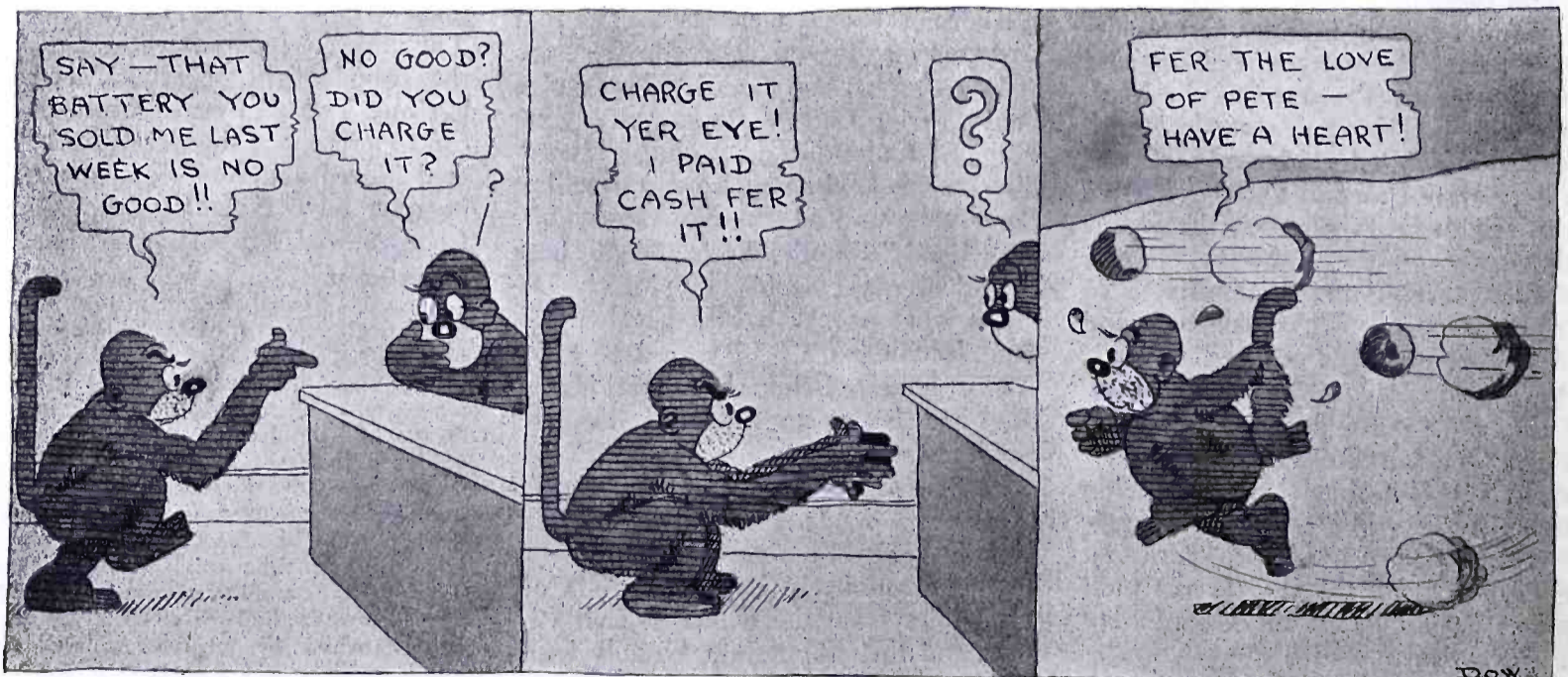

U and I

Selectivity and Its Applications to Reception

By Jerome Snyder

The several factors which determine the selectivity of a receiver are here discussed in detail. An observance of the suggested precautions will do much to lessen interference.

SOME confusion exists in the use of the terms selectivity and sensitivity, these sometimes being used indiscriminately by the novice. Sensitivity refers solely to the ability of a receiver to respond to weak signals, regardless of the presence of interference, static and other sources of annoying signals. A receiver which is able to give a good response to an extremely weak signal is a very sensitive receiver. Selectivity refers to the ability of a receiver to select a signal of any desired wavelength to the exclusion of signals of other wavelengths. Thus a receiver which is able to select a signal of its own wavelength and at the same time reject all others would be a selective receiver. A receiver which could not discriminate between wavelengths 100 meters apart would be a poorly selective receiver. The selectivity of a receiver may be expressed as a percentage: If a receiver can discriminate between two wavelengths 10 meters apart on a wavelength of 400 meters, that is, if a receiver which tuned to 400 meters can reject a wavelength of 410 meters, or 390 meters, its selectivity may be expressed as $10/400$, which is 2.5% selectivity.

The selectivity of a receiver can be determined by its resonance characteristics. A receiver with a very sharp resonance curve will be more selective than one with a curve less sharp, Fig. 1. From these curves it is seen that the current effect in the receiver with the sharply tuned circuits falls off very rapidly as the resonance frequency is left. On the other hand the broadly tuned receiver gives very high current effects over a broad band of wavelengths. Thus it cannot discriminate very well between signals of different wavelengths.

What is it that makes one circuit more selective than another? A high resistance in a circuit results in a very broad resonance curve. This is the reason that spark transmitters may be heard over the entire wavelength of some receivers, for spark transmitters have relatively high resistance, hence send out a broadly tuned wave which will make even a selective tuner respond to it. Spark transmitters are therefore becoming obsolete. The same effect is observed in receivers. If they are poorly designed and have high resistance they are broadly tuned and hence less selective. The resistance present in receivers may be due to inefficiently designed inductance coils which have more wire for a given inductance than is really essential, or which have high distributed capacity, or which are wound on forms or are in the vicinity of material having high dielec-

tric losses, or it may be due to the presence of other coils or circuits in the receiver which resonate to the received wavelength and thus absorb energy and increase the resistance. These are only a few of the possible causes for a high resistance and hence a poorly selective receiver.

For low wave work the best type of coils are spiral or other wave wound inductances or compact multi-layer coils. These coils give minimum distributed

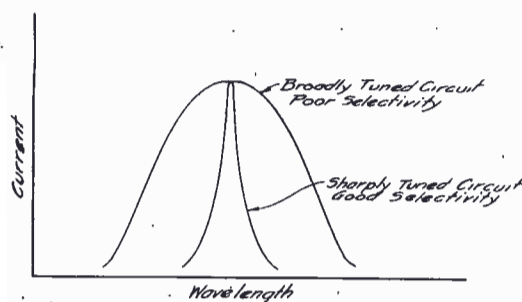

Fig. 1. Resonance Curves

capacity. The multi-layer coil probably uses somewhat less wire for a given inductance than any other type, hence its actual conductor resistance will be less. The dielectric losses of the wave wound coils are less than in other types due to the presence of less solid dielectric and more air dielectric. To avoid high losses due to absorption by resonating coils or circuits the best thing to do is to design receivers for a limited range of wavelengths, or to use separate coil systems for high and low wavelength ranges. Designing coils to cover a range from 150 meters to 3000 or more meters is bad practice, since it requires tapping the coil, and a part of the tapped coil may resonate to one of the received waves. Prof. Morecroft states that a coil should never be tapped at points less than half the coil. If it is absolutely necessary to take several taps from a coil it is suggested that the coil be wound in several sections, disconnected from one another, each section of which will probably have a period less than any in the wavelength range received. This, however, is not a complete remedy but will be better than tapping a continuously wound coil.

The selectivity of a circuit will be determined to some extent by the actual proportioning of capacity and inductance constants. A circuit may be designed to have great inductance or great capacity. Which is preferable? Here the reader must understand what effect is produced by either of these conditions on the response of a circuit to impressed signals.

A circuit having a high inductance is said to be a *stiff circuit*, or it is said to have a large *time constant*. By this is meant that it takes a long time for the

circuit to reach a given fraction of the final value. The greater the inductance of a circuit for a given resistance the greater is the time constant, hence the longer it takes for the circuit to reach its final value. The term *stiff circuit* therefore refers to the ability of the circuit to adjust itself to changes rapidly. Thus the greater the inductance of a circuit the stiffer it is, hence the more time it will take to adjust itself to new conditions in a circuit such as the responding to an incoming wave other than that to which it is tuned.

Consider the action of a circuit with high inductance and low capacity, namely a stiff circuit, and one with less inductance, hence a less stiff circuit, when voltages of different frequencies are impressed on them. Assume they are both tuned to the same frequency f and that a signal of frequency f is impressed on them. The current in the stiff circuit will take a longer time to reach its final value than in the other circuit but once this final current value has been reached in both circuit conditions are steady. If now an interfering signal of different frequency strikes both circuits, the stiffer circuit, that is, the one with more inductance, cannot adjust itself as readily to these new signals because of its inability to respond quickly to changes. The stiff circuit is therefore apt to select the desired signal better than the other circuit.

Another way of putting it is that with a large capacity and low inductance the damping of the circuit is greater. But damping is equivalent to resistance. Hence the circuit employing high capacity is more broadly tuned and therefore less selective. A very selective circuit would therefore have preponderant inductance rather than capacity.

There are other reasons for a large inductance rather than large capacity, which do not fall in with the subject matter here, but one of these might be mentioned. It is that a high inductance and low capacity means the developing of larger voltages across the coil, hence better detector response, since detector response is proportional to the square of the voltage applied.

The reasons given here for high inductance do not lead to the conclusion that the circuit should consist entirely of inductance and no capacity, as do many of the cheaper type of receivers. All inductance does not permit of the necessary fine tuning allowed by the condenser, and if inductance is made too large its resistance rise may all but spoil the effect of increase in the stiffness of the

Continued on page 66

The Effect of Poor Insulation and Leakage

By A. Reisner

With the knowledge of against what losses to guard, as here given, the transmitting amateur can do much to increase the range of his set. A minimum of energy loss means a maximum of radiation.

THE output of the average amateur transmitter is relatively low. He must therefore make every watt count effectively. The only way he can do this is to guard against every possible source of energy loss. One of the most prolific sources of loss arises from poor and defective insulation and leakage between different parts of the circuit. In order to appreciate the importance of this the amateur must realize that poor insulation or leakage are equivalent to the introduction of absorbing and wasteful resistance in the circuit. The following simple analysis of the problem will shed considerable light on the subject.

In order to center the problem on some specific part of the circuit we will consider the case of leakage across a condenser as in Fig. 1. The shunt resistance R represents the leakage path

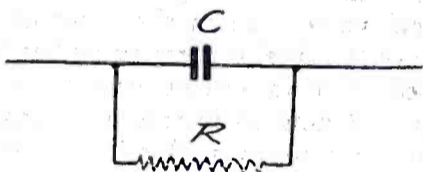

Fig. 1. Representation of Shunt Leakage Resistance

across the condenser which may be due to an imperfect dielectric or to defective insulation between the condenser terminals. Let C be the capacity of the condenser, E the radio frequency voltage across the condenser, I the radio frequency current through the condenser. If the dielectric of the condenser were a perfect insulator, and the condenser terminals were perfectly and completely insulated from one another, there would be no loss due to leakage. However, since such perfect insulation is generally not obtained, there always is some leakage. The loss of energy due to this leakage is generally represented as taking place in a resistance R as in Fig. 1.

The power lost due to leakage in the shunt resistance R is equal to E^2/R . The voltage E across the condenser is, however, given by the ratio $I/\omega C$. Substituting this expression for E in the power loss, we have

$$\text{Power loss} = \frac{E^2}{R} = \frac{\left(\frac{I}{\omega C}\right)^2}{R} = \frac{I^2}{R\omega^2 C^2}$$

This equation gives us the energy loss in a shunt resistance which represents the leakage. In practical work and calculations it is preferable to represent the loss as occurring in a series resistance, as in Fig. 2. The advantage here is that

we are enabled to determine how much the resistance of the circuit has increased due to leakage or faulty insulation. Let us represent this series resistance which gives the same loss of energy as the shunt leakage resistance by r . Then since I is the current through the condenser, it must also be the current through the resistance series r . The loss of power, therefore, in the series resistance is given by $I^2 r$. But this loss of power is the same as the loss of power in the shunt resistance. Equating these two values of power loss we have

$$I^2 r = I^2 / R \omega^2 C^2$$

Therefore

$$r = \frac{1}{R \omega^2 C^2} \quad (1)$$

We thus see that a shunt leakage resistance R has a corresponding series re-



Fig. 2. Representation of Series Leakage Resistance

sistance r in which the power loss is equivalent to that in the shunt resistance due to leakage. The relationship between the series and shunt resistances is given in (1). This equation therefore shows that the greater the shunt leakage resistance the smaller the equivalent series resistance and vice versa. The equivalent series resistance decreases the output of the circuit since it simply absorbs the energy in it. Let us take some practical numerical examples to illustrate the significance of the above analysis.

Suppose we have an antenna whose capacity is 0.0003 microfarads and that we are operating at a wavelength of 600 meters, frequency therefore being 500,000 cycles per second. Let us assume that, due to poor insulation or poor construction, there is a leakage path from antenna to ground having a resistance of 1,000,000 ohms. If we substitute these values in equation (1) we will get

$$r = \frac{1}{10^6 \times 4\pi^2 \times 25 \times 10^{10} \times 9 \times 10^{-20}} \Bigg\}_{\text{approx.}} = 1.1$$

In other words, a leakage path of 1,000,000 ohms across the antenna is equivalent, in this case, to the insertion of a resistance of 1.1 ohms in series with the antenna. If the normal resistance

of the antenna is 6 ohms this leakage will therefore increase it to 7.1 ohms, an increase of about 15% in the resistance of the antenna, which means that the efficiency of the set has been decreased by about 15%. If, however, little care is exercised in the choice of insulation and construction of the set, the leakage may well be greater. Suppose the leakage is half the above, say 500,000 ohms. If the above calculation is now made it will be found that the equivalent series resistance is now 2.2 ohms, or the antenna resistance has been increased by 2.2 ohms, with consequent great decrease in efficiency.

The great importance of insulation and efficiency is forcibly brought out by the above figures. All possible causes for such leakage should be diligently guarded against. Poor insulators are one of the main causes. There is no advantage gained in the use of insulators whose only advantage is low price. Only material of known and proved insulating qualities should be used. Care should be taken that the insulator is known to be a good insulator at radio frequencies. For there are materials which are excellent insulators at audio frequencies but which are not so good at radio frequencies. Also guard against any material which is known to absorb moisture. One other point should be noted in this connection. It will be noted in equation (1) that the equivalent series resistance is inversely proportional to the capacity. Hence the lower the capacity the greater the increase in the series resistance. Now in insulators it is very desirable that the capacity be low, for then the dielectric losses in them will be less. Thus it is doubly important that the insulation be good and have negligible leakage, for if the condition of low capacity is complied with but the leakage is high there will be a great rise in series resistance due to this low capacity.

Another factor tending to increase leakage is sloppy construction. Leakage does not necessarily have to take place from the antenna to the ground, or across the terminals of a condenser. Leakage may occur between any two points in a set if there is a difference of potential between them, and if the resistance of the path is low. Leakage paths are usually provided by poor soldering jobs and the smearing of solder paste over the set. When the hot iron is applied to a post which has been daubed with the soldering flux, the flux

Continued on page 72

An Exceptional Single Circuit Non-Regenerative Tube Set

By Jesse Marsten

This is essentially a home-made set. All details of construction are so fully and clearly presented that any boy novice should have no trouble in making it. It is designed solely for broadcast reception.

THE remarkable results obtained with this single circuit tuner are largely due to restricting the wavelength range to the broadcast band through the use of a specially constructed inductance coil designed to minimize losses. The circuit is the conventional one shown in Fig. 1, employing a fixed inductance and a variable condenser in series with the antenna, the coil being connected to ground. The voltage for the grid is taken off the terminals of the inductance coil. Inasmuch as the tube detector is a voltage-operated device and will therefore give better signals the greater the signal voltage applied to the grid, it is preferable to take the voltage from the coil terminals rather than from

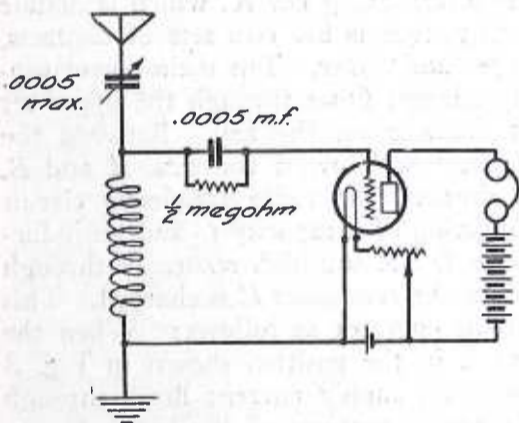
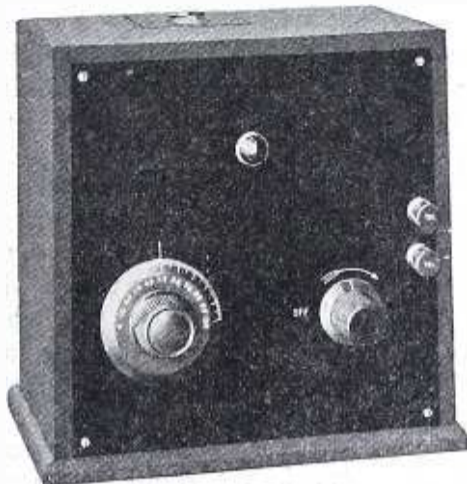

Fig. 1. Circuit Diagram

the condenser. For in the resonance condition of the circuit the high frequency voltage across the inductance is equal to the combined voltages across the series condenser and the antenna capacity. Maximum voltage is thus obtained across the coil rather than across either of the capacities.

The actual proportioning of the condenser and inductance values was based on practical experimental results obtained on a number of average broadcast antennas working on the broadcasting wavelengths. These antennas ranged between 70 and 100 ft. long, about 40 ft. high, all of them being single-wire antennas. It will thus be seen that the receiver is essentially a broadcast receiver. The constructional details of the receiver parts follow.

The inductance coil is fixed in value and has 45 turns of No. 28 enamel wire wound on a 3-in. fibre tube, having a 1/16-in. wall. The coil is wound in a single layer and the ends held in position by drawing the wire through two small holes, No. 56 drill will do, drilled at each side of the winding as shown in Fig. 2. The wire should be held in



The Completed Set

place by the use of a thin layer of shellac. The ends of the coil winding are thoroughly scraped and tinned and then soldered to the posts A and B in Fig. 2. One of these posts, A, is used for mounting the grid leak and condenser as seen in the same drawing. This post A is the common connection between inductance coil and grid leak. The grid condenser should be a 0.0005 microfarads capacity and grid leak should be 1/2 megohm. Any of the standard combination paraffined paper grid condensers and leaks may be employed.

The antenna series condenser should have a capacity of 0.0005 microfarads maximum. Any of the standard 23-plate condensers may be used for this purpose, care being taken that the con-

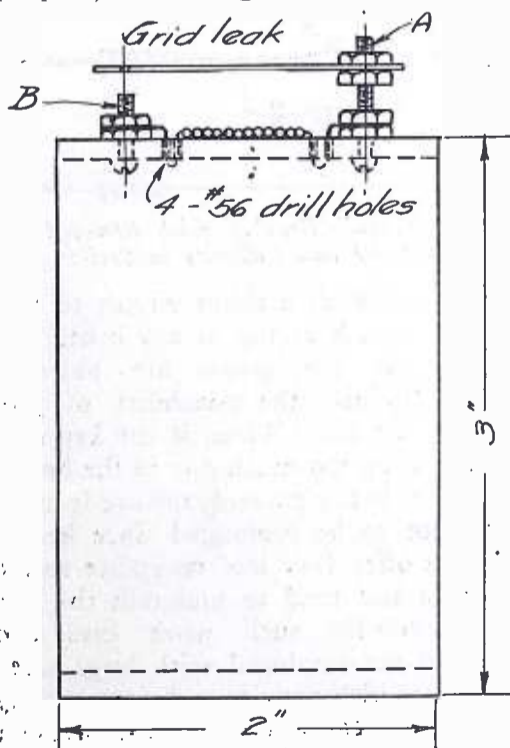

Fig. 2. Inductance Coil with Grid Leak and Condenser Mounting

denser is well built, rugged, that it does not have a jumpy movement, and that it is well insulated. The panel is drilled for the condenser in the usual way and the condenser mounted on it.

The filament rheostat is the standard 6-ohm rheostat having a moulded knob

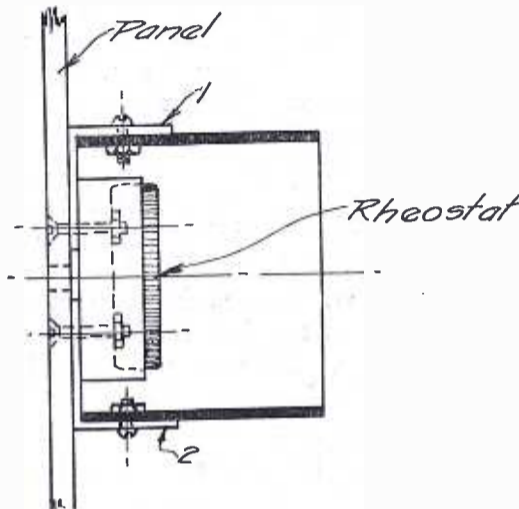

Fig. 3. Panel Mounting of Inductance Coil and Rheostat

with whitened indicator groove in the knob for noting the setting of the rheostat. In order to save space and avoid any extra drilling the rheostat and coil were mounted on the panel as a single unit, as shown in Fig. 3. Two pieces of angle brass 1 and 2, details of which are given in Fig. 4, are secured to the sides of the coil by means of two 6/32 R.H. screws and nuts as shown. The rheostat is then placed inside the coil

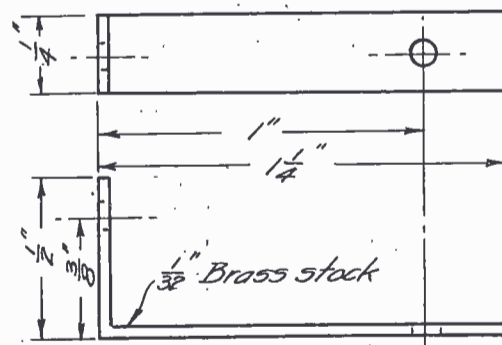

Fig. 4. Angle Bracket for Rheostat Mounting, 1/32in. Brass Stock

tube and the front end of the rheostat base, which is flat, is brought flush up against the other legs of the angle brass brackets in the manner shown in the sketch. The panel and angle brass are drilled so that the holes correspond with those in the rheostat and flat head 6/32 screws with nuts are used to fasten this combination to the panel. The rheostat is then seen to be inside the coil tube and takes no extra space. It is thus seen

Continued on page 86

An Interesting Application of Radio Circuits

By L. R. Felder

In accordance with our policy of showing the application of radio principles to non-radio uses this account of a d.c. circuit breaker is published. It is of interest as illustrating the fact that the radio engineering of today is the electrical engineering of tomorrow.

THE principles of radio are being more and more utilized in other industries and fields of endeavor. Witness, for example, the growth of multiplex wire telegraphy and telephony due to an application of radio principles, and the development of smelting furnaces which are heated by high frequency electric current. One of the interesting applications of radio circuits is that of interrupting heavy currents without the formation of injurious arcing at the key or switch contacts. This problem is of general interest in electrical and radio work, as in high power radio station work, for example, where the currents interrupted by the sending key are quite large. The opening of the key breaks the current, which then has a tendency to jump across the key contacts in the form of an arc. This arc, unless the key is enclosed, is dangerous for the operator, ruins the key contacts, and often results in setting up transient voltages which may burn out apparatus in the line. It is therefore essential that this arc be nipped in the bud, and here is where radio again comes to the rescue.

The principle underlying this particular application is the use of condenser circuits shunting the key contacts. Consider Fig. 1 in which we have the power

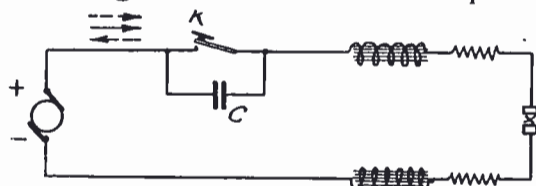

Fig. 1. Circuit Breaker with Condenser Shunt

line including the interrupting key K . The key is shunted by a condenser C . Experiment shows that when the circuit is broken and an arc is formed at the key contacts this arc is of the same nature as the Poulsen arc used for the generation of continuous wave oscillations, and that *radio frequency oscillations are set up in the condenser circuit shunting the key contacts*. These radio frequency currents oscillate at a frequency determined by the capacity of condenser C and the inductance in the condenser circuit which, in the case of Fig. 1, is the inductance of the connecting leads only. Now this radio frequency current which results from the formation of the arc at the key contacts flows through the condenser *and the arc*. We thus have two currents flowing through the arc at the key contacts: (1) the main supply current due to the generator, which current flows through the arc in one direction only as shown by the arrow in full line, and (2) the radio frequency

current due to the arcing which flows in alternate directions through the arc as shown by the dotted arrows. It will be clear that when the radio frequency current flows in the opposite direction to that of the main supply current these two currents will oppose each other in the arc, and if the radio frequency current amplitude is greater or equal to the direct current through the arc at the key contacts then the arc will be extinguished. Experiment proves this is what takes place, but of course the whole business is almost instantaneous and takes much less time to complete itself that it does to explain it.

In order that the radio frequency current generated in the condenser circuit by the arc be as great as the main d.c. supply current, or greater—which condition is necessary for extinguishing the arc—it is found important to use rather large condensers, between 0.1 and 0.5 microfarads being practical values. Further, inasmuch as the discharge current of the condenser is a radio frequency current whose period is determined by the capacity and inductance of the circuit it is found advisable to use a lumped inductance in the form of a coil, in series with the condenser to give the circuit a more advantageous frequency than could be obtained purely by the use of the inductance inherent in the connecting leads. By using such an inductance, which may be variable, the frequency of discharge may be controlled and varied so that best results are obtained. This circuit is shown in Fig. 2.

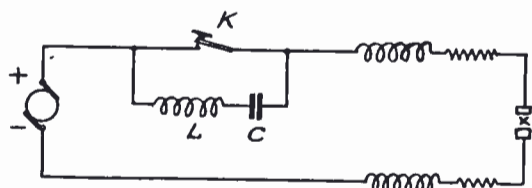

Fig. 2. Circuit Breaker with Shunted Inductance and Capacity in Series

In using such a shunt circuit to prevent too much arcing at key contacts a number of precautions are observed which diminish the possibility of prolonging the arc. Thus, if the key contacts heat up too much due to the breaking of the heavy current, the arc is much more apt to be prolonged since heated contacts offer very low resistance to arc currents and tend to maintain the arc. Therefore for such work keys and switches are employed with large sized contacts which provide sufficient cooling surface to carry the current without undue heating. Mica condensers have been found to be the best for the purpose here mentioned. Some improvement has

been noted in extinguishing the arc if the interrupting key or switch is placed in a hydrogen atmosphere, exactly as in the case of the Poulsen arc.

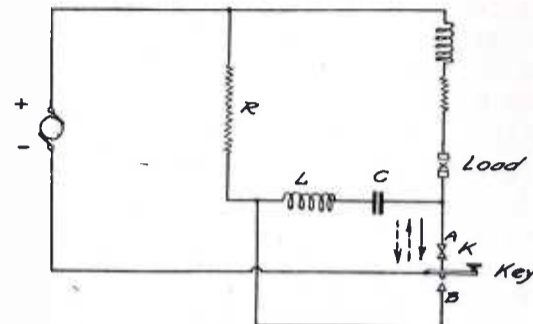

Fig. 3. Special Interrupting Circuit

Fig. 3 shows a special interrupting circuit which has been found to be very efficient. In this circuit we have the d.c. generator supplying the power through the interrupting key K , which is double acting, that is has two sets of contacts, upper and lower. The main power supply current flows through the upper set of contacts on the key. Between the topmost and lowest contacts, A and B , is shunted the radio frequency circuit consisting of a capacity C and an inductance L . R is a high resistance through which the condenser C is charged. This circuit operates as follows: When the key is in the position shown in Fig. 3 the main supply current flows through the upper contacts of the key. At the same time, however, the condenser C is being charged to the full line voltage through the high resistance R . When it is desired to break the current through the circuit for one reason or another, the key is very quickly thrown downward so that the lower key contacts now make contact. When the upper contacts are thus broken an arc immediately forms at these contacts due to the rush of the main direct current through them. At the same time, when the lower contacts on the key are made, the condenser C , which has previously been charged to the full line voltage, begins to discharge through the circuit C, L , the lower key contacts and arc, this discharge taking place at the frequency which is determined by the values of capacity and inductance. We then have again two currents through the arc, the main supply current shown by the full line arrow, flowing in one direction, and the radio frequency discharge current shown by the dotted arrows, flowing in alternate directions. When these two are opposed the arc current drops to zero and is extinguished, which takes about the time of one-quarter of a cycle. This application is used for the interruption of direct currents only.

QUERIES & REPLIES

ON C.W. PRACTICE

BY
Gerald M. Best
TECHNICAL ADVISOR



Questions submitted for answer in this department should be typewritten or in ink, written on one side of the paper. All answers of general interest will be published. Readers are invited to use this service without charge, except that 25c per question should be forwarded when personal answer by mail is wanted.

Please publish the circuit shown on page 30 of March RADIO, with two stages of audio frequency amplification. —W. P. M., Waco, Texas.

This circuit is shown in Fig. 1, the tubes being of the storage battery type.

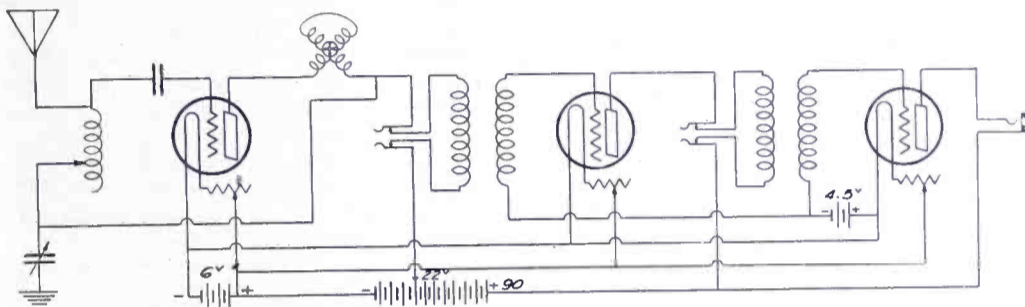

Fig. 1

Before the DeForest vacuum tube was invented, what was used for long distance reception to amplify the signals of the coherer detector?—W. A. W., Los Angeles, Calif.

So far as is known, no form of amplifier adapted for use in wireless telegraph existed previous to the vacuum tube. Various types of mechanical amplifiers were being developed about the time the vacuum tube was first discovered, but none had been used in connection with commercial radio development.

Kindly publish a table of the proper honeycomb coils for use with the standard 3-coil circuit.—W. G. M., Calgary, Canada.

This table is shown below. The coils mentioned in the table are with the assumption that you will use .001 microfarad condensers across the primary and secondary coils, and that your detector tube is a good one, capable of oscillating freely.

Wavelength Range	Primary	Secondary	Tickler
150-390	20	25	25
350-800	35	50	35
500-1500	75	100	75
1400-3750	200	250	200
3500-11000	600	750	400
10000-25000	1250	1500	750

Is "Magnet Transoil" necessary for oil cooling a 5-watter to get 50 watts, as explained in the June issue of RADIO, page 34, or could any good grade of oil be used? Would not the heat developed by continuous operation at say 1500 volts be liable to crack the oil-cooled glass of the seal? If not, will this cooling prevent

the blackening of the glass around the sealer wires, which results in the ultimate destruction of the tube? — J. L. P., Andover, Mass.

It is not necessary to use one particular brand of transformer oil for such a

purpose, and any good heavy oil will probably do the work. Any tube that is operated at such a tremendous overload cannot last for a great length of time in continuous operation, as the greatly increased plate current will eventually wear away the filament, and the tube will fail due to ruptured filament. I doubt very much if the cooling by oil will prevent the blackening you mention.

Why has there been a decided decrease in signal strength of all broadcasting stations on the same sets used prior to the change of wavelength on May 15th? —O. A. Due, Vallejo, Calif.

So far as I can determine, there has been no decrease in the number of letters the various broadcasting stations have been receiving from distant points, although I would expect such a decrease during the summer months, due to static, and the fact that not so many listen-in during vacation time. I would suspect that one of your tubes was losing its filament activity, and perhaps your "B" battery is running down.

Please publish a hook-up of a Navy loose coupler with detector tube only. Also publish diagram of a transformer coil, showing individual parts and their function. What size wire is used for the primary and secondary?—R. M. I., Outlook, Wash.

The circuit you requested is shown in Fig. 2. It is not quite clear what you mean by a transformer coil. Do you refer to inter-tube amplifying transform-

ers, power transformers for transmitting, or radio frequency transformers?

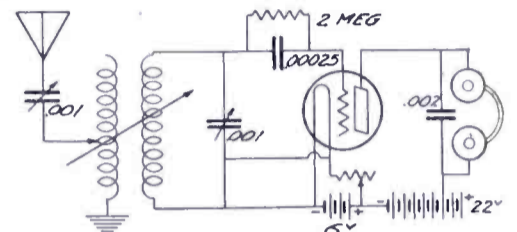

Fig. 2

Can a 1½-volt dry cell tube be used to advantage in the "DX Bringer-In" circuit shown on page 13 of May RADIO? —G. H. F., Portage, Mich.

A dry cell tube will work very well in this set, and of course will be more economical in filament consumption. It will necessitate a special socket, however, to fit the peanut tube, or an adaptor for the standard socket.

I have a Radio Corporation radio frequency transformer, and would like to use this transformer in a three-stage radio frequency amplifier, in conjunction with an ERLA and a Rauland radio frequency transformer. Will this be satisfactory, or should I have all three transformers of the same make?—C. M. E., Athena, Ore.

It is against the policy of this department to recommend specific pieces of apparatus, but you should be able to get the combination you mention above, to work satisfactorily, without having to buy two more transformers to make three alike.

Can buzzer modulation be obtained by loop absorption by connecting the buzzer to the loop?—R. E. M. S., San Francisco, Calif.

Yes, this is quite practicable, and many amateurs are using this scheme for a one-tube radiophone, although this method is not as efficient as a set using Heising modulation.

Please publish a circuit for two stages of radio frequency amplification, detector and two stages of audio frequency amplification, using two circuit jacks, and variometers in plate circuits.—O. J. S., San Mateo, Calif.

This circuit is shown in Fig. 3.

Referring to E. M. Sargent's article on page 33 of June RADIO—(a) Can soft

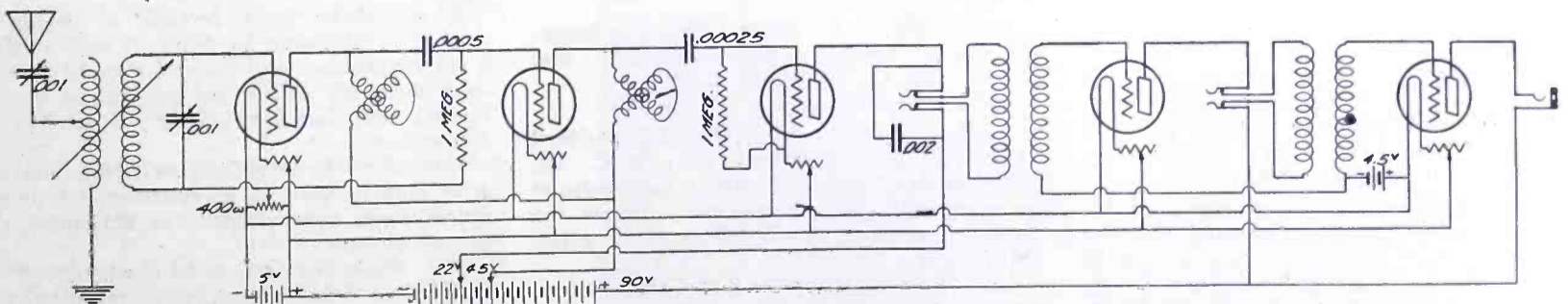

Fig. 3

iron strips be used as the transformer core? (b) Give number of layers and turns on 10-volt secondary; (c) number of turns on 375-volt secondary to increase voltage to 500 volts; (d) will this transformer take care of two 5-watt tubes?—R. B. H., San Francisco, Calif.

(a) Since the author specifies transformer iron, it is to be presumed that it is ordinary soft iron, and not silicon steel. (b) 21 turns No. 14 D.C.C. wire. 10 turns per layer, tap at 11th turn. (c) 952 turns. (d) Yes.

Please publish a circuit using a variocoupler, variable condenser, fixed condenser, 2 honeycombs for coupling and a crystal detector. Will this set give results on local reception?—M. S., San Francisco, Calif.

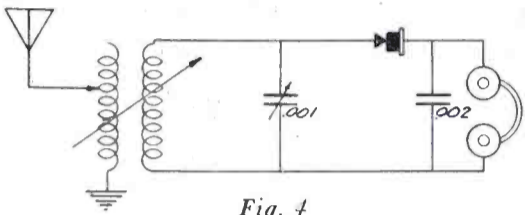

Fig. 4

The circuit you wish is shown in Fig. 4. If you have a variocoupler, the two honeycomb coils will not be needed. You should have no difficulty in hearing the local stations with this set.

It is desired to use transformer coupling between two 5-watt speech amplifiers and two 50-watt modulators in a radiophone circuit using Heising modulation. Please give specification for a transformer suitable for this purpose. Who manufactures transformers suitable for such purposes?—L. F., Roswell, N. M.

The only firm who has made use of transformer coupling in such a circuit is the Western Electric Co., and it is my understanding that such transformers are not for sale except as integral parts of a complete transmitting station. I would hardly attempt to build such a transformer unless it was designed by a voice frequency transformer expert who was thoroughly familiar with the circuit in which it would be used. It would be far better for you to try impedance coupling between your speech amplifiers and the modulator tubes, and at any rate you

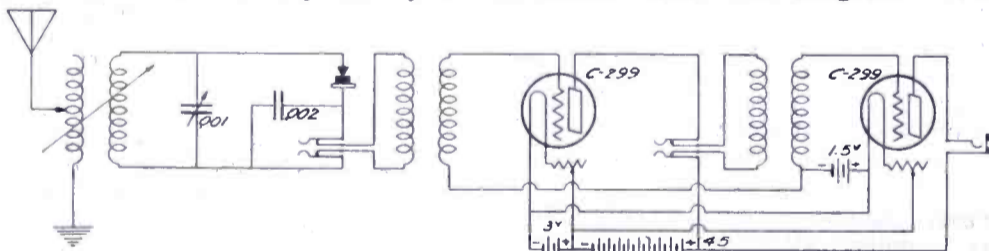

Fig. 5

would probably obtain a better low frequency characteristic by using impedance coupling rather than a transformer.

Can you give me the constructional data of the transformers used in the Western Electric 10-A Loud Speaking Outfit? What is the size of the condenser No. D-44386, used in this amplifier?—K. M. B., Waitsburg, Wash.

I regret that constructional data on these transformers are not available. The transformers are integral parts of the 7-A amplifier, and are not sold separately. It would be very difficult for you to try to make duplicates without accurate measuring apparatus.

I have a 50-cycle homecharger. I intend to move to a city having 60-cycle current. Can I use this charger on 60 cycles? Is the enclosed hook-up O. K. for a 5-watt spark coil set?—K. B., Santa Barbara, Calif.

If your homecharger was designed for 50 cycles, as it should have been to work efficiently, it will have to be re-adjusted for the new frequency, as the vibrating reed is tuned to 50 cycles, and will not change the polarity of the A. C. supply if it is not in tune with the incoming frequency. Your hook-up is O. K.

I notice when using a low-powered radiophone set that the plates get red hot, and have been wondering if this is usual. Even disconnecting the plate battery the plates still get hot. Why is this?—Sparks, Apia, Samoa.

If the set is not in tune, even a low-powered radiophone set will develop considerable heat. If the plates do not heat beyond a cherry red, you will have no trouble. I cannot understand how they can get hot with no plate battery in the circuit.

Please advise why I cannot obtain any more signal strength with my three-stage radio frequency amplifier than with the detector alone?—S. Y., Ione, Calif.

The trouble appears to be in the fact that your leads are too long, and you have no shielding between the various stages. Each stage should at least have the transformer shielded, and the wiring should be as short as possible. Fig. 7 on page 36 of July RADIO gives a good circuit for three stages of radio frequency amplification, so you might check your own circuit over for incorrect wiring, etc.

Please publish a circuit using one stage of radio frequency amplification, for both short and long wavelengths, using variometers for the short waves, and honeycomb coils for the long waves.—E. B. B., Fresno, Calif.

It would be difficult to obtain satisfaction with a radio frequency amplifier where it was desired to receive on both short and long waves. It would necessitate either two radio frequency transformers or resistance coupling in the radio frequency amplifier, which is not a very satisfactory method. If you wish diagrams for two separate amplifiers, I will be glad to give them to you.

Would like to know if a set hooked up as shown in Fig. 2, page 37, May RADIO, could hear concerts in San Francisco from Los Angeles. Would

like to have a circuit using a Dayton variocoupler, condenser, crystal detector and audio frequency amplifiers.—B. L., Newhall, Calif.

The circuit you refer to should easily be able to pick up concerts over a range of 500 miles or more at night. The circuit employing the crystal detector is shown in Fig. 5.

Please give me a crystal detector hook-up, using variocoupler, condenser, and phones.—J. C., Richfield, Calif.

This circuit is shown in Fig. 4.

In the article in June RADIO entitled "Converting a Receiver into a C. W. Transmitter," could I put a microphone in my single-circuit receiver? How far would it transmit?—W. C., Los Angeles, Calif.

The best place to locate the microphone would be in the antenna circuit. You could hardly expect to transmit

more than a few blocks with the receiving set which you now have.

Can I use a loop modulator in a spark coil C. W. Set, such as is shown in Fig. 2, page 35, July RADIO?—W. B., Bakersfield, Calif.

No, on account of the alternating current plate supply, which would be too unsteady for radiotelephony.

SHARP TUNING WITH SINGLE CIRCUIT

By DR. A. E. BANKS, 6ZB

Notwithstanding the fact that the employment of radio frequency insures that sharp tuning and increased distance so pleasing to the concert listener, one finds that the single circuit regenerative sets are still in the majority. The reason is twofold, first they are inexpensive, and again they are simple to operate. Many and long are the wails from owners of single circuits when it comes to eliminating interference however.

Months ago Dr. Austin pointed out that by certain simple arrangements of a single circuit it was possible to enjoy much better performance than with the plain circuit. This article will give the results of experience with the Austin modification, and both for amateur short waves and concert bands the addition seems well worth while.

In the first place a small condenser (fixed) is placed in series with the antenna, .00025 micadon seemed best to us. The variable

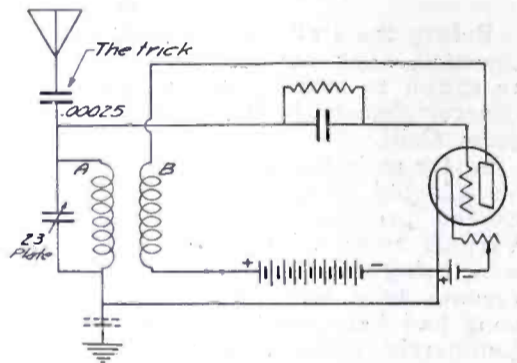

Modified Single Circuit Tuner

A=64 turns No. 18 D.C.C. on 2 3/4 in. tube.
B=50 turns No. 32 D.C.C. on 2 3/4 in. tube.
Arranged as variocoupler.

condenser is then *shunted* around the tuning coil. It was not found necessary to employ a series ground condenser as recommended by Austin.

6IZ of Coronado designed an inductance which covers both amateur and concert frequencies, and the following circuit shows all details. With the set made up as per diagram, one finds tuning very sharp, much superior to the regular single circuit affair, indeed a vernier is almost indispensable. Audibility is as good as, or better than the plain circuit, and control of regeneration is perfect. Even our own pet local BROADCAST station was eliminated from the fones when at Coronado, a feat for any tuner!

It will be noted that the inductances recommended do away with any necessity for taps, making for a real SINGLE CONTROL so dear to both the C.W. fiend and concert hound.

It would be quite feasible to design a method of plugging in different coils so that a wide variation of frequencies could be had in a moment. With the inductances shown the set will function perfectly from 150 to 800 meters.

Instead of the micadons, twisted enamelled wire may be used as a condenser, but it requires some experimenting to determine the correct amount.

Any single circuit may be changed over to the Austin arrangement in 15 minutes, and the results should more than repay the experimenter.

NEWS OF THE BROADCASTERS

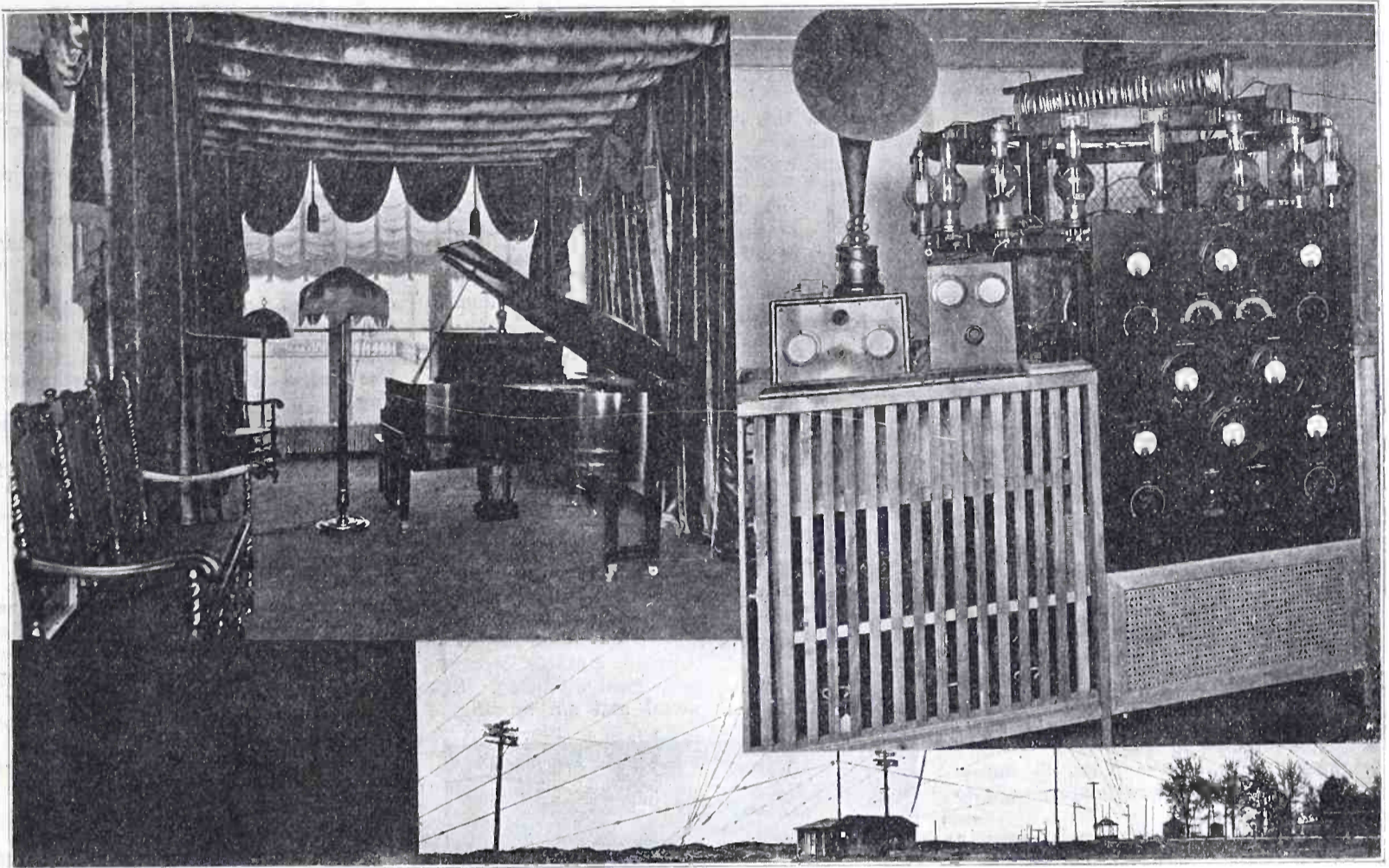

Radio Station WJAZ, Showing Antenna System, Transmitter and Crystal Studio

WJAZ TO REACH THE ARCTIC

WJAZ, the new Zenith-Edgewater Beach Hotel broadcast station at Chicago, in addition to supplying a high grade musical program for the radio-listeners on both the Atlantic and Pacific coasts, is to be used to communicate with Dr. Donald B. McMillan during his trip to the North Pole. On its opening night, while using but one-third of its 10 k.w. power, the station was reported from both coasts. Full power will be used in communicating with Dr. McMillan, whose ship is equipped with a 500-watt transmitter and Zenith receiving set.

A unique feature of WJAZ is the crystal studio which is surrounded with plate glass partitions. By this means the audience in the hotel dining rooms, terrace and beach promenade may see the artists and hear them by means of a small receiving set, as the glass is sound proof. The room has no echo, the walls and ceiling being hung with heavy red velour and the floor carpeted in deep blue.

The generators and the antenna are located 300 yards north of the studio on the lake shore, with no steel buildings on any side. The steel towers extend 175 feet into the air. The antenna is of the fan type with cage lead-in. An entirely new system of modulation is used, there being no need for the artists to be close to the microphones, the volume being controlled entirely by the operator in the triangular glass operating room.

The program is entirely a musical entertainment, starting at 10:00 P. M., Chicago Daylight Saving Time, and running until 2:00 A. M. on Tuesdays, Wednesdays, Thursdays, Fridays and Saturdays, 5:00 to 8:00 P. M. Chicago Daylight Savings Time, on Sundays. The highest class of classical music with excellent artists from the Crystal

Continued on page 44

RADIO STATION KFAE

One of the most interesting Class B stations in the Pacific Northwest is that operated by the State College of Washington, at Pullman, on the eastern border of Washington. This station was assembled and designed by the electrical engineering department of the college, under the direction of Dean H. V. Carpenter, and represents an attainment in scientific design and appearance which is not often seen in the average Class B station, and yet did not cost the state a cent, due to the generosity of friends of the college.

The transmitter is located in the basement of the four-story Mechanic Arts Building, and a studio equipped with a large variety of musical instruments is in an adjoining room. The transmitter consists of one 250

watt oscillator, and two 250 watt modulators, with a three stage speech amplifier to magnify the output of the microphone in the studio. The oscillation circuit is a transformer with tuned primary very loosely coupled to the antenna circuit, with a resulting sharp wave and minimum interference with other stations.

The antenna is 70 ft. above the roof of the building, and consists of a six wire flat top with steel towers at each end. The fact that the college is located on the top of a hill places the station in a commanding position, enabling it to cover a much larger area than is ordinarily possible.

The purpose of the station is to provide high class entertainment and educational features for the territory, and this was made possible by the generosity and public spirit of friends and students of the State College.

The operating schedule at present is Monday, Wednesday and Friday evenings from 7 to 8 p. m., and the service will be increased as rapidly as conditions will permit.

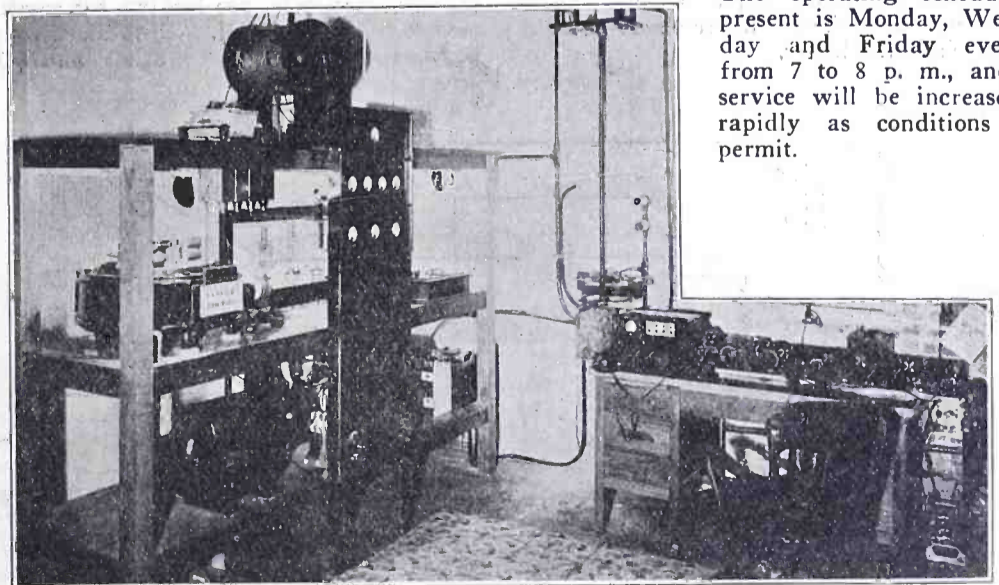

Radio Station KFAE, Pullman

*Later call changed to KWSE.
W.L.G. operator 1930-31.
James + Les Hatfield } also ops.
Ben Neikinko*

LETTERS TO THE EDITOR

A Good Hook-Up

Sir: As I have not yet seen in RADIO the hook-up that I am using, I am sending it in for the information of your readers. Although a single circuit, it tunes extremely sharp and oscillates well. With it I have received many d.x. amateurs and broadcasters. The local stations come in loud enough to operate a loud speaker on one tube.

L_1 consists of 40 turns of No. 22 D.C.C. wound on a 3½-in. tube. This coil is tapped at the center for the filament lead, which is

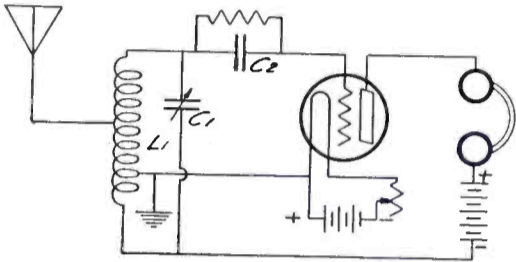

A Good Single Circuit Hook-up.

grounded. The plate half of the coil is tapped every four turns for the aerial.

C_1 is a .0005 mfd. variable condenser for tuning. C_2 is the usual grid condenser and leak. The B battery is to be varied to suit the individual tube.

Using this circuit and a 5-watt transmitter tube with 90 volts on the plate, the music from the local stations was loud enough to operate a loudspeaker.

This circuit is easy to tune and brings in C. W. well.

27 Spruce St.,
Bloomfield, N. J.

A. J. WYKES,
B.R.C.

Sir: The accompanying hook-up has been called to my attention as being a circuit which is extremely selective, sensitive, easy to operate and one not troubled by body capacity effects.

Following are specifications of the parts to be used in the circuit:

A and B are variocouplers of any standard make.

C , D and E are variable condensers of .0005 mfd. capacity.

Condenser E may have a vernier or a small vernier condenser, F , may be shunted around it.

G is an .00025 mfd. grid condenser.

H is a 2 meg. grid leak.

It should be noted that one side of each of the variable condensers is grounded and this should be the rotating member.

The secondary I of the variocoupler A must be connected correctly to get best results and connections should be reversed to find out which is the better.

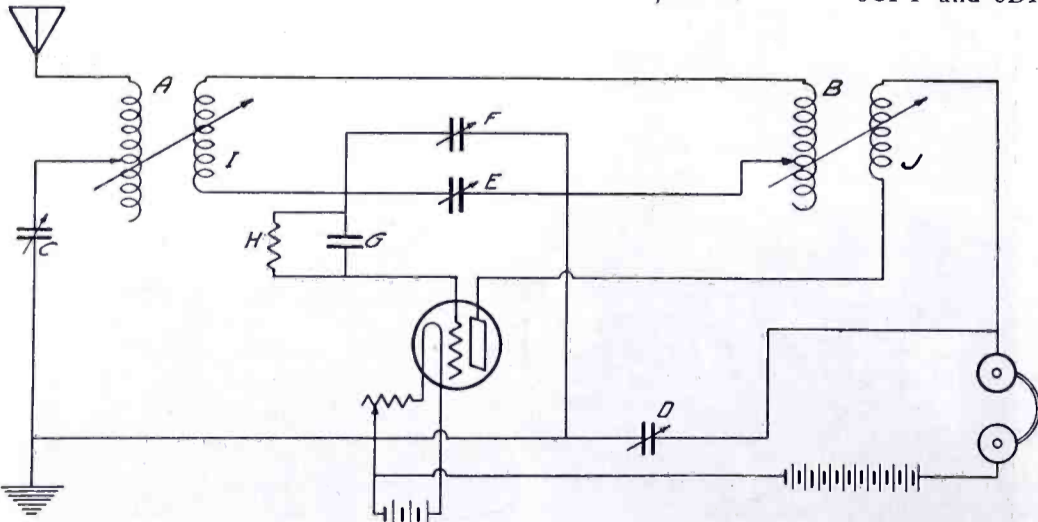

Hook-up Submitted by H. A. Eveleth

The tickler J must also be connected right to get regeneration.

The condenser D gives a vernier adjustment on the regeneration and permits very fine tuning.

I believe this circuit will be of interest to your readers.

San Francisco, Calif. H. A. EVELETH.

A Tree Ground

Sir: Your June cover suggests something that may be of interest to those who go camping and wish to "make this a radio summer." That is a ground connection. Pipes or rods are spoken of by some magazines. Forget them. The car will make a fair counterpoise, but if you are camping near a tree of any kind, cut a notch into the inner bark and drive the wire down alongside next to the wood, or use a spike the same way. I have yet to have it fail to work fine.

Very truly yours,
Yakima, Wash. C. L. TICE.

Still Another Good Circuit

Sir: Well here's another lil contribution to our friend ed. of RADIO. It is the berries here om. But can't say it works in all places and locations. But it sure works at 8DKC om. Single control for all amateur work and very selective. Very good oscillator. I cut the diagram in metal and am sending

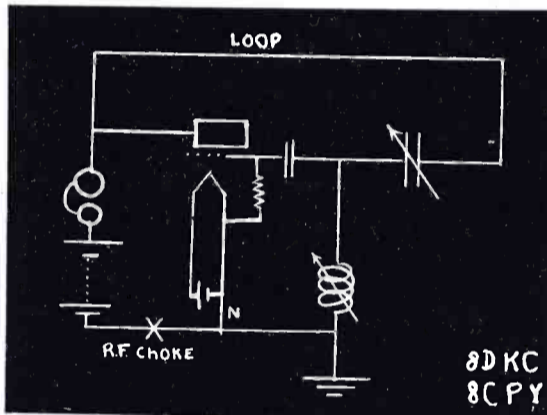

Experimental Circuit No. 24 at 8DKC and 8CPY.

Loop=Single No. 14 copper wire 50 ft. long and 30 ft. high. R. F. Choke=275 turns No. 28 SCC on 1 7/8 tube. Vari-Cond.=.0005 max. Vari-Coil=fm 15 to 50 turn 3-in. dia. No. 18 SCC. vari. at 1 turn. Grid Cond.=Per experiment. Grid Leak=Per experiment.

on so as to print direct from it. Dope on this set would vary to suit the location very much. Figures given are for 8DKC location amongst a young forest of trees. Hope this may be of interest to some of the bunch of experimenters who are looking for something new to play with. Hi. JAS. A. WITSON,
Kalamazoo, Mich. 8CPY and 8DKC.

Radio Inconsistencies

Sir: After spending a day reading two years or so of back numbers of various radio publications, the reader will become impressed or depressed at the multiplicity of ways in which a thing can and cannot be done.

Perhaps the wiring of a set is subject to the greatest variety of rules, as:

Always make neat, square corners.

Never bend the wire at right angles; always get from place to place with minimum of wire.

Cover all wiring with spaghetti.

Never use spaghetti on account of capacity effects.

Use tinned wire because of ease in soldering.

Never use tinned wire because of resistance of its "skin."

Greatest efficiency will be obtained from the use of litz.

It is practically impossible to get results from litz because of the difficulty of connecting all the strands.

Use acid in soldering all connections.

Use rosin in soldering all connections.

It is advisable not to use rosin in soldering as it is an excellent insulator and may separate the connection instead of joining it. Never solder any connections, as solder has an extremely high resistance when compared with copper wire.

Copper ribbon is far superior to wire in conductivity.

Best results will be had by using not larger than No. 20 D.C.C.

These are but a few of the things to be remembered when wiring a set:

Lighting the filament of your tube is a step not to be taken lightly because of the following phenomena—

Always light the filament to full brilliancy at once and avoid crystallization of same.

Unless you have free scope with the family bank roll do not ever turn on the filament suddenly, as this places a strain on it comparable to the injection of 290 lbs. of air pressure into a three-year-old Ford tire.

A study of aerial authorities reveals two outstanding features, namely: The short aerial is best. The long aerial is best.

In selecting a panel we have the choice of glass first because of its high dielectric and the ease with which it may be worked (?!?).

One writer assures us that the difficulties involved are not more serious than will be encountered in boring a similar number of holes in an equivalent thickness of Tillamook cheese.

Another does not recommend the attempt unless undertaken in a spirit of great optimism or under the supervision of two or more keepers.

Secondly, all conditions being normal, hard rubber offers many inducements and drawbacks.

If drilled wrong at first it may be melted and recast in its original form or it may be, at user's option, moulded into a variometer or length of tubing.

If left in the sun, the dials may perhaps assume a form that will permit of their use as end plates for a 45° variocoupler rotor. Its insulating qualities are unquestioned.

As a third example of panel practice we now have aluminum sponsored by a large and well known firm.

This will open up fields that have hitherto been passed by unnoticed. It will now be in order for writers to prime their pens and dive into the relative merits of zinc, copper, gold, silver, bronze or boiler iron as applied to their new use.

While discussing panels, it is well to remember the following tips:

Continued on page 78

Mott's Signals Heard in Australia

Since the initial report in June RADIO that 6XAD, operated by Major Lawrence Mott on Catalina Island, Calif., had been heard in Australia, complete confirmatory letters and pictures have been received. The signals were heard in both Australia and New Zealand when the transmitter was radiating 3.8 amperes from the 100-watt set employing two 50-watt Western Electric tubes. This constitutes a new world's record for low-power transmission, approximately 7000 miles, and congratulations are due not only to Major Mott but also to Messrs. Maclurcan, Spachman, Pike, Reed and Cooke, the Australian and New Zealand amateurs who heard the signals.

RADIO IN AUSTRALIA

By L. A. LANE

Conditions in Australia would suit those experimenters who look upon broadcasting as a kid's pastime, there being no broadcasting. Experimental licenses are granted, both transmitting and receiving, or receiving only, whichever the applicant applies and qualifies for. Every receiving station must have a license, and at present licenses are only granted to experimenters, there being no regulations under which a license can be granted for broadcast reception.

Transmitting is permitted under fairly favorable circumstances, experimenters being allowed a maximum of 25 watts and up to 440 meters. There are several experimental

differences among the various firms interested, the government of Australia called a conference of those concerned to arrange regulations and conditions under which broadcasting would be carried out. Great things are expected of this conference, but so far their report has not been published.

Receiving sets being licensed, regulations are in force controlling the circuits used. The so-called "single" and "two-circuit" regenerative receivers are prohibited, this being done to cut down receiver radiation, which has proved so troublesome in the United States.

Australia is a country of approximately the same area as the United States and has a population of about seven millions. So there are large areas sparsely populated and Radio is the only answer to many of the problems of communication; and the dissemination of information demands broadcasting.

MILWAUKEE RADIO AMATEURS' CLUB

Much interest in the Zenith receptor has been aroused among members of the Milwaukee Radio Amateurs' Club, Inc.; several have built models according to specifications recently given before a club meeting by R. H. G. Mathews, 9ZN, Engineer of the Chicago Radio Laboratory, and have reported favorably on the receiver's merits. Among these were E. T. Howell, Sc.M., vice president, and the club's recently-appointed assistant treasurer, F. W. Catel, 9DTK, some time an operator for the now defunct United Wireless Telegraph Company.

A good share of one of the season's last meetings was taken up with a discussion of the super-heterodyne receptor with E. T. Howell, 9CVI, and H. F. Wareing, pre-war 9AEX and president, leading. At the concluding meeting of the season of 1922-23 Business Manager L. S. Hillegas-Baird read Dr. D. B. MacMillan's parting message to A. R. R. L. members. This last statement was prepared by Dr. MacMillan shortly before he left for the arctic regions, taking with him an A. R. R. L. member as radio operator.

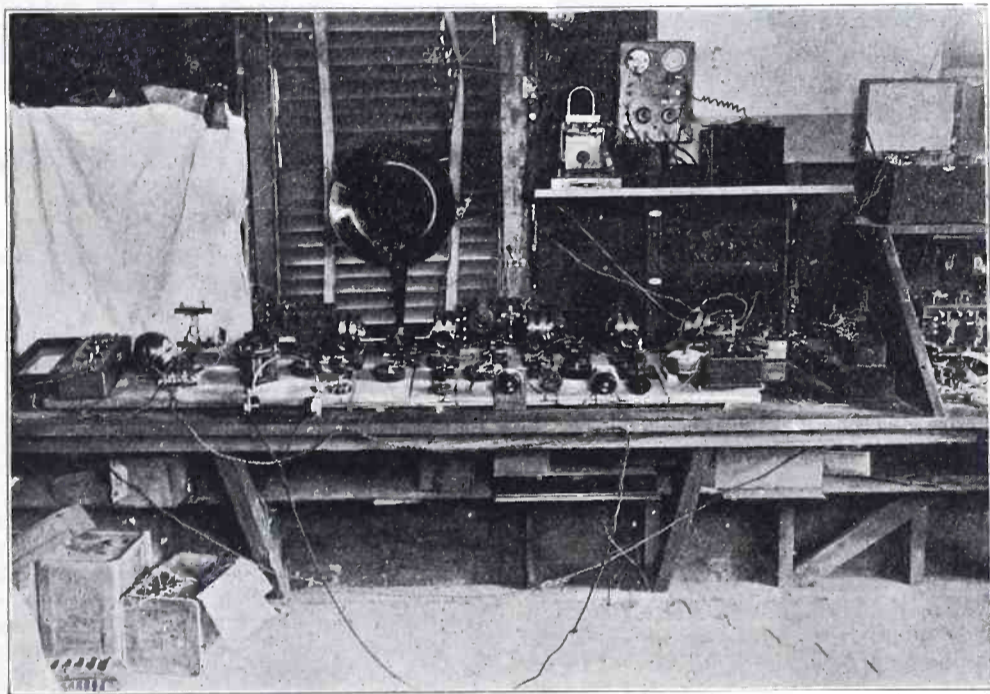

Receiving Set by Which Signals Were Heard.

The reception of these signals was the result of a privately-arranged test to be carried on by Major Mott with C. D. Maclurcan, F. B. Cooke and J. G. Reed of Sydney, Australia. The signal "Mott" was first heard accidentally by J. H. A. Pike of Epping, Sydney, who reported the fact to Mr. Maclurcan. On the night of May 4th Mr. Maclurcan and his associates, as well as Mr. Pike and Mr. C. A. Gorman of Arncliffe, heard the signals plainly at their three stations. The call "Mott" was also heard at Mr. Maclurcan's station on May 5th and 6th.

The accompanying picture and circuit diagram show Mr. Maclurcan's set. He received the signals with one radio frequency valve and detector. "In all cases the signals were very weak and immediately the adjustments were attempted to increase their strength they were lost, so that it was necessary to concentrate on the reading without endeavoring to amplify."

Major Mott is also in receipt of a letter from L. S. Spachman at Auckland, New Zealand, who copied the message "Spachman, de 6XAD, Mott, Avalon, Calif., Test, Bell, N. Z. C. M." on one valve. The signals were surprisingly loud, almost QSA in fact. Signals were heard several nights later by two other amateurs in Auckland.

Under date of May 19th Mr. Frank R. Rose of Selwyn St., Invercargill, N. Z., reports Mr. Mott's signals "as very strong and quite readable on one UV200 in a 3-coil circuit." Invercargill is 800 miles south of Auckland at the extreme end of South Island.

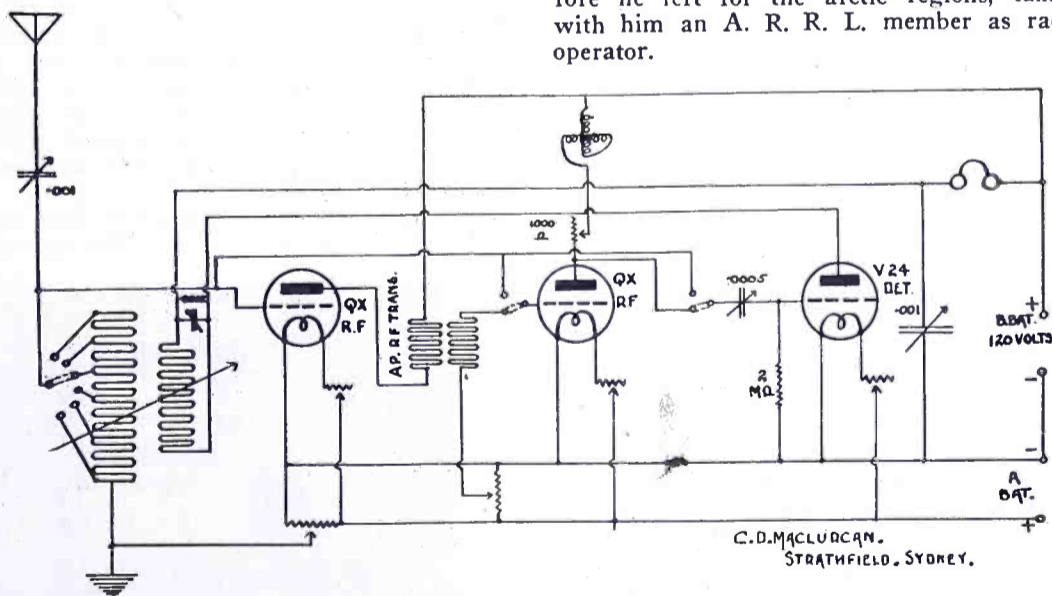

Hook-up Used by Maclurcan in Hearing 6XAD

radiophones in the larger cities that would be the envy of many American Hams if they set eyes on them. One experimenter, using a receiving tube, transmits his voice from Melbourne to Sydney, a matter of 550 miles. He uses an English "R" valve with 800 volts on the plate.

Seeing that broadcasting is prohibited, many experimental radiophone outfits are ostensibly experimenting with musical transmission, and some quite good concerts are put over. This has whetted the appetite of those who have heard them for regular broadcasting. To meet this need, and to settle

Regular weekly meetings on Thursday evenings in the Public Museum Trustees' Room will be resumed by the society about the middle of September. The club's directors and officers will hold several mid-summer meetings at which plans will be formed for the fall membership campaign. A society consisting of 100 per cent of the local radio amateurs and members of the American Radio Relay League Inc. is the goal to be set in the membership drive. The club's office, to which all general correspondence should be addressed, is 601 Enterprise Bldg., Milwaukee, Wis.

WITH THE AMATEUR OPERATORS

RADICAL CHANGES IN AMATEUR REGULATIONS

Further restrictions in the regulations governing amateur transmission, as issued from the Radio Inspector's offices, require that all amateur licenses be recalled in order that new ones may be issued in compliance with the new regulations.

The most drastic change is that the following restriction must appear on all amateur licenses: "This station is not licensed to transmit between the hours of 8 to 10:30 p.m., local standard time, nor Sunday morning during local church services." Further comment on this appears on the editorial page of this issue.

General and restricted amateur radio station licenses will be permitted the use of any type of transmitter (C.W., spark, A.C.-C.W., I.C.W., unfiltered C.W. and phone) with the restrictions that when using pure C.W. they are authorized to use wavelengths from 150 to 200 meters and using spark, A.C.-C.W., unfiltered C.W. and phone the wavelengths from 176 to 200 meters only can be used. The types of transmitters must be specified in the application and the license.

Special Amateur Radio Station licenses will be issued permitting the use of pure continuous wave transmitter only, authorizing the use of wavelengths from 150 to 220 meters.

For the purpose of application to Amateur Stations, pure C.W. is defined as follows:

A system of telegraphing by continuous oscillations in which the power supply is substantially direct current as obtained from (1) a generator (2) a battery, or (3) a rectifier with an adequate filter. (A filter is not deemed adequate if the supply modulation exceeds 5%.)

General Restricted and Special Amateur Stations are not permitted to use a transformer input exceeding one kilowatt, or equivalent of this power based upon watt input to plates if tubes are used. (Where input rating of tube is not specified by manufacturer this rating will be considered as double the manufacturer's output rating.)

A new class of Amateur operator's license is hereby established to be known as "Amateur Extra First Grade."

Licenses of this grade will be issued to persons passing the required special examination with a percentage of at least 75 and code speed in sending and receiving at least 20 words a minute, five characters to the word; who have had at least two years' experience as a licensed radio operator; who have not been penalized for violation of the radio laws subsequent to the date of these regulations.

RADIO STATION 9BXT

9BXT, operated by Elvin B. Chapman at Giltner, Nebraska, has been an active relay station during the past season, 2000 messages having been handled in the last five months.

Both the transmitter and the receiver are home made. The receiver is a single circuit using variometers, two step and Baldwin phones. This set, although it tunes easily, has proven to be more selective than the average single circuit, which makes it valuable for handling traffic. The transmitter consists of four 5-watt tubes in the sure-fire British Aircraft Circuit. The plate supply is obtained from a 550-volt Acme transformer, rectified by a 20-jar chemical rectifier, and filtered by 2 mfd. of condenser and a double coil choke. This gives nearly as pure DC as a generator. The radiation is the bugbear, as it is only 1 ampere. Loop absorption method of modulation is used for fone.

The antenna system consists of an um-

brella 60 ft. high and a fan counterpoise. Anyone wishing further information upon this type of aerial can obtain it upon request.

On phone distances up to 550 miles have been worked. On C. W. 380 stations in 33 states and all districts have been worked. Eight districts and Canada were worked in one

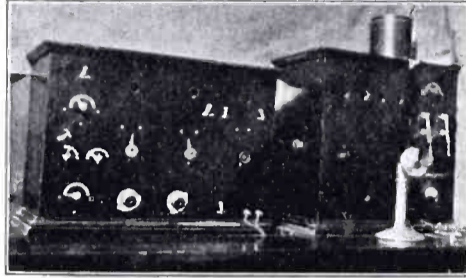

Radio Station 9BXT

night and traffic is handled with every district regularly. The C. W. sigs have been reported in 41 states, 5 Canadian provinces, Mexico and Hawaii, a distance of about 3300 miles. If anyone in Vermont, New Hampshire, Delaware, North and South Carolina, Mississippi and Alabama have heard 9BXT please send card, as no report from those states as yet. Any report from anyone hearing 9BXT will be answered and appreciated.

RADIO 5EK

Radio station 5EK, owned and operated by David Gordon Botts of Memphis, Tenn., is equipped with a 100-watt C. W. and I. C. W. transmitter and a 40-watt phone. The former has been heard in 48 states and every province in Canada, as well as Alaska, Holland, Cuba, Bahama Islands, Porto Rico and Hawaii. All districts have been worked, the greatest distance being with 6XAD. The set employs a sure-fire circuit with two 50-watt tubes with 1500-volt plate supply. The radiation is 3 amps. with C. W. and 2 amps. with I. C. W.

The phone set has eight 5-watt phones, four being used as oscillators and four as modulators with 750 volts on the plate. The radiation is 1½ amps. This set has been reported by 1AJP and has worked 3TA, 3GB (Can.), 4AR and 9YF, and has been reported from 34 states.

The aerial is a 4-wire cage 75 ft. long and 80 ft. high, with cage lead-in. The counter-



Radio Station 5EK

poise is made up of 12 wires with 20 ft. spreaders, 75 ft. long and 10 ft. high.

The receiving set is a Reinartz detector with 3-stage amplifier. "This set is the cat's knuckles" for C. W.

MEXICO CITY HAS NEW BROADCASTING STATIONS

Two radio telephone broadcasting stations were recently opened in Mexico City, a report from Consul Thomas D. Bowman, Mexico City, states. Various efforts have been made in recent months to obtain concessions for the establishment of such stations, but it is only recently that the government granted this permission. There appears to be great enthusiasm over local broadcasting, and it is believed that the market for radio sets in Mexico is favorable to considerable development by American manufacturers. Radio sets are now sold by electrical dealers, for the most part, although some American concerns have sent direct agents to promote sales. One dealer has estimated that approximately 150 sets have already been sold in Mexico City. It is reported that other broadcasting stations are to be created in Mexico.

S. S. Sonneborn, one of America's leading experts in the moulded and insulation parts field, has joined the organization of the Splitdorf Electrical Company with headquarters at the company's factory at Newark, N. J. Mr. Sonneborn acted for many years as general manager of the Electrose Manufacturing Co. and his associations in the electrical field generally are international in scope.

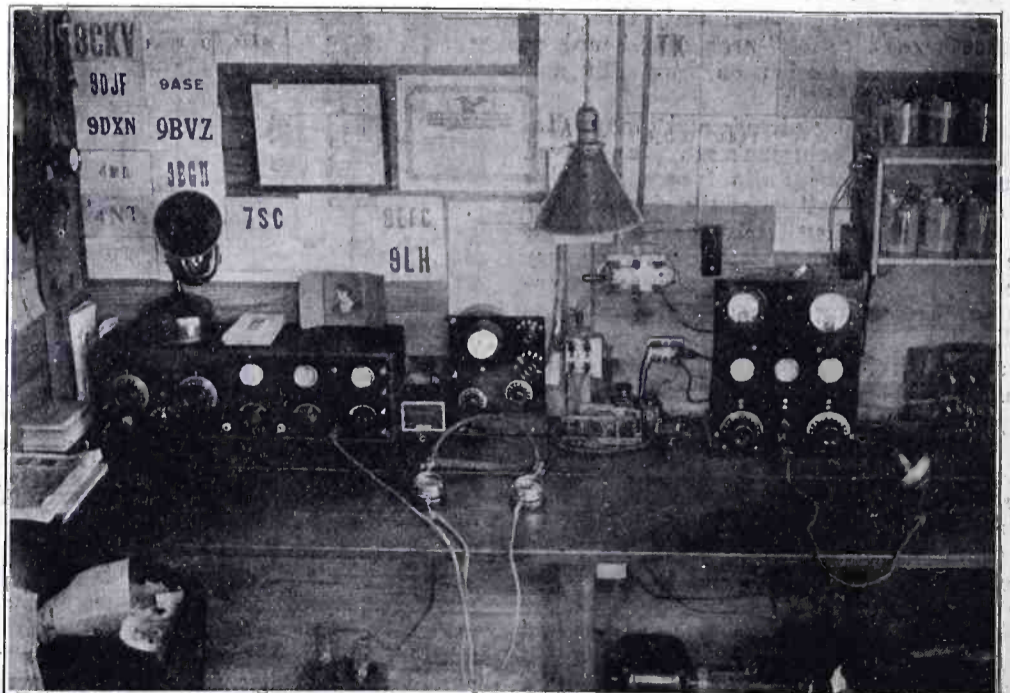

Radio Station 8AVD

NEW APPARATUS & SUPPLIES FROM THE RADIO MANUFACTURERS

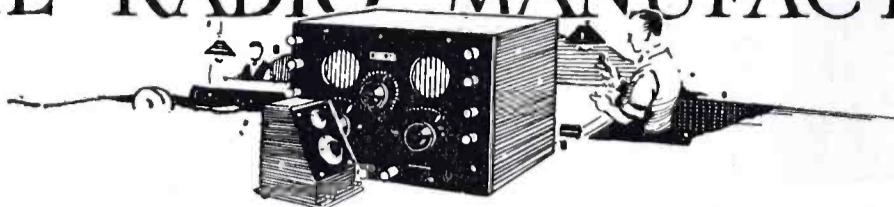

THE NEW GREBE CR-12

Radio fans will find the solution to many of their broadcast problems, in the new Grebe Receiver, the CR-12, wherein is employed radio frequency and regeneration, the two factors most important in long distance reception. One of the distinctive features of this Grebe product, is the simple manner in which that company has provided for its use with any tubes now on the market. A 201A may be used in the radio frequency circuit, a WD-11 as a detector, a UV-199 in the first stage of audio frequency amplification, and a UV-200 in the second stage audio frequency amplification. Such combinations may be used with either dry cells or a 6-volt storage battery, such as employed when using UV-200 or UV-201 tubes, and with no combination of tubes is more than one *A* battery necessary.



The New Grebe CR-12

Although the CR-12 is a four-tube set, the simplicity with which it may be tuned can only be compared with single-circuit receivers. Its selectivity is far greater than that previously obtained with the best types of coupled circuit regenerative receivers.

This receiver has but two tuning controls, one of which is calibrated to wavelengths, thus reducing to a minimum the elements of chance in tuning for a given station. With a wavelength of 200 to 600 meters, the set will receive all wavelengths which have come into effect since May 15th.

No outdoor antenna is used, in fact the antenna is supplied with the set, and consists of a silk-covered wire 20 ft. in length. This wire, although not unsightly, may be hidden in back of a picture moulding, or run along the baseboard.

An "operating switch," located at the lower right corner of the main panel, controls the filament circuits of the vacuum tubes and for the use of one or two stages of amplification at will.

Telephone jack and plug has been provided for those who wish to receive with the telephone headset, and the insertion of the plug in the jack automatically disconnects the loud speaker and transfers the signals to the telephones.

Distinguishing it from the usual Grebe cabinet design, the Grebe CR-12 cabinet is provided with compartments for the filament and plate batteries, and although it is not the intention of the Grebe Company to build a portable receiver, this new type is readily transportable, inasmuch as it is, with the exception of the loud speaker, self-contained.

FEDERAL No. 65 TRANSFORMER

The results of many trials as to what constitutes satisfactory radio music have proven that what the ear of the observer needs for complete satisfaction in the music is the presence of the lower tones of the orchestra. Its lack leaves a distinct feeling of dissatisfaction and insufficiency in the music, while its presence gives a completeness and satisfaction that constitutes the difference between good music and what the radio listener has been forced in the past to accept.

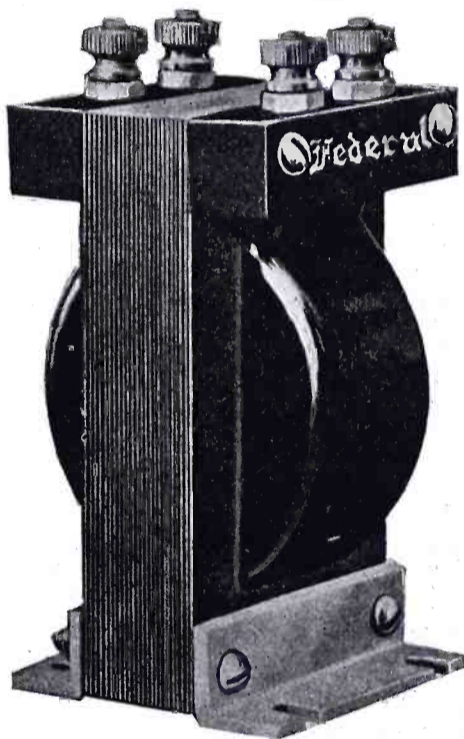

Federal No. 65 Transformer

While the problem of the loss of the lower tones is as serious in the transmitting equipment as in the receiving equipment, the fact that one transmitter serves many thousands of listeners has justified the great investment necessary for the construction of special faithfully reproducing microphone and voice amplifying equipment. But the problem of designing equally good equipment for the radio listener has been attended by the same difficulties and with the added limitation that comes with the fact that the selling price of such equipment must be such that it is well within the reach of the radio listener.

The No. 65 Federal Transformer has been designed to eliminate the objections that have so limited the beauty and faithfulness of reproduction in the past. Its design and construction is of such a nature that the notes of the bass viol, the kettle drum, the piano bass are carried through the system with a completeness and soundness that is amazing.

It is of such construction that each note that enters it is passed on to the vacuum tube with exactly the same fidelity and without a suggestion of any added tones, whether dissonant or not. When used with any of commonly available tubes the degree by which this exceptionally satisfactory amplification is claimed to be as near perfect as has been attained with any A. F. transformer.

A NEW "B" BATTERY

The Burgess Battery Company announces a new and more convenient type of large size *B* battery, No. 2158, which is being enthusiastically received by broadcast receivers who are making compact receiving sets and using dry cell *A* batteries. The new *B* battery may be called a "vertical battery," as it stands on end and has its terminals on the top similar to the dry battery. It is 4 in. by 3 in. cross section and 6 3/4 in. high and occupies less than one-half the space taken by the usual *B* battery of equal capacity. Its voltage is 22.5 and the terminals are two binding posts with knurled nuts. Incorporated in this battery are the well-known Burgess features of seamless drawn zinc cans, individual cell insulation, thorough moisture-proofing and improved series connections.

The advantage of this battery is that it can be conveniently connected in sets which have small vertical spaces in the back of the cabinet. A number can be bound together in compact units with dry *A* batteries and nicely used with portable sets. The battery is especially useful for loud speakers where four or more are used together to produce a high potential, as they can be easily tied or wired together into a solid package.

THE WARREN RADIO LOOP

Recent experiments with the Warren radio loop, well known because of its use on the radio roller chair on the boardwalk at Asbury Park, N. J., have developed an amazingly effective type measuring but 6 in. square by one-half in. thick. It makes any set portable by fitting neatly inside or setting on top of the cabinet. This type can be used, with or without a ground connection. Ground connection can be made either direct or indirect from a binding post on the loop. Although this ground connection reduces the directive qualities it greatly increases the strength of the incoming signals. Within five or ten miles of a broadcasting station this loop will pick up the programs excellently without any ground connection. Stations in Philadelphia, Newark, New York, Ridgewood, L. I., and Schenectady, N. Y., are clearly heard in Asbury Park on a standard make single-tube set. With the same aerial, a set employing a detector and two steps of audio amplification with a Magnavox Loud Speaker, has produced signals from all these stations loud enough to be heard all over a three-story house.

Exceptional results are obtained with this type loop by connecting the loop, shunted by a small variable condenser, directly to grid and filament of the amplifier and detector tubes, with no other tuning devices. All tuning is accomplished with the variable condenser, the whole operation being very simple. It is surprisingly selective, enabling the operator to shift reception from one station to another, provided there are but a few meters difference in the wavelengths. A loop requires finer tuning adjustments than an outdoor aerial but gives finer signals with a consequent reduction of (and frequently entire elimination of interference). Static is also greatly reduced.

Announcing Burgess "A" Dry Battery

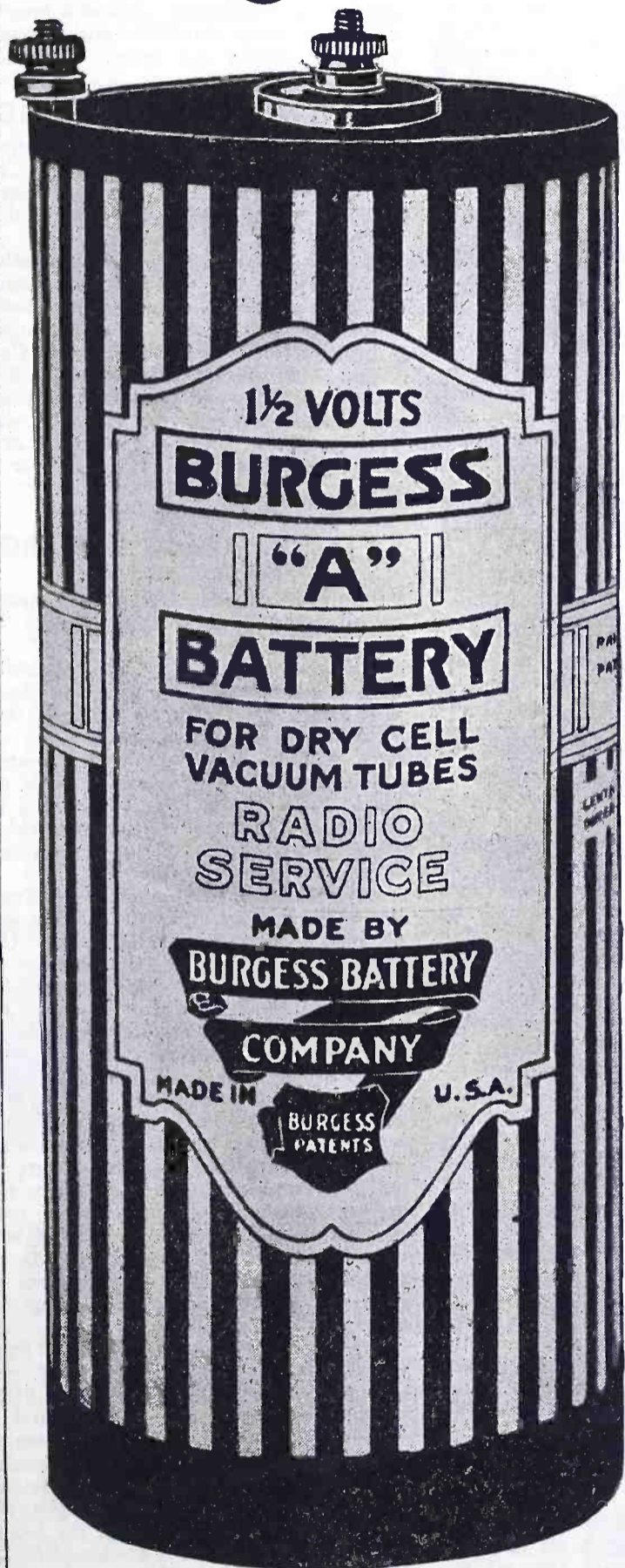

"A Laboratory Product"

THIS new dry battery for the "A" or filament circuits of dry cell vacuum tubes is a Burgess achievement which will not soon be forgotten.

Burgess has perfected a dry "A" battery which will give over twice the life, on vacuum tube service, of any ordinary No. 6 Ignition dry cell. It has a rapid recovery to high voltage after short periods of rest and practically no voltage lost when not in use.

This Burgess "A" dry battery will lead the "A" battery field just as the Burgess dry "B" battery has led in the field of "B" batteries. Ask any Radio Engineer about Burgess "B" Batteries.

Made only in single cell units. This makes it possible to wire up convenient combinations for all types of dry cell tubes, and eliminates the hazards and expense of multiple cell units.

Ask for the Burgess "A" Battery

when you are equipping your new set or replacing your old dry batteries. Sold by all progressive radio dealers.

BURGESS BATTERY COMPANY

Engineers—DRY BATTERIES—Manufacturers
FLASHLIGHT—RADIO—IGNITION—TELEPHONE

General Sales Office: Harris Trust Bldg., Chicago
Laboratories and Works: Madison, Wisconsin

Branches:
New York Boston Washington St. Paul Kansas City New Orleans

In Canada: General Offices and Works: Niagara Falls, Ont.
Branches: Toronto Montreal Winnipeg St. John

CHARGE YOUR RADIO BATTERY at HOME for a NICKEL

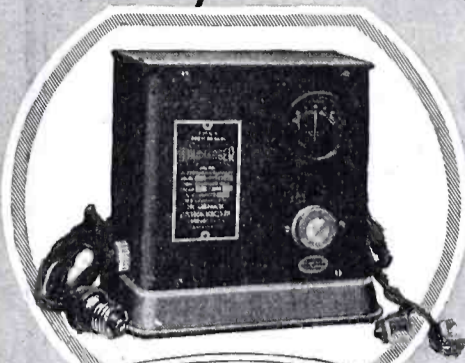

PATENTED ARMATURE
The HOMCHARGER'S only moving and wearing part—replaceable after thousands of hours' use for \$1.00. Tungsten contacts now used exclusively. Will not stick, corrode or wear excessively.

Enjoyable concerts and maximum receiving range are obtained only when your battery is fully charged.

THE HOMCHARGER

charges your "A" or "B" battery OVER NIGHT for a nickel without removing it from your living room. Operates silently—charging rate governed automatically. No fuss—no trouble—no dirt—requires no watching.

The HOMCHARGER is the ONLY battery charger combining all of these necessary features. SELF-POLARIZING—FIVE to EIGHT-AMPERE charging rate—UNDERWRITERS' APPROVAL—beautifully finished in mahogany and old gold—UNQUALIFIEDLY GUARANTEED. Over 100,000 now in use.

The minute you buy a radio set you need a Homcharger—get it then. All good radio and electrical dealers sell it complete with ammeter, etc., for \$18.50. \$25.00 in Canada.

Write for FREE circular showing why the HOMCHARGER is the BEST battery charger at any price.

MOTORISTS — THE HOMCHARGER will also charge your AUTO Battery.

Western Distributor
BERTRAM SMITH
405 San Fernando Bldg., Los Angeles, Cal.

THE AUTOMATIC
ELECTRICAL DEVICES CO.
117 West Third St.
Cincinnati, Ohio

Largest Manufacturers of
Vibrating Rectifiers in the World

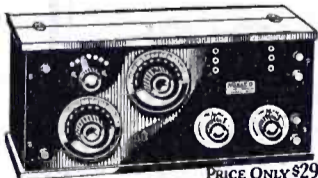

PRICE ONLY \$29.50



At this low price you get the efficiency of a \$50 set. It is a two tube radio frequency receiver—picks up stations 1500 miles away under good conditions—everywhere—any time. This outfit can be operated with a dry cell or storage battery. Cabinet is of solid mahogany and workmanship the finest throughout. Order direct or send for catalogue.

DEALERS—write for proposition—it's a winner.
AGENTS—wanted everywhere—write for territory QUICKLY

THE MIDWEST RADIO COMPANY
814 Main Street Cincinnati, Ohio

NEW BUREAU OF STANDARDS PUBLICATIONS

The U. S. Bureau of Standards has recently published several scientific papers which contain material of interest and value to radio engineers. No. 468 gives formulas and tables for the calculation of the inductance of polygonal form by F. W. Grover. The cases treated are triangular, square, hexagonal and octagonal coils. These coils are not only easy to make but also, as the supports of the wire are only at the vertices, there is a minimum of loss due to di-electric capacity as compared to circular coils. By the use of the formulas and tables it is possible to calculate the inductance of all such coils likely to be used in radio circuits.

No. 469, by F. W. Dunmore and F. H. Engel, describes directive radio transmission on a wavelength of 10 meters. This tells of successful experiments in the reduction of interference by means of the reflection of short waves. The paper gives the constructional details of the apparatus employed so that the results can be duplicated and the investigations continued.

No. 471 by J. H. Dellinger and J. L. Preston describes methods for measuring the properties of electrical insulating materials. These include phase difference, dielectric constant, and voltage effect at radio frequencies; volume and surface resistivity; density, moisture absorption; tensile, transverse, and impact strength, hardness, permanent distortion, machining qualities, thermal expansivity, and effects of chemicals.

RADIO TRADE NOTES

William N. Shaw, president of the Eise-mann Magneto Corporation, is spending several weeks in Great Britain and Continental Europe for the purpose of making arrangements for a distribution of Eise-mann radio products in foreign countries.

R. Calvert Haws, vice-president and general manager of the Shuman-Haws Advertising Company, Chicago, is visiting England and the continent in order, primarily, to make a first-hand study of European radio industries and markets. While abroad, he will secure European connections for radio clients of his agency and will also seek to arrange for American outlets for such meritorious European radio apparatus as he may encounter.

The Allen D. Cardwell Mfg. Corp'n of Brooklyn is now making a new type of receiver which is mounted flat on a board 12x24 inches, having all parts and connections visible. The purpose of this design is to effect certain economies for the buyer who plans to use various hook-ups or who wishes to keep all his parts visible for educational or demonstration work. The breadboard set utilizes one stage of radio frequency, detector and two stages audio amplification.

The Connecticut Telephone & Electric Co. of Meriden, Conn., has purchased the plant formerly occupied by The Wilcox & White Co., makers of the Angelus player-piano. This new addition will be known as Plant No. 2, and is but a short distance from the present Plant No. 1. It will be used for the general expansion of the business, which consists of ignition, telephone, radio and insulating products.

John L. Reinartz, inventor of the Reinartz Coil, has entered into an agreement with the Eugene T. Turney Laboratories, Inc., whereby the Reinartz Coil will be manufactured exclusively by Turney according to Reinartz specifications as published in QST in March, 1922. As the Reinartz Coil is a spiderweb winding with appropriate taps, and as Eugene Turney holds the patents for spiderweb windings, the association of the two ele-

ments is a happy one. It is the intention of the Eugene T. Turney Laboratories to supply the trade with these coils as rapidly as possible.

The American Radio Exposition Co. of 120 Broadway, New York City is preparing to put on another radio show at New York from Oct. 6th to 13th. The fact that this company has already staged successful shows at New York and San Francisco bespeaks the probable success of another show under its management. It is planned to arrange for profit-sharing between the exhibitors and the show management. Advance reservations already indicate that there will be many exhibits of interest and value.

NEW RADIO CATALOGS

"Radio, The Third Year," is the title of a booklet from P. C. Kullman & Co., 110 Nassau St., New York, telling what radio is doing in the world and what is doing in radio.

Bulletin No. 628 from the Automatic Electrical Devices Co. of Cincinnati, Ohio, is a complete treatise on the theory, construction and operation of the A. C. Homcharger.

Bulletin No. 34 from the Allen D. Cardwell Corp., 81 Prospect St., Brooklyn, N. Y., gives the specifications and advantages of the Cardwell improved type of variable air condensers. These are made with 11, 21 or 41 plates for tuning and 43 plates for transmitting.

WJAZ TO REACH THE ARCTIC

Continued from page 37

Studio is alternated with dance music every second number from the orchestra in the Marine dining room.

The use of radio by Dr. McMillan to keep in touch with civilization in the otherwise awful Arctic solitudes is one of the most romantic applications of this new art. There is a question as to whether communication can be established through the Arctic auroral band. The results attained as well as the studies of terrestrial magnetism which are the primary objects of the expedition will be of great scientific interest.

Dr. McMillan will take with him as wireless operator Donald H. Mix of Bristol, Connecticut. Mix was selected by Captain McMillan from five men who were chosen by Mr. Hiram Percy Maxim, president of the American Radio Relay League. Realizing the tremendous interest which the use of Radio on an expedition of this character would arouse in the public mind, Maxim sent out a request for volunteers to all A. R. R. L. members. Hundreds responded. Not only technical ability as an operator and the ability to withstand hardships were requisites, but in particular the faculty for making oneself congenial among a small crew of men, on an ice-bound ship. Dr. McMillan's crew consists of only seven men. Mix represents Captain McMillan's choice from among some of the best wireless operators in the country.

Once a week Mix will transmit from the *Bowdoin* a five hundred-word story of Arctic adventure and will transmit also diagrams of all new lands and harbors and lands found and charted. At such time as it has been prearranged for Mix to attempt to get his wireless message through, Hiram Percy Maxim will issue a request for all amateurs who are members of the League to stand by and tune in for Station WNP. The sending station on the *Bowdoin* has been assigned by the government the call letters WNP, "Wireless North Pole." The government has assigned wavelengths of 200, 300 and 400 meters, and has also given permission for Station WNP to use whatever wavelength it may find necessary for experimental purposes.

Tell them that you saw it in RADIO

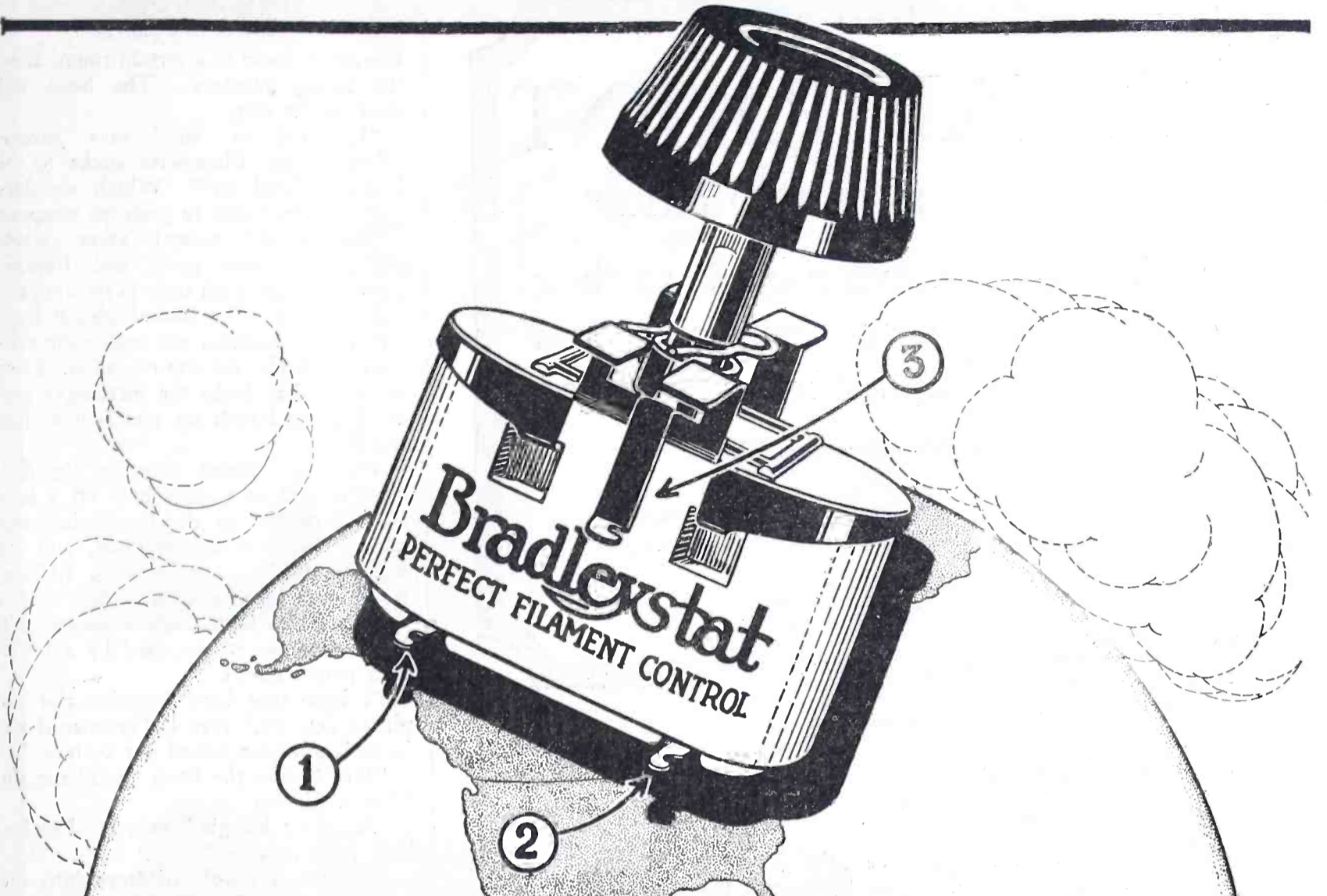

Use *Any* Tube with the Universal Bradleystat



A Letter from an Ohio Radio Dealer

"The Bradleystat has met with our entire approval. We have made it regular equipment on all Westinghouse RC sets sold by us and have installed many Bradleystats on Crosley and other receivers, with perfect satisfaction."

Dealers

New counter cards, technical folders and other sales helps are ready for you, explaining the wonderful opportunities of the Universal Bradleystat. Be prepared to meet the demand of thousands of radio set users who are clamoring for the Universal Bradleystat.

Price, \$1.85

Parcel Post, 10c extra

TRY any tube—old, new or foreign—in your radio set. The new Universal Bradleystat with three terminals will give perfect filament control for any tube you may select. There is no need of tearing down your set to install a new rheostat whenever you change tubes. A simple change of connections gives you noiseless, stepless, perfect control.

Bring your set up-to-date by installing the Universal Bradleystat with three terminals. It is for sale by all radio dealers at the same price as the old Bradleystat, now used in several hundred thousand radio sets. Remember, the Universal Bradleystat is guaranteed to give satisfaction.

Allen-Bradley Co.

Electric Controlling Apparatus,
288 Greenfield Avenue, Milwaukee, Wis.

Manufacturers of Graphite Compression Rheostats for Twenty Years

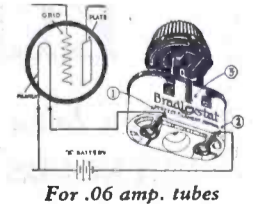
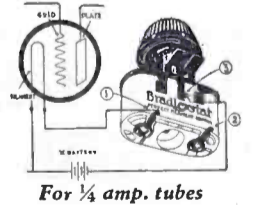
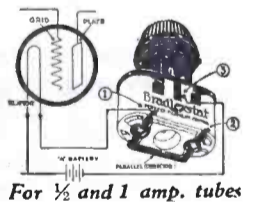

Tell them that you saw it in RADIO

ATWATER KENT

RECEIVING SETS AND PARTS

are ideal for summer use due to their compact and rugged construction and the fact that they are moisture-proof.

Send for the illustrated folder

ATWATER KENT MANUFACTURING COMPANY
4947 Stenton Ave. Radio Dept. Philadelphia

Makers of
THE WORLD'S HIGHEST GRADE IGNITION
STARTING AND LIGHTING

Cotogrip ★

"Built First to Last"

This little beauty was approved by our engineers only when convinced that they had produced the one socket that combines all the essential features of a good socket.

1. Positive Cotogrip Contacts.
2. Hard Rubber Insulation.
3. Rugged Construction.
4. Compact Design.
5. Concealed Mounting.

It is impossible to show the unique mechanical action of Cotogrip contacts in a photograph. It is different from any other socket you have ever seen. This socket will interest you in every way.

You ought to have one.
Ask Your Dealer

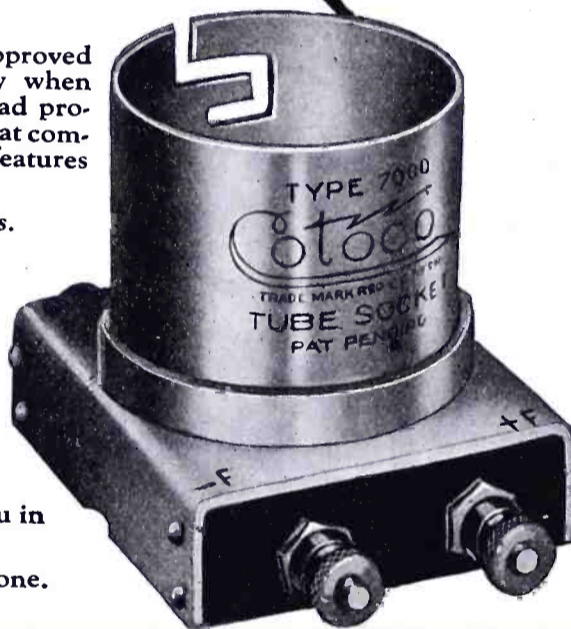

COTO-COIL CO. PROVIDENCE

Pacific Coast Branch, 329 Union League Bldg. Los Angeles, Cal.

Try **REYNOLDS RADIO Service**

9ZAF

from **DENVER**

KLZ

The exclusive distributors of

KENNEDY EQUIPMENT

IN THIS TERRITORY

If you have a **KENNEDY Receiver** you have the best in Radio

REYNOLDS RADIO CO., Inc., 1534 Glenarm St., Denver, Colo.

Largest distributors of Radio Apparatus in the West

? Did YOU receive our 68-page Catalogue ?

JIMSON'S COUP

Continued from page 20

We are to come to a certain room, above the living quarters. The bozo will show us the way.

"Up and at 'em," says Jimson. "Richard the Planchette sticks by his friends. Lead on!" Which we does.

We doesn't stop to grab no weapons. I has a .45 tucked away where it'll do the most good, and Jimson's travellin' light with only brass knuckles and a bowie. We looked plumb innocent on the outside, but under the skin, Julie O'Grady, we was no ladies. From the sorry like looks the messenger give us, I gets a hunch we was headin' into trouble.

We was. Seems, they has the Senorita stabled in a dirty hole off a back alley, accordin' to the bozo's information. He leads on McDuff, and we follows, trailin' into a dark hallway which was about one man wide and a couple of men high. We no sooner gets inside than we is concussed by a lot of high power smells.

"I hope that here Senorita aint too plumb delicate," says I, "because if she is, she's probable passed out by now."

"Hist!" says the bozo, givin' me the Maxim silencer.

"All right kleagle," says I, "I'm ku-klux from now on."

We goes a couple of steps into the hall—the bozo first, Jim on second and me third. Before we can see where we're goin' all hell busts loose. Me—I aint never seen a cloudburst of hombres before. They come from everywhere. They all seems to have it in for me and Jimson, although we aint neither of us ever seen 'em before.

I aint got no time to see is they healthy or doin' poorly. I busts a couple and lamps Jimson doin' his bit. The messenger has gone entire. Bein' kinda dark and them jumpin' mavericks kinda chocolate colored, it was sure difficult to tell what was a face. Twice I wallops a shadow thinkin' it was a hooman expression and once I hits myself an uppercut in the jaw, owin' to a heavy swing goin' wild. But in the main I done pretty well.

"Polica!" shrieks the bozo, from somewheres down near the floor.

"Shut up," says Jimson. "They aint no good any time. Git yoreself a chair leg and hit 'em under the ear. How you comin' Bud?"

"Fine," says I, slammin' a couple of heads together. "Only the place is kinda crowded."

"Well, it's gonna get better," says Jimson. "Some of the folks appears to be leavin'," he says, heavin' a couple over the rail and kickin' an opera singer in the slats.

"Where's Hermes?" I asks, twistin' off somebody's ear.

Continued on page 48

Tell them that you saw it in RADIO

SE-AR-DE

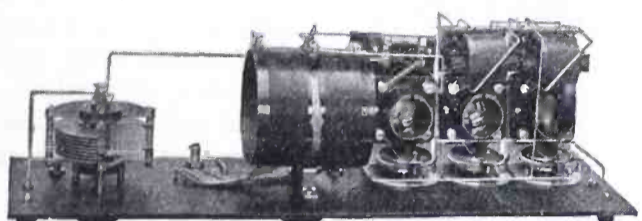

TYPE AD2 SHORT WAVE RECEIVER..... \$49.00
150 to 630 Meters—Knock Down Form only

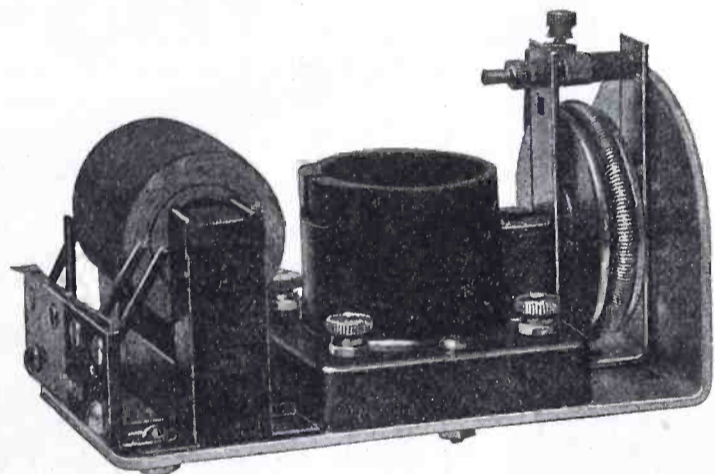

No. 198 Amplifying Unit.....\$7.50
No. 211 Detector Unit.....\$2.40
No. 206 Detector Unit (30 ohm).....\$3.00

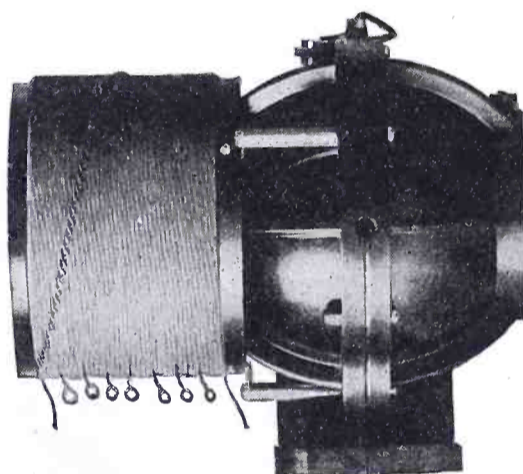

No. 165.....\$13.00
SE-AR-DE Radiometer with
B. W. Inductance

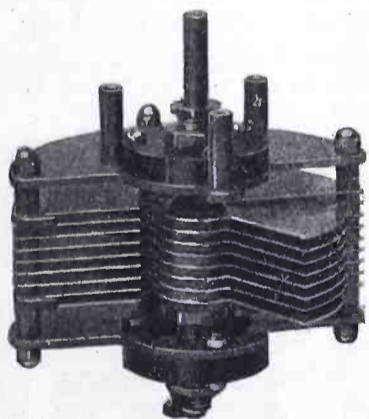

No. 185 Variable Condenser
\$4.25
Cap. .00035 m. f. 17 plates



No. 193
Vernier
Adjuster
\$0.35



No. 164 Knob and Dial
\$0.75
Molded Bakelite

R. MITCHELL CO. :

255 Atlantic Avenue
Boston, Massachusetts

For 47 years Manufacturers of Scientific and other equipment
Look for trade mark on every piece
Jobbers and Dealers write for discounts

Tell them that you saw it in RADIO

"The World is Mine!"

MU-RAD RECEIVERS

THE thrill of great distances—that is the special privilege of MU-RAD owners due to the extreme sensitivity and delightful efficiency of their sets. Cities for thousands of miles in every direction, a dozen states, ships at sea, far-away Hawaii, Cuba and Canada—all contribute to their entertainment.

Requires only a two-foot loop aerial. Professional results for the most inexperienced because MU-RAD RECEIVERS are so simply operated.

Absolute guarantee of 1000 miles reception.

Write for Literature.

MU-RAD LABORATORIES, INC.

806 FIFTH AVE. ASBURY PARK, NEW JERSEY



RADIO INSTITUTE OF AMERICA

TRAINING IN ALL COMMERCIAL BRANCHES OF RADIO

If you cannot attend the Radio Institute of America in person the same instruction can come to you through our recently inaugurated "HOME STUDY COURSE"—Investigate.



Detailed information free on request.

Conducted by

THE RADIO CORPORATION OF AMERICA

331 Call Bldg.
98 Worth St.

Phone Douglas 3030
Phone Franklin 1144

San Francisco, Calif.
New York City

Tell them that you saw it in RADIO

Continued from page 46

"Aqui senior!" squeaks the prune, down on the floor where he's gnawin' an ankle or two.

We heaves and pulls and finally gets him up on his feet. He was pretty mused up but he was game all right.

"Ah—senor—you have save my life," says he, standin' on a couple of faces so's he could salute us.

"Forget it," says Jimson. "Where's the seniorita?"

The bozo leads and we follows, as per before, climbin' over groanin' and wallerin' carcasses. At the end of the hall, we comes to a door. The bozo knocks.

"Si?" says a voice and in we goes.

Who should we see but a fat, mean-lookin' maverick with a surprised look. The messenger kinda steps back.

"Ruiz!" he says, scared like.

Jimson and me both tumbles that somethin's gone wrong with the party. Also that the pescado Ruiz is some set back that we aint all banged up and in chains maybe.

"Ah—Dios," says he, backin' away.

"Dios is it," says Jimson, real polite. "Give him the raise, Bud."

I does. I shoves Mr. Colt's well known offspring under his nose.

"Alto alli!" says I, snappy.

He done a sky-reach immejit.

"Viva!" says the messenger, reachin' into his shoe for a knife and slippin' Ruiz a wall eye. I grabs his arm and shakes my head.

"Where's the Seniorita?" says Jimson. "Pronto!"

Ruiz starts a shrug which don't finish, owin' to me pokin' him with the muzzle where the sun don't shine.

"Quien sabe?" he remarks.

"Oh, is that so?" says Jimson, right back. "Aint it lucky I used to be a cop and knows a few little tricks. Bud, gimme yore pocket-knife will yuh, whilst I digs out this maverick's eyeballs so's I can see what he's got inside his head."

That fixes him. He falls on his face and begins to grab Jimson around the knees and weep. Even the messenger gits the humor of it and begins to grin.

"Por Dios—she is safe," says Ruiz. "No one have harm the hair of thee head. Santa Clara—all is well."

"Santa Clara—maybe you're a liar and maybe you aint," says Jimson. Le's get a look at her."

Ruiz indicates that she is across the hall. So we crosses over, me holdin' the gat on his spine and Jimson and the messenger bringin' up the rear. We has to bust down the door, because the Seniorita was that scared she wouldn't unlock it for nobody. When we does get in, final, we gets a shock.

The Seniorita was a lady rhinoceros—absolute. She might have been a good

Continued on page 50

proven best filament control



- challenges the world

Proven by every test to surpass any and all rheostats and filament controls, Fil-Ko-Stat rightly challenges the world.

Laboratory research proves Fil-Ko-Stat to have a fine adjustment area (which means ability to control filament heat and electronic flow) eighteen times greater than that of the wire rheostat and several times that of the next best filament control.

Actual use proves Fil-Ko-Stat the most accurate control for any tube from "peanut" to "power." Full resistance 30 ohms.

—it has no screws or adjustments to tamper with. It is triple tested and regulated at the factory to the ideal "off" position for

UV 200, 201, 201A, WD11, WD12,
UV199, DV6A, W. E. Peanut, etc., etc.

—it is non-microphonic, operates noiselessly, eliminating all "frying."

—it has no disks to break or chip and its reliability and durability are guaranteed by the manufacturer.

If you have never tried tuning with your filament control, start with a Fil-Ko-Stat. It brings in strong and clear D. X. stations you never heard before.

If your dealer has no Fil-Ko-Stats in stock, send his name and your remittance direct to

RADIO STORES CORPORATION

Sole International Distributors

Dept. R8 . . . 218-222 West 34th Street, New York

**2000 Miles on 1 Tube
with a FIL-KO-STAT**

*From Paul H. Woodruff
Editor Industrial Power, Chicago.*

"I am of the opinion that the Fil-Ko-Stat is the best filament control and have recommended it highly. It is a fact that, I picked up two Los Angeles stations, KHJ and KWH with a single tube regenerative detector shortly after installing it."

*Recommended and sold by
dealers in high quality
radio supplies.*

Takes the place of your rheostat!
Occupies little space on panel.
No redrilling necessary.

Made and guaranteed by



PRICE

\$2

The filament kontrol

of infinite adjustment

FIL-KO-STAT

DISTINCTLY DESIGNED TO UTILIZE THE GREAT TUNING POSSIBILITIES OF THE VACUUM TUBE ITSELF.

Tell them that you saw it in RADIO



NOBODY WANTS TO WEAR HEAD PHONES DURING HOT STUFFY WEATHER

A small efficient Loud Speaker ruggedly built will be welcome in any camp outfit. The AUDIOPHONE Jr. is just the thing.

Light in weight and easily assembled or dismantled without tools. Doesn't require any battery. The tone quality is exceptional and enough volume to entertain the whole camp party.

See it at your dealers or write direct.

THE BRISTOL CO.

Waterbury, Conn.

Bristol Audiophone
made in two sizes—
AUDIOPHONE SR.

Diameter of horn,
15-inches.

Weight, 10-pounds.

Price, \$32.50.

AUDIOPHONE JR.

Diameter of horn,
11-inches.

Weight, 7-pounds.

Price, \$22.50.

Bulletin 3006-W de-
scribes them.

Boston
Detroit

New York
Chicago

Philadelphia
St. Louis

Pittsburgh
San Francisco

New York Coil Company's Radio Products



Perfect Radio satisfaction throughout entire Summer with loop or indoor aerial with two stages Radio Frequency, employing our new Radio Frequency Transformers at but \$4.00 each. Totally unlike any other. All difficulties eliminated. Regardless of previous disappointments, these Transformers will do what others claim. No extravagant unsubstantiated claims. Money back guarantee. A few dollars will construct a Set equal or superior to any made, and you can build it. They work on the new wave lengths.

A NEW Receiving Set at \$18.00

A NEW Inductance Switch at \$1.50

A NEW Vernier Condenser at \$1.00

Our Mica Fixed Condensers are Interesting

All described in new literature

"The line of no disappointments"

NEW YORK COIL COMPANY

338 Pearl St.

N. Y. City, N. Y.

VARIOMETER—WORK-RITE

Given free with two subscriptions to
"RADIO." Send us \$5.00 and get
this free radio premium.

"RADIO"

San Francisco, Cal.

Continued from page 48

looker in B.C.1492 or before, but as was she was a nut-cracker. She had a couple of chins, and a mean eye, and a handsome moustache, and her general build was a cross betwixt a circus tent and a stevedore. When we gets the first look at her, she's got a gag between her teeth and her hands tied. Further, she is that mad, she could have et a couple of shovels and never noticed it.

"You done fine by her," says Jimson to Ruiz, real sarcastic. "You couldn't have treated her nicer, was she yore own mother-in-law."

Jimson unties the lady whilst I lines Ruiz up against the wall where he's safe. When the Senorita gets her breath, she cuts loose. For a delicate female, she sure swung a mean bunch of words. The way she goes up and down on Ruiz' ancestors was neat and purty. For a time I thinks she's maybe gonna flam her boiler, the steam she's carryin'. But by and by, she begins to kinda run out of cuss words. Jimson has to hold her or she would have clawed Ruiz up to a finish.

"Come on," says Jimson. "We got work to do. You said enough for awhile. Write him the rest. We got to be movin'."

The lady sees the point and we starts out. The messenger says once we get out of the place he'll find Peri for us. He seems kinda puzzled because Peri aint around. Ruiz declares he aint seen him.

So we parades out. Some of the carcasses we has left down the hall was comin' to life. Ruiz, with Kid Colt under his ear palavers to 'em in choctaw, and we goes through all nice and safe, the which was lucky for him, because I sure would have blew his works north was there any funny business. Outside we bumps into Peri, all out of breath, and still full as a goat.

"Ah — thee bee-eautiful Senorita — safe, safe, safe!" say he. He kisses her hand and she puts her foot in his face and gives him a shove.

"Where you been while the party was on?" asks Jimson.

"I have try, senors but, alas — I could not," says he, beginnin' to weep.

"Now aint that too bad," says Jimson. "I never know it to look at you."

After he snivvles a bit, we finds out that some friends of Ruiz has locked him up in the back room of a bum cafe whilst they was workin' on us. Only just now has he got away.

"Hum," says Jimson, givin' Ruiz a mean look. "I reckon we got quite a few to settle with this maverick."

"Not here, senors," says Peri, lookin' 'round. "Maybe soon come soldados and then—all will be lost. Come—we hurry."

We did. He snakes us down alleys,

Continued on page 52

MURDOCK HEAD SETS

No. 56 "SOLID"

Best at any price!

15 years of "knowing how" by the largest and oldest manufacturer of head sets. There are more Murdock Head Sets in use than of any other make, and probably as many in use as all other makes.

Because

All parts are moulded into a solid mass so that nothing can get loose or out of adjustment.

No head sets are more carefully adjusted and tested, but the final test is your test. If head set is not in your opinion equal to any head set at any price, return it within 14 days to the dealer and get a new one or get your money back. We will reimburse the dealer.

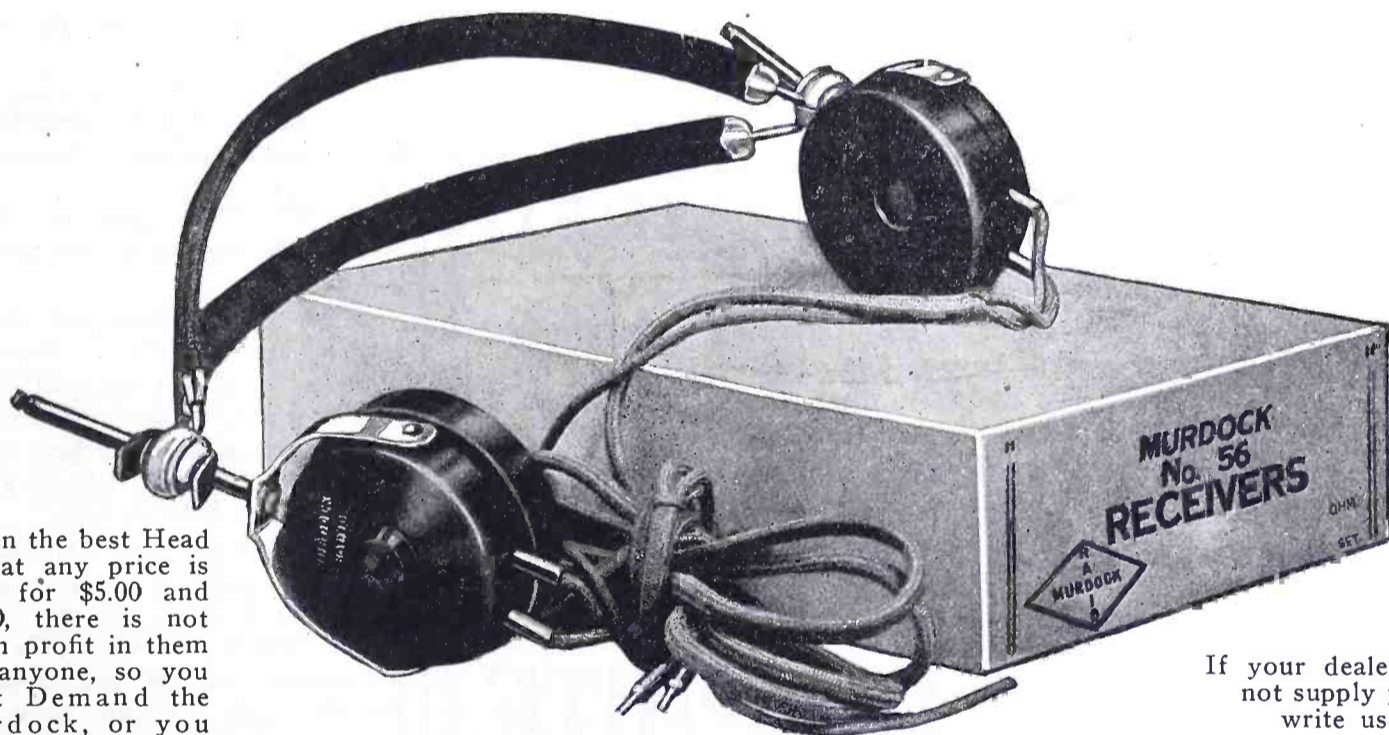

When the best Head Set at any price is sold for \$5.00 and \$5.50, there is not much profit in them for anyone, so you must Demand the Murdock, or you may not get it.

Write for free catalogue.

If your dealer cannot supply you write us.

No. 500 Loud Speaker
\$5.00
Equal to any loud speaker
at four times the price.

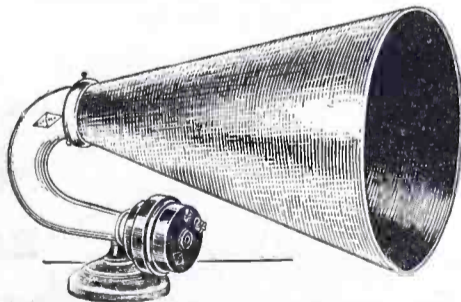

We will replace within 14 days any loud speaker that is not satisfactory.

Complete Stock of All Murdock Radio Apparatus Carried
in Warehouses of Pacific Coast Agents.

KEELER WHITE COMPANY

509 Mission St.
San Francisco

211 So. San Pedro St.
Los Angeles, Calif.

Polson Bldg., 71 Columbia St.
Seattle, Washington

Tell them that you saw it in RADIO

The Best Headset



At Your
DEALERS
\$5.00

Highest Audibility
Perfect Matching
Greatest Volume

Why Strain Your Ears?

"T-B-H" Head Sets reproduce clearly and naturally. No "Fuzz" or "Tinny" tone. Extremely sensitive.

Aluminum cases—6 Foot cord—Weight 12 oz.
Type 6-A 17500 Turns (2200 ohms) Hard Rubber caps.....\$7.00
Junior 16000 Turns (2000 ohms) Composition caps.....\$5.00

If your dealer does not carry them : Dealers and Jobbers
he will order them for you. Write For Discounts

The T-B-H Corporation
Dansville, New York, U. S. A.

DISTRIBUTORS:
The Eastern Specialty Co., Phila- Donaldson Radio & Service Station, Marie A. Alvarez,
delphia, Pa. (Metropolitan Dis- Kansas City, Mo. Havana, Cuba.
trict & South Atlantic States.) (Southwestern States.) (Cuba)

RADIO TUBES REPAIRED \$1.50 \$1.50 \$1.50

Send old tubes with \$1.50 and receive by return mail a guaranteed tube. Be sure and state in your letter type wanted.

DETECTORS OR AMPLIFIERS
NEW TUBES—CUT PRICES

Price List of New and Repaired Tubes Free!

UV201 \$3.50 - - WD12 \$3.50

RADIO TUBE EXCHANGE

453 WASHINGTON ST. W. H. BRYANT BOSTON, MASS.

ELECTRIC SOLDERING IRON

EVERY RADIO FAN has been looking for this iron for both radio and home use. Operates on A. C. or D. C. current.

\$2.28

GUARANTEED one year. Sent anywhere in U.S. or Canada. Parcel Post prepaid on receipt of money order for \$2.28.

FANS Send 2c stamp for our list of RADIO BARGAINS

RADIO BARGAINS
17 N. LA SALLE ST. - CHICAGO

Marle Transformers

Audio and
Radio
Frequency

Superior
Quality
Reasonably
Priced

Ask Your Dealer!

Manufactured by
MARLE ENGINEERING CO.
Orange, N. J.

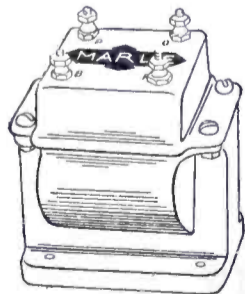

RUSONITE

CRYSTAL RECTIFIER

MULTIPOINT

(Patent Pending)

THE PERFECT SYNTHETIC
CRYSTAL DETECTOR

SENSITIVE OVER ENTIRE SURFACE

No hunting for "Spots." Loud and Clear. Endorsed
by Thousands of Satisfied Users.

Sensitiveness Price
Guaranteed Mounted **50c**

14 K. Gold Supersensitive
RUSONITE CATWHISKER, Price **25c**
Permanent. Will not Oxidize.

RUSONITE REFLEX CRYSTAL
Manufactured Expressly for Reflex Circuits.
Will Stand Up Under Heavy Plate Voltage
Guaranteed Price **\$1.00**
Mounted

Order from your dealer or direct from
RUSONITE PRODUCTS
15 Park Row. New York, N. Y.

Long Distance

Crystal Set

We receive prog-
rams from Atlanta
Minneapolis, Davenport, Fort Worth, Dallas, Kansas
City, St. Louis, Denver on Crystal without batteries.
Usual crystal set requires only easy, inexpensive
changes. Send stamp for further information or \$1
for copyright drawings and instructions. Everything
clearly explained. Satisfaction GUARANTEED.

Leon Lambert, South Volutsia, Wichita, Kan.

Continued from page 50

and up dirty streets. After a time we comes to an open space. I sees a couple of poles stickin' up. Jimson grins.

"Ha," says he. "Radiotelegrafico,"

"Si," says Peri.

Ruiz acts kinda nervous, as does the messenger who has been trailin' along, lookin' for a chance to stick his knife in Ruiz when I aint lookin'. Peri digs up a key and we goes inside. Its a wireless station, all o.k., with plenty of wires, and switchboards and such truck. Peri bows.

"All—at the service of the senor," says he to Jimson. "The yacht is but wait the word. While the senor is call thee yacht-Peri will accompany weeth the boo-tiful Senorita to thee hotel and secure thee theengs for travel. Yes? No?"

That's all right with us, and as the Senorita seems willin', we lets 'em amble off—Peri bowin' and scrapin' and the messenger bozo trailin' along behind. Ruiz we sits in a chair whilst Jimson does the honors with the machinery, after lightin' up.

There's a call book hangin' on the end of the table and after a lot of huntin' Jimson final finds the name of the yacht—El Mirador.

"WVXO," says he, yankin' a switch like the op on the SS Mahoney shows him.

A lot of generators and things starts movin' and growlin'. Ruiz was for climbin' the side of the wall but I makes him sit tight. Jimson tries out the key and he gets a lot of racket.

"All set," says he, like he knew what he was doin'.

"Here's hopin'," says I, rollin' myself a long one.

Whilst I puffs, Jimson works the gears. There's a lot of radio racket and a funny smell, and a spark crackin' up on the wall. Jimson calls over and over again. Then he takes a listen with a dinkus he clamps over his bean.

"Don't hear nothin'," says he.

"Push down harder on the key," says I. "Maybe she's a long ways out."

He does. He raises hell, to tell the truth. He makes more noise'n a couple of Irish at a Swede picnic. But every time he stops and lissens, he hears the same thing—nothin'. Me—I gets restless and Ruiz is so plumb scared he aint breathin' without I say so. Finally right in the middle of the fuss, we hears a thump-in'.

"I got 'em," says Jimson. "Somebody just knocked over a chair on the upper deck," he says.

"Nothin' like it," says I. "It's somebody knockin' at the door."

I backs that way, keepin' Ruiz covered, and turns the knob. The next minnit I'm layin' on my back with a soldier sittin' on my chest and the whole

Continued on page 54

BIG RADIO MAP FREE!

A wonderful two-color radio map 27 in. x 34 in., showing location of all radio broadcasting stations—Navy and Army stations—Canadian stations, etc.

**Free with
one subscription to
"RADIO"**

This map is divided into four divisions of time—Pacific, Mountain, Central and Eastern time.

*Limited Supply of these
Maps on hand.*

Use the Coupon—
Mail it Now.

RADIO, Pacific Bldg.,
San Francisco, Cal.

I enclose \$2.50. Send
"RADIO" for 1 year and the
big free radio map.

Name

Address

Where is 469 Meters?

The new radio regulations, assigning special wavelengths to each station, make it necessary to know the wavelength of each setting on your receiving set. The WAVOMETER will tell you this. From it, you can adjust your set to any desired wavelength. Instead of hunting half the schedule for your favorite station, set your dials from the WAVOMETER and be on the wave when the program begins.

Works with any receiving set.

Range 180 to 600 meters.

Easy to operate.

Accurately calibrated.

Radio's most interesting experiment.

Price \$6.50 Postpaid

E. M. SARGENT CO.

"An Exclusive Radio Supply House"

1200 Franklin St.

Oakland, Calif.



Natural
Re-PRODUCTION
Atlas
AMPLITONE
LOUD SPEAKER

\$25

NO BLAST or distortion. Its exclusive, patented feature,—the adjustable, double diaphragm,—produces the radio programs in their original naturalness. Tuneable to your set and receiving conditions.

Let your ears be the judge. Hear the Atlas Amplitone at your dealers.

Atlas AMPLITONE Unit
The double diaphragm unit for use with your own base or horn or with phonograph attachment.....\$13.50
Unit without attachment.....\$12.50

Write **TODAY** for Booklet "E"

E. F. BALDWIN, Representative
550 Howard St., San Francisco, Cal.

Multiple Electric Products Co. Inc.
ORANGE ST. RADIO DIVISION NEWARK, N. J.

TUBES REPAIRED

We repair six volt vacuum tubes and guarantee them to work like new.
Money refunded if not satisfied. Eight hour service.

Detectors, \$2.50 **Amplifiers, \$3.00**

Broken Glass Shells replaced—No extra charge

MAIL ORDERS RETURNED C. O. D.

AL. D. BERGEZ CO.

Dealers Write for Special Proposition

172 Fifth Street

San Francisco, California

Continued from page 52

bunch of us is under arrest. All except Ruiz. I looks over at Jimson and they's six uniforms kinda wrapped around him. There's about twenty of 'em in the place.

The boss, a little coyot' with a sword hands out a line of talk to us, the which I don't make nothin' of. Jimson, however kinda tumbles.

"Stung," says he, and quits fightin'. The uniforms seems real relieved and lets him stand up.

"What's happened?" I asks.

"We're pinched," says Jimson.

"For what?" I asks. "Aint we aidin' the government?"

"We didn't have no permit to work the government's radio station," says Jimson.

"That's all right," says I. "When Kid Napoleon here knows the facts, he'll shake us by the hand," I says.

"Maybe," says Jimson. He begins to palaver, usin' high grade espanole, the which aint taught in gradin' camps where I learns mine. Then Ruiz chimes in on the party, and he and Jimson and Napoleon has a good time, with plenty of hand-wavin'. Final, Napoleon makes a speech and Jimson sits down kinda of weak.

"Holy mackerel!" says he, weak-like.

"What now?" asks I.

Jimson gives me a look like a cow what's tired and would rather sleep.

"We're smugglers," says he.

"Oh, are we?" says I, plumb sarcastic. "Who says so?"

"This here Ruiz person," says Jimson. "We snuck in here and was tryin' to signal our gang," he says, "when the loyal troops of el gubernante catches us at it, cold. This here Ruiz is a secret agent," he says, "an' he's been watchin' us for days. There aint no such person as Peri, and the Senorita never was."

Slow and dismal them remarks soaks in. I sees it all. We has been framed. As it stacks up, we is in about as bad as it is possible to be.

"I paid twenty-five thousand pesos for that yacht," moans Jimson, holdin' his head. "Now they say there aint no yacht."

Somethin' flashes in my head.

"Lissen," says I. "There's a port-hole," says I.

Jimson raises his head and looks at me.

"How come?" he asks.

"Pesos is pesos," says I. "And you know the customs of this country," says I.

I sees Jimson's face light and I knows the shot has gone home. For, when we leaves the Useless Mahoney to come ashore we has about a million pesos strapped around us in money belts. For half that amount, we could have bought the whole government.

Continued on page 56

NEW!

TUBES			
UV199	\$ 6.50	C301A	\$ 6.50
C-299	6.50	OT 1-A	6.50
UV200	5.00	UV202	8.00
C-300	5.00	UV203	30.00
UV201	5.50	UV216	7.50
C301	5.50	WD11	6.50
UV201A	6.50	WD12	6.50

NEW!

VERNIER VARIABLE CONDENSERS

VARIABLE CONDENSERS
17 Plate K & C.....\$3.50

UNITED 26 plate..\$5.50	UNION	HEATH, 23 plate..\$5.50
UNITED 46 plate. 6.50	CONSTRUCTION	MIGNON, Balanced,
Kellogg 23 plate.. 7.75	COMPANY	.00047
Kellogg 43 plate.. 8.75	23 plate.\$6.00	.00075
	43 plate. 7.00	.0015

NEW!

REFLEX TRANSFORMERS ERLA.....	\$5.00
RADIO FREQUENCY TRANSFORMERS ERLA, 1, 2 or 3.....	4.50

DUBILIER CONDENSERS

MICADONS: 00025.....	35c
.001.....40c 003.....	40c
.002.....40c 006.....	75c
K & C Grid Condensers..	25c
K & C Mica Condensers:	
.001	60c
.002	75c
.006	\$1.00

VARIABLE GRID LEAKS

FRESHMAN	\$1.00
FRESHMAN (without	
condenser)	75c
C. R. L. with condenser	\$1.85
C. R. L. without cond...	1.50
DURHAM VAR. GRID	
LEAK	75c
REMLER GRID LEAK..	40c

PLUGS

CARTER, double.....	\$1.50
Carter, Single.....	1.00
Four Way Plugs.....	\$1.50
Pacent	50c
Frost	60c

CITIZENS CALL BOOKS 50 CENTS

MISCELLANEOUS

Fleron Vernier Adjusters.....	65c	American Beauty Soldering Irons.....	\$6.50
Series Parallel Switches.....	55c	Post Electric Soldering Irons.....	6.00
Solderall	25c	Solderette	1.50
Soldering Irons	\$2.50		

IF IT'S NEW, WE HAVE IT!

Standard Sets or Parts Always in Stock

THREE STORES

WARNER BROS.

THREE STORES

350 Market Street San Francisco 428 Market Street

Oakland--Twenty-second and Telegraph Avenue

Get a Lefax Radio Hand-book Free

Subscribe to "RADIO" for 18 months (\$3.75) and we will send you the \$3.50 Lefax Book Free!

"RADIO" San Francisco

The choice of foremost Engineers for over 17 years.



Sold by all dealers

BRACH
VACUUM RADIO PROTECTOR

Approved by the National Board of Fire Underwriters

Ask YOUR Insurance Agent

L.S. BRACH MFG. CO., Newark, New Jersey

SOLDERALL

Metal in Paste Form



Handy Tubes Every Electrical Connection Needs

Solderall for Perfect Reception The Only Convenient Metal Solder

SAVE MONEY!
Turn to Page 73

Amplification perfection

with an audio transformer means PURE TONE QUALITY with MAXIMUM VOLUME.

The AMERTRAN

AUDIO TRANSFORMER



Price \$7 Ask your electrical dealer, or sent carriage charges collect. (Wt. 1 lb.)

is acknowledged by professional radio engineers to be the Standard of Excellence for audio amplification.

The reason for the popularity of the AmerTran among professional radio men is apparent in the Amplification Chart shown in our Circular No. 1005.

Turn ratio, 5:1. Amplification ratio, 30-40 times audibility in the flat part of the curve.

American Transformer Company

Designers and builders of radio transformers for over 20 years.

174 Emmet St. Newark, N. J.

Pacific Coast Office Rialto Bldg., San Francisco

THE GOTTSCHALK

TRADE MARK

Loud Speaker that gained such rapid popularity

Not merely a head-phone instrument



The Latest Development to produce a loud speaker that surpasses anything on the market at any price

Powerful Volume Producing Mica Diaphragm Element

Employed In An Entirely New Manner

Assures Maximum Clarity With Total Elimination of Distortion

Patent Pending

Will Positively Not Rattle

No Metallic Ring—Beautifully Finished Moderately Priced

Greater Volume with Less Energy

Supersensitive for Long Distance Reception

The Price: **\$22.00**

Dealers—Write at once for trade proposition.

GOTTSCHALK ELECTRIC & MANUFACTURING CO.
992 Howard St., San Francisco

RADIO MAPS of U. S.

35c Postpaid
"RADIO"
Pacific Bldg.
San Francisco

RADIO "BUGS" Get Into Business For Yourself

Why not turn your hobby into money? You can easily make \$15.00 a day, or as much more as you like, by our wonderful plan of selling Radio direct to the millions of people just waiting for our better parts or sets. We furnish everything you need at lowest factory prices and tell you how to build a profitable business of your own.

Knott products are up to the minute. Knott plans are unique and unbeatable. Radio is just beginning to come into its own. Are you? Want to make more money? Want to be your own boss? Write TODAY for FREE instructions How to Sell Real Radio.

E. R. KNOTT MACHINE CO.
1-H. Ellery St. S. Boston 27, MASS.



High Efficiency
HEAD SETS

- Army and Navy Type:
2500 ohm, per pair.....\$10.00
3200 ohm, per pair.....\$12.00
Swedish-American Type:
2200 ohm, per pair..... \$8.00
Victor Type:
Double pole, single coil, per pair \$6.00
Keystone Type:
Double pole, single coil, pr. \$5.00

American Electric
COMPANY
CHICAGO, U. S. A.
For 30 Years Makers of Good Telephones

NOVO "B" BATTERIES

with insulated binding posts and 7" Copper Wire Connectors

Pacific Coast Representatives

MARSHALL & CO.
Union League Bldg., Los Angeles, Calif.

FREE VACUUM TUBE RADIO SET

The Set you always Wanted, FREE
A real RADIO SET—Listen in on Concerts, Lectures, Singing, etc. Can receive 75 to 100 miles and more.

RUSH your name and address and we will tell you HOW you can get a VACUUM TUBE RADIO SET

ABSOLUTELY FREE

Don't delay. Write today for FREE RADIO PLAN
Home Supply Co.
Dept. 878
181 Duane St. New York

"Hear it by Radio"
Denver's Largest Exclusive Radio Wholesalers
PARAGON DISTRIBUTORS
THE ROCKY MOUNTAIN RADIO CORPORATION
1512-1516 Broadway Denver, Colorado

Continued from page 54

"Righto," says Jimson, and he leads Napoleon aside.

From where I sits, with a couple of soldados on me, I sees the move has Ruiz puzzled. He tries to horn in but Napoleon waves him to one side and listens right steady to what Jimson's sayin'. The way Jimson offers to bribe him would have done the heart of any grand jury good. Finally he gives in, although I aint seen him tryin' to keep away from temptation none—much. When I sees him grin, I knows we are settin' pretty.

"I'll give him what I got," says Jimson, speakin' to me in code, "an' you stay submarine about the rest," he says.

I nods, showin' I understands, and Jimson unfastens his shirt and begins to claw. Then he gives a wild yell.

"They got it," he shrieks. "Them dirty, low-down bozos back there in that hallway got it," he yells.

I clamps a sick hand on my own stomach and finds out they done me dirt too, the which I hadn't noticed up to that moment. We was nicked, cool and purty—for the whole business. Napoleon looks kinda puzzled. Then he gets mad.

"Weno," says he and gives a command.

We is both yanked to our feet and pointed out the door. I gets a glimpse of Jimson and tears is runnin' down his cheeks.

"They got it," he says, "the cock-eyed wampuses got it all," he says.

Me I'm that full I couldn't have lifted my hand to my own grandmother.

And that's how we come to get four months in jail for somethin' we didn't do.

This was in May. September 1, they lets us out. I aint tellin' nobody how we spent the time in between. Only I know we got madder day by day until the guards took to shovin' food through the bars to us instead of bringin' it in. The American consul sees that we gets transportation back to the states, but he aint very friendly.

Me—I makes the mistake of tryin' to explain what happened and how we was framed for tryin' to help a bee-ootiful Senorita out of a jam, but the consul holds up a hand.

"I aint asked you boys no question," says he, "and I aint aimin' to. It's enough you're Americans and wants to go home. The records shows you was smugglers and beat up a prominent citizen, one Valesquo Ruiz, staged a riot in a prominent cafe, attacked a number of soldiers, tried to shoot a policeman, broke a window in the bank, set fire to a hotel, and took vi'lent possession of government property. Outside of that you was peaceful and law-abindin'. My

Continued on page 58

Tell them that you saw it in RADIO

Chelsea Condensers



No. 1

PRICES:

No. 1 Table.....	.001	\$5.00
No. 2 Table.....	.0005	4.50
No. 3 Panel.....	.001	4.75
No. 3a Panel without dial..		4.35
No. 4 Panel.....	.0005	4.25
No. 4a Panel without dial..		3.85
No. 5 Panel.....	.00025	3.75
No. 5a Panel without dial..		3.35
No. 6 Panel vernier.....		2.90
No. 6a Panel without dial..		2.50
No. 7 Table with vernier....		6.75
No. 8 Panel with vernier....		6.50

Genuine Bakelite Construction

The best and most complete line of condensers in existence.

Write for our catalog No. 7

Chelsea Radio Co.
152 Fifth Street
CHELSEA, MASS.



"Read'em" Binding Posts

With knobs that won't come off

Anyone can "read 'em." Irremovable knobs. All popular styles—Antenna, Ground, Fones, A and B Battery plus and minus—abbreviations of different names engraved on knobs. Radio users—ask your dealer for "Read 'em." Dealers—write for our proposition on this big seller. Write Dept. B for liberal profit proposition.

The Marshall-Gerken Co.
Manufacturers
Toledo Ohio



Speaking of Portable Sets—

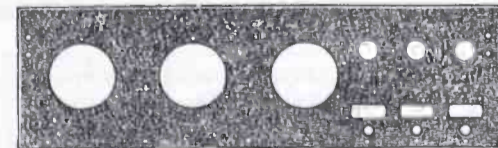
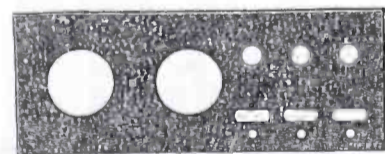

AN ideal vacation set may be built with these units.

No special packing case is required, owing to the absence of protruding knobs and smooth surface of panel.

The concave dials, aside from adding attractiveness to a receiving set, increase its utility.

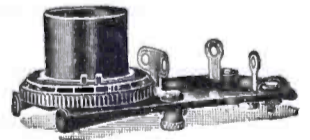
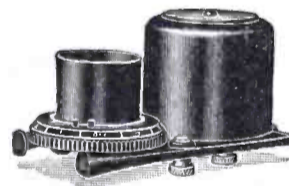

Descriptive literature on request.

EISEMANN MAGNETO CORPORATION

William N. Shaw, President
BROOKLYN, N. Y.

DETROIT

CHICAGO

SAN FRANCISCO

Tell them that you saw it in RADIO

A 5-WATT RADIOPHONE

Continued from page 16

The filter consists of two Acme 1½ henry choke coils and two 1-mfd. Western Electric Co. condensers No. 21 AA tested for 1000 volts.

Two mica condensers are necessary, one .0008 mfd. capacity for the grid

be said that you will learn more in half an hour's tinkering with it than could be written in a volume.

This set is very compact and if you are interested in a small transmitter it is just the one you ought to build.

This set can be built with the key switch on the same panel for changing

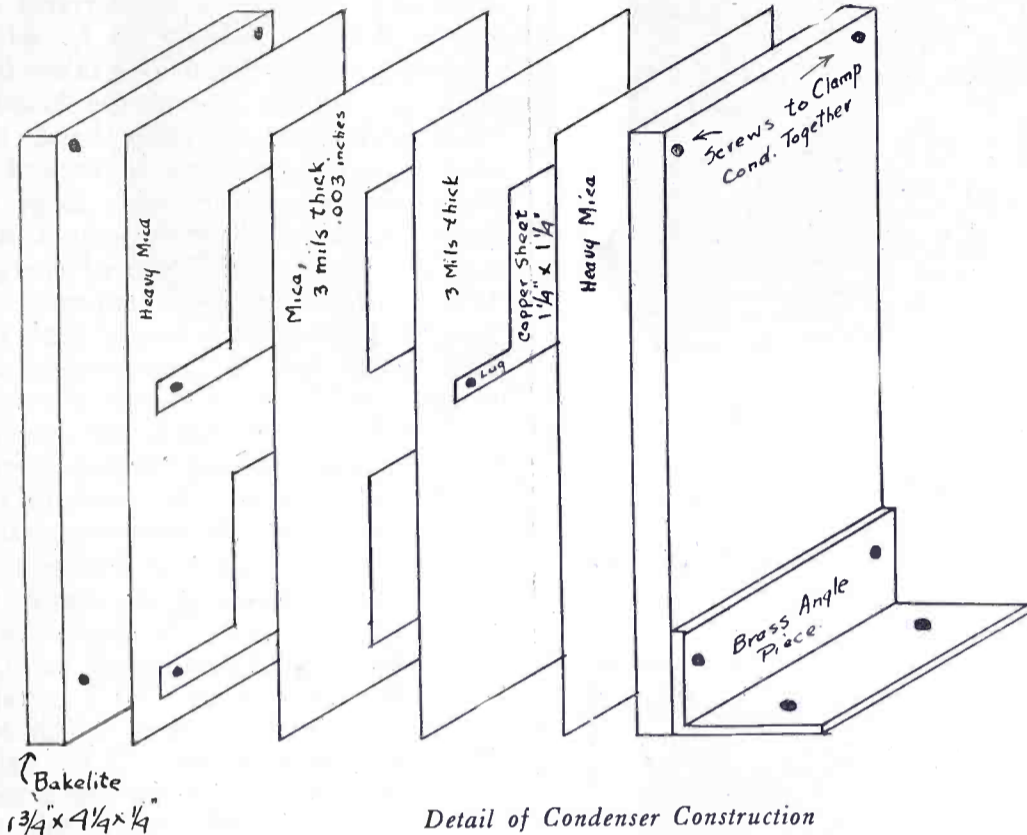

Detail of Condenser Construction

circuit, and one .0015 mfd. for the antenna circuit. They can be made into one unit as shown. This will save space and labor. The grid condenser consists of two pieces of copper foil 1¼ in. square separated by a sheet of mica .003 in. (3 mils) thick. A heavy piece of mica is put on both sides of the condenser to keep it from touching the bakelite plates. The antenna condenser is made up of three pieces of copper foil 1¼ in. square separated by two pieces of 3 mil. mica. After these parts are finished the two condensers are clamped between the two bakelite plates and the piece of angle brass is used to fasten it to the base.

After everything has been set up and is ready for a trial throw in the 110-volt switch and start to form the rectifier plates. The transformer secondary should be watched carefully as it will get very hot because the rectifier is a dead short circuit on it until the plates are formed. The forming will take 15 or 20 minutes and the transformer should only be put on for two or three minutes at a time and then allowed to cool off. Once the plates are formed no further trouble will be experienced with the secondary heating.

The modulating is done by placing one turn of heavy wire around the middle of the inductance and connecting a microphone of low resistance to it.

As to the operation of the set, it can

from sending to receiving and cutting in the 110 volts on the transformer or this switch may be left out and an external switch used with the set.

**Big Money
for YOU in
RADIO**

**Earn \$50 to \$250 a Week
Spare Time or Full Time Positions**

Amazing expansion of radio has opened up thousands of wonderful positions. Thousands of men needed as radio mechanics, salesmen, inspectors, draftsmen, broadcasting operators, ship operators, executives, etc. Qualify for one of these finest positions in radio or earn big money in spare time erecting, building, selling, repairing radio sets.

Easy To Learn At Home

You can easily and quickly become a Certified Radio-trician at home in spare time through the help of National Radio Institute, the Oldest and Largest Radio School in the World. Radio experts help you. Instruments supplied with course.

**Write For New Book
"Your Opportunities in Radio"**

Learn more about the amazing opportunities in this world's fastest growing industry, and how YOU can easily qualify for a big pay spare time or full time position. Mail post card or letter NOW.

**NATIONAL RADIO INSTITUTE
Dept. 10-G Washington, D. C**

Tell them that you saw it in RADIO

"A-B-C of Radio"

*An illustrated
non-technical
radio book*

25c Per Copy

**"RADIO"
Pacific Building
San Francisco**

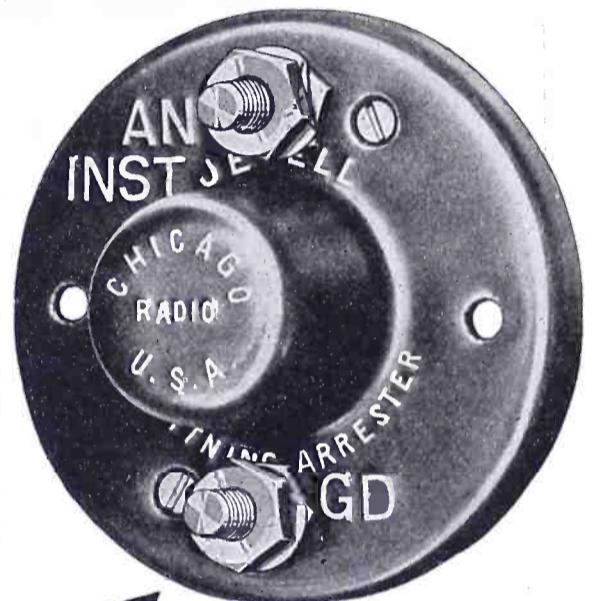

**JEWELL
LIGHTNING
ARRESTER**

**Approved by
Underwriters**

The latest regulations of the National Board of Fire Underwriters call for a lightning arrester on every building having an outside aerial.

The Jewell Arrester has passed all the Underwriters' tests and carries their approval.

The case is made of porcelain with a brown finish that harmonizes with interior woodwork. The price is right.

PRICE \$1.10

ORDER FROM DEALER

**JEWELL ELECTRICAL
INSTRUMENT CO.**

**1650 Walnut St.
Chicago**

Introducing the "SR 25"

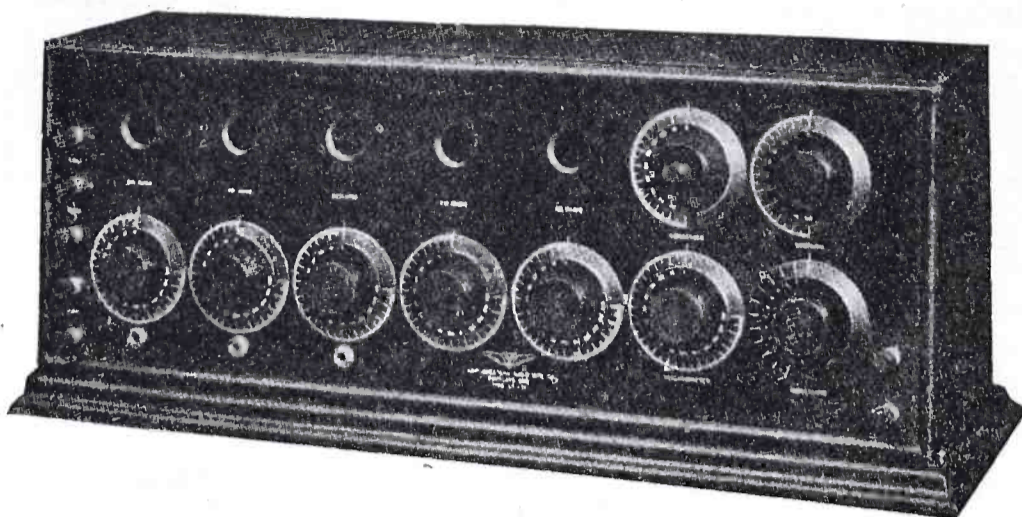

WE INVITE YOUR ENQUIRIES

Hallock and Watson Radio Service

192 Park Street

"KGG"

Portland, Ore.

"UNITED"

*Radio Instruments Will Multiply
the Joy of Your Radio Evenings*

Our new million dollar plant with its unequalled equipment of precision tools and our staff of trained radio experts have enabled us to develop condensers and transformers which offer

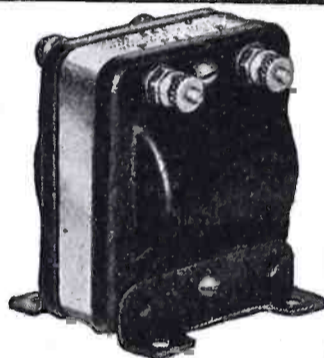

- 1—Finer tuning, under more perfect control.
- 2—Clearer reception, from any distance.
- 3—Welcome freedom from discordant noises.

"United" Audio-frequency Amplifying Transformer Magnetically shielded, Ratio 5 to 1. Price \$4.50.

"United" Variable Condensers, with new Vernier Dial Adjuster

43 plate \$6.50	11 plate \$5.50	3 plate \$4.75
23 plate 6.00	5 plate 5.00	Postpaid

Try your Dealer First. If he does not carry the line, remit to us and give us his name and address.

UNITED MFG. & DISTRIBUTING CO.

9705 COTTAGE GROVE AVENUE

New York Office:
50 Church St.
New York, N. Y.

CHICAGO,
ILL.

San Francisco Office:
709 Mission St.
San Francisco, Cal.

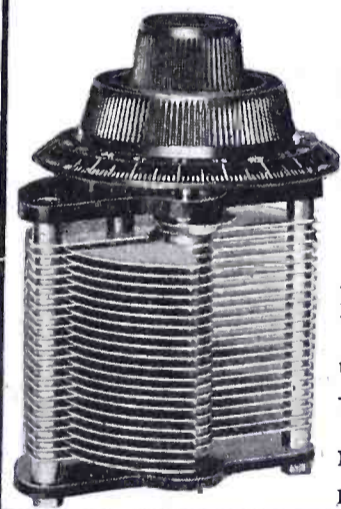

"B" BATTERIES

AN
EVEREADY
PRODUCT

43V. Batteries, tapped.....\$5.00
22½V. Batteries, Navy Type..... 3.00
22½V. Batteries, Commercial Type..... 2.00

Latter two types especially adapted to
Cunningham and Radiotron Tubes.
Postage Prepaid Anywhere in U. S.

ETS-HOKIN & GALVIN

Wireless Engineers

10 Mission Street

San Francisco

"EURACO PRODUCTS"

(Guaranteed)

Compact — Interchangeable — Accurate
Most Efficient



Price 60 cents per Unit
Mfgs. of

MICA CONDENSERS, GRID LEAKS,
MOUNTINGS

Interesting Proposition for Dealers

European Radio Company

1342 East 22nd Street

Brooklyn, N. Y.

RESONANCE PHENOMENA

Continued from page 28

This problem may also be looked at from the point of view of energy distribution. If a circuit is well designed and sharply tuned as in Fig. 2 the amount of energy which is received by this circuit is confined in a very narrow region of frequencies, due to the sharp curve. Most of the energy is concentrated on one particular frequency as f_2 , while very little is distributed over other frequencies. In the case of the broadly tuned circuit, on the other hand, the amount of energy which is received is distributed over a very wide range of frequencies, all of them receiving a substantial amount of the received energy. As a result, since no one frequency receives very much more energy than another, there will be considerable interference. The more sharply a circuit is tuned the greater will be the amount of energy which is concentrated in the one desired frequency we want to receive, hence the less the interference and the greater the efficiency in reception.

The same considerations apply to transmitting circuits. A transmitting circuit has resistance, inductance and capacity also, hence it also has a certain resonance curve the shape of which depends upon its constants. If its resistance is high it will have a broad resonance curve, with the result that it will radiate energy over a broad range of frequencies. This means that it is not radiating most efficiently since its energy is scattered over a number of frequencies. Furthermore it means that it will affect receivers on different wavelengths, and hence will produce interference. Sharply tuned circuits will result in less interference and greater efficiency, and one way to secure this beneficial result is to design circuits with low resistance.

Not only does the resistance of the circuit influence the shape of the resonance curve and the sharpness of tuning, but the factors of inductance and capacity also have some effect. This is due to the fact that every radio circuit has what is called a *decrement* or *damping factor* which is proportional to the ratio of capacity to inductance. This decrement has the same effect as resistance. The greater the decrement the broader the tuning and vice versa. This means that if a radio circuit has mostly capacity and very little inductance it will have a very broad resonance curve, while if it has more inductance and less capacity the resonance becomes sharper. This does not mean that one should use all inductance and hardly any capacity. For if this is done it will be found that the resistance of the inductance coil, which increases as the inductance is increased since more wire is used, will counterbalance the advantage obtained

Continued on page 64

Tell them that you saw it in RADIO

WORKRITE TUNER TEAM

WorkRite Super Variometer

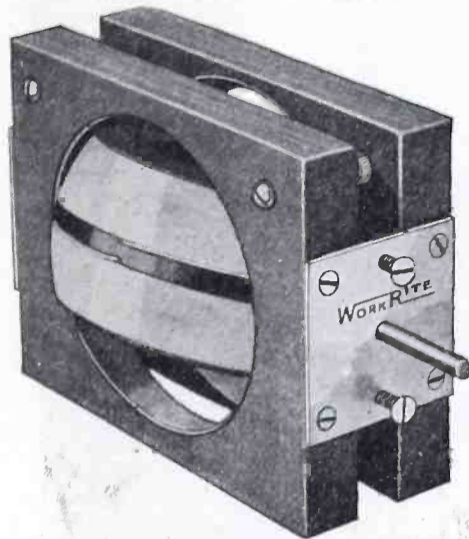

WorkRite 180° Super Variocoupler

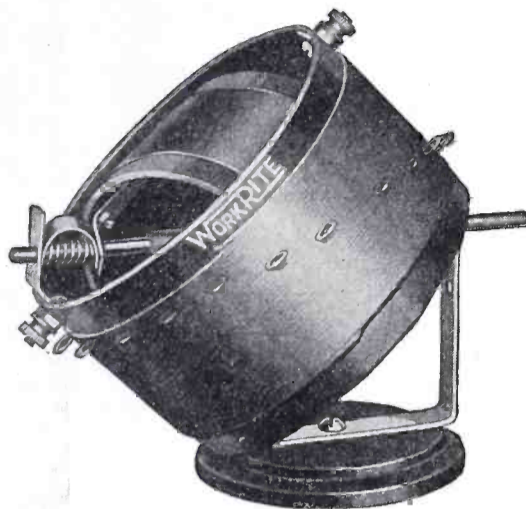

\$3.50

EACH

**Enormous
Production**

Makes

This

Price

Possible

Two WorkRite Variometers and one WorkRite Variocoupler make up the "WorkRite Tuner Team", the most selective circuit possible. The WorkRite Variometer is made from fine grade mahogany, handsomely finished. Very sensitive and sharp to tune. All metal parts are made from brass and nicked. The WorkRite 180° Super Variocoupler is made from moulded Bakelite. It is wound with green silk and has 12 taps. Range 150 to 705 meters. Look at this low price.

WorkRite Super Variometer.....\$3.50

WorkRite 180° Super Variocoupler.....\$3.50

New WorkRite Vernier Rheostat \$1.00

The latest and best in Rheostats. 50,000 adjustments for \$1.00. Pushing the knob way in turns off the filament. Turning the knob gives the very finest adjustment. Often a turn of 1/32 inch will clear up a station or separate two stations. This Rheostat is made with three different resistances so that there is a WorkRite Rheostat for any tube now on the market.

WorkRite Vernier Rheostat, 6 ohms..... \$1.00

WorkRite Vernier Rheostat, 15 ohms..... \$1.10

WorkRite Vernier Rheostat, 30 ohms..... \$1.25

WorkRite E-Z-Tune Dial

When you want to get a very fine adjustment on your variometers, variocouplers, condensers, etc., you always grasp your dial on the outer edge for more leverage. Right there is where you will find a knurled flange that just fits your grasp on the WorkRite E-Z-Tune Dial. You can easily make a turn of a hair's breadth. Made of the finest material, highly polished. Easily the "Snappiest" dial on the market. 3 1/2 in. diameter. Specify whether 3/16 in. or 1/4 in. shaft.

Price 75c

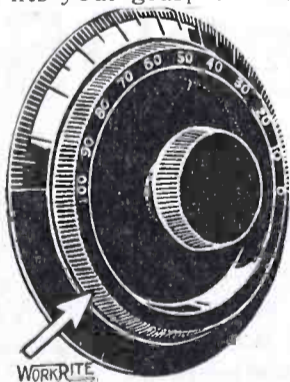

WorkRite Resistance Cartridge



No need to buy a new Rheostat to get the required 30 ohms resistance for the UV 199 Tubes or the 15 ohms for the 201A and 301A Tubes. Just put a WorkRite Resistance Cartridge in the circuit with your old 5 or 6 ohm Rheostat. Price 15 or 25 ohm.. **40c**

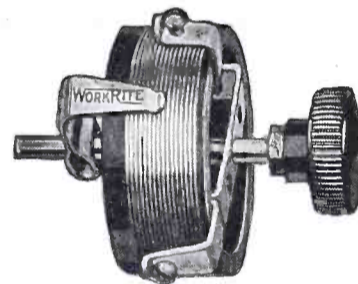

PATENT APPLIED FOR

WorkRite Nonmicrophonic Socket

Here is the right socket for your UV 199 Tube. It is moulded with a sponge rubber base in one piece which is even better than



the soft rubber recommended for use with this **60c** tube. Very neat and attractive. Price.....

Other WorkRite Products

WorkRite Hydrometer

You need one for your "A" Battery. Full instructions for the care of battery included with each instrument. Price 75c

WorkRite Switch Set

Just what you want. Remove parts and use the block for a template in drilling panel. Switch arms and points made to work together. Price complete, 50c.

WorkRite Concert Headset

Extremely sensitive and free from distortion. Phone cases made from aluminum. Try the WorkRite Concert Phones side by side with any on the market. Price \$6.00

WORKRITE NEUTROFORMER

An air-core transformer for use in the Neutrodyne method of receiving. Bakelite wound with the exact number of turns and spacing of green silk wire for maximum efficiency. Price \$2.00

THE WORKRITE MANUFACTURING COMPANY

5526 EUCLID AVENUE

Western Representative:
B. KRUGER, 231 Douglas Bldg., Los Angeles, Cal.

CLEVELAND, OHIO

Tell them that you saw it in RADIO

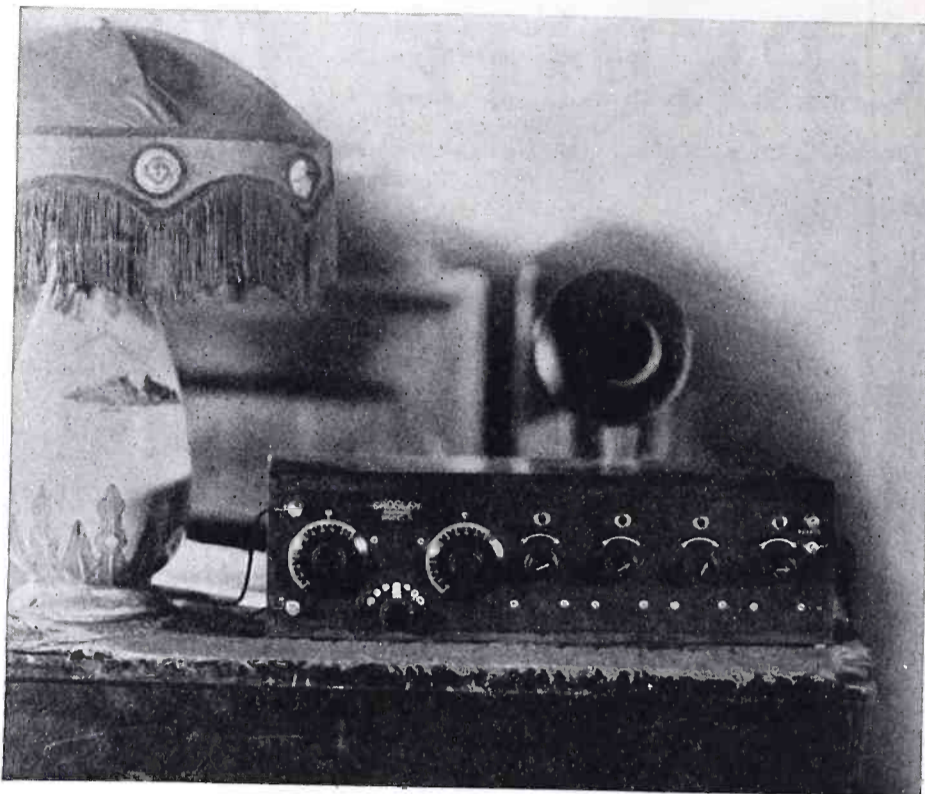

PERFECT PERFORMANCE

Crosley Model X Gives Better Radio Reception

The popularity of Crosley Model X is becoming more manifest each day.

This four tube set—still priced at \$55—maintains its marvelous record of bringing in distant stations.

A man writing from Chatham, Va., says: "First let me state I own a Crosley Model X and you couldn't buy it for the United States mint. I have picked up over 130 stations in the U. S. and have listened to Havana, Canada, North Dakota, San Francisco, all Texas, and ships at sea. Keep up the good work!"

You can depend upon an instrument bearing the name

CROSLEY

This name has been accepted as a guarantee of the highest quality at the lowest cost.

All Crosley sets are equipped with the Crosley multistat, the universal filament control rheostat for all makes of tubes.

Wave length range, 200 to 600 meters.

Other Crosley parts include: Variable Condensers, Knobs and Dials, V-T Sockets, Variometers, Vario Couplers, Rheostats and the well-known Crosley Radio Frequency Amplifying Tuner.

A Crosley Instrument performs everything claimed for it—and more besides.

For Sale by Best Dealers Everywhere

Write for Free Catalog

Crosley Manufacturing Company

819 Alfred Street
Cincinnati, Ohio

New York Office, C. B. Cooper, 1803
Tribune Bldg., 154 Nassau St.
Phone Beekman 2061.
Chicago Office, 1311 Steger Bldg., 28
E. Jackson Blvd., E. A. Stemm,
Mgr.

Boston Office, B. H. Smith, 755 Boyl-
ston St., Room 316.
Philadelphia Office, J. H. Lyte, 65
North 63rd Street.
St. Louis Office, Robert W. Bennett
Co., 1326 Syndicate Trust Bldg.

We announce a new model—to be known as Model X-J. This has all the features of Model X and in addition—new molded sockets, new rheostats, new condensers, with molded plates and jack for head phones. Price—\$65.

Tell them that you saw it in RADIO



Perfect Performance Guaranteed

A Type V, Armstrong Regenerative Receiver—\$20
ACE Formerly known as Crosley Model V. For performance
E no receiver at its price can equal it.

An Evansville, Ind., man writes: "The other night I tuned in Kamach, Hawaii, and held the concert for one hour. The music was clear and the speaking distinct." This is indeed a tribute to efficiency.

Ace Receivers are licensed under Armstrong U. S. Patent 1,113,149.

All Ace sets are equipped with the Crosley multistat, the universal filament control rheostat, for all makes of tubes.

Wave length range, 200 to 600 meters.

Ace Instruments perform all we claim—and more besides.

Live Jobbers and Dealers are eagerly taking advantage of the sales these instruments and the other Precision instruments and parts are bringing them.

Free catalog on request

New York Office, C. B. Cooper, 1803 Tribune Bldg., 154 Nassau St. Phone Beekman 2061.

Boston Office, B. H. Smith, 755 Boylston St., Room 316.

Chicago Office, 1311 Steger Bldg., 28 E. Jackson Blvd., R. A. Stemm, Mgr.
 Philadelphia Office, J. H. Lyte, 65 North 63rd St.
 St. Louis Office, Robert W. Bennett Co., 1326 Syndicate Trust Bldg.

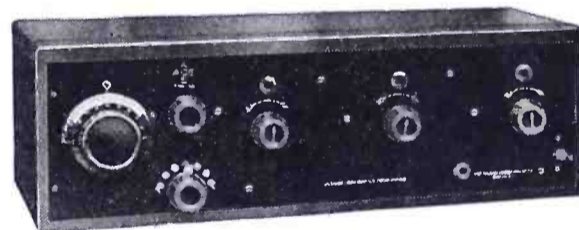

We announce the Ace Type 3B—a new 3-tube Armstrong Regenerative set with filament switch, jack, new Crosley molded sockets and condensers with molded plates. This is one of the latest and most efficient sets on the market today for steady performance.

THE PRECISION EQUIPMENT COMPANY

POWEL CROSLY JR., PRESIDENT

819 GILBERT AVE.

CINCINNATI, OHIO

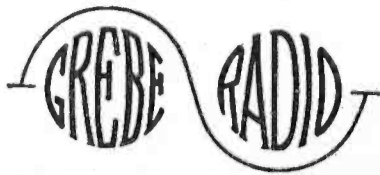
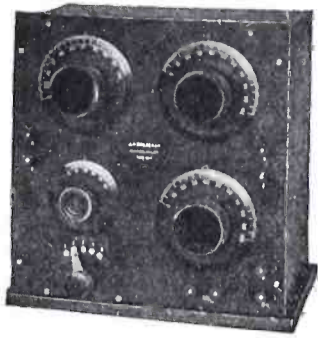

**RADIOLA EQUIPMENT
AND RADIO CORPORA-
TION PARTS.**

When You Want It Quickly

mail your order with check or money-order to us. Our mail order department is exceptionally well organized to give you immediate delivery; and our location insures better mail service than ordinary. Any standard, advertised radio part is in our stock—and we pay the postage. Try us.

**COAST RADIO COMPANY, INC.
EL MONTE, CALIF.**

KUY 6XAX 6IM

RT-A 2

The Audio Frequency Transformer that gives you perfect Tone Quality and High Amplification without distortion. Moisture-proof—it is ideal for the seashore.



Letters received every day state that RT-A2 passes every test and fulfills the most critical requirements of experts and amateurs.

Use RT-A2 transformers at once and enjoy better radio reception.

Price \$6.50 at all good dealers.

RASLA SALES CORPORATION

National Distributors
DEPT. C, 10 E. 43rd ST. NEW YORK CITY

**BROWNLIE
QUICK CONTACT**

Reg. U. S. Pat. Off.



CRYSTAL

A Natural Mineral for your Set

Your Catwhisker contact can move over the entire surface without loss of programme. Fourteen years of crystal making now gives you the world's best product for all uses. Reflex, Radio Frequency and Crystal Receivers.

**Price Mounted
and Guaranteed 30c**

Order From Your Dealer, or Sent Postpaid on Receipt of Coin.

ROLAND BROWNLIE, Mfr.
22-24 Saunders Street
MEDFORD, MASS.



**WE REPAIR
WD-11, \$3.50**

and OTHER
VACUUM TUBES

Excepting
VT-I and VT-II

MAIL ORDERS Solicited and
Promptly Attended To

H & H RADIO CO.
512 Clinton Avenue NEWARK, N. J.

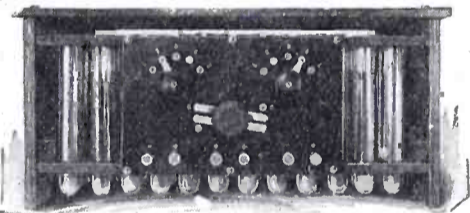

**KICO Storage "B" Batteries give
long service at low cost**

Alkaline type, will not sulphate or buckle. Life unlimited. Not harmed by short-circuiting, overcharging, or standing idle. Panel switches afford single cell variations. Easily re-charged from any 110-volt A.C. line by means of small home rectifier. One charge lasts three to six months in detector plate circuit.

Prices without rectifier:		Plain	(With Panels)
16 cell	22 volt.	\$5.50	
24 cell	32 volt.	\$7.25	\$11.75
36 cell	48 volt.	\$9.50	\$14.00
50 cell	68 volt.	\$12.50	\$17.00
78 cell	100 volt.	\$17.50	\$22.50
108 cell	145 volt.	\$23.50	\$28.50
Unmounted rectifier..		\$1.00	
Mounted rectifier....		\$2.50	

SATISFACTION GUARANTEED

All batteries are sold with the privilege of receiving your money back if not satisfied within a 30-day trial. Write for full information on "A" and "B" Batteries.

KIMLEY ELECTRIC COMPANY, Inc.
2669 MAIN STREET BUFFALO, N. Y.

Continued from page 60

by increasing the inductance and decreasing the capacity, and thus make the resonance broad again. In such a case there is always a compromise and a reasonable size inductance which has not too much resistance is generally employed with a moderate capacity.

The phenomenon of resonance discussed in this article is called "series resonance" since we are concerned with the current flowing in the series circuit of Fig. 1. To summarize the characteristics of series resonance as explained here in detail we have the following. The reactance of a series resonant circuit is zero, and its impedance is a minimum. Hence the current at resonance is always a maximum. It is for this reason that circuits are tuned to resonance with the incoming waves. A low resistance produces a sharp resonance curve, whereas a high resistance produces a broad resonance curve. Hence the latter results in interference and inefficiency. The former is therefore a characteristic of all well designed circuits. Too much capacity and too little inductance also produces a broad resonance curve, while too much inductance may result in increased resistance. A compromise between inductance and capacity values is therefore always chosen.

This covers the case of single circuits and series resonance. There are, however, very important conclusions to be drawn when we consider the case of more than one circuit, such as the two-circuit or loose coupled receiver or transmitter. Coupling effects influence resonance markedly. Furthermore we have the case of "parallel resonance" which has some very important applications in the elimination of interference. These subjects will therefore be treated in succeeding articles.



Tell them that you saw it in RADIO

UNIVERSAL MOTION

Continued from page 12

place. They are not fastened at the front end.

The tubes which fit over these slider rods are of different lengths, the one attached to the middle coil or the primary being longer than the one attached to the secondary coil. The length of each should be carefully worked out so that the tube will reach from the furthest after position of its coil to at least one inch forward of the face of the panel. On this forward end is placed a knob, with which the coil can be adjusted.

Turn this knob and the coil swings to and fro in front of the stationary winding; push or pull this knob and the coil approaches or retreats from the motionless tickler. Here, now, is permitted a greater variety of tuning than ever secured before. The result is better and clearer signals with a maximum of volume.

But it is evident that without pressure of some sort on the bearings the two movable coils would swing back into a vertical position as soon as the grip was taken away from the knobs. To provide this necessary pressure, a tension spring is added as shown. Details of this spring are given in the upper right hand corner of the sketch. The three extension views of the tuner show how the spring is applied and adjusted, so that nothing more need be added except perhaps to say that while spring brass is called for, it is not necessary. Heavy plate brass will serve the purpose.

Amateurs mounting any form of coupler in this manner, whether it be two-coil or three-coil, honeycomb or spiderweb, will appreciate the convenience and advantage of having their movable coil or coils free to swing to and fro or in and out as the need may be.

CALLS HEARD

Continued from page 42

By 5GO, 446 Pender St., E. Vancouver, B. C.
 C. W.: Can.—(3ni), (4ao), (4bv), (4cl), (4cn), (4co), (4dq), (4er), (4fn), (5ct), 9a, (9bg), (9bp), (9bx), 3si, 3gk.
 U.S.: 2fp, 3aro, 4bq, 5be, 5jk, 5kc, 5mn, 5xb, 5za, (5aec), 5ado, 5agj, 5xad, 5zak, 5zat, (5zav), 5zaba, (6bu), (6ea), (6et), (6ti), (6vm), (6zz), (6rm), (6ku), (6lv), (6ahu), (6aiy), (6alv), (6alx), (6anb), (6anm), (6aoi), (6aop), (6aqp), (6arb), (6aup), (6avf), (6aun), (6awt), (6awx), (6bel), (6bhk), (6bih), (6bip), (6bly), (6bnt), (6bnu), (6bon), (6bou), (6bpv), (6bun), (6buy), (6bvg), (6bvs), (6can), (6cbd), (6cej), (6xad), (6zh), 7's too mch, (7dh), (7hm), (7ly), (7aiy), (7zf), (7zn), (7zu), 8cf, 8jy, 8wi, 8xg, 8aqo, 8asc, 8cmi, 8dac, (9aap), (9abu), (9ape), (9aul), (9bji), (9bto), (9bxm), (9bzf), (9cjc), (9cks), (9dgv), (9dlf), (9zt).
 Pse qsl my 10-20 watts C. W.

By 9DMA, Caledonia, Minnesota.

C. W.: 3bva, 3jj, 3pz, 3su, 4dt, 4jk, 5agj, 5fx, 5pv, 5nz, 5ye, 5zak, 5zav, 5zb, 7zu, 8bno, 8cjj, 8cur, 8ft, 8hn, 8hv, 8jy, 8vq, 8wx, 8xb, 8zv, 8zw, 8zz, 9aal, 9aap, 9aav, 9aaw, 9aer, 9aja, 9aky, 9alx, 9anj, 9any, 9ape, 9aps, 9apv, 9apw, 9arc, 9arz, 9arl, 9ayi, 9azn, 9bak, 9bbq, 9bch, 9bfb, 9bhd, 9bik, 9bjb, 9bxc, 9bkj, 9bri, 9brk, 9btl, 9bzi, 9caa, 9cfi, 9cfk, 9chk, 9chn, 9cho, 9cip, 9cks, 9cmk, 9cno, 9ctg, 9cwr, 9dan, 9daw, 9der, 9dew, 9dge, 9dhr, 9dhq, 9dis, 9djb, 9dku, 9dvh, 9dxn, 9dxy, 9efb, 9ehj, 9ehn, 9ekf, 9ejt, 9ht, 9ig, 9vb, 9ve, 9ss, 9zt.
 Spark: 9aaw, 9aaj, 9axk, 9lf. All qsl crd and pse qrk.



7411

NEW RADIO DRY CELL "A" Battery for WD-11 Tubes

The Dry Cells in this 1½ volt NEW Eveready "A" Battery were developed especially for use with WD-11 Vacuum Tubes. They last longer than Dry Cells made for other purposes. Longer Service Hours Means Economy. Made in three sizes—7111 one cell, 7211 two cells, 7411 four cells.

FOR BETTER RESULTS USE

EVEREADY
 RADIO BATTERIES

—they last longer

Made on the Pacific Coast—fresh and full of pep

National Carbon Company, Inc.

599 Eighth Street

San Francisco, Calif.

"GRANOLITE"

Universal Loud Speaker Radio Horns

The All-Wood, perfect reproducing horn you have been looking for.

"GRANOLITE" Universal Radio horns are positively superior to all others, because we have embodied in their construction perfect acoustic qualities, careful workmanship, high grade, carefully selected materials, strength and beauty of design. The base construction and equipment is universal, permitting the installation and use of any of the standard and well known loudspeakers and receivers.

"GRANOLITE" is hydraulically treated wood, which after being put through our secret processes is developed into a new material which we have named "GRANOLITE", because it represents a combination of the lightness of weight and basic tonal qualities of native wood with the tensile strength of granite.

"GRANOLITE" Loud Speaker Horns are made from granolited wood and are guaranteed to give satisfaction. They will not warp, crack, chip, or peel. The bell is accurately shaped and the exceptionally clear acoustic properties are the result of months of careful and exhaustive tests, which have enabled us to place a horn on the market, embodying everything that is required to give a clear, perfect reproduction of sound exactly as received and thus eliminating the various troubles and objections encountered in connection with the use of fiber and metal horns.

"GRANOLITE" horns are made in three sizes: No. 1. A small one, 15" high, with 8" bell for crystal receivers; No. 2. A medium size, 19" high with 9½" bell for private use in the home, and a large size, our No. 3, which is 25" high with a 14" bell for concert halls, moving picture houses, theaters, etc.

Granolite horns are finished in either dull or bright black lacquer, dark brown, bronze, ivory or verdi-green. When ordering be sure to specify finish desired. Our standard finish is dull black, which will be supplied unless otherwise specified.

LIST PRICES

- No. 1 Horn 15 inches high..... \$ 8.00
- No. 2 Horn 19 inches high..... 10.00
- No. 3 Horn 25 inches high..... 12.00

Above prices apply to horn and base only. If horn is wanted complete with receiver add \$6.00.

Granolite horns are manufactured solely by

GRANOLITE ART PRODUCTS CO.

222-224 4th Street

Milwaukee, Wis.

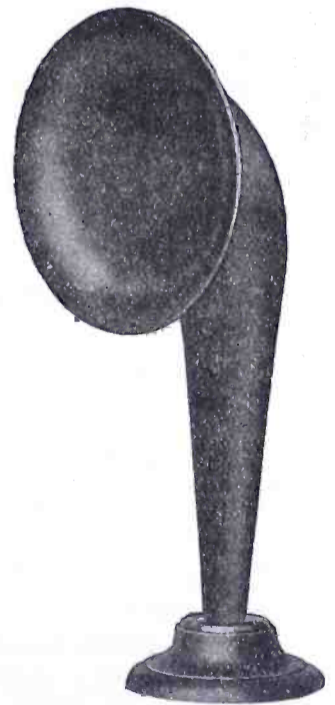

"Granolite"

Made in three sizes:

- No. 1 with - 7 1/2 inch bell; height, 15 inches.
- No. 2 with - 9 1/2 inch bell; height, 19 inches.
- No. 3 with - 14 inch bell; height, 25 inches.

Tell them that you saw it in RADIO

RADIO SPECIALTIES

Made in our Own Plant from our Own Designs



When Radio sprang into popular demand we were ready for it. Our thirty years' prior experience in supplying, first, the Electrical and Telegraph industries, and later, the wireless "bugs," with highly-perfected electrically-correct equipment and devices, made us one of the few plants in the country that was fully prepared to meet all demands.

"Signal" Radio Products cover the Whole Line—from complete Sets to the smallest accessories. Here are two of many specialties:

"Signal" R130 Vernier Condenser Attachment

A welcome convenience. Attach to any rotary condenser, without drilling. Simply put it in the place of the old dial. Gives extremely fine adjustment. Bakelite Dial Assembly is itself a 2 plate condenser, with a rotating condenser plate between knob and dial. Makes a Vernier Condenser out of any ordinary condenser.

Price—\$2.50

If your dealer cannot supply you send us his name and address with money order at above price and article will be shipped postpaid.

DEALERS: Write for our Radio Catalog and discount sheet!

"Signal" R33 Vernier Rheostat

A unique single-knob Filament Control that has a fixed relationship to the panel. No "pushing-in" or "pulling-out." Gives a wonderfully fine control of filament. Yet is rugged in construction. Both coarse and fine adjustment with the same knob. Adds mightily to the effectiveness of any receiver.

Price—\$1.50

SIGNAL Electric Mfg. Co.

Factory and General Offices:
1913 Broadway,
Menominee, Mich.

Atlanta
Boston

Chicago
Cleveland

Minneapolis
Montreal
Toronto

New York
Pittsburgh

San Francisco
St. Louis

You'll Find Our Local Address in Your Telephone Directory

SELECTIVITY AND RECEPTION

Continued from page 31

circuit. For better selectivity, therefore, the circuit should be designed so that there is more inductance than capacity present.

For telegraph reception this selectivity is most desirable. For radio telephone reception some reservations must be made. In radiophone reception we have to deal, not with a wave of one definite frequency, but with a wave band of frequencies, due to the modulation of a radio frequency by an audio frequency. Thus the standard practice is to regard the radiophone wave as consisting of frequencies lying between the sum of the radio and audio frequency and the difference of the radio and audio frequency. When we consider that the audio frequency of speech is not a definite frequency but may vary from 50 cycles to say 2000 cycles it is evident that in radio telephony we have to deal with a large number of frequencies. For accurate reproduction of speech, therefore, the receiving system must be able to respond readily and without lag to all these frequencies. If the circuit is very stiff with large time constant, therefore low decrement, it will not be able to follow these rapid changes in frequency without lag and the result is that distortion may result. It is seen, consequently, that the condition of high selectivity is not so very desirable for radiophone reception. With a high decrement circuit, therefore less selective circuit, the receiving system will be able to respond more readily to varying frequencies, thus producing less distortion. This discussion applies equally well to the antenna system, since the waves first are impressed on the antenna. For radiophone reception it must be concluded that a selective circuit is less desirable than for telegraphy. Not only does this apply to the receiver but the transmitter is subject to the same considerations. If the transmitting antenna is not able to follow rapid variations of frequency, that is, if it is a stiff circuit having low decrement, the radio frequency variations will not be properly modulated with the result that distorted speech will be sent out. Broader tuning and less selectivity is therefore more essential in telephony than in telegraphy.

The intensity of the signal received by an antenna depends on the height of the receiving antenna. The greater the height the louder the signal. Thus with large antenna interfering signals produce great interference. If the height of the receiving antenna is reduced the interfering signals will be less intense, but the desired signals in the antenna will likewise be proportionately reduced. The low antenna also gives a better signal-static ratio than the high antenna.

Continued on page 68

USE A.C.H. SHARP TUNER DIALS

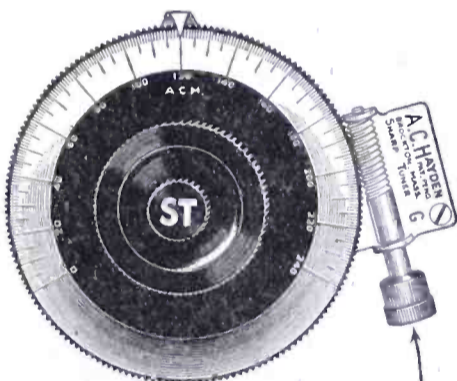

Why the A.C.H. is different

3 in. DIAL

156-10-1

4 in. DIAL

215-10-1

Positive movement, no friction to slip, and no back lash in the spiral machine cut worm gear. (NOT MOULDED.)

Your Choice of

Rough tuning with dial or one thousandth of an inch in either direction with the Sharp Tuner Knob. Both controlled by center Knob ST.

Eliminates a vernier condenser. Locks instrument automatically. Dial grounded, reducing body capacity.

Money Back Guarantee

Price A.C.H. 3" Dial complete.....\$2.50

Price A.C.H. 4" Dial complete..... 5.00

Regular fitting 5/16" hole, 1/4" and 3/16".

Bushings, 5c. each extra. 10c. for all.

Free Plan with mail orders on request.

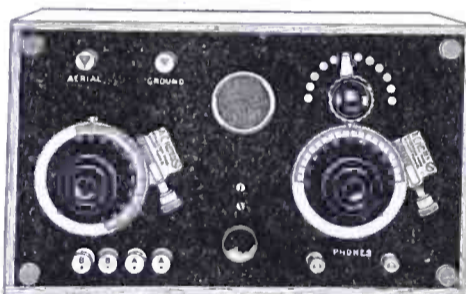

A.C.H. DETECTOR SET

Not wired—Price \$20.00

Including 2 3-in. A.C.H. Dials

Three ways to purchase:

1. Send money-order or check for \$20.00, we will send same prepaid.
2. Send any amount and when we receive a total of \$20.00 we will send same prepaid. Make last payment when you want your set.
3. Send for list of parts and when you purchase all assemble entire set.
Total cost.....\$20.00

A. C. Hayden Radio & Research Co.

Brockton, Mass., U. S. A.

Mail Orders sent prepaid in U. S. A.

Tell them that you saw it in RADIO

KC RADIO

**KUALITY CERVICE
KILBOURNE & CLARK MFG. Co.**

Head Office & Works, Seattle

BRANCH OFFICES

Portland, 305 Larrabee St. Phone 6156
San Francisco, 591 Mission St. Phone Sutter 40
Los Angeles, 1103 W. 10th St. Phone 581-002
New York City, 80 Washington St.

**A HIGH-GRADE COMPLETE LINE
OF RADIO PARTS FOR EX-
CLUSIVE USERS**

For 10 years we have built radio apparatus for ships, shore stations, U. S. Navy, amateur and experimental use.

**WATCH THIS SPACE FOR
THE LATEST SPECIALTIES**

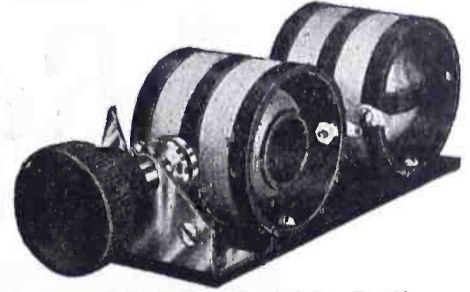

Continuously variable Radio Frequency Amplifying Transformer

Two Stage\$10.00
Single Stage 5.50
Range 150-550 Meters

ATTENTION! Radio Fans

For a limited time we offer you Radio Supplies that are exceptional values. You cannot secure better from any source.

**COMBINATION
No. 1**

- 2 Variometers
- 1 Variocoupler
- 3 Dials, 3"
- 1 Vernier Rheostat
- 1 Inductance Switch

All for **\$11.00**

**COMBINATION
No. 2**

- 1 Mahogany Variometer
- 1 Condenser, 11 Plate
- 2 Dials, 3"
- 1 Vernier Rheostat

All for **\$6.25**

EXTRA PARTS

- Filament Rheostat,
Plain **65¢**
- Bakelite Rheostat,
vernier **\$1.15**
- All Wave Coupler. . **\$5.00**
- Dials, 2-in. **20¢**
- Dials, 3-in. **25¢**
- Amp. Unit, 1 stage. . **\$6.00**
- Moulded Variometer. **\$3.75**

- Midget Vernier
Condenser **\$1.00**
- Mahogany Variometer
eter **\$3.25**
- Grid Leak and Cond. **15¢**
- Inductance Switch . . **25¢**
- Condenser, 11 plate. **\$1.50**
- R. F. Transformer. . **\$2.50**
- A. F. Transformer. . **\$3.00**

Send us your order; same will be shipped immediately, Parcel Post prepaid.

ROSS RADIO SERVICE

Mail Order Service Only

693 Mission Street, San Francisco, Cal.

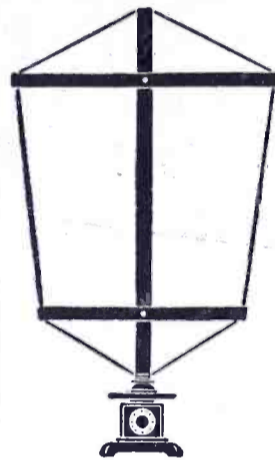

**STATIC
and Inter-
ference is
Reduced
to a
Minimum**

**Better
Reception
with the**

NASSAU

Pat. Pend.
Price \$35.00
Jobbers and Dealers
write for
Proposition



TRADE MARK

Eliminates Aerial and Ground.
**The Secret is in the Patented Winding
1500 MILES ON LOUD SPEAKER**

With 2 stages radio and
2 stages audio frequency
amplification.

Write for Circular "R"

Manufactured by

NASSAU RADIO CO. Inc.
60 Court St., Brooklyn, N. Y.

BROADCAST PROGRAM

**A weekly magazine devoted
to Western Broadcasting.**

5c per copy.

26 issues for \$1.00.

BROADCAST PROGRAM

**449 Pacific Bldg.
San Francisco, Cal.**

MONTROSE CONDENSERS

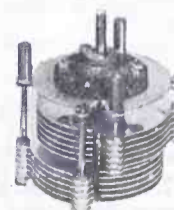

- 11 Plate Vernier \$2.20
- 23 Plate Vernier 2.55
- 43 Plate Vernier 3.35
- 3 Plate Condenser75
- 11 Plate Condenser 1.20
- 23 Plate Condenser 1.55
- 43 Plate Condenser 2.00
- .00025 mfd. Bal. Vernier 2.70
- .0005 mfd. Bal. Vernier 3.30
- .001 mfd. Bal. Vernier 4.00

MONTROSE MFG. CO.

1200 Bedford Ave.

Brooklyn, N. Y.

Tell them that you saw it in RADIO

Continued from page 66

The Receiver

famous thru Performance

Telmaco



Type B-R Receiver

fully meets the requirements of the discriminating purchaser because of the following features:

EFFICIENCY OF OPERATION: Securing volume, distance (1500 miles with single tube is not unusual), selectivity; broadcasting stations one-half mile distant are tuned out by a slight turn of condenser dial.

EASE OF OPERATION enabling the novice to secure satisfactory results.

HIGHEST QUALITY OF WORKMANSHIP AND MATERIALS.

\$25.00 PRICE within the reach of everybody.

Manufactured exclusively for us by

Tri-City Radio Electric Supply Co., licensed under Armstrong U. S. Patent No. 1113149, Oct. 6, 1914.

Telmaco BA 2-Stage Amplifier for the Above \$20.00

Our New Radio Guide Book Sent at Your Request

Our new 64-page Catalog No. TCR contains twenty of the most popular radio circuits printed in blue. These include the Hazeltine Neutrodyne, Grimes Inverted, Colpitts, Flewelling, Reinartz, Diode Electrad, Heterodyne, Super-Regenerative and many others. Each article used in circuit is attractively pictured instead of appearing in straight schematic form. Besides containing blue prints, the best in radio is also illustrated and described. Catalog sent postpaid for ten cents. Each Circuit worth double. Send for your copy today!

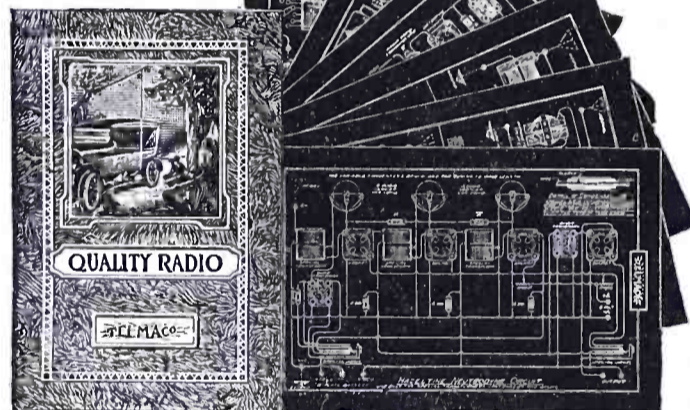

JOBBER We have an attractive proposition for a few more bona-fide Jobbers

DEALER If your Jobber cannot supply you order direct

TELMACO
Quality Radio Exclusively

Radio Division
TELEPHONE MAINTENANCE CO.
20 So. Wells St., Dept. 00, Chicago, Ill.

A loosely coupled receiver tends to exclude the weak interfering signal due to the low antenna. For we can tune the loosely coupled secondary circuit and so bring in the desired signal more strongly while the loose coupling keeps the interfering signal out. Even with loose coupling, however, if the interfering signal is loud on account of using a high antenna, it will force its way into the receiver secondary and cause much interference.

The loop antenna has an extremely high selectivity characteristic. This is largely due to its directional properties. It also has the marked advantage of a very good signal-static ratio, which is one of the reasons the loop has been so effective in different methods for the reduction of static interference.

Radio frequency amplification in connection with either low antennas or loops has been widely recommended for interference elimination. If the waves are of widely differing frequencies and the radio frequency amplifier amplifies them all indiscriminately not very much selectivity will be secured. However, as radio frequency amplifiers are built today, they amplify very strongly on one wave and less on the others. This is particularly true of tuned radio frequency amplifiers. They will amplify very strongly the wave to which they are tuned and hardly at all other waves. It is very evident therefore that the radio frequency amplifier is certainly a very selective device, and efficient in reducing interference. An important characteristic of the radio frequency amplifier is that it operates best on very weak signals. Thus nearby interfering stations which produce strong reactions in the receiving station will have very little effect on the radio frequency amplifier. Furthermore since the radio frequency amplifier operates best on very weak signals it goes hand in hand with low antennas and loops. Thus this combination of low antenna or loop and radio frequency amplifier makes a very selective receiving system.

DRY CELL "A" BATTERIES

Considerable mystery and misunderstanding still surrounds the proper use of the dry battery on the A circuit of radio receiving sets. Much of the information published on this subject has been incorrect and misleading and many users have been needlessly dissatisfied with the dry cell tube. To aid in spreading accurate and reliable information concerning the proper use of dry cells in connection with the several vacuum tubes on the market, the National Carbon Company, the largest dry battery manufacturer in the world, has carefully prepared a booklet entitled "The Story of Eveready Dry Cell Radio A Batteries for Dry Cell Vacuum Tubes." The information in this booklet will enable the user to obtain the maximum of service and satisfaction from dry cells.

POSITIVE RESULTS

are being obtained by thousands of satisfied users of the

Eastern Coil Sets For the Cockaday Circuit

The remarkable features which are making this circuit more popular each day are its simplicity of construction and control—wonderful selectivity—distance records—clearness and loudness of reception—and the fact that all capacity squealing, interference, etc. are eliminated.

Made as per specifications of Mr. Cockaday, using No. 18 wire with D coil bank-wound.

Complete set of B, C and D coils—Price \$2.75

Hook-up, directions and material list furnished free with each set of coils

MAIL ORDERS FILLED—DEALERS COMMUNICATE
EASTERN RADIO MFG. CO., Dept. R
22 Warren St. New York, N. Y.



D. X.

Special
3000

Ohm Phones
List Price
\$3.25

Very sensitive for D.X. work. Good discount to Dealers. Send for sample.

THE RADIO SHOP OF NEWARK, INC.
Dept. D.X. 76 Springfield Ave., Newark, N. J.

Tell them that you saw it in RADIO

INTERFERENCE

Continued from page 10

gain the advantage of its greater abstractive power and still "tune sharp" by using loose coupling. The sharpness of this type of set is strictly up to the operator. If he will keep his honeycomb coils tight together, or the secondary windings of his variocoupler in the same plane as the primary, the set will be less selective than a single circuit outfit. To the user who will take the time and trouble to learn to operate it, the use of a coupled circuit set is the best means of cutting out all interference from radio sources, including spark signals.

It is unfortunate that this source of interference has to be included in a paper of this kind, for the spark transmitter is an anachronism. Small antennae, coupled circuits, and sharp tuning all help, as with the classes of interference already considered, but, if the station is powerful and near at hand, the Q. R. M. pounds in spite of everything.

When the spark gets so bad that listening becomes an aggravation instead of a pleasure, try a wave trap. There are two distinct types of these, and the use of either will cut down the tuned signal slightly, but will reduce spark

produce a whistling note, it is useless to try to separate them, either by tuning or trapping. The third is that, for wavelengths near to that for which the trap is set, your tuning settings will be

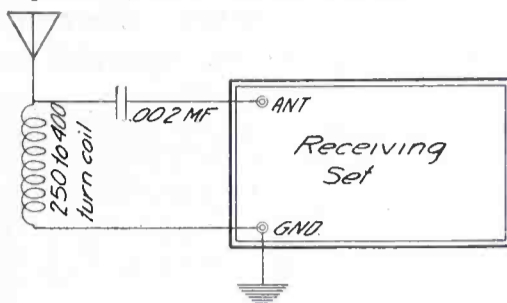

Fig. 2. Series Wave Trap

greatly disturbed, and you may find a shorter wavelength at the extreme upper end of your wavelength range and a longer one at the extreme bottom. Once you have mastered these vagaries, the trap becomes a very useful adjunct indeed. The method of use is fairly obvious. First set the condenser of the trap so that the interferent signals are a minimum. The use of the vernier is almost essential here. Then tune in the desired wave in the usual manner, with due regard, of course, to changed primary setting, due to the presence of the trap.

Probably the most serious kind of interference is that for which listeners-in are themselves responsible—that due to oscillating receiving sets. Many such sets are capable of causing interference over a radius of five miles, and practically all of them are capable of a half mile, or mile radius. Many operators seem to enjoy the whistles produced, when they themselves are responsible, but, if you yield to temptation and set up a series of wails just to show him what it sounds like, you not only spread the disturbance to a wider radius and make yourself as obnoxious to the neighborhood as he is, but you are likely to start counter-reprisals and a general state of warfare, which is bad for yourself, and radio in general. If you will operate your set just under the point of oscillation, you will get maximum results and cause no interference. It takes a little more skill, but is worth while.

Many listeners are troubled by noises from other than radio sources. If the antenna or lead-in runs parallel with power wires carrying alternating current, there is likely to be a powerful hum in the receivers, which cannot be tuned out. If possible, the antenna should be run at right angles to the wires causing the interference and the lead-in kept as far from the house wiring as possible. If the hum is still annoying, filter it out as shown in Fig. 3. Neither condenser nor coil is critical as to size, but the natural wavelength of the coil should be above the longest wavelength it is desired to receive, in order to get best results, and the minimum disturbance of tuning settings.

Tell them that you saw it in RADIO

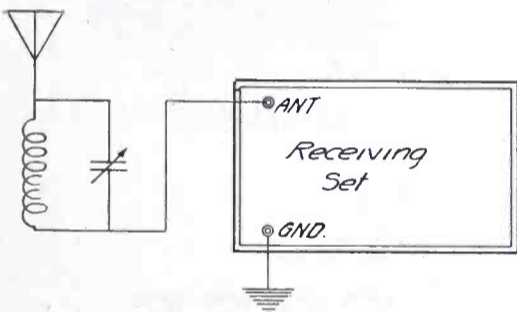

Fig. 1. Series Wave Trap

interference 90% or more. Fig. 1 shows a series trap. The condenser should be about a .001 mfd. ("43 plate"), preferably with a vernier. The coil may be a honeycomb, Giblin, or spiderweb, and 50 turns are about right for trapping out commercial wavelengths. The parallel trap is shown in Fig. 2. This arrangement preferably takes a smaller condenser and a larger coil than the series trap, a 23 plate, or even an 11 plate being satisfactory. The coil should be about 75 turns for 600 meter stations.

The effectiveness of any trap depends largely upon low losses, which means that the high frequency resistance of the coil should be low and the condenser well insulated.

In using a trap, there are several things to remember. One is that it will work better on phone or C. W. than it will on spark signals, but that, unless you are very near to the transmitting station, a trap should not be necessary to eliminate these. Another is that, if two stations have so nearly the same wavelength that they heterodyne each other; that is, their waves combine to

WHEN YOU BUILD A SET

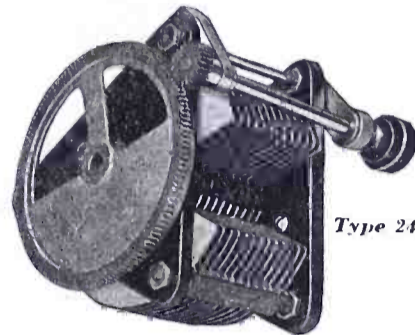

Type 247

Here are the essentials—

1. A quality Condenser—type 247—fitted with reduction gearing for fine capacity adjustment:

2. A Rheostat (or Potentiometer)—type 301, designed especially for UV-199 and 201A tubes:

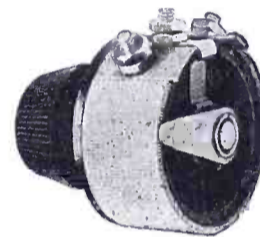

Type 301

3. A UV-199 Tube Socket, ruggedly built of molded Bakelite, with phosphor bronze springs:

4. And the well known General

Radio Co. Amplifying Transformer giving maximum amplification without distortion.

All of these styles are guaranteed by the General Radio Company.

For dependability and results build your set round these essentials.

Ask for Bulletin 914-C. It contains our complete line of receiving equipment.



Type 299

General Radio Co.

Manufacturers of Electrical and Radio Laboratory Apparatus

Massachusetts Avenue and Windsor Street

Cambridge - - Mass.

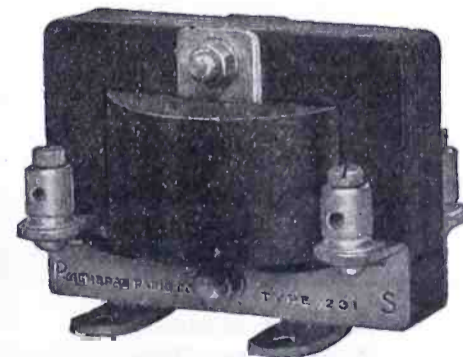

Type 231

Large Carbon and Copper Contactors that can not BURN or STICK

Sturdy Vibrator gives steady dependable service.

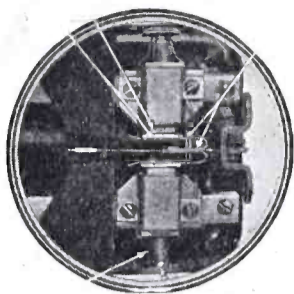

Adjustment Held Permanent

Easily adjusted When Required

F-F BATTERY CHARGER

Contactors Can't BURN or STICK

They also permit a desirably high charging current that makes for quick and easy storage battery charging.

The F-F Charger is fool-proof and shock-proof. Its simplicity, the satisfactory service it gives year after year, is the result of ten years experience making them.

\$15.00

F. O. B. Cleveland

Type 6 Charges 6 Volt Storage Battery from any 110 Volt 60 Cycle lamp socket at average rate of 6 Amperes.



Buy from your dealer. There's a type for every need. If he can not supply you, write for literature or enclose remittance covering express or postal charges on 9 lbs.

Write for Complete Details in Bulletin No. 33

The France Mfg. Co.
10433 Berea Road
Cleveland, Ohio

Western Representative:
EMMETT F. ANNIS

327 Dooly Bldg., Salt Lake City, Utah
67 2nd St., San Francisco, Calif.

Pioneer Manufacturers of Patented Battery Chargers

The last trouble that I shall refer to is what may be termed "pseudo-static"—noises that sound like static, but really originate in the set itself. Loose wires, corroded battery connections, worn out batteries, are responsible for

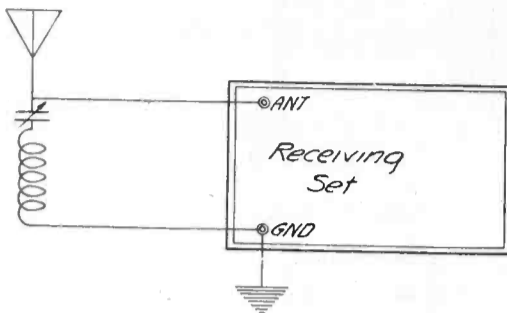
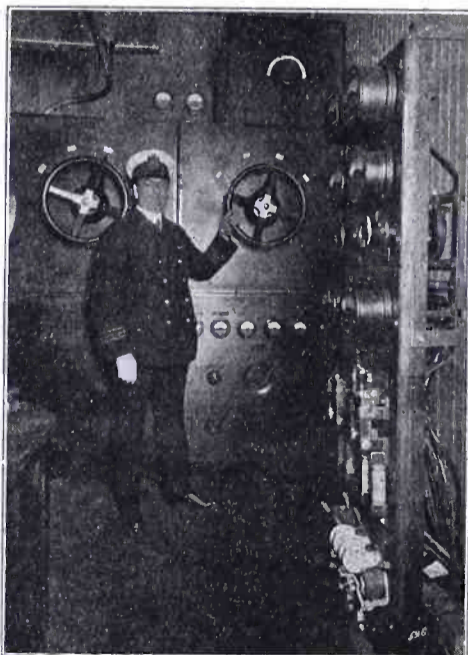

Fig. 3. Parallel Wave Trap

many of these sounds. Soldering paste, leaky insulation, and poorly adjusted grid leaks for many more. During the last winter I restored several sets to usefulness by putting the honeycomb coils in the oven and baking the moisture out of them. If you try this, see that the oven door is left open a trifle, and that the temperature does not get too high, or you may carbonize the insulation.

It is to be noted that all of the interference in this last class is strictly preventable and due to sloppy construction or maintenance. Proper care pays big dividends with a radio set, as with an automobile. Examine your connections regularly, dust out the variable condenser (but don't bend the plates while doing it), keep your storage battery up, and do not let your dry batteries reach the stage of corrosion and "pseudo-static" will hold no terrors for you.



Control Equipment for 20 K.W. Transmitter on S.S. "Leviathan."

Tell them that you saw it in RADIO

SHARPER TUNING

—This Midget Vernier will improve your D.X. reception. It is easily mounted on your panel. Ruggedly constructed of best materials.

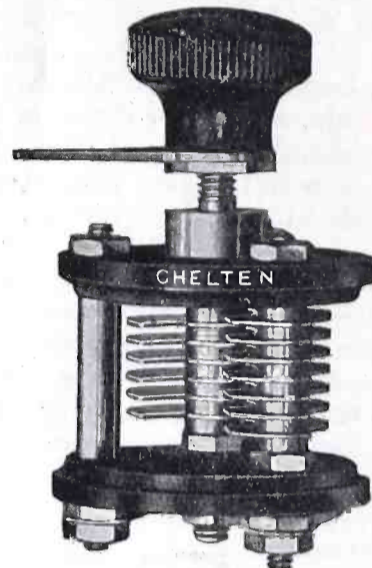

Actual Size

—This Condenser

FREE

Subscribe to RADIO for one year (\$2.50) and get this \$1.50 Vernier Variable Condenser free of charge!

This offer good for 60 days only.

ORDER NOW!

--- COUPON ---

RADIO, Pacific Bldg.,
 San Francisco, Cal.
 Herewith is \$2.50. Send me "RADIO" for one year and a Chelten Midget Condenser.
 Name
 Address

Radio's Seven Questions

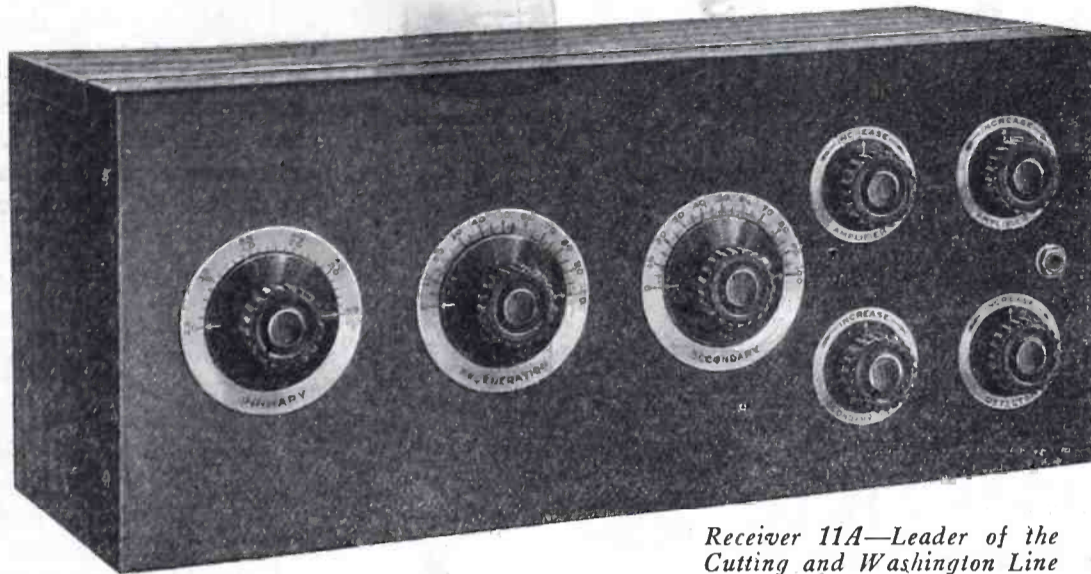

Receiver 11A—Leader of the Cutting and Washington Line

Here are the seven questions you should ask before you choose a radio set---to sell or to use--and the C&W answers



Dealers Distributors

Write for details of the Cutting & Washington Selling Plan, and interesting book—"The Future of Radio Retailing." No obligation.

Cutting & Washington Radio Corp.
Minneapolis, Minnesota

1. **Who designed it?** Dr. Fulton Cutting and Mr. Bowden Washington, international famed radio engineers, pioneer designers of U. S. Naval Radio Equipment, designers and builders of America's first commercial receivers.
2. **Who built it?** The world's largest manufacturers of automatic electric equipment, assuring precision and perfection of workmanship.
3. **Is it simple?** C&W Receivers introduce entirely new ideas that make for remarkable simplicity of operation without sacrifice in audibility and sharp tuning.
4. **Has it long range?** C&W owners have their choice of the Nation's broadcasting, under good atmospheric conditions.
5. **Does it tune sharply?** Recent audibility tests prove that C&W Receiver, 11A, gives louder, clearer reception and eliminates interference better than any other receiver in its class.
6. **Armstrong Patent?** C&W Equipment is fully licensed under this famous patent, which is admittedly best for radiophone reception.
7. **Manufacturer Responsible?** The Cutting & Washington Radio Corporation has practically unlimited financial resources. Its dealers are responsible. Your C&W Receiver will be serviced.

Cutting and Washington

America's Pioneer Manufacturers of Commercial Radio

Tell them that you saw it in RADIO

The **Standard** **ALL-AMERICAN** Transformers

Audio and Radio Frequency

now being used in radio sets manufactured by leaders in the industry.

These manufacturers have expended a great deal of time and money in the testing of transformers to give best results. They can not afford to take chances. Their preference of "All-American" Transformers is your guide to real satisfaction.

Ask your dealer to show you "All-American" Transformers. Handsome in appearance, accurate in design, splendid results always; you will want them for your set.

Free Offer Book of Hook-ups containing twenty-five successful circuits. Send 2c stamp to cover postage.

RAULAND MFG. CO.
200 No. Jefferson St., Chicago, Ill.



Radio Frequency Transformer

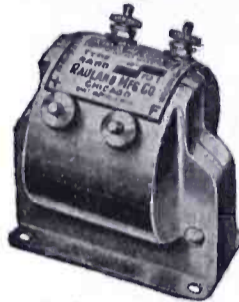

Audio Frequency Transformer

POOR INSULATION

Continued from page 32

thins and begins to run along the surface of the panel or other insulating material on which it happens to be mounted. Leakage along this flux path is thus made very easy. Just enough soldering flux should be used to make a good job. It is not necessary to swamp the posts in solder paste. Another effect of poor soldering is generally found in scorched panels and insulation. The heat from the hot iron is often transmitted directly to the insulating material with the result that it scorches. Carbonization results, thus offering a sure low resistance path for leakage. Good soldering will eliminate much leakage.

Finally we have to consider proper disposition of leads when wiring a set. Obviously maximum leakage will take place between leads which are at the greatest difference of potential. Care should therefore be taken to avoid running high and low potential leads near each other. Ground and antenna leads should be spaced as far apart as possible, since the greatest potential difference generally exists between these two leads. Likewise with other leads which are greatly different in voltage. Observing this precaution will incidentally result in added benefits. For capacity currents are prone to flow between points at different potentials, and the nearer these points are the greater the flow of these parasitic currents. By thus spacing wires at different potentials we not only avoid chance of leakage but also decrease the possibility of capacity currents flowing.

This is an opportune time to clear up a certain misconception which is prevalent about insulation. In general amateur radio practice thickness of insulation, for insulation purposes, is not the essential factor. Breakdowns and leakage do not generally occur through the thickness of the insulation. Breakdowns and leakage almost invariably take place across the surface of the insulator. Hence it is not so important from the electrical point of view to use thick insulation as it is to have great length between live points on the insulator. The greater this length the less the chances for leakage and breakdown.

Apart from these leakage considerations insulation material should be chosen having the least dielectric constant. The object of this is to decrease the dielectric losses in the insulation. The dielectric losses are proportional to the magnitude of the current flowing through it. The capacity current flowing through the dielectric is directly proportional to the capacity which in turn is directly proportional to the dielectric constant of the insulating material

Continued on page 74

CLEARANCE SALE

I have just finished a six weeks' tour of all the large Eastern cities, including Chicago, Boston, New York, Philadelphia and St. Louis, and could not find a RADIO store as large or as completely stocked as mine. But it is impossible to stock everything and I will hereafter concentrate on fewer lines, retaining only those of the highest quality and greatest popularity. It will even be necessary to discontinue some lines of unexcelled quality.

THEREFORE, NOW IS YOUR CHANCE

to buy high grade radio receiving sets and parts at

GREATLY REDUCED PRICES

If interested, please write for price list

PAUL FRANKLIN JOHNSON

560 East Colorado Street

Pasadena, California

"Everything worth while in Radio"

STANDARD RADIO RECORD

A new 195 page Radio Record just out! A real necessity. Every radio bug needs a copy.

Only 75c Postpaid

RADIO—Pacific Bldg.—San Francisco

Tell them that you saw it in RADIO

Any of These Supplies **FREE!**

Great premium offer for 60 days only

Free

Chelton Midget Variable Condenser given free with one subscription to "RADIO" for one year.

Free

A. C. Variocoupler free with two subscriptions to "RADIO" for one year each.

Free

Work-Rite Variometer free with two subscriptions for one year each.

Free

23 plate Variable Condenser, A. C. type, free with only one subscription to "RADIO."

Loud Speakers **FREE**

GOTTSCHALK (\$22.00)

Free with only five subscriptions to "RADIO" for one year each.

VICTORY (\$16.50)

Free with only four subscriptions to "RADIO" for one year each.

MAGNAVOX (\$35.00)

Free with sixteen subscriptions to "RADIO" for one year each.

All premiums fully guaranteed by the manufacturers as well as by the publishers of "RADIO"

RADIO BOOKS

Free with only one subscription

C. W. MANUAL.
STANDARD RADIO RECORD.
RADIO ATLAS OF WORLD.
LARGE RADIO MAP OF U. S.
"ABC OF RADIO."

One of the above books free with one subscription.

\$2.50 Per Year is the Subscription Price

TAKE YOUR CHOICE OF ONE OF THESE UNUSUAL OFFERS. MAIL COUPON NOW!

RADIO, Pacific Bldg., San Francisco, Cal.

Herewith is \$..... Send "RADIO" for one year to:

Name

Address

Name

Address

Premium desired

.....

Tell them that you saw it in RADIO

The RHAMSTINE* VICTOPHONE

(for your phonograph)

Universally Popular

Price **\$7.50**

Complete with cord



In combination with your phonograph, the Victophone thoroughly solves your loud-speaker problem, and gives you a most attractive unit.

Made in the Rhamstine* shops where quality comes first, the Victophone affords a combination that is essentially different. Its tone quality is unsurpassed.

Get the Victophone and add to the attractiveness of your home.

Manufactured by

J. THOS. RHAMSTINE*

2162 E. Larned Street, Detroit, Mich.

*Maker of Radio Products

Thousands Acclaim Melco-Supreme

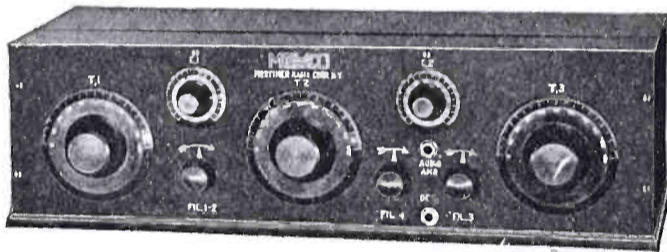

and are both proud and happy over the fact that they own the

REAL RADIO-FREQUENCY RECEIVER

Operation is simplicity itself. No aerial or loop needed—merely a 10-foot wire. By covering all Broadcasting Ranges from 175 to 750 Meters, wonderful program selectivity is assured.

AMPLIFICATION is extremely high per stage without the slightest loss of tone quality. Melco neither distorts the wave nor interferes with other members of the radio audience. Single tuning adjustments—a feature of the Melco—permits unusually long distance reception.

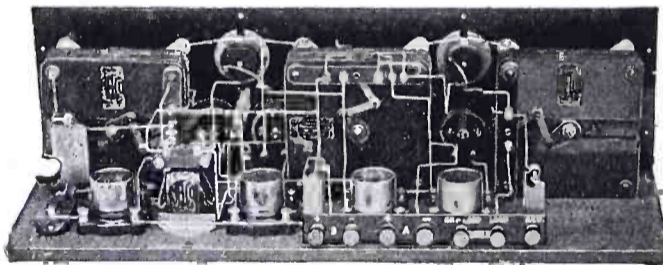

Mr. Cockaday in his article on Tuned Radio-Frequency Amplification in August Popular Radio refers to Melco-Supreme.

Write for Our Complete Literature

AMSCO PRODUCTS, Inc.

Successor to Mortimer Radio Corp. and Advance Metal Stamping Co.
BLOOME and LAFAYETTE STS. FAIRBANKS BLDG. NEW YORK CITY

!! TUBES !! REPAIRED

- U.V.199 or C.299.....\$3.50
- U.V.202 or C.302.....\$3.50
- A & P or Moorehead Det.....\$2.75
- A & P or Moorehead Amp.....\$3.00

24 Hour Service

Tubes returned Parcel Post C.O.D.
ALL TUBES GUARANTEED

RADIO TUBE EXCHANGE

200 Broadway, New York, N. Y.

Loud Speaker in Your Auto

No cumbersome aerial required

The Ideal portable set weighs only ten pounds, including detector and two-stage amplifier with all batteries. Carry it like a camera. Just the set for the auto, camp, or home. Absolutely guaranteed as efficient as any detector and two-stage set made, and at a cost of slightly more than some detector sets.

Get our complete instructive catalogue and information on loud speaker for crystal sets

Steinmetz Wireless Mfg. Co.
5704 Penn. Ave. Pittsburgh, Penna.

Continued from page 72

used. Thus the greater the dielectric constant of the insulation the greater the capacity current, and the greater the dielectric losses. It is for this reason that best engineering practice demands that radio insulation materials have low dielectric constants. (This consideration does not, of course, apply to dielectrics used primarily in the construction of condensers. Here we may desire to have high dielectric constants).

The above covers in a fair way the considerations and precautions to be observed in the matter of insulation and leakage. If these are given proper attention by the amateur he will be in a fair way to increase the efficiency of his installation. Every little bit counts they say, and the saving of a watt here and a watt there may be just what will make possible DX transmission.

FADING

Continued from page 18

wave does not always (nor necessarily) hold its perfectly round shape. The obstacles in its path such as trees, veins of ore in mountains, large steel buildings, etc., distort the contour of the wave and at its best resembles (if you could visualize it) a jelly fish whose contour is ever changing into all kinds of shapes in the water. See Fig. 2, where this is made clear. Several drawings are shown representing the same wave at different times in the same afternoon.

That the intervening layers of atmosphere have something to do with the fading of radio waves is a certainty, but it is no subject to discuss at this date. There have been too little data compiled to be of any material value.

I have taken several observations and find that the duration of fading from certain stations varies from day to day. At no time will it be possible to observe fading of the same nature from any one station on any two occasions. For your information I show in Fig 3 five observations made from the same station operating on the same wavelength each time an observation was made. The station selected was the Atlanta Journal. This station is practically due east of me and this probably accounts for the fading recorded. It is a known fact that stations east and west of an observer record the greatest amount of fading. These observations were only taken on nights when it was possible to record fading of a different nature and thereby produce five different curves.

More practical work of this kind should be done by those interested in this phase of the art and published for the benefit of all concerned. This explanation I believe throws considerable light on the subject and gives us an actual understanding of the fading effect.

Tell them that you saw it in RADIO

—it's free!

Lieut. J. B. Dow's "C. W. MANUAL" will be sent to you free of charge if you subscribe to "RADIO" for one year. This 112 page manual is the best book on the subject of C. W. transmission.

Only 150 copies left

THE supply of copies of this famous manual is almost exhausted. Unless you order a copy this month, you will probably be unable to secure a copy anywhere—at any price. Single copies are for sale at \$1.00 each.

**Right now is the time
to send us the coupon**

-----**COUPON**-----

RADIO, PACIFIC BUILDING
SAN FRANCISCO, CALIF.

Send me "RADIO" for one year and a free copy of the C. W. MANUAL. I enclose \$2.50.

Name

Address



NA-ALD
Special Socket
No. 499

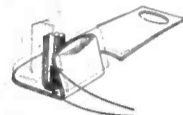

NA-ALD
De Luxe No. 400

It's the contact that counts

A careful examination will show that each contact in Na-ald sockets and adapters is of a wiping nature on a broad surface, and of sufficient tension, and so designed that tension is permanent, no matter how often the bulbs may be removed and how much the connecting prongs in the tubes vary.

It is little realized that sockets are being sold which, owing to faulty choice or control of material, develop current leakages from plate to grid that rob many otherwise well-made sets of their efficiency. Na-ald sockets in their design avoid all these troubles.

NA-ALD SOCKETS

Na-ald No. 499.....	\$0.50
Na-ald Adapter, No. 429...	.75
Na-ald De Luxe, No. 400...	.75
Na-ald Small Space, No. 401...	.35
Na-ald W. D. 11, No. 411...	.75
Na-ald Two in One, No. 450	.50

Booklet with diagram of Hazeltine's Neutrodyne Circuit and Other selected circuits packed with each Na-ald product.

Alden Manufacturing Co.

Manufacturers of Sockets for Every Tube and Requirement
Dept. H 52 Willow St.
Springfield, Mass.



*Make Your Set The Sensation
of Your Town!*
with

The RADIOXOR

**Simple---
Inexpensive---
Certain---**

Can be attached to any set, operating head phones or loud speaker, crystal or Vacuum Tubes, Loop, Plug or Outdoor Aerial.

Send your name, address and type of set on a post card for details.

Selling like wildfire, so act promptly. Orders filled in order of receipt.

Willart Sales Company

Worlds Tower Building
110 West 40th Street New York City

**SEE PAGE 73 — IT
WILL INTEREST
YOU!**

"ESCO" BATTERY CHARGERS

To meet an insistent demand for

**Rugged, Reliable
Neverfailing
Motor-Generators**

For charging Batteries used in wireless operation, we have developed a complete line of many sizes. With or without panel boards. "ESCO" quality thruout. You KNOW what THAT means.

Ask for Bulletin 242

**ELECTRIC
SPECIALTY
COMPANY**

**215 South Street
STAMFORD
Conn., U. S. A.**

Pioneers in developing
Quality Wireless Apparatus

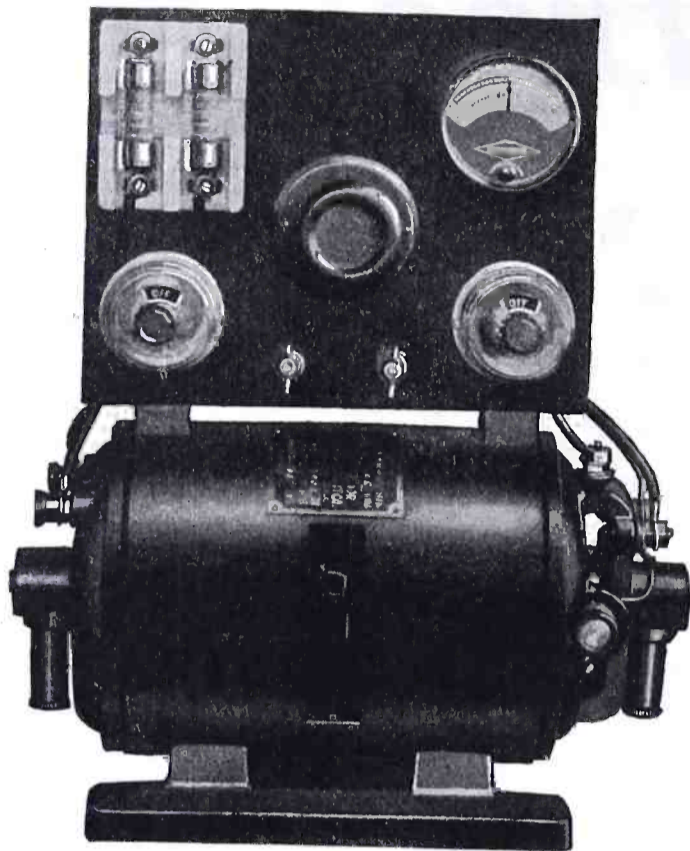

SINGLE CIRCUIT NON-REGENERATIVE SET

Continued from page 32

that the coil, grid condenser and leak, and rheostat comprise one unit. The mounting of the grid condenser on the brass screw post *A* provides an electrical connection automatically without the necessity of soldering an extra connection to the coil, which would otherwise be required.

The vacuum tube socket is mounted on one of the variable condenser posts by means of the brass bracket shown in

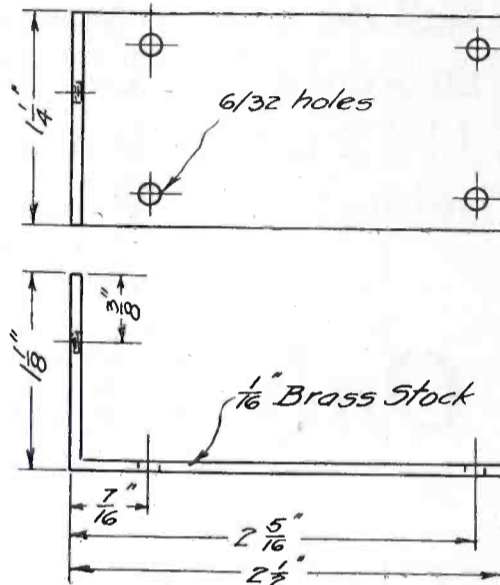

Fig. 5. Bracket for Mounting Tube Socket, 1/16 in. Brass Stock

detail in Fig. 5. One leg of the angle brass bracket is secured to one of the condenser posts by means of nuts as shown in Fig. 6, this having been found to be perfectly secure and rugged. The socket is then screwed down to the other side of the brass bracket by means of four screws.

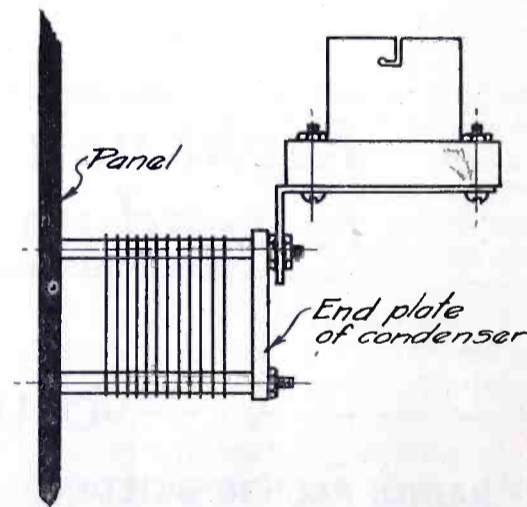

Fig. 6. Socket Mounting on Variable Condenser

The telephone binding posts are on the front panel. A sub-panel, made of 3/8-in. black fibre, in accordance with the specifications shown in Fig. 7, was fitted into a recess cut in the back of the cabinet and binding posts for antenna, ground, *A* and *B* batteries mounted on it. All connections, excluding telephones, were therefore made in the back

Freshman FIX-O

A Fixed Resistance Leak Combination—4 in ONE



Freshman Condenser
Leak Mounting
Freshman Fixed Leak
SAFE-T HANDLE

Price Complete
65c.

Furnished in any value of resistance from 1/2 to 10 Megohms

Separate Condenser and Mountings..... 40c
Separate Leaks with Safe-T Handle..... 30c

At your dealers. Otherwise send purchase price and you will be supplied without further charge.

Chas. Freshman Co. Inc.
Radio Condenser Products
106 SEVENTH AVE. NEW YORK

static?

John A. Burchichter, 207 E. Ohio St., Indianapolis, Ind., writes:

"My set is about ten blocks from one of the local stations and when they started broadcasting, it meant that ended everything for the evening. After your Wave Trap was installed, they were tuned out completely.

"Had expected with the approach of warm weather to take down my set until next fall, but while other local 'Listeners In' are almost entirely cut off by STATIC, I am enjoying the programs just as much as in the cold months.

"Have covered distances that heretofore have been impossible and really consider the Wave Trap the greatest invention since radio."

use THE ORIGINAL WAVE FILTER \$8.50 PREPAID
FERBEND
TRADE MARK
Wave Trap
PATENT APPLIED FOR

**17 E. SOUTH WATER ST.
CHICAGO**

W D II TUBES PRICE \$4.90

For August and September only
Guaranteed new and Genuine
IMMEDIATE DELIVERY
NEW JERSEY RADIO CO.
P. O. Box 43 Roseville Sta.
Newark, N. J.

The Welsh PEANUT Detector Tube

W. T. 501, \$2.00
Can be used in any tube set or to convert any crystal set into tube set. Used on 3 dry cells or one 6-V "A" battery. Write for booklet.

RADIO RESEARCH GUILD
40 Clinton St., Newark, N. J.

Tell them that you saw it in RADIO

of the set. All binding posts are the so-called "Read-Em" binding posts, that is, initialed to facilitate connections, as made by the Marshall-Gerken Co. Fig.

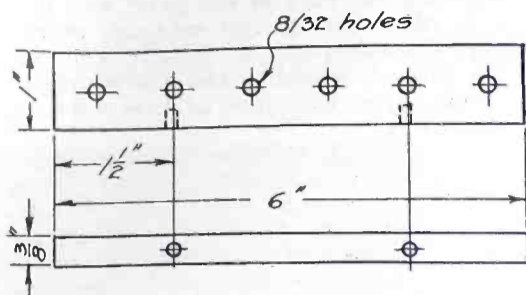

Fig. 7. Fibre Sub-Panel

8 shows the rear of the cabinet and the manner in which the sub-panel is set in. The sub-panel is held down to the cabinet base by means of two flat-headed wood screws shown by the sketch.

All the wiring inside the cabinet is made with No. 14 bare copper and all wire connections soldered. The front panel which is made of composition hard rubber, the drilling layout of which is shown in Fig. 9, is secured to the cabinet by means of four nickel plated screws screwed into four corner posts. The cabinet is made of birch wood with a walnut finish, and has door on the top, which may be opened by means of the metal ring. The vacuum tube is inserted into the socket through this door. In the upper center of the front panel is a ruby jewel of the telephone pilot lamp type as ordinarily employed on telephone switchboards. This is placed directly in front of the tube, the light from the tube being transmitted through the glass lamp. This is an indication of whether the tube is burning and from the bril-

liancy of the light transmitted through the ruby jewel is an indication of how brilliantly the tube is burning. It also adds to the neatness of the set.

Operation is very simple, there being but two controls: (1) filament current control, and (2) wavelength control, on right and left sides of the front panel

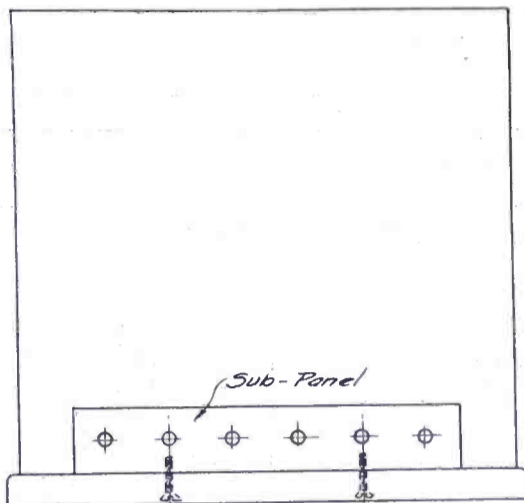

Fig. 8. Sub-Panel Mounting on Rear of Panel

respectively. The arrow on the panel above the filament control knob indicates the direction of rotation of rheostat for increasing filament current, the word OFF being the position where filament circuit is opened by the rheostat handle. The wavelength setting for any particular station will be indicated by the engraved line directly above the variable condenser dial.

This set brings in all the local broadcasting. It has, however, also given some unusual long distance reception for a single circuit non-regenerative set.

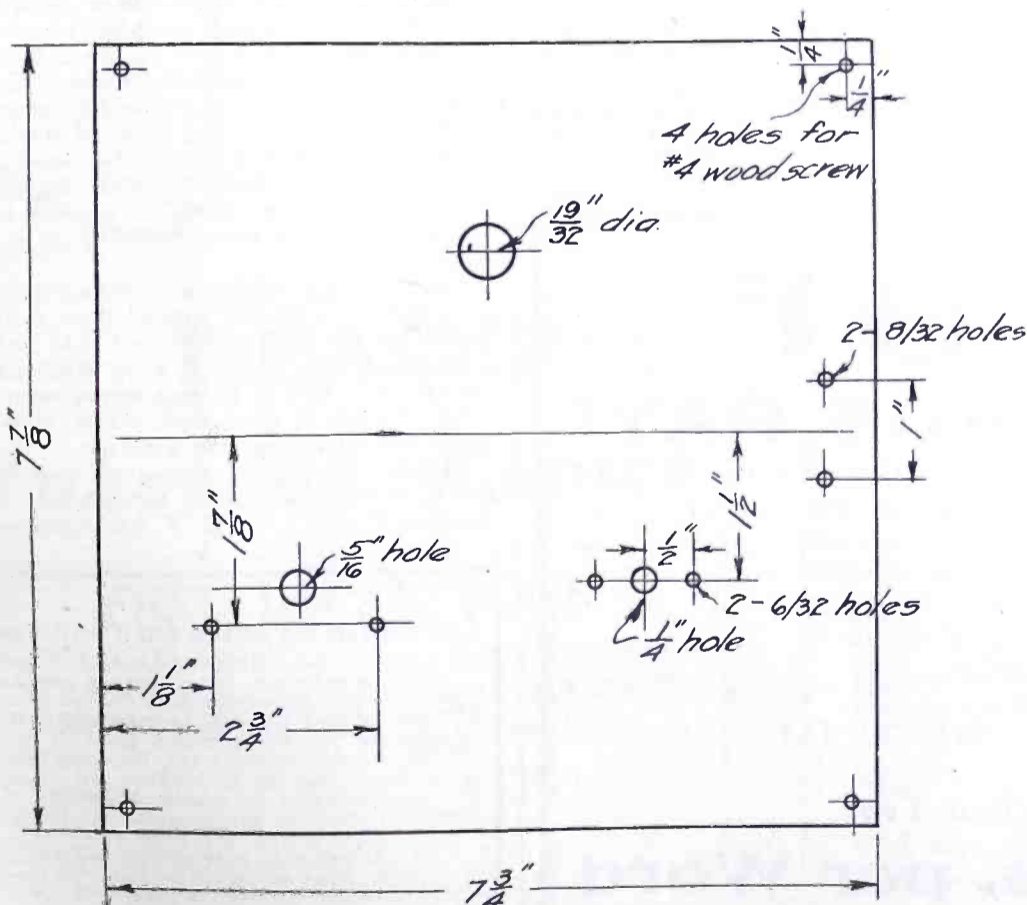

Fig. 9. Drilling Layout of Panel



a Chi-Rad Special!
for W.D. 11 tubes—

Standard, threaded rubber, Willard's, specially adapted for use with W.D. 11 tubes. Supply current at 2 volts to one W.D. 11 tube for 210 hours on a single charge. Rechargeable. Brand new, size 4x5 1/2 x7 inches—Chi-Rad guaranteed.

2-Volt Willard Charged... \$7.50
2-Volt Willard Dry..... 6.50

These same Willards can be adapted to deliver 8 volts for pure D.C. for C.W. Transmitters. Better than a generator because no filter is necessary. Much less expensive.

In lots of 40 (320 volts) \$160.00 (Better prices on larger quantities)

Specify dry or charged when ordering.

Chicago Radio Apparatus Co.
415 S. Dearborn St., Chicago, Ill.

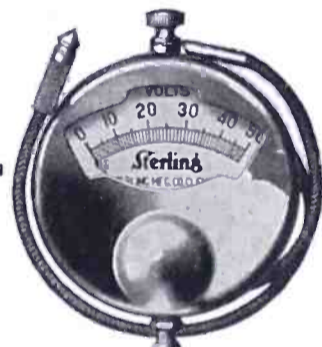

Actually a Daily Necessity

Regardless where you are or whether it is for radio work, electrical testing or around automotive jobs, the most indispensable little device to have in your pocket is a

STERLING Pocket Voltmeter

It is made accurately, carefully calibrated, good looking and durable. It registers the voltage instantaneously and is reliable throughout.

No. 34B 0-30 Volts List Price \$2.25
No. 34C 0-50 Volts List Price \$2.75

Also Sterling Ammeters and Voltmeters of various types at attractive prices.

Other Sterling Devices—

Filament Rectifiers, Filament Meters, Portable Rectifiers, Audio and Radio Frequency Transformers, 12 Point Rotary Switches.

The Sterling Mfg. Co.
2849 Prospect Ave., Cleveland, O.

DETSCH & CO.

555 Turk Street San Francisco, Cal.
Pacific Coast Representative

RADIO MAILING LISTS		Per M.
12,422 Radio Dealers, U.S. by States	Per list	\$7.50
1,614 Radio Mfrs., U.S. by States	Per list	\$15.00
1,760 Radio Supply Jobbers, U.S. by States		15.00
260 Radio Stations		4.00
257 Mfrs. complete Radio Sets		4.00
67 Radio Battery Manufacturers		1.50
Ready to send on receipt of remittance		
Trade Circular Addressing Co.		
166 W. Adams St., Chicago		

Tell them that you saw it in RADIO

★ ★ RADIOADS ★ ★

A CLASSIFIED ADVERTISING SECTION READ BY BETTER BUYERS

The rate per word is five cents, net. Remittance must accompany all advertisements. Include name and address when counting words.

ADS FOR THE SEPTEMBER ISSUE MUST REACH US BY AUGUST FIRST

EDISON ELEMENTS for STORAGE "B" Batteries. I handle only first grade, full capacity plates. Six to ten cents per pair, postpaid, depending solely upon quantity ordered. A. J. Hanks, 608 Montgomery St., Jersey City, N. J. (6 T. Exp. Oct.)

RADIO WORLD, THE GREAT NATIONAL WEEKLY—published every seven days with all the latest news, developments and pictures of the radio field. 15c a copy. \$6.00 a year (52 numbers), \$3.00 six months, \$1.50 three months. Special to radio readers. Send \$1.00 and we will send you the next eight issues of RADIO WORLD. Pub. Office, 1493 Broadway, New York. (tc)

Vacuum Tube Hospital
We repair and guarantee them.
Agents, Dealers, and Customers Wanted.
George H. Porell Co., Inc.
West Somerville, Mass.

RADIO GENERATORS—500 Volt, 100 Watt, \$23.50. High Speed Motors, Federal Phones, \$5.50. Battery Charges, \$12.50. Motor Specialties Co., Crafton, Pittsburg, Pa. (tc)

C. W. and RADIO PHONISTS—Our new converters will satisfy your need for a more efficient and durable direct current plate supply. No armatures to burn out. Output from seven hundred to two thousand volts at .4 amperes. Synchronous Motors, Transformers and other parts sold separate. Write immediately. Kimley Equipment Mfg. Co., 290 Winslow Ave., Buffalo, N. Y. (tc)

WANTED—Radio Engineer to travel extensively. Must be capable of highest type of sales service work in demonstrating and introducing line of patented radio equipment for well known manufacturer of thirty years standing. Write, stating experience, education, age and salary desired. Box 333, "RADIO", San Francisco.

RADIO FANS—Make your own "A" and "B" batteries. Our catalog tells you how. All kinds of radio apparatus and materials. Stamp for catalog. PACIFIC SCREW CO., Dept. W, 645 N. E. 53rd St., Portland, Oregon.

ARC & SPARK SYSTEMS
Send for Descriptive Circular QRD.
Interesting and Instructive.
Pacific Radio School 433 Call Bldg., San Francisco

BUILD YOUR SETS WITH QUALITY PARTS and get sure results. Radio Parts Co., Box 56, Unellen, N. J. (Gt-exp. Nov.)

A radio designer of Receiving Sets and Circuits that is confined to his home desires connection with reliable firm or persons needing special problems or circuits worked out. Miniature portable tube sets a specialty. Write "RADIO", Box 222.

LIGHTNING STRANGE BATTERY COMPOUND.

Charges discharged batteries instantly. Eliminates old method entirely. Gallon free to agents. Lightning Co., St. Paul, Minn.

Sell—Signal Loose-coupler 2500 meters, \$5. New Natrometer, \$15. Have other instruments. E. Schuessler, 2209 Wheeler St., Cincinnati, Ohio.

EXCHANGE: "Library of Practical Electricity" new in original carton for 4 used or 3 new 5 watt or 1 used 50 watt power tube. M. S. Andelin, Helper, Utah.

HOW TO MAKE COMMERCIAL TYPE RADIO

APPARATUS. By M. B. Sleeper. The experimenter will be able to get a world of ideas for the design and construction of his next piece of radio equipment from the very clear descriptions and the 98 clearly illustrated figures. This book describes in detail, Grebe, Wireless Improvement, Marconi, Western Electric, and other companies apparatus. Receiving, transmitting, land station, motor boat, yacht, airplane, etc. These designs were developed through years of experience by the foremost radio engineers, 75c postpaid (not stamps). Catalog free. Ray Dobbins, 146 West 27th Street, Indianapolis, Ind.

C. W.—For sale Transmitter consisting of Westinghouse 500 v. 100 W. MG. set panel complete with Jewell TC Meter, Milliamp and voltmeter. Westinghouse filament transformer. 2 Western Electric "E" Tubes. Also receiver with UV 200 and "B" battery. First check for \$175.00 takes all. Sent postpaid. R. E. Metivier, 837 2nd Street, Eureka, Calif.

FOR SALE—3 circuit receiver with 3 stage amplifier, \$120. Weston 2 volt meter for WD-11, \$5.25. Cotoco Condenser, \$3.00. Perfect condition. Ralph Kunau, Sabula, Iowa.

MAGNAVOX TYPE R3 \$7. Latest nationally advertised improved reproducers in original factory sealed cartons. List \$35. Introductory offer \$25. RADIO CENTRAL, Dept. P, Abilene, Kansas.

SELL or TRADE: Chicago Radio Laboratory regenerator and one step amplifier. What have you? Thad Bryan, Ocean Springs, Miss.

FOR SALE—Complete five watt phone equipment, including power transformer, Kenetron rectifier, filter circuit and parts for oscillator, modulator and speech amplifier. All new R. C. A. equipment. Box "A", RADIO.

PHANTOM PORTABLE CIRCUITS. Used on train or automobile. Set of four \$1.00 or free with Radiotron or Cunningham tubes. RADIO CENTRAL, Dept. P, Abilene, Kansas.

Building a Radio Set? Write for Monthly Bargain list—Postage Paid on all Orders. Taylor Radio Shop, Minonk, Illinois.

LETTERS TO THE EDITOR

Continued from page 38

Shield the back of the panel to eliminate body capacity.

Shielding the back of the panel will give rise to eddy currents and reduction of efficiency; don't do it.

The ground connection has a large following among space consumers as a fruitful topic of disputation.

General opinion seems to favor the rapid arrival of the wire from the ground post of the set to the nearest water pipe, whether said pipe be in the basement or on the observation platform of the Woolworth Building. By some the water pipe is considered insufficient, even when part of the system in a city of 500,000 souls.

With great enthusiasm another states that a three-foot iron rod driven into the surface of the Mojave Desert is all that could be desired.

(This latter method has been improved of late by the addition of a bucket of salt water to the base of the rod.)

And "do not lose sight of the fact that a set will function beautifully with no ground at all," say other experts.

When tackling the subject of radio frequency words fails utterly and the reader must, himself, decide as to the sincerity of the various authors or their eligibility to hold high offices in the Ananias Club.

Last, and by no means least, the searcher after the ideal hook-up may rest his faith on some of these rocks of radio practice. The single circuit; using either spiderweb, honeycomb, single wound, bank wound or figure 8 wound inductances.

The double circuit; using any one or various combinations of the above with the added brain fatigue of deciding on the proper size of the variable condensers necessary.

The three circuit; a high class, all wool, joy getter for the dealer in radio supplies. Gives the prospective builder all the materials necessary for admission to the inner circle of How-to-get-the-greatest-number-of-parts-into-a-home-made-receiver; contains everything in the two first mentioned or any combination thereof with added deluge of variometer and variable condensers.

And in the distance may be heard the low rumble of approaching four circuits and perhaps even more to surround and confuse the helpless vacuum tube and its timid owner.

From the foregoing it will be found that those who would profit by what they read should take a dozen or so of assorted ideas of each kind and shake them up in a hat and draw one.

After having drawn a sufficient number to perpetrate a set and carried them to their conclusion the builder will find that he has a set which suits him well as to performance but which is full of hideous errors from the point of view of all authors whose ideas he failed to draw from the sombrero.

Moral: Too many cooks can sure play hob with the diner's input terminal.
Atwater, Calif. H. F. MANCHESTER.

Let radio experts buy for you

Why hunt from store to store? Save time, trouble and money—a group of Radio Experts in New York will act as your personal representative, buy for you any standard make of radio equipment you want, from the smallest part to a complete set, either assembled or unassembled, and deliver it to you prepaid—all for less than if you did your own buying. Satisfaction guaranteed. Also disinterested advice on all radio problems—free. Write for plan.

Personal Service Purchasing Bureau
505 5th Avenue Desk 14, New York

PROOF THAT RADIOADS PAY!

35 So. San Diego Ave.,
Long Beach, Calif.
June 14, 1923.

"RADIO",
San Francisco, Calif.:

It certainly pays to put an ad in
"RADIO-ADS"!!

Yours,
SIX ZEE JAY.

Let Us Prove It For You, Too!

Rate Only 5 cts. per Word

Tell them that you saw it in RADIO

Lefax Radio Handbook

Distributed in the West by Pacific Radio Pub. Co., Inc.

LEFAX Radio Handbook is the one Book on Radio that keeps abreast of developments. As quickly as the authors learn new facts about the subject, the information is passed on to you. It comes all printed in loose-leaf form, all pages numbered and properly classified. Lefax is the only Book on Radio that doesn't, cannot grow old.

Note the little rings in the center of the book. Those rings are hinged. They are instantly opened—by a slight finger pressure—to receive the perforated pages. Once an ordinary book is bound, it cannot be changed—but Lefax can. You buy Radio information *complete* when you buy Lefax. We furnish, free for a year, pages containing additional information. You need Lefax Radio Handbook.

A COPY FREE with one subscription to "RADIO" for 18 months.

ADDITIONAL loose leaf pages are mailed to you as they are issued — free of charge for one year. Automatically keeps itself up to date. Every radio experimenter needs this book. Send for your copy today. Immediate deliveries.

The One Best Book on RADIO



LEFAX Never Grows Old

\$ 3 50

DEALERS: We are Western Distributors for this Book. Write for trade discounts!

Take Your Choice---Use Either Coupon

FREE LEFAX BOOK

"RADIO"—Pacific Bldg., San Francisco. Herewith is \$3.75. Send me a free copy of LEFAX and "RADIO" for 18 months.

Name

Address

"RADIO" Pacific Building, San Francisco.

Herewith is \$3.50. Send one Lefax Radio Handbook to:

Name

Address

Tell them that you saw it in RADIO

You Can't Beat This Big Offer!

MONEY saved is money earned. Radio enthusiasts want the most for their money. Here is an opportunity for you to get unusual value for your subscription dollars.

"POPULAR RADIO" and "RADIO" (San Francisco) known the nation over for the wealth of practical information they contain, in addition to a mass of most timely radio news, valuable constructional data for those who "roll their own," feature articles by the leaders of the industry, the latest radio developments and discussions on everything worth-while

talking about, have joined forces in a great money-saving clubbing offer in order to give *you* these leading two radio publications at a cost very little more than the subscription price of either magazine alone. Just imagine—you can subscribe to *both* "POPULAR RADIO" and "RADIO" for a full year for only \$3.00—a saving to you of \$1.50 over what you would pay for them separately.

If you are already a subscriber to either magazine—or both—you can extend your subscription for another year at this unusually low rate.

This is undoubtedly one of the most liberal subscription offers yet made

**"POPULAR RADIO" and "RADIO"
—one full year for only
\$3.00—a saving of \$1.50**

Here's the little coupon that will save you big money if you mail it before August 20th.

Don't turn this page until you have clipped the coupon and started it on the way to "RADIO."

RADIO, Pacific Building
San Francisco, Calif.

Send me "POPULAR RADIO" and "RADIO" for one full year. I enclose \$3.00.

NAME

ADDRESS

REMLER

APPARATUS
THAT RADIATES
QUALITY



**Remler
Socket
Adaptor
Type 499**

For using C-299 or UV-199 Tubes in sockets designed for C-11 and WD-11 Tubes.

Price \$1.00



**Remler
Socket
Adaptor
Type 599**

For using C-299 or UV-199 Tubes in sockets designed for use with standard storage battery tubes.

Price \$1.00

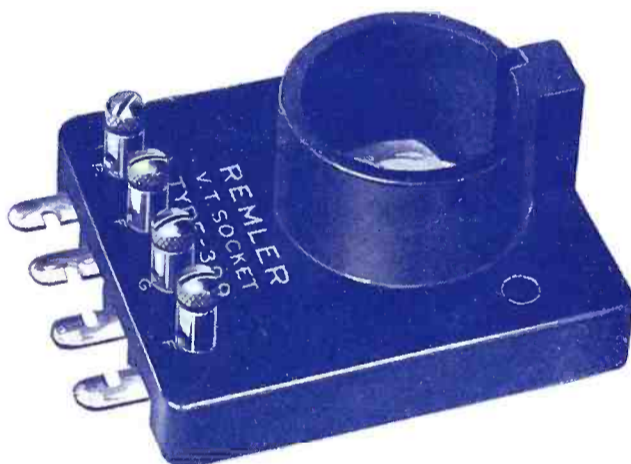

**Remler Dry Battery Tube Socket, Type 399
For Table or Panel Mounting, Price \$1.00**

Three New REMLER Items

of unquestionable merit, for use with C-299 and UV-199 Tubes

THESE three new appliances, a socket and two adaptors, for the C-299 and UV-199 dry battery tubes, are in every detail representative of *Remler Quality Apparatus*.

They are perfect not only from the standpoint of manufacturing quality and appearance, but from the standpoint of mechanical and electrical design.

Each of these items provides for the easy insertion of the tube in such a manner that it will not be jarred and

become damaged, and have that strong positive contact so essential in any tube socket or adaptor to insure quiet and efficient operation of the circuit in which it is used.

We are pleased to recommend these three items to the public as being representative of the quality of all Remler apparatus. We are confident that your use of any of these articles will make you permanent Remler customers. Ask your dealer to show them to you, or write direct for our complete descriptive bulletin.

REMLER RADIO MFG. COMPANY

Factory and Home Office
248 FIRST STREET, SAN FRANCISCO

154 W. Lake Street
Chicago, Ill.

30 Church Street
New York City, N. Y.

"WRIGHT" IS RIGHT IN RADIO

This Mark



Signifies

Standardized Radio Equipment



Side view showing method of element contact

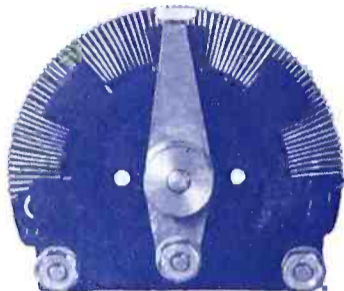

WRP Universal Rheostat



View of interchangeable resistance element removed

Thousands of radio enthusiasts have found the WRP Universal Rheostat to be the greatest improvement of the day in radio accessories. The entirely new principle of element design has revolutionized the potentiometer and rheostat making it possible to combine both in one unit and adaptable to many uses. Elements are easily interchangeable without removing any screws permitting adjustment in resistance for any changes in tubes or circuits.

Dealers everywhere can supply you. If your dealer is out of them order direct.

WRP Universal Rheostat
without knob or element,
 $\frac{3}{16}$ shaft only 75

WRP Universal Resistance
Element 3, 10, 20 or 30
ohms 35

WRP Universal Resistance
Element 200, 300 or 400
ohms 50

Another New Standardized Radio Necessity



Showing WRP Tubular Battery Adapters with battery in place

WRP Tubular Battery Adapters

The latest addition to the Wright line of Standardized Radio Equipment is shown here—WRP Tubular Battery Adapters. These adapters will fill a need which has been felt by every radio user in hooking up his set with a 3-cell flashlight battery. The battery is held firmly in the most convenient place, perfect contact is made at both ends, and the battery can be removed easily without unhooking a single connection. Price (without battery), \$0.40.

WRP Standard Socket Adapter

WRP Standard Socket Adapters are scientifically designed for the adaptation of the new C-299 and UV-199 vacuum tubes to the regulation tube socket. They are so accurately constructed that both tube and socket fit snugly allowing no play in which the tube can wobble. There are no prongs to become disengaged with contact springs.

Phosphor bronze of the highest grade is used in the contact springs, combining sturdiness and elasticity.

Internal capacity is reduced to the minimum by keeping the contact springs well separated, not allowing them to overlap.

There is no solder used in the construction, which might corrode and spoil your signals. There are no nuts or screw connections to become loose and give trouble.

Knurled and overlapping edge makes it convenient to remove the adapter from the socket easily. Pure bakelite is used throughout for insulation, and contact springs are located to admit of minimum leak resistance between tube elements.

For greater efficiency, economy of space and more consistent results use the new C-299 or UV-199 tubes adapted with WRP Standard Socket Adapters.



WRP Standard Socket Adapters at dealers anywhere \$1.

Attention Radio Dealers—Standardized Radio Equipment serves you unmeasurably in two ways—First, it allows you to eliminate duplication in your stock as the WRP units will fit any set, and Second, it allows you to sell many more accessories and increase the number of your satisfied customers because you never have to say "This or that will not fit your set." Don't allow your stock of WRP Standardized Radio Equipment to run down. Order in advance to take care of the increasing demand for these high grade standard units.

THE H. EARLE WRIGHT COMPANY

MANUFACTURERS and DISTRIBUTORS

131-133 Eighth Street

"The Home of Radio Center"

SAN FRANCISCO

IF IT'S FROM WRIGHT'S IT WILL FIT YOUR SET