

ELECTRONIC TECHNICIAN

WORLD'S LARGEST ELECTRONIC TRADE CIRCULATION



NOVEMBER 1964



TV - 1965



IN THE UPPER MIDWEST TOO, SERVICEMEN AGREE:

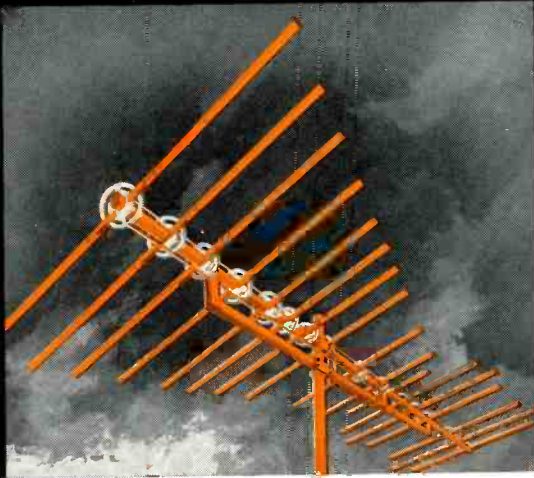

JERROLD PARALOG IS THE GREATEST!

Still the raves come in! TV service dealers all over the country keep switching wholeheartedly to Jerrold-Taco PARALOG antennas.

These dealers in Minnesota and North Dakota have gone 100% Paralog after putting it to the test under the roughest reception and weather conditions. And they've found that Paralog goes up easiest, stays

up without callbacks, and delivers by far the best pictures on all channels.

How about *you*? Have you tried the Jerrold-Taco Paralog side-by-side with its nearest competition? If not, see for yourself what's made the Paralog line the selling sensation in TV antennas.



**HARRY PFLAUM, HAUGNERS
TV & RADIO, DEVILS LAKE, N.D.**

"Every time we put up a Paralog antenna we create a satisfied customer. We are pleased with the construction and ease of installation of Paralog, and its terrific set performance."



**LOUIS ALLERY,
ROY'S RADIO & TV, ROLLA, N.D.**

"In our part of North Dakota we need the best-constructed and best-performing antenna made. Paralog is all of this and then some. And installation is easy because of factory preassembly."

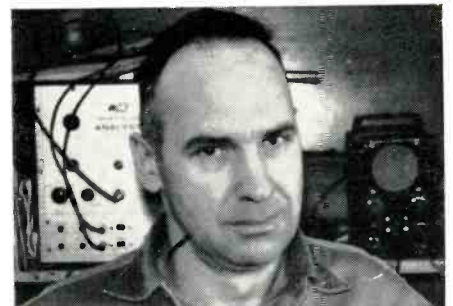

**ED JOCHIM, NESTORS
RADIO & TV, LANGDON, N.D.**

"Paralog withstands the terrific ice and wind problems we have here in Langdon, where other antennas have failed. We also like the ease and speed of installation."



**EUGENE DOLL,
DOLL'S TV, PERHAM, MINN.**

"Business has been terrific on Paralogs in our territory. And no wonder. Everybody who buys a Paralog is happy with the reception. We've gone to Paralog 100%."



**LAWRENCE DARGUS,
DARGUS RADIO & TV, WARREN, MINN.**

"Paralog antennas really perform well here in northern Minnesota—better than any other we've tried. And they're built rugged to withstand our rough winters."

For complete information, write

**DISTRIBUTOR SALES DIVISION,
JERROLD ELECTRONICS,
PHILADELPHIA, PA. 19132**



ELECTRONIC TECHNICIAN TEKFAX

COMPLETE MANUFACTURERS' CIRCUIT DIAGRAMS
AND TECHNICAL INFORMATION FOR SIX NEW SETS

ELECTRONIC TECHNICIAN TEKFAX

COMPLETE MANUFACTURERS' CIRCUIT DIAGRAMS
AND TECHNICAL INFORMATION FOR SIX NEW SETS

882

MAGNAVOX
Color TV Chassis
45 Series

November 1964

GROUP
147

Schematic No.	
ADMIRAL 883	RCA 885
TV Chassis D4, 1D4, 2D4 and 8D4	Color TV Chassis CTC16 Series
MAGNAVOX 882	WESTINGHOUSE 887
Color TV Chassis 45 Series	TV Chassis V-2475-1, -4
PHILCO 884	ZENITH 886
TV Chassis 15J27	Color TV Chassis 25MC30 Series

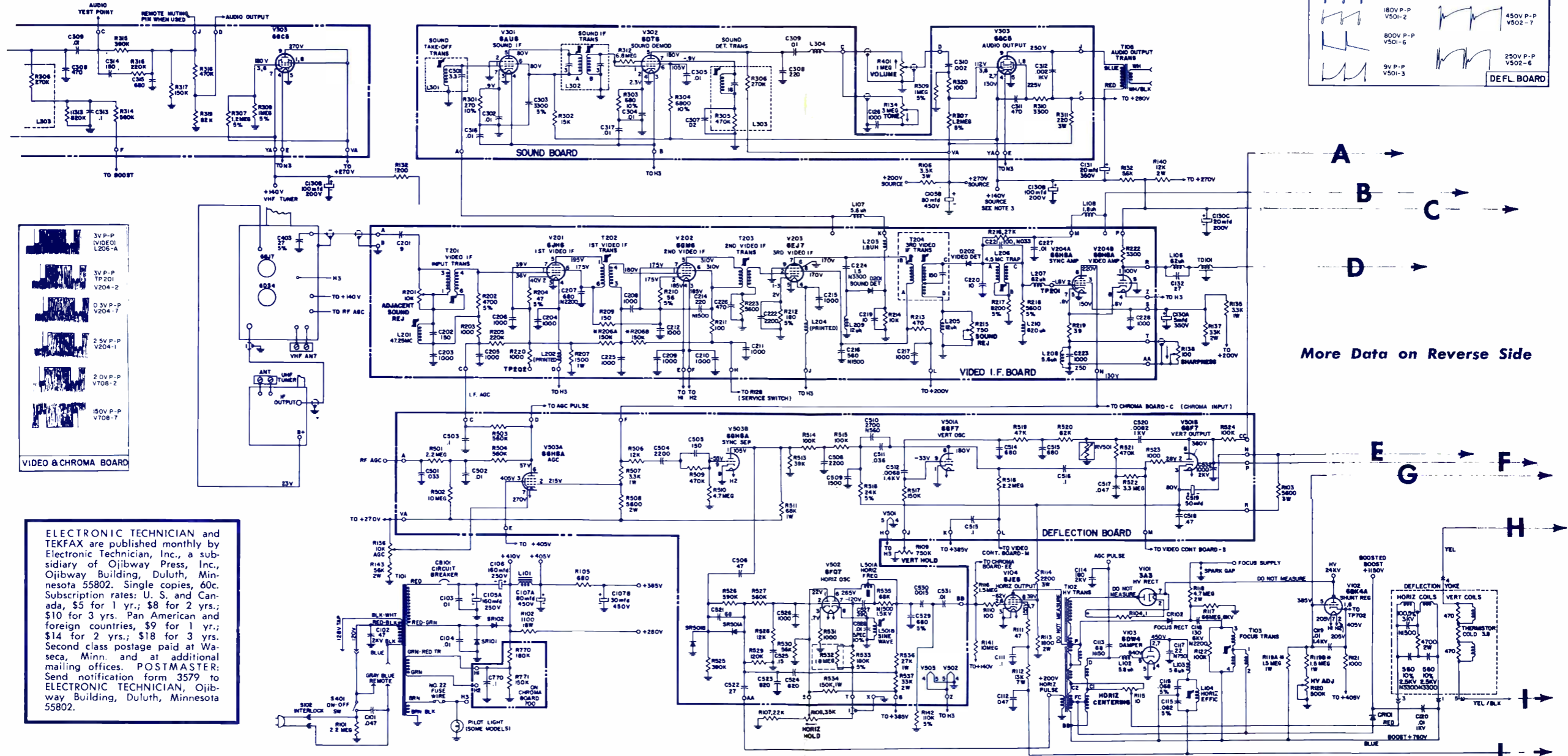
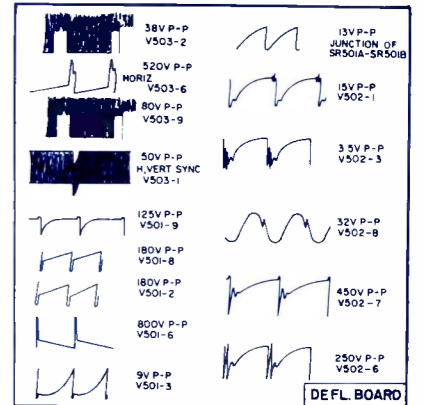
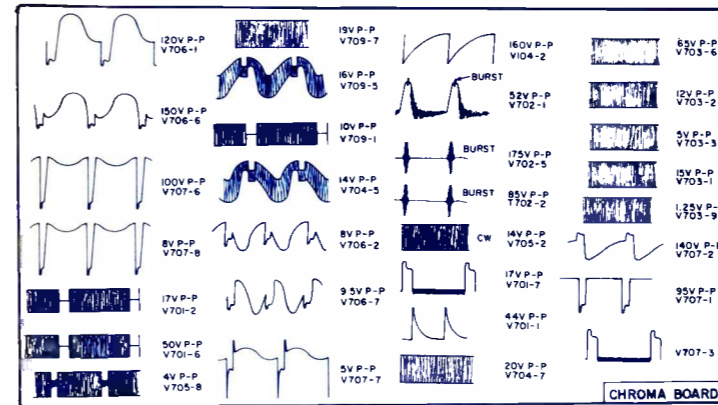

More Data on Reverse Side

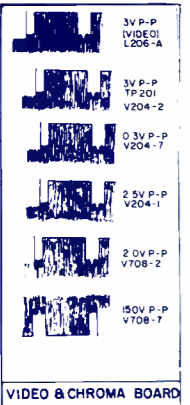

ELECTRONIC TECHNICIAN and TEKFAX are published monthly by Electronic Technician, Inc., a subsidiary of Ojibway Press, Inc., Ojibway Building, Duluth, Minnesota 55802. Single copies, 60c. Subscription rates: U. S. and Canada, \$5 for 1 yr.; \$8 for 2 yrs.; \$10 for 3 yrs. Pan American and foreign countries, \$9 for 1 yr.; \$14 for 2 yrs.; \$18 for 3 yrs. Second class postage paid at Waseca, Minn. and at additional mailing offices. POSTMASTER: Send notification form 3579 to ELECTRONIC TECHNICIAN, Ojibway Building, Duluth, Minnesota 55802.

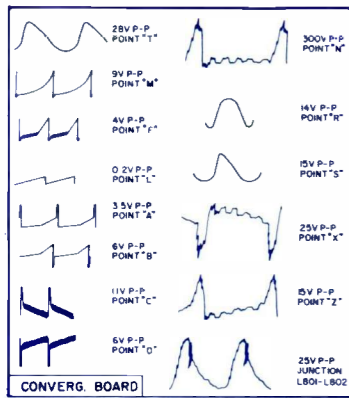

CHASSIS VERSION DIFFERENCES

CHASSIS VERSION	SOUND BOARD	R719	R720	COLOR INDICATOR
45-01-00	USES BOARD "A"	47K	56K	USED
45-02-00	USES BOARD "B"	47K	56K	USED
45-03-00	USES BOARD "A"	NOT USED	1.5K*	NOT USED
45-04-00	USES BOARD "B"	47K	56K	USED

* R720 CONNECTED TO +270V ON 45-03-00 CHASSIS

- NOTES UNLESS OTHERWISE SPECIFIED
- ⊗ INDICATES RESISTOR PAIR MATCHED WITHIN 2%
 - ⊙ INDICATES VOLTAGES MEASURED WITH COLOR BAR PATTERN APPLIED
 - ALL OTHER MEASUREMENTS ARE MADE WITH NO SIGNAL APPLIED
 - ⊕ VOLTAGE WILL NORMALLY READ 150V WITH NO SIGNAL
 - ALL CONTROLS SET FOR NORMAL OPERATION
 - WAVE FORMS MADE USING A RAINBOW GENERATOR WITH 3V AT TP301
 - LINE VOLTAGE 120V AC
 - ALL CAPACITORS ABOVE 1μF ARE IN MFD AND ALL CAPACITORS BELOW 1μF ARE IN PFD

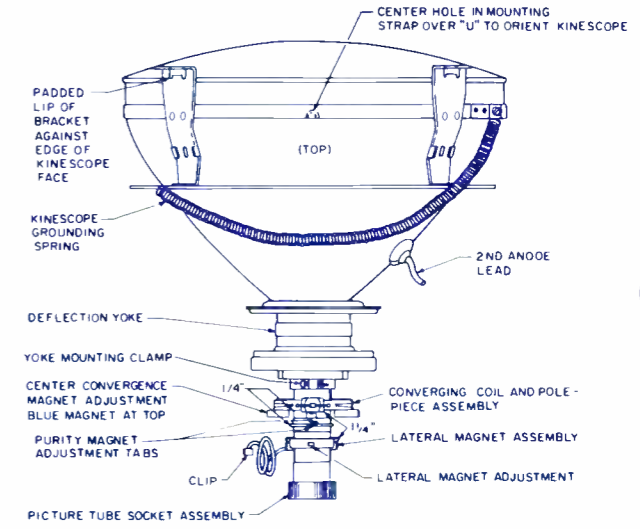
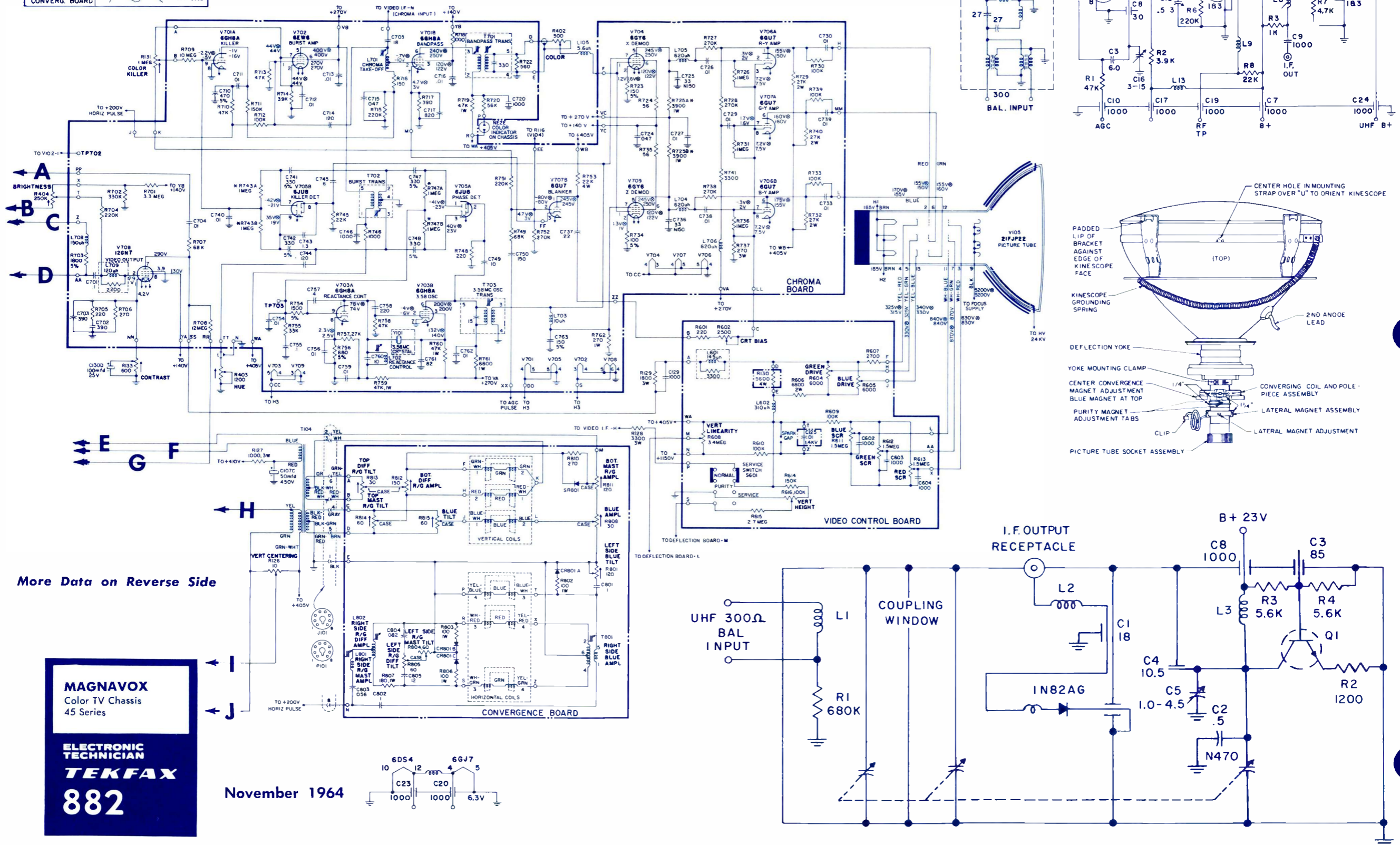

More Data on Reverse Side

MAGNAVOX
Color TV Chassis
45 Series

ELECTRONIC TECHNICIAN

TEKFAX

882

November 1964

ELECTRONIC TECHNICIAN TEKFAX

883

COMPLETE MANUFACTURERS' CIRCUIT DIAGRAMS
AND TECHNICAL INFORMATION FOR SIX NEW SETS

ADMIRAL
TV Chassis
D4, 1D4, 2D4 and
8D4

November 1964

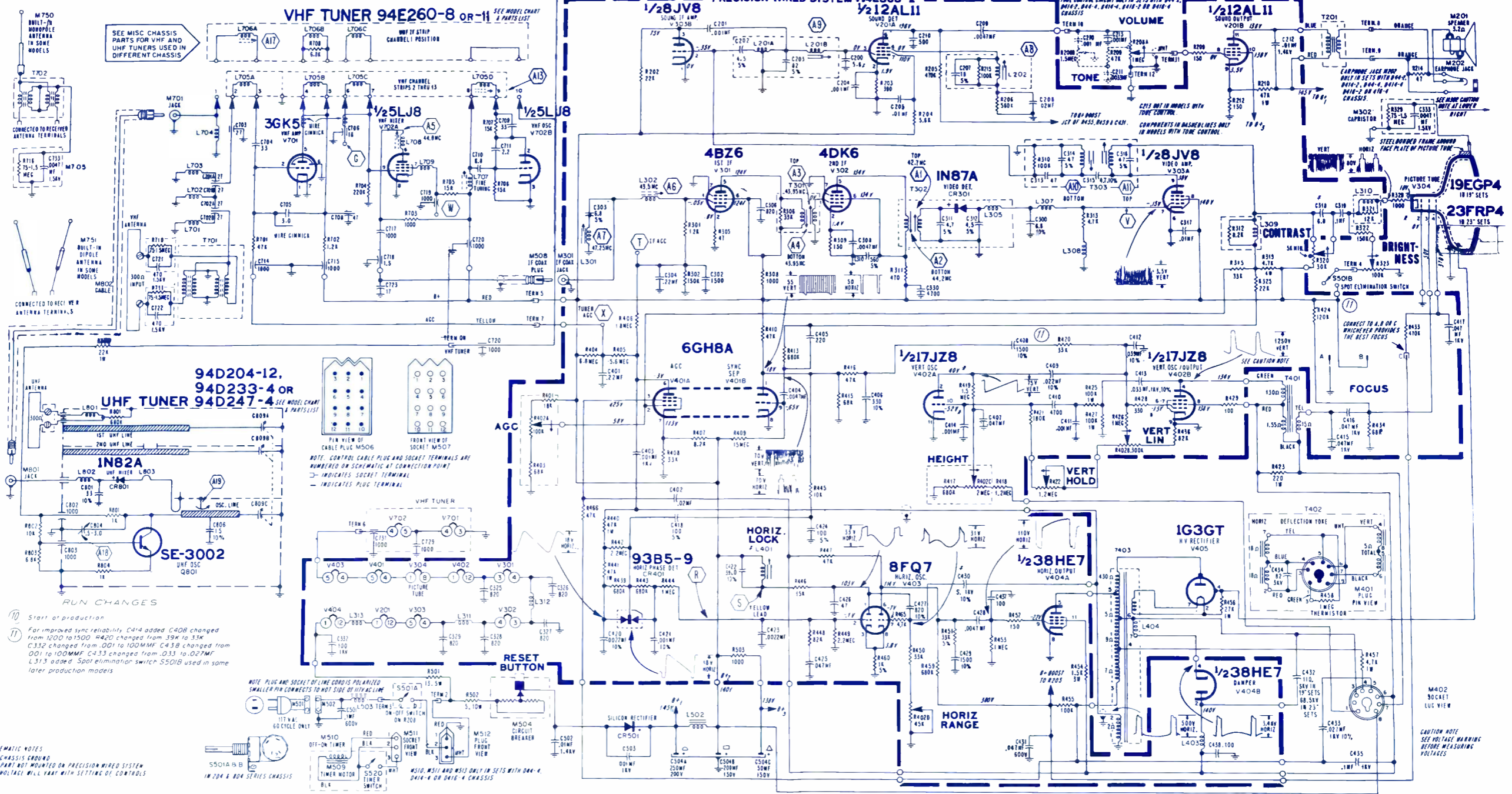
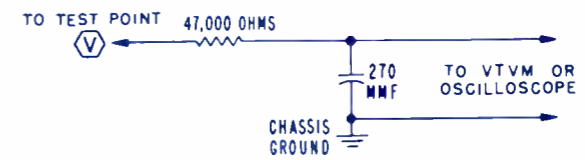
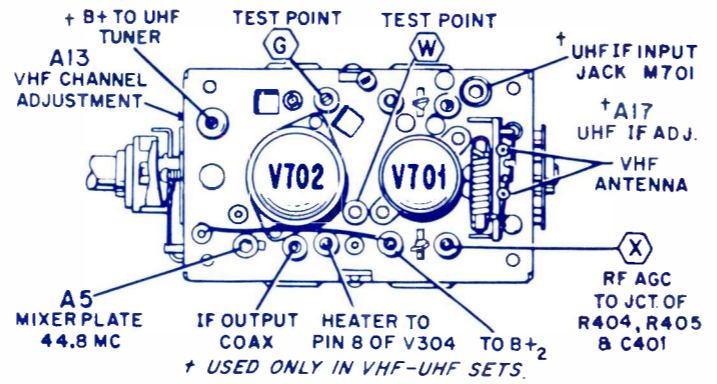
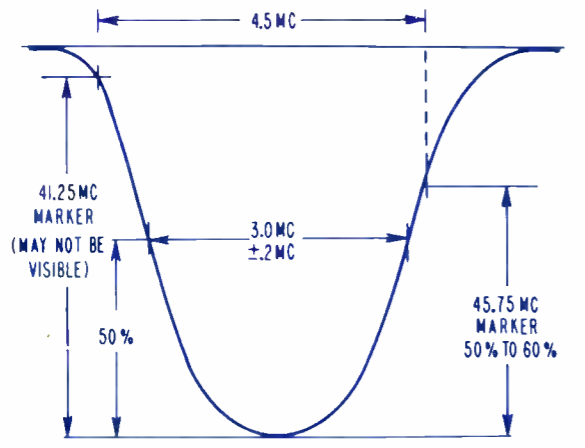

RUN CHANGES

10 Start of production

11 For improved sync reliability, C414 added, C408 changed from 1200 to 1500, R420 changed from 39K to 35K, C332 changed from .001 to 100MMF, C438 changed from .001 to 100MMF, C433 changed from .033 to .027MF, L313 added. Spot elimination switch S501B used in some later production models.

SCHEMATIC NOTES

⊕ CHASSIS GROUND
⊕ PART NOT MOUNTED ON PRECISION WIRED SYSTEM
⊕ VOLTAGE WILL VARY WITH SETTING OF CONTROLS

ELECTRONIC TECHNICIAN TEKFAK

COMPLETE MANUFACTURER'S CIRCUIT DIAGRAMS AND TECHNICAL INFORMATION FOR SIX NEW SETS November 1964

1. ALL VOLTAGES TAKEN UNDER NO SIGNAL CONDITIONS. ANTENNA REMOVED AND TUNER OFF CHANNEL.
2. VOLTAGES MEASURED WITH A PRECISION MODEL 88 V.T.V.M. FROM POINT INDICATED TO CHASSIS GROUND.

3. ALL COIL RESISTANCES READ WITH COIL IN CIRCUIT.
4. BALLOONS ⑧, ⑨, ETC., SHOWN ON SCHEMATIC, INDICATE WAVEFORM TEST POINTS.

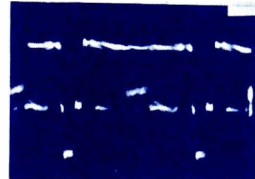

① 2.5 volts p/p, 15,750 cps (max. contrast)

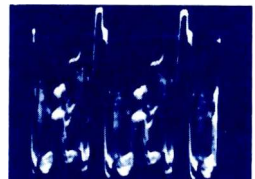

③ 75 volts p/p, 15,750 cps (max. contrast)

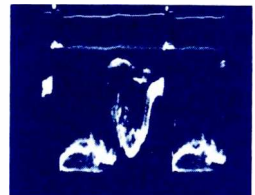

⑤ 60 volts p/p, 60 cps

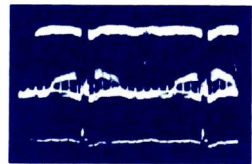

② 2.5 volts p/p, 60 cps (max. contrast)

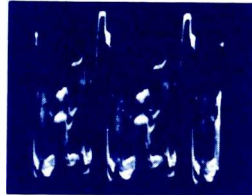

④ 60 volts p/p, 15,750 cps

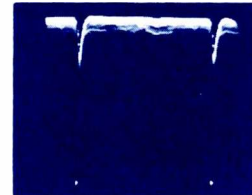

⑥ 40 volts p/p, 60 cps

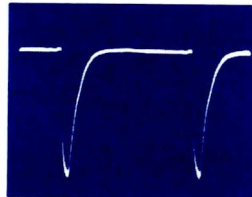

⑦ 40 volts p/p, 15,750 cps

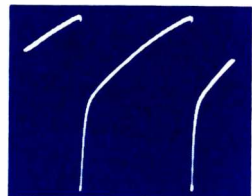

⑧ 36 volts p/p, 60 cps

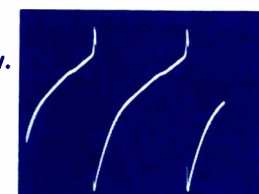

⑨ 70 volts p/p, 60 cps

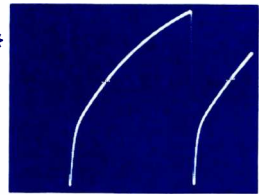

⑩ 38 volts p/p, 60 cps

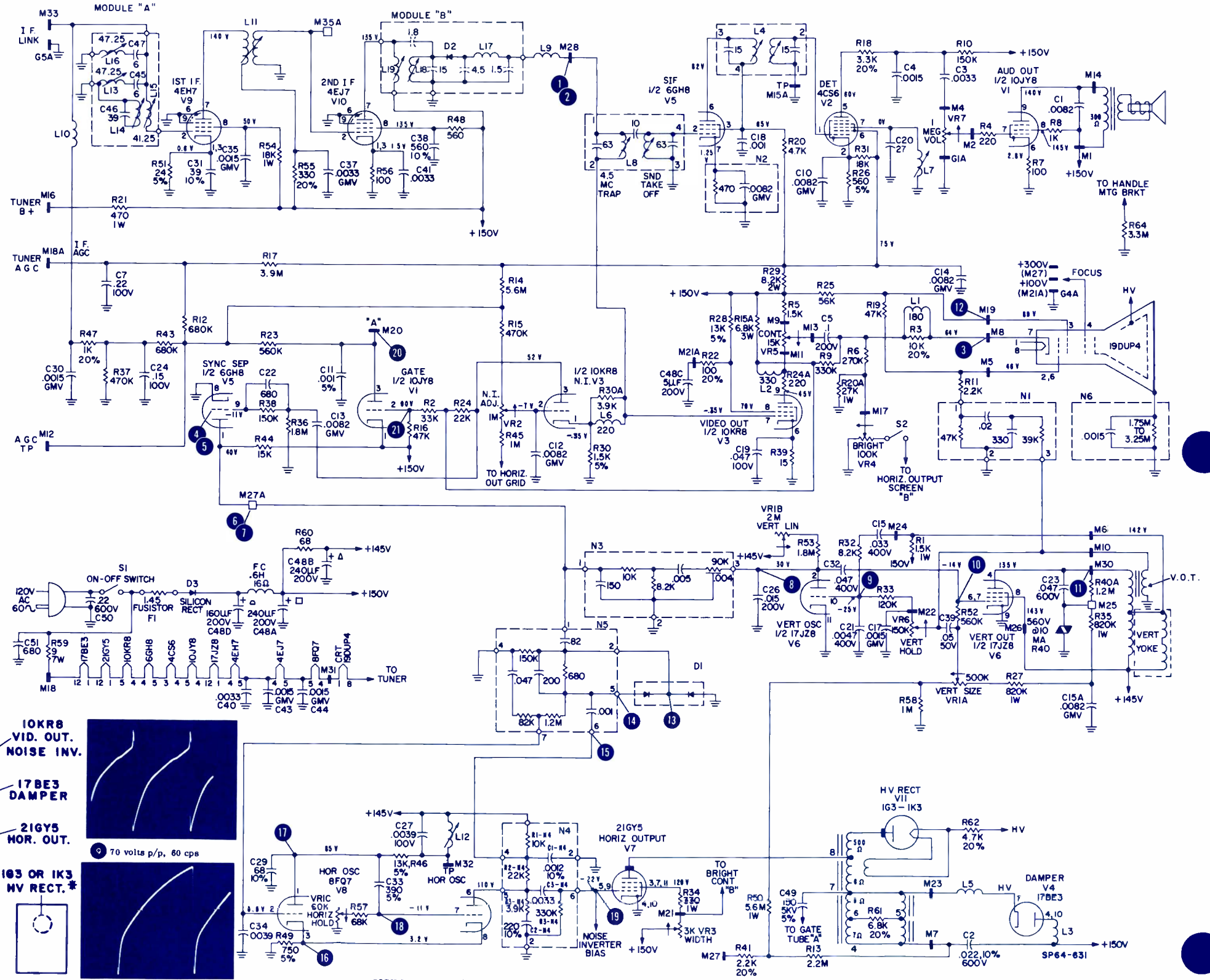

OSCILLOSCOPE WAVEFORM PATTERNS

These waveforms were taken with the receiver adjusted for an approximate peak-to-peak output of 2.5 volts at the video detector. Voltage readings taken with raster just filling screen and all controls set for normal picture viewing except photos 1, 2 and 3 where contrast was set for maximum. The voltages given are approximate peak-to-peak values. The frequencies shown are those of the waveforms, not the sweep rate of the oscilloscope. All readings were taken with a Model ES-550B Precision Oscilloscope.

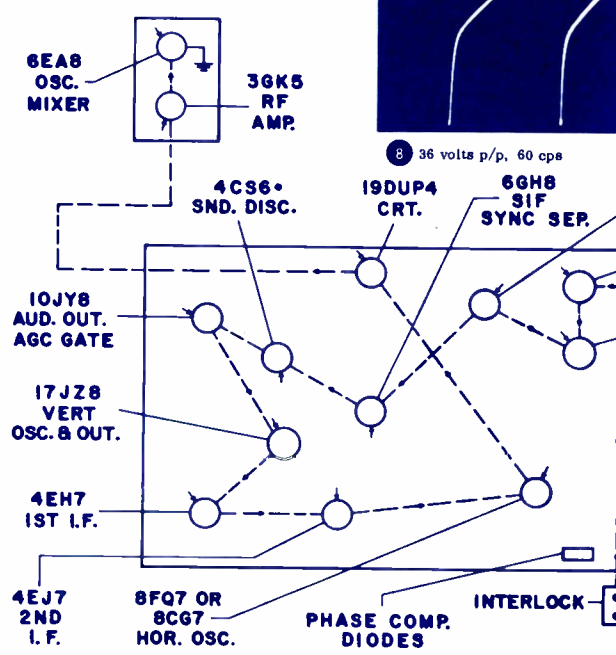

ELECTRONIC TECHNICIAN TEKFAX

COMPLETE MANUFACTURERS' CIRCUIT DIAGRAMS
AND TECHNICAL INFORMATION FOR SIX NEW SETS

885

RCA
Color TV Chassis
CTC16 Series

November 1964

BALLOONS ①, ②, ETC., SHOWN ON
SCHEMATIC INDICATE POINTS OF
OBSERVATION OF THE WAVEFORMS.
USE LOW CAPACITY PROBE WHEN
OBSERVING WAVEFORMS.



More Data on Reverse Side

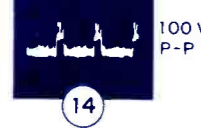
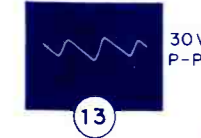
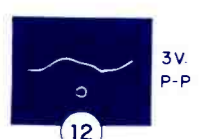
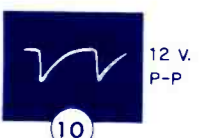
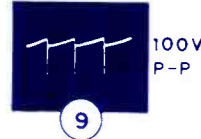
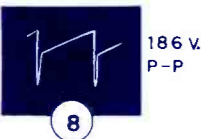
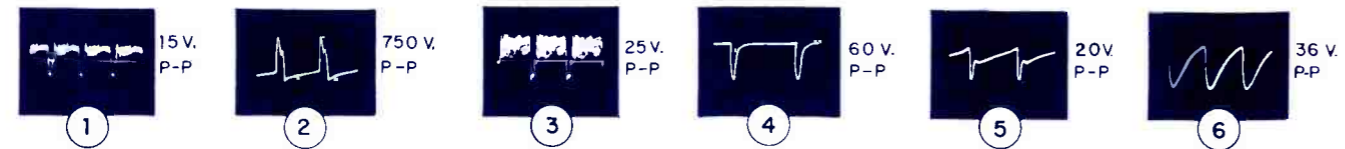
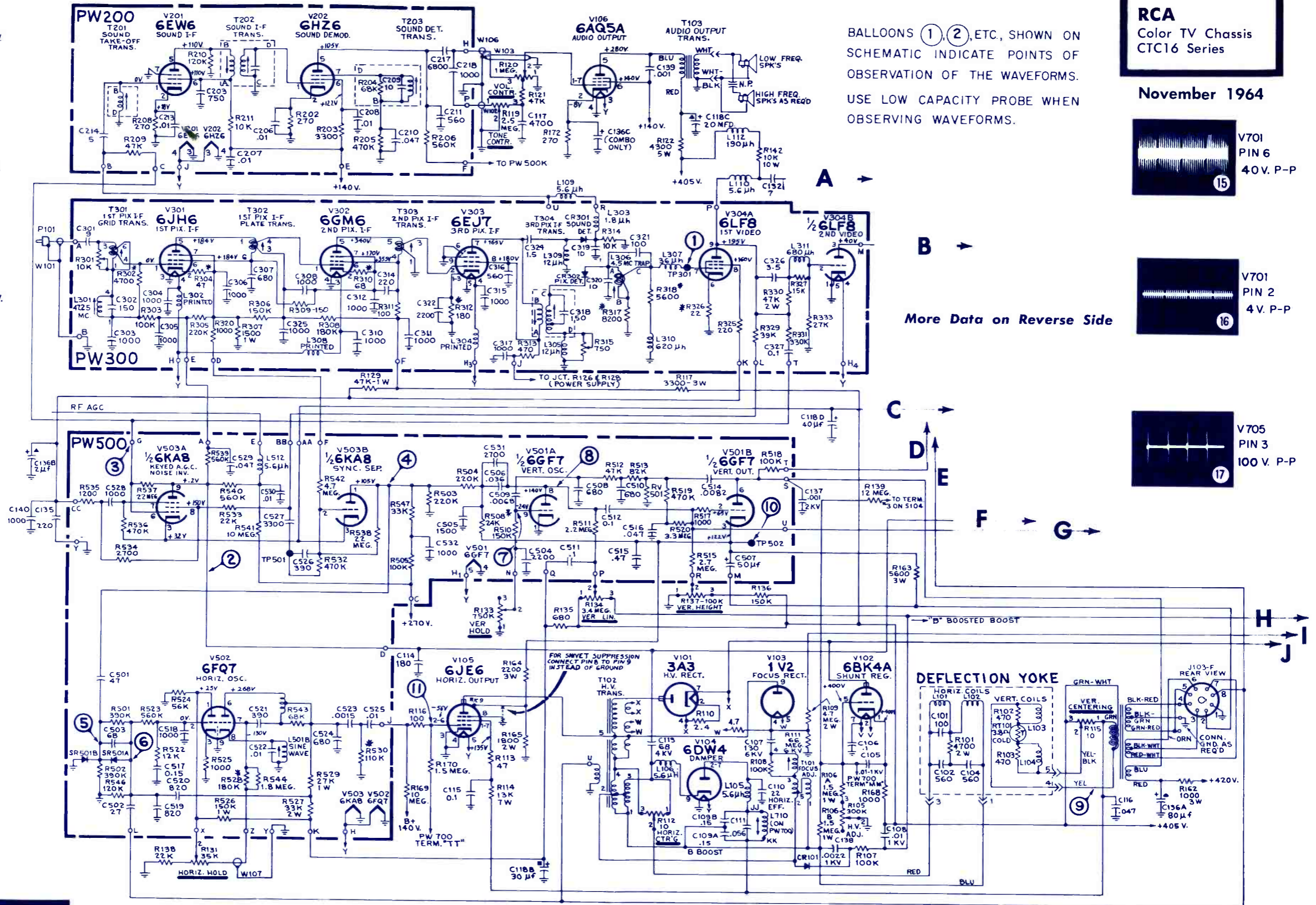



V705
PIN 2
15 V. P-P

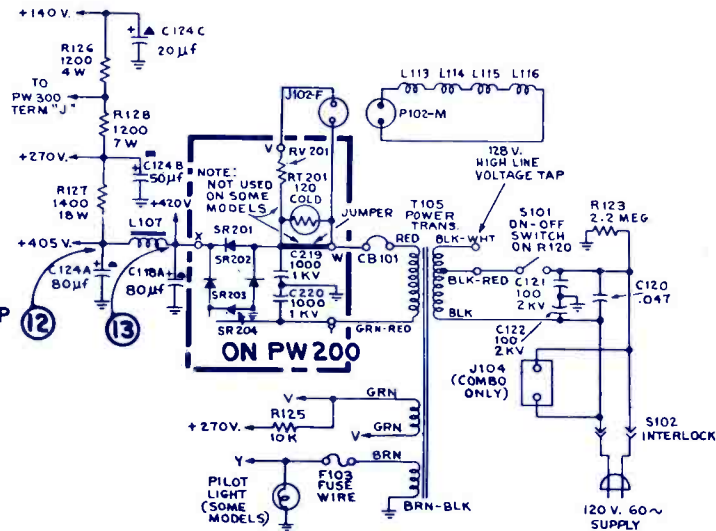

V709
PIN 1
0-20V. P-P
SET AT 5V. P-P
WITH R145

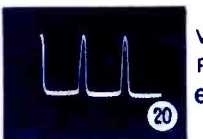
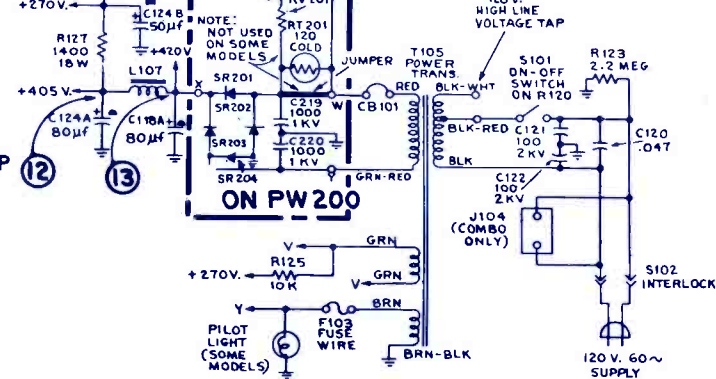

V702
PIN 1
65V. P-P

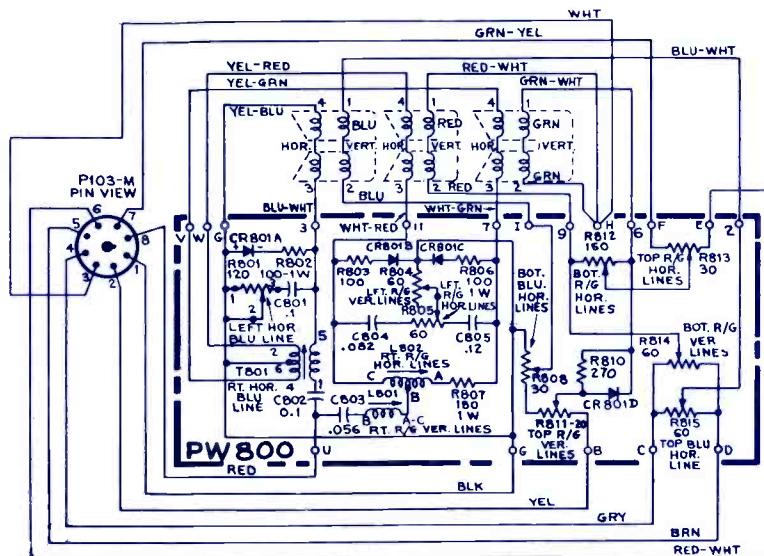
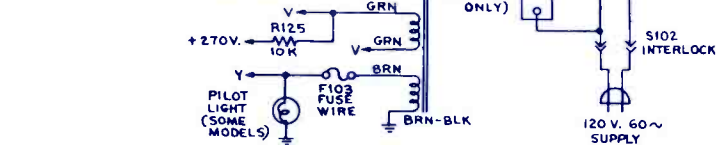

More Data on Reverse Side

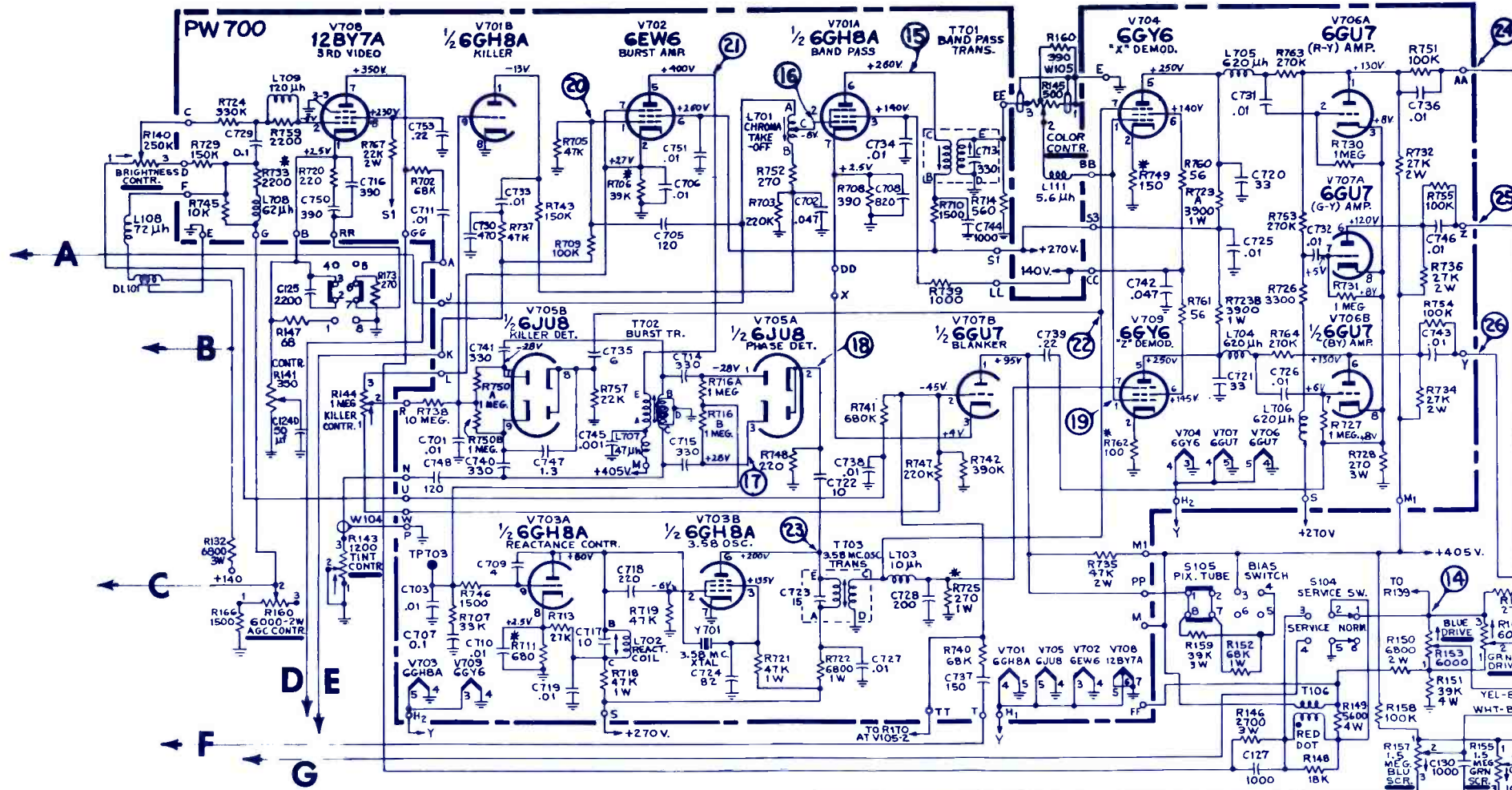
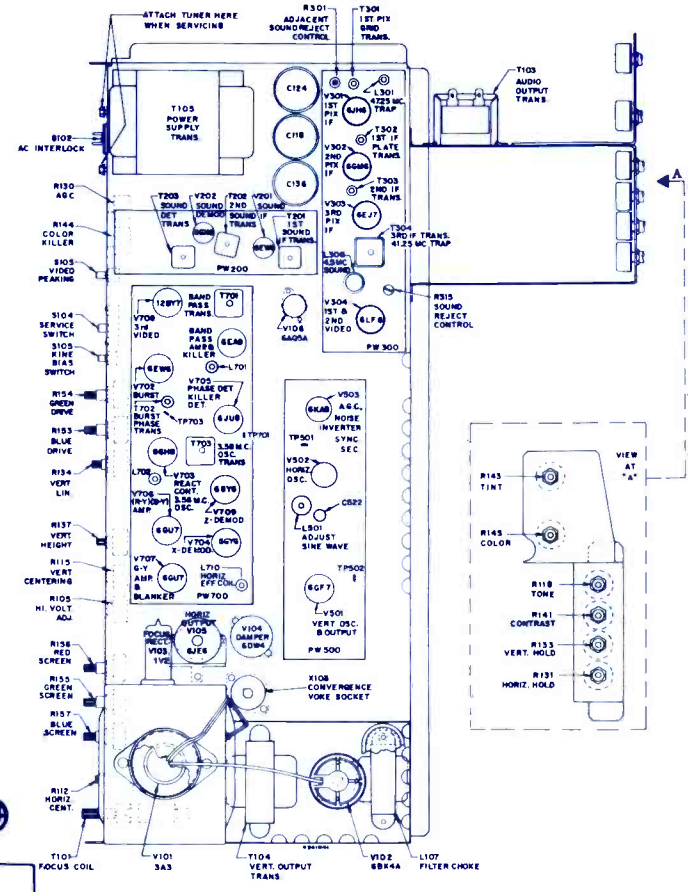

RCA
Color TV Chassis
CTC16 Series
**ELECTRONIC
TECHNICIAN**
885

November 1964

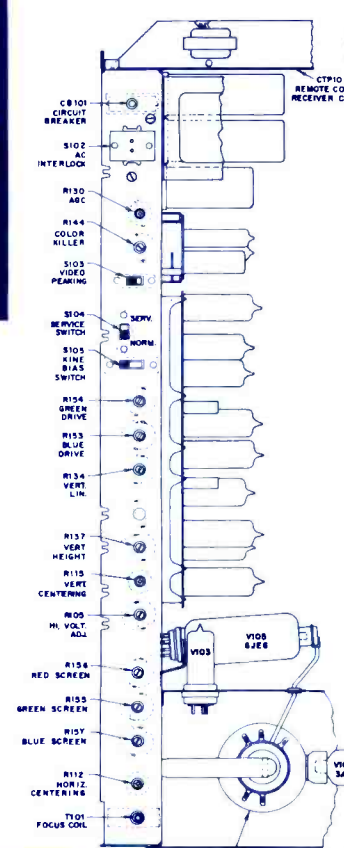

V702
PIN 5
200V. P-P



V709
PIN 7
25V. P-P



V703
PIN 6
100V. P-P

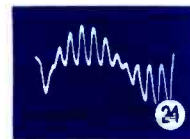

PW 700
TERM. (AA)
140V. P-P

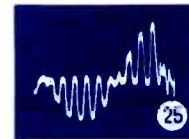

PW 700
TERM. (Z)
50V. P-P

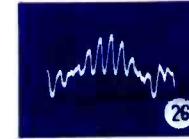

PW 700
TERM. (Y)
160V. P-P

ELECTRONIC TECHNICIAN TEKFAQ

886

COMPLETE MANUFACTURERS' CIRCUIT DIAGRAMS
AND TECHNICAL INFORMATION FOR SIX NEW SETS

ZENITH
Color TV Chassis
25MC30 Series

November 1964

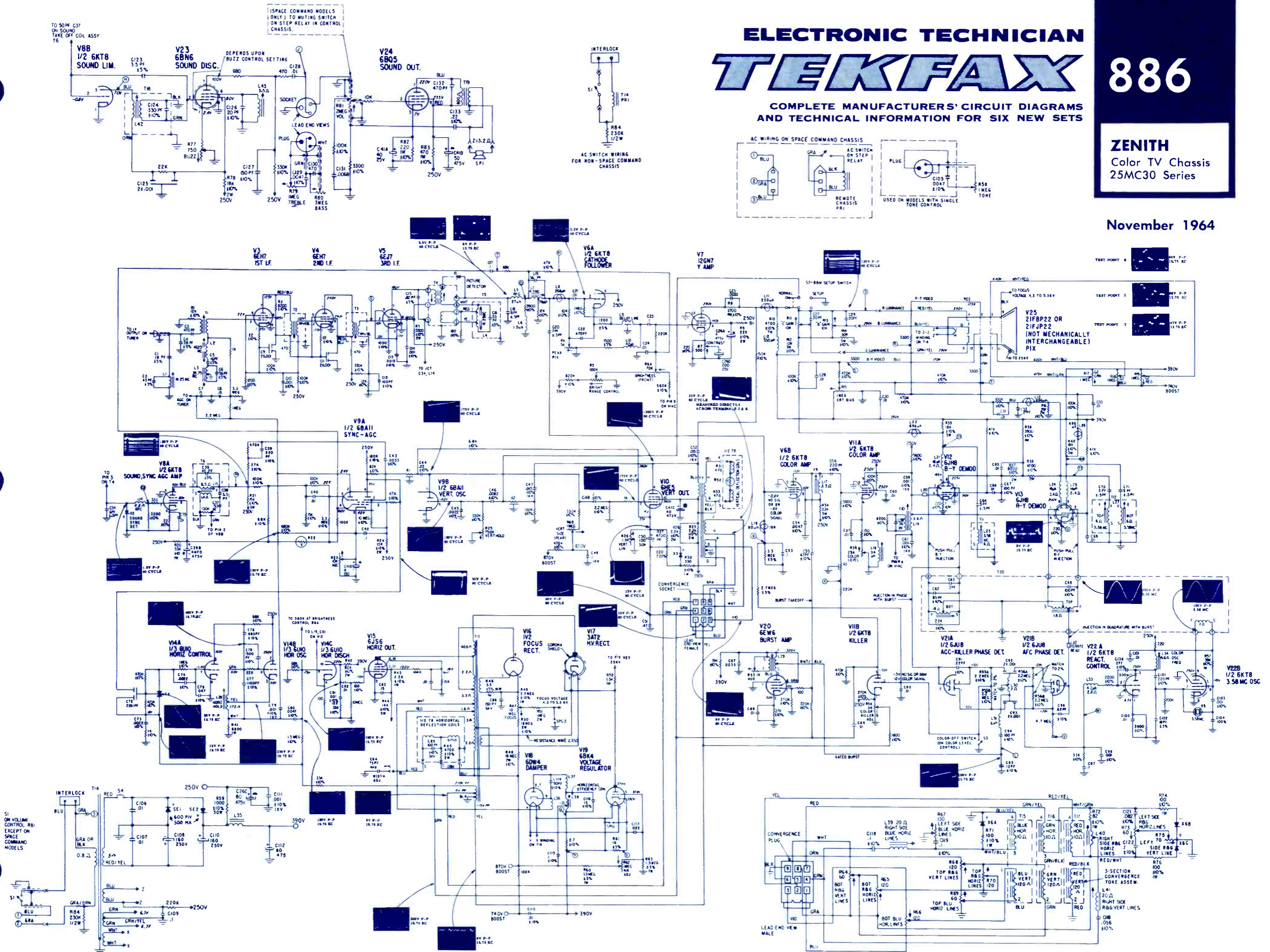

887

WESTINGHOUSE TV Chassis V-2475-1, -4

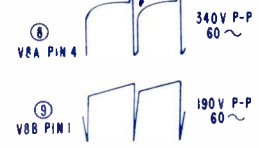

ELECTRONIC TECHNICIAN TEKFAK

COMPLETE MANUFACTURER'S CIRCUIT DIAGRAMS
AND TECHNICAL INFORMATION FOR SIX NEW SETS

- NOTES:
1. ALL CAPACITANCE VALUES LESS THAN 1 ARE IN MF AND VALUES GREATER THAN 1 ARE IN PF WHILE ALL RESISTANCE VALUES ARE IN OHMS, 1/2 WATT UNLESS OTHERWISE INDICATED.
 2. D.C. VOLTAGES MEASURED FROM B-WITH A VTVM, NO SIGNAL APPLIED, LINE VOLTAGE AT 120 V.A.C.
 3. WAVEFORMS WERE TAKEN WITH CONTROLS SET FOR NORMAL PICTURE

4. MAKES CONTACT ON CHAN #1
 5. CIRCLED NUMBERS REFER TO WAVE FORMS.
 6. V 2475-1 CRT IS 19 CMP4 - SAFETY GLASS SHIELD REQUIRED.
V 2475-4 CRT IS 19 EJP4 - NO GLASS SHIELD REQUIRED.
- * PART OF QUADRUPLE CONTROL ASSY.

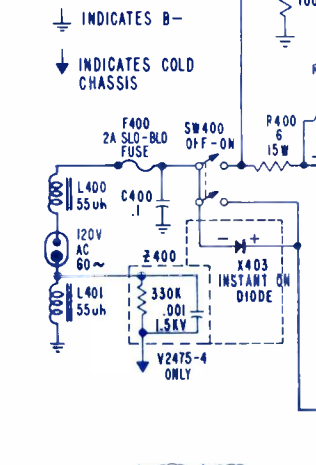
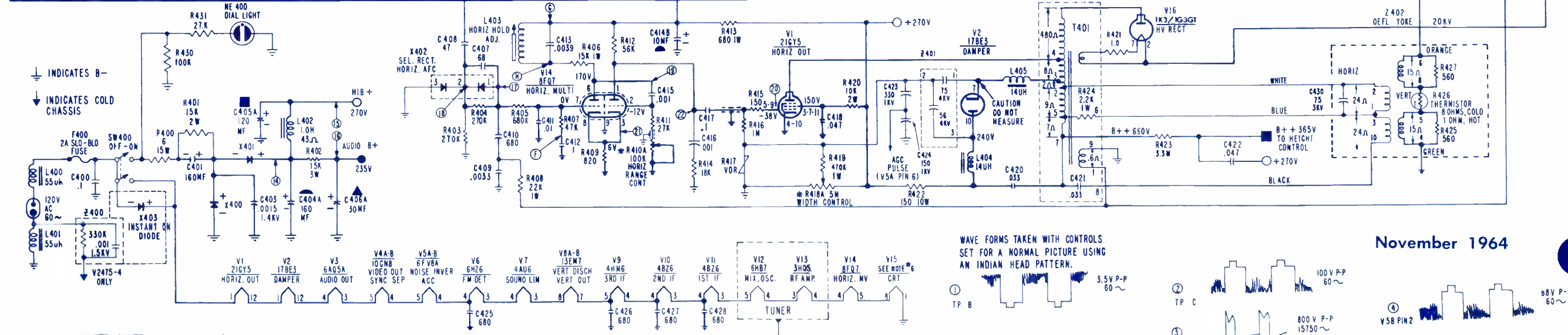
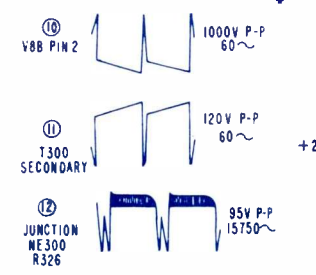
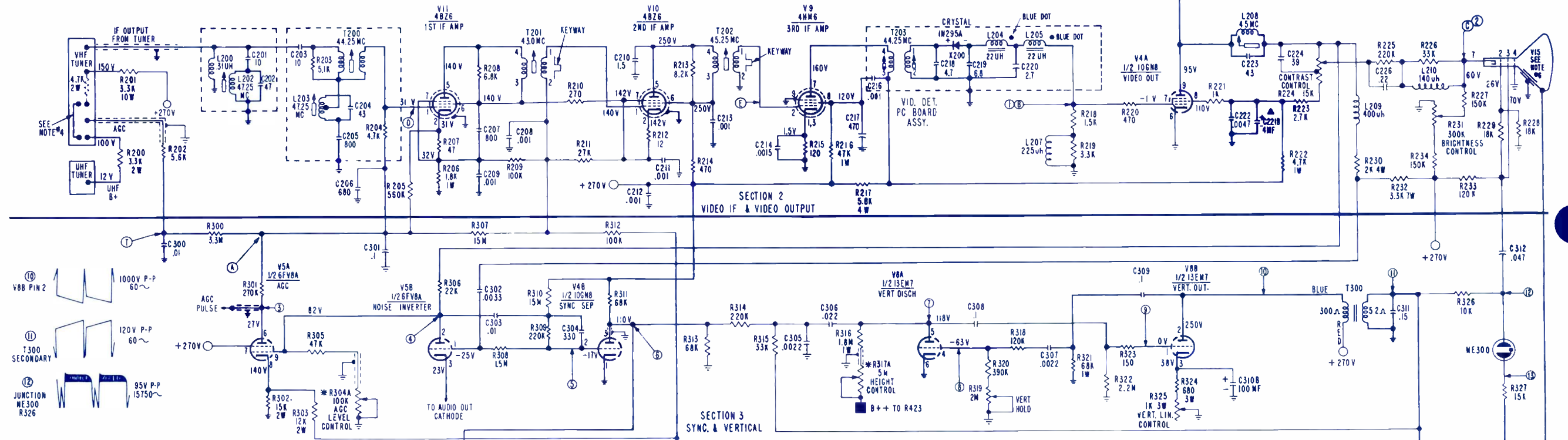
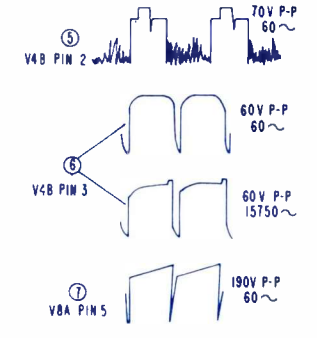
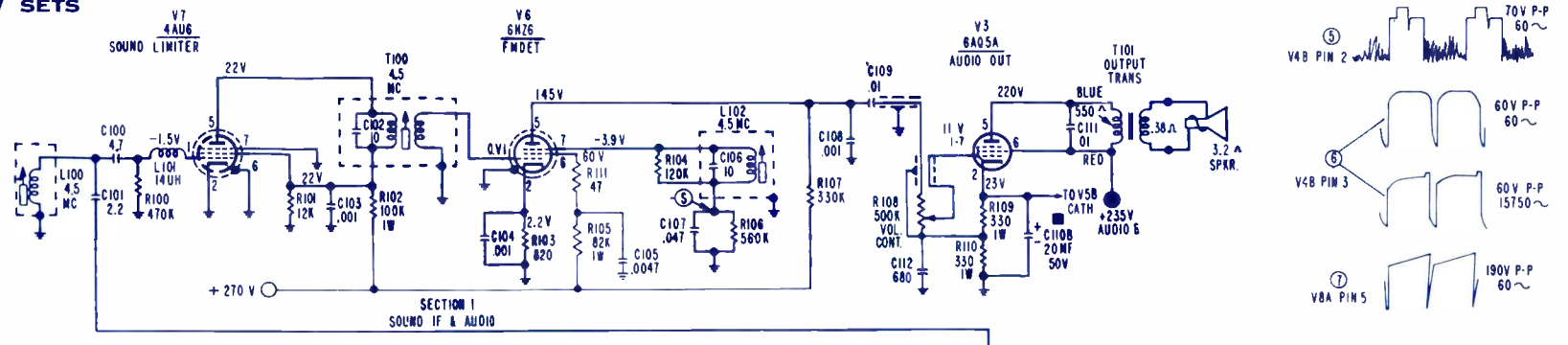
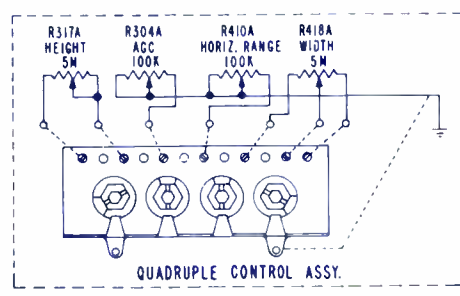

WAVE FORMS TAKEN WITH CONTROLS SET FOR A NORMAL PICTURE USING AN INDIAN HEAD PATTERN.

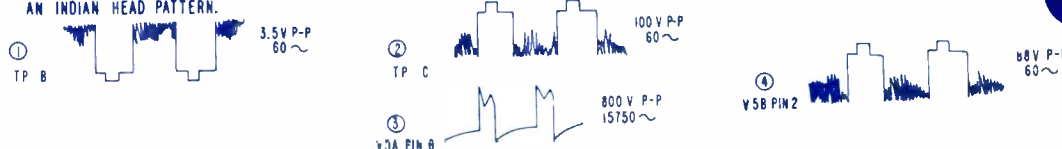

November 1964

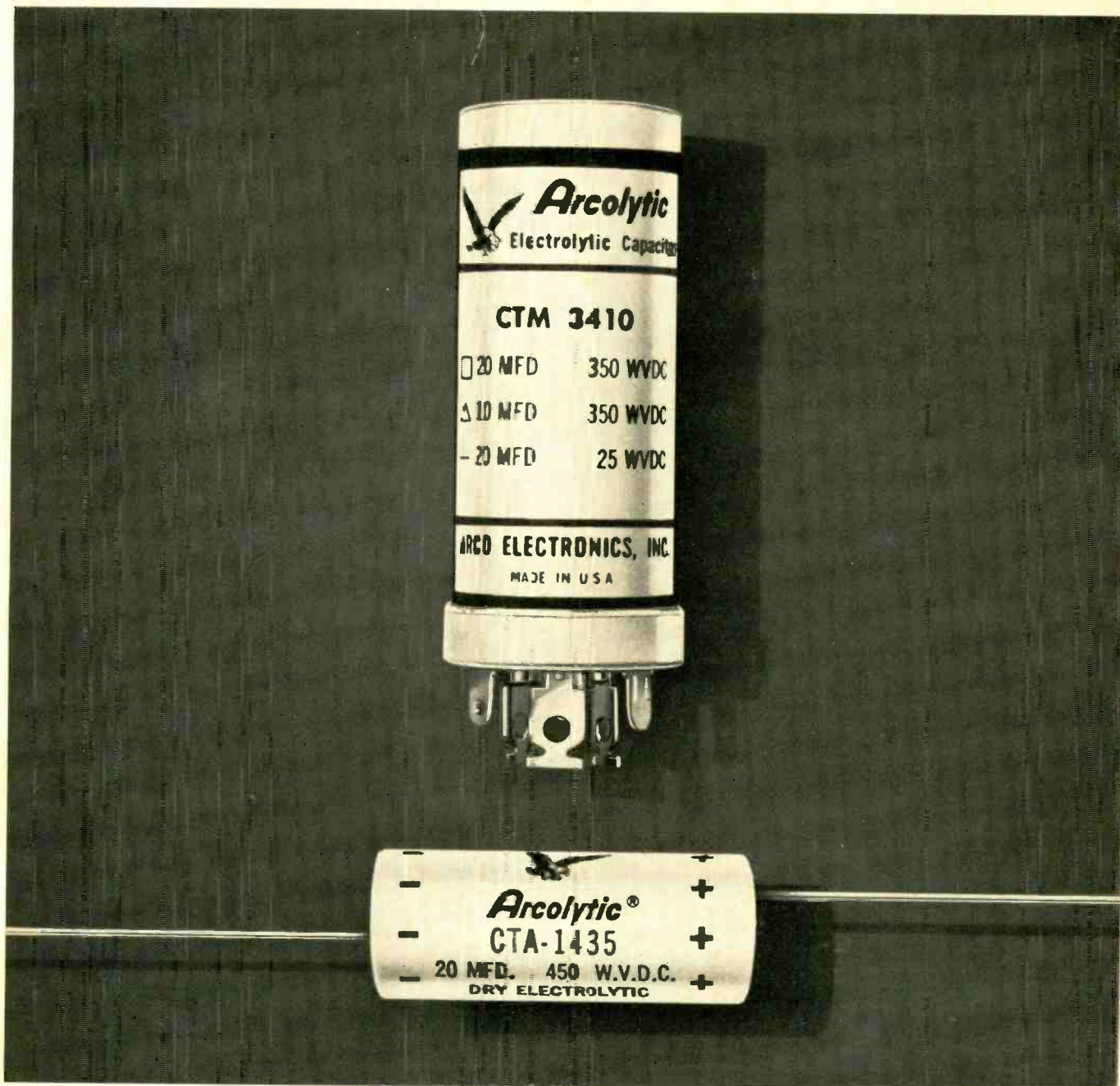

For quality and service...**ARCOLYTIC!**

These superior quality electrolytic capacitors are made of 99.99% pure aluminum foil... designed to operate at 85°C, and withstand high ripple and surge voltages. All are made and tested to EIA RS-154. Premium grade materials and construction make Arcolytics last longer—on the shelf... and in the set! Over 1400 values to meet all requirements for tubular and twist-mount electrolytics—single, dual, triple or quad-



ripule capacitance in voltage combinations for radio, tv and industrial electronics. All unconditionally guaranteed! No extra charge for this high quality. You can get your Arcolytics in any quantity within 24 hours from coast to coast. They're stocked in depth at Arco's reserve warehouses serving authorized

Arco distributors throughout the nation. Call your Arco distributor today!

ARCO

electronics inc.

Community Drive, Great Neck, New York

Branches: Dallas 7 □ Los Angeles 35

--- for more details circle 15 on post card

**MAKES MORE . . . AND MORE
ACCURATE TESTS THAN ANY SERVICE TUBE TESTER EVER BUILT.**

**TRIPLE SHORTS
SENSITIVITY
TESTS**

**DYNAMIC
TEST FOR
EYE TUBES**

**TESTS
HEATER CURRENT
ON SERIES
TUBES**

**TESTS
REGULATOR &
REFERENCE
TUBES**

**TRUE
RECTIFIER
TEST**

**231
HEATER
VOLTAGES**

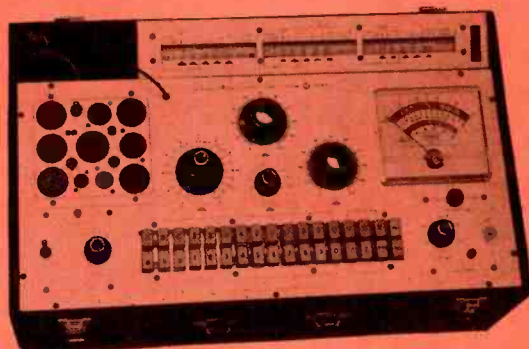

**New Tube Test Data Issued Regularly - Keeps You Up To Date
Between Roll Charts - No Charge !**

JACKSON MODEL 658A DYNAMIC OUTPUT TUBE TESTER

DYNAMIC OUTPUT PRINCIPLE - A sensational improvement on the time tested Jackson principle. In the dynamic output test, variable D.C. bias voltage, plus variable A.C. signal voltages are applied to control grid. Variable D.C. voltage is applied to the plate and screen. The metering circuit a low impedance bridge type, then reads only the A.C. component of the plate current. Obviously this is the most valid kind of test for amplifiers, it considers the entire output curve of the tube, not just a small portion.

This principle coupled with the many Jackson features make this tester the biggest dollar value in the business.

DEALER NET **\$234.95**

**See Your Franchised Distributor and See This One for Yourself -
While You Are There, Ask About a Trade-In Deal**



Jackson model 805 Vacuum Tube Voltmeter

Features Taut Band Suspension Meter, taut band suspension eliminates pivots and jewels, eliminating pivot friction and error due to pivot fall-over. No movement springs, spring set or hysteresis eliminated. May be operated in any position without degrading performance and is four times more sensitive than conventional movements. Also features static free face, burn out proof meter and direct probe.

DEALER NET **\$79.95**

"Service Engineered Electronic Test Equipment"



The Jackson Electrical Instrument Company Dayton, Ohio

... for more details circle 37 on post card
ELECTRONIC TECHNICIAN

NOVEMBER 1964
VOL. 80 NO. 5

ELECTRONIC TECHNICIAN

WORLD'S LARGEST ELECTRONIC TRADE CIRCULATION



RON KIPP Publisher
JACK HOBBS Managing Editor
QUINTO BOCCHI Technical Editor
DOUGLAS HEDIN Industrial Editor
JOHN BAILEY Assistant Editor
ERNEST BLUM Assistant Editor
EARL HINTZ Production Manager
MAGGIE KANE Advertising Production
JIM GHERNA Art Director
JOE WOLKING Circulation Mgr.
DONNA GEARY Circulation Fulfillment



AN OJIBWAY
PUBLICATION

OJIBWAY PRESS, Inc.

Ojibway Building
Duluth, Minn.
55802

AREA CODE 218 727-8511

Sales Offices:

NEW YORK: Ron Kipp, 555 Fifth Ave.,
New York, N.Y. 10017
AREA CODE 212 MU 7-8080

CHICAGO: William Klusack, 221 N.
LaSalle St., Chicago, Ill. 60601
AREA CODE 312 CE 6-1600

CLEVELAND: Arnold T. Suhart, 6207
Norman Lane, Cleveland, Ohio 44124
AREA CODE 216 YE 2-6666

LOS ANGELES: Boyd B. Garrigan, 1655
Beverly Blvd., Los Angeles, Calif.
90026
AREA CODE 213 MA 8-8556



Copyright 1964 by Ojibway Press, Inc., Duluth, Minn. 55802. Reproduction and reprinting prohibited except by written authorization of the publication. Subscription price: \$5 for 1 year, \$8 for 2 years, \$10 for 3 years. Foreign, \$9 for 1 year, \$14 for 2 years, and \$18 for 3 years. If you have a change of address or a question about your subscription, write: ELECTRONIC TECHNICIAN, Circulation Department, Ojibway Building, Duluth, Minnesota 55802. BE SURE TO SEND ALONG THE ADDRESS LABEL FROM YOUR MOST RECENT ISSUE.

COVER:

The shape of things to come are being reflected in today's new TV models.

FEATURES

What You'll Find in 1965 TV Sets	45
<i>A detailed technical report of some important circuits used in current model TV sets</i>	
Picture Tubes—Black and White and Color	49
<i>A review of new CRT developments</i>	
Filters Can Do Funny Things	51
<i>H. L. Davidson tells of his experiences with unusual filter capacitor symptoms</i>	
Sound—The Easy Section	54
<i>Bill Ganglinger shows you how NOT to repair the TV sound section</i>	
Choosing and Using Audio Oscillators Part II	57
<i>Art Walters continues his in-depth series on audio oscillators</i>	
Are Your Business Costs Climbing Too Fast?	59
<i>Ernest Fair tells how to cope with rising business costs</i>	
FM Stereo Receiver Alignment	60
<i>Stanley Janas gives simple instructions on using a multiplex generator</i>	
CRT Implosion Protection	62
<i>C. M. Kesser analyzes advantages of the banded CRT</i>	
INDUSTRIAL ELECTRONICS SECTION	73

DEPARTMENTS

Technical Digest	22	Shop Hints	68
Letters to the Editor	32	New Products	82
Editors' Memo	38	New Literature	100
Sync on Business	40	Industry News	104
'Tough Dogs'	66	Advertisers Index	106

TEKFAK . . . 16 PAGES OF THE LATEST SCHEMATICS

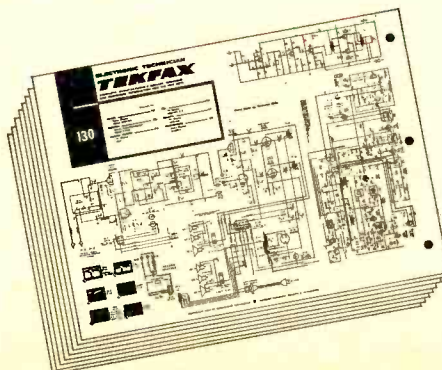

ADMIRAL: TV Chassis D4, 1D4, 2D4 and 8D4

MAGNAVOX: Color TV Chassis 45 Series

PHILCO: TV Chassis 15J27

RCA: Color TV Chassis CTC16 Series

WESTINGHOUSE: TV Chassis V-2475-1, -4

ZENITH: Color TV Chassis 25MC30 Series

top money maker in
the service business

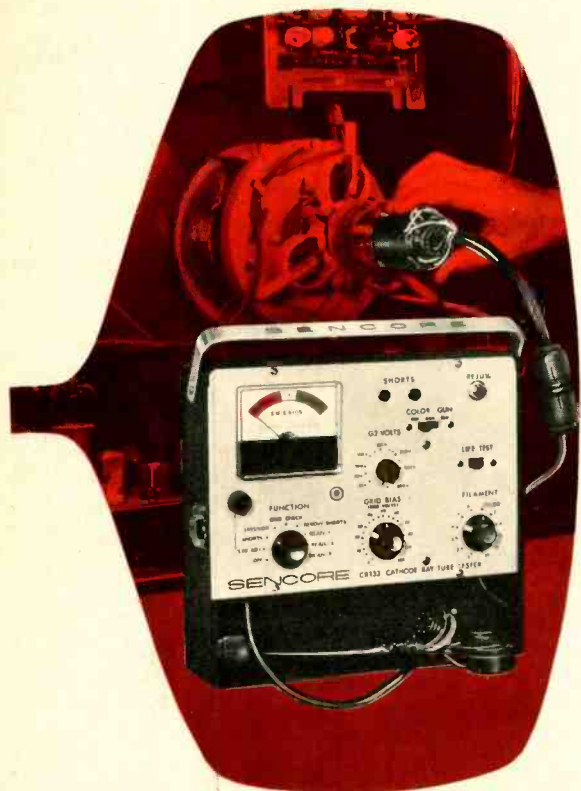

NEW IMPROVED SENCORE CR133 CRT CHECKER & REJUVENATOR

The new, improved CR133 CRT Checker is designed to test all present picture tubes — and it's ready for future tubes too! Two plug-in replaceable cables contain all sockets required. The compact, 10 lb., CR133 checks CRT emission, inter-element shorts, control grid cut-off capabilities, gas and expected life. Checks all tubes: conventional B&W, new low drive B&W, round color tubes and new rectangular color picture tubes. Exclusive variable G2 Volts from 25 to 325 Volts insures non-obsolescence when testing newly announced "semi-low" G2 CRT tubes. New Line Voltage Adjustment insures the most accurate tests possible. Uses well-filtered DC for all checks to avoid tube damage and reading errors. Color guns are individually tested as recommended by manufacturers. Exclusive automatically controlled rejuvenator applies rejuvenation (ACR) voltage as required by individual tube condition; precisely timed to prevent over-rejuvenation or tube damage. The ACR feature is most useful for color tube current equalization to insure proper tracking. Hand-wired and steel-encased for protection of meter and panel in truck or shop, the new improved CR133 is only . . . **\$89⁹⁵**

The famous CR128 CRT Checker and Rejuvenator is similar to above, but with a three position G2 slide switch and without Line Voltage Adjustment at \$69.95

professional quality — that's the difference!

SENCORE

426 SOUTH WESTGATE DRIVE • ADDISON, ILLINOIS
... for more details circle 56 on post card

TECHNICAL DIGEST

Admiral

Color TV Chassis D11 — Field Adjustment of Sync and Phase

To make color sync adjustment in the field, tune in color bar generator or color program. Short test point TP5-6 to ground. Adjust C3 (reactance coil

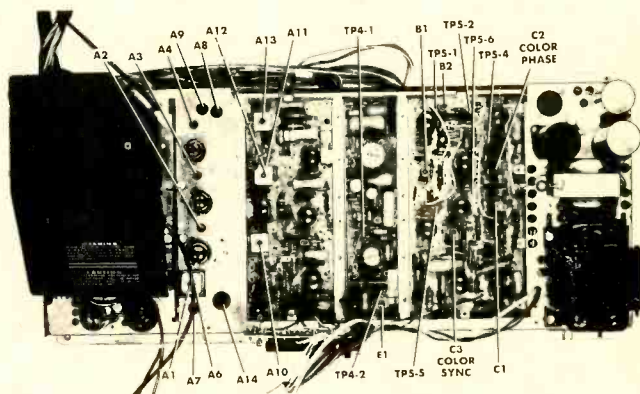

Test point and adjustment locations on Admiral color chassis D-11.

L507) for least amount of "barber-poling" or color-drift in picture. Remove ground from TP5-6, check color sync action.

To make color phase (tint) adjustment, tune in color bar generator or color program. Set tint control to approximate mid-rotation, and set color fidelity control at neutral position. Adjust C2 (burst transformer T502) for correct registration of color bar or most natural flesh tones. With tint control at extreme clockwise position, flesh tones should appear green. Natural flesh tones should be at mid-rotation.

General Electric

TV Chassis DA—RW365 Power Tuning Function

The power tuning motor and drive mechanism is mounted on the rear of the VHF tuner and when activated by the remote receiver, drives the shaft of the VHF tuner. Also mounted to the rear of the tuner is a microswitch (S555) for the TV receiver ON/OFF function. The microswitch is in series with the main receiver switch and is activated by a cam fastened to the tune selector shaft. A program switch (S552) is mounted at the front of the VHF tuner. This switch is activated by the fine tuning slugs. To program a channel IN, merely select the channel, then properly fine tune. To program a channel OUT, turn the fine tuning counterclockwise several tunes.

The ON/OFF program wheel and micro-switch (S-555) assembly allows one channel position to be selected as the automatic ON/OFF position for the main chassis. The program wheel is a flat metal cam with a hole in the center for the tuner shaft and has 13

WHY

risk your reputation with "just-as-good" capacitors?

When you pay little or no attention to quality in tubular replacement capacitors, you leave yourself wide open for criticism of your work . . . you risk your reputation . . . you stand to lose customers. It just doesn't pay to take a chance on capacitors with unknown or debatable performance records when it's so easy to get guaranteed dependable tubulars from your Sprague distributor!

There's no "maybe" with these 2 great **SPRAGUE DIFILM® TUBULARS!**

The ultimate in tubular capacitor construction. Dual dielectric . . . polyester film and special capacitor tissue . . . combines the best features of both. Impregnated with HXC[®], an exclusive Sprague synthetic hydrocarbon material which fills every void in the paper, every pinhole in the plastic film *before it solidifies*, resulting in a rock-hard capacitor section . . . there's no oil to leak, no wax to drip. Designed for 105°C (220°F) operation without voltage derating.



DIFILM® BLACK BEAUTY®
Molded Tubular Capacitors

The world's most humidity-resistant molded capacitors. Tough, protective outer case of non-flammable molded phenolic . . . cannot be damaged in handling or installation. Black Beauty Capacitors will withstand the hottest temperatures to be found in any TV or radio set, even in the most humid climates.



DIFILM® ORANGE DROP®
Dipped Tubular Capacitors

A "must" for applications where only radial-lead capacitors will fit . . . the perfect replacement for dipped capacitors now used in many leading TV sets. Double-dipped in rugged epoxy resin for positive protection against extreme heat and humidity. No other dipped tubular capacitor can match Sprague Orange Drops!

For complete listings, get your copy of Catalog C-616 from your Sprague distributor, or write to Sprague Products Company, 65 Marshall Street, North Adams, Massachusetts.



WORLD'S LARGEST MANUFACTURER OF CAPACITORS

just in time for the
fm and uhf boom!
an all transistorized
field strength meter.



THE ALL NEW SENCORE FS134 FIELD STRENGTH METER

Once again, you can turn to the roof tops for a fast dollar in antenna installations. But this time, you can do it the easy way. No more running up and down ladders, locating cumbersome AC extension cords, lugging heavy tube operated field strength meters on the roof, or worse yet, getting the shock of your life from the AC line as you hold onto a soil pipe. Here is a new portable field strength meter to fill your every need in VHF, UHF or FM antenna installations. Many customers want all antennas on one mast thus creating interaction. Here is where the FS134 goes to work. You can optimize antenna location and orientation in seconds. Just connect the antenna, tune in the station and adjust. Self-contained speaker blasts forth the sound from the TV or FM station to insure that you have the exact signal that you are looking for. The FS134 is so light weight (only 9 lbs.) that you can take it with you up the chimney if necessary. Get rid of the assistant at the other end of the transmission line and the needless "yelling" back and forth. Get the FS134 today . . .

only **\$199⁵⁰**

COMPARE TO ANY OTHER FIELD STRENGTH METER AT TWICE THE MONEY

- Sensitivity . . . 5 microvolts on VHF and FM, 15 microvolts on UHF
- Input impedance . . . 300 ohms or 75 ohms with plug-in transformer
- 500 KC band width
- Powered by easy to get "C" cells
- 4 inch meter with 2 percent accuracy calibrated in DB and microvolts.

professional quality — that's the difference!

SENCORE

426 SOUTH WESTGATE DRIVE • ADDISON, ILLINOIS

--- for more details circle 57 on post card

TECHNICAL DIGEST

POWER TUNING
REPLACEMENT PARTS

ET2X212	LEVER—Power Program Wheel, Die Cast
ET72X18	MOTOR & GEAR DRIVE ASSEMBLY—
	Power Tuning Includes (1) thru (7)
ET41X43	ROTOR & PINION GEAR ASSEMBLY— (1)
	Power Tuning Motor
ET1X41	SCREW—Hex Head, # 24 x 1/4" (2)
	Program Wheel
ET55X31	SWITCH—On-Off w/Leaf, Activated by
	Program Wheel (1)
ET51X51	SWITCH ASSEMBLY—Power Tuning Motor (1)
L-ET2X327	WHEEL—Program On-Off Selector Disc (2)

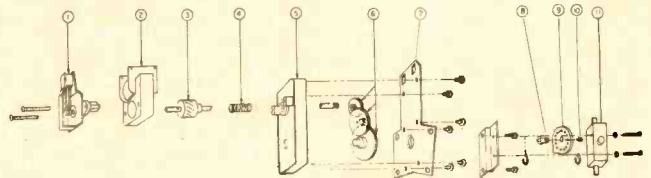

Exploded view and schematic of drive and control mechanism for G-E power tuning DA chassis.

small holes in a circle around the center hole (9 in exploded view). A channel number is located adjacent to each small hole and a 3/16 in. hex head screw is assembled through a selected channel hole in the cam and is then mated with the threaded hole in a lever mounted directly behind the cam. To change position of the OFF/ON program wheel, remove the 3/16 in. hex head screw, and rotate the wheel until the hole with the desired channel number aligns with the threaded hole in the lever, then replace the screw.

Philco

TV Tuners VHF TT-165 and UHF TT-155A—Disc Removal

If it becomes necessary to remove tuner discs in servicing the "N" line chassis, this can be accomplished in the following steps: (1) Remove tape holding driving disc and driven disc together. (2) Remove "C" washer in front of driving disc and remove driving disc. (3) Remove "C" washer in front of channel indicator disc and remove indicator. (4) Remove "C" washer and flat washer in front of driven disc and remove disc. (5) To replace, reverse procedure. Caution: Be sure to replace tape that was removed in step one. Note: The film is mounted into the channel indicator disc, but is removable for replacement purposes. Should the film have to be replaced, proper posi-

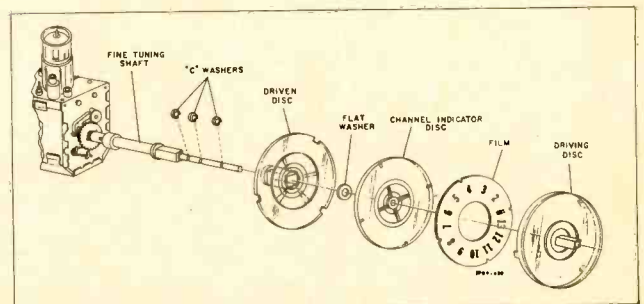

Disc placement for Philco TT-165 and TT-155A tuners.

For window-size blow-ups of this message, send 10¢ to Sprague Products Co., 65 Marshall St., North Adams, Mass., to cover handling and mailing costs.



Is "do-it-yourself" TV Service as dangerous as they say?

When a TV set starts "acting up," a tube is often involved. At least, that's where the trouble *appears* to be.

Some people will pull the back off the set, remove the tubes, and take them to the "do-it-yourself" tube tester at the neighborhood store. The test instrument shows which tubes are faulty (but not always—some faults do not show up on these testers). Replacements are purchased, then inserted into the set. Reception improves, and the trouble has been caught and corrected.

BUT HAS IT?

The self-service test instrument checks *tubes*. It can't test the *more than 500 other parts* in

your set! It can't show you the *source* of the trouble that probably blew the tube. Neither can it show the damage often suffered by other parts due to the faulty tube.

Mere tube replacements do not always cure these trouble spots. Weak links continue to exist, *setting up chain reactions of damage, trouble, and expense!*

The total failure of many a good TV set can be traced directly to "do-it-yourself" tinkering.

Your TV set is the most complicated device you own—far more complex than even your automobile. When you need TV service, call an expert technician—your fully trained and experienced Independent Service Dealer.

AFTER ALL, YOU WOULDN'T ENTRUST YOUR JOB TO AN AMATEUR, WOULD YOU?

THIS MESSAGE WAS PREPARED BY SPRAGUE PRODUCTS COMPANY,
DISTRIBUTORS' SUPPLY SUBSIDIARY OF SPRAGUE ELECTRIC COMPANY, NORTH ADAMS, MASSACHUSETTS FOR . . .

YOUR INDEPENDENT TV-RADIO SERVICE DEALER

add an fm-stereo service center
with this one new
sencore unit!



THE SENCORE MX129 FM STEREO MULTIPLEX GENERATOR & ANALYZER

FM-Stereo growth continues to mount and is fast becoming as big a field as Color TV. This means more FM-Stereo service business for you, now and in the future. Is your shop equipped? It can be — completely and economically — with the MX129, the FM-Stereo "Service Center in a Case." The instantly stable, 19-Transistor, crystal controlled MX129 is the most versatile, most portable (only 7½ pounds), most trouble free and efficient multiplex unit on the market — just like having your own FM-Stereo transmitter on your bench or in your truck. Powered by 115 volts AC, it produces all signals for trouble shooting and aligning the stereo section of the FM receiver . . . can be used to demonstrate stereo FM when no programs are being broadcast. Self-contained meter, calibrated in peak to peak volts and DB, is used to accurately set all MX129 controls and as an external meter to measure channel separator at the FM-Stereo speakers. **NO OTHER EQUIPMENT IS REQUIRED.** **\$169⁵⁰** only

SIGNALS AVAILABLE FOR ALIGNMENT, TROUBLE SHOOTING AND ANALYZING:

FM-RF carrier with composite multiplex audio signal with 38kc suppressed carrier, 19kc pilot and 67kc SCA signals • Multiplex signal formed by 60 or 1000 cycle internal tones or any external signal • Full control over left and right channel amplitude (modulation) • External 67kc SCA signal available for trap adjustment • Composite signals available for signal injection FM detector •

professional quality — that's the difference!

SENCORE

426 SOUTH WESTGATE DRIVE • ADDISON, ILLINOIS

— for more details circle 58 on post card

TECHNICAL DIGEST

tioning must be observed. Be sure to note position of film before removal.

The drawing represents VHF tuner, follow same procedure in assembling the discs from UHF tuner.

RCA

Current Sets, UHF Tuners — General Description

The KRK 120 transistorized UHF tuner is used in current RCA TV sets. The tuner has three basic versions, the KRK 120J, K, and L. The KRK 120J

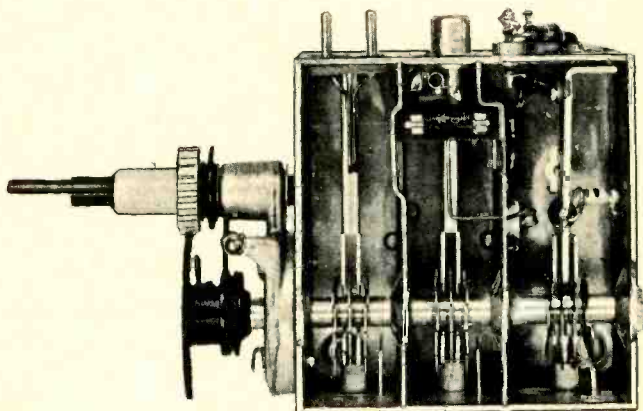

RCA KRK-120 UHF Tuner

series uses an SE1037 transistor, the KRK 120K series a 35449 transistor, and the L series uses a GM-380 type transistor. The oscillator circuit of each tuner varies with the transistor used, but all use the same supply voltage connected to the same input terminal. As an assembly, the tuners are interchangeable. If a transistor fails the replacement must be the same type as the original. The transistors are easily identified. The KRK 120J version uses a transistor that has a black epoxy case with a plastic, button type, lead protector cemented to the case. Both the KRK 120K and KRK 120L transistors have a silver color metal case with the type number.

Supply voltage for each version is either 270 vdc through a 22K resistor, or 250 vdc through a 20K resistor. The tuner draws approximately 11.4 ma and the supply voltage at the input is plus 19 vdc.



The oscillator circuit is a modified Colpitts. The transistor is used in a common base configuration and the feedback signal is coupled from the collector terminal to the emitter by internal transistor capacitance.

Westinghouse

Phono Amplifier, Models H-105/106ACS — Circuit Operation

The phono cartridge in this transistorized instru-

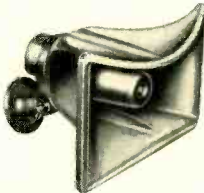
Plan your paging/talk-back speaker installations around University ...the most complete line.

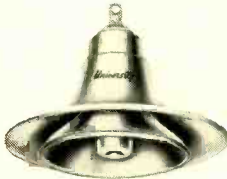
APPLICATION	REQUIREMENT	RECOMMENDED SPEAKER	SPECIFICATIONS
Complete coverage for small areas with low ambient noise levels. Spot coverage to assure uniform sound volume in large systems.	Wide dispersion. Good frequency response. Weatherproof. Compact size. *OLB	 UNIVERSITY MODEL MIL-A	7.5 watts 350-13,000 cps 120° dispersion 7 ³ / ₁₆ " dia. 6 ⁷ / ₈ " deep In 4, 8, and 45 ohm impedances.
Same as above and where overhead obstructions are encountered.	Same as above but with greater control of dispersion pattern, reducing reverberation and spill over. *OLB	 UNIVERSITY MODEL CMIL-A	7.5 watts 350-13,000 cps 120° x 60° dispersion 6 ¹ / ₄ " high, 9 ¹ / ₂ " wide, 8 ¹ / ₂ " deep In 4, 8, and 45 ohm impedances.
Coverage of sizeable areas with moderate ambient noise level. Amusement parks, warehouses, loading docks, portable P.A. systems.	High power handling capacity, high efficiency, greater low frequency response. Utmost reliability. Weatherproof. *OLB	 UNIVERSITY MODEL IB-A	25 watts 250-13,000 cps 90° dispersion 10 ¹ / ₄ " dia., 9" deep In 4, 8, and 45 ohm impedances.
Same as above and where overhead obstructions are encountered.	All of the above, but with exclusive University Wide Angle horn for reducing reverberation. *OLB	 UNIVERSITY MODEL CIB-A	25 watts 250-13,000 cps 120° x 60° dispersion 7 ³ / ₈ " high, 14" wide, 12" deep In 4, 8, and 45 ohm impedances.
Ceiling suspension of speakers to cover wide area. Using minimum number of units. Factories, department stores, depots.	Uniform 360° sound dispersion. Built-in driver. High power handling capacity. *OLB	 UNIVERSITY MODEL IBR-A	25 watts 300-10,000 cps 360° dispersion 13" dia., 10 ¹ / ₄ " deep In 4, 8, and 45 ohm impedances.

*OLB - Patented University Omni-Lok Bracket directs and locks speaker in any plane with a twist of the wrist.

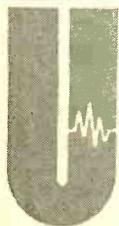

University paging/talk-back speakers offer high microphone sensitivity for reliable talk-back communications. Their rugged construction assures lifelong dependable operation. Above all, University "High A" (High Audibility) engineering assures a degree of intelligibility that has never been matched in speakers of this type. For free catalog, write desk ET-11, LTV UNIVERSITY DIVISION, Oklahoma City, Oklahoma.

LTV UNIVERSITY
A DIVISION OF LING-TEMCO-VOUGHT, INC.
9500 West Reno, Oklahoma City, Oklahoma

... for more details circle 69 on post card

america's most popular
tube tester

... because it
finds the
"tough dogs"
others miss!



THE NEW SENCORE TC130 MIGHTY MITE III TUBE TESTER

New in looks and compactness, updated with many exclusive features. The MIGHTY MITE tester, long America's most popular tube checker because it has the versatility and reliability professional servicemen demand! The MIGHTY MITE III checks them all — more than 2,500 tubes plus picture tubes, including the new frame grid tubes (has four extra sockets for latest tubes). It's fast and thorough, checks for control grid leakage, then, with the flick of a switch, tests for interelement shorts and cathode emission at full operating levels. Uses costly moving coil meter for high sensitivity (100 megohms) to find those "tough dog" tubes other low-sensitivity testers miss. In versatility, reliability, portability and operating simplicity, the TC130 is your best buy in tube checkers at

\$74.50

COMPARE THESE MIGHTY MITE III FEATURES:

Lower voltage for Nuvistors and all frame grid tubes • Unique circuit tests for inter-element shorts, each and every element • Checks cathode emission at full operating levels • Checks control grid leakage at 100 megohms sensitivity, like "eye tube" testers.

Speed-indexed set-up cards greatly reduce look-up time • Simplified panel layout speeds checks, prevents errors • Burn-out proof, stick-proof meter • Sturdy, all-steel case, rubber feet • Styled for modern, professional look

professional quality — that's the difference!

SENCORE

426 SOUTH WESTGATE DRIVE • ADDISON, ILLINOIS
... for more details circle 59 on post card

TECHNICAL DIGEST

ment is equivalent to a voltage generator in series with a small capacitor. If the output of the cartridge were connected directly to the input of the amplifier, bass attenuation and excessive high frequency response

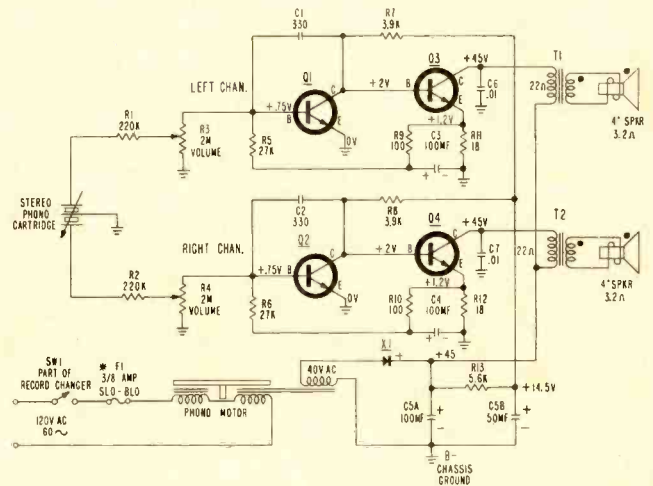

Schematic of Westinghouse H-106CS stereo amplifier.

would result. The addition of R1 levels off the frequency response and further compensation is achieved by negative feedback through capacitor C1. The base bias of Q1 is established by a network which consists of R9 bypassed to ground by C3 and R5. The ac signal at the emitter of Q3 is filtered by R9 and C3 so that only a dc voltage is applied to the base of Q1.

The amplifier has built-in protection against excessive transistor current caused by high ambient temperature. A rise in temperature causes an increase in current through Q3, and therefore, through R11. This increases the positive voltage at the Q3 emitter. The forward bias of Q1 is increased slightly allowing Q1 to conduct more. The collector voltage of Q1 will become more negative and since the base of Q3 is connected to the collector of Q1, the forward bias of Q3 decreases. This holds the current in Q3 to a safe value.

The power supply circuit utilizes a secondary winding on the record changer motor to supply 40 vac to the rectifier, X1. The 45 vdc output of the power supply is fed to the collectors of the power amplifiers while 14.5 v is supplied to the driver stages. As is customary in stereo amplifiers, references are made here to only one channel — the left.

MOVING?

Be sure to let us know your new address. Please enclose a complete address label from one of your recent issues.

TWO NEW HIGH-PERFORMANCE CB TRANSCEIVERS FROM LAFAYETTE...*Leader In CB Equipment*

NEW! LAFAYETTE 23-CHANNEL CRYSTAL-CONTROLLED DUAL CONVERSION 5-WATT CB TRANSCEIVER



Model HB-400

169⁵⁰

With Advanced "Range-Boost"

- ✓ Ruggedly Built For Reliable 2-Way Radio Communication
- ✓ Easy To Use... Easy To Maintain. With Every Feature CB Users Want!

- Frequency Synthesis Offers 23 Crystal Controlled Transmit/Receive Channels—No Extra Crystals Needed!
- "Range-Boost" Circuit for Increased Sideband Power... Greater Range!
- 17-Tube Performance With 13 Tubes
- Low Noise Nuvistor "Front End"
- 5 Double-Tuned IF Transformers
- Sensitive 3/10 μ V Dual Conversion Receiver
- Built-in 117V AC & 12V DC Power Supply
- Plug-in Facilities For Lafayette Selective Call Unit
- Imported

NEW! LAFAYETTE ALL-TRANSISTOR DUAL CONVERSION 5 WATT CB TRANSCEIVER With Mechanical Filter For Ultra-Sharp Selectivity

- ✓ 100% Solid-State... Full 5-Watt Performance!
- ✓ 11 Rugged Silicon Mesa Transistors Used In Critical Areas
- ✓ Small, Compact—Only 3" High!
- ✓ Low Battery Drain—Less Than 350 ma on Receive, 850 ma on Transmit!

- 12 Crystal Transmit & Receive Positions
- 23 Channel Tunable Receiver with Spotting Switch
- 15 Transistors, 5 Diodes
- Sensitive 5/10 μ V Dual Conversion Receiver
- Variable Squelch, plus ANL
- For 12V DC, or 117V AC with Optional Solid State AC Power Supply
- Imported



Model HB-500

139⁵⁰

**Dealerships
Now Available for**

LAFAYETTE'S NEW "HOT-LINE"

Lafayette Radio Electronics, "World's C.B. & Electronics Center" has available dealerships for its new "Hot Line" of Citizens Band equipment. A leader in the C.B. field, Lafayette equipment has been performance proven and customer accepted.

Lafayette is now introducing its new C.B. "Hot Line" for '65—Transceivers, Walkie-Talkies, Accessories, etc. Engineer-designed, precision-crafted and field-tested to make Lafayette THE NAME in Citizens Band.

Be the first one to hook-up with Lafayette's

NEW "HOT-LINE."

Get complete information without obligation—mail the coupon today.

LAFAYETTE RADIO ELECTRONICS CORP.
Dept. ASETK-4
111 Jericho Turnpike
Syosset, L. I., N. Y. 11791

Mr. Robert Laub:
Please send me full information on how I can become an exclusive Lafayette dealer. I understand there is no obligation.

Name

Address

City State Zip

--- for more details circle 41 on post card

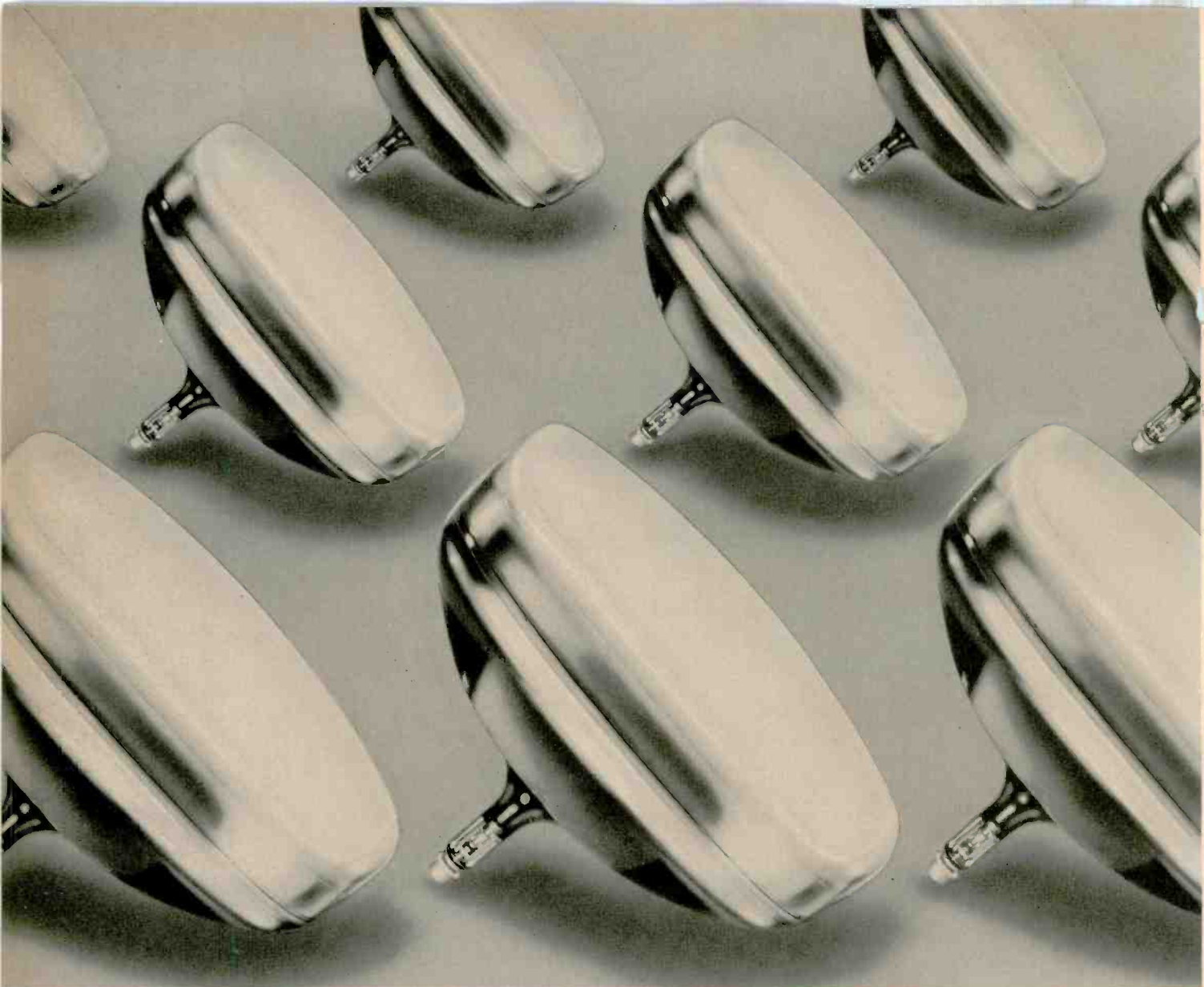

THE QUALITY OF YOUR SERVICE DEPENDS ON THE PARTS YOU USE...DEPEND

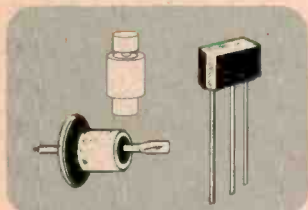

Diodes, Rectifiers, Condensers and Resistors
Complete variety for all makes and models.



Universal Controls
With or without on-off switch. Standard taper, 3 inch shaft, half flat. 1 meg, 2 meg, 500 K. Complete selection. Fit Philco and other makes.

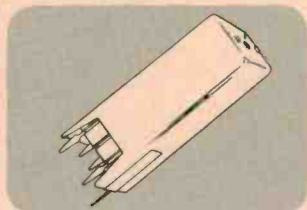

I.F. Transformers
For printed circuits, 4 lug, 5 lug or 6 lug types . . . to fit Philco or other makes. Dependable Philco Quality.

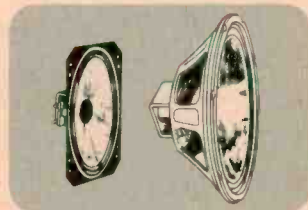

Replacement Speakers
All sizes, round, oval or rectangular types. 3.2, 8, 16, 20 ohms. From tiny 1 3/4" to giant 15" sizes.



Philco Receiving Tubes
To fit any make, any model TV or radio, manufactured to exact Philco standards, thoroughly inspected. Original factory cartons.



Rotary Switch Antenna
High gain type with 6 position switch for best possible signal selectivity. 3 section brass dipoles. Padded cast iron base.



Contact Cleaner
Philco TV and Radio Contact and Control Cleaner, Lubricant in self spray can, complete with protective cap and spray nozzle.



Philco TV Yoke
Genuine Philco TV yokes, made to original factory specifications. Accurately wound and inspected. Packed in individual boxes, ready to install.

There's a Philco Fully Stocked Parts Center Near You!

IF YOU NEED A PHILCO PART...YOU CAN GET IT FAST...HERE'S WHY

1. Philco has a nationwide network of Parts distributors—THERE'S one in your area.
2. Philco distributors are backed up by Parts Warehouses with millions of dollars in Parts inventory.
3. NEW Parts for NEW Philco models are shipped automatically along with the NEW products.
4. All Parts orders are handled by experienced Parts specialists.
5. ALL EMERGENCY orders are transmitted over the nation's largest industrial communications system and processed within 24 hours.

Whatever you need—whenever you need it—if it's a Philco Part just dial your Philco distributor. He has thousands of Philco Parts right now on his shelves. If the item you need is temporarily out of stock—he can get it for you FAST. You may **DEPEND** on your Philco Parts distributor.

Customer Confidence Begins When You Use Genuine Philco Star Bright 20/20 Picture Tubes

Every CR Tube you replace represents a high-dollar service sale for you . . . and your customer. Play it safe with a brand that's known for Quality . . . PHILCO. All material and parts used in the manufacture of Philco Star Bright 20/20 Picture Tubes are new except for the envelope, which prior to reuse, has been inspected and tested to the same standards as new envelopes.

ON YOUR PHILCO DISTRIBUTOR FOR ALL YOUR PARTS AND ACCESSORIES

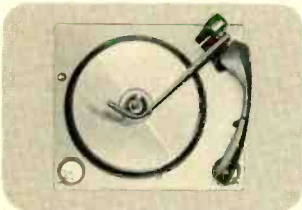

M62A 4-speed Record Changer
Intermixes all size records. Light-weight tone arm with retractable scratch protection assembly and famous Euphonics U8 cartridge. Changer ideal for built-in installations or "modernizing" record playing equipment. Template and instructions included.

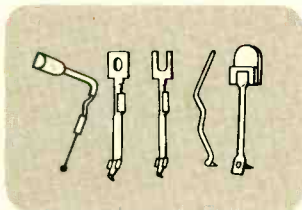

Philco Phono Needles
A complete selection of types and numbers for Philco and most all other makes. Carefully made, attractively-packaged. ALL TIP TYPES and sizes, including Diamond. Special now available—"THE BIG 18 KIT." This attractive compact metal case contains 18 of the industry's fastest selling needles.

Your Philco Distributor Features These Famous Makes

PHILCO • PHILCO-Bendix • CROSLEY • EVEREADY Batteries and Flashlights • CAROL Cables • GOODRICH V-Belts • GC Products • AUDIOTEX • WALSCO Products • COLORMAGIC Antennas • PRECISION Test Equipment • SPRAGUE Capacitors

Philco Parts are Available Through a nationwide network of Parts Distributors. Mail the Coupon Today for the Name of the One Nearest You.



PARTS AND SERVICE OPERATIONS

PHILCO

A SUBSIDIARY OF *Ford Motor Company*

... for more details circle 53 on post card

Philco Parts & Service Operations
C & Tioga Streets, Phila. 34, Pa.

I am interested in receiving information about special Philco Parts offers, prices and facts. Please send me the name of the nearest Parts distributor.

Name _____

Address _____

City _____ Zone _____ State _____

"Costs a bit more than 1 transistor VHF amplifiers."

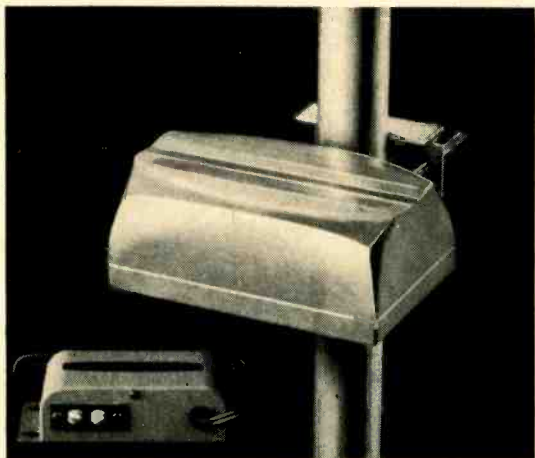

"It should—it has two transistors."

"Fine, but is it worth the difference?"

"You bet, when you measure the couple extra dollars against the many hours of superb TV reception you will enjoy."

"Tell me more."

"The new Blonder-Tongue Vamp-2 outperforms all home VHF amplifiers on the market, tube or transistor. Brings in sharp, clear pictures."

"But, what's the real advantage of two transistors?"

"More signal power, lower noise for snow-free reception."

"But, I hear transistor units can overload from strong local TV stations?"

"Not this one, that's where the extra transistor pays off."

"I've got two sets."

"The Vamp-2 delivers strong signals to two sets. It has a built-in splitter. Great for color TV. List \$38.95."

"Supposing I don't want to lay out the few extra dollars for the Vamp-2?"

"Simple solution. The new Blonder-Tongue Vamp-1... the best one-transistor model on the market. Lists at \$25.50."

(This message was paid for out of the gross profits of BLONDER-TONGUE, 9 Alling St., Newark 2, N.J.)



... for more details circle 21 on post card

LETTERS TO THE EDITOR

Tops

I value your "down-to-earth," practical approach. Your magazine is "tops" on my reference shelf.

ROBERT H. KAUFMAN
Schenectady, N.Y.

'Leg-Pulling?'

Regarding Mr. George Langdon's letter of inquiry (ELECTRONIC TECHNICIAN, August 1964, page 24) on components listed in H. O. Smith's article for VTVM improvements (ELECTRONIC TECHNICIAN, November 1963, page 43), my delving into the same problem has revealed that the 2N560 (a diffused NPN silicon MESA transistor) is manufactured by only Western Electric and National Semiconductor in this country, and in Canada by Northern Electric. The 1N673 crystal diode is made by Western Electric, Delta Semiconductors, Western Semiconductors, and supposedly, by Transitron Electric Corp. (Transitron does not include it in their lists as late as April 1964.) No substitute for either the transistor or the diode has been listed in the literature thus far surveyed, but General Electric shows their 2N1613 (a Planar Passivated NPN silicon transistor) as being their nearest equivalent to the 2N-560.

Although complete data on the 2N560 was obtained, not even a price quotation could be found for the 1N673. The only price quotation available for the 2N560 was by National Semiconductor, whose 1960 price was \$46.75 net each in lots of 1 to 99! Unless this price has been reduced drastically, a tabulation of the components could be about as follows:

2 2N560's	@	\$46.75...	\$ 93.50
1 2N297	@	1.75....	1.75
3 200 μ f, 10 v	@	1.20....	3.60
1 100 Ω Pot	@	0.75....	0.75
1 100 Ω 1/2 w 5%	@	0.25....	0.25
1 750 Ω 1/2 w 5%	@	0.25....	0.25

\$100.10

Add to this the cost of the 1N673 (another "inexpensive" little trinket?), sales tax, postage, etc., and one awakens to the realization that

What's all this talk about "exact replacement" Twist-Prong Electrolytics?

What is an "exact replacement?" To CDE it's the proper capacitor to do the job intended—available when you need it. To others, it means number matching by the service technician—matching the numbers on the old unit with those of the replacement—without regard to availability or cost. CDE's new Twist-Prong line is based on our service-oriented definition.

Matching numbers may be fun, but there comes a time when it's a losing game. In Twist-Prongs the growth in ratings used in original equipment has been phenomenal. Even the loudest advocates of number matching have to hedge. One advertises over 1700 "exact replacements"—catalogs about 1200—and, of that 1200, lists possible alternates for 297 "if the listed capacitor is not available." Then, there's the problem of popular and "less popular items"—or, you're lucky if your distributor has the number you're trying to match in stock.

To Cornell-Dubilier, the availability of a proper replacement to do the job intended is most important. That's why we've designed a complete new Twist-Prong line for the professional electronic service technician. It's a line that recognizes the broad tolerances inherent in electrolytic manufacture and widely recognized throughout the industry—a fact you've used repeatedly in making replacements. It's a line that enables your distributor to have a complete stock so units will be available when you need them. It's an "exact replacement" line in the proper sense of the word.

Only the CDE Twist-Prong line is designed to make your job easier. A new Twist-Prong Replacement Guide and Cross Reference details manufacturers recommended in-stock replacements for every current Twist-Prong rating. The line is listed, too, in the new CDE Replacement Component Selector. Ask your distributor for copies today and end the old fashioned matching numbers game.

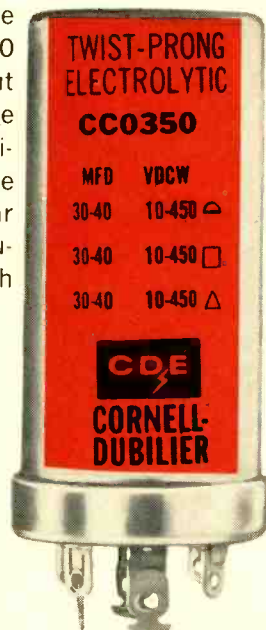

CDE **CORNELL-DUBILIER**
INNOVATION WITH RELIABILITY

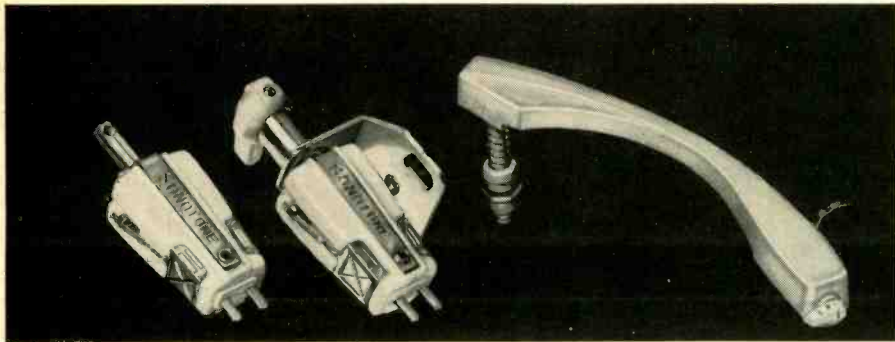

How to turn crystal

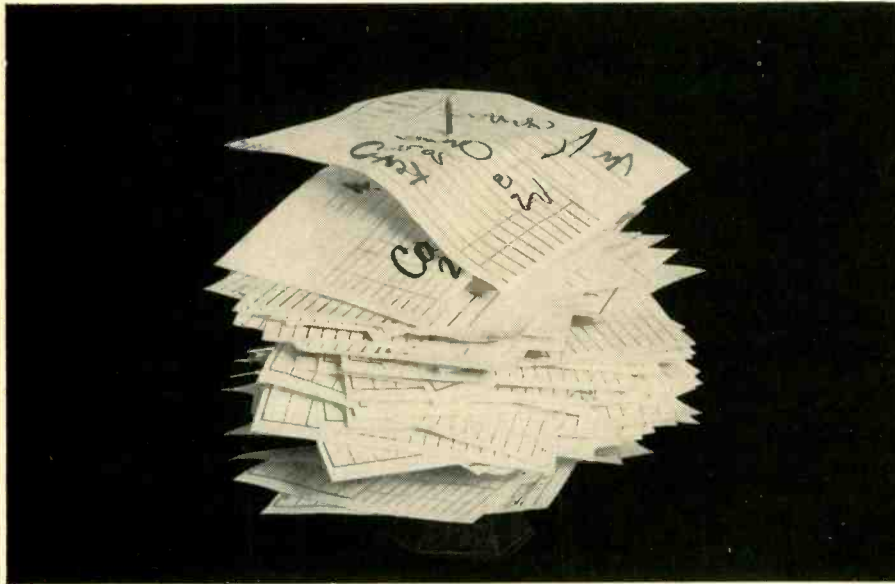

into gold

You can strike it rich with the new Sonotone line of crystal cartridges. It offers direct replacements for "Ronette," "Vaco" and "BSR" models with typical Sonotone quality.

Here are the extras you get—New improved crystal elements for longer pickup life. Mono ("14T") and stereo ("20T") models. High output voltage. Modern turnover type for LP, 45 and 78 rpm records. Available with or without mounting brackets or turnover knobs to fit most arms.

Oh yes, they come in a slim, lightweight plastic tonearm, too. You have a choice of the mono ("14T") or stereo ("20T") cartridge. It's easy to install because it's prewired. It has a shielded cable, spring mounting post and a plated finger lift. It's complete with arm rest and all necessary hardware. Get details today. Write:

SONOTONE
audio products

Sonotone Corp., Electronic Applications Div., Elmsford, New York
Cartridges • Speakers • Microphones • Headphones • Hearing Aids • Batteries

LETTERS TO THE EDITOR

he has just purchased a rather expensive substitute for a flashlight cell, and that the improvement is just a little impractical for the average technician — unless, of course, said technician just happens to have a handful of these little "nuggets" in his junkbox!

Is it possible that Mr. Smith has been engaged in a bit of "leg-pulling?" If not, then why design a circuit around such rare and expensive components without so much as a suggestion as to where they could be obtained nor as to possible substitute components?

JAMES L. MORGAN

Houston, Texas

From The Horses' Mouth

Sorry about the unavoidable delay on information regarding the VTVM conversion.

Rectifier CR1, listed as 1N673, can be replaced by a general purpose rectifier capable of at least 50 PIV and 200 ma forward current.

Transistor Q1, listed as 2N297, can be replaced by a general purpose PNP audio power transistor such as 2N301 or 2N301A.

Transistors Q2 and Q3 are the critical components. To select a replacement for the 2N560, it is necessary to select a silicon NPN type with a low collector to base saturation voltage. It is necessary to use a silicon transistor because of the higher emitter-to-base voltage obtained with silicon. Emitter to base drop of silicon is about 0.7 compared to 0.2 for germanium.

In general, the cost of silicon NPN type transistors are rather high. The most economical replacement for the 2N560 that I could find is the G-E 2N2712.

I sincerely hope that this is the information your readers desired. I will be glad to supply whatever additional information that I can.

HERBERT O. SMITH
Western Electric Co.

We checked recent catalog prices as follows: Substitute for 1N673 \$0.47. Substitute for 2N297 \$1.52. Substitute for 2N560 (G-E 2N2712) \$1.20.—Ed.

--- for more details circle 60 on post card

CENTRALAB MAKES COLOR TV SERVICING EASIER WITH

**QUALITY IN DEPTH
COVERAGE IN DEPTH**

WHEN YOU NEED A CONTROL for a color tv set, you can be sure that Centralab will provide an *exact replacement*. Rely on Centralab's total coverage: buzz controls, dual concentrics, twins, and of course, all your single control requirements. Centralab coverage goes hand-in-hand with Centralab *quality*: These units can't loosen, shafts can't pull out. In fact, it's hard to tell the difference from the original manufacturer's control; but you can rely on Centralab quality and guarantee your replacement.

WHEN YOU NEED A CERAMIC CAPACITOR for a color tv set, you can be sure that Centralab will provide an *exact replacement*. Rely on Centralab's total coverage: discs and tubulars, any standard voltage, any standard capacitance. Centralab *pioneered* the ceramic capacitor, has the experience, know-how, and acceptance to assure you that Centralab quality goes hand-in-hand with Centralab coverage.

WHEN YOU NEED A PACKAGED CIRCUIT for a color tv set, the chances are it's a snowy day in August. Centralab invented them, makes most of them—but we can't sell many replacements because they so rarely go bad. (That's quality!) Just in case, though—we can provide the exact replacement. (That's coverage!)

**SEE YOUR
CENTRALAB DISTRIBUTOR
FOR COLOR TV COMPONENTS**

P. O. BOX 591, MILWAUKEE, WISCONSIN 53201
In Canada: Centralab Canada Ltd., P.O. Box 400, Ajax, Ont.

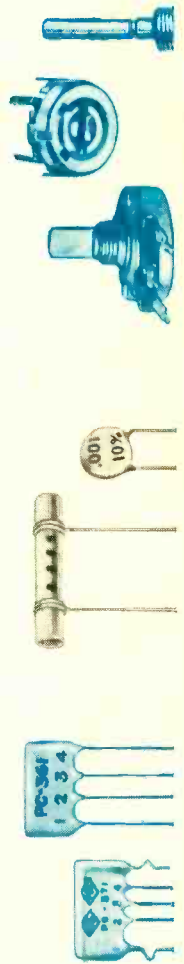
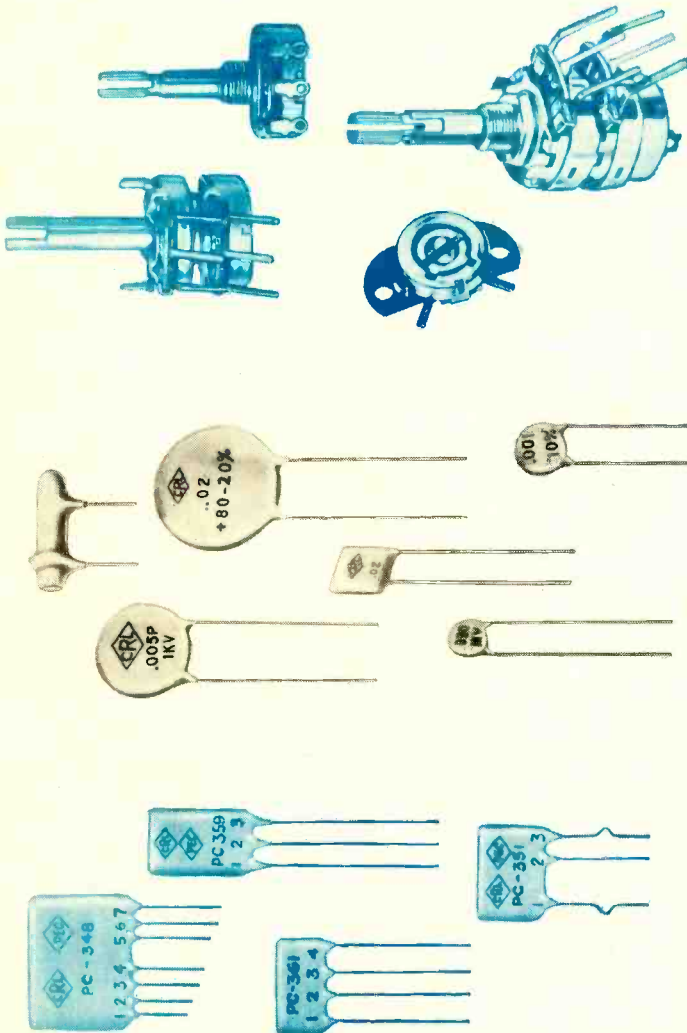

DIVISION OF GLOBE-UNION INC.

FREE!

2 EXTRA DE-SOLDERING TIPS WORTH \$1.20...



when
you buy
the *Ungar* #270
De-Soldering Kit

ONLY \$5.83 EACH AT YOUR AUTHORIZED DISTRIBUTOR

Buy this kit, and mail the enclosed bonus coupon to Ungar. We will send you #861 Triangle Tip and #863 Cube Tip... a \$1.20 value — absolutely FREE.

The Ungar #270 Kit meets every requirement for fast, safe, easy component desoldering and removal. Avoids lug breaking, shorting and printed board rupturing.

Ungar's De-Soldering Kit speeds up work and increases efficiency. Here's how: The slotted tip melts solder quickly so that lugs bent close to the

printed board can be lifted and straightened out in a fraction of the time.

The bar tip makes it easy to de-solder all multiple straight line network components.

A variety of cup tips is a must for de-soldering tube sockets or jif transformers. The Ungar kit includes the 5/8", 3/4", and 1" size — a complete assortment for most jobs.

The two FREE tips are ideal for electrolytic capacitor removal, tube socket pins, and harness leads.

BONUS OFFER

FREE...A DE-SOLDERING BOOKLET

For Just Visiting Your Authorized Ungar Distributor! Get it now!

UNGAR ELECTRIC TOOLS
ELECTRONIC DIVISION OF ELDON INDUSTRIES, INC. Hawthorne, Calif. 90252

... for more details circle 68 on post card

LETTERS TO THE EDITOR

The Void

Thanks to your schematic service I have recently had access to the diagram of a Westinghouse stereo amplifier which I have endeavored to copy. It is pictured in your Circuit Digest (TEKFAX), plate 126. I have several technical questions I would like to ask Westinghouse about this circuit. Would you please tell me where to send my questions for immediate and accurate answers?

CARMEN CAPRIGLINE
(No Address)

We would have answered you directly but you did not include your address in the letter. Try Westinghouse Electric, TV-Radio, at Box 71, Metuchen, N.J. — Ed.

More on Engineering Certification

Enjoyed reading your article, "Look Up — Move Up," in the August issue. Please send more information.

JOSEPH R. BEAVERS
Tucson, Ariz.

... This is an item which has been needed for quite some time and will be of considerable value to technicians

J. DONNELL JR.
Austin, Tex.

Please forward further information on certified technicians. I have had six years experience maintaining two-way radio equipment

H. L. WISE
Clallam Bay, Wash.

Several technicians here are interested in learning more about the Institute for the Certification of Engineering Technicians. Please send further information.

JOHN A. HONEY
Chief Technician
Benton Harbor, Mich.

After growing up with the CATV industry as manager and Chief technician in my present job since 1951, I would like to apply for cer-

Prices effective January 1, 1963

Tarzian offers
**FAST, DEPENDABLE
TUNER REPAIR
SERVICE (ALL
MAKES)**

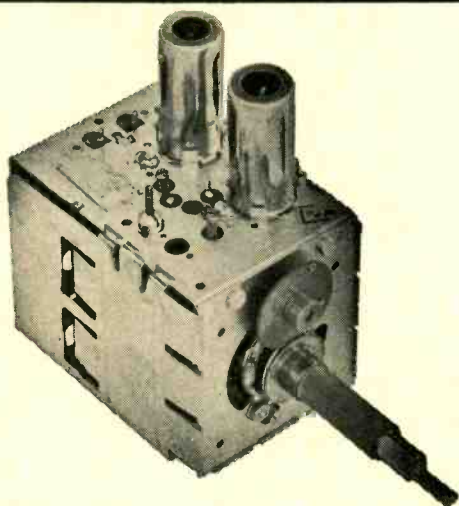

It just makes sense that a manufacturer of tuners should be better-qualified, better-equipped to offer the most dependable tuner repair and overhaul service.

Sarkes Tarzian, Inc. pioneer in the tuner business, maintains two complete, well-equipped Factory Service Centers—assisted by Engineering personnel—and staffed by specialized technicians who handle **ONLY** tuner repairs on **ALL** makes and models.

Tarzian-made tuners received one day will be repaired and shipped out the next. Allow a little more time for service on other than Tarzian-made tuners.

Tarzian offers a 12-month guarantee against defective workmanship and parts failure due to normal usage. And, compare our cost of \$9.50 and \$15 for UV combinations. There is absolutely no additional, hidden charge, for **ANY** parts except tubes. You pay shipping costs. Replacements on tuners beyond practical repair are available at low cost.

Ⓢ Tarzian-made tuners are identified by this stamping.

When inquiring about service on other tuners, always give TV make, chassis and Model number. All tuners repaired on approved, open accounts. Check with your local distributor for Sarkes Tarzian replacement tuners, replacement parts, or repair service.

 **SARKES TARZIAN, INC.**
Bloomington, Indiana

MANUFACTURERS OF TUNERS . . . SEMICONDUCTORS . . . AIR TRIMMERS . . . FM RADIOS . . . AM/FM RADIOS . . . AUDIO TAPE . . . BROADCAST EQUIPMENT

NOVEMBER 1964

ONLY
\$9.50
INCLUDING

ALL PARTS
(except tubes)
and LABOR

24-HOUR SERVICE
1-YEAR WARRANTY

**TWO SERVICE CENTERS
TO SERVE YOU BETTER**

**See your distributor, or use the
address nearest you for fast fac-
tory repair service**

537 South Walnut St.
Bloomington, Indiana
Tel: 332-6055

10654 Magnolia Blvd.
North Hollywood, Calif.
Tel: 769-2720

LETTERS TO THE EDITOR

tification as a Senior Engineering Technician . . .

JOHN S. WARNER
St. Clair, Penn.

. . . I have had a total of 15 years' electronic experience, including formal training . . . I would like com-

plete information . . .

RICHARD E. RIPPE
Rancho Cordova, Calif.

I read with interest your article published in the August issue of ELECTRONIC TECHNICIAN Magazine concerning certification of engineering technicians. It's about time we technicians banded together to help advance our cause. I am in full support of ICET . . .

KENT L. ANGELL
Brigham City, Utah

EDITORS' MEMO

CB and the FCC

The Federal Communications Commission has finally taken the "bull by the horns" in an effort to preserve the Citizens Radio Service. The FCC is trying to make CB work as originally intended: to permit any Citizen, previously ineligible for other radio services, to establish private two-way radio communications systems for business and personal convenience.

CB channels were established by the FCC in 1958 to serve the private interests of citizens over 18 years of age—but it was not to be used as a diversionary toy.

Pleasure boat owners were given an economical method of voice contact with the boat house or home; campers and hunters could roam safely through national parks or deep woods. Doctors, salesmen, construction workers, TV radio service technicians and civil defense organization could use CB as an effective communications medium. And just plain "John Doe" could use CB to call his home from a car, inching its way along a snow-blocked highway or a mid-town traffic jam, to report being late for dinner.

But many CB license holders have been using CB equipment as a substitute for Amateur Radio equipment—without having to assume "ham" licensing responsibilities. Citizens radio was being jammed by illegal talk, promiscuous transmissions and even music broadcasts by irresponsible individuals. CB radio was fast becoming a giant hobbyist "party line."

We believe the overwhelming majority of the 700,000 CB license holders will eventually benefit by present and subsequent FCC regulation. We believe proper regulations will help CB radio grow and become one of the important sales and service sectors in the two-way communications market.

As single-sideband CB equipment becomes more widely used, the CB bands can easily accommodate many more transceivers. And at an average cost of about \$350 for a two-way installation, this is a multi-million dollar market that no one can ignore.

Perma-Power HOLIDAY SPECIAL!
GENUINE
EVERSHARP
CARTRIDGE FOUNTAIN PEN
in deluxe gift package
YOURS FREE
WITH EVERY VU-BRITE 12-PACK

This is not a cheap ball-point, or an advertising giveaway. It's the identical top-quality writing instrument (manufactured by Parker) you've seen in retail stores for \$2.95. It makes a perfect gift—and it's Perma-Power's gift to you when you buy 12 Vu-Brites.

BRIGHTER TV PICTURES MEAN BRIGHTER SMILES ON YOUR CUSTOMERS' FACES!
Bring fading, dull picture tubes back to original brilliance with Vu-Brite—the leading single-purpose britener. Model C-401 Parallel, C-402 Series.



LOOK WHAT YOU SAVE!

12 Vu-Brites—usual dealer net	\$10.68
Eversharp pen and cartridge	2.95
TOTAL VALUE	\$13.63
SPECIAL OFFER	9.95
TOTAL SAVINGS	\$ 3.68

HURRY! DEAL ENDS DECEMBER 15, 1964

Perma-Power COMPANY • 5740 N. TRIPP AVE. • CHICAGO, ILL. 60646

— for more details circle 52 on post card

NEW DIRECTIONS IN SPACE



Channel Master is so far ahead in indoor antenna design, it isn't even funny.

There's something new in the air! A truly exciting and complete line of heads-up indoor antennas for TV and FM—**fourteen** in all. Designs that are strikingly different. Beautiful Compact. Space-saving. With exclusive cork-cushioned legs and corrosion-resistant brass elements. Every one of them looks beyond today toward tomorrow. And their looks are matched by advance-engineered performance that gives incomparable, **true** new gain. (Up to 4 DB).

Channel Master 6-in-1 all-channel antennas. The first indoor units to use **outdoor type** elements such as yagis and stacked bow-ties. Assures absolutely matchless pull-in power and interference control for color and black-and-white (in both VHF and UHF). FM Stereo

and FM. These are honest all-channel models. Because they have **two** separate transmission lines . . . one for UHF and the other for VHF. And each 6-in-1 antenna has a 4-in-1 counterpart for VHF/FM only, which is equally outstanding.

The prices (fair-traded) start \$4.98. But here's the big-profit news: For only a dollar more than the VHF model, you can offer your customer the 82-channel version. You'll go pretty far with a step-up line like Channel Master.

From left to right: 4-in-1 Alpha for VHF/FM with "Automagic" Clarifier Switch. \$7.95. 6-in-1 Canaveral-82 . . . all-channel and FM with unique "Butterfly Dipole". Gives more gain than stacked dipole. \$10.95. 4-in-1 Gamma for VHF/FM. \$5.95.



CHANNEL MASTER

© Channel Master Corporation 1964 Ellenville, New York

--- for more details circle 24 on post card

*before you buy any
color generator...
get all the facts*



only one has all
these features and
it's only 99⁵⁰*

LECTROTECH V6

Any comparison will prove that the Lectrotech V6 truly stands alone. Provides all of the time-tested standard features plus many Lectrotech exclusives for the fastest, most reliable color installation and servicing. The V6 gives you: Crystal-controlled keyed rainbow color display • All cross hatch, dots, vertical lines only, horizontal lines only • Red-blue-green gun killer (usually extra or not available on other color bar generators) • Exclusive Dial-A-Line feature (Horizontal adjustable 1 to 4 lines wide) • Exclusive solid state reliability • Exclusive voltage-regulated transistor and timer circuits • Exclusive simplified rapid calibration • Off-On Standby Switch • Adjustable dot size • Color level control • Connects to antenna terminals (no connections needed inside of set) • Power transformer-line isolated, to prevent shock hazard • Lightweight and portable, only 4½" H. x 7¾" W. x 10¾" D. Weight, 7½ lbs.

*Except our own V7

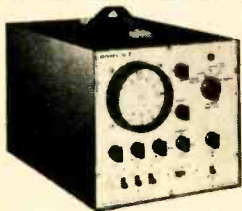

V7 Sensational new Lectrotech V7 — the only complete Color TV Test Instrument.

Has all the features and performance of the V6 PLUS Lectrotech's exclusive built-in Color Vectorscope for simplified visual color servicing.

Complete.....only **189⁵⁰**



See your distributor or write for details before you buy any color generator.

LECTROTECH, INC.

1737 Devon Avenue • Chicago, Illinois 60626

Dept. T-11

... for more details circle 42 on post card

SYNC ON BUSINESS

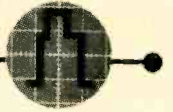

Replacement parts for General Electric radios will be available from Workman Electronic Products as nationwide distributor. This arrangement will increase the availability of G-E radio replacement parts to radio service-dealers as numerous jobbers will stock the parts on their shelves.



The "Shoe Polisher" award was presented to Mercury Sales Company of New York. This award was a result of Mercury's lead in sales at the half-way mark



during the Wen "Summer Tool Special" merchandising promotion program. Shown from the left: Winner Joel Salzburg, partner Mercury Sales; Dean Peel, Wen national sales manager; Winner Jack Rosen, partner Mercury Sales; James Beaver, director of marketing for Wen and Fred Pickel, Wen sales manager for the area which Mercury represents. The award presented to Mercury sales is an electric shoe polisher with an attached gold plaque, 5 x 7 in., shaped in the form of the Wen Products logo.



A special line of receiving tubes that allows operating voltages of color TV receivers to be reduced from 400 to 270 v are now being manufactured by Sylvania.



The Hi Fi speaker line of the Jensen Manufacturing Co. reportedly will not appear in any major mail-order catalogs this fall. It is said Jensen has instituted a program to aid the local Hi Fi dealer in effectively merchandising their products. While the line will be listed in some local catalogs for promotional purposes, major emphasis will be placed on local store operations. The line has not been fair traded because of the many variations in applicable state laws, the announcement concluded. If this develops into a trend, it will make a lot of service-dealers happy.

NEW DIRECTIONS IN SPACE

by CHANNEL MASTER

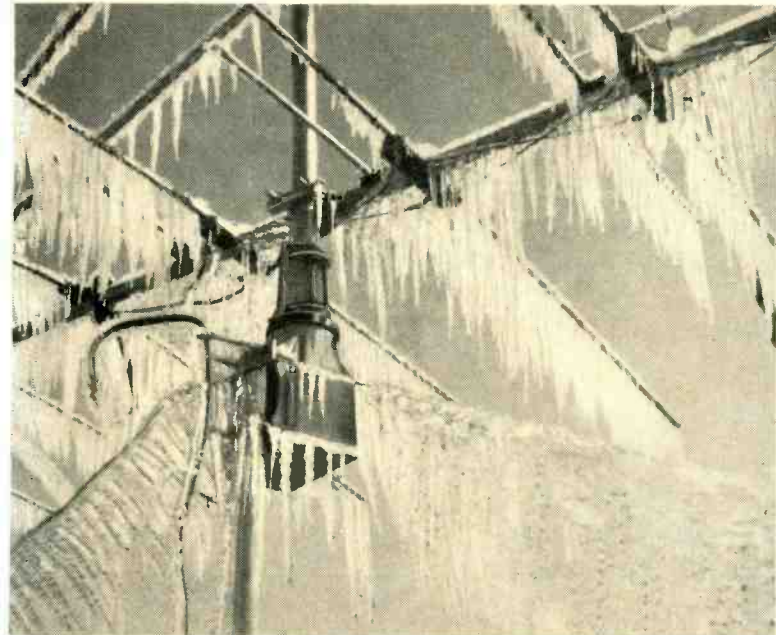

*A rotator so powerful it can turn a 329 lb. ice-loaded installation**

Other rotator makers may get the shakes at the thought. But ice or no, with the Tenn-a-liner, even the heaviest antenna array will turn. Easily.

That's because the Tenn-a-liner's Torque is truly super. It's so "weather-proof positive", in fact, that it will work even in a 70 mile gale.

Feature for feature . . . Tenn-a-liners are rapidly becoming the smart "Dealers' Choice" in rotators. They are getting to know this is the brand that stands up—**never** acts up. Why? Here's one reason. Tenn-a-liners never use soft zinc or aluminum in their "guts". Only **hard-steel**. Their thrust bearing (yes, it's **built in**) and their gears are built strictly for heavy duty.

And don't forget: The Automatic Tenn-a-liner (Model 9524) is the **only one** anywhere that can aim an antenna within **one** degree of transmitter location. Even our manual unit (the Compass, Model 9520) is the finest of its kind. It has the simplest fingertip control . . . plus lots of extra features. And a **lower price** than any other. **In actual laboratory test.*

An antenna that dares guarantee it will kill ghosts . . . even in color

Its name? The COLORAY. And believe us when we say there's nothing quite like it.

It hates ghosts. It loathes interference. The kind that bounces off the tall city buildings right onto your customer's television screens.

The COLORAY* is designed to kill these "twin menaces" not only in black-and-white reception; it murders them in color. In Blue. Green. Red. Yellow. Even shocking Pink. That's saying a lot. Remember, more color sets than ever will be sold this year; and color ghosts are even tougher to watch than black-and-white ones.

We're so sure of the COLORAY that we offer a money-back guarantee—if it doesn't do a better job than any other city antenna.

Model 3110-G includes E.P.C. protective "Golden Overcoat". Also available in kit form, Models 3115-G, 3116-G.

**Patent Pending*



AUTOMATIC



COMPASS



The Coloray actually has a higher front-to-back ratio than a 10-element single-channel yagi. Just compare the polar pattern of the Coloray with those of most commonly used city antennas.

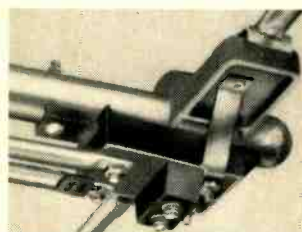

The secret? A unique transposed phasing harness with an impedance balancing power equalizer circuit.

The antenna that challenges

NEW Swept Element

"COLOR-VE-LOG"

BY

FINCO

Finco's Color Ve-Log challenges all competition on color or black and white reception and stands behind this challenge with a "Guarantee of Supremacy". ■ The swept element design assures the finest in brilliant color and sharply defined black and white television reception — as well as superb FM monaural and stereo quality. ■ FINCO precision-engineered features make these advanced-design antennas indispensable to good home sight-and-sound systems. And, of course, they carry the famous unconditional guarantee from the leading manufacturer in the field — FINCO. ■ Promote the Color Ve-Log Antennas with pride, sell them with confidence, and profit handsomely.

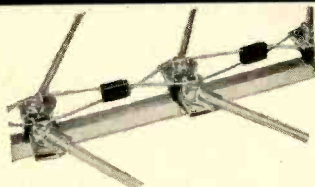

One-piece cross-over drive line assembly has no joints between adjacent driven elements. Eliminates loose connections, shorts, broken drive line sections. Polystyrene snap-lock spacers, with center 'air insulator' space.



Elements are made of triple thick aluminum to stand up in severe weather. Die stamped bracket fastened with tough, thick-gauge rivet holds proportional length sleeve reinforcing shell into which element fits.

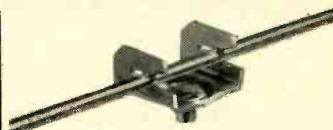

First from Finco and exclusive — double contact between drive line and driven element bracket assembly for perfect drive-line support and electrical continuity. Positive, vibration-free, non-corrosive contact.



Boom reinforcing back up brackets at elements add triple strength to the riveted assembly, mounted on a rigid, non-crushable 1" heavy duty square boom. Boom rolled square from 1 1/4" diameter round aluminum for increased strength.

Write for color brochure #20-307, Dept. 110.

all competition!

LOG



VL-10
 9 driven elements
 1 parasitic element
 List price \$34.95

Featuring Finco's Exclusive Gold Corodizing



Finco's boom-mast bracket, rust-proofed by zinc plate-gold di-chromate dip process, is the finest available. It has positioned cleats to assure sag-free positive direction of the antenna. Locks tight. Can't tilt. Antenna stays in proper position at all times.



High impact polystyrene insulators are reinforced with strong aluminum shields. This gives quadruple strength in supporting triple-thick snap-in elements. Lifetime assembly with fitted aluminum cup to hold oversized aluminum rivet.

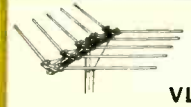

VL-5
 5 element VHF-FM
 5 driven elements
 List price \$16.95

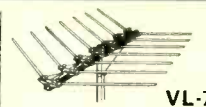

VL-7
 7 element VHF-FM
 7 driven elements
 List price \$23.95

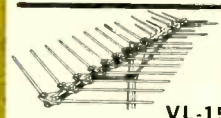

VL-15
 15 element VHF-FM
 9 driven elements
 6 parasitic elements
 List price \$46.95



VL-18
 18 element VHF-FM
 9 driven elements
 9 parasitic elements
 List price \$54.50

The FINNEY Company • 34 Interstate Street • Bedford, Ohio
 --- for more details circle 29 on post card

why **two** JFD UHF log-periodic TV antennas?

Because our engineers realize that **no** single antenna design is the answer to **all** UHF reception conditions.

UHF frequencies are more adversely affected by surroundings. Degradation due to receiver noise is greater on UHF. Also, UHF signal losses are greater than VHF.

Consequently, our R & D Laboratories in Champaign, Illinois, have developed **two** new UHF antenna concepts based on the acclaimed patented Log-Periodic formula of the Antenna Research Laboratories of the University of Illinois:

JFD LPV-U LOG-PERIODIC UHF ANTENNAS

1

for reception of UHF Channels 14 to 83 and VHF 7 to 13 in cluttered city or hilly areas where high gain and sharp directivity is needed for crisp ghost-free UHF reception in B/W or COLOR!

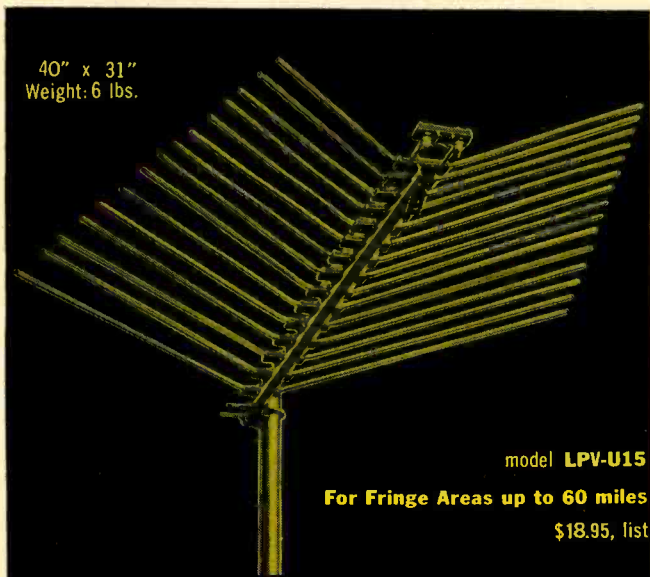

26° to 29° narrow "E" plane (horizontal) beamwidths eliminate ghosts resulting from horizontal reflections—and combine with . . .

"H" plane (vertical) beamwidth, as low as 40°, to give over-all high gain.

- Exclusive new UHF Log-Periodic frequency independent design provides flat, high gain across the band—excellent 300 ohm match gives below 2:1 VSWR.
- 30% to 50% more effective gain and directivity than corner reflectors and stacked bowtie-screens on UHF channels 14 to 83—plus a bonus VHF gain of up to 6 db on channels 7-13.
- Inline solid aluminum rod construction for least wind and ice loading area.
- Beautifully gold alodized for lasting eye-appeal.
- 100% pre-assembled—nothing to swing out or tighten—no movable joints.
- Stainless steel take-off terminals.

2

JFD UHF ZIG-A-LOG LOG-PERIODIC UHF ANTENNAS

where the "ultimate" in UHF color, and black and white reception is required.

model **LPV-ZU10** 1-Bay Zig-A-Log \$17.95, list

31" H. x 6" W. x 43" D.
Weight: 4 lbs.



Provides rotator-less reception of stations as far as 48° apart—up to 60 miles distant. (If the LPV-ZU10 receives 707 micro-volts or more signal voltage when pointed directly at each of the stations, then it will receive all stations clearly when pointed toward the center of the group of stations desired. The angle between stations on extreme left and right, however, should not exceed 48°.)

- Gain: 13.5 to 14 db. VSWR: under 1.8:1. 300 ohm impedance.

- Outperforms 8-Bay bowtie screen reflector antenna.

- Ultimate in corrosion-protection: Gold alodized aluminum elements . . . Rohm & Haas Implex & square crossarm . . . stainless steel take-off terminals.

31" H. x 29" W. x 43" D.
Weight: 6 lbs.



model **LPV-ZU20**

"E" plane stacked Zig-A-Log array
\$37.50, list

TAME
THE ANTI-GHOST SYSTEM
KEEP TV FREE

Narrow 25° "E" (horizontal) and 30° "H" (vertical) plane patterns minimize ghosts caused by horizontal and vertical reflections in flat fringe terrain up to 90 miles from transmitters.

- Gain: 16-17 db, VSWR: under 2:1. 300 ohm impedance.
- Today's most powerful UHF array—matches effective gain of large parabolics—with much less wind, snow and ice-loading area.
- Locks on transmitter signal—no need to re-orient.
- Ultimate in corrosion-protection: Gold alodized aluminum elements . . . Rohm & Haas Implex & square crossarm . . . stainless steel take-off terminals.

Whether the location calls for VHF . . . or UHF . . . or FM . . . or VHF/UHF/FM—there is a JFD Log Periodic antenna to suit your installation needs—perfectly.



WRITE FOR BROCHURES 624 & 711 FOR FULL DATA.

BETTER YET, GET THEM FROM YOUR DISTRIBUTOR TODAY!

JFD JFD ELECTRONICS CORPORATION
15th Avenue at 62nd Street, Brooklyn, N. Y. 11219
JFD Electronics-Southern Inc., Oxford, North Carolina
JFD International, 64-14 Woodside Ave., Woodside 77, N. Y.
JFD Canada, Ltd., 51 McCormack Street, Toronto, Ontario,

--- for more details circle 40 on post card
LICENSED UNDER ONE OR MORE OF U.S. PATENTS 2,958,081;
2,985,879; 3,011,168; 3,108,280 AND ADDITIONAL
PATENTS PENDING IN U. S. A. AND CANADA. PRODUCED
BY JFD ELECTRONICS CORPORATION UNDER EXCLUSIVE
LICENSE FROM THE UNIVERSITY OF ILLINOIS FOUNDATION.

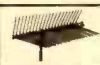
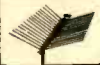
FOUR JFD LPV-U LOG-PERIODICS TO CHOOSE FROM:

Model	Range	Outperforms	List
 LPV-U21	up to 80 miles	12-bay bowtie-screen	\$27.95
 LPV-U15	up to 60 miles	8-bay bowtie screen	18.95
 LPV-U9	up to 40 miles	4-bay bowtie-screen	12.50
 LPV-U5	up to 25 miles	corner reflector	6.95



**WHAT YOU'LL FIND IN
1965**

A detailed technical report
of some important circuits
used in current model TV sets

TV SETS

■ A number of circuit improvements have been incorporated in the 1965 TV sets. With 1965 the first full model year under the governmental ruling on all-channel reception, new and improved transistorized UHF tuners are featured.

Wide use is being made of the steel banded implosion proof CRT. New in the 1965 lines are the 25 in. and 13 in. CRTs. New phosphors, which greatly increase brightness, are being used in present 21 in. color CRTs and before the end of 1964 manufacturers will be delivering the 25 in. rectangular color CRT containing these rare earth elements.

A number of transistorized American made personal portable TVs have appeared on the scene. The continued increase of transistors in TV requires technicians to learn more about semiconductor circuitry.

Admiral

New with Admiral is the color fidelity control which changes the dc voltages on the grids of the blue

and green guns. With the control at maximum cw, the center tap of resistors R526 and R544 (Fig. 1) is at ground potential. Note that R526 is 1.2 MΩ while R544 is 3.3 MΩ. This lowers the blue grid voltage about 8 percent below that of the green grid. Both grids are slightly below the red grid voltage since the color fidelity control does not affect it, making a sepia picture and background.

When the color fidelity control is turned to the maximum cw position, it places 400 v at the junction of R544 and R526. Since the blue grid has less resistance (R544, 1.2 MΩ) it will have higher voltage than the green grid (R526, 3.3 MΩ) by about 5 percent. So we now have the blue grid higher by 5 percent than the green grid, and both about 30 v above the red grid, giving a distinctly blue picture and background.

The automatic color intensity circuit (Fig. 2) automatically adjusts the bias on the first bandpass amplifier to variations in burst level, thus providing a relatively constant output of chrominance information.

Color killer bias is developed in the color killer detector and also serves to bias V501B (the first bandpass amplifier). The amplitude of the transmitted burst is compared with the 3.58 constant local oscillator signal and develops a negative voltage. This voltage varies,

thus changing the bias on the first bandpass amplifier, but it is always of a negative value sufficient to keep the color killer biased to cutoff.

An automatic degaussing circuit (Fig. 3) is incorporated in many Admiral color models for 1965. Starting from a cold condition, a thermistor, M117, has a resistance of approximately 36Ω. When power is applied, a substantial amount of the line voltage appears across the coils located on each side of the picture tube because they are directly across M117. The ac field neutralizes any residual magnetism in the area of the picture tube face. As the current continues to flow through M117, heating occurs which lowers its resistance to approximately 0.4Ω. Thus the current is gradually reduced through the degaussing coils and applied to the power transformer. Finally, to assure complete removal of the ac field, a bifurcated switch thermally coupled to M117 opens, disconnecting the coils. The remaining current in the coils is dissipated by the resonant circuit formed by C140 and the degaussing coils. In addition to controlling the demagnetizing function, the thermistor M117, is used to protect the rectifiers and tubes from starting power surges.

Admiral's bandpass amplifier circuit is shown in Fig. 4. The color signals are taken from the cathode

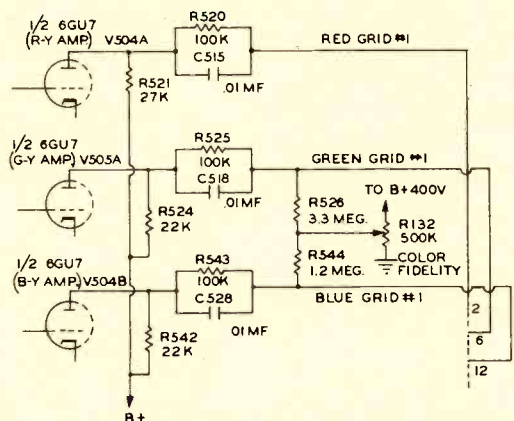

Fig. 1—Schematic of Admiral's color fidelity control circuit.

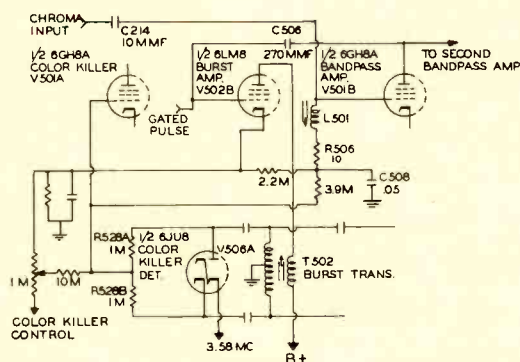

Fig. 2—Admiral automatic color intensity circuit.

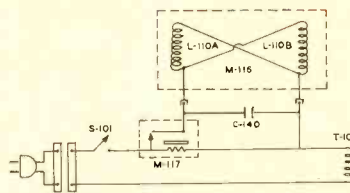

Fig. 3—Automatic degaussing circuit used in 1965 Admiral color TV.

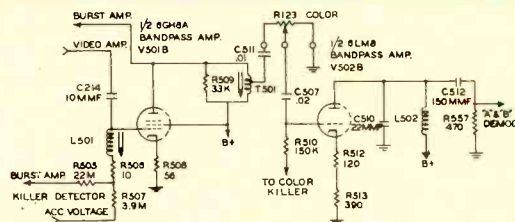

Fig. 4—Simplified circuitry of bandpass amplifier employed in Admiral color TV.

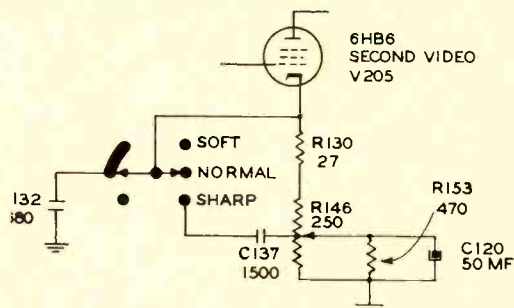

Fig. 5—Admiral's picture peaking switch circuit.

of V204, first video amplifier, and applied to a resonant circuit consisting of C214 and L501 to the first bandpass amplifier V501B. After amplification in V501B, the signal passes through the plate transformer T501, and C511 to the color intensity control, R123. The second-bandpass amplifier completes the chain of amplification and supplies the necessary signal for the A and B demodulators, V503 and V507.

Custom models feature picture peaking circuitry shown in Fig. 5. The picture peaking switch is located with the contrast control knob. Each position alters the video response by adding or deleting C132, 680 pf and C137, 1500 pf capacitor from the cathode circuit of V205 second video amplifier. The switch can be used to minimize snow and color spill-over apparent on some programs.

The anti-snivet circuit (Fig. 6) built into this chassis applies 45 v B+ to the horizontal output tube suppressor grid. This voltage slightly alters the operating characteristic of the tube and prevents undesirable oscillations. Snivets are caused by spurious oscillations in the horizontal output tube. Although they rarely occur, they would be displayed on the right side of the screen. Snivets appear as a black vertical line or a small oval.

Emerson

The 1965 Emerson series filament chassis utilizes a modified form of electron-coupled Colpitts sine wave

oscillator in the horizontal circuits. The basic resonant frequency of the circuit (Fig. 7) is determined by the horizontal hold coil (L12), in conjunction with capacitors C39 and C40 which are connected across it. A study of the circuit diagram will reveal that C38 in series with the dynamic grid-to-cathode resistance of the tube, is connected in parallel with C39, which is one of the major frequency-determining components.

Because the dynamic grid-to-cathode resistance of the tube varies with changes in applied grid voltage, it can be seen that the shunting effect of C38 across C39 will also vary with changes in grid voltage, causing a corresponding change in the oscillator's frequency. The actual voltage applied to the grid varies with the output of the horizontal phase detector diodes, where it is developed by comparing a sample pulse of the oscillator frequency (obtained from the horizontal output transformer) with the horizontal pulse from the sync separator output.

Although the components responsible for determining the oscillator frequency in this circuit are limited to C38, C39, C40 and L12, improper operation could easily result from the presence of abnormally high voltages (either positive or negative) on the input grid of the tube, caused by a defective set of diodes or associated components in the horizontal phase detector circuit.

This manufacturer has brought out a compact 11 in. portable TV which contains 22 transistors, 13 sili-

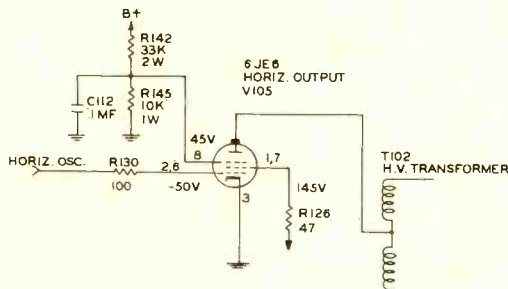

Fig. 6—Anti-snivet circuit reduces spurious oscillations in Admiral color chassis.

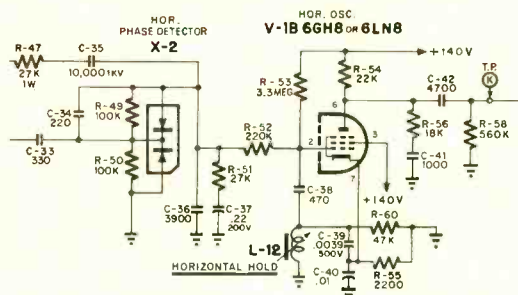
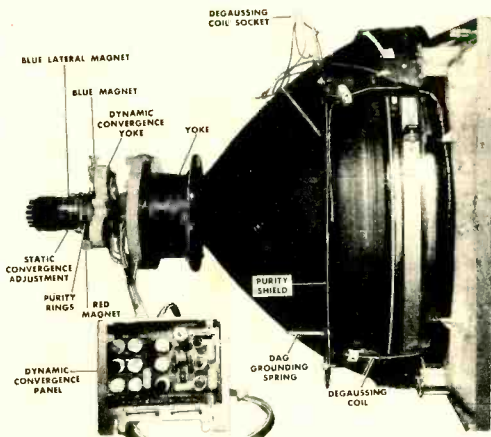

Fig. 7—Schematic of Emerson's horizontal oscillator circuit.



View of Admiral color CRT showing location of degaussing coil.



Emerson's 11 in. all transistor portable TV.

con diodes and one silicon gate controlled switch. This set marks Emerson's entry into the transistorized TV field.

General Electric

The G-E TA chassis is fully solid-state (except for the picture tube, of course) and can be powered from a 120 vac source or from the lighter socket of a car having a 12 v negative ground electrical system. A 9 in. CRT with bonded implosion protection is used in the set. The tandem tuning system selects and tunes all 82 channels. The TA contains 24 transistors and 18 semi-conductor diodes. Most of its components are mounted on a single 8 x 6 in. circuit board. A full schematic of the TA chassis appeared in the TEKFAK Section of the October 1964 issue of ELECTRONIC TECHNICIAN. Circuitry used in this chassis is new to most TV technicians but in the near future schematics of this type will probably be commonplace.

The vertical oscillator and vertical output stages of the TA chassis are shown in Fig 8. The vertical oscillator transistor, Q18, is connected in a blocking oscillator circuit. Forward bias on the base-emitter junction is obtained from the voltage divider R204, R205, R206. Consider the oscillator to be free running (no sync pulse). When a voltage is applied from the power supply, the emitter voltage is of a magnitude which causes Q18 to conduct. The voltage developed by transformer winding, T201A, is induced into the larger winding T201B. This increases the forward bias on the base-emitter junction and Q18 conducts heavily. The

emitter-base electron flow quickly charges C205. The negative plate of C205, which is connected to the base becomes sufficiently negative to turn off the transistor and drive it beyond cut-off C205 now slowly discharges through R205 and R204 until the base-emitter junction is sufficiently forward biased to cause Q18 to conduct and repeat the cycle.

Synchronizing pulses from the clipper are integrated by R207, R209, C203 and C207. The resulting pulse is fed to winding T201C through C206. The negative-going sync pulse from the clipper is inductively coupled from T201C to T201B in a manner which produces a positive-going pulse.

Vertical hold (frequency) control R205 is adjusted until the free running speed of the oscillator is slightly slower than the frequency of the positive-going sync pulses. The sync pulses then will cause the oscillator to conduct just before Q18 would normally come out of cut-off in its free running state.

Y201 and R208 damp oscillations from T201B which are developed when Q18 is driven into cut-off. This reduces the level of negative bias which is discharged by R205, R204, allowing the vertical hold control to be operated over a greater range. C204 filters horizontal information from the vertical oscillator circuit.

To develop the sawtooth waveform necessary to drive the vertical output transistor, Q19, consider C209 and C210 as a single capacitor in series with R211 across the power supply. The capacitor charges slowly

Continued on page 101

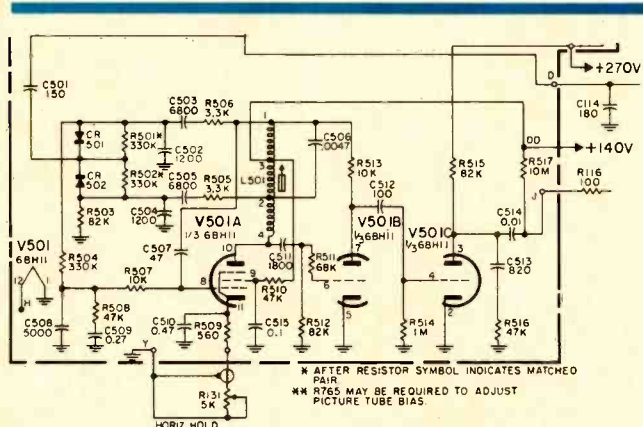

* AFTER RESISTOR SYMBOL INDICATES MATCHED PAIR
** R765 MAY BE REQUIRED TO ADJUST PICTURE TUBE BIAS

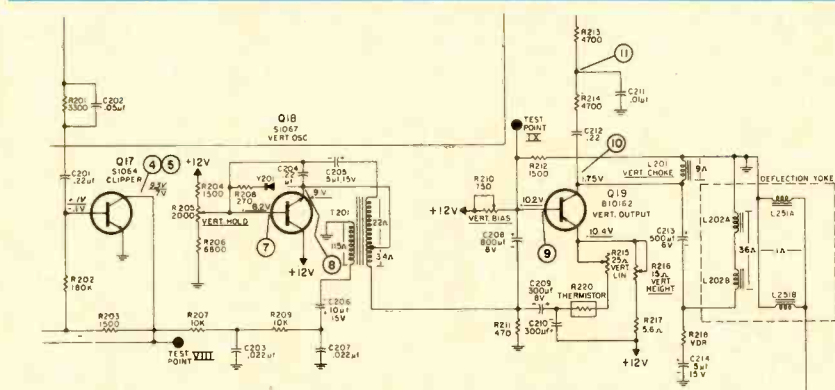

Fig. 8—Schematic of vertical oscillator and output stages of G-E transistorized portable chassis.

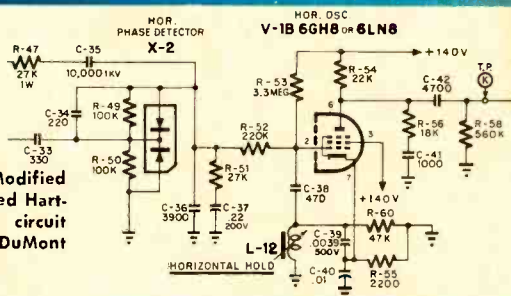
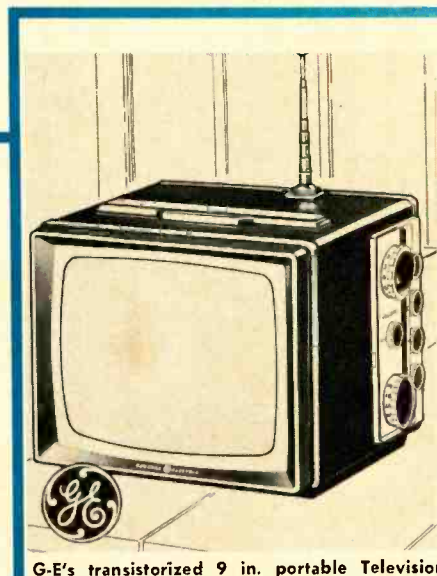

Fig. 10 — Modified electron-coupled Hartley oscillator circuit used in 1965 DuMont line.

Fig. 9 — Compactron tube, 6BH11, is employed in horizontal oscillator circuit in G-E FY color chassis.



G-E's transistorized 9 in. portable Television

PICTURE TUBES

BLACK AND WHITE AND COLOR

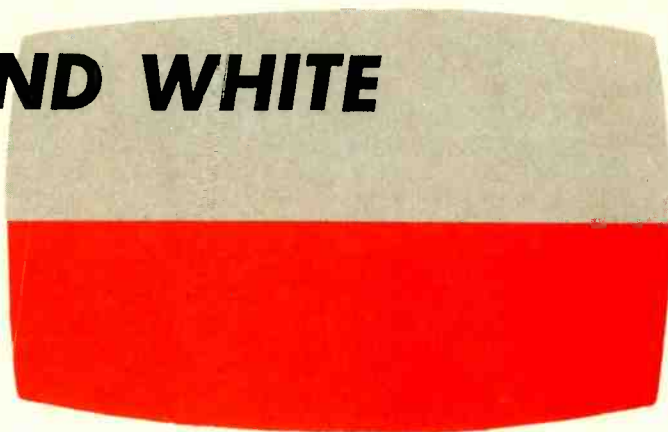

■ A number of monochrome and color CRT developments have been introduced during the past several years.

Various methods of implosion protection, for example, have been utilized with the steel banded tube fast becoming a favorite among black and white TV manufacturers. The steel band applied around the rim of the CRT offers implosion protection formerly provided by separate glass safety shields. This type of construction simplifies replacement procedures since no separate safety glass is required and a steel rim is employed as an integral part of the mounting system. The banded tube is available in most black and white CRT sizes.

The 25 in. black and white CRT is being used by a limited number of manufacturers and increased usage will depend on customer acceptance of the larger size. Industry sources expect a wider 1965 selection of models containing the 25 in. CRT. And it is indicated that the 23 in. steel banded type will probably be the standard large-size B/W CRT for years to come.

The 13 in. CRT has been added

to the growing list of small size tubes. With U.S. manufacturers entering the transistorized small screen field, the number of small tube sizes will continue to grow. Indications point to the entry of domestic manu-

facturers in the tinyvision (screens of less than 9 in.) market, a field previously dominated by Japanese manufacturers. The true portability market potential remains virtually unexploited.

Sylvania engineer examines the new phosphor dot screen of a 21 in. color CRT containing phosphors based on the rare earth element europium.



PICTURE TUBES

Continued

Color Developments

Despite numerous announcements of new color CRT developments, reports indicate the present 21 in. 70 deg round color tube will be the backbone of the industry for some time.

Sylvania recently announced a 21 in. 70 deg color tube having phosphors based on the rare earth ele-

ment europium. Tubes using these new phosphors provide about 40 percent more brightness. This improved 21 in. tube is currently in production and will be used by various color TV set manufacturers.

RCA has also developed a new production method for its 21 in. round tube using an improved screen process which results in a much higher light output.

Several CRT manufacturers have sampled the 90 deg 25 in. rectangular color tube and deliveries are now being made. The 25 in. tubes will also utilize the newly developed rare earth phosphors.

The overall length of the RCA 25 in. 90 deg color tube is slightly less than 21 in. which is 4½ in. less than the standard 70 deg type. The aspect ratio of 3.12 to 4.0 is more consistent with telecasting signal standards. The tube has a screen area of 295 sq. in. compared to 261 sq in. for the 21 in. round type and the curvature of the faceplate has been flattened in comparison to the 70 deg CRT.

Both RCA and Sylvania have announced a 19 in. rectangular color CRT which should be ready for sampling early in 1965. Zenith's Rauland division is also producing 25 in. rectangular color CRT's and 19 in. samples are due in 1965.

At present there are four U.S. color CRT manufacturers but RCA is reported to be contributing a large percentage of the output. Sylvania, Rauland and National Video are other manufacturers in the field. National Video has been concentrating on the efficient production of a 23 in. rectangular color tube for Motorola, while the others have been turning out the round 21 in. 70 deg tube. Both Philco and Admiral have announced plans for manufacturing the 21 in. round color CRT with limited production scheduled for 1965.

Sears Roebuck has been marketing a 16 in. color set manufactured by Toshiba in Japan. The set utilizes a 16 in., 70 deg, three gun color CRT. Significant changes in color set design have been made in Japan by Sony. This manufacturer uses a one gun, 19 in. Chromatron CRT. TV sets using the Chromatron tube may be sold in the U.S. next fall according to reports from the manufacturer. No U.S. companies are presently licensed to manufacture the Chromatron color tube.

Continued research in the field by a number of firms will undoubtedly develop other types of color display devices but in the foreseeable future technicians will service TV sets containing three gun, shadow mask type color tubes. ■

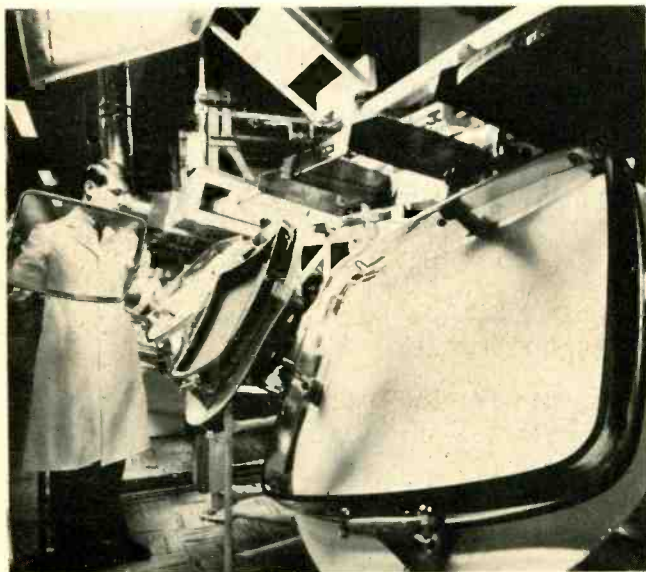

Faceplates for RCA 25 in. rectangular color CRTs are being prepared for application of 1.25 million tiny phosphor dots.

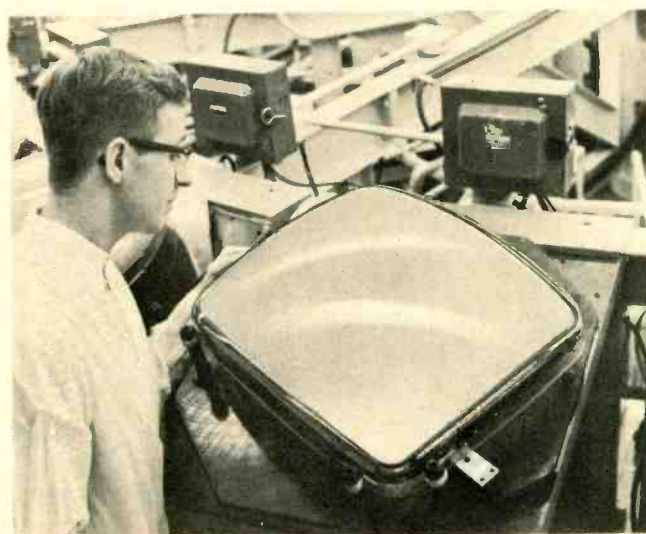

A 25 in. rectangular Zenith color CRT undergoing inspection at Rauland plant.

FILTERS CAN DO FUNNY THINGS



Watch those symptoms carefully
or you'll end up
chasing mirages

by H. L. Davidson

■ The phone rang just as I opened the shop door one morning. An amused-sounding male voice said "I have the funniest looking TV picture you ever saw. I've got the local beauty contest on and the gal has a lot of curves—but all in the wrong places." Then the man laughed.

When we arrived at his home to look over the set, we found, much to our surprise, that he was quite sober and what he said was true.

This sure looked like a cathode-heater short in the RF oscillator or an IF tube. But after I replaced both tubes I had changed my mind. Then I pulled the RF oscillator tube again and saw a horizontal dark line appear across the screen and run up the white raster. It certainly must be a bad filter capacitor, I thought.

The chassis was removed and a good 100 μ f was jumped across the one in the set. Sure enough, the curves disappeared. This was capac-

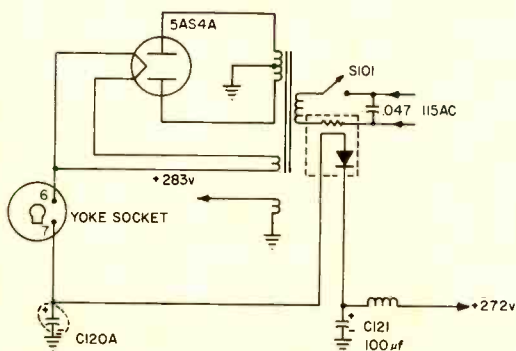

Fig. 1—Schematic of power supply area showing position of defective C120A capacitor.

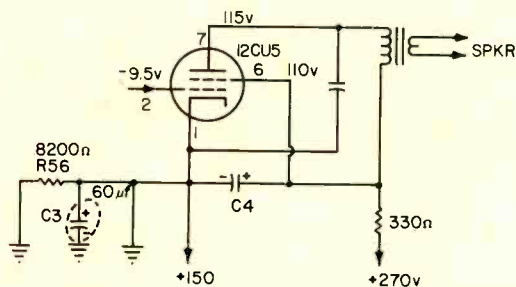
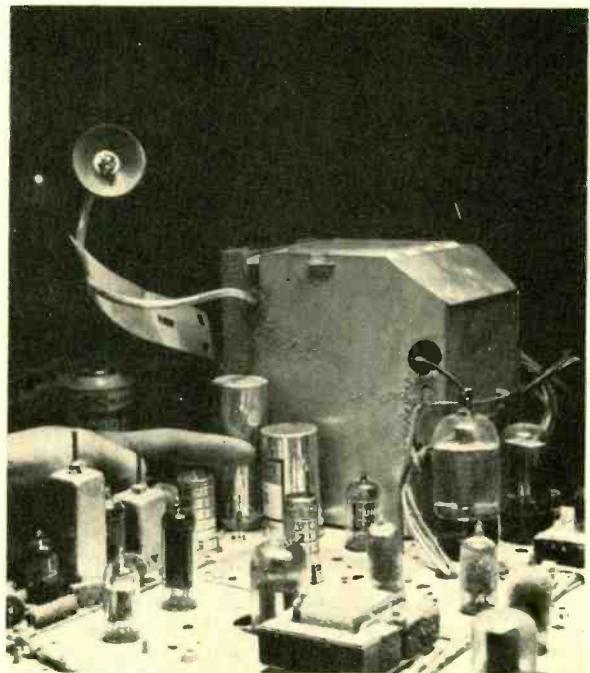

Fig. 2—Defective C3 capacitor in Admiral chassis sound section caused distorted sound and picture pulling.



Finger points to filter can containing C120A in KCS121 chassis.

FILTERS CAN DO FUNNY THINGS

Continued

itor C120A in an RCA KCS121 chassis. Capacitor C120 is a pack consisting of a 100 μ f and a 10 μ f rated at 400 v, plus a 30 μ f and 20 μ f rated at 50 v. The entire capacitor pack was replaced (Fig. 1).

When the defective filter was removed from the chassis a white "sour-cream" substance could be seen around the bottom metal ring.

Watch Those Symptoms

There's nothing really funny about a defective input filter to a TV-radio technician. But if your not careful, the symptoms might throw you off a little. Sometimes AGC trouble will do the same thing. And many times we jump to premature conclusions about TV troubles. The odds in favor of "hitting" are slim—it comes out mostly

"misses". In this particular case there was very little hum in the speaker. The picture would bend a little to the right from the left side of the screen. Of course, with a picture on the screen you could not see the 60 cps lines. You could see them on the raster when the oscillator tube was removed. Sometimes a tube tester won't show these shorted input tubes so I always like to sub one or more new tubes.

Another Case

This Admiral portable was brought into the shop and the ticket read "distorted sound, sound not clean, picture pulling, especially on strong signals." This looked like AGC or sync trouble. The sound was not only garbled and distorted, but acted as if the fine tuning control was turned way off station.

Of course the AGC and sync tubes were checked and substituted—without favorable results. Could be a filter capacitor again, I thought. It was! Capacitor C3 in the cathode circuit of the 12CU5 sound output tube had dried up. Again, when the filter was removed, it had that same "sour-cream-look" under it (Fig. 2).

If you take a second glance at the output circuit, you'll see the

150 v source feeds from pin 1 of the output tube, right where that bad filter joins in and goes to the AGC keying and sync circuits. We were half right when I said it looked like AGC and sync trouble. But I guess we technicians are like the customer—just hoping it will be a "little ole" tube.

And Another

The next one was a Silvertone model 2100 and it looked like a "doozer." The picture was only a quarter in. wide on the far left side of the screen. And it was plenty bright, too. The sound was OK and after the set was on a few minutes you could smell and see a curl of smoke drifting up from the chassis. After a few minutes you could smell those burned resistors a mile away. Well, ten feet away.

One thing we knew, for sure, there's a short some place. Looked at first like a shorted filter capacitor, or a shorted bypass capacitor in the horizontal circuit. Tubes checked OK and none were shorted. The back was removed and a cheater cord plugged in. It didn't take long to locate the smoking resistor. "Sap" was boiling out of it. The resistor was R44, shown in Fig. 3.

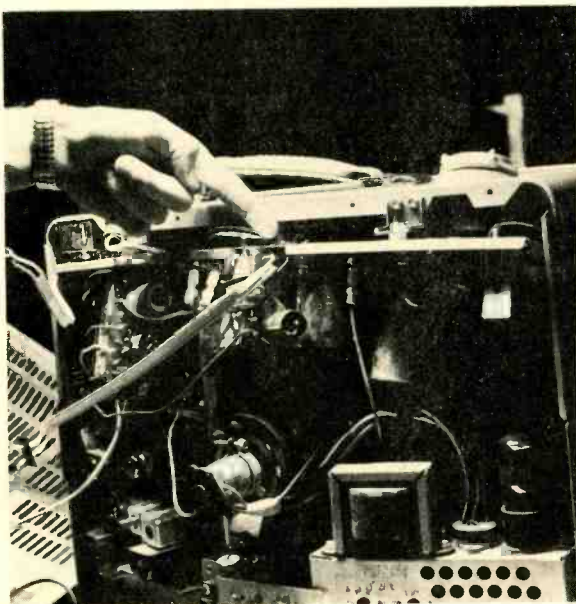

Finger points to filter C3 in the cathode circuit of the 12CU5 in an Admiral portable PL17UF3LR chassis.

Fig. 3 — Location of C2B and R44 in Silvertone chassis.

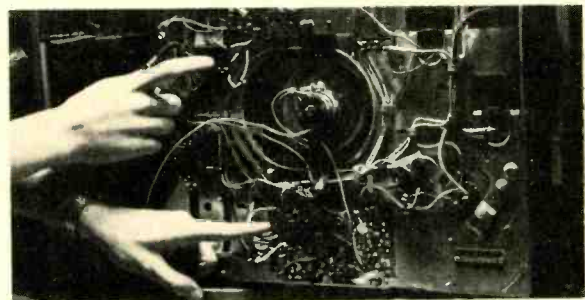
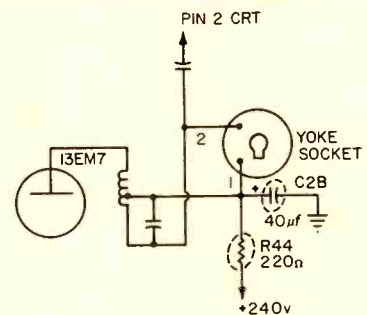

Finger at top points to location of filter C2B and one at bottom to burned resistor in Silvertone chassis.

A quick voltage check showed 225 v on one side of the resistor and 200 v on the other side. Gosh, this meant only 25 v was being dropped across this 220Ω resistor. This surely didn't make sense. The filter capacitor C2B couldn't possibly be shorted. But you guessed it, the thing was open (Fig. 3). I slapped a new one across it and everything went back to normal. A new voltage reading was taken and the voltage increased from 225 to 235 on one side and from 200 to 225 on the other side. To be safe, I replaced the whole filter block. C2A is 100 μf, C2B is 40 μf and C2C is 20 μf at 300 v. Resistor R44 was also replaced because its value had changed to about 300Ω and actually had sweated a lot. A finger points to the bad capacitor and resistor in photo.

More Trouble

It was one of those crazy days when nothing went right. The truck wouldn't start and had to be pushed. And in this excitement, I left the call list at the shop and had to go back after it. Then on my first call I knocked a pretty vase off the TV set and it broke into a million pieces. Tough on the insurance.

You guessed it, this just wasn't my day.

On top of this, as I rang the doorbell at the next stop, the lady of the house said, "You'll never believe it, but I've got a buzz saw in my TV." I said that I could believe anything after today. I turned on the set and the woman ran off to the kitchen. The set sure sounded like a buzz saw. The woman peered around the doorway and said, "Didn't I tell ya' so!" These women always seem to be right.

The set had brightness—a jumping raster — and a buzz saw for sound. It was a little out of focus, and it didn't make a bit of difference where the volume control was set. You couldn't adjust the sound level up or down because it was too loud. I smelled filter trouble here and pulled the chassis in without horsing around with tube substitutions.

A new capacitor was shunted across each filter in the set. The noise sounded like vertical 60 cps. It was still loud and capacitor substitutions made little difference. Looking a little closer, and making voltage checks, it was found that the voltage on the vertical output tube was quite low. The 220Ω resistor, R132 (Fig. 4), had a crack

in it, on the bottom side, where you'd hardly see it. I replaced the resistor and the voltage returned to normal. But some 60 cps hum remained. The filter wasn't shorted and could not have burned up the 220Ω resistor.

Checks showed that the 6CZ5 tube had shorted and burned the resistor partly open. The filter had dried up. C120B (Fig. 4) was replaced and the set was back to normal.

It is always best to replace the entire filter pack when one section is bad, however. This will frequently save a few costly call backs. C120A and B is a 100/20 μf 400 v electrolytic capacitor. Its circuit location is shown in Fig. 4.

Intermittent Roll

A Silvertone model 528-35601 would work perfectly at times, and then would roll. You would have to go up and stop the vertical roll and the picture would sync in. The horizontal hold was good enough and didn't drift out of sync.

When I looked at the picture a little closer, I noted that it would sometimes pull a little to the right and a dark strip would go up about

Continued on page 70

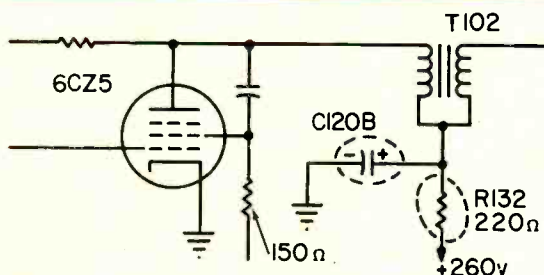

Fig. 4—Dried up filter C120B caused 'buzz-saw' sound.

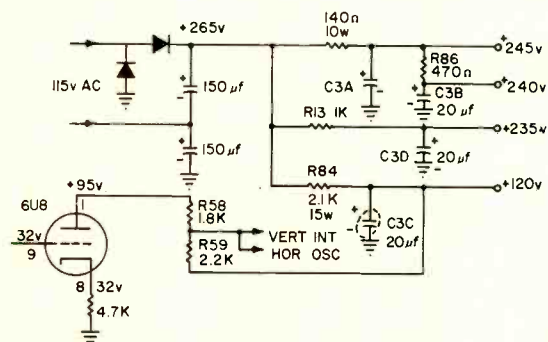

Fig. 5—Defective C3C in Silvertone model 528-35601 caused vertical and horizontal problems.

Fig. 6—Defective filter C132A in KCS108 caused 60 cps hum in speaker.

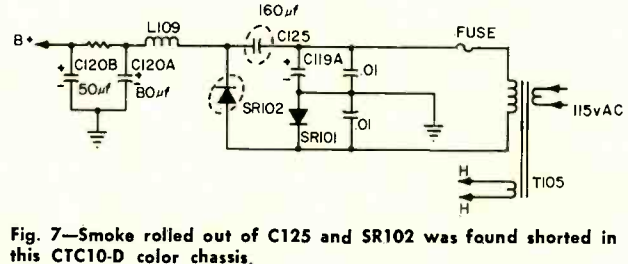
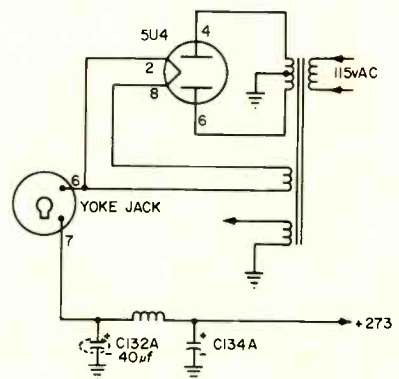

Fig. 7—Smoke rolled out of C125 and SR102 was found shorted in this CTC10-D color chassis.

SOUND—

The Easy Section

An old timer shows you how not to repair the TV sound section

by William R. Ganglinger

■ TV sound troubles can be pretty frustrating even though the sound section is generally considered one of the easy sections in TV sets.

I've kept records of all kinds of "way-out" jobs over the years and classified them on cards by the type of trouble and the make of set. It takes a little extra time but I think it has been worth all the extra effort.

The other day I was looking through some of the cards when I noticed, with nostalgic consternation, that some of them were "dogs" from TV sound sections. Since then, I've reasoned that this section gave me more than a normal amount of trouble because I considered it an *easy* job. If I could case-history some of these problems, I decided, it would help other technicians avoid a lot of trouble.

Audio Affects Video

The first card I looked at showed the set's symptom in one simple written line: "Picture washes out when volume is increased." I re-

membered that I had blamed the schematic lay-out because it took me so long to find the trouble. I just couldn't seem to see the relationship.

When I finally got organized I found that all the IF tubes' plate and screen voltages dropped when the volume was increased. Tracing the supply circuit I found the IF plate and screen voltages were both supplied by a voltage divider circuit which included the audio

output tube. The voltage was taken from the output tubes' cathode.

Going back another step I found that the voltage on the output tube grid also increased when the volume was increased. That was all it took! I realized then that this was a gated-beam circuit and the volume control was in the voltage amplifier plate circuit. The output coupling capacitor (see Fig. 1) turned out to be leaky and increasing the volume control setting al-

Fig. 1—Most gated-beam sound stages have volume controls in the plate circuit. Failure of the output stage coupling capacitor changes stage bias as the volume is varied.

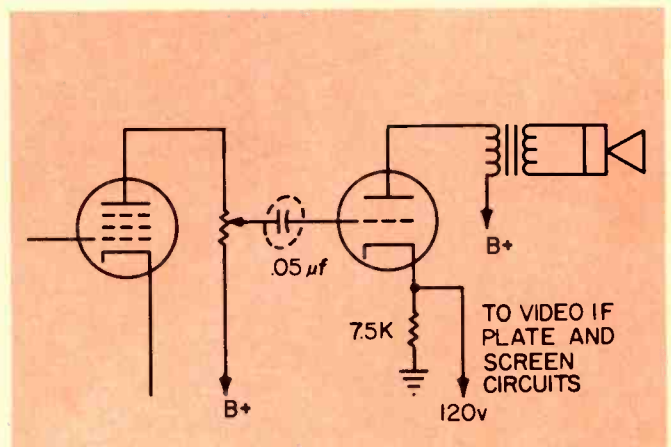

lowed more plate voltage to leak onto the output grid. This caused the tube to conduct very heavily and reduce the supply voltage to the IF.

Distortion and Buzz

I flipped to another card and after reading the symptoms I remembered, in detail, the pains I went through with this set: "Set comes on normally and gradually starts to distort and buzz."

This began with a house call. The set used a ratio detector and I naturally suspected alignment trouble. Since this one can be easily adjusted in the field, I had made it a habit to touch up the alignment by listening to music while adjusting the top and bottom slugs of the detector transformer alternately for the loudest and clearest sound. I had found out early that voice was unsatisfactory for adjustment since it was more difficult to hear distortion.

After a little touch up the set worked perfectly. I collected the house call charge and left. The next afternoon I got a call from the customer with a new but very similar complaint: The set distorted and buzzed when it was first turned on and gradually got better — never good, though.

I returned to the scene and pulled the set for a bench check. I knew the detector was drifting — a lot of them do. Somewhere I had read that a cure for sets that needed periodic detector alignment was to wire a 20 pf, N750, temperature sensitive capacitor in parallel with the capacitor already

across the ratio detector's secondary. The capacitor in this set was already 150 pf (Fig. 2). I had used this trick on several sets and found it worked well. It was simple; just wire in the capacitor and touch up the alignment.

I wired in the capacitor across the secondary and fired up the set. It worked beautifully. I forgot all about touching up the alignment. Not to let this one out-do me again, I set the chassis aside and let it cook. I returned to it a short time later and turned up the volume. The sound was terrible. I remembered that the slugs should have been touched up and went to work hoping that I had finally found the trouble. Once again the sound came in loud and clear.

I turned off the set and let it cool til the next morning. When I turned it on I was no farther ahead than I was in the beginning. Suddenly something struck — probably divine inspiration! I had checked the tubes — maybe I should substitute now. (For some people that would have been natural. For me, however, it was an inspiration.) It was a hard pill to swallow but the audio amplifier directly following the detector was bad. Drift problems in tubes rarely show up in testers and because of that problem I've never let myself forget it.

I pulled another card at random. Some marks appeared on the card indicating that I'd seen this trouble more than once. Continuous noise in the sound accompanied by some horizontal tearing. It was a combination symptom but looked

like a very simple case of corona leakage in the high voltage section.

I looked around under the chassis and then pulled the lid on the cage. I couldn't see where it had been arcing so I turned the set on. The symptoms were still there but I couldn't detect the arcing. I turned out the shop lights but I was still unable to see anything.

There was an old Circuit Digest (now TEKFAK — Ed.) lying on the bench from another service job so I rolled it up into a listening tube. I couldn't hear a thing. I pulled out the scope without knowing what I would do with it. I probed through the sound section. It was full of noise; probing on back through the video, IF and tuner I still found noise. That pretty much settled it. The noise was either coming through the power supply or it was being radiated, or both.

I sweated over this one a long time. Although the major symptom was in the sound section the trouble was not there. On a hunch, I finally changed the 20 kv, 500 pf capacitor (Fig. 3) in the cage and the trouble was gone. Apparently the capacitor was arcing inside. This was unusual because these barrel capacitors (sometimes called 'door-knobs', 'cart-wheels', and a few private names that I called this one) rarely fail and when they do it is usually a complete short which is easy to find. Anyway, it was one case where a gambler's hunch was about all I had to go on and it paid off.

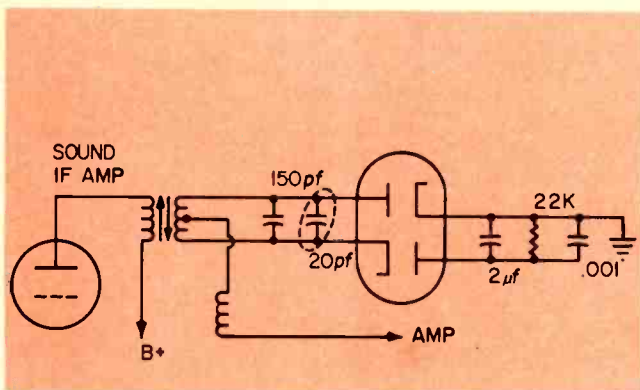

Fig. 2—A 20 pf temperature sensitive capacitor across the detector transformer secondary often stabilizes ratio detectors that need frequent alignment.

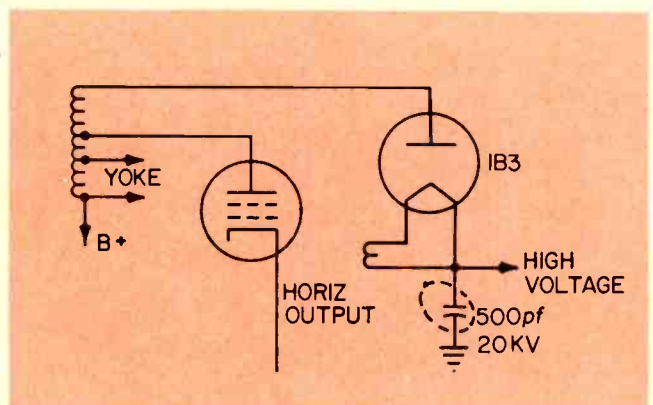

Fig. 3—The high voltage filter capacitor rarely fails. This one was very 'secretive.'

SOUND

Continued

Distortion

The next card recorded a problem which wasn't really a dog but it chased me up a tree anyway. It was a console-type chassis from one of the early sets. The customer said the sound was good at low levels but garbled when the volume was turned up. He had pulled the chassis from the cabinet but didn't bring the speaker with it. After getting all the information I could from the customer I hooked up the bench speaker to the chassis. This must have been my lucky day. The set performed just like the customer said — even with my speaker.

As it turned out I wasn't so lucky after all. The chassis used the push-pull audio output shown in Fig. 4. Most distortion is caused by leaky coupling capacitors so I went quick-

ly around the amplifier grids trying to find one that was leaking. No luck.

Push-pull outputs have a bad habit of distorting sound when one half is out of order so I read the voltage on the plate, screen and cathodes of the output tubes. Everything looked OK. I checked the voltages all the way back through the amplifier but everything there appeared normal too. I spent about an hour fooling around before my better judgement told me to get the scope out. I fed a sine wave into the first audio amplifier and scoped the output. Sure enough the sine wave was a mess. It looked like something that should be coming from a power supply.

I went back to the output tube grids and the waveshapes looked about right. But at the plates, one

waveshape looked normal and the other was almost non-existent. I pulled the tube to put in another. I noticed, when the tube was out, a burned area across the socket. I measured the voltage around the pin contacts again. It was the same at the plate and the screen grid — with the tube out!

I wired in a new socket and checked the voltages again. This time I found the plate voltage was up and the screen voltage was down with the tube out of its socket.

I plugged in a new tube and the set worked beautifully. Apparently some foreign material had burned on the socket and left a highly conductive path between the plate and the screen pins. The plate was being pulled down to "normal" operating voltage by this and the screen was holding close to normal but a little higher — probably because of the filters in the screen circuit. The filter probably accounted for the very weak signal at the plate too.

Actually, if I had made more accurate measurements on the first go-round I probably could have found the trouble a lot sooner. I looked at the remaining old push-pull tube and noticed it was burned too. No use to even try it. I plugged in a new tube in the other half of the push-pull to make sure it would be reasonably well balanced and buttoned it up.

Through all the "dogs" I've worked on, I've decided one thing: There really isn't such a thing as a "dog." If the technician keeps strictly on the "trail" and knows the sets' circuitry, he just can't get chased up a tree.

Of course, once in a while there just seems to be one "dog" around that insists on snapping at your heels . . . ■

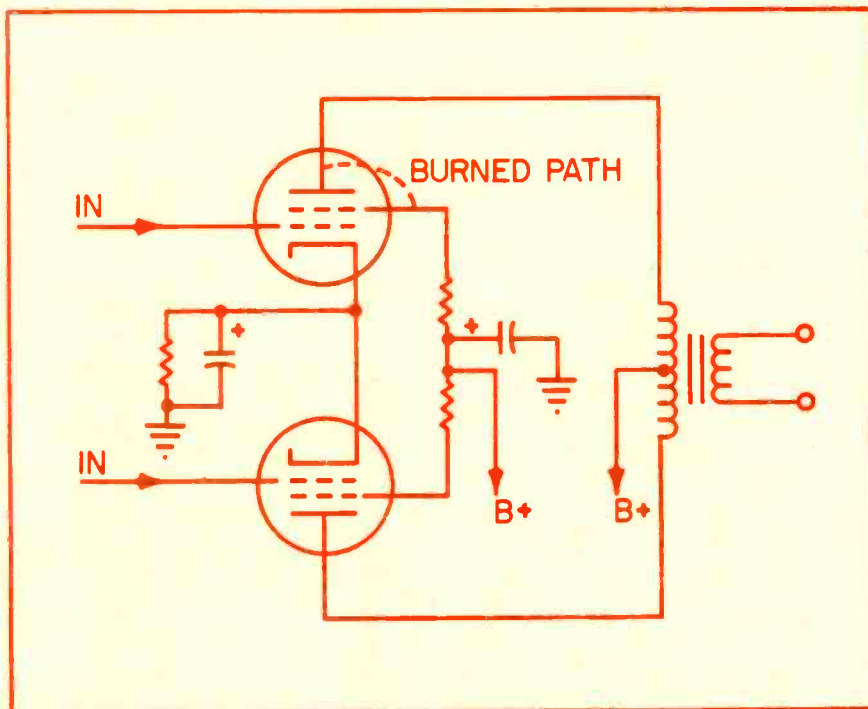

Fig. 4—A burned area on the output tube socket made the socket voltages look almost normal. The scope revealed the only clue that led to a solution of the problem.

Choosing and Using AUDIO OSCILLATORS

Pick an instrument to fit specialized needs

Part II

by Arthur M. Walters

Hewlett-Packard Co.

■ To make rapid full-range frequency-response measurements it is convenient to use an oscillator which will cover the entire audio band in a single rotation of the dial. This can be accomplished in several different ways.

Two RF oscillators, one fixed and one variable, may be combined to produce a wide sweep audio beat in a mixer stage. The radio frequencies are chosen so that the variations are a small percentage of the varied RF, so practical size variable reactors may be used. The RF will be from two to ten times the maximum beat frequency. But under these conditions a small percentage of drift or calibration instability, in either of the two oscillators, will cause large frequency errors in the output

beat. These errors will be especially large at the lower frequencies. So a zero beat null adjustment is a necessity before using such an instrument. Cost tends to be high in relation to performance, since so many circuit elements must be optimized.

A simpler alternate choice is the RC Wien-bridge circuit where both R and C, in effect are varied together. The usual range resistors in the Wien-bridge are replaced with a precision resistor and capacitor network. The impedance of this network varies with frequency. By proper network design, the tuning range of an oscillator can vary by a ratio of 1000 to 1. Thus an oscillator with one continuous range of 20 to 20,000 cps can be built. No null adjustments are required.

In using audio sweep oscillators, it is desirable to have a logarithmic scale on the dial. This is required for at least two reasons. First, it is conventional to display audio response on log paper, so each octave of the band will occupy the same space. The lower frequencies are thus spread far apart, the higher frequencies compressed. This convention is to correlate audio response curves with human hearing. We hear the *same change* in pitch between 110 and 220 cps, for example. Secondly, when we make a steady sweep across the band, we must dwell longer on the low frequencies simply because they *are* low in frequency; that is, it takes longer to produce any given number of low-frequency cycles. So, if

Audio signal generator designed for application where lowest distortion is required.



we sweep the dial at a steady rate, the log scale will automatically proportion the time given each part of the band as it should be.

A sweep oscillator will, of course, save time even in making simple point-by-point plots of response, by eliminating band-switching. It is a still better time-saver, though, if it is automatically driven smoothly through its range. Motor drive is commonly applied. The sweep oscillator provides an auxiliary dc output voltage that is accurately related to output frequency. The full range response of an audio component may be quickly viewed on an oscilloscope, or automatically plotted on paper, with an ac/dc converter and an X-Y recorder, or both together. Care must be taken to set the sweep slow enough so each portion of the spectrum gets due time. (It takes 1-20 sec to produce one cycle at a 20 cps rate!) The fastest practical sweep time for adequate measurement across the range 20 to 20,000

cps is found to be around 40 sec. and more is desirable for best observation. Narrower portions of the band may, of course, be swept in less time. Dial stops may be set to restrict the sweeping to any desired part of the band.

Using Audio Oscillators

In most applications, audio oscillators supply testing signals. The response of other equipment to those signals will be the subject of interest. Often the frequency response of the equipment will be measured. Distribution, power-output capability, linearity, modulation, gain and efficiency are all inter-related; measurements of any of these will often require an audio oscillator test signal source. In every case it will be necessary to consider the characteristics of the signal source as they relate to the equipment under test, to be sure the characteristics being measured are actually those of the equipment, rather than those of the signal source. The main problems which arise are concerned with termination, signal level, and extraneous pickup.

Termination

Most audio oscillators are designed to work into a "nominal" load, usually 600Ω . This is because long-distance audio transmission is standardized at this value; equipment is therefore designed to perform within specifications when terminated in a 600Ω load. Other impedance values are also in use. Studios commonly use 50 and 250Ω channels, especially for microphones. Some oscillators have provision to switch among several output impedances. Low impedance transmission is virtually always in push-pull or balanced-line pairs. Strict conventions apply to measurements of these systems, so almost all audio oscillators are provided with at least 600Ω outputs to match them. But the oscillators are not confined to such uses. It is simple enough to connect them single-ended, and to use them to drive high impedance loads, or even highly reactive loads, including filters.

Most audio generators have three output terminals. One is ground; the other two are the balanced output. One of the signal terminals may be grounded to make a single-ended source. Since many oscillators use an unbalanced "tee" attenuator at the output, fully balanced output is available only if the control is set for maximum output.

A few audio generators have four terminals. Two provide the push-pull pair, one is ground, and the fourth is a center-tap between the balanced pair. This configuration allows the generator to be matched to the conventions of any audio system. The center-tap may or may not be grounded at the generator; it may be connected to the center-tap of the balanced input on the tested equipment, if that equipment uses a balanced input. (This may be through the shield on the interconnecting cable, or through a separate wire in the cable, depending on the grounding conventions of the system under test.) Generally, multiple grounds will cause ground loop hum. For any case, the four-terminal arrangement provides an appropriate connection. In a single-ended output, for example, the CT terminal will be left unconnected, and ground will be strapped to either signal terminal. The single-ended output then is taken from the other signal terminal and ground. The ground strap is omitted to float the single-ended output, which is often desirable.

To make sure of meaningful results, we should know what interactions to expect between the oscillator and the tested device.

The oscillator circuit will give the output characteristics, or simple tests will reveal the facts. If the oscillator has a true source impedance of 600Ω , then an open-circuit output from it will drop to half voltage when a 600Ω resistor is bridged across the output terminals. This is equivalent to a constant-voltage source in series with a resistance equal to the output rating, and it may actually be just that. To test low impedance high level devices, an amplifier of suitable quality must follow the oscillator.

Continued on page 70



Audio sweep oscillator delivers range 20 to 20,000 cps in single dial rotation. It may be motor driven for automatic sweep measurements.

Are Your Business Costs Climbing Too Fast?

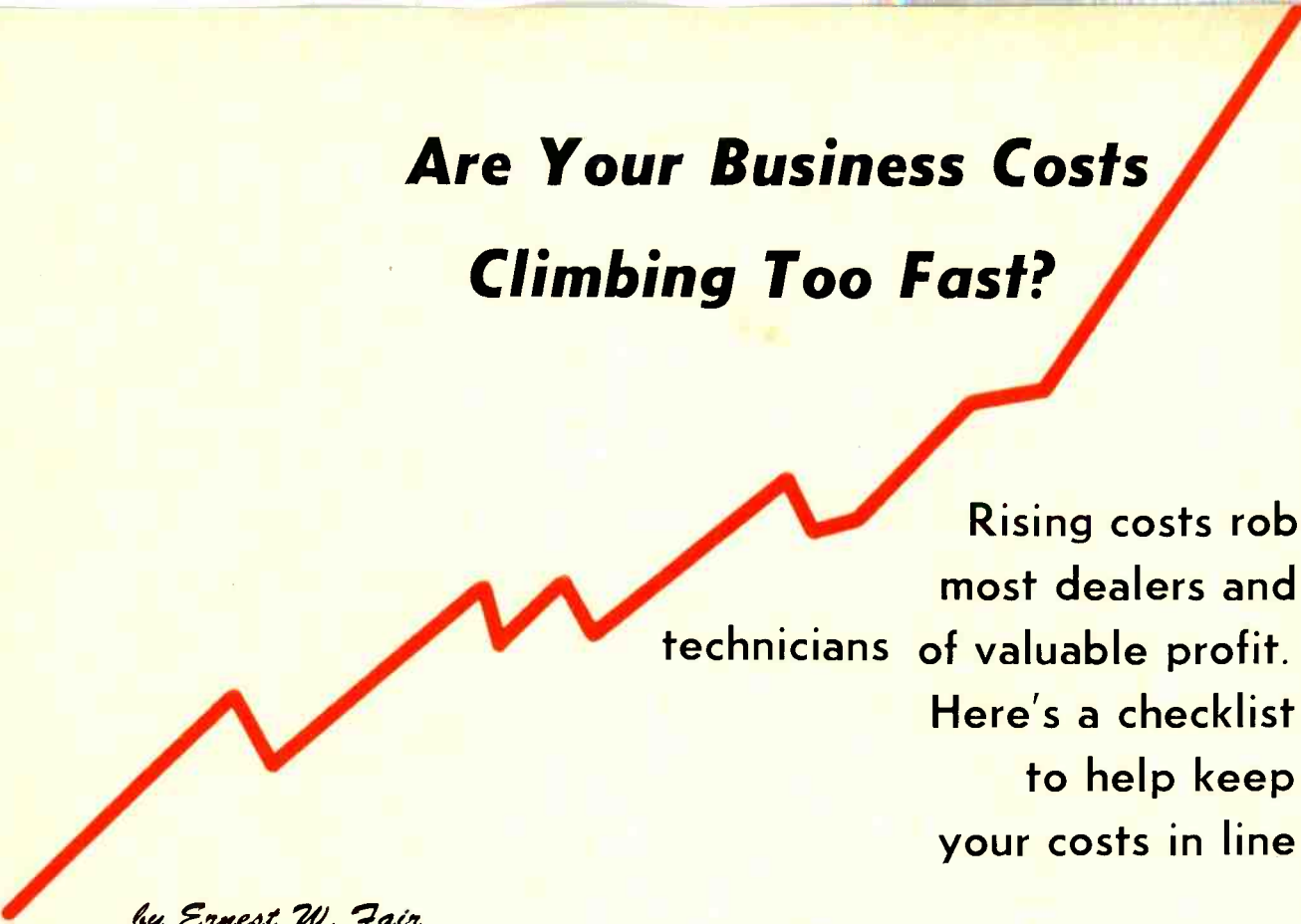

Rising costs rob most dealers and technicians of valuable profit. Here's a checklist to help keep your costs in line

by Ernest W. Fair

■ Most service-dealers and technicians today are confronted with rising costs of doing business. Some important reasons for business cost increases in the average TV-radio shop are listed here. By checking operation against this list you should be able to hold your costs in line, providing you take measures to correct any problem that may appear in your business.

- Are we paying too much for supplies, materials or parts? It's easy to slide into a buying "rut" and overlook good supplier opportunities. Just ask yourself these questions and consider the possibilities.

- Are we paying too much for professional business services? Bookkeepers, accountants and lawyers charge fees that are anything but uniform—and reasonable.

- Is inventory shrinkage eating away profit? Theft, mishandling, deterioration, carelessness and other such ailments can reduce profits for the less-than-alert shop operator.

- Is overtime being paid out that isn't charged to customers? Few shops can carry such a load; profit margins are just not good enough to permit it.

- Is money being wasted on insurance coverage? Business insurance needs change from time to time; your needs should be reviewed at least once each year for possible money-saving opportunities.

- Are we paying high interest rates? New loans may be possible at lower interest rates.

- Is our parts and supply inventory larger than necessary for today's business needs? Maintaining an unneeded inventory ties up capital that you can put to more profitable use elsewhere.

- Has the business been paying taxes that no longer

apply under present operating methods? If a good, hard look hasn't been taken at this facet for the last three years, it's time to start looking.

- Are we doing business with too many unprofitable customers? Every shop owner knows who the unprofitable customers are, after catering to them only to hold their business—which is seldom really profitable.

- Is at least 95 percent of the services offered profitable? Unprofitable services—offered purely for customer convenience—should be reduced to a low point.

- Is too much expended for rent or lease costs? This is worth checking, especially if the lease renewal time is near.

- Are profit-dollars being wasted in the careless use of utilities? This may seem unimportant, but over a year's time it can amount to several hundred dollars of profit and that is important.

- Is the shop open longer than really necessary? Customer needs and habits *do* change.

- Have credit losses been rising? No shop owner can afford credit losses if he wants to stay in business—even a \$25 loss for one month can hurt badly.

- Is employee turnover too high? Employee training is expensive, regardless of the job to be filled. Constant personnel turnover eats seriously into profits.

- Finally, do you have too many or too few employees? Either way, costs are up and profits down.

By checking these points now, and periodically reviewing them in the years ahead, your business should be able to look forward to growth, free of the numerous unnecessary expenses that hold back so many enterprises. ■

FM STEREO RECEIVER

by Stanley Janas

Sencore, Inc

A reliable multiplex generator is necessary to accurately align an FM stereo receiver. Before we can use it effectively, however, it would be appropriate to study a few essential facts about FM/stereo broadcasting.

FM/Stereo Broadcasting

The main channel transmitted by an FM/stereo station contains the sum of the left and right signals (L plus R) with audio information within the range of 50 to 15,000 cps. This fact makes the system compatible as any standard monophonic FM receiver will pick up this information.

The stereo sub-channel contains the difference information (L-R). This difference signal amplitude modulates a 38 kc subcarrier by means of a balanced modulator

which produces sidebands between 23 and 53 kc with the carrier suppressed. A 38 kc signal must be inserted at the receiver to effect demodulation. A 19 kc pilot carrier is added to the transmitted signal. This 19 kc signal is recovered by the receiver and is used to synchronize the receiver with the transmitter.

The SCA (Subsidiary Communications Authorization) extends from 60 to 74 kc—frequency modulated on a 67 kc carrier. The SCA carrier occupies 10 percent of the total modulation. A graphic illustration of the composite stereo signal is shown in Fig. 1.

The Stereo Generator

The block diagram of a stereo generator is shown in Fig. 2. This instrument is fully transistorized.

Unlike some generators, this one uses a 76 kc crystal-controlled oscillator instead of a 19 kc oscillator. Output of this oscillator, after passing through a pulse shaper, (Fig. 2), triggers a bistable multivibrator which results in a frequency division of two. This becomes the 38 kc subcarrier.

The 38 kc squarewave generated at the mv collectors is used to trigger the left (L) and right (R) gates. The left and right information is sampled at a 38 kc rate—similar to the operation of a switch being alternately opened and closed between two circuits at a 38 kc rate (Fig. 3). This system is commonly known as the "time multiplex method."

Since our L and R information is switch-derived, we also have odd harmonics of 38 kc (3rd, 5th, 7th,

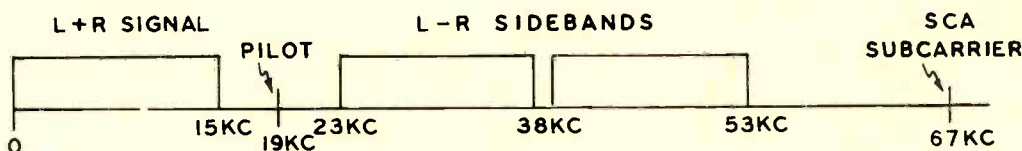
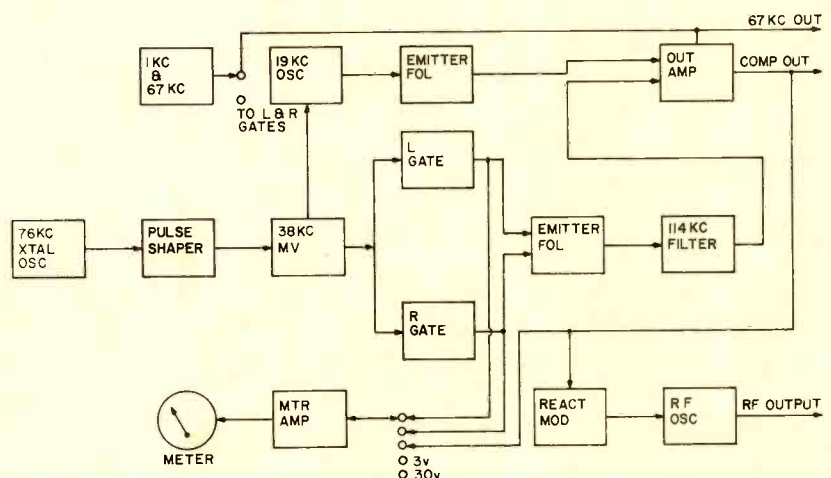

Fig. 1—The frequency spectrum of modulation used for transmitting FM/stereo.

Fig. 2—Block diagram of an FM/stereo multiplex generator.



ALIGNMENT

Use a multiplex generator to achieve adequate channel separation.

9th etc.). The filter shown in the block diagram must attenuate the lowest harmonic frequency (114 kc, 3rd harmonic), but it must pass all frequencies below 75 kc.

The pilot oscillator (19 kc) is synchronized by the squarewave pulse from one side of the 38 kc mv. Because the mv is essentially crystal controlled, the 19 kc oscillator signal is fed into a low gain phase correction amplifier which also serves as a buffer between the oscillator and the operational amplifier. The phase relationship between the 19 kc oscillator and the 38 kc subcarrier is extremely important — a shift in phase of only several degrees, for example, can seriously affect the receiver's separation figure.

A 1 kc phase shift oscillator in the tone position and a colpitts oscillator in the 67 kc (SCA) position, constitutes a duplex tone generator circuit. The 1 kc tone generator's output is 7.0 v P-P and the SCA output is 8.0 v P-P.

The composite multiplex signal generated is the same as that normally transmitted from an FM station during transmission of a stereo

program. It consists of right and left channel information properly combined, a crystal controlled 19 kc pilot and when desired, a 67 kc SCA signal. The composite signal is available from a front panel jack and also modulates an FM oscillator for front end injection.

The instrument's RF signal output is tunable from 95 to 105 Mc and is externally adjustable. The output is 3000 μ v and the output impedance is 300 Ω .

The P-P reading voltmeter utilizes a high input impedance current amplifier. The output of the meter amplifier is fed into a voltage doubler with a high time constant to attain true P-P readings. The meter is used to internally monitor left signal level, right signal level, or composite signal level. It also provides two external meter ranges of 3 v and 30 v P-P. The external ranges are also calibrated in db for direct db readings when making stereo separation measurements.

FM/Stereo Multiplex Circuit

A typical FM/stereo multiplex circuit is shown in Fig. 4. The 19

kc pilot is removed from the composite signal by a tuned circuit (L3, C46, R93) and amplified by V7A. Diodes CR5, CR6 and V7B form a frequency doubler. The 38 kc output of this stage is used to gate the left and right channel diodes, CR2 and CR3. The 180 deg phase change necessary for left and right channel demodulation is accomplished with a center tapped secondary.

The composite signal is also fed into the diode detectors through C51, L5, C53, L6, R44 and C54. Two outputs (left and right signal) are obtained from the detector.

Receiver Alignment

Alignment of this type of multiplex adapter is relatively simple and the procedure used may be applied in adjusting many other adapters currently in use.

The RF signal from the generator is injected at the antenna input of the FM receiver. Optimum results are obtained if the external antenna is disconnected. Tune the receiver to around 100 Mc, a sudden quieting will indicate that your receiver

Continued on page 71

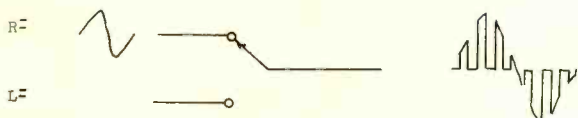

Fig. 3—Composite signal of time division multiplex—right only.

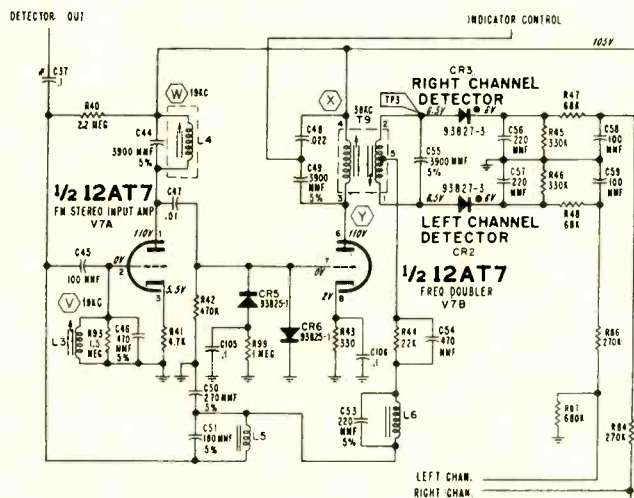

Fig. 4—Common multiplex adapter circuit.

Banded tube offers solution to numerous problems

CRT Implosion Protection

by C. M. Kesser

Electronic Tube Div.
Westinghouse Electric Corp.

Steel-guard banded tube reduces
implosion danger to low minimum.

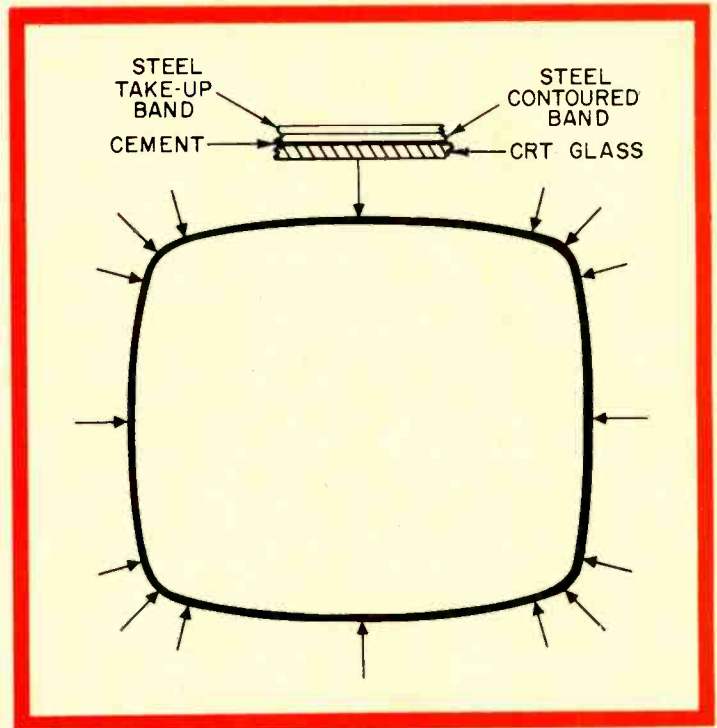

An evolutionary development process is taking place in TV picture tubes. One important factor in this development is a system designed to protect the ultimate consumer from the danger of implosions. As we know, an implosion is the "inward" collapse of a CRT's glass envelope.

To provide protection from implosion, early systems utilized a separate flat safety glass mounted $\frac{1}{4}$ to $\frac{1}{2}$ in. away from the CRT. Modifications of this include a curved, tempered safety window. These designs had the disadvantage of permitting dust and grime to accumulate on the tube face — reducing picture brightness and quality — necessitating periodic dismantling and cleaning by qualified personnel. One solution to this problem was a curved "window" bonded to the CRT with a thin layer of clear resin.

This innovation, although effective

in dealing with the dust problem, was costly. Costs were reduced by eliminating the epoxy resins in the "dry sandwich" approach. In this case, a formed rubber or plastic gasket spaced the window panel from the picture tube and sealed the edge against migrant dust and grime. The disconcerting effect of two reflective surfaces reappeared, however, when the refractive-index-matching epoxy was eliminated.

Banded Tube

One solution to these problems is the banded tube with integral mounting lugs. The banded tube has no additional safety panel to trap dust and grime. In intimate contact with the screen, the outer surface of the tube can now be treated to decrease obnoxious specular reflections. The costly items of epoxy resin and a separate safety window have been replaced

by a contoured rim band, a very small amount of epoxy resin and a steel tension strap.

The implosion safety of the banded tube is obtained by immobilizing the outer rim of the glass CRT. When the tube face is struck a blow and a crack travels to the rim, the crack is an indication that the perimeter is attempting to "grow." If this were permitted to expand, a keystone would be knocked from the glass rim and the tube would collapse or implode. To prevent this action, a contoured steel rim band is placed around the perimeter of the tube face. The rim band is bonded to the tube by a very rigid epoxy cement. The epoxy cement fills in all the unevenness between the glass surface and the metal rim band creating a solid sheath encircling the CRT. After curing, it bonds to the glass and to the rim band making an extremely rigid structure. The rim band is then

strapped to the tube using a high tensile strength steel strap. This tension strap is applied with 1700 or more lb of tension and then mechanically locked in place with a clinched seal. This CRT face structure is so rigid that even blows from a hammer simply bounce off or poke small harmless holes in the tube face.

Safety Evaluation

To evaluate the relative safety of the banded tube system and compare it to conventional implosion protective systems, Underwriters' Laboratories undertook an extensive testing program. The resultant group of tests was designed to thoroughly evaluate all factors entering into the manufacturing of the banded tube. Before a tube manufacturer can receive the Underwriters' Laboratories recognition and have its tubes listed by U. L., a quantity of tubes of each size must be tested by U. L. and judged acceptable according to its stringent standards.

Initially, a portion of the banded tubes submitted to U. L. had to be subjected to various heating and freezing cycles to adequately test the epoxy resin and its adherence to the glass bulb and steel rim band. Actual testing of the tubes is broken down into three phases, a) a "guiltine" test where the back or glass

funnel is struck to induce an implosion, b) a 5 ft-lb test utilizing a 2 in. diameter ball weighing 1.18 lb, c) a 15 ft-lb test utilizing a 5 lb missile. The latter two tests are performed by dropping the objects freely from specified heights allowing them to strike the face of the tube. In none of these tests may a single tube exceed the limits prescribed by U. L..

Only after complying with these stringent tests may a tube manufacturer obtain Underwriters' Laboratories recognition. In addition, U. L. maintains a surveillance over manufacturing processes by periodically selecting random tubes during manufacture and testing these to the same criteria as the original approved samples.

Independent tests to evaluate the safety of the banded tube system have also been made using household objects and sports equipment. In one series of tests objects were hurled at the picture tube face. These included glass ash trays, "pop" bottles and baseballs. These were thrown with sufficient force to shatter the glass objects. Other tests involved striking the tube face with a baseball bat, a broom handle with a metal end, roller skates and a golf club. In all cases it was impossible to cause an implosion. Careful measurements of energy expended in this type of test showed

only 3-4 ft-lb being generated, thus proving that the tests designed by Underwriters' Laboratories have a large safety factor.

All this means that the ultimate consumer can enjoy clear, bright TV pictures at all times. Accumulation of dust and grime on the CRT is easily removed because there is no separate safety glass.

To the TV set manufacturer it means lower mounting costs by using the integral mounting "ears" to hold the tube in the cabinet. It means lower assembly costs since the separate window and necessary gaskets, brackets and screws have been eliminated. Elimination of additional safety windows makes it possible to shorten the cabinet and provide more compact furniture styling. And this means lower cabinet costs made possible by shorter tubes and the elimination of the separate safety window.

Obtaining recognition and listing by Underwriters' Laboratories on sets using these tubes also costs less. The picture tube manufacturer has previously borne the burden of this by securing U. L. approval of his manufacturing process. It also opens the possibility of a new approach with the anti-glare feature on the tube face providing set owners with reflection-free pictures.

And all of these benefits are derived without sacrifice of safety! ■

Banded tube withstands blows from thrown objects.

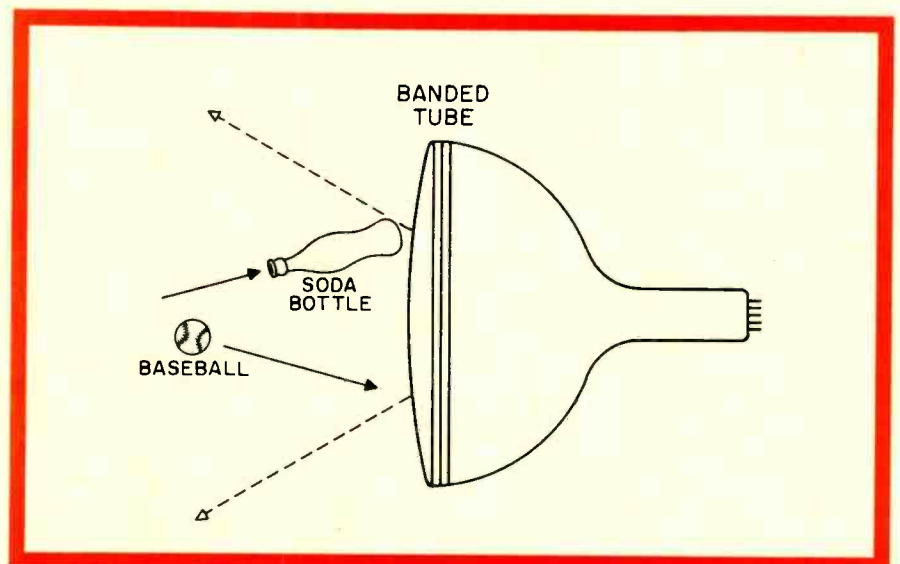



Receiving Tubes

AN OLD FASHIONED GOOD DEAL

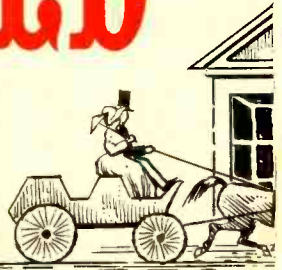

Get in on a deal like you haven't seen for years.

From October 15 through December 15, your General Electric Receiving Tube Distributor is offering an old fashioned good deal on top quality merchandise. It is all available to you with the purchase of G-E tubes.

During this limited time, only you limit how much and how often you choose. And, from the wide choice of merchandise, you can select gifts for yourself, your wife, your home, or your shop.

Ask your G-E Distributor*, he can tell you how easy it is to have AN OLD FASHIONED GOOD DEAL on General Electric Receiving Tubes. Stock up on merchandise and tubes at the same time. *Distributor Sales, Owensboro, Ky.*

*Premiums available at option of your G-E Distributor.



Perfume set by D'Orsay comes in gift box. "Intoxication" scent will send you as well as your playmate. Order ETR-3916.



General Electric alarm clock is compact, fits crowded night table. Beige case with white dial and contrasting numerals. Order ETR-3917.



Steak knives—four to a set—have serrated edges, stainless-steel blades. Knives have good looking stag handles. Order ETR-3927.

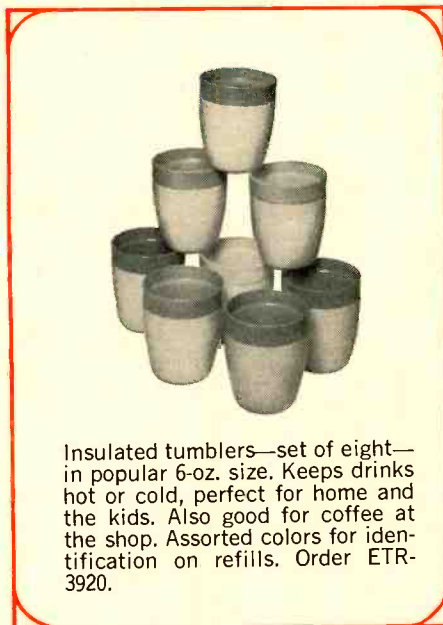

Insulated tumblers—set of eight—in popular 6-oz. size. Keeps drinks hot or cold, perfect for home and the kids. Also good for coffee at the shop. Assorted colors for identification on refills. Order ETR-3920.



Party-Perk makes 25 cups of coffee—keeps perfect serving temperature too, all automatically. Plenty of coffee for parties at home—or for a coffee break at the shop. Order ETR-3922.

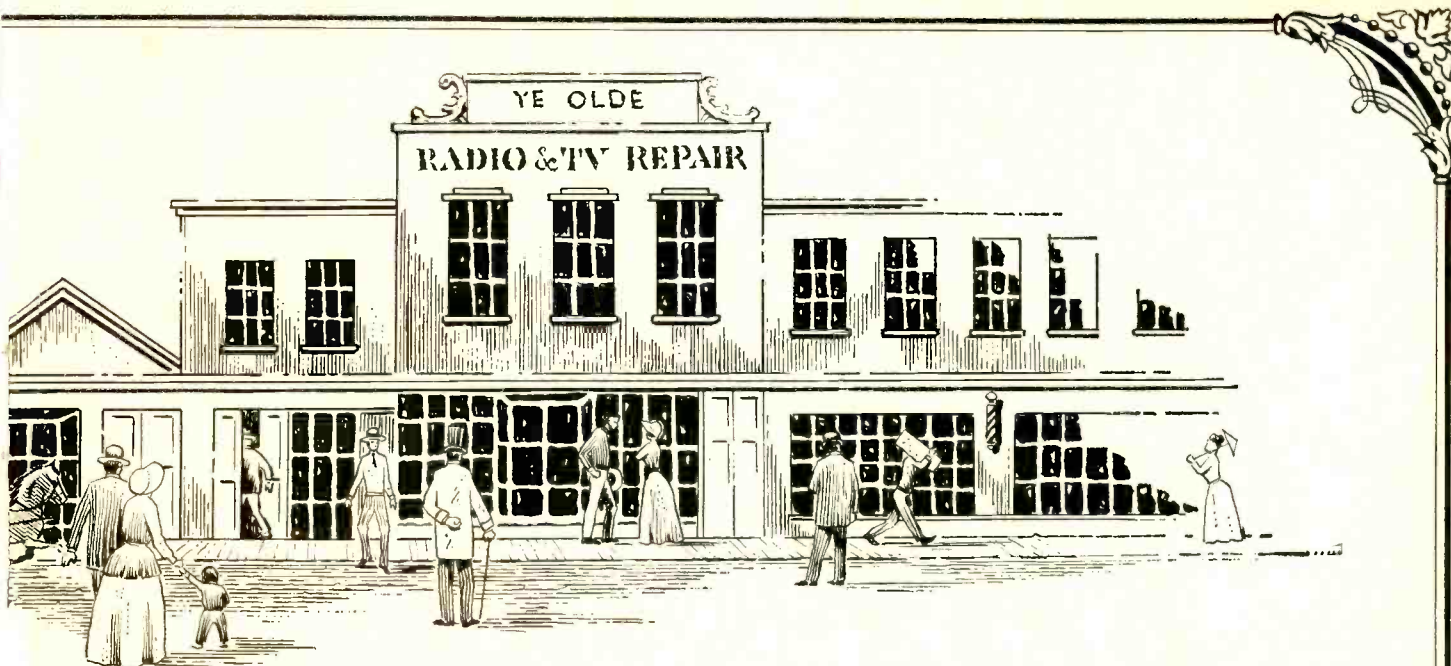

Black and Decker 1/4" utility drill is the jack-of-all drills . . . the handiest home tool you ever saw. UL listed drill from a top-name manufacturer. Order ETR-3918.



G-E electronic speed control lets low cost power tools do work of costly more powerful tools. Use at work or home for any universal motor-driven tool with name-plate rating up to 5A, 120V, ac. Particularly good for resistive type soldering irons to give low-heat tip temperatures for printed circuits. Order ETR-3921.



G-E "Penline-120" soldering iron is small and fast. Tucks in a tool kit and has 40 watts power. Three interchangeable tips do almost any soldering job. Ideal for tight spaces in radio, TV and hi-fi sets. Order ETR-3919.

Three pair of Anchor Knit stretch nylon socks in stylish Fisherman knit. Vyrene elastic tops. One each of blue, brown and black. Order ETR-3923.



Shirt-jacket of 100% Ban-Lon[®] with long or short sleeves. A style introduced this summer and now available in winter weights. Your choice of assorted colors. Order ETR-3924.

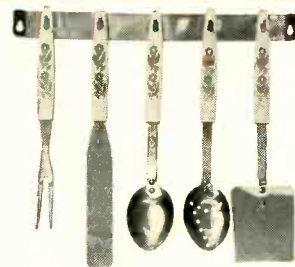

5-piece stainless steel kitchen set with wall bracket. Heavy-duty insulated handles with popular provincial decoration. Order ETR-3925.

GENERAL  **ELECTRIC**

270-04

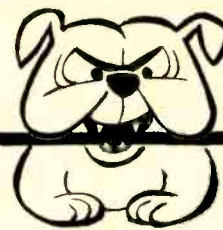

Difficult Service Jobs Described by Readers

High Resistance Coil

An Admiral 20U6E was brought into the shop with an intermittent video fault. The receiver was switched on and the screen indicated age or sync trouble. The sound was fair. Pertinent tubes were replaced and no improvement in picture was noticed. The age and sync circuit voltages were checked with a VTVM and found to be normal. After I observed the picture more closely it appeared somewhat negative. After five minutes of operation the set started operating normally and I was unable to complete all the voltage checks.

The receiver was switched off and allowed to cool. The negative picture indicated probable video amplifier or video detector trouble so I began checking these stages. While making resistance checks in the grid circuit of the video amplifier stage L-8, a peaking coil, was found to have a resistance of 5500 Ω . The normal resistance of this coil is 1 Ω . When the set heated up the high resistance connection on the coil disappeared, thus permitting normal video operation.

The ends of the coil winding were resoldered to the mounting wire

removing the high resistance connection and solving our intermittent situation.—*L. Davidson, Fort Dodge, Iowa.*

Corroded Clip

A new customer brought a Japanese made transistor radio into our shop. He said that the battery had been replaced ten times during the last three months. The radio was inoperative when brought in. I replaced the battery and the radio operated normally. To check the excessive consumption of batteries, the radio was connected to a transistor power supply. The current drain was 10 ma (slightly higher than normal for this unit). The B plus electrolytics were all checked and found to be OK. The feedlines from the battery were disconnected individually, a decrease in current drain was noticed after cutting each line. After the last feedline was removed, the meter still showed a 3.5 ma drain. The switch was turned off and the milliammeter read the same. I removed the battery clip wholly from the set and the clip was the only thing connected to the power supply—the meter

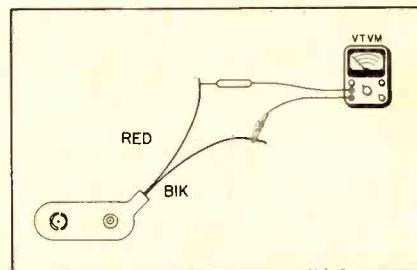

The VTVM indicated a reading of 900 Ω between red and black leads of battery clip.

still indicated the same 3.5 ma reading. The clip was disconnected and the resistance checked. The VTVM showed a 900 Ω reading between the clip terminals. Here was our problem. Corrosion, probably caused by a leaky battery, developed a resistance across the terminals. This resistance imposed a continuous drain on the battery. A new battery clip was installed and when the radio was connected to a power supply the current drain was normal. When the switch was turned off the ammeter reading was zero. As the battery life in the radio increased greatly, we acquired a new and happy customer.—*Charles Yountz, Lexington, N. C.*

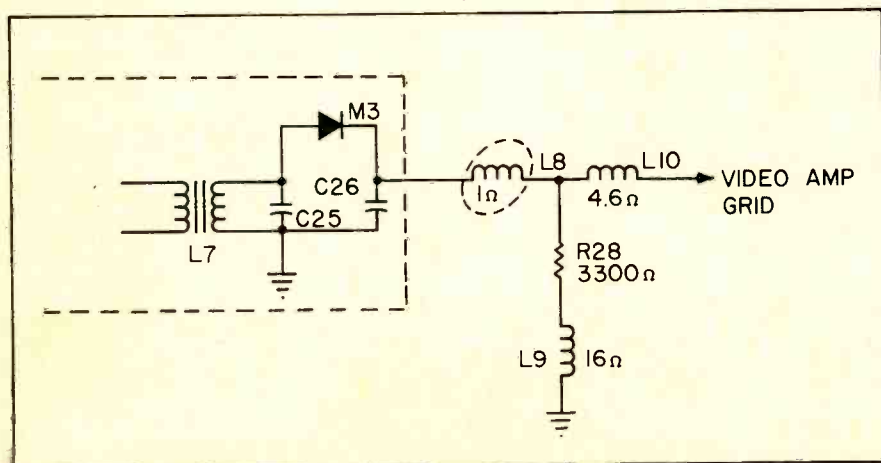

High resistance connection in peaking coil, L-8, caused faulty operation of video amplifier.



"... I'd like it by 5 o'clock"

NOW

*convergence and color adjustments
are easier, faster, more accurate!*

NEW B&K MODEL 1240 LOW PRICED PORTABLE COLOR GENERATOR

with crystal-controlled keyed rainbow color display!

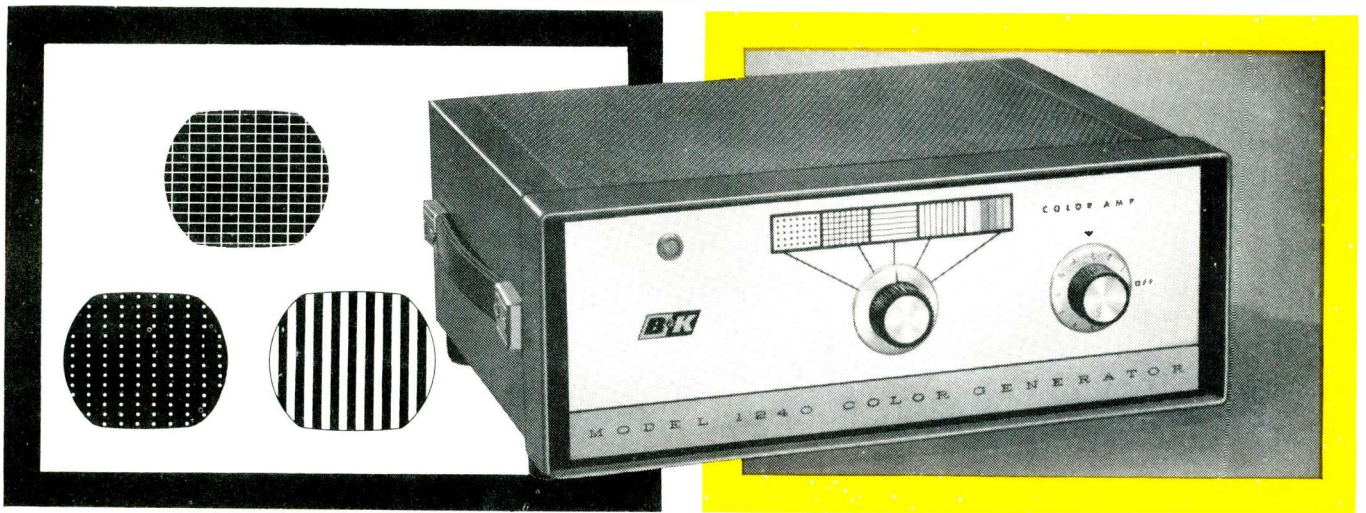

Thinnest Horizontal Lines! Smallest Visible Dots!
(Just one raster scanning line thick)

**Simplifies In-Home (or Shop)
Color TV Set-Up and Servicing**

You're the color TV expert when you use the "1240." You have the advantage of B&K quality—with features not available before at such surprisingly low cost.

Provides crystal-controlled keyed rainbow color display on TV screen to test color sync circuits, range of hue control, and align color demodulators. Shows ability of TV receiver to display color values.

Provides dot pattern, crosshatch, horizontal and vertical lines. Highly stable crystal-controlled count circuit with small-step count assures greater reliability and stability of color, dots, and lines. All horizontal lines and

only
\$134⁹⁵_{NET}

dots are just one raster scanning line thick. Lines begin off-screen and end off-screen, with no break in line. Dot brightness is adjustable with easily accessible control. Chroma Level Control simplifies color sync trouble-shooting.

Operates on channels 3, 4, and 5, and adjustable without removing cabinet. No connection inside TV set is needed. Power transformer operated and line isolated to prevent shock hazards. Operates reliably on 105-125 VAC, 60 cps. (Color Gun Killer is available as optional accessory.) Extreme lightness and portability (9 lbs.) make it ideal for in-home servicing.



*See it at your B&K Distributor
or Write for Bulletin AP21-T*

B & K MANUFACTURING CO.
DIVISION OF **DYNASCAN CORPORATION**
1801W. BELLE PLAINE AVE. • CHICAGO, ILL. 60613

Canada: Atlas Radio Corp., 50 Wingold, Toronto 19, Ont.
Export: Empire Exporters, 123 Grand St., New York 13, U.S.A.

--- for more details circle 17 on post card

SHOP HINTS

TIPS FOR HOME AND BENCH SERVICE

Grille Cloth Installation

The majority of grille cloths used in Hi Fi and other custom installations are made of nylon. It is difficult to get a tight fit when installing a nylon grille cloth. An easy method of tightening the cloth is to expose it to a heat lamp. Holding the lamp close to the grille, move it back and forth until the cloth shrinks into position. Treatment of nylon grille cloth in this manner insures a tight, neat appearing fit. —Paul T. Hennig, Milwaukee, Wis.

Extra Stereo Speaker

A customer had a phonograph in the den—quite a distance from the kitchen—where his wife wanted to hear the records while preparing dinner. Another speaker was needed. The kitchen radio happened to have a large seven-in. speaker, so I used this radio to serve two purposes. A SPDT switch was employed to switch the speaker, in the radio, to the stereo-phonograph player or back to the radio itself. A regular phono jack was installed on the masonite back so the stereo hookup could be disconnected. Be sure and mount the switch on the masonite back, close to the top of the radio for easy switching. —Homer L. Davidson, Ft. Dodge, Iowa.

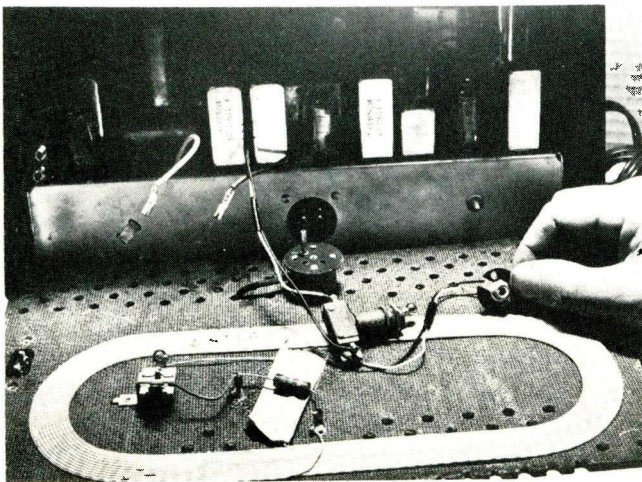

Switch and jack installed in radio enables user to listen to stereo in kitchen.

Automatic Screwdriver Adapter

In recent years many electronic manufacturers have been using 1/4 in. hex head screws to hold the

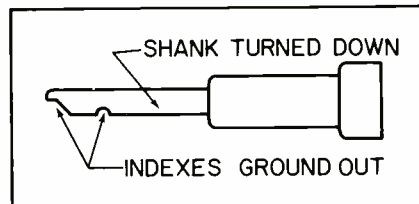

Modifications necessary to adapt 1/4 in. shank to fit automatic screwdriver.

backs on TV combinations, organs and stereo consoles. Numerous screws are used on each instrument, thus a great amount of time is spent removing and replacing backs. A useful tool for speeding up screw removal can be made by adapting a 1/4 in. socket shank to an automatic screwdriver. The necessary shank modifications are illustrated here. —Jan Girardot, Denver, Colo.

Circuit Killer

It is frequently desirable to disable an electron tube circuit in a radio or TV to facilitate troubleshooting, checking wave forms, or IF alignment. In most cases involving parallel tube filaments this can be done by pulling the tube. Exceptions are series filament strings

and occasional multi-element tubes where pulling the tube would disable one or more circuits in addition. Killing a circuit under these circumstances becomes a difficult task and usually requires access to the tube socket and a soldering iron. In printed circuits the problem is complicated further. Understandably, the temptation is to try and get by without temporarily disabling the stage. Sometimes this can lead to the loss of more time and the generation of more grey hairs than if the thing had been done correctly at first. To solve this problem in our shop we began saving old tubes which were OK except for low emission or in the case of multi-element tubes, OK except for low emission in one section. The cathode pin of the tubes selected are clipped off and the top of the tube is dipped in white enamel. Each tube type is then noted on the dried enamel with black ink. These tubes are stored near the bench in a flat block of rigid foam plastic in which holes are punched as needed to hold the tubes upright. The tube identities on the white enamel are then readily visible. The cost of this system is practically nil, and it almost automatically keeps up to date since new tube types are added as fast as they come into the shop for replacement. —Bob Hutson, Poway, Calif.

SHOP HINTS WANTED

\$3 to \$10 for acceptable items. Use drawings to illustrate whenever necessary. A rough sketch will do. Unacceptable items will be returned if accompanied by a stamped envelope. Send your entries to Shop Hints Editor, ELECTRONIC TECHNICIAN, Ojibway Building, Duluth, Minn. 55802. The hints published in this column have not necessarily been tried by ELECTRONIC TECHNICIAN editors and are the ideas of the individual writers.

MIRACLE WORKER

in professional TV service shops

PINPOINTS ANY TV TROUBLE FAST! UPS YOUR PROFIT!



DELUXE B&K

MODEL 1076 B&W and COLOR TELEVISION ANALYST

*with Crystal-Controlled Keyed Rainbow Color Display
and Highly-Stable Horizontal Oscillator Sync*

FLYING SPOT SCANNER

*transmits B&K patterns or your own
pictures onto TV screen*

It's like having your own TV station! You can inject your own TV signals at any time, at any point—and quickly solve tough dogs, intermittents, any TV trouble, as you watch the generated test pattern on the raster. Checks any and all circuits in any stage throughout the video, audio, r.f., i.f., sync and sweep sections of the TV set. No external scope or waveform interpretation is needed. And if you wish, you can transmit your own slide-pictures.

Makes Color TV Servicing Easy, Too.

Generates white dot, crosshatch and color bar patterns for convergence. Generates crystal-controlled keyed rainbow color display to check color sync circuits, check range of hue control, align color demodulators. Demonstrates correct color values.

Saves time and work for the "pro." Makes servicing easier and faster for the beginner technician. Most valuable instrument in TV servicing.

Net, \$329.95

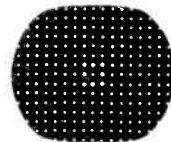
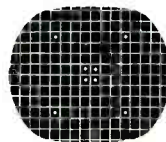
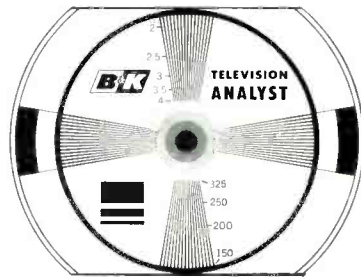

*Profit with a B&K Service Shop
See your B&K Distributor
or Write for Catalog AP21-T*

B & K MANUFACTURING CO.
DIVISION OF **DYNASCAN CORPORATION**
1801 W. BELLE PLAINE AVE. • CHICAGO, ILL. 60613
Canada: Atlas Radio Corp., 50 Wingold, Toronto 19, Ont.
Export: Empire Exporters, 123 Grand St., New York 13, U.S.A.

... for more details circle 18 on post card

... FILTERS

Continued from page 53

3 in. into the picture. Although this dark strip was hardly visible, you could bet it was 60 cps trouble. By placing a good capacitor across the 115 v line filter, it was found that the capacitor was bad. The 60 cps was introduced into the plate load of the amplifier and then on into the vertical circuit.

The C3C μ f capacitors (Fig. 5) was defective and the entire can was replaced. A 200/20/20/20

μ f at 300 v is in one can and located directly beneath the CRT.

Recognized By Experts

Most skilled, long-time technicians will recognize this next trouble right off. A KCS88 RCA chassis was brought to the shop. It had a 60 cps hum in the speaker.

The input filter capacitor, C132A, an 80 μ f job, was defective (Fig. 6). In the same can is another 80 μ f 200 v capacitor. It was easy to spot this capacitor as it leaked a white pasty substance.

Another RCA chassis, a KCS 108, also had 60 cps hum in the speaker. At times the trouble looked like AGC. This was a defective input capacitor also. In this case, there was little hum in the speaker and the picture pulled horizontally and was difficult to hold in horizontal sync. The raster shivered a little. There was no sign of electrolyte leakage. This was the same defective input filter but with a little different indication on the screen.

An RCA KCS83 chassis had the same input filter bad but the top of the picture was black clear across the screen. Normal hum was noticed in the speaker. A black line ran through the middle and bottom of the picture. These black lines were stationary when a station was tuned in. You could pull out the oscillator tube and the lines would move up the screen. No pulling appeared in the picture.

A Color Case

Snap, crackle and pop came the sound from the color set. This wasn't a breakfast food commercial. After the big pop, smoke started to roll out. This was a CTC10-D RCA color chassis.

We found a blown 3½ amp fuse and the new one we put in went out right away. The set was pulled to the shop and a jumper wire was clipped momentarily across the fuse holder. Of course this is when the snap, crackle and pop occurred. Smoke rolled out of the bottom of a capacitor. The jumper wire was quickly removed and things quieted down.

The silicon diode, SR102 (Fig. 7), was found to be completely shorted and C125 filter was doing the smoking. You can see by the schematic that this filter is in a voltage doubling network.

I have replaced a lot of filter capacitors during the past seventeen years and some of these mentioned are odd and funny. But I will never forget the metal shell of a capacitor can that flew right through the air, after exploding. The thing missed my nose by 2 in. and sounded like a cannon. ■

... AUDIO OSCILLATORS

Continued from page 58

To drive high impedance circuits, it is a good idea to bridge the os-

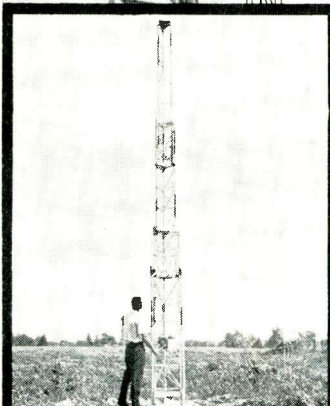
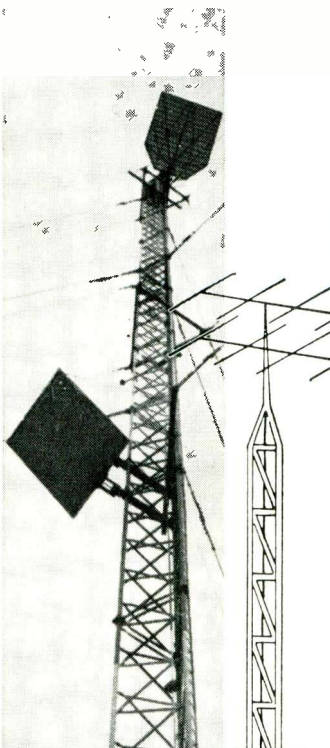

ROHN

The most Famous Name in TOWERS of ALL KINDS!

Here are the advantages you get when you insist on ROHN TOWERS

LARGEST FULL RANGE OF TOWERS—you can get anything from home TV and amateur radio towers to heavy-duty communication and micro-wave towers. Included are 500 foot self-supporting towers, 1,000 foot guyed towers, "fold-over" and crank-up towers. Regardless of your needs, ROHN can supply it.

UNQUESTIONED LEADERSHIP IN DESIGN AND MANUFACTURE—you get the latest in advanced tower engineering. All communication towers are engineered to EIA specifications, and are proved by thousands of installations. No other manufacturer can surpass the quality and fine reputation of ROHN.

QUALITY MATERIALS AND WORKMANSHIP—Only highest quality steel is used which fully meets the specifications for the job. ROHN towers are hot-dipped galvanized **after fabrication**—a feature ROHN pioneered!

SERVICE WHEREVER YOU WANT IT—ROHN representatives are world-wide. Complete erection service for communication systems, broadcasting, micro-wave, and other needs is available; also competent engineering service to help you.

Settle for the BEST in TOWERS—ROHN—today the world's largest, exclusive manufacturer of towers of all kinds!

Also available: Rohn Lighting Kits, Microwave Passive Reflectors, Tower Installation Service and Engineering Assistance. Representatives World-Wide to Serve You.

For your needs, contact your local ROHN salesman, distributor or dealer; or write direct for information.

SEND THE HANDY COUPON INDICATING YOUR NEEDS

ROHN
Manufacturing
Co.
BOX 2000
PEORIA, ILLINOIS

Send me complete literature on the following ROHN Products:

- | | |
|---|--|
| <input type="checkbox"/> Home TV Towers | <input type="checkbox"/> Amateur Towers |
| <input type="checkbox"/> Communication Towers | <input type="checkbox"/> AM-FM Broadcasting Towers |
| <input type="checkbox"/> Micro-Wave Towers | <input type="checkbox"/> Government |

Name _____

Firm _____

Address _____

City _____

State _____

"World's Largest EXCLUSIVE Manufacturer of Towers; designers, engineers, and installers of complete communication tower systems."

- - - for more details circle 54 on post card

cillator output with a resistor of approximately its rated load. (Variations of ± 10 percent are entirely satisfactory.)

Signal Level

Almost every audio oscillator has a level control which works somewhere inside the circuit. Generally it is desirable to keep it in the upper portion of its range, since signal-to-noise ratio will be more or less degraded at the lower settings. The output level in the higher range of settings is often higher than that desired for testing purposes. Further more, for many measurements, precisely controlled level variation of the driving signal is essential. The happiest solution for this combination of needs is an accurate level meter at the oscillator output, followed by a precision calibrated step attenuator. These may be incorporated in the instrument, or may be added externally. It has become conventional to call the instrument a *signal generator* if it incorporates a meter and a precision calibrated attenuator. To distinguish between them, instruments which lack these are conventionally called simply *oscillators*. ■

... FM STEREO

Continued from page 61

is tuned to the output frequency of the generator.

The first adjustment is made at the stereo input amplifier (19 kc tuned amplifier). Turn both the left and right level controls to zero. Attach the external meter lead to the plate of V7A (pin 1) and set the meter switch on the 3 v P-P scale. If a generator without a built-in meter is used, a high input impedance P-P ac meter is required. The pilot level control is adjusted to the lowest level that will give a useable reading on the meter.

Adjust transformers L3 and L4 for a maximum voltmeter reading. These two adjustments are relatively sharp and a few degrees in either direction should indicate a peak or minimum reading. Next move the meter lead to either terminal 1 or 2 of the 38 kc tank, T9, and adjust first the primary then the secondary of the transformer for maximum reading. A final "touch

up" of the 38 kc adjustments will be made when checking separation of the speakers.

With the pilot signal set at zero, modulate both left and right channels with the 1000 cps tone and set level control on each to read 5 v on meter. This will produce a monophonic signal. Adjust the FM receiver balance and level controls until the ac voltage across the speakers is identical. Turn the right level control to zero and set the 19 kc pilot signal at 10 percent modulation. The ac voltage across each speaker is measured again. The me-

ter reads directly in db so the reading at the right speaker is subtracted from the left output reading. A 20 db separation is considered normal, if the difference is less than 20 db the 38 kc plate transformer (T9) will have to be touched up.

With the meter connected across the left speaker, carefully readjust T9 primary first then T9 secondary for maximum meter reading at left output and minimum tone level from the right speaker. By careful listening and with a sharp eye on the meter optimum separation can be achieved. ■

easily service transistor radios...and make money!

B&K
Model 960

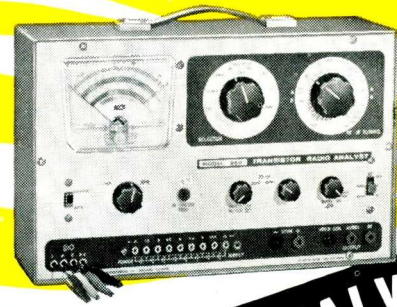

TRANSISTOR RADIO ANALYST

with Exclusive Dyna-Trace Single-Point Probe and Built-in Metered Power Supply and VTVM.

Check all circuits - Pinpoint any trouble... in minutes

This is the way to profit from transistor radio servicing. *There's no hit or miss, no waste of time and work.* The B&K "960" Analyst gives you a complete transistor radio service shop in one easy-to-use instrument. It provides signal-generator, power supply, milliammeter, VTVM, battery tester, ohmmeter, and both in-circuit and out-of-circuit transistor tester—all in one. Also speeds servicing of tube-type radios. Brings you new customers, and new profit.

Net \$9995

Unique Point-to-Point Signal Injection
Easily enables you to troubleshoot any stage of any transistor radio—fast.

Built-in Metered Power Supply
Makes it easy to operate radio under test. Provides from 1 to 12 volts in 1½ volt steps. Supplies bias taps.

Simplifies In-Circuit Transistor Test
Dyna-Trace single-point probe needs only the one contact to transistor under test. Gives fast, positive meter indication.

Built-in VTVM
Includes essential high-input-impedance vacuum-tube voltmeter for correct servicing.

Test All Transistors Out-of-Circuit
Meter has "good-bad" scale for both leakage and beta; and direct-reading beta scale. Also automatically—determines NPN or PNP. Meter is protected against accidental overload and burn-out.

See Your B&K
Distributor
or Write for
Catalog
AP21-T



B&K MANUFACTURING CO.
DIVISION OF DYNASCAN CORPORATION
1801 W. BELLE PLAINE AVE. • CHICAGO 13, ILL.
Canada: Atlas Radio Corp., 50 Wingold, Toronto 19, Ont.
Export: Empire Exporters, 253 Broadway, New York 7, U.S.A.

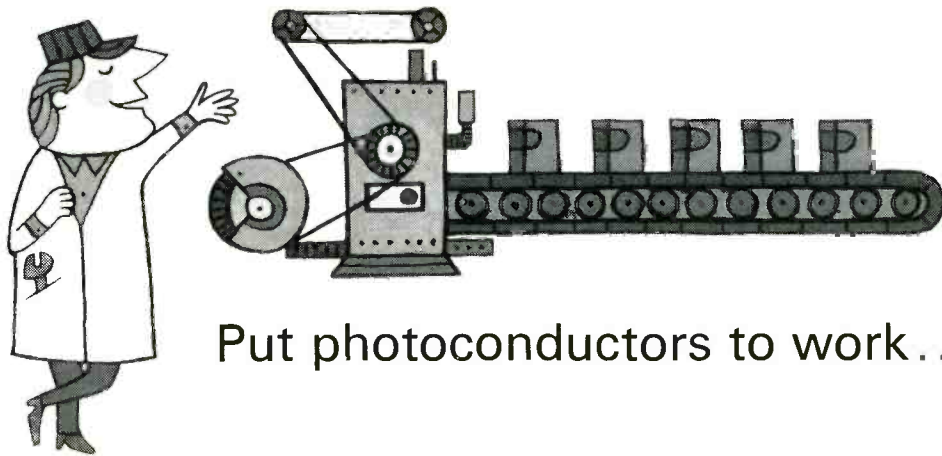

Put photoconductors to work...

new Sylvania kit shows you how



The information contained herein is supplied without assuming any responsibility for its use, from a patent viewpoint or otherwise, and no license under Sylvania's patent rights is granted thereby either expressly or by implication.

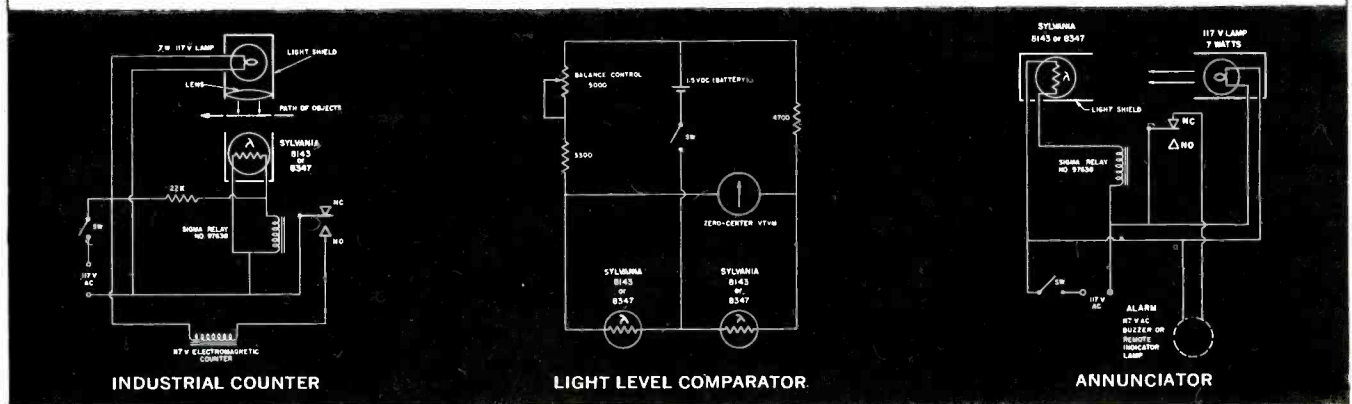

Count containers on a conveyor... compare materials by their light reflectivity... increase safety with a machine light-beam alarm... just a few of the many ways you can put light to work, using the new Sylvania Photoconductor Kit.

This kit contains 3 Sylvania photoconductors, one Sigma AC/DC relay, a 22,000-ohm 1-watt resistor, a mounting

bracket, and a 52-page booklet that details many ways the components can be used for measurement and control. It has all the basic parts for your own experimental setup, to help you discover how practical Sylvania photoconductors are. Individual photocells may then be obtained from your distributor.

The Sylvania Photoconductor Kit

PCK-10 is available now from Sylvania Electronic Distributors everywhere, for less than you would pay for the component parts. Or send \$9.95 (plus 50 cents handling charge) to Dept. PCK-10, Sylvania Electric Products Inc., 1025 Westminister Drive, Williamsport, Pa., and we'll send you the kit postpaid.

Mention this publication.

SYLVANIA

SUBSIDIARY OF
GENERAL TELEPHONE & ELECTRONICS



--- for more details circle 64 on post card

INDUSTRIAL ELECTRONIC SECTION

INDUSTRIAL ELECTRONIC

SECTION

CONTENTS

Phase Shift Part I 74

Louis Frenzel, Jr. begins an in-depth series on this important subject

Clean Up With Fluorocarbon Solvents 77

How 'Freon' TF performs as an electronics cleaning agent

New Products 79

NOVEMBER • 1964 • VOL. 80 • NO. 5

To maintain modern
electronic equipment properly,
you must thoroughly understand
this important principle

PHASE SHIFT

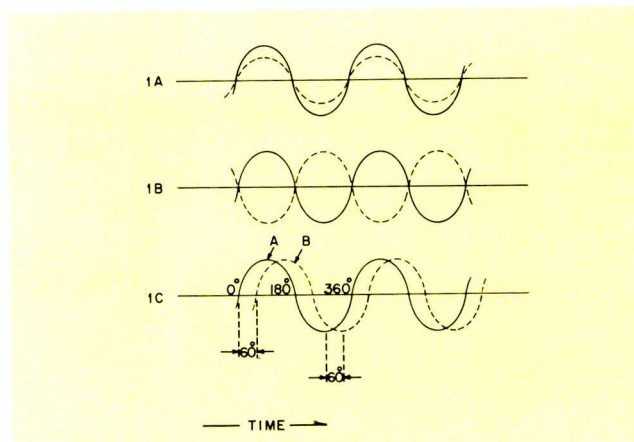

Fig. 1—Basic phase relationships: (A)—in-phase sine waves, (B)—phase inversion or 180-deg phase shift, (C)—out-of-phase sine waves

Part I

by Louis E. Frenzel, Jr.

■ Phase shift is here to stay! Sound trite? Maybe. But too many technicians don't know where or why or, even worse, that it's here at all.

Ask a good technician about diagnosing and correcting troubles in electronic circuits and he'll tell you, "To fix them you gotta understand them." So let's take a look at the why's and wherefore's of phase shift. Since it's too important a subject to cover in one article and still do a good job, we'll split it up into sections—each month we'll cover a different topic.

What is Phase Shift?

Phase shift is a common occurrence in all electronic circuits where ac is present. In some cases the phase shift is undesirable and will introduce detrimental effects, while in other cases the phase shift is purposely introduced to obtain a desired result.

Phase shift is defined as a time displacement between ac signals of the same frequency and waveshape. This means that the signals do not reach their maximum, minimum and zero values at the same time. Fig. 1C shows two sine waves that are out of phase. Here the maximum, minimum and zero values of current or voltage do not occur simultaneously. Two in-phase sine waves are shown in Fig. 1A. No phase shift is present, so the sine waves are in step with one another. Fig. 1B shows a special case of

phase shift called phase inversion. Here the zero values coincide but the maximum positive value of one wave is reached when the other wave is maximum negative and vice-versa.

Phase shift is designated as being either leading or lagging—one signal is chosen as a reference, and the other is said to either lead or lag the reference with respect to time. The input sine wave signal to a circuit is usually chosen as the reference, and the output will either lead, lag or be in phase with the input. If sine wave A in Fig. 1C is the input reference and sine wave B is the output, we can say that the output, B, lags the input, A, because it starts later in time. If sine wave B is the reference signal, we can see that waveform A leads it because A starts earlier in time.

Since phase shift is a time difference between two sine waves, it can be measured in seconds, milliseconds, microseconds or other units of time. When expressing the phase shift in time units, however, it is helpful to know the frequency of the signal involved. If the frequency is known, the period (time for one cycle) of the sine wave can be found from the formula $p = 1/f$, where p is the period in seconds and f is the frequency in cps. By comparing the time shift with the period, a much better indication of the magnitude of the phase shift can be obtained. For

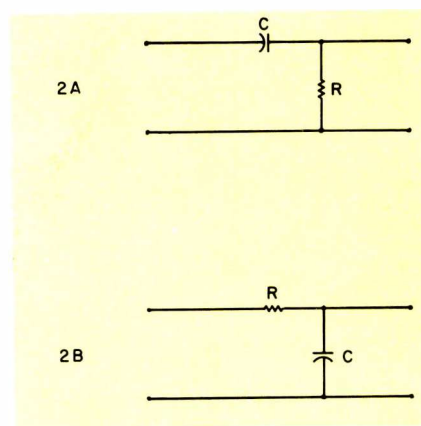

Fig. 2—Basic RC phase shift networks

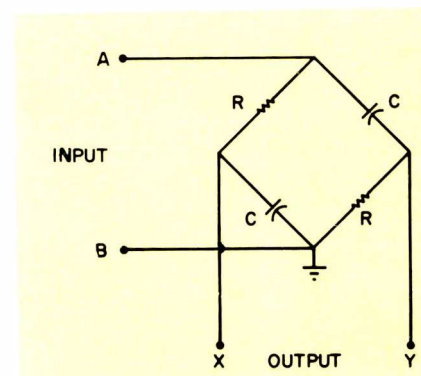
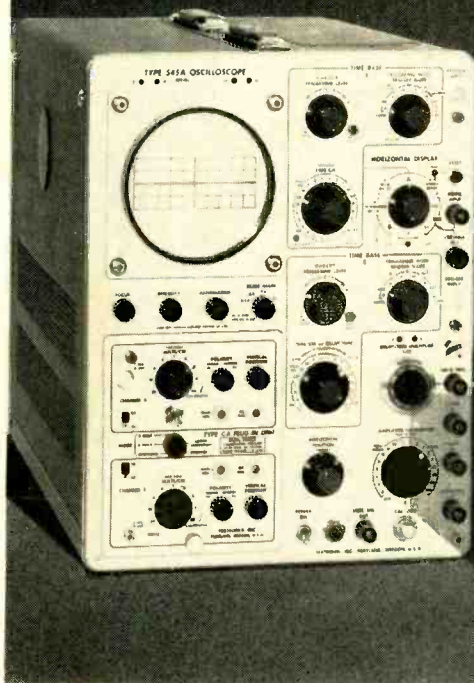

Fig. 3—RC bridge 90-degree phase shifter

example, a 10- μ sec shift at 100 cps ($p = 1/100 = 10$ msec) is very small—almost negligible. But a 10- μ sec shift at 25 kc ($p = 40$ μ sec) is quite substantial. At this frequency it represents a quarter-cycle displacement.

While time is a perfectly satisfactory way to express phase shift. By using one cycle of a sine wave as a reference (of time), the phase

proved improved



This was the proved Type 545A at \$1550.

Used by more engineers than any other commercial laboratory oscilloscope, the Type 545A became the standard of the industry.

User suggestions and research innovations helped it grow and develop into the world's best known laboratory oscilloscope—through five years as the Type 545, another five years as the Type 545A.

Over the years, better circuit components and design techniques led to simpler operation and application, greater accuracy and reliability, easier maintenance and calibration.

Seventeen amplifier plug-in units were developed to provide quick adaptability for particular applications. Other features were added or improved to update performance specifications.

With the dual-trace unit, the Type 545A provided 50 mv/cm sensitivity for a wide range of dc-to-24 Mc applications.

Further updating of the "A" Model to implement additional improvements has resulted in a new "B" Model—as the "A" Model was developed from the early Type 545.

So, now, the Type 545A is superseded by the Type 545B. Instrument support will continue to be available for the "A" Model, however, for at least 10 years.

Tektronix, Inc.

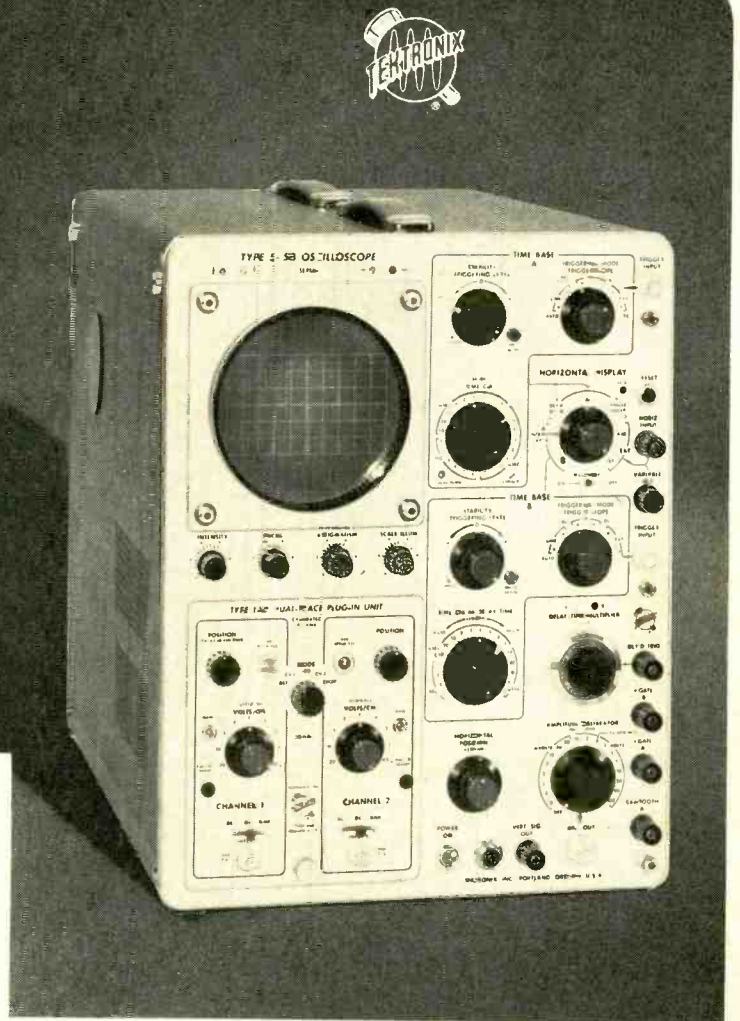

Here is the improved Type 545B at \$1550.

Looks about like the Type 545A. But added capabilities and convenience further enhance its value.

New crt. Internal no-parallax illuminated graticule. Improved resolution, uniform focus over the full 6-cm by 10-cm (50% greater) display area. New hybrid vertical amplifier—greater stability and reliability. Fixed-tuned delay cable, prevents misadjustments. Triggering beyond 30 Mc. Sweep delay, single-sweep, other features and refinements that equal or excel those of the present "A" Model.

Use all your Tektronix Type A to Z Plug-In Units at equal or better frequency response, or the new Type 1A1 or 1A2 Dual-Trace Plug-In Units for 50 mv/cm at dc-to-33 Mc. The Type 1A1 also offers 5 mv/cm at dc-to-23 Mc dual-trace, and, by cascading the two amplifiers, approximately 500 μ v/cm at 2-cps-to-14 Mc.

Price at \$1550 is the same as the Type 545A and includes two probes. Full field-engineering services back up every instrument.

But to hear the complete story, call your Tektronix Field Engineer. He will know if a Type 545B offers the best solution to your measurement problem. If the Type 545B appears to be the answer, try it. Use it in your own application—with one of your 17 letter-series plug-ins or one of the new amplifier plug-in units.

Available throughout the world

--- for more details circle 65 on post card

PHASE SHIFT

Continued

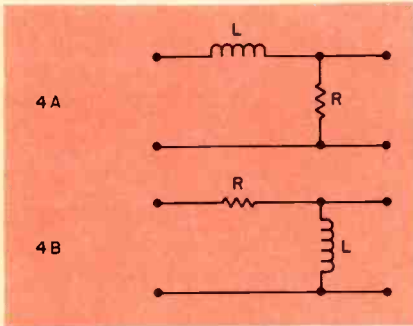

Fig. 4—Basic LR phase shift circuits

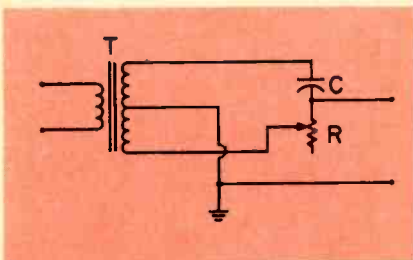

Fig. 5—Variable, constant output 0- to 180-deg phase shifter

shift can be expressed as a fraction of one cycle. A cycle is divided into 360 equal parts or degrees, and the degree is the unit used to express the amount of phase shift present. Since 360 deg represents a full cycle, a 180-deg shift will represent a half-cycle shift. A 90-deg shift is a quarter-cycle displacement, and so on. In Fig. 1C, the two signals are displaced from each other approximately one-sixth of a cycle, or 60 deg ($1/6 \times 360 = 60$). Phase shift is measured at the zero-axis crossing points or between corresponding positive or negative peaks, as shown in Fig. 1C. This method is independent of frequency, because every cycle of any frequency contains 360 deg and because the cycle, not time, is being used as the reference.

Phase Shifters

A phase shifter is an electrical or electronic circuit that introduces a time shift. There are many circuits that will produce a controlled phase shift, but those discussed here are the ones most commonly used.

A very important type of phase shifter is the one that produces phase inversion—a 180-deg phase

shift (Fig. 1B). An iron core transformer gives a 180-deg shift if its primary and secondary windings are properly connected. (The transformer can also be connected so that no phase inversion takes place, in which case the primary and secondary signals will be in phase.)

Phase inversion is also produced by an ordinary electron tube voltage amplifier. The output plate-voltage signal is exactly 180 deg out of phase with the input grid signal. Because the base and collector signals in a common emitter transistor amplifier are 180 deg out of phase with each other, this circuit is a phase inverter also.

The commonly used phase shifters are those made up of resistors and capacitors. The two basic RC phase-shifter circuits are shown in Fig. 2. Each is theoretically capable of producing a phase shift of 0 to 90 deg, depending upon the values of R and C. The actual value of the phase angle will also depend on the input frequency, because the capacitive reactance (X_C) is a function of frequency as well as capacitance. The circuit of Fig. 2A produces an output that leads the input signal, while the circuit of Fig. 2B produces a lagging output. Each circuit is a voltage divider, and the output voltage is less than the input (the actual value is determined by the values of R and X_C).

The circuits of Fig. 2 can be used in a variety of ways to produce phase shift. Either circuit may be cascaded to increase the amount of phase shift. Since such arrangements are also cascaded voltage dividers, the phase-shifted output is attenuated considerably.

Both circuits in Fig. 2 combine to form the bridge phase shifter, shown in Fig. 3. In this circuit the resistance is made equal to the capacitive reactance at some frequency. At this frequency the phase shift produced by each RC section is 45 deg. The output voltage between terminal X and ground lags the input voltage by 45 deg, while the output voltage between terminal Y and ground leads the input voltage by 45 deg. These two outputs together across terminals X and Y form a balanced signal that is shifted 90 deg from the input signal.

Phase shifters using inductors and resistors are also used in some applications. Like the RC circuits,

they can be arranged to produce either a leading or lagging phase shift that can have a value between 0 and 90 deg depending upon the values of L, R and the input frequency. Two such phase shifters are shown in Fig. 4. The output of circuit A lags the input while the output of circuit B leads the input.

LR phase shifters are much less popular than the RC type because capacitors are smaller, less expensive and come in a wider range of values than inductors. But inductors are useful at the higher frequencies where they are small, inexpensive and easy to make.

The phase shifter of Fig. 5 is capable of producing a phase shift from 0 to 180 deg. For this reason, it is very popular and has found wide application. The values of R and C are chosen to give the desired phase-shift range for the frequency in use. By varying R from zero to maximum, the phase angle will change from 180 deg to 0. The output signal amplitude will be equal to the voltage across one-half of the transformer secondary. The circuit can produce either a leading or a lagging phase shift; as shown it produces a leading output, but reversing the positions of R and C will cause the output to lag the input. Transformer T is connected so that it introduces no phase shift.

An inductor may replace the capacitor in this phase shifter, but capacitors are generally preferred for reasons mentioned earlier.

The transformer in this circuit can be replaced by any other device capable of supplying a push-pull or balanced-to-ground signal to the RC network. An electron tube or transistor split-load phase inverter of the type commonly used in driving a push-pull audio amplifiers has been used successfully.

There are two phase shifters that deserve special mention. The first is a double-tuned RF transformer. When both the primary and secondary windings are resonated with capacitors to the same frequency, the voltage across the secondary will lead the voltage applied to the primary by exactly 90 deg at the resonant frequency. Of course, at other frequencies this phase relationship no longer holds—at frequencies lower than the resonant frequency the phase shift is greater than 90 deg and below the resonant

Continued on page 79

Clean Up With Fluorocarbon Solvents

Modern cleaning agent is nontoxic, chemically inert and thermally stable but it does a bang-up job of cleaning electronic equipment

by Dr. Albert W. Bauer
E. I. du Pont de Nemours & Company

■ Fluorocarbon compounds, developed originally in the early 1930's specifically as refrigerants, are becoming increasingly important maintenance tools.

Over the years these compounds have been found extremely useful in a number of unrelated applications — in addition to their original use as refrigerants, they also are employed widely as aerosol propellants, solvents, cleaning agents, fire extinguishing agents, dielectric gases and liquids and blowing agents for rigid and resilient polymeric foams.

The Freon fluorocarbons in general — including solvent applications, where such factors are particularly important — are nonflammable, virtually nontoxic, chemically and physically pure, chemically and thermally inert and exceptionally stable, and they have a wide range of freezing and boiling points, which enables them to be tailored for specific needs (their boiling points range from -198 F. to 700 F.).

The fluorocarbon compound that is most widely used in solvent cleaning applications is Freon TF, a clear, water-white liquid that boils at 117.6°F and freezes at -31°F.

One of the main advantages of Freon TF solvent in electronic cleaning is that it exhibits a selective solvent action which permits its use in the removal of oil, grease, dirt and other contaminants from electronic and mechanical compo-

nents without harm to metal, plastic or elastomeric parts. Because of this selectivity in maintenance operations, complex systems may be cleaned without costly disassembly and reassembly.

Metal surfaces are often thoroughly cleaned with fluorocarbon solvents even though the gums and oxidized materials that have been removed from the surfaces may not be completely dissolved by the solvent. This is possible because the low surface tension of Freon TF enables it to thoroughly wet all the surfaces of most materials, and its high density makes it a good carrier of undissolved soils during ultrasonic agitation. The contaminated solvent can be recovered to a high degree of purity by a simple still system.

The dielectric properties of Freon TF solvent and its high resistance to the flow of electric current, shown in Table I, allow for considerable freedom in cleaning electric and electronic equipment and permit the use of new, more effective cleaning techniques than have been available in the past.

For example, electric and electronic equipment can be operated while completely immersed in Freon TF solvent — in fact, the self-cleaning effects of operating rotating electric equipment or making and breaking contacting devices or switches during such immersion assures an effective cleaning job. Even many television sets and tape



Relay being operated while submerged in 'Freon' TF.



Motor running under 'Freon' TF.

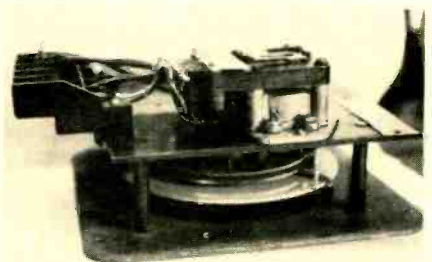
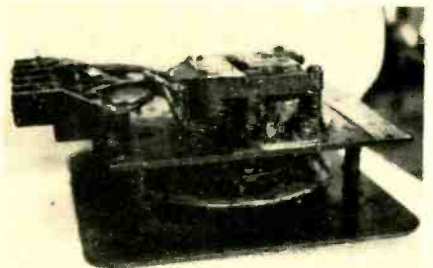

Dirty 'Flexopulse' timer (top). Same timer (bottom) after 3 minutes in ultrasonic tank containing 'Freon' TF.

SOLVENTS

Continued

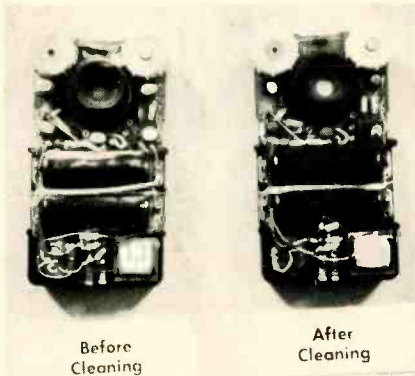

Sonotone hearing aid is cleaned in ultrasonic bath containing 'Freon' TF.

recorders can be operated safely and efficiently, cleaning themselves in the process, while completely immersed in a bath of Freon TF solvent.

Fluorocarbon compounds can be used cold for wiping, spraying, flushing, brushing or dipping, either with or without ultrasonics. They also can be employed as boiling dips or as vapor rinses. Frequently, a complete Freon TF cleaning sys-

tem will consist of a combination of these techniques. For example, a cold-dip soak may be followed by any of several combinations of ultrasonic and/or vapor rinses.

For optimum results in terms of cleaning effectiveness and cost, cleaning agents must be used in properly designed systems. Cleaning equipment designed specifically for use with Freon TF solvent is readily available from a number of reliable manufacturers.

Also available is Freon precision cleaning agent, trichlorotrifluoroethane, an ultra-pure grade of Freon TF solvent with a total residue content no greater than one part per million by weight. It is used primarily in critical cleaning applications, such as in missiles, space vehicles, and guidance systems, and in other operations requiring "white room" conditions.

In many cases, soils are a complex mixture of organic and inorganic contaminants and cannot be removed by solvent action alone. Since the chemistry of soils varies, the chemistry of the cleaning agent must be adjusted accordingly to remove them. For this reason, Freon TF is used as the base for a variety of solvent formulations, all of which inherit most of the desirable properties of the parent com-

pound and extend the cleaning action of Freon type cleaning systems to cover the range of soil types. Examples of such solvents are Freon TA, TMC and T-WD 602.

Experience has shown that soil is the major cause of many electronic and instrument malfunctions and that cleaning often is all that is needed to get a unit back into operation. Even where soil is not the cause of the malfunction, initial solvent cleaning often speeds up considerably the process of diagnosis and repair. In some cases, it also is possible to clean instruments, switches and relays without interrupting their operation by spray-applying the solvent.

Time for disassembly and reassembly currently represents a large portion of instrument maintenance costs. Since assembled instruments can be cleaned in Freon cleaning agents, lower-paid, unskilled help can do the cleaning with higher productivity at lower maintenance cost.

Experience in cleaning instruments at industrial plants with Freon TF solvent is shown in the following actual examples:

- Electronic stripchart recorder (gear train assembly), 30 sec.
- Fractional horsepower motor (entire assembly immersed), 60 sec.
- Portable radiation counters (run while immersed), 60 sec.
- Electronic transmitter (printed circuit assembly), 60 sec.
- Switches and switchgear, 30-60 sec.
- Crossbar switches (completely immersed), 3 min.

Table II lists the types of soil most often encountered in electronic and instrument systems and the Freon cleaning agent recommended for removal. These cleaning agents are suggested for typical soil types. Tests will indicate whether they perform satisfactorily or whether a different cleaning agent should be tried. Of course, the type of cleaning equipment used also helps determine which agent will do the job.

The simplest equipment consists of an ultrasonic tank and lid for direct-immersion cleaning. A recirculating filter and small recovery still could be included as accessories. Higher degrees of cleanliness may require an ultrasonic vapor degreaser, which has the advantage of economical use of solvent plus continuous recovery. ■

Table I — Electrical Properties of Freon TF

Dielectric Strength	31 KV (a)
Dielectric Constant (100 cps)	2.41
Dissipation Factor (100 cps)	0.01%
Specific Resistivity (DC)	10^{16} ohm-cm
a-KV-RMS (60 cps) per 0.1," 25°C, 1 atm (ASTM-D 877-49)	
b-25°C, ASTM-D 257-61	

Table II — Recommended Cleaning Agents

Type of Soil	Cleaning Agent for Removal
Oil	Freon TF
Oil and dirt	Freon TF
Dust	Freon TF
	Freon T-WD 602/Freon TF
Dirt (caked on)	Freon T-WD 602/Freon TF
Paints, Resins	Freon TMC
Metal Tarnish	Ammoniated Freon T-WD 602/Freon TF



NEW PRODUCTS

MINIATURE TIMER 400

A miniature programming cam timer offering 1 to 4 individual load switches packaged in a plastic hous-

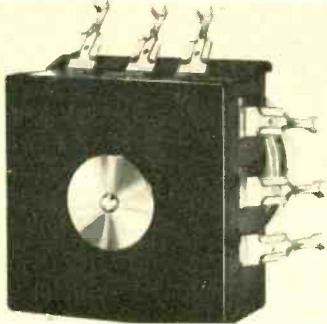

ing is announced. The Series CLV timer is an OEM product, available with factory cut and sequenced cams. The timer is available with time cycles ranging from 6 sec to 3 hr or more. Load switching is accomplished with internal switches carrying loads up to 15 amp, non-inductive. Industrial Timer.

INDUSTRIAL OSCILLOSCOPE 401

The Type 503 scope features identical vertical and horizontal amplifiers. The report states that

... PHASE SHIFT

Continued from page 76
frequency it is less than 90 deg.

This is a very simple and popular 90-deg phase shifter. It is found in phasing type SSB generators as the carrier shifter, in the phasing circuits of color TV receivers, and in the Foster-Seeley phase discriminator used as a detector in FM receivers.

Another special phase shifter is the delay line. This is either a distributed - constant, or lumped constant, transmission line that produces a lagging phase shift. It is essentially a low-pass filter that imposes a fixed time delay on all input signals below the cutoff frequency. Over its band pass, the sine-wave phase shift increases linearly with frequency.

Delay lines are generally used to delay pulses and other complex, non-sinusoidal waveforms, but they have found use in sine-wave phase shift applications. ■

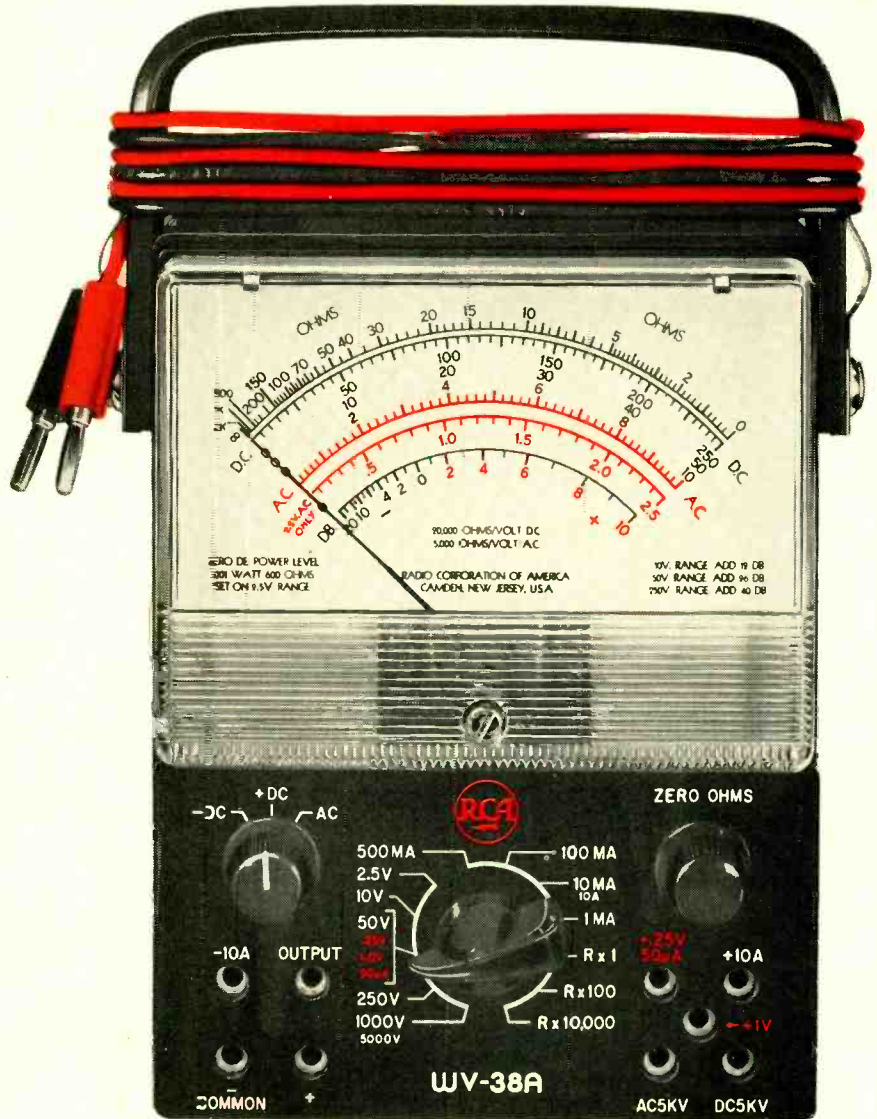

NOW BETTER THAN EVER!

The famous RCA WV-38A Volt-Ohm-Milliammeter

NEW FEATURES...

COLOR-CODED FRONT PANEL MARKING simplifies operation, reduces chance of error.

METER MOVEMENT PROTECTED AGAINST BURNOUT. Special silicon diodes guard meter against overload.

PLUS...

POLARITY REVERSAL SWITCH. Reverses polarity of test leads without need for re-connecting. Handy for checking front-to-back resistance ratio of electrolytic capacitors and many types of semiconductor devices.

39 DIFFERENT MEASUREMENT RANGES.

MEASURES CURRENT from 50 microamps full scale to 10 amps full scale.

SPECIAL 0.25 volt and 1.0 volt (full-scale) DC ranges... useful in checking transistor circuits.

... and many additional features that have made this instrument the best V-O-M buy on the market today. **Only \$47.95***. Kit version, WV-38A(K), only \$29.95*.

See it at your Authorized RCA Electronic Instrument Distributor.

*Optional distributor resale price. Prices subject to change without notice. Prices may be higher in Alaska, Hawaii and the west.

RCA ELECTRONIC COMPONENTS AND DEVICES, HARRISON, N.J.



The Most Trusted Name in Electronics

TRIPLETT

FINEST OF ITS KIND

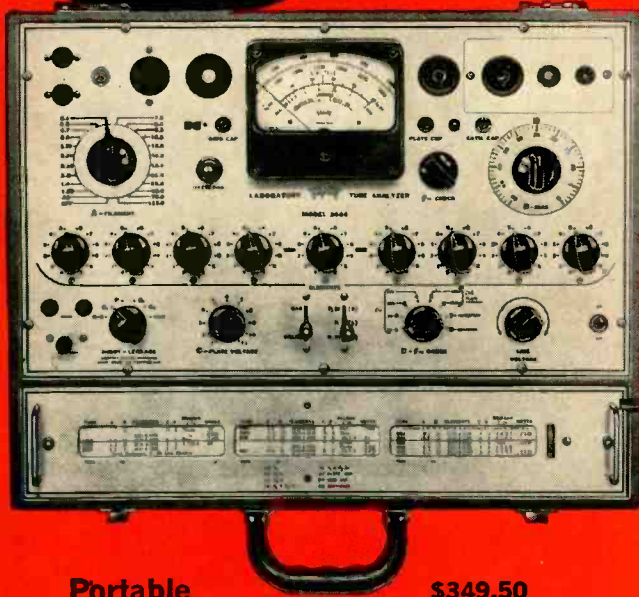

Portable **\$349.50**
True Dynamic Mutual Conductance

MODEL 3444 TUBE ANALYZER

FACTS MAKE FEATURES:

- 1** The only tube tester under \$1,000 that is simple and fast to operate, and will measure tube characteristics at known readable potentials.
- 2** The only tube tester under \$1,000 that is simple and fast to operate, and provides readings to:
 - (a) Plot tube characteristic curves.
 - (b) Measure grid current at known potentials.
 - (c) Compare cutoff characteristics of dual tubes.
- 3** The only tube tester under \$1,000 that is simple and fast to operate, and reads directly in micromhos with a self checking Gm circuit.

This superb unit speedily and accurately solves the most perplexing tube analysis problems. Measures true Gm without any compensating factors; using proper value DC electrode potentials. Checks PLATE current cutoff. Checks GAS under actual operating conditions. Checks RECTIFIERS under load. Checks THYRATRON firing voltage and grid currents. Checks DUAL section tubes with only one lever movement. Provides SHORTS and leakage measurements from 0-10 megohms using a filtered DC supply of 85 volts. Case: Wood, gray leatherette covered, 15³/₁₆" x 18³/₁₆" x 7³/₄".

TRIPLETT ELECTRICAL INSTRUMENT COMPANY, BLUFFTON, OHIO

- - - for more details circle 67 on post card

THE WORLD'S MOST COMPLETE LINE OF V-O-M'S.
AVAILABLE FROM YOUR TRIPLETT DISTRIBUTOR'S STOCK.

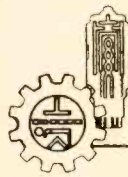

NEW PRODUCTS

differential input provides an effective method of eliminating unwanted common-mode signals. Common mode rejection ratio is 100:1 from 1 mv/cm to 0.2 v/cm, and 50:1 from 0.5 v/cm to 20 v/cm. Some other characteristics listed by the manufacturer include: a sweep magnifier which expands the center portion of the normal sweep to fill 10 cm, a sweep range from 1 μ sec/cm to 5 sec/cm calibrated in 21 steps, an amplitude calibrator which provides 2 square wave voltages at the front panel and regulated dc supplies. Tektronix.

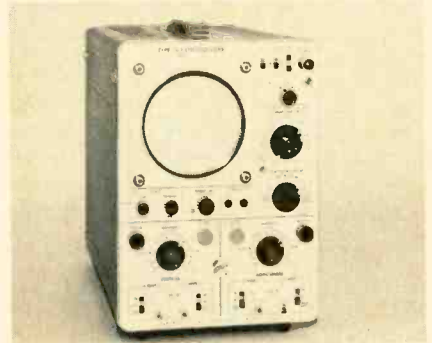

ULTRASONIC CLEANING

402

A high efficiency ultrasonic cleaning system is said to use frequencies from 20 to 100 kc. The Model 909 has a capacity of 30 gal with inside dimensions of 20 x 20 x 16 in. and a 1000 w generator. Four casters enable the entire unit to be moved between various cleaning areas. Power requirements: 115 v, 60 cps. Standard accessories: variable power output, cavitation activity meter and thermostatically controlled heater system. Crest.



ULTRASONIC WAND

403

A five ft fiberglass extension containing pre-amplification circuitry and a 15 kv isolation transformer is announced. The wand, weighs 38 oz. and will reportedly operate up to 1500 hr on a single mercury cell. Delcon.



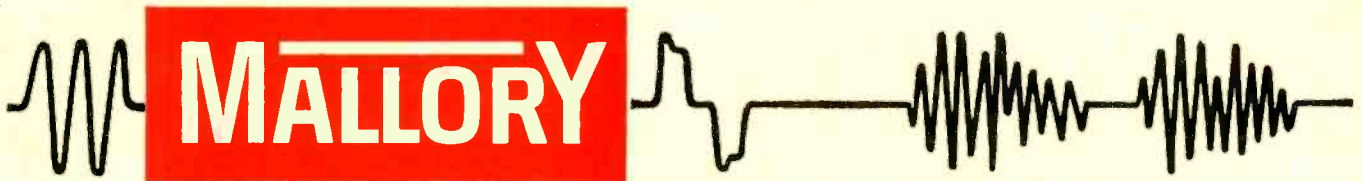

Tips for Technicians

Mallory Distributor Products Company
P.O. Box 1558, Indianapolis, Ind. 46206
a division of P. R. Mallory & Co. Inc.

How to choose and use replacement controls

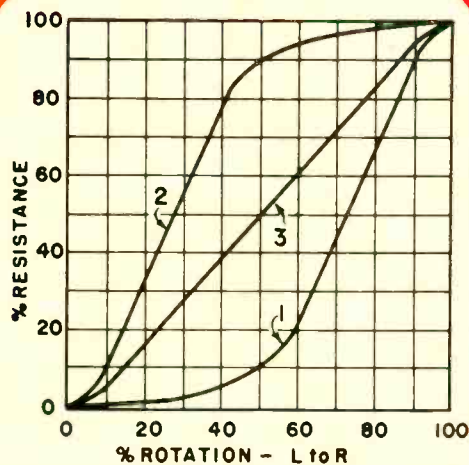

1—Audio taper. 2—Reverse taper. 3—Linear taper.

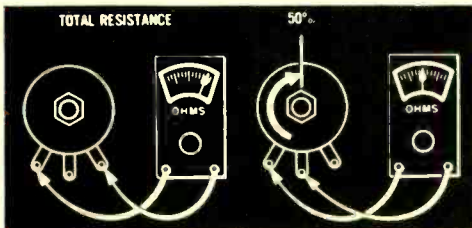

Using ohmmeter to check control taper



STA-LOC technician kit

There's more to replacing a volume control, "pot", or trimmer than simply selecting the proper value in ohms and watts. Naturally you *need* the proper value, but you also need the correct *taper* or the circuit won't perform properly.

What's taper? Briefly, it's the way resistance changes as you rotate the shaft. There are three basic tapers normally used which match the needs of different kinds of circuits. The chart shows how each of the three works.

Audio taper (often called left hand logarithmic by people who like big words) gives you a small increase in resistance at the beginning of shaft rotation and a faster increase toward the end (clockwise rotation). This matches the response of the human ear and is the reason audio tapers are generally used in volume controls and similar shunt circuits.

Linear taper is just that. Resistance change is exactly proportional to shaft rotation. All standard wire-wound controls have linear tapers. Carbon controls with linear tapers are commonly used in tone controls, sweep controls and other straight voltage-division uses.

Reverse taper (right hand logarithmic) is the opposite of an audio taper. You'll get a big change in resistance in the first half of shaft rotation and very little in the last half. This taper is used with cathode voltage controls such as TV contrast and many bias voltage controls.

In the Mallory STA-LOC® control system, it's easy to remember which taper is which. Linear controls end with "L", and audio with "A", and reverse with "R".

You can check which taper is used in an unknown control by connecting an ohmmeter as shown in the drawing.

First, measure total resistance. Then turn the shaft to 50% of rotation. If resistance is 50% of total, you have a linear taper. If it is 10% to 20% of total you have an audio taper. If it is around 80% of total you have a reverse taper.

To be sure you have the exact control when you need it, ask your Mallory distributor to show you one of the STA-LOC technician kits. With a STA-LOC kit you can make exact on-the-spot replacements of any of literally *thousands* of single, dual, push-pull, tandem, or clutch controls. Pieces snap together and *stay* together. STA-LOC kits are sensibly priced and are real money-makers and time-savers. See your Mallory distributor for everything you need in controls, capacitors, batteries, switches, resistors, and semiconductors.

- - - for more details circle 43 on post card



Be a wise owl!

How to cut call backs, increase profit on receiving tubes!



Engineered for peak performance... priced for extra profit! Every Admiral Supertron Electronic Tube must pass rigorous *super-quality* control tests and life tests to meet the high premium standards required for circuit approved tubes.

The remarkable Admiral price and volume discount helps you make *more dollar profit* on every service job! Reduce expensive call backs.

Order a complete supply of new Admiral Supertron Receiving Tubes today... start pocketing big profits tomorrow! Call your Admiral Distributor now!

Be wise... standardize on

Admiral® SUPERTRON RECEIVING TUBES

Always Precision Crafted Quality

... for more details circle 12 on post card

NEW PRODUCTS

AMPLIFIER TRANSISTORS 200

Introduced is a line of high-frequency, small-signal amplifier transistors specifically directed toward TV

GERMANIUM HIGH FREQUENCY TRANSISTORS

DESIGNED for:

- 2N3283 TV RF AMPLIFIERS FM RF AMPLIFIERS
- 2N3284 FM RF AMPLIFIERS, MIXERS TV MIXERS TV IF AMPLIFIERS
- 2N3285 TV AND FM OSCILLATORS
- 2N3286 GENERAL PURPOSE HIGH-GAIN LOW-NOISE AMPLIFIERS

SILICON HIGH FREQUENCY TRANSISTORS

DESIGNED for:

- 2N3291 TV RF AMPLIFIERS FM RF AMPLIFIERS
- 2N3292 FM RF AMPLIFIERS, MIXERS TV MIXERS TV IF AMPLIFIERS
- 2N3293 TV AND FM OSCILLATORS
- 2N3294 GENERAL PURPOSE HIGH-GAIN LOW-NOISE AMPLIFIERS

and FM applications requiring high-gain, low-noise devices. The line includes both NPN silicon types, 2N3291 through 2N3294, and PNP germanium types, 2N3283 through 2N3286. The report stated that all devices have guaranteed forward AGC characteristics which is an important consideration for RF or IF amplifier application. Motorola.

MINIATURE ELECTRIC DRILL 201

A tiny battery-powered drill designed for light duty drilling and grinding is announced. The tool accommodates drills up to 1/8 in. dia. It is designed primarily for light-duty aluminum, plastics, gold, silver, platinum, and similar material drilling. The miniature drill operates from any dc source from 4 to 12 v, depending on the power required. An auto battery, bell battery or laboratory power supply will serve satisfactorily as a power source. Normal operating current is less than 1 a at 6 v. Jensen Tools.



Sensational Performance!

New small size!

Hand wired modular construction!

HALLMARK 1250



suggested list \$169.50

Get on the profit line with the "hottest" CB going — the new Hallmark 1250!

Hand wired top performance and reliability in a size so compact (only 4"x6 1/4"x10") it fits any vehicle. Built like a 15 watt unit, the new full wave silicon bridge easily provides the power for maximum output and modulation. A dual powered, 12 channel, crystal-controlled unit, the 1250 has 0.3 μ v sensitivity and 45 db selectivity. Other features include electronic switching, ferrite speaker and sturdy snaps for easy access to crystal sockets and chassis.

SPECIAL OPTION! Model 1250 X — with plug-in transistorized power supply! \$189.50, suggested list.

Write for information on the complete Hallmark line!

Hallmark 512. 12 channel CB.

Hallmark 3000. FCC type accepted 30 watt transceiver for business service.

Transceiver Tester. Battery powered, crystal-controlled signal generator.

Power Supply. Transistorized plug-in to replace vibrator power supply.



HALLMARK INSTRUMENTS

2620 Freewood Dr. P. O. 10941 Dallas 20, Texas FL 7-0184

... for more details circle 34 on post card

ELECTRONIC TECHNICIAN

LOOK AT THESE 14 NEW OVAL SPEAKERS IN THE JENSEN CONCERT AND VIKING SERIES!

What have
we done
for you
lately?

Maintaining our position as the number one independent producer of automotive speaker equipment, we've added many new oval speakers for automotive and general use. Some are quite specialized in their application, for example: model P5X8U9 is the exact replacement for the Ford Motor Company Falcon, Fairlane, Comet and Meteor passenger cars; the P6X10U9 is the exact replacement for Ford and Mercury 1962-63-64 passenger cars. All model numbers with the suffix U3 and T3 are of 3-ohm impedance for use in several General Motors vehicles. The P5XT20 and P5X7T40 models having center-tap voice coils are for Motorola auto radios.

The Viking series models 4X8W3 and 4X10W3 are 3-ohm impedance economy speakers used in some General Motors vehicles.

For our complete line of Concert, Viking and Weather Master series speakers, send for Jensen Catalog 1090.

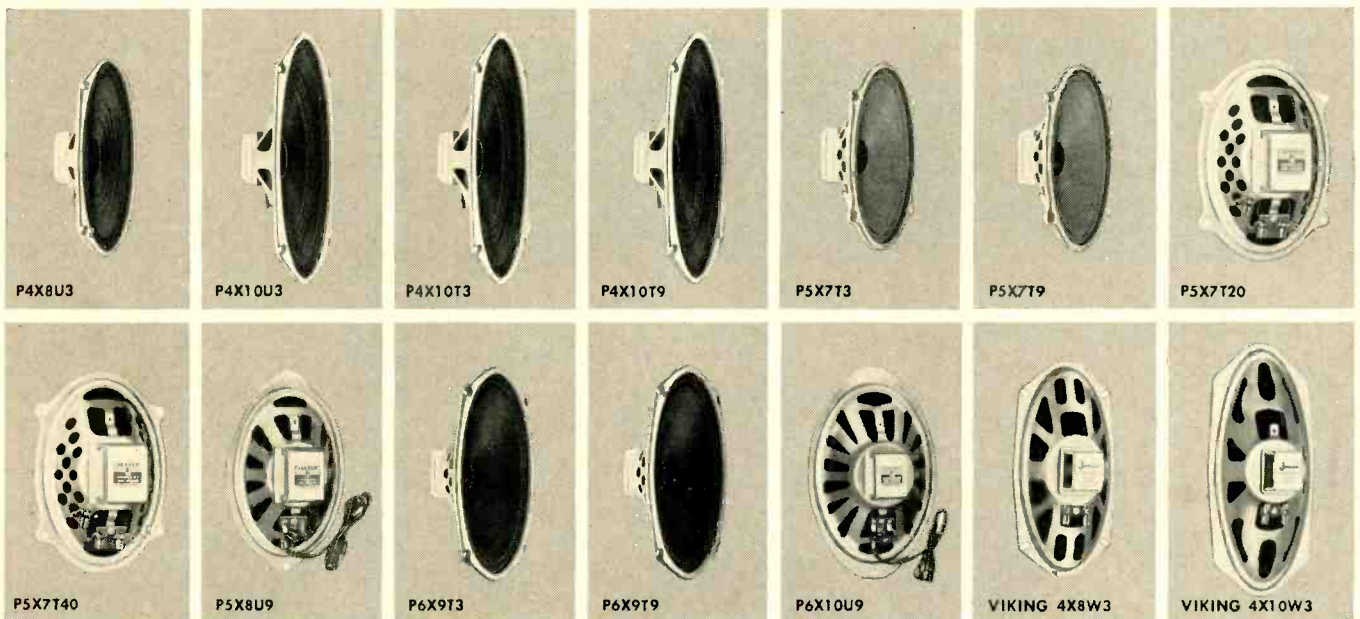

CONCERT SERIES

Nominal Size, Inches	List Price	Model Number	Magnet [†] Wt., Oz.	Voice Coil			Dimensions, Inches		
				Imped. Ohms	Power Watts**	Dia. Inches	H & W	Depth	Baffle Opening
4 x 8	\$7.50	P4X8U3	1.73*	3.2	7.0	1	4 x 8	2 ⁷ / ₃₂	3 ⁵ / ₁₆ x 7 ¹ / ₁₆
4 x 10	8.10	P4X10U3	1.73*	3.2	7.5	1	4 ³ / ₁₆ x 10	2 ²¹ / ₃₂	3 ¹³ / ₁₆ x 9 ¹ / ₂
4 x 10	8.70	P4X10T3	2.5**	3.2	8.5	1	4 ³ / ₁₆ x 10	2 ¹¹ / ₁₆	3 ¹³ / ₁₆ x 9 ¹ / ₂
4 x 10	8.70	P4X10T9	2.5**	8-10	8.5	1	4 ³ / ₁₆ x 10	2 ¹¹ / ₁₆	3 ¹³ / ₁₆ x 9 ¹ / ₂
5 x 7	8.20	P5X7T3	2.5**	3.2	9.0	1	5 x 7 ¹ / ₄	2 ¹ / ₂	4 ¹ / ₄ x 6 ¹ / ₂
5 x 7	8.20	P5X7T9	2.5**	8-10	9.0	1	5 x 7 ¹ / ₄	2 ¹ / ₂	4 ¹ / ₄ x 6 ¹ / ₂
5 x 7	8.85	P5X7T20	2.5**	20 CT	9.0	1	5 x 7 ¹ / ₄	2 ¹ / ₂	4 ¹ / ₄ x 6 ¹ / ₂
5 x 7	8.85	P5X7T40	2.5**	40 CT	9.0	1	5 x 7 ¹ / ₄	2 ¹ / ₂	4 ¹ / ₄ x 6 ¹ / ₂
5 x 8	8.00	P5X8U9†	1.73*	8-10	8.0	1	5 x 8 ³ / ₁₆	2 ¹ / ₄	4 ¹ / ₄ x 6 ¹ / ₂
6 x 9	8.50	P6X9T3	2.5**	3.2	10.0	1	6 ³ / ₈ x 9 ¹ / ₈	3	5 ¹ / ₄ x 8 ¹ / ₈
6 x 9	8.50	P6X9T9	2.5**	8-10	10.0	1	6 ³ / ₈ x 9 ¹ / ₈	3	5 ¹ / ₄ x 8 ¹ / ₈
6 x 10	8.40	P6X10U9†	1.73*	8-10	9.0	1	6 ³ / ₈ x 10 ³ / ₁₆	3	5 ¹ / ₄ x 8 ¹ / ₈

VIKING SERIES

4 x 8	6.00	4X8W3	1.00	3.2	6.0	1/16	4 x 8	2 ⁵ / ₈	3 ¹ / ₂ x 7 ¹ / ₂
4 x 10	6.50	4X10W3	1.00	3.2	6.0	1/16	4 ³ / ₁₆ x 10 ¹ / ₁₆	3	3 ⁵ / ₈ x 9 ³ / ₈

*DP-Alnico 5 magnets. **Program power. Peak power is twice program rating. †Two-eared speaker housing. *Performance equivalent to EIA 2.15 oz. **Performance equivalent to EIA 3.16 oz.



JENSEN MANUFACTURING COMPANY / DIVISION OF THE MUTER COMPANY / 6601 SOUTH LARAMIE AVENUE, CHICAGO 38, ILLINOIS
Canada: Radio Speakers of Canada, Ltd., Toronto • Argentina: Ucoa Radio, S.A., Buenos Aires • Mexico: Fapartel, S.A., Naucalpan, Mex.

- - - for more details circle 39 on post card

I. F. & R. F. COILS

30,000 O.E.M. Replacement Parts in our Catalog No. 164
 Even non-listed items receive our same day service
 Just send us model no., part no. or defective unit

across the nation
 it's

MILLER QUALITY PRODUCTS

J. W. MILLER

J. W. MILLER COMPANY

Factory: 5917 S. Main Street Los Angeles 3, Calif U.S.A. Phone ADams 3-4294—FAX No. XCM

... for more details circle 45 on post card

NEW PRODUCTS

MOLDED PHONO JACK 202

A molded phono jack with a closed circuit feature is announced. The molded body is made of high dielec-



tric plastic. It can be used in all types of commercial applications: TV, amateur, broadcast and sound recording equipment, receivers, tuners, tape decks and high fidelity components, the manufacturer reported. Switchcraft.

LOOP HEX KEYS 203

A series of loop handle hex keys is announced. It is said the loop handle provides greater torque and convenient use of the hex key in tight areas. The hex keys are avail-

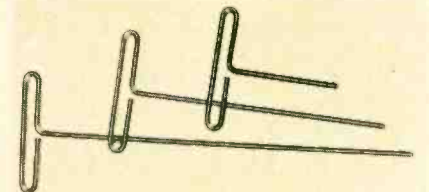

able in three lengths: 9, 6 and 3 in., each in 11 sizes from 5/64 through 3/8 in. Eklind Tool.

TEST CLIP 204

A miniature, insulated test-lead clip is announced. The clip is designed to reach difficult areas in

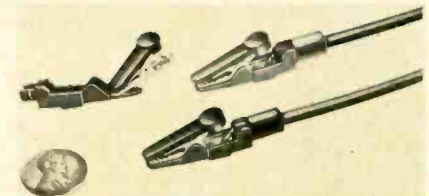

electronic chassis. Insulated with nylon, the clip is said to prevent accidental shorts or contacts with power leads. The sleeve pivots out

Long after the television set has been replaced . . .

COLUMBIA'S PERMALINE WILL STILL BE ON THE JOB!

Permaline is the only television transmission cable durable enough to be guaranteed, in writing, for 15 or 25 years! Because of its extremely high quality, Columbia Wire has never had to replace as much as one foot of Permaline.

This is why it is preferred by technicians who recognize the economies of using quality products having an initial cost slightly higher than others. With quality products, such as Permaline, costly call-backs are eliminated while customer satisfaction and repeat business increases. Ideal for color television.

On your next antenna installation, do yourself and your customer a favor—use Columbia Wire's Permaline television transmission line.

Columbia WIRE & SUPPLY CO.

2850 Irving Park Road • Chicago 18, Illinois

... for more details circle 26 on post card

you get **PRODUCT PLUS** from your Sylvania Distributor

suddenly

**COLOR TV
HAS A NEW
RED STANDARD**

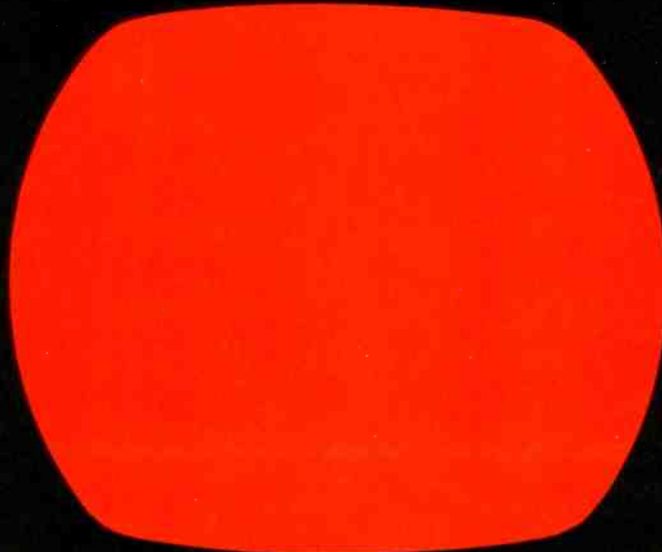

Sylvania's new EUROPIUM RED.

New COLOR BRIGHT 85 picture tube brings more natural color to television and increases monochrome brightness 43%.*

The startling news in the television industry is Sylvania's new picture tube, and its new, truer red phosphor.

EUROPIUM RED, developed at GT&E Laboratories, is the brightest red known to the industry. And, to match it, now the full brightness of blue and green is used. The result is a color picture tube that gives the entire television industry a boost.

Because the COLOR BRIGHT 85 tube is *really* bright, dealers can demonstrate color TV effectively in normally lighted showrooms. As the set's brightness is adjusted, the colors remain true—not shifting to unnatural tones in the highlights of the picture.

Another thing, black and white performance is far better than you've ever seen before in a color tube. Be-

sides the increased brightness, there's improved contrast in a sharp, vivid picture.

The new, exciting COLOR BRIGHT 85 picture tube is a product plus from Sylvania for the entire color television industry, and particularly for dealers. In color, as in black and white, you know it's good business to handle the Sylvania line.

SYLVANIA
SUBSIDIARY OF
GENERAL TELEPHONE & ELECTRONICS GTE

NEW CAPABILITIES IN: ELECTRONIC TUBES • SEMICONDUCTORS • MICROWAVE DEVICES • SPECIAL COMPONENTS • DISPLAY DEVICES

*Tests show the COLOR BRIGHT 85 tube is 43% brighter, on the average, than standard color picture tubes.



Can you service mobile radio and CB?

It's a big business . . . and getting bigger every day. There are thousands of mobile radio systems now in use plus thousands more marine and CB sets. **BUT . . . ONLY MEN WITH COMMERCIAL FCC LICENSES ARE LEGALLY AUTHORIZED TO SERVICE THEM.** Don't let this profitable new business get away from you. At home, in your spare time, a Cleveland Institute training program will prepare you for the tough new FCC License Exam . . . is backed by this remarkable offer: "If you complete the CIE program yet fail the FCC License Exam specified, all tuition will be refunded". Get details. Send coupon for our book "How to Get a Commercial FCC License". There's no obligation.

Cleveland Institute also offers the following Electronics courses: Electronics Technology, Industrial Electronics, Broadcast Engineering, and Electronic Communications.

ACT NOW . . . SEND COUPON FOR FREE BOOK

Cleveland Institute of Electronics

1776 E. 17th St., Dept. ET-12
Cleveland, Ohio 44114

Please send me your free brochure "How to Get a Commercial FCC License".



Occupation _____ Age _____

Name _____
(Please Print)

Address _____ County _____

City _____ State _____ Zip _____

Now training over 15,500 students through Electronics Home Study.

NEW PRODUCTS

of the way so that the lead wire may be soldered to the metal clip. Known as model 1410M, it is made of cadmium-plated steel. Industrial Devices.

REPLACEMENT TONEARM 205

A replacement tonearm complete with crystal cartridge (choice of stereo or mono) is announced. The

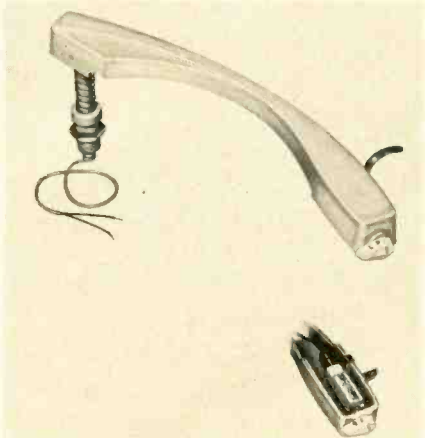

arm is prewired with shielded cable, ready for installation. It comes complete with spring mounting post, plated finger lift and arm rest. The cartridge is the turnover type and plays all records. It is light gray in color and is packaged with installation instructions and hardware. Sonotone.

TRANSISTOR RADIO 206

Announced is a six transistor radio, only 11/16 in. deep, which achieves its slim silhouette through



folded down rather than vertically mounted transistors. It is powered by four penlight batteries. The chassis is mounted in an impact-resistance case molded into the shape of a book. Its over-all di-

Why doesn't everybody stock

Jensen[®]
SNAP-IN CARTRIDGES?

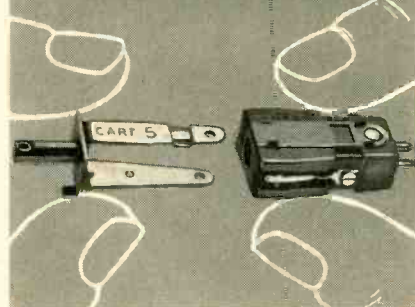

If you've been shying away from profitable cartridge replacement business because of the cost and connotations of cumbersome inventories, let Jensen get you back on the right "track." Here's how:

- Less inventory
- Complete coverage
- Superior performance
- Respected, accepted brand name

Why doesn't everybody stock Jensen Snap-In Cartridges? Give 'em time. Soon they will.

SPECIAL K-1964 DEAL

Write for details on special Dealer Starter Kit K-1964—12 brackets and 6 interchangeable cartridge bodies which will replace 80% of all basic cartridge requirements.

World's finest phonograph needles, cartridges, drives, accessories

Jensen[®]
INDUSTRIES, INC.
301 Interstate Rd., Addison, Ill.

In Canada: A. T. R. Armstrong,
P.O. Box 244, Islington, Ontario

for more details circle 38 on post card

ELECTRONIC TECHNICIAN

EICO's complete new color TV lab for the pro

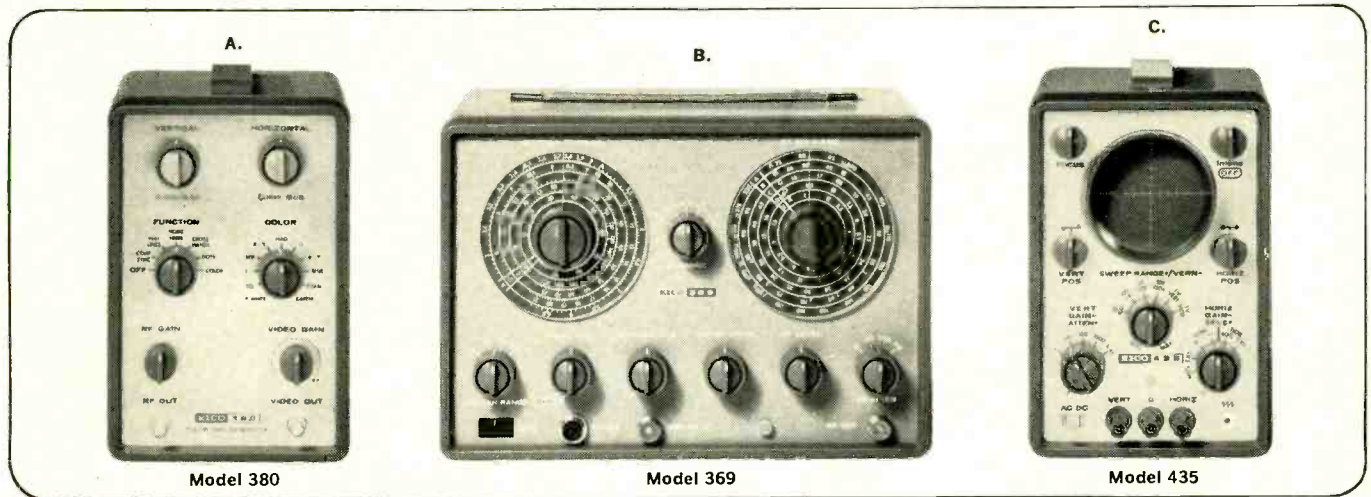

Model 380

Model 369

Model 435

Color TV servicing is a job for professionals—and Eico's new color TV test equipment is designed to their requirements. Professional service engineers can't afford to waste time on apparent set troubles caused by makeshift, inaccurate test signals, or on test equipment that is inherently difficult to use or incapable of fast, accurate determinations. Critical professionals know they can depend on EICO for accuracy, reliability, and laboratory standard performance. Moreover, EICO has now successfully reduced equipment size while improving performance, to permit convenient on-location servicing. No wonder the pros choose EICO!

(A) PROFESSIONAL PERFORMANCE IN COLOR TV TEST INSTRUMENTS/ (A) MODEL 380 SOLID STATE N.T.S.C. STANDARD COLOR SIGNAL & DOT-BAR GENERATOR (PAT. PEND.) Entirely unique in both providing completely standard 100% fully saturated N.T.S.C. color signals, including both chrominance and luminance signals exactly as specified, and in being completely transistorized. Color burst is precisely gated and delayed according to N.T.S.C. standards, and phase angles are permanently established by taps on a linearly distributed delay line, so that no adjustments are ever required. Use of saturated transistor for switching and delay provides square "clean" waveforms without significant overshoots or ringing for excellent signal definition. The design of the 380 is an absolute protection against obsolescence, and assures the professional service engineer that apparent set trouble is not caused by a non-standard test signal. In addition to generating 11 different color signals, one at a time, for hue and demodulator adjustments, the Model 380 generates dots, crosshatch, horizontal lines, and vertical lines for convergence and linearity adjustments. Both video and RF outputs are provided, with gain controls. Three crystal-controlled oscillators are employed for color burst and color information, convergence and sync signals, and RF output on TV channel 3 (exchangeable for TV channel 4). Entirely stable and inherently rugged by solid state design, the Model 380 is also outstandingly compact and weighs only 4 lbs. SIZE (HWD): 8½ x 5¼ x 6¾ inches. Kit \$129.95. Wired \$169.95.

(B) MODEL 369 TV-FM SWEEP & POST-INJECTION MARKER GENERATOR (CRYSTAL-CALIBRATED) For easiest, fastest visual alignment of color or B&W TV, and FM receiver RF & IF circuits. Five sweep ranges from 3-220 mc and four marker ranges from 2-225 mc, plus a crystal marker oscillator that turns on when a crystal is plugged into the panel socket (4.5 mc crystal supplied for TV sound alignment). Controllable inductor sweep circuit is purely electronic and has no mechanical parts to wear out. Retrace blanking, and a 3-stage AGC circuit that keeps the amplitude of the swept signal even when the widest sweep width of 20 mc is used. With the 369, circuit response is not affected by markers and markers are not affected by traps in the circuit. Only the sweep signal is applied to the circuit under test. A demodulator cable picks up the output signal and feeds the demodulated signal to a mixer stage in the 369 where the markers are added, then the combined signal is led to a 'scope. Separate trace size and marker size controls can be used independently. SIZE (HWD): 8½ x 12½ x 7½ inches. Kit \$89.95. Wired \$139.95.

(C) MODEL 435 DC WIDEBAND 3" OSCILLOSCOPE You'll be able to complete many more color or B&W TV service calls on location if you can take your 'scope with you. EICO's 435 is really portable (½ the size of conventional 5" scopes) and fully equipped to do the job. Quality equal to or better than the finest 5" TV service scopes is achieved with a far sharper, brighter trace on a flat-face CRT. Direct-coupled, push-pull V amplifier, with 4-pos. frequency-compensated decade attenuator has no low frequency phase shift, and is flat from DC-4.5mc (+1, -3db). Far more accurate p-p voltage measurements than ever before with a Zener diode-controlled

square wave calibrating voltage, and an edge-lit calibration grid. Easier to use for TV servicing with pre-set TV-V and TV-H positions in addition to 4 sweep ranges, automatic sync limiter and amplifier, and full retrace blanking. Amazingly easy to build because of professional interior packaging that has eliminated crowding and permits easy access to any component. SIZE (HWD): 8½ x 5¼ x 12½ inches. Kit \$99.95. Wired \$149.95.



ONE MORE MATCHING INSTRUMENT EQUIPS YOU FOR FM STEREO SERVICING MODEL 342 FM MULTIPLEX SIGNAL GENERATOR.

The EICO Model 342 is a compact, efficient instrument essential for test or alignment of the multiplex circuits of FM Multiplex Stereo tuners, receivers, and radios. FM Stereo is a field as fast-growing as color TV, and a multiplex generator is an absolute must for getting a share of the increasingly important and profitable service business. The circuitry of the Model 342 is of the design lab quality needed for restoring original performance quality to the costliest equipment, but the controls have been simplified for fast, uncomplicated operation. With it, you can quickly measure and adjust channel separation and balance, or the input level needed for synchronization or switch-over to stereo operation. The Model 342 provides signals as perfect as those available from generators costing many hundreds of dollars. It provides both a controlled amplitude composite audio output for direct signal injection beyond the detector into a multiplex section, and the same signal modulating an FM RF carrier at about 100mc (adjustable) with controlled deviation ± 75kc (100% modulation) for connection directly to the antenna terminals. Either a built-in 1kc oscillator (below 0.3% distortion) or an external audio oscillator may be used to provide the left only, right only, difference, or sum signals. The 19kc pilot signal is crystal controlled and may be switched on or off independently of the composite signal. The signal may be obtained without audio information and only the 19kc pilot injected. An oscilloscope sync output is provided, with a choice of either 19kc sync or internal 1kc/external oscillator sync. In addition, an input is provided for connecting an external audio oscillator to provide an SCA signal when required. Another important and valuable feature of the Model 342 is dual inputs and amplifiers for a stereo source to permit FM MULTIPLEX STEREO demonstrations to customers when there are no stereo programs being broadcast. Modern compactron tubes are used to obtain a lightweight, compact package that is easily portable. SIZE (HWD): 8½ x 5¼ x 12½ inches. Kit \$119.95. Wired \$179.95.

ET-11

EICO EICO Electronic Instrument Co., Inc.
131-01 39th Avenue, Flushing, N.Y. 11352

Send new 1965 catalog featuring more than 230 EICO Products.

Name _____

Address _____

City _____ Zone _____ State _____

- - - for more details circle 28 on post card

sooner
or
later...



you will demand the extra quality and precision of Nortronics tape heads! All Nortronics heads feature:



laminated core structures and deposited quartz gaps for superior high frequency response, and . . .



hyperbolic, all-metal faces for intimate tape-to-head contact—longer wear with minimum oxide loading.

Now, you can demand the best! Offer your customers Nortronics tape heads . . . *designed and produced to the highest standard of excellence.*

Get full details! Write today for your FREE copy of Nortronics Tape Head Replacement Guide.



8133 Tenth Ave. N., Minneapolis, Minn. 55427

... for more details circle 55 on post card

NEW PRODUCTS

mensions are 3 1/16 x 4 15/16 x 11/16 in. Toshiba.

REVERBERATION KIT 207

A car radio reverberation sound system that can be mounted in either the trunk or firewall is introduced.

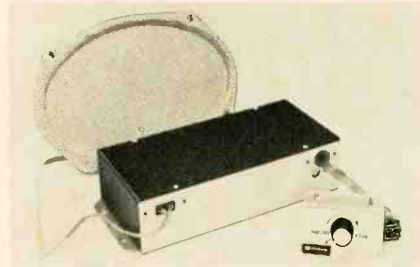

It is said the unit develops a stereophonic effect with all car radios by electronically restoring the natural sound reverberations lost in ordinary radio transmission. It comes complete with fader control, rear speaker and all necessary connecting cables. Gibbs.

BUZZ CONTROLS 208

A line of buzz controls is announced. These controls can be used wherever a specialized wire-

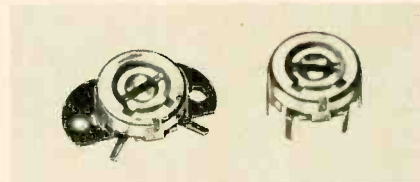

wound exact replacement is needed. Some exact replacement uses are convergence controls in color TV sets; AGC, linearity, and vertical and horizontal hold in B/W sets; bias and sensitivity in auto radios; and hum balancing in stereo and Hi Fi. Rated at 2 w, the controls are available in 21 values, from 1.5 to 5000Ω. Centralab.

POWER ROTATED HAMMER 209

A power rotated hammer for drilling holes in masonry is an-



nounced. Known as the Model 728, the unit delivers 2900 blows per minute at 500 rpm and weighs 14 1/2 lb. The tool may also be used as a hammer for chiseling, chipping and demolition work and for drilling. Skil.

HI FI/TV ADAPTER 210

An adapter which is said to reproduce TV sound in true Hi Fi is announced. The unit is supplied with a tube clamp attached to the end of a 6 ft insulated wire. The clamp is placed around the glass of the sound detector tube in the TV receiver picking up sound. The other end of the wire is connected to the adapter. A patch cord furnished



with the adapter is then connected to the auxiliary input of the amplifier or receiver. Trutone.

SIGNAL GENERATOR 211

A solid state combined signal generator and frequency meter is announced. The frequency of the instrument is adjustable in 1 cps increments up to 50 Mc and in 10 cps increments between 50 Mc and 500 Mc. The output is continuously adjustable from plus 7 dbm to -130 dbm into a 50Ω load, with an accuracy of plus or -2 db, the announcement said. This corresponds



to a voltage output from over 0.5 v to less than 0.1 μv. The frequency synthesizer employs a phase-locked oscillator which may be operated as a free-running continuously vari-

The greatest indoor TV antenna ever made

Tops all others in the roughest TV reception area in the U.S.A.— San Francisco.

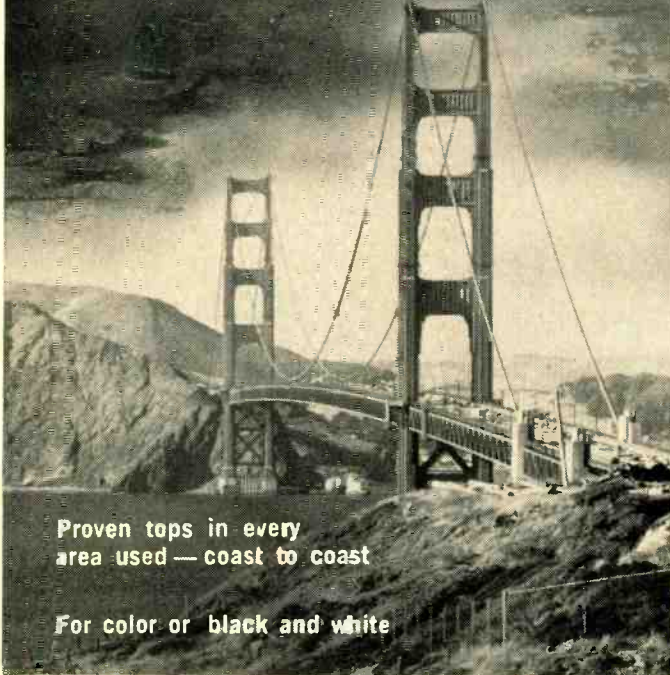

Proven tops in every area used — coast to coast

For color or black and white



The Hi-Lo 202 covers all channels VHF (2-13) and UHF (14-83). Exclusive patented spiral feature guarantees 300 ohm match from antenna to where — on top of TV set. Operates anywhere — full profit to you — top satisfaction from customers.

List Price ... **9⁹⁵**

Outdoors — install the industry's top all-color, all-channel Yagi, the Tricraft ACY-9.

High gain, sharp directivity, high front to back ratio. Outstanding fringe reception on all VHF channels. Pre-assembled for rapid installation with Hi-Lo's patented "Allsnap" method of assembly. List Price **16⁷⁵**

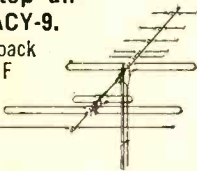

Hi-Lo

See your distributor or write

MANUFACTURING CORP.

1124 W. Newport Ave., Chicago 60657

Send complete details

Dept. ET-10

Name _____

Street _____

City _____

--- for more details circle 36 on post card

NOVEMBER 1964

KIT or ASSEMBLED!

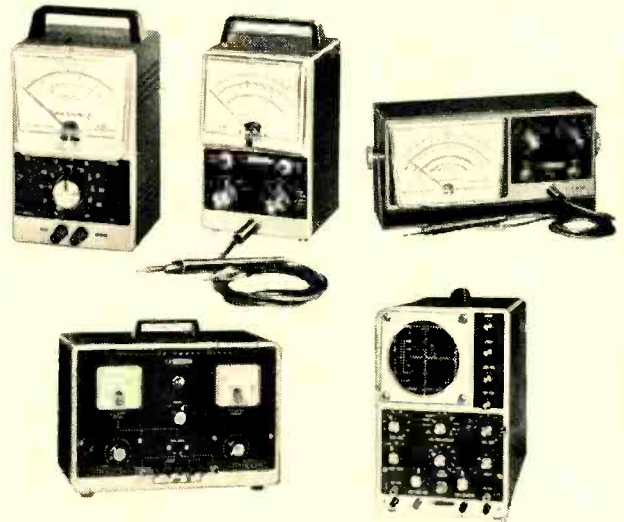

Either Way, These HEATH Instruments Are Your Best Buy!

Heathkit IM-21 Laboratory AC VTVM!

• 10 voltage ranges—0.01 to 300 volts RMS full scale • ± 2 db, 10 cps to 1 mc • 10 megohm input impedance for high accuracy • Calibrated DB scale • VU-type ballistic damping of meter movement.

Kit IM-21, 5 lbs... \$33.95 Assembled IMW-21... \$52.95

Heathkit IM-11 VTVM... World's Largest Selling VTVM!

• 7 AC (RMS & Peak to Peak), 7 DC, 7 Ohms ranges • Wide frequency response ± 1 db, 25 cps to 1 mc • Easy-to-read 4½" 200 UA meter • 1% precision resistors • Single AC/Ohms/DC probe with switch.

Kit IM-11, 5 lbs... \$24.95 Assembled IMW-11... \$39.95

Heathkit IM-13 "Service Bench" VTVM!

• 7 AC, 7 DC, 7 Ohms ranges • Separate 1.5 & 5 v. AC scales • ± 1 db, 25 cps to 1 mc • Large 6" 200 UA meter • Tilts to any angle • 1% precision resistors • Single AC/Ohms/DC probe with switch • Mounts anywhere.

Kit IM-13, 7 lbs... \$32.95 Assembled IMW-13... \$49.95

Heathkit Variable-Voltage Regulated Power Supply!

• Ideal for design & development • B+, Bias & Filament voltages • DC output variable 0-400 volts, 125 ma max. • Output varies less than 1%, no load to full load • Ripple less than 10 mv • Voltage & Current Panel Meters.

Kit IP-32, 16 lbs... \$56.95 Assembled IPW-32... \$84.95

Heathkit "Extra-Duty" Wide Band 5" Oscilloscope!

• Professional styling & features • 5 MC bandwidth, ideal for color servicing • Rise time 8 microseconds or less • Sweep range 10 cps to 500 kc plus 2 switched preset frequencies • Push-pull vertical & horizontal output.

Kit IO-12, 24 lbs... \$76.95 Assembled IOW-12... \$126.95



FREE CATALOG

Fully describes these and over 200 other different and exciting Heathkits at savings of 50% or more! Fill out the coupon below and send for your FREE copy today!



HEATH COMPANY, Dept. 24-11-1
Benton Harbor, Mich. 49023

Please send my free 1965 Heathkit Catalog.

Enclosed is \$ _____, plus postage. Please send model(s) _____

Name _____
(Please Print)

Address _____

City _____ State _____ Zip _____

TE-132

--- for more details circle 35 on post card



New stick-on wiring system eliminates mechanical fasteners

New "Scotchflex" Brand Flat Cable System lets you install low-voltage hookups anywhere in seconds. Applies like tape to tile, concrete, brick, paneling, any surface. No stripping necessary . . . sharp "U" shaped prongs in the connectors pierce the insulation and establish firm contact with each of the round wire conductors. "Scotchflex" Cable saves installation time and provides better looking wiring on intercoms, call systems, hi-fi, and other low voltage systems. For details, write: 3M Co., St. Paul, Minn. 55119.

3M Electrical Products Division
MINNESOTA MINING & MANUFACTURING CO.

"SCOTCHFLEX" IS A REGISTERED TRADEMARK OF 3M CO.

--- for more details circle 46 on post card

NEW PRODUCTS

able signal source covering the 10 kc to 500 Mc range in eleven bands. In the free mode of operation, the frequency is read directly from a large, calibrated dial. At any point in its range, the oscillator may be phase-locked to the internal crystal reference for full synthesizer accuracy and stability the report said. Singer.

AUTO RADIO TRANSISTOR

212

What is said to be an exact replacement for the AR series auto radio power transistors is introduced. The AR transistors are used extensively in auto radios manufactured by Philco the report said. The replacement is known as Par 12. Semitron.

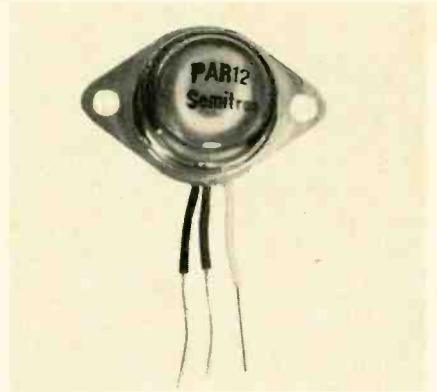

"TORQUE WRENCH" MANUAL

SENT
UPON REQUEST



Formulas
Applications
Engineering Data
Screw Torque Data
Adapter Problems
General Principles

P.A. STURTEVANT CO.
ADDISON QUALITY ILLINOIS

Manufacturers of over 85% of
the torque wrenches used in industry

--- for more details circle 63 on post card

ARROW Staple Gun Tackers

SAVE YOU TIME AND MONEY!

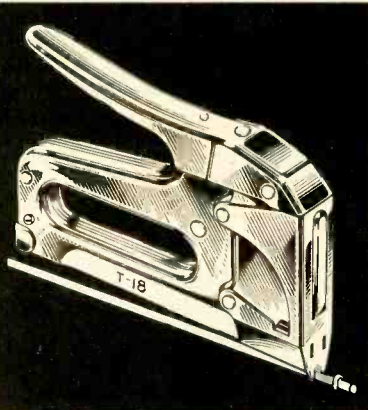

Tapered striking edge gets into tight corners!

MODEL T-18 — For wires 3/16" and less in diameter. Loads (85) T-18 staples with 3/16" crown, divergent-pointed, of .050 wire in 3/8" leg length.

MODEL T-25 — For wires up to 1/4" in diameter. Loads (85) T-25 staples with 1/4" crown, wedge or divergent-pointed, of .050 wire in 9/32", 3/8", 7/16" and 9/16" leg lengths.

Write for catalog
and information.

ARROW FASTENER COMPANY, INC.

One Junius Street • Brooklyn 12, N. Y.

SAFE!

Can't damage wire because staples automatically stop at right height! Won't even break 1/4" hollow glass tubing.

FAST!

Proved by test 10 times faster than old hammer method. Saves you 70% in fatigue and efficiency . . . saves many dollars.

HOLDS!

New staples get tremendous holding power from tack points that spread to lock into wood!

- All-steel construction with chrome finish.
- Jam-proof patented mechanism for trouble-free operation.

--- for more details circle 16 on post card



RECOMMENDED BY
PHILCO
for COLOR
 & BLACK AND WHITE
 TV INSTALLATION

COLORMAGIC

Patent Pending

FHR FUNDAMENTAL HARMONIC RESONANCE...GC'S EXCLUSIVE DESIGN PROCESS!
 Colormagic elements resonate on the fundamental harmonics within both the high and low bands. Colormagic FHR outperforms the average second harmonic TV element by producing a tight, laser-linked directivity of signal...higher gain! It's in the elements!

GC "GOLD-GUARD" anodizing process guards against pitting, chipping, rust and corrosion...makes the Colormagic series the best protected, all-weather line available!

GC "SOLID-SEMBLED" construction insures quick, easy installation...rigid-lock elements snap securely into place!

Compare! Colormagic Antenna Systems offer pencil-point polar patterns...laser-linked directivity...flat plateau response curve...no traps or peaks...excellent for color or black & white TV reception.

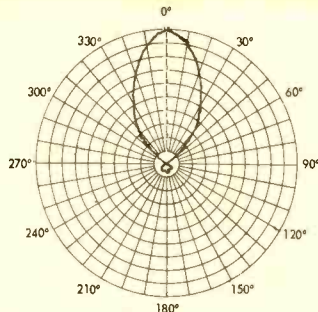

15 All-New Colormagic Combo-Couplers permit cross-direction reception of UHF-VHF-FM antenna combinations...each unit encased in high-impact polystyrene case...supplied with stainless Steel mounting strap. Complete sales program available.



See your GC Distributor! He'll fill you in on this "prestige" package. *CONSIDER THE ELEMENTS INVOLVED!* ...then GO COLORMAGIC! If not stocked locally, write us for name of Distributor nearest you.

GC ELECTRONICS
 DIVISION OF TEXTRON ELECTRONICS, INC.

EASTERN PLANT: HICKSVILLE, L.I., N.Y.
 MAIN PLANT: ROCKFORD, ILLINOIS, U.S.A.
 WESTERN PLANT: LOS ANGELES, CALIF.

NEW PRODUCTS

PAGING SPEAKER 213

A paging and talkback speaker is introduced. The model HU-12NT paging and talkback speaker in-

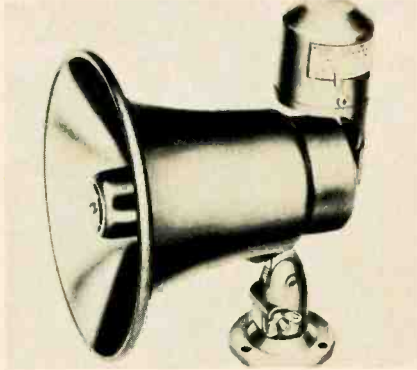

cludes a weatherproof line transformer with a selection of 70.7 and 25 v power taps. Specifications listed power, 7.5 w, and a selection of impedances ranging from 45 to 8000Ω. Atlas Sound.

MICA CAPACITOR KIT 214

A special kit featuring high volt-



age, dipped mica capacitors, type VDM, is announced. The assortment is designed especially for TV application and provides two pieces each of the 14 most popular values, ±5% tolerance at 1000 wvdc. Standard tolerances are 5%, closer tolerances are available. Capacitance value, working voltage and tolerance are clearly printed on each unit. Arco.

ALLEN SCREWDRIVER SET 215

An allen type screwdriver set is announced. It consists of a regular

size 4 1/8 in. screwdriver handle, nine interchangeable allen-hex type 4 in. blades with hex sizes from 0.050 through 3/16 in. and a 4 in. extension shaft. Deep-set or awkwardly placed screws are easier to reach with the tools in this set than with

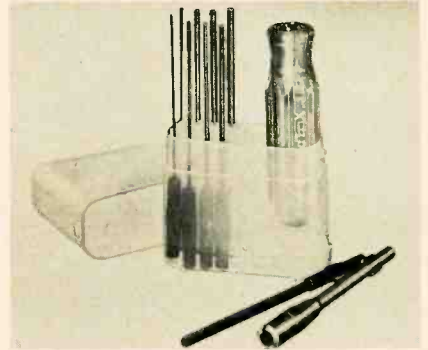

conventional type keys, the manufacturer claims. Xcelite.

SOLDERING GUN 216

A soldering instrument that makes possible heat volume ranges from 25 to 450 w in one small gun is announced. By changing tips the gun is automatically ready for heavy, medium or light duty. The fine point tip provides a range of



SELF-SERVICE TUBE TESTERS are BIG INCOME PRODUCERS

NEW MODERN EYE-STOPPING TESTERS... TOPS in PERFORMANCE... QUALITY... and VALUE

MERCURY SPECIAL OFFER!

MODERNIZE YOUR EXISTING SELF-SERVICE TUBE TESTERS

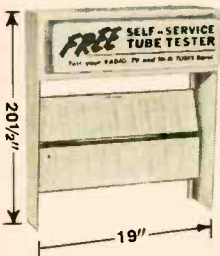

with the
**202 PANEL and
TOP HOUSING
ASSEMBLY**

Only **\$115⁸⁵** Net

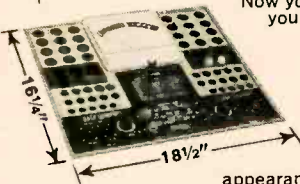

Now you can convert your present tube testers into up-to-date efficient units with the MERCURY 202 PANEL and TOP HOUSING. The improved appearance, versatility and performance will enable you to increase your tube sales immeasurably.

Here is everything you want in self-service tube testers at down-to-earth prices. **MORE VERSATILITY**—Tests emission, shorts and gas of over 1400 tube types including the very latest NUVIATORS, NOVARS, COMPACTRONS, etc. . . . Also tests fuses, pilot lights, 6 and 12 volt auto radio vibrators, all type batteries under load. **SMARTER LOOKING**—Modern cabinet design finished in a rich green and white color combination with gold trim . . . Eye-stoppers in any location—will attract do-it-yourself customers as never before and sell tubes in a big way. **MORE QUALITY FEATURES**—Completely self-service . . . Only two easy-to-use controls are required to test any tube . . . Easy-to-read quick flip tube charts list over 1400 tube types . . . Engineered to accommodate new tube types as they are introduced. Etched aluminum panel always retains its handsome appearance . . . 63 phosphor-bronze beryllium tube sockets assure positive contacts and long life. Replace old self-service tube testers with Mercury testers and spark-up your present locations . . . place them in new locations and be assured of the greatest profit results.

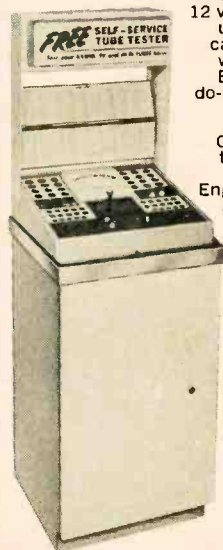

Slightly higher in the West



Model 202-LB
(Lo-Boy Floor Model)
Dealer Net **\$184⁵⁰**

Model 202-C
(Counter Model)
Dealer Net **\$129⁹⁵**

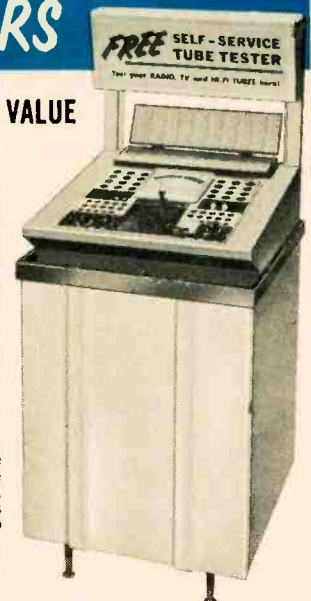

Model 203-LB
(Deluxe Lo-Boy Floor Model)
Dealer Net **\$254⁵⁰**

Model 203-C
(Deluxe Counter Model)
Dealer Net **\$166⁹⁵**

MERCURY ELECTRONICS CORPORATION, 111 ROOSEVELT AVENUE, MINEOLA, NEW YORK

... for more details circle 44 on post card
ELECTRONIC TECHNICIAN



for color and UHF...

Belden All-Weather Lead-In delivers 25% to 51% more power

It's no great news to you that when your customer pays a good price for a color TV set, he's going to be pretty choosy about the quality of his picture. He'll be a lot more aware of a poor color picture than a poor black and white picture.

So it's to your advantage . . . and his . . . to install the best TV lead-in you can get your hands on . . . Belden All-Weather Permohm*! When wet, this all-channel, 300-ohm line delivers 25% to 51% more signal power to the receiver. This means clearer color and UHF TV reception the year 'round in all areas . . . including areas where there's extreme salt spray, rain, snow, ice, and industrial contamination.

Save yourself callbacks and headaches. Install Belden All-Weather Permohm . . . and forget it. That's pretty good insurance for pennies a foot!



**Be a Cartoon
Gag Writer!
Win a \$25.00
Savings Bond**

Send us your gag ideas for future cartoons. For each of your gag ideas used, we'll send you a \$25 Savings Bond. Write Belden Manufacturing Company. Attention: Mrs. Madelsa Allison, P.O. Box 5070-A, Chicago, Illinois 60680.

*This month's winner: E. J. Stanmyre,
Route 2, Box 306, Canton, North Carolina

Better Built . . . Better Buy . . .

Belden

WIREMAKER FOR INDUSTRY
SINCE 1902 · CHICAGO

*U.S. Patent No. 2782261

8-9-4

power supply cords • cord sets and portable cordage • electrical household cords • magnet wire • lead wire



... for more details circle 20 on post card

TRANSISTORIZED POWER CONVERTER

12 VOLT DC to 117 VOLT AC

FOR \$ **29.95** DEALER
ONLY NET

POWERFUL 125 WATT CONTINUOUS DUTY. PROVIDES 117 VOLT 60 CYCLE A.C. BY PLUGGING INTO CAR OR BOAT 12 VOLT CIGARETTE LIGHTER RECEPTACLE.



MODEL
BX125

MADE
IN U.S.A.

ASK YOUR ELECTRONIC
PARTS DISTRIBUTOR FOR

TRANSVERTER

Designed and Manufactured by:

WORKMAN *Electronic*
SARASOTA, FLORIDA PRODUCTS, INC.

for more details circle 73 on post card

NOW... you can sell Hallicrafters COMMAND LINE



NEW FM 3-WAY RADIO for industry and commerce

This is an excellent opportunity for experienced electronic sales and service companies to represent Hallicrafters COMMAND LINE FM 3-way radio. New sales concept. No inventory. No financing problems. Complete factory back-up. Equipment for all frequencies, competitively-priced, up to \$100 less per unit. Lead-producing national advertising; comprehensive technical literature; plus Hallicrafters 31-year reputation for quality through craftsmanship help you sell.

For details,
contact Norman A. Sholseth



hallicrafters

5th & Kostner Aves., Chicago, Ill. 60624
Phone: 312-826-6300

for more details circle 33 on post card

NEW PRODUCTS



25 to 100 w, the medium tip from 100 to 200 w and the 200 to 500 w range is covered by the heavy duty tip. Price \$13.95. Wen.

STEREO GENERATOR KIT 217

An FM stereo generator, available in kit form, generates an audio or composite stereo signal for multi-



plex adapter adjustment. It can also be used to deliver an RF carrier, modulated by these same signals, to produce an on-the-air signal similar to those transmitted by an FM station, the announcement said. Switch-selected frequencies for modulation or separate use include 400, 1000 and 5000 cps; 19 and 38 kc and two special SCA (subscription service) frequencies of either 65 kc or 67 kc. A crystal-controlled 19 kc adjustable-level pilot signal is provided to check the lock-in range of stereo receivers. The generator also provides other functions. Heath.

VHF/FM ANTENNA 218

Announced is a VHF-FM antenna called "COLOR-VE-LOG"

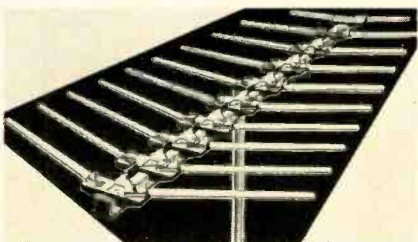

designed to operate on both VHF and FM bands. The announcement indicated that the antenna would give high gain on color and B/W telecasts plus monophonic and stereo FM reception. Finco.

XENON POWER SUPPLY 219

A power supply for 1000-w mercury-xenon short-arc lamps is announced. The supply furnishes con-



stant wattage dc for lamps used in high-intensity illumination, instrumentation, optical readout systems, projectors and other applications. Sola.

SOLDERING Aid 220

A soldering aid for TV-radio service technicians is announced. Essentially a large enameled steel

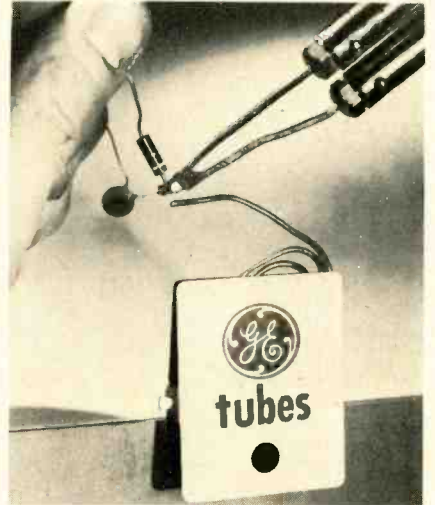

clip, the device will hold either small parts or solder. This service aid can be either screwed to the edge of the work bench or used self-supporting. It will hold parts in position until the solder sets. G-E.

COLOR SIGNAL GENERATOR 221

A color bar generator which produces ten keyed color bars for aligning and troubleshooting color circuitry is introduced. The generator



This emblem brings action

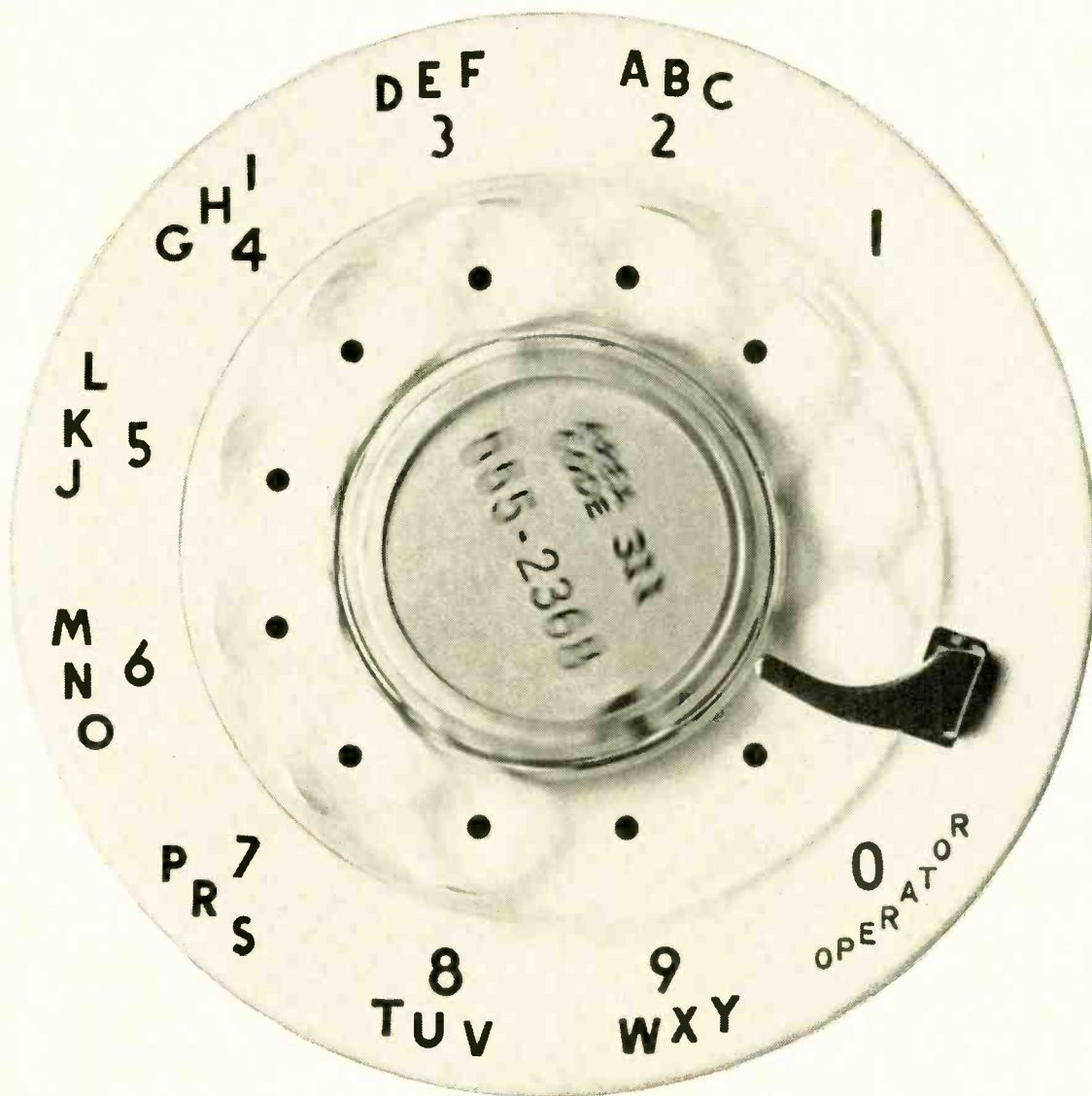

Display this Yellow Page emblem freely.* It means business...it reminds prospects to look for your ad when they're ready to buy.

And people who read the Yellow Pages are ready to buy. (Aren't you when you look in the Yellow Pages?)

*That's if you're in the Yellow Pages. If not, call your Yellow Pages man — he's in the Yellow Pages under ADVERTISING — DIRECTORY & GUIDE. - - - for more details circle 14 on post card

NEW PRODUCTS



output includes a pattern of 54 dots, a crosshatch pattern, a horizontal

bar pattern and a vertical bar pattern. It is factory set to channel 3 and can be tuned to channels 2 or 4. Seco.

MAGNET AND SCRIBER 222

A compact tool which combines



a powerful magnet on one end and a reversible scriber on the other end is announced. A clip is provided for keeping the tool in a pocket when not in use. Moody Machine.

TRANSISTOR IGNITION 223

A transistor ignition system which leaves the standard ignition intact is announced. The unit is prewired so the user can switch to either system. It is available for either 6 or 12 v negative ground battery system. Radatron.

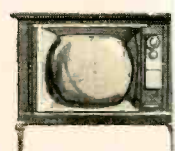
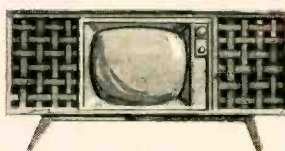
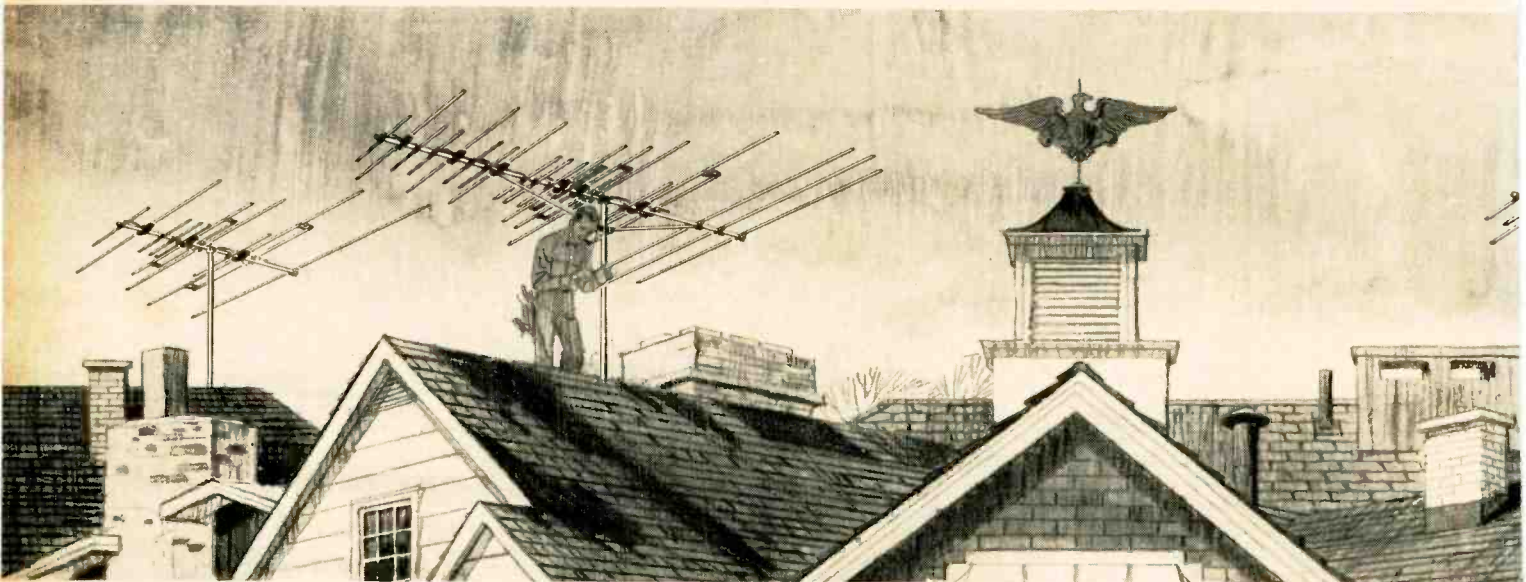

Why are most Color Television Sets

BECAUSE EXPERIENCED COLOR TV DEALERS KNOW THAT WINEGARD COLORTRONS ALWAYS DELIVER THE BEST COLOR PICTURES POSSIBLE!

And it's just plain, common sense . . . when a man invests \$400-\$1000 or more in a color TV set, he expects—and deserves—the finest possible color reception!

Most people who demand the finest in color TV reception choose Winegard Colortron. Here's proof:

Look on top of the largest retail stores in the country . . . they demonstrate their sets connected to Winegard antennas; or look on the homes of the famous TV and movie stars in Hollywood; or on the studio buildings of all three major TV networks; even atop the Whitehouse in Washington. Wherever the best color is seen, you'll see a Winegard Colortron . . . it's the TV antenna made for color.

What's behind Colortron's Superior Performance? Balanced Design! Just what is Balanced Design? It's the perfect combination of high gain, accurate impedance match, complete band width, and pinpoint directivity . . . and only Colortron has it!

For example:

Gain and Bandwidth—A superior color antenna must have high gain and complete bandwidth. But the response must be flat if it is to be effective. Peaks and valleys in the curve of a high gain antenna can result in acceptable color on one channel and poor color on another. *No all-channel VHF-TV antenna has more gain with complete bandwidth across each and every channel than Colortron.* Look at the Colortron frequency response in this oscilloscope photo. Note the consistently high gain on all channels. Note the absence of suck-outs and roll-off on end channels. Note the flat portion of the curve . . . there is less than 1/2 DB variance over any channel.

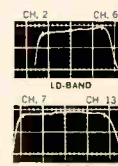

Impedance Match—the two 300 ohm "T" matched Colortron driven elements have far better impedance match than any antenna using multiple 75 ohm driven elements. The Colortron transfers maximum signal to the line without loss or phase distortion through mismatch. The oscilloscope photo here shows the Colortron

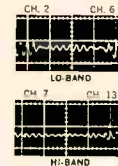

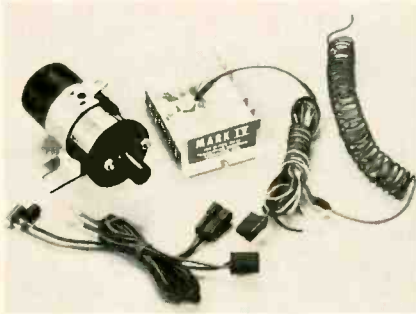

SNAP-IN CARTRIDGE 224

A snap-in cartridge for phono-graphs using tubes or transistors



and high or low mass tone arms is introduced. Snap-in brackets, with and without retractor springs, are available for mounting in tone arms employing 7/16 and 1/2 in. mounting centers. The bracket fastens to the tone arm with two screws

and the cartridge snaps into the bracket for easy installation. The major advantage of the snap-in design is ease of installation. The manufacturer reports a highly enthusiastic response to this snap-in line. It was said that the cartridge enables service technicians to cut down on inventory. This cartridge design also incorporates a snap-in type needle. In designing this line of cartridges and needles the manufacturer claims that the easier a part is to change the easier it is to sell. Jensen Industries.

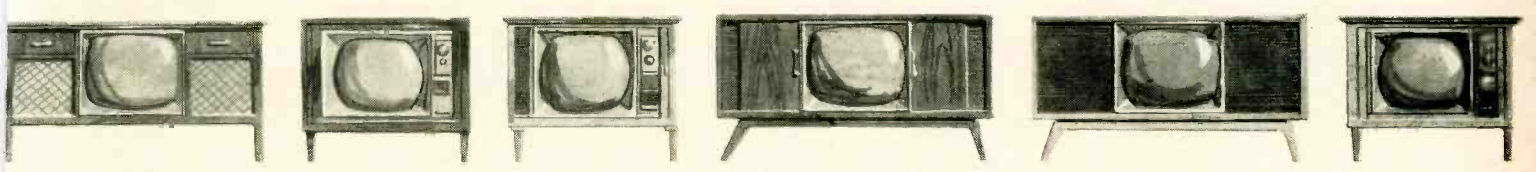
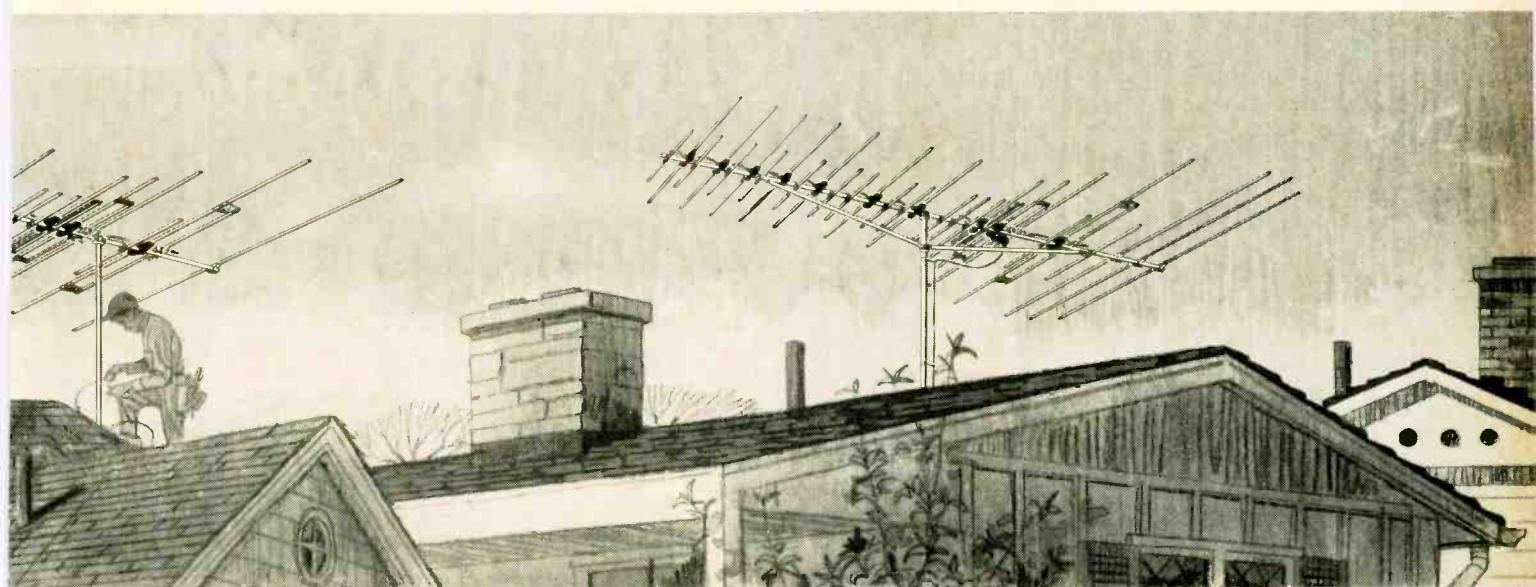

connected to **Winegard** Antennas?

VSWR curve (impedance match). No current VHF-TV antenna compares with it across all 12 channels.

Directivity—An antenna with sharp directivity and good signal-to-noise characteristics is necessary for perfect color. Extraneous signals, picked up at the back and sides, produce objectionable noise and ghosts in black and white reception. But in color TV, they frequently ruin reception. *Winegard Colortron has the most ideal directivity pattern of any all-channel VHF antenna made.*

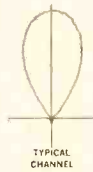

The Unsurpassed Performance of Balanced Design is Matched Only by the Colortron's Unsurpassed Construction!



Colortron has been engineered for maximum strength, minimum weight and minimum wind loading. The result is a streamlined,

lightweight antenna that stays stronger longer. Colortrons have even been wind tested to 100 m.p.h.

Advanced-design snap lock hardware makes Colortron the easiest antenna to install. Winegard Colortron also has the finest *Gold Anodized finish* of any TV antenna made.

Winegard Helps You Sell . . . With *More* National Consumer Advertising *Than All Other Brands Combined!* Look for Winegard . . . on AFL Football over ABC (over 1,500,000 viewers per game) . . . in Life Magazine (over 13,000,000 readers per issue) . . . in Parade (the big Sunday supplement with 21,000,000 readers per issue).

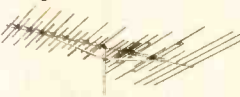
This is the Season for TV buying . . . The season for you to stock up on Winegard Colortrons. Remember . . . over 2,000,000 Color TV Sets will be sold this year and *the antenna made for color TV* is Winegard Colortron. Order today!

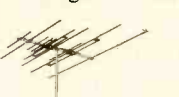
- 
COLORTRON ANTENNA
 Model C-44 • Gold Anodized • \$64.95
- 
COLORTRON ANTENNA
 Model C-43 • Gold Anodized • \$51.90
- 
COLORTRON ANTENNA
 Model C-42 • Gold Anodized • \$34.95
- 
COLORTRON ANTENNA
 Model C-41 • Gold Anodized • \$24.95



3019-N KIRKWOOD • BURLINGTON, IOWA

— for more details circle 70 on post card

Electron Beam

Advances Welding Art

▪ A 6 kw electron beam welder with an 18 in. cube welding chamber reportedly is capable of welding at full penetration through half-in. steel with better than ten to one depth to width in the weld zone.

The business end of the welder, an electron gun, may be mounted externally in fixed position or inside the welding chamber in movable fixtures. The basic welding fixture is a rotary table equipped with a six-in. three-jaw chuck. Removable doors at each end allow for extension chambers of any length to accommodate longer work pieces. An integral part of the table is an electronically controlled variable speed motor which may be mounted for vertical, horizontal or any other angle of rotation.

Rated at 30 kv, 300 ma, the unit is designed for 6 kw continuous or 9 kw short duty cycle. Vacuum working

NEW 'CONTROLLED INCIDENT WAVE'* ANTENNA



U540 TRACKER — \$29.95 list
Gold Anodized

HERE'S THE PHOTOGRAPHIC PROOF OF TRACKER'S TREMENDOUS PULLING POWER. EACH OF THESE STATIONS WAS PICKED UP ON THE TRACKER INSTALLED IN OUR BURLINGTON, IOWA LABS!



Peoria
75 miles away



Springfield
110 miles away



Peoria
75 miles away

TWICE

New! Winegard TRACKER all-channel UHF Antenna

- BRINGS HUNDREDS OF THOUSANDS OF TV VIEWERS INTO RANGE OF GOOD UHF RECEPTION FOR THE FIRST TIME.
- The TRACKER, in combination with Winegard's all-new UHF 212 Transistorized amplifier, is the biggest contribution to UHF reception in a decade.
- Brings new plus profit opportunities for thousands of Winegard dealers.

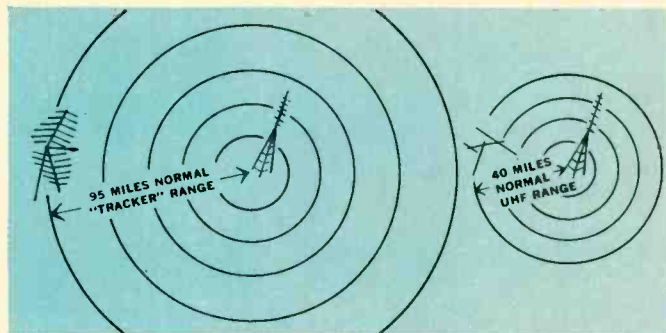

NOW UHF WITH THE SAME LONG DISTANCE RANGE AS VHF

With the development of the Winegard Tracker antenna and UHF 212 transistorized amplifier, UHF has been brought within reach of thousands of customers in your area who were outside UHF reception. This opens a new source of profits to Winegard dealers in the sale of UHF antennas, amplifiers, converters and other UHF accessories.

*At the Winegard laboratories, our engineers have discovered a new and more efficient way to focus the reflected signal (incident wave) on the collector element. For the first time, this made possible a UHF antenna with as good a signal capture ability as a VHF. The first antenna designed around the "controlled incident wave" principal is the Tracker.

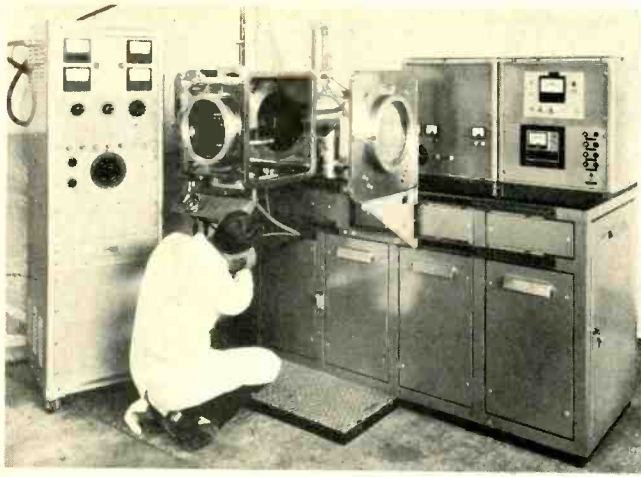

pressure is listed at under 10^{-5} torr. Pump down time is under five minutes. The electron beam welder was developed by Brad Thompson Industries, Inc. ■

Six kw electron beam welder penetrates half-in. steel.

THE RANGE of ordinary UHF antennas!

How good is the Tracker? With pre-amp, it's actually 17 times more sensitive than ordinary UHF antennas.

While other high gain antennas maintain high gain for only about 30% of the band, the Winegard Tracker has extremely high gain across *all* UHF channels 14-83. The Tracker does not favor some channels at the expense of others. Trackers' exceptional VSWR of 1.5: 1 or better on all channels is the best 300 ohm impedance match yet obtained on a broad band UHF antenna. It's an amazing antenna that will extend the range of UHF far beyond what you have previously known.

ADVANCED CONSTRUCTION FEATURES



Tracker is factory pre-assembled, has one-piece mast clamp . . . light weight . . . ALL ALUMINUM (NO STEEL). GOLD ANODIZED for all weather protection.

COMPACTLY PACKAGED

All elements unfold . . . snap in place in seconds with Winegard's new snap-lock automatic hardware. Box size 45" x 7" x 4 1/2".

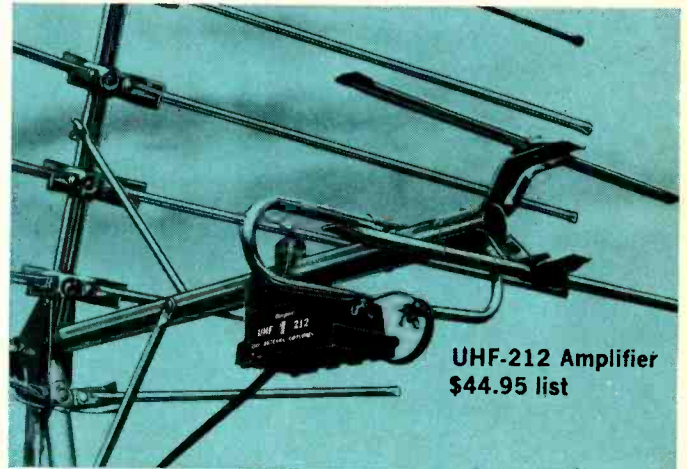

UHF-212 Amplifier
\$44.95 list

• NEW WINEGARD UHF 212 TRANSISTORIZED AMPLIFIER MOUNTS ON TRACKER.

For fringe and difficult reception areas, Winegard's new UHF-212 Twin Transistor amplifier maximizes the pulling power of the TRACKER to bring UHF signals to areas that previously could receive only VHF. It boasts an extremely high gain across all channels, 14-83, with a bandpass of 460MC to 900MC, yet the noise measured figure does not exceed 7DB even at the high end of the band.

The circuitry of the UHF-212 is completely enclosed in a black polystyrene, weather-proof housing with pre-notched twin-lead slots. Included is a unique 5-way mounting bracket for easy attachment to any UHF antenna boom or mast, under a roof eave, on side of house or wall. Separate power supply draws only 1.4 watts, plugs into any 117 VAC, 50/60 CPS outlet, and includes a detachable mounting bracket.

Try the TRACKER and UHF 212 now. See for yourself the best-performing UHF antenna and pre-amp on the market. Write for spec. sheets today.



Winegard Co.

ANTENNA SYSTEMS

3019-M Kirkwood • Burlington, Iowa

--- for more details circle 71 on post card



NEW UHF-VHF COUPLER CA-283 — Serves as coupler or splitter for channels 2-83. List \$4.50.



New UHF-VHF PIGTAIL SPLITTER (CS-283) — Attaches to back of set. Separates UHF-VHF to proper terminals. List \$3.00.



NEW SUPER COUPLERS—2 set CC200 list \$4.50, 4 set CC400 \$5.50.



NEW MATCHING TRANSFORMER (TU-1483) — for channels 14 to 83. 75 to 300 ohm. List \$5.00.



UHF ANTENNA AMPLIFIER (UHF-110X) — Single transistor amplifies channels 14-72 only. List \$34.95. UHF-110T—transistor model. List \$34.95.

HOW

SEMISTRON TRANSISTORS & DIODES REPLACE OVER 3000 SEMICONDUCTORS



only
25¢
Postpaid

POCKET-SIZE EDITION OF FAMOUS SEMISTRON REPLACEMENT AND INTERCHANGEABILITY CHART ON SEMICONDUCTORS

- The only complete replacement program for the professional technician, hobbyist, experimenter.
- Performance-proven, guaranteed, American-made.
- Service-engineered to the specs & safety ratings of the transistors they replace.
- Instant availability thru local distributors coast-to-coast.

SEMISTRON

Semitronics Corp.
265 Canal St.
N. Y., N. Y. 10013

- Send Pocket-size Chart; I enclose 25¢ for handling.
- Send 19" x 22" Wall-size Chart; I enclose 25¢ for handling.

ET-11

Name.....

Address.....

City..... State..... Zip Code.....

- - for more details circle 55 on post card

Olson

FREE

Fill in coupon for a **FREE** One Year Subscription to **OLSON ELECTRONICS' Fantastic Value Packed Catalog** - Unheard of **LOW, LOW PRICES** on Brand Name Speakers, Changers, Tubes, Tools, Stereo Amps, Tuners, CB, Hi-Fi's, and thousands of other Electronic Values. Credit plan available.

NAME.....

ADDRESS.....

CITY..... ZONE..... STATE.....

If you have a friend interested in electronics send his name and address for a **FREE** subscription also.

OLSON ELECTRONICS, INC.

317 S. Forge Street Akron, Ohio 44308

- - - for more details circle 51 on post card

NEW LITERATURE

TEST EQUIPMENT KITS 300

A 32-page catalog lists a wide selection of TV-radio test instruments available in kit form or factory wired. The catalog also covers stereo, tape recorders, speakers, amateur and citizens band equipment. Eico.

REPLACEMENT GUIDE 301

This 10-page brochure describes replacement flyback, yoke, vertical output and power transformers and chokes for color TV sets. Triad.

STEREO ACCESSORIES 302

An illustrated catalog describes a line of patch cords, adapters, Hi Fi wire, audio controls and switches. Robins.

STEREO SPEAKERS 303

A 24-page catalog describes a line of stereo speakers, speaker components, speaker system kits and stereo headphones. The booklet also includes information on speaker enclosure design. Jensen Mfg.

ELECTRONIC KITS 304

Numerous illustrations of electronic kits are included in this 108 page catalog. A selection of items for the homeowner and hobbyist is included. Heath.

STEREO CONSOLES 305

A 20-page booklet covers a line of stereo consoles. A portion of the booklet is devoted to a non-technical description of stereophonic sound. H. H. Scott.

INVERTER-TYPE SCR 306

A four-page bulletin describes the characteristics and applications of a line of inverter-type SCRs. Westinghouse.

CARTRIDGE RATINGS 307

A six-page brochure contains comparative ratings of 10 magnetic

stereo cartridges. The cartridges are rated on the basis of frequency response, separation between channels and over-all quality of music reproduction. Audio Dynamics.

TIMING RELAYS 308

An eight-page booklet covers a line of industrial rated timing relays. Methods of operation, operating specifications and design features are included. A section outlines major considerations for proper timing-relay selection. Cutler-Hammer.

PHONO PRODUCTS 309

A catalog illustrates a line of imported turntables and bases, cartridges and tone arms. A description of record-care equipment is included. Elpa.

MOVING?

Be sure to let us know your new address. Please enclose a complete address label from one of your recent issues.

**IT ONLY COSTS
1/100 OF 1¢ MORE*
PER SOLDER JOINT
TO KNOW YOU
ARE USING THE
WORLD'S FINEST
CORED SOLDER**



ERSIN
Multicore
FIVE-CORE SOLDER
SOLD ONLY BY RADIO PARTS DISTRIBUTORS

*Based on cost comparison in current catalogs.
MULTICORE SALES CORP., PORT WASHINGTON, N. Y.

- - - for more details circle 48 on post card

ELECTRONIC TECHNICIAN

Continued from page 48

to approximately 2 v, resulting in 10 v across R211. At this point the vertical oscillator conducts and quickly discharges the capacitor to zero, resulting in 12 v across R211 and the oscillator cuts off. The capacitor again charges and the sawtooth cycle is repeated.

A sawtooth signal from R211 drives the base of Q19, a PNP transistor, through C208. Base bias is derived from the voltage divider R210 and R212.

The output at the collector appears across L201, the collector load, which is connected to the vertical yoke windings through C213.

R218 and C214 suppress oscillations in the yoke during retrace time, when the yoke field collapses. R218 is a voltage-dependent resistor whose resistance becomes very low when the flyback pulse from the yoke is present. The large load on the yoke then suppresses any tendency toward oscillation.

The linearity control, R215, is adjusted to feed back a voltage from the emitter which will control the charging rate of C209 to produce a linear picture. R216 controls the amplitude of the sawtooth at the output of Q19.

R210 adjusts the bias on the base of Q19. It is adjusted while looking at the picture after the height and linearity controls are correctly set. Observe the top of the picture and adjust R210 until the top just compresses slightly. Then adjust R210 until the top of the picture is just out of compression.

The RC network C212, R214, C111, shapes the output pulse of Q19 into a spiked waveform which is the vertical blanking pulse. This pulse is fed to the video amp emitter through R213.

The horizontal oscillator (Fig. 9) of the FY G-E color chassis utilizes a 6BH11 compactron. V501 contains three sections, a reactance control pentode, V501A a triode oscillator V501B and a horizontal discharge triode V501C.

The sinewave oscillator V501B has a balanced tank coil connected to the plate through R513 and to the grid through C511 and R511. The portion of L501 between terminals 1 and 2, in parallel with C506, is the balanced tank coil which determines the oscillator frequency. The center tap at terminal 3 is connected to ac ground at B plus (140v). The section of L501 between terminals 2 and 4 is autotransformer-coupled to the balanced tank coil and provides feedback to the grid to sustain oscillations.

The reactance pentode V501A is also connected across the balanced tank coil. C507 connects coil terminal 1 to the grid with a phase shift of 90 deg out of phase with the plate which makes V501A look like a reactance to L501. The plate of V501A is connected to coil terminal 2 through the oscillator feedback section of the coil which also serves to prevent V501A from unbalancing the frequency determining tank circuit.

Sinewave reference voltages from terminals 1 and 2 of the coil are connected respectively to the anodes of CR501 and CR502, the horizontal phase detector. This action alone will produce a zero voltage output from the phase detector caused by cancellation of equal but oppositely polarized voltages across R501 and R502. In the same manner, a zero voltage will

You get your "ticket" to greater income

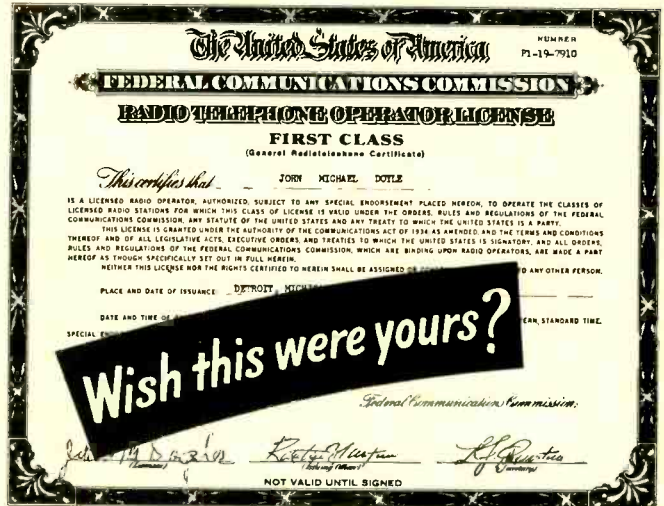

or your money back

THERE'S A WORLD OF OPPORTUNITY FOR THE MAN WITH AN FCC LICENSE

All it takes is a few spare hours a week and NRI's FCC License Course to open the way to increased opportunities in Communications. With an FCC License, you're ready to operate, service and install transmitting equipment used in aviation, broadcasting, marine, mobile and Citizens-Band communications.

What does it take? Men with absolutely no training or experience in Electronics complete the course in 10 months. A Technician or man with some background can easily cut that time in half. And because NRI has a greater enrollment than any other school of its type, training costs you less than comparable courses offered by other schools. Further, YOU MUST PASS your FCC exams or NRI refunds your tuition in full.

Get full details today about NRI FCC License Course plus 9 other home-study instruction plans offered by NRI, oldest and largest school of its kind. Mail coupon for free catalog. There's no obligation. No salesman will call. NATIONAL RADIO INSTITUTE, Washington, D.C.

MAIL NOW for FREE CATALOG

	NATIONAL RADIO INSTITUTE Electronics Division Washington, D. C. 20016		14-114
	Please send me complete information on FCC License Training and other NRI courses, as checked below. (No salesman will call.)		
<input type="checkbox"/> FCC License <input type="checkbox"/> Complete Communications <input type="checkbox"/> Aviation Communications <input type="checkbox"/> Marine Communications <input type="checkbox"/> Mobile Communications	<input type="checkbox"/> Radio-TV Servicing <input type="checkbox"/> Industrial Electronics <input type="checkbox"/> Electronics for Automation <input type="checkbox"/> Basic Electronics <input type="checkbox"/> Math for Electronics		
Name _____ Age _____ <small>PLEASE PRINT</small>			
Address _____			
City _____ State _____ Zip _____			
ACCREDITED MEMBER NATIONAL HOME STUDY COUNCIL			

... for more details circle 49 on post card

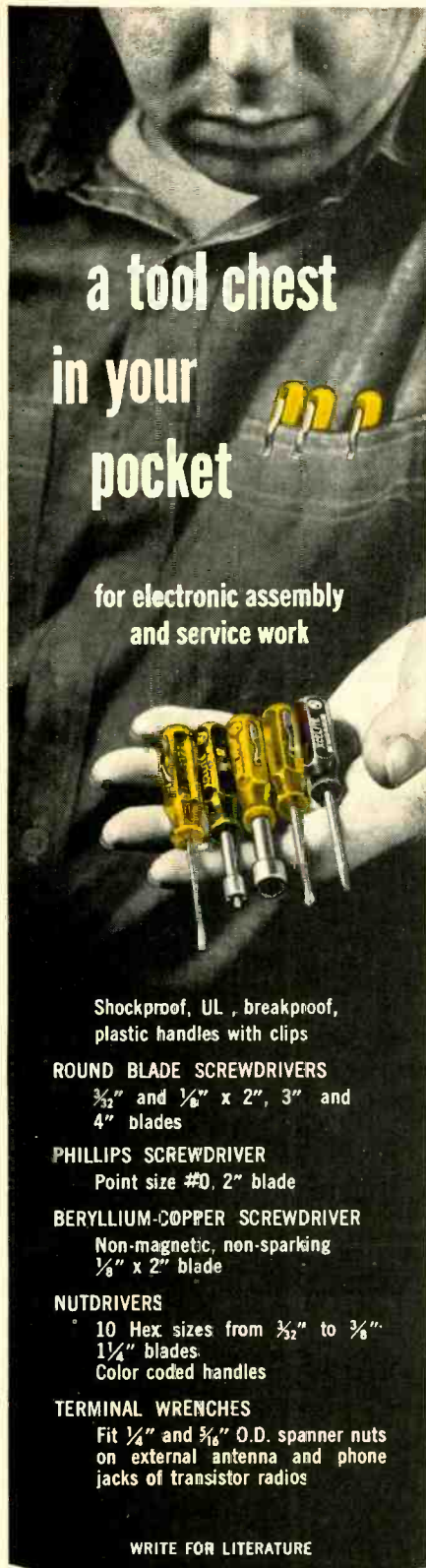

a tool chest
in your
pocket

for electronic assembly
and service work

Shockproof, UL, breakproof,
plastic handles with clips

ROUND BLADE SCREWDRIVERS

$\frac{3}{32}$ " and $\frac{1}{8}$ " x 2", 3" and
4" blades

PHILLIPS SCREWDRIVER

Point size #0, 2" blade

BERYLLIUM-COPPER SCREWDRIVER

Non-magnetic, non-sparking
 $\frac{1}{8}$ " x 2" blade

NUTDRIVERS

10 Hex sizes from $\frac{3}{32}$ " to $\frac{3}{8}$ "
 $\frac{1}{4}$ " blades
Color coded handles

TERMINAL WRENCHES

Fit $\frac{1}{4}$ " and $\frac{3}{16}$ " O.D. spanner nuts
on external antenna and phone
jacks of transistor radios

WRITE FOR LITERATURE

XCELITE

**PROFESSIONAL
POCKET TOOLS**

XCELITE, INC., 14 Bank St., Orchard Park, N.Y.
Canada: Charles W. Pointon, Ltd., Toronto, Ont.

for more details circle 74 on post card

be produced if horizontal negative sync pulses alone from the sync separator through C501 are connected to the common cathodes of CR501-CR502. Any change in the oscillator frequently will unbalance the phase detector and produce a correction voltage at the anode of CR501 which is fed to the grid of V501A through R504 and R507. With V501A in parallel with L501, the change in reactance returns the oscillator to the correct frequency. R508, C508, and C509 provide damping to prevent oscillator hunting. The RC networks C502, C503, R506 and C504, C505, R508 act as low pass filters to prevent coupling of sync pulses to the oscillator circuit. R503 is the grid return to ground of V501A. R131, the horizontal hold control, varies the effective reactance of V501A.

The waveform at the grid of the oscillator V501B is a sinewave with the positive half cycle clipped. This waveform along with he shaping network R513, R514 and C512 produces a modified square wave at the plate of V501B and the grid of the horizontal discharge triode V501C.

The purpose of the discharge triode is to prevent oscillator phase shift caused by variations in the out-put circuit of V103 which might be coupled back to the oscillator resulting in top curl and other undesirable conditions in the picture. The waveform at the plate of V501C is shaped by C513 and R516 and coupled to the grid of V103 through C514 and R116.

DuMont

The 1965 DuMont TV chassis employs a modified form of electron-coupled Hartley sine-wave oscillator in the horizontal circuit. The resonant circuit varies somewhat from that commonly found in a Hartley-type oscillator, since it uses both a tapped coil and a split capacitance, assuring a more stabilized ratio of feedback signal for the tube's input grid.

Major frequency-determining components in this circuit (Fig.10) are composed of the horizontal hold connected across it. Proper frequency is maintained by the shunting effect of C52 (in series with the dynamic plate resistance of the triode section of the tube) across the coil. Since the dynamic plate resistance of the triode section varies with changes in the bias voltage applied to its grid, a corresponding change in the shunting effect of capacitor C52 across the horizontal hold coil will result, maintaining the oscillator at the required frequency.

In actual operation, the grid voltage is made to vary horizontal phasing diodes, where it is developed by

comparing a sample pulse of the oscillator frequency (obtained from the horizontal output transformer) and the horizontal pulse from the sync separator. Improper oscillator performance can result not only from failure of one of the major frequency-determining components C54, C55 and L11, but from the failure of the shunting capacitor (C52) or its associated triode circuitry. Defective components in the horizontal phase diode circuit could also cause an unstable oscillator stage.

The December issue of ELECTRONIC TECHNICIAN will contain circuit information on additional 1965 sets, including Magnavox, Packard Bell, Philco, RCA, Satchell Carlson, Sylva, Westinghouse and Zenith. ■

STATEMENT REQUIRED BY THE ACT OF OCTOBER 23, 1962 (39 U.S. Code, 4369) SHOWING THE OWNERSHIP, MANAGEMENT AND CIRCULATION OF ELECTRONIC TECHNICIAN published monthly at Duluth, Minnesota for November 1964.

1. The names and addresses of the publisher, editor and managing editor are: Publisher, Ron Kipp, 555 Fifth Avenue, N.Y., N.Y. 10017; editor, none; Managing Editor, Jack Hobbs, Ojibway Building, Duluth, Minnesota 55802.

2. The owner is: (If owned by a corporation, its name and address must be stated and also immediately thereunder the names and addresses of stockholders owning or holding 1 percent or more of total amount of stock. If not owned by a corporation, the names and addresses of the individual owners must be given. If owned by a partnership or other unincorporated firm, its name and address, as well as that of each individual must be given.) OJIBWAY PRESS, INC., Ojibway Building, Duluth, Minn. 55802. (Sole stockholder — OJIBWAY PRESS, INC., Ojibway Building, Duluth, Minn. 55802) Royal D. Alworth, Jr., 1605 Alworth Building, Duluth, Minn.; Robert L. Edgell, 1 East First Street, Duluth, Minn.; Albert J. Forman, Woodbrook Drive, Springdale, Conn.; H. B. Fryberger, Jr., 712 Lonsdale Building, Duluth, Minn.; William B. Fryberger, 712 Lonsdale Building, Duluth, Minn.; C. E. Fuller, Jr., 711 Alworth Building, Duluth, Minn.; Verne D. Johnson, Jr., 302 East Superior Street, Duluth, Minn.; E. A. Kuefner, 1725 Vermillion Road, Duluth, Minn.; S. R. Mason, 212 Medical Arts Building, Duluth, Minn.; Arthur E. A. Mueller, Mueller Building, Wausau, Wis.; Nornat Company, c/o Trust Dept., Northern City Bank, Duluth, Minn.; Robert E. Nickerson, 168 Mason Street, Greenwich, Conn.; Jeno Paulucci, 200 North 50th Ave. West, Duluth, Minn.; Howard Reed, 174 Waverly Road, Scarsdale, N.Y.; Antia Reing, 1 East First Street, Duluth, Minn.; Marshall Reing as custodian for Janet Reing, 1 East First St., Duluth, Minn.; Mary Anne Reing, 2032 Belmont Road N.W., Washington, D.C.; L. M. Rosenthal, 330 East 49th Street, New York, N.Y.; Martin Wold Company, 7 East First Street, Duluth, Minn.

3. The known bondholders, mortgagees and other security holders owning or holding 1 percent or more of total amount of bonds, mortgages, or other securities are: If there are none, so state.) None.

4. Paragraphs 2 and 3 include, in cases where the stockholder or security holder appears upon the books of the company as trustee or in any other fiduciary relation, the name of the person or corporation for whom such trustee is acting, also the statements in the two paragraphs show the affiant's full knowledge and belief as to the circumstances and conditions under which stockholders and security holders who do not appear upon the books of the company as trustees, hold stock and securities in a capacity other than that of a bona fide owner.

5. The average number of copies of each issue of this publication sold or distributed, through the mails or otherwise, to term paid subscribers during the 12 months preceding the date shown above was (This information is required by the act of October 23, 1962, to be included in all statements regardless of frequency of issue.) 80,835. Sales through news agents: None. Free distribution (including samples) by mail, carrier delivery, or by other means 3,399. Total number of copies distributed: 84,234.

(Signature) Dean Myhran
Vice President

NOW

from ALLIANCE—the world's leading antenna rotator manufacturer...

NEW

T-45

TENNA-ROTOR®



The new Alliance T-45 Tenna-Rotor® will meet the most exacting requirements of today's TV viewers. It has the same built-in quality that has won millions of satisfied customers for other Alliance products.

A new, patented five wire bridge circuit provides a precision system that's unaffected by motor current, cable length and line voltage variations. This improved electrical system, plus stable indication and expanded meter scale, assures positive antenna direction and readability through a stepless 360° cycle.

The T-45's motor is stronger — has more torque — to support, hold and turn the largest new antennas. Outstanding engineering — and smart styling — make the T-45 America's finest manually operated antenna rotator. Order the T-45 and other quality Tenna-Rotors® from Alliance — the world's leading manufacturer of antenna rotating devices.

"TV's better color getter"

For Complete Details write...



The
ALLIANCE
Manufacturing Co., Inc.
Alliance, Ohio

(Subsidiary of Consolidated
Electronics Industries Corp.)

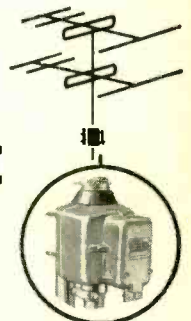

--- for more details circle 13 on post card

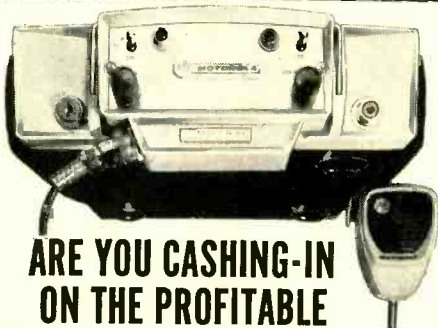

ARE YOU CASHING-IN ON THE PROFITABLE 2-WAY RADIO SERVICE BUSINESS?

- ★ Motorola will train you for this rewarding, elite profession
- ★ Send for our FREE EVALUATION EXAM. Prove to yourself that you are ready to learn FM 2-way radio servicing.

Opportunities in 2-way radio servicing are virtually unlimited. ■ Just one of the hundreds of successful Motorola Service Stations writes, "we would be pleased to interview any graduate of your school that has received some training in 2-way radio maintenance. We are an established firm, 10 years old, with a promise of expansion governed by our ability to obtain competent technicians." ■ Get all the facts today. There is no obligation and no salesman will call.



MOTOROLA TRAINING INSTITUTE

4545 West Augusta Blvd. • Chicago 51, Illinois • Dept. AEH445

- Send me FREE entrance exam.
- Send full details on Home Study Course on FM 2-way Radio Servicing
- Send me details on how you can help me prepare for an FCC License.

Name _____ Occupation _____

Address _____

City _____ Zone _____ State _____

--- for more details circle 47 on post card



FOR THE ULTIMATE IN TV TUBE PERFORMANCE

SPECIFY GRIFFITHS GUN MOUNTS

Griffiths unique and patented method of treating cathodes (processed in an air-conditioned, humidified, atmosphere) results in the closest tolerance of finished tubes. For the mark of quality... Ask for the Griffiths Grid, "the grid with the lid."

See your independent Tube Manufacturer

GRIFFITHS ELECTRONICS

1301 E. Linden Avenue, Linden, N. J. P.O. Box 602
Area Code 201 925-7300

--- for more details circle 32 on post card

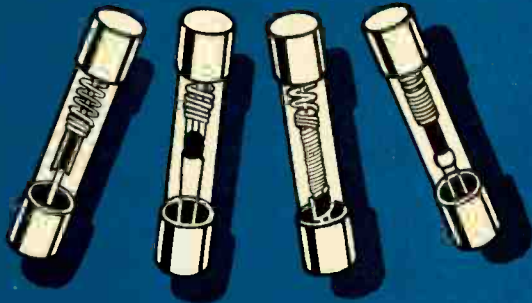

FUSETRON dual-element Fuses

time—delay type

“Slow blowing” fuses that prevent needless outages by not opening on motor starting currents or other harmless overloads—yet provide safe protection against short-circuits or dangerous overloads.

BUSS

Write for BUSS
Bulletin SFB

BUSSMANN MFG. DIVISION, McGraw-Edison Co., St. Louis, Mo. 63107

ary-July was 5,010,218. This figure included 90,186 color TV sets for July, and 689,531 for the first seven months of 1964. Monochrome TV receiver production for July was 427,231, compared to 384,291 in July 1963, and the January-July total was 4,320,687 units, compared to 3,844,212 for the same 1963 period.

Zenith 25-in. Color TV

Zenith Sales Corp. introduces a 25-in. color TV receiver. The rectangular color tube was developed and manufactured by the Rauland Corp. It is a three gun, shadow mask type with a projected viewing area of 300 sq in., a 90 deg deflection angle, and is 4 in. shorter than the 21-in. round, 70 deg color tube.

Zenith Sets Record

L. C. Truesdell, Zenith Sales Corp. president reports that the company has sold more than 1,250,000 TV receivers in less than 9 months of 1964, a new all-time record and the sixth straight year of million-plus TV set sales. Truesdell said his company is aiming for a sales figure of 1,750,000 TV sets in 1964.

Olympic Distributors

Two Olympic distributors are named by Morton M. Schwartz, president of Olympic Radio and Television Sales Corp., Long Island City. They are Spicola

BUSS: 1914-1964, Fifty years of Pioneering....

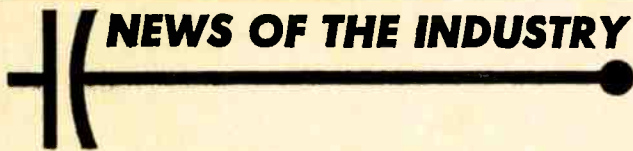

RCA Hits Millionth Set

RCA announces that the sale of TV receivers had passed the million mark during August 1964, more than a month ahead of last year's record pace. Raymond W. Saxon, Division Vice President and General Manager, Home Instruments Division said the continued growth of color TV, accompanied by a sizeable increase in the company's black-and-white TV business, will establish 1964 as the company's biggest television sales year in units, dollars and profits.

TV Set Sales/Production Up

Distributor sales and production of monochrome TV sets during July were up substantially from comparable figures in July 1963 according to a report by Electronic Industries Association's Marketing Services Department. Sales of monochrome TV sets totaled 557,183 for July, compared to 448,441 in July 1963. The July figures brought the total for the first seven months of this year to 4,000,256, compared to 3,405,249 for the same period of 1963. Total TV production for July was 517,417 units and the total for Janu-



SIGNAL
ACTIVATING
•
LAMP
INDICATING
•
SERIES
HKA

BUSS FUSEHOLDERS

FOR 1/4" x 1 1/4" INCH BUSS GLD FUSES, 1/2 TO 5 AMPS.

When fuse opens, indicating pin completes a circuit that lights indicating lamp in holder and makes contact on external signal circuit. External signal can be an audible alarm or another lamp mounted at a distance, or it can operate a relay.

BUSS

Write for BUSS
Bulletin SFB

BUSSMANN MFG. DIVISION, McGraw-Edison Co., St. Louis, Mo. 63107

... for more details circle 22 on post card
ELECTRONIC TECHNICIAN

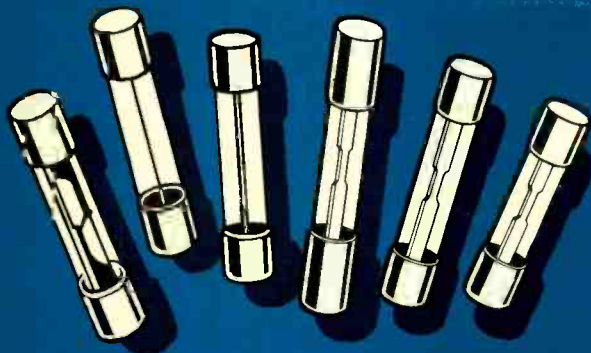

BUSS quick-acting Fuses

"Fast Acting" fuses for protection of sensitive instruments or delicate apparatus;—or normal acting fuses for protection where circuit is not subject to starting currents or surges.

BUSS

Write for BUSS
Bulletin SFB

BUSSMANN MFG. DIVISION, McGraw-Edison Co., St. Louis, Mo. 63107

Philco Produces 21 in. Color Tube

J. S. Vansant, manager of Philco's color tube production operation, announces that prototype production on a 21 in. color tube is under way and expects the tube to be in quantity production by the first quarter of 1965. The manufacturing facility is in a wing of the Lansdale Division's cathode ray tube operation. Prototype samples are expected to be available in the last quarter of this year, Vansant said.

Mallory Opens New Plant

G. Barron Mallory announces that the Mallory Capacitor Co. will open a plant at Glasgow, Kentucky, early next year. He said the 85,000 sq ft plant will be suitable for production of almost any kind of electrolytic capacitor and employment may eventually reach 500. The all-steel plant includes a complete environmental control system (temperature, dust and humidity), Mallory said.

Production Transfer

Admiral Corp. announces the start of production of VHF and UHF TV tuners and TV picture tube yokes in its McHenry, Illinois facility which had been leased to another company since 1958. Employment is expected to reach 300 by the end of the year. C. S. Rossate, vice president-production, said the components had been produced previously at the company's major electronics plant in Harvard.

...New Developments in Electrical Protection

Appliances, Inc., Tampa, Florida, and Robinson TV Distributors, Las Vegas, Nevada. Spicola Appliances will distribute the complete line of Olympic electronic products in southwest and central Florida. Robinson TV will cover Clark, Lincoln, Nye and Esmeralda Counties in Nevada and Cedar City and St. George counties in Utah.

Storm Finder Radar

Six more "storm finder" radars that detect and track hurricanes and tornadoes up to 250 miles away are being purchased by the weather bureau from Raytheon. Used by the weather bureau to issue earlier and more reliable storm warnings, the units reportedly will strengthen coverage of the Bureau's present radar weather station national Network. Earlier, the weather bureau had installed adequate coverage in "Tornado Alley" and along the Atlantic hurricane belt. The new radar will fill the gap in the basic network between these two areas. Six new units are scheduled to be delivered starting in the spring of 1965.

Sony Opens Facility

Videoflight, Inc., a subsidiary of the Sony Corp. has opened service facilities in Jamaica, N.Y. Videoflight was formed to handle Sony's airborne live television and film entertainment system. The new facility will transfer motion pictures to video tape for airplane passenger communication or entertainment.

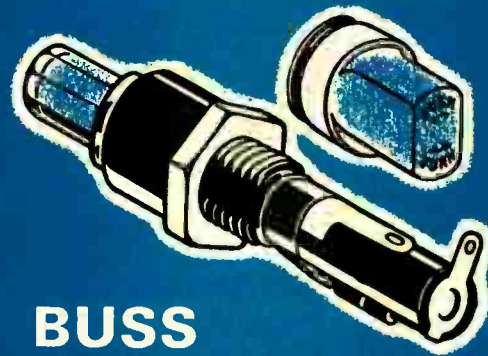

FLATSIDED
KNOB ALSO
AVAILABLE

BUSS FUSEHOLDERS

LAMP INDICATING SERIES HJ AND HK
FOR $\frac{1}{4}$ x 1 AND $\frac{1}{4}$ x $1\frac{1}{2}$ INCH FUSES

Quick, positive, visual identification of faulted circuit. Bayonet type, *transparent* knob permits indicating light to be readily seen.

Fuseholder designed to withstand severe vibration. Terminals held mechanically as well as by solder.

Holder can be used in panels up to 3/16 inches thick.

BUSS

Write for BUSS
Bulletin SFB

BUSSMANN MFG. DIVISION, McGraw-Edison Co., St. Louis, Mo. 63107

... for more details circle 22 on post card

Winegard Dealer of the month

No. 29 of a Series

Bill Eastlake says: "We've installed approximately 200 Winegard Antennas in the last two years and have yet to receive a complaint."



Jack Wright, West Essex TV's antenna specialist, loads his truck with Winegard Antennas.

Winegard salutes West Essex Television Service, Inc., Caldwell, New Jersey.

Bill Eastlake, service mgr. at West Essex TV and Appliance, and Jack Wright, their antenna specialist, have found that it pays to install the best. "We've seen that it does not pay to put up cheap antennas and therefore we use Winegard exclusively. We haven't had a single call-back since we switched to Winegard."

The confidence Bill Eastlake and Jack Wright have shown in Winegard comes from installing them and seeing them in action. They're two more important service men who know Winegard's standards of excellence first hand.

Winegard Co.

Antenna Systems

D3019-K Kirkwood • Burlington, Iowa

--- for more details circle 72 on post card

Advertiser's Index

Admiral Corporation	82
Alliance Mfg. Company	103
American Telephone & Telegraph	95
Arco Electronics, Inc.	19
Arrow Fastener Co., Inc.	90
B & K Manufacturing Co.	67
B & K Manufacturing Co.	69
B & K Manufacturing Co.	71
Belden Mfg. Company	93
Blonder-Tongue	32
Bussmann Mfg. Div.	104-105
Centralab, Electronics Div. of Globe-Union, Inc.	35
Channel Master Corp.	39
Channel Master Corp.	41
Cleveland Institute of Electronics	86
Columbia Wire & Supply Co.	84
Cornell-Dubilier	33
EICO Electronic Instrument Co., Inc.	87
Finney Company	42-43
GC Electronics	91
General Electric Co., Receiving Tubes Dept.	64-65
Griffiths Electronics	103
Hallcrafters Company	94
Hallmark Instruments	82
Heath Company	89
Hi-Lo Mfg. Company	89
Jackson Electrical Instrument Co.	20
Jensen Industries, Inc.	86
Jensen Manufacturing Co.	83
Jerrold Electronics	2nd Cover
JFD Electronics	44
Lafayette Radio Electronics Corp.	29
Lectrotech, Inc.	40
P. R. Mallory & Co., Inc.	81
Mercury Electronics Corp.	92
J. W. Miller Company	84
Minnesota Mining & Mfg. Co.	90
Motorola Communications	103
Multicore Sales Corp.	100
National Radio Institute	101
Nortronics, Inc.	88
Olson Electronics, Inc.	100
Perma-Power Company	38
Philco Corporation	30-31
Radio Corporation of America Electronic Components & Devices	79, 4th Cover
Rohn Manufacturing Co.	70
Sarkes Tarzian Tuner Service Div.	37
Seco Electronics	3rd Cover
Semitronics Corp.	100
Sencore, Inc.	22
Sencore, Inc.	24
Sencore, Inc.	26
Sencore, Inc.	28
Sonotone Corp.	34
Sprague Products Company	23
Sprague Products Company	25
P. A. Sturtevant Company	90
Sylvania Electric Products, Inc.	72
Sylvania Electric Products, Inc.	85
TechPress, Inc.	106
Tektronix, Inc.	75
Texas Crystals	106
Triplett Electrical Instrument Co.	80

Ungar Electric Tools	36
University Loudspeakers	27
Winegard Company	96-97
Winegard Company	98-99
Winegard Company	106
Workman Electronic Products, Inc.	94
Xcelite, Inc.	102



3 PLANTS TO SERVE YOU BETTER



**HERMETICALLY SEALED
PRECISION GROUND
CUSTOM-MADE
NON-OVEN CRYSTALS**

Gold or silver plated, spring mounted, vacuum sealed or inert gas, high freq. stability, 10 milliwatt max. current cap. Meet mil. specs. 1000KC to 1600KC (Fund. Freq.)

1601KC to 2000KC (Fund. Freq.)	\$5.00 ea.
2001KC to 2500KC (Fund. Freq.)	4.00 ea.
2501KC to 5000KC (Fund. Freq.)	3.50 ea.
5001KC to 7000KC (Fund. Freq.)	3.90 ea.
7001KC to 10,000KC (Fund. Freq.)	3.25 ea.
10,001KC to 15,000KC (Fund. Freq.)	3.75 ea.
15MC to 20MC (Fund. Freq.)	5.00 ea.

OVERTONE CRYSTALS

15MC to 30MC Third Overtone	\$3.85 ea.
30MC to 40MC Third Overtone	4.10 ea.
40MC to 65MC Third or Fifth Overtone	4.50 ea.
65MC to 100MC Fifth Overtone	6.00 ea.
DRAKE 2-B Receiver Crystals	\$4.00

(All Channels—Order by Freq.)

OVEN-TYPE CRYSTALS

For Motorola, GE, Gonsset, Bendix, etc. Add \$2.00 per crystal to above prices

SUB-MINIATURE PRICES slightly higher

ORDER FROM CLOSER PLANT



TEXAS CRYSTALS

DEPT. T
1000 Crystal Drive
FORT MYERS, FLORIDA
Phone 813 WE 6-2109

Division of



AND
4117 W. Jefferson Blvd.
LOS ANGELES, CALIF.
Phone 213-731-2258

--- for more details circle 66 on post card

New from TECHPRESS

**WANT A SPECIFICATIONS
AND SUBSTITUTION BOOK
ALL IN ONE?**

Transistors, that is . . .

Well, we've got one. It lists over 5,000 transistor types, their specs, and over 16,000 direct substitutes for these types. The substitutes (chosen by an electronic computer) are listed in the order of their accuracy of substitution.

The specifications comprise: maximum P_c at both ambient and case temperatures; maximum I_c , V_{CE} , V_{CB} , and V_{EB} ; maximum I_{EBO} at a given V_{EB} ; typical f_{re} of a given V_{CE} , I_c , and frequency; transistor type; case diagram, and f_t .



Basic, down to earth explanations of transistor specifications make Transistor Specifications and Substitution Handbook (Second Edition) the most authoritative and complete specifications OR substitutions book on the market.

At your distributors now . . . only \$1.95

TechPress Publications
Brownsburg, Indiana, 46112

MODEL 107B FEATURES "NO-SET-UP" TESTING

40 prewired sockets accommodate 63 basic pin arrangements for testing all modern TV, radio, industrial and foreign tubes. Also included is a plug-in chassis with 8 sockets wired to 14 lever type pin selectors for testing tubes circuit by circuit. To eliminate errors in reading, all information reads on *one* meter and *one* scale. Three comprehensive tests—Grid Circuit Test, Dynamic Mutual Conductance Test and Cathode Emission Test. Model 107B is always up to date—data book pages covering new tubes are mailed periodically to registered owners. ONLY \$189.50 net.

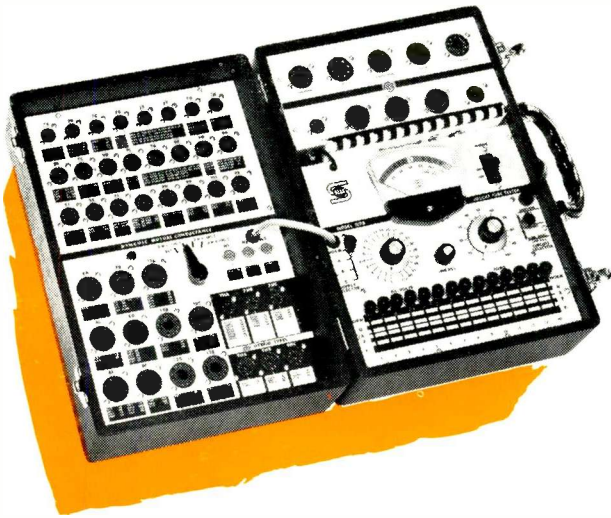

SECO'S patented Grid Circuit Test detects "hard to find" tube faults

GRID CIRCUIT TEST makes up to 11 simultaneous checks
for leaks, shorts and grid emission

MODEL 98 FEATURES PICTURE TUBE TEST

Tests over 400 cathode ray picture tubes including 110° deflection types—has 12-pin picture tube socket. Also has replaceable plug-in chassis for receiving tubes—guaranteed up-to-date including novars, nuvistors, 10-pin types, compactrons and magnovals. This chassis can be replaced for new tubes or customized for special uses. Dial controls isolate or transpose tube circuits and select test current—Grid Circuit Test, Tube Merit Test and Heater Current Test. Removeable cover holds speed-indexed tube data cards, pin straighteners and condensed operating instructions. ONLY \$99.50 net.



MODEL 88—COMPLETE TESTER AT LOW COST

Performs the same picture tube test as Model 98. Tests all receiving tubes including novars, nuvistors, 10-pin types, compactrons and magnovals. Grid Circuit Test, Tube Merit Test and Filament Continuity Test—you can find cathode emission, leaks, shorts, grid emission, gas error, filament continuity and cathode-to-heater emission. Stationary receiving tube chassis. Unit comes complete with speed-indexed setup data, pin straighteners and 12-pin picture tube socket on a 3-foot cable. ONLY \$74.50 net.



For complete information on Seco test equipment, see your electronic supply distributor or write:

SECO ELECTRONICS, INC.

1211 S. CLOVER DRIVE • MINNEAPOLIS, MINNESOTA 55420
A DIVISION OF DI-ACRO CORPORATION

... for more details circle 11 on post card

TOY

RCA
presents
a...

Festival!



Get these and other wonderful toys *now*—in plenty of time for Christmas. **THEY'RE AVAILABLE WITH YOUR PURCHASE OF FAMOUS RCA ENTERTAINMENT RECEIVING TUBES FROM YOUR PARTICIPATING RCA DISTRIBUTOR.** Shown below are some of the toys.



AMF ROADMASTER 26" BICYCLE. The sleek "Skyrider" in both boys' and girls' models. Chrome-plated headlight and other "most wanted" features will make it the hit of the year under your Christmas tree.

Boys (TFP-9675): red with white trim
Girls (TFP-9685): blue with white trim

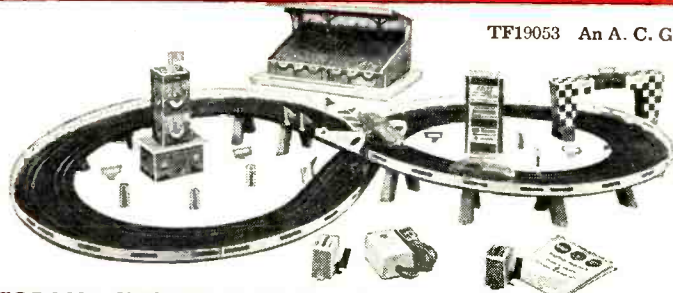

TF19053 An A. C. Gilbert Toy

GILBERT

AUTORAMA SPEEDWAY RACE. Action car racing with separate speed controls for each car. New "See-Saw Ramp" can be used as a jump ramp for extra thrills. Comes with all accessories to simulate a race track.



DELI-CAT. Cute as a button. Comes with brush for stroking her long silky hair. Prettiest little cat a girl ever owned.

IDEAL TF7325-0 An Ideal Toy



TINY PEBBLES DOLL. From the "Flintstone" family of TV fame...a prehistoric peach of a doll. Jointed arms and legs. 12" high.

IDEAL TF0720-3 An Ideal Toy

TF4722-5 An Ideal Toy



U.S.N. ANZIO INVADER. A 31" landing craft complete with tank destroyer, helicopter and pilot, 14 combat-ready soldiers with weapons. Made of rugged plastic.

These and other exciting toys are available **NOW** with your purchase of RCA Entertainment Receiving Tubes. See your nearest participating RCA Distributor for details.

RCA ELECTRONIC COMPONENTS AND DEVICES, HARRISON, N.J.



The Most Trusted Name in Electronics