

COMPUTERS — MACHINES THAT "THINK"

RADIO & TELEVISION NEWS

Van Lines Inc.
145
Arlington

JANUARY
1957
35 CENTS

World's Leading Electronics Magazine

**POWER REQUIREMENTS
FOR HI-FI**

FROM SUN TO SOUND

**LOW PLATE-POTENTIAL
TUBES**

**SERVICE TECHNIQUES FOR
MODULAR CIRCUITS**

**SHORTENED
ROTARY BEAM ANTENNAS
FOR THE AMATEUR**

BUYING A TONE ARM

**LOW-COST
SCANNING GENERATOR**

THE "UNIVAC" ▶
(See Page 41)

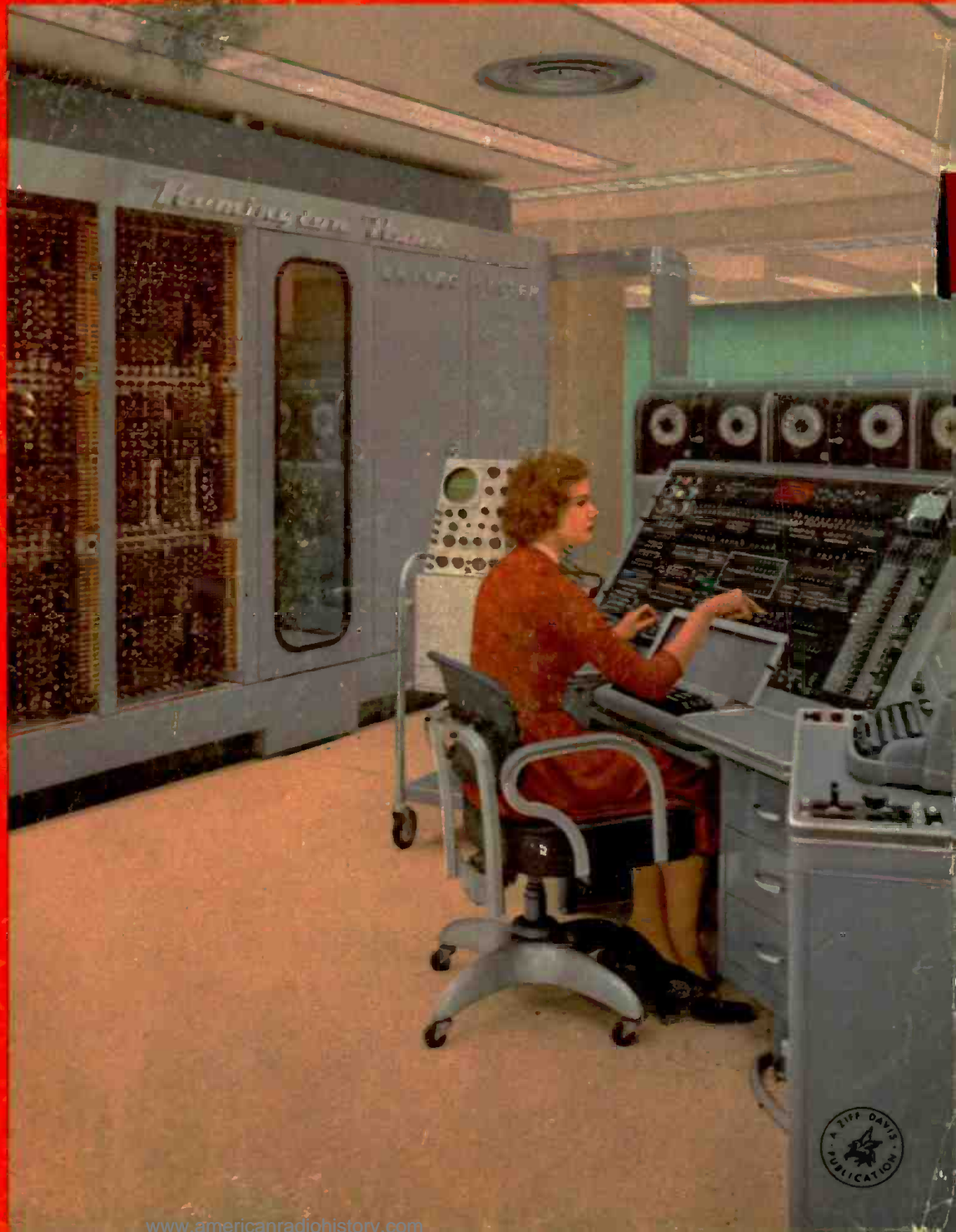

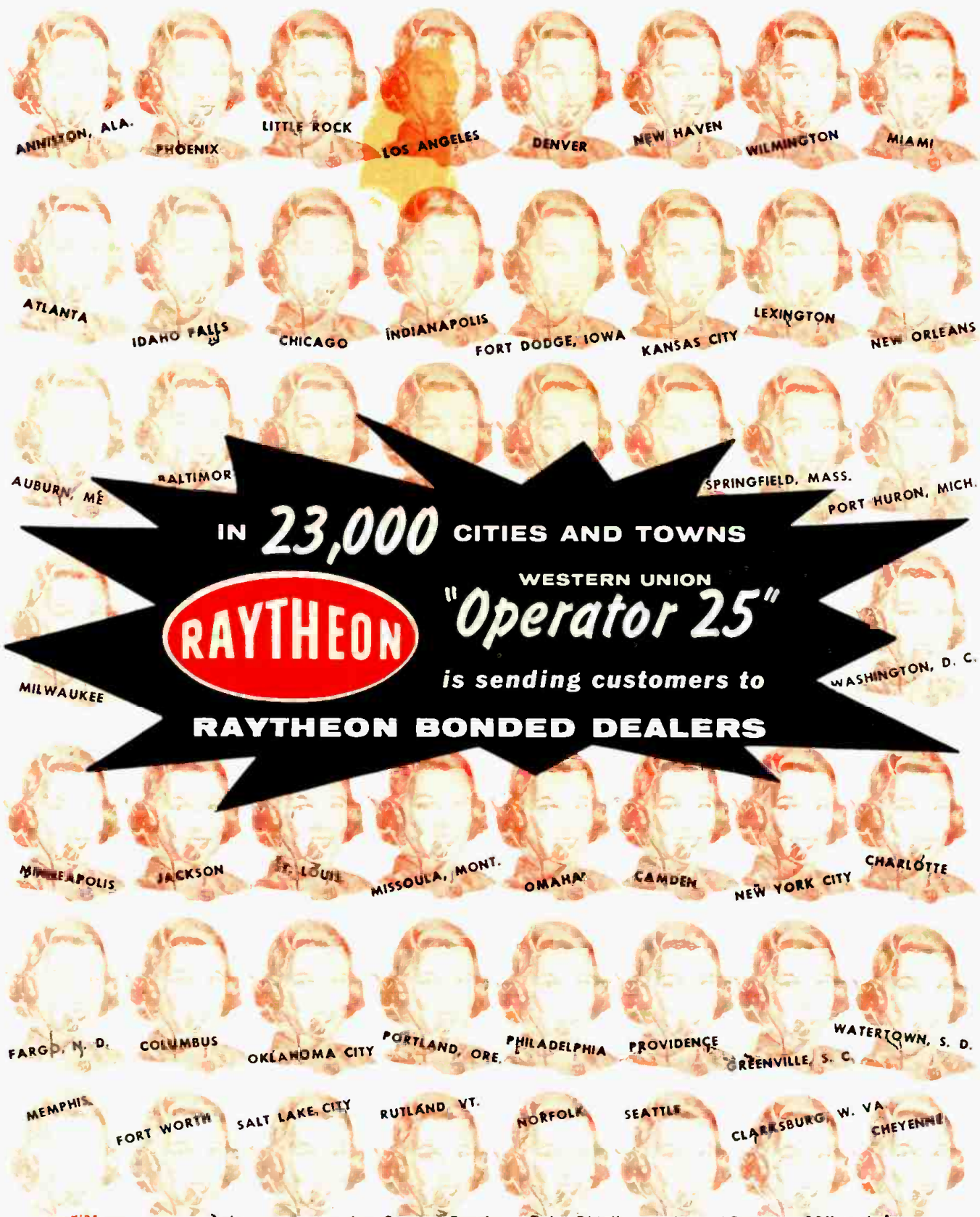

ANNISTON, ALA.

PHOENIX

LITTLE ROCK

LOS ANGELES

DENVER

NEW HAVEN

WILMINGTON

MIAMI

ATLANTA

IDAHO FALLS

CHICAGO

INDIANAPOLIS

FORT DODGE, IOWA

KANSAS CITY

LEXINGTON

NEW ORLEANS

AUBURN, ME

BALTIMOR

SPRINGFIELD, MASS.

PORT HURON, MICH.

IN **23,000** CITIES AND TOWNS



WESTERN UNION
"Operator 25"

is sending customers to

RAYTHEON BONDED DEALERS

MILWAUKEE

WASHINGTON, D. C.

MILWAUKEE

JACKSON

ST. LOUIS

MISSOULA, MONT.

OMAHA

CAMDEN

NEW YORK CITY

CHARLOTTE

FARGO, N. D.

COLUMBUS

OKLAHOMA CITY

PORTLAND, ORE.

PHILADELPHIA

PROVIDENCE

GREENVILLE, S. C.

WATERTOWN, S. D.

MEMPHIS

FORT WORTH

SALT LAKE CITY

RUTLAND, VT.

NORFOLK

SEATTLE

CLARKSBURG, W. VA.

CHEYENNE

THEY'RE RIGHT...



Ask your Sponsoring Bonded Raytheon Tube Distributor about "Operator 25" and the many other important advantages of being a Raytheon Bonded Electronic Technician.

RAYTHEON MANUFACTURING COMPANY

Receiving and Cathode Ray Tube Operations

Newton, Mass. • Chicago, Ill. • Atlanta, Ga. • Los Angeles, Calif.

Raytheon makes all these Receiving and Picture Tubes, Reliable Subminiature and Miniature Tubes, Semiconductor Diodes, Power Rectifiers and Transistors, Nucleonic Tubes, Microwave Tubes



An Invitation...

To men who want to "go places" in TV SERVICING

Find out about this **NEW**,
ALL-PRACTICE WAY
of becoming a **Professional**
TV SERVICEMAN

If you have some Radio or Television experience, or if you know basic Radio-Television principles but lack experience—NRI's new Professional Television Servicing course can train you to go places in TV servicing. This advertisement is your personal invitation to get a free copy of our booklet describing this training in detail.

Learn-by-Doing "All the Way"

This is 100% learn-by-doing, practical training. We supply all components, all tubes, including a 17-inch picture tube, and comprehensive manuals covering a thorough program of practice. You learn how experts diagnose TV defects quickly. You see how various defects affect receiver performance—picture and sound; learn causes of defects, accurately, easily, and how to fix them. You do more than just build circuits. You get practice recognizing, isolating, and fixing innumerable troubles.

You get actual experience aligning TV receivers, diagnosing the causes of complaints from scope patterns, eliminating interference, using germanium crystals to rectify the TV picture signal, obtaining maximum brightness and definition by properly adjusting the ion trap and centering magnets, etc. There isn't room on this or even several pages of this magazine to list all the servicing experience you get.

UHF & COLOR TV Making New Boom

Installing front-end channel selector strips in modern UHF-VHF Television receivers and learning UHF servicing problems and their solution is part of the practice you get. To cash in on the coming color TV boom you'll need the kind of foundation in knowledge and experience this training gives.

Get Details of New Course Free

Once again—if you want to go places in TV servicing, we invite you to find out what you get, what you practice, what you learn from NRI's new course in Professional Television Servicing. See pictures of equipment supplied, read what you practice. Judge for yourself whether this training will further your ambition to reach the top in TV servicing. We believe it will. We believe many of tomorrow's top TV servicemen will be graduates of this training. Mailing the coupon involves no obligation.

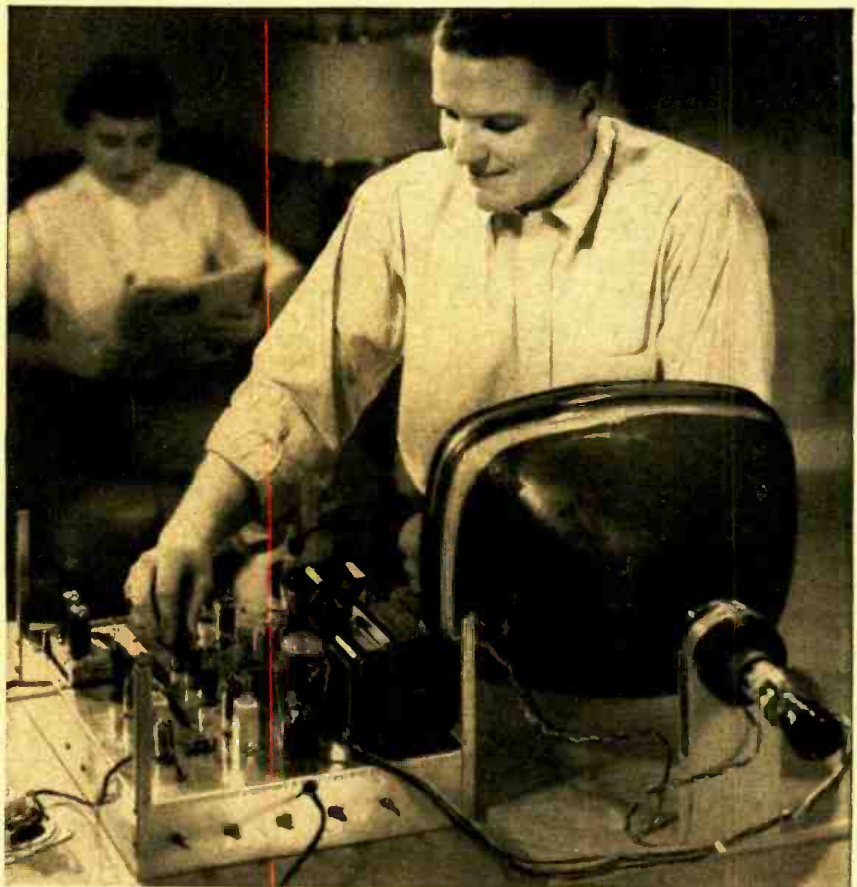

Train at home easily, quickly, for TV's top servicing jobs. NRI's Professional Television Servicing course includes a 17-inch picture tube and all other tubes and components to build a complete TV Receiver, Oscilloscope, Signal Generator, H.F. Probe. Complete training, including all equipment, available now for a low introductory price—under \$200 on easy terms.



National Radio Institute, Dept. 7AET
16th and U Sts., N.W., Washington 9, D. C.

Please send my FREE copy of "How to Reach the Top in TV Servicing." I understand no salesman will call.

Name.....Age.....

Address.....

City.....Zone.....State.....

APPROVED MEMBER NATIONAL HOME STUDY COUNCIL

RADIO & TELEVISION NEWS is published monthly by Ziff-Davis Publishing Company, William B. Ziff, Chairman of the Board (1940-1953), at 64 E. Lake St., Chicago 1, Ill. Entered as second-class matter July 21, 1948, at the Post Office, Chicago, Ill., under the act of March 3, 1879. Authorized by Post Office Department, Ottawa, Canada, as second-class matter. SUBSCRIPTION RATES: Radio & Television News—one year U. S. and possessions, and Canada \$4.00; Pan-American Union countries \$4.50; all other foreign countries \$5.00.

Publisher
OLIVER READ, D.Sc., WIETI

Editor
WM. A. STOCKLIN, B. S.

Technical Editor
MILTON S. SNITZER

Service Editor
SIDNEY C. SILVER

Associate Editor
P. B. HOEFER

Assistant Editor
J. JUSTER

Television Consultant
WALTER H. BUCHSBAUM

Art Editor
FRANK SAYLES

Art and Drafting Dept.
J. A. GOLANEK
W. K. VAHLSING
JAMES A. ROTH

Advertising Director
L. L. OSTEN

Advertising Manager
MURRAY GOLDMAN

Midwest Adv. Manager
JOHN A. RONAN, JR.

Western Adv. Manager
JOHN E. PAYNE



COVER PHOTO: The Remington Rand "Univac" installed in the accounting offices of Consolidated Edison in New York speeds the processing of customers' bills and saves untold hours of manual accounting operations. (Ektachrome by Seymour Zweibel, Gotham Film Productions, Inc.)

ZIFF-DAVIS PUBLISHING COMPANY

President
B. G. DAVIS

Vice-President
H. J. MORGANROTH

Vice-President
M. H. FROELICH

Vice-President & Circulation Dir.
M. MICHAELSON

Secretary-Treasurer
G. E. CARNEY

Art Director
AL GRUEN

BRANCH OFFICES

CHICAGO (11)
 64 E. Lake St., AN 3-5200

LOS ANGELES (14)
 215 W. 7th St. (Room 412) Trinity 8043

*First in radio-
 television-audio-electronics*

Average Net Paid Circulation 258,790

Radio News Trademark Reg. U. S. Pat. Office



Reg. U. S. Pat. Off. Television News Trademark Reg. U. S. Pat. Office.

CONTENTS

JANUARY, 1957

EDITORIAL—INDUSTRY NEWS

For the Record.....	O. Read	8
Spot Radio News.....	Washington Correspondent	22
New TV Grants Since Freeze Lift.....		22
Behind the Giant Brains (Part 1).....	Frank Leary	37
The "Univac"—An Electronic Brain for Industry.....		41
Low Plate-Potential Tubes.....	C. E. Atkins	47
Atomichron—World's Most Accurate Clock.....		63
What's Ahead for the TV Industry.....		94
Transistor Life Tests.....		104

HIGH FIDELITY AND AUDIO

Power Requirements for Hi-Fi.....	David Haffler	44
Electronic System for 2-Way Speaker Operation.....	Robert G. Vaughn	50
Buying a Tone Arm.....	N. H. Crowhurst	51
A New Master-Control Preamp.....		54
Realistic High Fidelity—The Power That Drives the Speaker (Part 9).....	H. A. Hartley	64
Certified Record Revue.....	Bert Whyte	70
New Hi-Fi—Audio Equipment.....		138

SERVICING

Television-Radio

From Sun to Sound.....	Perry Sheneman	42
Sylvania's New Color TV Line.....	Walter H. Buchsbaum	46
Distributors and Service Technicians Join Hands.....	William Leonard	56
Design Features of 9" G-E Portables.....	Jack Najork	57
Service Techniques for Modular Circuits.....	Harold Bernstein	60
Mac's Service Shop.....	John T. Frye	76
Handling FM-to-TV Interference.....	George D. Philpott	112
Service Industry News.....		124
Antenna News.....		126

Test Equipment

An Electrometer—A Very High Input Resistance V.T.V.M.....	Donn G. Shankland	67
Low-Cost Scanning Generator.....	Larry Dorst	68
A V.H.F. Field-Strength Meter Adapter.....	Gene Brizendine, W4ATE	71
New Tube Tester Data.....		95

AMATEUR AND COMMUNICATIONS

Shortened Rotary Beam Antennas for the Amateur.....	Herbert S. Brier, W9EGQ	72
Ham Communications from President's Train.....		111

ELECTRONIC CONSTRUCTION AND THEORY

Crystal Photocell Circuits.....	Allan M. Ferres	58
---------------------------------	-----------------	----

DEPARTMENTS

Within the Industry.....	30	What's New in Radio.....	151
Manufacturers' Literature.....	97	Technical Books.....	156
Calendar of Events.....	142	Sales Aids.....	165



ZIFF-DAVIS PUBLISHING COMPANY
 WILLIAM B. ZIFF (1898-1953) FOUNDER
 Editorial and Executive Offices
 366 Madison Ave., New York 17, N. Y.
 MU 7-8080



Member
 Audit Bureau of
 Circulations

VOLUME 57 • NUMBER 1

Copyright © 1956 by Ziff-Davis Publishing Company. All rights reserved.

SUBSCRIPTION SERVICE. All communications concerning subscriptions should be addressed to Circulation Dept., 64 E. Lake St., Chicago 1, Ill. Subscribers should allow at least four weeks for change of address. Include your old address as well as new—enclosing, if possible, an address label from a recent issue of this magazine.

CONTRIBUTIONS: Contributors are advised to retain a copy of their manuscripts and illustrations. Contributions should be mailed to the New York Editorial Office and must be accompanied by return postage. Contributions will be handled with reasonable care, but this magazine assumes no responsibility for their safety. Any copy accepted is subject to whatever adaptations and revisions are necessary to meet the requirements of this publication. Payment covers all author's, contributor's, and contestant's rights, title, and interest in and to the material accepted and will be made at our current rates upon acceptance. All photos and drawings will be considered as part of the material purchased.

RADIO & TELEVISION NEWS



G. F. Beane, W. Virginia, was a truck driver. He took the DeVry Tech Training Program, and is now tape recorder engineer at Webcor Co.



Edward Hahn, Illinois. Now an electronics technician with Televiso, Inc. DeVry Tech training helped him prepare for his present position.



Nick Barton, Illinois, a DTI grad, now has his own business and tells us he is "literally snowed with work."



George D. Crouch, California, was a retail store clerk. He took the DeVry Program, and today is in business for himself.

IF THESE MEN CAN DO IT WHY CAN'T YOU?

DEVRY TECH Will Tell You FREE
How You May Prepare At Home For

the **Big-Opportunity Fields**

TELEVISION

RADIO • ELECTRONICS

TIRED OF THE SAME OLD JOB?

If you're under 55, you're not too old to consider a new type of job. If you feel the need of a change and want to look ahead to the opportunities in Television-Radio-Electronics, mail the coupon below. Let DeVry Tech tell you about its industrial training program ... about the good pay jobs open to trained men. Find out if you are qualified for DeVry Tech training.

LEARN WITH REAL EQUIPMENT

DeVry Tech puts tools and parts in your hands to build your own test equipment, loans you home training films to follow, explains problems in simple, down-to-earth language.

You need no previous technical experience to prepare at home or in our million-dollar Chicago Training Center. If you are between 17 and 55, send today for free booklet, free sample lesson and additional information.

A word of advice to Veterans and Non-Veterans from JACK DEMPSEY

"Let DeVry Tech give you an honest opinion of the great opportunities in the electronics



field. This school is now in its 25th year. I've known it a long time and, believe me, it makes no idle claims. It is interested only in producing top-flight technicians. And in placing them, too. The DeVry Placement Service is in contact with some of the nation's biggest businesses ... it serves DeVry graduates well. Why wait and wonder? Maybe your future depends on sending in the coupon below *right now!*"

Draft-Age Men ... Be sure to get valuable information just for you.

Get these Valuable Facts



Free

"One of America's Foremost Electronics Training Centers"

Accredited Member of National Home Study Council



DEVRY TECHNICAL INSTITUTE

CHICAGO 41, ILLINOIS

FORMERLY

DEFOREST'S TRAINING, INC.



MAIL TODAY FOR FREE FACTS

DEVRY TECHNICAL INSTITUTE
4141 Belmont Ave., Chicago 41, Ill., Dept. RN-1-N

Please give me free facts about the many opportunities in Television-Radio-Electronics, including the 3 publications, and how DTI may prepare me for my start in this billion-dollar field.

Name _____ Age _____

Please Print

Street _____ Apt. _____

City _____ Zone _____ State _____

1050

DeVry's Canadian Training Center is at
580 Roselawn Avenue, Toronto 12, Ontario

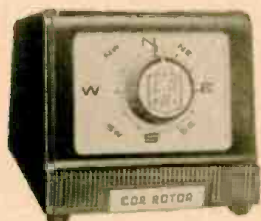

AR-22



TR-2



TR-4

5-star feature...



1 the best color TV picture

the growth of color TV means an even greater demand for CDR Rotors for pin-point accuracy of antenna direction.



2 a better picture on more stations

CDR Rotors add to the pleasure of TV viewing because they line up the antenna perfectly with the transmitted TV signal giving a BETTER picture . . . and making it possible to bring in MORE stations.

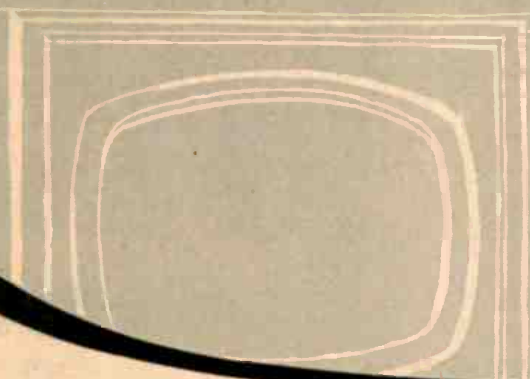

CDR ROTORS

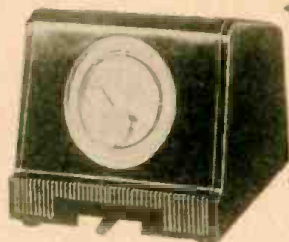

TR 11 and 12



AR 1 and 2



3 tested and proven dependable

thousands and thousands of CDR Rotors have proven their dependability over years of unflinching performance in installations everywhere in the nation. Quality and engineering you know you can count on.



4 pre-sold to your customers

the greatest coverage and concentration of full minute spot announcements on leading TV stations is working for YOU . . . pre-selling your customers.



5 the complete line

a model for every need . . . for every application. CDR Rotors make it possible for you to give your customer exactly what is needed . . . the right CDR Rotor for the right job.



CORNELL-DUBILIER
SOUTH PLAINFIELD, N. J.



THE RADIART CORP.
CLEVELAND 13, OHIO

**GREATEST
ADVANCE IN
SHOP-METHOD
HOME TRAINING**

EARN MORE MONEY... GET INTO TELEVISION ELECTRONICS - RADIO

Learn **ALL 8 PHASES** in **ONE MODERN HOME-STUDY COURSE**
At Home - In Spare Time

YOU GET ALL THIS NEWEST PRACTICAL EQUIPMENT

- Parts to build a modern TV set, including all tubes plus a large screen Picture Tube
- Parts to build a powerful Superhet Receiver, standard broadcast and short wave
- Parts to conduct many experiments and build Continuity Checker, RF Oscillator, TV Circuits, Audio Oscillator, TRF Receiver, Signal Generator
- A Valuable Professional Multitester



**19 BIG KITS
YOURS TO KEEP**

YOUR NATIONAL SCHOOLS TELERAMA COURSE COVERS ALL 8 PHASES

- | | |
|------------------------------------|--------------------------------|
| 1. TELEVISION, INCLUDING COLOR TV | 5. PREPARATION FOR FCC LICENSE |
| 2. RADIO, FM AND AM | 6. AUTOMATION |
| 3. INDUSTRIAL ELECTRONICS | 7. RADAR AND MICRO WAVES |
| 4. SOUND RECORDING AND HI FIDELITY | 8. COMMUNICATIONS |

YOU ARE NEEDED IN THE TELEVISION-ELECTRONICS-RADIO INDUSTRY!
You can build a secure future for yourself if you get into Electronics NOW! Today's shortage of trained technicians creates tremendous opportunities. National Schools Shop-Method trained technicians are in constant and growing demand for high-pay jobs in Broadcasting and Communications, Electronic Research, Servicing and Repair, and many other branches.

Let National Schools, a Resident Technical School for over 50 years train you for today's unlimited opportunities in electronics! Our Shop Method trains you to be a MASTER-TECHNICIAN. Completely up to date, developed by experienced instructors and engineers, your Telerama Course will teach you all phases of the industry quickly, clearly and correctly. You can master the most modern projects, such as Color TV, printed circuits - even prepare for FCC License without taking a special

course. You can handle sales, servicing, manufacturing, or make good money in your own business. SEND FOR FACTS TODAY!

EARN AS YOU LEARN. Many of our students earn their entire tuition and more in Spare Time jobs we show them how to do while learning.

YOU GET EVERYTHING YOU NEED - Clear, profusely illustrated lessons, shop-tested manuals, modern circuit diagrams, practical job projects - all the valuable equipment shown above

- many other materials and services
- consultation privilege with our qualified staff, and Graduate Employment Service. **EVERYTHING YOU NEED** for outstanding success in Electronics

RESIDENT TRAINING AT LOS ANGELES

If you wish to take your training in our Resident School at Los Angeles, the world's TV capital, start NOW in our big, modern Shops, Labs and Radio-TV Studios. Here you work with latest Electronic equipment - professionally installed - finest, most complete facilities offered by any school. Expert, friendly instructors. Personal attention. Graduate Employment Service. Help in finding home near school - and part time job while you learn. Check box in coupon for full information.



FREE! Fully illustrated "Career" Book in TV-Radio-Electronics. PLUS actual sample lesson - yours at no cost, no obligation. **CLIP COUPON NOW... MAIL IT TODAY!**

APPROVED FOR G. I. TRAINING

NATIONAL SCHOOLS

4000 S. FIGUEROA ST., LOS ANGELES 37, CALIF.

187 N. LA SALLE ST., CHICAGO 1, ILL.

IN CANADA: 811 W. HASTINGS ST., VANCOUVER, B. C.

NATIONAL SCHOOLS

TECHNICAL TRADE TRAINING SINCE 1905
LOS ANGELES 37, CALIFORNIA

GET FAST SERVICE - MAIL NOW TO OFFICE NEAREST YOU!

NATIONAL SCHOOLS, DEPT. RH-17
4000 S. FIGUEROA ST. LOS ANGELES 37, CALIF. OR 187 N. LA SALLE ST. CHICAGO 1, ILL.
Rush free TV-Radio "Opportunity" Book and sample lesson. No salesman will call.

NAME _____ AGE _____

ADDRESS _____

CITY _____ ZONE _____ STATE _____

Check if interested ONLY in Resident School training at Los Angeles.
VETERANS Give date of Discharge _____

Star Performer
at a Modest Price

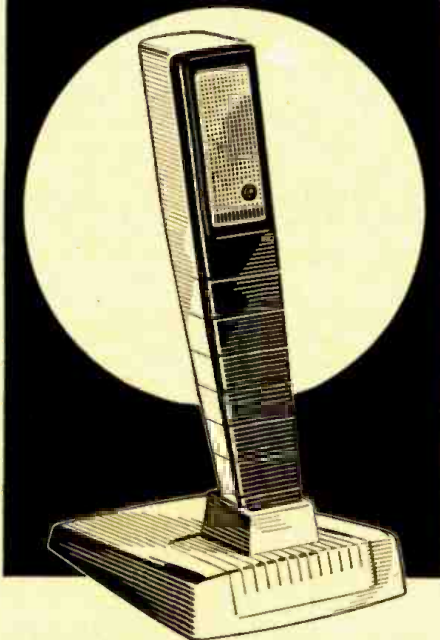

E-V Model 927 Microphone. 1 $\frac{1}{16}$ " wide x 1 $\frac{1}{32}$ " deep. 7 $\frac{1}{16}$ " long. Weight: 14 oz. with cable. Complete with desk stand and 5' cable.....\$22.50 List.

Electro-Voice

Model 927 Crystal Microphone

No one—not even Electro-Voice—makes one microphone that does *everything*. Electro-Voice does make the closest thing to an all-purpose microphone on the market, the Model 927. For public address, call and paging systems, for dictating machines and home recorders, for amateur radio, for every general communications need.

Maximum versatility at a modest price. That's what you get in the E-V Model 927. Designed primarily for hand use, it comes complete with a heavy die-cast slip-in stand for desk use. Attractive, streamlined microphone case of sturdy die-cast metal and plastic in metalustre medium gray. It's omni-directional, has a 60 to 6,000 cps frequency response, can be used with any standard amplifier.

See your E-V Distributor or write for booklet N71, "A B C's of Microphones."

Electro-Voice®

ELECTRO-VOICE, INC. • BUCHANAN, MICHIGAN
Canada: E-V of Canada Ltd., 1908 Avenue Road, Toronto, Ontario, Export: 13 East 40th Street, New York 18, U. S. A. Cables: ARLAB

For the **RECORD.**

LEE DE FOREST'S ALADDIN'S LAMP

IT WAS just fifty years ago that a piece of wire bent back and forth in the form of a grid was first used as an element in a vacuum tube. The inventor was the renowned Lee De Forest, affectionately called the Father of Radio. Few men have contributed more towards the advancement of science than Lee De Forest. The tremendous importance of his discovery is reflected in the sales of TV and receiving tubes for the first nine months of 1956 when over eight million TV picture tubes having a value of approximately \$147,000,000, plus over 347 million receiving tubes valued at nearly \$280,000,000 were sold.

De Forest was experimenting with an electrolytic detector for wireless signals in the year 1900. He was working by the light of a Welsbach burner and noted that the light dimmed and brightened as his spark transmitter was operated. The illusion served its purpose well. De Forest realized that latent forces could be utilized in a Hertzian detector far better than any previously known device. His first commercial Audion appeared in 1906. De Forest, at the time, was exploring the behavior of a Bunsen burner flame using two platinum electrodes held close together in the flame together with an outside circuit comprising a battery and a telephone receiver. When one electrode was connected to an antenna and the other to ground, De Forest heard signals from a wireless telegraph transmitter in the telephone receiver. This was known as a "flame detector." During the period 1903-1905, De Forest considered the phenomenon known as the Edison effect and by 1904 he had outlined a plan of using a gas heated by an incandescent carbon filament in a partially exhausted gas vessel as a wireless detector in place of the open flame. It was not until 1905 that De Forest had the opportunity to prove that the same detector action, found in the vicinity of an incandescent platinum wire in the glass flame, also existed in gas surrounding the filament of an incandescent lamp.

De Forest used small incandescent lamps for his experiment and introduced a second electrode which could be operated either hot or cold. De Forest called the battery used for lighting the filament the "A" battery and the other, for convenience, was called the "B" battery. This nomenclature has been used ever since. De Forest had found that the influence of high frequency impulses could be impressed to better advantage on the conducting medium by adding a third

electrode. This new electrode was first applied to the outside of a cylindrical lamp bulb. De Forest's patent of 1906 shows this progenitor of the third electrode. He concluded that if this were placed within the lamp, then the weak charges would be more effective in controlling the electronic current passing between the filament and plate. He then tried two plates, one on either side of the filament. One was placed in the telephone circuit, and the other in the high frequency circuit connected to the antenna. It was in this circuit that De Forest first used a "C" battery.

De Forest realized that if this third electrode were placed directly in the path of the current between the filament and plate, he would obtain the maximum effect of the incoming impulses upon the current flow. He also realized that this electrode must not be in the form of a plate, but must be a perforated element which would permit the current to reach the anode. De Forest's patent, filed January 1907, illustrated the preferred form which the idea promptly assumed.

During the summer of 1912, De Forest was working on problems of the Audions as amplifiers in cascade arrangements for telephone repeaters. It was then that he discovered that if the input or grid circuit was indirectly coupled with the output, or plate, inductance, the Audion would function as a generator of continuous alternating currents. He demonstrated this type of circuit for the production of alternating currents of audible frequency and showed that weak high frequency currents could be generated by substituting radio frequency coils for the original iron-core coils. When the Audion was introduced as an oscillator in 1914, it replaced the arc in radiotelephony.

De Forest's inventions and circuitry are too numerous to be covered in an editorial. Literally hundreds of wiring diagrams were developed, and experimenters throughout the world undertook to improve the Audion's performance by designing circuits in which it could perform most capably. De Forest's small piece of platinum wire and an additional battery had literally transformed the Fleming valve into a vacuum tube possessing unlimited applications.

Electronics, as we know it today, would not have been possible were it not for the invention of the three element Audion. To Dr. Lee De Forest is due a debt of gratitude for his contributions to science and to our way of life. O. R.

free!

ALLIED'S 1957 value-packed 356-page CATALOG



the only COMPLETE catalog
for everything in electronics

World's Most Complete Stocks

- Latest Hi-Fi Systems and Components
- Super-Value KNIGHT-KITS • P. A. Systems and Accessories • Recorders and Supplies • TV Tubes, Antennas, Accessories • Amateur Receivers, Transmitters, Station Gear • Test and Lab Instruments
- Specialized Industrial Electronic Equipment • Huge Listings of Parts, Tubes, Transistors, Tools and Books...

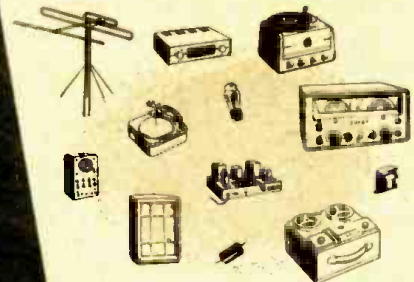

FEATURING

SUPER-VALUE knight-kits: Finest electronic equipment in money-saving Kit form—Test Instruments, Hi-Fi kits, Hobbyist kits, Ham kits. Easiest to build and you SAVE MORE.

EVERYTHING IN HI-FI: World's largest selection of quality Hi-Fi components and complete music systems—available for immediate shipment from stock. Own the best in Hi-Fi for less!

EASY-PAY TERMS: Only 10% down, up to 18 months to pay. Available on orders over \$45. Fast handling—no red tape.

Get ALLIED's 1957 Catalog—it's complete, up-to-date—356 pages packed with the world's largest selection of quality electronic equipment at lowest, money-saving prices. Get every buying advantage at ALLIED: fastest shipment, expert personal help, lowest prices, guaranteed satisfaction...

send for the leading
electronic supply guide



ALLIED RADIO CORP., Dept. 1-A-7
100 N. Western Ave., Chicago 80, Ill.

Send FREE 356-Page 1957 ALLIED Catalog

Name

Address

City Zone ... State



Our 36th year

ALLIED RADIO

World's Largest Electronic Supply House

January, 1957

GUIDE

AUTRONIC-EYE[®]

TRAINING COURSES

MEAN MORE

BUSINESS FOR YOU!



Courses for experienced service technicians provide latest repair information—enable you to do the job faster and more efficiently.

Quick, accurate circuit diagnosis and repair to factory specifications boosts your profits. That's why so many qualified auto technicians attend these Guide training courses at no cost other than transportation and living expenses.

The Guide Lamp diploma, awarded only to those who successfully complete the course, is proof that you're equipped to give more and better service to more people—and that means business.

If you're an auto radio service dealer, come yourself, or send your technicians. There's one of 30 GM Training Centers near you. Apply through your local United Motors Service Division Distributor or write

GUIDE LAMP DIVISION • GENERAL MOTORS CORP. • ANDERSON, INDIANA

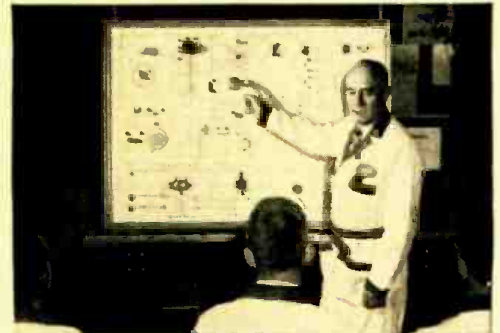

Jumbo-size operational panel of Guide's Autronic-Eye Circuit puts all parts out front for better, more efficient instruction.



Thirty modern GM Training Centers offer newest equipment and latest service techniques. There's one nearby . . . no matter where you live.

BLINKY MEANS BUSINESS!

Can You Call a Man a "Failure" at Thirty?

Men who think that success is only a matter of "a few years" are failures . . . however young they are!

How often have you heard some young man in business say, "I'll admit the job I have now isn't much but, after all, I'm only in my twenties."

Or: "Just about every executive in the company I work for is between 45 and 65. I have plenty of time to get ahead."

This *mistaken* idea that success comes automatically with time is easy to understand. Promotions do come regularly and effortlessly to young men of promise. *But* the day arrives, often abruptly, when that promise must be *fulfilled*. Native ability and intelligence can carry a man only to the mid-way point in business—beyond that he must *prove* his capacity to justify a position of executive responsibility. That calls for a practical, working knowledge of business fundamentals.

The time to build that knowledge—to lay a solid groundwork for your future progress—is now . . . *now* while time is still on your side. If you fail to recognize that fact, you'll know only struggling, skimping and regret when your earning power should be at its height.

FOR THE BUSINESS MAN WHO REFUSES TO STAGNATE



HALF the world is half asleep! Men who could be making twice their present salaries are coasting along, hoping for promotions but doing nothing to bring themselves forcefully to the attention of management. They're wasting the most fruitful years of their business lives... throwing away thousands of dollars they'll never be able to make up.

If you want to discover how to start to succeed while you're still young—if you want to avoid the heartbreak of failure in later years—send today for "Forging Ahead in Business"... one of the most practical and helpful booklets ever written on the problems of personal advancement. You will discover

what the qualifications of an executive are in today's competitive market... what you must know to make \$15,000, \$20,000 or more a year... what you must *do* to accumulate this knowledge.

"Forging Ahead in Business" was written for ambitious men who seriously want to get down to bed-rock in their thinking about their business future; there's no charge for the booklet because, frankly, we've never been able to set a price on it that would reflect its true value. Some men have found a fortune in its pages. If you feel that it's meant for you, simply fill out and return this coupon. Your complimentary copy will be mailed to you promptly.

ALEXANDER HAMILTON INSTITUTE
Dept. 514, 71 W. 23rd St., New York 10, N. Y.
In Canada: 57 Bloor St. W., Toronto, Ontario, Canada

Please mail me, without cost, a copy of your 48-page book—
"FORGING AHEAD IN BUSINESS"

Name

Firm Name

Business Address

Position

Home Address



ALEXANDER HAMILTON INSTITUTE 71 West 23rd St.
New York 10, N. Y.

January, 1957

HIGH POWER **LOW POWER** **AC POWER** **DC POWER**

POWER-LAB

BY **precise** OPERATES YOUR WHOLE BENCH & SHOP

KIT or WIRED

YOU'LL START AND END EACH WORKING DAY WITH THE POWER-LAB

For the first time in the industry, one instrument takes the place of more than 11 pieces of equipment and makes you wonder why no one ever did this before . . . the most useful, often used, test device in your shop.

Here's the story . . . now, you can get all this COMPLETE IN ONE KIT (kit or wired):

- ★ A BATTERY ELIMINATOR
- ★ A BATTERY CHARGER
- ★ A HIGH CURRENT LINE VOLTAGE VARIAC
- ★ AN AC LINE VOLTAGE METER
- ★ AN AC LINE AMMETER
- ★ AN AC LINE WATTMETER
- ★ AN AC LINE ISOLATION TRANSFORMER
- ★ A LOW VOLTAGE, HIGH CURRENT AC SUPPLY
- ★ A DC LINE VOLTAGE VARIABLE SUPPLY
- ★ A DC HIGH CURRENT AMMETER
- ★ AN AC BIAS BOX



MODEL 711
(100 Watts of Isolation) 711K — \$49.95 kit
711W — \$64.95 wired

MODEL 713
(300 Watts of Isolation) 713K — \$62.95 kit
713W — \$79.95 wired

When you buy POWER-LAB by Precise, you get all the advantages of owning a battery eliminator for servicing auto radios (even signal seekers), an AC-DC Converter, a supply for transistor sets, AND OF MAINTAINING A CONSTANT 115 volts in checking on TV set variations. You can even run the set down to 105 volts for testing for horizontal jitter and back up to 125 volts for high voltage breakdown, thereby eliminating the cause of many call-backs due to arcing . . . PLUS

. . . PLUS . . . PLUS . . . the 101 uses you'll find each day for POWER-LAB versatility.

Just look at these specs . . . the switches used are more than ample to carry related loads required and the quality of every component is EXCELLENT. You could easily pay three to four times the price of the POWER-LAB for the equipment to perform only a few of the functions of the POWER-LAB!

ALL SPECS BELOW ARE FOR MOD. 711 AND 713 UNLESS OTHERWISE SPECIFIED

	VOLTS	MAXIMUM	CONTINUOUS
Low Voltage DC	2 ranges 0-15v Full Wave 0-30v Full Wave Bridge	20 amps* 20 amps*	10 amps* 10 amps*
Low Voltage AC	0-24v		20 amps
High Voltage AC	No Isolation 90-140 volts	20 amps 2000 watts	10 amps 1000 watts
High Voltage AC	Model 713 with Isolation 90-140 volts		3 amps 300 watts
High Voltage AC	Model 711 with Isolation 90-140 volts		1 amp 100 watts
High Voltage DC	110-180 volts	1 amp**	.075 amp**

There's NO OTHER INSTRUMENT LIKE THE POWER-LAB ON THE MARKET. Here again, Precise engineering is proud to be the first to supply a need that has too long existed in the service trade.

Your Distributor will be proud to show you THE POWER - LAB

Prices slightly higher in the West. Prices and specifications subject to change without notice.

*Depending on voltage.
**May be increased up to 10 amperes at additional cc

WRITE FOR CATALOG RN-1-7

SEE THE MANY MORE PRECISE INSTRUMENTS AND PROBES AT YOUR DISTRIBUTOR TODAY!

precise DEVELOPMENT CORP. OCEANSIDE, NEW YORK, U.S.A.

MEN 17-55!
HERE'S A NEW
OPPORTUNITY
FOR YOU!

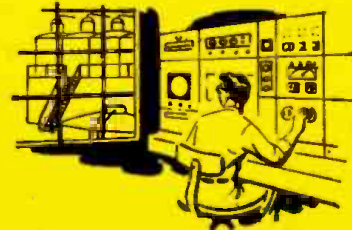
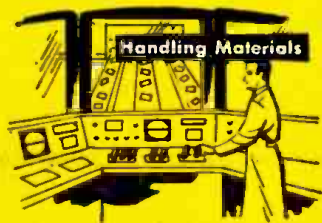

PREPARE AT HOME FOR A
PROFITABLE CAREER IN
AUTOMATION
ELECTRONICS*

Get in on the Ground Floor of this
Fast-Moving Field

Want a better job? . . . more money? . . . better working conditions? These are the things that can come to a man when he has a skill to offer . . . especially when that skill is in a newer field where ground floor opportunities often lead to well-paying positions. Such a field is the Electronic applications to AUTOMATION — and what a field! Many plants, large and small, in various parts of the country are looking for ways of using automatic electronic control equipment to help turn out a better product and at lower cost. This equipment must be designed, installed and maintained — calling for well trained men. That's where YOU may come in!

You need no special technical experience . . . no previous knowledge of Automation Electronics . . . to prepare for a future that can be bright and more secure. For now there is a proved way to get this important know-how. Mail coupon for complete details. Men 17 to 55 preferred.

***WHAT IS AUTOMATION ELECTRONICS?**

Simply stated, this refers to the marvelous electronic controls that will help regulate the much talked about "automatic factory" — as well as other amazing automatic equipment in plants, offices and elsewhere. It is a gateway to some of the most desirable opportunities in the amazing, newer field of Automation.

ONE OF AMERICA'S
FOREMOST ELECTRONICS
TRAINING CENTERS



DEVRY TECHNICAL INSTITUTE
 CHICAGO 41, ILLINOIS
 FORMERLY
DEFORREST'S TRAINING, INC.



Industrial Processing

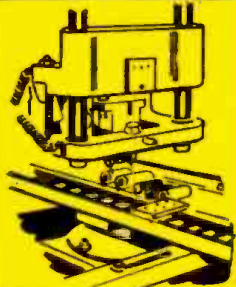

Making Electronic devices



Recording and billing



Anti-aircraft gun control

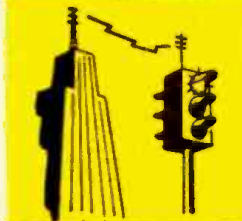

Traffic control signals

A New Training Program!

As one of the leading organizations of its kind, the DeVry Technical Institute has years of experience in teaching Electronics, Television and Radio. So it is only natural for this training institute to develop a new program to prepare men for good jobs in instrumentation — as well as in the design, installation and maintenance of Electronic controls — as applied to Automation.

EMPLOYMENT SERVICE

Following the same proved method used to train thousands of other men, you get valuable practical experience from actual electronic equipment. You also receive well-illustrated texts and effective moving pictures to show important basic principles—a wonderful home training advantage! To top that off, DTI provides actual employment help when you have completed the training—all of which can open the way to many new and exciting opportunities.

Accredited Member of
 National Home Study Council

MAIL THIS COUPON TODAY!

DEVRY TECHNICAL INSTITUTE, Dept. RN-1A-N
 4141 Belmont Avenue, Chicago 41, Ill.

I would like a FREE copy of your booklet, "Automation and YOU." Also further information about the newer Electronic opportunities in AUTOMATION, and facts on how you may help me to prepare.

Name _____ Age _____
 Please Print

Street _____ Apt. _____

City _____ Zone _____ State _____

1012 DeVry's Canadian Training Center is at
 580 Roselawn Avenue, Toronto 12, Ontario



MOST ACCEPTABLE

FROM DELCO RADIO ...

come the **coils**

with highest performance.

You trust them . . . so do your customers!

The core of quality service and really fine radio performance is always in Delco Radio coils. Delco Radio coils are made with powdered-iron cores, specially treated and compressed to exact shape on tolerance-true machines in Delco Radio's own plant. Skilled craftsmen wind and test the entire assembly so that you can depend on Delco Radio coils for *uniform* performance characteristics.

Your UMS-Delco Electronics Parts Distributor carries a complete line of Delco Radio parts, including precision-built Delco Radio coils. See him today! And, keep your eye on the Delco Wonder Bar Radio as advertised in leading consumer publications. It'll be helping you tune in to a greater service market.

DELCO



RADIO

DIVISION OF GENERAL MOTORS, KOKOMO, INDIANA



A GENERAL MOTORS PRODUCT — A UNITED MOTORS LINE
Distributed by Delco Electronic Parts Distributors

A complete line of original equipment service parts from the

WORLD LEADER IN AUTO RADIO

RADIO & TELEVISION NEWS

No antennas ever made can match the performance and sales appeal of these outstanding Channel Master models.

"Showman" indoor antenna
models for VHF or VHF-UHF reception

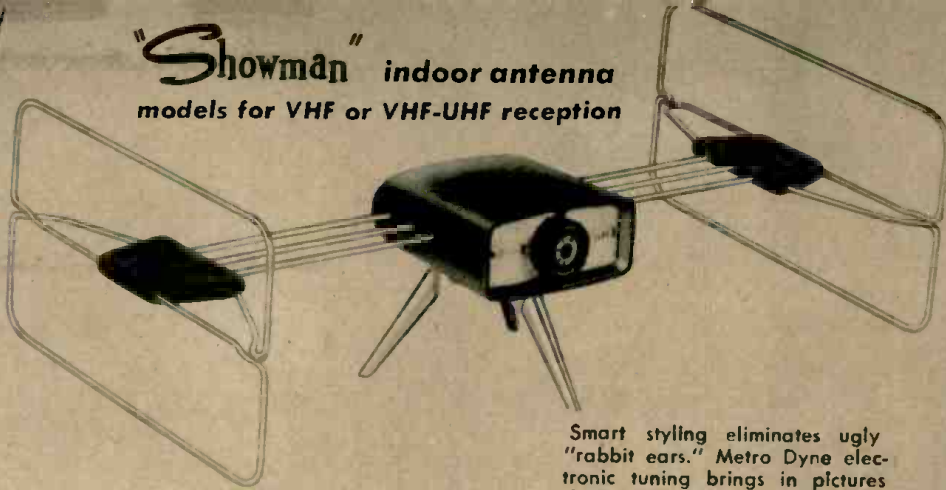

Smart styling eliminates ugly "rabbit ears." Metro Dyne electronic tuning brings in pictures sharp and clear.

T-W outdoor antenna

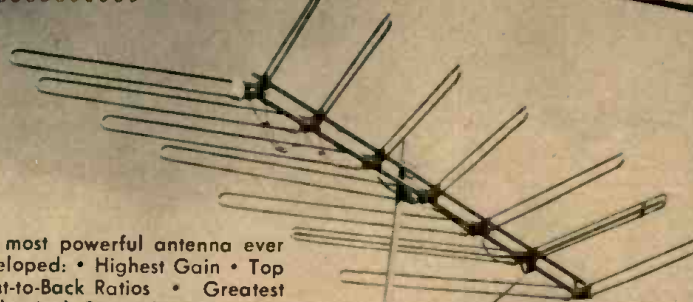

The most powerful antenna ever developed: • Highest Gain • Top Front-to-Back Ratios • Greatest Mechanical Strength.

MORE PROFITS for CHANNEL MASTER dealers

In every TV reception area Channel Master dealers are racking up new sales records with the most popular TV antennas on the market today. Superior products plus consistent consumer advertising is a double-barrelled profit combination you can't beat. When you feature the Channel Master line you always have that extra selling edge . . . that extra PLUS that means faster turnover . . . easier sales . . . bigger profits.

Isn't it time you called your Channel Master distributor?



Channel Master's massive national and local advertising program . . . establishes you as the local TV authority . . . is creating loads of new prospects right in your own selling area . . . and is opening millions of homes to antenna replacement.

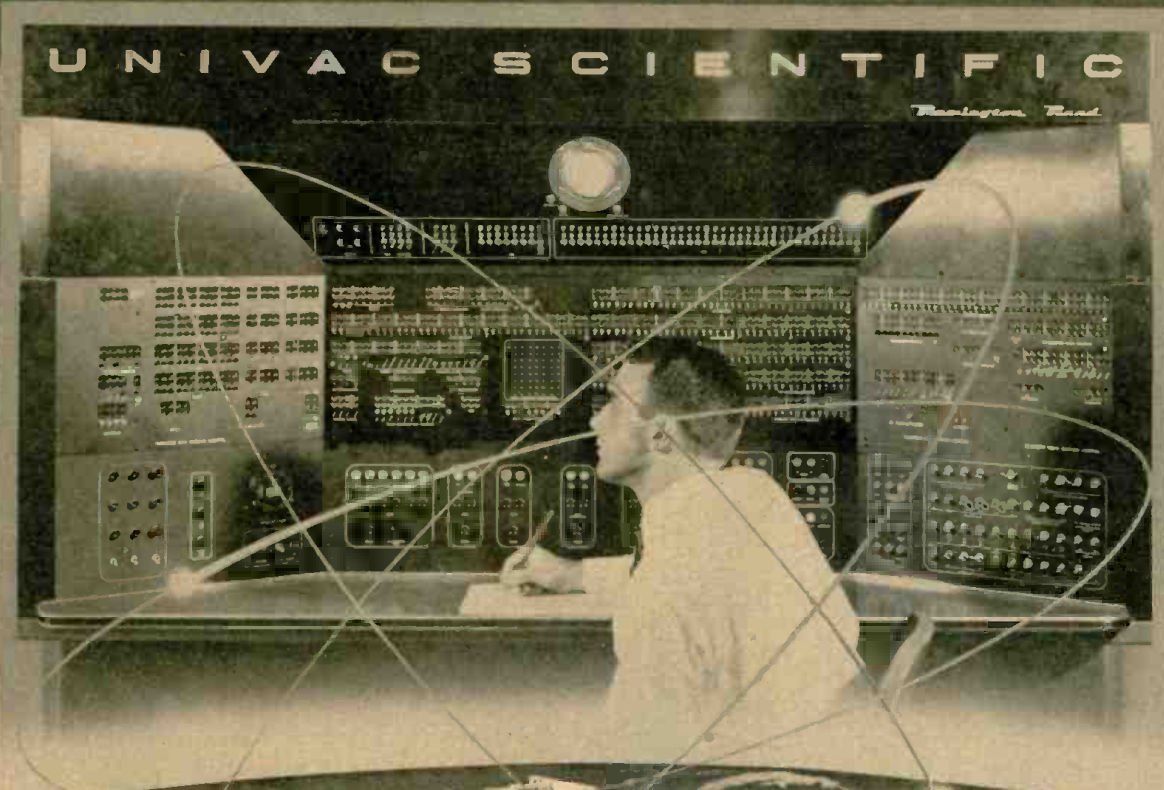

Challenge: Help develop the first electronic control center for a nationwide network of automated factories

Think of it . . . Completely automatic factories, hundreds of miles apart, all operated by a single Remington Rand Univac® computing system. Flow of materials, processing, quality control, packaging, even market analysis, controlled from the electronic "brain center" . . . control so complete that when a shift in the wind changes the draft of a chimney at a distant plant, the computer corrects the firing of a boiler.

Far fetched? Not at Univac. The Univac team of scientists, engineers and technicians has already designed the completely automatic factory. They have built a computer (Univac Scientific) capable of remote control of ten to a hundred factories. The next step—central control of chains of automated plants—will completely revolutionize American industry.

This is the kind of challenge that awaits you at Univac. As a Univac engineer or technician you'll find top salaries, excellent working conditions and opportunities unlimited—unlimited as the future of Univac itself.

IMMEDIATE OPENINGS FOR:

FIELD LOCATION ENGINEERS with a college degree in a scientific or engineering field and experience in electronics. Extensive electronic background may substitute for some college. Many opportunities for rapid advancement.

FIELD LOCATION TECHNICIANS with technical school background and preferably some experience in electronics. These positions can lead to full engineering responsibility.

Send Complete Resumé to:
Remington Rand Univac.
DIVISION OF SPERRY RAND CORPORATION

MR. PHIL WILSON
Dept. 5J-9
1902 W. MINNEHAHA AVENUE, ST. PAUL W4, MINNESOTA

©Reg. U.S. Pat. Off.

PROFIT COMES BACK!

to phono cartridge and needle market with

Electro-Voice®

POWER-POINT

(THE CARTRIDGE WITH
JEWEL* PLAYING TIPS)

CUT INVENTORY COSTS

Power-Point Replaces over 90%
of All Popular Phono Cartridges

REPLACE CARTRIDGE AND NEEDLE IN SECONDS

(Just Slip Out—Slip In)

E-V Power-Point actually gives you more working capital by cutting, drastically, the number of different cartridges and different needles you need in stock to do an adequate replacement business. Power-Point *alone* replaces over 90% of all popular phono cartridges. You save valuable time, troublesome service calls . . . you can replace Power-Point in less time than it takes to read this sentence! Remember too, almost a million Power-Points are now in use, and the number is growing fast. Additional millions will be demanded by the replacement market!

What is Power-Point?

A nylon-encased unit combining ceramic cartridge and two jeweled* playing tips. A Power-Point cartridge can be changed in seconds, replaces virtually all popular phono cartridges, costs less than two needles alone. It has low inertia, superior tracking ability, wide range, low distortion, minimum needle noise and record wear. It is non-inductive, hum-free, unaffected by moisture or temperature. It actuates all changer mechanisms.

*Superior synthetic sapphire or natural diamond.

Four Power-Point Types, each \$3.95 list

Model 51-1 (Red): two 1-mil sapphire tips.

Model 52-2 (Green): two 2-mil sapphire tips.

Model 53-3 (Black): two 3-mil sapphire tips.

Model 56 (Blue): turnover mounted 1-mil and 3-mil sapphire tips

Three Mounting Mechanisms

Model PFT-1 Power-Point Fixed Mount, 50c list.

Model PT-1 Power-Point Turnover Mount, \$1.00 list.

Model PT-2 Power-Point Turnunder Mount, \$1.00 list.

MAIL COUPON TODAY!

Electro-Voice

ELECTRO-VOICE, INC., BUCHANAN, MICHIGAN

Send me complete information about Electro-Voice Power-Point cartridges, sales-aids and display.

Company _____
Address _____
City _____ State _____
Signed _____

An intrstng exprmnt in spch

Some day your voice may travel by a sort of electronic "shorthand" when you telephone. Bell Laboratories scientists are experimenting with a technique in which a sample is snipped off a speech sound—just enough to identify it—and sent by wire to a receiver which rebuilds the original sound. Thus voices can be sent by means of fewer signals. More voices may economically share the wires.

This is but one of many transmission techniques that Laboratories scientists are exploring in their search for ways to make Bell System wire and radio channels serve you more efficiently. It is another example of the Bell Telephone Laboratories research that keeps your telephone the most advanced on earth. *The oscilloscope traces at right show how the shorthand technique works.*



**BELL TELEPHONE
LABORATORIES**

*World center of communications research
Largest industrial laboratory in the United States*

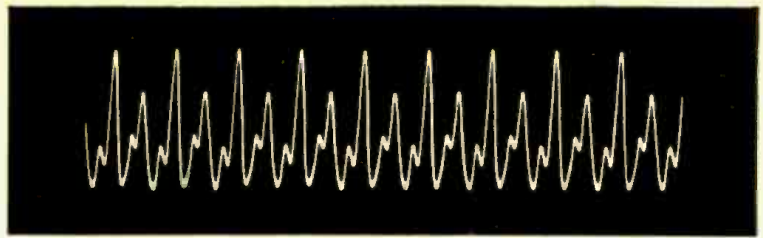

Vibrations of the sound "or" in the word "four." Pattern represents nine of the "pitch periods" which originate in puffs of air from the larynx when a word is spoken.

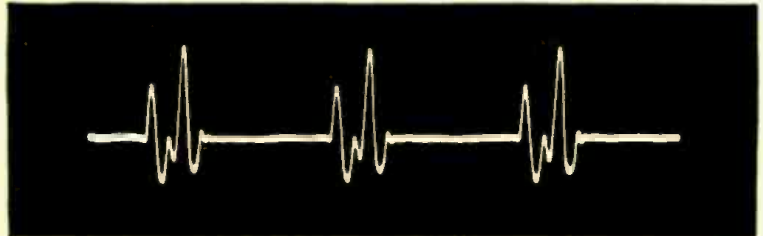

An electronic sampling of the "or" sound. One "pitch period" in three has been selected for transmission. This permits great naturalness when voice is rebuilt. Intelligible speech could be sent through a 1 in 6 sampling.

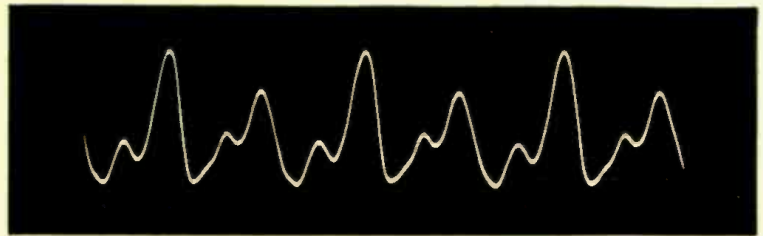

The selected samples are "stretched" for transmission. They travel in a narrower frequency band than complete sound.

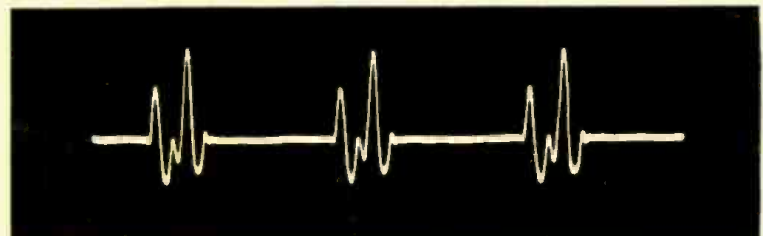

Using the stretched sample as a model, the receiver restores original frequency. In all speech, sounds are intoned much longer than is needed for recognition—even by the human ear. Electronic machines perform recognition far faster than the ear.

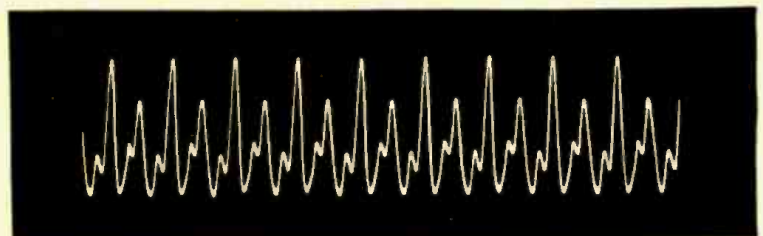

The receiver fills in gaps between samples, recreating total original sound. Under new system, three or four voices could travel at once over a pair of wires which now carries only one—and come out clearly at the end!

You Can Train at Home for Good Pay Jobs in RADIO-TELEVISION

Fast Growing Industry Offers Good Pay, Security, Bright Future

LESSON AND CATALOG FREE MAIL CARD

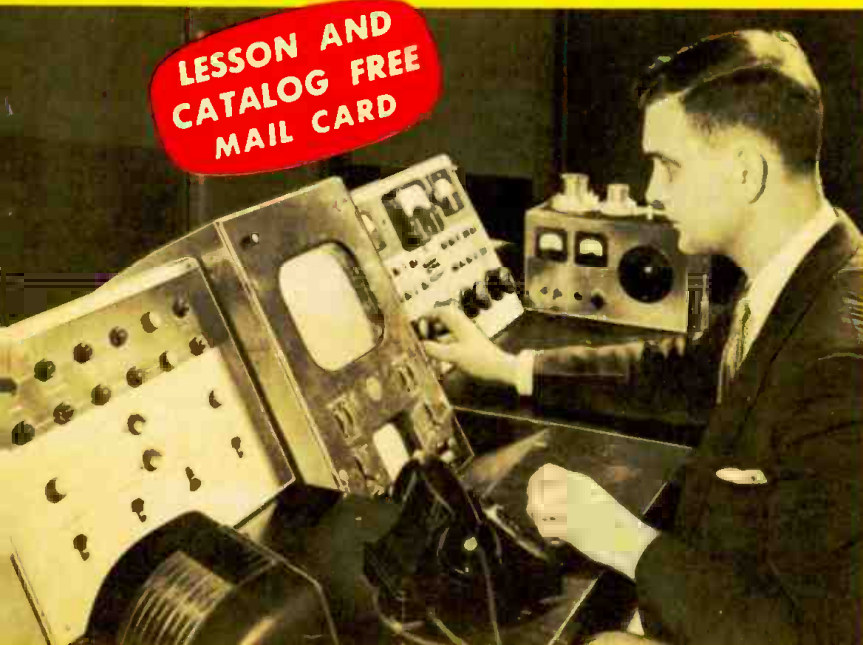

Training PLUS OPPORTUNITY is the ideal combination for success. Today's OPPORTUNITY field is Radio-Television. Over 125 million home Radios plus 30 million sets in cars and 40,000,000 Television sets mean big money, opportunity for trained Radio-Television Technicians. More than 4,000 Radio and TV Broadcasting stations offer interesting and important positions for technicians, operators. Color Television, portable TV sets, Hi-Fi, other developments assure future growth. Radio, Television are both growing. Need for trained technicians is increasing!



J. E. SMITH
Founder

Find Out What Oldest and Largest Home Study Radio-Television School Offers You

Since 1914—for more than 40 years—N.R.I. has been training ambitious men at home in spare time for Radio-TV. Thousands of successful graduates say N.R.I.'s 50-50 training method is a fast, easy, effective way to higher earnings, desirable jobs. Carefully planned experiments and practice with equipment supplied free of extra charge, bring basic principles, techniques to life right in your own home. Find out what dependable training can do for you.

You Learn by Doing—Get Practical Experience with Kits N.R.I. Sends

Nothing takes the place of practical experience. As part of N.R.I. Servicing Course you build AC-DC Radio Receiver and Vacuum Tube Voltmeter shown below. Use them to make tests, conduct experiments, get practical experience. All equipment yours to keep.

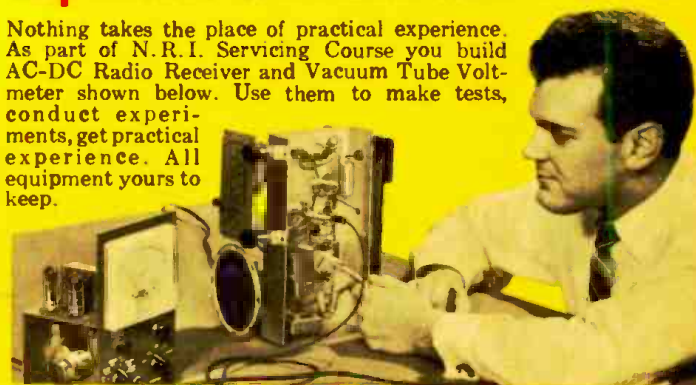

Add to Your Income Starting Soon

Make \$10-\$15 a Week Extra Fixing Sets in Your Spare Time

Soon after enrolling, many N.R.I. students start earning extra money fixing neighbors' radio sets. Many earn enough extra to pay entire cost of course and provide capital to start their own full time Radio-TV business after getting N.R.I. Diploma. If you want a job with a future, find out how you can train at home for Radio-Television. Mail Postage Free postcard for Sample Lesson. See how practical it is to learn at home. Get 64-Page Catalog, too. See equipment you get, outlines of courses, facts about opportunities in this growing field. Prices of N.R.I. Courses are low, terms easy.



N.R.I. Training leads to good pay jobs like these. **BROADCASTING:** Chief Technician, Chief Operator, Remote Control Operator. **SERVICING:** Home and Auto Radios, P. A. Systems, Television Receivers, Electronic Controls, FM Radios, Hi-Fi. **SHIP AND HARBOR RADIO:** Chief Operator, Assistant Operator, Radiotelephone Operator. **POLICE RADIO:** Transmitter Operator, Receiver Serviceman. **GOVERNMENT RADIO:** Operator in Army, Navy, Marine Corps, Coast Guard, Forestry Service Dispatcher, Airways Radio Operator. **IN RADIO PLANTS:** Design Assistant, Transmitter Design Technician... **AND MANY OTHERS.**

N.R.I. TRAINED THESE MEN

Thanks N.R.I. for Good Start



"Right now I am doing spare-time repairs on Radios and Television. Going into full time servicing soon." **C. HIGGINS**, Waltham, Mass.

Quit Job to Start Business



"I decided to quit my job and do TV work full time. I love my work and am doing all right financially." **W. F. KLINE**, Cincinnati, Ohio

Engineer with Station WHPE



"I operated a successful Radio repair shop. Then I got a job with WPAQ and now I am an engineer for WHPE." **VAN W. WORKMAN**, High Point, N. C.

N.R.I. Started His Way up



"I was a cab driver earning \$35 a week. Then I enrolled with N.R.I. Now tester with TVmaker." **J. H. SHEPHERD**, Bloomington, Ind.

See Other Side

CUT OUT AND MAIL CARD NOW

SAMPLE LESSON AND CATALOG BOTH FREE

NO STAMP NEEDED! WE PAY POSTAGE

This card entitles you to Actual Lesson on Servicing, shows how you learn Radio-Television at home. You'll also receive 64-Page Catalog.

NATIONAL RADIO INSTITUTE, Dept. E
Washington 9, D. C.

Please mail me the FREE sample lesson and 64-Page Catalog. (No Salesman will call.)

Name.....Age.....

Address.....

City.....Zone.....State.....

Approved Member, National Home Study Council



Practice Servicing-Communications with Kits of Parts N.R.I. Sends



YOU BUILD AC-DC Superhet Receiver

N.R.I. Servicing Course includes all needed parts. By introducing defects you get actual servicing experience practicing with this modern receiver. Learn-by-doing.

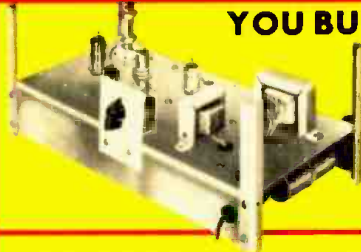

YOU BUILD Signal Generator

You build this Signal Generator. Learn how to compensate high frequency amplifiers. practice aligning typical I.F. amplifiers in receiver circuits. Make tests, conduct experiments.

YOU BUILD Broadcasting Transmitter

As part of N.R.I. Communications Course you build this low power Transmitter, learn commercial broadcasting operators' methods, procedures. Train for your FCC Commercial Operator's License.



YOU BUILD Vacuum Tube Voltmeter

Use it to earn extra cash fixing neighbors' sets; bring to life theory you learn from N.R.I.'s easy-to-understand texts.



Radio-Television Can Give You a Good Job with a Future

N.R.I. Graduates do Important Work — Get Important Pay



Chief Engineer with Station

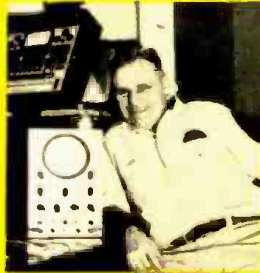

Paid for Instruments out of Earnings



Has Own Radio-TV Business

"I am Chief Engineer of Station KGCU in Mandan, N. D. I also have my own spare time business servicing high frequency, two-way communications systems." R. BARNETT, Bismarck, N. D.

"I am doing very well in spare time TV and Radio. Sometimes have three TV jobs waiting and also fix car Radios for garages. I paid for instruments out of earnings." G. F. SEAMAN, New York, N. Y.

"We have an appliance store with our Radio and TV servicing and get TV repairs. During my Army service, N.R.I. training helped get me a top rated job." W. M. WEIDNER, Fairfax, S. D.

Here is a line of work that people respect—a vocation where you can advance, win a place for yourself, earn good pay and gain much personal satisfaction in what you are able to do. And you can learn at home in your spare time. Smart fellows everywhere are using their spare time to develop new knowledge, new skills. They know it is the trained man who gets ahead, gets the better job, drives the better car, is respected for what he knows and can do.

Be a Skilled Technician

The technical man is looked up to. He should be. He does important work, gets good pay for it. Radio-Television offers that kind of work. There are more than 40 million Televisions, 150 million home and auto Radios. Millions more are sold each year. There are splendid opportunities for the man well trained in Radio-Television Servicing or Broadcasting, Micro-Wave Relay, Aviation and-Police Radio, Two-Way Communications for buses, taxis, trucks, etc. are expanding—making more jobs, greater opportunity.

You Can Train in Spare Time

Keep your job until you're ready for a better one. Learn at home. N.R.I. Courses are planned for men who can study only during spare time. You get many kits to build equipment, get practical experience. You work on circuits common to both Radio and TV. Equipment you build "brings to life" things you learn in N.R.I.'s easy-to-understand texts. Experienced N.R.I. instructors, technicians, specialists devote full time to making sure you get the best and simplest Radio-TV training. Train as fast or as slow as you like.

Tested Way To Better Pay

N.R.I. Training is practical, thorough. You get the benefit of N.R.I.'s 40 years experience training men for success in Radio-Television. Most successful N.R.I. men start without any knowledge of Radio, many without a high school education. Find out what Radio-Television training can mean to you. Make a decisive move today toward becoming one of that select group—a Radio-TV Technician. Send for Actual Lesson and 64-Page Catalog, both FREE. NATIONAL RADIO INSTITUTE, Dept. E, Washington, D. C.

See Other Side

FIRST CLASS
Permit No. 20-R
(Sec. 34.9, P. L. & R.)
Washington, D. C.

BUSINESS REPLY CARD

No Postage Stamp Necessary If Mailed In The United States

POSTAGE WILL BE PAID BY

NATIONAL RADIO INSTITUTE

16th and U Sts., N. W.

Washington 9, D. C.

SAMPLE LESSON AND CATALOG BOTH FREE

CUT OUT AND MAIL POSTAGE-FREE CARD



for the expanding independent service-dealer

More and more independent service-dealers are strengthening their competitive position by broadening their activities. They are adding to radio and television service: Marine, mobile and citizen radio . . . sound systems . . . industrial equipment . . . special electronic devices . . . etc.

These forward-looking independent service-dealers are discovering expanded lines of CBS industrial tubes and semiconductors ready to help

them in their profitable new fields. New PA-5 and PA-17 reference guides describe respectively over 200 CBS industrial receiving, power and special-purpose tubes . . . and a wide line of CBS crystal diodes, transistors and silicon power rectifiers.

Both guides are free . . . from CBS Tube distributors or direct. Just ask for Bulletins PA-5 and PA-17.



tubes • semiconductors

Reliable products through Advanced-Engineering

CBS-HYTRON

Danvers, Massachusetts

A Division of Columbia Broadcasting System, Inc.

BEST BUILT YET

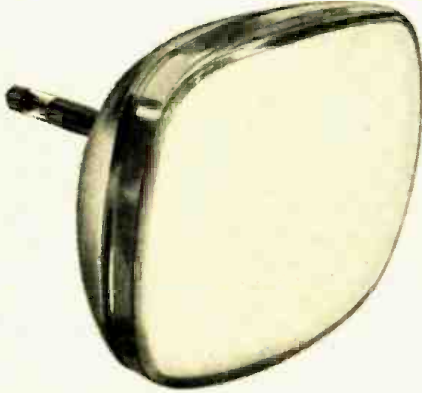

BEST FOR EVERY SET



All Tung-Sol Tubes are engineered to one standard of quality—Blue Chip Quality. Whether they're for famous set makers or leading service dealers, Tung-Sol Tubes are identical in design and performance. Tell your supplier you'd rather have Tung-Sol!

Blue Chip Quality

TUNG-SOL®

MAGIC MIRROR ALUMINIZED

**PICTURE TUBES
RECEIVING TUBES**

TUNG-SOL ELECTRIC INC., Newark 4, N. J. Sales Offices: Atlanta, Ga., Columbus, Ohio, Culver City, Calif., Dallas, Tex., Denver, Colo., Detroit, Mich., Irvington, N. J., Melrose Park, Ill., Newark, N. J., Seattle, Wash.

TUNG-SOL makes All-Glass Sealed Beam Lamps, Miniature Lamps, Signal Flashers, Picture Tubes, Radio, TV and Special Purpose Electron Tubes and Semiconductor Products.

Spot Radio News

★ Presenting latest information on the Radio Industry.

By RADIO & TELEVISION NEWS'
WASHINGTON EDITOR

THE MAMMOTH TV very-high—ultra-high allocation problem, that scores of experts have been trying to resolve for years, now has been formally turned over to a TV allocation study organization, who will attempt to develop a body of facts that can be used by the FCC to determine the soundest approach to channel allocations.

The group, it was said, will not become involved in product research or in the economic and sociological aspects of the allocation situation. Studies of these factors will be assigned to other special committees composed of engineering specialists and marketing experts.

All members of all groups, however, will base their analyses on the basic conditions outlined in the *crash* research notice issued by the Commission in the early fall of '56.

CLOSED-CIRCUIT TV, featuring programs ranging from native folk dances to demonstrations of the use of color TV in medical science, is having a terrific impact on visitors to the United States central exhibits at international trade fairs now being staged in various parts of the world.

In Afghanistan, experiencing its first look at TV, His Majesty, Mohammed Zahir Shah, participated in the first telecast in the history of the country during his visit to the U. S. Pavilion in Kabul. Accompanied by an entourage of 300, including members of the

Royal Family, the King saw himself on the TV eye, which proved to be one of the hits of the exhibit. Six monitors located at strategic spots through the show were crowded constantly as Afghans and visitors delighted in seeing themselves and friends in action.

A similar TV eye is currently fascinating large turnouts at the American exhibit in Izmir, Turkey. More elaborate TV closed circuits, operating from attractive glass-enclosed studios, have been installed at our exhibits in Stockholm, Damascus, Salonika, Vienna, and Zagreb. At these fairs, viewers can see performances by local singers, instrumentalists, dancers, puppeteers, comedians, and dramatic actors, as well as demonstrations of a variety of products and devices which are on view in the American pavilion. Do-it-yourself demonstrations, the workings of farm implements and household appliances, etc., are shown by way of monitors. Fairgoers are also able to see step-by-step techniques of homesewing from a pattern stage to machine operation and finally the modeling of finished house dresses.

The largest of the closed-circuit TV operations are in the Damascus and Stockholm exhibit areas. Erected in the center of a U-shaped building, the Damascus studio permits fair visitors to watch programming in the courtyard and on fifteen monitors scattered throughout the zone. Two cameras and six technicians man the operations.

NEW TV GRANTS SINCE FREEZE LIFT

Continuing the listing of construction permits granted by FCC since lifting of freeze. Additional stations will be carried next month.

STATE	CITY	CALL	CHANNEL	FREQUENCY	POWER*
Washington	Walla Walla	—	8	180-186	3.04
Wyoming	Casper	—	2	54-60	.208
Virginia	Arlington	—	20	506-512	.676

New Call Letter Assignments

STATE	CITY	CALL	CHANNEL	FREQUENCY
Florida	Palm Beach	WPTV (Formerly WJNO-TV)	5	76-82
Kentucky	Ashland	WALN-TV (Formerly WPTV)	59	740-746
Louisiana	New Orleans	WWEZ-TV	32	578-584
Oregon	Coos Bay	KOOS-TV	16	482-488
Texas	Alpine	KAMT-TV	12	204-210

*ERP—(effective radiated power, kw.)

JERROLD Introduces **TRAP-EASE***

**Revolutionary New TV
Filter Knocks Out
Adjacent Channel
Interference... Opens
New Sales Market For
The Television Trade!**



Only \$19.95 List

This tunable "deep notch" antenna trap (greater than 50 db) permits TV viewers to remove "beat" or "herringbone" patterns caused by strong adjacent channel sound or video carriers. Permits clear reception of even weak distant stations.

Works with any TV receiver and any 300 ohm antenna that would normally bring in pictures from the distant stations if the interfering adjacent channel was not on the air. Does not affect reception of regularly viewed channels.

BRINGS IN PICTURES FROM OUT OF NOWHERE! **TRAP-EASE**
Before TRAP-EASE is Installed After TRAP-EASE is Installed **EASILY**
INSTALLED
ON ANY
TV SET!

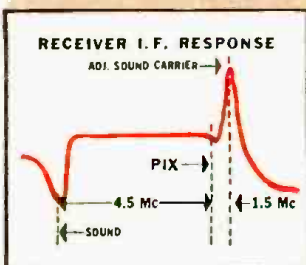
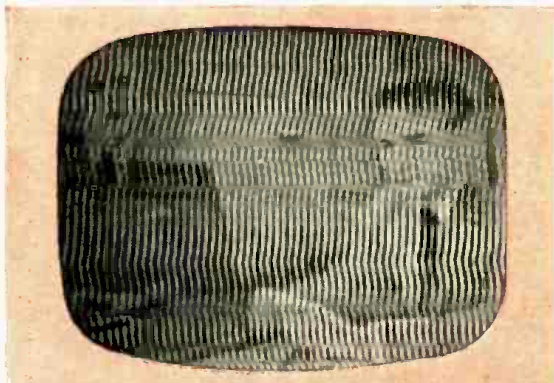

In case shown Receiver AGC is held down by a strong adjacent channel sound carrier. This lowers receiver gain and prevents proper reception of the desired channel. "Beat" or "Herringbone" pattern is predominant on the screen.

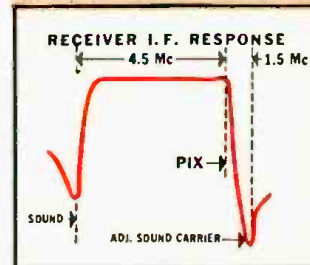

The adjacent sound carrier has been suppressed by some 50 db, which: (1) Enables the signal level of the desired channel to control the AGC action of the receiver. (2) Completely removes the "beat", leaving a clear, strong picture.

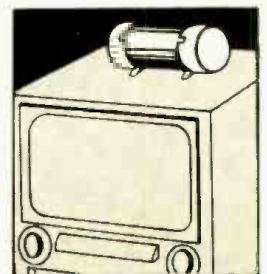
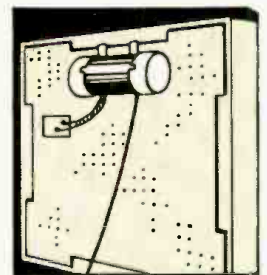

TRAP-EASE SELLS ITSELF

Let the amazing performance of the Jerrold Trap-Ease do its own selling. One demonstration and the Trap-Ease sells itself with the greatest of ease. Simple to demonstrate either in your store—or in the customer's home.

MONEY BACK GUARANTEE

Never before a TV accessory that achieves such startling results. Contact your Jerrold distributor today for details on the complete sales promotion package available to you.

TWO MODELS AVAILABLE

Low Trap-Ease (Model HQ-91) covers Channels 2 to 6.
High Trap-Ease (Model HQ-92) covers Channels 7 to 13.

JERROLD ELECTRONICS CORPORATION

23rd and Chestnut Streets • Philadelphia 3, Penna.

Simply connect the Trap-Ease in series with the antenna lead-in and mount on rear or top of TV receiver. Handsome contemporary design and soft color tones of the unit harmonize with today's modern or traditional cabinet decor.

*©Jerrold Electronics Deep Notch Adjacent Channel Trap

www.americanradiohistory.com

PHAOSTRON

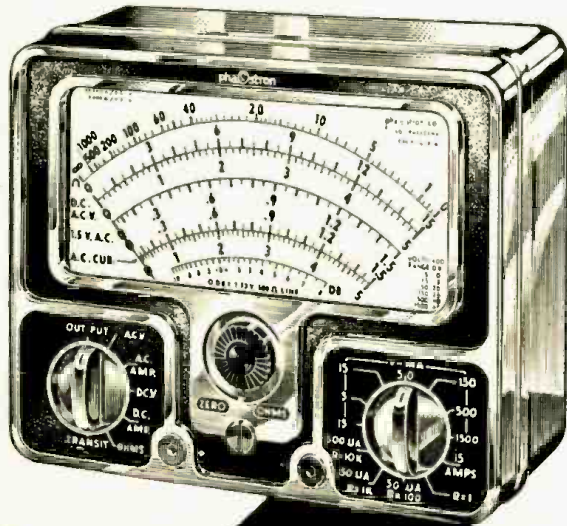

Here Is The Best Value Ever Offered In An Electrical Measuring Instrument...

METER PROTECTION
The meter movement is protected up to 1000 times overload by rectifier network.

"555A"
A.C.-D.C. V.O.M.

ONLY THE PHAOSTRON "555A" V.O.M. (VOLT OHM MILLIAMMETER) MEASURES A. C. and D.C. CURRENT and VOLTAGE AS WELL AS RESISTANCE AND HAS ALL THESE FEATURES:

- Unbreakable Metal Case of Highly Polished Chrome
- Separate Range and Function Switches
- Anti Magnetic Shielding
- Easy-to-Read, Large 4-Color Scales
- 43 Unduplicated Ranges
- Only 2 jacks
- 3% D.C. ... 4% A.C. Permanent Accuracy

ACCESSORIES AVAILABLE
Genuine Leather Carrying Case \$7.95
Panel Mounting Adapter \$1.50

"555A" V.O.M. complete with probes and batteries or your Parts Distributor

\$44⁵⁰

Write today for full details or ask your dealer

PHAOSTRON INSTRUMENT AND ELECTRONIC COMPANY
151 Pasadena Avenue, South Pasadena, California

According to reports, hourly, crowds of several thousands collect in and around the pavilion at night to watch well-known Syrian performers put on shows. The big hit of the program is the *double-or-nothing* quiz show which had to be expanded from a half hour to a full hour to satisfy audience interest. Every twenty minutes, a Syrian announcer interrupts the program to explain how the television circuit operates. In Sweden, there are thirteen monitors in operation.

The Vienna exhibit consists of a simulated fully equipped hospital operating room. An operation performed on a medical mannequin is transmitted via a miniature camera mounted in the operating light. In similar fashion, minute details of dental surgery are shown on color-TV monitors. Another feature of the display is built around a color-TV microscope through which images are magnified for analysis. Transmission in color displays the necessary color differentiation in cells and tissues. Demonstrators, playing the roles of surgeons, are provided with throat or hand microphones so that their commentaries may be heard by the public.

In addition to television, our electronics industry is represented in the foreign exhibits by a wide variety of radios, including those transistorized and powered by the sun, those small enough to place in the palm of a hand and table models; tape recorders and oscilloscopes; high-fidelity phono equipment, etc. At Izmir, there is a graphic display of the history of broadcasting from the crystal set era to the newly-developed solar-battery radios.

Record shops gaily decorated with album jackets have been installed in show quarters in Stockholm, Zagreb and Bari, Italy. In Bari, there's a large exhibit of hi-fi equipment in operation in a colorful garden adjacent to the exhibition building. Records can be played in eight glass-enclosed booths. There are eight tape machines in operation at other fairs which visitors can use to record and play back their own voices.

A BOLD BID for channel 2 to serve as a mobile band appeared in a recent petition to the FCC entered by the American Trucking Association; the Commission was asked to reallocate that channel for fixed scatter service.

In commenting on its request, the association said that the motor carrier industry must now share three of the 12 frequencies in the 25-50 megacycle band with passenger carriers. All of these frequencies, they said, are severely congested and conditions are getting worse every day.

The ATA petition pointed out that the "... Commission's decision not to reduce channel separations in the 25-50 band, which offered the best prospect for immediate satisfaction of the motor carrier industry's need for additional assignments in the very-high band will ... adversely affect the ra-

(Continued on page 132)

GET IN ON THE TV



L. C. Lane, B.S., M.A.
President, Radio-Television Training Association. Executive Director, Pierce School of Radio & Television.

BOOM!

TRAIN FOR A TOP-PAY JOB AS A TELEVISION TECHNICIAN NO PREVIOUS EXPERIENCE NEEDED — study AT HOME in your SPARE TIME

Next to the atom and hydrogen bombs, the biggest noise being made today is by the booming radio-television-electronics industry.

Now, while the boom is on in full force, is the time for you to think about how you can share in the high pay and good job security that this ever-expanding field offers to trained technicians.

Just figure it out for yourself. There are more than 400 television broadcasting stations operating right now

and hundreds more to be built; more than 34 million sets in the country and sales increasing daily. Soon moderately priced color television sets will be on the market and the color stampede will be on.

All these facts mean that good jobs will be looking for good men. You can be one of those men if you take advantage of my training now — the same training that has already prepared hundreds of men for successful careers in the radio-television-electronics field.



No experience necessary! You learn by practicing with professional equipment I send you. Many of my graduates who now hold down good paying technician jobs started with only grammar school training.

If you have previous Armed Forces or civilian radio experience you can finish your training several months earlier by taking my FM-TV Technician Course. Train at home with kits of parts, plus equipment to build YOUR OWN TV RECEIVER. ALL FURNISHED AT NO EXTRA COST!

After you finish your home study training in the Radio-FM-TV Technician Course or the FM-TV Technician Course you get two weeks, 50 hours, of intensive Laboratory work on modern electronic equipment at our associate school in New York City, Pierce School of Radio & Television.

COLOR TV TECHNICIAN COURSE—All new! Learn the latest. Be prepared for those Color TV servicing profits ahead! Contains the most up-to-date servicing data, procedures and circuits. For men with radio or TV training or experience.

**RADIO-FM-TV
TECHNICIAN
TRAINING**

**FM-TV
TECHNICIAN
TRAINING**

**Sylvania Now Sponsoring
RTTA's Color TV
Technician Course**
One of the nation's largest electronics manufacturers and marketers Sylvania Electric Products Inc. in its continuing effort to cooperate with independent service dealers is now sponsoring the RTTA Color Television Technician Course. Available to Authorized Sylvania Dealers.

VETERANS!

My School fully approved to train Veterans under new Korean G. I. Bill. Don't lose your school benefits by waiting too long. Write discharge date on coupon.

**YOU GET
THESE
free!**



LEARN BY DOING
As part of your training I give you the equipment you need to set up your own home laboratory and prepare for a BETTER-PAY TV JOB. You build and keep an Electromagnetic TV RECEIVER designed and engineered to take any size picture tube up to 21-inch, (10-inch tube furnished. Slight extra cost for larger sizes.) . . . also a Super-Het Radio Receiver, AF-RF Signal Generator, Combination Voltmeter-Ammeter-Ohmmeter, C-W Telephone Transmitter, Public Address System, AC-DC Power supply. Everything supplied, including all tubes.

EARN WHILE YOU LEARN Almost from the very start you can earn extra money while learning by repairing radio-TV sets for friends and neighbors. Many of my students earn enough each week to pay for their entire training from spare time earnings . . . start their own profitable service business.

FCC COACHING COURSE Qualifies you for Higher Pay! Given to all my students AT NO EXTRA COST. Helps you qualify for the TOP JOBS in Radio-TV that demand an FCC license! Full training and preparation at home for your FCC license.

Radio-Television Training Association

52 EAST 19th STREET • NEW YORK 3, N. Y.

Licensed by the State at New York • Approved for Veteran Training

MAIL THIS COUPON TODAY!

Mr. Leonard C. Lane, President
RADIO-TELEVISION TRAINING ASSOCIATION
Dept. RT-1D, 52 East 19th Street, New York 3, N. Y.
Dear Mr. Lane: Send me your NEW FREE BOOK, FREE SAMPLE LESSON that will show me how I can make TOP MONEY IN TELEVISION. I understand I am under no obligation.

(PLEASE PRINT PLAINLY)

Name _____ Age _____

Address _____

City _____ Zone _____ State _____

- Color TV Technician Course
- Radio-FM-TV Technician Course
- FM-TV Technician Course
- TV Studio Technician Course

VETERANS!
Write discharge date

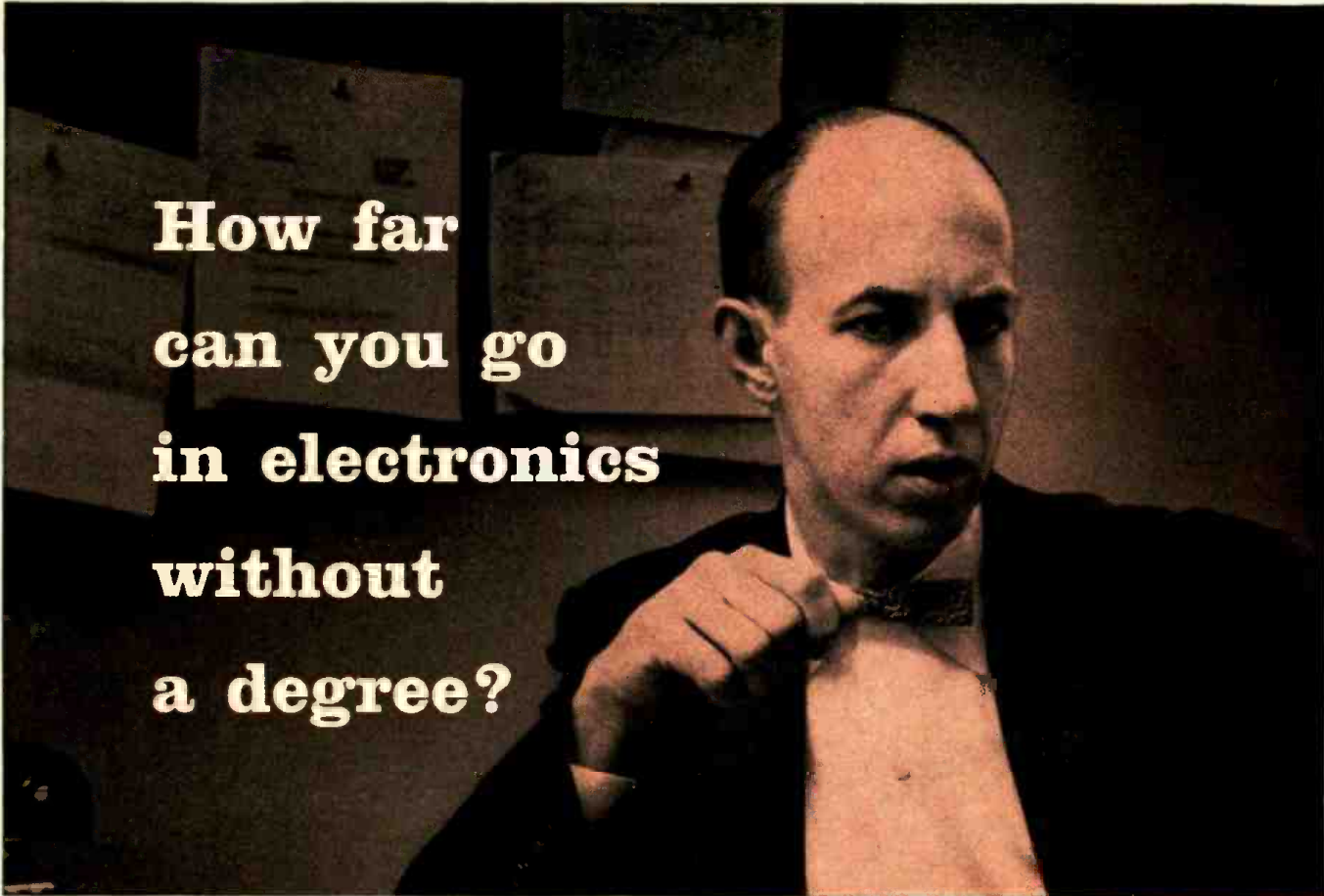

How far can you go in electronics without a degree?

32-year-old Bill Miles talks frankly about the technicians' biggest problem

2 years ago, degreeless Bill Miles had reached a blind alley in his career. Yet today, with IBM, he's actually supervising engineers in America's biggest electronics project. Here's how this technician broke through the "education barrier."

"Training and local assignments," recalls Bill Miles, "were what caught my eye when I saw an IBM ad in 1955. So I investigated. Now here I am with an advanced electronics education under my belt—and responsibility as a Group Supervisor in Project Sage. I work on the world's largest and most advanced computer. I live in my home town. And my future in the company is what I make it. Yet only 2 years ago, I thought I'd gone as far as a technician ever could!"

Becomes radar technician

Bill's background is typical of thousands of capable, ambitious technicians who never acquired a formal engineering degree. His interest in electronics, aroused in Camden, New Jersey, high school, was nourished by a 3-year stint as Aviation Radar Technician in the Navy's "Black Cat" air-sea rescue squadron.

Takes night courses

Discharged in 1946, Bill married a girl he'd known in high school. During the

next 9 years, Bill was teacher in a radio-TV institute, TV service man, TV company technician, and chief supervisory TV technician. All the while he pursued an engineering education at night. But growing family responsibilities made it more and more difficult.

Finds doors barred

However, feeling he was equipped for greater responsibility, Bill, now 30, investigated several companies but found that, while they liked his abilities, his lack of degree barred the door to any significant future advancement.

Enters IBM school

In May 1955, when he moved his family to Kingston, New York, and started at IBM, Bill wasn't quite sure what to expect. The 9-month training course—valued at \$10,000 per man—had been the big magnet for him. He hoped the future would match his expectations.

Meets head of school

"Sixty of us started school at IBM, attending class 8 hours a day. The course consisted of about 20 subjects, mostly dealing with computer circuits and units,

and maintenance techniques. The teaching was adult, superb. After the first 20 weeks, our living expense allowance, over and above salary, rose to \$59.50 a week. We kept our own grades, and every 6 weeks when we reviewed them with the instructors, they asked us for ways to improve the course. I expected a casual 'hello' when I met the Division Manager of Education, but he talked to me for an hour about myself and my interests. The real concern IBM has for you as an individual, both before and after they hire you, is undoubtedly one reason why we all began to take a lot of pride in this outfit."

Joins home-town computer site

Bill had joined IBM as a Field Systems Engineer. After graduation, when 10 of his classmates were immediately promoted to specialized assignments, Bill was assigned to a computer site near his home in Mt. Holly, New Jersey, with IBM paying his moving expenses. For the first two months he helped install the SAGE computer, an important link in America's air defense. Ultimately, such computers will ring America's entire air defense perimeter. Looking back, Bill notes, "I'll admit the work was laborious and difficult, but still I have a sense of great accomplishment. Together we all helped create something of value from almost nothing."

World's largest computer

"The computer is probably the largest one in the world, with over a million components. Flattened out, it would probably fill a ball field. The computer analyzes radar data on every object in the sky. Then it checks each object against available traffic information and identifies it as either friendly or hostile. It can make suggestions, but it can't send a Nike missile against what it thinks is a 'baddie.' Only airmen can make that decision."



Bill gets \$10,000 computer education at IBM Kingston

Supervises fifteen

Recently promoted to Group Supervisor, Bill now directs an entire shift of 15 men, reporting to a Group Manager. His job: to maintain the computer in combat readiness. "I have to be familiar with the entire system. I rely on two types of specialists to help me: computer units men who are specialists in certain areas; systems engineers for the over-all computer."



Miles does diagnostic programming on the Maintenance Console of the Sage Computer



Miles nails down problem with Site Manager R. Schimmel

Buys house, car

Bill has bought a 7-room house in Mt. Holly. When not busy with his son and twin daughters, he likes to bowl. He drives a '56 automobile. He's enjoying the good life, and expects it to get even better. His employee benefits alone represent a cash value of many hundred dollars a year. He expects the IBM-sponsored General Education Program will prepare him for higher management responsibilities. Later, Bill's manager said, "He's currently assuming the responsibilities of an electrical engineer."

But the question remains: Is Bill really an engineer?

The "professional" engineer

"No, I certainly don't consider myself a 'professional' engineer, qualified to design machines, for instance. But the point is, I'm doing work ordinarily done by engineers . . . work usually denied to men without a degree."

IBM upgrades technicians

Could he do this elsewhere? "Of all the companies I know, IBM appears to be one of the few upgrading the technician to the level of engineering responsibility. Fortunately for me, IBM had the imagination to get men without degrees and encourage them to rise in responsibility and income to the level of their native talents . . . not what their formal education dictates."



"Student" Bill Miles diagrams computer circuit

Both titles gain

Is this a sign that the educational system is wrong? "Not at all," answers Bill Miles. "A Doctor's, a Master's, a B.S. degree stand for something and always will. But if a technician can perform many jobs that traditionally belong to the engineer, they both stand to gain. The technician, because he gets much of the engineer's salary, satisfaction and recognition; the engineer, because he is free to do work which *only* a man with his formal training can do. When everybody wins, and nobody loses, it's the sign of a good thing."

Since Bill Miles joined IBM, opportuni-



Home-town assignment pleased Miles' wife, son, twin girls

ties in the Project Sage program, destined for long-range national importance, have grown more promising than ever. If IBM considers your experience equivalent to an E.E., M.E. or Physics degree, you'll receive 8 months' training, valued at \$10,000 per man, as a Computer *Systems Engineer*. If you have 2 years' technical schooling or the equivalent experience, you'll receive 6 months' training, as a Computer *Units Field Engineer*, with opportunity to assume full engineering responsibility. Assignment in area of your choice. Every channel of advancement in entire company open—and IBM is leader in a field that's skyrocketing in growth. All the customary benefits and more. WRITE to Nelson O. Heyer, IBM, Kingston, New York. Include the questions you would want answered. You'll receive a prompt reply.

CUSTOMER ENGINEERS: opportunities are also available, locally, for servicing IBM machines, after training with pay. Contact the nearest IBM office.

IBM MILITARY PRODUCTS

DATA PROCESSING • ELECTRIC TYPEWRITERS
TIME EQUIPMENT • MILITARY PRODUCTS



New "Convertible" 20-watt Amplifier and Pre-Amp with controls, in one versatile unit, only \$99⁹⁵

THE new General Electric Convertible is a dual-chassis design. In a single, amazingly flexible and low cost unit there's a powerful amplifier, with 20 watts of undistorted output—plus a pre-amplifier with seven panel-mounted controls. It gives you sound reproduction as it was meant to be heard.

There's New Installation Flexibility, too! With the General Electric dual-chassis design, the ampli-

fier and pre-amp may be mounted independently in built-in systems. Or, as one complete unit, the handsome Convertible cabinet may be placed on a bookshelf or table.

Write today for new hi-fi ideas and the name of your dealer. He can show you the full line of G-E Hi-Fi components. *General Electric Company, Special Products Department, Section R151, Electronics Park, Syracuse, New York.*

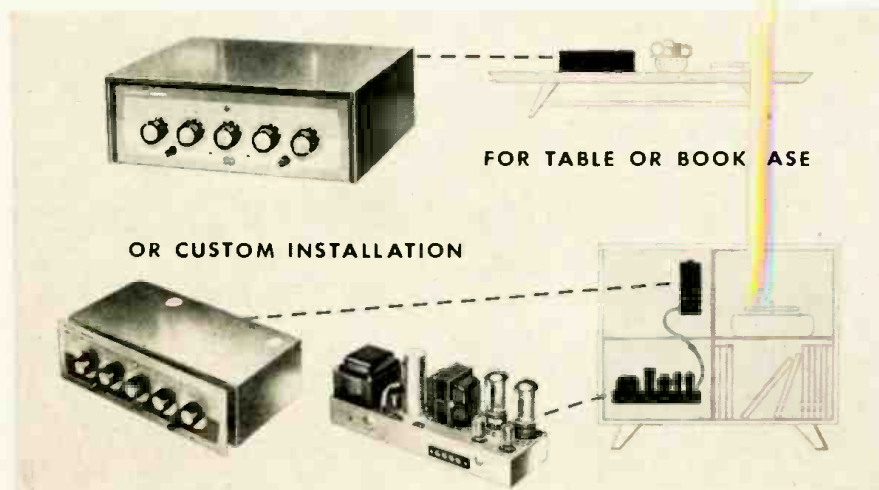

*Progress Is Our
Most Important Product*



GENERAL ELECTRIC

RADIO & TELEVISION NEWS



← *The data that Launched
Thousands of Careers
is Yours FREE to show*

**HOW YOU CAN BE SUCCESSFUL
IN RADIO-TV-ELECTRONICS**

Send for Your Booklet Today!

YOU CAN plod along for years, getting a paltry increase now and then, enjoying little security, finding your work dull and drab.

Then something happens. Things look up. You become more confident. Your earnings rise. You feel more important.

"Luck," some may say.

"Contacts," others may suggest.

But in your heart, you will know the answer: "Training." And it all may have started the moment you filled out a coupon requesting a copy of a free booklet named "Your Future in the New World of Electronics." From this data you get knowledge of where you stand in Electronics. Tremendous expansion leaves this gigantic industry pleading for trained men. Top manufacturers sold billions of dollars worth of electronic merchandise in 1956. By 1960, the radio-electronics industry should do no less than 15 billion dollars per year, not counting military orders.

Today there are over 97,000 radio-equipped police cars; at least 87,000 taxis are radio equipped; 37,730 civilian planes have radio; 35,000 American ships have radio.

Today there are over 132,000,000 radios in use. There are 38,000,000 TV sets and 477 TV stations in operation. Color TV is coming into its own. Countless positions must be filled—in development, research, design, production, testing and inspection, manufacture, broadcasting, telecasting and servicing. To fill these posts trained men are needed—men who somewhere along the line take time to improve their knowledge, their skills. Men who, today, perhaps, take two minutes to send for a booklet.

"Your Future in the New World of Electronics" shows you how CREI Home Study leads the way to greater earnings through the inviting opportunities described above.

However, CREI does not promise you a "snap." With an accredited technical school such as this, you must *study* to convert your ambition into technical knowledge you can sell in the fabulous Electronics market.

Since its founding in 1927, CREI has provided thousands of professional radio men with technical educations. During World War II CREI trained thousands for the Armed Services. Leading firms choose CREI courses for group training in electronics, at company expense, among them United Air

Lines, Canadian Broadcasting Corporation, Trans-Canada Airlines, Sears, Roebuck and Co., Bendix Products Division and All-American Cables and Radio, Inc.

CREI courses are prepared by recognized experts in a practical, easily understood manner. You get the benefit of time-tested materials, under the personal supervision of a CREI Staff Instructor, who *knows* and *teaches* you what industry wants. This is accomplished on your own time, during hours selected by you, and controlled by your own will power. This complete training is the reason that graduates find their CREI diplomas keys-to-success in Radio, TV and Electronics. CREI alumni hold top positions in America's leading firms. At your service is the CREI Placement Bureau, which finds positions for advanced students and graduates. Although CREI does not guarantee jobs, requests for personnel far exceed current supply.

Now is the time of decision for you. Luck will not propel you forward unless it finds you trained. Contacts won't budge you an inch unless you have the skill to back them up. The answer is: Technical Training . . . and willingness to learn. Together they will bring you increased earning in this new Age of Electronics. Fill out the coupon below and mail it now. We'll

CREI resident instruction (day or night) is offered in Washington, D. C. New classes start once a month.

KOREAN WAR VETERANS: If eligible for training under the new G.I. Bill of Rights, check the coupon for full information.

promptly send you your free copy of "Your Future in the New World of Electronics." The rest—your future—is up to you.

MAIL THIS COUPON Today!

CAPITOL RADIO ENGINEERING INSTITUTE

ECPD Accredited Technical Institute Curricula
DEPT. 111-D, 3224 16th St., N. W., Washington 10, D. C.

Please send me your course outline and **FREE** Illustrated Booklet "Your Future in the New World of Electronics" . . . describing opportunities and CREI home study courses in Practical Electronics Engineering.

- CHECK FIELD OF GREATEST INTEREST
- Practical Radio Electronics Engineering (B)
 - Broadcast Radio Engineering (AM, FM, TV)
 - Practical Television Engineering
 - Practical Aeronautical Electronics Engineering

Name Age

Street

City Zone State

CHECK: Home Study Residence School Veteran



To help us answer your request intelligently, please give the following information:

EMPLOYED BY

HOURS AT WORK

TYPE OF PRESENT WORK

SCHOOL BACKGROUND

ELECTRONICS EXPERIENCE

IN WHAT BRANCH OF ELECTRONICS ARE YOU MOST INTERESTED?

Send today
for your complete
catalog

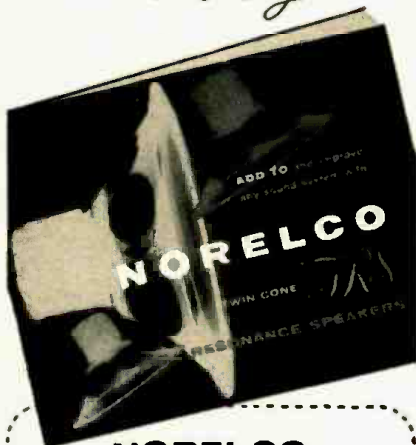

NORELCO
**F.R.S. SERIES*
FULL RESONANCE
TWIN-CONE
SPEAKERS



Norelco's twin-cone speakers are designed to meet the problem of high and low frequency dispersion in a single speaker. The large (heavy) cone is designed to produce good bass while the small (light) cone radiates higher frequencies.

Eliminating operating inefficiency experienced in multiple speaker cross over systems, Norelco's twin-cone is driven by a single voice coil—producing a flat response with exceptional reproduction of transients. Based on economy and value any one of the Norelco FRS twin-cone speakers is your best choice. If your neighborhood dealer does not stock Norelco write direct to North American Philips Company, Inc. giving your dealer's name and address.

ADD TO... and improve any
sound system with **Norelco**[®]
*FULL RESONANCE SPEAKERS



Write today to Dept. G1 for brochures and prices of these unique speakers.
North American Philips Co., Inc.
100 E. 42nd Street
New York 17, N. Y.

Within the Industry

JAY CARVER has been appointed to the post of advertising and sales promotion manager of *Electro-Voice, Inc.*, Buchanan, Michigan manufacturer of microphones and high-fidelity equipment.



Mr. Carver moves up to his new position after six months of managing wood product sales of the firm. He was formerly advertising manager of *Cabinart*, a division of *G & H Wood Products* of Brooklyn, N. Y.

LEON PODOLSKY, technical assistant to the president of *Sprague Electric Company*, is this year's recipient of the engineering award presented annually at the Fall Meeting of the RETMA and IRE.

The award, a gold plaque, has been presented each year since 1941 to an individual in recognition of outstanding contributions or services to the electronics industry.

Mr. Podolsky's citation reads: "Awarded for his outstanding contributions to international standardization in the field of components for electronic devices." He has served as technical advisor and chief delegate of the U.S. on electronic components at the meetings of the International Electrotechnical Commission since 1952. He is also chairman of the RETMA International Standards Committee and chairman of the ASA committee on electronic components.

MILTON R. SCHULTE who has been a vice-president of *Tung-Sol Electric Inc.* since 1951 and a director since 1953 has been elected to the newly created post of executive vice-president.



He joined the firm in 1923 immediately following his graduation from Stevens Institute. He has worked for no other firm. Starting as a draftsman, Mr. Schulte became foreman of the lamp department in 1925 and three years later was made superintendent of radio tube manufacture.

FEDERAL TELEPHONE AND RADIO COMPANY has established a Puerto Rican manufacturing subsidiary which will be known as **FEDERAL CARIBE, INC.** The new unit is located at Santa Isabela, near Ponce, on the southern shore of the island. It will produce selenium rectifiers, starter switches, and other

electronic components . . . **VARIETY ELECTRIC CO., INC.** of Newark, N. J. has changed its corporate name to **VARIETY ELECTRONICS CORP.** to more accurately reflect the category of products distributed by the firm . . . **L. A. YOUNG SPRING & WIRE CORPORATION** has purchased the assets of **GONSET COMPANY, INC.**, Burbank, Cal, manufacturer of communications electronic equipment. It will be operated as a division of the parent firm . . . **MAGNECORD, INC.** of Chicago has established a **MAGNE MATIC** division to specialize in the development and manufacture of magnetic tape recording equipment for industrial applications.

DR. BEN R. GOSSICK has been appointed to the post of chief engineer in charge of the circuitry department of the Semiconductor Products Division of *Motorola Inc.*

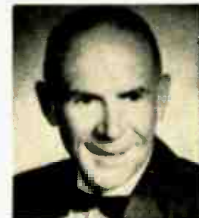

In his new position, he will be responsible for transistor electrical evaluation, testing procedures, and specifications. His function also includes customer circuit engineering and transistor circuitry research.

He was formerly associated with the *Oak Ridge National Laboratory* and *RCA*. He will make his headquarters at the division's Phoenix, Arizona plant.

SYLVANIA ELECTRIC PRODUCTS INC. has opened an 87,000 square foot distribution center in Los Angeles and another 79,000 square foot unit in the San Francisco area, more than doubling its warehousing and sales office facilities in California . . . **FAIRCHILD RECORDING EQUIPMENT CO.** has moved to a new and larger plant at 10-40 45th Avenue, Long Island City 1, N. Y. . . . **CANNON ELECTRIC COMPANY** of Los Angeles has added 100,000 square feet of space to its East Coast facility with the signing of a 10-year lease in the Salem, Mass., Industrial Center. It will be used for manufacturing purposes . . .

The Radio Division of **BENDIX AVIATION CORPORATION** has opened a new 100,000 square foot Engineering Center which will be used for projects covering guided missiles, ground and airborne radar, aviation communications, and mobile two-way radio systems . . . **ELECTRONIC ENGINEERING COMPANY OF CALIFORNIA** has broken ground for a new laboratory and general office at 1601 E. Chestnut Street in Santa Ana. The 41,000 square foot building is expected to be completed by the end of March . . . The Elec-

Prepare for a Good Paying Job—Or Your Own Business

Learn PRACTICAL RADIO-TV
with **25 BIG KITS**

of equipment I send you while
you train with me . . . for valuable
shop bench experience . . .



**17" to 24"
PICTURE TUBE**

This is the new Sprayberry Training Television receiver, built and tested in sections for greatest instruction value.

I now offer this fine modern oscilloscope to help you learn practical television servicing.

You will build this powerful short wave and broadcast superhet radio receiver for valuable shop instruction practice.

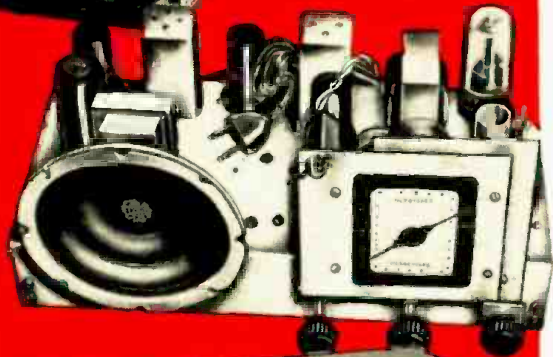

You build the new Sprayberry Tester. 18-range Volt-Ohm-Milliammeter readings plus output meter and condenser and resistor substitution selector.

In addition to modern lesson training, I also give you plenty of home practice on actual Radio-Television equipment . . . you will build and use the units shown here plus many more. All this equipment is yours to keep . . . keep everything you need to set up your shop.

"I Will Train You at Home in
RADIO-TELEVISION

On Liberal No Obligation Plan!"

New Equipment! New Lessons! Enlarged Course! The true facts are yours in my big new catalog . . . **YOURS FREE . . .**

JUST MAIL COUPON!

I can train and prepare you in as little as 10 months to step into the big opportunity Radio-Television service field. Train *without* signing a binding contract . . . without obligating yourself to pay any regular monthly amounts. You train entirely at home in spare hours . . . you train as fast or as slowly as you wish. You'll have your choice of **THREE SPRAYBERRY TRAINING PLANS** . . . planned for both beginners as well as the more experienced man. Get the true facts about the finest most modern Radio-Training available today . . . just mail the coupon for my big new 56 page fact-filled catalog plus sample lesson—both **FREE.**



Frank L. Sprayberry
President, Sprayberry
Academy of Radio

Train the Practical Way—with Actual Radio-Television Equipment

My students do better because I train both the mind and the hands. Sprayberry Training is offered in 25 individual training units, each includes a practice giving kit of parts and equipment . . . all yours to keep. You will gain priceless practical experience building the specially engineered Sprayberry Television Training Receiver, Two-Band Radio Set, Signal Generator, Audio Tester and the new Sprayberry 18 range Multi-Tester, plus other test units. You will have a complete set of Radio-TV test equipment to start your own shop. My lessons are regularly revised and every important new development is covered. My students are completely trained Radio-Television Service Technicians.

NEWEST DEVELOPMENTS

Your training covers **UHF, Color Television, FM, Oscilloscope Servicing, High Fidelity Sound and Transistors.**

See for Yourself . . . Make Your Own Decision . . . Mail Coupon Today!

The coupon below brings you my big new catalog plus an actual sample Sprayberry Lesson. I invite you to read the facts . . . to see that I actually illustrate every item I include in my training. With the facts in your hands, you will be able to decide. *No salesman will call on you.* The coupon places you under no obligation. Mail it now, today, and get ready for your place in Radio-Television.

SPRAYBERRY ACADEMY OF RADIO
111 North Canal Street, Dept. 25-G, Chicago 6, Illinois

Mail This Coupon For Free Facts and Sample Lesson

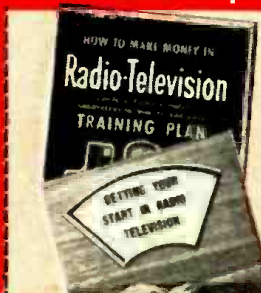

SPRAYBERRY ACADEMY OF RADIO
Dept. 25-G, 111 N. Canal St., Chicago 6, Ill.

Please rush all information on your **ALL-NEW** Radio-Television Training Plan. I understand this does not obligate me and that no salesman will call upon me. Include New Catalog and Sample Lesson **FREE.**

Name _____ Age _____
Address _____
City _____ Zone _____ State _____

tronics Division of **FAIRCHILD CAMERA AND INSTRUMENT CORPORATION** has moved into its new headquarters on Aerial Way North in the Landia Industrial Park, Syosset, Long Island, N. Y. . . . **REEVES INSTRUMENT CORPORATION** has established a West Coast office at 1216 Fifth Street, Santa Monica, Cal. This office will handle the Los Angeles area . . . **FEDERAL ELECTRIC CORPORATION** has opened a new plant on Garibaldi Ave. in Lodi, N. J. The new building will house the Training and Publications Divisions of the company . . . **ELECTRONICS MEASUREMENTS CORPORATION** has moved its entire manufacturing and executive facilities to 625 Broadway in New York . . . **UNITED STATES DYNAMICS CORPORATION** has dedicated building and production facilities at 1250 Columbus Avenue in Boston, Mass. The new 20,000 square foot plant will be used for the manufacture of electronic components and systems and for research and development of commercial and military gear . . . The offices of the TV receiver department of **HOTPOINT CO.** have been moved to 715 S. 25th Ave., Bellwood, Ill. . . . **GENERAL PRECISION LABORATORY INCORPORATED** has started construction on its second engineering building in Pleasantville, N. Y. The 22,000 square foot building is expected to be ready for occupancy by the end of July . . . **WHEELER LABORATORIES, INC.** has begun construction of a second laboratory to be devoted to antenna engineering in Smithtown, N. Y. The plant will be an 11,000 square foot unit, forming one terminal of a 1000 foot antenna range . . . **WARWICK MANUFACTURING CORPORATION** of Chicago has opened a new research center in Zion, Illinois . . . Ground has been broken on Pleasant Valley Boulevard in Altoona, Pa. for a 190,000 square foot, fully air-conditioned tube plant by **SYLVANIA ELECTRIC PRODUCTS INC.** Completion is scheduled for late 1957 . . . **U.S. ENGINEERING CO., INC.** has moved to 5873 Rodeo Road, Los Angeles 16, Cal. . . . **ELECTRO-MEASUREMENTS, INC.** has moved into a modern 26,000 square foot plant at 7524 S.W. Macadam Ave., Portland 1, Ore.

* * *

VINTON K. ULRICH has been named head of applications engineering for *Raytheon Manufacturing Company's* Receiving Tube Division. He was formerly general sales manager of *David Bogen Co., Inc.* . . . **DR. GEORGE ROKA** has joined *Marvelco Electronics Division* as director of the semiconductor division. He was formerly manager of semiconductor activities at *Delco* . . . The broadcast and television equipment department of *Radio Corporation of America* has appointed **EDWIN C. TRACY** to the post of manager. He will make his headquarters in Camden, N. J. . . . **ROBERT L. SHAW** has been named national sales manager of the radio and television division of *Sylvania Electric Products, Inc.* The post is a new one . . . *Standard Coil Prod-*
(Continued on page 168)

Free!

**An FCC license can be your
Guarantee of Success in Electronics!**

MAIL COUPON NOW..

Here's proof FCC Licenses are often secured in a few hours of study with our coaching at home in spare time . . .

**Every month our trainees
get jobs like these:**



Boyd Daugherty:

"I am pleased to inform you that I recently secured a position as Test Engineer with Melpar, Inc. (Subsidiary of Westinghouse). A substantial salary increase was involved. My Cleveland Institute training played a major role in qualifying me for this position."

Boyd Daugherty
105 Goodwin Ct., Apt. C
Falls Church, Va.



Irving Laing:

"Your lessons are helping me a lot in my Navy work. You cover topics that were not presented by the Navy at the E. T. School . . . Your course has helped greatly to get my 2nd class FCC ticket. I am now a radio and T. V. engineer at WTVS and WDTR in Detroit, Michigan."

Irving J. Laing
15887 Robson
Detroit 27, Michigan

Top Grade Employers Like These

AMERICAN AIRLINES: "We are very interested in receiving applications from Cleveland Institute graduates."

BENDIX RADIO: "We shall look forward to receiving completed applications from your students."

PHILCO: "We have employed a great number of well qualified electronics personnel who were graduates of Cleveland Institute."

WESTINGHOUSE: "We would appreciate your listing our current openings in your monthly Job Opportunities."

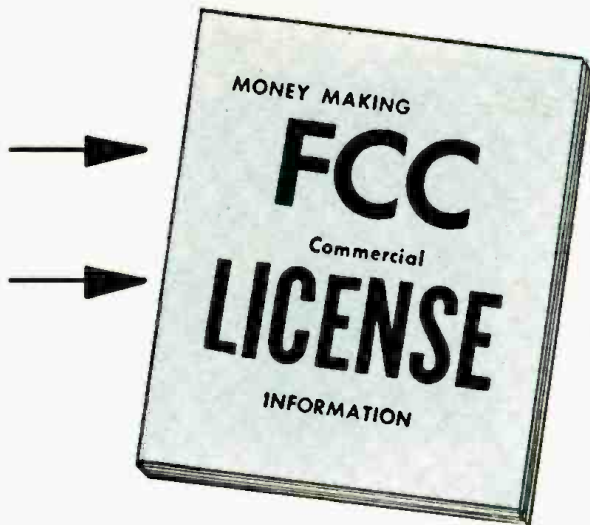

WE GUARANTEE TO TRAIN YOU UNTIL YOU RECEIVE YOUR FCC LICENSE

If you fail to pass your Commercial License exam after completing our course, we guarantee to continue your training, without additional cost of any kind, until you successfully obtain your Commercial license.

..RECEIVE ALL 3 BOOKLETS

Name and Address	License	Time
Walter Eggers, Pacific Grove	1st	12 weeks
Paul Reichert, West Salem, Ohio	2nd	10 weeks
Harold Phipps, LaPorte, Indiana	1st	28 weeks
John H. Johnson, Boise City, Okla.	2nd	12 weeks
James Faint, Johnstown, Pa.	1st	26 weeks



FREE!



Bob Thompson:
In a year and a half, he received his first class FCC license. He isn't through yet. He is continuing his training with Cleveland Institute. His goal is much higher than his present position with Eastern Airlines, so, he is adding technical "know-how" to his practical experience. You can be sure he will go far.
Bob Thompson
2935 Ironwood Drive
Nashville 14, Tennessee



James Glen:
When Jim enrolled, he was a temporary employee of the City of Tacoma, Washington. He was helping wire and install an interoffice phone system. In the space of 14 months, he completed the Master Course and received his first class license. He is now installing and maintaining mobile and microwave equipment.
James S. Glen, Jr.
2920 Knob Hill Road
Tacoma, Washington

Look To CLEVELAND INSTITUTE

- | | |
|------------------------------------|---|
| Aerojet-General | International Telephone & Telegraph Co. |
| American Airlines | Mohawk Airlines |
| American Telephone & Telegraph Co. | Motorola |
| Bendix Radio | North American Aviation, Inc. |
| Braniff Airways | Northwest Airlines |
| Burroughs Corp. | Philco |
| Capital Airlines | RCA |
| Continental Air Lines, Inc. | Ryan Aeronautical Co. |
| Convair | TWA |
| General Electric | Union Switch & Signal Co. |
| Glenn L. Martin Co. | United Airlines |
| Goodyear Atomic Corp. | Western Electric Co. |
| IBM | Westinghouse Electric Co. |
- *(Plus Many Others)

Accredited by National Home Study Council

Cleveland Institute of Radio Electronics

Desk RN-1 4900 Euclid Ave., Cleveland 3, O.

Please send Free Booklets prepared to help me get ahead in Electronics. I have had training or experience in Electronics as indicated below:

- | | |
|---|---|
| <input type="checkbox"/> Military | <input type="checkbox"/> Broadcasting |
| <input type="checkbox"/> Radio-TV Servicing | <input type="checkbox"/> Home Experimenting |
| <input type="checkbox"/> Manufacturing | <input type="checkbox"/> Telephone Company |
| <input type="checkbox"/> Amateur Radio | <input type="checkbox"/> Other_____ |

In what kind of work are you now engaged? _____

In what branch of Electronics are you interested? _____

Name _____ Age _____

Address _____

City _____ Zone _____ State _____

Special Tuition Rates to Members of Armed Forces

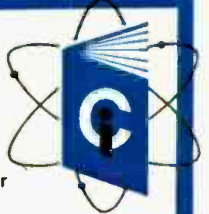

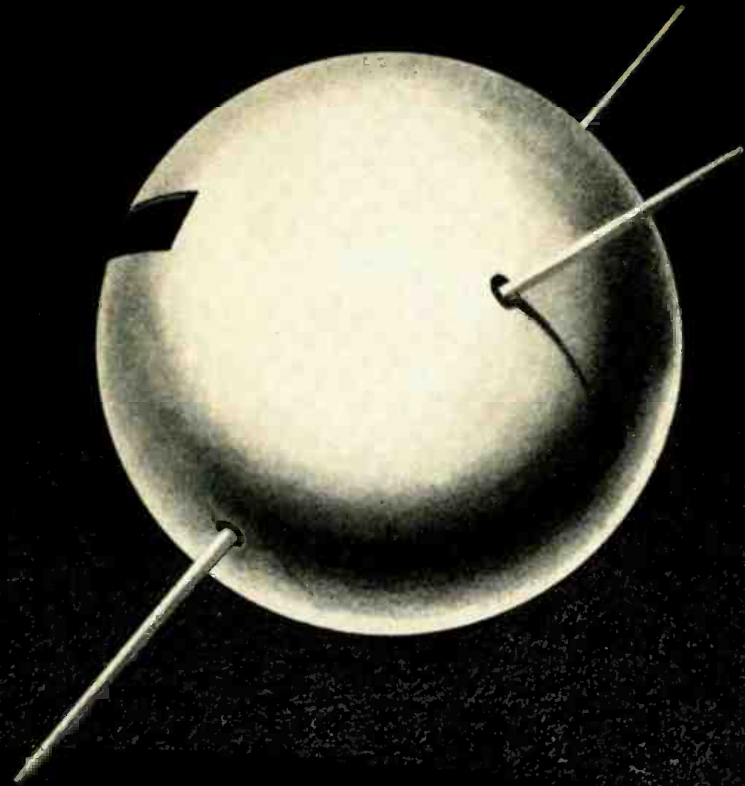

A NEW FRONTIER FOR TECHNICIANS

RCA offers an opportunity for you to apply your technical skill to its Missile Test Project at Patrick Air Force Base, Florida—"Launching Site of the Satellite."

Here at the world's longest missile testing range, extending from Florida far across the South Atlantic, you can enjoy improved status with the recognized leader in Electronics. Unprecedented growth opportunities are offered in various phases of data acquisition, transmission and processing, including Radar—Communications—Optics—Computers—Timing—Telemetry.

At RCA's Missile Test Project you will enjoy technical advancement

combined with famous Florida living. Your family will appreciate the ideal climate—allowing year 'round outdoor activities—and pleasant social surroundings.

Immediate assignments are available in Florida, the Bahama Islands, and aboard tracking ships in the South Atlantic. Attractive home leave policy and salary differential make the Bahama Islands and tracking ship assignments especially attractive for single men.

Let the Missile Test Project become *your* symbol of the future. Join in our assault on the frontier of space!

For complete information about this new and challenging field, write to:

Personnel Manager, Dept. N-16A
RCA Service Company, Inc.
Missile Test Project
P. O. Box 1226
Melbourne, Florida



RADIO CORPORATION of AMERICA

**NEW! COLOR and Black-&-White
LAB & TV 5" OSCILLOSCOPE #460
KIT \$79.95. Wired \$129.50**

The **FINEST** professional 5 mc wide-band scope value. Ideal for research, h-f & complex waves, plus Color & Monochrome TV servicing. Flat from DC to 3.58 mc ± 1 db (color burst freq.), flat DC to 4.5 mc $\pm 1, -3$ db. Vert. sens. 25 rms mv/in. Vert. Z 3 megs. Has the following outstanding features not found in scopes up to several times its price, kit or wired:

VERTICAL AMPLIFIER: direct-coupled (DC) thruout to eliminate l-f phase shift; push-pull thruout for negligible distortion; K-follower coupling between push-pull pentode stages for extended h-f resp. (minimizes h-f phase shift, extends useful resp. to 10 mc); full-screen undistorted vert. defl; 4-step freq-compensated decade step attenuator up to 1000:1. **SWEEP CIRCUIT:** perfectly linear sweeps, 10 cps - 100 kc (ext. cap. for down to 1 cps); pre-set TV vert. & hor. positions (30 & 7875 cps); automatic sync. ampl. & limiter eliminates sync amplitude adj. **PLUS:** direct or cap. coupling; bal. or unbal. inputs; edge-lit engraved lucite graph screen; dimmer; anti-glare filter; bezel fits std photo equip. **OTHER IMPORTANT FEATURES:** High intensity trace CRT. Finest sq. wave resp. (.06 usec rise time). Push-pull hor. ampl., flat to 400 kc, sens. 0.6 rms mv/in. Built-in voltage calibration. Intensity mod. Sawtooth & 60 cps outputs. Astigmatism control. Retrace blank-

ing. Instant, drift-free full-screen vert. positioning & 2X full-screen hor. positioning. Bal., cal., astig. adj. externally accessible. 5UP1 CRT, 2-6AU8, 2-6CB6, 1-12AU7A, 2-6J6, 1-6AX5, 1-1V2. Deep-etched satin aluminum panel, rugged grey wrinkle steel cabinet. Designed for easy building at home with no special equipment. 13" x 8 1/2" x 16". 30 lbs.

SCOPE DIRECT PROBE* = PD: KIT \$2.75. Wired \$3.95. Eliminates stray-pick-up & signal re-radiation.

SCOPE DEMODULATOR PROBE* = PSD: KIT \$3.75. Wired \$5.75. Demodulates AM carriers between 150 kc and 250 mc.

SCOPE LOW CAPACITY PROBE* = PLC: KIT \$3.75. Wired \$5.75. For signal tracing in high frequency, high impedance & wide-band circuits (as in TV) without distortion from overloading or frequency discrimination.



for **COLOR** and Monochrome TV servicing

**New! PEAK-to-PEAK VTVM #232
& UNI-PROBE (pat. pend.)
KIT \$29.95. Wired \$49.95**

UNI-PROBE: exclusive with EICO! Terrific time-saver! Only 1 probe performs all functions—a half-turn of probe-tip selects DC or AC-Ohms.

The new leader in professional peak-to-peak VTVMs. Latest circuitry, high sensitivity & precision, wide ranges & versatility. Calibration without removing from cabinet. New balanced bridge circuit. High Z input for negligible loading. 4 1/2" meter, can't burn-out circuit. 7 non-skip ranges on every function. 4 functions: +DC Volts, -DC Volts, AC Volts, Ohms.

Uniform 3 to 1 scale ratio for extreme wide-range accuracy. Zero center. One zero-adj. for all functions & ranges. 1% precision ceramic multiplier resistors. Measure directly peak-to-peak voltage of complex & sine waves: 0-4, 14, 42, 140, 420, 1400, 4200. DC/RMS sine volts: 0-1.5, 5, 15, 50, 150, 500, 1500 (up to 30,000 v. with HVP probe, & 250 mc with PRF probe). Ohms: 0.2 ohms to 1000 megs. 12AU7, 6AL5, selenium rectifier; xfmr-operated. 8 1/2" x 5" x 5". Deep-etched satin aluminum panel, rugged grey wrinkle steel cabinet. 7 lbs.

**New! DELUXE PEAK-to-PEAK VTVM #249
with 7 1/2" METER & UNI-PROBE (pat. pend.)
KIT \$39.95. Wired \$59.95**

All the advanced & exclusive features of #232—PLUS the extra convenience and readability of its big 7 1/2" meter. Your ideal bench instrument.

VTVM RF PROBES* #PRF-11 or PRF-25:
KIT \$3.75. Wired \$4.95. Accuracy $\pm 10\%$. Use with any 11 or 25 megohm VTVM.

VTVM HV PROBE #HVP-2: Wired \$4.95. Complete with multiplier resistor. Measures up to 30 kv with any VTVM or 20,000 ohms/volt VOM.



Calibration without removing from cabinet.

*Only EICO Probes have all these features: fully shielded; rugged terminal board parts mounting; shock mounted floating construction; swivel-action; color-coding; easy parts accessibility.



150 kc to 435 mc
with ONE generator!

**New! RF SIGNAL GENERATOR #324
KIT \$26.95. Wired \$39.95**

for **COLOR** and Monochrome TV servicing

New wide-range, stable generator — better value than generators selling at 2 or 3 times its cost! Ideal for: IF-RF alignment, signal tracing & trouble-shooting of TV, FM & AM sets; marker gen.; 400 cps audio testing; lab. work. **6 fund. ranges:** 150-400 kc, 400-1200 kc, 1.2-3.5 mc, 3.5-11 mc, 11-37 mc, 37-145 mc; 1 harmonic band 111-435 mc. Freq. accurate to $\pm 1.5\%$; 6:1 vernier tuning & excellent spread at most important alignment freqs. Etched tuning dial, plexiglass windows, edge-lit hairlines. Colpitts RF osc., directly plate-modulated by K-follower for improved mod. Variable depth of int. mod. 0-50% by 400 cps Colpitts osc. Variable gain ext. mod. amplifier: only 3.0 volts needed for 30% mod. Turret-mounted coils slug-tuned for max. accuracy. Fine & Coarse (3-step) RF attenuators. RF output 100,000 uv; AF sine wave output to 10 volts, 50-ohm output Z. 5-way jack-top binding posts for AF in/out; coaxial connector & shielded cable for RF out. Tubes: 12AU7, 12AV7, selenium rectifier; xfmr-operated. Deep-etched satin aluminum panel, rugged grey wrinkle steel cabinet. 8" x 10" x 4 3/4". 10 lbs.

The specs are the proof...

**4 NEW BEST BUYS
by EICO**

**COMPLETE
with Preamp, Equalizer and Control Section
New! 20-WATT Ultra-Linear Williamson-
type HIGH FIDELITY AMPLIFIER #HF20
KIT \$49.95. Wired \$79.95**

A low-cost, complete-facility amplifier of the highest quality that sets a new standard of performance at the price, kit or wired. Every detail, down to the etched, brushed solid brass control plate, is of the fine quality EICO is famous for.

Rated power output: 20 watts (34 w peak). **IM distortion (60 cps):** 6 kc/4:1 at rated power: 1.3%. **Mid-band harmonic distortion at rated power:** 0.3%. **Maximum harmonic distortion between 20 and 20,000 cps at 1 db under rated power:** approx. 1%. **Power response (20w):** ± 0.5 db 20-20,000 cps; ± 1.5 db 10-40,000 cps. **Frequency response (1/4 w):** ± 0.5 db 13-35,000 cps; ± 1.5 db 7-50,000 cps.

5 feedback equalizations for LP's & 78's including RIAA. Variable turnover feedback tone controls do not affect volume & permit large boosts or cuts at either end of audio spectrum with mid-freqs. unaffected. Loudness control & separate level set control on front panel. Low Z output to tape recorder. 4 hi-level switched inputs: tuner, tv, tape, auxiliary (xtal/ceramic phono or 2nd tuner); 2 low-level inputs for proper loading with all leading magnetic, FM & quality xtal cartridges. Hum bal. control. Extremely fine output transformer has interleaved windings, tight coupling, careful balancing & grain-oriented steel. 8 1/2" x 15" x 10". 24 lbs.

These amazing EICO values are NOW IN STOCK at your nearest distributor. Examine them side-by-side with ANY competitor. You'll see for yourself why indeed EICO is your BEST BUY. Fill out coupon on reverse page.



TURN PAGE FOR MORE EICO VALUES...

84 Withers Street, Brooklyn 11, New York

Prices 3% higher on West Coast.

**the specs are
the test that tells
who's best!**

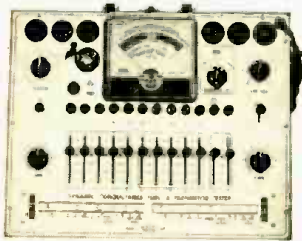

for COLOR & Monochrome
TV servicing

**NEW! DYNAMIC
CONDUCTANCE TUBE &
TRANSISTOR TESTER #666**
KIT \$69.95 WIRED \$109.95

Unexcelled testing thoroughness & accuracy. Checks transistor collector current & Beta using internal dc power supply. Tests all receiving tubes including subminiatures (& Color & Monochrome tv pic tubes with accessory adapter). Composite indication of mutual conductance, plate conductance, & peak emission. Simultaneous sel. of any 1 of 4 combinations of 3 plate, 3 screen, & 3 ranges of control grid voltage. Grid voltage variable over 3 ranges with 5% accurate pot. New series-string voltages for 600, 450 & 300 ma types. 5 ranges meter sens. with 1% precision shunts & 5% accurate pot. 10 SIX-position lever switches for free-point connection of every tube pin or cap. 10 pushbuttons for rapid insert of any tube element in leakage circuit & speedy sel. of individual tube sections. Direct reading of inter-element leakage in ohms. New gear-driven rollchart. Steel case with cover & handle. Sensitive 200 ua meter.



NEW

for COLOR & Monochrome
TV servicing

**TV-FM SWEEP GENERATOR
& MARKER #368**
KIT \$69.95 WIRED \$119.95

The FINEST service instrument of this type ever offered in either kit or wired form at ANY price! Outstanding ease & accuracy in FM & TV (including Color) alignment. Entirely electronic sweep circuit with accurately biased inductor: superb linearity on both sides of selected center freq. Newly-designed AGC circuit automatically adjusts osc. for max. output on each band with min. amplitude variations. Sweep gen. range 3-216 mc in 5 OVERLAPPING FUND. BANDS. Sweep width continuously variable from 0-3 mc lowest max. deviation to 0-30 mc highest max. deviation. Variable marker gen. range from 2-75 mc in 3 FUND BANDS plus a calibrated harmonic band (60-225 mc). Variable marker calibrated with internal marker gen. 4.5 mc xtal included. Ext. marker provision. Double pi line filter. Edge-tilt hairlines eliminate parallax.

Turn page for other EICO ad



**FREE 1957
EICO CATALOG!**

Tells you how to SAVE 50% on
your test equipment costs!

TUBE TESTER #625
KIT \$34.95
Wired \$49.95

- tests 600 ml series string type tubes
- illuminated roll-chart

Pix Tube Test Adapter\$4.50

Now! GEIGER COUNTER #803
KIT \$19.95 Wired \$29.95

(See literature)
Professional, all-electronic, sensitive, rugged—at lowest cost! Indicates by neon lamp & headphone clicks.

9" PUSH-PULL OSCILLOSCOPE #425
KIT \$44.95
Wired \$79.95

7" PUSH-PULL OSCILLOSCOPE #470
KIT \$79.95
Wired \$129.50

VACUUM TUBE VOLTMETER #221
KIT \$25.95
Wired \$39.95

DELUXE VTVM 214 (7 1/2" METER)
KIT \$34.95
Wired \$54.95

RF SIGNAL GENERATOR #320
KIT \$19.95
Wired \$29.95

150 kc-34 mc, calibrated harmonics to 102 mc. Pure or mod. RF, & Colpitts osc. 400 cps sine outputs.

NEW! REDI-TESTER #540
KIT \$12.95
Wired \$15.95

Multi-range ac/dc voltmeter, ammeter, ohmmeter, leakage checker for home & auto repairs.

#944 FLYBACK TRANSFORMER & YOKE TESTER
KIT \$23.95
Wired \$34.95

- fast check all flybacks & yokes in or out of set.
- spots even 1 shorted turn!

Range 500 kc-228 mc on fund. Cont. sweep width control, 0-30 mc.

KIT \$34.95
Wired \$49.95

TV/FM SWEEP GENERATOR #360
5MC-4.5MC CRYSTAL \$3.95 ea.

1% accuracy on all 7 ranges. Range 75 kc-150 mc. Volt reg.

KIT \$39.95
Wired \$59.95

DELUXE RF SIGNAL GENERATOR #315

Sep. volt-meter & ammeter

KIT \$29.95
Wired \$38.95

6V & 12V BATTERY ELIMINATOR & CHARGER #1050

Sep. hi-gain RF & lo-gain audio inputs. Special noise locator. Calibrated wattmeter.

KIT \$24.95
Wired \$39.95

DELUXE MULTI-SIGNAL TRACER #147

Reads 0.5 ohms -500 megs, 10 mmfd-5000 mfd power factor.

KIT \$19.95
Wired \$29.95

R-C BRIDGE & R-C-L COMPARATOR #950B

HI-FI PREAMPLIFIER #HF-61
KIT \$24.95 Wired \$37.95. With Power Supply: KIT \$29.95. Wired \$44.95

Feedback circuitry thruout! Preamp-equalizer, tone controls, scratch & rumble filters, K-follower output.

20,000 Ohms/Volt MULTIMETER #565
KIT \$24.95
Wired \$29.95

1000 Ohms/Volt MULTIMETER # 536
KIT \$12.90
Wired \$14.90

VTVM PROBES

Peak-to-Peak	KIT \$4.95	Wired \$6.95
RF	\$3.75	\$4.95
High Voltage Probe-1		\$6.95
High Voltage Probe-2		\$4.95

SCOPE PROBES

Demodulator	\$3.75	\$5.75
Direct	\$2.75	\$3.95
Low Capacity	\$3.75	\$5.75

For FREE 1957 catalog, mail coupon NOW!



84 Withers St. • Brooklyn 11, N. Y.

Prices 5% higher on West coast and subject to change without notice.

EICO, 84 Withers Street R-1
Brooklyn 11, New York

Send FREE 1957 Catalog and name of neighborhood EICO jobber.

Name.....
Home Address.....
City.....Zone.....State.....
Occupation.....

Over a Decade of Know-How & Value Leadership in Kits & Instruments — Over 1 Million Sold to Date!

Behind the Giant Brains

The IBM 650 magnetic drum data processing machine built for commercial use. This machine is designed to meet the accounting and computing needs in areas between those now served by the company's very large and its smaller machines.



By FRANK LEARY

ON A RAW afternoon in February, 1946, officials of the Federal government and the University of Pennsylvania, several luminaries of the world of science, and representatives of the press met at the Moore School of Electrical Engineering, on the University of Pennsylvania campus in Philadelphia.

Norbert Wiener, the MIT math professor who was to start a whole cross-section of America using the term *cybernetics*, arrived characteristically without an overcoat. Others parked their wraps and were shown into a large room at the back of the building. Racks of electronic apparatus surrounded them. They were told they were *inside* an electronic calculator which could solve complex differential equations—such as an equation in external ballistics—faster than most people could state the problem. Some were excited, others politely interested, a few were bored. They watched the electronic gadgetry being put through its paces: punched cards with problem data were fed in, cards with answers were punched seconds later. Someone checked the results; they were correct. The press asked some questions, got some answers, and then everybody went to dinner.

These men had been summoned to witness the first public showing of the Moore School's electronic numerical integrator and calculator (a mouthful of description shortened by Army Ordnance officers into the acronym ENIAC). It was not an occasion that seemed particularly world-shaking, but the outgrowths from this machine have been giving the world its share of shudders ever since.

The whole pattern of our existence is being shaped by electronic computers, or "giant brains," to use Edmund C. Berkeley's much abused term. These

Part 1. Historical development and principles of electronic computers. Here's the story about the devices that are now beginning to shape our lives. To be concluded next month.

computers can not only solve complex problems in advanced mathematics, but models now in existence can handle all kinds of information, from a payroll to the Bible. One, the *Remington Rand "Univac,"* a lineal descendant of the ENIAC, was recently used by the *Thomas J. Nelson Publishing Company* to compile the Concordance for the Revised Standard Version of the Holy Bible. Other systems are gradually infiltrating our daily lives: our social security accounts, our insurance policy information, our income tax records, all are being converted onto files of magnetic tapes, which can be swiftly and efficiently processed by these automatic electronic computers.

The Monster on the Second Floor

The reactions of people associated with them are as varied as opinions about the proper proportions for a martini. Some people—notably the designers—feel that these computers are the greatest boon to mankind since the invention of the round wheel. Others, seeing phantoms of technological displacement, redeployment, and unemployment, regard the introduction of electronic brains into everyday affairs with great distaste. More considered opinions place atomic energy and automatic computers on the same level, as the two most important technological advances to have come out of the War.

In the New York office of one of the major manufacturers of the giant elec-

tronic computers, a system has been set up to operate as a computing service bureau on the second floor of the building. One of the old-line employees of this corporation refers consistently to the machine as "the monster on the second floor." No amount of persuasion, exhortation, or scientific evidence can convince him that it is anything but a monster.

War Babies

ENIAC, the first of all these electronic "monsters"—no more monster than the thermostat that turns your heat on and off—has been working around the clock at Aberdeen Proving Grounds ever since it was moved there in 1948. Another of the computer industry's grandparents sits where it was first built, at Harvard. This is the famous Aiken Relay Calculator Mark I, first of all truly automatic computers, built in 1944 by Harvard Computation Laboratories for the U. S. Navy. The two of them, different in concept but complementary to each other, have sired many progeny.

Mark I was not electronic; ENIAC was. Mark I was automatically sequenced, which is to say, it was capable of automatically performing a series of instructions fed to it from punched paper tape; ENIAC recognized patterns of instructions set up in advance on wiring panels. Modern computers, which are generally both electronic and automatically sequenced, are logically descended from both "old" designs.

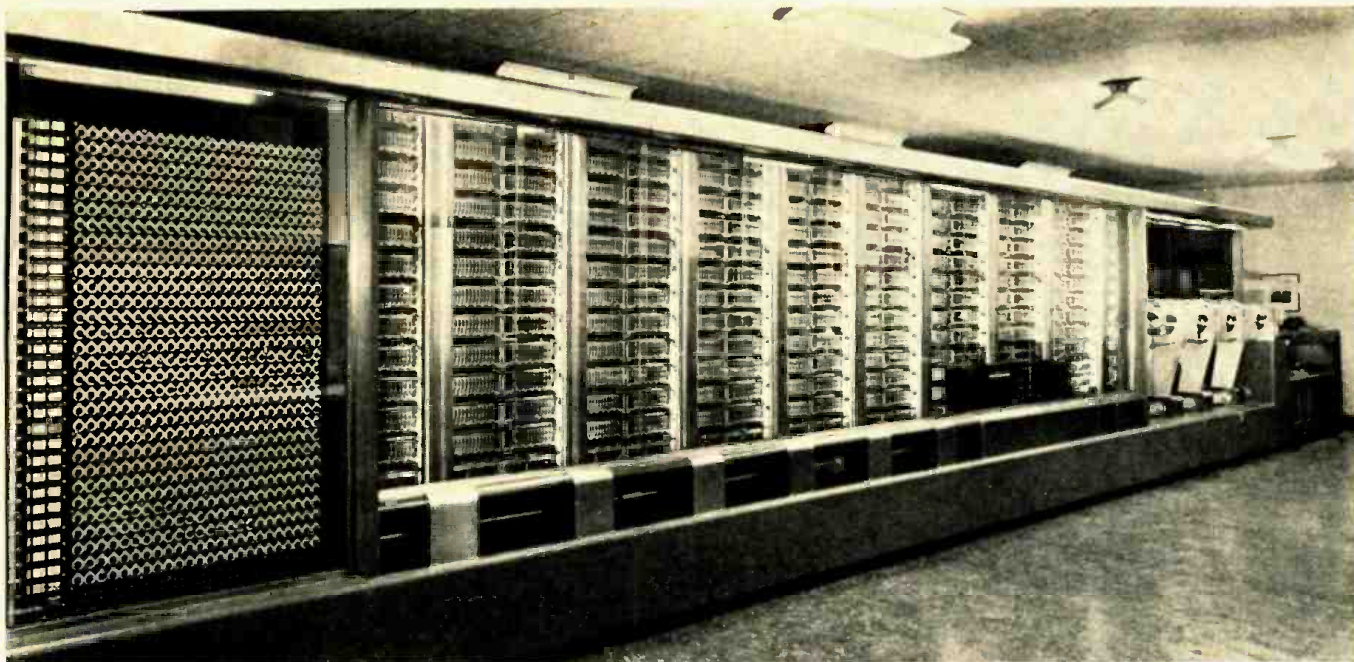

All computing and processing of information in the Harvard Mark I was performed by means of high-speed relays. This is what the calculator looks like today, after some modifications have been made.

Mark I and ENIAC were both "war babies." Army Ordnance, trying to supply complete ballistic data on new weapons to Army field commanders, had pricked up its ears when John W. Mauchly, then an assistant professor on the staff of the Moore School, and now an executive of *Remington Rand's* "Univac" division, had suggested an electronic calculator as a possible solution; Ordnance funds sponsored the construction of ENIAC. Mark I, designed by Harvard's Howard Aiken and built by his staff in cooperation with *International Business Machines Corporation*, was fostered by the similar needs of Navy Ordnance.

From these original wartime projects have sprung the burgeoning family of electronic digital computers—computers which recognize and electronically process actual numbers, or alphabetic characters, and not varying voltage levels, or turns of a cogwheel or gear or axle. The latter, called analogue computers, form a completely different family, with a somewhat similar heritage, but with different parents, and different uses.

The Tributary Currents

Several separate streams have joined to form the torrent of activity that the computer industry has become.

The principal headwater is an old and familiar one: man has always sought ways of harnessing nature to serve him. Mathematicians are no exception, and creative mathematicians especially have frequently bridled at the plain stickwork involved in the rigorous proofs of their theories. Pascal, Leibnitz, Gauss, and Maxwell are among the great scientists who designed and built mechanical aids to calculation. These machines were of some help to their creators, but of little general use.

Another stream first was struck by

a watchmaker named Jacques de Vaucanson, who, in 1741, invented a delicate automatic loom for weaving figured silks. The designs in the silks were established by patterns of holes punched in a metal drum; the holes controlled the raising and lowering of the treadles. In 1804, Joseph Marie Jacquard adapted the idea to a much larger scale for weaving tapestries, rugs, and other heavier materials. To increase the utility of his automatic loom, Jacquard used as controls punched sheets of stiff paper which could be changed fairly easily. Within eight years, eleven thousand Jacquard looms had been placed in operation in France.

The name of Charles Babbage, one of the two men in history ever to hold the Lucasian professorship of mathematics at Oxford University, is a revered one in the computer field, for Babbage was the first to envisage a truly general-purpose computer. He also merged the de Vaucanson-Jacquard idea, of storing information as punched holes in a sheet of paper, with the idea of mechanical computation.

Babbage began work on what he called a *difference engine* in 1823. The purpose of the engine was to provide mechanical assistance for advanced mathematical computations. The British government offered some financial support to his project, and he was able to draw up working diagrams and specifications. But this was the era of Watt's steam engine, when the criterion for the fit of a piston within the cylinder wall was that a thin sixpence could just be slipped between the two; built to such tolerances, Babbage's difference engine, and his later *analytical engine*, could never be made to produce reliable answers. Eventually the government withdrew support, and the Babbage designs became historical

curiosities. Many of today's mechanical and electronic calculators, however, possess a logical organization remarkably similar to the analytical engine which was the triumph and despair of Babbage's life.

Enter the Census Bureau

Mechanical tabulators, capable of simultaneously registering horizontal and vertical sums, were the next important development. These grew, quite naturally, out of the needs for statistical analysis, and many of the most important advances were made in the U. S. Bureau of the Census. For example, Charles Seaton, who was Chief Clerk of the Census Bureau, invented such a mechanical tabulator in 1872. And in 1887, Dr. Herman Hollerith, then chief of Census' tabulation section, further adapted the Jacquard punched-paper control system to the accumulation of statistical data. This was a most important stride in mechanical computation, for it introduced into a working system the concept of mechanically stored (remembered) information, which could be used for many calculations or tabulations without the necessity for re-entering the data from a keyboard. The Hollerith equipment was one of the ancestors of familiar punched-card equipment.

During the eleventh decennial census (1890), another member of the Census Bureau staff, James Powers, developed another kind of mechanical tabulator which also used punched cards. The Hollerith holes were rectangular; the Powers holes were round. Both types of equipment were used by Census for years—are still in use, in fact. Both men left the Census Bureau to merchandise their ideas in the commercial world. Descended from the Powers' idea are the familiar *Remington Rand* and *Underwood-Samam* round-hole cards, while Hollerith's idea

is found in the equipment of *International Business Machines, Compagnie des Machines Bull*, and others.

Just prior to Hollerith's and Powers' inventions, a host of mechanical "arithmetic engines," which we would today call adding machines, were patented. One of the most important of these was the 1885 adding machine of William Seward Burroughs, probably the first to be designed for production in quantity. These machines were the ancestors of the modern desk calculator, now emerging, complete with high-speed electronic and magnetic components, as a serious contender for the attention of the computing public.

For years following the invention of the various kinds of punched-card tabulators and calculators—until about the time of World War II—these machines were the highest order of mechanical aids to computation. But the third major contributory stream actually had appeared as early as December, 1919, when a paper describing an electronic "trigger circuit" that could be used for counting pulses of electrical energy was published in the first volume of *Radio Review*. The authors of the paper were W. H. Eccles and F. W. Jordan; the Eccles-Jordan trigger circuit, and its many modifications—multivibrators, one-shot trigger pairs, and so forth—all of which are familiar to the world of television and radar, are foundation blocks of the electronic digital computer as we know it.

While punched-card calculators were growing larger and more complex, a small group of scientific minds saw the coming of an era when mechanical devices, however fast, efficient, and succinct, would not be capable of keeping pace with the need for information. All over the country, the capacity of punched-card calculator centers was exceeded and expanded and exceeded again. In the late thirties, men in widely separated activities began asking "can we apply electronics to this problem?" And more and more frequently, the answer was "yes."

The Analogue Computers

A group of scientists and engineers, sparked by the physicist Vannevar Bush, had meanwhile been pursuing another tack. During the twenties, Bush had merged an idea of Lord Kelvin's, some of Babbage's concepts, and the then-recent development of mechanical torque amplifiers. From this merger, he developed a reliable mechanical device for the rapid and automatic analysis of differential equations. Several of these differential analyzers were built from his plans at various universities in this country and Europe. They were not digital calculators as envisaged by Babbage and as built by the various punched-card manufacturers. They formed a major group within the completely different class of analogue computers.

Analogue computers derive their name from the fact that they compute by mechanical or electrical analogy.

The turning of a gear, or a set of gears, through part or all of a revolution may be used to represent, by analogy, a parameter in an equation. Or the movement of a diagonal slide in a rectangular frame may represent another parameter. Various torque converters or torque amplifiers perform operations analogous to mathematical computations.

A simple analogue computer could be made from two circular gears in the ratio of 3.1416 to 1. Turning the larger gear would cause the smaller to be displaced 3.1416 times as much. If angular displacements were shown on a pair of calibrated dials, one could multiply by π (approximately) on this simple device. Numerical values for a diameter could be entered on the larger dial, and instantaneous approximate values for the circumference would be read on the dial for the smaller gear. (Such a device would, of necessity, produce approximations, since π cannot be exactly represented by a ratio of integers.)

Similarly, a large variable resistor might be wound on a card shaped like a sine curve, instead of being wound on the usual rectangular card. The angle of displacement of the wiper arm would then be a parameter in the equation; the voltage applied across the resistor would be multiplied by the *sine* of this angle when tapped by the wiper. Another wiper 90° displaced from the first would simultaneously produce a voltage analogous to the *cosine* of the same angle.

Complexes of such mechanical and electrical analogies could be assembled into computing systems which represented the equations of external ballistics, for example. Such analogue computers were much used during the second World War for artillery fire-control, in conjunction with radar tracking systems. *Bell Laboratories, Sperry, Westinghouse, and General Electric*, among others, all built analogue computers for the Army and



Punched paper tape, such as that which is shown in the photo in use in the famous Bell Relay Calculator, was the source of Harvard Mark I's instructions and programming.

Navy. More recently, such systems have been used in industry for a.c. network analysis, for the analysis and synthesis of gas distribution systems, and in many instances for the simulation of fairly complex machinery or systems (such as missile systems or ultra-thin high-speed propeller blades) prior to their design and construction. Because they work so readily with physical measuring and instrumentation apparatus, and with mechanical or electronic controls, they are also natural choices for the needs of industrial automation.

The Differences

Analogue computers are eminently suited for representing involved equations in physical form. In design work, they permit the varying of parameters by analogy, to determine the effect of such variations on the system as a whole. As control systems for indus-

The ENIAC as it looked when it was installed at the Moore School of the University of Pennsylvania. The hundreds of cables, carrying control and information signals from one part of the computer to another, all had to be set up before a problem was run. Newer computers are somewhat more sophisticated, can vary operations through a stored program of instructions.

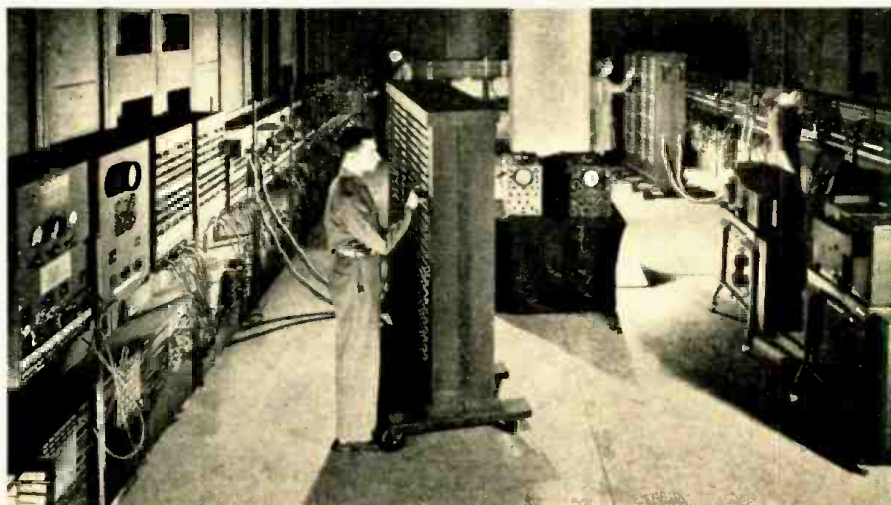



← Herman Hollerith's electric counting machine as used in the 1890 census. The accumulated and tabulated results were presented on the counter dials, and had to be copied off by hand.

The first die-set punch, developed by → Powers for the census of 1910. The operator set up on the keyboard all the values to be punched; she then used the knee-treadle to gang-punch the card.

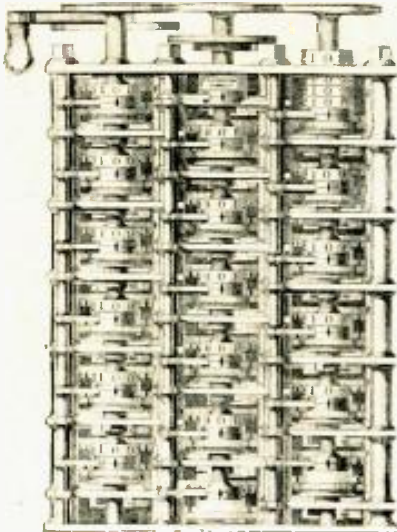

← The accumulator of Charles Babbage's difference engine, from an old woodcut.

trial automation, they can adjust valves, speed up or slow down transfer systems, and so forth, as required by the standards of the output product desired.

Analogue computers possess two inherent limitations. First, they cannot easily be used for dissimilar problems. The computer itself is a mechanical or electrical analogy to an equation; changing the equation means changing the hardware of the computer. Second, they are generally only precise to two or three significant figures, depending on the fineness of construction; and their accuracy depends, not only on the accuracy of the input data, but also on the instruments which present the answers (calibrated oscilloscopes, meters, counters, etc.), and on the subjective "feel" of the operator who inspects these presentations.

A digital computer can process ordinary numbers or alphabetic characters without any trouble at all. It can handle continuously variable data only by "digitalizing" it—sampling the value

of the continuous function at regular time intervals and giving it a numerical representation—and then applying the methods of numerical analysis; but it can generally do far more types of work than an analogue computer, and, once the information is translated into discrete digital form, it never loses a decimal point of precision. Furthermore, the accuracy of the digital computer's work can easily be checked by inverse operations (proving addition by subtraction, etc.), by identical parallel operations compared for identical answers, or by many other means.

General-purpose digital computing systems are far simpler than analogue networks (although some of them are much larger); they can basically only add, compare, and discriminate between relative magnitudes, store (or remember, if you prefer) information, and shift the information around. Mostly they subtract by inverse addition, multiply by repeated addition, and divide by alternately performing repeated additions and subtractions. Depending on their discriminatory abilities, they can select paths of action, or sort information, or start (or stop) a process. They can, in other words, be empowered to make decisions.

Note well: *be empowered* to make decisions. The two most mystifying things, to many people outside the

field, are that these machines seem to make decisions, and seem to remember information. Neither one is at all mysterious.

How Machines Remember

Memory, for example, as a machine function, is quite familiar to everyone. A thermostat remembers two things: you tell it how hot you want it to be by setting the value on a dial (which at the same time sets a control contact), and a bimetallic thermometer tells it how hot it actually is. When the thermometer tells it that the temperature has fallen below your setting, it turns on the heat.

A wall switch remembers that you turned it on, but the little button on a flashlight, which must be locked to remain on, does not; as soon as you release it, it "forgets" it was on and goes out. An annoying characteristic of certain cathode-ray tube phosphors, for television purposes, is persistence; this is nothing more than the phosphor's "remembering" the current which excited it into phosphorescence, and continuing to glow after the current is gone. The characteristic was used to advantage in a type of computer memory.

A magnetic tape or wire, or an acetate or vinyl disc, remembers the information put on it for a long time. Materials which are truly elastic cannot remember; they snap back into their normal state too readily. Brittle materials (such as glass after its elasticity has been exceeded) are crude memories only, because they cannot be restored. The most concentrated effort in developing memory systems has been expended on hysteretic materials—materials which exhibit a time-lag between the removal of a stimulus and the restoration of the material to its normal state. Magnetic materials are an ideal example; after the magnetizing current is removed, a certain amount of magnetism remains in the material (for a period of time depending on the material). And much of the most fruitful effort in designing and building computer memories has been devoted to magnetics research.

How Machines Make Decisions

The way the thermostat "decides" to turn on the heat is an excellent illustration of the type of decision-making common in the computing machine. When the actual temperature sensed by the thermometer falls below the setting of the contact, the heat comes on. Now the thermostat setting is an artificially established control point, set by a human operator; the control contact is moved closer to or farther from the contact on the bimetallic thermometer as the operator decides the temperature should be higher or lower. The ability to reach a decision to turn heat on or off is built into the thermostat, in that electrical power connects through the two contacts to start a blower motor or automatic stoker.

A computer, which can compare

quantities and discriminate between them, can choose one of several paths of action in terms of the relative magnitudes of the two quantities. The ability to select the alternate routes is built into the computer; the criteria for the selection are given to it by the controlling human agency. The giant brain and the simple thermostat both have the same degree of mindless unawareness of what they are doing.

In making its decisions, the computer merely transfers control when one quantity equals another, exceeds another, becomes less than another, or goes through zero. If control is transferred to an instruction which tells it to "add," it adds; "stop," it stops; "rewind tape," it rewinds tape, and so forth.

A set of values can be given to the computer, and its comparison circuits can check each one of the set, making several "yes-no" choices which lead to a compound conclusion. In making these choices, the computer actually seems to be exhibiting a complex type of judgment, but each single decision remains a "yes" or "no" choice. The computer's secret is that it handles the most complicated problem in the world in the simplest and most primitive steps. It is exactly like an expert player of "Twenty Questions," who can narrow down on a single object out of all the objects in the world by getting twenty "yes-or-no" answers.

It is an error to romanticize, humanize, or personify these devices. They are completely unimaginative servants; they can do exactly what they are told, provided a tube doesn't burn out, and provided also that what they are told is consistent with what they can do; but they can do no more. They are controlled by the men who make them, the men who operate them, and the men who program them. They are especially at the mercy of the men who turn them off when the day is through.

Any time a computer seems to show imagination, it is because someone used imagination in designing its program. If a "giant brain" solves a problem, it is because someone (a) knew exactly how to go about solving that problem, and (b) knew precisely how to instruct the equipment in the procedures for solving that problem. If anyone ever gets one of these computers to write a symphony, for example, it will be because that person knows the laws of melody and harmony, counterpoint, orchestral placement, musical structure, and scoring, and knows what limits to set, and knows further how to translate all these laws, maxims, and principles into an abecedarian lingo that the simpleminded "brain" can follow. Anyone who can do that could write the symphony himself, in less time than it would take to get the computer to do it. The only advantage would be that the computer could turn out an infinitude of remarkably similar symphonies at an extremely rapid rate.

(Concluded next month)

COVER STORY

The "Univac"

An Electronic Brain for Industry



BUSINESS and industry, hard-pressed for information to aid management, turn to computers for help—and find it!

The giant electronic computers no longer rank as laboratory curiosities or frightening science-fiction robots. Imaginative businessmen, hard-pressed by a shortage of clerical help, have put them quietly to work in the accounting office, the stockroom, and wherever else work can be routinized.

First of the giant brains to be built specifically for business, the Remington Rand "Univac" has been familiar to most Americans through the role it has played in predicting the outcome of the last three national elections. On last November's election evening, with less than 1/2 per-cent of the votes (300,000) counted, the "Univac" predicted at 7:15 p.m., EST, that the odds were 100 to 1 in favor of an Eisenhower landslide and that only 87 electoral votes were likely to wind up in the column of candidate Stevenson. By midnight, "Univac" had virtually pinpointed the final results with a forecast that President Eisenhower's plurality would be 9,269,524, totalling 58 per-cent of the popular vote to Stevenson's 42 per-cent. (The actual plurality, as of the time of this writing, is very close to 9,312,700).

The first political forecast of "Univac" was made back in 1952. Then, with 3,380,000 votes reported, "Univac" also quoted odds of 100 to 1, predicting 438 electoral votes for Eisenhower and 93 for Stevenson (final returns: 442 to 89). At that time, only six "Univac" systems had been sold; these six were all the general-purpose business data-processing systems that had ever been built. Now about a dozen large office-equipment and electronics manufacturers are engaged in the building of big computers; half a hundred more companies are building major systems components. What was a minor novelty in 1951 has become a several-hundred-million-dollar industry in the remarkably brief ensuing period of a little over five years' time.

The "Univac" system shown on the cover of this month's issue is one of the two such systems installed by the Consolidated Edison Company of New York to process its customers' accounts. Over a hundred large-scale computing systems of this type are already working for American business and industry across the land, in various government agencies, and in a great many military establishments and equipment, as are described in the article "Behind the Giant Brains," in this issue.

The distinguishing feature of the "Univac," when it was introduced in 1951, was not its computing speed; its own predecessor, the "Binac," could compute almost two times as fast, and many other machines released before or since were faster than the Remington Rand development. "Univac's" forte was in flexibility; it was one of the first big computers to be able to handle numbers and alphabetic characters with equal ease; it was the very first computing system to use high-speed magnetic tape recording to get information into the computer and get results out. High-speed tape input and output, of course, permits the rapid handling and processing of information in volume. Since most problems of business and industry are characterized by masses of alphabetic or numerical information on which a relatively small amount of computing or processing is done, input-output facilities make the difference between a scientific computer and a data processor which is truly applicable to large-scale business problems.

"Univac" is also unusual in being a self-checking computer. Over a third of the circuitry in the large central computer cabinet is devoted to checking and verifying operations. Every arithmetical process, all transfers of information, and even the instruction set-ups, control functions, and so forth, are checked. Inconsistencies, discrepancies, etc., cause the computer to stop and alert the operator to their presence and location. Since the machine cannot introduce an undetected error, processed results are thoroughly reliable.

It is difficult to estimate the savings which have accrued to dozens of computer users, because these savings are both direct and indirect. Not only do companies relieve pressure on their overburdened clerical staffs, and eliminate the many machines which formerly did the work now done by computers; but they also do work which they had never planned, hoped, or intended to do before; work which only a high-speed electronic computer can make possible. And in this realm, of course, there is no basis for comparison. But in every case, companies which have leased or purchased such computers made their decisions to do so after their own staffs had made exhaustive surveys which pointed conclusively to substantial and measurable savings over other systems. In this field, as in almost any other, the searching criterion of economy has brought us into the electronic age.



Fig. 1. A zip-open holder in the leather carrying case permits exposure of sun battery.

From Sun to

By PERRY SHENEMAN
Admiral Corporation

IT HAS long been known that the energy the earth receives from the sun is equivalent to approximately one and one-half horsepower per square yard. Theoretically, if this energy were harnessed, it could provide an economical and reliable source of universal power. For over two thousand years the world's scientists have searched for an efficient solar-energy conversion method whereby this free source of power could be put to work.

The search came to an end about two years ago when scientists from the *Bell Telephone Laboratories* presented to the National Academy of Sciences a "solar battery." This amazing device could enslave power from the sun by transferring solar energy directly, instantly, and efficiently into electrical energy. The discovery of the solar battery developed out of the study of semiconductors of electricity based on the *p-n* junction used in transistors. This junction, in this case, is a slice of silicon—the second most abundant element on earth.

First the silicon must be purified until the ratio of non-silicon atoms is 1 to 10,000,000; for although silicon represents 2.5 per-cent of the earth's crust, pure silicon is rarely found. Then the purified silicon is contaminated deliberately with a minute amount of impurity. This treatment causes the silicon slice to become *n* or negative-conductive material. The slice of silicon is treated again by heating it in a tube containing still another impurity. This creates a shallow *p* or positive layer on the surface.

The result of the process is a *p-n* junction. When the silicon is now exposed to light, the surface becomes positive and the interior negative. With wires connected to the exterior and interior of the silicon, a voltage potential is available for useful work.

The solar battery utilizes 6 per-cent of the energy received from the sun. In efficiency, this far exceeds that of thermocouples and photoelectric cells. In fact, it compares favorably with the efficiency of steam and gasoline engines. It can be seen readily why researchers envisioned that some day solar batteries, possibly containing many silicon cells, would supply cheap, reliable power for home and industrial use.

The *Admiral Corporation* recognized the solar battery as an excellent potential power source for a portable radio, and engineering personnel were assigned the task of determining if such a device were feasible. After 18 months of development work, *Admiral Corporation* introduced the world's first sun-powered tubeless radio designed for the consumer market.

The solar battery ("Sun Power Pak") developed to power the radio consists of 32 individual quarter sections of silicon solar cells connected in series. This arrangement delivers a total of 9 volts at 15 milliamperes. The solar cells of the battery are encased in a block of clear plastic with a silicon oil center. The plastic covering and oil center not only allow the best focusing of sun on the surface of the silicon cells, they also protect the cells from shock damage. The block measures approximately 6 inches long, 4 inches wide, and $\frac{1}{2}$ inch thick. As shown in Fig. 1, the solar battery is mounted in a common carrying case with its associated receiver during actual use, in such a way that it can be exposed to light while the receiver is in operation.

The solar cells are most efficient when exposed to light of the upper spectral region ranging from red to infrared. They can convert more than 15 per-cent of the sunlight they receive

into electrical power. The unit is so sensitive it can operate satisfactorily on overcast days, or from an artificial source of light such as an electric bulb or infrared lamp. It can operate over a temperature range of 185 degrees to minus 60 degrees (Fahrenheit). Fig. 2, which shows how the solar battery may be energized by artificial light, also demonstrates the use of the battery on its own stand, separate from but connected to its receiver.

The radio used with the "Sun Power Pak," automation-produced, contains six transistors and two germanium diodes. It has a maximum power output of 250 milliwatts and a sensitivity of 175 microvolts. Printed wiring is used throughout the chassis.

Without the "Sun Power Pak," the tubeless radio can be operated by six flashlight batteries. Because the set requires less than one-tenth the power consumed by a conventional portable radio (15 ma.), the batteries will last from 700 to 1000 hours before requiring replacement.

Circuit features, shown in Fig. 3, are as follows: A 2N172 *n-p-n* transistor is used as an autodyne converter, two 2N146 or one 2N147 and one 2N145 *n-p-n* transistors are used for the 1st and 2nd i.f. amplifiers. Transistors, like triode tubes, must be neutralized when used as r.f. amplifiers. Capacitor C_6 and resistor R_6 , also C_{10} and R_{12} , provide feedback in each stage that is equal and opposite in polarity to the feedback through the relatively high base-to-collector capacity. Since transistor amplifiers have a low input impedance, special tapped i.f. transformers are used. The 1st and 2nd i.f. transformers are double tuned to provide optimum bandwidth consistent with good selectivity.

The overload diode conducts on



Fig. 2. A house lamp will also charge the power pack, shown here on its own stand.

Sound

How a practical solar battery, now on the market, energizes a companion transistor radio.

strong signals, and its shunt resistance across the primary of the 1st i.f. transformer reduces the gain of the circuit to prevent overloading in a strong signal area. This diode, therefore, acts to "assist" the more conventional a.v.c. action provided by the bias fed to the 1st i.f. amplifier from the second-detector diode, CR₂.

The second detector is a standard 1N295 germanium diode. A type 310 p-n-p transistor is used as a first audio amplifier and driver to supply the audio-output amplifier. The output stage uses two 352 p-n-p transistors operated as a push-pull class "B" amplifier.

The "Sun Power Pak" is sold as an accessory item. When it is plugged into the jack on the back of the radio, the regular battery is disconnected. The radio will then play on electrical energy from the sun or a 150-watt lamp.

The selling price of the "Sun Power Pak" is \$185.00. The price seems high until one realizes that pure silicon, from which it is made, presently costs over \$300.00 a pound. Eventually, the cost will be reduced as metallurgists develop new refining methods along with mass production efficiencies. Nevertheless, the "Sun Power Pak" radio and the unlimited potential

which it represents are important electronic achievements.

Servicing the Radio

In the servicing of transistor radios, precautions must be taken to prevent damage to transistors and other components designed to operate with relatively low supply voltages. Transistors may be damaged by external heat or by heat generated within the circuit as a result of excessive current flow. Most transistors are hermetically sealed. If the seal is broken and the crystal is exposed to air and moisture, the performance of the transistor will be seriously affected.

To prevent possible damage to the transistors while servicing the radio, remember these few basic rules: When replacing components connected to a transistor socket, remove the transistor before doing any soldering. If the transistor should be wired into the circuit without the use of a socket, grasp the lead between the transistor base and the soldered junction with long-nose pliers before doing any soldering or unsoldering. The pliers will help dissipate the heat.

Always solder as quickly as possible. Use only 50/50 or 60/40 (60% tin, 40% lead) low melting-point rosin-core solder. Make certain that the soldering iron is hot enough to melt solder quickly before touching it to the soldered connection. Also, watch battery polarity closely. Reversing the power-supply battery may damage a transistor or one of the low-voltage electrolytic capacitors commonly used in transistor radios.

Never remove or replace a transistor without turning the receiver off. In some circuits the resulting voltage transient could do harm. The current
(Continued on page 118)

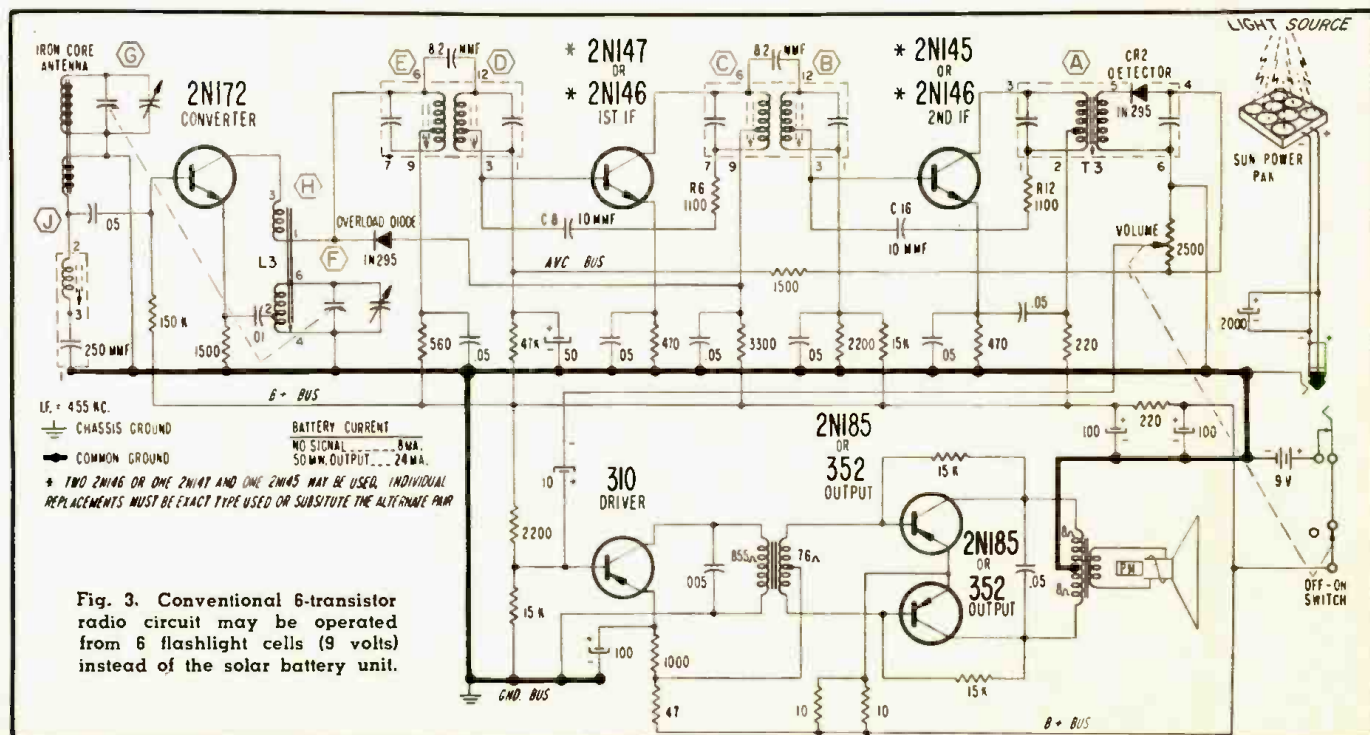

Power Requirements for Hi-Fi

By
DAVID HAFLER
Dyna Company

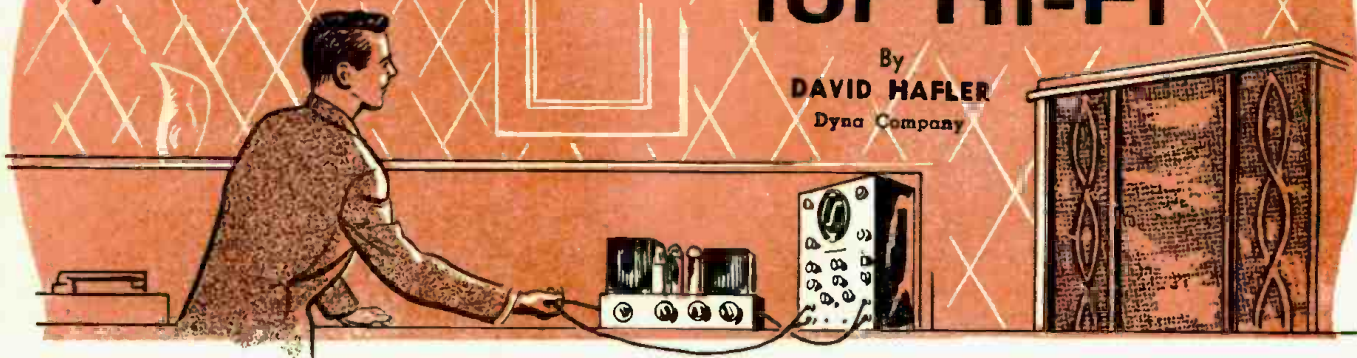

An advocate of high power audio amplifiers for home use gives his reasons—including a simple scope test for you to use to check your own amplifier. Don't miss Hartley's arguments for lower power in his article in this issue.

NOWHERE in the art of audio is there more controversy than trying to answer the question, "How much power is necessary for high-fidelity reproduction of music in the home?" Opinions range from milliwatts to hundreds of watts, but these opinions are based more on conjecture than on scientific reasoning and experiment.

Starting in pre-World War II days many authorities expressed the opinion "10 watts is enough." They talked about "average" power requirements of a fraction of a watt and "peak requirements" ten times average. This concept of ten times peak was based on the sluggish ballistics of vu meters in recording and radio studios and, of course, has no relationship to the dynamic peaks of musical crescendos. In this post-war period, the dynamic range of records, FM stations, and tape far exceeds that of 78 r.p.m. shellac records and AM broadcasts. Therefore, the "ten times" ratio is an archaic concept, and power requirements for modern program sources are far higher than in the days when ten watts were enough.

The author has observed that changing from a 10-watt amplifier to a 25-watt unit made an immediate improvement in cleanliness of sound. The 25-watt amplifier handled the loud climaxes with obviously improved ease and lower distortion. Changing from 25 watts to 50 watts resulted in further improvement in sound quality—even on loudspeakers of 25-watt rating and less. Higher power correlated with cleaner, more natural reproduction—particularly in the low-fre-

quency portion of the audible spectrum.

These observations are at variance with the opinions of the "ten watts is enough" school; but if we ask "enough for what," the problem is brought into its true perspective—how much power is required for realistic sound intensities under home listening conditions with home equipment? The qualification "realistic" means that sound pressures at the ear are comparable to those in the concert hall, and it also means that distortion is minimized over a wide band and transient attack is preserved. A truly low distortion system does not sound objectionably loud as realistic levels are approached. Systems which are obviously too loud invariably are high distortion systems in which the objectionable qualities stem from irritating distortion content rather than from excessive sound pressures.

There have been demonstrations which indicate that a conservatively rated 60-watt system hits overload only occasionally in a concert hall when reproducing the actual sound levels of a small ensemble such as a woodwind quintet. It is unfortunate that these demonstrations did not include the Carabinieri Band, the Boston Symphony, or other groups in which brasses, drums, or massed strings appear. Anyone who has felt the solid impact of the bass drum, or the snarling blare of horns and trumpets, or the ensemble power of 50 unified string instruments realizes immediately that these are loud and take tremendous power to reproduce realistically. Yet some superficial tests have been made which indicate that very

little power is required for normal use.

Most tests of power requirements are made by scaling down measured concert hall intensities to living room acoustics and then correcting for speaker efficiency. For example, a measured 200 watt intensity in a concert hall might be simulated with one-half watt in the home. To obtain one-half watt out of a 5% efficient speaker requires 10 watts of input; therefore, "ten watts is enough." This is fine theory which is meaningless because it does not go far enough.

Why High Power?

There are several reasons why simple measurements do not truly show power requirements. First, even if the same actual acoustic power is radiated from a loudspeaker as from the original sound source, it will not sound as loud unless stereophonic reproduction is used. Therefore, the same degree of realism requires more power from a loudspeaker than emanates from the actual sound source. Verification of this astonishing fact can be accomplished readily by paralleling the two channels of a stereo system and noting the drop in the loudness level which occurs even though the total power radiated by the speakers is unchanged. The use of a monaural sound system increases the amount of power required past that which is indicated by direct measurement and computation.

Another little known but highly significant factor which increases the power required for realistic reproduction is the loss in damping of the loudspeaker which occurs on peak signals. A low internal impedance, approaching a short circuit, is generally the most desirable source for a loudspeaker in order to obtain crisp, solid sound. When the amplifier is driven hard, the internal impedance tends to increase, and when overload is reached, there is no longer a short circuiting effect and

no braking of the speaker cone motion. This results in hangover and blur, and realism is lost.

It is particularly difficult to avoid approaching overload in the low-frequency region since the distortion characteristic of combined amplifier and speaker rises at low frequencies. The better the amplifier, the less it contributes to this increased distortion, but the number of amplifiers on the market which deliver rated power at 20 cps at less than 1% distortion can be counted on the fingers of one hand. Even these few will show a rise in distortion at high output levels when they are mismatched by the rising speaker impedance which is found in the low-frequency range. Thus the overload point (as judged by increasing distortion) is reached below the nominal power rating of the amplifier. There are many combinations of amplifier and speaker where an amplifier rated at 25 watts cannot deliver 2 clean watts to the speaker at 40 cycles. Obviously the 25-watt rating fails to indicate the inadequacy of the system to deliver sufficient clean power. Therefore, the nominal rating of a system at mid frequencies must be far in excess of customary expectations in order to be able to deliver power requirements at low frequencies.

These considerations indicate the difficulty of trying to theorize concerning how much power is required. It would seem to be more simple to conduct an empirical investigation, but even this has difficulties.

An Experimental Approach

The logical way to evaluate power requirements is to set up a system, determine what is an adequate level and measure the power being used. Both of these elements—determination of adequate level and measurement of power used—create problems.

How much level is necessary for realism is a subjective factor which cannot be evaluated by instruments but which requires the considered opinion of people who know how music should sound. In the experiments on which the conclusions of this article are based, a group of people which included music lovers, audiophiles, and musicians were given a chance to adjust the loudness level until the playback from records and tape was at a level which they considered to be realistic. In addition, tests were made in which a piano was recorded in a living room, and the tape playback was adjusted so that comparison with the original sound showed equal intensities to a group of knowledgeable judges. Thus test levels were those which closely approximated actual instrumental levels, scaled to living room acoustic environment.

Great difficulties were encountered in setting up an experimental approach to measure the actual power being delivered to the loudspeaker system. Short duration bursts of sound could not activate meters to furnish accurate readings. The use of neon

lights and similar types of peak measuring devices was also found to lead to erroneous conclusions on music with very short duration peaks and of rapidly changing dynamic characteristics.

The use of an oscilloscope as a voltmeter permitted determination of *voltage* output from the amplifier. However, since power is a combination of voltage and impedance ($P = E^2/Z$), and the impedance varies with the frequencies used, it was not practical to derive power measurements directly by this system. Fortunately, oscilloscope procedures can be used indirectly to establish the power requirements, and this is done as follows:

The signal from the amplifier is connected to the vertical input of the scope. The signal to the amplifier is connected to the horizontal input of the scope; and the internal sweep in the scope is shut off. This way the input *versus* the output of the amplifier is shown. Proper adjustment of the gain controls result in an oscilloscope trace such as is shown in Fig. 1A where a straight line with a slope of 45° appears. (This presupposes no phase shift in the amplifier.) As the input to the amplifier is increased, the trace increases in a horizontal direction. As long as the amplifier output is linear and non-distorted, it will increase proportionately with the input, and the scope trace will remain linear and at the same slope. As soon as the amplifier approaches overload the vertical extensions of the trace flatten out as shown in Fig. 1B. This type of trace instantly reveals that the amplifier has passed the overload point.

This is a very simple and basic overload test. It does not require knowledge of how much power is being delivered. If an amplifier of a given power rating is overloaded, realistic reproduction would obviously require an amplifier of higher power rating. The fact that the overload is a result of inability of the amplifier to deliver its power into a mismatch of impedance—or whatever other factor causes the overload—is immaterial. This type of test proves conclusively whether or not sufficient power capacity was available. Further, this test eliminates conditions of speaker overload and limits the analysis to the power amplifier alone.

The most elegant characteristic of

this testing procedure is that it also indicates how much more power would have been required in order to have permitted undistorted reproduction. This is established by noting that the horizontal trace is unaffected by output clipping. After vertical clipping, the horizontal trace continues to extend if the input signal continues to increase. Comparison of horizontal trace with the clipped vertical trace can be used to indicate the extent of input signal past the point at which the amplifier is overdriven. This can be used to show how much more power would have been required to handle the input levels used. As an example, in Fig. 1C the horizontal trace is twice that of the clipped vertical trace. This means that the amplifier would have required handling of an input signal twice as large to avoid overload clipping. Since we are talking in terms of linear systems, the output *voltage* would have been twice as great if clipping had not occurred. Twice as much voltage across a constant impedance would have required that the power rating be increased by four times, since power varies as the square of the voltage. In the condition of Fig. 1C the amplifier would have had to have four times the power rating of the one used, in order to have handled the signal without distortion.

Thus this procedure permits checking the adequacy of the amplifier power rating; and if this is found lacking, permits establishing how much more power would have been necessary for realistic reproduction.

Experimental Tests

Actual tests were performed using these techniques. Although these were conducted with various speaker and amplifier combinations, the reference speaker system used was the *AR-Janszen*. This was selected, despite its low efficiency, because it was one of the few systems in which the distortion over the entire 20 cycle to 20,000 cycle spectrum could be kept below 5% over the dynamic range anticipated. The efficiency of this speaker combination is between 1% and 2%. Conclusions established with this speaker system can be extrapolated to others by allowing for relative efficiencies.

(Continued on page 78)

Fig. 1. (A) Full amplifier output versus input without overload. (B) Amplifier is now being slightly overdriven. (C) Here a serious overload occurs and the amplifier would require four times present power capacity to avoid clipping shown.

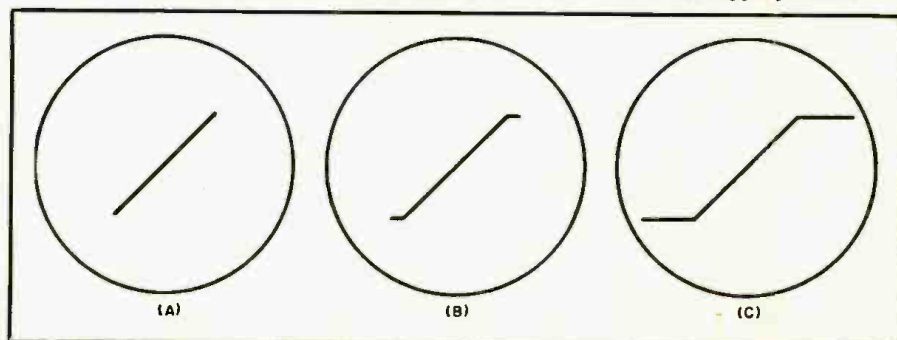

Sylvania's New Color TV Line

By
WALTER H. BUCHSBAUM
Television Consultant
RADIO & TELEVISION NEWS

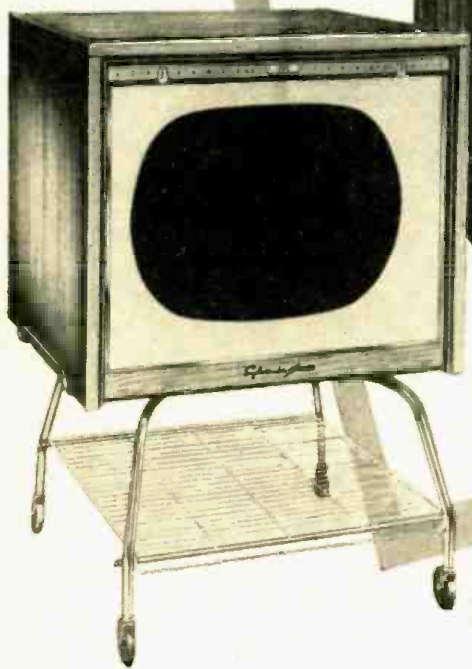

Fig. 1. The "Granada," a table model with side speaker, is the basic set.

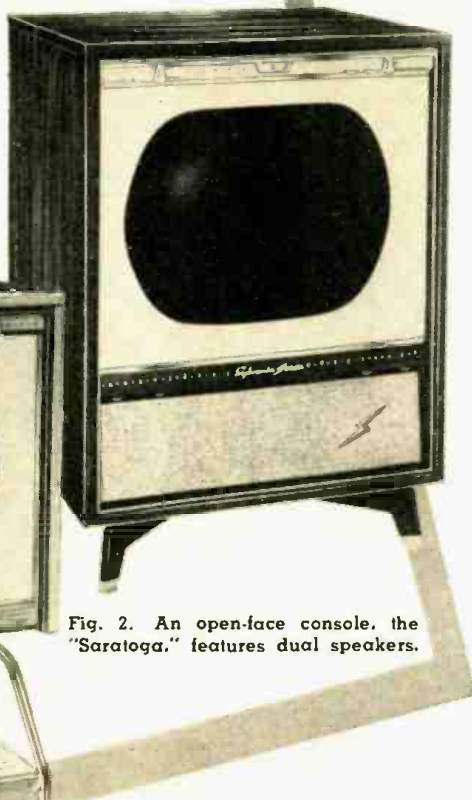

Fig. 2. An open-face console, the "Saratoga," features dual speakers.

Partially concealed controls produce streamlined appearance; a novel channel-tuning lever is used.

ALTHOUGH a certain amount of standardization is found in every color TV receiver, the 1957 line of *Sylvania* color models contains a number of novel features. Some are electrical, some mechanical, and a few are of more interest to the set owner than to the service technician. These features as well as *Sylvania's* price and service policy, will be considered here.

Models and Prices

The basic chassis for all *Sylvania* color sets is the type #1-534-1, with the major differences between models involving cabinet size, finish, and loud-speaker size. Fig. 1, model 31T304B, the "Granada," lists at \$605.00 in blonde while the same set with the letter suffix "M" for mahogany costs \$595.00. These models use a v.h.f. cascade tuner, but equivalents are available at slightly higher prices for both v.h.f. and u.h.f. reception. The inclusion of u.h.f. is indicated by the letter

"U" following the set's model number.

An open-faced console model is shown in Fig. 2. This is the 31C606M "Saratoga" which lists at \$695.00 for the mahogany finish and \$715.00 for the blonde Korina veneer version. The console has one 4-in. and one 8-in. PM speaker, both mounted behind the cloth-covered baffle board below the picture tube, while the table-model receiver uses a 5 $\frac{1}{4}$ -in. PM speaker mounted at the upper right-hand side of the cabinet.

Service Policy and Warranty

Like all TV manufacturers, *Sylvania* provides a standard 90-day guarantee on all parts and one year for the color picture tube. At the time of writing, no factory service has been offered. The manufacturer relies on franchised dealers for monochrome installation and repair, and expects to continue this policy with color. To enable its distributors and dealers to service

color TV receivers, *Sylvania* is offering a one-week factory training course for service technicians. The course consists of classroom lectures combined with actual work on color receivers. The total of 48 hours of instruction usually gives the student quite a good knowledge of color service.

The independent service technician who is not part of the *Sylvania* dealer system can get full color TV information from the manufacturer's Service Department. Detailed circuit diagrams with voltage readings and waveforms are provided, as well as a booklet explaining color TV and special circuits.

Operating Features

The location of the operating controls and the method of channel tuning is probably the most outstanding feature for the set buyer. Channel tuning is performed by means of a lever, which actuates the conventional cascade turret tuner through a rack-and-gear arrangement and is also linked to a channel number display drum. By pushing the lever to the right a new station is tuned in, but for fine tuning a partially concealed wheel must be adjusted.

The other controls are similarly concealed, as can be seen in Figs. 1 and 2. Only the rim of each knob is visible, which gives the appearance of a smooth cabinet without any knobs and dials protruding. Both console and table models have a tone control and only two color controls for the viewer's use. These are the hue or color phase control and the chroma or color gain control. All other controls and adjustments are accessible from the rear of the receiver.

Adjustment and Operation

To receive a color program, turn the "color" control first to its extreme left position until the switch clicks. Next adjust the monochrome controls for proper contrast and brightness, and make sure that the fine-tuning adjustment is correct. In other words, the first series of steps is concerned with obtaining a good monochrome picture.

After this has been accomplished, turn the "color" control slowly to the right until the picture becomes tinted. If colors appear to have the wrong hue—observation of flesh tones will generally provide the most accurate indication—adjust the "hue" control carefully for the most natural tones. When this is achieved, the "color" control is once more adjusted, this time until all colors are properly bright. Make sure, in this last step, that white objects remain white.

-30-

With the transistor in the output stage, use of these new tubes in auto radios makes possible a vibratorless supply.

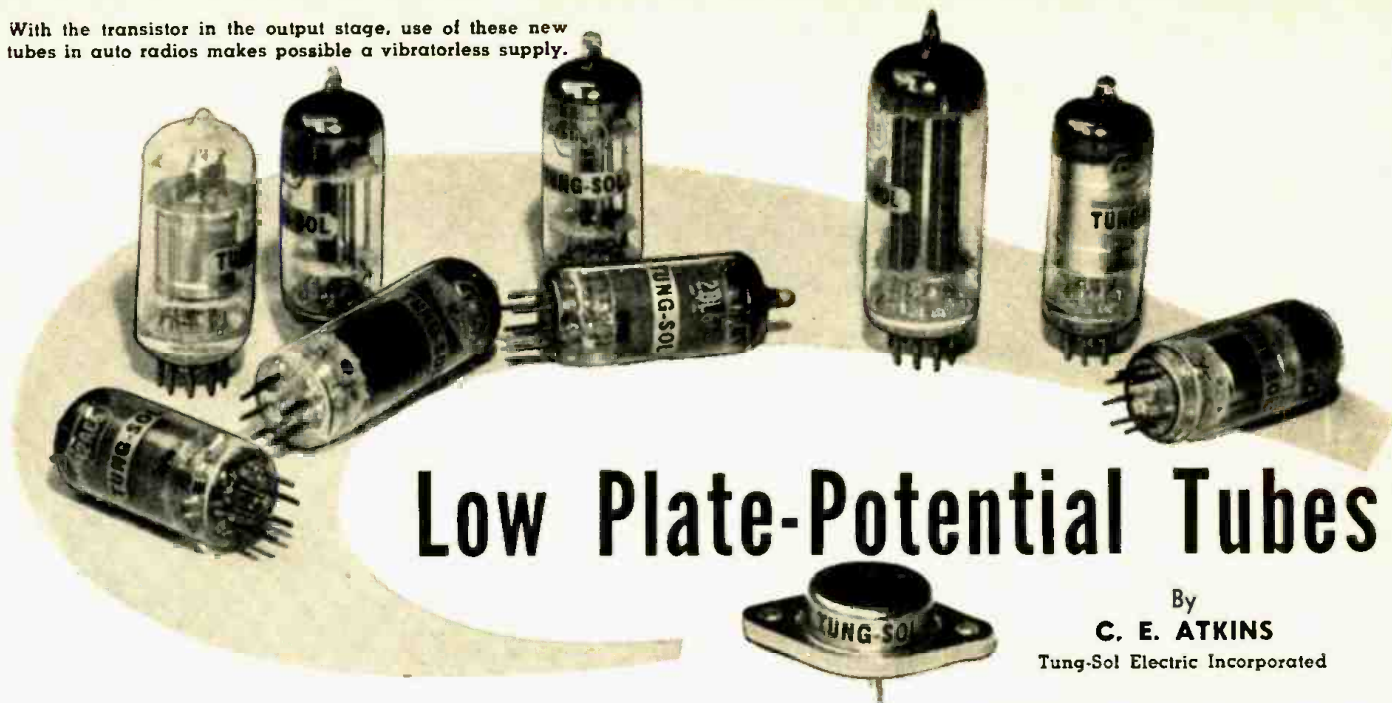

Low Plate-Potential Tubes

By
C. E. ATKINS

Tung-Sol Electric Incorporated

Re-evaluation of design parameters led to this new family of tubes for direct operation from a 12-volt source. With a compatible power transistor, they make the elimination of vibrator power supplies in automobile radios possible.

THE development of the transistor by Bardeen, Brattain, and Shockley of Bell Telephone Lab. in 1948 started a new phase in the technology of communication and electronic instrumentation. The rapid development of transistors provides many challenging opportunities to achieve results heretofore difficult or impossible with vacuum tubes.

Of immediate interest are those applications where the special advantages of the transistor can be most fruitfully employed. A clear-cut example is the hearing-aid field, where the transistor inroad is complete. Another intriguing opportunity is in automobile radios, and this field received early attention from application engineers. Many experimental, and a few commercial, all-transistor automobile sets have been made. They have many good features but are presently expensive and an adequate, economically practical, supply of the varied transistor types needed for volume production of such sets is not yet at hand.

Probably the most attractive feature transistors afford in auto-radio design is the chance to eliminate the vibrator power supply. Aside from its cost and the jealously husbanded space it requires, this facility is a cause of considerable field trouble. The car manufacturers rank vibrators No. 1 among the components needing attention during the early period of service. Furthermore, in doing its job, the vibrator does not suffer in silence. Vibrator noise which is both mechanical and electrical (in the form of r.f. hash and low-frequency hum) is an irritation to

the set designer. His mastery of this problem, often incomplete, also results in minor annoyance to the customer.

A single power transistor providing power output levels that are out of the question with vacuum tubes operating at low anode potentials allows one to discard the vibrator power supply; provided the functions of amplification, heterodyning, detection, and automatic gain control can be fulfilled with vacuum tubes at low potentials. Whether provision of such functions was feasible has been a hotly debated subject.

Tung-Sol took a lively interest in this matter shortly after March 1952 when the Lamp Department began work on 12-volt sealed-beam lamps. One of the motor car companies had advised it was changing from 6 volts to 12 volts in its automobiles, principally to obtain better ignition, but also to save some copper. Later, the other car companies made the same switch and furthermore adopted the convention of a negative ground connection. In the past, many makes of automobiles had the positive terminal grounded. This lack of standardization would have been awkward.

Incidentally, the writer has been unable to rationalize the choice of polarity made by different car manufacturers. In the past, although he has inquired extensively of automotive people. One quaint story was to the effect that a certain ground polarity was required because its opposite caused ground currents returning from the rear axle via the drive-shaft to deplate the crank-shaft bearings. In any case, the trend just noted opened the

way for a realistic consideration of a hybrid receiver employing one power transistor and 4 or 5 vacuum tubes.

Most tube engineers were loathe to embark on a tube program for low plate-potential service. There was a history of unhappy consequences whenever set designers tried using tubes at too low an anode potential. For instance, during the war the 6AJ5 was designed in a hurry because the 6AK5 proved unusable in production communication equipment running at 28 volts, even though this type had been used successfully in a pilot run. There was an old rule of thumb to the effect that the μ of a tube must always be less than the plate potential. Operating difficulties were sometimes encountered with triodes having a μ of 100 operating in a.c.-d.c. sets with anode potentials of 80 to 100 volts.

If one attempted to use much bias on the tube, the plate current would be cut off. This sometimes happens in practice. Because of this, some engineers expressed the offhand opinion that practical tubes at 12 volts E_p must have an amplification factor, or μ , of less than 10. They felt that, since the grid bias had to be approximately -1 volt (due to contact potential), there would be no plate current if the μ were higher than this value. Although the μ decreases rapidly as the plate voltage is reduced below 20 volts, it is possible to have an appreciable plate current and G_m under these conditions.

In fact, one is surprised that the I_p is higher than a prediction based on the tube's characteristics at 100 volts would lead one to expect. From inspection of the plate families of the type 12AJ6 (a diode-triode) at high and low plate voltages respectively, it can be seen that the μ , which was 112 at 250 volts, drops to 50 in the neighborhood of 10 volts. Fig. 1 is a dramatic display of this effect, where the μ of the 12AJ6 is shown to drop

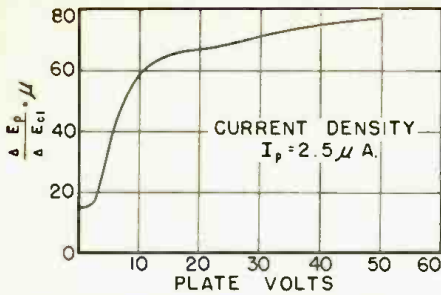

Fig. 1. Change in μ of triode section of the 12AJ6 as plate voltage changes.

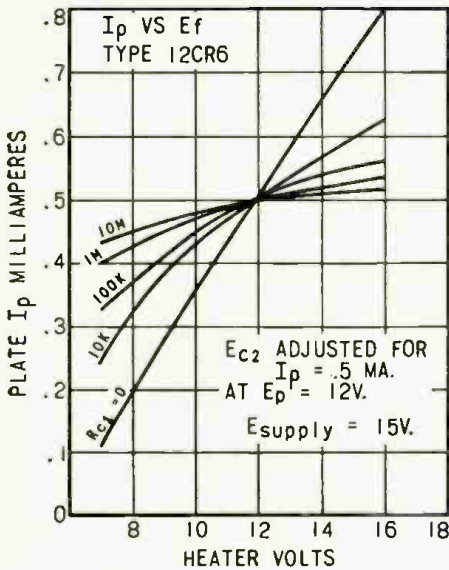

Fig. 2. Control-grid resistance (R_{c1}) affects change of I_p vs heater voltage.

from 77 to 50 volts E_p to 15 at 1.5 volts E_p . The plate current was held constant at the different values of E_p in taking this data.

It is believed the reason for this phenomenon is that, as the grid bias approaches zero, the potential minimum which is normally at or very close to the cathode moves over in the direction of the grid plane. This changes the effective geometry of the tube, thus lowering the μ . Also, the initial velocities of the emitted electrons are more nearly comparable to the accelerating field due to the plate

at these low anode potentials. This undoubtedly modifies the behavior of the tube.

Another serious pitfall was thought to be contact potential. Since this would establish the bias at which these low-voltage tubes would operate, many engineers felt that variations of contact potential between different production lots (or during life in the same tube) would seriously affect the performance of any equipment using them. Contact potential had been the villain in many an ill-fated marriage of tube and circuit. However, a deeper insight into the inter-relation between contact potential and other tube parameters revealed how it might be possible to exploit the very feature that generated the apprehension.

One facet of this many-sided situation is depicted in Fig. 2. This is a plot of plate current vs heater voltage in the 12CR6. By shifting the screen voltage for each value of control-grid resistor, it is possible to adjust I_p so that it is always .5 ma. with 12 volts on the heater. Hence, all the curves intersect at this point. Note the dramatic difference in slope between the condition of zero grid resistor and that where 10 megohms is employed. Even using 1000 ohms makes a considerable improvement. These phenomena stem from the fact that with higher heater voltage (and consequent greater cathode temperature), more current flows to the No. 1 grid because of the greater velocity possessed by the emitted electrons. Of course, more current will go to the plate and other electrodes as well.

If the resistance in the grid-to-cathode path is low, there can be no change in grid potential as the grid current increases. If this grid resistance is high, the grid develops a negative voltage which will increase with increasing cathode temperature. This rising voltage at the grid will prevent the more energetic electrons from reaching the plate. Hence, there is a kind of compensation which, as Fig. 2 shows, tends to hold the plate current more nearly constant. In the same manner G_m and other tube character-

istics are leveled out as well. Also, this compensation affords a measure of balance when the effective cathode area or the cathode activity changes. At Tung-Sol, several new tube designs have been evolved embodying this principle.

In the composition of a hybrid auto set, there appeared to be these problems the tubes must solve:

1. *Driving the power output transistor:* This step required a shift from voltage amplification to current amplification, calling for some power output from a vacuum tube. It was estimated this might be as much as 50 milliwatts.

2. *Getting gain:* Voltage amplification could use either low-impedance or high-impedance circuitry. The earliest endeavors took the form of tubes with larger cathodes giving higher G_m at the price of lower R_p and greater grid-plate capacitance. After some preliminary experimentation, this approach was temporarily side-tracked because the conventional tubes with lower G_m but high R_p and low C_{gp} appeared to give a quicker answer. Already designed i.f. transformers could be used, and some early sets were made using standard tubes selected for the best low-voltage operation. As a matter of fact, while the design of most of these tubes has undergone considerable revision, one of them, the 12AJ6, remains unchanged. It is merely a 12AV6 with special processing, tested under the low-voltage conditions.

3. *The a.g.c. problem:* The fact that the input signal at the first r.f. grid is commensurate with the plate voltage posed some new and nasty problems.

4. *Stability of gain:* Since 12-volt auto sets are expected to function effectively at supply voltage from 10 to 16 volts inclusive, this apparently heroic requirement had to be met. Good life is also required under these conditions.

Returning to problem 1, the transfer of power, it was felt 50 milliwatts might be needed to drive the transistor. Whether this will remain so depends, of course, upon the power gain of available transistors. In some respects, a suitable driver tube is the keystone of a successful hybrid radio set.

As Fig. 3 shows, conventional tubes, even relatively high-power examples, are inadequate to do the job. Only the newly developed 12K5 comes anywhere near the power-output objective. The availability of peak current approaching 40 milliamperes in the vicinity of zero bias is achieved in the 12K5 by employing the structure depicted in cross-section in Fig. 4. The plate family and transfer characteristics obtained with the special design are shown in Fig. 5.

In the 12K5 the space-charge grid principle is employed. This was first disclosed by Langmuir in 1913. By providing a No. 1 grid adjacent to the cathode with a positive accelerating potential applied to it and a control grid disposed between this accelerator

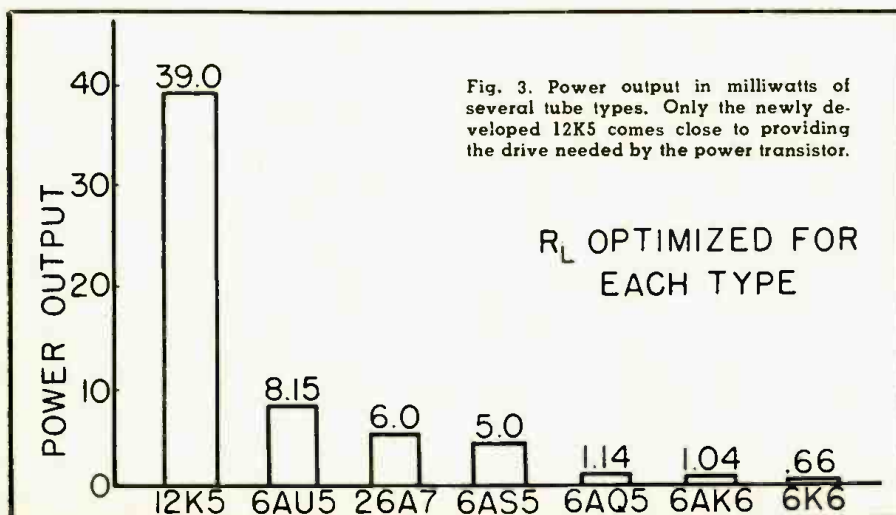

Fig. 3. Power output in milliwatts of several tube types. Only the newly developed 12K5 comes close to providing the drive needed by the power transistor.

and the plate, Langmuir was able to make tetrodes with very high transconductance. When screen-grid tubes became commercially available after 1926, sporadic efforts were made to use this principle in equipment. However, most of the tetrodes and pentodes available to the equipment designer did not operate well under space-charge conditions. Furthermore, it was not good engineering economics to provide the power required by the space-charge grid, as the gain in transconductance did not generally warrant the cost entailed in exploiting it.

But in a car radio there is a different kind of logic. Since the voltage is low, it is easily provided by the car-carried battery. The 50 or 100 ma. required for the space-charge grid is minuscule in the over-all current needs of the modern automobile. Accordingly, this ancient stratagem, long discarded, was revived for the tube that became the 12K5. The geometry of this type provides a fine-pitch No. 1 grid having 150 turns-per-inch spaced .018" from the cathode, which is fairly large, with an area of 1.8 square centimeters. The grid-to-cathode spacing is generous and poses no manufacturing difficulties. The No. 2 or control grid, having 80 turns-per-inch, is a bit closer to both No. 1 grid and plate. Here the spacing is approximately .012" each way. Holding this configuration is a bit tricky in production.

This disposition of elements provides the desired features. It is believed that the fine No. 1 grid to which the 10- to 16-volt car-battery potential is applied accelerates the electrons and groups them into thin sheaths. It is well known that the factor that limits current in thermionic devices is the repelling effect of the electrons upon one another when they are crowded together. The provision of a multitude of layers where the space-charge density is low probably helps to achieve high space currents with low applied potentials. In addition to its power-output performance, the 12K5 is an excellent low-voltage relay control tube. It is possible to achieve 8 or 10 ma. of plate current with only 2 volts of plate potential.

As mentioned earlier, providing adequate automatic gain control was a real problem. The usual a.g.c. potential has a magnitude comparable to the anode potential of the i.f. amplifier. This is insufficient to protect the No. 1 grid of the first stage against positive excursions on very strong signals. Accordingly, there is bound to be spill-over through the first stage, and this can be sufficient to overload the converter tube. However, designers hit upon the expedient of applying additional a.g.c. voltage to the suppressor grid of the r.f. tube in order to limit the amount of signal getting to the following stage. To do this successfully, certain compromises have been forced on the tube designer.

With high impedance i.f. transformers, it is necessary that the amplifier tube have a correspondingly high dy-

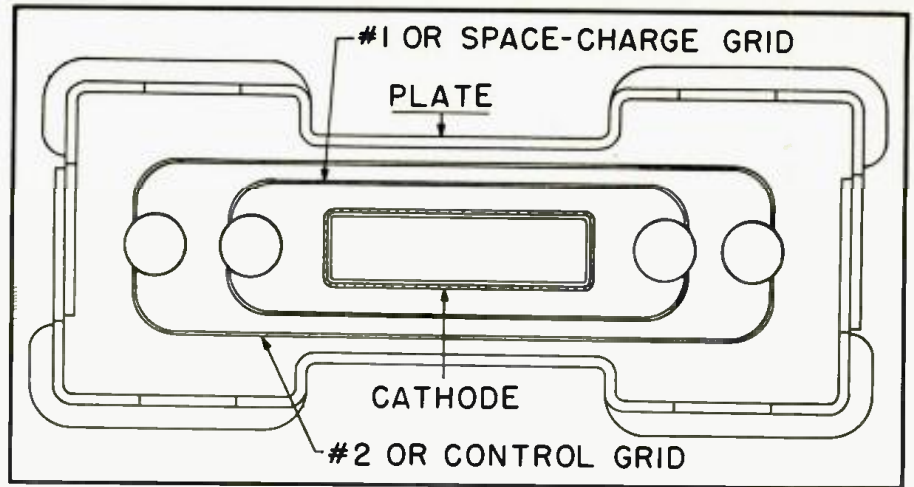

Fig. 4. Location of special space-charge or accelerating grid in 12K5 tetrode.

namic plate resistance (R_p). This has been difficult to achieve in tubes operating at low anode potentials. The beam-forming plates and suppressor grids, which are effective in high potential devices, do not give the same favorable results in the region of 10 to 15 volts. In fact, the suppressor grids employed in these hybrid r.f. tubes are probably more useful in reducing the control-grid-to-plate capacity than they are in providing effective suppression.

The R_p of a tetrode is considerably influenced by secondary emission from the anode. These secondary electrons leave the plate and are collected by the screen grid. Since the magnitude of this effect is sensitive to the applied potentials, a condition exists whereby small increments of anode potential can cause either a drop in plate current or too rapid a rise in plate current. In the latter case, R_p will be too low whereas, in the former case, it will be negative. Either of these effects can be harmful. On many tubes it was found that a nice balance between negative and positive R_p along the plate volt-ampere curve resulted in R_p values which were astonishingly high (several megohms where, without this effect, the R_p would have been a few hundred-thousand ohms).

This dip in the characteristic is shown in the curves for the 12AD6 in

Fig. 6A. Those readers who are old enough to remember the early screen-grid tetrodes (type 24A), will recognize this shape as the dynatron kink. Pentodes were introduced to cope with this characteristic. A coarse-pitch No. 3 grid placed between the screen grid and the plate served to thwart the return of electrons from plate to screen. Because of the geometry involved, this grid did not adversely affect the flow of primary electrons to the plate to any great extent. As stated earlier, suppressor-grid techniques do not function as well with tubes at low voltages. While suppressor grids are still used in the hybrid-set tube designs, it is mainly to help reduce the grid-plate capacity and because this grid is sometimes needed to secure adequate a.g.c.

It was found necessary to rely on special materials and processing in order to iron out the plate characteristic and secure the needed control over the R_p . The efficacy of these measures is greatly facilitated by the important fact that these tubes are used at very low voltages, so that there is very little plate or screen dissipation. The heat developed by the electrodes in more conventional operation has the effect of disturbing or destroying any surface film left on the electrodes by special processing. In contrast, it is (Continued on page 130)

Fig. 5. Characteristics of the 12K5 obtained with construction shown in Fig. 4.

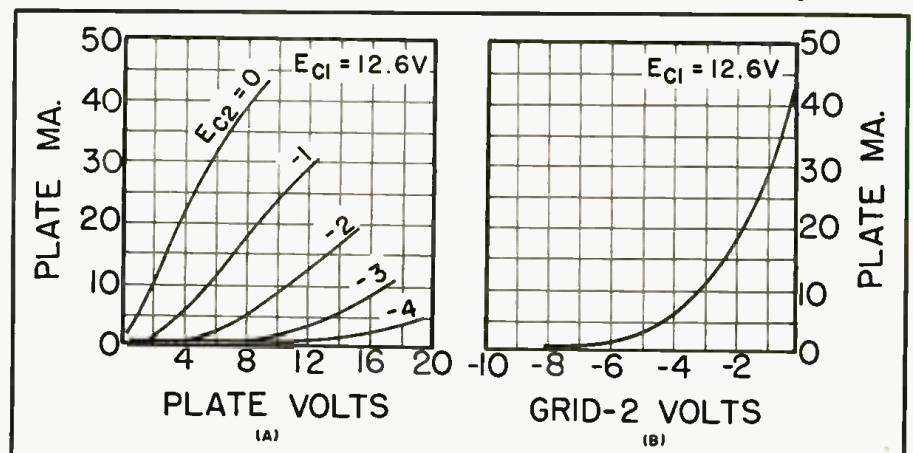

Electronic System for 2-way Speaker Operation

By ROBERT G. VAUGHN

Details on a simple two-stage circuit designed to be used as a high-frequency amplifier for improving reproduction.

IN THE operation of systems using separate speakers for high- and low-frequency ranges, commonly known as "woofer-tweeter" combinations, it has been standard practice to accomplish separation of frequency bands in the low impedance circuit between the output transformer and speaker voice coils. The low impedance makes this circuit unwieldy for the purpose and imposes practical restrictions and disadvantages.

There is a distinctly better method of operating such a speaker system which has advantages unobtainable with other methods as well as important features which have nothing to do with crossover networks. The assumption that a separate high-frequency amplifier would be much more expensive than an adequate low-impedance dividing network is unwarranted because it overlooks a very important fact. This is that an adequate high-frequency amplifier may be small in comparison to the wide-range amplifier already in operation and may cost just a fraction of the price of the larger unit. The reason, of course, is the reduced power requirements in the high-frequency range.

Experiments made with simple record playing equipment show that a

minimal two-stage amplifier with a single output tube, such as a 6V6, is adequate as a high-frequency amplifier when used in combination with a main amplifier of about 20 watts output. These tests showed that with this method a worthwhile improvement is realized even without using a special high-frequency speaker, irrespective of the pickup used. It may be applied to any existing system having an amplifier and speaker system which performs satisfactorily at low frequencies.

With this method, frequencies above approximately 800 cps are diverted from the main power amplifier into the high-frequency amplifier and fed to a separate speaker, which may or may not be especially designed for this purpose. A simple filter attenuates frequencies above this point at the rate of 6 db per octave in addition to any equalization present, before they get into the main or low-frequency amplifier. Frequencies below 800 cps are attenuated so rapidly in the high-frequency amplifier they soon drop out altogether. In its design, none of the special precautions necessary for low-frequency power amplification have to be considered. An inexpensive output transformer will be entirely

satisfactory and only the simplest filtering is required.

The possibility of intermodulation distortion virtually disappears because no large low-frequency voltages are present in the high-frequency amplifier. The large low-frequency noise voltages developed in record reproducing equipment never get into the high-frequency amplifier at all. The separate gain controls for each amplifier afford complete and exact control of power supplied each speaker without any possibility of interaction between the units.

Reference to the circuit diagram of the high-frequency amplifier used in these experiments shows it to be almost identical to any other two-stage, single-ended-output audio amplifier. Actually, there is a world of difference in its performance and this is due, almost entirely, to the values of coupling and input capacitances. The input impedance corresponds to 250 μ fd. in series with 500,000 ohms. Thus it may be connected directly to any crystal or ceramic pickup with virtually no effect on its response. In the case of a variable reluctance or any other type pickup requiring a preamp, it is connected at the preamp output. Little, if any, advantage is sacrificed because of this necessity. Equalization remains exactly as before.

In all cases, the simple high-frequency filter shown in the diagram is connected at the input of the main amplifier. The values given assume an input impedance of 500,000 ohms. There will be an insertion loss of 6 db which can be tolerated in most cases. No changes whatsoever are required in the amplifier itself if its low-frequency power response is at all satisfactory.

The feedback resistor, R_7 , was chosen to give 10 db of feedback with a *Stancor* 3830 transformer, using the entire secondary. With any other transformer, its value may be different and must be determined by experiment.

While there may be an advantage in using a special high-frequency speaker if one with a cut-off below 800 cps is available, it cannot be said to be absolutely necessary. It is obvious that the importance of speaker efficiency, if not of range, is less with this system because, within limits, it may be compensated by adjustment of the high-frequency gain. It was found that an ordinary 12-inch speaker without any sort of baffle (which, incidentally, may be entirely neglected if desired above 800 cps) gave quite satisfactory performance. The advantage of the wider angle of projection of exponential horn speakers may be important in many cases, however. The most pleasingly realistic and surprising results were obtained, as might be expected, with a wide separation of speaker, as wide as the room permitted, about 20 feet. It is a simple matter to hang a speaker in a far corner of the room, for appearance sake it may be mounted on a small panel, and

(Continued on page 147)

Circuit of the high-frequency amplifier which covers range from 800 to 30,000 cps.

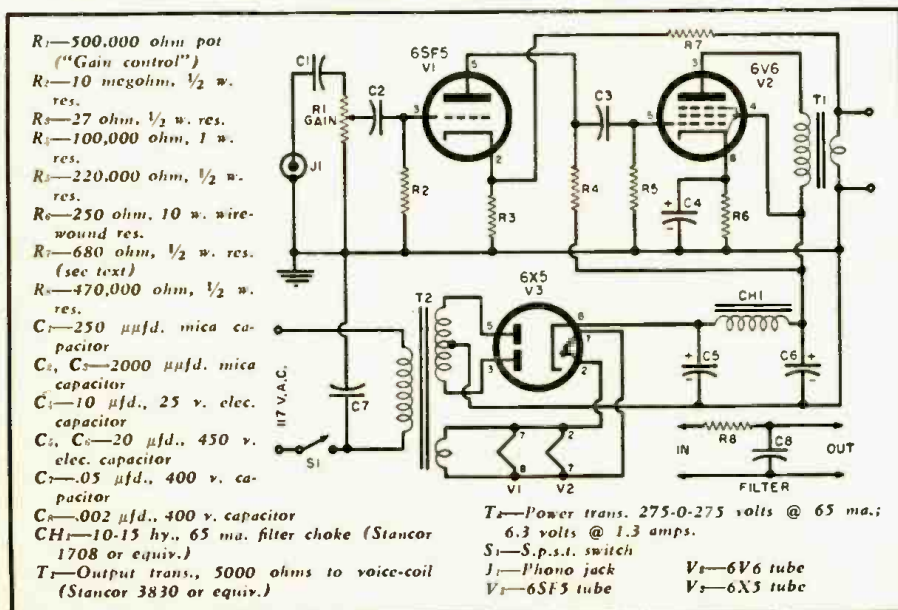

Buying a Tone Arm

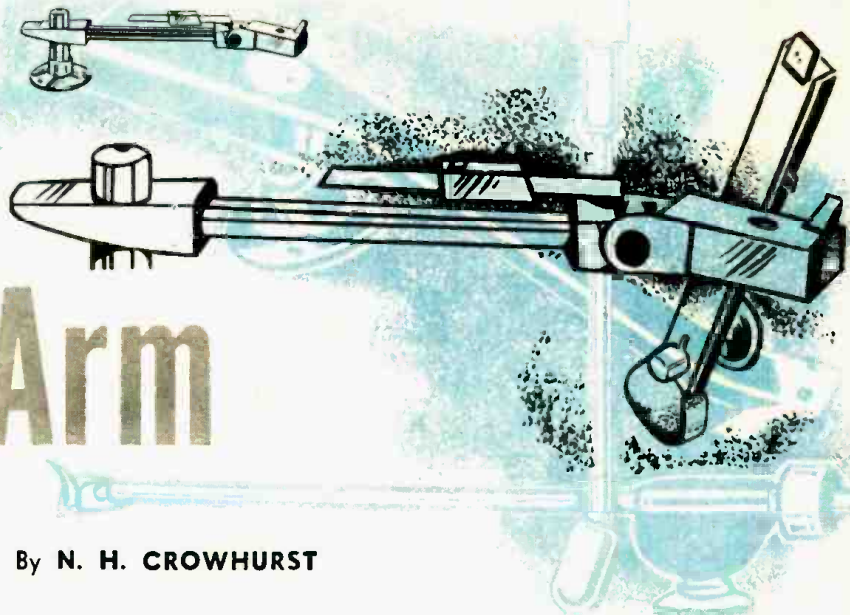

By N. H. CROWHURST

How to pick right unit for your particular high-fidelity system and discussion of most important factors involved.

THE name "tone arm" is really a hangover from the early days of reproduction, before electrical methods of recording were introduced. The tone arm was the swiveling channel that conveyed the sound waves generated in the sound box to the horn that was the acoustic phonograph's counterpart of the modern loudspeaker. It literally conveyed the tone from the sound box to the horn. Reproduction has come a long way since those days!

Early experimental electrical pickups were first strapped to the tone arm of an acoustic phonograph as a quick and ready means of giving the new idea a tryout. Hence when arms began to be designed specifically for carrying the pickup, it was only natural that the old name should be carried over to the new part.

Even the first electrical reproducers were a considerable improvement on the acoustic systems, because they made available extended frequency range and considerably reduced the peakiness of the reproduction. But those early electrical pickups were a far cry from the modern high quality product. High fidelity is an ideal hobby for the perfectionist. Better loudspeakers, better amplifiers, better pickups—each in turn receives attention with a view to approaching perfection.

As the quality of loudspeaker units improved, it became evident that the enclosure in which the loudspeaker was mounted plays an important role in the quality of reproduction. Early arms for carrying pickups were, like early loudspeaker enclosures, merely regarded as a means of holding the electrical unit so it could do its job. But modern developments have shown that attention to the design and construction of the tone arm is as important to successful pickup from a record as attention paid to the design of an enclosure is to reproduction from a loudspeaker.

In each case it is at the low-frequency end of the spectrum that the means of mounting—in the case of the loudspeaker, the enclosure, in the case

of the pickup, the tone arm—influences the over-all response of the system. In fact, a tone arm has to perform several functions satisfactorily to give good reproduction under all circumstances.

While there is a variety of extremely good tone arms on the market, it is not possible, at present, to pick out one as being "best" in all respects. Each model has its good features and its bad points. The best we can do here is to outline the requirements and the purposes served by different features in a tone arm so that each reader can select for himself the combination of characteristics that will best serve his purpose. To tackle this, we will take different features in turn and point out the pros and cons of each.

Long or Short Arm?

This question is principally linked to the problem of tracking, that is, making sure the direction of stylus travel is always perpendicular to the groove. If it is not perpendicular to the groove, then the way in which the stylus moves in tracing a sine wave along the groove will no longer be sinusoidal, but will take the form shown in Fig. 1A. Fig. 1B shows how this waveform can be synthesized from the funda-

Fig. 1. (A) Output from pickup cartridge when movement of stylus is not at right angles to direction of groove and (B) the waveform synthesized by a fundamental and a second harmonic. Refer to discussion in the text.

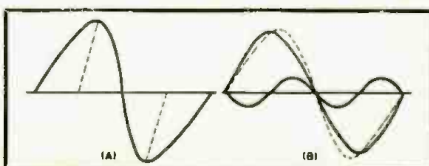

mental and a second harmonic component.

Thus, failure to track correctly will introduce a component of second harmonic distortion proportional to the error of tracking angle from the true perpendicular, or 90 degrees. In addition to harmonic distortion there will be intermodulation distortion when more than one frequency is present, as is the case with practical recordings. All tone arm manufacturers supply necessary instructions, and usually a mounting jig, to assist in making sure that the tone arm is correctly mounted to obtain minimum tracking error. But a simple explanation of how tracking error is reduced to a minimum for a given length of arm will serve two purposes here: it will help to get a clearer picture of why the correct mounting position is so important; and also it will show exactly the effect of tone arm length on this tracking problem.

Records are made with a cutter head that travels on a lathe mechanism at right angles to the groove, as shown in Fig. 2A. This insures that the modulation recorded in the groove is at right angles to the direction of the groove, throughout the recording. A hinged tone arm can only produce an approximation of this ideal at the reproduction end.

First consider a straight tone arm with the stylus mounted so as to move at right angles to the line of the tone arm as shown in Fig. 2B: for any particular radius of groove the tone arm can be mounted so as to give the correct movement, as shown by the solid line position; but as soon as the tone arm moves from this set radius, the tracking is no longer true—the angle of movement is no longer at right angles to the direction of the groove,

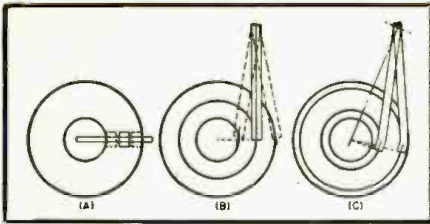

Fig. 2. Approaches to tracking. (A) In recording, the cutter head traverses a bar along a radius of the recording, which gives true tracking at all points. (B) A straight arm can only achieve correct tracking at one point, represented by the solid line. Dotted lines represent other positions that depart from correct tracking. (C) An arm with the pickup mounted at an angle can achieve correct tracking at two points, as shown here; keeps much closer than a straight arm for rest of its traverse. This matter is covered in text.

as illustrated by the dotted lines in Fig. 2B.

It is impossible, using an *effectively* straight tone arm, to produce correct tracking at *more than one radius on the record*.

Notice that the direction of deviation from correct tracking is the opposite way, depending on whether the radius is larger or smaller than that for which the mounting is correct. By using a curved arm, or having the pickup mounted at an angle on the end of a straight arm, it is possible to set the pivot so that the tracking is correct at *two different radii* during the playing of the record. This means that the deviation from correct tracking will be considerably reduced throughout the entire recording as illustrated in Fig. 2C.

The new relation can be better understood by referring to the diagrams of Fig. 3. Fig. 3A is a repetition of the method of mounting in Fig. 2B to suit one particular radius. The solid

Fig. 3. A demonstration of the geometry involved in the tracking problem. (A) Straight arm, with single correct position. (B) Bent arm, single correct position. (C) Bent arm with modified mounting to give two correct positions. (D) Longer bent arm, showing reduced deviation from accuracy over the entire range of movement. Refer to Fig. 2.

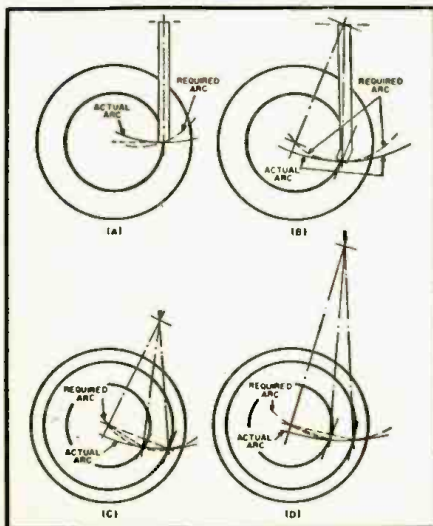

radius shows the actual movement of the stylus point with the tone arm pivoted at the position shown. The dashed-line radius going through the same pivot point shows a stylus point movement that would be necessary, holding the line of the arm through the same pivot point, for tracking to be maintained throughout the recording. This would, of course, necessitate an arm that changed its length as it pivoted around its fulcrum. Notice that this deviation is in the opposite direction on either side of the central point.

In Fig. 3B is a similar construction for the head mounted at an angle as in Fig. 2C. In this construction the tracking is arranged to be correct at the central point and two curves are again drawn to show the actual movement about the pivotal point and the required movement using the same pivot to maintain correct tracking. Notice, in this instance, that the deviation in length of the arm on each side of the central point is in the same direction, instead of in opposite directions as in Fig. 3A.

By making a slight adjustment in the pivot point, as shown in Fig. 3C, the tracking is slightly incorrect at the central radius, but becomes correct a little distance on either side of it. In this way a minimum error can be achieved throughout the whole playing band of the record.

Now compare Fig. 3C with Fig. 3D which represent the same method of mounting with arms of different lengths relative to the diameter of the record being played. Notice that the shorter arm, represented by Fig. 3C, shows greater deviation from correct tracking than Fig. 3D, as represented by the spacing between the two curves over the width of the record band to be played.

Now we are in a better position to answer the question about the length of the tone arm. To maintain the nearest approach to correct tracking through the whole band of recording, the longer the tone arm the better. Whatever its length, however, the best tracking will be achieved:

(a) by having the pickup mounted at an angle relative to the tone arm pivot so that the stylus movement is perpendicular to the line joining the center of the turntable to the tone arm pivot at a point approximately in the middle of the playing band of the record, as shown in Fig. 4.

(b) by setting the pickup slightly forward from the position for correct tracking in the middle of the record band, so as to give perfect tracking at two points, a little in from the extremities of the band.

This means that to obtain the best possible playing over each of the different size records available, the angle of pickup mounting should be altered to suit. However, by using a longer arm, and regarding the total playing bandwidth as being from the largest diameter on a 12-inch disc to the smallest diameter on any kind of disc played, the best compromise can be

achieved for playing all kinds of records without having to change the angle of pickup mounting and the position of the tone arm pivot.

Ten-inch and twelve-inch discs are, to some extent, interchangeable as regards groove modulation, having both the old 78 rpm groove and the micro-groove or 33 1/3 rpm so it is not practicable to make different mountings for each of these diameters. On the other hand, for equipment designed to play only the smaller 45 rpm discs it is feasible to use a shorter arm with the pickup mounted at an angle to suit the playing of this particular disc.

This means that a considerably shorter arm is practical for operation on a unit designed to play 45 rpm discs only. For the more usual type of equipment, designed to play all three different speeds, the *practical* solution is an arm and pickup mounting that is common to all sizes of disc; it is hardly practical to make a mounting for the 45 rpm pickup at a different angle and radius from the pivot than the pickup used for 10-inch and 12-inch records. But the use of a longer arm will insure a closer approach to correct tracking throughout all of these records.

The problem that sometimes occurs with a long arm is that of getting it into the cabinet chosen: a longer arm necessitates a larger space to get the pivot in the correct position, and hence a larger cabinet to enclose the whole mechanism.

Straight or Curved?

This question is closely linked with the previous one and is, to some extent, a matter of esthetic choice. The important thing is that the pickup should be mounted at the correct angle to suit the length of arm and the mean diameter of the groove to be played; whether this angle is achieved by utilizing a curved arm with the pickup mounted straight on the end of it, or by using a straight arm and mounting the pickup at an angle, is immaterial from the viewpoint of achieving correct tracking.

Some prefer the curved arm for psychological reasons, because the angle of the arm tip is in line with the direction of the groove where the stylus rides in it, and this seems more logical.

On the other hand, the straight arm can sometimes save space, as illustrated in Fig. 5. When the arm is at its position of rest, with the pickup parked outside of the record diameter, the greatest distance from the turntable, apart from the pivot itself, will be the outward curve of the arm. This will mean that the dimensions of the motorboard will have to be extended in two directions instead of just the one necessary to include the pivot in a corner. The straight arm allows one dimension to be smaller than is possible with a curved arm of the same length. This is probably only a matter of an inch or two and may not al-

ways be important, but in some instances it may make the difference between fitting or not fitting a certain arm into a certain cabinet size.

Pivot Construction

This is another feature in which tone arm practice differs widely between one manufacturer and another. The pivot allowing vertical movement of the pickup may coincide with the vertical pivot of the tone arm, about which it turns, or it may be nearer the pickup. The latter arrangement reduces the vertical inertia effectively applied at the pickup stylus point which can prove advantageous.

All pivots should be as free from friction as possible, because any friction will be liable to impose distortion on the system. Friction is not to be confused with viscous damping, which merely limits the speed at which movement can take place.

In considering the general mechanical construction and positioning of the pivot, the important factor to remember is that the pickup is only required to move very slowly laterally, as it follows the spiral groove from the start of the record to the end. With modern recordings allowance is not necessary for eccentricity of the groove, because this would produce a very definite wow. For this reason, recordings must be made with the center hole well centered so the groove is a true spiral. On the other hand, recordings do sometimes warp to some extent so that the pickup has to go up and down as the record rotates.

To follow the groove, an ideal modern pickup may only need a stylus force of about 1 gram to keep it in the groove and maintain tracking. The tone arm should be so designed that up and down movement, due to slight warping of the disc, does not appreciably modify this stylus force. Of course, it is bound to modify it to some extent, due to the vertical inertia of the arm. This is the advantage of an arm where the pivot allowing vertical movement is nearer to the pickup head than is the tone arm pivot for horizontal movement.

For some applications another factor requires consideration. This is when the system is subject to vibration or movement, as, for example, if it is to be played in a vehicle while traveling (can *this* be high fidelity?!). Under these circumstances the arm needs to be dynamically balanced for both vertical and horizontal movement, so that jolts will not jerk the stylus out of the groove or produce undue stress on it. This is a somewhat special application, but if you are thinking of it, attention is necessary.

Arm Shape and Structure

It may be thought that provided the arm has suitable mechanical characteristics, as described previously, its actual shape is immaterial. In practice, however, its mechanical performance is largely dependent on the shape and construction of the arm.

The important thing from the viewpoint of over-all frequency response is the low-frequency resonance that a tone arm can contribute to the performance of the pickup. This resonance is caused by the movement of the arm as driven through the compliance of the pickup. One resonance at least is unavoidable, this is a resonance produced between the compliance of the pickup movement and the mass of the arm, moving laterally as a whole.

Careful choice of the pickup and arm combination can put this resonance at a position in the frequency response where it will be unimportant, but bad design of the tone arm can result in additional resonances. These may cause trouble and arise due to the fact that the arm does not always vibrate as a whole, but sets up subsidiary resonances at much higher frequencies. Any arm that has the same cross-section throughout its length is more liable to set up multiple vibration as harmonics of its natural vibration, some of which are shown in Fig. 6, and thus contribute irregularities to the response not inherent in the pickup itself.

This is a general argument in favor of an arm with a tapered structure, wider at the base or pivot end, and narrowing down to a smaller section where the pickup fits on to it.

An important feature in choosing a pickup and tone arm combination is to ascertain that the fundamental resonance does not occur in the region of 30 cycles, which is the frequency where most turntables generate their rumble. The resonance can be quite pronounced and could amplify the rumble considerably. It is also undesirable that the frequency should be above 30 cycles as this will produce unnatural accentuation of low frequencies in the program material. The best position for the resonance is below 30 cycles and, if possible, well below, that is, below 20 cycles.

The major possibility of damping this resonance is, of course, in the design of the pickup itself, because the arm is moving as an entire mass and has to have freedom of pivot movement in order to allow the pickup to track. However, viscous damping can help reduce its amplitude. But the principal possibility for damping the resonance is in the compliance of the pickup.

Usually the damping of the pickup

Fig. 4. Detailed diagram showing how the correct arrangement is related. See text.

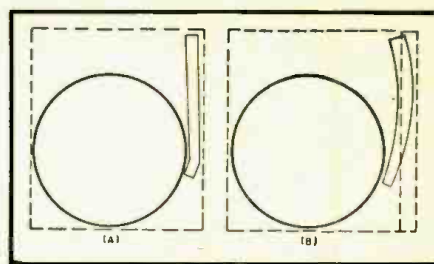
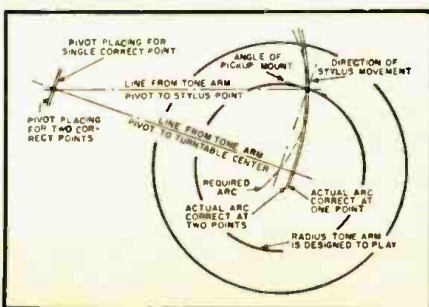

Fig. 5. How an arm with angled mounting for pickup (A) can save space in comparison with curved arm (B) of same length. The difference is shown dotted in (B) of diagram.

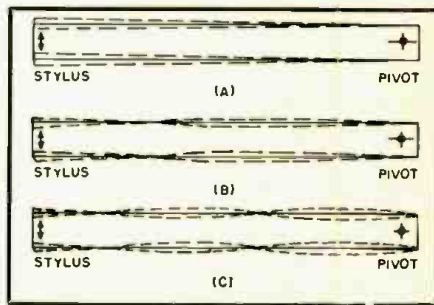

Fig. 6. Modes of tone arm resonance. (A) Basic fundamental resonance between the mass of the tone arm and pickup compliance. (B) First overtone resonance in the tone arm itself and (C) second overtone.

is designed to achieve the correct response at the high end of the band. It is not feasible to adjust the pickup damping so as to achieve perfect response at both ends of the band, so careful choice of tone arm is the best solution.

A simple way of checking for the low-frequency resonance effect is to use a 78 rpm frequency test disc, with frequencies from 50 cycles upwards, and run the turntable at 33 rpm which will reduce these frequencies to the region of 20 cycles. Comparison of the response to different frequency grooves will then show how much peaking effect the tone arm and pickup exhibits. This will enable different combinations to be checked and a suitable choice to be made.

The writer does not expect that you will be able to find a combination without any resonance at all. The thing to look for is a resonance that does not color the program material appreciably nor produce distortion due to any vibration that might occur at this frequency.

What About Viscous Damping?

As far as playing is concerned, viscous damping is usually unnecessary. It will seldom be adequate to damp out the low-frequency resonance, so its primary purpose is as a safety precaution against dropping the stylus onto the platter with undue force, which might damage either the stylus or the stylus arm in the pickup. Viscous damping insures that, if the arm is dropped, it descends to the record at a slow rate and with insufficient impact to do any damage.

If the arm is only to be used for
(Continued on page 143)

A New Master-Control Preamp



Front panel view of high fidelity control unit. Dual controls are used to simplify appearance.

High fidelity audio preamp with seven inputs, tone, level, loudness controls, and five equalizations settings. Rumble and scratch filters are also included.

AUDIOPHILES who are assembling their high-fidelity systems progressively now have a new master-control preamp kit available for consideration, the *Eico Model HF-61*.

Designed to be used with any high quality amplifier, the new preamp is housed in a handsome cabinet measuring 4 $\frac{7}{8}$ " wide, 12 $\frac{3}{4}$ " long, and 4 $\frac{7}{8}$ " high. The circuit is so designed that the unit may be used separately or may be built-in by removing the housing.

There are two unique and outstanding features which have been incorporated in the design of this preamp. The first involves a new feedback type control for bass and treble tone adjustments. The circuit provides low distortion and wide frequency range yet the controls do not affect the volume nor interact on each other. As turnover at both ends varies with the amount of boost and attenuation, boost or cut at the extremes of the audio range is possible without affecting the mid-range. Neither of these controls affect the tape output jack.

One novel feature of the tone control circuit is that the midpoint (flat response characteristic) is not sharp in its adjustment. There is actually a range of rotation about the midpoint where flat response can be obtained.

The second unique feature is the loudness control, a *Centralab* "Compentrol" unit which raises or lowers the volume in strict accordance with the Fletcher-Munson curve. This control is quite effective; for flat over-all response the loudness control should be set at maximum.

As the control is turned counter-clockwise from maximum clockwise

rotation, not only does the volume decrease, but there is an increasing emphasis on the bass and treble in accordance with the Fletcher-Munson configuration. An uncompensated level control is also provided to permit the proper operation of any system.

A feature unique with kit-type preamps is the inclusion of built-in high- and low-end noise elimination filters. These filters are not only valuable when listening to worn records or poor program material but are especially important in tape recording.

The flat positions of the filter controls should be used in direct listening to clean records played on high-quality turntables or cleanly recorded or live AM broadcasts.

It is interesting to note that the filter circuits provide relatively sharp cut-offs whereas the tone controls provide gradual, frequency-proportional changes in the response. One type of control is not a substitute for the other, however, and both may be used to achieve any desired response. It is worth noting that the "variable turnover" tone controls employed in the circuit may be used to further sharpen the cut-off if desired and in order to shift the cut-off frequencies in either direction.

According to the manufacturer, frequency response of the preamp (at the 5 volt level) is ± 1 db from 8 to 100,000 cps and $\pm .3$ db from 12 to 50,000 cps. The IM distortion (60 and 6000 cps, mixed 4:1) ranges from .2 per-cent at .5 volt output to 1.5 per-cent at 5 volts. Harmonic distortion is less than .82 per-cent from 20 to 20,000 cps at the 3 volt level.

Equalization for RIAA, *Columbia*,

London, European 78's, and American 78's is provided on the input selector switch along with positions for tape, TV, tuner, and auxiliary inputs.

Tone controls have a range of about 15 db boost and cut at 50 cps for the bass control, and 15 db boost and cut at 10 kc. for the treble control. Hum and noise are 60 db below 2 volts on the low-level phono inputs, and 75 db below 2 volts on the high-level inputs.

Rumble and Scratch Filters

Reference to the schematic diagram shows that the high- and low-end filter circuits actually consist of dual-section low-pass and high-pass RC networks within a feedback loop. Thus two 6 db per octave turnovers are combined to obtain a final slope that is 12 db per octave, assuming zero input resistance and no output loading. Over-all feedback is used to control the sharpness of the initial turnover. Filter circuits are inserted in the feedback pair audio amplifier by two front panel 3-position slide switches.

Rumble (low vibration) occurs at about 29 cps in 4-pole record changer and turntable motors and at approximately 58 cps in the inexpensive changers and players of the 2-pole variety. Recorded rumble (29 cps) will also sometimes be found in discs recorded before the development of the improved techniques in use today. Transmitted program material may also include such records. Reduced rumble is one of the objectives in the design of turntables and changers for high-fidelity use, but the extent to which it is eliminated depends on the quality and condition of the turntable or record changer used. That is why

the rumble filter circuits are provided. Note that whether the rumble itself is audible or inaudible (depending on the rumble frequency and the extreme low-frequency response of the speaker system), it may still overload the amplifier and cause distortion in the audible region.

Use the "50 cps" position whenever recording on tape from records in order to eliminate any trace of subsonic rumble from appearing at the recording head and eventually magnetizing it with increased distortion level as a result. The 50-cps cut-off also eliminates tape overload from noisy components below this frequency and thus provides cleaner tapes. In general, the 50-cps cut-off is useful for eliminating the effect of moderate rumble in 4-pole record changers, whether in direct listening or recording. The 100-cps cut-off serves to eliminate noise, rumble, and hum that may be found in older records. It aids in reducing the effect of severe rumble in 4-pole changers as well as rumble from 2-pole changers. The "50 cps" and "100 cps" positions may also be used to restore tonal balance on AM broadcast listening, if desired. The rule for tonal balance, based on a statistical study of audience reactions, is that the product of the extremes of the audio spectrum reproduced should be about 500,000.

Many people feel that full bass response is more important than tonal balance and ignore such considerations. The use of the high-end filters to eliminate scratch and high-frequency distortion when recording from or listening to records, and for noise elimi-

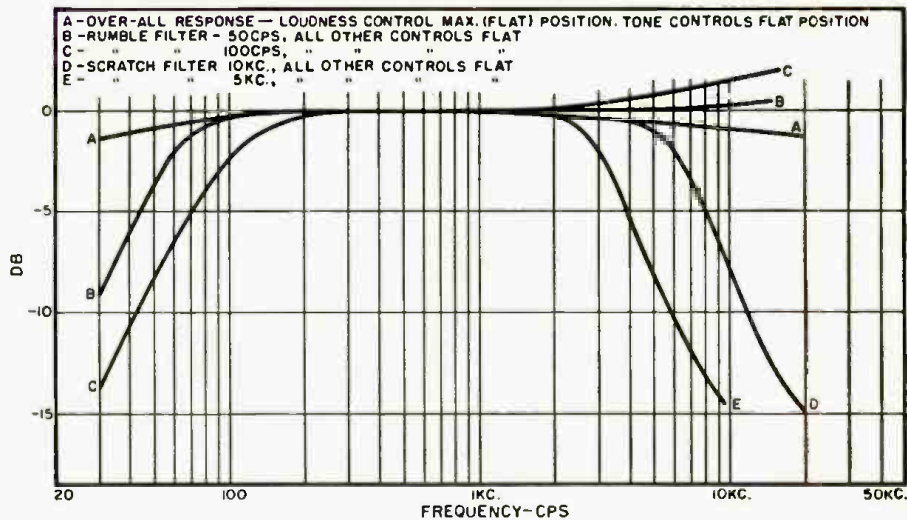

Curves showing over-all response of the preamplifier along with both rumble and scratch filter characteristics. It was the above performance which your editors consider most important in the design of this unit. The editors were gratified to note the sharp roll-offs at both ends of the above response curves which we ran. Rumble filter curves are down about 4 and 8 db at 50 cps while scratch filter curves are down about 8 and 15 db at 10 kc. It should be pointed out that due to construction differences and component tolerances, somewhat different figures may be expected on other units. According to the manufacturer, the average figures to be expected are: for the rumble filter, curves are down 6 and 16 db at 50 cps; for the scratch filter, curves are down about 7 and 20 db at 10 kc.

nation from AM broadcasts, will result in cleaner tapes and more enjoyable listening. The "10 kc" position is useful for reducing the annoyance of high frequency distortion and noise from records or broadcasts. The "5 kc" position is useful for reduction of noise on older or scratchy records, particularly older 78 rpm records, and for elimination of noise above 5 kc. on AM broadcasts.

The preamp will operate on 50 or 60 cycle a.c. at from 105 to 125 volts. The Model HF-61A (\$24.95 in kit form) does not include its own power supply but can be driven by the amplifier with which it is used providing the amplifier can supply 350 volts at 10 ma. d.c. and 6.3 volts at 1 amp. The Model HF-61 (\$29.95 in kit form) has its own self-contained supply. Power consumption is only 15 watts.

Schematic diagram of the Eico HF-61 master-control preamplifier. A Centralab "Compentrol" is used as the loudness control. Rumble and scratch filters are shown in "Flat" positions. For other positions, see the table showing shorted contacts.

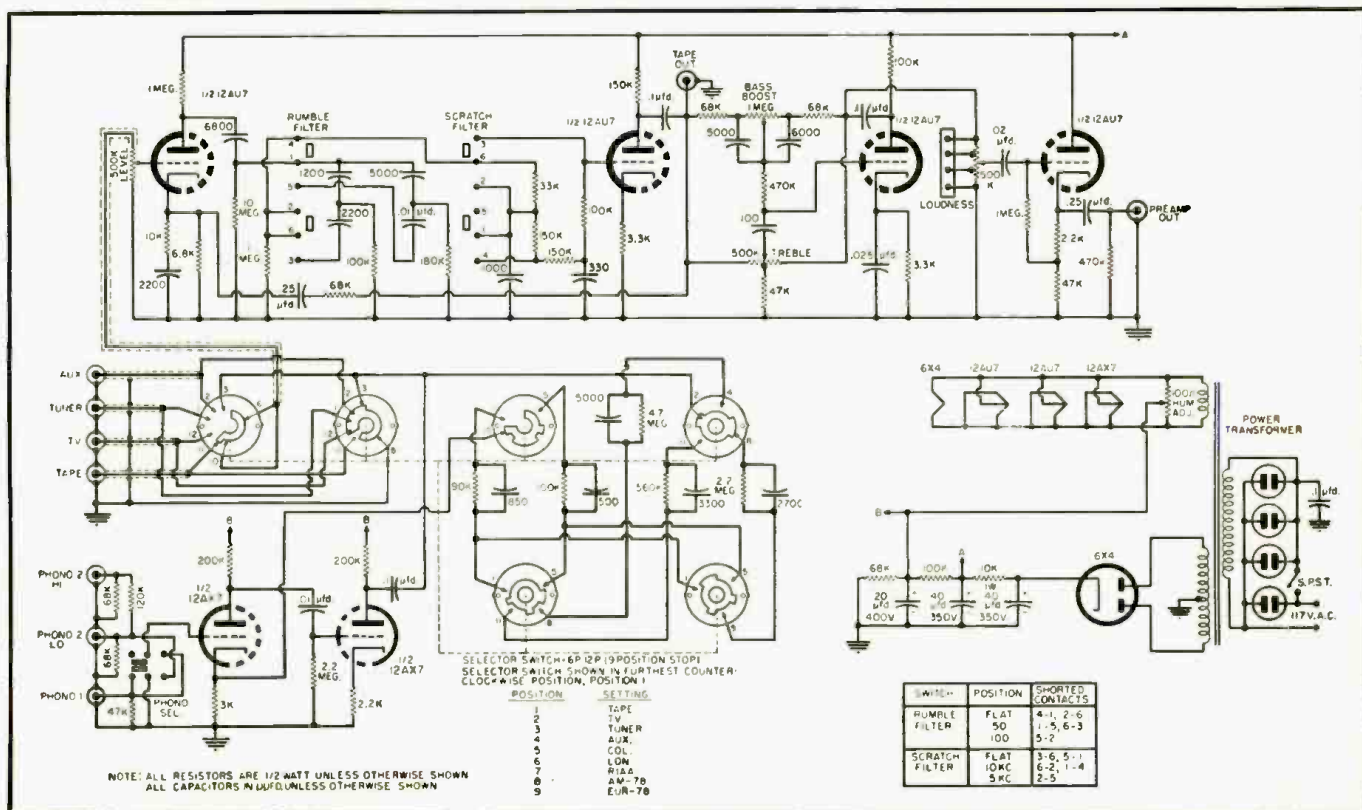

Distributors

and Service Technicians

Join Hands

By **WILLIAM LEONARD**

Two segments of the industry get together to settle past differences, agree on a program.

HIGH among the problems that have beset the independent service industry in its efforts to bring about some degree of stability in the operation of an electronic service business has been its relations with parts distributors. The rapid growth of the billion-dollar electronic service industry while it was tied to a system of distribution that had been created to serve a market made up of radio amateurs, experimenters, and radio technicians brought about inequities in distribution that cause continual confusion in the operation of a consumer service business.

Spurred by statements made by Joseph DeMambro, president of NEDA, to the effect that the National Electronics Distributors Association planned to work with service associations to improve the relations between distributors and the service industry, a meeting was called that brought together representatives of service associations in Pennsylvania and New Jersey. Purpose of the meeting was to formulate a plan for cooperation between the service industry and parts distributors.

The initial program, which detailed ten suggestions for the improvement of jobbing practices and six for the service industry, was sent to service associations in Pennsylvania, New York, New Jersey, Connecticut, New Hampshire, Massachusetts, and Rhode Island for their consideration, suggestions for improvement, and for ratification in whole or in part.

Subsequently a meeting was held in Bridgeport, Connecticut, to formalize the program for presentation to

NEDA. This meeting, under the chairmanship of Frank Silverman, president of TELSAs of Connecticut, was attended by more than 100 delegates representing associations in the seven northeastern States.

The Bridgeport meeting, termed by the participants as the Eastern States District TV Service Conference, formalized a program of cooperation that includes ten points for the improvement of distributor practices and ten points for the improvement of service practices.

Distributor Rules

Titled the "Ten-Point Program for Distributor-Service Relations," the plan, as it was presented to a NEDA Committee early in December, detailed the following:

Point 1: Parts distributors will arrange to sell a package deal if the standard discount is to be obtained. All sales under the minimum package deal to be sold at progressively smaller discounts.

Point 2: Development of a system of classification and identification to be issued to personnel (service technicians and shop operators) for the purpose of obtaining trade discounts. There would, perhaps, be several degrees of classification and a simple, uniform identification system acceptable to both jobbers and service.

Point 3: Jobbers discontinue the use of repair shops for other than authorized warranty repairs.

Point 4: Jobbers advise counter, repair shop, warehouse, and other help to discontinue the solicitation of service work as being in competition with

the jobbers' own servicing accounts.

Point 5: Jobbers should eliminate the use of net prices in advertising and merchandising displays. Only the manufacturers' list prices should be advertised or publicized.

Point 6: Jobbers should make all published material of an educational nature, and of new and advanced developments in the field, available as soon as possible.

Point 7: Jobbers should make all merchandising displays and related material available to the trade for display in order to assist in obtaining public acceptance of their products.

Point 8: Jobbers should, collectively and as a matter of course, cooperate with all local service associations in sponsoring educational forums.

Point 9: Symposiums and exhibitions of all new and advanced electronic equipment should be sponsored jointly by the local service associations and the parts jobbers for the benefit of the local electronic service trade.

Point 10: Eliminate all premium and sales gimmicks and their allied promotion.

Service Industry Rules

The following are some of the ways that we in the service industry can be helpful to our parts distributors:

1. Make all purchases from independent, established jobbers.

2. Discourage the purchase and/or use of surplus merchandise.

3. Refuse to purchase unbranded and bulk tubes and parts.

4. Destroy all defective tubes and parts, unless requested not to do so by our customers.

5. Refuse to accept and return to the sender electronic parts and tubes, mail order catalogues, and similar direct mail material which is sent indiscriminately.

6. Encourage service shops to carry adequate stocks of parts, tubes, and test equipment.

7. Refrain from sending retail customers to wholesale jobbers as much as possible.

8. Lend every support and cooperation to jobbers who help to establish local service associations.

9. Cooperate wholeheartedly with any educational program instituted by independent jobbers.

10. Do all that is possible mutually to aid the jobbers in stabilizing the industry.

Immediately after the approval of the dual ten-point program by the delegates to the Eastern States District TV Service Conference, a committee sent copies of the plan to practically every known association in the industry with a request for suggestions and endorsements of the program.

Backed by these endorsements from associations in all sections of the country, the committee for the service industry, headed by Mr. Silverman, presented the program to the distributors' association as a national service association plan for cooperation. —30—

Design Features of 9" G-E Portables

By
JACK NAJORK
Field Service Representative
General Electric Company

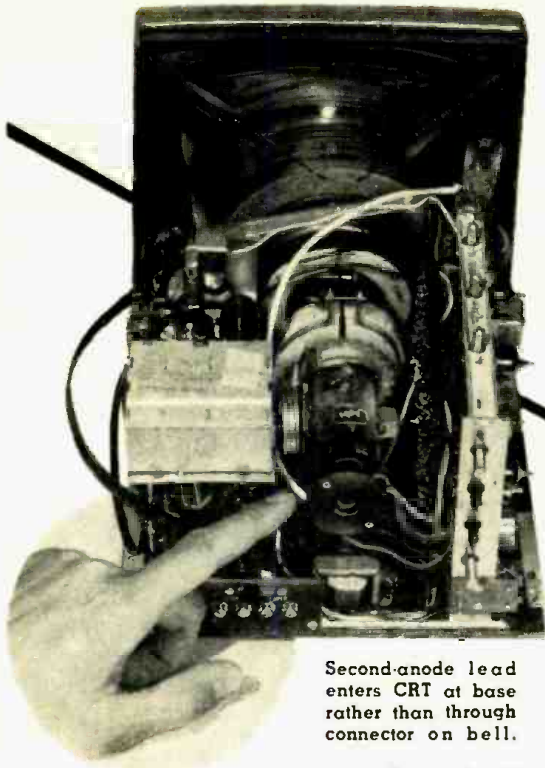

Second-anode lead enters CRT at base rather than through connector on bell.

Removal of wrap-on aluminum cabinet exposes interior parts for service.

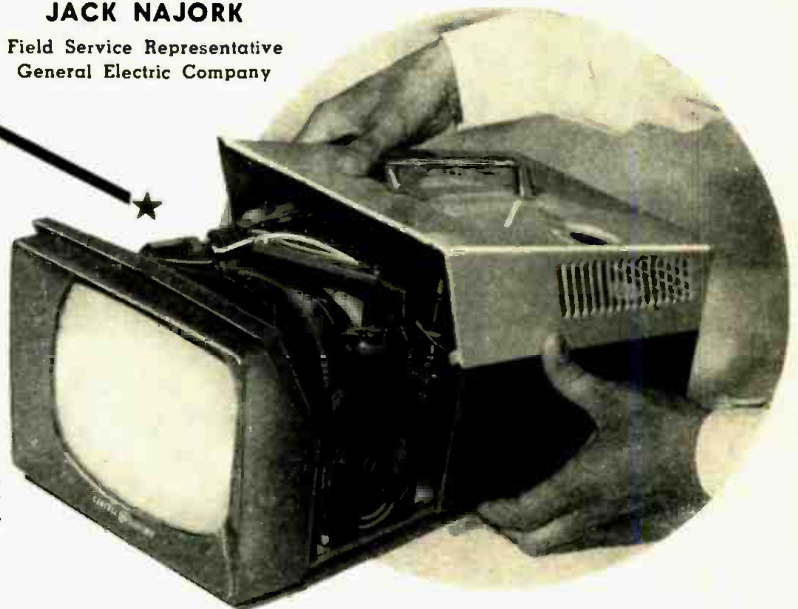

WEIGHING less than 13 pounds and no bigger than a breadbox, *General Electric's* new 9-inch portable TV receiver (models 9T001, 9T002) introduces many innovations in design, manufacture, and serviceability. A new, lightweight, rectangular picture tube, printed and dip-soldered circuits, aluminum cabinet, miniature components, and wider use of semiconductors contribute to its lightness and compactness.

The prohibitive heat problem which would result with the use of conventional 600-ma. heater tubes has been eliminated by the use of the new 300-ma. types. This step alone reduces heater power consumption and the accompanying heat dissipation problem from approximately 70 watts to 35 watts, and reduces total power consumption of the receiver to 70 watts.

Because the average consumer feels that service charges should be in direct proportion to the initial cost of the equipment, serviceability becomes an important consideration in the design of a low-cost, compact receiver. To this end, the physical layout of the receiver has been arranged to allow easy access to all tubes and major components as well as the new, twist-lock type of a.c. fuse shown in the chassis side-view photograph.

Fig. 1 shows the block diagram of the receiver which employs 12 tubes plus one tube rectifier, one selenium power rectifier, and five semiconductors. Built-in u.h.f. adds a 6AF4 oscillator tube and a mixer diode. The tuner is a conventional 12-position pentode type and this is the only major component that has not been min-

Use of semiconductors and 300-ma. heater tubes makes lighter weight and compact size practical.

iatized for this application. With u.h.f.-equipped receivers, a 13-position v.h.f. tuner is used, together with the added u.h.f. tuner, to provide single-conversion reception.

The two i.f. stages operate at 40 mc. and feed a germanium diode detector which, in turn, drives the pentode section of the 12CT8 video amplifier. The triode section of this tube operates as a sync clipper, with a.g.c. voltage developed in this stage for application to

the i.f. and tuner stages. A 10C8 triode-pentode is used as a vertical oscillator-output stage; this same tube type is also used as a combination first and second audio amplifier. Horizontal circuits consist of a dual selenium a.f.c. phase detector, 7AU7 stabilized horizontal oscillator, 18A5 horizontal output, 17H3 damper, and 1V2 high-voltage rectifier. Audio circuits make use of a 6AU6A 4.5-mc. amplifier and

(Continued on page 160)

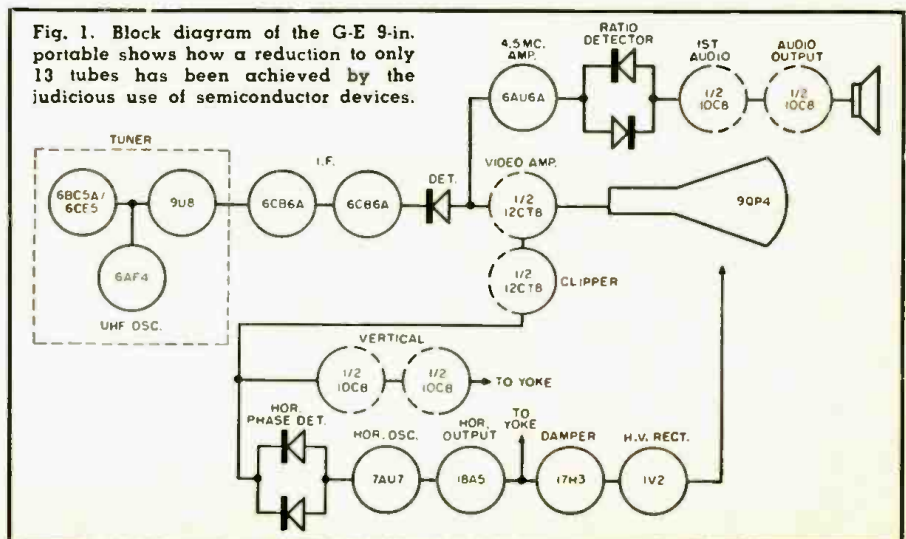

Crystal Photocell Circuits

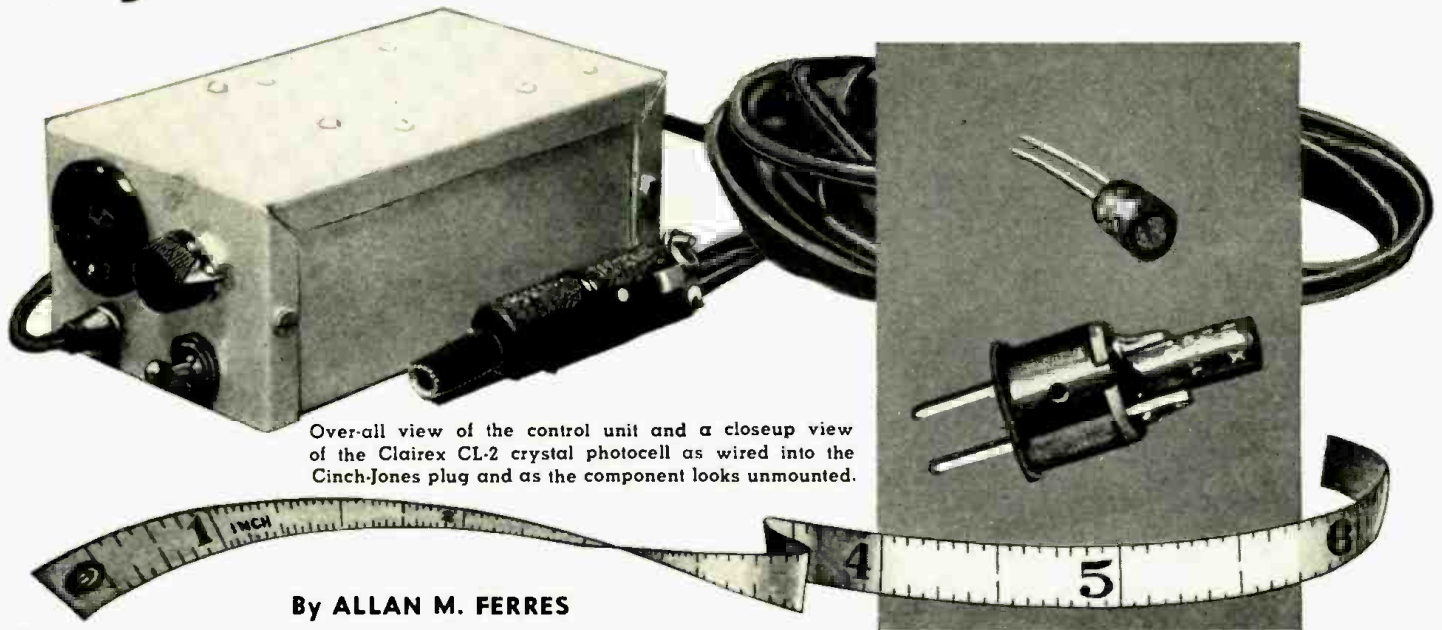

Over-all view of the control unit and a closeup view of the Clairex CL-2 crystal photocell as wired into the Cinch-Jones plug and as the component looks unmounted.

By ALLAN M. FERRES

The development of this tiny, light-sensitive cell makes possible an interesting variety of compact control units.

THE photoelectric cell is a most interesting subject for the electronic experimenter. When connected to relays, the number of uses to which it can be put is limited only by the ingenuity of the experimenter. It can be used for such diverse applications as announcing a patient in a doctor's waiting room, turning on house lights and advertising signs at dusk, automatically opening and closing doors, warning householders of intruders, preventing shoplifting, etc. The list seems almost endless, but may now be even further extended with the development of the crystal photocell.

This tiny cell has several advantages over the high vacuum and gas-filled tubes usually employed in photoelectric relay circuits. Its characteristics are such that light-controlled relays may now be used in applications which are impractical with the conventional photoelectric tubes.

The crystal photocell is a very small device about the size of a lead pencil eraser, $\frac{1}{4}$ " in diameter and $\frac{1}{2}$ " long. The light sensitive element is a pure cadmium sulphide crystal which responds to light over the entire visible spectrum. The crystal is a semiconductor, its resistance decreasing with an increase in light intensity. Its electrical characteristics are such that it may be operated at a considerable distance from the associated amplifier and relay. This factor and its small size make it ideal where concealment of the device is desirable, or where space is limited. The crystal is so

sensitive that operation is practical with normal room illumination when used with a simple amplifier. This eliminates the necessity for using special exciter lamps and optical equipment. In some applications, the relay may be operated directly by the crystal itself. Its low cost and mechanical ruggedness make the crystal photocell an ideal device for light-controlled relay experiments.

This article describes a control unit using a simple, basic photocell amplifier and relay circuit. Four other circuits are also discussed which will be of interest to experimenters.

The basic circuit, shown in Fig. 1A, is sensitive enough to operate at one-tenth of a footcandle of light. A protective resistor, R_1 , the crystal photocell, the Clairex CL-2, and the variable load resistor, R_2 , are connected in series across the 117-volt a.c. line. C_1 , which shunts the load resistor, charges to peak voltage on each cycle to provide a higher striking voltage for the thyatron. The miniature thyatron, its current-limiting resistor, R_3 , and the relay are also connected across the line through the switch S . The relay is a plate-circuit type having a coil resistance of 5000 to 8000 ohms and an operating current of not more than 6 milliamperes and provided with s.p.d.t. contacts. C_2 shunts the relay coil to prevent chattering. The light, bell, or other device to be operated plugs into receptacle SO . As a photocell relay is usually operated continuously, no a.c. "on-off" switch is in-

cluded, but, of course, one may be added if desired, in series with the line cord.

The starter anode of the 5823 thyatron obtains its voltage from the voltage divider made up of R_1 , the crystal cell, and R_2 . When the cell is dark, its resistance is high and the starter anode voltage is too low to allow the thyatron to draw plate current. When light strikes the cell, its resistance drops, increasing the voltage across R_2 , and the tube conducts. With the switch on, the relay contacts are wired so that the line voltage is connected to the output receptacle only during the interval of time when the light on the cell is interrupted. When the switch is off, a momentary interruption of the light will remove the plate voltage from the thyatron and power will be furnished to the receptacle continuously, even though the light to the cell is restored. This locking type of operation is desirable when the device is used to sound an intruder alarm bell.

As shown in the photographs, the necessary parts can be easily mounted in a 2" x 3" x 5" case. No ventilation of the case is needed as the power dissipated in the unit is less than one watt. The placement of the parts is not at all critical, so any convenient arrangement may be used. Socket terminals 2, 5, and 6 of the 5823 should not be used as tie points as these pins are used for internal connections in the tube. The crystal photocell is wired into a Cinch-Jones type P-302-FHT plug. A matching receptacle is mounted on the case, so that the cell can be either attached to the case or used at a distance of 20 feet or so from it by means of an extension cord.

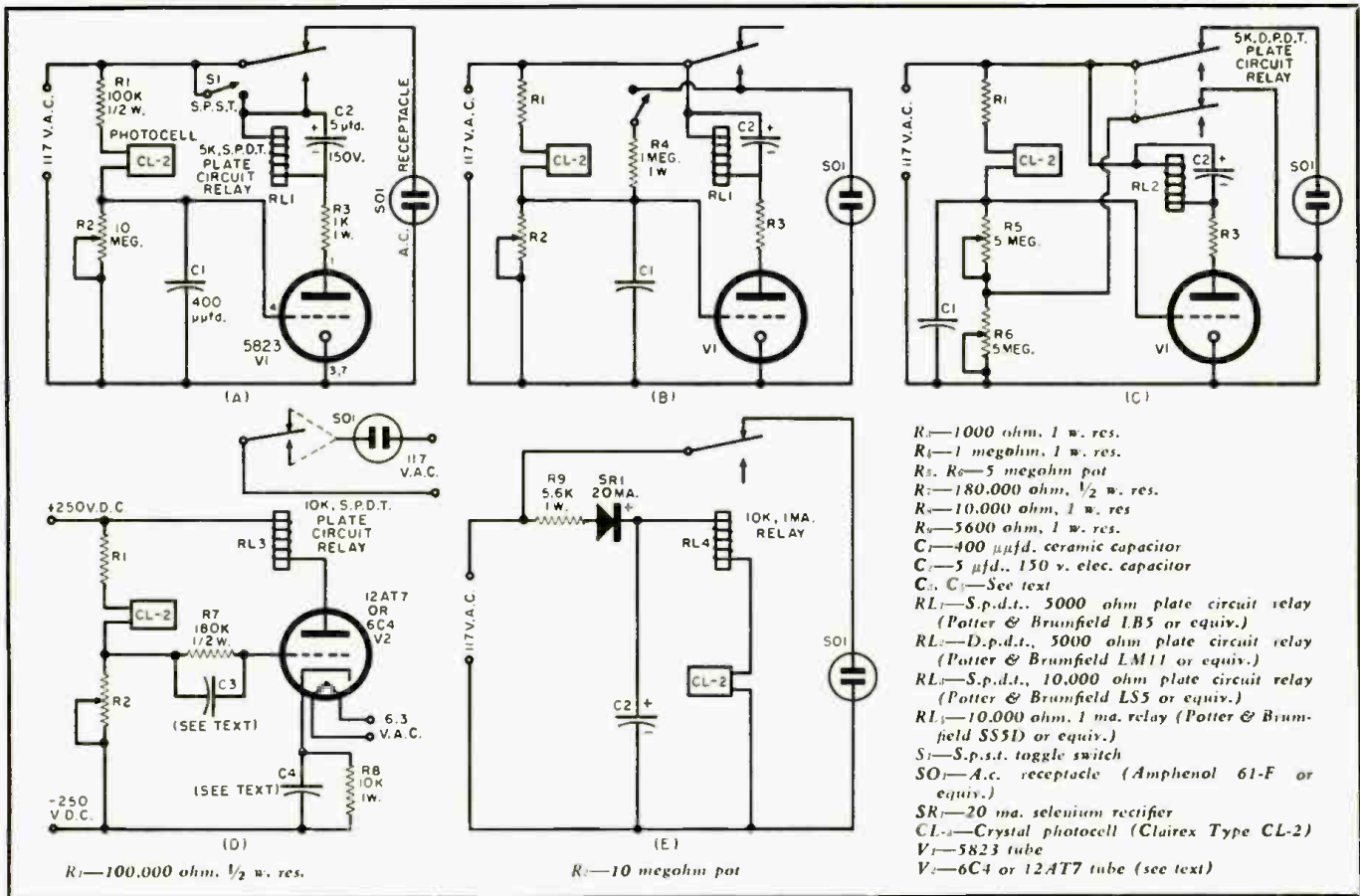

Fig. 1. Five practical circuits using the Clairex CL-2 crystal photocell. (A) Basic circuit which will operate at 1/10th footcandle. (B) Variation of basic circuit in which power is furnished to the output receptacle when light falls on cell. (C) Circuit for operating lighting sequences. (D) Circuit for high speed operation at low illumination levels, and (E) A simple setup to be used as "intrusion" alarm.

Ordinary lamp cord is adequate for this purpose, provided that its insulation is good, as leakage between the conductors will reduce the sensitivity and may cause erratic operation. The cell can be shielded from stray illumination by a short length of cambric tubing.

The unit is put into operation by turning switch *S₁* to "on," plugging the line cord into an a.c. outlet, and pointing the photocell toward a source of light. *R₂* is adjusted so that a steady blue glow appears in the thyratron and the relay pulls in. Cutting off the light to the cell will cause the blue glow in the tube to disappear and the relay will drop out. The adjustment of *R₂* is not critical, except with very low levels of illumination. Line voltage variations will have little effect on the operation of the unit.

Fig. 1B is similar to the basic unit except that power is furnished to the output receptacle when light falls on the cell, instead of when the cell is dark. The switch must be set to "on" for locking operation. The only additional part required is *R₄*, a 1-megohm, 1-watt resistor which is wired to hold the tube in conduction when the relay pulls in. This circuit might be used to open a gate or garage door when the car's headlights illuminate the cell.

Fig. 1C is a good circuit to use to turn on signs or lights at dusk, and to turn them off again at dawn. The cell load resistor is divided into two

parts, and an additional set of relay contacts is used to change the value of the load when the relay drops out. This modification of the circuit is desirable to insure positive operation of the relay at the time of day when the light is slowly fading down to the operating value. *R₅* must be adjusted first so that the relay pulls in, turning off the artificial light at the desired amount of daylight, and then *R₆* is adjusted to turn on the light at dusk. The photocell must be shielded from the artificial light, or the light will blink on and off in a form of oscillation.

The circuit shown in Fig. 1D is useful when high speed operation is required at very low illumination levels. The value of cathode capacitor, *C₁*, depends upon the amount of light available. For .1 footcandle, *C₁* should be 100 μfd. and for 1 footcandle, 10 μfd. is adequate. 150-volt capacitors should be used. If fast recovery from an overload of light is necessary, *R₂* must be shunted by capacitor *C₃*, its value being determined experimentally, under actual operating conditions. The relay pulls in when the cell is exposed to light and drops out when the

(Continued on page 102)

Over-all view of the photocell unit. It is built into a 2" x 3" x 5" case. The placement of parts is non-critical as there is no heating. CL-2 unit is at right.

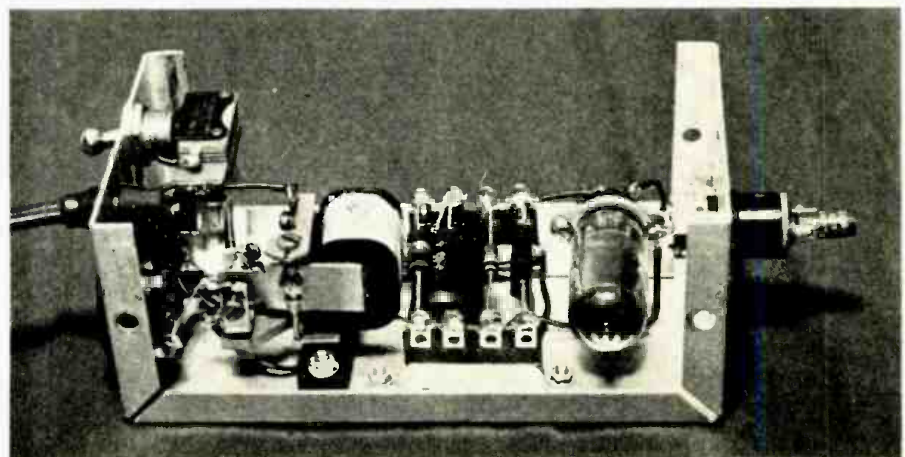

Service Techniques for Modular Circuits

By HAROLD BERNSTEIN

Fig. 1. This sweep circuit module board is used in some Emerson 120306 TV chassis.

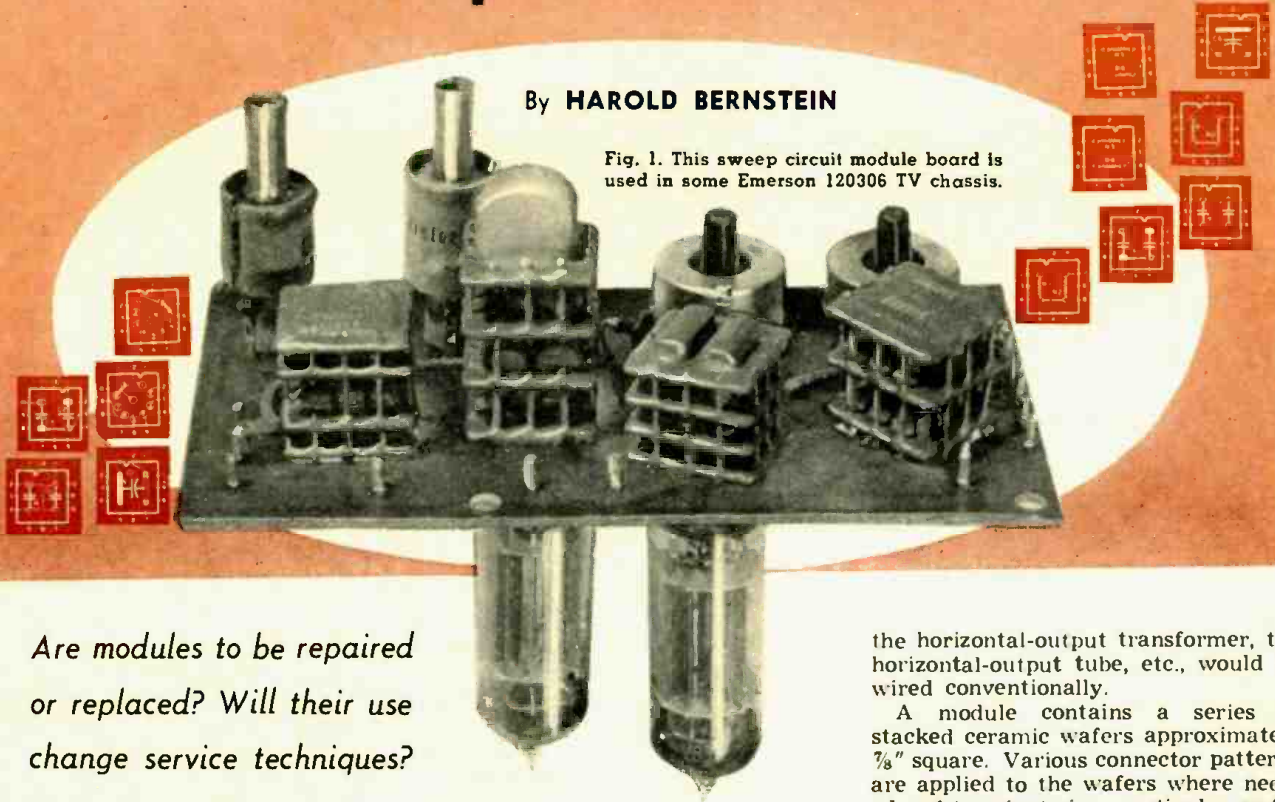

Are modules to be repaired or replaced? Will their use change service techniques?

WITH receivers using modular circuitry well on their way—at least two manufacturers have released sets using modules as of this writing—it is to the advantage of the service technician to become familiar with the practical aspects of this type of circuit. Although the use of modules in home receiver equipment is new, enough information is available concerning these units to enable consideration of their replacement and repair.

Most service technicians have already been exposed to and have acquired some experience in the servicing of TV and radio receivers using etched (printed) circuit wiring. Generally, the use of etched wiring has simplified certain phases of servicing, since many components can be replaced without having to remove the chassis from the cabinet. Circuits using etched wired boards with conventional components usually occupy the same area, if not more, than a conventionally wired chassis using point-to-point wiring. This is primarily due to the fact that components must be placed adjacent to one another and cannot be stacked, as was usually done prior to the use of etched circuit boards. Also, etched wiring paths cannot cross one another unless an electrical connection is to be made.

One way to reduce the size of a given etched circuit board would be to cut it in several sections and place one section on top of the other with the

necessary connecting wires and spacers added. A module, as shown in Fig. 1, in effect does just this and, therefore, the use of modules will permit more compact design of both radio and TV receivers. Fig. 2 shows an exploded isometric view of two of the decks of a module used in conjunction with a 6CG7 horizontal control and oscillator tube. With the exception of the horizontal frequency and phase coils, all other components associated with this circuit are contained in this one module.

Construction of a Module

Modules can contain a tube socket plus a wide assortment of components. Furthermore, a module usually contains only those components associated with a particular circuit. It is this design factor which will make servicing of modular receivers simple, in many respects, as compared to conventional or etched wired receivers. An exception to this would be the use of a multi-section tube where each tube section has a different circuit application. The module associated with this type of tube would, therefore, contain components in more than one circuit.

Modules will also be made without a tube socket and can also contain components which are only a part of a given circuit. An example of such an application would be a module containing only those components in the grid circuit of a horizontal output tube. The screen-dropping resistor,

the horizontal-output transformer, the horizontal-output tube, etc., would be wired conventionally.

A module contains a series of stacked ceramic wafers approximately $\frac{7}{8}$ " square. Various connector patterns are applied to the wafers where needed and terminate in a particular wafer notch. Specially designed components are then fastened or printed in place, depending upon the size and type of the component.

When all of the components are in place, the wafers are stacked in their proper order and the 12 riser wires are added. These riser wires not only serve as mechanical supports, but as electrical connectors as well. Each component will be connected between two or more riser wires; that is, no junction will be made between components unless this junction is also connected to some riser wire as well. This factor is important, as will be shown later, and greatly simplifies the repair of modules. After all of the wafers and risers are fastened in place, the complete unit is coated with an opaque resin and baked. All of these construction steps are performed by automatic machines, which also electrically test the module. Each ceramic wafer contains a locating notch between riser wires 12 and 1.

The etched circuit boards will probably also have some form of locating point, such as an etched dot or a small hole. In the event the locating notch is not clearly visible on the deck closest to the etched board, examine the other decks since some of the opaque resin coating may have partially filled up one or more of the locating notches. Looking at the dip soldered side of the etched board (top of tube socket, if used), risers are counted in a counter-clockwise direc-

tion starting just to the right of the locating notch.

Approximately 13 modules could make up a complete TV receiver. The tuner and the low- and high-voltage power supplies would be wired conventionally. *Emerson Radio & Phonograph Corporation* has developed a completely modularized TV receiver but presently plans releasing it (Chassis 120306) using only one modular etched circuit board. This board (shown in Fig. 1), using four modules, will contain the vertical and horizontal oscillator and sweep circuits as well as the sync phase-inverter circuit. Two of these modules contain a tube socket as well. This chassis (120306) will also be manufactured by *Emerson* using an etched wired sweep board containing conventional individual component parts. Both boards can be used interchangeably and will, therefore, permit accurate comparisons as to cost, production ease, serviceability, etc.

Troubleshooting and Repair

As already pointed out, an individual module will usually contain those components which are part of a specific circuit. The methods used by service technicians to isolate the receiver defect to a given tube or tubes could readily be extended to include the module or modules. The procedure to use which is not too different, at the outset, from conventional techniques, would be as follows:

1. By eye and ear, check picture and sound to determine which stage or stages might be causing difficulty. A good knowledge of the receiver's signal path (block diagram) will help.

2. Replace the suspected tube or tubes.

3. If trouble is not due to a faulty tube, quickly check the low-voltage power supply or any other suspected conventionally wired section by means of a voltmeter. If trouble still persists, replace the suspected module. These will usually be located near, if not actually house, the suspected tubes. If more than one module is suspected, it would be a good idea to narrow the trouble down to one module by voltmeter, scope, signal injection, etc.

In all probability, manufacturers using modules in their TV sets will extend their tube troubleshooting charts to include modules. This should greatly reduce the amount of labor usually connected with the more complicated shop repairs. You will undoubtedly recall examples of repairs which took many hours of your time only to end up with the replacement of an inexpensive resistor or capacitor. Trying to account for this labor on your customer's repair bill is also a problem since most people are not familiar with the difficulty of certain types of repairs.

The use of modules should, in the long run, materially reduce the average repair time per set. This should permit an increase in work output which, together with the higher list price of a module (as compared to a

single component), should result in more equitable servicing profits. Also, due to the higher list price of a module, the total repair charges to the customer, in general, will not appear to be so overweighted by labor charges, misleading as that appearance can be.

Replacing a TV Module

Generally speaking, components used in TV receivers are larger than those used in radios with the exception of i.f. coils and transformers, which are approximately the same size. When a tube socket is a part of the module or when a large component is mounted to the deck closest to the etched board, it is necessary for the etched wiring board to have a square cut-out to permit the tube socket or component to fit through and allow the module to be flush with the top of the etched circuit board. Where a socket or large component is not a part of the bottom deck (A), individual holes may be used for each riser rather than a large square cut-out. This type of mounting method will be found mostly in radios, and the removal of same will be described later.

Where a square cut-out is used on an etched board, it is necessary to bend each of the riser wires over to make contact with the etched wiring. This is usually accomplished by a special tool which bends all of the riser wires at the same time. The complete etched wiring board is then dipped in a solder pot where all connections are soldered simultaneously. To remove such a module for replacement purposes, the following procedure is recommended:

1. Insert the small sharp tip of a low-wattage soldering iron (approximately 35 watts) under a riser wire and pry riser upward as solder melts. Repeat for all riser wires of module to be removed.

2. Make sure all the riser wires are bent so as to fall within the etched wiring board cut-out.

3. Note the position of the locating notch in the module wafers with respect to the etched board before removing the module from the board.

Fig. 2. Exploded view of two adjacent decks shows construction detail of module. Risers are joined in actual use.

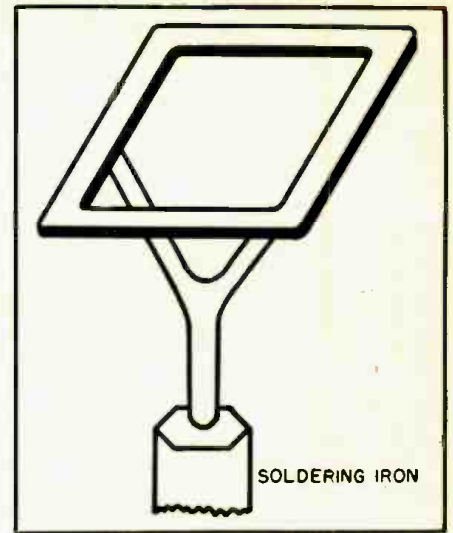
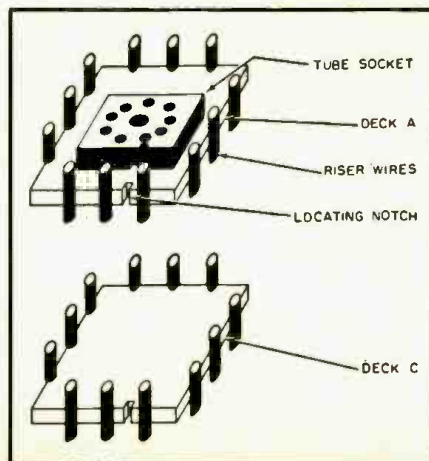

Fig. 3. Specially designed soldering tip for unsoldering all twelve risers of the modular unit at the same time.

(This is usually next to some type of locating mark on the etched circuit board.)

4. Replace new module in board, making certain the module locating notch is in the proper position.

5. Bend risers over etched wiring and individually solder each riser by means of a low-wattage iron. Make certain all solder splashes are removed to prevent possibility of short.

If reasonable care is exercised in removing the suspected module, no damage should result. In the event, therefore, that the replacement module does not repair the trouble, the riser wires of the original could be straightened out and the module used over again as a replacement.

Radio Module Technique

Since a radio has few stages and components as compared to a TV receiver, the use of modules will not appreciably simplify radio service as in the case of TV. You will probably find that two small modules can replace all of the individual components in a radio receiver with the exception of controls, electrolytics, filter resistor, large coils, and transformers. Since it is not practical to use a separate module for each circuit in a radio receiver, you will generally find that all resistors and capacitors which are a part of the r.f. and i.f. stages of the radio will be in one module, while all components (except those just mentioned) in the audio circuit of the receiver will probably be part of another module.

Since the majority of radio failures are due to tubes and components which are not included in modules (electrolytics, tubes, oscillator coils, volume controls, etc.), the type of service will generally be the same as for a conventional radio.

If the trouble is traced to a component in one of the modules and it is decided to replace the complete module, the following procedure should be followed:

1. Remove defective module by dip-

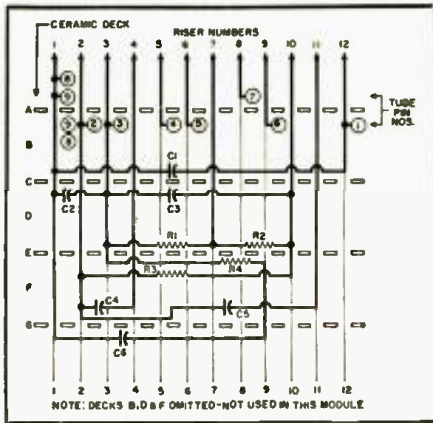

Fig. 4. A wiring schematic is most useful for troubleshooting. Other renderings of the module are in Figs. 5 and 6.

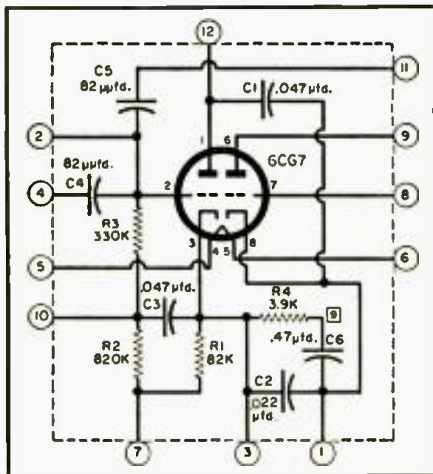

Fig. 5. Schematic diagram of the tube and modular stage rendered in other ways in Figs. 4 and 6. Numbers in circles refer to riser wires to which the indicated points connect. Where a riser number is shown in a square, it indicates that the riser has been clipped at some point inside the module itself, and the point indicated is therefore not available for testing at the dip-soldered side of the set's etched-circuit board.

ping underside in a small solder pot or apply a solder iron with a hollow square-shaped tip (this type of tip, shown in Fig. 3, will probably be made available soon) to all of the risers at the same time.

2. While the heat is being applied to all of the risers by one of the above methods, pull the defective module away from the etched circuit board.

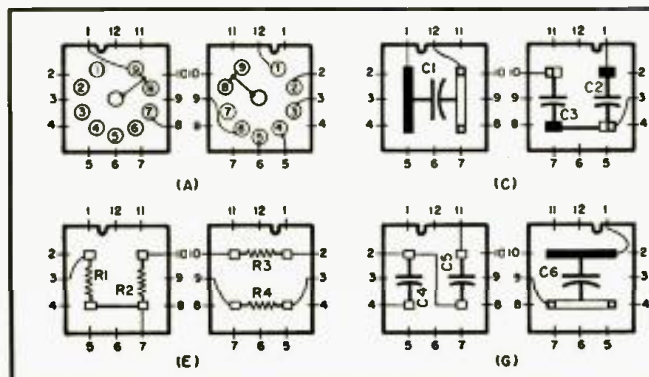

Fig. 6. Deck-by-deck construction details of the horizontal-oscillator and a.f.c. module, also shown in Figs. 4 and 5. This type of diagram cannot be used as readily for servicing as the one shown in Fig. 4, but may be useful in drawing up the equivalent of the Fig. 4 schematic.

(Note the location of the module-positioning notch with respect to the etched board. This is usually next to some type of locating mark on the etched circuit board.)

3. Place a new module in the etched board, making certain to position it as the original, and individually solder each riser in place. A low-wattage iron should be used for this purpose to prevent the possibility of damage to the etched wiring.

Repairing Modules

As already pointed out, the use of modules will speed up certain types of receiver repairs, especially if trouble exists in a feedback circuit (horizontal a.f.c.) or is of an intermittent nature. By replacing the complete module in a given circuit, all components in that circuit are changed at the same time. There will be times, however, when the exact replacement module is not immediately available, and it might be more advisable actually to repair the module.

During the process of troubleshooting the receiver, you might also trace the source of difficulty to a single component just as easily as to a specific module. With this condition, it would be more economical to repair the module.

The first step in repairing a defective module is to determine which component in the module requires replacement. This can usually be accomplished by standard service procedures. The easiest components to check are those which would materially change a voltage, resistance, or waveshape reading at a tube pin if defective. Open plate supply resistors, shorted bypass capacitors, open shunt video peaking coils, open coupling capacitors, etc., are good examples of easy-to-locate components.

To check a capacitor which has other components shunted across it presents a more difficult problem. Either a special type of capacity checker which can check capacitors in the circuit must be used or one side of the capacitor must be temporarily disconnected from the circuit. To do this in a module, however, is more difficult than in a conventional chassis and would require the cutting of one or more risers. If the capacitor checks good, the cut risers would have to be repaired, and another component

checked. Since this type of repair is very time-consuming, it should only be attempted in the event that a replacement module is not available.

After the defective component is isolated by voltage, resistance, or waveshape measurements at tube pins, you will then have to physically locate the module and the exact wafer to which the component in question is connected. The schematic diagram will indicate the module and risers to which the component is connected but will not show the ceramic wafer (deck A, B, etc.) to which the component is attached. Before proceeding with the repair, it is necessary to know how many other components are connected to the same risers. This is easily accomplished by referring to a module drawing, as shown in Fig. 4.

In the event such a diagram is not available, one can be prepared if a drawing, such as the one shown in Fig. 6, is provided. Fig. 4 is much easier to work with since it clearly shows the easiest method of repairing a module. When converting Fig. 6 to Fig. 4, it will also be necessary physically to look at the module and indicate in Fig. 4 the exact position of all cut risers.

Fig. 5 is a conventional schematic of the circuit built into the module. It is not as useful in troubleshooting as the wiring schematic, Fig. 4.

Before going into the actual repair procedure, we should like to point out several facts about the module diagram shown in Fig. 4. The arrows indicate the points at which the module is wired into the etched board. The components are shown attached not only to their proper risers, but to the proper ceramic wafer (deck). Note that no components are on decks B, D, or F. Components that may appear to be located on these in Fig. 4 are actually on the topsides of the decks below or on the undersides of the decks above. Not all of the risers are electrically used and some of them are used between only a few of the ceramic decks. It is generally easier to repair a component which is located on the wafer farthest from the etched board. The most difficult ones are generally located on the wafer closest to the etched board (deck A).

If a circuit analysis indicates that R_1 is open, the module could be repaired simply by soldering a new resistor between risers 3 and 7. This is most conveniently done on the dip-soldered side of the etched board. If R_1 were shorted, however, it would first be necessary to remove it from the circuit. Before doing this, Fig. 4 should be carefully studied to determine if such a repair is practical and, if so, the simplest way to handle it. If riser 3 were cut between decks C and E, it would also remove R_1 from the circuit. If it were cut between decks A and C, it would remove C_2 , C_3 , and R_1 from the circuit as well. If riser 7 were cut between decks C and E, it would eliminate only R_1 .

(Continued on page 162)

Atomichron— World's Most Accurate Clock

THE ATOMICHRON, a multi-purpose frequency producing instrument, was unveiled recently by National Co., Inc., of Malden, Mass. The most accurate clock in the world, the Atomichron is the first atomic beam clock available for commercial use. By maintaining synchronism with the natural resonant frequency of the cesium atom, the device is the most accurate primary frequency standard in the world, it was said.

The extreme stability will permit: increased speed and volume of long distance telephone communications in higher frequencies of the spectrum; greater volume of industrial communications; extension of power and pipe line control systems; and increased accuracy in electronic navigational equipment. In the high frequency spectrum, the Atomichron will permit the use of radio receivers and transmitting equipment of unprecedented narrow bandwidths and precise frequency control, eliminating crowded air waves often resulting in one station or channel interfering with another. In the area of navigation, the device is being used by the Air Force in its experimental long-range "Navarho" navigation system.

How It Works

Electrons, and most sub-atomic particles, act in many respects like tiny bar magnets. The outer electron in an atom, like cesium, finds itself in the magnetic field of the nuclear magnet and tends to align itself just like a compass needle. If the electron is disturbed, it will vibrate about its position like the needle. Frequency of the vibration of the analogous compass needle is determined by the magnet strength of the needle, the field in which it is located, its weight, and shape. Corresponding quantities for the electron are fixed, unchanging, and identical for all electrons and cesium nuclei. It is the quality of not changing which makes the vibration frequency a primary standard and the Atomichron constantly corrects an auxiliary vacuum-tube oscillator to operate at the frequency of this electron resonance. (See diagram at right.)

A reservoir of cesium atoms is placed at one end of a long, evacuated chamber. As heat is applied, individual cesium atoms drift away from the pool. In the diagram, two cesium atoms of different orientations of nucleus and electron are considered to be given off and to begin drifting through the atomic beam tube, where they come under the influence of two permanent magnets and an r.f. field. The orientation of nucleus and elec-



Dr. J. R. Zacharias (left), a key figure in development of the Atomichron, H. C. Guterman (center), and J. H. Quick (right), chairman and president of National Company, view the atomic beam tube.

Front view of the Atomichron, which stands 7 feet high and weighs about 500 pounds. Unit costs \$50,000.

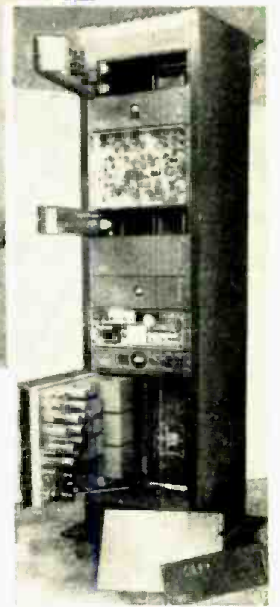

First practical atomic primary frequency standard with stability better than 0.5 second in 300 years.

tron in atom #2 is such that it is attracted to the strong pole of the first magnet, and deflected away from the r.f. chamber. Atom #1 exists in an energy state which causes it to be deflected away from the magnet and toward the r.f. chamber.

When the r.f. field is near the cesium resonance frequency, atom #1 will probably emit a photon and change its energy state to the configuration of atom #2. If the r.f. field is not near

cesium resonance, the atom will probably remain at its original energy level.

As the atom passes through the second magnetic field, and if its energy state is unchanged, it is deflected away from the strong pole of the second magnet. If it has changed its energy state in the r.f. field, it is deflected toward the strong pole. In this case, however, deflection toward the strong

(Continued on page 120)

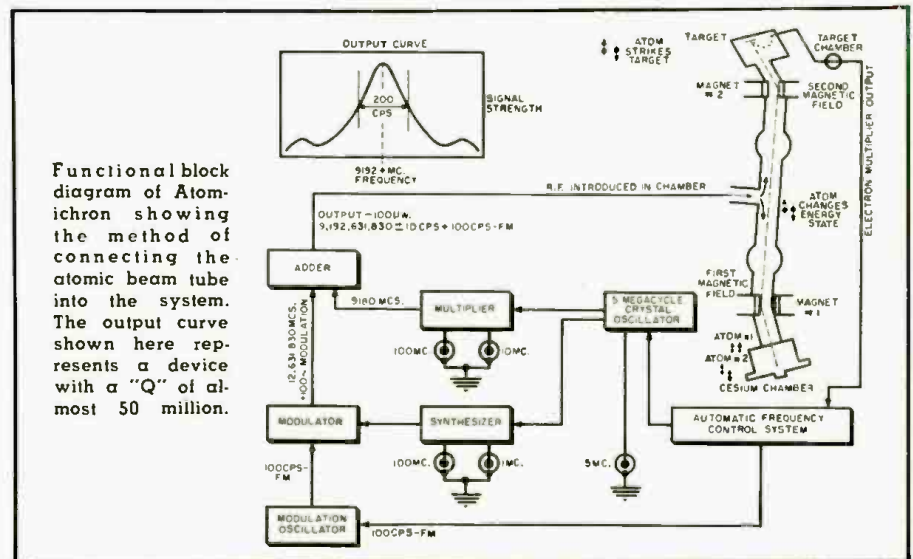

Realistic High Fidelity

The Power

that drives the Speaker

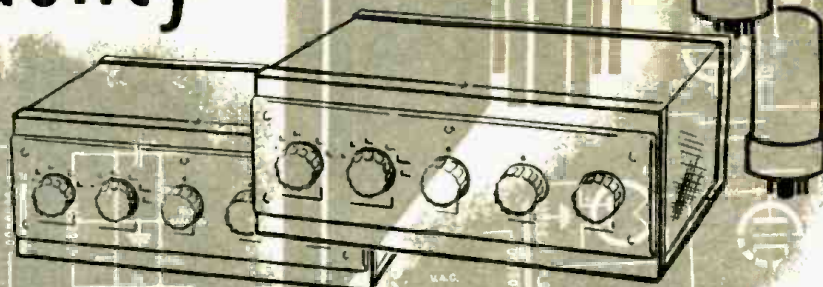

By
H. A. HARTLEY
Audio Consultant

Part 9. Output stage characteristics — including power requirements and loudspeaker matching.

THOSE parts of this series dealing with speakers could justly be deemed controversial. There are several ways of designing near-perfect speakers and there are several ways of judging them. The "end product" is called high fidelity, and whether this results in realism must be a matter of opinion. As no speaker is perfect, the type of distortion present may be acceptable to one listener but not to another, and the musical taste of the designer himself will literally color the reproduction. As your editor pointed out in a note, there are several schools of thought in speaker design, simply because positive and precise measurement of the sound of music is not possible. Moreover, however conscientiously I strove to give an impartial account of the important features of speaker design, I suppose it was inevitable that I should feel that my way was the best way, otherwise I wouldn't have done it that way!

When it comes to considering the power required to drive the speaker there can be (or, perhaps, should be) no argument at all. There should be no conflicting schools of thought. Our requirements can be stated precisely—there must be no distortion in the amplifier output within audible limits, and this can be achieved at reasonable cost. Further, the amplifier performance can be measured with precision, so an absolute and objective standard of performance can not only be postulated but achieved and proved. In addition, I, as a writer, have no financial or business interests in any amplifier extant or projected. All I want is undistorted power for the speakers of

my choice, and I assume that that is what you want too.

I had hoped to give the answer in a single article, and when I wrote this part and read it through I had to tear it up because it did not answer the basic question—what is the best output stage? As a result of much experience I know what I prefer, but when I recalled that in this presumably exact field of amplifier design there is a strong body of opinion in favor of triode output stages and another equally insistent on tetrodes or pentodes,

EDITOR'S NOTE: The author of this article advocates fairly limited output powers. Don't miss the article in this issue by David Hafler, who gives the reasons for the use of higher audio output powers.

something more was needed than just another resumé of the various types of output stages. And the high-fidelity enthusiast must have heard of or tried dozens of different circuits, each of which was supposed to be the last word in perfection. Writing an article on an amplifier is the easiest form of technical journalism; the demand is insatiable, for everybody wants something better, and most amateurs can build an amplifier if they can't build a speaker.

This is my thirtieth year in speaker design. All that time I have wanted better and still better amplifiers; being something of a specialist I have gone through the process, year after year, of hooking up every circuit that has come along, in the belief that others knew more about it than I did. I don't know any more about amplifiers than others, but I have found out where

most of these didn't match up to my requirements, and it is that knowledge I shall try to give you. This article, therefore, will deal with the approach to the problem; the next will constructively criticize the various types of hi-fi output stages so that you can make your own selection.

How Much Output Power?

Any exhibitor at an audio fair knows quite well that if he stages a demonstration with artistic restraint, with a genuine desire to display his equipment as it should be heard in a civilized home, he will lose business. It isn't a case of one exhibitor trying to shout the next man down; it is what draws the crowds that matters. Every show has a large proportion of acoustic rubbernecks, wise guys who don't know much about music, but reckon they know a lot about hi-fi. They dash from one room to another, listen for a minute and off to the next, rather like the traditional Yankee doing a three-day tour of Europe. If nothing very much seems to be happening in room A and room B is raising hell, then the crowd will be in room B, whatever the real quality of reproduction. In due course these people will report to their friends that the company in room A doesn't know how to put on a show. A manufacturer hires a room at an audio show for the sole purpose of selling his equipment, and whether he likes the noise he creates in that room or not, his main interest is the order book. If he gets the orders, he is doing the right thing; if he doesn't, he isn't. And that seems to be all there is to it.

But there is more to it, for this unfortunate state of affairs has preconditioned the audio fan into assuming that hi-fi and hi-volume go hand-in-hand, and that is not only bad for your

neighbor but bad for yourself. If you have never been to a first-class symphony concert, I suggest you go to one. You will get the shock of your life, for the first thing that will strike you is the *fragility* (the only word I think fits the case) of the orchestra. I am assuming you normally run your equipment at a fairly high "realistic" volume, and what you will find is the conductor working quite hard, egging on the instrumentalists to do something grand, and all that comes out is a thin strain of music which, if it is a Mozart or Haydn program, may be so quiet that any noise from the audience will ruin the whole thing. If, however, it is the *Dies Irae* from Berlioz's Requiem, with full orchestra, 16 tympani, 4 brass bands and a choir of 300, then it doesn't matter very much what the audience does; it will be something like Haydn being played at an audio fair. The great "trick" record of the 1952 New York Fair was the fine *Westminster* recording of the Haydn "Military" Symphony (No. 100). Haydn composed far finer symphonies, but could I demonstrate these? No! Over and over again I was asked to put on "The Military and give it all you have. I want to hear that big bass drum." And I had to do it or out they went! Music is more than big bass drums, and that was no way to demonstrate realistic sound reproduction.

If you are a regular concertgoer you are accustomed to the refinement of good music beautifully played and conducted. If you can get the same pleasure from a record of a work you love as you got in the concert hall, you have a good reproducer, and the volume will be adjusted to suit.

The amount of power required to produce that volume depends on the size of the room, the way it is furnished, and the sensitivity of the speaker. As I have explained in an earlier article, a horn-loaded speaker is more efficient than a direct radiator, and the sound output of the latter depends on whether it is enclosed in a housing which projects the sound from the back of the diaphragm or absorbs it. Order of sensitivity is, therefore, horn-loaded, direct radiator in acoustic phase-inverter, direct radiator in infinite baffle or closed box. For these three types of speaker systems the output power required for an average living room of about 2500 cubic feet is about 3, 6, and 11 watts *undistorted peak*. As the smallest high-fidelity amplifier generally available is a 10-watt job, and others are available with claimed undistorted outputs up to 60 watts, there seems to be something wrong with my figures. Which brings us to the situation that there is more in assembling a hi-fi system than buying an amplifier whose looks and price appeal to you and using it to drive the speaker of your choice.

The apparently simple process of connecting a speaker to an output stage by means of an audio transformer is, in reality, an extremely

complicated business indeed. The problem is usually avoided by adopting what might be called technical clichés. Given the optimum load of the output stage, as revealed in the tube catalogues, and the nominal impedance of the speaker, the ratio of primary to secondary turns in the output transformer is obtained from the formula:

$$\text{Ratio} = \sqrt{\frac{\text{Optimum load of output stage}}{\text{Speaker impedance}}}$$

It is common knowledge that a reserve of power will guard against distortion through overload on peaks, and if the amplifier tends to distort, either through poor design or because of the critical load of tetrodes and pentodes, put in some negative feedback which will reduce distortion and lower the plate impedance of the output stage. It seems so easy. Now let us consider what really does happen.

Output Transformer Characteristics

To conform to the foregoing ratio formula it is obvious that the transformation ratio must be constant for all frequencies if the load (*i.e.*, the speaker) has constant impedance. A transformer is an impedance matching device, and the load reflected onto the output tubes is that of the impedance of the secondary circuit multiplied by the turns ratio squared. This is with an ideal transformer, but practical transformers are not ideal. At low frequencies the ratio is less by a factor which includes the plate resistance of the output tubes, the resistance, and inductance of the primary winding. At high frequencies loss of ratio results from leakage inductance (through imperfect coupling between the two windings), self-capacity of the windings (acting as a short circuit at high frequencies). To make things more difficult, the transformer will peak at a high frequency through resonance of a low-"Q" circuit formed by the primary reactance and resistance and the self-capacity of the windings; beyond this peak the response falls rapidly.

The design of audio transformers is a perfectly straightforward matter for a competent technician, but is too complex to be included in this series. The

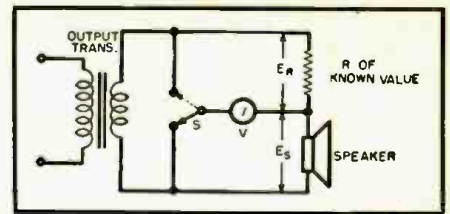

Fig. 34. Hookup for impedance measurement of loudspeaker. See text for details.

reader will probably buy his output transformer from a specialist manufacturer, but the best results will not be obtained by using a so-called universal transformer. As you can see, even a well designed transformer will not have a constant transformation ratio unless the actual output tubes are specified as well as the speaker impedance. A tapped secondary may not have equal coupling for all frequencies, and although the primary inductance may be adequate to give good bass, the actual value of the primary inductance depends not only on the lowest frequency to be reproduced, but the relationship between the optimum load and the a.c. resistance of the output tubes. Different tubes may have the same load resistance yet differ in their plate resistance. This, in turn, determines the damping factor and accounts for the triode-pentode controversy. The a.c. resistance of triodes is about a quarter of the optimum load; tetrodes and pentodes have an a.c. resistance about five times the load resistance. A good deal of the prejudice against the latter is due to the fact that they are not properly used.

Loudspeaker Characteristics

Apart from the acoustic performance of a speaker, it has two properties which are directly associated with the output stage—power-handling capacity and impedance. Advertisements and catalogues frequently state that some particular model is, say, a 15-watt speaker, but this bald statement means nothing beyond an implication that it is suitable for use with a 15-watt amplifier. It may not be.

As far as frequency is concerned,

Fig. 35. Impedance curve of a typical 4 ohm loudspeaker with a bass resonance at 70 cps. Eight and 16 ohm speakers would have proportionate variations of impedance.

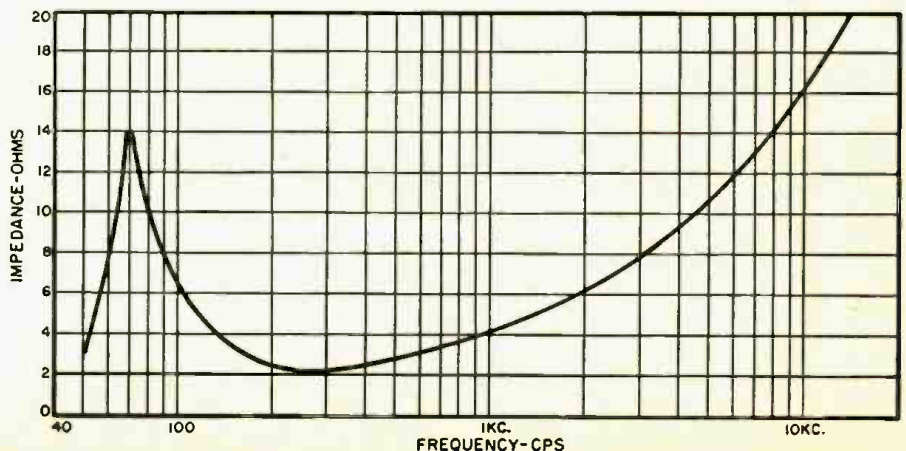

the power-handling capacity of a speaker depends on the flux density in the gap, the freedom of suspension and the size of the cone. Fig. 13 (Part 4) gives some information on this: it indicates that for speakers of 5% efficiency with a free movement of cone and coil of $\frac{1}{4}$ inch (a fairly usual state of affairs) a 5-watt input produces maximum deflection at 30 cps in a 15-inch speaker; at 45 cps in a 10-inch speaker; and at 80 cps in a 5-inch speaker. Any greater power can only result in gross distortion and mechanical damage. It follows that the application of any power greater than 5 watts is restricted to those frequencies higher than those just listed at which the cone movement does not exceed $\frac{1}{4}$ inch. In any case, the lower limit of non-distorted reproduction is the bass resonant frequency, for below that the output is mainly third harmonic. A speaker has, therefore, virtually no power-handling capacity below bass resonant frequency, and above that is limited by the cone size—free movement factor. (Certain types of enclosures can modify the bass response, as described previously in this series, but acoustic output of a speaker and its enclosure should not be confused with the fundamental power-handling capacity of the speaker itself.)

At higher frequencies, where cone movement is of no consequence, the limiting factor is dissipation of heat generated in the voice coil. If watts go into the coil, the inductive component is wattless, but the resistive component must create heat, and if the temperature rise is too great the coil assembly will be destroyed. Some readers may have had the unhappy experience of burning out a speaker when no signal was fed into the amplifier, simply because there was enough supersonic oscillation in the output stage to do the damage. It has happened to me. At middle and high frequencies, therefore, the power-handling capacity of the speaker is a function of the actual size of the voice coil and the heat radiating abilities of the adjacent metal parts.

Finally is the question—what is the

impedance of the speaker? It is not the figure quoted by the manufacturer, for it varies widely with frequency. Quoted speaker impedances follow on from an old rule-of-thumb concept that the impedance of a speaker is approximately twice the d.c. resistance of the voice coil. For design purposes in cheap equipment this is near enough not to matter, but it is not near enough for the best results. The speaker manufacturers quote as usual impedances 4, 8, and 16 ohms, and the output transformer manufacturers obligingly tap their secondaries at these figures.

There are dozens of versions of the so-called "equivalent loudspeaker circuit," which consist of more or less complicated networks of resistance, inductance, and capacitance; the variations derive from different opinions of how the various parts of a speaker's construction and behavior shall be interpreted in terms of inductance and capacitance. Pure resistance does not vary with frequency but the inductive and capacitive reactances do, so the impedance of the speaker must vary with frequency. In general, there is a sharp rise in impedance at bass resonant frequency, then the normally quoted impedance at about 500 to 1000 cps; after this the impedance rises at an increasing rate owing to the inductance of the voice coil. How, then, if you cannot get a guaranteed impedance curve from the maker of your speaker, can you determine its impedance? The simple answer is to measure it, and this is almost obligatory in the case of multi-channel systems with dividing networks, for a very complicated total network is involved.

Fig. 34 shows the output transformer of an amplifier which is fed from an audio oscillator. Across the secondary a known resistance R and the speaker under test are connected in series. An a.c. peak voltmeter can be connected across either R or the speaker. R must be either a noninductive wirewound resistor or a bank of composition resistors of a wattage as high as the audio power from the amplifier. If R were not used, the speak-

er might be burned out with steady high inputs. Signals of various frequencies are injected into the amplifier and readings at each frequency taken across R and then across the speaker. Call the voltages across these E_R and E_S respectively, then:

$$\text{Impedance of speaker} = \frac{R \times E_S}{E_R}$$

It is important to take a careful reading exactly on the bass resonant frequency, indicated by a sharp rise in the voltage reading across the speaker. When all the readings are taken, a curve is drawn, which will look like Fig. 35, which is a curve of a typical 4-ohm speaker with a bass resonance at 70 cps.

If the output transformer has been chosen to give the optimum load with a secondary impedance of 4 ohms, then there will be serious mismatching at the bass resonant frequency and in the extreme treble. It has been my experience that, since all frequencies are equally important, such a speaker should be considered to have an average impedance of 8 ohms. You will notice that the rise in impedance is much greater in the extreme treble than at the bass resonant frequency. This has an effect on the reproduction when the speaker is coupled up for its nominal impedance.

If you study the figures for triodes and tetrodes or pentodes in the tube manuals, you will see that the latter give more power and less distortion than triodes for a given plate supply, but this is only when the load is reasonably correct. The optimum load gives the optimum power without distortion, but if that amount of output power is required and the load is wrong, distortion is excessive. Triodes are not as critical as to optimum load, and unless the amplifier is driven hard, the distortion from this mismatching will not be enough to worry about. As it is seemingly impossible to produce a speaker with constant impedance, a speaker assessed at its nominal impedance will give less distortion in the extreme highs with triodes than with pentodes when the amplifier is driven hard; hence the term "pentode quality." But as you can now see, this is not due to pentodes as pentodes but because the wrong load is applied to them at high frequencies. There are ways of getting over this difficulty, as I shall explain in the next article; for the moment, my suggestion of doubling the nominal impedance will give much better general quality.

Negative Feedback

There is a good deal of misapprehension as to what negative feedback can do. In later articles the practical application will be discussed in a technical way; for the moment I shall summarize what it can do and what it cannot do in terms of the performance of a typical audio power amplifier.

Negative feedback reduces the gain of an amplifier. The "feedback factor"

(Continued on page 148)

Fig. 36. The ideal curve of a multi-stage amplifier to give a level response from 50 to 15,000 cps with 30 db of negative feedback and a safety margin of 10 db (to guard against instability following heavy transients) is shown by the solid line below. The dashed line shows the response of a well designed amplifier without step circuits. The step circuits for the desired bass and treble attenuation are shown below their respective portions of the frequency spectrum. These are seen to consist of the networks designated "R" and "C" in the pentode amplifiers.

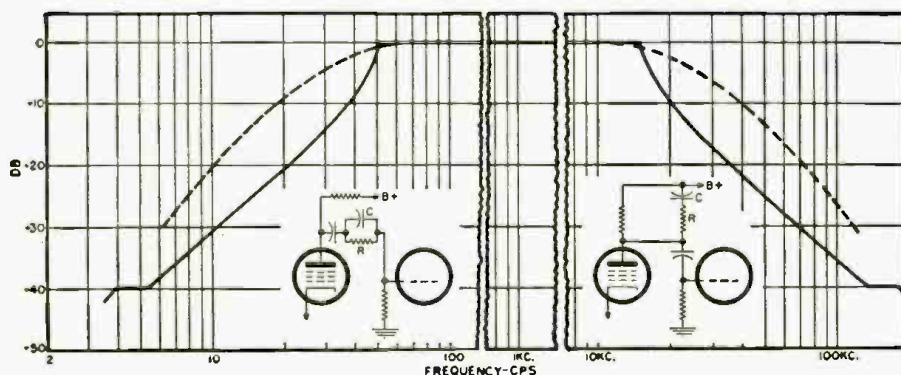

By **DONN G. SHANKLAND**

Front panel and internal views of an inexpensive vacuum-tube electrometer.

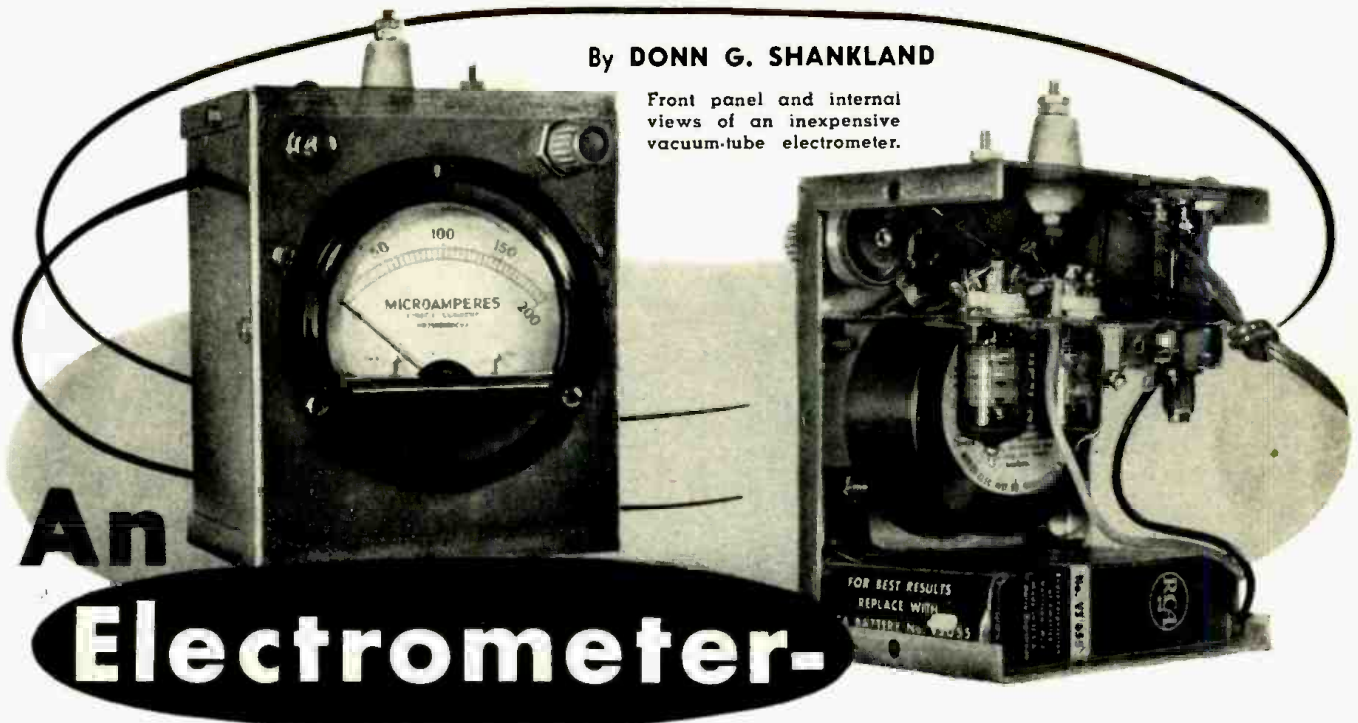

An Electrometer— A Very High Input Resistance V.T.V.M.

Inexpensive, easily built servicing instrument has input resistance of about 100,000 megohms for high Z circuits.

HAVE you ever tried to measure the voltage drop across a 10-megohm resistor? As you know, a multimeter is a virtual short across such resistors on the low voltage ranges, and even a vacuum-tube voltmeter, with its 11-megohm input resistance, will draw enough current to change the voltage being measured. How, then, can one measure such voltages as grid bias in a superregenerative detector, automatic volume control voltages, and some screen voltages?

The answer lies in the use of an "electrometer," a device of extremely high input resistance. Such units are normally quite expensive, but this article will describe such a unit which can be built by anyone familiar with a drill, file, and soldering iron.

The instrument is basically a simple triode amplifier connected as a cathode follower, with a conventional voltmeter reading the cathode voltage. See Fig. 1. Such a connection has a very high resistance, as the grid is normally held negative with respect to the cathode by virtue of the cathode-follower action, so the only load the input circuit sees is that due to the grid current of the tube. Most tubes have a grid current of about .01 μ a. although specially designed tubes can be operated at even lower grid currents. For this instrument, a 6AK5 was chosen, as its grid current is about 10^{-4} μ a. and the tube is easily available. A better tube would be the 959 acorn tube, but it is more expensive new, and sur-

plus ones are not always available. Two defects of the circuit shown, however, are that the voltmeter will indicate the tube bias even if the grid is at zero voltage, and the voltage read will vary considerably with changing supply voltage and different tubes.

To overcome these defects, a balanced circuit is actually used. In this, the voltage difference between the cathodes of two similar tubes is measured. See Fig. 2. With the grid of the left-hand tube grounded, the voltmeter reads zero, as the two cathodes should be at the same potential. When a voltage is applied to the input, the voltmeter reads this as a change in the cathode voltage. An analysis of the circuit shows that the voltage across the cathodes in this case is $E_{cathode} = 1/(1 + 1/\mu) E_{input}$ and so, since μ (the amplification factor of the tube) is quite large and does not vary greatly, the voltage indicated is the true voltage. The small correction for the $1/\mu$ term is achieved in this instrument with a calibrating resistor. Also, if the power supply voltage changes, the cathode voltages change together, cancelling a large part of the possible error. The resistor, R_z , is a zero-set resistor to correct for small differences in tubes and the cathode resistors, R_K .

The construction of the device proceeds in three stages: mechanical, wiring, and calibration. The unit was built in a Bud "Minibox" measuring 3" x 4" x 5" with a hole cut to fit the meter used (0-200 μ a.). A chassis was

built of copper sheet and the tube sockets were mounted and partially wired. A 45-volt battery, RCA VS-055, just fits in the space below the meter and is held with copper clips. The filament transformer and switch were mounted at the top of the case as shown in the photographs.

A porcelain feedthrough insulator was used for the grid connection of V_1 (Fig. 3). Care must be taken that nothing touches this lead and that the insulator is clean as leakage resistance here could affect the operation of the device. Steatite sockets must be used
(Continued on page 114)

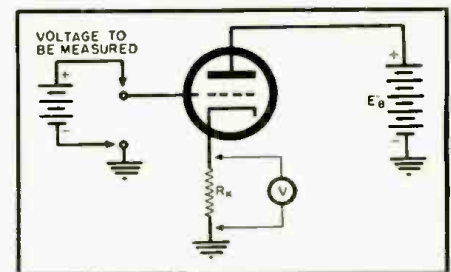
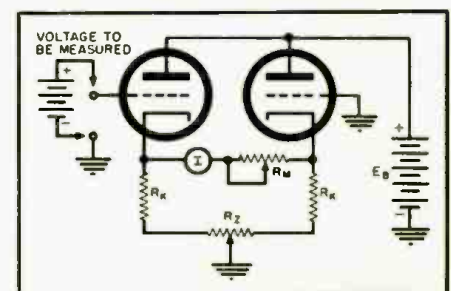

Fig. 1. The basic electrometer circuit.

Fig. 2. Addition of balancing circuit.



Low-Cost Scanning Generator

By LARRY DORST



The completed saw-tooth substitution box makes a compact unit for the bench.

Substitute vertical or horizontal saw-tooth pulses to deflect TV sets are supplied by junk-box unit.

A SCANNING generator that will put out a saw-tooth waveform with enough amplitude to drive a horizontal amplifier should find its place on the workbench of the busy television technician.

As a general rule, quite a bit of the trouble experienced in television servicing originates in the vertical or horizontal sweep circuits. If some method of direct substitution similar to that used in checking the oscillator tubes themselves could be employed, it seems this would be the answer. Not only is substitution generally conclusive, but it is also time-saving. With a scanning generator, this type of substitution could be accomplished and a large number of tedious tests could be eliminated.

The fact that a generator of this type can be built from parts found around the shop makes it a worthwhile project for anyone who wishes to make a quick check of the horizontal and vertical oscillator circuits of almost any television set.

The instrument to be described was tried on virtually every known make of television set and it was found that there was sufficient drive to the grid of either vertical or horizontal amplifier stages.

The peak-to-peak output voltage of the instrument was of sufficient amplitude to drive the grids of the vertical or horizontal amplifier circuits of the set under test by injecting the saw-tooth signals into the preceding coupling circuits. This approach to the problems of no high voltage or of lack

or deterioration of vertical sweep will give evidence as to the point at which the trouble may be originating.

How It Works

Primarily, the circuits of both horizontal and vertical stages in the instrument are simple multivibrators of the type found in most television sets. The horizontal oscillator stage, which is a 12AU7, oscillates at a frequency determined by the resistor and capacitor combinations found in the grid, plate, and cathode circuits of the dual triode.

The horizontal generator is V_1 , while V_2 is the vertical saw-tooth output stage. These conventional cathode-coupled multivibrators, as Fig. 1 illustrates, do show some difference from their cousins in TV sets: there is no provision for a pulsed input in either stage to accomplish exact synchronization.

As will be seen shortly, an advantage results from this arrangement. Also, if desired, an optional synchronizing input can be added to the circuit, with jacks brought out to the front panel for connection to sync take-off points in the receiver.

With the selector switch in the horizontal position, the plate voltage is fed from the "B+" supply to the plate resistors of V_1 . The 15,750-cycle saw-tooth output from C_1 goes through the switching circuit to the output terminals on the front panel. One output terminal, J_1 , is at ground potential going through the test lead to the chassis of the set under test. The hot output

terminal, J_2 , can be connected directly through the test lead to the grid of the horizontal amplifier.

The output may also be fed through the coupling circuits, such as the drive control and other components in this portion of the circuit. By connecting the output of the generator to the output plate of the horizontal oscillator tube of the set under test, it is possible to test a large number of these components to see if they will pass the saw-tooth voltage to the grid of the horizontal amplifier.

After the raster has been formed by applying the saw-tooth voltage to the grid of the horizontal amplifier it is now possible to adjust the hold control R_1 . The picture may be brought into a momentary lock-in position. The picture will not stay completely locked in, but will keep framing due to the lack of horizontal sync voltage from the sync separator and phase detector circuits. This is not a disadvantage, due to the fact the hold control on the scanning generator allows one to free-wheel the picture and view the sync information.

The principle of the vertical multivibrator circuit is primarily the same as the circuit of the horizontal oscillator stage, the only difference being in the size of the components used to change the operating frequency of the circuit.

Once again the operation procedure is very similar to the horizontal check. This time the vertical position is set on the selector dial and a vertical saw-tooth now exists at the output terminals.

The hot lead from the output terminal goes to the grid of the vertical amplifier, or through the coupling networks, and a raster is formed on the

television screen. The vertical hold control of the generator now controls the circuit and the picture can be locked in near its framing frequency.

The power supply is a conventional full-wave rectifier type and it is highly recommended that the plate voltage to the oscillators be kept quite close to 320 to 340 volts d.c. Any large change may upset the oscillator stages so they will not lock in at the proper frequency.

If desired, either horizontal or vertical oscillators of the scanning generator may be locked in so that the picture can be viewed without free wheeling the hold controls. It is possible to feed horizontal sync from the phase detector of the set under test, or feed vertical sync from the integrator circuit of the set under test.

Input terminals can be mounted on the front panel to accommodate this type of input. The terminal leads can be run directly to the input grid of V_1 or V_2 .

Since a single saw-tooth source cannot provide output that will meet the exact waveform amplitude and shape requirements for all sets, there will, of course, be deviations in linearity and height or width. However, that should not detract from the usefulness of having a saw-tooth generator available for test substitution.

The chassis layout is not critical and may be arranged to accommodate the parts on hand.

A chassis $5\frac{3}{4}'' \times 4\frac{7}{8}''$ was used with a $6'' \times 6'' \times 6''$ cabinet and ample room was found to mount all parts. The cost of building this unit is quite small. Using all new parts, it can be done for less than \$20.00.

-30-

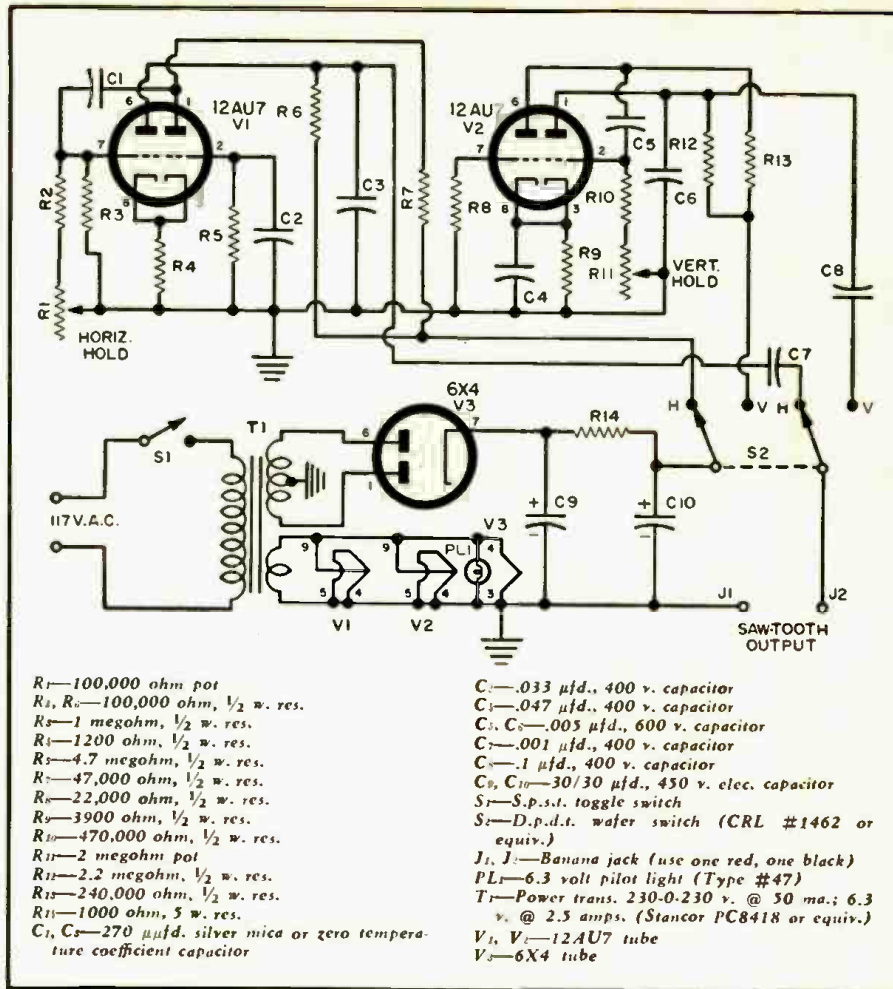
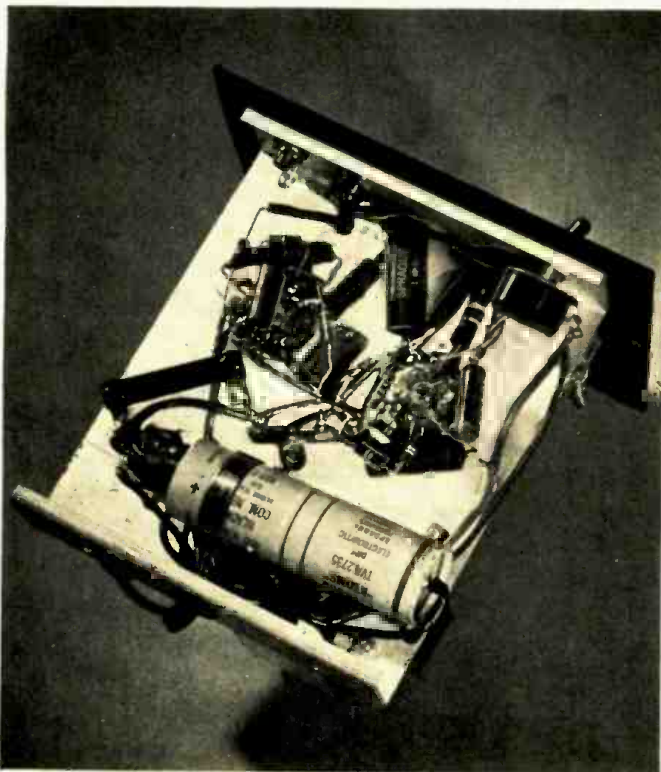

Fig. 1. Complete schematic diagram and parts list for the substitution saw-tooth scanning generator. One multivibrator, V_1 , provides a horizontal saw-tooth for receiver checking. Another multivibrator, V_2 , fulfills a similar role at the vertical rate.

Bottom view of the scanning generator chassis shows relatively straightforward layout and wiring practice used in assembly.



Top view of the generator out of its housing indicates the uncluttered layout obtained despite the small size of the device.



Certified
RECORD REVUE

By **BERT WHYTE**

AS YOU can imagine, ever since my column on three-channel stereo, I have had many letters and other communications on the subject. There would seem to be little doubt that there is a great deal of interest in this field. Well, things in the world of three-channel stereo have been going very slowly since my column and I have had nothing to report. However, within the past two weeks a great deal has been popping! To take first things first, *Mercury* has constantly been adding to its backlog of three-channel stereos, with another 30-odd tapes "in the can" since I first told you of this activity. Work is progressing on dubbing facilities, but nothing concrete yet. You never know how close help is to home, until you need it! Most readers of this column probably know the byline of a Mr. Charles Boegli, whose writings have appeared in the pages of *RADIO & TELEVISION NEWS* with some frequency. Mr. Boegli was kind enough to contact me about three-channel stereo, and it seems that a company of which he is an officer is about to conclude negotiations with a Japanese firm for the importation of three-channel stereo tape heads. Leave it to our astute Japanese friends! As far as I can learn, these will be offered for sale in this country and will conform closely to *American* manufacturing standards. In addition to this startling development, the Japanese have embarked on a program of three-channel recording and reportedly have already quite a backlog and facilities for dubbing them. Not long after this news, I learned from another source that still another Japanese outfit was engaged in three-channel stereo recording and they are purported to have over 60 tapes ready for dubbing! What the material is (other than I know it is mostly symphonic) and what it sounds like, I don't know at this moment, but I am supposed to have a demonstration in a few weeks time. I might add that if present plans jell in time, several of the people involved in this Japanese deal have stated that they hope to be able to demonstrate the three-channel stereo at the Los Angeles Audio Show. Obviously all this activity can have nothing but a salutary effect on stereo affairs in this country. Let's hope so, and soon!

**THE UNABASHED VIRTUOSO
TIGER ON THE KEYS**

Stephen Kovacs, pianist. *Elektra* 106, and *Elektra* 111 respectively. RIAA curve. Price \$4.98 each.

If you particularly savor piano music in the lighter vein, these two *Elektra* discs should prove most gratifying. Stephen Kovacs is a remarkable talent and in the range of material covered displays virtuosity far beyond its demands. In fact, so good is this fellow that one wonders at his predilection for this lightweight stuff when he is so obviously of concert-hall calibre. Well, I guess

that's Mr. Kovacs' affair, and if he doesn't mind lavishing his talent on this relatively trivial repertoire, we'll just sit back and enjoy ourselves. With his technical command, his keen humor, and his depth of feeling he makes newly interesting such tired war-horses as "Danse Macabre," "Humoresque," "Flight of the Bumble Bee," "12 St. Rag," "Sabre Dance," and others including (shelp me!) the "Beer Barrel Polka." Sound fanciers of piano won't be disappointed either as this is one of the most technically satisfactory piano recordings on LP. Quite interesting is the fact that the microphone used was an *RCA-M13026A*, a bi-directional ribbon type discontinued by *RCA* back in the 1930's! Whatever shortcomings this mike had, it would certainly seem to be one of the best piano mikes available. The sound seems very wide-range, utterly clean, and with an especially good transient response. Little or no ringing can be heard, and hammer action noise was minimal. Add intelligently spacious acoustics and it all adds up to a superbly realistic piano sound. A pair of fine "show-off" records.

**RACHMANINOFF
SONATA IN G MINOR FOR CELLO
AND PIANO**

Zara Nelsova, cellist, and Artur Balsam, pianist. *London* LL1480. RIAA curve. Price \$3.98.

This lovely work has been recorded once previously . . . an excellent performance by Schuster and Pennario on a *Capitol* disc. For those who may have "built-in" prejudices against chamber-style music, let me assure you that if you will listen to this work you will like it. One would have to have a very narrow perception of music to be unmoved by its immediate and ingratiating charm. Performance-wise, Nelsova seems to be more at ease with the score than was Schuster . . . her technical fluency is beyond reproach, her cello has a gorgeous fat tone, very warm and intimate. Balsam is somewhat reticent in his playing, but is generally satisfactory. Sound-wise this is a superb recording of the close-up variety, but with sufficient room tone to sustain liveness. The cello and piano are ultra-clean in their projection and the engineers have managed an exceptional balance between them. This disc has a slight edge in over-all quality as compared to the *Capitol* version, but both have their virtues and one's preference is largely a matter of personal taste.

**VERDI-MACKERRAS
THE LADY AND THE FOOL
WEBER-BERLIOZ
LE SPECTRE DE LA ROSE
MINKUS**

The opinions expressed in this column are those of the reviewer and do not necessarily reflect the views or opinions of the editors or the publishers of this magazine.

DON QUICHOTTE

New Symphony Orchestra conducted by Robert Irving and Anatole Fistoulari. *London* LL1518. RIAA curve. Price \$3.98.

This is most obviously a record for the ballet enthusiast. The Minkus and Weber scores were previously issued by *London* on a 10 inch disc, as was the Verdi-Mackerras suite. The sound, which was excellent in the 10 inch version, seems to have been improved in this new 12 inch coupling. Whether this is new cutting techniques or whatever . . . strings, brass, and woodwind are cleaner, much better definition is notable, and dynamic range appears extended. Robert Irving and Fistoulari are old and practised hands with ballet scores and do full justice to the material. The Verdi derivation is to me the most interesting, consisting of music taken from 11 of his operas, which except for "Ernani" are relatively obscure. That their obscurity is no doubt deserved detracts in no way from the material excerpted, which for the most part is highly listenable. All in all a most satisfactory recording which should enjoy a brisk sale among balletomanes and more casual listeners as well.

**MENDELSSOHN
PIANO CONCERTOS #1 AND #2
Peter Katin, pianist. London Symphony
Orchestra conducted by Anthony Collins.
London LL1453. RIAA curve. Price
\$3.98.**

This is the third recording to appear in which the two Mendelssohn piano concertos are coupled. Taken as a pair, they have literally no competition either in sound quality or performance. Considered as separate entities, Katin is still top man in the 2nd concerto and more than holds his own in the first concerto, even if he can't pre-empt Gilels' superb reading on a *Colosseum* disc. Splendidly endowed with technical ability, Katin is not yet matured sufficiently to match the refinement of playing exhibited by Gilels. However, when sound quality is also considered this evens the score for Katin as much of the Gilels advantage is lost in the altogether miserable sound of the Soviet tapes. Katin's playing is full of fire and spirit, but he never oversteps the bounds of good taste by committing any pianistic excesses. His attitude is obviously respectful and as such he makes these oft-played works newly enjoyable. With fine support from Anthony Collins and the men of the *London Symphony Orch.*, and with some of *London's* best piano recording, this disc is highly recommended, especially to those who have had a surfeit of the Tchaikovsky, Grieg, and Schumann concertos.

**DEBUSSY
IBERIA
LA MER
PRELUDE TO THE AFTERNOON OF
A FAUN**

Detroit Symphony Orchestra conducted by Paul Paray. *Mercury* MG50101. RIAA curve. Price \$3.98.

Lately there has been a regular rash of recordings of the "Prelude to the Afternoon of a Faun", and it goes without saying that "La Mer" and "Iberia" are hardly new to the LP catalog. But with really great music familiarity cannot breed contempt, and indeed with recordings there is always the hope that the newest will be that elusive phantom, the "definitive" version. This recording presents Paul Paray's statement on the three greatest Debussy works and it is, I think, as close to "definitive" as we are likely to encounter. Wow! I can already hear the yowls from the Toscanini camp on the matter of "La Mer." As long time readers of this column know,

(Continued on page 144)

A V.H.F. Field-Strength Meter Adapter

By GENE BRIZENDINE, W4ATE
Profitable Products

Details on an inexpensive and compact unit which can be used with practically any service-type volt-ohm-milliammeter.



The adapter in place on the author's Simpson 260 meter and close-up of the adapter unit.

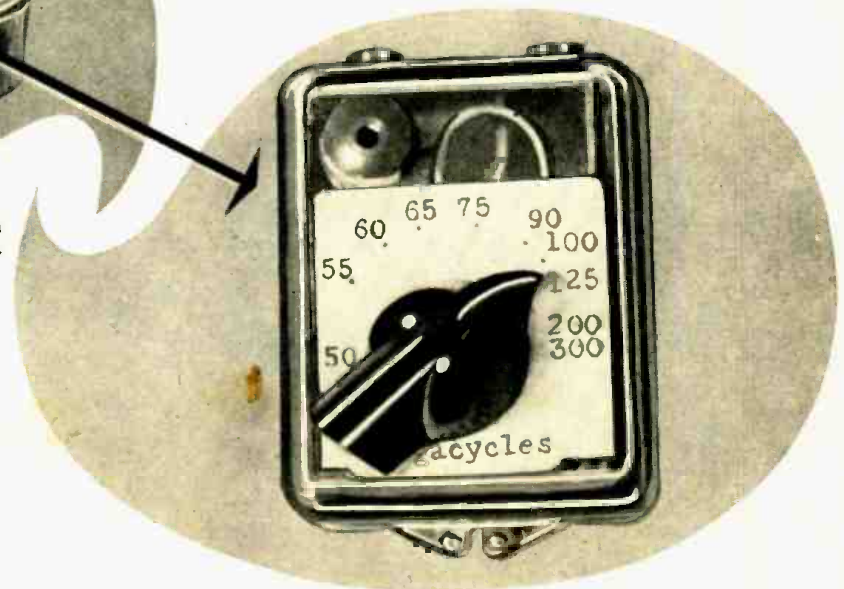

THE field-strength meter adapter to be described is low in cost, compact, and wide-range. Since the costliest item in a field-strength meter is usually the sensitive microammeter, it was decided to utilize the low-current movement already available in the average volt-ohm-milliammeter. The popular *Simpson 260* meter was used by the author but other makes are equally adaptable.

The circuit is simplicity itself, utilizing a wide-range $\frac{1}{2}$ π circuit, a semiconductor diode, and an r.f. bypass capacitor. The extremely wide coverage of the meter adapter is made possible by the use of a special tuning capacitor which is marketed by *Lafayette Radio*. By using this unit, which measures only $1" \times 1" \times \frac{5}{8}"$, the tuning range is 50 through 300 megacycles.

The adapter is assembled in a $1\frac{1}{4}" \times 1\frac{1}{2}" \times 2\frac{3}{4}"$ hinged plastic box of the type now popular for packaging small items like transistors and fishing lures. First, hold the box above the position it will occupy on the meter. Mark the point for drilling the hole which fits around the "Ohms Zero" knob. After drilling this hole, position the box again and accurately locate and drill the holes for the output pins. Finally, drill a hole for the antenna pin jack.

The output pins are simply two small plated nails, cut to proper length for a snug fit into the meter pin jacks. The pins are passed through soldering lugs and soldered to the lugs. Now solder small, flexible wires to the lugs. Next, with the box in position on the meter, pass the pins through their holes in the box, into the meter pin jacks. Apply the iron to the nail heads and, as the plastic softens, press the lugs into the plastic material. Allow complete cooling before removing from the meter. Seated with a bit of care, the pins are solidly anchored to the box.

The horseshoe tank (a $1\frac{1}{2}$ -inch length of No. 14 wire) should be bent

around any round object so that it will fit the capacitor terminals. The tank should be soldered to the tuning capacitor before assembly in the box. The dial scale was first temporarily taped outside the box for calibration purposes. The antenna connection is tapped onto the tank at the mid-point. The usual precautions should be exercised in soldering to the diode and other small parts. The antenna is made of a length of $\frac{1}{8}"$ brass welding rod. Its length, although not critical, may be cut to the shortest length which gives adequate meter readings. For some uses around high-powered transmitters, no antenna may be required.

The dial scale was calibrated using a signal generator as the standard.

The generator output was coupled to the field-strength meter tank, using a one-turn link on the generator lead. Alternatively, any oscillator or transmitter of known frequency may also be used as the calibrating standard.

The scale points were transferred to another sheet of paper, using carbon, and final markings were typed in. The finished scale is placed inside the case, for protection. Finally, the case was sealed, using *Duco* cement sparingly, on the joining surfaces. After the unit is dry, it is very sturdy and serviceable.

In use, the adapter is plugged into the meter and placed where the meter deflection is visible during transmitter or antenna adjustments. Possibly its most useful application has been in tuning up mobile, marine, and aircraft transmitters where the lack of space precludes the use of elaborate or bulky instruments.

In addition to antenna system adjustments, the adapter also serves as an absorption frequency meter and is useful in the tuning of multiplier stages for maximum field output. It will also help to locate leaky shielding and, with headphones clipped to the output pins, modulation quality and carrier hum may be judged.

All in all, this tiny adapter more than pays its way for the small space it occupies in the service technician's kit.

Complete schematic diagram and parts list for the v.h.f. field-strength meter unit.

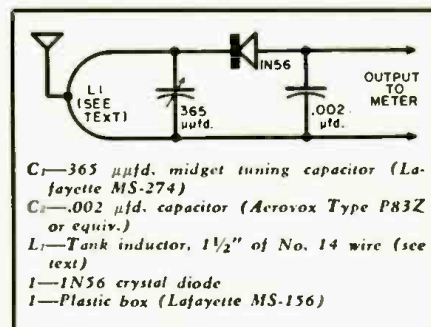

Shortened Rotary Beam Antennas for the Amateur

Hams from Eimac put up a beam antenna for "Field Day" operations under the call letters W6UF/6. The antenna is a 20-meter "Bantam" beam mounted on a TV antenna crank-up tower. Its husky "bow-tie" elements and silver-plated loading coils produce a half-size beam offering essentially full-size performance.

By
HERBERT S. BRIER,
W9EGQ



The advantage of using a shortened rotary beam is often not fully appreciated by hams. Here is the true story!

FEW experienced radio amateurs need to be told the advantages of a rotary beam antenna, especially for working DX on the frequencies of 7 mc. and above. Most of the more successful amateurs use them on the 14-, 21-, and 28-mc. bands. A smaller percentage (those with the strongest signals) use them on 7-mc., and a few even use them on the 3.5-mc. band.

Figs. 1A and 1B compare the radiation patterns of a $\frac{1}{2}$ -wave antenna and a typical rotary beam antenna. The difference between them is equal to the difference in the light emitted from an unshielded light bulb and from the same light bulb in a flashlight. The available energy is concentrated in one direction, instead of being sprayed all around the compass.

When transmitting, a rotary beam permits putting all your transmitter power in the desired direction. When receiving it gives an equal boost to incoming signals from the desired direction, while reducing the strength of signals arriving from other directions, thereby reducing interference on the desired signal tremendously.

With high-frequency radio conditions now good and getting better, this is time for amateurs without beams to put them up and start beaming. This includes Novices on 21 mc. (and 7 mc.).

Most rotary beam antennas use a $\frac{1}{2}$ -wave driven antenna and one or

two *parasitic elements*. Depending upon their adjustment, they accept power from the antenna and re-radiate it to modify the radiation pattern of the antenna alone.

A 2-element parasitic beam consists of the driven element and one parasitic element. When the parasitic element is made 5% shorter than the antenna and is spaced about 0.1 wavelength in front of the antenna, it functions as a *director*. A director increases the power radiated in the forward direction from the antenna 3.5 times (5.5 db). At the same time, the signal radiated in other directions is sharply reduced.

Making the added element 5% longer than the antenna and spacing

it 0.15 wavelength behind the antenna changes it to a *reflector*. Forward gain will then be about three (4.8 db), again with reduced signals in other directions.

Adding both a reflector and a director to the antenna results in a power gain of seven to eight (8 to 9 db) and a front-to-back ratio of 100:1 (20 db), if the parasitic elements are spaced 0.15 to 0.2 wavelength from the antenna element. More parasitic elements may be added, but the size of the array goes up much faster than its gain does. Therefore, few amateurs use more than three elements for frequencies below 30 mc.

For comparison purposes, a typical 2-element, 14-mc. beam will consist of a 33' long antenna and a 31' 4" director seven feet in front of it. A 3-element beam will have a 34' 6" reflector in addition and will be about 20 feet long. Parasitic arrays for the other amateur bands will be proportionately larger or smaller. It should be noted, however, that none of these dimensions is to be considered "final." Many factors can combine to change dimensions in an actual beam.

Shortened Beams

For the average amateur with the room for it and the facilities to support and rotate it, there is little doubt that a full-size rotary beam comes close to being the ideal antenna. The rub is that there are many circumstances that make it impossible to erect one, even for the 10-meter band. One of them is lack of room. Another is the unhappy fact that a beam that

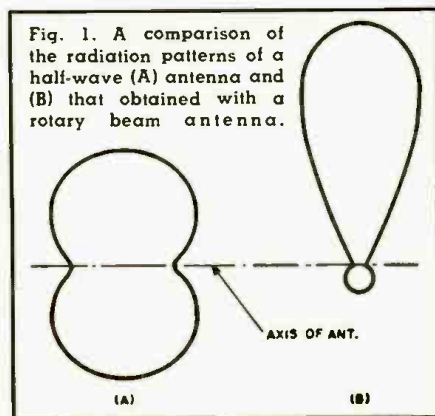

Fig. 1. A comparison of the radiation patterns of a half-wave (A) antenna and (B) that obtained with a rotary beam antenna.

looks like a streamlined beauty to a ham, usually looks ten times as large and one-tenth as beautiful to his wife, landlord, parents, or neighbors.

To help overcome these circumstances, shortened beams may be used. They take advantage of the fact that any electrical conductor has capacity, inductance, and resistance distributed throughout its length. When an antenna is cut to operate at a certain frequency, its inductive and capacitive effects neutralize each other, and the antenna readily accepts and radiates power at the desired frequency.

An antenna shorter than the proper length appears as a capacitive reactance to the exciting frequency, and this reactance must be tuned out in some manner before the antenna will accept power. This can be done by cutting the antenna in half and inserting a loading coil of the proper inductance.

In a parasitic beam, the reflector and director elements can be shortened in the same manner, remembering to resonate them 5% below and above the antenna resonant frequency.

Loading an antenna element in this manner reduces its radiation resistance somewhat, compared to a full-size antenna, because it has less active radiating area. In the absence of losses, and assuming equal power input, this reduction would cause a corresponding increase in antenna current to maintain the same radiating efficiency.

Unfortunately, all antennas do have losses, and even the best loading coils have higher losses than the sections of antenna they replace. These losses reduce the amount of power available to be radiated; consequently, a shortened antenna is not quite as efficient as a full-size one. The difference is not as great as some skeptics would have you believe. Naturally, however, shortening should not be carried too far.

Carefully checking all available information on the effect of shortening elements in parasitic arrays indicates the following: at first, as the elements of normal construction are shortened, the efficiency drops off quite slowly from that of a full-size beam. As the process continues, the efficiency starts dropping off more rapidly, and by the time element lengths have been cut in half, output is down about 40%. Beyond this point, output drops off very rapidly.

Of course, the foregoing pre-supposes low-loss construction and careful tuning after each adjustment of element lengths.

One way to reduce the size of the loading coil, and thus the losses, in shortened elements is to make the elements of large diameter tubing. Doing so increases their effective capacity, which tunes the coils. This is done automatically in practical arrays, because fairly large diameter elements of aluminum tubing are used anyway so that they will be self supporting and will not flop around in the wind.

SPECIFICATIONS ON COMMERCIAL SHORTENED BEAM ANTENNAS

Gonset Company, 801 South Main Street, Burbank, California. Makers of the Gonset "Bantam" 2-element beams for the 14-, 21-, and 28-mc. amateur bands, featuring "bow-tie" element construction.

BAND	ELEMENT LENGTH	BOOM LENGTH	GAIN F/B RATIO	APPROX. PRICE
14 mc.	16'6"	10'	Almost equal to full-sized 2-element beam	\$59.50
21 mc.	16'6"	10'	Almost equal to full-sized 2-element beam	59.50
28 mc.	10'7"	5'	Almost equal to full-sized 2-element beam	44.50

Fed with 52-ohm coaxial cable (RG-8/U), not supplied.

Mosley Electronics, Inc., 8622 St. Charles Rock Road, St. Louis 14, Missouri. Makers of the "Vest-Pocket" shortened 2- and 3-element beams for the 7-, 14-, 21-, and 28-mc. amateur bands. Center-loaded low-loss coils weather protected in clear acrylic cases.

BAND	MODEL	ELEMENTS	LONGEST ELEMENT	BOOM LENGTH	GAIN	F/B RATIO	APPROX. PRICE
7 mc.	VPA40-2	2	36' 1 3/4"	14'10"	5 db	19 db	\$74.95
14 mc.	VPA20-2	2	22'10 1/4"	6'	5 db	20 db	44.73
14 mc.	VPA20-3	3	23' 1 1/4"	12'	7 1/2 db	28 db	66.37
21 or 28 mc.*	VPA1015-2	2	13'11 1/2"	4'6"	5 db	15 db	39.89
21 or 28 mc.*	VPA1015-3	3	13'11 1/2"	10'	7 1/2 db	20 db	59.68
*May be adjusted to operate in either band							
7, 14, 21 mc.	VPA-3B (triband)	4	36'	15'	5 db	20 db	135.00
14 & 28 mc.	VPA1020 (dualband)	6	22' 6"	12'	7 1/2 db	28 db	120.79
21 & 28 mc.	VPA1520 (dualband)	6	22' 6"	12'	7 1/2 db	28 db	129.90

All Mosley beams fed with 52-ohm coaxial cable (RG-8/U), not supplied.

Radio Specialties, Inc., 652 Union St., Brooklyn, N. Y. Makers of 2- and 3-element "Shortbeams" for the 7-, 14-, and 21-mc. amateur bands. Center-loaded with low-loss coils weather protected with Bakelite covers.

BAND	MODEL	ELEMENTS	LONGEST ELEMENT	BOOM LENGTH	GAIN	F/B RATIO	APPROX. PRICE
7 mc.	RS2-40	2	33'	12'	4.4 db	15 db	\$74.95
14 mc.	RS2-20	2	16'	6'	4.4 db	15 db	49.95
14 mc.	RS3-20	3	16'	12'	4.8 db	20 db	59.50
21 mc.	RS2-15	2	13'	6'	4.4 db	15 db	44.95
21 mc.	RS3-15	3	13'	12'	4.8 db	20 db	54.95

Also available are dual 2-element "Shortbeams" for any combination of the above bands and a 3-element, 14-, 21-, and 28-mc. "3 Bander," using four special loading devices in each of its 28' elements. All Radio Specialties beams fed with 52-ohm coaxial cable (RG-8/U), not supplied.

Telrex, Inc., Asbury Park, N. J. Makers of "Super Minibeams" for the 3.5- to 28-mc. amateur bands. Features high strength and high gain in minimum practical size.

BAND	MODEL	ELEMENTS	LONGEST ELEMENT	BOOM LENGTH	GAIN	F/B RATIO	APPROX. PRICE
3.5 mc.	80-M-370	2	64'	36'	3.2 db	15 db	\$370.00
7 mc.	40-M-365	2	46'	14'	3.4 db	16 db	180.00
14 mc.	20-M-56-79	2	29'	10'	4.8 db	14 db	79.50
21 mc.	15-M-56-67	2	18'9"	6'10"	4.8 db	14 db	67.50
28 mc.	1030-S	3	13'7"	9'	7 db	18 db	36.50

"Hairpin" loading stubs supported along the center boom, rather than loading coils, are used to resonate the higher-frequency "Super Minibeams." All Telrex beams are fed with 52-ohm coaxial cable (RG-8/U), not supplied.

World Radio Laboratories, Inc., 3415 West Broadway, Council Bluffs, Iowa. At present, has only one shortened beam in its line. It is for the 14-mc. band and features two low-loss coils per element for loading.

BAND	MODEL	ELEMENTS	LONGEST ELEMENT	BOOM LENGTH	APPROX. PRICE
14 mc.	"Globe Spannette"	3	21'	18'	\$54.95

May be fed with any standard transmission line from 52-ohm coaxial cable to 450-ohm twin-lead. Line not supplied. Also available is a 3-element, 14-, 21-, and 28-mc. beam, using four special loading devices in each element. Boom length 20'. Price \$99.75.

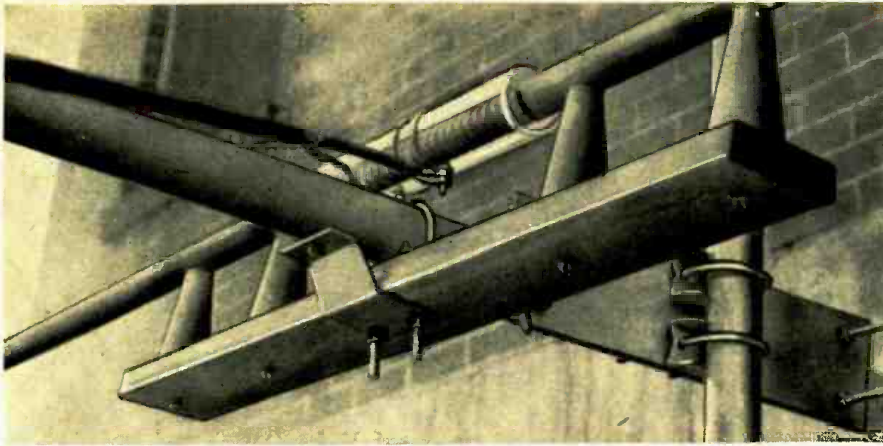

This photo of the center of a Mosley "Vest Pocket" beam shows the antenna loading coil and how power from the RG-8/U transmission line is coupled into it. The loading coil for the reflector and director are similar, except that the coupling link is omitted. Method of supporting elements to boom and boom itself are also shown.

A further increase in element capacity can be obtained by making each half element of two, fanned-out lengths of tubing joined together with a cross-piece at the ends. A complete element then looks like a bow tie, with the loading coil representing the knot.

Another approach to the problem of reducing coil losses is to use two loading coils per element, one near each end, instead of one in the center. The closer to the end of the element a coil is placed, the less current it carries; therefore, coil losses should be less. On the other hand, there is also less capacity across the coil to tune it, making more turns necessary. The best compromise between these conflicting factors occurs when the coils are placed approximately half way between the center and each end of the element.

The different manufacturers of the shortened arrays listed in the accompanying table take advantage of all these methods to shorten elements lengths 18% to 50%.

Covering Several Bands

All conventional parasitic type an-

tennas work efficiently over only a relatively narrow range of frequencies, approximately plus or minus 75 kc. of the design frequency on 14 mc. for a typical shortened beam, with proportionate coverage on the other bands. To cover additional bands, therefore, requires stacking separate antennas Christmas-tree fashion at least five feet apart, or use of 2- or 3-band arrays. They consist of independent antenna systems mounted on a single support boom and adjusted for minimum interaction between them.

Support and Rotation

The nicest thing about shortened beams is that they can be supported on properly guyed TV antenna towers. Also, up to three elements on 14 mc. or two on 7 mc. can be rotated by a good *heavy-duty* TV antenna rotator. Among the suitable rotators for the purpose are the *C-D-R* AR-22 and TR-4. The latter is available with special heavy-duty gears as model HD-4. Equivalent rotators of other manufacturers are equally satisfactory. For multi-band installations, rotators designed especially to turn amateur

beams are required, unless the beam drive shaft is brought within reach of the operator for manual rotation.

How high should the antenna be erected? The stock answer to this question is "as high as possible." Translated into actual figures, every foot of height up to 50 feet helps, especially in working DX. Below 30 feet, results usually drop off rather rapidly. Above 50 feet, improvement comes slowly, unless the added height boosts the antenna above utility wires and other obstructions.

Ideally, the antenna should be erected at the desired height in the center of a large field completely free from all obstructions. In practice, we put it on top of the house or garage or in the back yard. If the antenna is put on the roof of a building and the building is of steel frame construction, effective antenna height is usually its height above the roof, rather than its height above the earth. Under these circumstances, the height of the building is useful only to help clear nearby obstructions. Over a wooden building, however, the effective antenna height approximates its height above the earth.

Expected Results

It would be nice if it were possible to predict just how much better results will be obtained when using a beam antenna, compared with those obtained from a non-directional one. Unfortunately, this is not possible, because so many unpredictable variables are involved. However, many amateurs who have never worked a foreign DX station before erecting a simple beam are able to work them regularly with a beam. What you can expect is that, with your beam, you will hear signals much more clearly, and you will get out more consistently. In other words, those periods in which you cannot raise anyone, no matter what you do, come much less frequently and last a shorter length of time with a beam.

The 3-element Telrex "Super Minibeam" of W9VEY, Hillsboro, Ill., mounted atop a 50-foot TV antenna tower and rotated with a TR-4 rotator. Installation has been in operation several years.

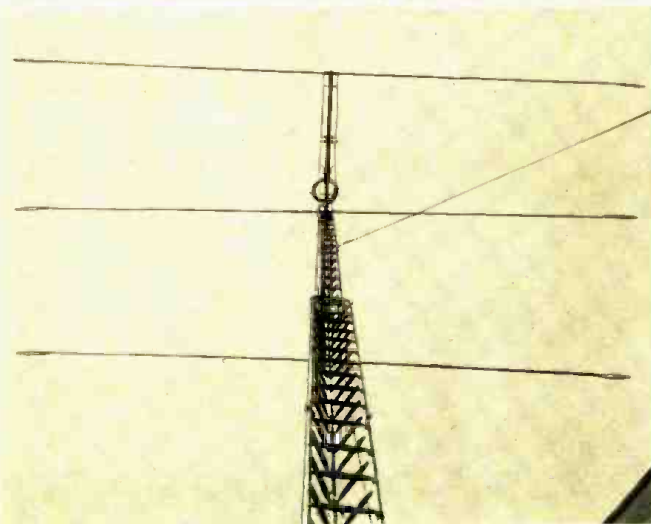

The 3-element, 20-meter "Globe Spannente" of World Radio Lab. uses a pair of low-loss loading coils in each element. "Carpet beaters" at the ends of elements act as vibration dampers.

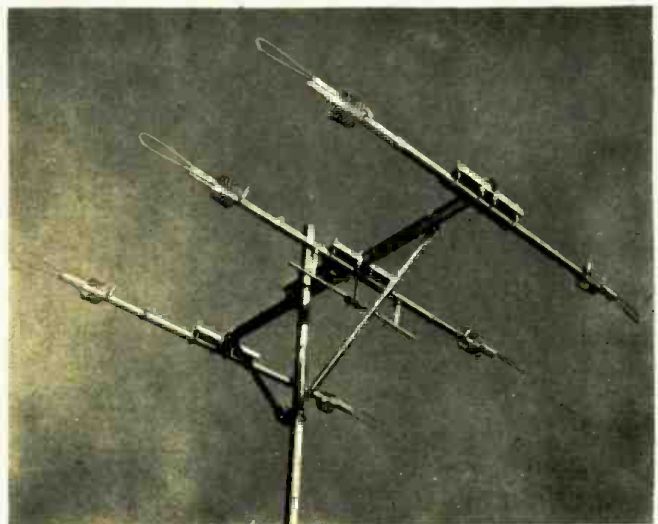

**"I cut testing time in half"
... "doubled our tube sales" ***



"Adds to my income and saves me unprofitable call-backs."

"We have two... one for the shop and one for house calls."

"Paid for itself several times. Really indispensable."

"Best tube tester I've ever owned. Simple to operate. Saves time."

"Makes lots of money for us. Wonderful instrument."

"Serves my purpose best for speed and dependability."

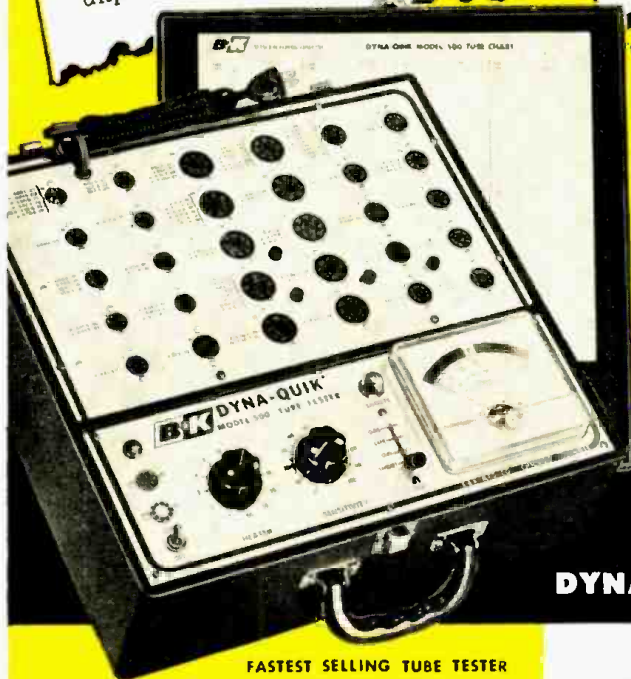

B&K MODEL 500

DYNA-QUIK

DYNAMIC MUTUAL CONDUCTANCE TUBE TESTER

FASTEST SELLING TUBE TESTER
IN THE WORLD

**Tests over 95% OF ALL
POPULAR TV TUBES — IN SECONDS**

Accurately makes each tube test in seconds
Checks average TV set in minimum minutes

Tests each tube for shorts, grid emission, gas content, leakage, and dynamic mutual conductance.

Ingenious life test detects tubes with short life expectancy.

One switch tests everything. No multiple switching. No roll charts.

Shows tube condition on "Good-Bad" scale and in micromhos. Large 4½-inch plastic meter has two highly accurate scales calibrated 0-6000 and 0-18,000 micromhos.

Automatic line compensation is maintained by a special bridge that continuously monitors line voltage.

Built-in 7-pin and 9-pin straighteners are mounted on the panel.

* NAMES ON REQUEST



Makers of Dyna-Quik, CRT,
Dyna-Scan and Calibrator

B & K MANUFACTURING CO.
3726 N. Southport Ave. • Chicago 13, Illinois

**One extra tube sale on each of 5 calls a day
pays for the Model 500 in 30 days**

Enthusiastic comments like those above come from servicemen all over the country. *Actual experience shows an average of close to 2 additional tube sales per call!*

Instead of the "trial and error" method of substitution testing, the Dyna-Quik 500 quickly detects weak or inoperative tubes. Cuts servicing time, saves costly call-backs shows each customer the true condition and life expectancy of the tubes in the set, and makes more on-the-spot tube sales. Helps keep customer good-will, give a better service guarantee, and *make more profit!*

The B&K Dyna-Quik 500 measures *true dynamic mutual conductance*. Completely checks tubes with laboratory accuracy under actual operating conditions right in the home... *in a matter of seconds*. Saves time and work in the shop, too. Simple to operate. Easily portable in luggage-type case. Weighs only 12 lbs. **NET, \$109⁹⁵**

See Your B&K Distributor or Write for Bulletin No. 500-N



Model 1000 DYNA-SCAN
Picture and Pattern Video
Generator Complete Flying
Spot Scanner. Net, \$199.95



Model 400 CRT
Cathode Rejuvenator Tester.
Tests and repairs TV picture
tubes. Net, \$54.95



Model 750 CALIBRATOR
Designed to check and adjust
test instruments with labora-
tory accuracy. Net, \$54.95



By JOHN T. FRYE

TURN ABOUT

BARNEY was not himself. For one thing, he was not chattering away like a magpie, and this in itself was abnormal; moreover, he seemed to be lost in thought as he worked away at the service bench alongside Mac, his boss. Finally the latter put down his solder gun and demanded:

"What's eating you this morning? Did Margie stand you up last night, or did some ham in Lower Slobbovia give you a bad signal report on that glorified diathermy machine you call a transmitter?"

"You *know* I never have woman trouble," Barney boasted; "but you're pretty warm with that second guess. I've got a bug in my transmitter that's about to drive me goofy. About three months ago the transmitter started blowing fuses. At first this would happen only about once a week, although occasionally two fuses might go in a quarter of an hour; but lately the condition has grown much worse. Last night I couldn't say, 'Boo,' into the mike without going off the air. And I'm using fuses plenty heavy enough to carry the rated current drawn by the transmitter."

"Does this happen on c.w. or phone?"

"Always on phone, and that's what has me sweating," Barney said ruefully. "I'm afraid it's the modulation transformer insulation breaking down between a winding and the core. If it is, that's going to make an awful dent in my bank account; but still worse is the fact that I'm not positive that the transformer is causing the trouble. If I bought a new modulation transformer and then found the trouble still persisted, I'd be ready for one of those white jackets with the wraparound sleeves."

"Does the fuse just let go quietly, or are there other symptoms that show up the instant it blows?"

"I always hear a sort of spitting noise that sounds like an arc-over, but I know it's not in the plate tank capacitor or the antenna-loading capacitor, for I've been looking right at these two in a darkened room when the fuse

let go, and I didn't see any fire. The arc must be somewhere out of sight—which again points at the modulation transformer."

"Let me see now," Mac said as he rubbed a thumb along the sharp outline of his chin; "the same high voltage flows through the centertap of the primary of your modulation transformer to the plates of the modulator tubes and also goes through the secondary winding to the plate of the final amplifier tube. Is that right?"

"Check," Barney said. "That means either the primary or secondary winding could short to the core and cause the trouble; but a short could develop a lot of other places, too. Either one of the modulator tubes could develop an internal short; so could the final tube; the plate-blocking capacitor in the final tank circuit could arc over internally; some of the feedthrough insulators could be breaking down—oh there are lots of places for an arc to occur that could blow a fuse. That's what makes it so headachy."

Mac walked over to a drawer, pulled it open, and took out a half-dozen little porcelain sockets. "Maybe you can pinpoint the source of the trouble with these," he suggested. "They take standard screw-type panel lamps. It's my idea you insert lamps of appropriate current carrying capacity at strategic points in the circuit and then see which lamp or lamps blow when the arc occurs. Lamps rated at 150, 250, and 500 milliamperes should take care of about all the currents in the high-voltage part of your rig."

"Hey! Wait a minute! I think you've got something," Barney said with enthusiasm. "You mean I can put one lamp in the lead going to the centertap of the primary of the modulation transformer. Another could go in the 'B-plus' lead of the secondary of that transformer, and still another could be in the other lead of this winding that goes up to the final amplifier. If the lamp in the primary lead goes out when the short circuit occurs, I can forget the rest of the circuit and con-

centrate on the plate circuit of the modulator tubes. On the other hand, if the lamp burns out in the 'B-plus' lead to the secondary, but the one in the other lead of this winding stays okay, I can be sure I have an arc between the secondary winding and the core. And if the one burns out in the lead going to the final amplifier, I'll know—hey, wait a minute; since the same current will be flowing through this lamp and the one in the other lead as well, one lamp is as likely to go first as the other if the trouble is in the final amplifier."

"You've got a point there, but that's why I suggested lamps of different current ratings. Suppose you put a 500 ma. lamp in the 'B-plus' lead and a 250 ma. lamp in the lead going to the final amplifier. A short circuit between the winding and the core will take out the 500 ma. lamp quickly; but if the short happens on beyond the 250 ma. lamp, it will burn out and leave the 500 ma. lamp okay. Another point is this: if you can arrange the lamps so that you can see them and still have a little separation between them, the flash of the overloaded lamp, even though seen out of the tail of your eye, will reveal which part of the circuit is carrying too much current. Once you have established that, you can use more lamps, strategically placed, to corner the trouble in the smallest possible unit of the circuit. In using lamps in some leads, it may be easier to solder them in place rather than employ these sockets."

"Well, I'll surely give it the old college try tonight," Barney promised as he slid the sockets and several assorted pilot lamps into a paper sack. "This thing has worn me down until I'm ready to try anything. If I don't find it tonight, I'm going to call on Madam Miranda, the crystal ball gazer, tomorrow."

When Mac came down to open up the shop the next morning, he was astonished to find it already open. Barney greeted him at the door with a dazzling grin spread all over his freckled Irish face.

"Are you ever a right thinker!" he exclaimed. "Thanks to that suggestion about the lamps, I found my rig trouble; and it was *not* the modulation transformer!"

"What was it?" Mac asked.

"It was a nasty little feedthrough insulator that had cracked and was arcing to the chassis down inside out of sight. This insulator fed the voltage from the high side of the modulation transformer to the final amplifier; so both the d.c. voltage and the audio voltage were impressed upon it. A lamp on one side of the insulator went out every time I heard the arc, but the one on the other side never did. When I took the insulator apart, it was very easy to see where the arc had blackened the chassis and charred one of the little paper anti-strain washers. I replaced the insulator and then could

(Continued on page 96)

HOW MANY CAN YOU ANSWER "YES?"

1. Do you wish to extend your experience in electronics systems?
2. Would you like to instruct others in advanced fire control systems and laboratory techniques?
3. Would you like to handle a responsible position representing a leading electronics organization?
4. Do you believe that you can accurately relate your findings and studies in technical language?
5. Are you interested in such devices as analog computers, digital computers, power supplies, transmitters, receivers, and microwave antennas?
6. Do you enjoy working with people?

If you can answer "yes" to four of the above questions and have an Electrical Engineering or Physics degree, chances are that you can qualify for one of the several engineering positions in the Hughes Field Engineering department.

In addition to giving you well-rounded experience in electronic systems and controls, Hughes offers you training at full salary, moving and travel allowances, per diem expenses, and many other benefits. For further information write Mr. W. A. Barnes at the address below.

HUGHES

RESEARCH AND DEVELOPMENT LABORATORIES
SCIENTIFIC STAFF RELATIONS
Hughes Aircraft Company, Culver City, Calif.

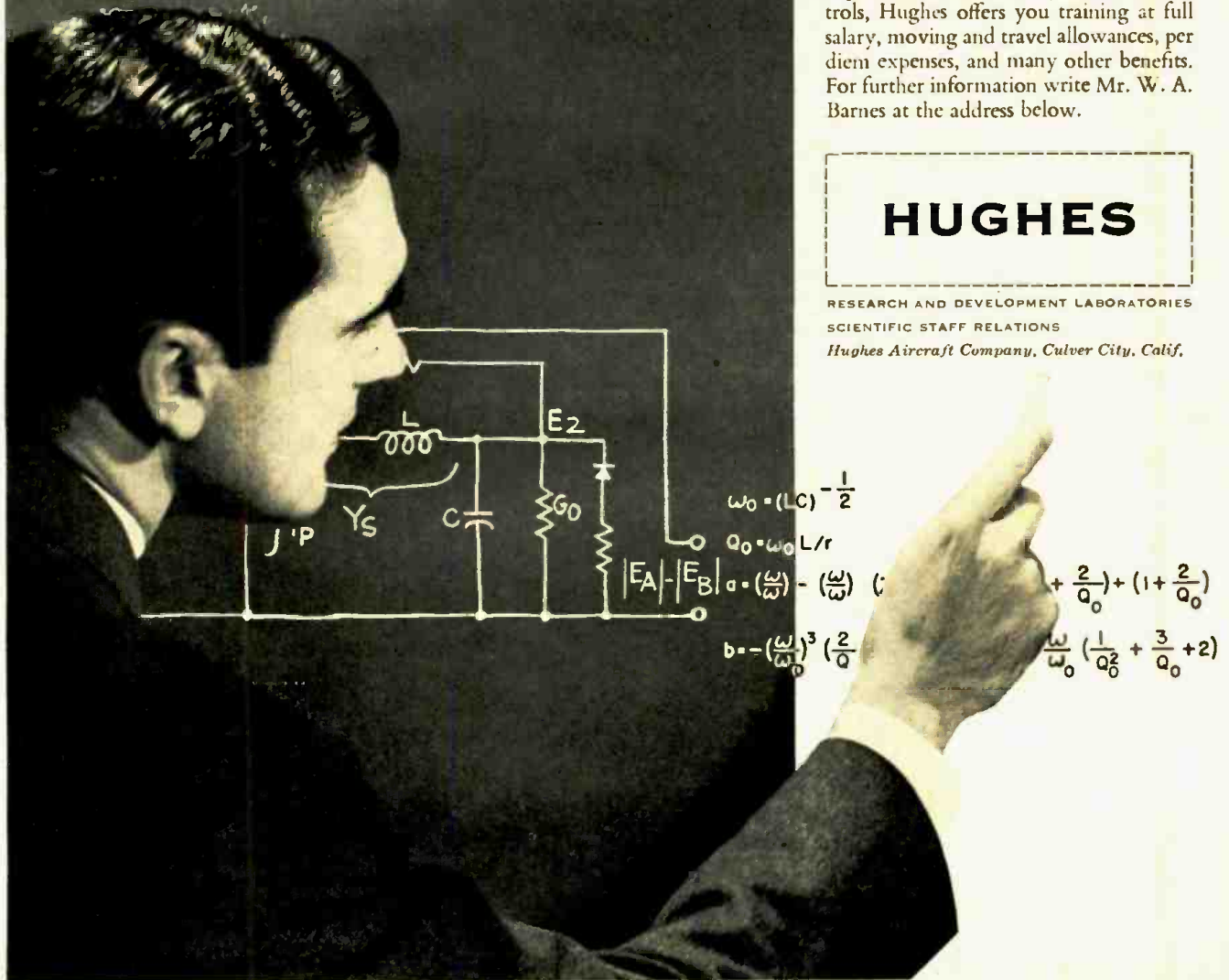

4 great high fidelity
tape recorders from a name
that stands for precision...

DeJUR

tape deck for the components owner
portables for people on the go
consolette for music lovers

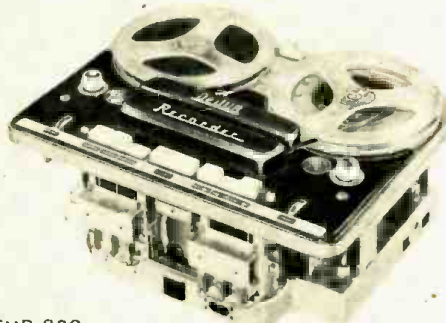

TMB-820
"Dual Professional" Basic Tape Recorder

Push-button, custom-installation tape deck ready to combine with present sound system. At 7 1/2" equals or exceeds performance of "professional" machines operating at 15"/sec. Also 3 3/4"/sec. speed. Push-button track reversal. Heavy-duty hysteresis synchronous motor.

\$329.50



CR-820 "Consolette"
with HI-Five Speaker System

"Dual Professional" basic unit housed in furniture-weight Korina cabinet. HI-Five speaker system in special acoustical chamber gives magnificent audio quality. \$499.00



TK-820 "Dual Professional" Portable

Same controls and specs as the TMB-820 but complete with HI-Five Speaker System in travel case. Acclaimed by experts as finest portable under \$500!

\$399.50

PTR-90

"Embassy" Portable

Three-speaker portable dual track with all the classic DeJUR features: superb audio quality, 7 1/2" and 3 3/4" speeds, magnificent performance. \$299.50



You're always sure with

DeJUR

Audio Equipment

DEJUR-AMSCO CORPORATION,
LONG ISLAND CITY 1, N. Y.
CHICAGO, ILL.
BEVERLY HILLS, CALIF.
DEJUR INTERNATIONALE,
GMBH, WEST GERMANY

---SEND COUPON FOR COMPLETE SPECIFICATIONS---

DeJUR-AMSCO CORPORATION, Dept. RN1, 45-01 Northern Blvd., L.I.C. 1, N.Y.

Please send me, without obligation, complete specifications.

Name _____

Address _____

City _____ Zone _____ State _____

Power Requirements for Hi-Fi
(Continued from page 45)

Tests conducted in an actual living room readily confirmed the fact that the reason higher powered amplifiers sound better is because realistic music requirements require in excess of 25 watts with efficient speakers, and in excess of 100 watts with the most inefficient speakers. For example, with the AR-Janscen combination it was impossible to obtain realistic piano reproduction on a direct comparison with the original loudness level with less than 100 watts of power. On commercial recordings in which volume compression is used, 50 watts of capacity was adequate. However, on tapes made directly from live sources, with dynamic program material, occasional overload was experienced with a 50-watt amplifier even with moderately high efficiency speakers.

The most significant fact in these experiments was that the visual overload on the scope correlated with traces of roughness in the reproduction showing that overload is audible. The type of distortion which was evidenced by overload was that which is attributed frequently to "record break-up," "lack of stylus tracking," and similar excuses. Much of the criticism of sound reproduction which has been levelled at program sources seems to arise from inadequate power capacity in the playback systems. This overload condition is particularly offensive to the ear when the associated amplifier has a poor recovery characteristic under overload conditions.

It is suggested that audio enthusiasts who have an oscilloscope available try the tests outlined in this article. It is amazing at how low an average level some visual evidences of clipping appear. As the playback level of the system is increased, many loud passages will be seen to cause amplifier overload even when they do not sound tremendously loud. Once the type of sound associated with overload is recognized, it will be found that many systems overload very frequently. This is particularly true of demonstrations in sound rooms and audio shows where demonstration levels far exceed the capacity of the equipment, but where large crowds create such a high ambient noise level that demonstration levels are increased above normal requirements. The problem of insufficient amplifier power capability is one which will be more acute in the future since the trend toward greater recorded dynamic range continues. The power requirements of the future may well be in excess of 100 watts, particularly if speaker efficiencies are further reduced.

REFERENCES

1. Hafer, David: "Control of Amplifier Damping Factor," RADIO & TELEVISION NEWS, July 1953.
2. Hafer, David: "A 50 Watt Power Amplifier," RADIO & TELEVISION NEWS, June 1956.

RCA offers you the finest training at home in **Radio-TV electronics, TV servicing, Color TV**

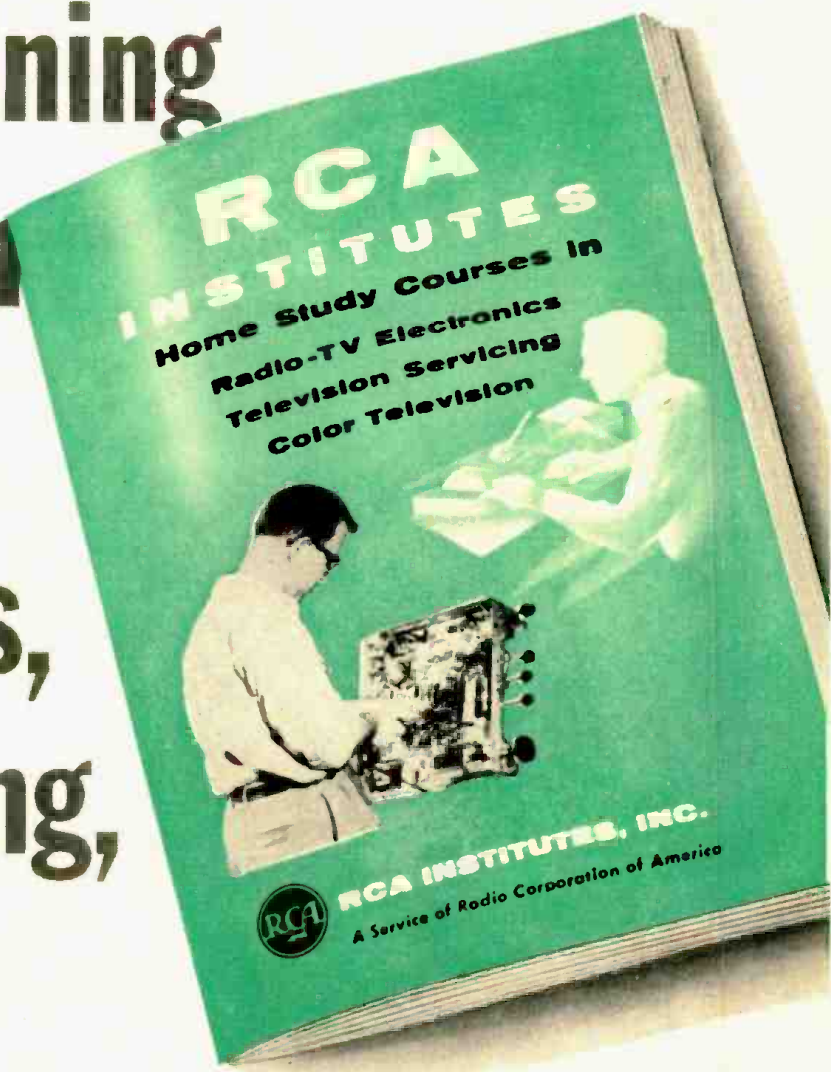

SEND FOR THIS FREE BOOK NOW!

The instruction you receive and equipment you get (and keep) will start you on your way. Pay-as-you-learn. You pay for only one study group at a time. This 52 page book contains complete information on Home Study Courses for the beginner and the advanced student.



RCA INSTITUTES, INC.
A SERVICE OF RADIO CORPORATION OF AMERICA
 350 WEST FOURTH STREET, NEW YORK 14, N.Y.

RCA Institutes, Inc., Home Study N-17,
 350 West Fourth Street New York 14, N. Y.
 Without obligation, send me FREE CATALOG
 on Home Study Courses in Radio, Television
 and Color TV. No salesman will call.

Name.....
 Please Print
 Address.....
 City..... Zone..... State.....

VETERANS
 KOREAN G.I.
 P.L. 550
 CHECK HERE
 ()

New



MODEL O-11

Shpg. Wt.
21 Lbs.

\$69⁵⁰

- * An improved model of what was already an outstanding instrument.
- * Performance is unmatched in this price range.
- * Incorporates the extra features required for color TV servicing.

Extra!

A FULL YEAR TO PAY

SEND FOR DETAILS OF HEATH
TIME-PAYMENT PLAN.

**5
BIG
REASONS
WHY**



**HEATH
COMPANY**

A SUBSIDIARY OF DAYSTROM, INC.

BENTON HARBOR 15, MICH.

HEATHKIT ETCHED CIRCUIT, PUSH-PULL

5" Oscilloscope Kit COLOR TV

The previous Heathkit oscilloscope (Model O-10) which was already a most remarkable instrument, has been improved even further with the release of the Heathkit Model O-11. It incorporates all the outstanding features of the preceding model, *plus* improved vertical linearity, better sync stability, especially at low frequencies, and much-improved over-all stability of operation, including less vertical bounce with changes in level. These improvements in the Model O-11 circuit make it even more ideally suited for color TV servicing, and for critical observations in the electronic laboratory. Vertical response extends from 2 CPS to 5 MC without extra switching. Response only down 2.2' DB at 3.58 MC. The 11-tube circuit features a 5UP1 cathode-ray tube. Sync circuit functions effectively from 20 CPS to better than 500 kc in five steps. Modern etched circuit boards employed in the oscilloscope circuit cut assembly time almost in half, permit a level of circuit stability never before achieved in an oscilloscope of this type, and insure against errors in assembly. Both vertical and horizontal output amplifiers are push-pull. Built-in peak-to-peak calibrating source — step-attenuated input — plastic molded capacitors and top-quality parts throughout — pre-formed and cabled wiring harness — and numerous other "extra" features. A professional instrument for the serveshop or laboratory. Compare its specifications with those of scopes selling in much higher price brackets. You can't beat it!

1 FEWER DOLLARS BRING MORE REAL QUALITY.

- Factory-to-you sales eliminate extra profit margin.
- "Build-it-yourself" eliminates labor charge.
- Heath purchasing power cuts component costs.

2 PERSONAL SERVICE ASSURES CUSTOMER SATISFACTION.

- You deal directly with the manufacturer.
- We are interested in you before and after sale.

Heathkits®

ARE YOUR BEST BUY...

3 PROVEN DESIGNS MEAN RELIABLE PERFORMANCE.

- Research and development efforts concentrated on kits only.
- All kits guaranteed to meet advertised specifications.

4 EVERY KIT BACKED BY WORLD-WIDE REPUTATION.

- The world's largest manufacturer of electronic equipment in kit form.
- Producer of more than a million electronic kits for the home workshop and industry.

5 EASY TIME-PAYMENT PLAN TO FIT YOUR BUDGET.

New HEATHKIT ETCHED CIRCUIT 5" Oscilloscope Kit

GREATEST SELECTION . . .

Whether your particular special interest is in servicing, ham-radio, high-fidelity, or just experimenting—there are Heathkits to fill your needs. You can equip an entire service shop or lab, buy a complete ham station or high-fidelity system, or set up a really deluxe home workshop, by choosing from the more than 70 different "do-it-yourself" electronic kits by Heath. Just glance through the kits displayed in this ad, and you will get some idea of the tremendous array of low-priced, high-quality electronic equipment available.

This new and improved oscilloscope retains all the outstanding features of the preceding model, but provides wider vertical frequency response, extended sweep-generator coverage, and increased stability. A new tube complement and improvements in the circuit make these new features possible. Vertical frequency response is essentially flat to over 1 mc, and down only 1½ DB at 500 kc. The sweep generator multivibrator functions reliably from 30 to 200,000 CPS, almost twice the coverage provided by the previous model. Deflection amplifiers are push-pull, and modern etched circuits are employed in critical parts of the design. A 5BP1 cathode-ray tube is used. The scope features external or internal sweep and sync, one volt peak-to-peak reference voltage, 3-position step-attenuated input, adjustable spot-shape control, and many other "extras" not expected at this price level. A calibrated grid screen is also provided for the face of the CRT, allowing more precise observation of wave shapes displayed. The new Model OM-2 is designed for general application wherever a reliable instrument with good response characteristics may be required. Complete step-by-step instructions and large pictorial diagrams assure easy assembly.

- * Brand new model with improved performance specifications.
- * Full 5" scope for service work at a remarkably low price.
- * Attractively styled front panel in charcoal gray with sharp white lettering.
- * Easy to build from step-by-step instructions and large pictorials. Not necessary to read schematic.



MODEL OM-2

\$42.50

Shpg. Wt.
21 lbs.

HEATHKIT LOW CAPACITY PROBE KIT

Oscilloscope investigation of high frequency, high impedance, or broad bandwidth circuits encountered in television requires the use of a low-capacity probe to prevent loss of gain, circuit loading, or waveform distortion. The Heathkit low-capacity probe may be used with your oscilloscope to eliminate these effects. It features a variable capacitor, to provide correct instrument impedance match. Also, the ratio of attenuation can be varied.

No. 342

\$3.50

Shpg. Wt. 1 lb.

HEATHKIT ELECTRONIC SWITCH KIT

This handy device allows simultaneous oscilloscope observation of two signals by producing both signals, alternately, at its output. It features an all-electronic switching circuit, with no moving parts. Four switching rates are selected by a panel switch. Provides actual gain for input signals, and has a frequency response of ± 1 DB from 0 to 100 kc. Sync output provided to control and stabilize scope sweep. Will function at signal levels as low as 0.1 volt. This modern device finds many applications in the laboratory and service shop. It employs an entirely new circuit, and yet is priced lower than its predecessor.

MODEL S-3

\$21.95

Shpg. Wt. 8 lbs.

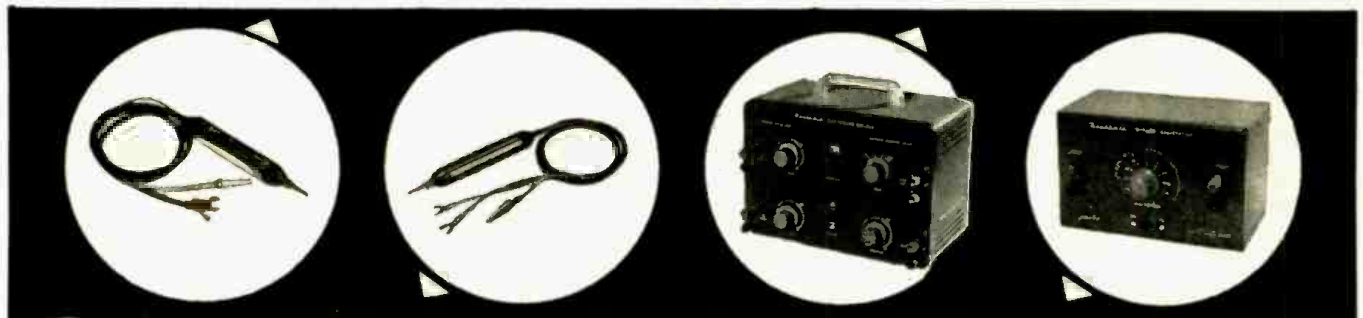

HEATHKIT SCOPE DEMODULATOR PROBE KIT

Extend the usefulness of your oscilloscope by employing this probe. Makes it possible to observe modulation of RF or IF carriers found in TV and radio receivers. Functions much like an AM detector to pass only modulation of signal, and not the signal itself. Among other uses, it will be helpful in alignment work, as a signal tracer, and for determining relative gain. Applied voltage limits are 30 volts (RMS) and 500 volts DC. It uses an etched circuit board to simplify assembly.

NO. 337-C

\$3.50

Shpg. Wt. 1 lb.

HEATHKIT VOLTAGE CALIBRATOR KIT

This entirely new voltage calibrator produces near-perfect square wave signals of known amplitude. Precision 1% attenuator resistors assure accurate output amplitude, and multivibrator circuit guarantees good, sharp square waves, as distinguished from clipped sine waves. Output frequency is approximately 1000 CPS. Fixed outputs selected by panel switch are: .03, 0.1, 0.3, 1.0, 3.0, 10, 30, and 100 volts peak-to-peak. Allows measurement of unknown signal amplitudes by comparing to known peak-to-peak output of VC-3 on an oscilloscope. Will also double as a square wave generator at 1000 cycles for determining gain, frequency response, or phase-shift characteristics of audio amplifiers. Equally valuable in the laboratory or in radio and TV service shops.

MODEL VC-3

\$12.50

Shpg. Wt. 4 lbs.

HEATHKIT ETCHED CIRCUIT VACUUM TUBE



MODEL
V-7A

\$24⁵⁰

Shpg. Wt.
7 lbs

- * Easy to build — a pleasure to use.
- * 1% precision resistors employed for high accuracy.
- * Etched circuit board cuts assembly time in half.

Voltmeter Kit

The fact that this instrument is the world's largest-selling VTVM says a great deal about its accuracy, reliability, and overall quality. The V-7A is equally popular in the laboratory or service shop, and represents an unbelievable test equipment bargain, without a corresponding sacrifice in quality. Its appearance reflects the performance of which it is capable. A large 4½" panel meter is used for indication, with clear, sharp calibrations for all ranges. Front panel controls consist of a rotary function switch and a rotary range selector switch, zero-adjust, and ohms-adjust controls. Precision 1% resistors are used in the voltage divider circuits and etched circuits are employed for most of the circuitry. This makes the kit much easier to build, eliminates the possibility of wiring errors, and assures duplication of laboratory instrument performance. This multi-function VTVM will measure AC voltage (rms), AC voltage (peak-to-peak), DC voltage, and resistance. There are 7 AC (rms) and DC voltage ranges of 0-1.5, 5, 15, 50, 150, 500, and 1500. In addition, there are 7 peak-to-peak AC ranges of 0-4, 14, 40, 140, 400, 1400, and 4000. 7 ohmmeter ranges provide multiplying factors of X1, X10, X100, X1000, X10K, X100K, and X1 megohm. Center-scale resistance readings are 10, 100, 1000, 10K, 100K ohms, 1 megohm, and 10 megohms. A DB scale is also provided. The precision and quality of the components used in this VTVM cannot be duplicated at this price through any other source. Model V-7A is the kind of instrument you will be proud to own and use.

HEATHKIT Etched Circuit RF PROBE KIT

This RF probe extends the frequency response of any 11-megohm VTVM so that it will measure RF up to 250 megacycles within ± 10%. Employs printed circuits for increased stability and ease of assembly. Ideal for extending service and laboratory applications of your Heathkit VTVM. No. 309-C

\$3⁵⁰

Shpg. Wt. 1 Lb.

HEATHKIT 20,000 OHMS/VOLT VOM KIT

Sensitivity of this instrument is 20,000 ohms-per-volt DC and 5,000 ohms-per-volt AC. Measuring ranges are 0-1.5, 5, 50, 150, 500, 1500, and 5000 volts for both AC and DC. Also measures current in the ranges of 0-150 microamperes, 15 ma, 150 ma, 500 ma, and 15 a. Resistance ranges provide multipliers of X1, X100, and X10,000, resulting in center scale readings of 15, 15,000, and 150,000 ohms. DB ranges cover from -10 db to +65 db. Housed in attractive black bakelite case with plastic carrying handle, this fine instrument provides a total of 25 meter ranges on its two-color scale. It employs a sensitive 50 microampere, 4½" meter and features all 1% precision multiplier resistors. Requires no external power, and is, therefore, valuable in portable applications where no AC power is available. MODEL MM-1

\$29⁵⁰

Shpg. Wt. 6 Lbs.

ETCHED CIRCUIT PEAK-TO-PEAK PROBE KIT

Use this peak-to-peak probe with your 11-megohm VTVM to measure peak-to-peak voltages directly on the DC scales of the instrument. Will measure p-to-p voltages in the frequency range of 5 kc to 5 mc. Employs etched circuit boards for increased circuit stability and simplified construction. Extend the usefulness of your VTVM. NOTE: No. 338-C Not required for the Heathkit V-7A VTVM. **\$5⁵⁰** Shpg. Wt. 2 Lbs.



HEATHKIT 30,000 VOLT DC HIGH VOLTAGE PROBE KIT

This probe provides a multiplication factor of 100 on the DC ranges of the Heathkit 11-megohm VTVM. Precision multiplier resistor mounted inside the two-color plastic probe body. Plenty of insulation for completely safe operation, even at highest TV potentials. Designed especially for TV service work. No. 336

\$4⁵⁰

Shpg. Wt. 2 Lbs.

HEATHKIT HANDITESTER KIT

The Model M-1 measures AC or DC voltage at 0-10, 30, 300, 1000, and 5000 volts. Direct current ranges are 0-10 ma. and 0-100 ma. Ohmmeter ranges are 0-3000 (30 ohm center scale) and 0-300,000 ohms (3,000 ohm center scale). Uses a 400 microampere meter for sensitivity of 1000 ohms-per-volt. A very popular test device for the home experimenter, electricians, and appliance repairmen, and for use as an "extra" instrument in the service shop. Its small size and rugged construction make it perfect for any portable application. Easily slips into your tool box, glove compartment, coat pocket, or desk drawer. Top quality, precision components employed throughout. MODEL M-1

\$14⁵⁰

Shpg. Wt. 3 Lbs.



HEATH COMPANY
A Subsidiary of Daystrom, Inc.
BENTON HARBOR 15, MICH.

CONTROLLED QUALITY . . .

Incoming parts inspection, and inspection of material coming off of our own production line assures you of the finest "build-it-yourself" kit that money can buy. Each kit contains all the components you need for assembly—and you can have confidence in the quality of the parts themselves. In addition to this inspection procedure, an extensive proof-building program for each new kit guarantees easy-to-follow instructions and reliable performance.

HEATHKIT NEW AUDIO VACUUM TUBE

Voltmeter Kit

- * Brand new circuit for extended frequency response and added stability.
- * Ten accurate ranges from 0-.01 to 0-300 volts.
- * Modern, functional panel styling. "On-off" switch at both extreme ends of range switch.



MODEL AV-3

\$29⁹⁵

Shpg. Wt.
5 Lbs.

This brand new AC vacuum tube voltmeter emphasizes stability, broad frequency response, and sensitivity. It is designed especially for audio measurements, and low-level AC measurements in power supply filters, etc. Employs a cascode amplifier circuit with cathode-follower isolation between the input and the amplifier, and between the output stage and the preceding stages. An extremely stable circuit with high input impedance (1 megohm at 1000 CPS). Response of the AV-3 is essentially flat from 10 CPS to 200 kc, and is usable for tests even beyond these frequency limits. Increased damping in the meter circuit stabilizes the meter for low frequency tests. Nylon insulating bushings at the input terminals reduce leakage, and permit the use of the 5-way Heath binding post.

The extremely wide voltage range covered by the AV-3 makes it especially valuable not only in high-fidelity and service work, but also in experimental laboratories. AC (RMS) voltage ranges are 0-.01, .03, .1, .3, 1, 3, 10, 30, 100, and 300 V. Decibel ranges cover -52 DB to +52 DB. An entirely new circuit as compared to the previous model. Employs 1% precision multiplier resistors for maximum accuracy. Handles AC measurements from a low value of one millivolt to a maximum of 300 volts.

HEATHKIT AUDIO WATTMETER KIT

This instrument measures audio power directly at 4, 8, 16, or 600 ohms. Load resistors are built in. Covers 0-5 MW, 50 MW, 500 MW, 5 W, and 50 W full scale. Provides 5 switch-selected DB ranges covering from -10 DB to +30 DB. Large 4½" 200 microampere meter and precision multiplier resistors insure accuracy. Frequency response is ± 1 DB from 10 CPS to 250 kc. Functions from AC power line. Use in the audio laboratory or in home workshop.

MODEL AW-1

\$29⁵⁰

Shpg. Wt. 6 Lbs.

HEATHKIT AUDIO ANALYZER KIT

This multi-function instrument combines an AC VTVM, an audio wattmeter, and an intermodulation analyzer into one case, with combined input and output terminals and built-in high and low frequency oscillators. The VTVM ranges are .01, .03, .1, .3, 1, 3, 10, 30, 100, and 300 volts (RMS). Wattmeter ranges are: .15 MW, 1.5 MW, 15 MW, 150 MW, 1.5 W, 15 W, 150 W. IM scales are 1%, 3%, 10%, 30%, and 100%. Provides internal load resistors of 4, 8, 16, or 600 ohms. A valuable instrument for the engineer or serious audiophile.

MODEL AA-1

\$49⁹⁵

Shpg. Wt. 13 Lbs.

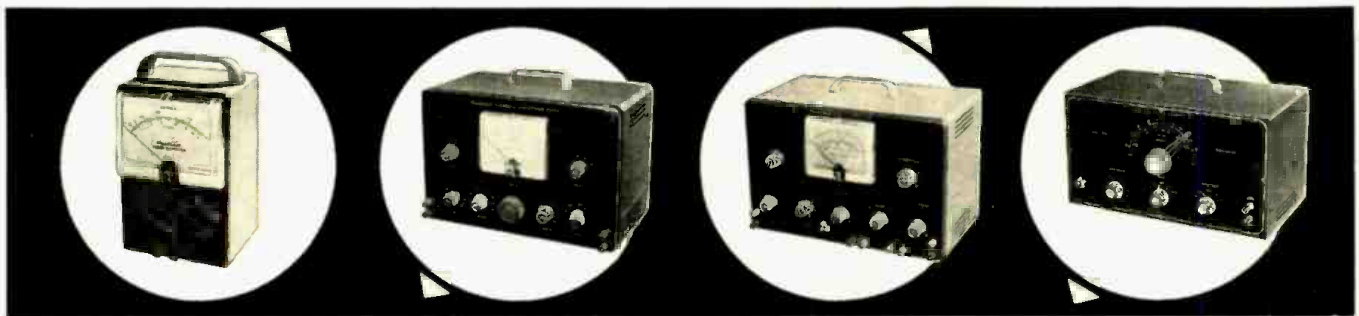

HEATHKIT HARMONIC DISTORTION METER KIT

The HD-1 is equally valuable for the audio engineer or the serious audiophile. Used with a low-distortion audio signal generator, this instrument will measure the harmonic content of various amplifiers under a variety of conditions. Functions between 20 and 20,000 CPS, and reads distortion directly on the panel meter in ranges of 0-1, 3, 10, 30, and 100 percent full scale. Built-in VTVM for initial reference settings and final distortion readings has voltage ranges of 0-1, 3, 10, and 30 volts. 1% precision resistors employed for maximum accuracy. Features voltage regulation and other "extras". Meter calibrated in volts (RMS), percent distortion, and DB.

MODEL HD-1

\$49⁵⁰

Shpg. Wt. 13 Lbs.

HEATHKIT AUDIO OSCILLATOR KIT

Producing both sine waves and square waves, the Model AO-1 covers a frequency range of 20 to 20,000 CPS in three ranges. An extra feature is thermistor regulation of output for flat response through the entire frequency range. AF output is provided at low impedance, and with low distortion. Produces good sine waves, and good, clean square waves with a rise time of only two micro-seconds for checking square wave response of audio amplifiers, etc. Designed especially for the serviceman and high-fidelity enthusiast. A real dollar value in test equipment.

MODEL AO-1

\$24⁵⁰

Shpg. Wt. 10 Lbs.

HEATHKIT



MODEL
AG-9

\$34⁵⁰

Shpg. Wt.
8 lbs.

- * Less than 0.1% distortion — ideal for hi fi work.
- * Large 4½" meter indicates output.
- * Step-type tuning for maximum convenience.

Audio Generator Kit

This particular audio generator is "made to order" for high fidelity applications. It provides quick and accurate selection of low-distortion signals throughout the audio range. Three rotary selector switches on the front panel allow selection of two significant figures and a multiplier for determining audio frequency. In addition, it incorporates a step-type output attenuator and a continuously variable attenuator. Output is indicated on a large 4½" panel meter calibrated in volts and in db. Attenuator system operates in steps of 10 db, corresponding with the meter calibration. Output ranges are 0-.003, .01, .03, .1, .3, 1, 3, and 10 volts rms. A "load" switch provides for the use of a built-in 600 ohm load or an external load of higher impedance when required. Output and frequency indicators accurate to within ± 5%. Distortion is less than .1 of 1% between 20 cps and 20,000 cps. Total range is 10 cps to 100 kc. New engineering details combine to provide the user with an unusually high degree of operating efficiency. Oscillator frequency selected entirely by the switch method means that accurate resetability is provided. Comparable to units costing many dollars more, and ideal for use in critical high fidelity applications. Shop and compare, and you will appreciate the genuine value of this professional instrument.

HEATHKIT RESISTANCE SUBSTITUTION BOX KIT

The RS-1 contains 36 10% 1-watt resistors ranging from 15 ohms to 10 megohms in standard RETMA values. All values are switch-selected for use in determining desirable resistance values in experimental circuits. Many applications in radio and TV service work.

MODEL RS-1

\$5⁵⁰

Shpg. Wt. 2 Lbs.

HEATHKIT CONDENSER SUBSTITUTION BOX KIT

This kit contains 18 RETMA standard condenser values that can be selected by a rotary switch. Values range from 0.00001 mfd to 0.22 mfd. All capacitors rated at 400 volts or higher. Capacitors are either silver-mica, or plastic molded.

MODEL CS-1

\$5⁵⁰

Shpg. Wt. 2 Lbs.

HEATHKIT AUDIO GENERATOR KIT

The Model AG-8 is a low cost, high performance unit for use in service shop, or home workshop. It covers the frequency range of 20 cps to 1 mc in five ranges. Output is 600 ohms, and overall distortion will be less than .4 of 1% from 100 cps through the audible range. Output is available up to 10 volts, under no load conditions, and output remains constant within ±1 db from 20 cps to 400 kc. A five-step attenuator provides control of the output. Precision resistors are employed in the frequency determining network.

MODEL AG-8

\$29⁵⁰

Shpg. Wt. 11 Lbs.

HEATHKIT DECADE CONDENSER KIT

Precision, 1% silver-mica capacitors are employed in the Model DC-1 in such a way that a selection of precision capacitor values is provided ranging from 100 mmf (.0001 mfd) to 0.11 mfd (110,000 mmf) in 100 mmf steps. Extremely valuable in all types of design and development work. Switches are ceramic wafer types.

MODEL DC-1

\$16⁵⁰

Shpg. Wt. 3 Lbs.



HEATHKIT DECADE RESISTANCE KIT

The Model DR-1 incorporates twenty 1% precision resistors arranged around five rugged switches so that various combinations of switch positions will provide a total range of 1 ohm to 99,999 ohms in 1-ohm steps. Switches are labeled "units," "tens," "hundreds," "thousands," and "ten thousands." Use it for ohm-meter calibration in bridge circuits as test values in multiplier circuits, etc.

MODEL DR-1

\$19⁵⁰

Shpg. Wt. 4 Lbs.

HEATHKIT VARIABLE VOLTAGE REGULATED POWER SUPPLY KIT

This power supply is regulated for stability, and the amount of DC output available from the power supply can be controlled manually from zero to 500 volts. Will provide regulated output at 450 volts up to 10 ma, or up to 130 ma at 200 volts output. In addition to furnishing B-plus, the power supply provides 6 volts AC at 4 amperes for filaments. Both the B-plus output and the filament output are isolated from ground. Ideal power supply for use in experimental work in the laboratory, the home workshop, or the ham shack. Large 4½" panel meter indicates output voltage or current.

MODEL PS-3

\$35⁵⁰

Shpg. Wt. 17 Lbs.



HEATH COMPANY

A Subsidiary of Daystrom, Inc.

BENTON HARBOR 15, MICH.

BONUS PERFORMANCE . . .
 If a single word had to be selected to describe Heath Company advertising policy, it would be "conservative." By this we mean that the performance specifications and features are not exaggerated, and that the descriptions are accurate. We specify performance on the conservative side so you can be sure of equaling or exceeding our specifications. In almost every instance our kits will do more than we claim. Extra care in construction, and calibration against on accurate standard can extend performance well beyond advertised levels.

HEATHKIT

Signal Generator Kit

- * No calibration required with pre-aligned coils.
- * Modulated or unmodulated RF output.
- * 110 mc to 220 mc frequency coverage.

Here is an RF signal generator for alignment applications in the service shop or the home workshop. Thousands of these units are in use in service shops all over the country. Produces RF signals from 160 kc to 110 mc on fundamentals on five bands. Also covers from 110 mc to 220 mc on calibrated harmonics. RF output is in excess of 100,000 microvolts at low impedance. Output is controllable with a step-type and a continuously variable attenuator. Front panel controls provide selection of either unmodulated RF output or RF modulated at 400 cps. In addition, two to three volts of audio at approximately 400 cps are available at the output terminals for testing AF circuits. Employs a 12AU7 and a 6C4 tube. Built-in power supply uses a selenium rectifier.

One of the most outstanding features about the Model SG-8 is the fact that it can be built in just a few hours, even by one not thoroughly experienced in electronics work. Complete step-by-step instructions combined with large pictorial diagrams assure successful assembly. Pre-aligned coils make calibration from an external source unnecessary.



MODEL SG-8

\$19⁵⁰

Shpg. Wt. 8 lbs.

HEATHKIT LABORATORY GENERATOR KIT

This laboratory RF signal generator covers from 100 kc to 30 mc on fundamentals in five bands. The output signal may be pure RF, or may be modulated at 400 cycles from 0 to 50%. Provision for external modulation has been made. RF output available up to 100,000 microvolts. Output controlled by a fixed step and a variable attenuator. Output impedance is 50 ohms. Panel meter reads RF output or percentage of modulation. Incorporates voltage regulated B+ supply, double shielding of oscillator circuits, copper plated chassis, and other "extras."

MODEL LG-1
\$48⁹⁵

Shpg. Wt. 16 lbs.

HEATHKIT TV ALIGNMENT GENERATOR KIT

This improved sweep generator model provides essential stability and flexibility for work on FM, monochrome TV, or color TV sets. Covers 3.6 mc to 220 mc in four bands. Provides usable output even on harmonics. Sweep deviation from 0-42 mc, depending on base frequency. All-electronic sweep circuit eliminates unwieldy mechanical arrangements. Includes built-in crystal marker generator providing output at 4.5 mc and multiples thereof, and variable marker covering 19 to 60 mc on fundamentals and from 57 to 180 mc on harmonics. Effective two-way blanking.

MODEL TS-4A
\$49⁵⁰

Shpg. Wt. 16 lbs.



HEATHKIT LINEARITY PATTERN GENERATOR KIT

This instrument supplies information for white dots, cross-hatch pattern, horizontal bar pattern, or vertical bar pattern. It feeds video and sync signals to the set under test, with completely controlled gain, and unusual stability. Covering channels 2 to 13, the LP-2 will produce 5 to 6 vertical bars and 4 to 5 horizontal bars. The dot pattern presentation is a *must* for the setting of color convergence controls in the color TV set. Panel provision made for external sync if desired. Use for adjustment of vertical and horizontal linearity, picture size, aspect ratio, and focus. Power supply is regulated for added stability. Essential in the up-to-date TV service shop.

MODEL LP-2
\$22⁵⁰

Shpg. Wt. 7 lbs.

HEATHKIT CATHODE RAY TUBE CHECKER KIT

This instrument checks cathode emission, beam current, shorted elements, and leakage between elements in electro-magnetic picture tube types. It eliminates all doubt for the TV serviceman, and even more important, for the customer. Features its own self-contained power supply, transformer operated to furnish normal test voltages for the CRT. Employs spring-loaded switches for maximum operator protection. Large 4 1/2" meter indicates CRT condition on "good-bad" scale. Luggage-type portable case ideal for home service calls. Special "shadowgraph" test permits projection of light spot on screen. Also gives relative check of picture tube screen coating.

MODEL CC-1
\$22⁵⁰

Shpg. Wt. 10 lbs.

HEATHKIT



MODEL
TC-2

\$29⁵⁰

Shpg. Wt.
12 lbs.

- * Attractive counter-style cabinet.
- * Wiring-harness simplifies assembly.
- * Large 4½" meter with two-color "good-bad" scale.
- * Separate tube element switches prevent obsolescence.

HEATHKIT PORTABLE TUBE CHECKER KIT

This portable tube checker is identical, electrically, with the Model TC-2. However, it is housed in an attractive and practical carrying case, finished in proxylin impregnated material. The cover is detachable, and the hardware is brass plated. This rugged unit is ideal for home service calls or any portable application.



MODEL
TC-2P

\$34⁵⁰ Shpg. Wt.
15 lbs.

HEATHKIT DIRECT READING CAPACITY METER KIT

Operation of this instrument is simplicity itself. One has only to connect a capacitor to the terminals, select the proper range, and read the capacity value directly on the large 4½" meter calibrated in mmf and mfd.

Ranges are 0 to 100 mmf, 1,000 mmf, 0.01 mfd, and 0.1 mfd full scale. Precision calibrating capacitors supplied. Not susceptible to hand capacity effects. Residual capacity less than 1 mmf. Especially valuable in production line checking, or in quality control.

MODEL CM-1

\$29⁵⁰

Shpg. Wt.
7 lbs.



HEATH COMPANY
A Subsidiary of Daystrom, Inc.
BENTON HARBOR 15, MICH.

Tube Checker Kit

This fine piece of test gear checks tubes for quality, emission, shorted elements, open elements, and filament continuity. Will test all tube types normally encountered in radio and TV service work. Sockets provided for 4, 5, 6, and 7-pin large, rectangular, and miniature types, octal and loctal types, the Hytron 9-pin miniatures, and pilot lamps. Condition of tubes indicated on a large 4½" meter with multi-color "good-bad" scale. An illuminated roll chart is built right in, providing test data for various tube types. This tester provides switch selection of 14 different filament voltage values from 0.75 volts to 117 volts. Individual switches control each tube element. Close tolerance resistors employed in critical test circuits for maximum accuracy. A professional instrument both in appearance and performance.

The Model TC-2 is very simple to build, even for a beginner. It employs a color-coded cable harness for neat, professional under-chassis wiring. Comes with attractive counter style cabinet, and portable cabinet is available separately. At this price, even the part-time serviceman can afford his own tube checker for maximum efficiency in service work.

HEATHKIT TV PICTURE TUBE TEST ADAPTER

Designed especially for use with the Model TC-2 tube checker. Use it to test TV picture tubes for emission, shorts, etc. Consists of 12-pin TV tube socket, 4 ft. cable, octal connector, and necessary technical data. Not a kit.



MODEL 355

\$4⁵⁰

Shpg. Wt.
1 lb.

HEATHKIT VISUAL-AURAL SIGNAL TRACER KIT

Although designed primarily for radio receiver work, this valuable instrument finds extensive application in FM and TV servicing as well. Features a high-gain channel with demodulator probe, and a low-gain channel with audio probe. Will trace signals in all sections of a radio receiver and in many sections of a FM set or TV receiver. Uses built-in speaker and electron beam eye tube for indication. Also features built-in wattmeter and a noise locator circuit. Provision for patching speaker and/or output transformer into external set.

MODEL T-3

\$23⁵⁰

Shpg. Wt. 9 lbs.



HEATHKIT CONDENSER CHECKER KIT

The Model C-3 consists of an AC powered bridge for both capacitive and resistive measurements. Bridge balance is indicated on electron beam eye tube, and capacity or resistance value is indicated on front panel calibrations. Measures capacity in four ranges from .00001 mfd to .005 mfd, .001 mfd to .5 mfd, .1 mfd to 50 mfd, and 20 mfd to 1000 mfd. Measures resistance in two ranges, from 100 ohms to 50,000 ohms, and from 10,000 ohms to 5 megohms. Selection of five different polarizing voltages for checking capacitors, from 25 volts DC to 450 volts DC. Checks paper, mica, ceramic, and electrolytic capacitors. Indicates power factor of electrolytic condensers.

MODEL C-3

\$19⁵⁰

Shpg. Wt. 7 lbs.

PIONEER DESIGN . . .
 New and unique approaches to instrument and equipment designs are a Heath Company tradition. We concentrate all our development efforts on kit projects, since this is our prime activity—and not just a sideline. This logically results in more efficient, more reliable circuit designs—and you benefit from this constant engineering progress. Buying from the undisputed leader in the electronic kit field assures you of completely modern equipment, with outstanding advanced design features.

HEATHKIT

Impedance Bridge Kit

- * 1/2% precision resistors and silver-mica capacitors.
- * Battery-type tubes, no warm-up required.
- * Built-in phase shift generator and amplifier.

The Model IB-2 is a completely self-contained unit. It has a built-in power supply, a built-in 1000 cycle generator, and a built-in vacuum tube detector. Provision has been made on the panel for connection to an external detector, an external signal generator, or an external power supply. A 100-0-100 micro-ampere meter on the front panel provides for null indications. Measures resistance from 0.1 ohm to 10 megohms, capacitance from 10 mmf to 100 mfd, inductance from 10 mh to 100 h, dissipation factor (D) from 0.002 to 1, and storage factor (Q) from 0.1 to 1000. 1/2 of 1% decade resistors employed for maximum accuracy. Typical accuracy figures are: resistance, ±3%; capacitance, ±3%; inductance, ±10%; dissipation factor, ±20%; storage factor, ±20%. Employs a Wheatstone bridge, a Capacity Comparison bridge, a Maxwell bridge, and a Hay bridge. Special two-section CRL dial provides maximum convenience in operation. Use the Model IB-2 for determining values of unmarked components, checking production or design samples, etc. A real professional instrument.



MODEL IB-2
\$59⁵⁰ Shpg. Wt. 12 Lbs.

HEATHKIT "Q" METER KIT

The Q Meter permits measurement of inductance from 1 microhenry to 10 millihenries, "Q" on a scale calibrated up to 250 full scale, with multiplying factors of 1 or 2, and capacitance from 40 mmf to 450 mmf, ±3 mmf. Built-in variable oscillator permits testing components from 150 kc to 18 mc. Large 4 1/2" panel-mounted meter is feature. Very handy for checking peaking coils, chokes, etc. Use to determine values of unknown condensers, both variable and fixed. Compile data for coil winding purposes, or measure RF resistance. Distributed capacity, and Q of coils.

MODEL QM-1
\$44⁵⁰
 Shpg. Wt. 14 Lbs.

HEATHKIT ISOLATION TRANSFORMER KIT

This device isolates equipment under test from the power line. It is rated at 100 volt-amperes continuously, or 200 volt-amperes intermittently. AC-DC sets may be plugged directly into the IT-1 without the chassis becoming "hot." Additionally, since the IT-1 is fused, it is ideal for use as a buffer between the power line and a questionable receiver, or a new piece of equipment. Protects main fuses. Features voltage control, allowing control of the output from 90 volts to 130 volts. Panel meter monitors output voltage. A very handy device at an extremely low price.

MODEL IT-1
\$16⁵⁰
 Shpg. Wt. 9 Lbs.

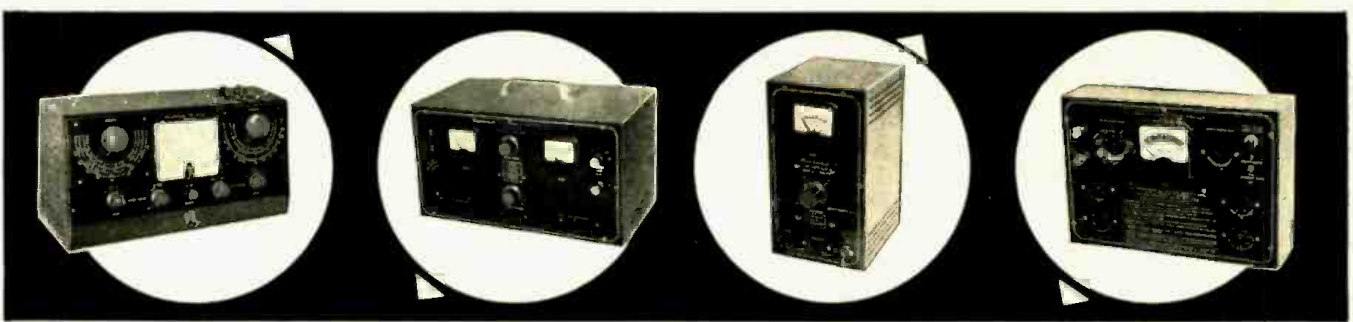

HEATHKIT 6-12 VOLT BATTERY ELIMINATOR KIT

This completely modern battery eliminator will supply DC output in two ranges for both 6-volt and 12-volt automobile radios. The output is variable for each range, so that operating voltage can be raised or lowered to determine how the receiver functions under adverse conditions. Range is 0-8 volts DC or 0-16 volts DC. Will supply up to 15 amperes on the 6-volt range, or up to 7 amperes on the 12-volt range. Two 10,000 microfarad output filter capacitors insure smooth DC output. Two separate panel meters indicate output voltage or output current. Makes it possible to test automobile radios inside at the workbench. Will also double as a battery charger.

MODEL BE-4
\$31⁵⁰
 Shpg. Wt. 17 Lbs.

HEATHKIT 6-VOLT VIBRATOR TESTER KIT

This instrument functions very much like a tube checker, to test auto radio vibrators. Vibrator condition is indicated on a simple "good-bad" scale. Tests for proper starting and overall quality of operation, of both interrupter and self-rectifier types of 6-volt vibrators. The model VT-1 is designed to operate from any battery eliminator capable of delivering continuously variable output from 4 to 6 volts DC at 4 amperes or more. It is an ideal companion unit for the Heathkit Model BE-4 battery eliminator. The construction book for the VT-1 contains vibrator test chart for popular 6-volt vibrator types. A real time saver!

MODEL VT-1
\$14⁵⁰
 Shpg. Wt. 6 Lbs.

HEATHKIT DX-100 PHONE AND CW



**MODEL
DX-100**
Shpg. Wt.
107 Lbs.

\$189⁵⁰

Shipped motor freight unless otherwise specified.
\$50.00 deposit required on c.o.d. orders.

- * Phone or CW on 160, 80, 40, 20, 15, 11 and 10 meters.
- * Built-in VFO, modulator, and power supplies.
- * High quality components used throughout for reliable performance.
- * Features 5-point TVI suppression.

Transmitter Kit

The Heathkit DX-100 transmitter is in a class by itself in that it offers features far beyond those normally received at this price level. It takes very little listening on the bands to discover how many of these transmitters are in operation today. A truly amazing piece of amateur gear. The DX-100 features a built-in VFO and a built-in modulator. It is TVI suppressed, and uses pi network interstage coupling and output coupling. Will match antenna impedances from approximately 50 to 600 ohms. Extensive shielding is employed, and all incoming and outgoing circuits are filtered. The cabinet features interlocking seams for simplified assembly and minimum RF radiation outside of the cabinet. Provides a clean strong signal on either phone or CW, with RF output in excess of 100 watts on phone, and 120 watts on CW. Completely bandswitching from 160 through 10 meters. A pair of 1625 tubes are used in push-pull for the modulator, and the final consists of a pair of 6146 tubes in parallel. The VFO dial and meter face are illuminated, and all front panel controls are located for maximum convenience. Panel meter reads driver plate I, final grid I, final plate I, final plate voltage, and modulator current. The chassis is constructed of heavy #16 gauge copper-plated steel. Other high-quality components include potted transformers, ceramic switch and variable capacitor insulation, silver-plated or solid-silver switch terminals, etc. All coils are pre-wound, and the main wiring cable is pre-harnessed. The kit can be built by a beginner from the comprehensive step-by-step instructions supplied. It is a proven, trouble-free rig, that will insure many hours of "on-the-air" enjoyment in your ham shack.

HEATHKIT COMMUNICATIONS TYPE ALL BAND RECEIVER KIT

This receiver covers 550 kc to 30 mc in four bands, and is ideal for the short-wave listener or beginning amateur. It provides good sensitivity and selectivity, combined with good image rejection. Amateur bands clearly marked on illuminated dial scale. Employs transformer type power supply—electrical bandspread—antenna trimmer—separate RF and AF gain controls—noise limiter—headphone jack—and automatic gain control. Has built-in BFO for CW reception.

CABINET: Fabric covered cabinet with aluminum panel as shown. Part 91-15A. Shipping weight 5 Lbs. \$4.95

MODEL AR-3
\$299⁵

INCLUDING NEW
EXCISE TAX
(Less Cabinet)
Shpg. Wt. 12 Lbs.

HEATHKIT VFO KIT

You can go VFO for less than you might expect. Here is a variable frequency oscillator that covers 160, 80, 40, 20, 15, 11, and 10 meters with three basic oscillator frequencies, that sells for less than \$20. Provides better than 10 volt average RF output on fundamentals. Plenty of drive for most modern transmitters. Requires a power source of only 250 VDC at 15 to 20 ma. and 6.3 VAC at 0.45A. Incorporates a regulator tube for stability. Illuminated frequency dial reads frequency directly on the band being employed. Temperature-compensated capacitors offset coil heating.

MODEL VF-1
\$19⁵⁰

Shpg. Wt. 7 Lbs.



EASY ON THE BUDGET!

You can buy Heathkits on an easy time-payment plan that provides a full year to pay. Write for complete details and special order blank.



NEW HEATHKIT CW TRANSMITTER KIT

The brand new Heathkit Model DX-20 Transmitter is one of the most efficient little rigs available today. Featuring an entirely new circuit, it is ideal for the novice, and even for the advanced-class CW operator. A 6DQ6A final amplifier provides plate power input of 50 watts. A 6CL6 oscillator is employed, and a 5U4GB rectifier. The transmitter features one-knob bandswitching to cover 80, 40, 20, 15, 11 and 10 meters. It is designed for crystal excitation, but may be excited by an external VFO. A pi network output circuit matches antenna impedances between 50 and 1000 ohms. Front panel controls are functionally located for your convenience. If you appreciate a good signal on the CW bands, this is the transmitter for you!

MODEL DX-20
\$35⁹⁵

Shpg. Wt. 18 lbs.



HEATH COMPANY
A Subsidiary of Daystrom, Inc.
BENTON HARBOR 15, MICH.

DOLLAR-SAVING ECONOMY . . .

There would be no particular achievement in selling inexpensive merchandise at a low price—although it is being done every day. However, there is something to crow about when, through tremendous purchasing power and factory-to-you distribution, Heath Company can offer top-quality equipment, using name-brand components, at such low prices. This is real economy, as opposed to the so-called "bargains". Needless to say, there is a big difference.

The DX-35 features a 6146 final amplifier to provide 65 watts plate power input on CW, with controlled carrier modulation peaks up to 50 watts on phone. In addition, it is a most attractive transmitter. Modulator and power supplies are built-in, and the rig covers 80, 40, 20, 15, 11, and 10 meters with a single band-change switch. Pi network output coupling provided for matching various antenna impedances. A 12BY7 buffer stage provided ahead of the final amplifier for plenty of drive on all bands. 12BY7 oscillator and 12AU7 modulator. Provision for switch selection of three different crystals. Crystals reached through access door at rear. Front panel controls marked "off-CW-stand-by-phone", "final tuning", "antenna coupling", "drive level control", and "band change switch". Panel meter indicates final grid current or final plate current. A perfect low-power transmitter both for the novice, and for the more experienced operator. A remarkable power package for the price. Incidentally, the price includes tubes, and all other components necessary for assembly. As with all Heathkits, comprehensive instruction manual assures successful assembly.

HEATHKIT PHONE AND CW

Transmitter Kit

- * 6146 final amplifier for full 65-watt plate power input.
- * Phone and CW operation on 80, 40, 20, 15, 11, and 10 meters. Pi network output coupling.
- * Switch selection of three crystals — provision for external VFO excitation.



MODEL DX-35

\$56⁹⁵ Shpg. Wt. 24 Lbs.

HEATHKIT ANTENNA IMPEDANCE METER KIT

This instrument employs a 100 microampere panel meter and covers the impedance range of 0-600 ohms for RF tests. Functions up to 150 mc. Used in conjunction with signal source, such as the Heathkit Model GD-1B grid dip meter, the Model AM-1 will determine antenna resistance and resonance, match transmission lines for minimum standing wave ratio, determine receiver input impedance, etc. Will also double as a phone monitor. A very valuable device for many uses in the ham shack.

MODEL AM-1

\$14⁵⁰

Shpg. Wt. 2 Lbs.

HEATHKIT "Q" MULTIPLIER KIT

The QF-1 functions with any receiver with an IF frequency between 450 and 460 kc that is not AC-DC type. Operates from the receiver power supply, requiring only 6.3 VAC at 300 ma. and 150 to 250 VDC at 2 ma. Simple to connect with cable and plugs supplied. Provides additional selectivity for separating two signals, or will reject one signal and eliminate heterodyne. A big help on crowded bands. Provides an effective Q of approximately 4,000 for sharp "peak" or "null". Tunes to any signal within the IF bandpass of the receiver, without changing main receiver tuning dial.

MODEL QF-1

\$9⁹⁵

Shpg. Wt. 3 Lbs.

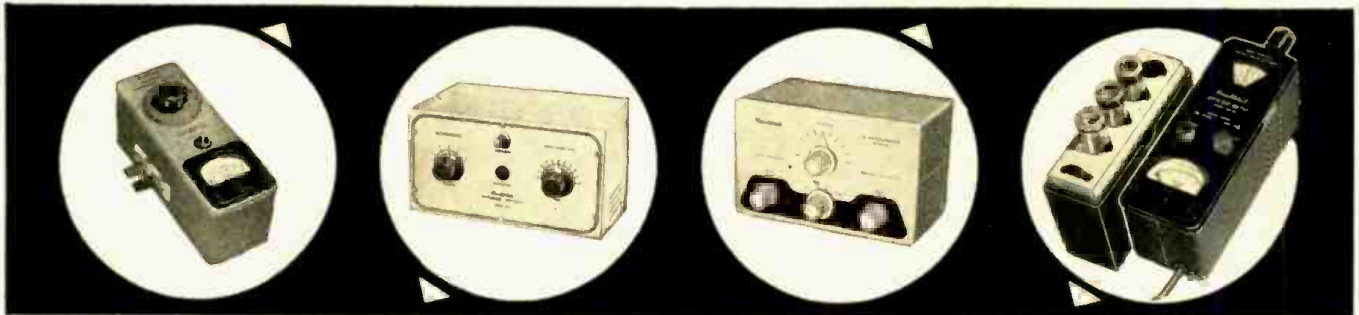

HEATHKIT ANTENNA COUPLER KIT

This device is designed to match the Model AT-1 transmitter to a long-wire antenna. In addition to impedance matching, this unit incorporates an L-type filter which attenuates signals above 36 megacycles, thereby reducing TVI. Designed for 52 ohm coaxial input. Handles power up to 75 watts, 10 through 80 meters. Uses a tapped inductor and variable capacitor. Neon RF indicator on front panel. Copper-plated chassis—high quality components throughout—simple to build. Eliminates waste of valuable communications power due to improper matching. A "natural" for all AT-1 transmitter owners.

MODEL AC-1

\$14⁵⁰

Shpg. Wt. 4 Lbs.

HEATHKIT GRID DIP METER KIT

The grid dip meter was originally designed for the ham shack. However, its use has been extended into the service shop and laboratory. Continuous frequency coverage from 2 mc to 250 mc with pre-wound coils. 500 microampere panel meter employed for indication. Use for locating parasitics, neutralizing, determining RF circuit resonant frequencies, etc. Coils are included with kit, as is a coil rack. Front panel controls include sensitivity control for meter, and phone jack for listening to zero-beat. Will also double as an absorption-type wavemeter.

MODEL GD-1B

\$19⁹⁵

Shpg. Wt. 4 Lbs.

HEATHKIT BROADCAST BAND



MODEL BR-2
(Less Cabinet)
Shpg. Wt. 10 Lbs.

\$18⁹⁵

INCLUDING NEW
EXCISE TAX*

ATTENTION BEGINNERS . . .

This kit is an ideal "first project" if you have never built a Heathkit before. A good chance to "learn by doing."

- * Miniature tubes and high-gain IF transformer.
- * Rod-type built-in antenna. Good sensitivity and selectivity.
- * 5½-inch PM speaker.
- * Provision for phono jack.
- * Transformer-operated power supply.

Receiver Kit

You need no previous experience in electronics to build this table-model radio. The Model BR-2 receiver covers 550 kc to 1620 kc and features good sensitivity and selectivity over the entire band. A 5½" PM speaker is employed, along with high gain miniature tubes and a new rod-type built-in antenna. Provision has been made in the design of this receiver for its use as a phonograph amplifier. The phono jack is located on the back chassis apron. A transformer operated power supply is featured for safety of operation, as opposed to the usual AC-DC supply commonly found in "economy radio kits." Don't let the low Heathkit price deceive you. This is the kind of set you will want to show off to your family and friends after you have finished building it.

Construction of this radio kit is very simple. Giant size pictorial diagrams and detailed step-by-step instructions assure your success. The construction manual also includes an explanation of basic receiver circuit theory so you can "learn by doing" as the receiver is built. The manual even provides information on resistor and capacitor color codes, soldering techniques, use of tools, etc. If you have ever had the urge to build your own radio receiver, the outstanding features of this popular Heathkit deserve your attention.

CABINET: Proxylin impregnated fabric covered plywood cabinet available for the BR-2 receiver as shown. Complete with aluminum panel, reinforced speaker grill, and protective rubber feet. Shipping weight 5 lbs., part No. 91-9A. **\$4.95***

HEATHKIT PROFESSIONAL RADIATION COUNTER KIT

This sensitive and reliable instrument has already found extensive application in prospecting, and also in medical and industrial laboratories. It offers outstanding performance at a reasonable price. Front-panel meter indicates radiation level, and oral indication produced by panel-mounted speaker. Meter ranges are 0-100, 600, 6,000 and 60,000 counts per minute, and 0-.02, .1, 1 and 10 milliroentgens per hour. The probe, with expansion cord, employs type 6306 bismuth counter tube, sensitive to both beta and gamma radiation. It is simple to build, even for a beginner.

MODEL RC-1
\$79⁹⁵

Shpg. Wt. 8 Lbs.



- * Amazing new circuit for high efficiency.
- * Compact, portable and rugged.
- * Stable circuit requires only one 67½ volt "B" battery and two 1½ volt "A" batteries.

HEATHKIT CRYSTAL RECEIVER KIT

The crystal radio of Dad's day is back again, but with big improvements! The Model CR-1 employs a sealed germanium diode, eliminating the critical "cat's whisker" adjustment. It is housed in a compact plastic box, and features two Hi-Q tank circuits, employing ferrite core coils and variable air tuning capacitors. The CR-1 covers the standard broadcast band from 540 kc to 1600 kc, and no external power is required for operation. Could prove valuable for emergency signal reception. This easy-to-build kit is a real "learn by doing" experience for the beginner, and makes an interesting project for all ages.

MODEL CR-1
\$7⁹⁵

INCLUDING NEW
EXCISE TAX*
Shpg. Wt. 3 Lbs.

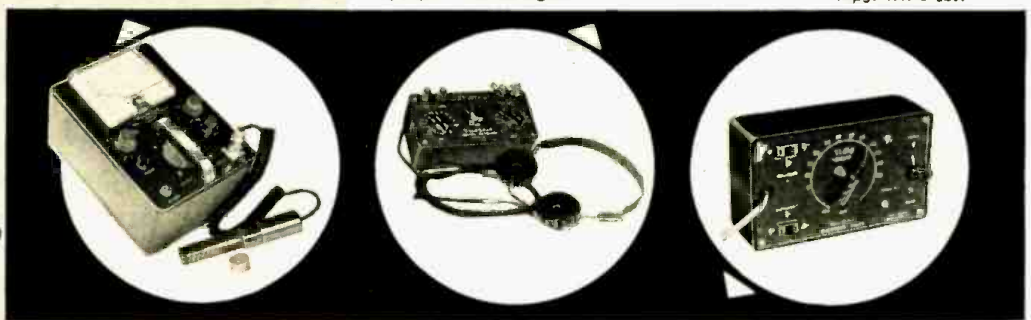

HEATHKIT ENLARGER TIMER KIT

The Model ET-1 is an easy-to-build device for use by amateur or professional photographers in controlling the timing cycle of an enlarger. It covers the range of 0 to 1 minute with a continuously variable, clearly calibrated scale. The timing period is pre-set, and the timing cycle is initiated by depressing the spring-return switch to the "print" position. Front panel provision is made for plugging in the enlarger and a safelight. The safelight is automatically turned "on" when the enlarger is "off". Handles up to 350 watts. The timing cycle is controlled electronically for maximum accuracy and reliability. Very simple to build in only one evening, even by a beginner.

MODEL ET-1
\$11⁵⁰

Shpg. Wt. 3 Lbs.



HEATH COMPANY
A Subsidiary of Daystrom, Inc.
BENTON HARBOR 15, MICH.

COMPREHENSIVE INSTRUCTIONS . . .
 The step-by-step assembly instructions provided with each Heathkit are the finest available anywhere. Each manual begins at the beginning, and assumes no previous training or experience on the part of the kit builder. This means that our kits can be built successfully by anyone who can follow instructions. As a matter of fact, new manuals are tested by having the kit built by someone in our office who has had no previous experience in electronics. This is your guarantee of complete and thorough instruction material.

HEATHKIT HIGH FIDELITY

Preamplifier Kit

- * 5 switch-selected inputs, each with its own level control.
- * Equalization for LP, RIAA, AES, and Early 78's.
- * Separate bass and treble tone controls, and special hum control.
- * Clean, modern lines and satin-gold enamel finish.

Literally thousands of these preamplifiers are in use today, because the kit meets or exceeds specifications for the most rigorous high-fidelity applications, and will do justice to the finest available program sources. Provides a total of 5 inputs, each with individual level controls (three high-level and two low-level). Frequency response is within 1 DB from 25 CPS to 30,000 CPS, or within 1½ DB from 15 CPS to 35,000 CPS. Hum and noise are extremely low, with special balance control for absolute minimum hum level. Tone control provides 18 DB boost and 12 DB cut at 50 CPS, and 15 DB boost and 20 DB cut at 15,000 CPS. Cabinet measures only 12-9/16" W. x 3¾" H. x 4¾" D, and it is finished in beautiful satin-gold enamel. 4-position turnover and 4 position roll-off controls provide "LP," "RIAA," "AES," and "early 78" equalization, and 8, 12, 16, and 1 flat position for roll-off. Derives operating power from the main amplifier, requiring only 6.3 VAC at 1 ampere and 300 VDC at 10 MA. Easy to construct from step-by-step instructions and pictorial diagrams provided.



MODEL WA-P2 (With Cabinet) Shpg. Wt. 7 Lbs.

\$19⁷⁵

HEATHKIT HIGH FIDELITY FM TUNER KIT

- * Illuminated slide-rule dial covers 88 to 108 MC.
- * Modern circuit emphasizes sensitivity and stability.
- * Housed in attractive satin-gold cabinet to match WA-P2 and BC-1.

This amazing new FM tuner can provide you with real high-fidelity performance at an unbelievably low price level. Covering 88 to 108 MC, the modern circuit features a stabilized, temperature-compensated, oscillator, A.G.C., broadbanded

IF circuits, and better than 10 UV sensitivity for 20 DB of quieting. A high gain, cascaded, RF amplifier is used ahead of the mixer to increase overall gain and reduce oscillator leakage. It employs a ratio detector for high efficiency without sacrifice in high-fidelity performance. IF and ratio transformers are pre-aligned, as is the front end tuning unit. This means the kit can be constructed by a beginner, without elaborate test and alignment equipment. The FM-3A is designed to match the WA-P2 preamplifier and the BC-1 AM **MODEL FM-3A** tuner. An illuminated slide-rule dial is employed for frequency indication. Step-by-step instructions and large pictorial diagrams assure success.

\$25⁹⁵
 INCLUDING NEW EXCISE TAX
 (With Cabinet)
 Shpg. Wt. 7 Lbs.



HEATHKIT BROADBAND AM TUNER KIT

This AM tuner has been designed especially for high-fidelity applications. It incorporates a low-distortion detector, a broadband IF, and other features essential to usefulness in high-fidelity. Special voltage-doubler detector employs crystal diodes for low distortion. Sensitivity and selectivity are excellent. Audio response is ± 1 DB from 20 CPS to 2 kc, with 5 DB of pre-emphasis at 10 kc to compensate for station roll-off. Covers the standard broadcast band from 550 to 1600 kc. Incorporates a 10 kc whistle-filter and provides a 6 DB signal-to-noise ratio at 2.5 UV. RF and IF coils are pre-aligned, and power supply is built-in. Incorporates AVC, two outputs, and two antenna inputs.

MODEL BC-1
\$25⁹⁵
 INCLUDING NEW EXCISE TAX
 (With Cabinet)
 Shpg. Wt. 8 Lbs.

HEATHKIT ELECTRONIC CROSS-OVER KIT

This unusual device functions to separate low frequencies and high frequencies so that they may be fed to separate amplifiers and to separate speakers. This eliminates the need for conventional cross-over circuits, since the Model XO-1 does the complete job electronically. Cross-over frequencies of 100, 200, 400, 700, 1,200, 2,000 and 3,500 CPS are selectable with front panel controls on the XO-1, and a separate level control is provided for each channel. Minimizes inter-modulation distortion problems. Handles unlimited power, since frequency division is accomplished ahead of the power stage. Attenuation is 12 DB per octave, with sharp "knee" at cut-off frequency.

MODEL XO-1
\$18⁹⁵
 Shpg. Wt. 6 Lbs.

HEATHKIT ADVANCED-DESIGN



MODEL W-5M
Shpg. Wt. 31 Lbs.
Express Only

\$59⁷⁵

MODEL W-5

Consists of Model W-5M plus Model WA-P2 pre-amplifier.

Shpg. Wt. 38 Lbs.
Express only... \$79.50

- * Full 25 watt output with KT-66 output tubes.
- * All connectors brought out to front chassis apron.
- * Protective cover over all above-chassis components.

HEATHKIT DUAL-CHASSIS—WILLIAMSON TYPE HIGH FIDELITY AMPLIFIER KIT

This 20-watt high-fidelity amplifier employs the famous Acro-sound Model TO-300 "ultra-linear" output transformer and uses 5881 output tubes. The power supply is built on a separate chassis, and the two chassis are inter-connected with a power cable. This provides additional flexibility in mounting. Frequency response is ± 1 DB from 6 CPS to 150 kc at 1 watt. Harmonic distortion is only 1% at 21 watts, and 1M distortion is only 1.3% at 20 watts. (60 and 3,000 CPS). Output impedance is 4, 8, or 16 ohms. Hum and noise are 88 DB below 20 watts. A very popular high-fidelity unit employing top-quality components throughout.

MODEL W-3M: Shpg. Wt. 29 Lbs. Express only... \$49.75

MODEL W-3: Consists of Model W-3M plus Model WA-P2 pre-amplifier. Shpg. Wt. 37 Lbs. Express only... \$69.50

HEATHKIT 7-WATT AMPLIFIER KIT

This amplifier is more limited in power than other Heathkit models, but it still qualifies as a high-fidelity unit, and its performance definitely exceeds that of many so-called "high-fidelity" phonograph amplifiers. Using a tapped-screen output transformer of new design, the Model A-7D provides a frequency response of $\pm 1\frac{1}{2}$ DB from 20 to 20,000 CPS. Total distortion is held to a surprisingly low level. Output stage is push pull, and separate bass and treble tone controls are provided. Shpg. Wt. 10 Lbs.

MODEL A-7E: Similar to the A-7D, except that a 12SL7 tube has been added for pre-amplification. Two inputs, RIAA compensation, and extra gain.

MODEL A-7D

\$17⁹⁵

INCLUDING NEW EXCISE TAX

\$19.95¹

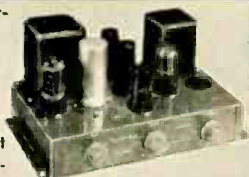

HIGH FIDELITY

Amplifier Kit

This 25 watt unit is our finest high-fidelity amplifier. Using a special design peerless output transformer, and KT-66 output tubes by Genalex, the Model W-5M provides performance characteristics unsurpassed at this price level. Frequency response is ± 1 DB from 5 to 160,000 CPS at 1 watt. Harmonic distortion is less than 1% at 25 watts and 1M distortion is less than 1% at 20 watts (60 and 3,000 CPS, 4 to 1). Hum and noise are 99 DB below 25 watts. Damping factor is 40 to 1. Input voltage for 5 watts output is 1 volt. Tubes employed are a pair of 12AU7's, a pair of KT-66's and a 5R4GY rectifier. Measures 13-3/32" W. x 8 1/2" D. x 8 1/4" H. Output impedance is 4, 8, or 16 ohms. Featured, also, is the "tweeter saver" which suppresses high frequency oscillation, and a new type balancing circuit requiring only a voltmeter for indication. This balance is easier to adjust, and results in a closer "dynamic" balance between output tubes. The Model W-5M provides improved phase shift characteristics, reduced 1M and harmonic distortion, and improved frequency response. Conservatively rated high-quality components are used throughout to insure years of trouble-free operation. No technical background or training is required for assembly. Step-by-step instructions are provided for every stage of construction, and large pictorial diagrams illustrate exactly where each wire and component is to be placed. An amplifier for music lovers who can appreciate subtle differences in performance. Just ask the audiophile who owns one!

HEATHKIT SINGLE CHASSIS—WILLIAMSON TYPE HIGH FIDELITY AMPLIFIER KIT

The 20-watt Model W-4AM Williamson type amplifier is a tremendous high-fidelity bargain. Combining the power supply and main amplifier on one chassis, and using a special-design output transformer by Chicago Standard brings you savings without a sacrifice in quality. Employing 5881 output tubes, the frequency response of the W-4AM is ± 1 DB from 10 CPS to 100 kc at 1 watt. Harmonic distortion is only 1.5% at 20 watts. Output impedance is 4, 8, or 16 ohms. Hum and noise are 95 DB below 20 watts.

MODEL W-4AM: Shpg. Wt. 28 Lbs. Express only... \$39.75

MODEL W-4A: Consists of Model W-4AM plus Model WA-P2 pre-amplifier. Shpg. Wt. 35 Lbs. Express only... \$59.50

HEATHKIT 20-WATT HIGH FIDELITY AMPLIFIER KIT

This high-fidelity amplifier features full 20-watt output using push pull 6L6 tubes. Built-in preamplifier provides 4 separate inputs, selected by a panel-mounted switch. It has separate bass and treble tone controls, each offering 15 DB boost and cut. Output transformer is tapped at 4, 8, 16, and 500 ohms. Designed primarily for home installations, but also used extensively for public address applications. True high-fidelity performance with frequency response of ± 1 DB from 20 CPS to 20,000 CPS. Total harmonic distortion only 1% (at 3 DB below rated output).

MODEL A-9B

\$35⁵⁰

Shpg. Wt. 23 Lbs.



HEATH COMPANY

A Subsidiary of Daystrom, Inc.

BENTON HARBOR 15, MICH.

HEATHKIT HIGH FIDELITY

Range Extending SPEAKER SYSTEM KIT

All prices marked with a ‡ include a new federal excise tax that now applies to receivers, tuners and some amplifiers, even though they may be in kit form. Since the tax is in effect as of July 5, 1956, we have no choice but to reflect it in our kit prices. This note is just to let you know we are not increasing our prices on some kits, but merely including this new tax in them.

Thank you,
HEATH COMPANY

- * High quality speakers of special design — 15" woofer and compression-type super-tweeter.
- * Easy-to-assemble cabinet of furniture-grade plywood.
- * Attractively styled to fit into any living room. Matches Model SS-1.



MODEL
SS-1B

\$99⁹⁵

Shpg. Wt. 80 Lbs.

This range extending unit is designed especially for use with the Model SS-1 speaker system. It consists of a 15" woofer, providing output between 35 and 600 CPS, and a compression-type super-tweeter that provides output between 4,000 and 16,000 CPS. Cross-over frequencies are 600, 1,600, and 4,000 CPS. The SS-1 provides the mid-range, and the SS-1B extends the coverage at both ends of the spectrum. Together, the two speaker systems provide output from 35 to 16,000 CPS within ± 5 DB. This easy-to-assemble speaker enclosure kit is made of top-quality furniture-grade plywood. All parts are pre-cut and pre-drilled, ready for assembly and the finish of your choice. Complete step-by-step instructions are provided for quick assembly by one not necessarily experienced in woodworking. Coils and capacitors for proper cross-over network are included, as is a balance control for super-tweeter output level. The SS-1 and SS-1B can provide you with unbelievably rich audio reproduction, and yet these units are priced reasonably. The SS-1B measures 29" H. x 23" W. x 17½" D. The speakers are both special-design Jensens, and the power rating is 35 watts. Impedance is 16 ohms.

HEATHKIT HIGH FIDELITY SPEAKER SYSTEM KIT



MODEL
SS-1

\$39⁹⁵

Shpg. Wt. 30 Lbs.

This speaker system is a fine reproducer in its own right, covering 50 to 12,000 CPS within ± 5 DB. However, the story does not end there. Should you desire to expand the system later, the SS-1 is designed to work with the SS-1B range extending unit — providing additional frequency coverage at both ends of the spectrum. It can fulfill your present needs, and still provide for the future. The SS-1 uses two Jensen speakers; an 8" midrange-woofer, and a compression-type tweeter. Cross-over frequency is 1,600 CPS, and the system is rated at 25 watts. Nominal impedance is 16 ohms. The cabinet is a ducted-port bass-reflex type. Attractively styled, the Model SS-1 features a broad "picture-frame" molding that will blend with any room decorating scheme. Pre-cut and pre-drilled wood parts are of furniture grade plywood. The kit is easy-to-build, and all component parts are included, along with complete step-by-step instructions for assembly. Can be built in just one evening, and will provide you with many years of listening enjoyment thereafter.

- * Special design ducted-port, bass-reflex enclosure.
- * Two separate speakers for high and low frequencies.
- * Kit includes all parts and complete instructions for assembly.

HEATH COMPANY A Subsidiary of Daystrom, Inc. **BENTON HARBOR 15, MICH.**

ORDER BLANK

NOTE: All prices subject to change without notice.

Enclosed find () check () money order for.

Please ship C.O.D. () postage enclosed for _____ pounds.

On Express orders do not include transportation charges — they will be collected by the express agency at time of delivery.

ON PARCEL POST ORDERS include postage for weight shown. ORDERS FROM CANADA and APO'S must include full remittance.

Name _____

Address _____

City & Zone _____ State _____

(PLEASE PRINT)

SHIP VIA

Parcel Post

Express

Freight

Best Way

QUANTITY	ITEM	MODEL NO.	PRICE

"GRIP" PRESENTING THE *New* SPINTITE[®] WRENCHES

PATENTS PENDING

FINEST QUALITY
STEEL SHANK
AND SLEEVE
○
BRIGHT PLATED
FINISH
○
STRONG
PLASTIC HANDLE

WITH THE EASY "FINGER-CONTROL"
GRIP AND RELEASE ACTION
FOR THOSE
HARD-TO-GET-AT PLACES —

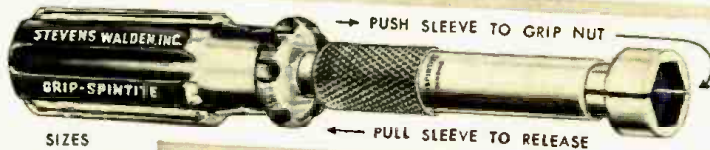

SIZES
3/16" TO 1 1/16"

BY THE MAKERS OF
THE ORIGINAL
SPINTITE
WRENCHES
OVER 150 STYLES
AND SIZES

ONE HAND OPERATION—

- GRIPS nuts or bolts of any material
- HOLDS firmly in any position
- TIGHTENS nut or bolt securely
- RELEASES at the pull of the fingers

101-4

STEVENS WALDEN Inc.

450 SHREWSBURY STREET — WORCESTER, MASSACHUSETTS
MAKERS OF WORLD-FAMOUS HAND TOOLS FOR OVER 50 YEARS

Write for
catalogue

CUT CHASSIS HOLES FAST!



Smooth, accurate openings made
in 1 1/2 minutes or less with
Greenlee Radio Chassis Punch

Save hours of tedious work. Quickly make smooth, accurate holes in metal, bakelite, or hard rubber with a GREENLEE Chassis Punch. Easy to operate . . . simply turn with an ordinary wrench. Round, square, key, and "D" types . . . wide range of sizes to make openings for sockets, plugs, controls, meters, terminal strips, transformers, panel lights, etc. Assure perfect fit of parts and professional finish to every job. Write for descriptive literature. Greenlee Tool Co., 1881 Columbia Ave., Rockford, Ill.



**PREPARES YOU FOR
YOUR LICENSE
EXAMINATION!**

- Questions on Basic Law
- Basic Operating Practice
- Basic Radiotelephone
- Advance Radiotelephone

Now, in one convenient volume, complete study-guide questions with clear, concise answers for preparation for all U.S.A. commercial radio-telephone operator's license examinations.

Paperbound

\$3.75 in U.S.A. (plus sales tax where applicable)



BUY FROM YOUR DISTRIBUTOR
Add 10% on direct mail orders to
EDITORS and ENGINEERS, Ltd.
Summerland 2, California

What's Ahead for the TV Industry

Dr. W. R. G. Baker takes optimistic view, expects growth, but also change.

IN HIS report to the fall meeting of the Institute of Radio Engineers and the Radio-Electronics-Television Manufacturers Association, Dr. W. R. G. Baker, president of RETMA and vice-president of the *General Electric Company*, anticipated a bright future for all facets of the TV industry. He accompanied his predictions with the observation that many forecasts for the electronics industry made in recent years turned out to be not optimistic enough.

Since Dr. Baker was unable to appear in person, his report was delivered by Arthur V. Loughren, president of IRE. Some of the highlights, statistical and non-statistical, included the following "guesstimates":

As compared to about 7 1/2 million TV sets being sold annually now, about 10 million a year will be the annual sale by 1960.

Closed-circuit industrial TV will quadruple over the next four years, with sales, now at the \$6 million mark, reaching \$24 million by 1960.

With the rapid development of scatter transmission techniques, transoceanic TV broadcasts are only a matter of time.

With many other nations throughout the world ready to begin TV broadcasting for the first time in 1957, the sales potential for foreign markets will continue to forge upward.

Truly portable transistorized TV sets will be on the market within two years.

Color TV will always cost more than monochrome receivers, and there will surely be no drastic downward revision of color prices in the immediate future, although eventually less expensive color sets are in the offing.

Looking into the immediate future, 1956 will end up as one of the best years for TV receiver sales despite the slackening off that characterized the first 9 months.

On the u.h.f.-v.h.f. dispute, Dr. Baker advised a go-slow attitude until a thorough study has been made.

Stating that there has been no precedent in industrial history for the growth of electronics, Dr. Baker pointed out, "Ten years ago it was an industrial infant and now it provides employment for one-and-three-quarter million Americans, which represents one person in every 40 in our total work force. And the amazing thing is that 75 per-cent of these jobs didn't exist just 10 years ago." —30—

New Tube Tester Data

Keep your Jackson tube checker up-to-date with this information on testing recent tube types.

JACKSON MODEL 648

Tube Type	Filament	Circuit		Plate Test	Tube Type	Filament	Circuit		Plate Test		
		D	E				D	E			
2B3	1.75	12	9	40XZ	6M3	6.3	139	6	13W		
2BN4	2.0	AC123	A57	38V	8AU8	8.4	A128	679*	75Z		
3AF4	3.0	A235	A46	28V			A124	A35	58V		
3BU8	3.0	A1249	358	65XZ	8AV8	8.4	A129	678*	18XZ		
			AB567	65XZ			A124	A35	22XZ		
3C2	3.0	12	9	32XZ	8BA8	8.4	A128	679*	32WZ		
4BC5	4.2	A234	AC156	14WY			124	A35	25WZ		
4BN6	4.2	C123	4567	65VY	8CG7	8.4	1237	A45	15WY		
4BU8	4.2	A1249	358	65XZ				A89	15WY		
			AB567	65XZ	8BH8	8.4	A128	679*	65Z		
4BX8	4.2	A1237	A45	38V			A124	A35	36Y		
			A89	38V	8CM7	8.4	A123	A89	65V		
4BZ8	4.2	A1237	A45	41V			126	A47	38Z		
			A89	41V	8CN7	8.4	A128	A79	32WX		
4CB6	4.2	AC1234	567*	16WY			123	5	60X		
4CE5	4.2	AC123	567*	50YZ				4	60X		
4DT6	4.2	A2347	AC156	75XZ	8CS7	8.4	126	AC34	35Z		
5BQ7	5.6	A1237	A45	41V			127	A89	70Z		
			A89	41V	8SN7	8.4	234	A17	15WY		
5BZ7	5.6	A1237	A45	41V			238	AC56	15WY		
			A89	41V	9AU7	9.4	123	A45	40WZ		
5CG8	5.0	A126	AC789*	22XZ			127	A89	40WZ		
		A123	AC45	20XZ	9U8	9.4	A125	C389*	20WY		
5CL8	5.0	A127	AC689	82Z			127	A46	36Z		
		A123	AC45	65Z	10C8	10.5	A127	AC689*	20WY		
5CM8	5.0	A125	A3C389*	16WY			123	A45	20YZ		
		A127	A46	45XZ	12AC6	12.6	A2347	AC156	80X		
6BN4	6.3	AC123	A57	38V			12AD6	AC156	100XZ		
6BU8	6.3	A1249	358	65XZ				AC46	45XZ		
			AB567	65XZ	12AE6	12.6	A237	AC14	95X		
6BV8	6.3	124	A35	18YZ			5	80X			
		129	6	60X			6	80X			
6BX8	6.3	A1237	A45	38V	12AF6	12.6	A2347	AC156	80X		
			A89	38V			12F8	12.6	A1269	357	
6BY8	6.3	1256	B479	40WZ				129	4	80X	
		123	8	60X	12K5	12.6	C123	457	8	80X	
6BZ8	6.3	A1237	A45	41V			12U7	12.6	A123	A15	83X
			A89	41V					A127	A89	83X
6CG8	6.3	A126	AC789*	22XZ	17AV5	17.	234	6	13W		
		A123	AC45	20XZ	17C5	17.	C123	456	35VW		
6CH8	6.3	A129	C358*	16WY	17CU5	17.	C123	467	22Z		
		124	AC67	16YZ	17DQ6	17.	1237	AB569	15W		
6CL8	6.3	A127	AC689	82Z	17H3	17.	124	3	20Z		
		A123	AC45	65Z	18A5	19.	A124	C367	37VW		
6CM8	6.3	A125	AC389*	16WY	25F5	25.	C123	A456	25Z		
		A127	A46	45XZ	35CD6	35.	124	AB369	15W		

*When testing this section for shorts, the K (Cathode) and G1 (Grid no. 1) positions of the shorts test switch will be reversed.

Here's how to GET MORE WORK OUT OF YOUR Oscilloscope!

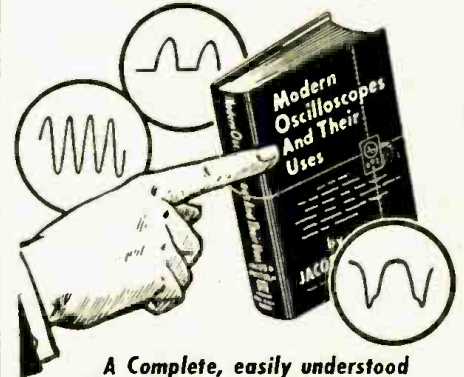

A Complete, easily understood guide to using the handiest service instrument of them all

MODERN OSCILLOSCOPES AND THEIR USES

By Jacob H. Ruiter, Jr.

Enlarged 2nd Edition

... contains the latest data ... everything you need to know about 'scopes!

MORE THAN 30 NEW PICTURES

... plus 50 more pages on use of 'scopes in Color TV servicing ... Industrial Electronics ... Teaching ... even in Atomic Energy work.

Oscilloscopes are gold mines for servicemen who learn to use them fast, fully and accurately on all types of work—and here is a new, enlarged 2nd edition of THE BOOK THAT REALLY SHOWS YOU HOW.

In clear, easily understood terms, it teaches you when, where and exactly how to use the oscilloscope ... how to interpret patterns ... how to use your 'scope to handle tough jobs easier, faster, and better.

It contains no involved mathematics—no complicated discussions. Instead, it gets right down to "brass tacks" in explaining how oscilloscopes operate. Then you learn exactly how to use them in lab work and on all types of A.M., F.M. and television service—from locating troubles to handling tough realignment jobs.

'SCOPES ARE "GOLD MINES" ... When You Learn to Use Them Right!

Each operation is explained step by step. You learn to determine just where and how to use the 'scope on specific jobs; how to make connections and adjust circuit components; how to set the controls; and HOW TO ANALYZE OSCILLOSCOPE PATTERNS fast and accurately.

370 illustrations including dozens of pattern photos make things doubly clear.

No other type of specific service training can mean so much to you in boosting your efficiency and earning power! Send coupon NOW for 10-day FREE examination!



'SCOPE EXPERTS get better jobs ... bigger pay!

PRACTICE 10 DAYS—FREE!

Dept. RN-17, RINEHART & COMPANY, Inc.
232 Madison Ave., New York 16, N. Y.

Send MODERN OSCILLOSCOPES AND THEIR USES for 10-day FREE EXAMINATION. If book is satisfactory, I will then send you \$6.50 promptly in full payment. If not, I will return book postpaid in good condition and owe you nothing. (SAVE! Send \$6.50 cash with order and we pay postage. Same 10-day return privilege with money refunded.)

NAME
ADDRESS
CITY, ZONE, STATE
OUTSIDE U.S.A. \$7.00 cash only. Money back if you return book within 10 days.

BUILD THE BEST—

BUILD ALLIED'S OWN

knight-kits

ALLIED stakes its 36-year reputation in the electronics field on your complete success and fullest satisfaction with KNIGHT-KITS. In the thousands who have discovered the ultimate in kit value in...



knight-kits

LOWEST COST because our giant buying power passes biggest savings on to you... you do the easy assembly and your finished instrument is equal in performance and appearance to equipment selling for several times the KNIGHT-KIT cost. (Easy Payment Terms available, too.)



knight-kits

EASIEST TO BUILD because KNIGHT-KIT "Step-and-Chek" instruction manuals are marvels of clarity—it's just like having a good instructor at your side. Proved professional design and premium quality parts help insure your building success.



knight-kits

MONEY-BACK GUARANTEE: When properly assembled, KNIGHT-KITS fully meet published specifications, or we refund your money.

WHEN YOU BUILD A KNIGHT-KIT
YOU BUILD THE BEST



For a Complete Selection of
Famous **knight-kits**
SEE PAGES 105-111

Available Only From

ALLIED RADIO
100 N. Western Ave., Chicago 80, Ill.

Mac's Service Shop (Continued from page 76)

bellow like a bull into the mike without the least sign of an arc or without popping a fuse."

"Well, I'm certainly glad you found your trouble," Mac remarked as he hung up his street coat and shrugged his way into his shop coat. "Now how's about helping me with mine? Listen to how badly this cussed record player distorts. It has a lot of years on it, but it still should sound a lot better than that."

He turned on the straight 78 rpm record player, and the music that issued from the speaker made Barney wince.

"Sounds like a bad needle," he suggested as he picked up the tone arm from the record.

"That was my thought, too; so I put in a brand new needle. If anything that made it worse. Then I decided it must be the cartridge, but a new one did not make a particle of difference. Finally I went over the amplifier with a fine-toothed comb, changing tubes, checking voltages, looking for leaky capacitors, etc.; but there is absolutely nothing wrong with that record player except that it sounds horrible!"

While Mac was talking, Barney had been carefully scrutinizing the needle with the tone arm practically rubbing his pug nose. Finally he removed the needle from the chuck and took it over to the bench light for an even closer inspection. Next, without saying a word, he got a new needle from a display card and installed it in the tone arm. When the arm was lowered to the still-spinning record, the music came forth clear and undistorted.

"Well I'll be darned!" Mac ex-

claimed. "I know I changed that needle. The new one must have been bad right from the start."

"Is that so hard to believe?" Barney wanted to know. "You recall that every now and then we find a defective new tube, a leaky new capacitor, or a new resistor that is not of the value indicated on it. It's true this happens very, very rarely; but it still happens. Why couldn't a phonograph needle slip through inspection once in a blue moon? Obviously this one did, for it has a point on it like a postoffice pen."

"Well, Irish, that's one time you certainly showed up the old man," Mac said ruefully.

"Aw, don't take it so hard," Barney consoled; "it was just my younger eyes that allowed me to spot the trouble."

"Nope. I'm not going to beg off on that excuse," Mac said firmly. "In the first place, I'll not admit I can't see just as well as you can. In the second place, I was guilty of doing something I've bawled you out for a dozen times: disregarding the obvious symptom. That sounded exactly like a bad needle right from the start, but after I put in a new needle and it sounded worse—and that should have tipped me off at once—I dismissed the needle possibility from my mind entirely and went looking for something else. I was just plain stupid, and I'll not deny it—or let you deny it."

"Okay! Okay! Have it your own way," Barney said agreeably; "but I'll wager if all the time service technicians have wasted because they failed to suspect a new component could be placed end-to-end, it would add up to a light-year or so."

"Which is about the same length of time it would take to straighten out that mixed metaphor," Mac remarked as he picked up his solder gun. —30—

An extensive program is under way at Bell Telephone Laboratories to develop traveling-wave amplifier tubes for communications applications. Here tests are being conducted on an experimental tube designed to provide 5 watts output with a bandwidth of 500 mc. in the 6000 mc. band. In this particular test, designed to detect and measure a certain type of nonlinearity in the tube, a 6000 mc. amplitude-modulated signal is fed to the traveling-wave tube. If nonlinearity exists, some of this amplitude modulation will be converted to phase modulation, which can then be detected in the amplified signal at the output of the traveling-wave tube. Note the very extensive use of elaborate r.f. plumbing in the test setup shown.

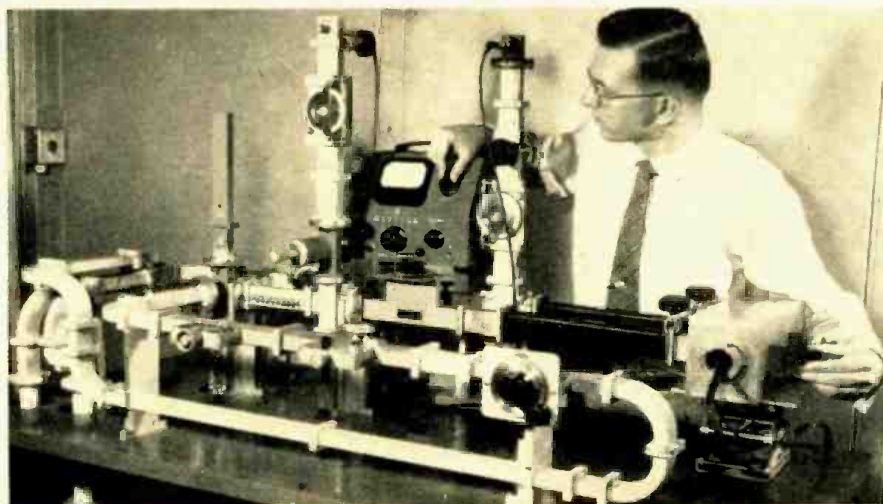



Manufacturers' Literature

CAPACITOR REPLACEMENTS

Cornell-Dubilier Electric Corporation of South Plainfield, N. J. has announced publication of its annual Replacement Capacitor Catalogue.

Prepared especially for distributors, Catalogue 200D-3, covers electrolytic, paper tubular, industrial, mica, ceramic, filter, and motor starting units. The 44-page, 3-color catalogue is sectionalized and thumb-indexed for quick reference.

Copies of the new catalogue will be supplied by the company's distributors or upon letterhead request direct to the manufacturer.

METAL BOX LINE

Zero Manufacturing Company, 1121 Chestnut Street, Burbank, Cal. has issued an elaborate 60-page catalogue which describes its line of deep-drawn and fabricated cases of aluminum, brass, and steel.

Included are special cases designed especially for electronic and instrument applications. The company stocks some 1400 standard items while custom sizes are available on special order.

Manufacturers are invited to write for a copy of this catalogue.

TRANSISTOR SPECIFICATIONS

General Transistor Corp., 130-11 90th Ave., Richmond Hill 18, N. Y. has issued a tentative specification and cross reference sheet on its line of hermetically sealed germanium *p-n-p* alloyed junction transistors.

Technical bulletin No. G-7 lists types, uses, maximum ratings, characteristics, and comparable reference types as manufactured by *Raytheon*, *G-E*, *Sylvania*, *RCA*, *CBS*, *Texas Instruments*, and *Philco*.

The company will supply a copy of this handy wall chart on request.

CAPACITOR CATALOGUE

Cornell-Dubilier Electric Corporation, South Plainfield, N. J. has issued a colorful 20-page brochure describing its line of "Tiny Mike" ceramic capacitors.

Catalogue No. 616 includes complete physical and electrical characteristics, photographs of the capacitors, and graphs of capacitance variation with temperature changes.

Write the manufacturer direct for a copy of this catalogue.

ASSOCIATION ENCYCLOPEDIA

Gale Research Company, 424 Book Tower, Detroit 26, Mich., has announced the publication of its "Encyclopedia of American Associations" which lists more than 5000 associa-

January, 1957

\$100,000 GUARANTEED PERFORMANCE

Hi-Lo is covered by a \$100,000.00 insurance policy issued by one of the largest insurance companies.*

Each and every Hi-Lo is backed by a money back guarantee. For the best reception, unsurpassed clear pictures, specify Hi-Lo, with the exclusive highest gain, spiral designs which are covered by the following U.S. patent numbers: 2,495,579; 2,583,745; 2,724,773; 2,748,387; 2,755,466; and Canadian Patents 1951 and 1956; other patents pending.



Hi-Lo Model 505 — Channels 2-83
The spiral antenna that is designed for maximum performance featuring the NEW TELESCOPING DIPOLES. This versatile antenna swivels on ball and socket in any direction. Gold spirals, plastic base blend with any room. LIST . . . \$14.95



Hi-Lo Model 101 — Channels 2-13.
The original and world famous antenna that is wanted, demanded and used for GUARANTEED FINEST RECEPTION. No rods to adjust. Provides clearest pictures faster. LIST . . . \$9.95



Hi-Lo Model 303 — Channels 14-83.
The UHF ANTENNA with the highest signal gain that is specially designed for ALL UHF areas. Luxurious gold upright and crossbar. LIST . . . \$5.95



Hi-Lo Model 404 Channels — 2-83.
NEW INDOOR ANTENNA that swivels with a gentle touch of your little finger. Dipoles swivel on ball and socket in every direction. Golden spirals and decorative plastic base blend with all furniture. RECEPTION IS GUARANTEED. LIST . . . \$12.95



Hi-Lo Model 202 — Channels 2-83
PEAK PERFORMANCE which is unsurpassed is guaranteed with this antenna . . . for ANY and EVERY area. The gleaming gold upright, shiny spirals, bakelite base, aluminum bars, modern design

*name upon request . . . all make this YOUR BEST ANTENNA BUY. LIST . . . \$9.95

INSIST ON THE GENUINE Hi-Lo Spiral Antennas!
Known and accepted everywhere, Hi-Lo is manufactured and GUARANTEED by the best antenna manufacturer in the world. Hi-Lo is consumer accepted and approved.

Hi-Lo TV ANTENNA CORP.
3540 North Ravenswood Avenue
Chicago 13, Illinois

THE FINEST TELEVISION AND FM ACCESSORIES by

Dynamic
ELECTRONICS

FOR BETTER RECEPTION Tested and specifications certified by New York Testing Laboratories, Inc.



Designed especially for Tape, Wire and Disc Recorders & Play Backs and HIGH FIDELITY, PHONOS, AMPLIFIERS, FM & AM TUNERS, TELEVISION RECEIVERS.

Guaranteed elimination of noise picked up thru the line caused by motors, ignition, neon, dishwashing, lighting & heating equipment, transmitters and electrical appliances.

- DUAL FILTER ACTION.
- PASSES ALL FREQUENCIES ABOVE 10 KC.
- AUTOMATIC ATTENUATION ABOVE 10 KC.

Model DF200 Introductory Price \$6.95.



Guaranteed complete suppression and elimination of disturbances in antenna system caused by ignition, dishwashing, X-ray, industrial RF, appliances, fluorescent, neon, and transmitters.

- Passes all frequencies above 40 mc.
- Rejects all frequencies below 40 mc.

Model T121 Introductory Price \$4.95

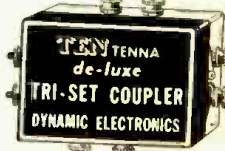

For highly efficient operation of any combination of 2 or 3 TV sets or FM Receivers from 1 Antenna of any type—absolutely no interaction.

- Less than 6db insertion loss.
- 40 to 50db rejection ratio.

Model T130 Introductory Price \$5.45



Assures removal of overload in strong signal areas. Will improve and remedy faulty A.C. circuits in TV & FM Receivers, regardless of cause.

- Eliminates ghosts and image tearing.
- Reduces audio and video distortion.

Model T115 Introductory Price \$4.95

FREE!

An 8-page booklet packed with every "Dynamic" accessory. "How to recognize and remedy your TV and FM problems."

Frequently poor reception occurs even though the receiver is in good condition and operating to the accepted standards of the manufacturer. In such cases, the problem can often be rectified and reception improved by using a properly designed external accessory.

There is a Dynamic accessory or service aid for practically every need. Satisfaction guaranteed or your money back!

Available at leading parts distributors
Manufactured by

DYNAMIC ELECTRONICS-NEW YORK, INC.
Forest Hills, Long Island, N. Y.

tions, societies, and chambers of commerce.

The associations are listed in six basic sections covering: trade, business, agricultural, and governmental; scientific and engineering; educational and social welfare; medical and health; general associations; and chambers of commerce.

The book sells for \$15.00 a copy and is available direct from the publisher.

TERMINAL BLOCKS

Curtis Development & Manufacturing Co., 3266 N. 33rd Street, Milwaukee 16, Wis., has compiled data on its line of terminal blocks and terminal block kits which it is issuing as condensed catalogue No. 556.

This 8-page brochure includes a technical description, specifications, and current prices on the firm's entire line. A new selector chart designed to pinpoint the best block for each application is also included.

The catalogue suggests combinations of various types of terminals within the same block for most convenient terminating of high current, control, and power circuits in a minimum space and with reduced cost.

This publication may be had by writing to John Eschweiler, sales engineer of the firm.

"MAGNEMITE" PORTABLE

Amplifier Corp. of America, 398 Broadway, New York 13, N. Y., has issued a 4-page data sheet giving complete information on its "Magnemite" portable, a battery-operated, spring-motor tape recorder.

The brochure describes in detail features of all fifteen models available in the line. A variety of single and multi-speed models is offered and the brochure tabulates all the pertinent data. Various mechanical and electrical components are fully described and individually illustrated.

Copies of this brochure will be supplied upon request to the manufacturer.

METER CATALOGUE

Greibach Instruments Corporation has issued a new 8-page catalogue describing its line of meters for factory, field, and laboratory use.

The publication includes two full pages of charts and diagrams describing the variety of scales and ranges available while another section illustrates some of the accurate meters.

Copies of this catalogue are available by writing Lawrence C. Oakley, engineering sales manager, in care of the company at Metuchen, N. J.

DUAL-RANGE POWER SUPPLY

Electro Products Laboratories, 4500 Ravenswood Ave., Chicago 40, Ill., has issued an illustrated catalogue sheet which describes its two-range d.c. power supply for servicing transistor radios.

The unit described, the Model D612T, offers power ranges of 8 and 16 volts and is designed to operate, test, and

Hi-Fidelity AM-FM Radio



FAMOUS MAKE
RCA LICENSED
Reg. Price \$139.50
FOR RADIO ALONE
Complete
Ready to Play

\$59.95

1957 MODEL SALE Price

Here is a complete Hi-Fidelity FM-AM radio made by one of the top manufacturers. This set is ideal for custom installations. Built-in 14 Watt Hi-Fidelity push-pull amplifier. Separate bass and treble controls, built-in AM and FM antennas, phono jack, output jack for tape recorder. Frequency Range 20-20,000 cycles \pm 2db. Output trans. tapped for 3.2, 8 and 16 ohms. T-11 tube set comes complete with crystal and magnetic phono inputs, including a 12" RCA extended range speaker. Size 12 1/2 x 7 1/2 x 7 1/2. Amplifier, Pre-amplifier, AM-FM tuner—ALL ON ONE CHASSIS. Schematic Diagram on Request.

Provides Endless Hours of Static-Free and Drift-Free FM Listening Pleasure
Just Out—Webcor 4-Speed Magic Mind Intermix Record Changer w/Flip over Cartridge \$27.95
Collaro RC-54 Changer w/GE-RPX-50-A \$32.50
Come in for free demonstration or send for yours today

Send for our low prices on the Hi-Fi components you require
BRAND NEW—GUARANTEED
Prompt attention given to mail orders.
Send \$20 on C.O.D. orders.
A \$5 dep. will reserve your set till needed

UNITED AUDIO CENTER
564 GRAND AVE., DEPT. RN, ENGLEWOOD, N. J.
2 Blocks South of Route 4—LO 8-1264
5 Minutes from Geo. Washington Bridge

RADIO and TELEVISION ELECTRONICS



in all Technical Phases
New Classes (Day and Evening) Start 1st of Dec., Mar., June, Sept.

Free Placement Service for Graduates
For Free Catalog write Dept. RN75
RCA INSTITUTES, INC.

A Service of Radio Corporation of America
350 WEST 4TH ST., NEW YORK 14, N. Y.

Save time — Step up efficiency in ELECTRONICS DESIGN

Here's a wealth of technical help for efficiently handling electronics design problems—help that gives you answers already worked out by the country's top electronics men—help that can save you hours of research and experimentation!

You'll find electronics mathematics and theory in concise form—design practices for hundreds of pieces of electronics equipment—and even the results of advanced electronic experiments. Radio, television, facsimile, sound, and scores of other phases of electronics are covered—and it's all condensed, classified, and indexed for quick, easy use.

ELECTRONICS DESIGN LIBRARY

Edited by Markus and Zeluff, *Electronics Magazine*
4 vols., 2151 pp., 9 x 12, 3534 illustrations

Contains 1083 articles culled from recent issues of *Electronics*—the cream of information essential to design of electronics equipment. The 4 big volumes are: *Electronics for Engineers, Handbook of Industrial Electronic Circuits, Electronics Manual for Radio Engineers, and Electronics for Communication Engineers.*

Special price saves you \$6.00
Regular catalogue price of books totals \$39.00; under this offer, price is only \$33.00, on easy terms.

EASY TERMS!

10 DAYS' FREE EXAMINATION

McGraw-Hill Book Co., Inc., Dept. RTN-1
330 West 42nd St., New York 36, N. Y.

Send me for 10 days' examination the ELECTRONICS DESIGN LIBRARY. In 10 days I will remit \$8.00, plus few cents delivery, then \$5.00 a month until \$33.00 is paid. If not satisfied, I will return books postpaid. (We pay delivery if you remit with this coupon; same return privilege)

(PRINT)
Name
Address
City Zone State
Company
Position
For price and terms outside U.S. write McGraw-Hill Int'l., N. Y. C. RTN-1

service all auto radios, including those using transistors from a.c. lines.

This data sheet is available by writing R. C. Crossley in care of the company.

CRYSTAL CATALOGUE

U. S. Crystals, Inc., 1342 S. La Brea Ave., Los Angeles 19, Cal. has issued a 6-page catalogue listing hundreds of crystals which the company carries in stock.

Crystals for the amateur, experimenter, and commercial user are all listed in tabular form. Special frequencies can be supplied on a custom basis, the company doing the regrinding.

Information on crystal sockets for use with the units described is also included in this free catalogue sheet.

"MURDER IN THE MODEL SHOP"

Servo Corporation of America, New Hyde Park, N. Y. has issued an amusing catalogue-cum-"detective story" entitled "Murder in the Model Shop."

Written in "thriller" fashion, the story recounts the solution of servo system and instrument design problems by use of the company's "Servo-board" electro-mechanical assembly kits.

Copies of this 48-page booklet will be supplied without charge as long as the present printing lasts. Write the manufacturer direct.

NEW MILLER CATALOGUE

J. W. Miller Company, 5917 South Main St., Los Angeles 3, Cal. has just released its new general catalogue. No. 57-A.

This 32-page publication lists nearly 1000 different replacement coils for television sets, radios, etc. Of particular importance is the new series of transistor antenna rods, oscillator coils, and i.f. transformers. The listing also includes a complete line of adjustable r.f. coils and chokes.

The components are pictured, with complete electrical and mechanical specifications provided on each item. An elaborate and complete index facilitates locating a specific component.

SHURE FACILITIES

Shure Brothers, Inc., 222 Hartrey Ave., Evanston, Ill. is now offering a descriptive brochure covering its new plant and manufacturing facilities.

The brochure outlines the scientific reasons why the firm will be able to serve its manufacturers and distributors more efficiently than ever. The new plant will be used for the manufacture and design of microphones, phonograph pickup cartridges, magnetic tape recording heads, and other precision electronic components.

A copy of the brochure is available from the Sales Department of the company.

INDIVIDUAL SCHEMATICS

In response to a steady demand for individual schematic diagrams covering receivers dating back to 1926. Su-

Short description of a Small Efficient TV System...

1 antenna .. IN
8 set lines .. OUT
10 db signal .. GAIN

all with
the



**DISTRIBUTION
AMPLIFIER**

model DA8-B

approved
for
Color-TV



\$89⁵⁰ List

Ideal for garden apartments, motels, TV showrooms, deluxe home installations and other small TV systems. The DA8-B is a broadband, all-channel unit that requires no tuning, impedance matching devices, preamps or other special fittings.

Features and Specifications:

- Low noise all-triode circuit
- More than 10db gain on all VHF Channels
- Inter-set isolation in excess of 22db
- Provision for 75-ohm cable or 300-ohm twin lead
- Prevents overload through 10:1 gain control range
- Built-in power supply
- Designed for continuous duty operation

NOTE: For larger systems, Blonder-Tongue will furnish Free planning service on request.

Sold by Radio-TV Parts Distributors and Jobbers.

Write for Installation Details and FREE Booklet—"TV for 2. or 3. or More"

Dept. KA-4

**BLONDER-TONGUE
LABORATORIES, INC.**
Westfield, New Jersey



Manufacturers of TV Cameras,
TV Amplifiers, Boosters, Converters,
Accessories and Originators of the
Masterline and 'Add-A-Unit'
Master TV Systems.



FIELD TECHNICIANS

Broaden the scope of your career with Bendix Radio!

Get these BIG ADVANTAGES!

- Professional status
- The prestige of representing the leader in its field.
- Top salaries
- Liberal field allowances

If you have 5 or more years of electronics experience, you benefit many ways as a Bendix Radio Field Engineer. You will receive full pay while you go to our company-sponsored school in Baltimore. Then, you will be given a key assignment in the United States or overseas with responsibility of maintaining search and surveillance radar equipment made by Bendix Radio.

Write, call or wire EMPLOYMENT SUPERVISOR Dept. R

Bendix Radio

DIVISION OF BENDIX AVIATION CORP
Towson 4, Maryland
(Phone VAlley 3-2200)



GET INTO ONE OF THESE TOP OPPORTUNITY FIELDS

ELECTRICITY

— Electronics or

TELEVISION

— Radio-Color TV

TRAIN IN THE GREAT SHOPS OF

COYNE

OLDEST, BEST EQUIPPED SCHOOL OF ITS KIND IN U. S.

Veterans and Non-Veterans—Prepare for a better job NOW that offers a real future, too! Get practical training in TELEVISION—RADIO—ELECTRICITY—ELECTRONICS—(Refrigeration & Electric Appliance Repair can be included). Learn on real equipment—no advanced education or previous experience needed. Lifetime employment service to graduates.

Finance Plan—enroll now, pay most of tuition later. Part time employment help to students.

FREE BOOK Clip coupon for Big Free Illustrated Book. No salesman will call. Act NOW.

B. W. COOKE President **COYNE** FOUNDED 1899
ELECTRICAL SCHOOL

A TECHNICAL TRADE INSTITUTE OPERATED NOT FOR PROFIT
500 S. PAULINA ST., CHICAGO, DEPT. 17-85H
ELECTRICITY • TELEVISION • RADIO • REFRIGERATION • ELECTRONICS

B. W. COOKE, Pres., COYNE ELECTRICAL School
500 S. Paulina St., Chicago 12, Ill., Dept. 17-85H

Send FREE BOOK and details on:

- TELEVISION-RADIO
 ELECTRICITY-ELECTRONICS

NAME.....

ADDRESS.....

CITY..... STATE.....

Another New Time-Saver

SENCORE FILAMENT CHECKER

MODEL FC-4



- ★ COMPLETELY NEW
- ★ MORE VERSATILE
- ★ LOWER COST



Quickly finds any open filament. Especially handy for servicing series filament TV sets and radios; only checker that checks all actals, locals, 7 and 9 pin miniatures automatically.

Continuity and voltage tester — no switches, merely plug in test leads.

AT LEADING DISTRIBUTORS EVERYWHERE
Mfg by



SERVICE

INSTRUMENTS CORP.
171 OFFICIAL RD., ADDISON, ILL.

Only \$295
DEALER NET WITHOUT LEADS \$2.75

- POPULAR SENCORE PRODUCTS
- Transistor Tester
 - Leakage Checker
 - Filament Tester
 - Voltage Regulator
 - Bias Supply

preme Publications, 1760 Balsam Road, Highland Park, Ill. has established a service whereby radio data will be available for 40 cents each while TV service material is priced at 75 cents per section for any one model.

The publisher will ship all material airmail, which should be a boon to technicians who have old sets on their benches and find they have no service data covering the receivers.

Full details on this new service and a free 48-page list of available material will be supplied on request.

C-D CAPACITOR DATA

Cornell-Dubilier Electric Corporation of South Plainfield, N. J., is currently offering copies of engineering bulletin No. 179 which describes and illustrates its new line of rectangular case a.c. capacitors.

The Type KGN units, rated at 236, 330, 440, and 660 volts a.c. and available in capacities from 1 to 60 μ f., are housed in compact, space-saving cases. Complete electrical and physical specifications are given on each of the units currently in the line.

The company will supply a copy of this bulletin on request.

BINDING POST BROCHURE

The Superior Electric Company, Bristol, Conn., is now distributing a colorful brochure describing its line of 5-way binding posts for a variety of electronic applications.

Bulletin BP656 describes the binding posts as being available in five different colors, in nickel-plated and nylon plastic types, and with a new soldering tip. Mechanical and electrical specifications are provided on these components along with a tabulation of the various units in the line.

SENSITIVE RELAYS

Hedin Tele-Technical Corporation, 87 Dorsa Ave., Livingston, N. J., is now offering new literature on its line of sensitive relays.

The sensitivity of these relays is described as starting as low as 5 mw. per contact up to several watts. They are available for either a.c. or d.c. applications in contact combinations from s.p.s.t. to t.p.d.t.

Those wishing full details on the line should contact the manufacturer for literature.

BOOK ON DE FOREST

The Mercer Publishing Company, 16 E. 52nd Street, New York 22, N. Y. has issued a 12-page, 5" x 7" booklet entitled "Lee de Forest, Father of the Radio Industry" in honor of the 50th anniversary of Dr. de Forest's invention of the grid vacuum tube.

Designed for mass distribution, the publisher suggests that the booklet might be of interest to company employees, stockholders, dealers, customers, schools, etc. The back cover of the booklet is left blank for a company imprint, if desired.

The booklets are available at a cost of from 3 to 10 cents each, depending

RADIO & TELEVISION NEWS

on the quantity ordered. Minimum order is \$1.00 (10 copies). Write the company for quantity prices.

B-T TELEVISION EQUIPMENT

Blonder-Tongue Laboratories, Inc. of Westfield, N. J., has issued a four-page data sheet covering its line of industrial and home TV equipment and accessories.

Included is data on an industrial TV camera, a booster and antenna booster, u.h.f. converters, "Masterline" TV system units, cable connectors. "Add-a-Unit" TV system gear, and "Exact-Match" accessories.

Copies of this data sheet will be supplied without charge on request.

GLOBAL TIME CONVERTER

Harrison Radio Corporation, 225 Greenwich Street, New York 7, N. Y. is handling the distribution of the "Daiger Global Time Conversion Simplifier" which is designed especially for the amateur DX-er and the short-wave listener.

Printed in two colors, the chart is designed to be affixed to the hamshack wall for fast and ready reference. The chart is available from the distributor for \$1.00 a copy postpaid. Remittance should accompany all orders sent to the company.

BASE STATION ANTENNA

A colorful brochure describing a 450 mc. base station antenna has been released by *Andrew Corporation*, 363 East 75th St., Chicago 19, Ill.

Bulletin 8417 pictures and describes the antenna and provides a gain pattern chart on the Type 201. A table

Development of the world's smallest known radar set, for use in battle area surveillance, was announced recently by the Department of the Army. Unit, built by Sperry Gyroscope Co., can spot a single enemy moving a half-mile away in darkness or fog; vehicles or large groups much farther away. Lightness and ruggedness is attained by eliminating a cathode-ray tube and substituting audible signals to indicate the presence of an object. Set is self-contained in a drum-shaped metal case, 14 inches high and 14 inches long. The low power needed by the set is supplied by a lightweight motor generator that is easily transportable on foot by one member of a two-man observation team. The weight of set and generator is 85 pounds.



showing improvement in relative gain obtained in an existing system through use of the company's antenna is also included.

Write the company for a copy of this brochure, complete system information, or for a copy of its general Catalogue 21.

"TWIST-MOUNT" ELECTROLYTICS

Pyramid Electric Company, 1445 Hudson Blvd., North Bergen, N. J., has issued a two-color, 18-page booklet listing all of its "Twist-Mount" electrolytics.

Form TMR-1 contains pertinent information about the line which is available in single, dual, triple, and quadruple units. The units are designed for 85 degree C operation and are assembled in aluminum containers as protection against moisture.

The booklets are being handled by the company's distributors and representatives or are available from the manufacturer direct.

ELECTRON MICROSCOPES

A 4-page folder which lists engineering and application information for the company's EM-100B and EM-75 electron microscopes is being offered free by the Instruments Division, *North American Philips Company, Inc.*, 750 S. Fulton Ave., Mount Vernon, New York.

Forty-four typical uses for electron microscopes are tabulated along with operating data for two units—one designed to handle the most difficult problems and the other for majority cases where minimum investment is important.

BUILD THE BEST— BUILD ALLIED'S OWN knight-kits

ALLIED stakes its 36-year reputation in the Electronics field on your complete success and fullest satisfaction with KNIGHT-KITS. Join the thousands who have discovered the ultimate in kit value in...



knight-kits

LOWEST COST because our giant buying power passes biggest savings on to you... you do the easy assembly and your finished instrument is equal in performance and appearance to equipment selling for several times the KNIGHT-KIT cost. (Easy Payment Terms available, too.)



knight-kits

EASIEST TO BUILD because KNIGHT-KIT "Step-and-Check" instruction manuals are marvels of clarity—it's just like having a good instructor at your side. Proved professional design and premium quality parts help insure your building success.



knight-kits

MONEY-BACK GUARANTEE: When properly assembled, KNIGHT-KITS fully meet published specifications, or we refund your money.

WHEN YOU BUILD A KNIGHT-KIT,
YOU BUILD THE BEST



For a Complete Selection of
Famous knight-kits
SEE PAGES 105-111

Available Only From
ALLIED RADIO
100 N. Western Ave., Chicago 80, Ill.

Crystal Photocell Circuits (Continued from page 59)

cell is dark. The wiring of the output receptacle is governed by the type of operation required. V_2 may be either a 6C4 or a 12AT7 with the sections connected in parallel. Higher operating speed is obtained with the 12AT7. The relay must be capable of fast operation to take full advantage of this circuit. In some applications, a counter may be used in place of the relay.

A simple circuit which will sound a chime when someone enters a doorway is shown in Fig. 1E. For the direct operation of the 1 milliampere relay, a light intensity of 40 to 50 footcandles is required. This can be conveniently obtained by placing a 25-watt lamp on the same side of the doorway as the photocell and reflecting its light into the cell with a magnifying mirror placed on the opposite door jamb. A shaving mirror is suitable for this purpose. A small magnifying lens should be mounted in front of the cell, focused to obtain maximum relay current. When the light on the cell is interrupted by someone entering the doorway, the relay will drop out and the chime, plugged into SO_1 , will sound.

Many other circuits and applications will occur to the experimenter as he works with light-sensitive cells. The graph of Fig. 2 and Table 1 provide a useful guide to the operating characteristics of the *Clairex* CL-2. When working out other circuits, care should be taken not to exceed the 50-milliwatt power rating of the cell as operation tends to become unstable above this point.

The service technician might well be able to add to his income by building and installing light-operated equipment in stores, doctors' offices, machine shops, etc. Building the basic unit described in this article, or one of the other circuits, is a good way to get started toward designing commercially profitable devices. In a more frivolous vein, they can be worked into some amusing parlor tricks.

The *Clairex* type CL-2 photocell is

Fig. 2. Average characteristics of the *Clairex* Type CL-2 crystal photocell. See article.

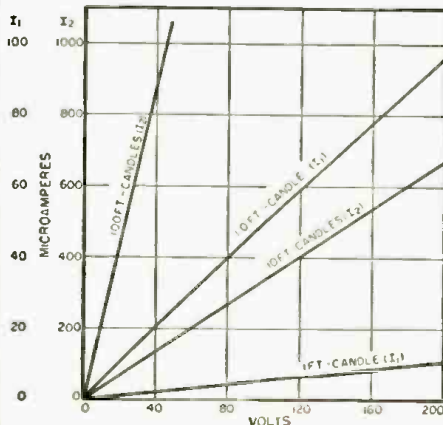

unbelievable!
BUT TRUE!

ONLY

the MIGHTY portable
REJUVA-CHECK

TESTS: Checks cathode emission
Indicates shorts and leakage
Estimates remaining life of the CRT
REPAIRS: Clears interelement shorts
and leakage
Removes cathode surface
contamination
REJUVENATES: Gives new life to
tubes by restoring
emission

SEND NO MONEY
ACT NOW! Pays for itself on one or two calls.
POSITIVELY NO OBLIGATION!

sensational
**PICTURE TUBE
TEST & REPAIR**

\$7.95
COMPLETE



RIGHT ON THE JOB!
FITS SNUGLY IN YOUR TUBE CADDY
ready to earn extra dollars for you . . .
FREE ACT NOW! Receive valuable imported
pin straightener and tube puller.

NAME.....
Address.....
City..... State.....
Save POSTAL CHARGES! Enclose \$7.95 with
coupon and we pay all postal charges. Same
NO-RISK refund privilege.

AT A STAGGERINGLY LOW PRICE
• The lowest price picture tube test and repair instrument
available.
• No other equipment needed to do the job.

RAD-TEL

KIT SALE (2 for the price of 1)

You get another identical kit absolutely free when you enclose this ad with your order! Applies only to same kit—no substitutions. AD MUST ACCOMPANY ORDER.

CERAMICON KIT \$1.99

Kit of 50 assorted ceramic discs, bi-plates, tubular condensers. All condensers popular sizes, used in TV & FM sets.

2 lbs. total
Get another \$1.99 kit FREE with this ad!



SOLDER LUG KIT 98c

Kit of 48 assorted solder lug terminal strips. Brand new. List \$1.

2 lbs. total
Get another 98c kit FREE with this ad!



NOB KITS Bag of 100, \$2.95

6 lbs. total
Assorted home, auto, TV knobs. All colors—plastic, wood, bakelite.

Get one bag of \$2.95 knobs FREE with this ad!



TV & FM COIL KIT 99c

Penking, video IF, RF coils. Kit of 20.

2 lbs. total
Get another 99c kit FREE with this ad!



INSULATED RESISTORS 99c

Kit of 100, 1/2 to 2 Watt.

2 lbs. total
Get another 99c kit FREE with this ad!



Write Dept. RN-1 for
**FREE CATALOG OF
TUBES &
PARTS**

Rad Tel TUBE CO.

Not A.M.I.
With Any
Other Tube
Mail Order Co.

No C.O.D.'s on this sale. Allow for postage. SUBJECT TO PRIOR SALE.

115 COIT ST., IRVINGTON II, N. J.

AN INDISPENSABLE HANDBOOK All the Latest Developments in RADIO, TELEVISION, ELECTRONICS, HI-FI

A much-needed basic illustrated manual for readers of this magazine. Covers all the latest developments in electronics, radio, television, hi-fi. An invaluable guide for the beginner; an authoritative "refresher course" for the technician, serviceman, "ham" and Hi-Fi enthusiast anxious to keep abreast of the numerous changes and improvements going on in this fascinating field. Written so anyone can understand it. 288 photos, charts, diagrams.

**FOR BEGINNERS
AS WELL AS
PROFESSIONALS**

CONTENTS INCLUDE:
Recent Developments in Electronics, Electrical Measuring Instruments, Oscillatory Circuits, Electron Tubes, Power Supplies, Amplifiers and Amplification, Tape Recorders, Acoustics, Microphones, Transmitting and Receiving Antennae, A-M and F-M Receivers, High Fidelity Systems, Transistors, Television.

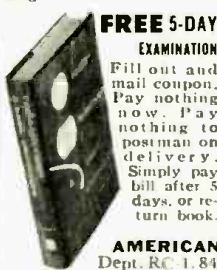

**FREE 5-DAY
EXAMINATION**

Fill out and mail coupon. Pay nothing now. Pay nothing to postman on delivery. Simply pay bill after 5 days, or return book.

**ONLY \$4.95
COMPLETE**

AMERICAN TECHNICAL SOCIETY
Dept. RC-1, 848 E. 58th St., Chicago 37, Ill.

AMERICAN TECHNICAL SOCIETY, Dept. RC-1
848 E. 58th St., Chicago 37, Ill.

Please send me "Radio-Television and Basic Electronics" for 5 days FREE EXAMINATION. If I keep the book after 5 days, you may bill me for \$4.95, plus shipping costs.

PRINT NAME.....

ADDRESS.....

CITY..... ZONE..... STATE.....

Check here if enclosing \$4.95 with coupon; we pay shipping charges. Money back guarantee.

Sensitivity:	100 μ a. at 100 v. and 2 footcandles
Dark current:	.01 μ a. at 100 v. and 2 footcandles after one minute.
Frequency response:	Output decreases 6 db per octave throughout audio range for modulated light
Time constant:	Inverse function of illumination. .15 second at 1 footcandle
Maximum ratings:	Voltage—300 volts peak. a.c. or d.c.; Power—50 mw.
Light response:	Entire visible spectrum. Maximum sensitivity near green portion. Good sensitivity to hard x-rays and gamma rays. Usable response near the infra-red region
Size:	1/4" diameter. 1/2" long.
Terminals:	1 3/8" leads, spaced 3/32"

Table 1. Specifications on CL-2 photocell.

available from the *Allied Radio Corporation*, 100 North Western Avenue, Chicago 80, Illinois; *Sun Radio and Electronics Company*, 650 Avenue of the Americas, N. Y. 11, N. Y., and from the *Clairex Corporation*, 50 West 26th Street, New York 10, New York. The net price is \$3.50.

The author wishes to thank Mr. Al Deuth of the *Clairex Corporation* for his cooperation in providing data necessary to the preparation of this article.

"EFFORTLESS" INVENTORY

By J. P. MURTHA

ALTHOUGH the "bookless bookkeeping" system to be described is not new, it has worked out nicely for us in handling the problem of tube inventory control in our shop.

When a service job requires a new tube, we put the old one in the carton and give it to the customer after removing the tube type identity tab from the carton. These tabs are kept in the caddy until calls for the day have been completed. At that time, they are sorted by type and entries of quantities used posted to a "tube stock used" sheet which shows days of the week. At the end of each week, this sheet is totaled. The data thus collected serves as a guide in determining the types and quantities of tubes to stock. By making a carbon copy of the form, it can be used as an order to the distributor. The accompanying purchase order can read "per list attached."

The same method can be used to control and check operations in a large shop. Initially, it would be necessary to inventory and prepare a "stock on hand" inventory sheet for each technician's tube caddy. Thereafter, the "week ending" inventory sheet would be used as the starting inventory for the following week. Each day stock would be replaced in the caddy by the stock clerk upon receipt of tabs.

At the end of each week a physical check of each caddy would be made. The starting inventory plus or minus additions or deletions should agree with totals of the "stock use" sheet. Such checks will accurately control tube stock.

The same method is adaptable to "in shop" bench repairs.

RADIO • TELEVISION • INDUSTRIAL ELECTRONICS

THIS professional TRAINING IS THE KIND THAT Really Pays Off!

... and it costs only a fraction of what you might expect to pay!

FIX ANY RADIO OR TV SET EVER MADE...easier...better...faster

Backed by the how-to-do-it methods so clearly explained in this one big 822-page book, you'll be prepared for fast, accurate service on any radio or television receiver ever made.

Radio & Television TROUBLESHOOTING AND REPAIR by Ghirardi & Johnson is far and away the world's most modern, easily understood guide. Step by step, it takes you through each service procedure... from locating troubles with less testing to repairing them promptly by fully-approved professional methods... the kind that enable you to handle tough jobs as slick as you now do the easy ones.

Best of all, the cost is only \$7.50 (or see money-saving combination offer in coupon).

COMPLETE SERVICE TRAINING

For beginners, this giant book is a complete training course. For

experienced servicemen, it is an easy way to "brush up" on specific jobs; to develop better methods and shortcuts and to find fast answers to tough jobs.

Here are just a few of the subjects covered: Components and Their Troubles; Basic Troubleshooting Methods; "Static" and "Dynamic" Testing; Practical Troubleshooting Tips and Ideas; AC/DC, 3-way Portable and Battery Set Troubleshooting Problems; Servicing Communications Receivers; a Complete Guide to Television Service; AM, FM, and TV Realignment Made Easy; Resistor, Capacitor, Inductor and Transformer Problems; Servicing Tuning, Selector and Switching Mechanisms; Loudspeakers; Servicing Recorders and Record-playing Equipment... and dozens more! 417 illustrations. Read TROUBLESHOOTING AND REPAIR for 10 days AT OUR RISK!

LEARN BASIC CIRCUITS FULLY...and watch service "headaches" disappear

It's amazing how much easier and faster you can repair radios, television sets and even industrial electronic equipment when you know all about circuits and what makes each one "tick."

You locate troubles in a jiffy because you know what to look for and where to look.

You make repairs lots faster, better and more profitably!

Actually, there are only a comparatively few BASIC circuits in modern equipment. Radio & Television RECEIVER CIRCUITRY AND OPERATION by Ghirardi and Johnson gives you a complete understanding of these as well as their variations. It teaches you to recognize them... to under-

stand their peculiarities and likely "troublespots"... and shows how to eliminate useless testing and guesswork in making repairs.

LEARN MORE—EARN MORE!

Throughout, this 669-page book with its 417 clear illustrations gives you the kind of above-average professional training that fits you for the better, big pay jobs in either servicing or general electronics.

Covers all circuits in modern TV and radio receivers, amplifiers, phono-pick-ups, record players, etc.

Price only \$6.75... or see money-saving offer in coupon. Examine it 10 days at our risk!

The books that EXPLAIN SERVICE so you can really understand it!

More radio-TV technicians have trained from Ghirardi books than any others of their kind! Almost 1300 pages and over 800 pictures and diagrams in these two new books explain things so clearly it's next to impossible for you to go wrong. Each book is strictly up-to-the-minute... NOT a re-hash of old, out-moded material.

FREE EXAMINATION...easy terms!

Dept. RN-17, RINEHART & CO., INC.
232 Madison Ave., New York 16, N. Y.

Send books indicated for FREE EXAMINATION. In 10 days, I will either remit price indicated plus postage or return books postpaid and owe you nothing.

Radio & TV TROUBLESHOOTING AND REPAIR (Price \$7.50) Radio & TV CIRCUITRY AND OPERATION (Price \$6.75)

COMBINATION OFFER... Both books only \$13.00 (Regularly price separately \$14.25... you save \$1.25)

(Combination offer is payable at rate of \$4 (plus postage) after 10 days if you decide to keep books, and \$3 a month thereafter until \$13 has been paid.)

Name.....

Address.....

City, Zone, State.....

OUTSIDE U.S.A. \$8.00 for TROUBLESHOOTING & REPAIR;

\$7.25 for CIRCUITRY & OPERATION; \$13.00 for both books;

Cash with order, but money refunded if you return books in 10 days.

MODERN RADIO AND TELEVISION SERVICING LIBRARY

receiver troubles

SAVE \$1.25

Make your training library complete! Get both these big books at the low price of only \$13.00 for the two (you save \$1.25).

MODERN RADIO AND TELEVISION SERVICING LIBRARY

receiver circuitry &

TELEVISION



AT HEADS YOU LEARN
BY DOING IN MODERN
ELECTRONICS LABORATORIES

HEALD ENGINEERING COLLEGE

Van Ness at Post, RTN
San Francisco, Calif.

Industry needs Electronic Trained Men Now! Qualify for BIG PAY JOB, 9 short months. No other type of training can compare with actual shop practice you get at Healds under expert instructors.

Bachelor of Science Degree, 27 Months

- Electronics Engineering (B.S. Degree)
- Electrical Engineering (B.S. Degree)
- Television Technician (9 Months) Color TV
- Electronics Technician (12 Months)

Heald College ranks FIRST West of the Mississippi in "Who's Who in America"

Approved for Veterans

DAY AND EVENING CLASSES

Register Now. Write for Catalog.

(No Obligation.)

Your Name

Address

City

State

Transistor Life Tests

Show no failures after 18,000 working hours at full power.

REPLACEMENT of transistors in portable radios and other electronic equipment may never be necessary if they are used within the limits set by the manufacturer, a G-E engineer suggested recently. In addition he said transistors are rugged enough to withstand the jolt of being fired from a mortar and still operate at full ratings. Speaking to a transistor reliability symposium sponsored by a Department of Defense advisory group, C. H. Zierdt, Jr., engineering consultant in G-E's Semiconductor Products Dept., reported results of tests run by the company on transistors made by it for use in consumer products as well as in military and industrial electronic equipment.

Life tests started in 1954 on transistors picked at random from regular manufacturing lots show no failures after 18,000 working hours at full power. This is equal to maximum load on the transistors eight hours a day for six years. Further, it was stated that it is now impossible to tell if the transistors ever will fail because they still look and act like new transistors. By comparison, specially constructed long-life vacuum tubes have a survival record of only 50 per-cent after less than half this time at full power. Vacuum tubes used in home radios have an even shorter life.

To check his results on the transistor life test, Mr. Zierdt said he tested 2050 transistors picked at random from ten different manufacturing lots between January and May of last year. Results of this check showed that only one-quarter of one per-cent of the transistors could not be operated at peak ratings after 1000 hours at full power. All of the transistors were still usable in portable radios. The other 99 3/4 per-cent of the transistors tested showed no signs of wear whatever.

Other test results included evidence that transistors are capable of withstanding substantial doses of nuclear radiation. Also it was found that germanium transistors are capable of operation at 100 degrees C. (212° F.) and storage at 135 degrees C. (275° F.). Previously, the upper operating temperature limit of germanium transistors was thought to be 85 degrees C. (185° F.) and the upper storage limit at 100 degrees C. (212° F.). This means that germanium transistors may be used in more military and industrial applications where higher temperatures are encountered.

HOW TO BE THE HAPPIEST CREATIVE ENGINEER IN CALIFORNIA



Engineers (E.E., M.E., Mfg., Sales) can have the kinds of jobs that creative men dream about. Top salaries and benefits. Suburban locations in Fullerton, Newport Beach, Richmond, or Palo Alto.

Write Beckman Instruments, Inc., 2999 W. 6th Street Los Angeles 5, California. Ask for Career File #21.

WANT TO BUY!

BC-224, BC-348 RECEIVERS

ARC-3 BC-788 R5/ARN-7

Cash or trade. Immediate action.

HARJO SALES CO.

503 N. Victory Blvd., Burbank, Calif.

FREE 3-in-1 PRECISION SCREWDRIVER SET WITH EVERY ORDER

regardless of size!

ALL TUBES UNCONDITIONALLY GUARANTEED FOR 1 YEAR

take your pick
any assortment

100

receiving

tubes

\$38

On orders of less than
100 tubes — 41c each

BRAND NEW TV PICTURE TUBES

RCA and DUMONT
Licensed

Partial Listing
No dud required

Type	T.M. Price
10BP4	\$10.95
12LP4	12.95
12QP4	10.00
14CP4	15.25
15DP4	16.95
16DP4	18.50
16CP4	19.25
16KP4	17.00
16RP4	\$17.00
17BP4	19.00
17CP4	21.00
17LP4	18.00
19AP4	23.00
20CP4	24.00
21ALP4A	24.00
21EP4	24.00

Picture tubes
F.O.B. PASSAIC, N. J.
via Railway Express

PRETESTED TUBES—INDIVIDUALLY BOXED

0Z4	6AUG	6SH7	12BA6
1B3GT	6AUSGT	6S7GT	12BE6
1H5GT	6AV5	6SK7GT	12AZ7
1LCS	6AV6	6SL7GT	12BH7
1LNS	6AX4GT	6SN7GT	12BY7
1H5GT	6AT6	6SQ7	12SA7
1Q5GT	6AHGT	6SR7	12SG7
1R5	6BA6	6T8	12S7GT
1S4	6BC6	6UB	12SK7
1S5	6BE6	6V3	12SL7GT
1T4	6BG6G	6V6GT	12SN7GT
1T5GT	6B16	6W4GT	12S07
1U4	6BK5	6W6GT	12SR7
1U5	6BK7	6X4	19T8
1X2	6BL7GT	6X5GT	19BC6G
304	6B06GT	6Y6G	25B06GT
354	6B07	7C5	25L6GT
3V4	6B5G	7C6	25Z5
5U4G	6BZ7	7E7	25Z6GT
5V4G	6C4	7F7	35D5
5Y3	6CB6	7F8	35C5
6AB6	6CD6G	7H7	35L6GT
6AC7	6F6	12AL5	35W4
6AC5	6HG6T	12AT7	35Y4
6AC7	6J5GT	12AUG	35Z5GT
6AF4	6J6	12AU7	50A5
6AK5	6K6GT	12AV6	50B5
6AL5	6L6	12AV7	50C5
6AQE	6S4	12AX7	50L6GT
6AS5	6S6GT	12AX7GT	117Z3
6AT8	6SA7	12BY7	

Free Postage on all prepaid continental U.S.A. orders. see handling charge on all orders under \$5.00. 25% deposit on all C.O.D. Subject to prior sale.

TUBE MART

DISCOUNT HOUSE

PRincott 3-0330

The Lokper Bldg. Passaic, N. J.



BUILD THE BEST—

get the most for your money in ALLIED'S own

knight-kits!

THE FINEST ELECTRONIC EQUIPMENT IN MONEY-SAVING KIT FORM

LOWEST COST

Our huge buying power means biggest savings for you. You do the easy assembly and your finished instrument is equal in performance and appearance to equipment selling for several times the low KNIGHT-KIT price.

LATEST DESIGN

Months of research, development and field-testing go into each KNIGHT-KIT to bring you proved, advanced design. To assure top performance, premium-quality parts are supplied in each kit. KNIGHT-KITS are guaranteed to meet published specifications, OR YOUR MONEY BACK.

EASIEST TO ASSEMBLE

All chassis and panels are punched; all parts are clearly marked; even the resistors are mounted on cards, and keyed for easy identification. Each instruction manual is a marvel of "Step-and-Chek" clarity. You get professional results even without experience.

MONEY-BACK GUARANTEE: KNIGHT-KITS FULLY MEET PUBLISHED SPECIFICATIONS, OR WE REFUND YOUR MONEY.



**FEATURING PHANTASTRON
LINEAR SWEEP CIRCUIT**

knight-kit LOW-COST GENERAL-PURPOSE 5" OSCILLOSCOPE KIT

Feature for Feature the World's Best Oscilloscope Value

Model F-146

\$49⁵⁰

This new oscilloscope delivers performance equal to wired units costing several times more and defies comparison with any other 'scope kit at anywhere near its price. It's the ideal choice for radio and TV servicing, audio work and hundreds of other applications—meets 90% of all 'scope requirements. Here are some of the features that make this kit a standout in its class: *Phantastron*

Sweep Circuit—versions of this circuit are used in \$1,000 'scopes; provides high linearity of sweep from 15 to 150,000 cps. *Regulated Calibration Voltage*—fully regulated square wave calibrating voltage is injected into signal circuit by spring return switch. *25 Millivolts Per Inch Sensitivity*—three times the sensitivity of other 'scope kits in its price class. *Retrace Blanking*—found only in high-priced 'scopes. *Vertical Amplifier*—frequency response ± 3 db from 3 cps to 1.5 mc (± 6 db to 2.5 mc). Input controls are frequency-compensated. Rise time, .25 microseconds. Impedance, 3.3 meg. and 45 mmfd. Includes positive and negative internal sync. Outstanding construction features: CRT protected by heavy rubber ring; sturdy steel case with disappearing handle. For easy assembly: pre-cut color-coded wire; resistors carded and keyed to match instructions; printed circuit; laced wiring harness; "Step-and-Chek" construction manual with wall-size picture diagrams. Supplied with all tubes including CRT, all parts, graph screen, wire, solder. Size, 9 $\frac{1}{4}$ x 13 $\frac{3}{4}$ x 17 $\frac{3}{4}$ ". Shpg. wt., 26 lbs.

Model F-146. Complete 5" Oscilloscope Kit. Net only **\$49.50**
 F-148. RF Demodulator Probe Kit. Net **\$3.45**
 F-147. Low Capacity Probe Kit. Net **\$3.45**

knight-kit TV-FM SWEEP GENERATOR KIT

Guaranteed Linearity • Fool-proof Calibration • Wide-Range • Electronic Blanking

All-new; precision-designed for lab use, TV and FM servicing, production line testing. Covers 300 kc to 250 mc continuous on 4 bands (all fundamentals). Center frequencies of VHF TV channels appear on scales. Exclusive KNIGHT-KIT sweep circuit assures perfect linearity—RF sweep output in excess of 0.15 volts, flat within 1 db, is available on all bands. Sweep width continuously variable, 0-13 mc. Dual crystal marker oscillator and input for variable marker (RF Signal Generator on next page is ideal). Phase control provides blanking shift, 0 to 130°. Step-type and continuous output controls; separate marker amplitude control. Filter connected to 0-50 mc output jack provides 20 db attenuation of frequencies above 50 mc to assure pure, fundamental output. Sweep voltage for 'scopes on front panel. Professional-looking blue-finish steel case with gray panel. Has "disappearing" handle. 8 $\frac{1}{2}$ x 12 x 7 $\frac{1}{2}$ ". With all parts, tubes, test cable, solder and multi-color pre-cut wire. Less crystal. Shpg. wt., 13 $\frac{1}{2}$ lbs.

Model F-123. TV-FM Sweep Generator Kit. Net only **\$44.75**
 P-286. 4.5 mc Crystal (.005%). Net **\$4.80**
 P-143. 5.0 mc Crystal (.02%). Net **\$3.95**
 P-145. 10.7 mc Crystal (.02%). Net **\$3.95**



Model F-123

\$44⁷⁵

EASY PAYMENT TERMS

if your total KNIGHT-KIT order is over \$45, take advantage of our liberal Time Payment Plan—only 10% down. Write for application form today.

ALL PRICES NET F.O.B. CHICAGO

SEE FOLLOWING PAGES >

order from **ALLIED RADIO** 100 N. WESTERN AVE., CHICAGO 80, ILL.

ALLIED'S own knight-kits... better by far

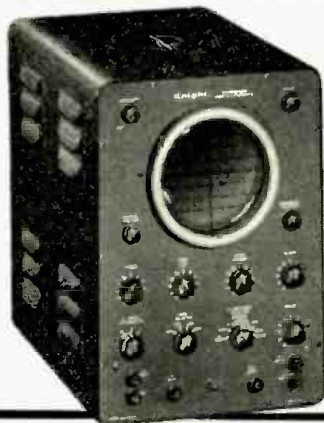

knight-kit 5" ALL-PURPOSE WIDE-BAND OSCILLOSCOPE KIT

2 Printed Circuit Boards • 5 Mc Width for Color TV

Model F-144

\$69⁰⁰

Wide-band, 5" Oscilloscope; equals or betters the performance of commercially-wired 'scopes costing several times the price. Two printed circuit boards and laced wiring harness assure wiring accuracy and reduce assembly time. Ideal for lab use, color TV servicing and high frequency applications. Provides unusually wide sweep range—from 15 to 600,000 cps. Locks in at frequencies as high as 9 mc. Vertical response, 5 cycles to 5 mc. Response, down only 1 db at 3.58 mc color burst frequency; down only 3 db at 5 mc. High vertical sensitivity of 25 mv/inch. Input capacity 20 mmf and 3.5 megs. Outstanding features: cathode-follower vertical and horizontal inputs; 2nd anode provides 1400 volts high-intensity trace; push-pull vertical and horizontal amplifiers; positive and negative locking; faithful square wave response; frequency-compensated attenuator; Z-axis input for intensity modulation; one volt P-P calibrating voltage; astigmatism control; blanking circuit to eliminate retrace lines; DC positioning control. Complete with CRT, all tubes and parts. Handsome, professional, blue-finished steel case with "disappearing" handles. 14½ x 9½ x 16". Shpg. wt., 40 lbs.

Model F-144. Wide-Band 5" Oscilloscope Kit. Net only **\$69.00**
F-148. Demodulator Probe. Net. \$3.45. F-147. Low Capacity Probe. 12 mmf. Net. \$3.45



NEW knight-kit VOLTAGE CALIBRATOR KIT

Model F-136

\$12⁷⁵

Permits the use of any scope as a precision peak-to-peak AC voltmeter. Provides a true square-wave voltage on scope screen. Range switch and calibrated potentiometer permit selecting any voltage between .01 and 100 volts, in 4 ranges. Fifth position of switch feeds external signal to scope for comparison. Constant output on line volt. variation from 80-135 v. ±6% on all ranges. Shunt capacitance only 15 mmf. Use any 20,000 ohms/volt VOM or a VTVM for initial calibration. Direct coupling of output provides ground reference for DC scopes. Portable case, 7¼ x 5¼ x 4¼". Ready to build. Shpg. wt., 5 lbs.

Model F-136. Voltage Calibrator Kit. Net. **\$12.75**



knight-kit LOW COST RF SIGNAL GENERATOR KIT

Model F-145

\$19⁷⁵

Build this wide-range extremely stable RF signal generator and save two-thirds the cost of a comparable wired instrument. Ideal for alignment of RF and IF stages in radio and TV sets, and for troubleshooting audio equipment. Delivers output on fundamentals from 160 kc all the way out to 110 mc; useful harmonics to 220 mc. Has built-in 400-cycle sine-wave audio oscillator for modulating RF; audio is also available externally. Features high-stability Colpitts circuit with precision-wound coils—no calibration necessary. Has input for external modulator. Maximum audio output, 10 volts. RF output, over 100,000 micro-volts. Step and continuous-type output attenuators. With all parts, tubes, wire and solder. Portable case, 7 x 10 x 5". Shpg. wt., 10 lbs.

Model F-145. RF Signal Generator Kit. Net only **\$19.75**



Model F-135

\$26⁵⁰

knight-kit VISUAL-AURAL SIGNAL TRACER KIT

A remarkable value in an instrument which permits visual and aural signal tracing of RF, IF, video and audio circuits—has highest gain in its price class. Traces the signal from the antenna to the speaker. Reproduces signal at plate or grid connection of any stage. Identifies and isolates "dead" stages. Features: usable gain of 91,000; "magic eye" with calibrated attenuators for signal presence indication and stage-by-stage gain measurements; built-in 4" PM speaker; single probe with plug-in head gives instant choice of RF or audio tracing. Provides noise test; built-in watt meter calibrated from 25 to 1000 watts; provision for external scope or VTVM. Blue-finish steel case. Shpg. wt., 13 lbs.

Model F-135. Signal Tracer Kit. Net only **\$26.50**



Model F-129

\$37⁹⁵

NEW knight-kit 6-12 VOLT BATTERY ELIMINATOR KIT

A valuable new unit for servicing auto radios, mobile gear, etc. Delivers continuously variable filtered DC output from 0 to 15 volts. Provides DC output at 0-8 volts or 0-15 volts. Continuous current rating: 12.5 amps at 6 volts, 10 amps at 12 volts. Can also be used as battery charger. Oversize rectifiers and transformer for better regulation and long life. Two meters provide simultaneous current and voltage readings; ranges: 0-15 volts DC; 0-20 amps DC. Doubly protected: fused primary and automatic-reset overload relay for secondary. Heavy-duty binding posts. Blue-finish steel case with "disappearing" handle. With all parts, solder and pre-cut wire. 9 x 12¼ x 7¼". Shpg. wt., 20 lbs.

Model F-129. Power Supply Kit. Net only **\$37.95**



knight-kit AUDIO GENERATOR KIT

Model F-137

\$37⁵⁰

An ideal audio frequency source for checking audio circuits and speaker response. Covers: 20 cps to 1 mc in 5 ranges. Output voltage: 10 volts into 600 ohms impedance. Offers the flat response of a lab standard—±1 db to 1 meg. Generator imp., 600 ohms. Less than .25% distortion from 100 cps through the audible range; less than .5% when driving 600 ohm load at maximum output. Cont. var. step-attenuated output. 17 lbs.

Model F-137. Audio Generator Kit. Net only **\$37.50**

knight-kit RESISTANCE SUBSTITUTION BOX KIT

Model F-139

\$5⁹⁵

Simplifies determination of resistor values needed in a circuit. 36 standard 1 watt resistance values between 15 ohms and 10 megohms with an accuracy of 10%. 18-position switch; also slide switch for multiplying values by 1000. Extra switch wafer serves as tie points, eliminating buss bar. 5 x 3 x 2". Complete with test leads and clips. 2 lbs.

Model F-139. Resis. Sub. Box Kit. Net **\$5.95**

knight-kit CAPACITANCE SUBSTITUTION BOX KIT

Model F-138

\$5⁹⁵

Makes it easy to find capacitor values needed in a circuit. Provides 18 standard capacitor values from .0001 mfd. to .22 mfd., ±20%. Values are 600 volts, except .15 and .22 which are 400 volt. 18-position switch selects all values quickly and easily. In bakelite case, 5 x 3 x 2". Complete with all parts, test leads and clips. 2 lbs.

Model F-138. Cap. Sub. Box Kit. Net. **\$5.95**

QUALITY ELECTRONIC TEST EQUIPMENT IN MONEY-SAVING KIT FORM

...easiest to build...you get more...YOU SAVE MORE

4 1/2"
Meter



Model F-128 **\$16⁹⁵**

**knight-kit
1000 OHMS/VOLT VOM KIT**

Exceptional accuracy and versatility at amazing low cost. Ideal for service shop, lab and Amateur use. Uses 4 1/2" meter (400 microamp movement) with separate scales for AC voltage and current. DC voltage and current, decibels and resistance. 38 ranges include: AC, DC and output volts, 0-1-5-10-50-100-500-5000 (1000 ohms/volt sensitivity); Resistance, 0-1000-100,000 ohms and 0-1 meg.; Current, AC or DC, 0-1-10-100 ma and 0-1 amps; Decibels, -20 to +69 in 6 ranges. Uses 1% precision resistors. 3-position function switch and 12-position range switch. Complete kit with bakelite case, (6 3/4 x 5 1/4 x 3 3/4"), batteries, pre-cut wire, solder and test leads. Shpg. wt., 2 1/2 lbs.

Model F-128, 1,000 ohms/volt VOM Kit. Net only **\$16.95**



Model F-140 **\$29⁵⁰**

**knight-kit
20,000 OHMS/VOLT VOM KIT**

Outstanding quality and performance at extremely low cost. Features 32 ranges; full vision 4 1/2" meter; accuracy ±2% of full scale; 50 microampere sensitivity for 20,000 ohms/volt input resistance on DC; front panel "zero adjust". Single switch selects function and range. Range: AC, DC and output volts, 0-2.5, 10-50-250-1000-5000; Resistance, 0-2000-200,000 ohms and 0-20 meg.; DC ma, 0-1-10-100; DC amps, 0-1-10; Decibels, -30 to +63 in 6 ranges. Uses precision 1% multipliers. Moisture-resistant film-type resistors. Complete kit with bakelite case (6 3/4 x 5 1/4 x 3 3/4"), batteries, pre-cut wire, solder and test leads. Shpg. wt., 5 lbs.

Model F-140, 20,000 ohms/volt VOM Kit. Net only **\$29.50**



**knight-kit VTVM KIT
with Printed Circuit Board**
Model F-125 **\$24⁹⁵**

An extremely stable, and highly accurate VTVM. Greatly simplified wiring—entire chassis is a printed circuit board. Maximum convenience in arrangement of scales; 3X AC and DC scale design permits utilization of best portion of each scale for most accurate readings. Also measures peak-to-peak for FM and TV work. Ranges: AC P-P volts, 0-4-14-40-140-400-1400-4000; AC rms volts and DC volts, 0-1.5-5-15-50-150-500-1500; resistance, 0-1000-10K-100K ohms and 0-1-10-100-1000 megohms; db scale, -10 to +5. AC response, 30 cycles to 3 mc. Low-leakage switches and 1% precision resistors. Balanced-bridge circuit. 4 1/2" meter, 200 microamp movement. Polarity reversing switch. Input res., 11 megs. Shpg. wt., 6 lbs.

Model F-125 Printed Circuit VTVM Kit. Net only **\$24.95**
F-126. Hi-Voltage Probe; extends DC to 50,000 Volts **\$4.75**
F-127. Hi-Frequency Probe; extends AC to 250 mc. **\$3.45**

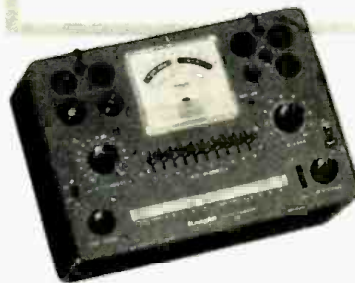

PORTABLE
MODEL

Model F-143 knight-kit LOW-COST TUBE TESTER KIT

\$29⁷⁵ Offers high accuracy, top versatility and convenience at lowest cost. Tests 4, 5, 6 and 7-pin large, regular and miniature types, octals, loctals, 9-pin miniatures and pilot lamps. Features test for new 600 ma series string tubes. Tests for open, short, leakage, heater continuity and quality (by amount of cathode emission). 4 1/2" square meter with clear "GOOD?-REPLACE" scale. With line-voltage indicator and line-adjust control. Choice of 14 filament voltages from .63 to 117 volts. Blank socket for future type tubes. Universal-type selector switches for any combination of pin connections. Single-unit, 10-lever function switch. Entire switch assembly is installed as a single unit—saves time and greatly simplifies construction. Illuminated roll chart lists over 600 tube types. Shpg. wt., 14 lbs.

Model F-143. Counter Model Tube Tester Kit. Net only **\$29.75**
Model F-142. Portable Model Tube Tester Kit. Net only **\$34.75**
F-141. TV Picture Tube Adapter for above. Net only **\$3.75**



knight-kit RESISTOR-CAPACITOR TESTER KIT

Model F-124 **\$19⁵⁰** Measures capacitance and resistance by accurate bridge method; checks for opens and shorts in paper, mica and ceramic capacitors; shows power factor of electrolytics. Large dial shows capacitance and

resistance at a glance; balanced-bridge circuit with "magic eye" null indicator measures power factor from 0-50%. Tests capacitors with rated voltages applied. 5 test voltages: 50, 150, 250, 350, 450. Capacity ranges: 10 mmf to 1000 mfd in 5 ranges. Resistance ranges: 100 to 50,000 ohms and 10,000 ohms to 5 megs. Accuracy, ±10%. Automatic discharge feature prevents after-test shock. Blue-finished steel case, 5 x 3 x 2". With tubes and all parts. Shpg. wt., 8 lbs.

Model F-124. Resistor-Capacitor Tester Kit. Net only **\$19.50**

NEW knight-kit TRANSISTOR & DIODE CHECKER KIT



Model F-149 **\$8⁵⁰** Checks leakage-to-gain ratio and noise level of all junction, point contact and barrier transistors. Also checks diodes, forward and reverse current conduction of selenium rectifiers; useful for continuity and short checks. Easy-to-read meter. Features: spring-return leakage gain switch; calibration control; separate sockets for PNP and NPN transistors. Headphones or signal tracer may be used with checker for noise measurements. Case, 5 x 3 x 2". With 22 1/2 volt battery. 2 1/2 lbs.

Model F-149. Transistor Checker Kit. Net **\$8.50**

EASY PAYMENT TERMS: If your total KNIGHT-KIT order is over \$45, take advantage of our liberal Time Payment Plan—only 10% down. Write for application blank.

ALL PRICES NET F.O.B. CHICAGO



Model F-119 **\$12⁵⁰**

knight-kit LOW-COST "IN-CIRCUIT" CAPACITOR CHECKER KIT

Tests capacitors while they are still wired in the circuit! Saves time and bother; an essential instrument for the service technician. Just press a button and the "magic eye" instantly shows opens and shorts (not leakage). Tests opens and shorts on any capacitor of 20 mmf or greater capacity, even if it is in parallel with a resistance as low as 50 ohms. Tests for shorts may be made on any capacitor even when it is shunted by as low as 20 ohms. Blue-finish steel case, 7 3/4 x 5 1/4 x 5". With tubes, all parts, wire and solder. Easy to assemble. Shpg. wt., 5 lbs.

Model F-119. Cap. Checker Kit. **\$12.50**

order from **ALLIED RADIO** 100 N. WESTERN AVE., CHICAGO 80, ILL. →

ALLIED'S own MONEY-SAVING knight-kits

FAMOUS knight-kits FOR HOBBYISTS & EXPERIMENTERS... FASCINATING, INSTRUCTIVE...



knight-kit
"SPACE SPANNER"
BAND SWITCHING
RECEIVER KIT

Model S-243 \$15.95

Thrilling Short Wave and Broadcast

Famous 2-band AC-DC receiver in easy-to-build kit form at a very low price. Pulls in thrilling short-wave (6 to 17 mc) and standard broadcast. It's fun listening to amateur, aircraft, police and marine radio. Features highly sensitive regenerative circuit. Bandswitch selects broadcast or short wave. Has 4" PM speaker and beam-power output tube for plenty of volume; headphone connectors for weak signal listening; slide switch cuts out speaker. Uses 12AT7 regenerative detector and audio amplifier, 50C5 power output, 35W4 rectifier. Six controls: Bandspreed; Main Tuning; Antenna Trimmer; Bandswitch; Regeneration; Audio Gain. Includes tubes and all parts. 7 x 10½ x 6". Shpg. wt. 4½ lbs.

Model S-243. "Space Spanner" Receiver Kit. Net only... \$15.95
S-247. Matching Cabinet for above. 2 lbs. Net... \$2.90



Model S-295 \$14.75

NEW knight-kit TWO-WAY INTERCOM KIT

New low-cost, easy to build intercom system kit. Ideal for use in home or office. Consists of Master unit and Remote unit, each with press-to-talk switch. Remote unit may be left "open" for answering calls from a distance, for "baby-sitting", etc. Remote may also be connected for "private" operation—cannot be "listened-in" on, but it can be called and can originate calls. Master unit includes high-gain 2-stage amplifier; each unit has 4" PM dynamic speaker. Complete with Antique White cabinets (4¾ x 6½ x 4¾"), all parts, tubes and 50 feet of cable (up to 200 feet of cable can be added). For AC or DC. Shpg. wt., 7 lbs.

Model S-295. Two-Way Intercom Kit. Net only... \$14.75

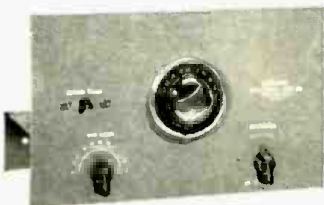

Model S-740 \$11.75

knight-kit

"OCEAN HOPPER" RECEIVER KIT

Tops for exciting broadcast, long wave and short wave reception. Highly sensitive regenerative-type circuit. Excellent headphone reception; can be used with 3-4 ohm PM speaker on strong broadcast band stations. Supplied with plug-in coil for standard broadcast; covers long wave and popular short wave bands with coils below. Pulls in thrilling foreign broadcasts, police, amateurs and aircraft. Controls: Main Tuning, Bandspreed, Antenna Tuning. Off-On-Regeneration. With all parts and tubes (less extra coils and headset). AC or DC. Shpg. wt., 5 lbs.

Model S-740. "Ocean Hopper" Kit... \$11.75

EXTRA PLUG-IN COILS

S-741. Long Wave, 155-470 kc. Net... 79¢
S-742. Short Wave, 1.65-470 kc. }
S-743. Short Wave, 2.9-7.3 mc. } Net
S-745. Short Wave, 7-17.5 mc. } each... 65¢
S-744. Short Wave, 15.5-35 mc. }



Model S-735 \$17.25

knight-kit

"RANGER II" SUPERHET RADIO KIT

Thousands have built and enjoyed the "Ranger" Broadcast Band Receiver. Carefully engineered for easy construction and powerful, sensitive performance. Latest Superhet circuit; tunes 540 to 1680 kc; covers entire broadcast band and exciting police calls. Features automatic volume control, built-in preformed loop antenna, ball-bearing tuning condenser. Develops excellent tone quality from Alnico V PM dynamic speaker. Supplied with following tubes: 12SA7GT converter; 12SK7GT IF amp.; 12SQ7GT det.-AVC-audio; 50L6GT audio output; 35Z5GT rect. Complete with handsome brown plastic cabinet (6 x 9 x 5) tubes, speaker, all parts, and instruction manual. AC or DC operation. Shpg. wt., 8 lbs.

Model S-735. "Ranger II" Superhet Radio Kit. Net only... \$17.25



Model S-730 \$19.95

knight-kit

3-WAY PORTABLE RADIO KIT

A low-cost portable radio covering the full standard broadcast band from 535 kc to 1650 kc. Delivers excellent reception on AC or DC current or from self-contained batteries. Sensitive Superhet circuit features automatic volume control, economical operation. Includes powerful 5" Alnico PM dynamic speaker, efficient ferrite loop-stick antenna. Supplied with following tubes: 1R5 converter; 1U4 IF amplifier; 1U5 detector-AVC-audio; 3V4 audio output. Complete with attractive portable case (7¾ x 10 x 5¼"), tubes, speaker, all parts and instruction manual. Shpg. wt., 6 lbs.

Model S-730. 3-Way Portable Radio Kit (less batteries). Net... \$19.95
J-651. Battery Kit for above... \$2.50

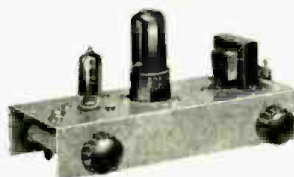

knight-kit LOW COST PHONO AMPLIFIER KIT

Model S-790 \$8.95

It's easy to build this fine-performing, low-cost compact phono amplifier. Ideal for use in a portable phono-graph—simply add any

record player and a 3 to 4-ohm speaker. Amplifier works with crystal or ceramic cartridges. Inverse feedback circuit for rich, clean tone quality. Delivers full 1½-watt output with less than .25 volt input. Includes efficient tone control; has AC outlet, controlled from amplifier switch. Complete with tubes and all parts. Size only 4½ x 7 x 4"—fits into almost any portable phono case. Shpg. wt., 3 lbs.

Model S-790. Phono Amplifier Kit. Net only... \$8.95

FAMOUS knight-kit CRYSTAL SET KIT

Model S-261

\$2.15

Thousands of beginners have started in radio and electronics by building the KNIGHT-KIT crystal set. This feature-packed set delivers loud, clear reception of local broadcast stations. A germanium crystal diode detector assures high sensitivity and simple operation—no crystal adjustment required. "Hi-Q" coil boosts sensitivity. Ball-bearing variable capacitor for easy tuning. With all parts and simple-to-follow instructions. Shpg. wt., 1 lb.

Model S-261. Crystal Set Kit. Net only... \$2.15
S-267. Accessory Kit. 2000-ohm headphones and all parts for outdoor antenna... \$2.95



Buy with confidence from ALLIED — America's Pioneer in Electronic Kits

finest quality electronic equipment in lowest-cost kit form

EASY-TO-BUILD HIGH PERFORMANCE KITS • WIDELY USED BY MANY LEADING TRAINING SCHOOLS



NEW knight-kit ELECTRONIC PHOTOFASH KIT

Model S-244
\$28⁵⁰

New feature-packed photoflash kit—designed for top quality dependability—available at a money-saving low price. Ideal for black and white or color photography. Xenon-filled reflector-bulb assembly gives over

10,000 flashes at less than 1/2¢ each! 1/700-second flash freezes the fastest action. Has 50 watt-second output. Provides light approximating daylight in spectral quality; permits the use of outdoor-type film indoors. Film guide number for color (ASA10) is 45. Designed for "X" or "O" shutters only. Requires sync cable (available from any photo supply dealer) and either battery or AC supply listed below. Complete outfit with battery weighs only 3 1/2 lbs. Kit includes all parts, carrying case and easy-to-follow instructions. Shpg. wt., 3 lbs.

Model S-244. Electronic Photoflash Kit. Net. **\$28.50**
S-246. AC Power Supply Kit. Easy to assemble. **\$3.75**
J-626. Battery for above (Burgess U-200) **\$8.47**

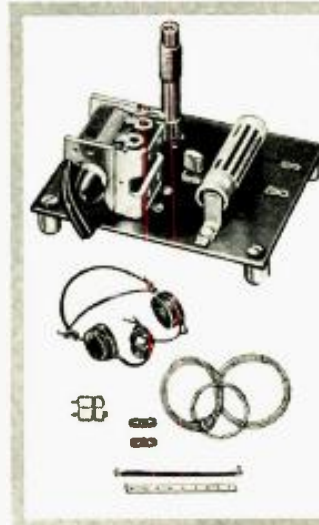

knight-kit TRANSISTOR RADIO KIT

Printed Wiring • Works from Penlight Cell

Model S-765 **\$4³⁵** Smooth Variable Capacitor Tuning

Experiment with the marvel of transistors! Printed circuit requires no wiring—just assemble with a few solder connections and enjoy excellent reception over the full AM broadcast band. No tubes to burn out—no crystal. Compact—fits in the palm of your hand—operates for months from a single penlight cell. Transistor provides plenty of power for strong headphone reception. Complete with all parts, transistor and penlight cell. Shpg. wt., 8 oz.

Model S-765. Transistor Radio Kit **\$4.35**
S-266. Accessory Kit. 4000-ohm headphones and all parts for outdoor antenna. **\$3.15**

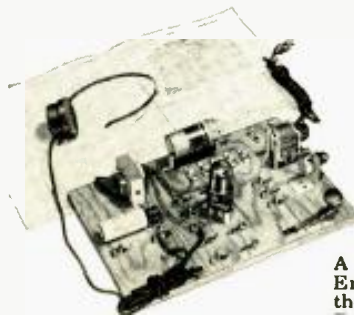

FAMOUS knight-kit LAB KITS

6-IN-1 RADIO LAB KIT

Model S-770 Build Any of 6 Electronic Projects
\$7⁹⁵

A fascinating and instructive kit. Enables you to build any one of the following projects: Standard Broadcast Receiver; Wireless

"Home Broadcaster"; Code Practice Oscillator; Code Practice Broadcaster; Signal Tracer; Sine Wave Generator. Perfect for beginners. Once basic wiring is completed, circuits may be changed without soldering. Safe to build and operate; only tools needed are screwdriver, pliers and soldering iron. The ideal kit for students and beginners in electronics. Kit includes mounting board, tube, all parts and easy-to-follow instruction manual. Less headphone (also serves as mike). Shpg. wt., 6 lbs.

Model S-770. "6-in-1" Lab Kit. Net only. **\$7.95**
J-112. Single 1000-ohm headphone for above. **\$1.05**
C-100. Antenna kit for above. **\$1.05**

10-IN-1 LAB KIT

Model S-265 Build Any of 10 Electronic Projects
\$12⁶⁵

A wonderfully instructive electronics kit. Ideal for experimenters, beginners—fun to build. Construct a sensitive Broadcast Receiver; Amplifier (for phono or mike); Wireless Phono Oscillator; Home "Broadcast Station"; Code Practice Oscillator; Capacity-Operated Relay, or any one of four other fascinating projects. Low voltages; safe to build and operate. Only tools needed are soldering iron, screwdriver and pliers. Perfect for self-instruction in circuit fundamentals, and packed with practical applications. Kit includes mounting board, tubes, all parts, hardware, microphone, and 12-page builders' manual. Shpg. wt., 10 lbs.

Model S-265. "10-in-1" Lab Kit. Net only. **\$12.65**
J-112. Single 1000-ohm headphone for above. **\$1.05**
C-100. Antenna Kit for above. **\$1.05**



knight-kit WIRELESS BROADCASTER KIT

Model S-705 This fascinating unit makes it possible to "broadcast" with phonograph or microphone through any standard radio receiver up to 50 feet away—without any connection to the set. May be used with crystal or magnetic cartridge, or with microphone.
\$9⁵⁰

Broadcasts a clear, full-toned signal. High-gain stage permits using magnetic cartridge without need for external preamp. Complete with all parts, tubes, wire and solder (less microphone). 4 1/2 x 5 x 6". Easy to assemble. Shpg. wt., 3 lbs.

Model S-705. Wireless Broadcaster Kit. Net only. **\$9.50**
S-556. Microphone for above with 5-ft. cable. **\$3.95**



knight-kit PHONO OSCILLATOR KIT

Model S-760 This low-cost phono oscillator may be used with any crystal phonograph for "broadcasting" recorded music through any standard radio receiver up to 50 feet away. Requires no direct connection to radio set. Operates on any frequency between
\$5⁸⁵

600 and 800 kc. Has controls for adjustment of modulation level and selection of clear frequency on radio receiver. Uses 50L6GT tube and 35Z5GT rectifier. Complete with all parts, tubes and instructions. 4 1/4 x 4 1/4 x 4 1/2". Shpg. wt., 1 lb.

Model S-760. Phono Oscillator Kit. Net only. **\$5.85**



knight-kit CODE PRACTICE OSCILLATOR KIT

Model S-239 Transistor Circuit—Powered by Penlight Cell
\$3⁹⁵

An ideal code practice oscillator. Uses transistor circuit. Extremely low current consumption—powered by single penlight battery. Provides crisp, clear tone (400 to 600 cps). Has input jack for earphone; screw-type terminal strip for key. In compact bakelite case (2 3/4 x 3 3/4 x 1 1/2") with anodized aluminum panel. Complete with all parts, transistor, battery and easy-to-follow instructions. Shpg. wt., 1 lb.

Model S-239. Code Practice Kit. **\$3.95**
See Next Page for Amateur Kits

ALL PRICES NET F.O.B. CHICAGO

order from **ALLIED RADIO** 100 N. WESTERN AVE., CHICAGO 80, ILL. →

ALLIED'S own knight-kits give you the most for your money

BUILD YOUR OWN QUALITY HI-FI AMPLIFIER!

knight-kit
BASIC 25-WATT
LINEAR-DELUXE
HI-FI AMPLIFIER KIT

Model S-755
\$44⁵⁰

Williamson-Type Circuit
 Printed Circuit Board
 Chrome-Plated Chassis



This super-quality hi-fi basic amplifier is designed to satisfy the most critical listener. Intended for use with tuners incorporating built-in preamp or with separate preamp. Incorporates latest Williamson-type circuit and has potted matched transformers. Delivers maximum output of 45 watts. Frequency response is: ± 0.5 db, 10 cps to 120 kc, measured at 20 watts. Harmonic distortion is only .15% right up to 30 watts. Intermodulation distortion is only .27% at 10 watts and only .4% at 20 watts, using 60 cps and 7 kc, 1:4 ratio. Hum level is -85 db below full rated output. Output impedance, 4, 8, 16 ohms. Input voltage for 25-watt output is 1.8 volts. Uses two 12AU7's, two 5881's, and a 5V4. Etched circuit is utilized in voltage amplifier and phase inverter stages to speed assembly. Has output tube balancing control, variable damping control, and on-off switch. Handsome chrome-plated chassis, 14 x 9 x 2". Overall height, 7". A deluxe true hi-fi amplifier equal in performance to amplifiers selling at over twice the price. Complete with all parts and tubes. Easy to assemble. Shpg. wt., 27 lbs.

Model S-755. Basic 25 Watt Hi-Fi Amplifier Kit. Net only **\$44.50**
 S-759. Metal enclosure for above; black finish. 3 lbs. Net **\$4.25**

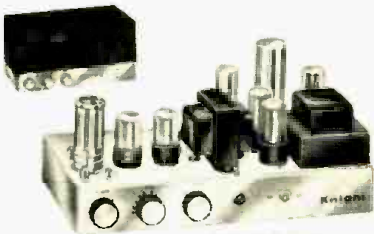

knight-kit
10-WATT HI-FI AMPLIFIER KIT

Model S-753 **Chrome-Plated Chassis**
\$23⁵⁰ Famous for wide response and smooth reproduction at low cost. Only 0.5 volt drives amplifier to full output. Frequency response: ± 1 db, 30-20,000 cps at 10 watts. Harmonic distortion less than 0.5% at 10 watts. Intermod. distortion less than 1.5% at full output. Controls: on-off-volume, bass, treble. Input for crystal phono or tuner. Chromed chassis; punched to accommodate magnetic cartridge preamp. Matches 8 ohm speakers. Shpg. wt., 14 lbs.

Model S-753. Amplifier Kit. Net **\$23.50**
 Model S-235. Preamp Kit for above ... **\$3.10**
 S-757. Metal Enclosure. 3 lbs. **\$3.95**

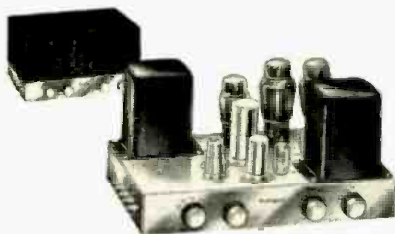

knight-kit
20-WATT HI-FI AMPLIFIER KIT

Model S-750 **Chrome-Plated Chassis**
\$35⁷⁵ True hi-fi for less! Frequency response, ± 1 db, 20-20,000 cps at 20 watts. Distortion, 1% at 20 watts. Hum and noise level: tuner input, 90 db below 20 watts; phono 72 db below 20 watts. 4 inputs: magnetic phono, microphone, crystal phono or recorder, and tuner. Controls: Bass, Treble, Volume, Selector. With compensation positions for 78 and LP records. Built-in Preamp. Outputs: 4, 8, 16 and 500 ohms. 23 lbs.

Model S-750. 20-Watt Kit. Net **\$35.75**
 S-758. Metal Enclosure. 3 lbs. **\$4.15**
 S-752. Chrome-plated escutcheon for cabinet installation of amplifier. Net **\$1.40**

LOW-COST TOP QUALITY KITS FOR THE HAM



knight-kit
Model S-255 50-WATT CW TRANSMITTER KIT
\$38⁹⁵ Built-in Pi-Type Antenna Coupler

Check the features packed into this new transmitter kit and you'll see why it's one of the greatest Amateur values ever offered. Compact and versatile, it is the perfect low-power rig for the beginning Novice or seasoned veteran. Features: 50 watts input to 807 final; high-efficiency 6AG7 modified-Pierce oscillator takes crystal or VFO without circuit changes; bandswitching coverage of 80, 40, 20, 15, 11-10 meters; pi-section antenna output matches line impedances from 50 to 1200 ohms — permits use with any type of antenna; no separate antenna tuner required. Crisp, clean, cathode keying of oscillator and final. Power take-off plug supplies filament and B-plus voltages for other equipment. Copper-finished chassis and cabinet interior, filtering, shielding, bypassing, and coaxial SO-239 antenna connector provide excellent TVI suppression. Meter reads either plate or grid current of final. Jacks for VFO, crystal and key. Supplied with all parts and tubes. Less crystal and key. 8 $\frac{1}{4}$ x 11 $\frac{1}{4}$ x 8 $\frac{3}{4}$ ". Shpg. wt., 18 lbs.

Model S-255. 50-Watt Transmitter Kit. Net. ... **\$38.95**



knight-kit
SELF-POWERED VFO KIT

Model S-725
\$28⁵⁰

Complete with built-in power supply! Careful design and voltage regulation assure high stability. Excellent oscillator keying characteristics for fast break-in without clicks or chirps. Full TVI suppression. Has plenty of handsread: separate calibrated scales for 80, 40, 20, 15, 11 and 10 meters; vernier drive mechanism. 2-chassis construction keeps heat from frequency determining circuits. Output cable plugs into crystal socket of transmitter. Output on 80 and 40 meters. With Spot-Off-Transmit switch for "no swish" tuning. Extra switch contacts for operating relays and other equipment. With all parts and tubes. 8 lbs.

Model S-725. Self-Powered VFO Kit. Net. ... **\$28.50**



NEW knight-kit
AMATEUR RF "Z" BRIDGE KIT

Model S-253 **\$5⁸⁵** Measures standing wave ratio (SWR) and impedance of antenna systems; also for adjusting antenna

networks for optimum results. Any VOM may be used for null indicator. High accuracy with 20,000 ohm/v VOM. Correction factor info supplied for other VOM's. With coax input and output connectors. Meters both input and bridge voltage. Calibrated dial gives direct impedance reading; includes 1% precision resistor for precise calibration adjustment. With all parts and handy plasticized SWR chart. 1 $\frac{1}{2}$ lbs.

Model S-253. "Z" Bridge Kit. Net only **\$5.85**

ALLIED RADIO

100 N. WESTERN AVE., CHICAGO 80, ILL.

Our 36th year

ALLIED RADIO CORP., Dept. 01.A-7, 100 N. Western Ave., Chicago 80, Ill.

Ship me the following KNIGHT-KITS:

Quantity	Description	Model No.	Price

\$ _____ enclosed. For parcel post include postage (express is shipped collect).

Name _____

Address _____

City _____

Zone _____

State _____

← *order Today*

LATEST ALLIED knight-kits



NEW for the
Serviceman

knight-kit
FLYBACK
CHECKER KIT

Model Y-118 **\$19.50**

Race through TV deflection circuit repairs for extra servicing profits with this new Flyback and Yoke Tester! Instantly checks all types of standard horizontal output transformers as well as linearity and width coils. Positively indicates shorted turns for any coil with a "Q" greater than 1, and inductance between .003 and 2 henries. Determines continuity of any circuit with resistance from zero to .5 meg. Checks wider range of inductances than any other similar unit. Has highly legible $4\frac{1}{2}$ " meter. Uses 6S4-A pulsed oscillator circuit. Supplied with all parts and test leads. $7\frac{3}{4} \times 5\frac{1}{4} \times 5"$. Shpg. wt. $5\frac{1}{2}$ lbs.

Model Y-118. Flyback Checker Kit. **\$19.50**
Net.....



NEW for the Ham

knight-kit
100 KC CRYSTAL
CALIBRATOR KIT

Model Y-256 **\$10.50**

New universal frequency calibrator to fit any communications receiver—priced so low every Ham

can afford it. Uses hermetically-sealed 100 KC crystal. Generates 100 KC markers all the way up to 35 mc. Compact case is only $3 \times 1\frac{1}{2} \times 1\frac{1}{2}$ "; has universal mounting flanges for mounting in any of several positions. Requires only 6.3 v. at .15 amps and 150-350 v. at 3-6 ma. Includes crystal zeroing trimmer and on-off switch which mounts on case. Connects to receiver input. Uses 6AK6 as electron-coupled oscillator. Complete with formed and punched case, 100 KC crystal, tube, all parts and instructions. Shpg. wt., 1 lb.

Model Y-256. Crystal Calibrator Kit. **\$10.50**
Net.....

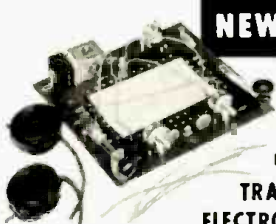

NEW for the
Experimenter

knight-kit
TRANSISTORIZED
ELECTRONIC LAB KIT

Model Y-299 **\$15.45**

It's sensational—learn how transistors operate—see all the projects you can make with this all-

new electronic marvel! You just assemble the basic parts once. Then you complete project after project (10 in all), just by inserting the "plug-in" leads into the proper jacks on the printed-circuit board—without additional soldering! You can complete and enjoy any of these: a fine AM radio; a wireless home "broadcaster"; phono amplifier; code practice oscillator; electronic timer, switch or flasher; voice-operated, capacity-operated and photoelectric relays. It's the most fascinating experimenters' kit ever developed! Includes all parts, two transistors, battery, headphones and special cards showing you how to plug in each project. Shpg. wt., 3 lbs.

Model Y-299. Transistorized Lab Kit. **\$15.45**
Net.....

use order blank
on opposite page

Ham Communications

from

President's Train

Record-breaking contacts with
45 states, 14 foreign lands.

TO PROVIDE the President of the United States with extensive communications facilities from a railroad train, a communications car is included in the President's train. This car, the Albert J. Myer, has also been outfitted with amateur radio equipment which was extensively used during the recent 1956 presidential campaign to advance the amateur cause and to bring to the attention of appropriate parties a tremendous existing communications facility, dedicated to public service.

The amateur station, W3WTE, operated by Al Hart, W4FB, recently completed a record-breaking series of contacts with stations in 45 states and 14 foreign countries. This was done in less than 21 hours of operation from a standing start 60 feet below street level at Union Station in Cleveland and along the trip to Washington, D. C.

The transmitting equipment used was an *Eldico* SSB 100A exciter and a SSB 1000 amplifier. These units were installed on their own rubber feet using wire braid as a snubber to prevent "walking" off the desk due to the car's vibration. The receiver used was a military 390A which is manufactured by *Collins*. The antenna was the permanent system which is normally used for official circuits. It consists of a capacity feed grid network atop the railroad car, which network excites a field whose lines of force go to ground through a return circuit rising vertically on the car, thereby making the car itself a non-directional vertical radiator. A continuous recording was taken throughout the operation using an *Ampex* 400 recorder.

Operating position in President's communications car where contacts were made.

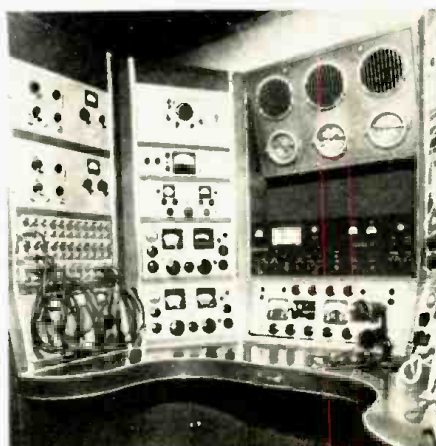

Your choice of school
is highly important
to your career in



INDUSTRIAL
ELECTRONICS



RADIO-
TELEVISION



ELECTRONICS
COMMUNICATIONS

Become an
**ELECTRICAL
ENGINEER**

or an
**ENGINEERING
TECHNICIAN**

MSOE in Milwaukee

Choose from courses in:

ELECTRICAL ENGINEERING

Bachelor of Science degree in

36 months. Communications option (radio-tv) Power option.

ENGINEERING TECHNICIAN

Assoc. in Applied Science degree
— 18 months.

Electronics Communications
Electrical Power.

MSOE — located in Milwaukee, one of America's largest industrial centers — is a national leader in electronics instruction — with complete facilities, including the latest laboratory equipment, visual aid theater, amateur radio transmitter — offers 93 subjects in electrical engineering, electronics, radio, television, electrical power, and electricity.

Advisory committee of leading industrialists. Courses approved for veterans. Over 50,000 former students. Excellent placement record.

QUARTERS STARTING OCTOBER, JANUARY, APRIL, JULY

Choose wisely — your future depends on it. Write for more information today!



MILWAUKEE

SCHOOL OF ENGINEERING

Dept. RT-157, 1025 N. Milwaukee Street
Milwaukee 1, Wisconsin

Send FREE career booklet.

I am interested in _____ (Name of course)
Name _____ Age _____
Address _____
City _____ Zone _____ State _____
If veteran, give discharge date _____

MS-57

no other plier
does so many jobs
SO WELL



CHAN NEL LOCK

No. 420

GRIPS LIKE A
PIPE WRENCH

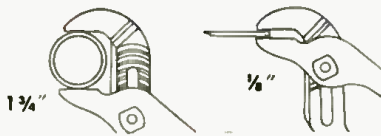

Help yourself to a Channellock No. 420 . . . the handiest plier of them all. With this handy plier, you can grip anything from a cotter pin to a 1 3/4" hex nut. And what gripping power! Just like a pipe wrench. What's more, Channellock is streamlined . . . easy to use in hard-to-get-at places. This all-round usefulness is the reason why Channellock is the favorite plier of craftsmen everywhere. It'll be your favorite, too . . . for the same reason. Ask your hardware man for a Channellock No. 420.

BE SURE IT'S A GENUINE CHANNELLOCK



CHAMPION DEPARTMENT TOOL Co. MEADVILLE, PA.

Handling FM-to-TV Interference

By GEORGE D. PHILPOTT

Slight alteration in oscillator coil of FM set will stop interference on specific TV channels.

CONFRONTED with the problem of FM receiver radiation interference on a television channel—or more than one channel—some technicians are at a loss as to the solution. In many cases, the offending FM set is upstairs, down in the basement, or may be on top of the kitchen range. Where a word of explanation to the customer is not sufficient to satisfy skeptical minds, the following alterations in the FM receiver might be necessary to eliminate the complaint.

The first step in the procedure is to determine exactly which TV channel suffers from interference; most likely, the customer will furnish this information quickly. Channels 5, 6, and 10 are the usual spots where FM receivers play havoc with picture reception. This is so because most FM sets with an i.f. frequency of 10.7 mc. radiate local-oscillator r.f.—at the fundamental frequency—on channels 5 and 6, and on the 2nd harmonic, on channel 10. This is the case where the FM set is designed so that the local oscillator tunes 10.7 mc. *below* the incoming station frequency. Most currently produced FM receivers are designed to operate on the low side in this way because the local oscillator is more stable and gives greater r.f. output at a lower frequency.

When channels 5, 6, and 10 are the ones being interfered with, it is possible to eliminate completely the wavy lines and bouncing sound by changing the operating frequency of the offending FM set's local oscillator. The task is not as rough as it might seem—if care is taken while making the alteration.

The oscillator coil in most FM receivers usually consists of about four turns of copper or silvered wire. It is air wound and about 5/8 inch in diameter. Carefully remove a single turn from the coil, making sure that lead dress

and termination points are undisturbed. With one turn of the coil removed, the receiver's local oscillator will now be operating on the *high* side of the FM carrier. Slight re-touching of the oscillator trimmer will position the stations where they belong on the dial.

Some receivers require a nominal amount of coil adjustment to regain proper station tracking and alignment, but the average service technician should have little trouble in accomplishing this accurately. With the receiver's oscillator operating on the high side, radiation from it will now fall in a portion of the radio spectrum not covered by the TV receiver. True, the FM oscillator will now radiate second-harmonic r.f. on TV channels 11, 12, and 13. However, second harmonic radiation is seldom strong enough at these frequencies to cause noticeable interference problems.

It is possible to reverse the above mentioned procedure when an interference problem is prevalent on channels higher in frequency than channel 10 because the FM oscillator is beating *above* the carrier: add one turn to the oscillator coil and change its frequency to the *low* side. However, this condition seldom occurs.

A word of caution and a reminder: Should altering the oscillator coil as recommended here cause the receiver to fail in operation on all or a portion of the FM band, the oscillator tube should be checked by replacement and all circuit voltages should be tested. Currently designed FM oscillator tubes and circuit components will function properly at much higher frequencies than demanded in standard FM reception; oscillator failure after coil alteration could indicate other trouble in that portion of the receiver, and standard troubleshooting procedure should then follow. —30—

MOUNTING AN OSCILLOSCOPE CALIBRATION GRID

By ORRIN D. FACKLER

THE AUTHOR recently constructed a Heathkit Model O-11 oscilloscope. An obvious difficulty with this scope is the inability of the thin plastic calibration grid to retain its rigidity for any length of time without becoming loose or warped.

One possible solution for this situation is to glue the grid to a wooden embroidery hoop, as suggested by James F. Sutherland, (RADIO & TELEVISION NEWS, November, 1956, page 184). Another method, possibly better, can be used to correct the problem.

Sandwich the calibration grid between

two pieces of plastic. The plastic used by the writer was 1/16-inch transparent Plexiglas. However, the kind or thickness isn't important. The plastic is cut into two circles, each having a diameter of 5 1/4 inches. The grid should also be trimmed to the same size and sandwiched between the two pieces of plastic. These should be bonded together by applying Duco cement to the edges and allowing sufficient time for the glue to dry. The finished unit may then be pressed into the felt-lined CRT front support with no danger of warping or twisting. —30—

RADIO & TELEVISION NEWS

Sensational Radio Shack Winter Sale!!

\$44.95 WEBCOR CHANGER

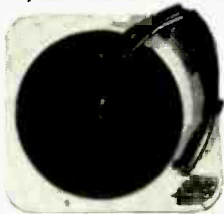

\$19.95 — Sonotone Cartridge
 4-Pole Motor
 NR-9914A
 Brand New, top quality WEBCOR Changers at a staggeringly low price! Many high fidelity features including shaded four-pole motor and Sonotone Dual Sapphire Ceramic Cartridge. Plays all 3 speeds and sizes. Intermixes 10" and 12" records. Packed in special Radio Shack Protective Carton. 16 lbs. Mounting Base No. NR-9917.....\$4.95

Tork 7-Day Timer

For Air Cond., Elec. Stoves, Store Lights.



\$6.95
 Brand New. Individually boxed. Contacts handle 30 amps. Designed for Air Conditioners. SPST — 115 V. AC. Turns on or off. Can Skip Days! Complete with heavy duty line cord. Wt. 4 lbs NR-5000A.

New! Personal Pocket Radio With Ear Plug!



\$11.95
 Big Set Performance for Private Listening Provision for Second Earphone! Extra-Sensitive High Q loop-stick antenna. Uses 3 tubes. All controls can be operated in pocket. Wt. 1 lb. No. NR-9940.

Wilson "Tiny Atom" DC Motor

Clear Plastic Case
 Operates from 1 or 2 flashlight batteries. Ideal for Model Builders, hobbyists. Precision construction. Alnico V Field. Brass sleeve bearings. Speeds from 3500 to 9200 rpm. Instantly reversible. NR-7900.
 Reg. \$2.50
\$1.49



ARCHER "LIPSTICK" XTAL MIKE!

Reg. \$21.00
\$5.95
 Amazing high quality microphone only 4 7/8" long and 3/4" dia. Response 50-10,500 cps! All metal case. Complete with 10' mike cable and new 180 swivel attachment. A Real Value! Wt. 2 lbs. NR-9950.



Realistic Hi-Fi-System — \$67.50

- ★ WEBCOR 3-SPEED CHANGER
- ★ REALISTIC 10W AMPLIFIER
- ★ REALISTIC SPEAKER SYSTEM

Can't Be Matched For Less Than
 No. WR-3
\$120.00

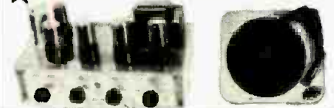

FREE! New Year Bonus. \$3.98 Columbia Album Mendelssohn Violin Concerto in E. ML 5085.

Realistic Hi-Fi FM Tuner

Worth \$69.50
\$39.95



Outstanding Hi-Fi-Buy! N-36-888.
 Rated "Best Buy" in High Fidelity Magazines and Consumer Surveys! Nothing better at less than 3 to 4 times our cost! Features Armstrong FM with Foster-Seeley discriminator. 5 uv sensitivity. AFC, tuner RF stage, built-in AC power supply. Uses 6 tubes, 2 duals. Range 88-108 mc. Super-small modernistic chassis 4 1/2" H. x 9 1/2" W. x 6 3/4" D. RETMA Guarantee. Wt. 6 1/2 lbs.

7x35 Prism Binocular Sale!

\$15.99
 • Coated Optics
 • Pigskin Case
 MICRONTA Guaranteed imported Prism Binoculars have die-cast bodies with clamped precision ground prisms. Hard-coated color corrected optics. Quantity Limited Wt. 2 1/2 lbs, No. NR-9024.



\$25.00 Transistor Radio Kit

\$11.95
 Complete With Speaker
 Now! A 2-Transistor Portable Kit with built-in speaker at a really practical price! Complete with plastic carry-case, 7 1/2" x 5" x 1 1/2". Calibrated dial. All necessary parts inc. Wt. 1 1/2 lbs. N-36-549.



New Fast f:3.5 35mm Camera!

\$18.95
 • Coated f:3.5 lens
 • Semi-wide angle
 • 40mm focal length
 • Flash sync.
 • PC flash tip
 • Shutter; bulb, 1/25 to 1/200
 Wt. 1 1/2 lbs. No. NR-9012
 Eveready case, \$2.95 No. NR-9012C, 1/2 lb.



Photo-electric Exposure Meter

"Flick" For Incident or Reflected Readings
\$6.99
 • New LVS synchro Compur readings
 • 1-hand operation light, compact
 • Apertures f:1.4-45
 8 sec to 1/1000
 Wt. 1 lb. No. NR-8296A



New Micronta Multitesters!

\$19.90
 With 1% wire-wound resistors, 3" meters! With silver-switch contacts, rubber leads! With Micronta-RETMA GUARANTEE!
 (Left) — 20,000 Ω/v DC, 8,000 Ω/v AC, 45 ua 3" meter, 5 KV DC scale. Ship. 4 1/4 lbs. No. NR-4002. (Not Shown) — 4000 Ω/v DC, 2000 Ω/v AC, 175 ua movement. Ship. 2 1/2 lbs. No. NR-6DD: \$9.95.



Midget Jewelers' Plier Set!

5 Popular types in zippered case! Precision drop forged, polished chrome plate!
 Reg. \$12.95
\$5.99
 Magnificent set includes: End Nipper, Diagonal Cutter, Round Nose, Flat Nose, Half-round Flat Nose. Our Skillman brand. Ship. 1 1/2 lbs. No. NR-9955.



HIGH SPEED Motor Tool!

\$8.99
 12 Mtd. Stones, \$1.19 No. NR-7067A. 6-025.
 Full-powered speed tool for grinding, cutting, routing. 115V AC-DC; high torque. No-load speed 20,000 rpm. 2 1/2 lbs. No. NR-7505.



Alcohol Blow Torch Closeout

Reg. \$5.90
\$1.44
 Exclusive purchase saves you more than 50%. Solidly built of chrome-plated brass; hardwood pistol-grip handle, wind shield. Wt. 2 lbs., No. NR-6997.



Glenn Miller 12" Lp Album!

Collector's Item! 5 12" RCA Lp's with story, discography. 60 originals. Wt. 3 1/2 lbs., No. NR-8300.
\$14.95
 Reg. \$24.95



Imported 2000-ohm Headphone

Reg. \$5.30
\$1.98
 Heavy chrome steel magnets, black headband, rubber leads, adjustable ear pieces. Wt. 3/4 lb., NR-9941.



Taylor Weather Kit Sale!

\$9.95
 • Made by Taylor Instrument Co. for \$24.95 Prepared with Encyclopedia Britannica, Chicago Museum of Science and Industry
 Complete weather forecasting kit has \$11 mercury column. You build 3 1/2" barometer, hygrometer, max.-min. thermometer, wind-cloud speed direction indicators. Free 48-page book. No. NR-9924. Ship. 10 lbs. Railway Exp.

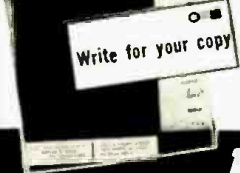

Brand New, Complete
ELECTRONICS CATALOG — 57

Send for new **TIME Payment PLANS!**

RADIO SHACK Corp

BOSTON, MASS. — 167 Washington St. NEW HAVEN, CONN. — 230 Crown St.

To: RADIO SHACK Corp., 167 Washington St., Boston, Mass.

RUSH: 1. _____ \$ _____
 2. _____ \$ _____
 3. _____ \$ _____
 Total \$ _____
 Name _____
 Address _____
 Time Plans _____
 Order By Mail, No C.O.D.'s Please

NEW! RAM® X-CHECKER®

SERVICE-ENGINEERED!

- helps solve a multitude of TV-electronic problems
- from the Voice of Authority in sweep components



The new RAM X-CHECKER is a substitution box allowing easy substitution or insertion of a resistor or capacitor, or a series combination of both, in an electronic circuit. The resistance substitution range is from 0 to 2500 ohms. The capacitance substitution range is from 20 to 450 mmfd. Both ranges are continuously variable and the values may be read directly from the scale calibration. Accuracy of the calibration is 10%. Dissipation of the resistor is 2 watts. Typical uses are:

- to eliminate sound bars on screen due to insufficient filtering action of 4.5 mc trap
- to correct lack of picture detail due to insufficient h-f response of video amplifier stage
- to correct insufficient raster width
- to correct improper magnitude of AGC or AFC pulse from flyback circuit
- to correct improper horizontal linearity, brightness or width
- to determine value of burned illegible resistors or capacitors
- to read unfamiliar codes
- to compensate for deterioration of parts
- to determine values in lab breadboard circuits
- to substitute directly for faulty components

\$7.95 NET See it at your local distributor or write to Ram for local wholesale source.



RAM ELECTRONICS SALES CO. • Irvington, N. Y.

Canadian Sales Division: Telequipment Mfg. Co., Ltd, London, Ontario.
Export Dept: Dage Corp., 219 E. 44 St., New York, N. Y.



Sandy Says!
You'll Like the Quality and Price

Anchor T-400

Tests and Repairs CRT tube in set, cotton or on bench



Complete with durable case and cover, only **\$39.95**

Factory Tested and Fully Warranted

TESTS FOR: Open connections, open elements, useful life, shorted elements, cathode emission and gaseous tube.

REPAIRS: Open elements. Corrects shorts. Reactivates low emission tubes and restores brightness.

AT YOUR DISTRIBUTOR OR WRITE:

anchor products co.
ELECTRONIC COMPONENTS
2712 W. Montrose • Chicago 18, Ill.

CAPACITOR ANALYZER & RESISTANCE BRIDGE

Mfd by Clough Brengle to Navy Specs.—Conventional analyzer for capacity—Range 10 MMFD-100MFD . . . Conventional ohmmeter 1 ohm to 10 megohms . . . operates from 115V-60 cycles . . . operating condition ea. **\$22.50**

COMMUNICATIONS RECEIVER—Type RBL-5—Mfd by National for US Navy and Merchant Marine—Frequency 15-600KC in 6 bands. Perfect for hams, distress band listeners, ships, etc.—Works from 115 volt-60 cycle. Gov't cost over \$600—Brand new with Tech manual (A perfect gift for ANY Radio Ham) **\$59.95**

ARC-5 TRANSMITTER
3-4MC Exc. Cond. W/Tubes **\$5.95**
5.3-7MC Exc. New W/Tubes **4.89**

ARC-5 RECEIVERS
3-6MC Fair Cond. W/Tubes **5.95**

807W/5933—Ruggedized 807 (worth \$12.50 net) New—Sylvania **\$1.59** **\$15 doz.**
TUBE TYPE 872/A—11V Rect.—New—boxed ea. **\$1.29** **\$12.00 doz.**

METER
• 2 1/2" RD—Triplett—0-200 Microamp DC—wht. scale—New **\$4.95**
• Running Time—RW Cramer—E21H—110V—60 cycle—5 digit **9.95**
• Weston 731—0-500 MA—DC New **7.95**
• Weston 731—0-R A—DC New **7.95**

MINIATURE MICROAMPMETER—0-200µ/a DC DeJur 1 1/2" sq. New boxed 10 for 50.00 **5.95 ea.**

OSCILLOSCOPE—RCA—Conventional 3" Oscilloscope made to rigid Navy Specs.—Excellent operating condition—115V, 60 Cycle INPUT **\$29.95**
PROBE for above scope New **2.95**

MAST SECTION MS-53—This is the section that can be screwed into each other to permit extending to any desired length. 38.4" ea. section (1 meter)
Close out SPECIAL. Sold only in lots of 10. Former price 59¢ ea. **\$2.00**
Now—while they last—Bundle of 10

TEST SET—TS 35A/AP—Sig., Gen. & Power Meter 8700-9500MC **\$49.95**
TEST SET—TS 58/AP—360-675MC—W/Accessories New **49.95**

REX RADIO SUPPLY
88 Cortlandt Street, New York 7, N. Y.

Electrometer (Continued from page 67)

and an effort made to keep them clean and free from flux drippings.

The 100,000 ohm calibrating rheostat was soldered to the bottom of the copper chassis. The 5000-ohm wire-wound zero-set potentiometer was installed on the panel opposite the "on-off" switch. The 117-volt leads to the filament transformer go to a terminal strip mounted on one of the screws holding the transformer. The one shown was cut out of a mounting board but any similar one could be used. The a.c. cord is fed through a grommet in the cover section of the cabinet. Wiring the device was somewhat challenging because of the small space available but it can be done if care is used. The battery is wired in permanently since the tubes do not draw current when the filaments are cold. The plate current is about 600 µa. so the battery should have a relatively long life. A ground terminal is provided on the outside of the case near the porcelain insulator.

To calibrate the meter when the wiring is completed and checked, set the 100,000-ohm rheostat at its high resistance limit and turn the instrument on. Ground the terminal of the feedthrough insulator and zero the meter with the zero-set. Then apply a known voltage across the input terminals (a five-cell flashlight was used. $E = 7.75$ volts) and adjust the rheostat until the meter reads the voltage applied. The 0-200 µa. scale corresponds to 0-20 volts across the input terminals. If the meter construction allows it, one can substitute a scale reading directly in volts. This completes the construction of the instrument.

For normal use, a probe can be constructed consisting of a 22-megohm resistor mounted in the end of a piece of plastic tubing. The wire connecting the resistor should then go to the terminal on the porcelain insulator. The value of the probe resistor is unimportant as long as it is above 10-megohms so that it provides proper isolation.

Fig. 3. Complete schematic diagram of simple vacuum tube electrometer.

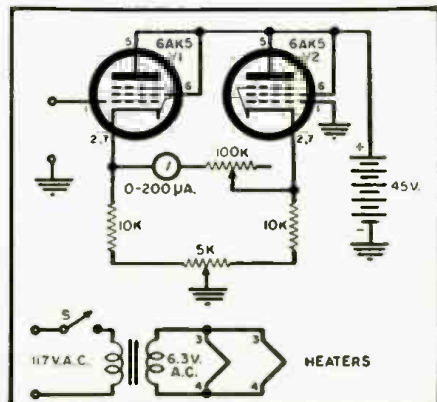

for just **27¢** per day—



PHOTOFACT—the world's finest TV-radio service data comes to you...keeps you right up-to-the-minute on new model releases...is delivered automatically by your Parts Distributor as each new Folder Set is issued. Yes, for just 27¢ per day...

PHOTOFACT can help you double your repair output



Exclusive PHOTOFACT features help you solve any service problem faster...help you earn more

PHOTOFACT offers you complete coverage on over 30,000 TV, Radio, Amplifier, Tuner and Changer models. And PHOTOFACT is a current service—keeps you right up with late model production—brings you these exclusive features...

Full Schematic Coverage: Famous "Standard Notation" uniform symbols are used in every schematic. Diagrams are large, easy to read and handle. Wave forms and voltages are shown right on the schematic for fast analysis. Transformer lead color-coding and winding resistances appear on the schematic. Schematics are keyed to parts lists and to parts on chassis photos.

Full Photographic Coverage: Photos of all chassis views are provided for each model; all parts are numbered and keyed to the schematic and parts lists for quicker parts identification and location.

Alignment Instructions: Complete, detailed alignment data is standard and uniformly presented in all Folders. Alignment frequencies are shown on radio photos adjacent to adjustment number—adjustments are keyed to schematic and photos.

Tube Placement Charts: Top and bottom views are shown. Top view is positioned as seen from back of cabinet. Blank pin or locating key on each tube is shown. Charts include fuse location for quick service reference.

Tube Failure Check Charts: Shows common trouble symptoms and tubes generally responsible for such troubles. Series filament strings are schematically presented for quick reference.

Complete Parts Lists: Detailed parts list is given for each model. Proper replacement parts are listed (with installation notes where required). All parts are keyed to chassis photos and schematics for quick reference.

Field Service Notes: Each Folder includes time-saving tips for servicing in the customer's home. Gives valuable hints for quick access to pertinent adjustments, safety glass removal, special advice covering the specific chassis, etc.

with PHOTOFACT by your side, you solve your service problems in just minutes...you SERVICE MORE SETS AND EARN MORE DAILY...

The regular monthly issues of Sam's PHOTOFACT provide you with up-to-the-minute service data on new models as they are produced, for as little as 27¢ per day! And this includes the "bonus" schematic service on new models hot off production lines to give you *immediately* the essential data you need.

With a current PHOTOFACT library at your fingertips, you can actually *double* your repair output, because *you save valuable time on every job.* YOU EARN MORE DAILY.

Learn how easy it is to sign up with your Parts Distributor to receive all Sams' PHOTOFACT Sets regularly as published each month. Learn for yourself how a small investment of only 27¢ per day can mean GREATER income for you.

SPECIAL OFFER: If you return the coupon below and indicate your interest in receiving PHOTOFACT regularly each month, we will arrange to have delivered to you, **ABSOLUTELY FREE**, a valuable and attractive Wall Holder for the "Index to Photofact Folders" as well as the latest copy of the Index. Be sure to give your Distributor's name.

HOWARD W. SAMS & CO., INC.
2203 E. 46th St., Indianapolis 5, Indiana

I am interested in receiving all new PHOTOFACT Sets regularly as published each month. Send full details (I understand there is no obligation on my part, and that I will receive without charge, the latest "Index to Photofact", along with Wall Holder).

I am a Service Technician: full time; part time.

My Distributor is: _____

Name: _____

Address: _____

City _____ Zone _____ State _____

Superior's New
Model TV-11

TUBE TESTER



SPECIFICATIONS

- ★ Tests all tubes, including 4, 5, 6, 7, Octal, Lock-in, Peanut, Bantam, Hearing Aid, Thyatron Miniatures, Sub-miniatures, Novals, Sub-minars, Proximity fuse types, etc.
- ★ Uses the new self-cleaning Lever Action Switches for individual element testing. Because all elements are numbered according to pin-number in the RMA base numbering system, the user can instantly identify which element is under test. Tubes having tapped filaments and tubes with filaments terminating in more than one pin are truly tested with the Model TV-11 as any of the pins may be placed in the neutral position when necessary.
- ★ The Model TV-11 does not use any combination type sockets. Instead individual sockets are used for each type of tube. Thus it is impossible

to damage a tube by inserting it in the wrong socket.

- ★ Free-moving built-in roll chart provides complete data for all tubes.
- ★ Newly designed Line Voltage Control compensates for variation of any Line Voltage between 105 Volts and 130 Volts.
- ★ **NOISE TEST:** Phono-jack on front panel for plugging in either phones or external amplifier will detect microphonic tubes or noise due to faulty elements and loose internal connections.

The model TV-11 operates on 105-130 Volt 60 Cycles A.C. Comes housed in a beautiful hand-rubbed oak cabinet complete with portable cover.

EXTRA SERVICE—The Model TV-11 may be used as an extremely sensitive Condenser Leakage Checker. A relaxation type oscilla-

tor incorporated in this model will detect leakages even when the frequency is one per minute.

\$47⁵⁰
NET

Superior's New
Model TV-12



TRANS-CONDUCTANCE TUBE TESTER

TESTING TUBES

- ★ Employs improved **TRANS-CONDUCTANCE** circuit. An in-phase signal is impressed on the input section of a tube and the resultant plate current change is measured. This provides the most suitable method of simulating the manner in which tubes actually operate in Radio & TV receivers, amplifiers and other circuits. Amplification factor, plate resistance and cathode emission are all correlated in one meter reading.
- ★ **NEW LINE VOLTAGE ADJUSTING SYSTEM.** A tapped transformer makes it possible to compensate for line voltage variations to a tolerance of better than 2%.
- ★ **SAFETY BUTTON**—protects both the tube under test and the instrument meter against damage due to overload or other form of improper switching.

★ **NEWLY DESIGNED FIVE POSITION LEVER SWITCH ASSEMBLY.** Permits application of separate voltages as required for both plate and grid of tube under test, resulting in improved Trans-Conductance circuit.

TESTING TRANSISTORS

A transistor can be safely and adequately tested only under dynamic conditions. The Model TV-12 will test all transistors in that approved manner, and quality is read directly on a special "transistor only" meter scale.

The Model TV-12 will accommodate all transistors including NPN's, PNP's, Photo and Tetrodes, whether made of Germanium or Silicon, either point contact or junction contact types.

Model TV-12 housed in handsome rugged portable cabinet sells for only

\$72⁵⁰
NET

ALSO TESTS TRANSISTORS!

Superior's New
Model TV-40

PICTURE TUBE TESTER

NOT A GADGET—NOT A MAKE-SHIFT ADAPTER, BUT A WIRED PICTURE TUBE TESTER WITH A METER FOR MEASURING DEGREE OF EMISSION—AT ONLY \$15.85



Of course you can buy an adapter for about \$5—which theoretically will convert your standard tube tester into a picture-tube tester; or a neon type instrument which sells for a little more and is supposed to be "as good as" a metered instrument. Superior

does not make nor do they recommend use of C.R.T. adapters or neon gadgets because a Cathode Ray Tube is a very complex device, and to properly test it, you need an instrument designed exclusively to test C.R. Tubes and nothing else.

Tests ALL magnetically deflected tubes . . . in the set . . . out of the set . . . in the carton! !

- Tests all magnetically deflected picture tubes from 7 inch to 30 inch types.
- Tests for quality by the well established emission method. All readings on "Good-Bad" scale.
- Tests for inter-element shorts and leakages up to 5 megohms.
- Tests for open elements.

EASY TO USE: Simply insert line cord into any 110 volt A.C. outlet, then attach tester socket to tube base (Ion trap need not be on tube). Throw switch up for quality test . . . read direct on Good-Bad scale. Throw switch down for all leakage tests.

Model TV-40 C.R.T. Tube Tester comes absolutely complete — nothing else to buy. Housed in round cornered, molded bakelite case. Only

\$15⁸⁵
NET

EXAMINE BEFORE YOU BUY!
USE APPROVAL FORM ON NEXT PAGE

Superior's New
Model TV-60

20,000 OHMS PER VOLT ALLMETER



FEATURES

- ✓ A sensitive, accurate Volt-Ohm-Milliammeter with giant meter and mirrored scale.
- ✓ An accurate direct-reading Capacity meter.
- ✓ A Kilovoltmeter.
- ✓ An R.F. Signal Tracer.
- ✓ An Audio Signal Tracer.
- ✓ Giant recessed 8 1/2 inch 40 Microampere meter with mirrored scale assures accuracy and easy-reading. All calibrations are printed in large easy-to-read type. Fractional divisions are easily read with the aid of the mirrored scale.

Includes services never before provided by an instrument of this type. Read and compare features and specifications below!

- ✓ The line card, used only when making Capacity measurements, need be plugged in only when using that service. It is out of the way, stored in its plicofilm compartment at all other times.
- ✓ A built-in Isolation Transformer automatically isolates the Model TV-60 from the power line when the capacity service is in use.
- ✓ Selected, 1% zero temperature coefficient metallized resistors are used as multipliers assuring unchanging accurate readings on all ranges.
- ✓ Use of the latest type of printed circuit guarantees maintenance at top quality standard in the production runs of this precise instrument.
- ✓ A new improved type of high-voltage probe is used for the measurement of high voltages up to 30,000 Volts. This service will be required when servicing color TV receivers.
- ✓ Simply plug-in the R.F. probe and convert the Model TV-60 into an efficient R.F. SIGNAL TRACER permitting the measurement of stage-gain and cause of trouble in the R.F. and I.F. circuits of A.M., F.M., and TV receivers.
- ✓ Plug in the Audio probe and convert the Model TV-60 into an efficient AUDIO SIGNAL TRACER. Measure the signal levels and comparative efficiency of hearing-aids, public-address systems, the amplifier sections of Radio & TV receivers, etc.

SPECIFICATIONS:

- 8 D.C. VOLTAGE RANGES: (At a sensitivity of 20,000 Ohms per Volt) 0 to 15/75/150/300/750/1500/7500/30,000 Volts.
- 7 A.C. VOLTAGE RANGES: (At a sensitivity of 5,000 Ohms per Volt) 0 to 15/75/150/300/750/1500/7500 Volts.
- 3 RESISTANCE RANGES: 0 to 2,000/200,000 Ohms, 0-20 Megohms.
- 2 CAPACITY RANGES: .00025 Mfd. to 30 Mfd.
- 5 D.C. CURRENT RANGES: 0-0.75 Microamperes, 0 to 7.5/75/750 Milliampere, 0 to 15 Amperes.
- 3 DECIBEL RANGES: -6 db to +58 db.

R. F. SIGNAL TRACER SERVICE:
Enables following the R.F. signal from the antenna to speaker of any radio or TV receiver and using that signal as a basis of measurement to first isolate the faulty stage and finally the component or circuit condition causing the trouble.

AUDIO SIGNAL TRACER SERVICE:
Functions in the same manner as the R.F. Signal Tracing service specified above except that it is used for the location of cause of trouble in all audio and amplifier systems.

Model TV-60 comes complete with book of instruction; pair of standard test leads; high-voltage probe; detachable line cord; R.F. Signal Tracer Probe and Audio Signal Tracer Probe. Plicofilm bag for all above accessories is also included. Price complete. Nothing else to buy. Only

\$52⁵⁰
NET

Superior's New
Model TV-50

GENOMETER

A versatile all-inclusive GENERATOR which provides ALL the outputs for servicing:
A.M. Radio • F.M. Radio • Amplifiers • Black and White TV • Color TV
7 Signal Generators in One!

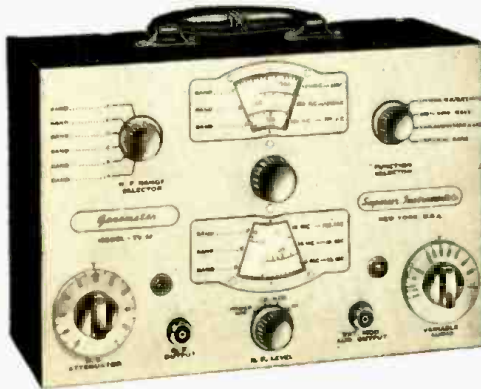

- ✓ R.F. Signal Generator for A.M.
- ✓ R.F. Signal Generator for F.M.
- ✓ Audio Frequency Generator
- ✓ Bar Generator
- ✓ Cross Hatch Generator
- ✓ Color Dot Pattern Generator
- ✓ Marker Generator

R. F. SIGNAL GENERATOR: The Model TV-50 Genometer provides complete coverage for A.M. and F.M. alignment. Generates Radio Frequencies from 100 Kilocycles to 60 Mcacycles on fundamentals and from 80 Mcacycles to 180 Mcacycles on powerful harmonics.

VARIABLE AUDIO FREQUENCY GENERATOR: In addition to a fixed 400 cycle sine-wave audio, the Model TV-50 Genometer provides a variable 300 cycle to 20,000 cycle peaked wave audio signal.

BAR GENERATOR: The Model TV-50 projects an actual Bar Pattern on any TV Receiver Screen. Pattern will consist of 4 to 16 horizontal bars or 7 to 20 vertical bars.

CROSS HATCH GENERATOR: The Model TV-50 Genometer will project a cross-hatch pattern on any TV picture tube. The pattern will consist of non-shifting horizontal and vertical lines interlaced to provide a stable cross-hatch effect.

DOT PATTERN GENERATOR (FOR COLOR TV) Although you will be able to use most of your regular standard equipment for servicing Color TV, the one addition which is a "must" is a Dot Pattern Generator. The Dot Pattern projected on any color TV Receiver tube by the Model TV-50 will enable you to adjust for proper color convergence.

MARKER GENERATOR: The Model TV-50 includes all the most frequently needed marker points. The following markers are provided: 180 Kc., 282.5 Kc., 456 Kc., 600 Kc., 1000 Kc., 1400 Kc., 1600 Kc., 2000 Kc., 2500 Kc., 3579 Kc., 4.5 Mc., 5 Mc., 10.7 Mc. (3579 Kc. is the color burst frequency.)

THE MODEL TV-50 comes absolutely complete with shielded leads and operating instructions.

\$47⁵⁰
NET

Only

SHIPPED ON APPROVAL NO MONEY WITH ORDER - NO C.O.D.

Try any of the instruments on this or the facing page for 10 days before you buy. If completely satisfied then send down payment and pay balance as indicated on coupon. **No Interest or Finance Charges Added!** If not completely satisfied return unit to us, no explanation necessary.

MOSS ELECTRONIC DISTRIBUTING CO., INC.
Dept. D-316, 3849 Tenth Ave., New York 34, N. Y.

Please send me the units checked. I agree to pay down payment within 10 days and to pay the monthly balance as shown. It is understood there will be no finance or interest charges added. It is further understood that should I fail to make payment when due, the full unpaid balance shall become immediately due and payable.

- | | | |
|--|---|---|
| <input type="checkbox"/> Model TV-11..... Total Price \$47.50
\$11.50 within 10 days. Balance \$6.00
monthly for 6 months. | <input type="checkbox"/> Model 60..... Total Price \$52.50
\$12.50 within 10 days. Balance \$8.00
monthly for 5 months. | <input type="checkbox"/> Model TV-12..... Total Price \$72.50
\$22.50 within 10 days. Balance \$10.00
monthly for 5 months. |
| <input type="checkbox"/> Model TV-50..... Total Price \$47.50
\$11.50 within 10 days. Balance \$6.00
monthly for 6 months. | <input type="checkbox"/> Model TV-40..... Total Price \$15.85
\$3.85 within 10 days. Balance \$4.00
monthly for 3 months. | |

All prices net. F.O.B. N. Y. C.

Name
Address
City Zone State

CRYSTAL Manufacturing Headquarters

We will grind and etch crystals to your specified frequency at the lowest cost in the industry—supplied in popular FT-243 holders, 1/2" pin spacing, .093" pin diameter—also in DC-34 holders, 3/4" pin spacing, pin diameter .156 or FT-171 holders, pin spacing 3/4" with banana plug pins (fits 5-prong tube socket).



In FT-243 holders from 2000KC to 10,000KC. In DC-34 or FT-171 holders from 1100KC to 8000KC (specify holder wanted).

Tolerance:

.05%	\$1.35
.01%	1.50
.005%	2.50

With thousands of frequencies in stock for immediate delivery, we list a few of the more popular frequencies. Write for complete listing. Crystals listed are in FT-243 holders but can be supplied in FT-171 holders at 79 cents. (Add 5¢ per crystal for postage and handling.)

**YOUR
CHOICE**
50¢
EA.
or
**11 FOR
\$5.00**
POST-
PAID

2910	6125	7173	8075
2945	6150	7175	8100
3000	6300	7200	8106
3190	6400	7206	8125
3195	6500	7225	8140
3245	6575	7240	8150
3525	6625	7250	8175
3655	6700	7273	8200
3825	6706	7275	8240
3885	6750	7300	8250
3955	6775	7306	8300
3995	6800	7325	8350
4110	6850	7340	8375
4190	6900	7350	8400
4845	6950	7373	8425
5030	7000	7375	8450
5300	7006	7400	8475
5305	7025	7406	8500
5700	7040	7500	8525
5800	7050	7606	8550
6000	7075	8000	8575
6025	7100	8006	8600
6040	7106	8025	8625
6050	7125	8040	8650
6075	7140	8050	
6100	7150	8073	

Novice Crystals 80 meter band within 1KC of specified frequency from 3701KC to 3749KC in 40 meter band from 7152KC to 7198KC within 1KC of specified frequencies 79¢; in DC-34, FT-171 or FT-243 holders (specify holder wanted) 79¢. (Add 5¢ per crystal for postage and handling.)

Stock crystals in FT-243 holders from 5675KC to 8650KC in 25KC steps 50¢.

FT-241 lattice crystals in all frequencies from 370KC to 540KC 50¢.
500KC crystals...\$1.00 455KC crystals...\$1.00

Address all mail to Dept. R

JOBBERS & MANUFACTURERS
Write For Quantity Prices & Catalog

Texas Crystals

The Biggest Buy in the U.S.

8538 W. GRAND AVENUE · RIVER GROVE, ILL.
ALL PHONES — GLADSTONE 3-3555

Terms: All items subject to prior sale and change of price without notice. All crystal orders MUST be accompanied by check, cash or M.O. WITH PAYMENT IN FULL NO C.O.D.s. Postpaid shipments made in U.S. and possessions only. Add 5¢ per crystal for postage and handling charge.

From Sun to Sound (Continued from page 43)

supplied by many ohmmeters on low resistance ranges is great enough to damage a transistor. Generally vacuum-tube ohmmeters with battery supplies of 3 volts or less are safe—if used only on the R x 1000 range or higher.

When making ohmmeter checks of the circuit, always remove the transistors. Check the polarity of the ohmmeter test leads. The voltage supplied by an ohmmeter may harm electrolytic capacitors in the circuit if applied in reverse polarity.

Always watch your test probes! If a slip of a test probe shorts the transistor base to the collector, the unit may be damaged. Most transistor radios use a number of electrolytic capacitors with low voltage ratings. Many capacitor checkers apply a test voltage sufficient to damage such a capacitor. Even a small voltage of incorrect polarity can cause damage. This must be remembered in making any ohmmeter checks of the transistorized circuit.

Before connecting any signal generator to the radio circuits, adjust the output attenuator for minimum output. Signal generators designed for vacuum-tube circuits can furnish more signal than a transistor can handle safely. Most transistor amplifiers have a relatively low input impedance. If the signal-generator output impedance is high, very little signal will be transferred to the transistor amplifier input.

Transistor Testing

The best way to check a transistor is by substitution. Transistors can, in an emergency, be checked for opens or shorts with an ohmmeter, providing a reasonable amount of care is taken.

An ohmmeter check is not a particularly good check. Never use an ohmmeter with a battery greater than 3 volts. Never use the low resistance ranges; instead use the R x 1000 range or higher.

In general, the forward current through a transistor should never be allowed to exceed 15 ma. A milliammeter can be used to determine whether any particular ohmmeter is safe to use in testing transistors. A junction transistor is more apt to become shorted than open. Transistors often become shorted because of excessive current flow, so a shorted transistor may be indicative of a circuit fault. For this reason, if a transistor is found to be shorted, check the circuit carefully before installing a new one. A shorted transistor will most often result in increased power supply current drain. Thus, a quick and useful check is to measure the current drain with a milliammeter connected in series with the leads from the battery power supply.

Care of the "Sun Power Pak"

The "Sun Power Pak" requires no service. However, a few precautions are worth noting. Occasionally clean the surface of the clear plastic with a cloth dampened in water. Do not use abrasive or window type cleaners. Use care to prevent scratching the surface of the clear plastic. When operating the set from an artificial light source, remember that the transparent plastic face will be damaged if exposed to excessive heat. For this reason, never allow the surface of this plastic to become any warmer than to be just uncomfortable to the touch.

Care should be taken to prevent dropping the "Sun Power Pak." Although it is sturdily constructed, it is possible to crack a silicon element if the "Pak" is subjected to a severe shock. If an element cracks, the unit will be inoperative.

Over a hundred dental students and dentists at the Montreal General Hospital are actually viewing this demonstration of dental techniques by means of a closed circuit TV setup. The camera is equipped with an Auto-Zoom lens to permit over-all as well as close-up views. An RCA ITV-6 television chain is employed here.

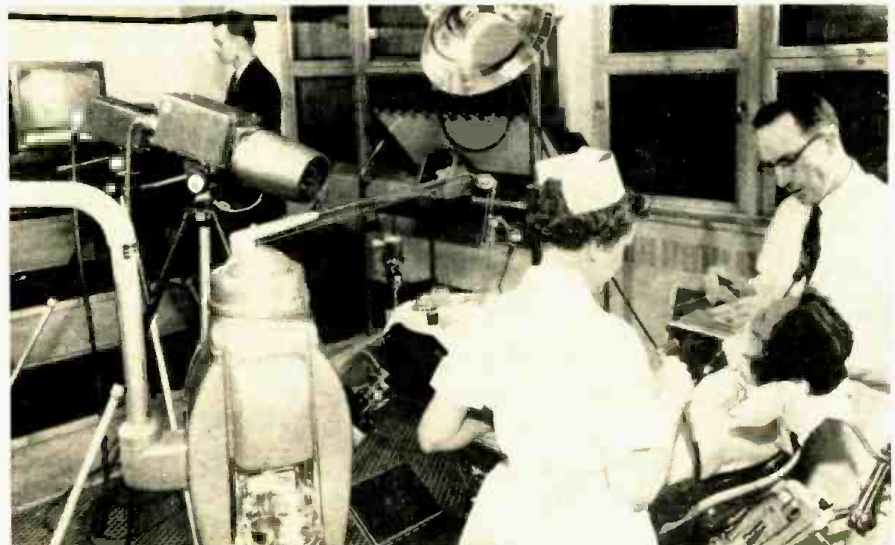

SHOW ANY PICTURE or PATTERN

at any time — ON ANY TV SET

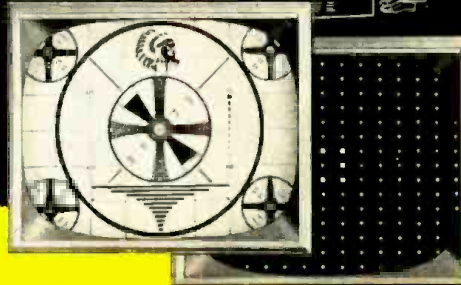

For Both Black & White and Color TV

Provides standard Indian Head Test Pattern for proper TV set alignment, and stable White Dot and White Line Patterns for color convergence adjustments.

For Merchandising & Industrial Uses

Provides closed circuit TV system. Transmits pictures or messages for advertising, educational and commercial visual communication.

MODEL 1000

B&K DYNA-SCAN PICTURE AND PATTERN VIDEO GENERATOR

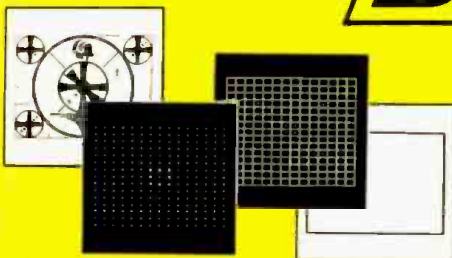

3 TEST PATTERN TRANSPARENCIES AND ONE CLEAR ACETATE SUPPLIED

- 1 Indian Head Test Pattern
- 2 White Dot Pattern
- 3 White Line Crosshatch Pattern

These are broadcast-quality transparencies, and assure accurate, high-definition TV images. You can also transmit your own transparencies of any subject you wish. The clear acetate can be used for special messages. Extra transparencies and acetate available.

Make the most of this *Complete Flying Spot Scanner*. It produces a composite video and sync signal that operates any standard black & white or color TV receiver. Can be used with one or more TV sets or fed into a master antenna system or community antenna system. Maximum resolution capability is well in excess of 450 lines; band width in excess of 5 mc. Projects and reproduces pattern or picture with high definition from any slide transparency. Transmits messages typed or written on clear acetate. Makes convenient stand-by and break-in for community distribution operation. Rugged, compact, portable, and ready to operate. **NET \$199⁹⁵**

See your B&K Distributor, or Write for Bulletin No. 1000-N

B & K MANUFACTURING CO.
3726 N. SOUTHPORT AVENUE · CHICAGO 13, ILL.



Model 950 Dyna-Scan Pickup and RF Generator only. Enables you to make your own picture and pattern video generator, at a saving. Supplied with three test pattern transparencies and one clear acetate. Net, \$69.95



Model 500 DYNA-QUIK
Dynamic mutual conductance tube tester. Accurately tests tubes faster. Net, \$109.95



Model 400 CRT
Cathode Rejuvenator Tester. Tests and repairs TV picture tubes. Net, \$54.95



Model 750 CALIBRATOR
Designed to check and adjust test instruments with laboratory accuracy. Net, \$54.95

LAMPKIN FREQUENCY and FM MODULATION METERS

NOW... on TIME PAYMENT PLAN

Enter the lucrative mobile-radio maintenance field—AT LOW COST!



Price \$220.00
Type 105-B Frequency Meter

Lampkin's new easy-payment plan makes it possible for you to start in mobile-radio maintenance NOW—and the monthly payments for your essential test equipment will be far less than your expected earnings.

You've read how mobile-radio is bursting its seams! NOW — you can start cashing in on this boom ... with a low down payment!



Price \$240.00
Type 205-A Modulation Meter

For free booklet "HOW TO MAKE MONEY IN MOBILE-RADIO MAINTENANCE," and other data—

USE COUPON TODAY

LAMPKIN LABORATORIES, INC.
MFM Division, Bradenton, Florida

At no obligation, please send me free booklet, technical data on Lampkin meters, and time-payment plan details.

Name _____
Address _____
City _____ State _____

LAMPKIN LABORATORIES, INC.
MFM Division
BRADENTON, FLORIDA

AUDEL'S TV TELS HOW TO ANSWER RADIO T.V. QUESTIONS RADIO SERVICE LIBRARY

HERE IS LATE INFORMATION IN A HANDY FORM FOR TELEVISION AND RADIO REPAIRMEN, SERVICEMEN AND STUDENTS

AUDEL'S T.V. RADIO SERVICE LIBRARY—Highly Endorsed—Over 1500 Pages—1048 Illustrations & Diagrams. 1001 Important Facts & Figures on Modern Television, Radio, Electronic Devices at your finger ends.

INCLUDES TRANSISTORS & Transistor Circuits, Record Changers, Rectifiers, P.A. Systems, Tape Recorders, Phonograph Pick-ups, F.M., Auto Radio; Radio Compass, Short Wave, Radar, etc.

ASK TO SEE IT! IT WILL PAY TO KNOW—The Basic Principles—Construction—Installation—Operation—Repairs—TroubleShooting. Shows How to get Sharp, Clear T.V. Pictures. Install Aerials—How to Test. Explains Color Systems, Methods of Conversion. Terms, etc. Includes Ultra High Frequency—Valuable for Quick Ready Reference and Home Study.

6 COMPLETE VOLUMES \$6
7 DAY TEST—PAY ONLY \$1 A Month
MAIL ORDER

AUDEL, Publishers, 49 W. 23 St., N.Y. 10, N.Y.
Mail AUDEL'S T.V. RADIO SERVICE LIBRARY (2 Volumes) \$6 on 7 days free trial. If O. K. I will remit \$1 in 7 days and \$1 monthly until \$6 is paid. Otherwise I will return them.

Name _____
Address _____
Occupation _____
Employed by _____ RN

120

for everything in hi-fi GET THE MONEY-SAVING 1957 ALLIED CATALOG



featuring the world's largest stocks of systems & components

free!
SEND FOR IT

Here's your complete money-saving guide to Hi-Fi. Shows you how to select a custom Hi-Fi music system for your home at no more than the cost of an ordinary phonograph. Tells you what to look for and how to save money. Offers the world's largest selection of complete Hi-Fi systems as well as individual amplifiers, tuners, changers, speakers, enclosures and accessories. Want to build-your-own?—see the famous Hi-Fi KNIGHT-KITS. For everything in Hi-Fi—for everything in Electronics, get the FREE 1957 ALLIED Catalog.

ALLIED RADIO AMERICA'S HI-FI CENTER
ALLIED RADIO CORP. Dept. B-17
100 N. Western Ave., Chicago 80, Ill.

Send FREE 1957 ALLIED Catalog

Name _____
Address _____
City _____ Zone _____ State _____

Atomichron (Continued from page 63)

pole has the effect of conducting the atom into a sensing chamber and to a target.

The atom strikes the target, is ionized, and is attracted to the cathode of an electron multiplier, which amplifies the cesium input current a million times. The electron multiplier output current varies with the number and rapidity of impingements of ionized cesium atoms on the cathode. As the frequency of the r.f. field varies, the impingements on the cathode decrease, causing a change in the magnitude of the electron multiplier output current. This effect is used as the first step in adjusting the frequency of the r.f. signal to return it automatically to the standard value.

The frequency of the r.f. signal which is applied to the atomic beam tube is derived from a 5 mc. crystal oscillator. The output is multiplied to 9180 mc. Meanwhile, a synthesizer combines harmonics and subharmonics of the output of the basic 5 mc. oscillator in such a manner that when the synthesizer output is combined with the multiplier output in the adder, an output frequency is produced that is the nominal resonance frequency of cesium—9192.631830 mc. The cesium resonance frequency signal is also phase modulated by the 100 cps output of the modulation oscillator. The purpose of this modulation is to provide a determination of the direction of variation whenever the output of the crystal oscillator drifts.

The atomic beam output signal is amplified for transmission to one winding of a two-phase motor. The current applied to this winding by the feedback amplification system is automatically and continuously compared by the motor to the current supplied directly to the other winding of the motor by the 100 cps modulation oscillator. If the r.f. frequency is above cesium resonance, the motor will operate in a direction which reduces the original error. If it is below resonance, the motor turns in the opposite direction. This rotation is then transmitted through a gear box to a variable capacitor which adjusts the output of the 5 mc. crystal oscillator to bring the frequency at the atomic beam back to standard.

Since the crystal oscillator is under continuous surveillance for precision, the basic output is a 5 mc. signal stable and reproducible to 1 part in 10¹¹. Higher frequencies are taken from the multiplier and sub-multiples are taken from the synthesizer as shown in the diagram.

Because of its relatively small size and mobility, the Atomichron now makes high precision time interval and frequency control practical for navigation, communications, and engineering systems without reliance on radio time signals.

for your next short-wave project...

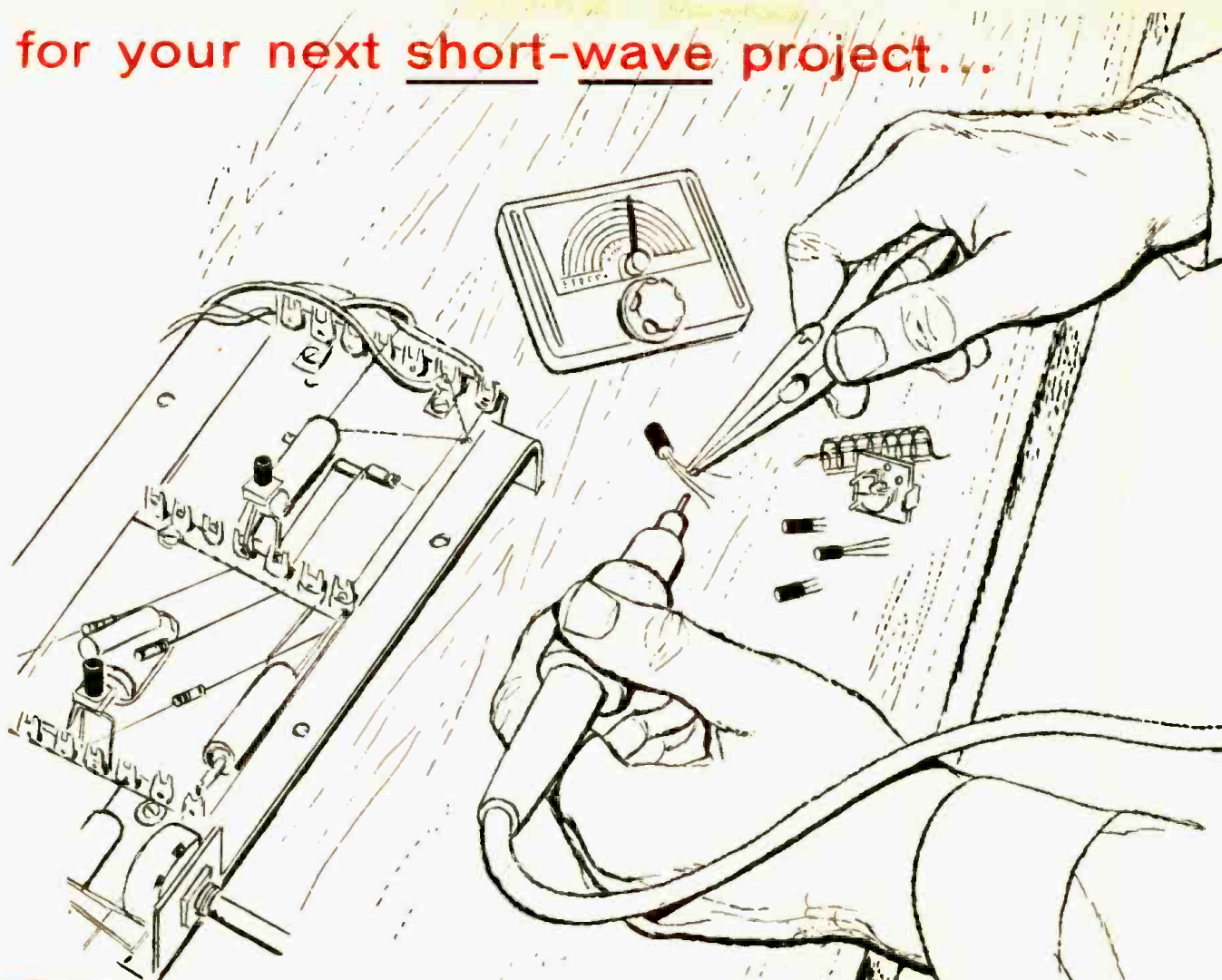

RCA-2N247 **DRIFT** TRANSISTOR

... enables practical construction of transistor RF- and IF-amplifiers operating at frequencies up to 20 megacycles

RCA-2N247 is a germanium p-n-p transistor featuring one of the most advanced developments in transistor design which opens new possibilities for experimenters who build high-frequency circuits. The new transistor offers many practical advantages including: (1) excellent operating stability, (2) high-input-circuit efficiency, (3) good automatic-gain-control capabilities over wide-input-signal variations, (4) good signal-to-noise ratio—at frequencies well into the short-wave regions.

Unique in design, the 2N247 uses RCA's alloy-junction technique and includes a "built-in" accelerating field not available in conventional transistor designs. The 2N247 is one more example of RCA's extensive program for advanced products of the highest quality.

For your next high-frequency application, try the new RCA-2N247 DRIFT Transistor available through your RCA Distributor. For technical data on the 2N247, write RCA, Commercial Engineering, Section A-41-NN, Harrison, New Jersey.

RCA TRANSISTORS*	
Service	Type
Class A AF-amplifier	2N77, 2N104, 2N105, 2N206, 2N215
Class A Low-noise AF-amplifier	2N175, 2N220
Push-pull Class B AF-amplifier	2N109, 2N217
Class A 455-Kc IF-amplifier	2N139, 2N218
Converter in 540-to 1640-Kc band	2N140, 2N219
Class A RF-amplifier	2N247

*All are p-n-p germanium-alloy types, hermetically sealed in insulated metal envelopes.



TAK(S)®

TRANSISTORS

RADIO CORPORATION OF AMERICA

Semiconductor Division, Somerville, N. J.

AMERICA'S FINEST VALUES IN "LOW COST" HIGH FIDELITY

ECONOMY 20 WATT AMPLIFIER \$22.95



NEW 1957 MODEL
 Push-Pull 6L6 Output Tubes
 Response 30-15,000 CPS
 Bass and Treble Tone Controls
 Input for Xtal or Dynamic Mike

With CU-14Y, 12" Coax Speaker... \$32.95
 With P15-CR, 15" Coax Speaker... \$42.95
 With Imperial IV System... \$39.95
 With HF-33GE... \$69.95

Model HF-20
 With Imperial VI... \$48.95

A tremendous High Fidelity amplifier value. Response 30 to 15,000 cps. Electronic bass and treble boost by separate tone controls. Use this amplifier with any record changer having crystal or variable reluctance cartridge, radio tuner or high impedance crystal or dynamic microphone. 20 watts power output. Use with any 4 or 8 ohm speaker or 250 ohm line. Chassis size 11 1/2" x 10 1/2" x 4 1/2". Complete with 6L6 tubes: 2-6L6, 2-6C4, 12AX7 and 5U4G. This is a terrific value. A ready to use high fidelity amplifier at less than the cost of a kit. Ship. wt. 17 lbs. Model HF-20, 20 watt Hi-Fi amplifier. McGee's sale price, \$22.95.

LOW-BOY 3-WAY HI-FI SPEAKER SYSTEM

for apartment size Hi-Fidelity. Available in blond or mahogany finish. Extra value made possible by our use of new TV cabinets. Converted into Hi-Fi speaker haffle with enclosed back. All dimensions may vary slightly. Approximately 19" high plus 8" legs. Over-all height 27", 19 1/4" deep and 23 1/4" wide. Equipped with 15" coaxial speaker and a 6" mid-range speaker on one side for augmented mid-range dispersion. Stock # GM-416 Mahogany Finish Stock # GB-416 Blond Finish

SALE PRICE
\$2995



3-1957 MODEL Hi-Fi SPEAKERS

- COMPLETE SYSTEMS WITH 4 SPEAKERS
- ACOUSTICALLY LINED ENCLOSURES

The new 1957 Hollywood, 4 speaker high fidelity speaker systems are expressly designed to give realistic reproduction from your Hi-Fi amplifier or FM-AM radio. Juice box bass response with brilliant, middle and high range response. All 3 models have genuine L-C crossover networks and variable brilliance controls. Only 2 wires to connect to the 4 or 8 ohm tap on your Hi-Fi amplifier. A fine speaker system to use with our Imperial 20, 30 and 34 high fidelity amplifiers, and all FM-AM chassis in our Radio & TV News offerings. Adjusting the twin tone controls on our Imperial amplifiers along with the brilliance controls on the Hollywood speaker systems you can have fidelity of your own personal taste. All 3 Hollywood models are housed in the same fine cabinet. Choice of either blond or mahogany finish. Baffles are fully enclosed and acoustically lined. Small enough in size for the average room, yet large enough for proper baffling. 35" high, 19" front to back, 25" wide. Specify cabinet finish when ordering, otherwise we will ship mahogany finish. Take \$3.00 discount when you order with any of the Imperial amplifiers or Exeep FM-AM chassis offered in this page ad.



Model M-4H, Hollywood 4 speaker high fidelity speaker system, 20 watts, response 20 to 17,500 cps. Choice of blond or mahogany finish enclosure. Features a 12" General Electric 6.8 oz. Alnico V magnet, aluminum voice coil woofer, plus 6" mid-range and 2 1/2" tweeters. Built-in variable brilliance L-C crossover network. Model M-4H, Ship. wt. 55 lbs. Price \$39.95.

Model V-4V, Hollywood 4 speaker high fidelity speaker system, 25 watts, response from 20 to 17,500 cps. Choice of blond or mahogany finish enclosure. Features a 12" General Electric 14 oz. Alnico V magnet, aluminum voice coil woofer, plus 6" mid-range and 2 1/2" tweeters. Built-in variable brilliance L-C crossover network. Model M-4H, Ship. wt. 55 lbs. Sale price, \$44.95.

Model Z-4Z, Hollywood 4 speaker high fidelity speaker system, 25 watts, response from 18 to 17,500 cps. Choice of blond or mahogany finish enclosure. Features a 12" Alnico V Utah heavy duty woofer, plus 6" mid-range and 2 1/2" tweeters. Built-in variable brilliance L-C crossover network. Model Z-4Z, Ship. wt. 57 lbs. Sale price, \$49.95.

IMPERIAL 30 WATT AMPLIFIER \$29.95

NEW 1957 MODEL
 Push-Pull 6L6 Output Tubes
 Response 15-20,000 CPS
 Bass and Treble Tone Controls
 Compensated Gain for G.E. Cart.
 Input for Xtal or Dynamic Mike

With CU-14Y, 12" Coax Speaker... \$39.95
 With P15-CR, 15" Coax Speaker... \$49.95
 With Imperial IV Speaker System... \$46.95
 With Imperial VI... \$55.95
 With HF-33GE... \$76.95



New 1957 model 7 tube Imperial 30 watt High Fidelity audio amplifier. A \$100.00 list value for only \$29.95. Features a heavy 4 lb., specially wound high fidelity output transformer with 15% inverse feedback; push-pull 6L6 output tubes and frequency response from 15 to 20,000 cps. Matches 8 or 16 ohm speakers. You can center your entire custom music system around this low cost 30 watt amplifier. This Imperial 30, 30 watt amplifier may be used with any radio tuner or record player. It will drive any speaker system that you may have. Use from one to ten 8 speakers or any 12" or 15" coaxial speaker or any 3-way speaker system. Tone compensated input for either a crystal phono pickup or a General Electric variable reluctance pickup. Also, has input for crystal or high impedance dynamic microphone. 4 control air mike gain, phono gain, treble tone and bass boost tone control. This amplifier weighs 21 lbs. net. Full size transformer components would cost you up to \$15.00 if purchased separately. Gold color chassis is 12 1/4" x 7 3/4" x 7 1/4" high. Complete with tubes: 6AT5, 12AU7, 6C4, 12AU7, 2-6L6A, plus 5U4G rectifier. Stock No. IMP-30, 30 watt Imperial High-Fidelity amplifier complete with tubes and diagram. Ship. wt. 23 lbs.. Sale price only \$29.95.

NEW IMPERIAL 24 WATT AMPLIFIER \$39.95

PUSH-PULL EL-34 ENGLISH MADE MULLARD OUTPUT TUBES
WILLIAMSON TYPE CIRCUIT
RESPONSE 15-20,000 CPS

With CU-14Y, 12" Coax Speaker... \$49.95
 With P15-CR, 15" Coax Speaker... \$59.95
 With Imperial IV Speaker System... \$56.95
 With SP12125CR... \$65.95. With HF-33GE... \$86.95. Model IMP-34X

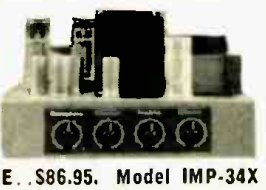

New 1957 model Imperial 34X, 24 watt high fidelity amplifier for the audio enthusiast who wants McGee's finest amplifier. This amplifier features push-pull EL-34 English made Mullard output tubes in a Williamson circuit. Heavy duty 6 lb. specially wound Williamson type ultra-linear output transformer in potted case has a response from 15 to 20,000 cps. MATCHES 8 or 16 ohm speakers. Amplifier has input for crystal pickup and built-in pre-amplifier for the popular General Electric and Goldring variable reluctance cartridges; as well as input for crystal or high impedance dynamic microphones. 4 control air mike gain, phono gain, tone gain and separate variable treble and bass boost tone control with on-off switch. Chassis size: 12 1/4" x 7 3/4" x 7 3/4" high. Complete with 7 tubes and diagram. Model IMP-34X, 24 watt high fidelity amplifier. Ideal for use with any of our high fidelity coaxial or multiple speaker systems. Ship. wt. 26 lbs. Sale price, \$39.95.

NEW IMPERIAL SPEAKER SYSTEMS

Imperial IV with 8" G.E. High Fidelity Speaker
\$1995



3-Way Imperial VI with 12" G.E. Speaker
\$2995

New 1957 Model IMPERIAL IV, High fidelity speaker system with General Electric 8" speaker. Moused in a high quality leatherette covered plywood cabinet 10" x 10" x 24" long. Fully enclosed; covered on all sides except back. Use as an auxiliary speaker or with any high fidelity radio, amplifier or home music system. The IMPERIAL IV contains a General Electric Model 850 or 9770 Norelco 8" extended range high fidelity 8" PM speaker with 6.8 oz. Alnico V magnet and curvilinear cone with 8 ohm voice coil and a 5" tweeter. Response 50 to 15,000 cps. Model IV Imperial \$19.95.

1957 Model Imperial VI, 3-way speaker system. Baffle is of heavy wood, leatherette covered. Similar in appearance to the Imperial IV pictured above, except 4" taller and 1" deeper. Equipped with 3 moused speakers: A 12" G.E. Model 1203 with 9 oz. Alnico V magnet, plus 5 1/2" PM for middle range and 3" tweeter. Simple to connect to any high fidelity amplifier. 18 ohm output. Ship. wt. 57 lbs. Sale price, \$29.95. Ideal for use with HF-20 and IMP-30 amplifiers described above.

McGEE'S NEW 1957 MODEL 25 WATT 12" COAXIAL SPEAKER

- ★ 14 1/2 oz. G.E. 12" WOOFER—
 - ★ 3 1/2" COAXIALLY SUSPENDED TWEETER—
 - ★ BUILT-IN CROSSOVER—
 - ★ ALUMINUM VOICE COIL WOOFER—
- \$1895**



McGee's new 1957 model, GE-120XT, 12" 25 watt high fidelity coaxial PM speaker. No frills or dummy pot cover, it's all speaker value. Features a General Electric 12", 14 1/2 oz. Alnico V woofer with aluminum voice coil and exponential moused seamless cone. The tweeter is a specially made 1.47 oz. Alnico V 3 1/2" speaker which extends the high frequency response to 17,500 cps. It is electrically connected to accept only the upper register of audio. Only two wires connect this complete high fidelity speaker to any 8 ohm amplifier. Ship. wt. 8 lbs. Stock No. GE-120XT. McGee Sale price, \$18.95. New 1957 model, 20 watt deluxe 12" coaxial PM speaker. Only 2 wires to connect to any 8 ohm Hi-Fi radio or amplifier. Features an aluminum voice coil General Electric 12" PM speaker with 10 oz. Alnico V magnet, plus a coaxially suspended tweeter. Crossover network built-in. Responds up to 17,500 cps. Stock No. GE-100XT, 12" coaxial PM speaker. Ship. wt. 8 lbs. Sale price, \$14.95.

NEW 1957—3-WAY HIGH FIDELITY SPEAKER SYSTEM

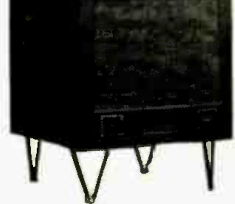

12" ALNICO V WOOFER
 6" MID-RANGE SPEAKER
 5" CONE TYPE TWEETER
 L-C CROSSOVER NETWORK
 LEATHERETTE CABINET
BRILLIANCE AND PRESENCE

SALE PRICE
\$2495

CONTROLS

MODEL ES-312
 Response 30-17,000 cps
 radio or amplifier. Response 30 or recreation room. Model ES-312, Ship. wt. 40 lbs. Suggested List Price \$40.00. Sale price only \$24.95.

New 1957 model ES-312, 3-way economy Hi-Fi speaker system. Complete with 12" woofer having a high efficiency 10" Alnico V magnet, 6" mid-range speaker and 5" tweeter with specially made cone. All speakers have Alnico V magnets. Built-in L-C type crossover network with two variable controls, to adjust volume of tweeter and mid-range for brilliance and presence. Moused in a tan leatherette cabinet 19" high, 20" wide and 20 1/2" deep. 6" wrought iron legs give an overall height of 25". Cabinet has matching grill cloth and enclosed back. Only two wires to connect to any 8 ohm output of Hi-Fi speaker up to 17,000 cps. An ideal system for apartment or recreation room. Model ES-312, Ship. wt. 40 lbs. Suggested List Price \$40.00. Sale price only \$24.95.

NEW 1957—5-WAY HI-FI SPEAKER SYSTEM ON BAFFLE BOARD

Model B-125, high fidelity 20 watt, 5-way speaker system, mounted on an 18" square baffle board. Has 12" G.E. 12" woofer, 6" mid-range speaker, plus a 4" high-range and 3" tweeter, all with Alnico V magnets. Built-in crossover network with variable brilliance control. Mount in your own cabinet or use for custom installation. Ideal for use with any Hi-Fi radio or amplifier. Completely wired, with only two wires to connect to any 8 ohm output. Ship. wt. 11 lbs. Stock No. B-125, 5-way, 20 watt Hi-Fi speaker system. Sale price \$18.95. (Take 10% discount if ordered with any radio or amplifier) Grill cloth, 75c extra.

SALE PRICE
\$1895

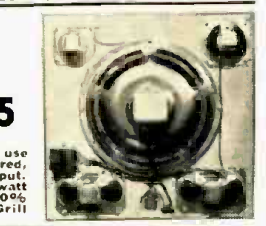

12" COAXIAL PM SPEAKER RESPONSE 25-17,000 CPS.

SALE PRICE
\$895
 EA.
 2 FOR \$17.00



Model 12-V3Y, New 1957 Model 12" coaxial PM speaker. Has high efficiency 12" woofer with Alnico V magnet and coaxially suspended 3 1/2" Alnico V tweeter. Built-in crossover with variable brilliance control on an 18" lead, for remote control of tweeter volume. 10 watts, response 25 to 17,000 cps. Ship. wt. 5 lbs. Stock No. 12-V3Y, 12" coaxial speaker. Sale price, \$8.95 each, 2 for \$17.00.

THEATER QUALITY HIGH FIDELITY SPEAKER SYSTEM \$3995

15" WOOFER PLUS—ELECTROVOICE MODEL 847 MID-HIGH RANGE SPEAKER—600 CYCLE LC CROSSOVER.

A theatre quality, powerful speaker system for homes and sound demonstration rooms. This speaker arrangement will connect to any high fidelity audio amplifier (8 ohms impedance) Features a 15" electro-dynamic heavy duty woofer which is equal to a PM speaker with up to 10 lbs. of Alnico V magnet. This woofer reproduces the low duty register from 600 cycles down to 20 cps. An Electro-Voice Model 847 horn type speaker is used for the middle range and high range of audio. These two speakers are connected to a 600 cycle inductive-capacitive crossover network. Built in the network is the field exciter for the 15" woofer. You could spend over \$100 for a speaker system and not beat this one. Stock No. EV-15847X, McGee's sale price, \$39.95.

22 TUBE ESPEY FM-AM HI-FI TUNER-AMPLIFIER SALE PRICE \$119.90

A REGULAR \$199.50 NET VALUE COMBINATION FOR \$119.90



FM/AM TUNER
ESPEY 14-TUBE MODEL 700G

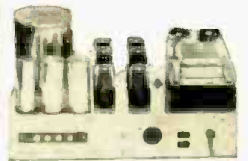

ESPEY 24 WATT
MODEL 501G AMPLIFIER

MODEL 700G
FM-AM TUNER
ONLY—
SALE PRICE
\$79.95

MODEL 501G
AMPLIFIER
SALE PRICE
\$39.95
If Ordered
with Tuner
\$49.95 SEPARATE

McGee offers you both the regular \$119.50, 14 tube Deluxe FM-AM tuner and the \$79.50 value B tube audio amplifier for the special sale price of only \$119.90. The Model 700G Espey tuner has its own built in power supply. Performance features are: Sensitivity 3 mv on 4 for 30 db quieting, AM selectivity 10kc at 6 db, FM 240kc at 6db. Audio response flat from 20 cps to 20,000 cps., with less than 1% percent distortion with one volt audio output. Chassis 14" long, 8 1/2" high and 10" deep. Features a one-piece molded, gold color plastic front which makes a custom installation both extremely attractive and easy at the same time. Full tuned RF stages-AFC on FM with defeating switch for easy FM tuning. Built-in Pre-amplifier for GE or other Popular variable reluctance cartridges. Three position equalizer switch for LP, AES or European records. Separate bass and treble tone controls with 23db boost. Chassis is equipped with AC outlet jacks, auxiliary input jacks for tape recorder, etc. Has built-in ferrite loop antenna for AM broadcast band and 300 ohm input for FM band. This fine quality FM-AM tuner is second to none. It has all of the features that you might expect of a tuner that would cost as much as \$200. All of the controls are on the front panel. This is a most desirable feature when the tuner is used in conjunction with a good audio amplifier, such as the 501G which was designed with no tone control or pre-amplifier circuits. The Model 501G, 8 tube ultra linear high fidelity, 24 watt audio amplifier is made to match the 700G tuner. This amplifier is offered separately at the special sale price of \$49.95, but costs you only \$39.95 when purchased with the 700G Espey tuner. This amplifier features less than 1/2 percent distortion with high fidelity response from 10 cps to 20,000 cps. Hum level so low it can be detected by electrical instruments only. Chassis size, 12"x5"x8". Output tubes: 4-6V6GT in push-pull Williamson oriented iron core. Output impedance taps of 4, 8 and 16 ohms. This output transformer, along with a \$20.00 value: Buy just the 700G FM-AM tuner at the special sale price of \$79.95, or buy both the 700G tuner and the matching 501G amplifier for \$119.90. Model 501G amplifier sale price, \$49.95 when purchased separately. Tuner shipping weight 20 lbs. Amplifier shipping wt., 22 lbs. See the special deals of the 700G-501G tuner-amplifier combination at \$119.90. Special discounts for extra money saving values. Also, special discount on speakers and speaker systems when ordered with your Espey tuner and amplifier.

ESPEY DEAL—1A
Espey 700G-501G tuner with 24 watt amplifier plus VM-95C GE 2 speed VM on metal base—1 Mil Diamond C Needle \$144.95
Net \$144.95

ESPEY DEAL—2
Espey 700G-501G tuner with 24 watt amplifier plus new 456 Collaro changer equipped with a GE RPX-052A cartridge. Net \$164.95

ESPEY DEAL—3
Espey 700G-501G tuner with 24 watt amplifier plus Garrard RC-9R equipped with a GE RPX-052A cartridge. Net \$194.95

SPE MENDED
Order any of the following speakers with your Espey tuner and amplifier:
12" coaxial PM, CU-14Y—\$10.00 extra
15" coaxial PM, P15-CR—\$20.00 extra
Imperial VI system—\$15.00
Imperial VI system—\$25.00
Norelco 9762-12" regularly \$59.50 at \$30.00 extra
EV84-15W system—\$150.00 extra.



COLLARO 456 - \$34.50
WEBCOR 1642-1
GARRARD RC-98

4-SPEED COLLARO Latest 1957 Model RC-456, Collaro 4 speed record changer. Plays all 4 speeds, 16, 33, 45 and 78 RPM both automatically and manually. Inter-mixes records of the same speed and shuts off after last record. Fast 6 second change cycle. Automatic disengagement of idler wheels eliminates flat spots that cause wow and flutter. All of the desirable features of the Model RC-456 plus 4 speed operation. Model RC-456 Automatic 4 speed automatic record changer, less cartridge. Sale price, \$34.50. Model RC-456 with G.E. variable reluctance cartridge with 3 mil sapphire and 1 mil diamond stylus. Sale price, \$46.95. Large spindle \$3.30 extra.

Webcor 1642-1, popular 3 speed changer on metal base with ceramic crystal cartridge. Sale price, \$27.95.
Webcor 1641-21, 3 speed changer, less base with RPX-050 G.E. VR cartridge. \$27.95. No. 1014, large 45 RPM spindle for 1641 and 1642 Webcor changers. \$2.44 extra.
Webcor CR-1631-27, Hi-Fi chrome changer with 2-separate plug-in cartridge shells, less cartridge, no base. Sale price, \$34.95.
Webcor CR-1631-27, same as above and with G.E. RPX-052A cartridge with 1 mil diamond stylus. Sale price, \$49.95.
Webcor CR-1631-21, Hi-Fi chrome changer same as above except has one piece tone arm with RPX-052A Golden Treasure cartridge. 1 mil diamond stylus. Sale price \$47.95.
No. 1915, large 45RPM spindle for 1631 series Webcor changer, \$2.44 extra. Precut mounting board for 1641 or 1631 series Webcor changer, \$1.96 extra.

New 1957 Garrard Model RC98, "Crown 11" 3-speed super automatic changer, one of the world's finest. Provides the greatest combination of Hi-Fi features ever found in an automatic changer. Model RC98 changer, less cartridge \$66.15. With VR cartridge, 1 mil diamond and 3 mil sapphire needles, RPX-052A—\$82.10. Large 45 rpm, center spindle \$3.43, extra.
Popular RC88 "Triumph" model with most of the features of the 98. RC88, less cartridge—\$53.41. With RPX-052A cartridge as above—\$69.36.

GOLDRING V. R. CARTRIDGE
WITH 2 SAPPHIRE STYLII \$5.95
WITH 1 MIL DIAMOND, 3 MIL SAPH. \$13.95

McGee offers the internationally famous Goldring variable reluctance phono cartridge, made in England and sold throughout the world to those who want the finest and most accurate music reproduction from 33 1/2, 45 and 78 RPM high fidelity phono records. (Input gain and compensation similar to G. v. r. cartridge required.) Furnished as standard equipment with sapphire 1 and 3 mil styli. A regular \$9.90 net item on sale at McGee for \$5.95. For \$13.95 with a diamond 1 mil stylus. These are the latest production, individually cartridge turnover, cartridge with mounting bracket. Fits one arm on most changers. Made for and bearing the famous Wilcox-Gay Recording name. No. 548 Goldring V.R. (Wilcox-Gay) cartridge, Net \$5.95. No. D546-05, Goldring V.R. (Wilcox-Gay) cartridge with diamond 1 mil stylus, \$13.95. 1 mil diamond stylus for Goldring V.R. cartridge, purchased separately, \$9.95.

8" NORELCO P14 \$7.95
Specially Priced at \$7.95 for this ad. Norelco imported from Holland 8" Hi-Fi PM Model 9760—fine audio reproduction from 75 cps to 19,000 cps—imp. 4 ohms. Flux density 11,000 Gauss. Powerful Alnico Magnet. A fine addition to your Hi-Fi speaker collection. 2 for \$15.00

12" NORELCO 9760 HI-FI SPEAKER \$19.95
Model 9760, 12" Norelco 20 watt extended range high fidelity PM speaker. Has a 1.8 ohm, Ticonal magnet. Response from 40 to 20,000 cps. Made by North American Phillips Co. of Holland. A single cone coaxial speaker with extra high frequency cone. 8 ohm voice coil. Resonance frequency 45 cps. Total flux density, 8000 gauss. Ideal for use with any Hi-Fi amplifier or FM-AM chassis. Sale price only \$19.95.
Model 9762, 12" Norelco 20 watt extended range high fidelity PM speaker. Better quality than above, in the 38 ohm, Ticonal magnet, greater flux density of 11,000 gauss and a metal high frequency mechanism built in the center of the large cone. Model 9762, 12" Norelco Hi-Fi PM speaker, Sale price only \$39.95.

WRITE FOR MCGEE'S 88-PAGE 1957 CATALOG
NEW 8 TUBE 6 VOLT PUSH-BUTTON MODEL \$37.95

New Model SM-7855-X, 8-tube, 6-volt universal mounting auto radio with push buttons and 6x9 speaker. Made for Hudson cars, but their compact construction lends them to underdash installation. Has push-out 6A05 high powered audio. Stock No. SM-7855-X with 6x9 speaker—\$37.95. With 2—5x7 speaker—\$39.95. With 1—5x7 speaker \$37.95. Specific speaker size wanted. Three-section top cow mounting antenna—\$2.29 extra.

McGee's Famous 12 AND 15 INCH COAXIAL P.M. HIGH FIDELITY SPEAKERS
\$12.95 \$23.95
12-Inch Model CU-14Y
15-Inch Model P15-CR

Model CU-14Y, 12" high fidelity coaxial PM speaker. Response from 30 to 17,500 cps. Full 6.8 oz. Alnico V magnet in the 12" woofer. Specially made high frequency tweeter. Built-in crossover network. Only two wires to connect to your radio or amplifier. Matches 3.2 to 8 ohm output. Don't confuse this speaker with many cheap speakers that are offered. This is a fine quality speaker. Stock No. CU-14Y. Sale price \$12.95 each, two for \$25.00.
Model P15-CR, 15" high fidelity coaxial PM speaker. Response down to 20 cps, and up to 17,500 cps. Full 6.8 oz. Alnico V magnet in the 15" woofer. Specially made coaxially suspended 5" high frequency tweeter. Built-in crossover network. Only two wires to connect. Matches 3.2 to 8 ohm output transformer. A regular \$62.50 list price. Model P15-CR. McGee's Sale Price, \$23.95.
McGee's new 15" Junior coaxial PM speaker, 15" woofer has 6.8 oz. Alnico V magnet. 3" coaxially suspended tweeter with crossover. Only two wires to connect to any 8 ohm radio or amplifier. Frequency response from 40 to 15,000 cps. Model No. M15-CR, 15" Junior coax PM speaker. Sale price \$16.95.

FAMOUS STANDARD COIL CASCODE TUNERS
TV-2000 series Standard Coil cascode tuners complete with 6J6 and 6BK7 or 6BQ7 tubes. Thousands of TV sets use this famous tuner. Tuning 12 channels (2 thru 13). For 21 mc I.F. circuit. This tuner will give 2 to 1 better reception than the old pentode type. Many servicemen replace all older tuners with this cascode model. Available with either 27" or 4 1/2" shaft length. A tremendous purchase makes our low \$12.95 price possible. Specify shaft length desired. Stock No. TV-2000-3. Sale price 2 FOR \$25.00
Matching knobs for Standard Coil tuners. Set No. SCK-2 for fine tuning and channel selector. Set VCK-2, matching volume and contrast knobs. Either set only 59c a pair.

STANDARD COIL PENTODE TUNERS \$7.95
SC-948, Standard Coil, 21 mc Pentode tuner with 6BC6 or 6AG5 and 6J6 tubes. Popular 12 channel, 2 thru 13, used in millions of TV sets. Why spend time repairing an old tuner when it may be easier to just replace it. Shaft can be cut to desired length. Available with 27", 3", 4 1/2" or 4 1/4" shaft. Specify length of shaft. Sale price, \$7.95 ea. 2 for \$15.00. Matched knob set 59c extra.

TWO-TUBE SARKES-TARZIAN TV TUNER WITH TUBES
2 1MC OR 4 1MC \$9.95
No. TT-3A, 2 tube Sarkes-Tarzian 12 channel TV tuner for 21mc. Used in CBS, Arvin, Crosley, etc. Ideal for general replacement. 3 1/2" shaft. With tubes, \$7.95 each, 2 for \$15.00.
No. TT-2C, 2 tube Sarkes-Tarzian 41 mc Cascode tuner with tubes, 4 1/2" shaft. Smallest cascode tuner made. Popular in many sets. \$7.95 each, 2 for \$15.00.
Either of the above tuners with 9" shaft, \$10.00 extra.
Type 3, 3 tube 21 mc Sarkes Tarzian tuner with tubes. Rotary switch type complete with 6A5, 6BD6 and 6AG5 tubes. Regular cost is several times our new low price of only \$4.95. Wired ready to hook-up to video and sound I.F. strip. Use with either separate sound or inter-carrier. Built-in fine tuning. 27" shaft. Net, \$4.95.

RCA KRK-12 TV TUNER
Brand New—with Tubes

SALE PRICE \$6.95
2 for \$13.00
RCA Model KRK-12, UHF-VHF TV tuner with tubes: 2-6BQ7A, 6AF4 and 654. A complete tuner with all 12 VHF strips, but with blank strips in the UHF positions. This tuner fits many RCA sets using 40 mc regency I.F.s. 27D382 also KCS-66, etc. Original tuner list was about \$50.00. We offer them new at about the value of the tubes. Ship wt. 10 lbs. McGee's sale price, \$6.95 each, 2 for \$13.00.

MINIATURE BROADCASTING STATION FOR MICROPHONE AND PHONO WITH CRYSTAL MICROPHONE SALE PRICE \$9.95
Sensational new model MCL-E3 miniature broadcasting station for microphone and phonograph. Can be received on any broadcast radio in the home. No wires to connect. Tuner in just like a radio station. Has input jacks for crystal mike or record player. Complete with 12KB and 70L7 tubes and instructions. Operates on 110 volts AC. Simple to operate. One control fades out microphone to record. Frequency can be adjusted so as not to interfere with local radio stations. Miniature broadcasting station, complete with crystal hand mike and instructions. Ship. wt. 4 lbs. Net price \$9.95.

MCGEE RADIO COMPANY PHONES F.O.B. KANSAS CITY SEND 25% OR FULL REMITTANCE WITH ORDER. TELEPHONE VICTOR 2-5092 1903 MCGEE ST., KANSAS CITY, MISSOURI

BUILD 16 RADIO CIRCUITS AT HOME

With the New DELUXE 1957 Progressive Radio "Edu-Kit" only **\$22.95**

A PRACTICAL HOME RADIO COURSE

Now Includes

- * Transmitter
- * Signal Tracer
- * Signal Injector
- * Code Oscillator

- No Knowledge of Radio Necessary
- No Additional Parts or Tools Needed
- Excellent Background for TV
- Unconditional Money-Back Guarantee



Reg. U.S. Pat. Off.

FREE Tool Set, Pliers-Cutters, Tester, Soldering Iron, Alignment Tool.

WHAT THE "EDU-KIT" OFFERS YOU

The 1957 "Edu-Kit" offers you an outstanding PRACTICAL HOME RADIO COURSE at a rock-bottom price. You will learn radio theory, construction and servicing. You will learn how to build radios, using regular schematics; how to solder and wire in a professional manner; how to service and trouble-shoot radios. You will learn how to work with punched metal chassis as well as the new Printed Circuit chassis. You will learn the principles of HF and AF amplifiers and oscillators, detectors, rectifiers, test equipment. You will learn and practice code using the Progressive Code Oscillator. You will build 16 Receiver, Transmitter, Code Oscillator, Signal Tracer and Signal Injector circuits, and learn how to operate them. You will receive an excellent background for TV. In brief, you will receive a basic education in Electronics and Radio, worth many times the small price you pay, only \$22.95 complete.

PROGRESSIVE TEACHING METHOD

The Progressive Radio "Edu-Kit" is the foremost educational radio kit in the world, and is universally accepted as the standard in the field of electronic training. The "Edu-Kit" uses the modern educational principle of "Learn by Doing." You begin by building a simple radio. Gradually, in a progressive manner, and at your own rate, you construct more advanced multi-tube radio circuits, learn more advanced theory and techniques, and do work like a professional radio technician.

THE KIT FOR EVERYONE

You do not need the slightest background in radio or science. The "Edu-Kit" is used by young and old, schools and clubs, by Armed Forces Personnel and Veterans Administration for training and rehabilitation. The "Edu-Kit" is used in 79 countries throughout the world. Designed for universal use, the "Edu-Kit" operates on any voltage from 105 to 125 volts, AC and DC. For use in countries employing higher line voltages, a 210-250 Volt AC/DC model is available.

THE "EDU-KIT" IS COMPLETE

You will receive all parts and instructions necessary to build 16 different radio and electronics circuits, each guaranteed to operate. Our kits contain tubes, tube sockets, variable, electrolytic and paper dielectric condensers, resistors, tie strips, coils, hardware, tubing, punched metal chassis, Instruction Manuals, etc. In addition, you receive Printed Circuit materials, including Printed Circuit chassis, special tube sockets, hardware and instructions. You also receive a useful set of tools, a professional electric soldering iron, and a self-powered, dynamic Radio and Electronics Tester. The "Edu-Kit" also includes Code instructions and the Progressive Code Oscillator. You will also receive lessons for servicing with the Progressive Signal Tracer and Progressive Signal Injector, a High Fidelity Guide, FCC Amateur License Training Book, and a Qals Book. All parts, components, etc. of the "Edu-Kit" are 100% unconditionally guaranteed, brand new, carefully selected, tested and matched. Everything is yours to keep. The complete price of this practical home Radio and Electronics course is only \$22.95.

TROUBLE-SHOOTING LESSONS

You will learn to trouble-shoot and service radios, using the professional Signal Tracer, the unique Signal Injector, and the dynamic Radio and Electronics Tester. Our Consultation Service will help you with any technical problems.

J. Stasaltis, of 25 Poplar Pl., Waterbury, Conn., writes: "I have repaired several sets for my friends, and made money. The 'Edu-Kit' paid for itself. I was ready to spend \$240 for a course, but I found your ad and sent for your kit."

FREE EXTRAS

- Set of Tools • Radio Book • Radio and Electronics Tester • Electric Soldering Iron • Tester Instruction Book • Hi-Fi Book • TV Book • Quiz Book • Membership in Radio-TV • FCC additional information • FCC Amateur License Training • Printed Circuitry

90 DAY UNCONDITIONAL MONEY-BACK GUARANTEE

ORDER FROM AD—RECEIVE FREE BONUS RESISTOR & CONDENSER KITS WORTH \$7

- "Edu-Kit" Postpaid. Enclose full payment of \$22.95
 - "Edu-Kit" C.O.D. I will pay \$22.95 plus postage.
 - Send me FREE additional information and brochure.
- "Edu-Kit" include FREE valuable Radio & TV Servicing Manuals. No obligation.

(Outside U.S.A.—C.O.D. "Edu-Kit" for 105-125 V. AC/DC \$23.95; 210-250 V. AC/DC \$26.45.)

Name _____

Address _____

PROGRESSIVE "EDU-KITS" INC.

497 Union Ave., Dept. 61E, Brooklyn 11, N. Y.



SERVICE associations that are carrying out aggressive campaigns against the extension of captive service are deeply conscious of the skeleton in their own closet—the unethical service shop. Although unethical operators represent a very small minority of the independent service shops, their machinations have been responsible for most of the bad publicity that continues to hurt the TV industry in many ways.

Unfortunately, the complexity of TV circuitry makes it easy for a larceny-minded technician to bilk customers for a comparatively long time before his activities are brought to light. The most flagrant violators of all codes of business ethics, of course, are the gyps who thrive on pulling sets to their shops. Their charges for even the simplest shop jobs are based on "all the traffic will bear."

The activities of these conscienceless crooks quickly come to the attention of the local Better Business Bureaus. Ridding the industry of them has been a frustrating experience to both the BBB's and the legitimate service shop operators who are constantly trying to clean up their own industry.

The cagiest, most larcenous characters in the service business are the replacement tube racketeers. A case in point is a service business in a large eastern city operated by technically untrained individuals. These men have developed a "racket" that will pay off for them as long as they can find unscrupulous technicians who will do their bidding.

In this racket, home TV service is promoted at \$4 per house call. However, the customer actually pays \$7 per call, since the \$4 is listed on the service order as charges for the "service call" and the customer pays an additional \$3 for "technical labor." Technicians who work for this outfit are paid good wages—but they are required to sell a minimum of \$12 worth of tubes on each call. Sooner or later, in one way or another, set owners learn how they have been taken in cases like this one. It creates a resentment against all independent TV service businesses.

One angle on how this bad publicity hurts all ethically operated service shops is shown in the continual "beating" that field service technicians get from set owners. The unjustifiable and unreasoned complaints and sarcastic criticism over TV service has driven many excellent technicians out of the consumer service field and into other activities of the electronics business.

A prime example of how utterly absurd some of these complaints are was

recently brought to the attention of your editor during a visit to a large shop in an eastern city. A very irate man called this business to "lay them out" because one of their service technicians insulted his wife. He claimed the technician had forced his wife to borrow money from a neighbor to pay for a TV service call. Although none of the office personnel knew the circumstances surrounding the call, the set owner used up more than thirty minutes of the time of three people, including the shop owner, with blistering comments about the discourtesies and crooked dealings of TV service shops.

When the technician reported in, the shop owner asked him about what happened when he made the service call. The technician was surprised to learn that any difficulty had arisen at all. When he presented the bill for payment, he said, the wife explained that her husband had taken the family check book with him and she would have to borrow a blank check from her neighbor. On a follow-up call to the home, the wife apologized to the shop owner for the behavior of her husband.

Similar experiences with suspicious or downright unreasonable people are the daily lot of the thousands of competent, honest, hard-working technicians who have elected to make a career out of electronic service work. These occurrences are driving many good men out of the service field, particularly since there are so many attractive jobs open in factories and other aspects of electronic work, including defense projects.

Unity in Philadelphia

Recently the five service associations in the Philadelphia area met to discuss the feasibility of forming a single organization in that area for the service industry which could represent all elements including the service dealers, contractors, and technicians. The associations involved in the discussion were the *Television Service Dealers Association*, the *Northeast Television Dealers Association*, *Allied Television Technicians Association of New Jersey*, the *Television Service Dealers Association of Delaware County* and the *Philadelphia Radio Servicemen's Association*.

The members of these several groups agreed they would have to find some organizational pattern that would permit the service industry as a whole to cope with such problems as captive service, increased operating costs, loss of technicians to set and electronic manufacturers, and curbing the activities of unethical shops.

The group felt that set producers, including those with service organizations, must realize their responsibility to those in independent service who have worked shoulder-to-shoulder with the manufacturer in establishing TV as a must in practically every home. They were also of the opinion that other elements of the industry should study and understand the load the independent service industry is carrying and provide the shop operator with fi-

financial aid and assistance in running his business profitably.

Promotion for Service Fair

The *Indiana Electronic Service Association* is moving forward rapidly with plans for their full-fledged Electronic Service Clinic and Fair to be held in Indianapolis during April 1957. The *IESA* is a state-wide organization composed of practically all local service associations now operating in Indiana. One of their major projects is to develop interest among dealers and service operators in sponsoring a licensing bill to be presented to the Indiana State Legislature.

The promotion and management of the mid-west Electronic Service Clinic has been turned over to a professional public relations and sales promotion organization called *Plans Incorporated*, which is headed by Edward J. Lanigan.

PR Man Engaged

The *Radio Television Guild of Long Island* recently engaged Richard T. Guidera, a professional public relations counsellor, to fill the post of executive secretary for the association. Mr. Guidera, a graduate of Harvard College, is an ex-marine who handled Marine Corps public relations in the metropolitan New York area for three years. In commenting on the duties of the newly appointed executive secretary, the *Guild News* said:

"The duties of the executive secretary will be to assist officers of the *Guild* with the association's administration, add continuity to the many programs conducted each year by the *Guild* for the membership, assist the editors of the *Guild News*, and work with the Distributors' Shopping Committee.

"Also included in the duties of the new office is the task of working to increase membership of the *RTG of LI* and thereby give it added strength and position within the Long Island community. This latest assignment is tied directly with the added duty of public relations director for the *Guild* and the coming program to increase patronage of member shops by the general public of Long Island."

The *RTG of Long Island*, which recently held its first and highly successful Long Island Electronic Fair and Clinic, is one of the industry's largest and most successful local service associations.

Licensing Bill Proposed

A bill to license service technicians and dealers, intended for presentation to the California State Legislature, is under study by members of the *Radio Television Technicians Association* and the *California State Electronics Association*. Individual copies of the first draft of the bill were mailed out to *CSEA* and *RTTA* members for comment and consideration. A final version, mutually acceptable to the membership of the organizations involved, will be proposed jointly to the legislature for enactment.

-30-



ON ONE COMPACT CHASSIS! FISHER FM-AM TUNER, AUDIO CONTROL AND 30-WATT AMPLIFIER!

New!

EVERYTHING YOU NEED!
ON ONE SUPERB CHASSIS!

THE FISHER "500"

THOUSANDS have asked us for it—and here it is! An extreme-sensitivity FM-AM tuner, a powerful 30-watt amplifier, and a Master Audio Control—all built on one compact chassis. Simply add a record changer and loudspeaker to the FISHER "500" and, as easily as that, you have a complete high fidelity system. Its quality—in the finest FISHER tradition. Its appearance—the timeless beauty of classic simplicity. Here is the most economical form in which you can own FISHER equipment.

Chassis Only, **\$239.50**

Mahogany or Blonde Cabinet, **\$19.95**

Outstanding Features of THE FISHER "500"

- Extreme sensitivity on FM and AM. Meter for micro-accurate tuning.
- Full wide-band FM detector for maximum capture ratio.
- Powerful, 30-watt amplifier; handles 60-watt peaks.
- Uniform response, 16 to 32,000 cycles.
- 4 inputs, including separate tape playback preamp-equalizer.
- 4, 8 and 16-ohm outputs match all existing speakers.
- Recorder output ahead of volume and tone controls.
- 7 Controls, including 9-position Channel Selector (AM, FM, AES, RIAA, LP, NAB, TAPE, AUX 1 and AUX 2), Loudness Contour (4-position), Volume, Bass, Treble, AC-Power, Station Selector.
- Beautiful, die-cast, brushed brass escutcheon and control panel.
- Pin-point, channel indicator lights.
- Smooth, flywheel tuning.
- Largest, easy-to-read, slide-rule dial, with logging scale.
- High efficiency FM and AM antennas supplied.
- 14 tubes plus 2 matched germanium diodes.
- SIZE: 13 7/16" w. x 12 3/4" d. (excluding knobs) x 6 1/4" high.

Prices Slightly Higher In The Far West

WRITE TODAY FOR COMPLETE SPECIFICATIONS

FISHER RADIO CORP., 21-23 44th DRIVE • L. I. CITY 1 • N. Y.

**MEASUREMENTS CORP.
SIGNAL GEN. MODEL 78B**

Gov't. Avr. Cost \$300.00
Used for alignment of radio I.F. freq. stages of radio receivers and other test operations requiring a C.W. or modulated R.F. voltages. 15 to 25 Mc and 195 to 225 Mc signal may be unmodulated or modulated at approx. 30% by an audio frequency of 400 or 8200 CPF.
Brand New..... \$39.50
Used Exc. \$29.50

COMMAND ARC-5 TRANSMITTER

T-20... 4 to 5.3 MC New
T-21... 5.3 to 7 MC \$5.95

Used... T-23 100-156 MC \$3.95
New... T-23 100-156 MC \$13.95
Used... 9.95
3 to 4 mc. like new... \$5.95

RECEIVERS
190-550 KC \$14.95
1.5-3.0 MC 7.95 \$9.95

RCA MOBILE RECEIVER

30-41 mc. AM Crystal Controlled. \$14.95 each.

DYNAMOTOR FOR ABOVE

6V DC Input-250 V DC Output. \$6.95 each.

RCA MOBILE TRANSMITTER

30-41 mc. AM Crystal Controlled. \$14.95 each.

DYNAMOTOR FOR ABOVE

6V DC Input-375 Volts 250 ma Output. \$9.95 each.

ALL 4 ABOVE USED UNITS \$39.50

FM WOBULATOR CAPACITOR

Frequency modulation unit with a permanent magnetic field and a moving coil mechanism driving a metal diaphragm supported at the rim. This diaphragm acts as a moving plate of the frequency modulator capacitor. W/instructions. Build TV sweep circuit. gen. BRAND NEW. \$2.75
2 for only \$4.95

Sweet Oscilloscope Deals

INDICATOR UNIT. For conversion to test scope, panchropter, analyzer, etc. Double deck chassis. 5CP1 mounted in tube shield. Less small tubes and crystal, but complete with GCP1. \$9.95
Exc. Cond. each

ASB-7 Radar Indicator Unit: For conversion to test scope or for use as modulation monitor. Has standard test-scope CR tube. H Cent. V Cent. Brill. Foc. Gain, and range selection switch. External power source was used. Tubes: \$9.95
4-6AC7, 3-6HG6, Less 1-5BP1, New. \$9.95

BC929 RADAR, \$9.95

BC-929 A Radar Indicator Scope. This unit could be rebuilt into a fine test scope. It is an ideal size. 8x9x14 priced with tubes 2-6SN7, 2-6HG6, 6G5, 6X5 and 2X2. This is a red hot buy. Scoop Price. New. \$9.95

LORAN APN-4

FINE QUALITY NAVIGATIONAL EQUIPMENT

Determine exact geographic position of your boat or plane! Complete, BRAND NEW installation consists of: 1B-6R/APN-4 Indicator; R-9H/APN-4 Receiver; IP-206 Inverter; Set of Plugs; Visor for Indicator; Operation manual; \$129.50
Brand New, Export packed. **\$129.50**
10GB INDICATOR, R9B RECEIVER, \$69.50
Excellent.

UHF TRANSCEIVER, APG-5

2500 Mc complete with 2C43, 2C40, 3E29, 1B27, VR105, 5Y3, 6AL5, 2 each \$39.50
2X2 and 8 each 6AK5.

PE109 INVERTER

12VDC input. 115 VAC. 1 1/2 amp, single phase, 400 cycle output. \$34.50
Brand New. \$27.50
Exc. used.

WRITE FOR NEW BULLETIN

ALL ITEMS F.O.B. CHICAGO 25% Deposit required with orders

R W ELECTRONICS

Dept. N 2430 S. Michigan Ave. Chicago 16, Ill.
PHONE: CALumet 5-1281-2-3

\$45.00 HI-FI Headset for only \$7.95

Uses annular grooved plastic fibre comes with voice coils as in speakers, and brand new chamois ear pads to obtain spacing for correct acoustical load. GIVES FINEST MUSIC REPRODUCTIONS! Imp.: 300 Ohms per unit or 600 Ohms when wire series.

USED, EXC. COND. \$4.95
WITH BRAND NEW CHAMOIS \$6.19
CUSHIONS

APG 5 or 15 CAVITY

10 Cm. 2C43 osc Xmitter, 2C40 Loc. Osc. Rec. 1B27 TR; tunes 2400 to 3000 MCS, less tubes. Price \$4.95

Radio Receiver 11-tube UHF tunable 234-258 MC receiver with schematic. Complete with tubes. 3 ea. of 6AK5. 7 ea. of 900L1. 1 ea. of 12A6. Like new \$6.95
Less Tubes. \$2.95

SCOPE TUBES

3BP1 \$1.95
3CP1
3EP1
3HP1
5AP1
5CP1
ea. 4 for \$7.00

DYNAMOTORS

Type	Input	Output	Excellent New
BO-77	12 VDC	1000 VDC 350 MA	\$14.95
BD-83	12 VDC	375-150 MA	1.95
DM-35	12 VDC	625 VDC 225 MA	9.95 19.95
DM-37	24 VDC	625 VDC 225 MA	6.95 9.95
DM-64	12 VDC	275 VDC 150 MA	3.95 5.95
DM-34	12 VDC	220 V 80 MA	2.95 4.95
DM-65	12 VDC	440 VDC 100 MA	14.95 19.95
DA-1A	24 VDC	230 VDC 100 MA	4.95
DM-28	24 VDC	230 VDC 100 MA	4.95
DM-32A2	12 VDC	250 VDC 60 MA	4.95

MOBILE HEAVY DUTY DYNAMOTOR: 14 V. INPUT-output: 1030 VDC 260 MA. Tapped 515 V. 215 MA. use or 6 V DC INPUT-500 V. 175 MA. While they last—DM-42-Excel. Condition. \$4.95
Brand New. \$9.95

MG-149F Inverter, 24 VDC input. 115AC. 400 cycles, 500 VA single phase. \$15.95
Exc.

RS-38 Navy Carbon Hand Mike. \$2.45 ea.
Exc.

1-96A Signal Generator 100-156 Mc. complete w/cords and cables. like new \$69.50

Varlac General Radio—Model 200 BO-130V. 1 Amp. Brand new. \$5.95 ea.

MN-26-C—Remote Control Navigational Direction finder and communication receiver. Manual DF in any one of three freq. bands. 150 to 1500 KC. 24V. Self contained dynamotor supply. Complete installation, including receiver, control box, loop, azimuth control. Left-Right Indicator, plugs, loop transmission line and flex. shafts, oper. & main. manual. Ideal for use in boats, etc.

BRAND NEW	\$39.50
MN-20-E Loop	4.95
MN-52-CRANK Drive, New	2.50
MN-28-C	6.95
MN-26-C Revr., New	19.95
MN-10-E Azimuth Indicator, New	9.95
DYNAMOTORS for above, 12VDC, MN-26	9.95

METER—3"-0-5 Ma. 270° Indication—By Pass Shunt and add scale. Excellent Condition. \$1.25
Five for \$5.00



NEW TV ANTENNA

Davis Electronics, 4002 W. Burbank Blvd., Burbank, Calif., has just introduced a new all v.h.f. TV antenna called "The Bandmaster." It is claimed that this antenna has a voltage stand-

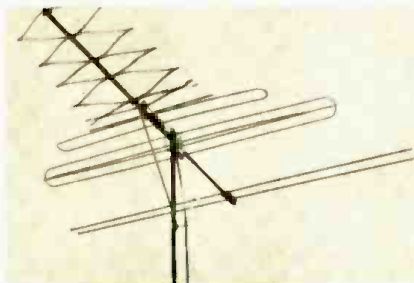

ing wave ratio which is uniformly less than 1.6 to 1 on all v.h.f. channels.

This antenna is a 10-element all-channel yagi type. Elements are completely pre-assembled at the factory.

PLANT EXPANSION

Alliance Mfg. Co., Inc., Alliance, Ohio, subsidiary of Consolidated Electronics Industries, has announced the lease, with option to buy, of three buildings formerly occupied by McCaskey Register Co. The addition of this space, approximately 81,000 square feet, will make it possible for the company to acquire additional products.

INDOOR ANTENNA

Snyder Manufacturing Company, Philadelphia, Penna., has added a model to its line of indoor "Directronic" antennas. To the conventional configuration of the indoor rabbit-ear design, the manufacturer has added crossed circular phasing elements in the "Picasso." This addition is said to improve rejection of ghosts and snow. The phasing bars and adjustable side elements are made of shiny brass and are mounted on a heavy tip-proof base.



On the latter is mounted the "Directronic" selector to permit optimum adjustment for each channel.

Ben Snyder, head of the company, is now in Europe on a one-month tour

ZYTRON "QUALITY BRAND"
RADIO & TV RECEIVING
TUBES
BRAND NEW
INDIVIDUALLY BOXED
Terrifically LOW PRICED!
Send TODAY for Complete Catalog
ZYTRON TUBE COMPANY
220 West 42nd Street - New York 36, N. Y.

JENSEN COMMUNICATION SPEAKER
Mounted in black, crackle-finish metal case. Heavy duty. Approx. 4x8". Can be used in hi-fi setup, like new, with 500 ohm matching transformer. \$9.95

SCR-522 TRANSCEIVER For 2 and 6 meter. Good cond. \$29.95

ASB RECEIVER For 420 MC operation. New, boxed. \$7.50

ARB RECEIVER 195 kc to 9 MC. Good, used cond. \$19.95

THIS MONTH'S SPECIAL
O-1 MILLIAMPER METER: 270° Indication. Just by-pass shunt and add scale. Used, good condition. \$1.95

NEW CATALOGUE NO. 110 IS OFF THE PRESS!
Get your free copy today!

J. J. GLASS ELECTRONICS CO.
1615 S. Main St. Los Angeles 15, Calif.

with the purpose of discussing mutual arrangements with manufacturers on the continent. He hopes to market his company's products through these foreign organizations while the Snyder organization in this country handles distribution in the Western hemisphere of products made by European companies.

HELICAL COLOR ANTENNA

JFD Manufacturing Company, Inc., 6101 16th Ave., Brooklyn, N. Y., has designed an antenna to meet the growing need for efficient low-band v.h.f. performance. This unit, the "Wonder-Helix Color-tenna," is intended to make up for the deficiency in many fringe-area antennas currently in use, where maximum gain is achieved on

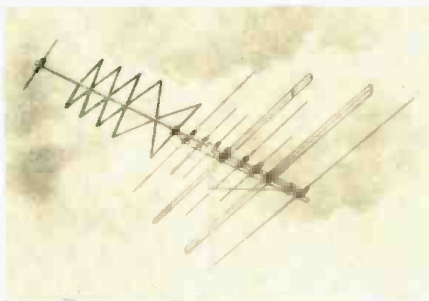

the high band, but only moderate-to-good response on the low band.

A pair of double-driven folded dipoles are phased for maximum signal

addition on the low band. A reflector, director, and deflector flatten the bandpass characteristic. A 5-turn flat-plane helix provides high narrow-lobe gain on the high band. Gain is reported greater than that of a double-driven 5-element broadband yagi with a front-back ratio of better than 10 to 1 on low-band channels and up to 14 to 1 on the high band.

Also featured are all-aluminum boom-braced construction to withstand ice loading and heavy winds, good 300-ohm match, and uniform response to meet the requirements of color reception.

NATIONAL SALES CONFERENCE

Winegard Company, Burlington, Iowa, successfully completed its first national sales conference this fall. All selling representatives were brought together in Burlington for the introduction of the new 1957 line and discussion of the recently launched ad campaign. The first day of the 3-day convention was devoted to technical sessions on the performance of the various models.

LARGER QUARTERS

Video Industries Company, 242 Madison Ave., Port Chester, N. Y., manufacturer of "Stacked-V" and "VICO" antennas for TV, has moved to a larger building. New facilities at the above address consist of 5000 ft. of manufacturing space on one floor plus 2200 ft.

of storage space. Former location was at Jane St. and Palmer Pl. in the same city.

ROTATOR CONTROL

Crown Control Company, Inc., New Bremen, Ohio, has aimed for greater eye appeal in the new 1957 version of

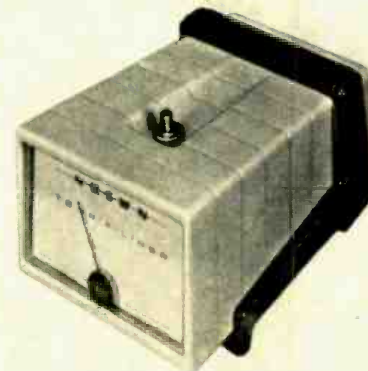

its CAR6B "Tenn-A-Liner" antenna rotator control unit. To blend with either blonde or dark interior furniture, the "Tenn-A-Liner" case is finished in beige and brown, with the former color predominating. A new dial offers greater readability, with positive directional indication, even when the motor is not operating. Finger-tip operation and positive braking to prevent windmilling are other features provided.

COYNE QUALITY
TELEVISION
RADIO - COLOR TV
 Home Training
at Unbelievably Low Cost



The future is **YOURS** in **TELEVISION!**
 A fabulous field—good pay—fascinating work—a prosperous future in a good job, or independence in your own business!

Coyne brings you **MODERN-QUALITY** Television Home Training; training designed to meet Coyne standards at truly lowest cost—you pay for training only—no costly "put together kits." Not an old Radio Course with Television "tacked on." Here is **MODERN TELEVISION TRAINING** including **Radio, UHF and Color TV.** No Radio background or previous experience needed. Personal guidance by Coyne Staff. **Practical Job Guides** to show you how to do actual servicing jobs—*make money early in course.* Free Life-time Employment Service to Graduates.

COYNE
ELECTRICAL SCHOOL
 A TECHNICAL TRADE INSTITUTE OPERATED
 NOT FOR PROFIT
 500 S. Paulina Street, Chicago 12, Dept. 17-MT5



Send Coupon for Free Book

and full details, including easy Payment Plan. No obligation, no salesman will call.

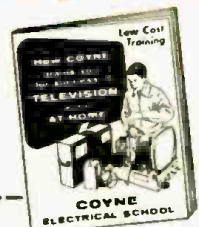

COYNE Television Home Training Division
 500 S. Paulina St., Chicago 12, Ill.
 Dept. 17-MT5
 Send Free Book and details on how I can get Coyne Quality Television Home Training at low cost and easy terms.

Name _____
 Address _____
 City _____ State _____

LAFAYETTE **SENSATIONAL VALUES!** IN COMPLETELY WIRED TEST EQUIPMENT at LESS than the PRICE of KITS!



LAFAYETTE SIGNAL GENERATOR

NEVER BEFORE HAS A COMPLETELY WIRED AND TESTED INSTRUMENT OF SUCH ACCURACY AND QUALITY BEEN OFFERED AT SUCH A PRICE!

- FREQUENCY 120 KC TO 260 MC
- 120 KC TO 130 MC ON FUNDAMENTALS
- LABORATORY ACCURACY AND QUALITY

22.50

A completely wired and tested instrument not to be confused with units sold in kit form at almost the same price, but with a quality and accuracy of instruments 3 to 4 times its price. Six overlapping ranges generate signals of 120KC - 320KC; 320KC - 1000KC; 1MC - 3.2MC - 11MC; 11MC - 38MC and 37MC - 130MC all on fundamentals with calibrated harmonics from 120MC to 260MC. Selector switch gives instant choice of ranges. Switch gives choice of internal modulation of 400 CPS or use of any external source at other frequencies. For audio testing the 100 cycle signal can be used accurately. Outputs are unmodulated RF, modulated RF and 400 CPS audio. RF output is in excess of 100,000 microvolts and jacks are provided for choice of either high or low RF output. Stability is insured by special circuit design. Has a fine adjustment RF control. AF output is 2-3 volts, AF input is 4 volts across 1 megohm. Large clear 3 inch etched dial plate and pointer are protected by transparent plastic bezel. Common AF terminals for EXT-MOD input and INT-AF for audio tests eliminate need for special AF output connectors. Machine engraved panel lettering. Handsome gray metal case with carrying handle. Measures 6 1/2" x 10" x 4 1/2". Comes complete with pair of leads, AC line cord and plug. Operates on 105-125V 50-60 cycle AC. Shpg. wt., 8 lbs.

LAFAYETTE LSG-10 SIGNAL GENERATOR **22.50**



LAFAYETTE CAPACITOR-RESISTANCE TESTER

COMPLETELY WIRED AND TESTED

21.50

- CHECKS ALL TYPES OF CONDENSERS FOR CAPACITY, LEAKAGE, OPEN SHORTS OR INTERMITTENT CONDITION
- DIRECT READING SCALES FROM .00001 TO 1000 MFD AND 100 TO 5 MEGOHMS

A stable and accurate bridge type circuit measures capacitance in 4 ranges of .00001-.005 MFD, .001 to 5 MFD, 1 to 50 MFD and 20 to 1000 MFD. Two resistance ranges of 100-50,000 and 10,000 to 5 megohms. Check leakage under actual load with choice of 25, 150, 250, 350 or 450 volts available by selector switch. Power factor control from 0 to 50%. Checks for leakage, open, short, or intermittent operation. All readings taken directly off scales after setting magic eye to maximum. Completely self-contained power supply. Attractively finished steel case with rounded corners and etched panel. Operates from 110V AC. Size 9 3/4" L x 7 1/2" H x 5 1/4" D. Shpg. wt. 10 lbs.

MODEL LC-15 **NET 21.50**

4 AND 6 TRANSISTOR SUPERHET KITS POCKET AND HOME RADIOS FOR SPEAKER AND EARPHONE OPERATION

POCKET SIZE: 4" L x 3-5/16" W x 1" D BUILT-IN ANTENNA! REQUIRES NO EXTERNAL ANTENNA OR GROUND!



2-TRANSISTOR PUSH-PULL OUTPUT KIT WITH SELF-CONTAINED SPEAKER IN PLASTIC CASE

Converts 4-Transistor Kit KT-94 into a 6-transistor home radio with speaker. Transistorized push-pull audio stage plugs into 4-transistor kit, suitable for group listening. Performance equal or superior to commercially wired sets selling at much higher prices. Kit includes 2 transistors, 2 transformers, 2 1/2" PM speaker, pre-punched chassis, speaker case (holds all components), battery, hardware, instructions and diagrams. KT-96—Shpg. wt., 1 lb. **Net 11.50**

2-TRANSISTOR PUSH-PULL OUTPUT KIT WITH SPEAKER SELF-CONTAINED IN BEAUTIFUL PLASTIC CASE

Completely self-contained, pocket size portable set which operates a miniature earpiece so only you can hear. The circuit uses 4 transistors (2 high frequency and 2 audio) plus a germanium diode, 2 IF stages and built-in high gain ferrite core and antenna. The result is a sensitive, stable and selective receiver covering the entire broadcast band. It requires no outside antenna or ground connection. The kit is supplied complete with transistors and all parts, including battery, and drilled and punched chassis. Pictorial and circuit diagrams are included with simple, easy-to-follow instructions. (Note: Earpiece and carrying case are not supplied.)

- KT-94—Complete Kit. Shpg. wt., 2 lbs. **Net 19.95**
- MS-311—Leather Carrying Case. **Net 1.95**
- MS-260—Super Power Dynamic Earpiece. **Net 3.95**

NEW POCKET AC-DC VOM MULTITESTER

2,000 ohm per volt Sensitivity on both DC and AC

- 160 μ s 3" METER
- 1% PRECISION RESISTORS
- SILVER CONTACT SELECTOR SWITCH



FULL SCALE RANGES
 DC Volts: 0-10; 0-50; 0-500; 0-1000 Volts—AC Volts: 0-10; 0-50; 0-500; 0-1000 Volts—DC Current: 500 μ a and 500 ma—Resistance: 0-10K; 0-1 Meg—Decibels: -20 to +22; +20 to 36 db (0 db—0.775 V)—Capacity: 250 mmfd to .2 mfd—.005 mfd to 1 mfd—Output Ranges: 0-10; 0-50; 0-500; 0-1000 volts

8.95

Best Buy in America! A very accurate and sensitive VOM. This Multitester is a complete instrument (not a kit) with per volt or both AC and DC. Single selector switch, 1% accuracy and ruggedness. In attractive plastic front panel, city range requires 50 volt AC source. Second capacity range requires 10 volt AC source. Size 1 1/2" x 3 1/2" x 1 3/8". Complete with test leads and batteries. Shipping weight 4 lbs.

RW-27A **Complete 8.95**

HIGH SENSITIVITY 20,000 OHM PER VOLT DC 10,000 OHM PER VOLT AC MULTITESTER

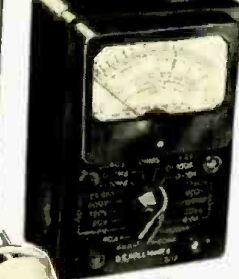

LOOK AT THESE FULL SCALE RANGES!
 D.C. Volts: 0-6; 0-30; 0-120; 0-600; 0-1200; 0-6000 Volts—A.C. VOLTS: 0-6; 0-30; 0-120; 0-600; 0-1200 Volts—RESISTANCE: 0-10K; 0-100K; 0-1 Meg; 0-10 Megohms—D.C. CURRENT: 0-60 Microamp; 0-6; 0-60; 0-600 Milliamps—DECIBEL: -20 to +17 db (0 db—0.774V)—CAPACITY: .0001-.01; .005-.15 mfd—INDUCTANCE: 20-2000 millihenry—OUTPUT RANGES: 0-6; 0-30; 0-120; 0-600; 0-1200 Volts

19.95

The new Lafayette high sensitivity Multitester is a complete instrument (not a kit). In addition to its unusual sensitivity of 20,000 OHMS PER VOLT ON D.C. AND 10,000 OHMS PER VOLT ON A.C., and the extraordinary number and scope of its ranges, it is packed with features that would make it cost at least twice as much if made in this country. Uses 1% precision resistors, silver contacts on selector switch, 35 un 3" meter. Dependable, rugged and accurate. Even the test leads are heavy duty with high voltage insulation. Voltage source required for low capacity range is 120V A.C. for high range capacity and inductance scale is 6V A.C. Attractive plastic front with metal bottom. Size 6 1/4" x 4 1/4" x 2 1/4". Complete with batteries and leads. Shipping weight 4 1/2 lbs.

RW-30A **Singly, Each 19.95**
 In lots of 3, Each 19.25

PROFESSIONAL TRANSCRIPTION TURNTABLE AND VISCOUS-DAMPED TONE ARM

THE FINEST TRANSCRIPTION TURNTABLE AND TONE ARM FOR THE PROFESSIONAL USER AND THE AUDIOPHILE



PK-100A TRANSCRIPTION TURNTABLE

New 3-speed instrument with built-in stroboscope and viewer for exact speed determination, and magnetic brake for instantaneous speed variation. Precision engineered to meet professional standards for wow, rumble and flutter control. Heavy 12" cast aluminum rim-driven turntable. Variable speed control permits adjustment of each speed within $\pm 7\%$ using efficient frictionless magnetic brake. Heavy-duty constant speed 4-pole induction motor freely suspended and isolated by shock-mountings to eliminate vibration transference. R-C filter network suppresses "pop" in speaker. Truly a delight for the connoisseur. Size: 13 1/2" x 14" and requires 2 3/4" clearance above and 3 3/4" below motorboard. For 110-130V and 60/50 cycle AC. Power consumption 12 watts. Handsome hammertone gray finish. Shpg. wt., 20 lbs.

PK-100-A **Net 49.50**

PK-90 VISCOUS-DAMPED TONE ARM

This transcription arm assures dependable and stable operation, utilizing the "floating action" principle of "viscous-damping." The arm is supported at a single point by a pivot and jewel bearing having negligible friction. Damping is accomplished by a silicone fluid occupying the gap between a ball and socket. This damping control permits high compliance and negligible tracking error, and prevents damage to either record or stylus should the tone arm be accidentally dropped. Low frequency resonance, skidding and groove-jumping are likewise minimized. The tone arm accepts all records up to 16" and accommodates virtually all hi-fi cartridges by means of precisely engineered adapters which simplify installation and provide proper stylus pressure.

This tone arm is a quality companion to the PK-100 with matching finish. Shpg. wt., 2 1/2 lbs. **Net 19.50**

72.50

COMBINATION DEAL

LAFAYETTE RADIO DEPT RA1

JAMAICA 33; N. Y. 165-08 Liberty Ave. Write for FREE Bargain Packed Catalog!

100 SIXTH AVE., NEW YORK, N. Y.
 BOSTON, MASS., 110 Federal St.
 PLAINFIELD, N. J., 139 West 2nd St.
 NEWARK, N. J., 24 Central Ave.
 BRONX, N. Y., 542 E. Fordham Rd.

FREE!
LAFAYETTE
CATALOG



**ELECTRONIC CATALOG
PACKED WITH MONEY SAVERS**

Packed with the largest selection of Electronic, Radio and T.V. Parts, and equipment, PA, Hi-Fi systems, tubes, antennas, Transistor Kits, parts and components, Test Equipment, new build your own kits, tools, books, Microscope, drafting equipment, Binoculars, Telescopes, All Radio, TV and Ham supplies — ALL AT GREAT SAVINGS — For the economy minded servicemen, dealer, engineer and technician. **CHUCK FULL OF BUYS! SEND FOR YOUR FREE COPY TO-DAY.**

35 WATT HI-FI AMPLIFIER KIT WITH METERED OUTPUT AND 4 PUSH-PULL PARALLEL NEW EL84 TUBES

New Lafayette high power amplifier kit with a host of features not in any other single amplifier. Calibrated output meter permits use as either a recording or reproducing amplifier. EL84 power pentodes provide high peak power and low distortion required for better audio quality. Features exceptional control versatility and ample inputs for all associated custom hi-fi equipment. DC operated preamp filaments and balancing adjustment to minimize hum. Meter can be switched to indicate either recording voltage or output level of amplifier. Features rumble filter, loudness control, separate bass and treble controls, silencing switch, speaker selector switch, output balancing adjustment and monitoring jack.



SPECIFICATIONS

FREQUENCY RESPONSE: ± 1 db 20-20,000 cps. HUM: 85 db below rated output. POWER OUTPUT: 35 watts with 4% total distortion at full rated output. INPUTS: TV Sound, Radio, Magnetic Phono, Crystal Phono, Tape. OUTPUT IMPEDANCE: 4, 8 and 16 ohms; high impedance for tape recorder. TUBE COMPLEMENT: 3-12AX7, 1-12AU6, 4-EL84, 1-5U4. FEEDBACK: Negative feedback loops virtually eliminate distortion. POWER: 117V, 60 cps. 80/150 watts with auxiliary power receptacles. Removable escutcheon. Size 12 3/4" L x 9 3/4" D x 4 1/2" H. A combination of high power, high fidelity, pleasing beauty and advanced engineering features unmatched at any price. Supplied in complete kit form with simplified easy-to-follow instruction sheets. Shpg. wt., 25 lbs. KT-115—Complete kit, instruction sheets. Net 59.50

LAFAYETTE'S FM-AM TUNER KIT

- SIMPLIFIED DETAILED INSTRUCTION MANUAL
- MEETS FCC REQUIREMENTS FOR RADIATION
- GROUNDED GRID TRIODE AMPLIFIER
- ARMSTRONG FM CIRCUIT WITH FOSTER-SEELEY DISCRIMINATOR
- AFC DEFEAT CIRCUIT WITH FRONT PANEL CONTROL



The excellence of its design and the quality of its components combine to provide this compact high-fidelity FM-AM tuner with superb characteristics normally found in units costing several times as much, and with performance unbelievable at this low price. Features Armstrong FM circuit with limiter and Foster-Seeley discriminator. Simplified tuning with slide-rule dial and flywheel counterweighted mechanism. AFC defeat circuit combined with tuning control. Attractive etched copper-plated and lacquered finish.

SPECIFICATIONS

FREQUENCY RANGE: FM, 88-108 MC; AM, 530-1850 KC. ANTENNA INPUT: FM, 300 ohms; AM, Ferrite loopstick and high impedance external antenna. CONTROLS: 2—a function control for AM, FM, PHONO, TV and a tuning/AFC defeat control. DISTORTION: Less than 1% rated output; FREQUENCY RESPONSE: FM, ± 5 db 20 to 20,000 cps; AM, ± 3 db 20 to 5000 cps. SENSITIVITY: FM, 8 μ V for 30 db quieting; AM, Loop sensitivity 80 μ V/meter. SELECTIVITY: FM, 200 KC bandwidth, 6 db down — 375 KC FM discriminator peak to peak separation; AM, 8 KC bandwidth, 6 db down. IMAGE REJECTION: 30 db minimum. HUM LEVEL: 60 db below 100% modulation. TUBE COMPLEMENT: 2-12AT7, 1-6BA6, 1-6BE6, 2-6AU6, 1-6AL5 plus 1-6X4 rectifier. Size 5 1/2" high x 9 3/4" wide x 9 3/4" deep (excluding knobs). CONSUMPTION: 30 watts. For 110-120V 60 cycles AC. Less metal case. Shpg. wt., 9 lbs. KT-100 Complete kit, less case. Net 34.95 LT-10 — Completely wired. Less metal case. Net 52.50 ML-100—Metal case for above, shpg. wt., 8 lbs. Net 5.00

New!



HIGH FREQUENCY TWEETER WITH ACOUSTIC LENS
DIRECT IMPORTATION
MAKES THIS PRICE POSSIBLE!

- FREQUENCY RESPONSE FROM 2000 CPS TO BEYOND AUDIBILITY
- LOUVERED ACOUSTIC LENS FOR UNIFORM SOUND DISPERSION
- HANDLES 25 WATTS OF POWER
- PRICED EXCEPTIONALLY LOW

14.95

New high frequency tweeter featuring a louvered acoustic lens for uniform sound dispersion and capable of handling up to 25 watts of distortion-free power. The directional tendency of high frequency notes is overcome by the natural wide dispersion angle of the short horn and the acoustic lens which disperses and radiates the high notes smoothly throughout the entire listening area. The lens is detachable for panel mounting, with a separate base for the tweeter furnished for external mounting where desired. Aluminum voice coil has 16 ohm impedance. Size: 4 1/4" long x 3" diameter, lens extends 2 1/2". Requires a crossover network, preferably one with a level control, such as the LN-2. With full instructions. Shpg. wt., 6 lbs. HW-7 Net 14.95

METAL-CASED CONE TYPE HI-FI TWEETER

FREQUENCY RESPONSE 2000-16,000 CPS • HANDLES 20 WATTS OF POWER

Highest quality cone type high frequency tweeter having a range from 2000 to 16,000 cycles. Especially efficient at higher end of audio spectrum where other cone type tweeters tend to lose clarity and volume. Entirely closed in a metal case with a base so that it can stand by itself or be mounted on a flat surface with mounting bracket supplied. Rated to handle 20 watts of power. A crossover network is required; the Lafayette LN-2 is ideal. Voice coil impedance 8-16 ohms. Size: 3 1/2" x 2 1/2" x 3" Diam. Shpg. wt., 8 lbs. Net 5.95



5.95
Net

CROSSOVER NETWORK • CAPACITIVE-INDUCTIVE NETWORK WITH CROSSOVER AT 2000 CPS • BUILT-IN LEVEL BRILLIANCE CONTROL



8.75

The frequencies above 2000 cycles are channeled to the high frequency tweeter by means of the high-Q inductance and capacitance comprising this efficient crossover network. The highs and lows are brought into acoustic balance by means of a continuously variable level-brilliance control. Control has a 2 1/2" ft. long cable for remote mounting. Network matches 8-16 ohm speakers with insertion loss reduced to a minimum. Enclosed in metal case 6" L x 2 1/2" H x 2 1/2" D. With full instructions. Shpg. wt., 5 lbs. LN-2 Net 8.75

2 WAY SPEAKER SYSTEM 40-16,000 CYCLES



A modest budget need no longer limit your HI-FI aspirations. The system consists of the G.E. 12" woofer with heavy 14.5 oz. alnico V magnet and 1 1/2" aluminum voice coil rated at 25 watts; the new metal cased HK-3 cone type tweeter; and the LN-2 crossover network with level and brilliance control. Both tweeter and network are described on this page. The complete 2-way speaker system covers the frequency range 40-16,000 cycles. Shpg. wt., 16 lbs. SY-87—Complete System. Net 27.50 SY-86—Complete System, same as above except the HW-7 Tweeter with acoustical lens is supplied instead of HK-3. Shpg. wt., 20 lbs. Net 36.50

New! **LAFAYETTE**
Mail Order Center

Lafayette Radio 165-08 Liberty Ave.
DEPT RA-2 JAMAICA 33; N. Y.

SEND FREE LAFAYETTE CATALOG

NAME _____

ADDRESS _____

CITY _____

ZONE _____

STATE _____

CUT OUT AND MAIL TODAY!

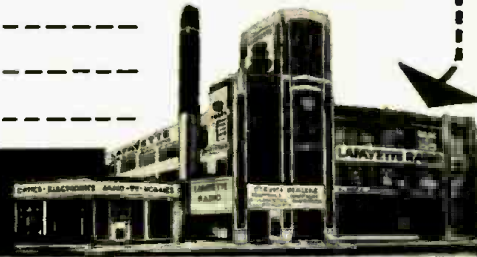

EXPAND YOUR PORTABLE TV SALES

WITH

ATR

INVERTERS

for changing your storage battery current to A. C. HOUSEHOLD ELECTRICITY

Anywhere...
in your own car!

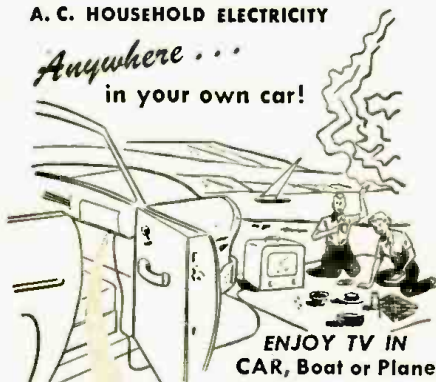

mounted out of sight under dash or in trunk compartment!



EASY TO INSTALL
EASY TO OPERATE

ATR INVERTERS

especially designed for operating standard 110 volt A.C. portable TV sets

also

- TAPE RECORDERS
- WIRE RECORDERS
- DICTATING MACHINES
- ELECTRIC RAZORS

for

- EXECUTIVES
- SALESMEN
- PUBLIC OFFICIALS
- POLICEMEN
- FIREMEN
- OUTDOOR MEN
- REPORTERS
- FIELD INSPECTORS
- DOCTORS
- LAWYERS, ETC.

See your jobber or write factory

✓ NEW MODELS ✓ NEW DESIGNS ✓ NEW LITERATURE
"A" Battery Eliminators, DC-AC Inverters, Auto Radio Vibrators



AMERICAN TELEVISION & RADIO CO.

Quality Products Since 1931

SAINT PAUL 1, MINNESOTA, U. S. A.

Low Plate-Potential Tubes

(Continued from page 49)

possible to obtain stability and long life at low voltages with special surfaces too fragile to long endure under the conditions of high voltage operation. Fig. 6B shows the change in the plate characteristic of the same tube depicted in Fig. 6A after it received special aging.

To gain a partial understanding of these phenomena, reference is made to an article by Matheson and Nergaard in the *RCA Review*, June 1951, entitled "High-Speed Ten-Volt Effect." This is a study of the behavior of anode currents in thermionic diodes with oxide-coated cathodes, operating with plate voltages in the region of 10 volts. In an ideal space-charge limited diode the current is proportional to the $3/2$ power of the applied voltage. It was noted, however, that in the neighborhood of 10 volts, there was a small deviation from this $3/2$ power. This was found only in diodes with an oxide-coated cathode. Experiments performed to discover the cause in the coating itself gave negative results, so a study was made of the anode.

An experiment was performed wherein an anode which had not previously been exposed to the cathode was rotated in place of one that had been in position when the cathode was broken down and activated. This new anode did not exhibit the 10-volt effect until after some time. The effect was then explained by the fact that a layer of barium from the hot cathode had condensed on the anode, thus giving rise to secondary emission. This phenomenon is, of course, applicable to triodes and tetrodes—or pentodes. The effect is manifested by the erratic change of R_p as the critical plate voltage is approached.

From the foregoing, one might think that this reflection of electrons—if such it is—might be eliminated by providing the anode with an especially clean naked surface. This has not proved feasible because it is hard to long maintain such surfaces in operating vacuum tubes. It has so far not been possible to make good tubes with bright nickel plates. If, however, carbonized nickel is used and the device is processed in such a way that there is probably a layer of cathode constit-

uents on top of this carbon coating, a composite surface is achieved which seems to be quite effective in curtailing reflected electrons.

This situation is analogous to that obtained when an optical lens or prism is coated with a thin film in order to increase light transmission by reducing reflection from the surface. To comprehend this parallel, you must recall that deBroglie in 1924 advanced the theory that electrons had wave properties as well as the particle characteristics assigned to them. This was verified experimentally by Davisson and Germer in 1927. According to this theory, electrons have an associated wavelength which varies inversely as the speed with which they are traveling.

Since 10-volt electrons proceed rather slowly, their wavelength is rather long as such things go. This wavelength is on the order of 3 or 4 angstrom units. This is of the same relative magnitude as the film thickness discussed in connection with the plate. With this state of affairs, it is credible that there is a relation between the deBroglie wavelength of the slow-moving electrons and the refraction characteristics of the various media these electrons move through when they impinge on the plate. The writer believes some such machinery operates to curtail reflection which, in turn, makes possible better control of R_p at these low operating voltages.

Thus, by using processing techniques not generally suited to vacuum tubes intended for conventional higher-voltage service, and by altering the electrode geometry to take advantage of contact-potential bias, Tung-Sol's engineers have designed a set of tubes that effectively perform with all electrodes energized by the 12-volt car battery. With a suitable power transistor, this makes possible an automobile radio without a vibrator power supply.

These tubes are not final in any sense. The writer believes many more and better types will be developed by the tube industry for this class of service before the day of the all-transistor car radio arrives.

In the development of these tubes, many engineers made worthwhile contributions. The program owes a special debt to Mr. Fred Crawford of the Tung-Sol design department for many important contributions, especially in the field of tube processing. -30-

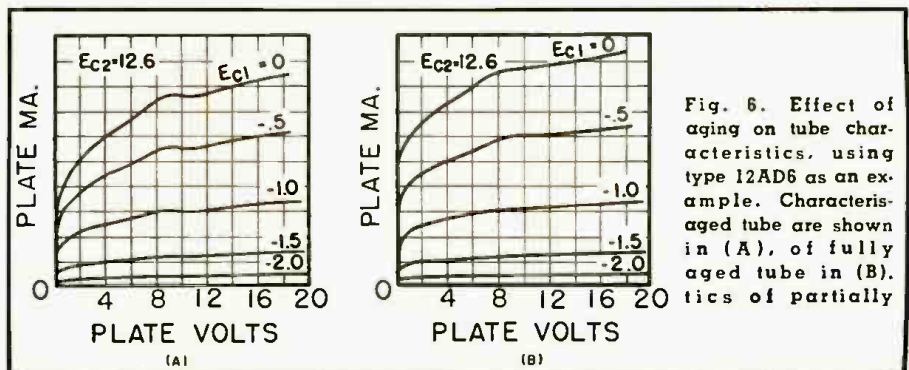

MICROPHONES & HEADSETS



F-1 BUTTON CARBON MIC.
(Pictured at left) High Gain—
Can be used on desk, car, hand,
or strapped to chest. Complete
with on-off Mom. Switch. NEW: **\$1.95**
RS-38 CARBON MIC. with PL-68
Plug U: \$2.50
T-17 Carbon Mic.—Used, checked
\$3.95; N: \$8.95
Sound Powered Mic., no cord,
used, Checked, \$1.00
HS-30 HEADSET—Hearing aid
type U: \$1.50
HS-18 HEADSET—1000 ohm.
U: \$1.95

Sound Powered—One headpiece only. U: \$1.00
Sound Powered Handset TS-10—Used, checked \$5.95
TS-9 Handset—Push to talk Sw. No plugs. U: \$3.95; N: \$5.95
TS-13 Handset—Push to talk Sw. w/PL-68 & PL-55 U: \$6.95

PRACTICE CODE TAPE:

SETS: INKED PAPER TAPES—For Code practice and training—for Radio Operators, Hams, Amateurs, Beginners, and Telegraphers. 15 lessons on a Set, on 16mm 400 ft. reels that can be reproduced on TG-34A and TG-10 Keyers. Price: SET of 15 Reels in wood **\$18.95** case

REELS: Lesson Reels available individually. Order by number desired. 1 thru 15. Each: \$2.00

TAPE PULLER MX-333—

Used with code practice equipment to reel 3/8" paper tape as it is passed through the recorder. AC induction motor with friction drive for varying speed. Operates on 110 V. 60 cycle. NEW: \$12.95; USED: \$9.95



POWER SUPPLY
110 V. For Army/Naval COMM. RECEIVERS
Eliminates set conversion.
For use w/BC-453-454-455-946 or any sets requiring 24 V. @ 1 A. & 250 V. @ 50 MA. Ready to use; has 4" speaker, volume control, CW and on-off switches. Complete with cord and plug f/rec. Price... NEW: **\$18.95**

FM RECEIVERS AND TRANSMITTERS

27 to 38.9 MC. FM RECEIVER

Four Pre-selected Channels & Squelch Circuit. Complete with 16 Tubes and Speaker. Set size: 6 3/4" W x 1 1/2" H x 1 1/2" D. Power required 12 or 24 VDC & 275 VDC 150 MA. BC-923 RECEIVER—Used, Checked \$34.95
12 V. DYNAMOTOR For BC-923: New: \$5.95; Used: \$3.95
A.C. POWER SUPPLY For BC-923. \$22.50
KIT of Parts & Wiring Diagram for BC-923... \$17.50

27 to 38.9 MC. FM TRANSMITTER

30 Watt companion to BC-923 Receiver. Four Pre-selected Channels. Voltage regulated M O control, using 2/815, 2/6S17, 1 each 6SL7, 6V6, 6J5, 6AG7, & VR-150 Tubes. Size: 11" x 11" x 18". Voltage required: 12 or 24 VDC & 300 VDC @ 400 MA. BC-924 TRANSMITTER... New: \$24.95; Used: \$14.95
Power & Control Plug 1/BC-923 or BC-924... \$1.00
Mounting Base FT-237 1/BC-923 & BC-924. Used: \$9.95

BC-603 RECEIVER: 20-28 MC variable tuning, 10 Pre-set push button channels, squelch circuit, 4" speaker; 10 Tubes: 2/12SG7, 2/6SL7, 1/6V6, 1/6J5, 3/6AC7, & 1/6H6. Prices: NEW: \$39.95; USED: \$29.95
PLUG for rear of Receiver... \$1.00
DYNAMOTOR: 12 V input; Output 220 V 89 MA—DM-34... NEW: \$4.95; Ref: \$2.95
BC-604 TRANSMITTER: 20-28 MC, 30 Watt, companion to BC-603 Receiver. Crystal control, 10 Pre-set channels, interphone communication; 8 Tubes 7/1619 & 1/1624... USED: \$18.95
PLUG for rear of Transmitter... \$1.00
DYNAMOTOR: 12 V input; Output 625 VDC 225 MA—DM-35... USED: \$9.95
FT-237 BASE for mounting Receiver & Transmitter (No Plugs required)... USED: **\$9.95**

NATIONAL DIAL

TYPE "N" Precision 4" divided scale with decimal vernier drive 5-1 ratio. Planetary drive fits 1/2" shaft, 100-0 scale. Prices: 3 for \$5.00. Each: **\$1.95**



RA-20 POWER SUPPLY

110 V. 60 cycle output 230 VDC 90 MA and 12.6 @ 2A. Size: 3 1/4" x 5 1/2" x 6 1/2". **\$9.95**
Used, Checked

WRITE US YOUR REQUIREMENTS:

Whatever your needs in Generators, Blowers, Inverters, Motors, etc.—write us. Chances are we have it!

TELEPHONE & CONTROL EQUIPMENT



REMOTE CONTROL RM-52—
(Pictured at right) Can be used with RM-53 or used as a separate telephone system. Up to 1/2 mile. Uses 4 flashlight batt. Also can be used as a direct remote control for radio equipment. Provides bias for Mic. & Sidetone to headset. High or Low Imp. Also Mic. & Phone Jacks.

USED: **\$2.95** NEW: **\$4.95**

TS-13 HANDSET for RM-53 or RM-52... Used: \$5.00

EE-8 FIELD TELEPHONE—Ideal for private telephone system for two or more phones, up to 17 miles. Hand ringer, generator with handset, carrying case. Uses 2 flashlight batt. Price—Used, Checked... \$14.95
WIRE—Weatherproof Twisted Pair: 500 ft. \$4.75—135 ft. \$1.00—2500 ft. \$19.95. Per Foot at 1 1/2¢.
CDMBAT WIRE—Rubber covered W-130... \$1.01 per Ft.

SCR-625 Famous ARMY MINE-DETECTOR

For Prospectors, Miners, Oil Companies, Plumbers, etc. Portable unit for locating all types of buried metal objects up to 24" or more depending on size and ground condition. Detection by means of a tone. Packed in a chest. Operating weight approx. 15 lbs. Shipping wt. approx. 40 lbs. Complete with batteries **\$39.95**

100—156 MC TRANSMITTER & RECEIVER—SCR-522 TRANS. & RECEIVER

RECEIVER: 100—156 MC. 4 Channel. Crystal Control, AM Voice Operation, 18 Tubes—Trans.: 2/832, 3/12A6, 1/6SS7, 1/6G6—Rec.: 1/9002, 1/9003, 3/12A6, 2/12AH7, 1/12C6, 1/12H6, & 3/12SG7. Complete with Tubes, Schematic, and Conversion Info. for amateur use—Good Cond. **\$34.95**
REC.—Chassis Only, w/Tubes \$19.95 without... \$9.95
TRANS.—Chas. Only, w/Tubes \$22.50 without... \$9.95
SCHEMATIC and Conversion Info. Only... \$2.50

BC-1158 TRANS. & MODULATOR;

Frequency coverage 53.3 to 95 MC. 50 Watt. RF Doubler, Amplifier and Modulator Sections, using 4/815 and 10/12SN7 Tubes. Can be converted to 2-6-10. or 20 Meters. Complete with Tubes, Meter, Blower. etc. NEW: **\$39.95** Used: **\$29.95**

NOW—OPERATE BEACON RECEIVER FROM 12 VOLT

BC-1206CM BEACON RECEIVER: 200-400 KC. 5 Tubes. 135 KC IF, operates from 24 VDC—**\$9.95**
New: \$3.95
Used: \$5.95



For 12 Volt operation, use this PM DYNAMOTOR 12 VDC input, output 24 VDC. Size: 2 1/2" x 4" x 4". 7" Dyn. Only **\$4.95**
Combination: New BC-1206 & Dynamotor... \$12.95

DYNAMOTORS & GENERATORS:

INPUT VOLTS:	OUTPUT VOLTS:	MA.	STOCK No.	PRICES USED:	NEW:
12 VDC	220	80	DM-34	\$2.95	\$4.95
12	225	100	O-402	5.95	8.95
12	625	225	DM-35	9.95	
12	230	90	PE-133		6.95
12	440	450	DA-12		14.95
12	230	100	DA-14		8.95
14	220	70	DM-24	4.95	7.95
14	1030	260	DM-42	4.95	9.95
14	515	215	BJ-83	3.95	
14	375	150	BD-87	3.95	
14 VDC	250	50	DM-25	6.95	8.95
14	1000	350	BD-77	14.95	
14	230	90	DM-21	6.95	
24	250	60	DY-2/		
24	250	60	DM-32	2.95	5.95
28	1000	350	PE-73	8.95	8.95

12 to 24 VDC PM Dynamotor—Supplies 24 VDC 2 A. from 12 VDC, also 500 V 50 MA. @ 6 VDC will supply 12 VDC & 250 V 50 MA. #0515... New: **\$4.95**



RADAR TRANS.

Transmitter Frequency 143 to 194 MC. using one 3A5 Tube. In plastic case 4 1/2" x 1 1/2" mounted top of 58" Yessing Antenna with 14" Dipole. Battery Case for holding 2 BA-30 1 1/2 V. & BA-38 103 1/2 Volt "B" 11. Has on & off Sw. Tel. Ant. mounts side of batt. case. Price: **\$4.95**

COMMAND EQUIPMENT

	USED:	NEW:
550 to 1500 REC. Navy...	\$14.95	\$19.95
550 to 1500 REC. Navy w/ant. loop. Sw.		24.95
1.5 to 3 MC. REC. Navy	9.95	
3 to 6 MC. REC.—BC-454	9.95	
6 to 9 MC. REC.—BC-455	7.95	
100 to 156 MC. REC.—R.28	10.95	18.95
2.1 to 3 MC. TRANS., Navy	7.95	9.95
3 to 4 MC. TRANS., Navy	5.95	
4 to 5.3 MC. TRANS.—BC-457	4.95	
5.3 to 7 MC. TRANS.—BC-458	4.95	
7 to 9 MC. TRANS.—Navy		7.95
100 to 156 MC. TRANS.—T.23	14.95	

TRANSFORMERS and CHOKES

115 V. 60 CYCLE PRI. TRANS.:	
600 VCT/100 MA—6.3 V/5 A.: 5 V/3 A.	\$4.95
240 VCT/35 MA—24 V/9A.: 6.3 V/6 A.: 6.3 V/3 A.	1.75
1500 VCT/260 MA—6.5 V/3 A.—6.5 V/5 A.—5 V/4.5 A.	9.95
700 VCT/150 MA—5 V/3 A.: 6.3 V/4.5 A. CSD.	3.95
2500 V/015 A.: 2.5 V/125 A.: 6.3 V/6 A.	5.95
1890 V/12.6 MA—Tapped 2.5 V/2 A.	5.95
1100 V/80 MA—7.5 VCT/3.25 A.	5.95
270 VCT/50 MA—6.3V/2.5 A—5V/2 A.	2.50
662 VCT/110 MA—6.3V/2 A—5V/2 A.	3.95
800 VCT/300 MA—12.6V/10 A—5V/3 A.	6.95
16 Volt 35 Amp. 115/230... \$14.95; 24V—1 Amp 1.50	
9 Volt CT—35 Amp.—Tapped 4.5 V.	5.95
12 Volt—Two separate windings—1 amp each... 7.95	
5 V/2 A.: 5 V/2 A.: 5 V/2 A.: & 5 V/6 A.	2.95
6.3 V/2.1 A. and 5 V/3 A.	1.75
600-0-600 VAC—200 MA. 12.5 V. 2 A.: 12.5 V. @ 2 A.: 5 V. @ 3 A.—H-108—Price: 8.95	
250-0-250 VAC—50 MA. 24 V. 1 A.: and 6.3 V. 1 A.—H-109—Price	4.95

Choke—12.5 Hy/100 MA.	\$1.95
Choke—8 Hy/150 MA—200 Ohm—Open Frame	1.25
Choke—5 Hy/150 MA—85 Ohm	1.50
Choke—10 Hy 250 MA—2 3/4" x 2" x 3" Potted	4.95
Choke—5 Hy/400 MA—1 1/2" x 4" x 5 1/2"	4.95
"A" Choke—1 Hy @ 1 A. 7 ohm. Size: 2 1/2" x 2 1/4" x 2 1/4"	Price: 1.95

TA-12B BENDIX TRANSMITTER

Frequency 300-600 KC and 3000 to 7000 CW & MCW 100 Watt. Four separate oscillators easily converted to cover 20-40-80 meters by using crystal for 10 Meter Band. Selector channel switch changes ECO, IPA, and Output Tanks at one time. All controls mounted on front panel. Uses 3/807, 4/12SK7; also has output Meter. Size: 15 1/2" x 10 1/2" x 6 1/2". Complete with Tubes, Plug and Cable... **\$32.95**

For Conversion—See Surplus Manual #2—Price: \$2.50

MP-28-BA MODULATOR & POWER SUPPLY For TA-12. Modulated Max. Signal Carrier output 75 Watts Class B. Uses 2/807, 1/6F6, 1/6N7. Dynamotor Input 24 VDC output 540 VDC 450 MA. Prices... New: \$14.00—Used: \$10.95

RA-10 BENDIX RECEIVER

150-1100 KC and 2-10 MC. Excellent for range and marine use. 7 Tubes: 3/6SK7, 1/6K7, 1/6C5, 1/6K6G, 1/6BK. Complete with Dynamotor, MR-9 Control Box, Plugs, Remote Tuning shaft. Size: 10" x 8 1/2" x 17". RA-10 DA—24 Volt 150-1100 KC & 2-10 MC. Used... \$34.95
RA-10 CA—12 Volt 150-1100 KC & 2-10 MC. U: \$39.95
RA-10 FA—24 Volt 150-400 KC & 2-10 MC. U: 29.95
Surplus Conversion Manual—#1 or #2... Ea.: 2.50
For List of contents in each Manual, send 3c stamp.

METERS:

WESTON AC AMMETER:
(Pictured) In portable leather case, with Test Leads, 2 1/2", 0-15 AC and 0-3 AC Scale. **\$5.95**

DC AMMETER HOYT: In portable metal case, with Test Leads, 4 1/2". Fan Mirrored Scale 0-15 ADC. **\$4.95**
DB METER—10 to Plus 6. Westinghouse 3".
NC-35 Imp. 600 ohms @ 1000 cycle... 4.95
0-1 MA Weston 506; 2 1/2" Rd... 3.95
0-3 RF AMMETER IS-128; 2 1/2" Rd... NEW: 2.95
0-8 Amp RF w/Thermocouple IS-89; 2 1/2" Rd... 4.95
0-15 AC-DC—2 1/2" Rd.; IS-122... 4.95
0-500 MA DC—2 1/2" Rd.; IS-22... 4.95
0-150 V. 60 cycle; Simpson; 3 1/2" Rd... 3.95
0-250 MA DC—Dejur, 3" Sq... 3.95
OUTPUT—5 Ranges, 4000 ohm Imp.—Used... 4.95



FAIR RADIO SALES 132 SOUTH MAIN ST. LIMA, OHIO

HENRY HAS IT HENRY HAS IT HENRY HAS IT FIRST

hallicrafters

New
SX 101



A "true" amateur receiver . . . far superior to anything previously manufactured anywhere. 20 monthly payments \$19.50 \$39.95 down Cash Price \$395.00

A FEW ITEMS IN STOCK FOR IMMEDIATE SHIPMENT ARE:

Model	Cash Down	20 Monthly Payments	CASH PRICE
S38D	5.00	2.47	\$ 49.95
S53A	9.00	4.45	89.95
S85	12.00	5.94	119.95
SX99	15.00	7.42	149.95
SX62A	35.00	17.32	349.95
SX100	29.50	14.65	295.00
R46B			17.95
HT30	49.50	24.50	495.00
HT31	39.50	19.55	395.00
S94-S95	6.00	2.97	59.95
S-102	6.00	2.97	59.95
S-106	6.00	2.97	59.95

Prices Subject to Change

Write, wire, phone or visit either store today.

Butler 1, Missouri
Phone 395



Henry Radio Stores

Granite 7-6701

11240 West Olympic Blvd. Los Angeles 64



"World's Largest Distributors of Short Wave Receivers."

TOP TRADE-INS

We try to top all offers. Your trade-in makes down payment. Write for our offer.

EASY TERMS

90 days open account or 10% down—up to 20 months. We finance. Payment within 90 days cancels all interest. Write for details.

ALL RECONDITIONED APPARATUS

Nearly all makes and models—Big savings—Ten day trial—90-day warranty, 90-day full trade back on new apparatus. Write for bulletin.

PERSONAL SERVICE—FAST DELIVERY

Your inquiries and orders handled same day. Write, phone or wire us.

COMPLETE STOCKS

Henry has everything in the amateur equipment field, new or used . . . transmitters and receivers.

Spot Radio News

(Continued from page 24)

radio use of the motor carrier industry. . . ."

Continuing, the association said that " . . . channel splitting in the 25-50 band now would relieve the existing and prevent future congestion and provide the much-needed additional frequencies without substantially affecting equipment investment in this band, which is bound to grow whether or not channel splitting is approved. . . ."

The petitioners said that they felt that the surrender of channel 2 to the mobile services would be in line with the removal many years ago of old channel 1 for reassignment to others. Also, it was noted, the move would be consistent with the suggestion that all TV go to the high bands.

Telecasters and set makers condemned the petition, declaring that there is absolutely no need for such a change. Truckers, they said, could use existing wire facilities at key stopover points, without inconvenience or any disruption of service.

A RESEARCH PROGRAM to study the effects of irregularities in the upper atmosphere on radio transmission has been undertaken by the Air Research and Development Command, in conjunction with the Stanford Research Institute at Menlo Park, California.

A group at the Institute will gather information about the reflection of very-high and ultra-high radio signals; transmission and reception of signals at these frequencies are frequently disrupted due to reflection from meteor and auroral ionization in the upper atmosphere.

The experts at the Institute intend to determine the characteristics of signal scattering and reflection by meteor trails in the 100 to 400 megacycle range; similarly the reflection of radio waves by the ionization associated with the aurora borealis will also be studied. The auroras are believed to be caused by high-speed electrically charged particles irregularly emitted from the sun which enter the earth's upper atmosphere. The earth's magnetic field guides the particles to the polar areas; the aurora borealis is visible in the north polar region and the aurora australis in the Antarctic.

Various research and academic organizations have conducted continuing studies of meteoric and auroral ionization in the frequency range below 100 megacycles. The result has been a much better understanding, at frequencies below 50 megacycles, of the frequency-time-amplitude relationship of the echoes. Correlating the lower frequency experiments and theory to the 100-1000 megacycle range, however, has not been scientifically feasible without the anticipated findings of the experiments, such as the Stanford program.

Bob Henry,
W0ARA
Butler, Mo.



Ted Henry,
W6UOU
Los Angeles



TALK · LISTEN · AROUND THE WORLD!



WITH THIS RADIO AMATEUR TRANSMITTER-RECEIVER! SENDS AND RECEIVES THOUSANDS OF MILES on Amateur 80 and 40 meter bands—also, Aircraft and foreign bands (3 to 8 mc). PORTABLE SELF-CONTAINED BATTERY POWERED! NO AC PLUG-INS. NO DANGEROUS HI-VOLTAGES. Low cost battery lasts for MONTHS. Crystal controlled

transmitter—Power input up to 5 watts—ENOUGH TO TALK 1 MILE OR 1000. REGENERATIVE RECEIVER pulls in weakest stations. Front Panel Send-Receive switch—No troublesome relays or complicated hook-ups. Uses any standard antenna. Size only 6" x 4" x 4" Wt. 3 lbs. TESTED—PROVEN—SIMPLIFIED—PRACTICAL—SAFE for radio beginners (NOVICE). Easy to get license. Full information included.

SEND ONLY \$5.00 (bill, check, m/c and pay postage on arrival or send \$14.95 and we will send postpaid. Complete kit includes all parts, tube, full instruction, loss batteries and crystal—or COMPLETELY WIRED AND TESTED FOR \$19.95! Steel Cabinet \$2.00 extra. Rush order today—NOW!

WESTERN RADIO
DEPT. BNT-12 KEARNEY, NEBRASKA

ELECTRONICS

PREPARE FOR A GOOD JOB!
BROADCAST ENGINEER
RADIO SERVICING AUTOMATION

TELEVISION SERVICING
BLACK & WHITE—COLOR

APPROVED FOR VETERANS AND SURVIVORS
OF VETERANS
BUILDING AIR CONDITIONED
SEND FOR FREE LITERATURE

BALTIMORE TECHNICAL INSTITUTE
1425 EUTAW PLACE, BALTIMORE 17, MD.

WE TRADE HIGHER!

IF YOU DON'T BELIEVE IT, WRITE US TODAY!



BRAND NEW! - FROM HALLICRAFTERS
MODEL SX101 \$395.00 NET

WRITE FOR FULL DETAILS ABOUT OUR TIME PAYMENT PLAN

All prices f. o. b. St. Louis • Phone CHestnut 1-1125

Walter Ashe
RADIO CO.
 P. O. BOX 4444 • PLAZA STATION
ST. LOUIS 1, MO.

 WALTER ASHE RADIO COMPANY **OUR 35TH YEAR**
 Rush "Surprise" Trade-In Offer on my.....
 for..... (show make and model of new equipment desired) RN-1-57
 Send NEW 1957 Walter Ashe catalog.
 Name.....
 Address.....
 City..... Zone..... State.....

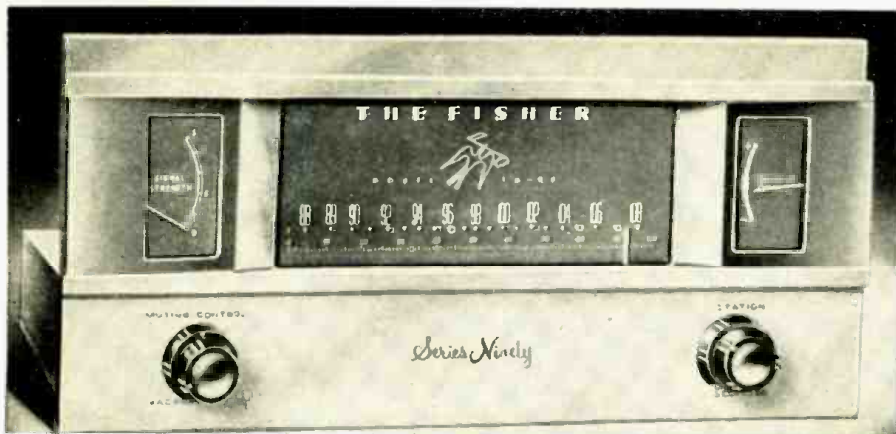

AMERICA'S LEADING FM TUNER • IN SENSITIVITY, APPEARANCE AND WORKMANSHIP

New!

THE 

FISHER

FM TUNER

MODEL FM-90

WHEN WE INTRODUCED our Model FM-80 FM tuner, it immediately established itself as the leader in the field. Today, the FM-80 is standard equipment in many broadcast stations, where its fabulous sensitivity and absolute reliability make it ideal for pickup of distant FM chain programs, for rebroadcast to the local communities. It took FISHER to improve on FISHER and the result is the new Model FM-90. It is some sixteen years since we produced our first FM tuner. The engineering skill and experience that only time, plenty of it, can bestow, are evident in every aspect of THE FISHER FM-90. We can truly say for it that it is the most advanced FM tuner now available.

Remarkable Features of THE FISHER FM-90

- TWO meters, for micro-accurate tuning. ▪ Revolutionary, dual dynamic limiters, assure noise-free reception where all others fail. ▪ Full wide-band detector for maximum capture ratio. ▪ *Exclusive*, variable inter-station noise eliminator. ▪ Full limiting on signals as low as 1 microvolt. ▪ Dual triode, cascade-tuned RF stage, four IF stages. ▪ Uniform response, 20 to 20,000 cycles. ▪ Three outputs (Main, Recorder and Multiplex). ▪ Dual antenna inputs (72 ohms or 300 ohms balanced). ▪ Four controls. ▪ 10 tubes plus four matched germanium crystal diodes. ▪ Special circuits for meter operation. ▪ Chassis completely shielded and shock-mounted. ▪ Beautiful, die-cast, brushed brass escutcheon and control panel. ▪ Dipole antenna supplied.
- SIZE: 13 7/16" w. x 6 1/2" high x 8 3/4" deep (plus 1" for knobs). ▪ WGT: 15 lbs.

Professional FM Tuner • \$149.50

MAHOGANY OR BLONDE CABINET: \$17.95

Prices Slightly Higher in the Far West

WRITE TODAY FOR COMPLETE SPECIFICATIONS

FISHER RADIO CORP., 21-23 44th DRIVE • L. I. CITY 1 • N. Y.

To carry out the project, two large special radars have been designed. One consists of a 50,000-watt FM broadcast transmitter operating at 100 mc., which has been modified for pulse transmission. The second radar utilizes a large klystron, generating power outputs up to 70,000 watts in the 200- to 400-mc. range. The transmitters are mounted in large van-type shelters.

Large 60-foot diameter parabolic antennas, specially designed by the Institute, will be used with the radars. The antennas will be movable in both elevation and azimuth.

A MAN-MADE BRAIN, a computing device which has a memory of 4096 words of 48-bit capacity, is now in operation at the Air Force Missile Test center in Cocoa Beach, Florida.

Known as FLAC (Florida Automatic Computer), it has been integrated into the missile-instrumentation system. It serves as the central element in a facility for the reduction of large quantities of missile flight test data, producing answers to problems in a small fraction of the time formerly required.

The device was developed to fill the need for an extremely versatile computer; one which would assimilate large amounts of varying types of information at high speed and produce an answer very quickly.

Data recorded during the firing of each missile had to be computed, correlated and analyzed before the next missile could be launched on its down-range (along the Florida Missile Test Range) flight. Computational devices then in use did not permit completion of this huge job in time to use the information for the following launching.

The new electronic brain is capable of 1750 arithmetical computations per second. In contrast to most computers, it is extremely compact. It consists of a small console, dual tracks packed with 17,000 diodes, circuit elements, 400 tubes used as amplifiers, plus peripheral input-output equipment, and an exceptionally large memory.

An unusual punch-paper tape type of reading device has been developed for the computer. The tape enables reading of up to 300 characters per second. A potentiality of 600 characters is expected when development work is completed.

A HIGH-SPEED ELECTRONIC missile tester, tagged RACE, which enables highly mobile, guided missile troops to strike targets faster and more effectively, was demonstrated recently to Army officers.

The new device was described as the first to bring automation into tactical combat areas to test, troubleshoot and service complex missile systems as they are emplaced at new launching sites.

At the push of a button, the device dynamically tests each missile unit, performing in minutes the hundreds of preflight tests that would consume vital hours by more conventional means. A master console employs

RADIO & TELEVISION NEWS

40¢ FOR ANY TUBE

WE WILL NOT BE UNDERSOLD
PROMPT SHIPMENT ON ALL ORDERS

\$37.00
 Per Hundred

DON'T PAY MORE FOR SET TESTED LONG LIFE DEPENDABLE RADIO & TV TUBES • BUY VIDEO INDIVIDUALLY BOXED • ALL GUARANTEED FOR ONE YEAR OR YOUR MONEY BACK

We Have OVER 1000 USED TV SETS

At all Times in Our Huge Warehouse

Buy one or more of these WORKING TVs to sell or use as your own second set! All Sets in GOOD WORKING condition!

Your Choice—Console or Table Model

10"\$23.00	19"\$58.00
12"\$28.00	20"\$64.00
14"\$33.00	21"\$72.00
16"\$40.00	24"\$99.00
17"\$46.00	

When ordering TVs, state whether table model or console is desired. Also preference on make of set. All TVs sent railway express F.O.B. Newark. On any quantity WIRE or CALL today!

FREE BONUS ANTENNA GIVEN WITH ANY TV SET ORDER!!



FREE RCA "CHEATER" CORD

GIVEN WITH ANY TUBE ORDER OF \$7.00 OR MORE!!

SEND for our **FREE** complete TUBE & PARTS LIST and order blank.

Some Standard Brand—Others With Famous VIDEO Brand

0A2	2X2	6AC7	6BK5	6SG7	TF8	12V6GT
0A3	3A4	6AG5	6BK7	6SH7	7N7	12X4
0A4	3A5	6AF4	6BL7GT	6SJ7GT	7Q7	14A7
0B2	3AL5	6AH4GT	6BN6	6SK7GT	7Y4	14B6
0C3	3AU6	6AK5	6BQ6GT	6SL7GT	7Z4	14Q7
0Z4	3BC5	6AL5	6BQ7	6SN7GT	12A6	19B6G6
1A7GT	3CB6	6AM8	6BY5G	6SQ7	12AH7GT	19T8
1B3GT	3Q4	6AN4	6BZ7	6SS7	12AT6	24A
1C7G	3Q5GT	6N8	6C4	6SV7	12AT7	25AV5GT
1F4	3S4	6AQ5	6CB6	6T8	12AU6	25BQ6GT
1H4	3V4	6AQ7GT	6CD6G	6U4GT	12AU7	25OD6G
1H5GT	4B27	6AS5	6CF6	6UTG	12AV6	25CU6
1J6GT	4B97	6ASTG	6CS6	6U8	12AV7	25L6GT
1L4	5AM8	6AT6	6CU6GT	6V3	12AX4GT	25W4GT
1L6	5AN8	6AU4GT	6E5	6V6GT	12AX7	25Z6GT
1LA6	5AQ5	6AU5GT	6H6GT	6W4GT	12AZ7	35L6GT
1LC5	5AT8	6AU6	6J4	6W6GT	12B4	35W4
1LH4	5AW4	6BU5GT	6J5GT	6X4	12BA6	35Y4
1LN5	5AZ4	6AV6	6J6	6X5GT	12BE6	35Z3
1N5GT	5J6	6AX4GT	6K6GT	6X8	12BH7	35X5GT
1S4	5T4	6AK5GT	6L6	6Y6G	12BY7	50A5
1S5	5T8	6BA6	6NTGT	7A5	12CU6	50B5
1T4	5U4G	6BC5	6S4	7A7	12SA7	50C5
1U4	5U8	6BC7	6STG	7B5	12SG7	50L6GT
1U5	5V4G	6BE6	6SA7	7B7	12SH7	80
1V2	5V6GT	6BF5	6SB7Y	7C5	12SJTGT	117N7GT
1X2	5Y3	6BG6G	6SC7	7C6	12SK7	117PTGT
2A7	5Y4G	6BH6	6SF5	7C7	12SNTGT	117Z3
2D2I	6AB4	6BJ6	6SF7	7F7	12SQ7	

FREE POSTAGE in U.S.A. and Territories on orders over \$5.00. 25c handling charge on orders under \$5.00. 25% deposit required on C. O. D.s. Please send approximate postage or freight on Canadian and foreign orders. Subject to prior sale.

VIDEO ELECTRIC COMPANY

79 CLINTON PL. NEWARK, N. J. Phone Humboldt 4-9848

IT'S THE BIGGEST AND BEST EVER

FREE THE GIANT
ALL NEW 1957
BA CATALOG

172
KING-SIZED
PAGES

EVERYTHING
IN RADIO
TV AND
ELECTRONICS

100'S OF
NEW ITEMS
LISTED HERE
FOR 1st TIME

21 PAGES
OF BARGAINS
NOT IN ANY
OTHER CATALOG

RUSH COUPON
TODAY!

BURSTEIN-APPLEBEE CO. Dept. M,
1012-14 McGee St., Kansas City 6, Mo.

Send Free B-A Catalog No. 571.

NAME _____

ADDRESS _____

CITY _____ STATE _____

lightning-fast computer elements to checkout all units of the entire missile system, provide necessary maintenance, and supply critical information for command decision during final countdown.

False answers are avoided by self-testing continuously during the missile checkout and confirming all answers at the master console. If trouble does obtain, the operator is warned immediately, naming exact rack, drawer, and chassis location of its own faulty component for immediate replacement.

Go-no-go panel lights monitor rapid progress of the tester through tests through the entire missile system, including guidance and tracking radars, firing controls, plus missiles on several launchers. At the completion of the checkout, the instrument gives a go signal for the firing station.

An electronic memory supervises the entire checkout procedure by controlling generators which transmit test signals to each missile unit via cable and microwave radio. The memory knows in advance what responding signals each missile unit should return, confirms each answer and marks wrong ones as troubles.

STATION GRANT ACTIVITY remained at its sub-par level, due to allocation difficulties, as this column was being prepared. Accordingly, few authorizations were issued, as the listing on page 22 reveals.

AN ERECTOR SET technique is speeding up the flight testing of airborne electronic equipment at the Wright Air Development Center in Dayton, Ohio.

The new approach has reduced to a matter of days the time required to install experimental electronic gear in a C-131B test plane. Previously required were weeks and even months in the case of especially complex installations.

In the new plan, electronic equipment is mounted on 30 by 30 inch racks in the shop. This can be done while the test plane is flight testing other items of equipment. When it lands, racks of equipment already tested are removed. The new racks are then bolted to plates anchored in the floor and ceiling of the plane, the electrical system is plugged in, and the plane takes to the air for another test.

A NUMBER OF EXPERTS have forecast that industry is setting an unparalleled growth pace, but a few weeks ago, the immensity of this expansion was graphically translated into some significant figures. It was noted that sales and revenues of the electronics industry, currently an \$11½-billion item, would within the next decade exceed \$22-billion annually.

In an appraisal of the present and future of the entire field, it was disclosed that the present investment of more than \$9-billion will grow to nearly \$15½-billion by 1966.

Fantastic growth figures for so young an industry! . . . L. W.

TV—ELECTRONICS
WTI GRADUATES IN BIG DEMAND

Take your pick and hold a key top paying job in Television, FM and AM Radio, Broadcasting, Radar, Automation, Computers, Missiles, etc. Over 35 job classifications open to WTI graduates. FCC license coaching included.

Complete, Modern Resident Facilities
You work with the latest laboratory equipment. Non-essential math and engineering theory omitted. Approved for veterans. Free Placement Service. Complete information in our FREE Booklet. Write Dept. R-257.

WESTERN TELEVISION INSTITUTE
341 W. 18th Street Los Angeles, Calif.

SCHEMATICS—CONVERSIONS
FOR SURPLUS GEAR

NEW LIST DI MANY ADDITIONS!
Send stamped, self addressed envelope for List D. Add 25c for chart explaining AN nomenclature. DO IT TODAY!

R. E. BOX 1220
GOODHEART BEVERLY HILLS, CAL.

GARAGE DOOR
OPENER Actuator Mechanism **\$24.50**

EASY TO INSTALL, SAFE, RELIABLE
WRITE for interesting free information . . . TODAY
P. E. HAWKINS CO.
631 Prospect Kansas City 24, Mo.

R-1/ARR-1 Receiver . . . \$2.95



Described in Radio TV News, Jan. 1949 for use as 220 Mc. converter. Essentially a two stage RF acorn tube superhet converter as it now stands. Also can be used for a pre-selector. Small enough for mobile; only 3 1/2" w x 3" h x 10" d. Rugged aluminum construction. Has four 9.51 acorn tubes. Filaments now operate on 12 or 21 V. by merely throwing switch in unit or can be easily modified for 6 v. operation. Dial is calibrated in range of 234-258 Mc. Operation can be changed for use from 50 to possibly 300 Mc. Cover not shown but included. Complete with conversion as written in above magz. Brand new. Ship. wt. 1 lbs. . . . **\$2.95**
ARR-1 Antenna for above receiver and freqs. Ship. wt. 1 lb. New. . . . **\$1.25**
Co-axial antenna relay for use with above or other transmitter-receiver combinations. Ship. wt. 2 lbs. New. . . . **\$1.25**

ER-25-6, 6 V. 25 AH Storage Battery



Plastic case size 7 1/2" x 2 1/4" x 6 3/4" h. Shipped dry charged. Fill with 1.265 sp. g. sulphuric acid. Ship. wt. 8 lbs.
New **\$3.95**

RL-42-B Antenna Reel/Motor . . . \$2.50



Used originally for remote controlling of automatic trailing wire antenna. Motor is 1/2 hp, x 21 V. DC with oil-less sleeve bearings. Gear train, breaking and disconnect mechanism, reversible and variable speed motor makes this an ideal unit for conversion to coil winders, etc. Ship. wt. approx. 5 lbs. **\$2.50.**

Leeds & Northrup Micromax Recorders

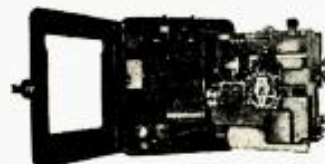

Strip type recorder used for controlling and recording wide variety of processes. Used originally for temp. range of 350-550° C. but may be changed for other applications. Operates on Wheatstone bridge principle using AC galvanometer movement. Original cost several times our low price. Removed from demilitarized equipment which in many cases was new. Sold as used but guaranteed, or money back if not satisfied. Ship. wt. approx. 165 lbs., **\$179.50 Ea.**

BAILEY METER RECORDERS

Used in application as above at same temperature range, etc. Operates on electronic principles using vacuum tubes. Used but guaranteed. Ship. wt. 165 lbs. **\$65.00 Ea.**



APN-1 ALTIMETER



Complete with all 14 tubes, dynamotor and wobblator. Frequency 460 mc. Excellent condition. Ship. wt. 23 lbs. Sale Price. . . . **\$7.95**

Freq. Crystals . . . Less Than 5c Ea.

Imagine crystals costing Govtmt. \$3.50 to \$12.50 ea. in this assortment. 100 brand new; various freqs.; plenty in hum bands. Practically all types of holders; all mounted; guaranteed to oscillate. Assortment of 100. Ship. wt. 4 lbs. . . . **\$4.95**

OAV-1 TEST SIGNAL GENERATOR \$19.95

This signal generator was used to provide a test signal of constant frequency in operation and alignment of IF amplifier stages in the CG-4B ACQ type receivers.



The generator covers the range between 150-250 megacycles. Amplitude modulated square wave output is obtained at frequencies of 1, 1, 10 and 100 kc. depending on the position of the freq. mod. pulse switch. A 15 Mc signal is also provided by a second osc. stage. Power is supplied by internal 115 V. 60 cycle AC supply connected to source by cord provided. Brand new with instruction book. **\$19.95**
Ship. wt. 62 lbs.

Brand New 12 V. Dynamotor

DM-40 Input: 12-14 V. 3.4 A. Output: 172 V.—133 MA. An ideal dynamotor to adapt to mobile uses on the new 12 V. cars. Don't pass up this buy even if your intended uses are not immediate. Size 6 3/4" L. x 3 1/2" dia. 4" lead with 6 pin Jones plug. Ship. wt. 7 1/2 lbs. . . . **\$2.75**

14 Amp. Battery Charger While Supply Lasts

Cost Govt. \$300 ea. Our purchase of large quantity allows this bargain. Charges 6, 12, or 21 V. batteries at 14 amp. rate max. Operates from 110 V. AC. Mfg. by Ward-Leonard. Size 12" w x 20" h x 10" d. Brand new in orig. packing; wt. approx. 80 lbs. They'll go fast at this low price, so order now. . . . **\$7.50**

M-1 ODOGRAPH \$179.50

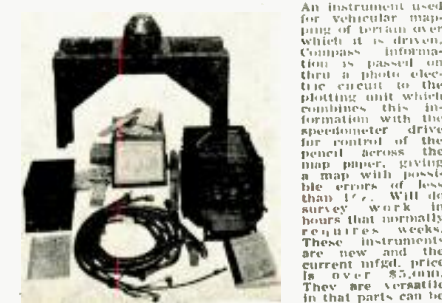

An instrument used for vehicle mapping of terrain over which it is driven. Compass information is passed on thru a photo electric circuit to the plotting unit which combines this information with the speedometer drive for control of the pen on the map paper, giving a map with possible errors of less than 1%. Will do survey work in hours that normally requires weeks. These instruments are new and the current retail price is over \$5,000. They are available in that parts can be adapted to other uses such as the compass unit to auto pilot boat control, etc. Ship. wt. 200 lbs. U.S. Corps of Engineers rebuilt units. . . . **\$179.50 complete**
Brand new units. . . . **\$279.50 complete**

Golf Car Motor \$4.50

New 1 1/2 hr. battery-operated motor for building up your golf car or other use. Operates from 12 to 24 V. with speed to 6000 RPM. Measures 11" dia. x 8" long. 5" shaft. Wt. 11 1/2 lbs. Ship. wt. **\$4.50**
13 lbs.



Trip Relay

Protect automatic machines in case of clogging or choking. Instantaneous class 9055 Type N. Mfg. by Square D Co. 600 V. max. Three ranges available—.067—.15 amp.; 23-47 amp.; and 56-117 amp. State choice. Ship. wt. 4 lbs. **\$1.95**
Brand new.

PERMOFLUX HI-FI SPEAKERS

Special! Hi-fi series Permoflux 61-1 speakers. Six inch, frequency response 50-12,000 cps. Originally \$16.00 ea. Ship. wt. 3 lbs. **\$3.25**
Sale Price.

TU-10-B Tuning Units—\$1.95 ea.



Used in the HC-475 transmitter, but the most favorable and acceptable piece of surplus gear for obtaining good cheap useable parts. The TU-10-B contains three double spaced transmitting type variable condensers of 10, 27, and 7 plate varieties; 3 mica transmitting type mica; 2 isoquartz shaft couplings; antenna coupling switch; two precision vernier dials, chokes, inductances, and other useable parts. Better order plenty, before supply is exhausted again. TU-7 and TU-9 also in stock, same price. Ship. wt. 13 lbs. Size 7 3/4" x 10 1/2" x 7 1/2". **\$2.50**
PRICE, Used, ea. . . . **\$1.95** New, ea. . . . **\$2.50**
ARR-1 Test Oscillator for 234-258 mc using gold plated cavity. Dry battery operated not incl. Size 6 1/2" x 7" x 9 1/2" with tubes. Excellent in new condition. Ship. wt. 7 lbs. **\$4.95 ea.**
Price.

TEST SET EE-1 . . . NEW—\$19.50



A test set for aircraft containing AC & DC volt, ohms, meter, tachometer, pressure gauge and test gauge cord and tools. In aluminum suitcase type case that opens forming sloping 2 sec. panel. Ideal for your test bench applications. Cost hundreds of dollars but yours in original evacuated shipping container. Ship. wt. 270 lbs. **\$19.50.**

Kerosene or GASOLINE HEATERS



Special! Brand New Evans. Blue-flame 50,000 BTU heater. Originally used for arctic aircraft heaters in far north. Ideal for camping, hold-day or in place of sabbatarian. Terrific outdoor camp stove. Compact 10" dia. x 12" high. Lightweight. Cost government many times low price. Stamped in original packing. Ship. wt. 47 lbs. Reduced Sale Price **\$4.95**

New Torque Amplifier Only \$9.75

FOR USE WITH SYNCHROS SIZE 5, 6, 7

Provides torque amplification and ease in rotation of input shaft. Rotating power applied to input shaft is reproduced in any direction on the output shaft. Torque supplied entirely by a 1/40 HP 110 V. AC motor through gear and planetary drive hook-up. Speed varies directly with rotation of input shaft with noticeable loss of accuracy. Motor requires capacitor of 85-120 mfd. for starting. Designed for use on gun control devices and cost the Govtmt. hundreds of dollars to mfg. in cast aluminum case. Size: 12" h. x 5 3/8" w. x 7 1/2" d. Wgt. 23 lbs.



Packed in original wood box. Shpg. wt. 45 lbs. Brand New **\$9.95**
Starting capacitor for above Torque Amplifier. New **\$1.00**

RADIATION COUNTER \$17.95

Manufactured by Barker-Williamson for AEC. Contains 0-20 microamp meter and all tubes. Battery operated (not included). Ship. wt. 17 lbs. **\$17.95**
Brand New



Oil Capacitors

4 mfd 600 V. GE. **\$1.00**
2 x 1 mfd. 600 V. GE. **\$1.00**
1 mfd. 1500 V. GE. **\$1.00**
1 mfd. 5000 V. GE. **\$1.00**
2 x 1 mfd. 5000 V. GE. **\$1.00**
2 mfd. 5000 V. I. **\$1.00**
3 x 2 mfd. 4000 V. GE. **\$2.00**
1 mfd. 4000 V. GE. **\$2.00**
12 mfd. 15000 V. GE. **\$3.75**
All leading popular brands. All new; not stopovers. Guaranteed.

SYNCHRO

Motor and Generator Only \$9.95 Per Pair

By simply connecting like wires of each unit and applying 110 V. 60 cycle current to junction of two rotor wires you have an electrical equivalent of a flexible shaft without the usual friction, backlash, and error. From your own applications such as remote reading weather vanes, remote control antenna rotation, liquid level indicators, etc. Popular size 5 6/16" x 3 1/4" dia. Cost Navy many times our low price. Ship. wt. 12 lbs. per pair. Removed from equip. Guaranteed. Per pair. **\$9.95**



G-E SELSYN 2J1G1—\$4.95 PR.

Brand new small size Selsyns for beam direction indicator and other devices. 57.5 volt 400 cycle. Connect rotors in series on 115 V. Will operate for intermittent duty on 60 cycles, approx. size 2 1/4" dia. x 4 1/2" long. Shpg. wt. 3 lbs. per pair. Sale Price. **\$4.95**



ESSE RADIO CO. 42 WEST SOUTH ST. INDIANAPOLIS 25, IND.

REMIT SHIPPING CHARGE AND INSTRUCTIONS WITH ALL ORDERS. OTHERWISE ORDER WILL BE SHIPPED EXPRESS COLLECT. ALL ITEMS GUARANTEED TO YOUR SATISFACTION OR MONEY REFUNDED IF RETURNED PREPAID WITHIN 10 DAYS OF RECEIPT

INTRODUCING

**AN ALL NEW
ELECTROSTATIC
TWEETER**

(MODEL 5-20)



REMARKABLE VALUE

AT ONLY \$29.⁵⁰

Combine this all New Electrostatic Tweeter with your present speaker system and realize the full capabilities of your Hi Fidelity System.

FEATURES

- Plug in combination with your present speaker system
- Built in crossover network and matching transformer
- Smooth response from 5000 to beyond 20,000 cycles
- Excellent transient response
- Uniform distribution of sound
- 360 horizontal omni-directional sound.
- Dimensions: 4½" x 4½" x 12"
- Hand rubbed cabinet in mahogany or blonde
- Radiating assembly guaranteed for 2 yrs.

Manufactured in the U.S.A.
Available at all leading Hi-Fi dealers. If your dealer can not supply, write
DEPT. R.

Pampa

ELECTRONICS CORP.
2324 PENNSYLVANIA AVE.
PHILA. 26, PA.

DEALER'S INQUIRIES
INVITED. WRITE DEPT. R.



New Hi-Fi-Audio

Equipment

NEW B&O MICROPHONE
Fenton Company, 15 Moore St., New York 4, N. Y., has recently introduced

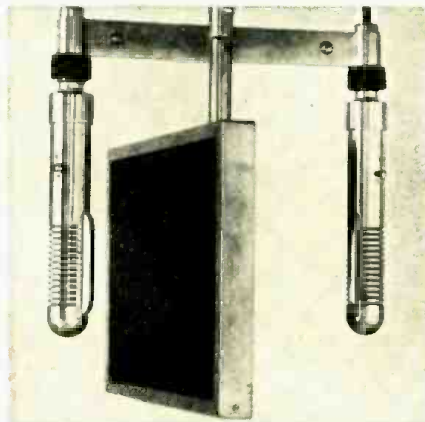

a new version of its popular B&O 50 microphone.

The new unit, the B&O 53, uses an identical magnet and ribbon assembly but has a multi-tapped output transformer having output impedances of 50, 250, and 40,000 ohms. It is housed in a cast iron body for better shielding. It weighs 19 ounces.

Supplied in either matte finish "TV grey" or satin finish chrome, the B&O 53 is supplied with 20 feet of cable, a female microphone connector, and snap-on bayonet adapter for ⅝ x 27" stand.

A new "Binor" rig for the correct positioning of microphones for stereophonic recordings is also being offered by the firm. The rig is designed to work with two of the B&O 50's or B&O 53's. Write the company for full details on the mikes and the rig.

MASCO "MUSIC MASTER"

Mark Simpson Manufacturing Co., Inc., 32-28 49th St., Long Island City 3, N. Y., has introduced its Model AFR "Music Master," a decorator-styled single chassis FM-AM tuner and 10-watt amplifier.

The unit also incorporates a quality preamp which permits the use of any good grade phono pickup. The preamp



is fully equalized for all LP records and has separate bass and treble controls.

At 10 watts audio output, the frequency range is from 20 to 20,000 cps with less than 1% distortion. The unit is housed in a black enclosure with a gold front panel and an illuminated tuning scale.

NEW G-E TWEETER

General Electric Company, Electronics Park, Syracuse, N. Y., has released a new high-frequency speaker which is rated at 8 watts.

The Model A1-404 is 2¾" in diameter with a 1-inch aluminum voice coil. It uses a 6.8 ounce Alnico V magnet. The speaker is shielded for protection against accidental impact damage.

The tweeter will operate with any 8-ohm single-cone speaker, irrespective of size. It has a frequency response, substantially flat, from 1500 to 15,000 cps. One of its most important features is the wide angle of dispersion at higher frequencies, resulting in smoother and more natural sound reproduction. The angle of dispersion is between 90 and 180 degrees. The direct radiator design eliminates the possibility of acoustic reflections characterizing horn-type operation.

NEW AMPEX STEREO CONSOLE

Amper Corporation, 934 Charter St., Redwood City, Cal., has added a con-



sole music system to its line of monaural and stereo tape equipment.

The new unit is a combination tape recorder and stereo phonograph with two separate amplifier-speaker systems arranged for the realistic projection of both stereo and monaural sound. The switching and control circuits are designed so that program material from the AM-FM radio or three-speed record changer may be listened to and recorded simultaneously. A jack is provided so that TV sound may also be played and recorded through the system.

Another new circuit makes it possible to mix and record with the program sound which is picked up by the professional microphone included with the system. An illuminated program level meter and an accurate tape position indicator further simplify the recording of professional calibre tapes. Stereophonically recorded tapes are played separately from the two recorded sound tracks through the dual amplifier-speaker systems.

Full details on the Model A423 console and other units in the company's new "A" line are available on request.

JENSEN-CABINART KITS

Jensen Manufacturing Company of Chicago and G & H Wood Products



Co., Inc. of Brooklyn, N. Y., have entered into an agreement whereby "Cabinart" will manufacture and sell a line of Jensen-designed cabinet kits especially for use with that firm's loudspeakers.

Seven basic cabinet kits are now being offered, ranging from the "Duette" to the "Imperial." A choice of highboy corner, which may be used against a sidewall, or lowboy, non-corner styles, is available for systems using 12" and 15" woofers.

All needed parts are furnished with the cabinet kit series, including hardware. The only tools needed to assemble the kits are a screwdriver, pliers, and a stapler.

OSCILLATOR WAND

The Stancil-Hoffman Corporation, 921 N. Highland Ave., Hollywood 38,



Cal., is now offering a new maintenance tool for fixed and portable magnetic recording equipment.

The Model AO11 oscillator wand is a source of either a 1000 cps or an 8000 cps tone. When it is held close to

FAIRCHILD DESIGN

We're often asked—"How will the use of the Fairchild Arm in conjunction with the Fairchild Cartridge increase the performance of my high fidelity system?" Since the 280A Arm is the housing best designed for this famed cartridge, the results will be immediately apparent to the critical listener.

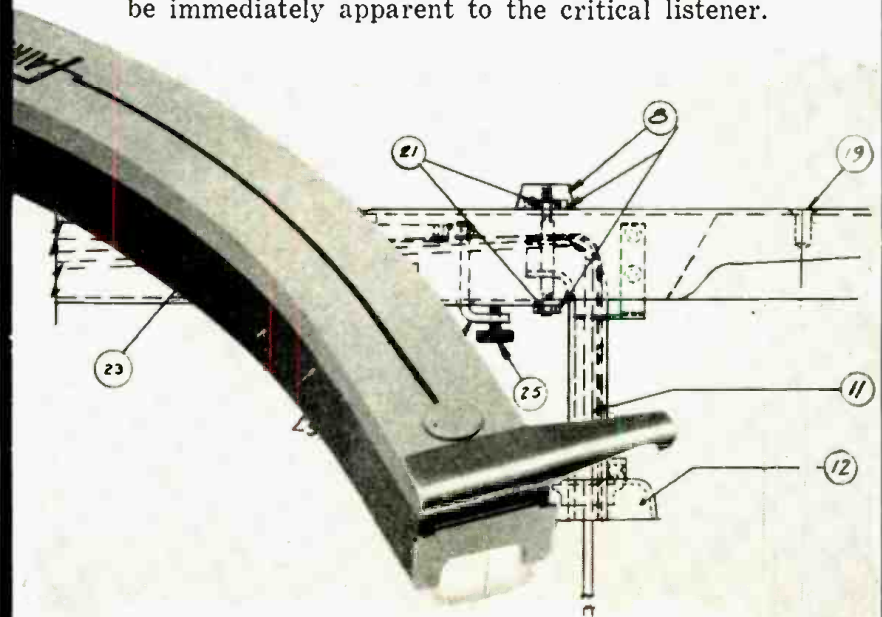

- It will reduce the fundamental resonance which is determined by the mass of the arm and the compliance of the cartridge.
- It will result in excellent tracking of the most heavily recorded passages.
- It will minimize side thrust and hence reduce distortion.
- It will allow complete freedom of motion without vibration or erratic performance.
- It will reduce tracking error to a minimum.
- It will provide unusual features of convenience and ease in handling.
- Most important, it will assure superb sound.

There is no question that a speaker housing is almost as important as the speaker itself. Similarly, the housing for the cartridge is equally important but often overlooked. The Model 280A Arm, the result of much experimentation and fundamental research^{*} can properly be classified as professional in performance, yet is modestly priced at only \$33.95.

^{*}Journal of the Audio Engineering Society, Volume 2, Number 3, July, 1954.

Find out what to look for in a transcription arm. Write Department "S" for free illustrated booklet "HOW GOOD IS YOUR ARM."

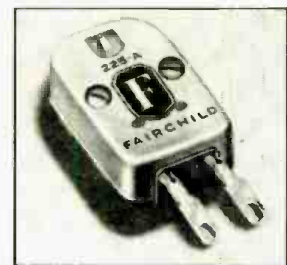

FAIRCHILD
RECORDING EQUIPMENT COMPANY
10-40 45th Avenue, Long Island City 1, New York

Introducing

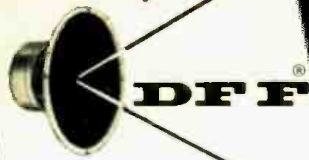

**DUOTONE
FIDELITY
FOCUS
Loudspeakers**

New Engineering Technique Assures You—Bell-Clear Highs; Vibrant-Undistorted Lows.

DUOTONE—For a quarter of a century, leader in the high fidelity industry, presents for the first time, **DFF, DUOTONE FIDELITY FOCUS LOUSPEAKERS**. A new high in manufacturing standards and procedures assures you of a superb quality seldom found in most other loudspeakers. Rigid specifications adhered to and exacting field trials were made before this fine line was presented to the public. It was only the results of these exhaustive tests that assured us of a product worthy of the HI-FI enthusiasts interests. Whether you choose a coaxial speaker such as the Royal or Medallion, or a woofer-tweeter combination like the Supreme and the Duchess, you will be more than satisfied with the excellent response these speakers afford. Stop into your HI-FI dealer's showroom and ask to hear them. Your reward will be the self-satisfaction of hearing excellent high fidelity sound reproduction. There's a **DUOTONE FIDELITY FOCUS LOUSPEAKER** to match your system and they are priced to \$53.97.

Write today for our FREE new booklet, "An Objective Study of Loudspeakers". It's designed to help you choose and install your speaker system.

12 in. Coaxial
Cat. No. 12CX-62
35 to 18,000
cps. Power:
25 watts Imp:
8 Ω



The ROYAL

12 in. Coaxial
Cat. No. 12CX-60
35 to 18,000
cps. Power:
15 watts Imp:
8 Ω



The MEDALLION

8 in. Coaxial
Cat. No. 8CX-50
50 to 20,000
cps. Power:
10 watts Imp:
8 Ω



The MARQUIS

8 in. Coaxial
Cat. No. 8CX-70
75 to 19,000
cps. Power:
6 watts Imp:
8 Ω



The VISCOUNT

4 in. Tweeter
Cat. No. 4-TX
1000 cycles to
beyond aud.
Power: 5 watts
Imp: 8 Ω



The DUKE

7 in. Tweeter
Cat. No. 7-TX
350 cycles to
beyond aud.
Power: 10 watts
Imp: 8 Ω



The DUCHESS



the playback head, either a 1000 or 8000 cycle tone will be induced into the playback head to check operation of the playback amplifier or film phonograph.

Held close to a dynamic microphone or any other moving coil pickup, the wand will induce the same tones. The wand may also be inserted in the input of a microphone preamplifier in order to record 1000 or 8000 cycles. The wand weighs only 9 ounces and is 8 inches long and 1½ inches in diameter.

CLOCK SPEAKER

American Elite, Inc., 7 Park Ave., New York 16, N. Y., has recently introduced a novel "clock speaker," the Model WLU-30.

The speaker is a 7" unit with 4 watt input and impedance of 5 ohms. Overall dimensions of clock speaker are 12½" diameter and 4" high. It is available in ebony or ivory finishes.

TAPE TRANSPORTS

Telectro Industries Corp., 35-18 37th St., Long Island City 1, N. Y., is now

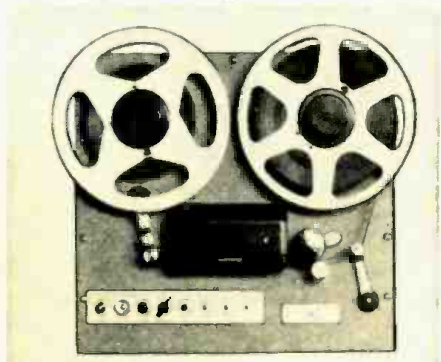

offering a new series of tape transport mechanisms suitable for hi-fi applications, studio work, and for telemetering and data recorder usage.

Tape speeds are 15, 30, and 60 inches per second. Instantaneous change of speed with automatic compensation is available at all three speeds. Push-button controls are provided for start, stop, wind, rewind, and record.

These new tape transport mechanisms are available in any number and combination of channels up to 28. Write the company for full details on specific applications.

SPEAKER SELECTOR

Dynamic Electronics-New York, Inc., 73-79 Woodhaven Blvd., Forest Hills, N. Y., is now offering its "Hi-3" speaker selector to the audiophile and audio trade.

The Model No. DS77 is designed to be used for temporary or permanent speaker coupling and comparison checks, and in connection with an audio output for switching to as many as three speakers at remote points.

The unit comes in a compact all-metal case with a 3-position switch. Write the manufacturer for full details and prices.

"SOUNDBOOKS"

Audio Master Corp., 17 East 45th St., New York 17, N. Y., is now mar-

keting a new and improved "Teflon" unit which provides up to eight hours of musical selections.

"Teflon" utilizes cartridges in the form of compact plastic-covered "Soundbooks," weighing less than a



pound each. These are comprised of unbreakable vinylite soundreels which need no winding or rewinding. The "Soundbook" is placed on the center spindle of the player, the control knob is switched on, the pickup placed against the reel, and 8-hours of uninterrupted music results. Additional cartridges are being released monthly.

Write the U. S. distributor for full details on the unit and on the program material available.

BASS—TREBLE EQUALIZER

Vidaire Electronics Mfg. Corp., Lynbrook, N. Y., has added a bass and treble equalizer to its line of radio, TV, and audio accessories.

The Model EQ-6 is of the network type and is designed for use in hi-fi speaker systems to compensate for speaker system deficiencies such as poor response of the speaker or enclosure and acoustical properties of the room.

Individual control of bass and treble is provided over a range of —6 db to



+3 db for bass and —3 db and +3 db for treble. The equalizer will operate with either 8- or 16-ohm speaker systems.

SCOTT AM-FM TUNER

Hermon Hosmer Scott, Inc., 385 Putnam Ave., Cambridge 39, Mass., is now offering its new Type 331-B AM-FM tuner with provision for stereo.

Carrying all of the features of the firm's 330-B tuner, the new unit also includes a complete equalizer-preamp so that the only addition required is a power amplifier to make a complete installation that includes a flexible

"front end" and versatile stereo AM-FM tuner.

The selector switch includes positions for five equalization curves and two high-level inputs; RIAA-NARTB-Ortho, original AES, original Columbia, original London, Eur. 78, and



other positions. FM. AM wide range, AM normal. AM distance. tape. TV, are also included. Bass and treble controls are provided, offering maximum boost of 17 db at 30 cps, and 19 db at 20,000 cps.

There are two low-level magnetic phono inputs and two high-level inputs for tape and TV. Outputs are for main output, tape recorder output, AM and FM binaural outputs, and provision for connecting a dynamic noise suppressor.

The case measures 15 1/4" x 4 3/4" x 12 1/2" and the unit weighs 17. pounds.

"NO-SPILL REEL"

ORRadio Industries, Inc., Shamrock Circle, Opelika, Ala., has recently introduced a "No-Spill Reel" as a convenience for its tape users.

The new reel utilizes two notches on opposite ends of the reel. A rubber band is slipped over the two notches, holding the tape securely in place on the reel. In addition, the new reel offers easier access to the threading



eye and 28 square inches of indexing space on the four large flange areas, two on each side.

The company's "Irish" brand tapes on seven-inch reels are all being delivered on the new reels at no extra cost.

CATALOGUES

PICKUP CARTRIDGE DATA

The Astatic Corporation of Conneaut, Ohio, has released a new pickup cartridge catalogue which should be of interest to audiophiles.

The single sheet catalogue, No. 33-1, contains a complete, up-to-date listing of all of the company's phono pickup cartridges, new and old stock numbers, illustrations of each cartridge, prices, and pertinent specifications.

Also available is a new 8-page pick-

January, 1957

Send for MusiCraft's **FREE** high fidelity catalog



Just off the press!
Jam-packed
with latest
hi-fi values!

Here's a *special* high fidelity catalog that you'll find particularly useful, because we have included *only* equipment which we at MusiCraft consider the *best*—from the standpoint of *compatibility* and stable operating efficiency—in every price range.

Page after page pictures the newest high fidelity equipment with detailed information about characteristics and specifications.

Whatever you want—whatever you need—speakers, tuners, amplifiers, turntables, "do-it-yourself" kits, etc.—MusiCraft's new catalog features all the top quality components from leading manufacturers.

Send now for your free copy of the new **MUSICRAFT HIGH FIDELITY CATALOG:**

MusiCraft

48 East Oak Street
Chicago 11, Illinois
Delaware 7-4150

name _____

address _____

city _____ zone _____ state _____

BEWARE OF IMITATIONS

There Is Only One Original Dependable **NO-NOISE**

Volume Control and Contact Restorer with Perma-Film



2 oz. bottle. Net to servicemen. **1.00**

Cleans, lubricates, protects—not a carbon-tet solution. Still available in the new 6 oz. spray can. Net to servicemen—\$2.25

"NO NOISE"

Also available in 8 oz. bottles and quart cans. At your nearest distributor.

TUNER-TONIC with PERMA-FILM

Cleans, lubricates, restores all tuners including wafer type. Won't change or affect capacitance, inductance or resistance. Won't harm insulations or precious metals, nor attack plastics. For television, Radio and FM. Eliminates all noise, oxidation and dirt indefinitely. Non-toxic. Net to servicemen. **\$3.25** Extra economical because a small amount does the job!



ELECTRONIC CHEMICAL CORP.

813 Communipaw Avenue

Jersey City 4, N. J.

DO YOU WANT A BETTER AMPLIFIER?

Build a 50 watt DYNAKIT USE A DYNACO TRANSFORMER TO MODERNIZE YOUR PRESENT AMPLIFIER



MARK II

\$69⁷⁵ net

A premium kit for the audio perfectionist, the Dynakit sounds better because it is designed for outstanding transient response and stability, for higher power at low distortion, and for complete and accurate reproducibility. The improvement over conventional circuits is immediately apparent to the discriminating listener.

The Dynakit combines unequalled quality with economy and simplicity. It features the finest of parts, like the superb Dynaco A-430 output transformer. At the same time construction is greatly simplified by the Dynaco pre-assembled printed circuit unit which includes the major portion of the wiring.

The Dynakit is sold complete with all parts and the pre-wired printed circuit assembly. Complete specifications are available on request.

AVAILABLE FROM ELECTRONIC PARTS AND AUDIO DISTRIBUTORS

DYNA COMPANY, Dept. RT, 5142 Master St., Philadelphia 31, Pa.

Dynaco super-fidelity transformers are a new design which permits lower distortion and wider frequency response in high fidelity amplifiers. Models are available from 10 to 100 watts including the 50 watt A-430 transformer which can be used to increase the power of Williamson Amplifiers to 50 watts.

MODELS

- A-410 10 watts 6V6, EL-84 \$14.95
- A-420 25 watts KT-66, 5881, EL-34 19.95
- A-430 50 watts 6550, EL-34 (6CA7) 29.95
- A-440 100 watts 6550 39.95
- A-450 100 watts PP par 6550, EL-34 39.95

(all with tapped primaries except A-440 which has tertiary for screen or cathode feedback)

Full data and details of Williamson Amplifier conversion available on request.

up cartridge cross reference index and needle listing, No. CRC-56. This index provides a handy reference for distributors and countermen of all *Astatic* cartridges as well as the cartridges of other makes that may be replaced by *Astatic* models. Also included in this index is a complete listing of all of the company's needles and its line of cutting heads.

SHURE REPLACEMENT MANUAL

Shure Brothers, Inc., 222 Hartrey, Evanston, Ill., is now offering copies of its new pocket-size replacement manual, the RM-56.

Designed for countermen and technicians, the manual gives complete replacement information and technical data on ceramic and crystal pickup cartridges and magnetic recording heads.

The manual is available without charge from all of the company's distributors or from the sales department of the manufacturer.

-30-

Sun	Mon	Tue	Wed	Thu	Fri	Sat
			2	3	4	5
						12
						19
						26

CALENDAR of EVENTS

JANUARY 14-15

Symposium on Reliability and Quality Control in Electronics. Sponsored by RETMA. Statler Hotel, Washington, D. C. Contact C. M. Reyersson, RCA, Bldg. 10-6, Camden 2, N. J., for full details on program.

JANUARY 23-25

Very-low-frequency Symposium. Sponsored by the Denver-Boulder chapter of the IRE and Boulder Laboratories of the NBS. Boulder Laboratories, Boulder, Colorado. Dr. J. R. Wait of NBS, Boulder, in charge of program.

JANUARY 28-29

Symposium on Microwave Ferrite Devices and Applications. Engineering Societies Auditorium, New York. Tore M. Anderson, 1539 Deer Park, Mountainside, N. J., in charge of publicity and program information.

JANUARY 30

Electronics in Aviation Day. Held at Sheraton Astor Hotel, New York City. Information on program from D. S. Little, 35 Bogart Ave., Port Washington, Long Island, N. Y.

FEBRUARY 6-9

High Fidelity Show. Sponsored by the Institute of High Fidelity Manufacturers. Location to be announced. Contact S. Cahn, Executive Secretary, Institute of High Fidelity Manufacturers, P. O. Box 284, Mineola, New York.

FEBRUARY 7-8

West Coast Convention of Audio Engineering Society. Ambassador Hotel, Los Angeles. Contact Ross A. Snyder, Ampex Corp., Redwood City, California, the western vice-president of the AES, for further information.

If you're interested in true high fidelity

YOU NEED THIS!

... The authoritative, easy-to-understand story of how a hi-fi loudspeaker works. Tells you how to judge a good loudspeaker... what to look for, listen for. 32 fascinating pages, including dozens of diagrams and delightful cartoons. *Only book like it!* A wonderful guide for everyone who has a hi-fi system. A *must* for everyone who plans to purchase one!

Yours FREE—just send a dime to cover cost of mailing.

University Loudspeakers, Inc., White Plains, N. Y.



HERE'S HOW TO GET YOUR START IN RADIO ELECTRONICS

No matter what part of radio-TV-electronics you plan to enter, this is the BASIC training you need!

Here's basic training you can really understand... training that can help fit you for a good pay radio-television-electronic career!

Ghirardi's RADIO PHYSICS COURSE is the oldest book of its kind... and still a best seller because it is so amazingly clear and complete. More experts now in electronics got their basic training from this giant book than any other of its type—and they'll recommend it to you today! Starts with Basic Electricity (over 300 pages) then takes you step by step through the entire radio-electronics field. Covers principles, theories and practices that are basic to even the most modern equipment. 972 pages; 508 pictures. 856 helpful self-review test questions. Price only \$6.50.

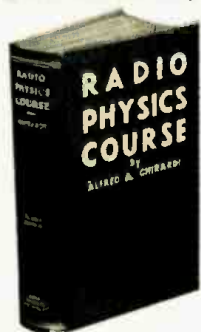

RADIO PHYSICS COURSE by A. A. Ghirardi Complete basic training for beginners

STUDY 10 DAYS FREE!

Dept. RN-17, RINEHART & CO., INC., 232 Madison Ave., New York 16, N. Y.

Send Ghirardi's RADIO PHYSICS COURSE home-training book for 10 days free examination. I will then either return book promptly or send you \$6.50 plus postage in full payment. (SAVE! Send \$6.50 with order and we pay postage. Same 10-day return privilege with money refunded.)

Name

Address

City, Zone, State

OUTSIDE U.S.A.—\$7.00 cash only. Money back if book is returned in 10 days.



UNIVERSITY LOUDSPEAKERS, INC. Desk S-11 80 South Kensico Ave., White Plains, N. Y.

Gentlemen: Please send me my copy of "Speaking about Loudspeakers." Enclosed is Dime to cover the cost of mailing.

NAME

ADDRESS

CITY

STATE

Tone Arms
(Continued from page 53)

playing perfectly flat discs viscous damping is no disadvantage and is a useful safety precaution, but if, at any time, it is required to play discs that are even slightly warped, the viscous damping can be a disadvantage. It is true that the damping is usually designed so the stylus will not leave the groove under these circumstances, but the following fact should be considered:

A certain minimum stylus force is necessary to maintain correct tracking in the groove. Viscous damping will cause a greater variation from the average stylus force than will an arm of the same inertia without viscous damping. This means that either the nominal or average stylus force must be increased so the minimum force, as the arm is falling, is always adequate to maintain tracking or else distortion will occur during this period.

If the stylus force is increased so that the minimum is always adequate, the average and maximum forces on the stylus will be such as to increase record wear on those parts of the revolution. This means that a record with any trace of warp will be subject to uneven wear from an arm using viscous damping.

It thus appears to be a question of which you value most: if you have some old discs that are in good condition, except for being warped, then a viscous damped arm is a disadvantage; if all of the discs are in good condition and do not suffer from warping, and you take precautions to see that they do not develop warps then a viscous damped arm does have the advantage of protecting your pickup against accidental dropping.

You may of course feel that the best precaution against this is careful handling. This in turn depends on whether you intend only to handle the equipment yourself, or whether someone else in the household may sometimes be permitted to play records. If the equipment is available for someone else to use, then viscous damping is a useful protection against accidental damage.

Yes, audio is a perfectionist's hobby. Manufacturers of audio equipment, especially tone arms and pickups, also have to be perfectionists, so they are always working to produce better and more competitive products. So what may be the best choice of arm this year may not still be the best choice next year. Just at the moment the tone arm is one component in a high-fidelity system in which there is room for improvement and on which various manufacturers are working. However, don't wait until the perfect tone arm is produced: if you wait for the perfect tone arm—or indeed for perfection in any other portion of an audio system—you will have to wait a very long time and you will never get any high-fidelity equipment at all!

BEST BUY IN HI-FI

Grommes



10PG 10 Watt High Fidelity Amplifier

Here is new styling with a full set of controls providing exceptional flexibility in a moderately priced amplifier. A simple efficient flat compact design features modern feedback circuitry, record compensator, loudness control, wide range bass and treble controls, rumble and scratch filters, and six inputs, including one for tape head. Frequency Response: ± 0.5 DB. 20 to 20,000 CPS. Distortion: 2% harmonic and 3% intermodulation at 10 watts.

Net Price to user.....57.50

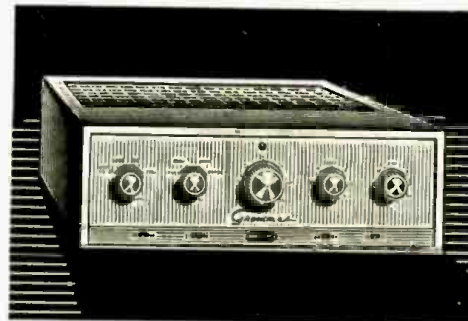

15PG 12 Watt High Fidelity Amplifier

The best buy in the medium priced field. The all new deluxe 15PG features the most advanced circuitry, the highest quality components and greater flexibility of controls. It features feedback throughout, separate turnover and roll-off record compensators, new loudness control, wide range bass and treble controls, rumble and scratch filters, and six inputs including tape head. Frequency Response: ± 0.5 DB. 20 to 30,000 CPS. Distortion: 1% harmonic and 2% intermodulation at 12 watts.

Net Price to user.....69.50



20PG 20 Watt High Fidelity Amplifier

An all new amplifier featuring new styling, advanced circuitry and greater control flexibility. The 20PG incorporates feedback throughout and has all the new features of the deluxe 15PG plus higher power in the output stage. Frequency Response: ± 0.5 DB. 15 to 30,000 CPS. Distortion: 1% harmonic and 2% intermodulation at 20 watts. Cabinet in charcoal gray with brushed brass trim and front panel.

Net Price to user.....89.50



GRT-3 HIGH FIDELITY FM-AM TUNER—A matching FM-AM Tuner for Grommes amplifiers and pre-amplifiers. Tuning is simplified by flywheel drive, tuning meter and AFC on FM. Circuit consists of tuned RF stage on FM and AM, dual limiters, wide band IF coils with high sensitivity and cathode follower audio stage. Net Price to user.....129.50

See the Grommes Hi-Fi Dealer in your area or write

Ask your dealer to also show you the Grommes Premier 212, a new deluxe equalizer pre-amplifier control center and the Premier 260, a new 60 watt basic amplifier. If your dealer cannot help you, write for complete details and where to buy.

Grommes Div. of Precision Electronics, Inc.
Dept. R-1, 9101 King Avenue
Franklin Park, Illinois

Send Free Hi-Fi Equipment Brochure.

Name.....

Street.....

City.....Zone.....State.....

IMPROVE your AMPLIFIER in 5 ways

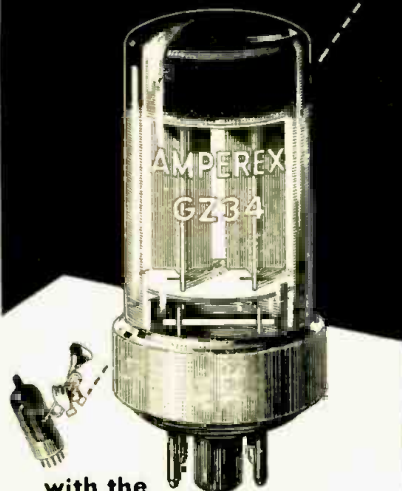

with the

Amperex® GZ34 RECTIFIER

A LOW-IMPEDANCE, INDIRECTLY HEATED, FULL-WAVE RECTIFIER WITH 250 MA OUTPUT CAPACITY

The unique AMPEREX GZ34 replaces without circuit changes, in the majority of amplifier circuits, an entire line of popular, heavy-duty 5-volt rectifiers—5U4G, 5V4G, 5T4, etc. — with the following benefits:

- Better voltage regulation due to lowered power supply impedance;
- Higher power supply output voltage for more power;
- Added filter condenser protection due to reduced ripple;
- Cooler operation due to lower voltage drop;
- Protection of costly power output tubes through delayed warm-up.

OTHER Amperex TUBES FOR HIGH-FIDELITY AUDIO APPLICATIONS:

EL84/6BQ5	9-pin power pentode; 17 W PP
6CA7/EL34	High-power pentode; 100 W PP
EF86/6267	Low-noise high- μ pentode
ECC81/12AT7	Low-noise medium- μ dual triode
ECC82/12AU7	Low-noise low- μ dual triode
ECC83/12AX7	Low-noise high- μ dual triode
EZ80/6V4	9-pin rectifier; cathode; 90 ma.
EZ81/6CA4	9-pin rectifier; cathode; 150 ma.

At All Leading Electronic Parts Distributors



**Amperex
ELECTRONIC CORP.**
230 Duffy Ave., Hicksville, Long Island, N.Y.

Certified Record Revue (Continued from page 70)

I have always championed the Toscanini reading of this work. While I still feel that it is one of the great performances on LP, I feel equally enamored of the Paray version, and with the infinitely superior sound he is afforded, the totality of effect is stunning. Paray was a friend of Debussy and he has always had a particular affection for the great Frenchman's music. That this association with Debussy has influenced Paray's readings of his scores there can be little doubt, and purportedly Paray conducts these three works in accordance with Debussy's intentions. If we accept this as a truism, we must then conclude that Toscanini's reading is a much more "personal" thing than we had supposed. At any rate, while the Toscanini and Paray readings have a degree of sameness there are many aspects of the score at which they are at variance with each other. If you generally favor the ardor and intensity of the Toscanini interpretations, after listening to this you would probably not change your views. The Paray has plenty of virility, but his approach is more linear than Toscanini's. There is considerably more lyricism in his view of the score and he essays a gradual build-up in the tensions of the work until the turbulent finale where he gives his men full rein and the orchestra blazes with excitement. In the "Prelude", Paray displays exquisite taste in phrasing and balance and his is the most lyrical approach. His only serious competition is the Inghelbrecht and Munch readings, and while these are estimable recordings they don't quite achieve the high level of inspiration with which Paray infuses his effort. Paray's "Iberia" is really a remarkable musical document. He manages the difficult task of keeping an over-all lyrical feeling in the score, as in the other works . . . and at the same time the rhythmic sections are relentlessly propulsive, a lavish but controlled outpouring of musical energy that I find quite irresistible. The word for his reading is exciting! Soundwise, this recording is quite a few steps ahead of any competing versions. With the almost universal affection with which these works are regarded, I can predict that with the exalted sound they are afforded this will be a very big seller for Mercury. From every respect of frequency response, dynamic range, transient response, orchestral balance, acoustics . . . this recording is the most! The important string work, the interplay of the first and second violins, the cello and contrabassi are all heard with crisp definition. The woodwinds which lend so much color to these Debussy scores are superbly articulate, yet have a mellow richness which is a lovely thing to hear. Brass is weighty, but sparkling in detail. Percussion which is the soul of "Iberia" is sharply graven and its transient contour faultlessly clean. The sonorous impact of the opening bars of "Iberia" is fabulous and sets a whole mood of expectant excitement. Best of all, remember as you listen to this wonderful recording of "Iberia" that some day, not too far distant, you'll be able to hear it in the matchless glory of *three-channel* stereophonic sound. I've heard it and the experience is beyond description.

BEETHOVEN

SYMPHONY #6 (PASTORALE)

Boston Symphony Orchestra conducted by Charles Munch. Victor LM-1997. RIAA curve. Price \$3.98.

With 16 previous recordings of this work in the LP catalogue, this 17th version does not stimulate me to take offense at duplication, but rather I protest that inundation is the

more appropriate term! Still, everyone wants to get into the act and I suppose we will eventually get immersed to the idea. Munch's contribution is a fairly straight-forward exposition of the "Pastorale" . . . a good unpretentious reading, somewhat lacking in poetry and drama, but clean of line and never overly fussy. The magnificent playing of the Boston men is one of the larger attractions, as is the sound which is well balanced, wide in frequency, dynamics, and with persuasively "live" acoustics. One cheering thought . . . this will probably soon be issued as a two-channel stereo!

STRAVINSKY

SONG OF THE NIGHTINGALE (SYMPHONIC POEM) PULCINELLA SUITE

L'Orchestre de la Suisse Romande conducted by Ernest Ansermet. London LL1494. RIAA curve. Price \$3.98.

The "Song of the Nightingale" is a symphonic poem or suite made up of music from Stravinsky's opera "Le Rossignol." The fine Angel recording of the opera was reviewed in these pages recently and for those people who may have been fascinated by the music but who found the singing and the French dialogue hard to digest . . . this purely orchestral version should be particularly welcome. Ansermet is at the top of his form in this work and his interpretation gives ample evidence that his reputation as one of the great conductors of Stravinsky's music is well deserved. The Pulcinella recording is interesting to compare with Stravinsky's own performance on a Columbia LP. Ansermet essays a slighter slower pace than does Stravinsky and generally does not get as much "zip or bounce" in his reading. Otherwise, Ansermet's ideas are remarkably parallel with Stravinsky. There is a wider gulf between the two recordings in matter of sound quality. The Columbia disc has modern wide-range sound, with excellent orchestral balance, and a full-bodied string tone. On the negative side, it has excessive pre- and post-groove echo. The London disc is a real whiz. The over-all sound has a much smoother, more refined quality than the coarser Columbia. In the highly atmospheric "Song of the Nightingale," there is a great variety of percussion . . . some of which is very subtle and a challenge to the powers of definition of any hi-fi system. All told, with the fine playing Ansermet elicits from his men and the fascinating subject matter, this is one of the most highly listenable recordings in recent months.

BACH

THE SIX CLAVIER PARTITAS (CLAVIERÜBUNG VOLUME 1)

Agi Jambor, pianist. Capitol PBR8344. RIAA curve. Price \$7.96. Two discs.

This is Capitol's first multiple record album and they are to be commended for their courage in issuing something as relatively esoteric as these Bach "Partitas." Mme. Jambor is a most sensitive and perceptive artist of considerable taste and objectivity. If she chooses to use the piano as her vehicle rather than the harpsichord, that is her concern, and we should not arbitrarily place a stigma on her for lack of authenticity. Admittedly the splendid Haydn Society version with Kirkpatrick at the harpsichord is a model of conformation, and good as Mme. Jambor is, she does not yet challenge the stature of a Kirkpatrick. However, her performance is completely honest, and if she can conquer a certain reticence in her playing and imbue the score with more warmth, hers will be a talent worth watching. The sound the Capitol engineers afford her is of a magnificence that more than atones for her minor sins of performance. One of the most beautifully natural-sounding piano recordings yet made . . .

RADIO & TELEVISION NEWS

exceptional in its clean delineation, pristine in its transient response, wonderfully "live" sounding in the felicitous acoustics and the chaste quietness of the surfaces.

RAVEL

BOLERO
RHAPSODIE ESPAGNOLE
LA VALSE
DEBUSSY

PRELUDE TO THE AFTERNOON OF A FAUN

Boston Symphony Orchestra conducted by Charles Munch. Victor LM-1984. RIAA curve. Price \$3.98.

"The Virtuoso Orchestra," as this disc is so aptly titled, is intended as a showcase for the Boston Symphony Orchestra and conductor Charles Munch's proclivities for the colorful repertoire of his native France. As the titles indicate, there is nothing new here, the works merely serving as vehicles for an amazing orchestral and conductorial *tour de force*. There will undoubtedly be some who will hurl the epithet "overblown" at these performances and sound, but I don't think anyone would deny that they are exciting! The "Prelude" is well done but too slow-paced for my taste . . . the "Bolero" and "Rhapsodie Espagnole" rank with the very best performances on record, and Munch's "La Valse" is surpassed only by the towering Paray reading. The sound here is one of the best efforts yet by Victor. There is a taut urgency, an intensity in the sound, that is almost overwhelming. Very wide in frequency and dynamic range, the transient response clean and unbridled, and a spacious acoustic perspective, all contribute to the outstanding realism of the sound. The definition of the string choirs, the punchy brass, the famed smoothness of the Boston woodwinds, and the measured impact of the percussion are quite beyond previous listening experience with the Boston group. One wonders, in fact, if "something new has been added," to the Victor processing armamentarium . . . like a new cutterhead or cutter amplifier, or some such thing. At any rate, one of the very best recordings in the whole of the Victor catalogue and highly recommended.

GRIEG

PIANO CONCERTO IN A MINOR
RCA Symphony Orchestra, Alfred Wallenstein conducting.

LISZT

CONCERTO #1 IN E FLAT
RCA Symphony Orchestra, Alfred Wallenstein conducting.

RACHMANINOFF
CONCERTO #2

RHAPSODIE ON A THEME OF PAGANINI
Chicago Symphony Orchestra, Fritz Reiner conducting.

Artur Rubenstein, pianist in each selection. Victor LM-6039. RIAA curve. Price \$7.96. Two discs.

Once again a generic title, "The Concerto", which merely serves as a "packaging medium" to display the prowess of the great Artur Rubenstein, in four of the most popular piano works in the concert repertoire. When Artur Rubenstein is "right," he is literally untouchable in quality of performance, and although the work of two different recording sessions is in this album, his playing is on an exalted plane in both. It is a pity that Rubenstein could not have had better support from Wallenstein, whose accompaniment in the Grieg and Liszt was quite ragged. Lack of rehearsal time, perhaps? I know Wallenstein can do better than this. In spite of his handicap, Rubenstein runs through the works with that fantastic grace, that assured composure

A beautiful home for your high fidelity components

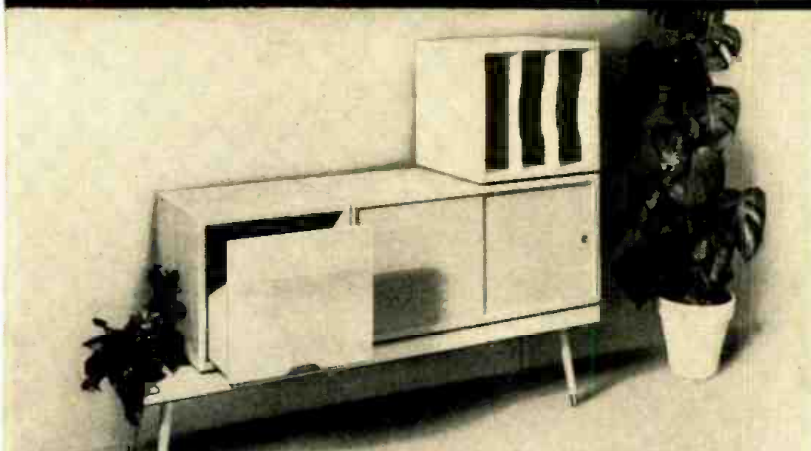

with the new MODULAR Series "100"

VERSATILE!
FROM 5 BASIC UNITS - DOZENS OF BEAUTIFUL COMBINATIONS!

FINE FURNITURE!
Birch hardwood which accepts a finish to match your fine furniture.

FINISH OR ASSEMBLE!
Anybody can do it. Complete instructions . . . every piece clearly lettered . . . all materials supplied.

Fine modular hardwood furniture in kits, or as assembled units ready to finish

. . . planned to go together in dozens of interesting ways. Equipment cabinets are engineered by audio experts to protect high fidelity mechanisms. The speaker enclosure is acoustically right, artistically in keeping, and mechanically correct. Start now to build your own grouping with River Edge modular units. You'll have a custom-look job that will fill you with pride.

EQUIPMENT CABINET	SPEAKER ENCLOSURE	RECORD CABINET	PLAYER CABINET	60 BENCH
				
Model 100. Holds record player, or tape recorder, tuner, amplifier. Kit \$39.50 Assembled \$48.50	Model 110. Bass reflex for speaker up to 12"; with tweeter to 9"x12". Kit \$38.50 Assembled \$48.50	Model 120. Three separated storage sections. Kit \$24.50 Assembled \$31.50	Model 130. Holds record changer, transcription turntable with 12" arm; or tape deck. Kit \$24.50 Assembled \$31.50	Model 140. Supports the units shown. 4 wooden legs with brass ferrules. Kit \$39.50 Assembled \$48.50



RIVER EDGE

A quality endorsed product of the B.I.C. Group

SEE your high fidelity dealer. WRITE for the Customized Cabinet Guide.



RIVER EDGE SALES CORP., Dept. VA-47
Port Washington, N. Y.

Please send Customized Cabinet Guide.

Name _____

Address _____

City _____ Zone _____ State _____

Learn to build COMPUTERS

Work at home, a complete program of study, no math necessary. Suitable for technicians, electronic instructors, engineers. Covers fundamentals of digital and analog computers. Kit of parts. Over 30 courses to choose from. Low cost. Catalog free.

OLIVER GARFIELD CO.
Dept. RT-17 31 Broadway New Haven, Conn.

AMPLIFIER CORP OF AMERICA

TWIN TRAX TAPE RECORDER REPAIRS

ELECTRONIC MAIN. CO.
172-24 Jamaica Ave.
Jamaica 32, New York

The only DIRECT Factory Service Station In U.S.A.

ENGINEERING

B.S. DEGREE in 27 MONTHS

Prepare for unlimited opportunities of the Electronic Age! Earn your B.S. degree in 27 months at Indiana Technical College. Intensive, specialized course. Comprehensive training in electronics, television, advanced radio theory and design, math and electrical engineering. Modern laboratories. Low rate. **B.S. DEGREE IN 27 MONTHS** in Aero., Chem., Civil, Elec., and Mech. Engineering; in 36 MO. in Math., Chem., Physics. Also preparatory courses. G. I. also. Enter March, June, Sept., Dec. Earn part of your expenses in Fort Wayne while studying. Catalog.

INDIANA TECHNICAL COLLEGE
917 E. Washington Blvd., Fort Wayne 2, Indiana

Please send me free information on B.S. ENGINEERING DEGREE IN 27 MONTHS as checked.

Electronics Chemical Aeronautical
 Civil Mechanical Electrical

Name _____

Address _____

NOT EVERYONE APPRECIATES THE HARTLEY

It is a proven, scientific fact that musical sounds *DISCRIMINATE*. They give more listening pleasure to one person than any other, due to the ability of some blessed ears to hear true pitch. Those of you who belong to this fortunate group will truly understand and appreciate the greatness that is the Hartley 215 Speaker system.



THE SPEAKER THAT PRODUCES NO SOUND

Whether it be a fanfare of trumpets or the roll of a drum, the sound of the instruments—nothing else—comes through the Hartley Speaker system. It is free from resonance—free from distortion. Laboratory tests confirm this statement.

REALISTIC HIGH FIDELITY

Substitute a Hartley 215 in any system and immediately you will hear the amazing difference. Designed by H. A. Hartley, famous audio consultant, it will provide you with the best sound reproduction possible, outperforming speakers of larger size.

Hartley 215 Speaker Systems

The renowned Hartley Baffle, with one, two, three or four drivers. Prices start at \$115.75 for the complete system. At franchised dealers or write for details:



HARTLEY PRODUCTS CO.

DEPT. 20 • 521 East 162nd Street
New York 51, N. Y.
LUDlow 5-4239

Now available at:

Grand Central Radio
124 East 44th St.
New York, N. Y.

Listening Post
2290 Fillmore St.
San Francisco, Calif.

Rabson's
119 W. 57th St.
New York, N. Y.

Olin S. Grove
2904 Telegraph Ave.
Oakland, Calif.

that marks his best efforts. It is a different story in the Reiner sessions where a most splendid rapport is much in evidence. With the richly sonorous, ultra-precise Chicago orchestra aiding and abetting him, Rubenstein makes of the two Rachmaninoff works testimonial of his incredible skill... a sonic legacy that probably will be studied in later years as models of their kind. It is difficult to conceive of a more positive statement on the Rachmaninoff works than Rubenstein here affords. The fire and dash of his technical brilliance, the compelling warmth and depth of feeling with which he imbues his traversal of the scores, all add up to an unforgettable musical experience. Soundwise, the Wallenstein sessions are good but unspectacular and not particularly distinguished. The Reiner sessions, on the other hand, are noteworthy for the splendid balance between piano and orchestra, the magnificent huge "liveness" of the piano tone afforded by the extraordinary acoustics of Orchestra Hall, the clarity and weight of the rich orchestral fabric. Don't fail to hear this album!

MARCHES FOR TWIRLING

Frederick Fennell conducting Eastman Symphonic Wind Ensemble. Mercury MG 50113. RIAA curve. Price \$3.98.

I've about run out of superlatives for Fred Fennell and his fabulous band recordings. If you like the measured tromp of marching feet, the color and gaiety of a parade, the splendid brazen voice of a mighty band, you can't fail to like the series of band recordings he has made for Mercury. This is the latest and one of the greatest and the repertoire should appeal to just about everyone. Band-King Sousa is represented by four of his pulse stirrin' specials, these being the "Stars and Stripes Forever," "The U. S. Field Artillery," "Semper Fidelis," and "Manhattan Beach." Among other favorites are Bagley's "National Emblem," Goldman's "On the Mall," and Bigelow's "Our Director." As usual the fidelity is positively hair-raising, with the OOM-PAH of the brass, the multi-hued voices of the woodwind, the soul-satisfyin' WHUMP of the bass drum, and shattering impact of cymbal reproduced with maximum articulation and lack of transient distortion. Dynamic range is almost dangerously extreme for some of the cheaper, poorly balanced phonograph pickups. Given top-notch equipment and a big speaker system, when played at the psychological approximation of concert-hall level, this will shake the fillings out of your teeth!

SCHUMANN

PIANO CONCERTO IN A MINOR SCENES FROM CHILDHOOD

Walter Gieseking, pianist. Herbert von Karajan conducting Philharmonia Orchestra. Angel 35321. RIAA curve. Price \$4.98.

For my money, this is the best Schumann Concerto since the late Dinu Lipatti's reading on an early Columbia LP. It is true that age has made some inroads on the technical command of Gieseking... he misses notes here and there, and commits other minor flubs. But one can forgive these occasional lapses for the privilege of hearing this Concerto come to life with Gieseking's remarkable insight and understanding of the score. One can savor his delicate phrasing, his brilliant play on dynamics, the care he lavishes on seeming minutiae, and the still greater care that these details do not become fussiness, nor his approach too pedantic. Karajan furnishes a most sympathetic accompaniment, and under his urgings the splendid Philharmonia responds with playing of great warmth and precision. In the "Kinderscenen," Gieseking has competition from several other fine artists, notably Novaes and Curzon, but still

makes off with top honors. Soundwise, the recording is good but not outstanding. Somehow it all seems a little cramped and does not have the usual open fullness typical of Angel concerto recordings. Piano and string tone *per se* are fine, everything is quite clean and near distortionless. In the over-all view, the restriction on the sound is noticeable but it's not so obtrusive that you can't lose yourself in the excellence of the performance and enjoy yourself quite thoroughly.

Stereophonic Tape

BACH

BRANDENBURG CONCERTOS (COMPLETE)

Jascha Horenstein conducting anonymous orchestra and soloists. Phonotapes Sonore PMI36. Two 7" reels, half track, 7½ ips. NARTB curve. Price \$13.90.

This is presumably the first two-reel tape release in the pre-recorded tape field. Certainly the "Brandenburg Concertos" would have to be issued in this format because of their length. The tape box is very cleverly designed so that when closed it has minimum bulk and looks like a somewhat obese single tape box, yet it contains the two tapes quite neatly and with a maximum of protection. The performances are quite good and, of course, have been widely admired when they were originally issued on Vox Records. The sound of the disc was quite good and these tapes are more so by a considerable margin. One notices the immediate improvement of inner detail, quite important in the "Brandenburg," the improved transient response, and the enhancement of the dynamic range. Frequency response appears to extend to the upper limits of the spectrum and I particularly listened for "blast overload" distortion in the brass parts, a common failing both in records and tape when Bach trumpets are played hard in the higher registers, and this effect was quite minimal. Hiss was noticeable but not obtrusive.

MOTORBOATING IN A TRANSISTOR PORTABLE

By JAMES A. McROBERTS

AN RCA Victor transistor portable (Model 7-BT-9J) developed motorboating on reasonably loud sound passages.

The cure consisted of installing an additional bypass capacitor of 50 µfd., 25 volt rating across the power bus and chassis. The "hot" power bus is positive in this set. Due to compactness of the unit, the added capacitor was installed over the existing capacitor C₁₅, near the output stage.

As the partial schematic below shows, the added 50 µfd. capacitor is a bypass on the final audio stage (class B) which has large fluctuations of current drawn from the battery. For most sets, the decoupling filter of R₁₈ (100 ohms) and C₁₅ (45 µfd.) suffice to keep the second audio ripple out of the preceding audio stage and the remainder of the set. The filter and the inherent filtering action of the battery was not sufficient in this instance, however.

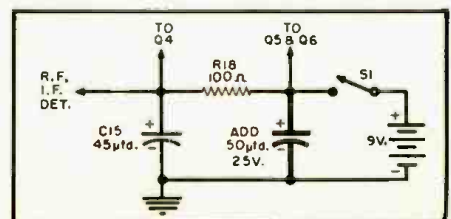

RADIO & TELEVISION NEWS

Two-Way Speaker Operation (Continued from page 50)

the improvement may prove startling. Full benefit from the possibilities may be obtained only with the flexibility this system affords.

For these experiments a wide-range ceramic pickup was used and although this pickup is not required to have equalization and the low-frequency speaker system was perhaps somewhat better than average (a 15-inch unit in a 12-cubic foot enclosure), it was found that a full 20 db of bass compensation was not at all excessive and, in fact, was enormously pleasing at low volume levels with proper adjustment of high-frequency gain. This corresponds to 20 db of bass equalization beyond that ordinarily present in systems using a constant velocity pickup.

With this system, operated as described, it is no mere figure of speech to say that the reproduced music takes on a "dimensional" quality. This is not an apt description, but it is perhaps the nearest approximation the language affords. Individual notes assume an identity they never had before. Even faint, high ones are not lost in the shuffle or masked by the bass. There is no way to describe the bass. Every note stands out, with a vibrantly realistic quality that defies description, but strangely even when very loud, does not mask the high notes. All notes, of whatever pitch, take on added luster.

It is interesting to note that while the amplifier gain controls may be said to act as tone controls in that they modify frequency response, there the similarity ends. Their effect is unlike any conventional tone control. Tone controls roll off one end or the other of the range and are, therefore, essentially restrictive devices, whatever they may be called. But operation of the separate gain controls in this system is restrictive only incidentally (and is a result either of the ear's nonlinearity or proximity of the crossover point) from the standpoint of frequency. Even so, it affects several octaves uniformly and independent of frequency, a radically different effect than that of a conventional tone control.

To illustrate, operation of a treble control so that noticeable roll-off of high-frequency response occurs, creates an impression that something has been lost, a quite accurate impression. But in this system reproduction of high-frequency gain, within reasonable limits, of course, creates no such impression. Nothing has been lost, one feels. It has merely moved away from you.

A master gain control in addition to the individual ones would be a convenience, but since its design would depend on many variable factors, it has not been incorporated in the schematic shown.

ARKAY Kits . . . lead the field

new!

ANOTHER ARKAY WINNER!!

SPECIFICATIONS:

POWER—30 watts @ 1% IM.
FREQ. RESPONSE $\pm 1/2$ db.—20-50,000 cps.

HUM—120 db. below rated output. Actually zero.

CONTROLS—(6) Func. selector, loudness, bass, treble, level set, 5-position level compensation control.

- 2 EL-34/6CA7 Super-Lin Williamson
- Special Output for Simultaneous Tape Recording and Monitoring



\$49.95

ARKAY Model FL-30 Hi-Fi AMP-PRE-AMP

Featuring a transistorized front end for use with a reluctance pick-up, this engineering masterpiece assures the finest in Hi-Fi reproduction for more than 30 labels (LP, RIAA, & EUR). Complete with rose gold panel and black cabinet.



ARKAY Model FL-10 Hi-Fi AMPLIFIER

A super lin. Williamson 12-watt Hi-Fi amplifier with built-in pre-amp. 18 watt peak with a frequency response of 20-40,000 cps. 4 controls including record equalization (LP, RIAA, EUR). Output impedances, 4, 8, & 16 ohms. Special output for simultaneous tape recording and monitoring.

\$28.95



ARKAY Model B-8 Hi-Fi Speaker System

Frequency Response: 10 to 20,000 cps. Crossover Frequency: 1600 cps. Power Rating: 25 watts. Impedance 16 ohms. Features a bass reflex, ducted port enclosure equipped with a low frequency speaker and a compression driven horn of special design. A variable balance control w/ network provides smooth continuous adjustment of the H/F speaker. \$35.95



ARKAY Model FM-6 FM Receiver Kit

4 UV sensitivity for 30 db. quieting, A.F.C. . . . grounded grid front-end; Foster-Seeley Discriminator. Temperature compensated oscillator circuit. 4 double tuned IF stages, limiter and discriminator give top selectivity and sensitivity. Built-in transformer operated power supply. \$25.75 Fed. Tax Incl.



ARKAY Model HFT-7 Hi-Fi AM-FM Tuner

4 UV sensitivity for 30 db. quieting. AFC with provisions for erase. Allows pinpoint, high selectivity tuning. Foster-Seeley discriminator, high efficiency AM loop stick antenna and temperature compensated oscillator circuit. Built in transformer operated power supply.

Now! Wired & Tested \$49.95
Kit Less Cover \$32.00
Cover for Above \$3.95
Fed. Ex. Tax Incl.



ARKAY RADIOS

Arkay manufactures a complete line of radios unmatched in the industry in quality and performance. They include: transistor portables, table models, multiband receivers, portables, and many other models. There is certain to be one to fit your requirements.



ARKAY Model 14T21 new! TV KIT

Very latest design used in sync. circuits results in excellent stability with extremely low noise characteristics. A. G. C. circuit results in maximum sync. hold characteristics. The only vertical chassis construction, series-string-heater type tubes, vertical retrace blanking circuits, and many more features. \$79.50

FREE!

GET THE NEW, BIG CATALOGUE & SPECIFICATIONS OF THE REMARKABLE ARKAY LINE—NOW AT YOUR LOCAL DEALER!

Prices 5% higher West of the Mississippi

ARKAY · 120 Cedar Street · N. Y.

EASY TO LEARN CODE

It is easy to learn or increase speed with an Instructograph Code Teacher. Affords the quickest and most practical method yet developed. For beginners or advanced students. Available tapes from beginner's alphabet to typical messages on all subjects. Speed range 5 to 40 WPM. Always ready—no QRM.

ENDORSED BY THOUSANDS!

The Instructograph Code Teacher literally takes the place of an operator-instructor and enables anyone to learn and master code without further assistance. Thousands of successful operators have "acquired the code" with the Instructograph System. Write today for convenient rental and purchase plans.



INSTRUCTOGRAPH COMPANY

4711 SHERIDAN ROAD, CHICAGO 40, ILLINOIS



college grads get ahead faster!

. . . have higher incomes . . . advance more rapidly. Grasp your chance for a better life. Share rewards awaiting college-trained men. Important firms visit campus regularly to employ Tri-State College graduates. Start any quarter. Approved for Vets.

Bach. Sc. degree in 27 months

Complete Radio Eng. courses (TV, UHF, FM, Electronics). Also Mech., Civil, Elec., Chem., Aero., Eng. 36-months in Bus. Adm. (Gen. Bus., Acctg., Motor Transport Mgt.). Superior students faster. More professional class hours. Small classes. Enrollment limited to 1550. Beautiful campus. Well-equipped labs. Prep courses. Enter Mar., June, Sept., Jan. Earnest, capable students (whose time and budget require accelerated courses and modest costs) are invited to write Jean McCarthy, Dir. Adm., for Catalog and "Your Career in Engineering and Commerce."



TRI-STATE COLLEGE

1617 College Avenue Angola, Indiana

for
changer
convenience
and
turntable
performance

the direct-drive

THORENS

CD-43



the only changer with
complete published
wow, flutter, rumble
performance figures

RUMBLE: for E 53 N motor mounted on CD-43, CBA-83, CB-33 and E-53PA units. (Reference level: 2.6 cm/sec., 1000 cps.)

	Total rumble level	100 cycle rumble	low frequency rumble
Best units.....	-52 db.	-53 db.	-55 db.
Average.....	-50 db.	-51 db.	-53 db.
Lower limit for all units equipped with E 53 N motors	-48 db.	-49 db.	-52 db.

FLUTTER: Less than 0.1%.

WOW: Less than 0.3%. Tests made with the standard 12" turntable weighing 2½ lbs.

These measurements are minimum quality control standards which must be met or exceeded by every THORENS RECORD CHANGER, PLAYER AND TURNTABLE!

ask your dealer to
demonstrate **THORENS**

Write for Thorens Catalog.



Realistic High Fidelity

(Continued from page 66)

is that portion of the output volts fed back to the input. It is usually given the Greek letter *beta*, β . Obviously β cannot be greater than unity, and if there is no feedback then it equals 0. If the gain of the amplifier is expressed in db, then β can be expressed in db. If we call the amplification of the amplifier *A*, without feedback, then the amplification after feedback is $A/(1 + \beta A)$. You may find this formula in textbooks with the sign in the denominator negative, but if it is negative feedback then β carries a negative sign itself, so my formula is finally correct. If in this formula you call *A* distortion or output tube plate resistance, these parameters are reduced by the same amount. So negative feedback reduces gain, distortion, and the effective plate resistance of the output tubes.

Reducing gain seems a futile sort of thing to do but it is quite important. In the absence of feedback the amplifier will have a certain frequency response, and it will tail off in the bass and treble. If, now, negative feedback is applied, it will be clear that less voltage will be fed back in the bass and treble simply because the output voltage is less, so there will be less loss of gain at each end of the frequency response and the feedback amplifier will show a wider flat response than the original. It sounds wonderful, which is why it is used so frequently, but now creeps in a very serious liability.

Change of phase occurs in every tube and every *RC* coupling. With triode output stages more amplification is needed than with tetrodes or pentodes, perhaps even to the extent of having to provide an extra stage to do it. At any rate the phase change in a multi-stage amplifier can become so progressively great that the negative feedback is changed into positive feedback and the amplifier becomes unstable.

Take only the bass roll-off in an ordinary *RC* amplifier. This usually results from a short time-constant in the interstage couplings and inadequate bypass capacitors. A generously designed amplifier not only uses large plate-grid capacitors but large bypass capacitors and a time-constant is chosen to avoid bass roll-off. Now it can be shown mathematically and experimentally that the conditions which cause bass roll-off cause large phase change. If, therefore, negative feedback is used to compensate bass loss, phase change may convert it into positive feedback. An indifferent amplifier can therefore be made better only by using limited feedback, and the final result will be less good than an originally well designed amplifier without feedback.

Remember this golden rule at all times: negative feedback is of real

service only to an amplifier that is very good without feedback.

Unfortunately a further complication now arises. Suppose you want to use a lot of feedback to reduce the output plate resistance (and consequently improve the damping factor). Your good amplifier has a fine bass response, even if it has several stages of amplification. Let us suppose that it is flat down to 20 cps and then rolls off to 2 cps. The phase shift at the lowest frequencies will be so great that you cannot use the amount of feedback you would like, and the amplifier will motorboat. The ideal amplifier for use with negative feedback must be provided with a response which absolutely cuts off all frequencies below a certain useful point. There are parallel arguments for the treble end, too, which need not be considered at this stage; I need only say that your basic good amplifier must have a level and undistorted response (within reason, of course) between the predetermined limits, and then cut off abruptly in both bass and treble by including suitably designed step circuits. (See Fig. 36.) Then, and only then, you can apply negative feedback and make a fine job better.

Negative feedback cannot increase the undistorted output of any power stage. If an amplifier without feedback gives, say, 10 watts with 2% distortion, application of negative feedback may reduce the distortion to 0.5% but if, as a result of the decreased gain you boost the input in the hope of getting more than 10 watts with 2% distortion you will find it is not possible. A simple demonstration will prove this.

Use an audio oscillator to drive your amplifier and with a resistive load on the output transformer secondary to equal the speaker impedance marked on the transformer, connect an oscilloscope across the load. Set the oscillator to any frequency you like, but 1000 cps is a very safe one. Any amplifier ought to be able to handle that frequency without distortion. Disconnect the feedback circuit. If there is variable feedback, so much the better. Using a sine-wave input, adjust the volume control until the tube picture is just not flat-topping, and note the height of the trace above the datum line. If you increase the input or turn up the volume control, the sine wave will now take on a flat top, getting a wider flat as you increase the signal to the output stage, but the trace won't get any higher.

Now connect the feedback circuit. The flat top will disappear because you have reduced the gain of the amplifier and so the output stage is not overloaded. You can increase the input until the flat top is on the point of appearing again, and if you have variable feedback you can increase the input still more and cut out the flat top by increasing feedback. But you can't heighten the trace. In other words, you can't get more power out of the tubes.

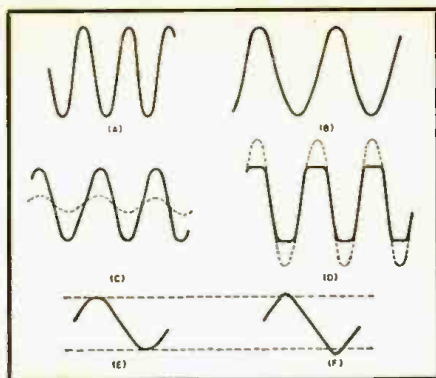

Fig. 37. Oscillograms illustrating the effects of negative feedback.

Fig. 37 shows tracings from an oscilloscope screen. Fig. 37A shows several cycles of a sine wave. These are too crowded since the sides appear to be nearly straight. Use the horizontal amplifier in the scope to widen the trace so that it looks like Fig. 37B. It can now be seen that no part of a sine wave is a straight line. Fig. 37C shows three sine waves; the dashed trace shows a rather small amplifier output, the solid trace the full undistorted output of the amplifier. If the output is further increased, the tops and bottoms of each cycle will be flattened, as shown solid in Fig. 37D. The sides seem to be straight but this is only an illusion similar to that in Fig. 37A. To compensate for the increased vertical amplitude (the dotted peaks in Fig. 37D show what the trace would be like with a larger output stage) the horizontal amplitude should be proportionately increased to simulate the conditions of Fig. 37B. Applying negative feedback to Fig. 37D will reduce the vertical amplitude and return it to conditions shown at Fig. 37C. Fig. 37E shows one cycle of a pure sine wave. If negative feedback is used to get slightly more output before flat-topping begins, the trace of Fig. 37E will be changed to that shown in Fig. 37F. The dotted horizontal lines indicate the height of Fig. 37E transferred to Fig. 37F. The gain is slight and the sides are straighter.

It is sometimes rather difficult to spot the divergence from a pure sine wave of the trace on a small tube. The fed-back distortion cleans up the wave shape but when maximum undistorted power is reached and further input or volume (gain) is applied there will be a *very slight* increase of height with feedback and the waveform will look sinusoidal; actually, however, the sides of the wave will be slightly straighter, implying some distortion. Without feedback the change in waveform is rather gentle until flat-topping starts, and it may be thought that the amplifier is performing better than it really is. With feedback the shape is seen to change quite suddenly. Feedback, therefore, reduces distortion before overloading starts, but the overload point is reached suddenly, from a practical point of view, with no greater output than that obtainable from an amplifier without feedback.

NOW THE

improved

SHURE

UNIDYNES

the world's most widely used fine microphones

PROVIDE

- 41% higher output!
- The perfect microphone choice for use with low-gain P. A. systems and tape recorders... in addition to their famed usage in finest quality public address systems.

The best is even better!

The unidirectional dynamic Unidynes are now more than ever your best choice in those installations where feedback is a problem, and for all fine-quality public address, theatre-stage sound systems, magnetic recording and remote broadcasting—where critical standards call for the finest-quality microphone operation.

Another example of the continuous creativity of the Shure Research and Development Laboratories.

55S Unidyne List Price \$79⁵⁰

556S Broadcast Unidyne

List Price \$120⁰⁰

IN ELECTRONICS SINCE 1925

The Mark of Quality

SHURE

SHURE BROTHERS, INC.

Microphones ~ Electronic Components

210 HARTREY AVENUE • EVANSTON, ILLINOIS



First Place

Twenty-four leading phono pickups have now been tested by The Audio League. The ESL Professional and Concert Series remain in first place.

These Audio League tests show that ESL electrodynamic cartridges are tops in smoothness, clarity, and naturalness of reproduction.*

In addition, record and stylus life are greatly extended by the ESL, which in this way saves the purchaser many times its own cost.

Join the musicians, engineers, and music lovers who have switched to the world's most advanced cartridge. Write for details and, even better, hear the difference at your dealer's.



FOR LISTENING AT ITS BEST

Electro-Sonic Laboratories, Inc.

Dept. R • 35-54 Thirty-sixth Street • Long Island City 6, N.Y.

Soloist Series from \$14.95 • Concert Series \$35.95 • Professional Series arm and cartridge \$106.50

*Authorized quotation No. 57. Please consult The Audio League Report, Vol. 1, No. 6-7 (March-April 1955) for the complete technical and subjective report. Subscription: 12 issues \$4. from P. O. Box 262, Mt. Vernon, N. Y.

THE VERY BEST IN CUSTOM TELEVISION

BY **TECH-MASTER**

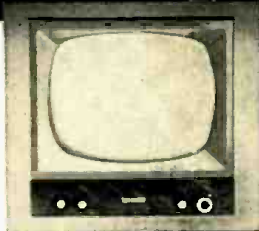
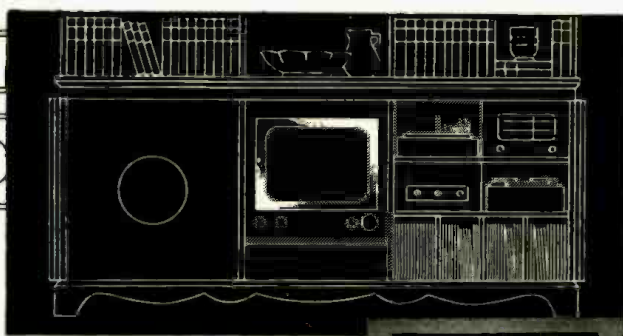
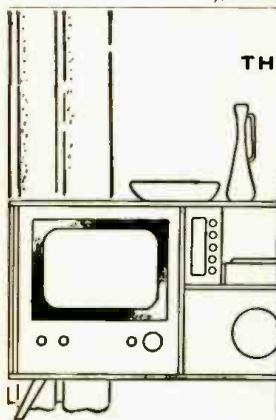

FOUND IN THE FINEST OF INTERIORS

As the custom installation signifies the ultimate in well-chosen decor . . . so the name Tech-Master stands for the utmost in Custom television. The reputation established with the manufacture of the renowned Model 630 chassis is further enhanced by the outstanding Tech-Master Audiophile and Sound Theatre.

See your Custom hi-fi dealer today . . . or write
TECH-MASTER CORPORATION
75 FRONT STREET, BROOKLYN, NEW YORK

ONLY TECH-MASTER HAS THESE OUTSTANDING PLUS FEATURES:

- World-famous 3 tube synchrolok picture circuit for constant picture stability. • 30 tubes fully used. • "Full Frame Mounting" . . . just a simple cutout is required for installation.
- High fidelity picture as well as exceptional audio reproduction.

The characteristics of the power output stage will be discussed more fully in the next article. For the moment it need just be pointed out that negative feedback, by reducing the effective plate resistance of the output tubes, provides a more favorable load impedance/plate resistance factor, thus improving the speaker damping factor and making tetrodes and pentodes more like triodes without impairing their better power efficiency.

The other point to be mentioned here is that the power output figures given in the tube manuals presuppose the use of a pure resistive load, and the load lines drawn on the characteristic curves are straight lines. The distortion can, therefore, be computed by simple graphical methods. But the load formed by an output transformer and speaker is not a pure resistive load but a reactive one. This has to be shown on the curves as an ellipse. The implications of this may not be quite clear to you for the moment, but it does mean that a reactive load reduces the undistorted output from the stage as compared with that obtained with a pure resistive load.

All these factors I have described have to be taken into account when considering the accuracy of my 3, 6, and 11-watt postulates. These are peak undistorted outputs and the mean output will be considerably less than that. But we have no room for distortion on peaks when providing realistic sound reproduction; it must be undistorted all the time. To provide a safety margin to take care of all the extraneous sources of distortion the simplest way is to use a bigger output stage and the margin I would suggest is 100%. So my figures for the three types of speakers first mentioned are, roughly, 7, 15, and 25 watts.

The danger is that with the extra power you may be tempted to run the volume a little louder than necessary and get distortion on peaks. Many equipments sound bad because they are overdriven, not because they are inherently bad.

(To be continued)

COGWHEEL EFFECT

By JAMES A. McROBERTS

THE Zenith 19L25 chassis displayed the wavering circles on the test pattern and in the pictures which are characteristics of the "cogwheel" effect. The 1 megohm resistor (R_{72}) connected between pins 1 and 2 of the 6AQ7GT had changed value to 1.5 megohm. Since this was originally a $\pm 10\%$ resistor, the resultant unbalance in the horizontal a.f.c. circuit caused it to hunt or oscillate about the horizontal oscillator frequency so that the cogwheel or piccrust effect would occur whenever an appreciable frequency difference existed between the incoming sync and the local horizontal oscillator frequencies.

When replacing resistor R_{72} , note that it has a mate, also labelled R_{72} between pins 2 (cathode) and 3 (another diode plate) of the 6AQ7GT. These two resistors should be equal in value rather than arbitrarily 1 megohm, $\pm 10\%$, so select for balance rather than tolerance. —30—

RADIO & TELEVISION NEWS



another
EXACT
REPLACEMENT
first



MDF-82 for exact replacement in over 30 DUMONT models and chassis; equipped with octal plug and ground clamp. Another in the complete line of exact transformers, yokes and coils. Merit is the only manufacturer of transformers, yokes and coils who has complete production facilities for all parts sold under their brand name.

MERIT

MERIT COIL AND TRANSFORMER CORP.
4427 N. CLARK ST., CHICAGO 40, ILLINOIS



What's New in Radio

TRANSISTOR RADIO KIT

Tran-kit Electronics, 467 South 5th Ave., Mt. Vernon, N. Y., has announced a new addition to its line of transistorized radio kits.

The Model TK-104 superhet uses four transistors and is completely subminiaturized. The circuit is constructed on a printed circuit board. The unit measures only 6" x 4" x 2".

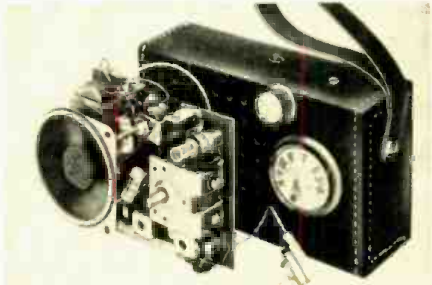

The self-contained speaker delivers 18 milliwatts and an external phone jack cuts out the speaker when the earphone is plugged in.

The kit, including a Texon leather case, comes with complete and detailed assembly instructions.

For full details on this and other kits in the company's line, write Dept. PR of the firm.

LOW-COST METER RELAYS

Simpson Electric Company, 5200 W. Kinzie St., Chicago 44, Ill., is now offering a new and improved series of low-cost meter relays which feature a simplified design with platinum alloy contacts and increased contact force.

Operating on power inputs of less than 50 millimicrowatts, the new relays will control up to one watt, a power amplification of 20 million times. The new units should find wide use in many special applications as well as standard alarm, control, and limit-setting circuits, where it has not been feasible to use meter relays heretofore.

The relays are a non-locking type, currently available in 2" d.c. and 3" a.c.-d.c. models as microammeters, milliammeters, ammeters, millivoltmeters, and voltmeters. Pyrometer types with bimetal compensation are also available.

SUPEREX TRANSISTOR KIT

Superelex Electronics Corp., 4-6 Radford Place, Yonkers, N. Y., is in production on a new transistor radio kit which features advanced circuitry and uses two penlight batteries for power.

The radio will give loudspeaker reception in good locations. The design features a printed circuit, matched transistors and a diode, a "Loopstick,"

BUILD THE BEST— BUILD ALLIED'S OWN knight-kits

ALLIED stakes its 36-year reputation in the Electronics field on your complete success and fullest satisfaction with KNIGHT-KITS. Join the thousands who have discovered the ultimate in kit value in...

knight-kits

LOWEST COST because our giant buying power passes biggest savings on to you... you do the easy assembly and your finished instrument is equal in performance and appearance to equipment selling for several times the KNIGHT-KIT cost. (Easy Payment Terms available, too.)

knight-kits

EASIEST TO BUILD because KNIGHT-KIT "Step-and-Chek" instruction manuals are marvels of clarity—it's just like having a good instructor at your side. Proved professional design and premium quality parts help insure your building success.

knight-kits

MONEY-BACK GUARANTEE: When properly assembled, KNIGHT-KITS fully meet published specifications, or we refund your money.

**WHEN YOU BUILD A KNIGHT-KIT
YOU BUILD THE BEST**

For a Complete Selection of
Famous knight-kits
SEE PAGES 105-111

Available Only From
ALLIED RADIO
100 N. Western Ave., Chicago 80, Ill.

Any 3 JAZZ Albums \$2.98 for

Choose the greatest jazz classics ever recorded... in the jazz style you like best!



4. Modern Jazz: Modern sounds by Mulligan, others. *Summertime, I Hear Music*, etc.



5. Cool Jazz: Great sounds by Charlie Parker and Stan Getz, kings of "modern" sax.



6. Dixieland: *Tiger Rag*, other Dixieland classics, with P. Barbarin, J. McPartland.



7. Swinging Jazz: Jo Jones and Basie alumni swing *Embraceable You, Caravan*, etc.



3. Big Band Jazz: Goodman, Dorsey, Basie, Shaw, *St. Louis Baby, Flat Foot Floogie*, etc.



2. Intimate Jazz: The soft, breathy voice of Lee Wiley sings *My Romance, My Funny Valentine*, etc.



1. Fun in Jazz: Fats Waller, the "Cheerful Little Earful" doing his greatest numbers.

TO INTRODUCE YOU to the superb artistry of these high-fidelity jazz recordings. The Jazztone Society offers you any THREE hi-fi jazz concerts shown above for only \$2.98! Not one record, but three 12-inch, quiet surface, long-playing (33 1/3 RPM) vinyl recordings containing up to 36 of the greatest jazz classics ever recorded!

All the Jazz Styles and All the Big Names

Here are the outstanding jazzmen of our time—interpreting all the important styles. You'll find the big-band jazz of Goodman and Dorsey, the cool sounds of Parker and Getz, the Dixieland stomp of McPartland, the modern, progressive jazz of Gerry Mulligan and many others, all on these superb Jazztone Society recordings.

How to Build a Great Jazz Collection at Huge Cash Savings

With the albums, you'll also obtain a Trial Membership in the Jazztone Society. Each monthly selection will be described in advance. You can ADDITION, in your own home, any or all the Society's releases for five days!

Return any you don't want. Pay only the special Member's price of just \$2.98 each (plus small shipping charge) for those you keep. You save more than 35%. And you may resign any time—after buying three selections during the first year.

Don't miss this opportunity to get 3 complete hi-fi jazz "concerts"—all for only \$2.98. Mail the coupon today!

The Jazztone Society, Dept. 3003
71 Fifth Avenue, New York 3, N.Y.

Send three Jazz Long-Play Albums circled below:

1. 2. 3. 4. 5. 6. 7.
If I keep them, I'll pay only \$2.98 (plus shipping) for all three. Also, enroll me as a Trial Member. Privileges: advance notice of releases; 5 day free trial on all discs; I may reject records before or after hearing them; I may cancel membership any time after buying 3 monthly selections. Future 12" long-play discs only \$2.98 each plus few cents shipping.

Name.....

Address.....

City.....State.....
For info. on Canadian service, address: 105 Bond St., Toronto 2, Ont.

all housed in an unbreakable grey plastic case.

A 16-page instruction book is included with the kit and makes assembly

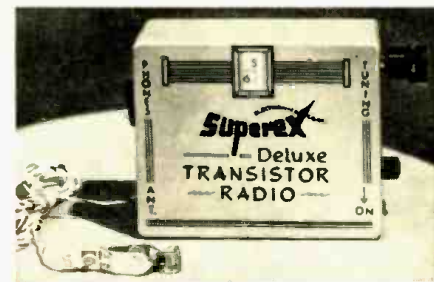

both easy and educational. Write the company for further details and price information.

ONE-INCH ROUND METER

International Instruments Inc., New Haven 15, Conn., is now in production on a new 1" round panel meter for flush mounting.

Designated as the Model 104, the new instrument is said to provide the longest scale arc in the smallest possible panel space. The unit is particularly adapted to portable, airborne, and other similar equipment where a high degree of accuracy must be combined with minimum size and weight.

The meter employs a miniaturized d'Arsonval type movement and accuracy is held to $\pm 3\%$ of full-scale deflection for d.c. instruments and $\pm 5\%$ for a.c. instruments.

Complete information on this new meter line is available from the manufacturer on request.

MODULARIZED RADIO

R & D Electronic Laboratories, Inc., 21-28 45th Road, Long Island City, New York, is now offering a low-priced modularized radio receiver kit in which two modules do the work of sixteen separate electrical parts.

The kit utilizes prefabricated printed circuits with modules, making it possible for the average experimenter to



assemble the set in less than half an hour. There is little wiring to be done and the only tool needed is a soldering iron. The kit comes complete with tubes, modules, printed circuit, speaker, and ivory colored plastic cabinet.

NEW COMPUTER TUBES

Sylvania Electric Products, Inc., is now offering five new electronic com-

RADIO & TELEVISION NEWS

BUY DIRECT FROM FACTORY

THE *New*

Transistorized VTVM-VOM KIT

NO AC source required
Has long battery life because of Transistors

2

PRECISION Lab & Service Instruments in 1

Combines a transistorized VTVM with a precision VOM (Voltmeter-Ohmmeter-Milliammeter) giving you: (1) additional vital functions... (2) instantaneous checking of VTVM readings... (3) eliminates doubtful results often obtained with a VTVM.

Completely self-contained. No AC power required; no vacuum tubes to go bad. Turn of switch converts to VOM. Double checks readings (VOM against the VTVM). Over \$60 in precision parts in kit, such as 1% Resistors, Shunts, Microammeter, etc. Anyone can assemble in a few hours. Only \$10 gets you started; balance in easy payments. Rush order direct to factory:—

TRANSVISION, INC. • NEW ROCHELLE, N. Y.

Transvision, Inc., New Rochelle, N. Y. RN-1
Enclosed find \$..... please send..... Transistorized VTVM-VOM kits.

Name.....

Address.....

City.....Zone.....State.....

\$29 KIT
\$49 assembled
Only **\$10** gets you started



CHROME VANADIUM 29 Pc. DRILL SET

Specially made for speed drilling. In sturdy plastic tool roll. Finest alloy steel deep-fluted and precision ground to the sharpest, longest lasting cutting edge obtainable; will easily and cleanly bite through hardwoods, plastics, aluminum, iron and the toughest steels. Unconditionally guaranteed for thousands of drillings. Full jobber length. Sizes by 64ths from 1/16" to 1/2". Limited quantity available at this low price, so hurry! NOW ppd. \$6.49 Also available with Turned Down Shafts to fit all 1/4" drills. In individual pocket roll, ppd. \$8.95



60 Pc. Set CHROME VANADIUM Wire Gauge Drills

Top quality high test Chrome Vanadium Drills designed for speed drilling through toughest steels, woods, plastic, iron and aluminum. Precision ground, long-lasting cutting edges. Guaranteed to give years of satisfaction. A full 60 pc. set nos. 1 through 60.

A \$14.95 value..... \$5.40
NOW ONLY..... plus 35c pp. & hdg.
Same set above available with Hicut Index..... \$6.65
container—Only..... plus 35c pp. & hdg.

75¢ ea. for Finest Imported PRECISION PLIERS

- Flat Nose
- Combination
- Diagonal Cutter
- End Cutting Nippers
- Round Nose
- One Side Flat—One Side Round
- Snide

FOR JEWELERS, OPTICAL WORKERS, HOBBYISTS, CRAFTSMEN OF ALL KINDS! These superb German instruments are of deep-forged, heat-treated high quality tool steel, fabricated to most exacting specifications. All-over ground and polished to smooth hard surfaces. Smooth working joints with just the right tension. Jaws meet perfectly to safely and securely hold even the most delicate objects in the hard-to-reach corners and angles. Each plier is 4" long and a veritable gem of precision and strength.

75¢ ea. . all 7 for \$5.00 ppd.

SET OF 6 SWISS PRECISION SCREWDRIVERS

Perfect for jewelers, watch-makers, hobbyists, etc. SIX DIFFERENT SIZES: NEW LOW PRICE \$7.25 ppd.

No. 4..... No. 6.....
No. 5..... No. 8.....
No. 3..... No. 10.....
Knurled body grip assures easy handling. Finest steel and craftsmanship. A hard-to-beat value from Switzerland.
Send Check or M.O. C.O.D. fee extra. MONEY BACK GUARANTEE.

SCOTT-MITCHELL HOUSE, INC.
DEPT. M-295, 611 BROADWAY, NEW YORK 12, N. Y.

puter tubes designed especially for the renewal market.

Four of the tubes, designated as the 5915A, 5964, 5965, and 6211, are miniatures. The 5915A is a miniature dual control heptode designed for computer applications involving long periods of operation under cut-off conditions. The 5964 is a miniature medium *mu* dual triode having a common cathode. The 5965 is a miniature twin triode designed for use in high-speed digital computers, each section featuring a high zero bias plate current, a sharp cut-off characteristic, and a separate cathode. The 6211 is a medium *mu* twin triode designed for frequency divider circuits in electronic computers and other "on-off" control applications involving long periods of operation under cut-off conditions.

The fifth tube, designated as the 6888, is an octal-based dual control pentode designed for long life and low failure rate in computers. It is used in pulse amplifier, core driver, and coincidence circuits.

ELECTRONIC SWITCH KIT

Heath Company of Benton Harbor, Mich., is now offering a completely redesigned version of its Model S-2 electronic switch.

The new kit unit allows simultaneous oscilloscope observation of two input signals by producing both signals, alternately, at its output. Four switching rates can be selected by



means of a panel switch. It provides gain for input signals and features frequency response of ± 1 db from 0 to 100,000 cps.

The circuit uses seven miniature tubes. Sync output is provided to control scope sweep. The instrument may also be used for observing input and output of amplifiers simultaneously.

ELIMINATOR-VIBRATOR CHECKER

Electronic Measurements Corporation, 625 Broadway, New York 12, N. Y., is now offering a combination battery eliminator and vibrator checker as the Model 905-6A.

Designed especially for the auto radio service technician, the new unit can supply 6 volts at 10 amps or 12 volts at 6 amps, continuously. The output voltage is variable from 0 to 8 volts or from 0 to 16 volts with smooth d.c. output voltage assured. It can also be used as a battery charger and is ideal for determining the starting points of vibrators.

January, 1957

STOP LOSSES due to inaccurate instruments

CHECK AND ADJUST

Your Test Instruments
with **LABORATORY ACCURACY**



Designed by
MILTON S. KIVER
Author of the Book
"Servicing and Calibrating
Test Equipment"
Published by
Howard W. Sams & Co., Inc.

New 750 **B&K** TEST EQUIPMENT CALIBRATOR

Calibrates VOM, VTVM and other meters, signal, sweep and marker generators and oscilloscopes.

Provides dc and ac voltages for checking voltage ranges of VOM, VTVM and other meters.

Standard resistances from 10 ohms to 10 megohms for checking reliability of each resistance range in VOM and VTVM.

Crystal oscillator generating harmonics over 300 mc for use as marker generator in all receivers, and to calibrate AM signal generator, and to align TV audio I.F. system.

Built-in tone generator for signal tracing amplifiers in all audio equipment. This tone also available at modulated RF.

Oscilloscope voltage calibrator in measuring peak-to-peak voltages of unknown waveforms.



Voltage Accuracy $\pm 1\%$ or Better

Avoid instrument errors that cause wrong decisions and time-killing rechecks in receiver testing. With the new, low-cost, laboratory-type Model 750 Calibrator you can quickly, easily check test equipment accuracy and make necessary adjustments.

Provides standard of $\pm 1\%$ or better in all of its voltage sections—enables you to calibrate your test instruments like the labs do, and give better service at lower cost.

Model 750 Calibrator

Complete with 5 mc crystal. Operates on 110-120 v., 60 c. ac. Sturdy metal case. Size: 8 3/4 in. high, 8 in. wide, 5 1/2 in. deep. Net wt. 6 3/4 lbs.

\$54.95
NET

See Your Distributor or Send For Bulletin 750-N

B & K MANUFACTURING CO.

3726 N. Southport Ave. • Chicago 13, Illinois

Makers of DYNA-QUIK, CRT, DYNA-SCAN and CALIBRATOR



SAVE ON SURPLUS!



BC-906-D Frequency Meter—144 to 225 mc. Battery operated. Complete with case.

Only **\$6.95**

TS-16/APN Test Set. Used for aligning and calibrating AN/ARN-1, AN/APN-1 and other

equipment. Has 28 volt vibrator power supply. Audio Generator, other valuable parts. Complete with all cables and wood case. . . . Only **\$11.95**
Case Only for TS-16/APN—Sturdy reinforced wood, 17 1/2" x 11 1/2" x 15". Has many uses. . . . Only **\$3.95**

FREE! Send for our bulletins or hundreds of quality surplus items.

All items shipped FOB our warehouse. On C.O.D.'s include 25% with order. Ohio residents add 3% sales tax. All items subject to prior sale.

KOPELOVE ELECTRONICS CO.

Dept. RN 157, 1919 East First St. Dayton 3, Ohio

Top Pay Jobs in TV-ELECTRONICS-RADIO

High pay, opportunity, prestige, security . . . all yours, as a qualified Electronics Technician! Get your training NOW in the big, recognized shops, Labs, and TV-Radio Studios at National Schools in Los Angeles, foremost since 1905. Here you work with latest Electronics equipment—professionally installed—finest, most complete facilities offered by any school. Expert, friendly instructors. Personal attention. Graduate Employment Service. Help in finding home near school. Part time job while you learn. Mail coupon NOW, TODAY . . . for full information.

NATIONAL SCHOOLS

National Schools Dept. RXH-17
4000 So. Figueroa Los Angeles 37, Calif.
Send Free Electronics Opportunity Book Today

Name _____ Age _____
Address _____
City _____ State _____

HARVEY's famous hi-fi consultants RECOMMEND

... the NEW
AUDAX
KT

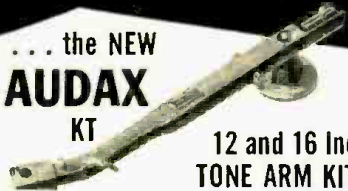

12 and 16 Inch
TONE ARM KITS

Here is an altogether new—and superbly logical—do-it-yourself development: professional-quality transcription pickup arms in kit form! You can assemble them in 10 to 20 minutes, with a small screwdriver or nail file as your only tool. Engineered by renowned audio pioneer Maximilian Weil, the KT-12 and KT-16 kits are further refinements of an already famous and time-tested AUDAX design, now brought to the ultimate degree of simplicity and perfection. They provide optimum performance with any cartridge and represent a saving of nearly 50% over their factory-assembled versions.

KT-16 kit (16-inch)	\$17.55
Same, factory-assembled	30.00
KT-12 kit (12-inch)	14.55
Same, factory-assembled	24.00



... the
DYNAKIT
MARK II
50-WATT
Power Amplifier Kit

This is the amazing do-it-yourself package that audio perfectionists have been choosing for over a year now in preference to more expensive amplifiers. Incorporating an ingeniously simple, unprecedentedly stable and utterly reliable circuit by David Hafler (of "Ultra-Linear" fame), plus premium-quality components such as the superb Dynaco A-430 output transformer, the DYNAKIT delivers 50 watts at any audible frequency with incredibly low distortion—harmonic, intermodulation, square-wave, phase, pulse or any other kind. Listening quality is unsurpassed; construction time is around three or four hours thanks to the pre-wired printed circuit board; price is still only

\$69.75

... and
the **W/B STENTORIAN**
'DUPLIX'
"Super Concentric"
12 Inch
Extended-Range
Speaker



A HARVEY Special!

Despite widely different tastes in loudspeakers, this beautifully made 12-inch coaxial unit has the virtually unanimous vote of critical high-fidelity enthusiasts as one of the smoothest and most natural-sounding transducers available. The huge magnet, the machined high-frequency horn, the extremely low-resonance bass cone, the carefully designed built-in crossover all contribute to the de luxe performance of the "Duplex," which even at its regular price is easily the equal of many more costly loudspeakers. At the present limited-offer price, it is a bargain without a rival.

Regularly \$119.00 HARVEY SPECIAL \$79.95

**MAIL ORDERS SHIPPED
SAME DAY AS RECEIVED**
Include with your payment a generous
allowance for shipping charges — the
excess will be promptly refunded.

HARVEY RADIO Estab. 1927
CO., INC.
1123 Avenue of the Americas **JU 2-1500**
16th Ave. at 43rd St. N.Y. 36, N.Y.

Housed in a single sloping rugged metal case, this combination unit is available in either kit or factory wired



form. The battery eliminator-charger can be purchased separately in either wired or kit form.

Write the manufacturer direct for full details on this and other instruments in the company's complete line of equipment.

TRANSISTOR RADIO KIT

Philmore Manufacturing Co., Inc., 113-115 University Place, New York 3, N. Y., is offering a two-transistor "portable" receiver which is being sold in kit form at a very moderate price.

The circuit is of the t.r.f. reflex type which will drive a 4" loudspeaker. Two transistors and a germanium diode are powered by a single 9-volt "A" battery. The tuning range is 550 to 2500 kc., which includes standard broadcast and some of the short-wave, police, and marine radio bands.

The whole circuit fits into a colorful plastic cabinet which measures only 7½" x 5" x 2½" over-all with retract-



able handle. The set weighs 1 pound, 6 ounces. An optional carrying case is available.

The kit comes complete with step-by-step wiring instructions.

SERVICE INSTRUMENTS

The Components Division of *Radio Corporation of America*, Camden, N. J., has developed two new instruments designed to simplify the servicing of radio and television receiving equipment.

The first unit is an r.f.-i.f.-v.f. marker adder (WR-70A) intended for use in sweep-frequency alignment of both black-and-white and color TV receivers. It is designed to be used with conventional marker generators. It

provides a choice of four different marker shapes, permitting the use of the marker best suited to the response curve.

The second unit is an audio signal generator (WA-44B) for the hi-fi enthusiast, industrial technician, service technician, and laboratory man. It features a wide frequency range from 11 cps to 100 kc. in four stages.

BERKELEY "FERRISTORS"

The *Berkeley Division of Beckman Instruments, Inc.*, 2200 Wright Ave., Richmond 3, Cal., is now offering a new line of "Ferristors" which are designed to replace vacuum tubes in certain types of electronic equipment circuits.

These midget ¾" cubes perform virtually all vacuum-tube functions: input amplifier, gate, time base, decimal counting unit, coincidence amplifier, and control circuitry. They are immune to damage from shock, vibration, and accidental overload and nei-

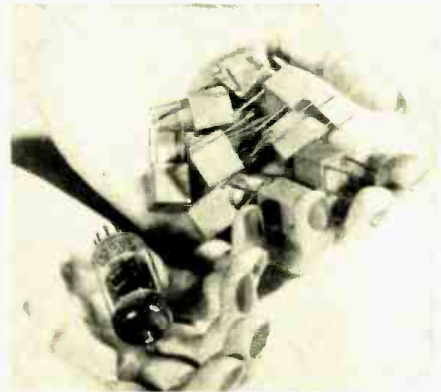

ther humidity nor temperature affect their performance.

The company is now making two classes of "Ferristors," one for high-speed magnetic amplifier applications and a second type for counting circuits. For full information on any of the units in the line, write to Department 1752 for a set of application notes. The data will be provided without charge.

RCA TRANSISTOR RADIOS

The *Victor Radio* and "Victrola" Division of *RCA* has introduced two new all-transistor pocket-sized radio receivers. These are the Models 8BT7 and 8BT8.

Both models use four transistors and weigh approximately one pound each. The "Winsome" is available in either two-tone gray or turquoise and antique white. The "Stetson," which includes a plug-in for an earphone, is available in a choice of charcoal and antique white or pink and antique white.

These receivers incorporate the newly developed *RCA* speaker which is only 2½" in diameter and a little over a half-inch thick. It was developed especially for transistor receiver applications. The "Winsome" will retail for \$39.95 while the "Stetson" will be offered at \$44.95.

-30-

Ham Special! Famous BC-645 XMITTER-RECEIVER



With **DIAGRAM** for Easy Conversion to **CITIZENS' BAND!**

BRAND NEW

Makes wonderful mobile rig for 420-500 Mc. Easy to convert for phone or CW 2-way communication. **CONVERSION DIAGRAM INCLUDED.** This swell rig originally cost over \$1000—yours for practically a song! You get it all in original factory carton. BRAND NEW, complete with 17 tubes, less power supply. **Conversion Instructions Included. \$29.50** Shipg. wt. 25 lbs.

PE-101C DYNAMOTOR for BC-645, has 12-24V input (easy to convert for 6V Battery operation)..... only **\$7.95**
UHF ANTENNA ASSEMBLY, for BC-645..... **\$2.45**
Complete set of 10 Plugs for BC-645..... **\$5.50**
CONTROL BOX for above..... **\$2.25**
SHOCK MOUNT for above..... **\$1.25**
CONVERSION BOOKLET, Instructions for most useful surplus rigs..... **\$2.50**

BRAND NEW SPECIAL PURPOSE TUBES

in Original Individual Packing

Type	Each	Lots of 12	Lots of 100
JAN CRP-730A MAGNETRON, Raytheon			\$3.45
6J6W	5.45	\$5.15	\$41.00
1625	.16	1.75	13.50
1626	.16	1.75	13.50
826	.44	4.95	39.50
2J724B	.35	3.95	29.50

TS-16/APN TEST SET, BRAND NEW, complete with all cables..... **\$12.95**

BENDIX DIRECTION FINDER

MN-26-C, 12-tube remote control Navigation Direction Finder and communications receiver, 150 to 1500 Kc in 3 bands, 28 V. DC input. Ideal for commercial navigation on boats and planes. Complete installation comprises:
MN-26-C Receiver, used, with 12 tubes..... **\$16.50**
MN-26-C with 12 Tubes, BRAND NEW..... **\$22.50**
MN-20-E Rotatable Loop..... **\$4.25**
MN-52 Azimuth Control Box..... **2.95**

MN26Y BENDIX DIRECTION FINDER 150 Kc. to 7 Mc. Complete with tubes, motor. BRAND NEW..... **\$26.95**
Used, like new, Incl. tubes and dynamotor..... **\$18.95**

NEW! Cathode Ray Tubes NEW!

3CP1 \$.88	5BP4 \$2.22
3FP7 \$.88	9LP7 \$ 1.88
5BP1 \$ 2.22		

Loran APN/4 Oscilloscope



Easily converted for use on radio-TV Service Bench!

BRAND NEW Completely Assembled Supplied with 5" Scope type 5CP1 and RCA 100 Kc. Crystal Unit..... **\$14.95**

BC-605 INTERPHONE AMPLIFIER, Easily converted to intercom set—ideal for office, home or factory! BRAND NEW, with original schematic..... **\$4.44**

DYNAMOTOR VALUES!

Type	Input	Output	Excellent Used	BRAND NEW
DA-19-A	28V 11A	400V .400A	\$4.99	\$6.95
DM-28	28V	224V .07A	1.95	4.95
DM-32A	28V 1.1A	250V .05A	2.95	5.95
DM-33A	28V 5A	575V .16A		
	28V 7A	540V .25A	1.95	3.95
DM-34D	12V 2A	220V .080A	4.25	5.50
DM-37	25.5V 9.2A	625V .225A	5.95	8.95
DM-40	14V 3.4A	172V .138A	1.75	3.45
DM-53A	28V 1.4A	220V .080A	3.95	5.95
DM-64A	12V 5.1A	275V .150A		7.95
PE-73C	28V 20A	1000V .350A	8.50	11.50
PE-86	28V 1.25A	250V .050A	2.95	5.24
PE-103	6V	500V .160A		
	12V	500V .160A	19.50	34.50
PE-186	28V 11A	400V .400A		6.95

SPECIAL G.E. DYNAMOTOR

INPUT: 28 V. D.C. @ 19 A.
OUTPUT: 1000 V. D.C. @ .350 A. **\$4.95**
Model 5D48B9A, BRAND NEW.....

2 VOLT BATTERY "PACKAGE"



1—2V. 20 Amp. Hr. Willard Storage Battery..... **\$2.45**
1—2V. 7 prong Synchronous Plug-in Vibrator..... **1.49**
1—Quart Bottle Electrolyte (for 2 cells)..... **1.45**
ALL BRAND NEW!
Combination Price..... **\$4.99**

Willard 6-Volt Midget Storage Battery 3 Amp. Hour, BRAND NEW, 3 1/2" x 1-13/16" x 2 1/2". Uses Standard Electrolyte..... Only **\$2.22**

JUST ARRIVED!

MODEL OAO-2 NAVAL RADIO TEST EQUIPMENT FREQUENCY METER, 110 V. 40 CYCLE AC, 105 to 147 Mc. Mfd by LIEBEL-FLARSHIEIN CO. BRAND NEW, Export Packed..... **\$44.50**
TS51/APG-4 TEST SET, 13-26 volts DC. Including all cables, complete with operating manual. BRAND NEW in original packing..... **\$49.50**

ASB-5 RECEIVER FOR 420 Mc BAND!

As featured in "OQ" for October 1956. Easily converted, makes a marvelous receiver for 420 Mc band, with RF amplifier! Supplied complete with all tubes. **\$1495**
OUR LOW PRICE..... **\$16.95**
ASB-5 INDICATOR..... **\$16.95**

I-95-M FIELD STRENGTH METER

Tunes 100 to 155 Mc. Made for Signal Corps. Like New..... **\$34.50**

AN/ARR-2 RECEIVER

BRAND NEW—A Terrific Value! Tuning Range 234 to 258 Mc. Tubes: 7-1001, 3-6AK5, 1-12A6. Only a few at this low price! Complete..... **\$8.88**
With 28 V. 1.6A dynamotor, complete..... **\$12.98**
110 VOLT AC POW. SUPPLY KIT for above..... **\$7.95**



DYNAMIC HANDMIKE, with "Press-to-talk" Switch, cord and plug—BRAND NEW, only..... **\$2.95**

DYNAMIC HEADPHONES, 600-ohm impedance, with large earphone cushions, cord and phone plug. BRAND NEW, special..... **\$2.95**

SOUND POWER HEADPHONE with Dynamic Mike, BRAND NEW..... **\$3.95**

HI-FI DYNAMIC HEADSET with Cushions Freq. Range: 40-14000 CPS. No Distortion. BRAND NEW..... **\$5.95**

MICROPHONES

Model	Description	Excellent Used	BRAND NEW
T-17	Carbon Hand Mike	\$5.45	\$7.95
T-30	Carbon Throat Mike	.33	.69
T-45	Navy Lip Mike		.99
RS-38	Navy Type	2.45	4.95
T-24	Carbon Mike		3.95
TS-9	Handset		4.95

HEADPHONES

Model	Description	Excellent Used	BRAND NEW
HS-23	High Impedance	\$2.25	\$4.35
HS-33	Low Impedance	1.99	4.65
HS-34	Low Imp. (featherwt.)	1.49	2.25
HS-16/U	High Imp. (2 units)	2.75	7.95
CD-307A	Cords, with PL55 plug and JK26 Jack		.99

BC-906 FREQ. METER—SPECIAL!



Cavity type, 145 to 235 Mc. BRAND NEW in original factory packing, complete with antenna. Manual included. OUR LOW PRICE..... **\$8.88**

BC-221 FREQ. METER..... **\$129.50**

BC-221 FREQ. METER CASE

Aluminum case for BC-221 or TS-164 Freq. Meters. With volt. reg. supply using VR105. 2 ballast tubes, relay, cable, etc. Inside front, 9 1/2" x 7 1/2" x 7 1/2". In. (Add 50c for side rear: 2" deep. packing)..... **\$3.99**
Shock-mounted.

Original Crystal for BC-221..... **\$8.45**
1000 Kc BRAND NEW.....

TG-5-B TELEGRAPH SET

Made for USA Army Signal Corps. A handy little field set for 2-way communication. Sturdy metal container, 6 3/4" x 4 1/2" x 4", with linged covers, complete with telegraph key and headset. BRAND NEW, in carrying case with \$9.95 shoulder strap. Used, exc. Cond..... **\$7.95**

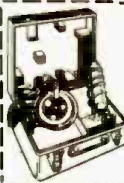

BUBBLE SEXTANT

Made for U. S. Armed Forces, by AGFA ANSCO. Actually worth \$150 or more! Has illuminated averaging disc for nighttime use. Complete with carrying case..... **\$9.95**
Only.....

WRITE FOR FREE CATALOG!

Please include 25% Deposit with order—Balance C.O.D. MINIMUM ORDER \$3.00. All shipments F.O.B. Our Warehouse N.Y.C.

G & G Radio Supply Co.

Dept. N-1
51 Vesey St., New York 7, N. Y. CO 7-4605
Branch: 5009 N. Neva Ave., Chicago 31, Ill.

BC1206-C BEACON RECEIVER

195 to 420 Kc. made by Setchel-Carlson. Works on 24-28 volts DC. 135 Kc. IF. Complete with 5 tubes. Size 4" x 4" x 6", Wt. 4 lbs. BRAND NEW..... **\$8.88**
BRAND New, less tubes..... **\$5.95**
USED, with tubes..... **\$5.95**
USED, less tubes..... **2.95**



SCR-522 2-METER RIG!

Terrific buy! VHF Transmitter-receiver, complete with all components. 100-156 Mc. 4 channels. Xtal-controlled, Amplitude modulated voice. They're going fast! Excellent condition. SCR-522 Transmitter-Receiver, complete with all 18 tubes..... **\$33.33**
COMBINATION..... Special

Receiver Only, with all tubes..... **\$19.50**
Transmitter Only, with all tubes..... **\$22.25**

ARC-5/T-23 TRANSMITTER

Includes 2-832A, 2-1025 Tubes. Special, Used..... **\$14.95**
BRAND NEW..... **\$21.50**

ARC-5 MARINE RECEIVER-TRANSMITTER

Navy Type Comm. Receiver 1.5 to 3 Mc BRAND NEW with 6 tubes..... **\$16.95**
Navy Type Comm. Transmitter 2.1-3 Mc BRAND NEW with 4 tubes and Xtal..... **\$12.45**

NAVY RECEIVER TYPE ARB

Four Band—195 to 9050 kc. Low Freq. Ship, Broadcast—45 to 80 meters. Includes tubes and dynamotor, for 2-1 volt operation. Easily converted for 110 V. 12 V. or 6 V. Schematic Included. Excellent Condition. Overall: 8 1/4" x 7 1/2" x 1 1/2". Wt. 3 1/2 lbs. COMPLETE WITH ALL TUBES, Special..... **\$21.50**



LORAN APN-4

FINE QUALITY NAVIGATIONAL EQUIPMENT

Determine exact geographic position of your boat or plane! Complete, BRAND NEW installation consists of: 1D-6B/APN-4 Indicator; 1E-9B/APN-4 Receiver; PE-206 Indicator; Set of Plugs; Vior for Indicator. Operation manual; Brand New, Export packed. COMPLETE..... **\$129.50**

SPECIAL APN-9A LORAN Receiver Indicator, less tubes, NEW (demilitarized)..... **\$29.50**

BRAND NEW SELSYNS

Operates from 57 1/2 volts, 400 cycles. New tested. Conversion diagram for 110 volts AC included. BRAND NEW, Any Type
211F1 Selsyn Generator.....
211G1 Selsyn Control Transformer..... **\$295** Each
211H1 Selsyn Differential Generator.....
CAPS FOR ABOVE..... **50c**

R24-ARC/5 NAVY TYPE BROADCAST RECEIVER

(Similar to BC-946)
520 to 1500 Kc. 6 tubes: 3-12SK7, 1-28K7, 1-2A6, 1-2K8. For dynamotor operation. Easily converted to 110 or 220 Volt, 2-1F stages, 3-gang tuning coil. Complete with all tubes, in original sealed carton..... **\$19.95**

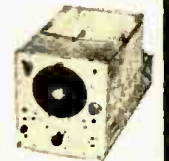

BRAND NEW
BC-457 TRANSMITTER—4-5.3 Mc. complete with all tubes and crystal. BRAND NEW..... **\$7.88**
BC-458 TRANSMITTER—3-3 to 7 Mc. Complete with all tubes and crystal. BRAND NEW..... **\$7.88**

BRAND NEW
BC-459 TRANSMITTER—7-9.1 Mc. complete with all tubes and crystal. BRAND NEW..... **\$11.95**
BC-696 TRANSMITTER—3 to 4 Mc. BRAND NEW complete with all tubes & crystal..... **\$8.88**

SCR-274 COMMAND EQUIPMENT

Type	Description	Excellent Used	BRAND NEW
BC-453	Receiver 191-500 KC.....	\$9.95	\$11.95
BC-454	Receiver 3-6 Mc.....	7.19	8.29
BC-455	Receiver 6-9 Mc.....	5.25	7.95
BC-456	Modulator.....	2.25	2.75
BC-450	3-Receiver Control Box.....		1.49
BC-451	Transmitter Control Box.....	1.25	1.49
BC-696	Xmt'r 3-4 Mc (like new).....		6.95

110 VOLT AC POWER SUPPLY KIT

For All 274-N and ARC-5 Receivers
Can be assembled quickly and easily on pre-drilled chassis. Plugs into the rear of any model 274-N receiver and delivers 24 volts as well as "B" voltage. Complete kit of parts with metal case, Instructions..... **\$7.95**
SPLINED TUNING KNOB for 274-N RECEIVERS. Fits BC-453, BC-451 and others..... **49c**
Only.....

BC-442 ANTENNA RELAY

Wonderful Value! Consists of 3/4 amp 250 RF Ammeter (antenna current indicator), 0-10 scale, Transmitter-Receiver Switching relay, in aluminum case with associated components. BRAND NEW..... **\$2.24**



STAN-BURN

CATHODE RAY TUBE SPECIALS

ONE YEAR GUARANTEE		
G. E.	Type	STAN BURN
\$15.80	10BP4	\$10.00
19.10	12LP4A	13.95
	12QP4	10.50
18.75	12UP4	15.00
20.75	14CP4	13.75
	15DP4	14.50
33.75	16AP4	18.50
32.20	16DP4A	15.25
23.50	16KP4	15.75
27.20	16KP4A	18.75
33.75	16P4	17.75
31.50	16LP4A	15.25
31.50	16WP4	15.25
23.50	17BP4	15.75
27.50	17BP4B	18.75
\$30.75	17CP4	\$20.50
33.90	17CP4	21.50
24.75	17LP4	18.00
37.00	18AP4A	24.00
28.35	20CP4	18.95
32.10	20CP4B	21.95
36.00	21AP4	25.00
29.75	21EP4A	20.15
33.50	21EP4B	23.25
30.90	21FP4	21.15
37.00	23MP4	26.25
29.75	21Y4	22.00
100.00	24AP4	56.00
46.60	24CP4A	38.00
48.20	24DP4A	39.00

*Aluminized—INQUIRE FOR ANY TUBE TYPE NOT LISTED
STAN-BURN CRT TUBES RCA LICENSED—MFD. BY LINCOLN
PRICES SUBJECT TO CHANGE WITHOUT NOTICE

\$20 WORTH OF ELECTRONIC PARTS IN GRAB-BAG consisting of: Porcelain sockets, c. speaker, c. formers, resistors, condensers, etc. ONLY \$1.98 (plus 50¢ postage).

TAPE RECORDERS—Famous Brand
SPECIAL
List Pr. \$249.95 \$169.00 List Pr. \$129.95 \$79.95
List Pr. 109.95 129.00 List Pr. 79.95 52.00
Write for complete illustrated details.

KITS! We stock the following manufacturers complete line of kits—see Index
EICO • QUALITY • ARKAY • PRECISE • KARLSON
JENSEN • CABINART • ELECTRO-VOICE • DYNA.
All domestic orders will be shipped prepaid for a limited time. Send us your list. Order by Manufacturer and model number.

VM 4 SPEED HI-FI CHANGER—Model 1210 with Renault, Sonotone or Astatic flip-over cartridge. \$22.95
RC456-4 SPEED COLLARO—BRAND NEW... \$29.95
45 RPM SPINDLE for above... \$2.98

MONARCH Model U4U 4 SPEED AUTO. INTERMIX CHANGER with crystal cartridge... \$22.95
Same with Gold Ring 500 S.S. 25.95
Same with G.E. RPX050 26.95
Same with G.E. RPX052-Diam. Sapph. 38.95
45 RPM SPINDLE for above... 1.88
TU-R MONARCH 3 Speed MOTOR & TURN-TABLE UNIT (less arm). NEW LOW PRICE! \$31.50

SONORA—4 TUBE SUPER HI-FI AC/DC—EBONY \$31.50
Above in RED-WHITE, MAHOGANY \$29.95
SONORA—17" TABLE MODEL TV... \$88.92

AMPLIFIER KIT—Model SBHF20—A terrific low cost high fidelity 20 WATT amplifier with equalizer and control sect. IM dist. (60 cps; 6 kc/4:1) at rated power; 1.3% power loss; 20-20,000 cps; ±1.5 db 10-40,000 cps. Freq. resp. ±0.5 db 13-35,000 cps; ±1.5 db 7-50,000 cps. Max. Harm. Dist. approx. 1%. 4-band Harm. Dist. 0.3%. COMPLETE KIT, READY TO BUILD... \$44.95
WIRED, READY TO PLAY... 69.95

DELUXE AMPLIF. KIT—Model SBFL30—An ultra fine 30 watt Hi-Fi amplifier in cabinet. Features: assures high gain low noise front end. Freq. Response: ±1 db 10-40,000 cps; ±1.5 db 20-20,000 cps, below 28 watts. 6 tube, 6 controls in ebony cab. with gold panel. Complete with 4 tubes, 4 controls, punched chassis, diagrams and manual of instruction, less solder and wire... \$44.95

HI-FI AM-FM TUNER KIT—Model SBHF77—A choice companion to the Amplifier above. Features: Foster-Szeley Disc. Grounded Grid Amplif. AFC with prov. for erase. Freq. Range: FM-88 to 108 mc. AM-535 to 1680 kc. 7 tube with sel. rect. Size 5 1/4 x 9 1/2 x 8" deep. Complete ready to build with all parts, tubes, illustrated manual. Shipping Wt. 9 lbs. Model SBHF77... \$29.95
Model SBFM6. For FM reception only... 22.95
Cover for above models... 3.50

HI-FI SPEAKER COMBO KIT—Fine sound reproduction in this handsome minimum cabinet. Features: 50-12,000 cps within ±5 db. True craftsmanship with two Jensen speakers—8 woofer and a compression-type tweeter, 1600 cps. Freq. resp. 25 watt system. Beautiful Karlgren cabinet with all parts pre-cut and pre-drilled in fine grade plywood, suitable for staining or polishing. Build them in one evening for years of listening pleasure. Model SBKDU-10 SPEAKER KIT with all parts. Model SBKX—Cabinet kit complete, with all parts. COMPLETE COMBO KIT... \$7.95

SONIC All Transistor Radio—Model TR500-AVC—Powerful Alnico speaker—Scuff proof TEXON in simul. Cowhide. Size 6 1/4 x 5 x 2 1/4". Wt.: Less than 3 lbs. Less batt. \$25.95
SONIC—Model 490—Hi-Fi Radio Phono Console with GARRARD deluxe 3 speed auto. record changer—all speeds—hi-fi cart. with dual sapph. needles. 2-12" and 2-8" P.M. speakers. MAHOGANY \$118.50
BLONDE... 124.50

SONIC—Model 480 Hi-Fidelity—Deluxe 3 speed GARRARD Automatic changer—all speeds, all sizes—Dual sapph. needles—3 speaker system (2 woofers and 1 tweeter). MAHOGANY... \$84.95
BLONDE... 90.95
Available with mahogany legs, extra... 9.95

TOP QUALITY RECORDING TAPE—Plastic base—1200 foot on 7" reel—Freq. resp. 50-15,000 cps. Red oxide base... Lots of 12, each 99c
Same 500 foot 6 1/2" reels... \$1.50

DEALERS: Write for low cost prices and catalogs on '56 models—HALL-CRAFTERS, SUPERIOR, NATIONAL, PRECISION, HICKOCK, TECHMASTER, CHANGERS, TUNG-SOL, MAJESTIC, GRUNDIG, ARKAY KITS, DELCO, GEN. MOTORS, BOGEN, GARRARD, KARLSON, HARMON-KARDON, ELECTRO-VOICE. Address all inquiries to Dept. RN-1.

COMPLETE HI-FI DEPT. SEND US YOUR LIST FOR LOWEST QUOTATIONS ON ANY ITEM.
We invite export inquiries and offers. Our export department will give special attention to expediting foreign orders at minimum commissions. We are authorized distributors for United Motors, all Delco and Gen. Motors Auto Radio parts in stock. We also carry complete line of popular makes of Radio Tubes at 50% discount. Also many other special purpose and transmitting types, and all electronic parts and equipment at lowest prices. Send us a list of your requirements for prompt quotations. Terms: 20% with order. Balance C.O.D. All prices F.O.B., NEW YORK Warehouse. Minimum order \$5.00. Write for our latest and most complete HI-FI LIST. ALL PRICES SUBJECT TO CHANGE WITHOUT NOTICE

STAN-BURN RADIO and ELECTRONICS CO.
558 CONEY ISLAND AVE. • B'KLYN 18, N. Y.

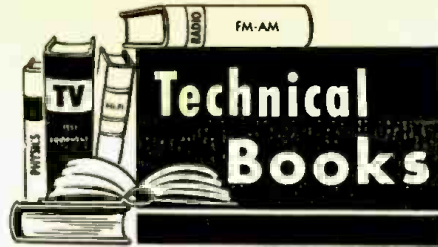

Technical Books

"PROCEEDINGS OF THE 1956 ELECTRONIC COMPONENTS SYMPOSIUM" Published by *Engineering Publishers*, GPO Box 1151, New York 1, N. Y. 240 pages. Price \$5.00. Paper bound.

This volume constitutes the authorized proceedings of the seventh national meeting on electronic components and materials sponsored by the AIEE, IRE, RETMA, and WCEMA and endorsed by agencies of the Department of Defense and National Bureau of Standards.

Forty-three different papers cover a wide variety of subjects. In addition the book contains information on new types of components and data on the improvements that have been made on conventional components.

"PROCEEDINGS OF THE CONFERENCE ON INSTRUMENTATION AND CONTROL IN THE PROCESS INDUSTRIES" Published by the *Armour Research Foundation of Illinois Institute of Technology*, Chicago, Ill. 101 pages. Price \$3.00. Paper bound.

This is a compilation of the papers presented at the Conference on Instrumentation and Control in the Process Industries held in Chicago in January 1956. Twelve papers were presented, representing all phases of the field and a wide and varied segment of the industry.

Those concerned with this specialized field will find this volume interesting and informative and a springboard to additional inquiry.

"PHOTOCONDUCTIVITY CONFERENCE" edited by R. G. Breckenridge, B. R. Russell & E. E. Hahn. Published by *John Wiley & Sons, Inc.*, New York. 640 pages. Price \$13.50.

This volume is a compilation of the papers presented by 45 authorities at the Conference on Photoconductivity held late in 1954 at Atlantic City. Since the papers include basic theory, phenomenological theory, interpretation of photoconduction phenomena, and recent data on the properties of important photoconducting materials, this book represents a definitive treatment of the entire subject.

Engineers in industry, government, and institutions of higher learning should find the availability of so much authoritative and useful data within a single set of covers a real boon.

"FREQUENCY MODULATION ENGINEERING" by Christopher E. Tibbs & G. G. Johnstone. Published by *John Wiley & Sons, Inc.*, New York. 432 pages. Price \$8.50. Second Edition.

Since it is only recently that the *British Broadcasting Corporation* has adopted FM broadcasting and set up the necessary equipment to handle this type of service, a training program had to be instituted to train the engineers who would be responsible for such transmissions.

This book, then, is one of the *BBC* training manuals which, although prepared especially for its own staff, is of interest and value to Stateside engineers. Chapters on the frequency modulation of a carrier wave, interference and noise structure, interference suppression, FM propagation, antennas for FM, FM transmitters, limiters and discriminators, FM receivers, measurements on FM equipment, and practical uses of FM signals are included.

This new edition, which supersedes the volume originally published in 1947, is characterized by a more practical approach than heretofore. Although the treatment is somewhat mathematical and the equipment discussed is of British origin, there is a wealth of data for all engineers within these covers.

"ELECTRONIC TUBES, CIRCUITS, AND DEVICES" by Lewis G. Blevins. Published by *Universal Scientific Company, Inc.*, Vincennes, Ind. 620 pages. Price \$4.50. Paper bound.

This volume is the last in a progressive series issued by this publisher and is intended for the slightly more advanced student. The text covers electron tube principles, and deals with electronic circuitry that employs tubes, industrial electronic controls, medium and v.h.f. radio transmission and reception, electronic computer circuitry, and electronic test instruments.

The inclusion of both schematics and pictorial diagrams makes it possible to use this volume as a home-study text as well as for the more formal courses of instruction. The various experiments outlined for the student can all be performed with standard, easily obtainable parts. The text is well illustrated by photographs, schematics, graphs, pictorials, etc.

"BASIC RADIO & RADIO-RECEIVER SERVICING" by Paul B. Zbar & Sid Schildkraut. Published by *McGraw-Hill Book Company, Inc.*, New York, for the RETMA. 105 pages. Price \$2.00. Paper bound.

This is another of the laboratory manual series being issued by the RETMA in its current training program for upgrading radio and television service technicians.

Like the previous volume, "Basic Electricity," this book is divided into "jobs" dealing with various sections of AM and FM receivers. The "objectives" are stated, the materials required to perform the experiments are listed, and then the project is explained. A test sheet on which the student can enter his results is included with each "job" section. As a laboratory manual designed to be used in conjunction with high school and

Make Money! You can sell these at a profit.

CROSEY TRANSISTOR BOOK RADIO

Increased power output achieved through twin transistors gives 5 times greater usable audio level than other receivers of this size using a subminiature output tube. 3 subminiature tubes of the latest multiple purpose type. One tube performs 2 functions, another performs 3 functions. Modern printed circuitry for long trouble-free operation. Unaffected by vibration. Automatic volume control compensates for variations in signal strength, holds volume as you set it. Permeability tuned I.F. transformers (iron core) are used to obtain best sensitivity, selectivity and frequency stability. Latest type ferrous core antenna enclosed in case. Covers standard broadcast band—540 to 1600 KC. Size 2 1/32" h. x 7" w. x 4 21/32" d. SHPG. Wt. 4 lbs.

Reg. \$52.50 List
\$29.88
Less Batteries



Genuine Top Grain Cowhide Binding

Stock No. RA-262
SET OF BATTERIES
4 Volt Mercury & 45 Volt "B"
Stock No. AS-242 **\$3.88**

EXTRA—FREE!

Included with each Crosley Book Radio is a kit with which the owner can inscribe his signature in 23 Karat Gold on the cover.

Continuous Play TAPE MAGAZINE

Repeats Recorded Messages Endlessly



\$1.89
Stock No. X-643

3 for \$5.00 Reg. Price \$12.50

Makes and plays recorded messages endlessly. Can be erased and re-recorded as many times as desired. Brand new. Offered at this low price because we can't supply mounting hardware. Can easily be mounted on receiver with homemade bracket. Repeat messages in stores, carnivals, rehearsals, etc. Each magazine is loaded with 100 ft. of finest double coated tape. Will record and play both sides consecutively. 10 minutes at 3 3/4 IPS or 5 minutes at 7 1/2 IPS.

VIDEO MONITOR

Electronic Set Protector



Stock No. X-644 **\$22.30** 3 for \$6.00

Complete with 2 Sylvania 6W4GT tubes (\$3.00 list pr.). Automatically limits line voltage until tubes in TV set warm up. No installation—just plug in.

Combination 6-12 Volt BATTERY CHARGER KIT

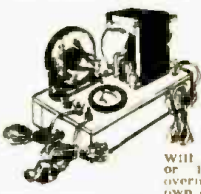

Stock No. KB-39
\$5.95 Each

Will charge either 6 or 12 volt battery overnight. Build your own dual voltage battery charger at a fraction of the cost of similar factory built models. Heavy duty selenium rectifier, oversize power transformer, and 2 1/2" dia. charge indicating meter. Supplied complete with all parts, wire, solder and fully illustrated instructions. Can easily be built in one evening. It's fun and instructive, too. SHPG. Wt. 7 lbs.

10-Piece SCREWDRIVER SOCKET SET

\$1.19 Ea.

Stock No. TL-124

Pocket tool kit. 5 hex sockets 3/16" to 7/16". Phillips and standard screwdriver blades, extension bar. All fit in unbreakable plastic handle with knurled chunk.



ATTENTION MANUFACTURERS: If you have large quantities of surplus electronic parts you wish to sell, call or write OLSON at once. We pay top prices.

SEND FOR NEW FREE CATALOG

Thousands of prices reduced on nationally famous brands
OLSON BARGAIN STORES IN:
CHICAGO—623 W. Randolph St.
CHICAGO—123 N. Western Ave.
CLEVELAND—2020 Euclid Ave.
PITTSBURGH—5918 Penn. Ave.
MILWAUKEE—423 W. Michigan
BUFFALO—711 Main Street

HOW TO ORDER

Mail your order to 278 E. Market St., Akron 8, Ohio. Send remittance with order. Add for postage 5c for each dollar's worth ordered—10c for each dollar's worth if you are more than 1000 miles away. **OLSON REFUNDS EVERY CENT NOT USED.** Or—send no money—we'll ship C.O.D. and you pay mail or expressman for merchandise and postage. **ALL MERCHANDISE 100% GUARANTEED. PLEASE—MINIMUM ORDER \$5.00.**

\$28.90 Less Than Regular Price HIGH FIDELITY OUTFIT



ALL FAMOUS BRANDS

BOGEN GARRARD
GENERAL ELECTRIC
NORELCO ARGOS



Complete Ready To Play
Stock No. AS-240

\$99.50

EVERYTHING BRAND NEW FACTORY SEALED CARTONS

The heart of this tremendous value is the Bogen HF-10 10 watt amplifier which features: separate bass & treble controls, record compensator, response from 30 to 20,000 cps & push-pull output. The Garrard RC 121 GE 4-speed changer is equipped with the new GE RPX-050A variable reluctance cartridge with "clip-in" sapphire needles. The base is fine mahogany finished and the top is ready cut. The Norelco speaker (Twice the power of Alnico 5). Guaranteed to out perform any speaker in its size or price range. Dual cone. A small cone is built in front of the large cone, thus, highs and lows are both faithfully reproduced. The Argos Bass Reflex Enclosure 23 1/2 x 10 1/2 x 13 1/2" delivers entire tonal range thanks to its acoustical padding. Back completely closed. Finished in luxurious mahogany wood grain plastic covering. Provided with adapter board so that any 8" or 12" speaker can be used without making changes. SHPG. wt. 60 lbs.

LOOK! YOU GET ALL THIS

- BOGEN HF-10 Challenger 10 watt amplifier \$39.95
- GARRARD RC121/GE 4-speed Record Changer & base with GE RPX-050A Cartridge 55.21
- NORELCO 9770M 8" "Ticonal" Hi-Fi Speaker 9.90
- ARGOS Bass Reflex Console Speaker Enclosure 22.05
- COVER to keep changer clean 1.29

Reg. Net Price \$128.40

All "Name Brand" outfit. "Bogen" acclaimed Best By Famous research organization. "Garrard" finest by any test. "Norelco" proudest model by Philips of Holland. "Argos" known for quality in consoles.
45 RPM Spline, if desired. \$3.43
Stock No. RP-27 ea.

ALTERNATE SYSTEM

Exactly as described above except we supply an Electrovoic 12" Model SP12-B speaker and a metal cage for the amplifier. A regular \$156.09 value.
Stock No. AS-241 **\$119.50**

Photo-Electric NIGHT LIGHTER

Sun Controlled Light Switch



\$10.94 Each

Stock No. X-638

Photo-electronic automatic light switch. Turns on lights or display signs at dusk and off at dawn. Not a clock. Intensity of natural daylight operates a relay thru a built-in photo-electric cell. No installation problem. Maximum load 300 watts. Size 3 1/2" x 4 1/2" x 3 1/2". 100% waterproof & guaranteed. SHPG. Wt. 4 lbs.

Crystal Hearing Aid EARPHONE

\$1.95 Stock No. PH-2
Each 3 for \$5.50



High impedance. Weighs less than 1/8 oz. 3 ft. cord. Flesh colored, inconspicuous when worn. Works well with crystal set.

DOUBLE HEADSET

Stock No. PH-6 **\$1.95** PAIR
3 pairs \$5.60



2000 ohm impedance. Large magnet, removable bakelite cups. Adjustable steel headband. 3/4" ft. braided cord, standard phone tips.

Smallest AUTOMATIC CHANGER

RCA Type 45RPM



\$14.88 EACH

Stock No. RP-31

Just imagine a fully automatic changer only 10" x 8" x 7" in size. Plays up to 12—records automatically with one loading. Equipped with low pressure tone arm mounted in smooth working bearing. Has reject button. Cartridge is the famous 1.5 Volt Ronette with sapphire stylus. Work with any radio, amplifier or TV. Operates on 110-125 V. 60 Cy. AC. SHPG. wt. 8 lbs.

TRANSISTOR RADIO KIT



Stock No. KB-40
\$3.94 Each
3 for \$11.00

Operates a month from a single penlite cell. Circuit uses a germanium diode detector plus a transistor audio stage to produce amazing volume and sensitivity over the entire AM broadcast band. Housed in an attractive plastic case, 1 5/16" x 2 1/2" x 3". High efficiency tuning coil. Use with any 2000 to 4000 ohm headset. (We recommend our Stock No. PH-6, described on this page.) Complete with all parts, including solder, wire & battery—less only headphones.

LIGHT OPERATED TRANSISTOR KIT

Uses Famous Sun Battery
\$5.36 Each
Stock No. KB-41
3 for \$15.00

Same kit as above, but uses sun battery in place of penlite cell to supply power. Imagine operating a radio from light power. The stronger the light the louder the volume. Use on picnic, at the beach, even in the home under a lamp. Produces a strong signal. Complete less headphones.

TRANSISTOR LOOP ANTENNA



Stock No. L-70
Reg. List **99¢**
\$2.50

Covers complete broadcast range from 540 to 1,650 KC. Use with 365 mmfd variable condenser. Adjustable slide top mounted. Size 5 x 1 1/2 x 3 1/4".

OLSON RADIO WAREHOUSE 278 EAST MARKET ST. • AKRON 8, OHIO

AIREX

THE ELECTRONICS SUPERMARKET

SALE

END OF YEAR

NEW HI-FI EQUIPMENT YEAR BOOK

Most complete guide in the industry. 128 pages crammed full of technical information of 100 mfrs. Lists over 700 items. 400 photos of the latest Hi-Fi merchandise, with costs. This is a limited edition!

\$1.95

Refundable with purchase

RECORD CHANGER BARGAINS

COLLARO RC54: New 4 speed intermix, automatic shut-off, weighted turntable, manual position, plug-in head, 4 pole motor. **\$29.95**

WEBSTER NEW 4 SPEED: changer with Magic Mind. Automatically changes from 33 1/3 to 45 RPM as the record drops. New 16 RPM speed. With ceramic cart, dual sapphire styli. **\$24.95**

WEBSTER NEW 3 SPEED: With 4 pole motor & GE RPX050A Reluctance cart & dual sapphire styli. **\$27.95**

NATIONALLY FAMOUS GOLDEN CASED RELUCTANCE CART TYPE RPX 052A: Triple play 003 mill sapphire & .001 mill diamond. Chip-in Stylus. Stylus pressure. **\$17.95**

NATIONALLY FAMOUS RELUCTANCE CART TYPE 050A: Triple play sapphire needles for all records, chip-in stylus pressure. **\$6.95**

DYNAKIT MARK II

The most compact high fidelity 50 watt amplifier made. 100 watt peak. Intermodulation distortion less than 1% at 50 watts, less than .26% below 35 watts. Response 6-20K ± 5dB ± 1dB 20-20K. Input 1.5 volts for 50 watt output. Damping factor of 15. 8 and 16 ohm taps. Uses 2-EL34, 6AN8 and 5U4GB. Complete with all components. Prewired XXXP circuit board. Only top quality parts used throughout. **\$69.75**

With bottom cover and cage. 27 lbs. **\$69.75**

45 RPM SPINDLES **GARRARD \$3.49** MONARCH **\$2.95**
WEBSTER **\$2.49** COLLARO **\$3.75**



Grommes Hi-Fi Amplifier Kit

10 Watts. 18 watts peak. Resp. 20-20,000 cps ± 1 db. Preamp. 4 inputs. Hum—80 db. 2% THD. 100Ω ± 10Ω at 10 watts. Complete with detailed step by step instruction manual, all resistors, capacitors, tubes, solder & solder. Easy to make. 2-12AX7, 2-6Y6. **\$24.95**

5Y3. Bass & Treble boost. Limited quantity.



New 20 watt amplifier kit, mdl. 61P4K.

30 watts peak. Response 20-20,000 cps ± 1/2 db. Hum—80 db. Full equalization and compensation. Complete with cable and 7 tubes. **\$59.50**



FM-AM TUNER KIT

Easy to assemble. Professional quality performance. 3 double tuned IF stages. Foster-Seeley discriminator, automatic frequency control & defeat. 7 tubes on FM & 20 microvolts on AM. FM selectivity 200K. Band width 8 dB down. AM 80K band width 2 dB down. 5 1/2" high x 9 1/2" wide x 8 1/2" deep. **\$29.95**

Complete with step-by-step instructions. **\$29.95**

FM TUNER ONLY—\$23.95 • COVER—\$3.95

These units are ideal in combination with the Grommes Hi-Fi Amplifier.

MULLARD HI-FIDELITY TUBES

Type	Replaces	Price	Type	Replaces	Price
EL34	KT66; 6CA7	\$4.35	ECC82	12AU7	\$2.20
EL37	6L6; 5881;		ECC83	12AX7	\$2.50
	KT66	\$3.50	6F6	222	
EL84	6BQ5	\$2.40	6F6	6267	\$2.75
ECC81	12AT7	\$2.60	GZ32	5V4; 5U4	\$2.95

FAMOUS UTAH SPEAKERS

12" coaxial, exclusive built-in crossover network assures a frequency response from 35 to 17,000 cps, 12 watt cap, 8 OHMS impedance. Reg. \$24.95. **\$12.88**

15" woofer—response 30 to 8,000 cycles, 21.5 oz. magnet, 25 watt capacity, 1 1/2" voice coil, 8 OHMS impedance. Reg. \$34.95. **\$19.95**

5" super tweeter—response 3000 to 19,500 cps, 25 watt capacity, 3/8" voice coil, 8 OHMS impedance, with built-in crossover network. **\$7.95**

Complete TV Set—Designed & Engineered by Tech-Master with Sylvania Aluminized Tube

- Designed for fringe area operation
- 6 microvolt sensitivity
- Automatic gain control
- Auto-transformer high voltage system
- Synchronized sound and video
- 3 stage stagger-tuned IF
- Heavy duty power transformer
- 2 stage video amplifier sweep circuit
- High gain Standard Coil tuner
- 17 KV high voltage output
- Automatic brightness control
- Complete with mounting brackets, Alnico V speaker and knobs
- Chassis with Sylvania Aluminized Tube.

21"

\$136.95

24"

\$147.95

27"

\$177.95

All merchandise is brand new, factory fresh & guaranteed. Mail & phone orders filled on receipt of certified check or MO of 20% of items as a deposit. Balance C.O.D., F.O.B. factory N. Y. Prices & specifications subject to change without notice.

AIREX RADIO CORP.

64 Cortlandt St. N.Y. 7 CO 7-2137

technical school training courses, this book should fill the bill nicely.

* * *

"MOST-OFTEN-NEEDED 1957 TELEVISION SERVICING INFORMATION" edited by M. N. Beitman. Published by *Supreme Publications*, Highland Park, Ill. 192 pages. Price \$3.00. Paper bound.

This is volume TV-12 in this publisher's series of schematics and service data on 1957 model television receivers released by some twenty manufacturers.

As with the earlier manuals in the series this book provides over-all information on each set, a schematic, a parts list, special service hints, installation tips, voltage and waveform readings, and a photograph of the chassis showing the location of pertinent components, test points, and adjustment controls. A chassis-number index is also included to facilitate locating a specific set.

* * *

"PROFITABLE RADIO TROUBLESHOOTING" by William Marcus & Alex Levy. Published by *McGraw-Hill Book Company, Inc.*, New York. 326 pages. Price \$5.95.

This book fills a gap in the literature which has not been adequately met since the U. S. Government's book, "Establishing and Operating an Electrical Appliance and Radio Shop," was released in 1946.

Subtitled "A Professional Guide to the Technical and Business Methods of Operating a Radio-TV Service Business," this volume is for all those who plan to open, have just opened, or are struggling with a newly opened radio service shop.

The authors explain how to operate and organize a profitable venture and outline the techniques for handling trouble both on the bench and from the customers. The business end of the book is perhaps the most unusual and most valuable part since it outlines how to get started, how to get business, how to handle customers, establishing charges, keeping records, etc. It is a valuable reference work for both newcomers and oldtimers who want to make more money.

* * *

"HANDBOOK OF BASIC CIRCUITS" by Matthew Mandl. Published by *The Macmillan Company*, New York. Unpagged. Price \$7.50.

In this unique presentation, the author has provided a schematic diagram, a description of circuit function, a discussion as to the purpose of the circuit, and information on the circuit's characteristics and function on some 136 standard circuits frequently encountered in electronic equipment, FM, AM, and TV receivers.

The material is presented alphabetically and cross-indexed in an expanded master reference list at the back of the book. The user who is, for example, looking for a specific filter circuit can find it under several categories depending on the application. In order to correlate the individual cir-

cuitry, a series of block diagrams has been provided in the appendix, covering such pieces of equipment as black-and-white and color TV receivers, FM receivers, black-and-white and color transmitters, AM and FM transmitters, etc.

* * *

"RADIO ELECTRONICS MADE SIMPLE" by Martin Schwartz. Published by *American Electronics Co.*, 1203 Bryant Ave., New York 59, N. Y. 184 pages. Price \$1.95. Paper bound.

This compact manual is written for those who are interested in radio and electronics but have insufficient technical background to understand the underlying principles involved.

Written in simple, non-technical language, the text covers d.c., a.c., vacuum tubes, power supplies, oscillators, transmitters, detectors, superhet receivers, and antennas. Three appendices include usual radio abbreviations, common radio symbols, and radio formulas. Mathematics is held to a minimum and diagrams and photographs are freely used to amplify the text material.

* * *

"SERVICING AND CALIBRATING TEST EQUIPMENT" by Milton S. Kiver. Published by *Howard W. Sams & Co., Inc.*, Indianapolis, Ind. 184 pages. Price \$2.75. Paper bound.

This is a practical "how-to-do-it" manual for the technician whose bread-and-butter depends on his ability to troubleshoot and service equipment in a minimum amount of time and with maximum efficiency.

The text itself is divided into five chapters dealing with the pitfalls to avoid when using test equipment, simple ways to check the accuracy of test equipment, keeping test-equipment operational records, preventive maintenance measures, and servicing test gear. The author points out that often the technician is at fault rather than the equipment and explains the proper operation of various items of service test gear.

As is the case with all of this author's books written for service technicians, the material is thoroughly practical and is written in concise, yet easy-to-understand form.

* * *

"INTRODUCTION TO PRINTED CIRCUITS" by Robert L. Swiggett. Published by *John F. Rider Publisher, Inc.*, New York. 98 pages. Price \$2.70. Paper bound.

So wide has the interest in printed circuitry become in the past few years there was a real need for a reference work on the subject. While printed circuitry has been partially covered in general volumes, this compact handbook deals with various manufacturing processes involved in producing these components, practical applications for such circuitry, and maintenance and servicing techniques for use with equipment incorporating printed circuits.

The book is written for technicians, engineers, and industrial personnel—in

STANLEY ELECTRONICS

joins the
"tube crushing program"

Send
for FREE
Catalog

In line with its policy of providing service and quality to its customers, Stanley Electronics of Passaic, N. J. has entered into an agreement with a crusher to crush and destroy any and all old or obsolete tubes to take them off the market.

For the first time: You can send all your old tubes to one location, Metallic Enterprises, Inc., 113 Mill St., Paterson, N. J. and receive credit dollars for them.

Our crusher will take them all. We allow you a 5¢ credit toward each tube you buy.

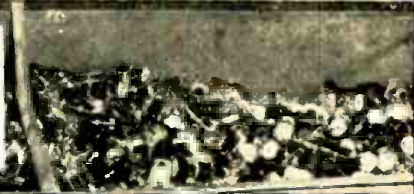

Broken Tubes — Smashed Tubes —
Tubes in any condition
are worth

Pull them out of your attic. Dig them out of your garden. Crush them before shipping if you want to. Regardless of the shape its in, any tube is worth money. Any quantity — 1 to a million.

5¢
ea.

HERE'S HOW IT WORKS . . .

Suppose you send in 100 old, broken or smashed tubes. You will receive 5¢ credit for each tube to be applied toward the purchase of 100 new tubes of any type you want. If your order is for less than the number you have shipped to the crusher, you will receive a credit for the balance to be used against any future purchases. Pack and ship your tubes as scrap material post or freight prepaid to Metallic Enterprises, Inc., 113 Mill St., Paterson, N. J. with a packing slip listing the quantity of tubes shipped for credit. Send Stanley a duplicate of that slip with your order so that proper credit can be given. — **DO NOT SEND ANY TUBES TO STANLEY.**

STANLEY 935 MAIN AVE.
PASSAIC, N. J.
ELECTRONICS CORP Gregory 1-2498

Your order will include one or more of these famous brands
UNCONDITIONALLY GUARANTEED FOR ONE YEAR

Prestested Tubes		Individually Boxed							
Tube	Price	Tube	Price	Tube	Price	Tube	Price		
0A2	70	2021	1.00	6A5UGT	60	65H7GT	43	12BA7	40
0A3	90	2V3G	.80	6A6	43	65J7	43	12B4	68
0A4G	60	2X2A	1.00	6AV5GT	85	65J7GT	45	12BE6	46
0B2	70	3B4	.51	6AV6	39	65K7	50	12BH7	60
0B3	90	3A5	1.00	6AWB	90	65K7GT	50	12BN7A	80
0C3	90	JABGT	1.35	6AX4	.67	65L7GT	57	12BK5	80
0O3	90	3AL5	.57	6AX5GT	57	65N7GT	57	12BY7	64
0Z4	43	3AU6	.57	6B4G	90	65Q7	41	12C06	1.05
1A3	60	3AV6	.57	6B5	90	65Q7GT	44	12J5GT	40
1A5GT	45	3B7	.57	6B6G	55	65R7	42	12M6	49
1A6	.35	3BA6	.60	6B7	89	65R7GT	43	12SA7	48
1A7GT	43	3BC5	.65	6B8	69	65S7	41	12SA7G	48
1A85	90	3BE6	.60	6BBG	69	677G	63	12S7	.55
1AC5	64	3BN6	.80	6BA6	47	678	68	12SH7	47
1AF4	58	3CB6	.60	6BA7	49	6U8	80	12S7CT	45
1AF5	.55	3C56	.60	6BC5	50	6V3	1.17	12SK7	48
1AX2	79	3D6	.45	6BD5GT	53	6V6GT	46	12SK7GT	50
1B3GT	68	3E5	.43	6BE6	44	6W4GT	40	12SL7GT	60
1B4P	35	3E6	.75	6BF5	40	6W6GT	53	13SN7GT	57
1B5	91	3F4	.80	6BG6	18	6X4	.39	12SQ7GT	40
1B7GT	.89	3Q4	.55	6BH6	51	6X5GT	39	12SR7	43
1C3	.58	3QS7	.57	6BJ6	47	6X6	75	12T23	25
1C5GT	41	3S4	.47	6BK9	68	6Y6G	60	12Z3	45
1C6	91	3V4	.58	6BZ7A	74	7A4.XXL	47	14A5	59
1C7G	91	4A1	1.00	6BZ7	88	7A5	.53	14A7	45
1C8	.64	4BQ7A	1.00	6C4	.37	6B06GT	70	14B6	40
1D5GP	43	4BQ7B	1.00	6C5GT	.35	7A6	.45	14F8	1.04
1D7G	93	5A8B	.90	6C6	47	7A7	45	14O7	.52
1E5GP	1.13	5AN8	.90	6C7A	.74	7A8	.45	19B6GG	1.18
1E7GT	41	5A58	.90	6C8	.37	7A9	79	19B6	.86
1E8	.65	5A8	.60	6C9	.35	7A7GT	60	19T8	70
1F4	43	5A05	.60	6C16	80	7AG7	55	24A	.39
1F5G	43	5A18	.60	6C16	47	7AH7	.55	25A7GT	1.50
1F7G	43	5A2B	.60	6C16	51	7AJ7	60	25AV9GT	78
1G4GT	67	5J6	.60	6C16	71	7AK7	75	25BK5	78
1G6GT	41	5T4	.69	6C06G	1.18	7AU7	.89	25B06GT	85
1H4G	43	5T8	.90	6C5A	51	7B4	44	25C06	1.05
1H5GT	47	5UB	.80	6C06	1.09	7B5	41	25L6GT	47
1H6GT	91	5U4G	.49	6D6	48	7B6	42	25Y5	45
1J6GT	47	5V4G	.58	6D6E	.60	7B7	43	25X5	38
1L4	.56	5K4G	.44	6E5	44	7B8	47	25Z6GT	37
1L6	51	5K8	.90	6E5GT	37	7C4	39	27	23
1LA4	57	5Y3G	.39	6F4	38	7C5	42	27L7GT	60
1LA6	47	5Y3GT	.39	6F6GT	38	7C6	.43	35A5	46
1L84	59	5Y4G	.43	67	.89	7C7	45	35B5	48
1LCS	.49	5Z3	.45	6G6G	.38	7E6	30	35C5	48
1LCS	.46	5Z4	.54	6H6GT	.38	7E7	.49	35L6GT	47
1LDS	.59	6A3	.81	6J4	2.00	7F7	.59	35W4	39
1LE3	.59	6A5G	1.11	6J5	.39	7F7	.59	35Y4	40
1LG5	.59	6A7	.57	6J6	.49	7F8	.70	35Z3	.41
1LM4	.64	6A8	.59	6J7	.43	7G7	.75	35Z5GT	39
1M5	.47	6A8GT	.59	6J7GT	.45	7H7	.50	45Z5GT	40
1NSGT	.50	6A84	.45	6J8G	.80	7I7	.75	50A5	48
1PSGT	.50	6A87	.80	6K5GT	.47	7K7	.75	50B5	48
1Q5GT	.59	6AC5GT	.59	6K6GT	.39	7L7	.59	50C5	48
1R4	.66	6AC7	.67	6K7	.39	7M7	.50	50L6GT	45
1R5	.51	6AD7G	1.00	6K7GT	.39	7O7	.59	75	.44
1S4	.34	6AF4	.79	6K8G	.65	7B7	.60	77	.39
1S5	.51	6AG5	.50	6K8GT	.65	757	.60	78	.39
1T4	.51	6AG7	.69	6L6G	.68	7V7	.82	80	.35
1T5GT	.58	6AH4	.80	6L6GA	.70	7W7	.68	83V	.60
1U4	.47	6AH6	.70	6L7	.42	7X6	.48	117L7GT	2.00
1U5	.50	6AK5	.54	6L7G	.44	7Y4	.35	117N7GT	2.00
1U6	.53	6AL5	.42	6M7	.60	7Z4	.40	117P7GT	2.00
1V7	.57	6A17GT	.70	6P5GT	.60	12A6	.40	37	.37
1V2	.50	6A05	.46	6O7G	.45	12A15	.43	117Z6GT	62
1V5	.66	6A0A	.42	6O7GT	.45	12A16	.41		
1W4	.63	6A07GT	.70	6R7	.49	12A17	.66		
1W5	.66	6A15	.60	6S4	.40	12A18	.43		
1X2A	.68	6AN8	.80	6S7G	.47	12A19	.56		
2A3	.50	6A55	.48	6S8GT	.55	12AV6	.42		
2A5	.57	6A56	2.00	6SA7	.48	12AV7	.67		
2A6	.71	6A57G	2.25	6SA7GT	.50	12AX4	.64		
2A7	.43	6A18	.39	6SC7	.48	12AX7	.64		
2A14	1.00	6A18	.39	6S07GT	.57	12AY7	.90		
2B7	.89	6A04	.65	6S07	.41	12BA6	.46		

Brand New DUMONT AND RCA 1k. TV PICTURE TUBES

One year Guarantee—in factory sealed carton. No dust returned

10 inch	\$10.95
12 inch	\$12.95
14 inch	\$14.95
16 inch	\$18.95
17 inch	\$19.95
19 inch	\$20.95
20 inch	\$20.95
22 inch	\$22.95

Add \$4.00 to above prices for aluminized tubes

TERMS: FREE POSTAGE on all Prepaid continental U.S.A. orders on receiving tubes only. 50¢ handling charge on all orders under \$5. 25% deposit on all COD's. Picture tubes F.O.B. Passaic, N. J. via Railroad-Freight.

SAVE ON EVERYTHING IN ELECTRONICS

Zenith
Motorola
Westinghouse
Admiral

SE
Sylvania
National Union
Tung-Sol

KITS! KITS!

HERSHEL'S KITS ACCLAIMED BEST!

ALL KITS CONTAIN THE FINEST ASSORTMENTS. OVER 10,000 SOLD!

- 30 TUBE SOCKETS
- 2 1/2 lbs. of HARDWARE
- 15 ROTARY SWITCHES
- 10 Electrolytic Condensers
- 40 Radio & TV KNOBS
- 40 BY-PASS Condensers
- 40 CARBON RESISTORS
- 60 MICA CONDENSERS
- 100 SET SCREWS
- 8 1N22 XTAL DIODES
- 50 Ceramic Condensers
- 15 Variable Condensers (Air and Mica)
- 50 RF CHOKES
- 20 POWER RESISTORS
- 1 Phono Motor 115 Vac.
- 50 TERMINAL STRIPS
- 200 ft. HOOK-UP WIRE
- 1 TRANS. 6.3V-110 Vac.
- 5 Meissner Plug-In COILS
- 5 PILOT PANEL LITES
- 50 FUSES 3AG UP
- 1 Meier Rectifier O-1MA.
- 1 IGN. COIL 3V-15,000 VSEC.
- 25-Ft. Phono-Mike Cable
- 3 SELENIUM RECTIFIERS (65 MA. 110V.)
- 1 PHOTO Electric CELL

YOUR CHOICE ANY KIT LISTED IN THIS AD 97c

- 10 STRAIN INSULATORS
- 1 TELEGRAPH KEY
- 5 MICRO SWITCHES
- 75-Ft. 300 OHM TV LEAD-IN
- 25 TV STAND OFFS
- 24 SHOCK MOUNTS
- 1 PHONO XTAL with NEEDLE
- 1 PIX TUBE BRIGHTENER
- 3 CONDENSERS (500 MMFD 20,000 Volt)
- 100 Ft. of SPAGHETTI
- 1 RCA Flyback Trans.
- 10 BATHTUB CONDENSERS
- 10 GRAIN WHEAT LAMPS
- 5 RADIO-PHONO CHASSIS
- 4 LOOP ANTENNAS (RADIO)
- 1 PHANTOM ANTENNA A-67
- 100 SPRINGS (RADIO-PHONO)
- 5 RADIO NOISE FILTERS
- 25-Ft. RG-58/U COAXIAL CABLE with PLUGS
- 2 Powerful ALNICO 5 Magnets

All New MYSTERY PACKAGE of ELECTRONIC PARTS

Worth \$40.00
 Our Price **\$3.95**
 It's the surprise of your life! 20 pounds of BRAND NEW usable GOVT. surplus. The ideal gift for hams, etc.

OIL CONDENSER \$1.65
 2 MFD. 3000 VDC. Pyralol Oil W/brackets. 1mg. 3000 VDC. removed from equip. 436-2436-2 1/2

ARC-5 COMMAND TRANSMITTER \$8.95
 7 1/2 Wc. 8 1/2 Band in Carbons. 1 h. tubes. Hottest Buy in the Country

TERMS: Cash with order or 25% DOWN—BALANCE C.O.D. ALL PRICES NET F.O.B. DETROIT MINIMUM ORDER \$2.00

HERSHEL RADIO CO. TYler B-9400
 5249 GRAND RIVER Detroit 9, Michigan

a TERRIFIC BARGAIN in a

SOLA CONSTANT-VOLTAGE TRANSFORMER
 Ends fluctuating line voltage!
OVER 60% OFF...



the factory price at a 1-Input 2,000 VA unit! And here's another bonus! This Air Forces 2,000 VA overstock. Sola Cat. No. 30768. has 4 Inputs! 90-125 V., 190-250 V., 60 cy. or 50 cy. Isolated secondary is constant 115.0 V. ± 1% from no-load to full-load of 17.4 amp. So, if you choose, use it as a 220-115 V. step-down. And slash \$147.50 off the factory 1-Input price!
 Brand new in original wood box. 4 cu. ft. Ship. wt. 254 lbs. F.O.B. Pasco, Wash. Only.
\$97.50
THE M. R. COMPANY
 P. O. Box 1220-A Beverly Hills, Calif.

brief—anyone who has anything to do with, or plans to use, printed circuits. The book is well illustrated and written in easy-to-understand form.

* * *

"HANDBOOK OF SEMICONDUCTOR ELECTRONICS" edited by Lloyd P. Hunter. Published by McGraw-Hill Book Company, Inc., New York. 832 pages. Price \$12.00.

This volume is the work of thirteen specialists who have pooled their talents to provide a complete manual covering the physics, technology, and circuit applications of transistors, diodes, and photocells.

Most of the book is devoted to circuit design and application data. Information is provided on low- and high-frequency amplifiers and switching circuits, direct-coupled amplifiers, transistor oscillators, and circuits using special semiconductor devices.

The book is self-contained and no

additional reference material is required of the user. An extensive 68-page bibliography covering the bulk of the literature on the subject of semiconductors is a valuable addition to this excellent volume.

* * *

"ELEMENTS OF RADIO" by Charles I. Hellman. Published by D. Van Nostrand Company, Inc., Princeton, N. J. 343 pages. Price \$4.95. Third Edition.

This is a new edition of a well-known and popular basic manual for the beginner. It provides the essentials of radio and deals with radio communication on an over-all basis.

There is a completely new chapter on transistors while the material on television and modern electronic applications has been revised and brought up-to-date. The appendix, including tube tables, basing diagrams, and transistor characteristic charts, has been revised and enlarged.

-30-

G-E 9" Portables (Continued from page 57)

a pair of germanium diodes as the ratio detector which drives the 10C8 audio stages. "B+" voltage originates from a single selenium rectifier supply which delivers 135 volts.

The 9QP4 picture tube, recently developed by the Tube Department of the General Electric Company, represents a considerable departure from conventional picture tube manufacturing in that the tube bulb is blown into shape in the same manner as a light bulb. Elimination of the usual heavy face plate by use of this technique results in a 9-inch tube with the remarkably low weight of two pounds.

A 70-degree electromagnetic deflection system is employed, together with electrostatic focus. Since the glass used in the manufacture of this tube

is not a perfect insulator, the high-voltage terminal appears on the base rather than on the bell of the tube. The value of this second anode supply is on the order of 8000 volts. Aluminization of the screen is not used because no improvement in brightness would be gained with the comparatively low anode voltage. A filter-type safety-glass is used, however, to improve the contrast ratio.

One photo illustrates the manner in which the wrap-on aluminum cabinet is removed to expose the interior of the receiver. Servicing of components on the one printed board is relatively simple because all components are on one side of the board while the reverse side is exposed and accessible.

Operating controls on top of the cabinet are channel selector and fine tuning; contrast; vertical hold; and volume—"on-off." Rear controls include brightness, horizontal hold, height and vertical linearity.

-30-



A novel feature is a convenient accommodation for the a.c. fuse. It is located on one side of the chassis in a housing that resembles an i.f. can. This makes it readily accessible for examination as well as replacement.

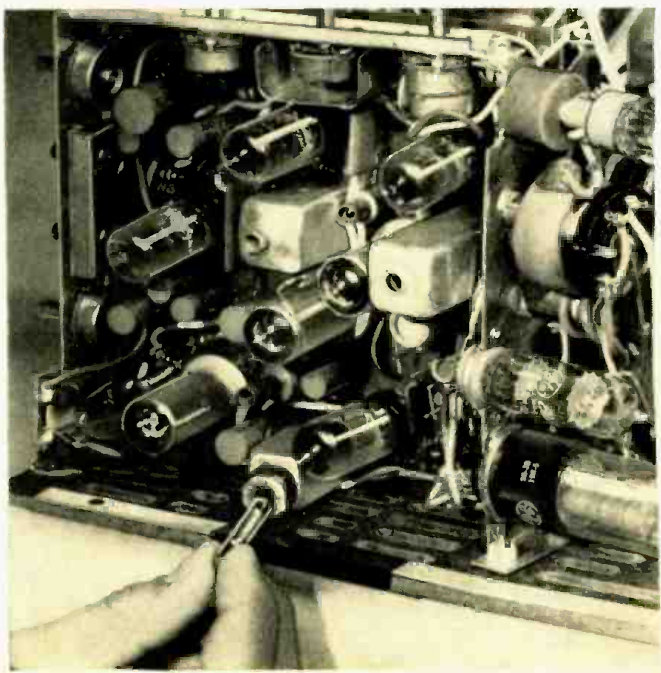

BUY THE WORLD'S FIRST COLOR TELEVISION ANNUAL!

136 PAGES COVERING EVERY PHASE OF COLOR TV:

■ **Fundamentals of
Color TV**
(A Complete Course)

■ **Color Sets On The
Market**

■ **Picture Tubes
and Components**

■ **Technical Analysis
of Sets**

■ **Servicing and Installing**

■ **Test Instruments for
Color TV**

■ **Converters, Color
Wheels, Vitascan**

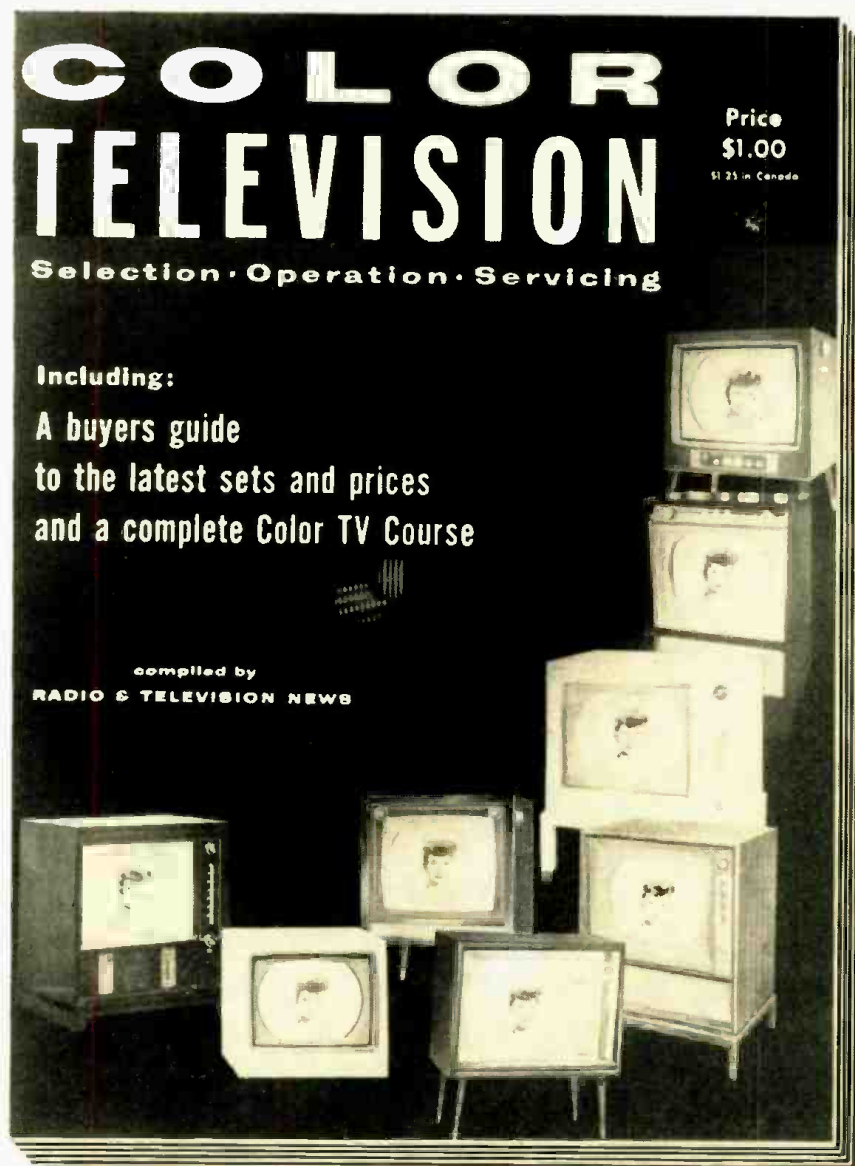

ON SALE DECEMBER 27 AT ALL NEWSSTANDS — ONLY \$1.00



ZIFF-DAVIS PUBLISHING COMPANY—

**Publishers of RADIO & TELEVISION NEWS, POPULAR ELECTRONICS,
AND HI-FI ANNUAL & AUDIO HANDBOOK**

GIGANTIC MOVING MOVING MOVING SALE

51 BIGGEST \$1 BUYS!

"KIT KING" KITS
EXCLUSIVE
WITH LEKTRON!

ANY \$1 ITEM IN THIS
AD FREE WITH
ANY \$10 ORDER!

SALE
ENDS
FEB. 1st!

LEKTRON'S FAMOUS DOLLAR BUYS! MORE FOR YOUR DOLLAR!

- SUBMINIATURE MIKE**, crystal, 2 1/2" sq. Crisp, clear response to 8,000 cps. Plastic case. Reg. \$1.50. **\$1**
- 5 SILICON DIODES**, 1N21, two 1N22, 1N23, 1N107. Reg. \$1.50. **\$1**
- 70 RESISTORS**, insulated IIC, A-B, etc. 2 ohms to 10 megs; 1/2, 1 & 2 W. 1%, & 5%. **\$1**
- 40 MOLDED CONDENSERS**, .001 to 0.1 mf up to 1000 V. Brown, black ceramic cased. Wt. 1.5 lb. Reg. \$8. **\$1**
- BENCH VISE**, heavy steel w/clamp type base, 1 1/2" jaws. Reg. \$1.50. **\$1**
- 15-PC. TWIST DRILL SET**, 1/16 thru 1/2" by 64ths in graduated plastic holders. Reg. \$4. **\$1**
- 70 TERMINAL STRIPS** and boards, 15 types; 1 to 20 screw & solder pins. 1 lb. Reg. \$5. **\$1**
- 60 TUBULAR CONDENSERS**, 30 types, .0005 to 0.5 mf to 1500V. **\$1**
- 70 MICA CONDENSERS**, 30 values, .00001 to .01mf to 1000V. Silver, 5%, 100 W. 1 lb. Reg. \$1.50. **\$1**
- 70 STANDARD KNOBS**, Ass'd. colors, bakelite & plastic. Wt. 2 lbs. **\$1**
- 125 RESISTOR SCOOP**, Carlson, 1/2 to 2W. 40 values; 2 ohms to 10 megs, 5%. Reg. \$1.50. **\$1**
- 150 COIL FORMS**, 15 types, ass'd. sizes. **\$1**
- 40 PLUGS & RECEPTACLES**, wide variety including fuse posts. Wt. 3 lbs. Reg. \$7.50. **\$1**
- FIVE ROLLS TAPE**, elec. trial, plastic, friction rubber; for home, shop, ind. Reg. \$2.50. **\$1**
- 25 SUBMINIATURE PARTS**, Ass'd. printed circuits, condensers. **\$1**
- FOUR G-E 1N69 DIODES**, Germanium, superior to commercial. In poly bag. Reg. \$3. **\$1**
- SUN BATTERY** & photocell, 1 1/2" dia. Better than famed B2M! Reg. \$1.50. **\$1**
- 10 "POLY" BOXES**, Ass'd. sizes, clear plastic hinged boxes w/ snap cover locks. Reg. \$2.50. **\$1**
- 40 OIL CONDENSERS**, Bathub, tubular, rect. .005 to 1 mf up to 600V. Wt. 3 lbs. Reg. \$15. **\$1**
- 30 POPULAR BULBS**, 1.5 to 6V, screw & bayonet types, miniature. **\$1**
- 25 PORCELAIN CONDENSERS**, tubular, 10 values; .001 to .03mf to 1000V. Wt. 1/2 lb. **\$1**
- 25 TUBE SOCKETS**, 4 to 11 prong, miniatures, sub-miniatures, octal, zip-line. Tube shield, tool. **\$1**
- 30 POWER RESISTORS**, W.V. Canidom, sand-enated, vitreous, 15 values; 5 to 50W; 35 to 1100 ohms. Wt. 2 lbs. Reg. \$1.50. **\$1**
- 15 ERIE TRIMMERS**, 8-50mmf, Reg. \$5. **\$1**
- 8-PC. NUTDRIVER KIT**, Plastic handle, 3/16, 7/32, 1/4, 5/16, 11/32, 3/4, 7/16" steel socket wrenches in plastic case. Wt. 1.5 lb. **\$1**
- 3 LBS. HARDWARE**, 4000 pcs. ass'd. screws, springs, washers, etc. **\$1**
- 100 RADIO PARTS!** Wide variety resistors, condensers, pots, plugs, relays, slugs, forms & more! Reg. \$10. **\$1**
- 100 CERAMIC CONDENSERS** U.S.A. first! Ass'd. types, top makers, 30 values, color-coded. **\$1**
- 2 TRANSISTOR COUPLERS**, Eliminate transform. & coupled amp. stages. 100K imp., 5000 DC ohms; center tapped. 1/2" x 1/2" x 1/2". Reg. \$3. **\$1**
- THREE TRANSISTORS**—Scoop! 3 CBS printed circuit transistors; plug. **\$1**
- 2 SUB-MINI I.F. XFMRs**, World's smallest—1 1/2" x 7/16". Double-ended hi-Q ferrite tuned core, 5 discs, encased. **\$1**
- 30 DISCS**, standoff, but-terfly ceramic condensers. Wide variety; 1mmf to .01mf. Reg. \$7. **\$1**
- 30 PRECISION RESISTORS**, W.V. & coll. 100, 30 values, 5% ohms to 1 meg; 1/2, 1 & 2W, 1% to 1W. 1/2 lb. Reg. \$1.50. **\$1**
- 15 ROTARY SWITCHES**, Ass'd. ceramic, bakelite units, multi-tap gangs. Wt. 3 lbs. Reg. \$1.50. **\$1**
- 5-PC. JEWELER'S SCREWDRIVER SET** for miniature work. All different in plastic case. Reg. \$1.50. **\$1**
- 10 ELECTROLYTICS**, Ft. & twist, tubular, rect. Ass'd. sizes, 8 to 500mf to 450V. Wt. 3 lbs. Reg. \$1.50. **\$1**
- 10 PANEL SWITCHES**, 115VAC, micro, push, power type, w/ON-OFF switchplates. Wt. 2 lbs. **\$1**
- 15 AC/DC LINE CORDS**, 2 cond. w/molded plugs. **\$1**
- 15 VOLUME CONTROLS**, Ass'd. values to 1 meg. Dual w/switch. **\$1**
- 2 TRANSISTOR LOOP-STICKS**, tapped. Match transistors, hi-Q ferrite adj. cores; superior selectivity; broad-band. Reg. \$1.25 ea. **\$1**
- 10 TRANSISTOR SOCKETS**, for sub-mini tubes. 100 Mica filled. Reg. \$1.50. **\$1**
- 40 SUBMINIATURE RESISTORS** in poly box, 1/2" long! 20 values, 15 ohms to 10 megs; 1/5 W. Reg. \$5. **\$1**
- 4 CRYSTAL DIODES**, Most used 1N34, 1N57, 1N58, 1N89 in poly box. Reg. \$5. **\$1**
- R/C SCOOP!** Chassis w/ 61 xfmr., 115VAC to 8.3 @ 1.5A; 3000 ohm relay; resistors, condensers, sockets. Wt. 2 lbs. Reg. \$1.50. **\$1**
- 3 HVT DUTY CHOKES**, 200ma, 311. Strap **\$1**
- 3 OUTPUT XFMRs**, (Choke any 100ma) 50H5, 35L5, 50L5, 6V6; to 3-4 ohms. Reg. \$1.50 **\$1**
- G-E PREAMP KIT** for magnetic cartridges, Chassis, parts, diagram, less 1 lb. Reg. \$4.50. **\$1**
- 175-ft. HOOKUP WIRE** in 25-ft. rolls. Ass'd. colors, stranding, insulation. 18 to 24. Wt. 2 lbs. **\$1**
- 8-PC. MAGNETIZED SCREWDRIVER SET**, Ideal for inaccessible places. Driv-ers hold screws in position. \$3.50 value. **\$1**
- 7 PILOT LITES**, Std. mtg. Amber jewel, enclosed. Miniature bayonet. Reg. 75c each. **\$1**
- 20 XMTG. CONDENSERS**, Ass'd. Attentia, ham, .00025 to .01mf to 51250VDC. Reg. \$25. **\$1**

Servicing Modules (Continued from page 62)

choice, therefore, would be the cutting of riser 3 or riser 7 between decks C and E. Let us assume that we cut riser 7. It would then be necessary to solder a new R₁ between risers 3 and 7, and a new R₂ between risers 7 and 10. These components should be soldered to the risers at the dip-soldered side of the etched board.

If C₁ were shorted, it would have to be removed from the circuit before a new C₁ could be added. Cutting riser 1 between decks A and C would also remove C₂ and C₃ from the circuit. Cutting riser 12 between decks A and C would only eliminate C₁, and would, therefore, be the simplest way of making the repair.

A diagonal cutter *should not be used* to cut a riser wire between any two ceramic decks, since permanent damage to the module could easily result. This tool cuts by means of a pinching action. It is during this pinching action that the riser wires immediately above and below the cutters are pushed outward. Since the ceramic decks tend to oppose such movement of the riser wires, the decks above and below the cut wire could crack very easily. A very-fine-toothed saw blade should be used for this purpose. A small power hand tool used with a thin abrasive disc (1/32" thick) could also be used for this purpose.

Some critical circuit applications may require that a defective component be completely removed from the circuit by cutting the risers on each side of the component rather than only one side. An example of this might be a defective video-amplifier coupling capacitor. Disconnecting one side of the defective capacitor removes it from the immediate circuit, but stray capacity between the defective capacitor and other components may introduce slight video smear or other undesirable effects.

Although it is most convenient to solder the new components directly to the risers at the dip-soldered side of the etched wiring board, there may be cases where this is not possible without having to add components. This condition might occur whenever a defective component is connected to one or more risers which do not directly connect to the etched board. Under these conditions, it might be best to solder the replacement directly to the risers between proper decks, as described in the following procedure:

1. Refer to a diagram similar to Fig. 4 and decide between which decks and to which risers you are going to solder. Carefully remove the insulation from this section of the riser wires.
2. Loop pigtailed of the replacement component around the scraped-off section of riser wires, and solder with a low-wattage iron. Pressure applied to the riser wire during soldering should be directed in toward the center of the

TRANSISTOR HOBBYCRAFT EXCLUSIVES

FOUR FEBRUARY SUPER BUYS! ONLY ONE DOLLAR EACH!

- FOUR SUB-MINI RECTIFIERS** for printed and transistor circuits, 1/2-wave, 1 & 2 W. leads. Reg. \$4. **FOUR FOR \$1**
- AMAZING TRANSISTOR BUY!** PNP, hermetically sealed. (Unable to mention name.) Satisfaction guaranteed. Reg. \$5. **ONLY \$1**
- THREE FERRI-LOOPSTICKS** Broad-band band. Adjustable hi-Q ferrite core. Hobby, scoop! **THREE FOR \$1**
- MINI-METER SCOOP!** Chromed, 1 1/2" round, 0 to 8 Amis AC. Model railroad, power supplies, mobile. Reg. \$3. **ONLY \$1**

GIANT SOLAR BATTERY

Never before! Powers 2-transistor radios w/sun, daytime ONLY or 60-watt lamp! Sealed in 2 1/2 x 1 1/2 x 3/4" molded case w/plastic window, mfg. holes. \$10 value! **\$2.98**

TRANSISTOR TRANSFORMER BUY!

LOWEST PRICE IN U.S.! Silicon steel, Interstate. Pri: 20,000 ohms; Sec: 1,000 ohms. Only 2 1/2 x 1/2". Reg. \$4.50. **ONLY \$1.77**

★WRITE FOR NEW '57 BONUS-BARGAIN BULLETIN!★

NOTE OUR NEW ADDRESS WHEN ORDERING

HOW TO ORDER

Check items wanted. Return entire ad with check or MO. Include sufficient postage, excess returned. C.O.D. 25% down. Rated, net 30 days. Print name, address, amount money enclosed, in margin. RTN-1

LEKTRON SPECIALTIES

131-133 Everett Ave., Chelsea 50, Mass.
EXCLUSIVE PRODUCER OF "KIT KING" KITS

SENDING RECEIVING SPEED

Be a "key" man. Learn how to send and receive messages in International Morse code. Communicate with operators around the globe. Learn at home quickly through famous Candier System. Used by best operators. Quality for Amateur or Commercial License. Write for FREE BOOK. **CANDLER SYSTEM CO.** Dept. 2A, Box 928, Denver 1, Colo., U.S.A.

FREE! COMIC AD CARD KIT

FREE CATALOG TOO! shows our complete line of TV Service Reports, Call Books, Phone Message Books, Job Tickets, Service Pricing Guide, File Systems, Service Contracts, Parts Warranties, P.O. Forms, Statement Books, Label Books, Sketch Pads, Cash Books, etc. See them at your parts jobber. **WRITE NOW!** **Oelrich Publications** 4308 Milwaukee Ave. Chicago 41, Illinois

LEARN TV

Work on late model sets—using modern equipment and service techniques: under qualified technician instructors. Short resident and correspondence courses—no unnecessary math or theory—also UHF and Color TV. APPROVED FOR VETERANS... day and night classes. Write for free literature, Dept. 1A for residence—Dept. 1AC for correspondence. **V.S.I. TELEVISION SCHOOL** 4570 Firestone Blvd., Box 359 South Gate, California

bigger BETTER BARGAINS at VIDEO



EICO TUBE TESTER

Model 625K

- Illuminated gear-driven "Speed Rollchart"
- New lever-action switches for individual testing of every element
- Tests all conventional and TV tubes

\$49.95 wired

Kit, **34⁹⁵**



NEW INDOOR ANTENNA

Both UHF and VHF. Brings better reception than most outdoor antennas. Use on top of TV. List price \$9.95.

YOUR PRICE

\$3.99 each

3²⁹

Lots of 3



Brand New PICTURE TUBES

- RCA Licensed
- One Year Unconditional Guarantee

Type	Price	Type	Price
10BP4	\$11.90	17BP4	\$20.63
12LP4	\$14.38	19AP4	\$24.81
14BP4	\$16.86	21AP4	\$28.79
16RP4	\$19.38	21EP4	\$28.79
16LP4	\$19.38	24AP4	\$42.50

Picture tubes shipped F.O.B. Harrison, N.J. Above types are most popular. However, you may order any equivalent size at the same price!

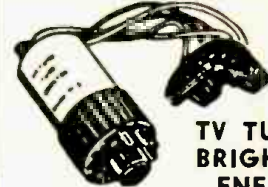

TV TUBE BRIGHT- ENER

Fits all makes of picture tubes, AC parallel circuits. Completely automatic. Easy to install.

99c each, single

Lots of 3

89¢ each

FREE POSTAGE in U.S.A. and Territories on orders over \$5.00. 25c handling charge on orders under \$5.00. 25% deposit required on C.O.D.s. Please send approximate postage or freight on Canadian and foreign orders. Subject to prior sale.

ELECTRIC COMPANY

79 CLINTON PL.

NEWARK, N. J.

Phone HUmboldt 4-9848



HIGH-PAY CAREERS

IN ELECTRONICS — TELEVISION — RADIO

Await Men with COMPLETE Training!

Nationally-recognized, accredited Central training is *designed* to get you into high-paying career positions in the shortest possible time. In addition, Central's "Progressive Plan" is so arranged that each phase of training you complete qualifies you for a more important, better-pay position. In just a few short weeks you are qualified for certain basic jobs. Then, with every additional training phase that you complete, you qualify "up the ladder" for more advanced types of positions. Central offers *complete* Electronics-TV-Radio training leading to an Associate of Science degree, and qualifying you as an *Electronics Engineering Technician!*

Thousands of Central graduates have been placed at almost every technical level in the electronics industry. Free nation-wide placement service.

3 PROVEN TRAINING PLANS

(Choose the one that fits your requirements)

- 1. HOME STUDY COURSE** (with 9 kits of equipment)—Qualifies you for diploma, FCC license, and a variety of electronics jobs (or transfer into advanced resident training).
- 2. HOME STUDY-RESIDENT COURSE** (with 9 kits of equipment)—Home study, followed by short period of resident training. Qualifies you for diploma, FCC license, and a wide variety of Electronics-TV-Radio positions (or continue with advanced resident training). An accredited technical institute curriculum.
- 3. FULL RESIDENT COURSE**—Qualifies you for Associate of Science (A.S.) degree and top-pay employment opportunities as Electronics Engineering Technician. Part-time employment opportunities available for students while training. An accredited technical institute curriculum.

Don't limit yourself! Get the facts on Centrals *complete* training that can take you just as far as you want to go in the electronics technician field. Send coupon *today* for FREE brochure on your opportunities in Electronics.

VETERANS!

Central offers courses approved under G.I. Bill

CENTRAL TECHNICAL INSTITUTE

Dept. W-17, 1644 Wyandotte St., Kansas City 8, Mo.

Tell me more about how you can qualify me for a high-pay Electronics career.

Name _____ Age _____

Address _____

City _____ State _____

If Korean veteran, give approximate discharge date _____

GET YOUR NEW

1957 *Radio Electronic* MASTER

(21st EDITION)

- What product best fills your needs?
 - What does it look like?
- How does it compare? • Who makes it?
 - What does it cost?

Up-to-the-minute answers to all these questions are in The MASTER. Containing four to five times the product coverage of any other buying guide—there is no catalog like it. It is 350 factory-prepared catalogs in one bound volume.

1546 PAGES...

the world's largest electronic parts catalog!



ONLY **\$2.95**
from parts distributors

SERVICEMEN, DEALERS! Buy, sell and bill direct from The MASTER. It shows list prices!

HAMS, EXPERIMENTERS! At your fingertips, those hard-to-get items found only in The MASTER.

HI-FI FANS! Pre-select components in your home. Hear them demonstrated at your dealer.

RESEARCH MEN! Specify, design more rapidly... all the latest data in one bound volume.

1546 PAGES OF THE MOST CURRENT DATA ON:
TUBES • TEST EQUIPMENT • CAPACITORS
CONTROLS • TRANSFORMERS • RELAYS
ANTENNAS • HI-FI • RECORDING & PA
WIRE & CABLE • RESISTORS • KITS, ETC.
• Over 125,000 items • Complete descriptions • Specifications—Prices
• 11,250 illustrations • Fully indexed
• 8½ x 11", 6 lbs.

No matter what electronic component you look for

YOU FIND IT FASTER IN THE MASTER

Get the 1957 edition from local parts distributors — or write for list.

THE Radio-Electronic MASTER
60 Madison Avenue, Hempstead, N. Y.

module. This tends to press the riser into the notches of the wafers adjacent to the point being heated and will maintain a good solder connection at these points.

Throughout all of the procedures outlined, care should be exercised to avoid damage to the module. If the protective coating should be inadvertently broken where it protects a component, it should be repaired. A rubber base cement such as *Pliabond* could be used for this purpose. The diagram of

Fig. 4 clearly shows the service technician what should or should not be attempted with regard to module repair.

As with anything new, it will undoubtedly take a little time for the servicing field as a whole to become fully accustomed to modules. It is hoped that this material has started the service technician on a working knowledge of the use, replacement, and repair of modules used in TV and radio receivers.

How Safe Is Safety Glass?

Rudely awakened by the noise of a loud explosion in the middle of the night, Edwin J. Pfiffner and the other members of his family went to the living room, only to find glass scattered all over it. The CRT in their TV receiver, which had of course, been turned off, had suddenly imploded. Although the safety glass in front of the CRT was covered with cracks, it performed its function in that it remained in one piece, as shown in the photo at the left. However, as the right-hand picture shows, the force of the implosion blew it out of the front of the set and it landed on the floor about 5 ft. in front of the cabinet, permitting glass from the imploded picture tube to be scattered over a considerable distance. As occurs in some cabinet designs, the safety glass was not sufficiently well secured to the cabinet to provide the maximum protection of which it is capable. On the other hand, it doubtless did much to retard flying particles. The incident is worth reflection by cabinet designers.





Sales Aids

V-M "KEY QUARTER" PROMOTION

V-M Corporation, 280 Park St., Benton Harbor, Mich., has developed a coordinated merchandising program covering the period to February 15th and promoting it as a highly profitable "Key Quarter" for retailers.

Keyed to the company's national advertising program in consumer magazines, the promotional package includes specially created window and in-store displays, outdoor advertising, transcribed radio spots, TV films, motion picture theater trailer films, newspaper ad mats, and full-color direct-mail literature for use by dealers.

Dealers have been supplied with complete advertising schedules and all necessary advertising materials for local tie-ins plus detailed instructions on how to implement these materials.

Write the company for full details on the promotion and the products which will be emphasized during the promotion period.

SELF-SERVICE DISPLAY

Walsco Electronics Corporation, 3602 Crenshaw Blvd., Los Angeles 16, Cal., has recently introduced a new self-service display which enables technicians to select instantly the required radio-TV alignment tool from among the 55 being offered by the firm.

The new unit eliminates buying errors by showing off the entire tool. Included in this complete alignment and specialty tool section are items for



1956-57 radio and color TV sets as well as three "Tel-A-Turn" tools with a built-in turn indicator.

For information on the display and the company's line of tools, write to Bob Mueller, sales manager of the firm.

NEW G-E TUBE CARTONS

General Electric Company's Tube Department has developed a new electronic tube carton that is functionally

January, 1957

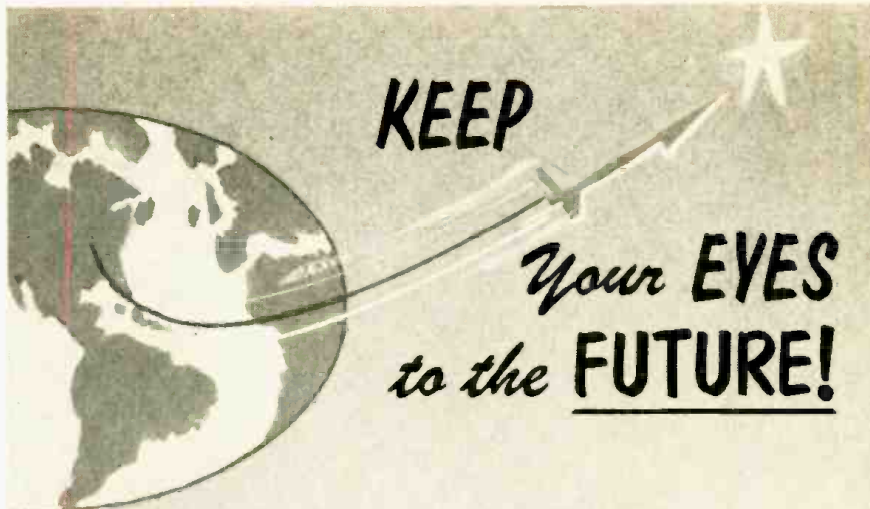

KEEP

Your EYES
to the FUTURE!

Do YOU Know

... the field of ELECTRONICS is the most advanced and fastest growing in the world, offering the largest range of jobs for technicians and engineers in history?

Do YOU Know

... PHILCO TechRep is the world's largest Field Service organization and because of this leadership can offer you—

- unlimited advancement
- opportunity to work any place in the world
- experience in the most advanced fields of electronics and guided missiles
- personal security, real challenge, top salary and compensation for your skills

Do YOU Know

- Philco electronic experts help prepare you for your TechRep Service career
- Philco's especially written Home Study Course keeps you posted on latest electronic techniques, including radar, guided missiles and transistors
- Philco provides financial assistance to continue your education

Do YOU Know

... Philco not only will help you select the position in Electronics best suited to you but can and will provide you with periodic reports as to the openings in our world-wide organization for which you may be qualified.

Get The FACTS About Your Future With Philco:

Send Now to Dept. 21

for The Complete Story on What Makes The Philco TechRep Division —

"First In Employment Opportunities"
PHILCO TECHREP DIVISION
22nd & LEHIGH AVE., PHILADELPHIA 32, PA.

OIL CONDENSER SPECIAL

.5 MFD 7500 V. Sprague, Aerovox. SPECIAL PRICE.....ea. \$1.49
3 for \$3.75
Compact 4 x 4 x 4(12) MFD 600V OIL COND. 85c
suitable for crossover networks, etc.....2 for \$1.59

SMALL PIONEER DYNAMOTORS

Ideal for Amateur or Commercial Service 5.5 to 6 Volt DC input—output 400 volts at 175 MA cont. or 275 MA intermittent duty. Comes complete with A & B filters, RF hash filter & internal cooling fan.....each \$14.95

DYNAMOTOR STARTING RELAY

12V DC coil. Solenoid type fully enclosed. Will easily handle 50 amps. Contacts and winding isolated from ground.....\$1.75
2 for \$3.00

MARION 2 1/2" METER

Basic 0-1 mil has dual scale, 0-100 ma and 0-500 VDC. Complete with 500 Volt Meter Multibuffer.....ea. \$3.95

SPECIAL VOLTMETER

BRAND NEW ROLLER SMITH 2 1/2" 18-36 VDC.....\$1.95

REVODEX MICROMETER DIAL

1" Diameter dial. Satin Chrome plated. Grad. 0-100 div. Black face front Grad. 1-10. Actually counts 1000 div. or 10 turns. Contains mounting hardware and full instructions. For rotors with ductors, helipot, or any other device with 1/4" shaft.....\$2.95

MB 1" Miniature Meter | Filament Transformer
0-1 mil. Scale calibrated | Pri. 110V. 30 cv. Sec-
ondary 6.3V @ 10 amps.
In 20 divisions.....\$3.95 | Good quality.....\$1.65

TELEPHONE HANDSET ELEMENTS

Receiving and carbon microphone elements fits standard W.E. or Conn. Tel. handsets. 65c ea. or \$1.10 pr.

G. E. RELAY CONTROL

(Ideal for Model Controls, Etc.)
Contains a sigma midget 8,000 ohm, relay (trips at less than 2 MA), high impedance choke, bimetal strip, neon pilot and many useful parts. The sensitive relay alone is worth much more than the total.....\$1.10 ea. for \$9.25
low price of.....2 for \$3.00

RELAYS

Sealed Claire SPST. Norm. closed 3000 ohm coil. 2 1/4 ma.
Claire Telephone Type 11,300 ohm coil DPDT contacts 10 amp 125V. Sens. 4MA.....ea. \$3.95
Cutter Hammer Contactor—110V 60 cy. 4 pole single throw. Norm. open 25 amp contacts. ea. \$6.95
Hermetically Sealed Relay Coil 110V AC 60 cy SPDT Contacts 5 Amps.....ea. \$1.85
12 Volt DPDT DC Relay.....ea. \$1.35
Cramer Time Delay Relay. 220V 60 cy. 45 sec. adj. 2 pole DT.....ea. \$6.95
G.E. Plug In Relay 5 prong 2000 ohm ea. \$1.75
SPDT.....2 for \$3.00

OIL CONDENSER SPECIALS BRAND NEW

2 MFD 600 VDC .50	10 MFD 2000 VDC 6.95
4 MFD 600 VDC .75	1 MFD 3000 VDC 1.85
6 MFD 600 VDC .85	1 MFD 4000 VDC 1.95
8 MFD 600 VDC .95	1 MFD 6000 VDC 6.45
10 MFD 600 VDC 1.19	1 MFD 10,000.....
12 MFD 600 VDC 1.50	1 MFD 10,000 VDC 22.00
2 MFD 1000 VDC .85	2 MFD 10,000.....
4 MFD 1000 VDC 1.35	VDC 39.95
15 MFD 1500 VDC 3.10	1 MFD 15,000.....
1 MFD 1200 VDC .45	VDC 29.50
1 MFD 1500 VDC .75	1 MFD 25,000.....
2 MFD 1500 VDC 1.10	VDC 49.50
6 MFD 1500 VDC 1.95	5 MFD 330 AC.....
15 MFD 1000 VDC 2.95	(1000 DC) .95
1 MFD 2000 VDC .85	20 MFD 330 AC 2.50
2 MFD 2000 VDC 1.50	8 MFD 600 C.....
4 MFD 2000 VDC 3.50	(2000 DC) 2.35

NEW PANEL METERS

G.E., WESTINGHOUSE, W.E., SIMPSON, etc.

1" METERS		2" METERS	
0-1 Mil.....\$3.95	0-1 1/2 Ma.....3.95	0-150 Ma (Basic).....3.45	
1 1/2" 0-5 Amps.....3.95	1-5 Ma.....3.45	1-5 Ma.....3.95	
Thermocouple 3.95	0-1 Amp DC.....3.95	0-2 Amp DC.....3.95	
2 METERS	0-500 Volts DC.....5.50	0-1000 Volts DC.....5.50	
0-50 Microamp.....\$5.95	50-500 Amps.....4.50	DC.....4.50	
0-5 Amps DC.....2.95	D-5 Mil AC.....3.95	D-1 1/2 Amps AC.....3.95	
0-200 Mil AC.....2.95			
0-150 MA RF.....3.49			
Ink. Thermo. 3.49			
0-9 Amps R.F.....2.95			

BUD CE2008

Variable Condenser. Isolantite insulation. Air gap. .03 Capacity 300 MMF. Reg. net \$4.65 ea. OUR PRICE.....\$1.65

CHOKES—Fully cased, hermetically sealed.
10 HENRY 80 (unshielded).....90c
8 HENRY 200 Ma.....\$1.95
10 HENRY 315 Ma.....3.50
3 HENRY 315 Ma.....3.50
6 HENRY 450 Mil.....4.95

Read 'n' Save Bargains

9 Pin tube pin aligner.....89c
Precision Meter Multimeter—1 Megohm 1% tolerance.....\$1.49 ea.
IRC MIA 1 Meg Resistor 35 Watts.....85c
HEINEMANN CIRCUIT BREAKER
110 V. 60 cy. 20 amps. Curve 4.....1.25
.01 MMF 1000 VDC MICAS......5 for .95
0.004 2500 VDC MICAS......5 for .95
0.025 600 V MICAS......5 for .95
1 MFD Oil Condenser 400 VDC.....20c ea.
10 for 1.50
Theradson Filament Transf. Int 115V. 60 cy. Secondary 2 1/2 V. 10 amps. 7500V Instal. 5 V. 3 Amps.....3.25

All merchandise sold on a 10 day money back guarantee basis

Min. Order \$3.00—25% with Order—F.O.B. New York

PEAK

ELECTRONICS COMPANY
66 W. Broadway, New York 7, N. Y., WO-2-5439

designed for maximum visibility, protection, and ease of handling.

The carton slogan "Easy Open-Easy Out" emphasizes that the design allows miniature tubes to be quickly slipped out of the carton, thus solving a problem that has long plagued service dealers. Lustrous orange and gray colors are combined with a new shiny black type in modern styling to provide maximum impact and identification. Tube type designations are stamped in large letters and numbers.

The new carton can be opened without tearing the self-locking tuck-in flap



simply by exerting pressure at the fold of the tab. Then gentle pressure on the side panels allows a miniature tube to slip easily out of the protective inner cell.

Tubes are being packaged in the new cartons at the rate of 10,000 an hour at the company's Owensboro, Ky. tube plant.

JFD "SELL-A-BRATION"

JFD Manufacturing Co., Inc. has kicked off a massive distributor-dealer "Sell-A-Bration" to merchandise its line of "Colortennas."

The promotion will enable a service dealer to earn merit points for each such antenna he sells. The bonus points can be earned any time between now and March 15th. Points will be redeemable for over 900 premiums ranging from fishing rods to MG sports cars and trips abroad.

The campaign will be implemented by displays, streamers, newspaper mats, direct mail literature, novelties, and TV and radio commercials. Service dealers interested in getting in on the "Sell-A-Bration" are invited to write the manufacturer for full details and a copy of the premium catalogue.

PICTURE TUBE CLEAN-UP

CBS-Hytron has introduced a "Garry Moore Picture Tube Clean-Up Plan" which is being promoted over the CBS television network.

The program, designed to aid the independent service dealer, consists of a demonstration by Garry Moore as to why the TV picture tube faceplate and protective glass needs cleaning. These glass surfaces, he demonstrates, accumulate enough smoke and dust in just a few months to cut down viewing enjoyment.

He then asks his viewers to "Pick up the phone and call an independent service dealer. If you do not have a favorite service-dealer, look under Ra-

MARINE RADIOMEN! READ THIS!

For 2 reasons: 1st, we are preparing a new flyer chock-full of marine radio money-makers for you. Send us your letterhead asking for one. 2nd, we have just made an extremely fortunate surplus purchase of brand new Impedance Bridges designed not only to measure reactance and resistance of components, but also to measure antenna resistance and reactance at marine frequencies. Range is 25 kc to 5 mc. Complete with accessory box of plug-in standards and educational instruction book with a special section devoted to marine antenna measurements. No power is required for the bridge. Carry it anywhere you carry your signal generator. This is what you have always needed to load and trim antennas to get all the power of your customers' transmitters into the air. Here is accurate laboratory equipment made for the U. S. Navy to exactly duplicate a commercial bridge presently being sold for \$590.00. Please order by our Cat. No. **\$125.00**
123-B11111. Shpg. wt. 60 lbs. Only

the 2 HOTTEST RECEIVERS IN SURPLUS !!!

Extremely easy to make power substitutes for both. Both come with schematics and instructions for the simple modifications required. Both are super-sensitive, super-selective superhets.
2 METERS—24, AR-5, 140-156 mc. in excellent condition with all 10 tubes. 4-channel crystal control. 420 MC: CPR-46ACJ, double conversion, 2 IF's. 3 lighthouses, brand new with ALL 12 TUBES!
YOUR CHOICE \$9.95 EACH... BOTH FOR \$17.95 ONLY....

HI-POWER LO-VOLTAGE

Terrific value xfmtr. With 115 V. 60 cy. to taps 1 & 2, out comes 15.1 V. at 40 amperes! Move from 2 to 3, 4, etc. to 8, and output reduces to 14.3 V., 13.9 V., etc. down to 11.3 V. Series the secondaries of two units to get 30.2 to 22.6 V. Ideal unit to use with either selenium or silicon rectifier to make DC supplies for dynamometers and inverters. With a low current tap-switch in the primary, you eliminate need for variac. Ship. wt. 20 **\$9.95**
Ius. Cat. 100TH21RN. Only

FREE! Big Bargain Catalog! Send for your copy.

All orders, FOB whse. Send 25c dep. with all C.O.D. orders. Item sub. to prior sale & change of price without notice. Min. order \$2.50.

ARROW SALES, INC.

Western Mailing Address:
Box 3007-R NORTH HOLLYWOOD, CALIF.
Central Mailing Address & Sales-Showroom
2441 S. MICH. AV., Dept. R, CHICAGO 16, ILL.
California Distributors: 5100 E. 5th St.
G. L. Electronics, Inc., 1632 Venice, Los Angeles
P.A.R.T.S., Inc., 2005 Empire Ave., Burbank

ALL NEW BIGGER THAN EVER!



NEWARK'S Complete ELECTRONICS Catalog No. 65

Here's everything in Industrial Electronics, High Fidelity, Radio, TV and Amateur Equipment

Write today

NEWARK ELECTRIC COMPANY

Mail Order Division... Dept. R-1
223 W. Madison St., Chicago 6, Illinois
4736 W. Century Blvd., Inglewood, Calif.

dio & Television Service in the yellow pages of the telephone book. Then call the service-dealer and tell him you

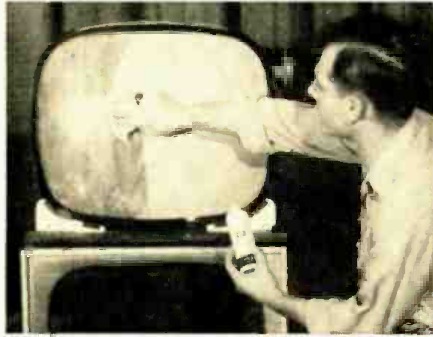

want the Garry Moore Special Television Picture Tube Clean-up."

Dealers have been mailed a broadside to enable them to tie-in with the promotion.

* * *

HANDY RESISTOR ASSORTMENTS

Clarostat Mfg. Co., Inc., Dover, N. H. has released a new power resistor assortment mounted on a handy wall card.

The "Greenohm" display includes six different selections of 2, 5, and 10 watt sizes and ranging from 5 to 50,000 ohms. The popular resistances selected for each card provide the technician with values best suited to his usual requirements. The resistance value of each resistor is marked on the card for ease in re-ordering or taking inventory.

—50—

The 1956 Nobel Prize in Physics has been awarded to Drs. William Shockley, Walter H. Brattain, and John Bardeen (left to right) for their invention of the transistor. The three physicists are shown at Bell Telephone Laboratories in 1948, discussing the crystal structure of semi-conductive materials which form the heart of the transistor. It was through such purely theoretical studies and extensive laboratory investigations that the new physical principle on which the transistor functions was discovered and explained. The invention of the transistor was announced by Bell Laboratories in 1948. Since that time the tiny transistor has evolved from a laboratory curiosity to a device that finds wide use in hearing aids, portable and mobile radios, new computing and control circuitry—until now its monthly sales run to about a million units.



SAMS BOOKS keep you ahead in ELECTRONICS

SAMS books cover every phase of Electronics for the service technician, engineer, student or experimenter. Listed below are a few of the many valuable SAMS books available at electronic parts distributors and leading book stores.



2 NEW SAMS BOOKS

"ELECTRONIC METAL LOCATORS"

by
Harold S. Renne

Explains how Metal Locators operate, describes commercial types available, shows how to construct home-built units, describes applications. Fully analyzes the three basic types of Metal Locators: transmitter-receiver, beat-frequency and induction bridge. Includes chapter showing construction details for several different units, including transistorized types. Reveals the interesting applications of Metal Locators in industry. Special chapters are devoted to prospecting and mine detection applications. Includes valuable bibliography. 124 pages; 5½ x 8½"; illustrated. Order today, postpaid only..... \$2.50

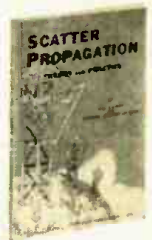

"SCATTER PROPAGATION Theory & Practice"

by Kamen & Doundoulakis

An invaluable book not only for engineers but for technicians who will play an important part in the installation, operation and maintenance of scatter propagation systems. Covers theory and characteristics of Scatter Propagation; equipment used in ionospheric communications systems; tropospheric propagation and equipment utilized; design and construction of parabolic antennas; the importance of Scatter Propagation for the electronic technician; discusses DEW Line and other northern radar and scatter lines. Written so you can understand it. 204 pages; 5½ x 8½"; illustrated. Order today, postpaid only..... \$3.00

USE THIS ORDER FORM

ELECTRONIC METAL LOCATORS.....\$2.50

Color TV Training Manual. Prepares the Technician for Color TV service work. Covers principles of the Color TV system; Color receiver circuits; installation and servicing sets. Includes color blocks outlining the use of color test equipment. 260 pages; 8½ x 11"; 300 illustrations. \$6.95

TV Test Instruments. Revised and enlarged to include latest data on instruments used in Color TV servicing. Tells clearly how to operate each type of test instrument used in TV service work. 180 pages; 8½ x 11"; illustrated.....\$3.50

Key Checkpoints in TV Receivers. Prepared by the Howard W. Sams engineering staff. Provides many applications for general TV service work, including time-saving information on how to make quick tests at key points to determine where trouble lies, and how to check overall performance of the receiver after repair, to insure against callbacks. 182 pages; 5½ x 8½"; illustrated.....\$2.00

Servicing TV Sweep Systems. Describes the operation, circuit function and circuit variations of vertical and horizontal sweep systems common to most TV receivers. Tells how to analyze circuits; troubleshoots for you. 212 pages; 5½ x 8½"; illustrated.....\$2.75

Radio Receiver Servicing. Covers the basic receiver types—gives time-saving hints for solving basic troubles, such as dead set, weak set, noisy set, etc. 192 pages; 5½ x 8½".....\$2.50

TV Servicing Guide. Explains how to apply proper trouble-shooting procedures based on analysis of symptoms (most of which are illustrated by picture-tube screen photos). Shows how to locate and eliminate trouble in every section of the receiver. 132 pages, 8½ x 11".....\$2.00

SCATTER PROPAGATION.....\$3.00

Tape Recorders—How They Work. Explains recording theory, tape characteristics, motorboard mechanisms, drive motors, amplifiers, magnetic heads, volume indicators, equalization circuits—covers everything you want to know about recorders. 176 pages; 5½ x 8½". \$2.75

Servicing AGC Systems. Describes the operation and circuit variations of the various types of AGC systems and explains the servicing techniques that can be applied. Illustrated by actual case histories and photographs of symptoms. 132 pages; 5½ x 8½"; illustrated.....\$1.75

Servicing & Calibrating Test Equipment. Shows you how to keep your test instruments in reliable working order, how to determine proper operation and avoid erroneous indications. Explains calibration procedures; gives method for performance record-keeping; shows simple ways to check instrument accuracy; describes proper maintenance and servicing of instruments. 192 pages, 5½ x 8½".....\$2.75

So You Want to Be a Ham. Tells you what you need to know about getting your license and acquiring equipment. Covers such subjects as: Conquering the Code; Getting Your Ticket; Going on the Air; Electronics as a Career; etc. 196 pages; 5½ x 8½"; illustrated.....\$2.50

There is an authoritative Sams book on virtually any Electronic subject in which you're interested. Check below for FREE Book List describing all Sams books.

Send Book List



...HOWARD W. SAMS & CO., INC.....

Order from your Parts Jobber today, or mail to Howard W. Sams & Co., Inc., Dept. 1-A7 2201 East 46th St., Indianapolis 5, Indiana.

Send books checked above. My (check) (money order) for \$..... is enclosed.

Name.....

Address.....

City..... Zone..... State.....

(outside U.S.A. priced slightly higher)

Look for SAMS BOOKS on the "Book Tree" at your Parts Distributor

"ONE DOLLAR" BUY

As much as \$15 worth — Everything Brand New and sold to you with a money back guarantee.

- 3 - 20KV—500 mmfd II. V. Cond. \$1
- 100 - ASSORTED 1/2 WATT RESISTORS. \$1
- 100 - FUSES 1 AMP standard size 1 1/4" x 1/4" ... \$1
- 4 - SETS SPEAKER PLUGS wired. \$1
- 100 - ASSORTED WHITE TUBE CARTONS. \$1
- 5 - HI-VOLT. ANODE LEADS with 18" leads. \$1
- 1 - 21" TV OPEN MASK with gray color. \$1
- 100* - FINEST NYLON DIAL CORD. \$1
- 300 - SELF TAPPING SCREWS #8/32 x 3/8" ... \$1
- 400 - ASST. SCREWS, NUTS, WASH, RIVETS. \$1
- 50 - ASST. TUBULAR CONDENSERS 85° ... \$1
- 70 - ASST. 1 WATT RESISTORS. \$1
- 35 - ASST. 2 WATT RESISTORS. \$1
- 35 - ASST. RADIO KNOBS screw and push-on. \$1
- 100 - KNOB SPRINGS standard size 3/8" x 1/2" ... \$1
- 50 - ASST. SOCKETS metal and miniature. \$1
- 50 - ASST. MICA CONDENSERS some in 5%. \$1
- 50 - ASST. CERAMIC CONDENSERS. \$1
- 10 - ASST. VOLUME CONTROLS less switch. \$1
- 5 - ASST. VOLUME CONTROLS with switch. \$1
- 20 - ASST. PILOT LIGHTS #44, 46, 47, 51. \$1
- 10 - PILOT LIGHT SKTS. bayonet type, wired. \$1
- 50 - ASST. TERMINAL STRIPS 1, 2, 3, 4 bus. \$1
- 10 - ASST. RADIO ELECTRO. CONDENSERS. \$1
- 5 - ASST. TV ELECTROLYTIC CONDENSERS. \$1
- 10 - 6 FT. ELEC. LINE CORDS with plug. \$1
- 5 - TV CHEATER CORDS with both plugs. \$1
- 10 - ASST. WIREWOUND RES. 5, 10, 20 watts. \$1
- 200* - HOOK-UP WIRE & SOLDER KIT. \$1
- 100* - TWIN 300' LEAD-IN heavy duty. \$1
- 5 - TV CRT. SOCKETS with 18" leads. \$1
- 10 - AC-DC ANTENNA HANKS each 20 feet. \$1
- 25 - ASST. MICA TRIMMER CONDENSERS. \$1
- 50 - TUBULAR CONDENSERS .1-200v. \$1
- 50 - TUBULAR CONDENSERS .02-400v. \$1
- 50 - TUBULAR CONDENSERS .001-600v. \$1
- 25 - TUBULAR CONDENSERS .01-800v. \$1
- 20 - TUBULAR CONDENSERS .25-600v. \$1
- 20 - TUBULAR CONDENSERS .047-600v. \$1
- 20 - TUBULAR CONDENSERS .001-1000v. \$1
- 20 - TUBULAR CONDENSERS .01-1000v. \$1
- 3 - I.F. MINIATURE TRANSFORMERS 450kc. \$1
- 3 - ELECTROLYTIC COND. 80/50 - 450v. \$1
- 4 - ELECTROLYTIC COND. 40/10-450v. \$1
- 3 - ELECTROLYTIC COND. 40/40 - 450v. \$1
- 4 - ELECTROLYTIC COND. 50/30 - 150v. \$1
- 4 - OVAL LOOP ANTENNAS ass't. hi-gain types. \$1
- 3 - LOOPSTICK ANT. new ferrite, adjustable. \$1
- 12 - RADIO OSCILLATOR COILS 450kc. \$1
- 3 - 1/2 MEG VOLUME CONTROLS with switch. \$1
- 1 - BEST 4" PM SPK. 1.47 oz. alnico #5 magnet. \$1
- 1 - 5" PM SPEAKER alnico #5 magnet. \$1
- 2 - \$2.50 SAPPHIRE NEEDLES 4000 playings. \$1
- 2 - SELENIUM RECTIFIERS 1-65ma. 1-100ma. \$1
- 5 - DIODE CRYSTALS 2-IN21, 2-IN23, 1-IN64. \$1
- 1 - \$6 INDOOR TV ANTENNA hi-gain 3 sec. \$1
- 50 - 100 OHM 1/2 WATT RESISTORS 5%. \$1
- 75 - 680 OHM 1/2 WATT RESISTORS 10%. \$1
- 75 - 470K OHM 1/2 WATT RESISTORS 10%. \$1
- 50 - 3.3 OHM 1 WATT RESISTORS 10%. \$1
- 50 - 3900 OHM 1 WATT RESISTORS 10%. \$1
- 50 - 15K OHM 1 WATT RESISTORS 10%. \$1
- 50 - 27K OHM 1 WATT RESISTORS 10%. \$1
- 50 - 120K OHM 1 WATT RESISTORS 10%. \$1
- 50 - 150K OHM 1 WATT RESISTORS 5%. \$1
- 50 - 470K OHM 1 WATT RESISTORS 10%. \$1
- 25 - 2.2 MEG OHM 1 WATT RESIST. 10%. \$1
- 25 - 2.2 OHM 2 WATT RESISTORS 5%. \$1
- 25 - 3.3 OHM 2 WATT RESISTORS 5%. \$1
- 25 - 270 OHM 2 WATT RESISTORS 10%. \$1
- 25 - 470 OHM 2 WATT RESISTORS 10%. \$1
- 25 - 100K OHM 2 WATT RESISTORS 10%. \$1
- 3 - AUDIO OUTPUT TRANSFORMERS 501.6 type. \$1
- 3 - AUDIO OUTPUT TRANSFORMERS 618 or 616 type. \$1
- 1 - SET TV KNOBS standard type, incl. escutcheon. \$1
- 1 - \$3 CRT BOOSTER new life to old tubes. \$1
- 1 - TUNER TAKE-OFF COIL #XM-752. \$1
- 1 - LATEST GOLD GRILL CLOTH 12" x 18". \$1
- 1 - LB SPOOL ROSIN CORE SOLDER 40/60. \$1
- 6 - SPIN TIGHT SOCKET SET 3/16" to 7/16". \$1
- 3 - TV ALIGNMENT TOOLS 7", 12", 18". \$1

HANDY WAY TO ORDER—Simply tear out advertisement and pencil mark items wanted, enclose with money order or check. No letter needed, envelope address is sufficient. You will receive a new copy of this ad for re-orders.

ON SMALL ORDERS—Please include stamps for postage, excess will be refunded. Larger orders will be shipped express collect.

CAPITAL ELECTRONICS
218 FULTON ST., N. Y. 7, N. Y. CO-7-7842

LMB BOX CHASSIS OFFERS FREE inside LMB boxes

10 tested kit diagram projects for the builder. Each one of these kit diagrams built by a recognized expert. Kit projects are complete in every detail. Circuit diagram, photo of project, both front and rear photo. Rear photo shows wiring and parts. Detailed instructions for building, complete parts list and approximate cost. Complete to build except parts and your distributor can supply the parts. Ask your distributor for the list of LMB kit Diagram Projects. If he does not have them, write to

LMB 1011 Venice Blvd. Los Angeles, 15, Calif.

Within the Industry (Continued from page 32)

ucts Co., Inc. has promoted **J. R. JOHNSON** to the post of vice-president in charge of sales and merchandising. **DR. JAMES F. BATTEY** is the new general manager of *Clevite Transistor Products* of Waltham, Mass. **MARSHALL P. WILDER** has joined *Allen B. Du Mont Laboratories, Inc.* as staff engineer in charge of the company's storage tube development program. The Audio Division of *Amper Corporation* has named **C. D. DuBOIS** national sales manager. **DANIEL J. TELL** has been appointed sales promotion manager of the television-radio division of *Westinghouse Electric Corporation*. He will make his headquarters in Metuchen, N. J. The appointment of **RICHARD M. KLEIN** to the newly created post of product engineering manager of the electronic product sales department has been announced by *Sylvania Electric Products, Inc.* **DAVID C. ADKINS** has been named public relations manager of *CBS-Hytron* of Danvers, Mass.

DR. RAYMOND H. DuHAMEL, research assistant professor and supervisor of the Antenna laboratory at the University of Illinois has been named head of the research and development antenna group at *Collins Radio Company*, Cedar Rapids, Iowa. **ROBERT S. BELL**, executive vice-president and general manager of *Packard Bell Electronics Corporation* has been elected president by the board of directors. **SAMUEL OLGCHAK** has rejoined *DeWald Radio Mfg. Corp.* as general sales manager. The appointment of **L. S. PRESTON** to the post of chief engineer has been announced by *Electronic Engineering Company of California*. **CECIL R. RUSSELL** has been named vice-president of the *J. B. Rea Company, Inc.*, Santa Monica electronic computer firm.

PETER G. BUTTACAVOLI has been promoted to the post of national service manager for the receiver division of *Allen B. Du Mont Laboratories, Inc.*



Formerly manager of the company's field technical services, Mr. Buttacavoli is well known for his lectures on television receiver servicing for both black-and-white and color TV sets. He has also served as technical supervisor and field service representative.

In his new post he replaces Joseph Hatchwell who has been named head of the company's new government division field service department.

RADIO CORPORATION OF AMERICA has honored five service organizations named winners in the company's national competition for achievement of TV customer satisfaction.

A ... Always
B ... Buy
C ... Columbia

MATCHED PANEL METERS
Brand New boxed. Factory Fresh. Guaranteed for one year. Available in either Round or Square Two Inch Size.
D.C. Milliamps D.C. Volts D.C. Amperes
A.C. Milliamps A.C. Volts A.C. Amperes
ALL RANGES IN STOCK. **\$1.85** up.
PRICED FROM
Write us your needs. Quick action!

ARR-5 RECEIVER
27-143 MC. AM or FM. 115 VAC. **\$49.50**
Good condition

FRA Frequency Shift Receiver Converter
115 V. 60 cyc. Will work with any teletype equipment. Excellent condition. **\$32.50**

Local Hi-Fi Manufacturer Goes Bust!
His loss is your gain! LOOK IT THESE BUYS!
BEEDE METER: 0-1 MA. 4" square. A truly beautiful job cased in Lucite. Brand new. Orig. cost approx. \$18.00.
A COLUMBIA SUPER-BUY \$7.95
AM-FM TUNING CONDENSER: 3-section. Was used in \$200.00 tuner combo. Brand new from assembly line. \$1.00
DIAL LIGHT ASSEMBLY: Brand new. Each .15c
IN-64 DIODE: New. Stock up NOW! Each .65c
20 MA METER RECTIFIER: Each .65c
AC 6' LINE CORD: UL approved. 6 for \$1.00
With plug

COMMAND GEAR—Excel. Cond.! Excel. Buys!
BC-453 RECVR. 14-35 MC. 0-500v. \$12.95
BC-454 RECVR. 3-13 MC. 80 meters. Only 4.95
BC-455 RECVR. 6-9.1 MC. 40 meters. 4.95
BC-457 XMTR. 4-5.3 MC. Special! 2.95
BC-458 XMTR. 2-3.7 MC. It's a steal! 2.95
4-5.3 MC. XMTR. Brand new, boxed. Only 4.95
5-3.7 MC. XMTR. Spunking new! Boxed! 4.95
BC-456 MODULATOR. Excellent cond. 4.95
BC-442 ANTENNA SWITCHING RELAY. With vacuum capacitor. New, low price 3.49
TRIPLE RECEIVER RACK. With shock mount 2.50
DOUBLE XMTR. RACK. With shock mount 2.50
ALL PLUGS: For SCIT-274N or AHC-5. 1.00
1625 TUBES: For spares. New, boxed. .25
TRIPLE RECEIVER CONTROL BOX. BC-450 .95
TRANSMITTER CONTROL BOX. Only .95
18 FT. FLEX CABLE TACH SHAFTS. To control receiver turret. Special. 1.95

All orders FOB Los Angeles. 25% deposit required. All items subject to prior sale. **MINIMUM ORDER \$3.00.**
OPEN FRIDAY NITE TILL 10 P.M.

Columbia ELECTRONICS
2251 W. WASHINGTON BLVD.
LOS ANGELES 18, CALIFORNIA

NEW—TRANSISTORIZED RADIO KIT

Model TK-104, a professionally engineered, completely transistorized super-het receiver kit.

- Printed Circuit Chassis 4 transistors
- Self Contained Speaker—18 mw. Output
- External Phone Jack
- High Gain Ferrite Loopstick Antenna
- Texon Leather Case
- Completely Sub-miniature
- Measures Only 6 x 4 x 2"
- Complete Easy To Follow Instructions

Model TK-201, a two transistor preamplifier kit on a printed circuit board. Complete with all parts and simple easy to follow instructions. The wide frequency range of this preamplifier will please even the most discriminate audiophile.

Order from your dealer or jobber or for more information write today to:

TRAN-KIT ELECTRONICS
467 SOUTH 5th AVE., DEPT. RT-1 MT. VERNON, N. Y.

The "President's Cup," presented by Frank M. Folsom, RCA president, was presented to Louis E. Randle, president of *Associated Distributors, Inc.* of Indianapolis, Ind.; and to the *RCA Service Company* branches in Dallas, Tex.; Fort Wayne, Ind.; Chattanooga, Tenn.; and South Portland, Me. Branch managers W. R. Seuren, R. C. Bryson, R. P. Malone, and H. G. Minnick accepted the awards for their branches.

The awards were made on the basis of speed and efficiency in handling customers' calls and in training service technicians for *RCA Victor* dealers.

-30-

PHOTO CREDITS

Page	Credit
37	International Business Machines Corp.
38	Cruft Lab., Harvard University
39 (top), 96, 167	Bell Telephone Labs.
39 (bottom)	University of Pennsylvania
40 (top left pictures)	The Bettman Archive
40 (right)	Remington-Rand
42, 43	Admiral Corp.
46	Sylvania Electric Products Inc.
47	Tung-Sol Electric Inc.
54	Electronic Instrument Co., Inc.
57, 160	General Electric Co.
60	Emerson Radio & Phonograph Co.
63	National Co., Inc.
101	Sperry Gyroscope Co.
111	White House Signal Agency
118	Perkin-Elmer Corp.
164	Edwin J. Pfiffner

ERRATA

In the article "Realistic High Fidelity—Horn Loudspeakers and Enclosures" on page 51 of our November 1956 issue, the term "Hypex" was improperly used. This term is an arbitrary and coined expression devised for use as a trademark, and is used currently for the p.a. speakers made only by Jensen Manufacturing Co. These horn speakers generally employ hyperbolic-exponential flares, which facilitate design features such as increased throat resistance near cut-off and reactance annulling of speaker stiffness by horn mass reactance. The Jensen trademark "Hypex" should only have been used with reference to speakers made by this company and not as a descriptive designation.

In the article "Bandpass and Rejection Filters" on page 149 of the above issue, a grid-return resistor has been omitted from Fig. 5. A 1-megohm resistor should be added between pin 7 of V_{1H} and ground.

In the article "New Transformer Design for Power Amplifiers" on page 74 of the above issue, the value of the current feedback resistor in Fig. 6 should be .33 ohm rather than 33 ohms. The decimal point was removed due to imperfect printing.

In the article "New Emerson Color Receivers" which appeared on page 68 of the November 1956 issue, the convergence magnets are incorrectly labeled in Fig. 2. The magnet identified as the blue convergence magnet should be red; and the one identified as the green convergence magnet should be blue.

The following component should be added to the parts list shown on page 55 of the November 1956 issue ("A Volume Expander for Hi-Fi"): $C_{12} = .022 \mu\text{fd.}, 400 \text{ v. capacitor.}$

With reference to the article "Designs of the Future," appearing on page 47 of our November 1956 issue, all design sketches were the work of Harley Earl of Center Line, Michigan and should have been so credited. Our apologies to Mr. Earl.

In A Class By Itself . . . Hallicrafters SX-101



Only
\$31.41
Per Month

Here's the top-flight receiver in the field, with seven ham bands on large slide rule dial; 1.8-2.4 Mc., 3.2-4.1 Mc., 7.0-7.3 Mc., 14.0-14.4 Mc., 21.0-21.5 Mc., 26.95-27.35 and 28.0-29.7 Mc., plus special 10 Mc. position for W.W.V. Includes coverage of most important M.A.R.S. frequencies. A dual conversion receiver with the exclusive Hallicrafters upper/lower side band selection, tee-notch filter, 50:1 tuning knob ratio with absolute resetability, built-in precision 100 kc marker crystal, and illuminated dual scale S-meter. S-meter functions with AVC off. Has five steps of selectivity from 500-5000 cycles and precision temperature compensation. 52 ohm antenna input. Direct coupled series noise limiter. 14 tubes plus voltage regulator and rectifier. Sensitive: —1 mv or less on all bands. Size: 20"x10½"x16". Shp. wt. 74 lbs.

R-45B Speaker, Wt. 13½ lbs. — \$17.95.

YOU NEED PAY ONLY \$39.50 DOWN; CASH PRICE IS \$395.00

Write for Our Complete List of Hallicrafter Models!

AT THE

WORLD'S LARGEST DISTRIBUTOR OF AMATEUR RADIO EQUIPMENT — PAY ONLY 10% DOWN!

Get the Story on the

WRL

*with printed circuit

GLOBE KING 500B: \$38.10 PER MO.
GLOBE CHAMPION 300: \$24.47 PER MO.
GLOBE SCOUT 65B: \$7.95 PER MO.
GLOBE CHIEF 90 KIT: \$5.00 PER MO.
*SCREEN MODULATOR KIT: \$13.95
*TRANSISTOR CODE OSCILLATOR: \$3.95
6 METER CONVERTER: \$24.95
SWR BRIDGE: \$16.95
*CONELRAD KIT: \$22.50

Free 1957 Catalog - Over 18,000 Items



Please Send Me: Free Catalog . . . Hallicrafter Information
 The WRL Product Story . . . and your

Latest Reconditioned Equipment List:



NAME: _____

ADDRESS: _____

CITY & STATE: _____

R & W
1/7

REVOLUTIONARY TEST CONNECTOR



Ask your jobber for E-Z Hook Test Probes. Amazingly simple fully insulated . . . patented Hook type design . . . nothing like it. Greatest improvement in self-holding connectors in years. New . . . different operating principle. Scientifically designed for better, safer connections. It's terrific. Get one today. E-Z Hook Test Products, 1536A Woodburn, Covington, Ky.

GET INTO ELECTRONICS



Valparaiso Tech trains for top flight positions. Tech. rep. field engineers, sales and specialists in communications, missiles, computers, radar, automation, color television. Basic and advanced theory and laboratory. Major companies visit school for our graduates. 21 months' course. High school grad. or equivalent. Dormitories—campus. Start Jan., April, July, Sept. G. I. approved. Write for catalog.

VALPARAISO TECHNICAL INSTITUTE
Dept. RD Valparaiso, Indiana

TAPE RECORDERS

Tapes—Accessories
Nationally Advertised Brands
UNUSUAL VALUES
Send for Free Catalog

DRESSNER
69-02 RA-174 St.
Flushing 65, N. Y.

MERITAPE

Low Cost, High
Quality Re-
cording Tape—
in boxes or
cans.

WRITE FOR BONUS CATALOG

New, Unused • Individually Boxed
TUBES FULL RETMA WARRANTY

No Electrical or Mechanical Rejects

024	.45	6AV5	.80	6K6	.45	12AX7	.55
1AX2	.95	6AV6	.45	6SA4	.45	12BA6	.50
1B3	.65	6X4	.50	6X4	.50	12E6	.65
1R5	.50	6AX5	.75	6X7	.65	12BH7	.65
174	.50	6BA6	.45	6XK7	.50	12BY7	.97
1U5	.45	6BC5	.60	6X7	.55	12TA7	.50
1X2	.85	6BE6	.45	6XN7	.55	12SK7	.45
3V4	.75	6BG6	1.15	6507	.55	12SN7	.56
5U4	.45	6BK7A	1.20	7A	1.15	12ST7	.50
5V4	.60	6BL7	.90	6T8	.75	25BQ6	.90
5Y3	.65	6BN6	1.19	6V6	.55	25L6	.62
6AC7	.65	6BQ6	.90	6W4	.45	25W4	.45
6AG5	.45	6BQ7A	1.30	6X4	.40	35L6	.49
6AK5	.60	6C4	.35	6X5	.45	35W4	.50
6AL5	.40	6C6	.50	6X8	.85	35Z4	.45
6AQ5	.45	6C06	1.08	2AT6	.60	50B5	.70
6AT6	.40	6CF6	1.25	12AT7	.65	50C5	.52
6AU4	.95	6CL6	1.6	12AU6	.41	50L6	.85
6AU5	.60	6J5	.40	12AY7	.40	7A	.85
6AU6	.45	6J6	.45	12AX4	.6R	83V	1.22

FAMOUS BRAND PHONO CARTRIDGES
Original Boxed Money Back Gtd.
RPX00A (001 & 002) "TETRAD" \$6.75
RPX052A Golden Treasure (HS) \$19.25
RPX053A Golden Treasure (HD) \$28.00

Replacement Needles "TETRAD" Diamond
RPJ013A (HS) (001 & 002) "TETRAD" \$10.98
RPJ010 or RPJ000 Single (H) "TETRAD" \$8.98
RPJ015 or RPJ035 Single (S) "TETRAD" \$1.65
RPJ003 or RPJ004 Single (H) "TETRAD" \$8.98
MG or 78 Single (D) "TETRAD" \$8.98

FINEST HI-FI RECORDING TAPE
1200 Ft.—7" Reel \$1.45 Lots
Money Back Gtd. \$1.45 Each of 12

Famous makes quality tape. Precision coated & Silk Gtd. Constant output. Splice Free. Pres. 714 IPS 40-15K. Oxide Wt. 1.3 FOR \$1.50 EACH. SINGLY @ \$1.59 EA.

NEW IMPROVED "TAB" HI-FI SPEAKERS

With Inbuilt Network Triconal Atinco 5 Plus Magnet. 4 to 8 Ohms V.C.
5" TRIAX. 25 Watt/20-20,000 Cycles. MODEL F15H3X \$37.50
12" TRIAX. 20 Watt/40-20,000 Cycles. MODEL F12H3X \$28.50
12" COAX. 20 Watt/35-18,000 Cycles. MODEL F12M2X \$22

"TAB" SPECIALS!

MILLEN 1 1/2" Chrome Knob, 180° CW = 10007, Reg. 75¢ SPECIAL 39¢ @ 3 for \$1
TRANSFORMER, 115 VAC/Pr. sec'd 24 volts @ 8 Amps, 50/0.83V & 18V or 24V, wgt 5 lbs. SPECIAL \$5
COMBO DC Power Parts Package 18 VDC @ 8 amp. Incl above transformer & F. W. Bridge Rectifier. \$20 Value. SPECIAL \$11.49
CIRAY TUBE 5B1 \$1.49; with socket. SPECIAL \$1.14
DIEML miniature PM motor 10,000 RPM, 1/2 to 28 VDC, Imp. 200. SPECIAL \$1.85
CRYSTAL DIODES IN238 @ 60¢; IN21 @ 6.5¢
VOLTMEETER AN Type 215" D'Arsonval 0-30 VDC. SPECIAL \$3
G.R. 314A Precision 50,000 ohm Pot. reg. \$1. "TAB" @ \$4
Electrometer CK5697/570AX, anal. tube. Raytheon. \$50. SPECIAL \$11.49
IMA DE JUR 3" Ind Blkte Cad = 310 meter. "TAB" @ \$4
ROOUMA DE JUR 3" Ind Blkte Cad = 310 meter. "TAB" @ \$3
Fountain Pen, Precision Oiler or Carbon Tip. SPECIAL @ \$1
NEW PHOTOFLASH 525mf/450VDC/5W Watt sec'ds, gtd low leakage, famous mfg. reg. \$13.95. SPECIAL \$6.95
C.M. 3PDT Toggle 10 amp 1/2 to 3/4 HP. \$2.00. SPECIAL @ 2 \$1
0-10MA New Miniature Sig. Precision swetted D'Arsonval Mtd. better 20% acc. Special @ \$4. 2 for \$7
Phone-CW-Filter, Cord, Plug & Jack 1020 ohm filter, reg \$10, USA. "TAB" @ \$1.98

"TABLITE" ELECTRONIC FLASH KITS
AC & Battery Inbuilt
All in One Camera Case

Uses new to coat to voltage super circuit constant bright light output. High duration 1/1000 to 1/2000 sec. K 6800; cost per flash less than \$10 (100 to 2000 flashes per set of batteries. All kits with inbuilt AC Pack. (Kits less batteries.)
MODEL 400B. 60W sec'd color 75+; B & W 225+. Recycles 2 sec'ds, less than 4 lbs. \$52.95
MODEL 600B. 120W sec'd color 100+; B & W 300+. Recycles 5 sec'ds, less than 5 lbs. \$39.95
2-240V Batteries @ \$10
SOLD WITH "TAB" MONEY BACK GUARANTEE

INFRARED SNOOPSCOPE
See In Dark Tube

Selected. G.T.D. & Tested for resolution. 1st class image converter viewing tube. Hi-sensitivity, simplified design 2" dia. Wilhelmite screen. Hi Resolution. Tube & Data. Special @ \$4.75; 2/\$9

KITS! KITS!

All Kits Contain Most Popular Values & Sizes

EXTRA: ONE FREE KIT WITH EACH \$10 KIT ORDER.

25 Precision Resistors	25 Power Resistors
10 Switches	65 Mica Cond's
25 Knobs	5 Crystal Diodes
25 Carbon Resistors*	25 Hookup Wire
36 Panel Lamps	100 Fuses
10 Electrolytic Cond's	35 Ceramic Cond
15 Volume Controls	10 Rotary Switches
25 Tube Sockets	6 Crystals
50 Tubular Cond's	60 Inductors & coils
50 Lugs & Eyelets*	5 Micro Switches
10 Bathing Oil Cond's	10 Wheat Lamps
5 lbs. Surprise Kit	40 Insulators
10 Xmit Mica Cond's	* In Plastic Box

ONE KIT EACH.....only **99¢**

"TAB" TERMS: Money Back Gtd (cost of mds only) \$5 min. order. F.O.B. N.Y.C. Add ship charges or for C.O.D. 25% Dep. Tubes gtd. via R-Exp Only. Prices shown subject to change.
Dept. 1R7, 111 LIBERTY ST., N. Y. 6, N. Y. PHONE RECTOR 2-6245-CABLE "TABPARTS"

INDEX OF Advertisers

JANUARY 1957

While every precaution is taken to insure accuracy, we cannot guarantee against the possibility of an occasional change or omission in the preparation of this index.

ADVERTISER	PAGE	ADVERTISER	PAGE
Airex Radio Corp.	158	Kaplove Electronics Co.	153
Alexander Hamilton Institute	11	L M B Box Chassis	132
Allied Radio Corp.	9, 96, 101, 105, 106, 107, 108, 109, 110, 111, 120, 151	Lafayette Radio	128, 129
American Technical Society	102	Lampkin Laboratories, Inc.	120
American Television & Radio Co.	130	Lektron Specialties	162
Amperex Electronics Corp.	144	McGee Radio Company	122, 123
Anchor Products Co.	114	McGraw-Hill Book Co.	98
Arkay Kits, Inc.	147	M. R. Company, The	160
Arrow Sales, Inc.	166	Mallory & Co., Inc., P. R.	Fourth Cover
Ashe Radio Company, Walter	121	Merit Coil & Transformer Corp.	151
Audel Publishers	120	Milwaukee School of Engineering	111
B. & K. Manufacturing Co.	75, 119, 153	Moss Electronic Distributing Co.	116, 117
Baltimore Technical Institute	132	MusicCraft	141
Barry Electronics Corp.	171	National Radio Institute	3, 19, 20
Beckman Instruments, Inc.	104	National Schools	7, 153
Bell Telephone Laboratories	18	Newark Electric Company	166
Bendix Radio	100	North American Phillips Co., Inc.	30
Blonder-Tongue Laboratories, Inc.	99	CBS-Hytron	21
British Industries Corp.	145	Candler System Co.	81
Burstein-Applebee Co.	136	Capital Electronics	168
		Capitol Radio Engineering Institute	29
		Center Electronics	171
		Central Technical Institute	161
		Century Electronics Co., Inc.	102
		Champion DeArment Tool Co.	112
		Channel Master Corp.	15
		Cleveland Institute of Radio Electronics	32, 33
		Columbia Electronics	168
		Cornell-Dublier	6
		Coyne Electrical School	100, 127
		DeJur Amco Corporation	78
		Delco Radio	14
		DeVry Technical Institute	5, 13
		Dressner	169
		Duotone Company, The	140
		Dyna Company	142
		Dynamic Electronics-New York, Inc.	98
		E-Z Hook Test Products	169
		Editors & Engineers, Ltd.	94
		Electronic Chemical Corp.	141
		Electronic Instrument Co., Inc. (EICO)	35, 36
		Electronic Main Co.	145
		Electro-Sonic Laboratories, Inc.	150
		Electro-Voice	8, 17
		Esse Radio Co.	137
		Fair Radio Sales	131
		Fairchild Recording Equipment Company	139
		Fisher Radio Corporation	28, 29
		G & G Radio Supply Co.	155
		Gardner Electronics Co.	147
		Garfield Company, Oilver	145
		General Electric	28
		General Motors Corp.	10
		Goodheart, R. E.	136
		Greentee Tool Co.	94
		Harjo Sales Co.	104
		Hartley Products Co.	146
		Harvey Radio Co., Inc.	154
		Hawkins Co., P. E.	136
		Heald Engineering College	104
		Heath Company	80, 81, 82, 83, 84, 85, 86, 87, 88, 89, 90, 91, 92, 93
		Henry Radio Stores	132
		Hershel Radio Corp.	160
		Hi-Lo TV Antenna Corp.	97
		Hughes Research and Development Laboratories	77
		Indiana Technical College	145
		International Business Machines Corp.	26, 27
		J. J. Glass Electronics Co.	126
		Jazztone Society, The	152
		Jerrold Electronics Corp.	23
		Oelrich Publications	162
		Olson Radio Warehouse	157
		Pampa Electronics Corp.	138
		Peak Electronics Company	166
		Phaotron Instrument & Electronic Co.	24
		Philco Techrep Division	165
		Precise Development Corp.	12
		Precision Electronics	143
		Progressive "Edu-Kits," Inc.	124
		R. C. A. Institutes, Inc.	79, 98
		RW Electronics	126
		Radiart Corporation, The	6
		Radio Corporation of America	34, 121
		Radio Ham Shack, Inc.	172
		Radio Shack of Boston	113
		Radio-Television Training Association	25
		Rad Tel Tube Co.	102
		Ram Electronics Sales Co.	114
		Raytheon Manufacturing Company	Second Cover
		Renington Rand, Inc.	16
		Rex Radio Supply Company	114
		Rinehart & Co., Inc.	95, 103, 142
		Sams & Co., Inc., Howard W.	16, 167
		Scott-Mitchell	152
		Service Instrument Co.	100
		Shure Brothers, Inc.	149
		Sprayberry Academy of Radio	31
		Stan-Burn Radio & Electronics Co.	156
		Stanley Electronics Corp.	159
		Stevens Walden, Inc.	94
		"TAB"	170
		Tech-Master Products Co.	150
		Texas Crystals	118
		Thorens	148
		Tran-Kit Electronics Co.	168
		Transvision, Inc.	152
		Triplett Electrical Instrument Corp. Third Cover	147
		Tri-State College	104
		Tube Mart	104
		Tung-Sol Electric Co.	22
		United Audio Center	98
		United Catalogue Publishers, Inc.	164
		University Loudspeakers	142
		V.S.I. Television School	162
		Valparaiso Technical Institute	169
		Video Electric Co.	135, 161
		Western Radio	132
		Western Television Institute	136
		World Radio Laboratories	169
		Zytron Tube Company	126

Classified

RATE: 50c per word. Minimum 10 words. March issue closes January 9th. Send order and remittance to: RADIO & TELEVISION NEWS, 366 Madison Ave., N. Y. C. 17.

RADIO ENGINEERING

COMPLETE radio, electronics theory & practice; television; broadcasting; servicing; aviation, marine, police radio. 18 or 21 months. Catalog. Valparaiso Technical Institute, Dept. N, Valparaiso, Ind.

FOR SALE

PRECISION 1054 tester 20,000 r/v \$90. N. Y. vicinity. SC 4-9857.

BUILD your own television test instrument from old TV set. Complete instructions \$2.00. Sterling Electronic Co., 129 W. Long Ave., New Castle, Pa.

WALKIE-talkie for less than \$10.00. Plans 50¢. Fabco Electronics, 7400-R Jackson Pk., Birmingham, Michigan.

ONE of the original General Electric FM receivers covering the old band 44-48 mc. \$10.00. Box 51 % RADIO & TV NEWS.

DIAGRAMS for repairing radios \$1.00. Television \$2.00. Give make, model. Diagram Service. Box 672-RN, Hartford 1, Conn.

TUBES—TV, Radio, Transmitting And Industrial Types At Sensibly Low Prices. New, Guaranteed, 1st Quality, Top Name Brands Only. Write For Free Catalog or Call Walker 5-7000, Barry Electronics Corp., 512 Broadway, New York 12N, N. Y.

DIAGRAMS—Radios, Amplifiers, Changers. \$1.00 Each. Television Service Data \$2.00. Unknown Models. Give Tube Layout And Part Numbers. Kramer's Radio Service, Dept. 656, 36 Columbus Ave., New York 23, N. Y.

COMPLETE Television Sets \$11.95. Jones TV, 1115 Rambler, Pottstown, Pa.

TUBES—RK15A, 725A, 706AY, G1299, 803. \$1.75 each. Allied Electronics, 111 North 41, Omaha, Nebraska.

DISGINTED with "HI" HI-FI Prices? Unusual Discounts on all your High Fidelity requirements. Write now. Key Electronics Co., 120 Liberty St., N. Y. 6, N. Y.

WANTED

CYLINDER and old disc phonographs. Edison Conqueror, Idelia, and Oratorio models. Berliner Gramophones and Zono-o-phones. Columbia cylinder Graphophones, and coin-operated cylinder phonos. Want old catalogues and literature on early phonos prior to 1919. Will pay cash or trade late hi-fi components. Box 50 % RADIO & TELEVISION NEWS.

AN/APR-4, AN/APR-9, other "APR-," "ARR-," "TS-," ARC-1, ARC-3, ART-13, everything surplus: Tubes, Manuals, Laboratory equipment. Describe, price in first letter. Engineering Associates, 134 Patterson Rd., Dayton 9, Ohio.

WANTED: Receiver R5/ARN-7, MN-62A Transceivers, RT18/ARC-1, AN/ARC-3, BC-788C, 1-152C, Collins. Bendix equipment, Test Sets, Dynamometers. Inverters. We pay highest prices. Advise quantity, condition, price first letter. Aircraft Radio Industries, Inc., 15 East 40th St., New York City, telephone LExington 2-6254.

ART-13/T47A Transmitters, \$175.00; ART-13/T47 Transmitters, \$125.00; BC-788 C Allimeters, \$175.00; ARC-3 Transceiver Complete, \$325.00; R5/ARN-7 Radio Compass, \$175.00; BC-318 Rec'r Modified, \$25.00; BC-318 Rec'r Unmodified, \$50.00; ARC-1 Transceiver, \$300.00; BC-312 Rec'r, \$50.00; BC-312 Rec'r, \$10.00; 1-152-C Indicator, \$50.00. Ship Via Express, C.O.D. Subject To Inspection To U. Finnegan, 49 Washington Ave., Little Ferry, N. J.

BC221's WANTED—Highest cash price for BC-221's paid even more if the unit has modulation and hasn't been tampered with. Original book needed. Write giving Model No. to Bolton Laboratories, Inc., Bolton, Mass.

BEFORE You Sell—Check With Rex! Wanted: Surplus military and commercial aircraft electronics. BC-788, 1-152, ARN-7, ARC-1, ARC-3, BC-221, RTA1B, ART-13, DY-21, APN-9, transmitters, receivers, test equipment, etc. Also Want Electronic Tubes: broadcast, transmitting, receiving, Magnetrons, Klystrons, miniatures, sub-miniatures, ruggedized, etc. For Top Prices Contact: Bob Sanett, W6Rex, 1524 S. Edris Dr., Los Angeles 35, Cal. Phone: REpublic 5-0215.

WANTED: ART-13 transmitters and parts—also ARC-1, ARC-3, and ARN-7. Have requirement for ARN-6 material. Iron Core Loops, need all types Collins and Bendix Aircraft Radio equipment. Florida Aircraft Radio & Marine, Inc., P.O. Box 205, International Airport Branch, Miami 48, Florida.

CASH Paid! Sell your surplus electronic tubes. Want unused, clean transmitting, special purpose, receiving, TV types, magnetrons, Klystrons, broadcast, etc. Also want military & commercial lab test and communications gear. We swap too, for tubes or choice equipment. Send specific details in first letter. For a fair deal write, wire or telephone: Barry, 512 Broadway, New York 12, N. Y. Walker 5-7000.

BEFORE You Sell Tell Rex! Wanted—Surplus Military And Commercial Aircraft Electronics: RC-788, 1-152, ARN-7, ARC-1, ARC-3, BC-221, RTA-1B, ART-13, DY-21, APN-9, transmitters, receivers, test equipment, etc. Wanted—Electronic Tubes: Broadcast, transmitting, receiving, Magnetrons, Klystrons, miniature, sub-miniature, ruggedized, etc. Top Prices Paid! For Fastest Checks, Sell to Rex! Write or phone description for immediate action. Bob Sanett, W6Rex, 1524 S. Edris Drive, Los Angeles 35, Calif. Phone: REpublic 5-0215, CResview 1-3856.

REPAIRS AND SERVICING

HIGH Fidelity Speakers Repaired. Amprite Speaker Service, 70 Vesey St., N. Y. 7, N. Y. Ba. 7-2580.

TAPE RECORDERS

RECORDERS, Tape, Hi-Fi. Wholesale Prices. Catalogue. Klarston, 215 E. 88th St., N. Y. C. 28.

PRE-RECORDED Tapes, Records, Accessories. Unusual Values, Catalog. Efesco Sales, 270-E Concord Avenue, West Hempstead, N. Y.

TAPE Recorders, Tape. Unusual Values. Free catalog. Dressner 69-02 R, 174 St., Flushing 65, N. Y.

INSTRUCTION

ENGINEERING Degrees earned by home study. (Residential courses also available). Pacific International University, (formerly American College of Engineering), Box 27724-C, Hollywood 27, California.

KNOW Morse Code in minutes. Revolutionary Code Teacher proved 10 years. 50¢ and self-addressed stamped-envelope to "Philkola-T", 7120 Lahser, Birmingham, Mich.

CORRESPONDENCE COURSES

USED Correspondence Courses and Books sold and rented. Money back guarantee. Catalog free. (Courses bought.) Lee Mountain, Pisgah, Ala.

RECORDS

LONG Playing Records 20 to 50% Discount Brand New Factory Fresh Unplayed—All Labels—Send 20¢ for catalogue to South West Record, 1103 Winbern, Houston 4, Texas.

MISCELLANEOUS

EAVESDROP with a pack of cigarettes, miniature transistorized radio transmitter. Complete Diagrams and Instructions. \$1.25. C. Carrier Co., 734 15th St., N.W., Washington, D. C.

TELEPHONE Extension in your car. Answer your home telephone by radio from your car. Complete diagrams and instructions. \$1.25. C. Carrier Co., 734 15th St., N.W., Washington, D. C.



on Famous
NATIONAL
HIGH FIDELITY



AM/FM Tuner Net \$189.95



20 Watt Ampl Net 84.95



H5 Preamp Net 49.95

Net \$324.85

COMPLETE only \$189.95

with 10W, instead of 20W. Amp.—Net \$269.90

COMPLETE only \$149.95

Limited Quantity at our special price. Mail orders 25% Deposit—Balance C.O.D. Full Line of Hi Fi Components, Tape Recorders, etc.

Get our Special Prices

CENTER ELECTRONICS CO.
Dept. N 72 Cortlandt St. New York 7, N. Y.

HQ for the 5 TOP QUALITY brands of

TUBES

AT SENSIBLE PRICES!

• 90-Day RETMA guarantee • Brand New
• Individually boxed • First quality only
WRITE FOR LATEST RECEIVING AND TV TUBE PRICE LIST, FREE!

1835	53.50	GL299	53.00	CK1026	2.35
1022	50.00	3047H	8.75	1620	53.00
CL 2	10.00	3047L	10.50	1624	1.25
2033	2.00	307A	.60	1625	1.30
2C39A	1.75	355A	12.00	1654	1.00
2C51	2.50	357A	15.00	2051	.65
2C53	9.95	371B	.90	5517	1.35
202	5.70	4038	1.25	5636	2.95
2E24	2.00	4038	2.75	5636A	2.95
2K25	19.75	404A	12.50	5642	1.00
2K25	19.75	404A	12.50	5642	1.00
2K55	15.00	416B	29.50	5646	4.50
3B2A	1.50	417A	2.75	5651	1.40
3B24W	5.00	417A	2.75	5654	1.40
3B29	5.50	5842	12.50	5656	4.50
3BP1	1.40	*450TH	44.00	5670	1.00
3C23	4.00	KU-610	3.50	5675	8.00
3C31	1.40	W6555		5676	1.45
3C45	6.00	658	90.00	5687	2.75
3K20000LK		GL673	13.00	5691	4.75
		703A	1.10	5692	5.00
		717A	.35	5693	4.75
*4-65A	30.25	723A B	7.00	5694	4.50
4-125A	30.25	723A B	7.00	5718	2.00
4-250A	35.00	725A	3.50	5719	2.00
4-400A	58.50	*750TL	35.00	5725	2.75
4B2	9.00			5726	6.00
EL3C	4.50	802	2.25	5744	1.25
4C35	13.50	803	2.00	5749	1.25
4B7	4.50	805	5.00	5763	8.00
*4PR60A	37.50	807	1.20	5812	1.00
5C22	19.10	807W		5814	.80
5R4WGY	8.00	933	1.50	5810	6.40
6AK5W	1.40	813	8.00	5871	1.35
6C4	1.20	814	2.75	5889	2.40
6G1	10.00	815	6.25	5910	4.5
6J4	1.90	816	1.00	5915	.50
6J6W	1.00	836	1.50	6111	4.95
6V6	2.5	837	1.50	6112	4.95
FG32	4.50	838	.70	6130	
*35TC	2.45	845	5.00	6345	6.00
VG5	25	866A	1.50	6146	4.55
32KV	8.00	872A	1.25	6161	60.00
RK60	1.35	917	2.00	6189	2.50
RK65	7.00	918	1.50	6200	3.00
HW69	2.50	927	8.00	6539	9.00
RKR72	0.90	930	1.50	6539	9.00
73	.40	954	.35	8008	3.25
V123A	5.00	955	.35	8020	2.00
VR-130	7.00	956	.35	8028	2.00
203A	2.50	957	.35	9002	.65
211	.50	991	.25	9003	1.35
250R	2.95	CK1005	.35	9004	.50
HK25	1.00	CK1007	.35	9006	.20

and many, many others. Over 1000 types in stock! WRITE! *(SURPLUS)

2 COLOR TUBE CARTONS

Keeps your tube stock neat. New safety partition prevents tube breakage. Distinctively identified in glossy red and black. The most distinctive tube carton available today. Minimum quantity: 100 of any one size. Write for case lot prices.

SIZE PER TUBE PER 100
 Miniature .6AU6, etc. \$1.00
 GT .6SN7, etc. 1.25
 Large GT .1B3, etc. 1.50
 Large G .5U4G, etc. 2.00

WHITE GLOSSY BOXES
 Completely blank. No printing or color. Otherwise same as above. Same high quality same low price. Specify "WHITE" when ordering. When color is not stated, 2 color cartons will be shipped.

TUBE STACKERS
 White glossy only. Ministacker holds 10 Mini tube cartons; "GT" stacker holds 10 "GT" cartons.

SIZE PER CASE
 Ministacker11c
 GT2c



5" DUMONT SCOPE MODEL 274A

AT LESS THAN HALF PRICE!
 Genuine Dumont model 274A, 5 oscilloscope, regularly sold for \$150, now available for LESS THAN HALF PRICE! Look at these features: Frequency response within 50% from 20 to 200,000 cps with recurrent sweepers from 8 to 30,000 cps. Similar X and Y amplifiers and provision for intensity modulation. Portable, light weight. Shpg. wgt. only 35 lbs. Used, clean, checked out and guaranteed.
 SPECIAL! F.O.B. N.Y.C. \$65.00

TEST EQUIPMENT BARGAINS!

- ABSORPTION WAVELENGTH METER, Radio type 758A \$5-00 MCS. (worth \$40.00) NEW! \$ 12.50
- OSCILLOSCOPE, Dumont 274A, Vv. good. \$ 75.00
- OSCILLOSCOPE, Dumont 208B, Vv. good. 110.00
- OSCILLOSCOPE, RCA W-88A, Vv. good. 95.00
- TV, X-TAL 13 CHANNEL MARKER, Kay (mega-marker) Incl. all 13 xtals. Vv. good. \$49.50
- VTVM, Ballantine 305. Rack mtd. L.N. \$235.00
- SQUARE WAVE GEN., Measurements Corp. model 71. Excellent cond. \$165.00
- MEGACYCLE (GDO) METER, Measurements Corp. model 59. Rack mtd. with probe and all coils. Like New! \$125.00
- "EPUT" (EVENTS PER UNIT TIME) METER, Berkeley model 554. Five digit, high speed counter. (Worth \$100.00) New! \$690.00
- UHF SIGNAL GENERATOR, Hewlett-Packard 616A 1800-4000 Mcs. L. NEW! \$1300.00
- SIGNAL GENERATOR, Measurements Corp. model 80. 0-400 Mcs. Vv. good. \$350.00
- SIGNAL GENERATOR, Measurements Corp. model 78FM. 86-110 Mcs. 30 Kc. deviation. Excellent condition. \$175.00

TRANSFORMER SPECIAL!

3100-0-3100 volts @ 1/2 amp!
 PRIMARY: tapped for 98-104-110-116-123 volts, 60 cycles AC.
 SECONDARY: 3100 volts each side of center @ 500 ma. 15 KV. impregnated mica insulation. Conservatively rated. Meas. 9" L x 8" H x 7 1/2" W.
 New, guaranteed. Shpg. wgt. 60 lbs. \$34.50

WRITE FOR "BARRY'S GREEN SHEET." FREE!

TERMS: 25% deposit with order, balance C.O.D. All merchandise guaranteed. F.O.B. N.Y.C.

BARRY ELECTRONICS CORP.
 512 Broadway, Dept. RN, N.Y. 12, N.Y.
 Call Day or Night—24 Hour Phone Service
 Phone: WALKER 5-7000

TUBE

SPECIALISTS to the WORLD
 SELECT THE TUBES YOU NEED FROM ONE OF THE
 MOST COMPLETE TUBE INVENTORIES IN THE WORLD

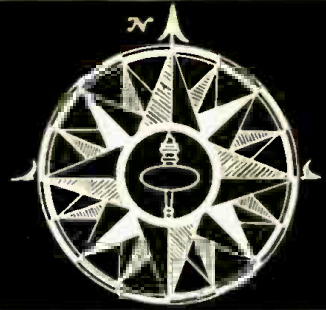

First Quality - Fully Guaranteed - No Seconds

RECEIVING TUBES

0A2	.69	6AD7G	1.50	6L6C	.98	12BF6	.60
0A4C	.95	6AF4	1.25	6L7	.95	12BH7	.89
0B2	.65	6AF6G	.85	6N7	.89	12BK5	.95
0Z4	.49	6AC5	.72	6Q7	.85	12B06GT	1.35
1A3	.68	6AC7	.98	6Q7GT	.79	12B7	.90
1A7	.52	6AM4	.85	6R7	.85	12BZ7	.95
1AD4	1.20	6AM6	.85	6R7GT	.68	12C8	.69
1AE4	.92	6AJ5	1.49	6S4	.57	12CUG	1.35
1AX2	.95	6AM5	.69	6S8GT	1.05	12HG	.59
1B3CT	.79	6AK5	.75	6S7	.79	12J5GT	.65
1C5GT	.52	6AL5	.58	6SA7GT	.79	12K7GT	.85
1C4	.65	6AL7	.95	6SB7Y	.87	12K8	.69
1C6GT	.49	6AM4	1.50	6SC7	.72	12Q7GT	.75
1H5GT	.58	6AM8	1.10	6SF5	.72	12SA7	.69
1J6GT	.69	6AN4	1.50	6SF5GT	.69	12SA7GT	.69
1L4	.74	6AM5	2.75	6SF7	.92	12SC7	.75
1L6	.79	6AN8	1.15	6SG7	.65	12SC7	.79
1LA4	.79	6AQ5	.57	6SH7	.74	12SH7	.65
1LA6	.85	6AQ6	.57	6SH7GT	.59	12S17	.65
1LB4	.85	6AQ7	1.15	6S17	.69	12S7	.69
1LC5	.79	6AR5	.70	6S17GT	.59	12S17	.85
1LC6	.79	6AR6	2.15	6SK7	.64	12S7	.75
1LD5	.95	6AS5	1.00	6SK7GT	.65	12S7	.59
1LE3	.79	6AS6	1.95	6SL7GT	.75	12S7	.59
1LG5	.85	6AS7G	2.35	6SN7GT	.75	12S7	.59
1LM4	.85	6AS8	1.15	6S07	.59	12V6GT	.73
1LN5	.79	6AT6	.52	6S07GT	.59	12W6GT	.87
1N5GT	.95	6AT8	1.05	6SR7	.55	14A4	.95
1Q5GT	.95	6AU4	1.05	6S7	.75	14A5	1.30
1R4	.65	6AUS	1.10	6S7T	.65	14A7	.75
1R5	.65	6AU6	.65	6T8	.95	14AF7	.95
1S4	.65	6BA7	.85	6U5	.85	14B6	.69
1S5	.65	6AV5	1.20	6U8	.95	14C7	.95
1T4	.65	6AV6	.53	6V3	1.25	14E6	1.05
1T5	.69	6AX4	.79	6V6	1.10	14E7	1.15
1U4	.69	6AX5	.69	6V6GT	.65	14F7	.85
1U5	.59	6B4C	.95	6W4GT	.65	14F7	1.10
1V	.65	6B8	.67	6W6GT	.79	14F8	1.10
1V2	.59	6BA6	.63	6X4	.48	14H7	.85
1V6	1.49	6BA7	.85	6X5GT	.49	14H7	.85
1X2A	.85	6BC4	1.50	6X8	.95	14Q7	.85
2A3	.95	6BF5	.68	6Y6	.89	14R7	1.20
2A6	.59	6BC7	1.20	7A4	.79	14S7	1.10
2X2	.49	6BD5	1.35	7A5	.69	14W7	1.25
2X2A	1.35	6BD6	.73	7A6	.78	14W7	1.25
3A3	1.08	6BE6	.65	7A7	.75	19BC6G	.89
3A4	.50	6BF5	.82	7A8	.75	19T8	.75
3A5	.64	6BF6	.68	7D7	1.65	25A5	1.25
3AL5	.65	6BG6G	1.75	7AF7	.89	25AX4	1.05
3AU6	.70	6BH6	.79	7AG7	.95	25BK5	.95
3AV6	.60	6BJ6	.69	7AH7	.95	25B06GT	1.25
3B4	2.95	6BK5	.95	7B4	.75	25CD6G	1.75
3B7	.39	6BK7	1.05	7B5	.65	25W4GT	1.30
3BC5	.80	6BL7	1.05	7B6	.75	25L6GT	.65
3BN6	1.05	6BM6	.68	7C7	.85	25W4GT	.72
3AL5	.65	6BG6G	1.75	7AF7	.89	25AX4	1.05
3AU6	.70	6BH6	.79	7AG7	.95	25BK5	.95
3AV6	.60	6BJ6	.69	7AH7	.95	25B06GT	1.25
3B4	2.95	6BK5	.95	7B4	.75	25CD6G	1.75
3B7	.39	6BK7	1.05	7B5	.65	25W4GT	1.30
3BC5	.80	6BL7	1.05	7B6	.75	25L6GT	.65
3BN6	1.05	6BM6	.68	7C7	.85	25W4GT	.72
3C6	.80	6BQ7A	1.15	7C5	.75	25Z5	.75
3CF6	.85	6BX7	1.20	7C6	.75	25Z6	.62
3D6	.39	6BY5C	1.25	7C7	.79	30	.65
3FL4	.85	6BZ7	1.20	7E7	1.15	32L7	.85
3Q4	.65	6C4	.75	7F7	1.10	35A5	.69
3Q5	.65	6C5	.48	7F8	1.10	35B5	.68
3S4	.65	6C5GT	.46	7F7	1.10	35C5	.68
3V4	.69	6C6	.49	7H7	.79	35L6	.65
4BQ7A	1.30	6C8C	.85	7I7	1.25	35V4	.44
4BZ7	1.35	6CB5	4.40	7K7	1.15	35Y4	.65
5AM8	1.05	6CB6	1.68	7L7	1.10	35Z4	.65
5AN8	1.10	6CD6G	1.75	7N7	.85	35Z3	.65
5AQ5	.75	6CF6	.90	7Q7	.95	35Z5	.55
5AS8	1.10	6CC7	.85	7R7	.95	41	.75
5AT8	1.10	6CL6	1.10	7V7	.95	42	.69
5AV8	1.15	6CM6	.85	7W7	.95	43	.79
5AW4	1.10	6CS6	.75	7Y4	.65	50A5	.68
5AZ4	.60	6CU6	1.30	7Y4	.65	50B5	.68
5F6	.90	6D6	.59	7Z4	.65	50C5	.68
5R4GY	1.45	6DC6	.95	12A4	.85	50L6	.62
5T4	.90	6E5	.75	12A6	.57	50X6	.85
5U4C	.58	6F5	.59	12A8GT	.79	50Y6	.78
5U8	1.10	6F6	.85	12AH7GT	1.05	50Y7	.78
5V4C	.88	6F6GT	.69	12AQ5	.70	53	1.25
5V6GT	.70	6F7	.85	12AT6	.48	70L7	1.15
5W4GT	.65	6F8C	.72	12AT7	.92	75	.65
5X4C	.75	6G6G	.72	12A7	.62	77	.47
5X8	1.05	6H6	.59	12AU6	.62	78	.57
5Y3CT	.49	6H6GT	.49	12AU7	.75	80	.59
5Y4C	.65	6J4	2.55	12AV7	.95	81	1.85
5Z3	.69	6J5	.49	12AW6	.82	83	1.19
5Z4	.59	6J5GT	.47	12AX4	.85	83V	.95
6A3	.95	6J6	.68	12AX7	.78	84/GZ4	.49
6A6	.82	6J7	.82	12AX7	.78	117L/M7	2.45
6A7	.89	6J7GT	.65	12AY7	1.15	117N/P7	2.45
6A8	1.05	6K6GT	.75	12B7	.85	117Z3	.68
6ABGT	.95	6K7	.64	12BA6	.60	117Z4	1.05
6AB4	.59	6K7GT	.59	12BA7	.89	117Z6	.95
6AB7	.95	6K8	1.10	12BA7	.89		
6AC5	1.05	6K8GT	.95	12BD6	.70		
6AC7	.85	6L6	1.69	12BE6	.65		

TRANSMITTING TUBES

0A3/VR75	.86	5J2P	6.35	876	.72	5687	2.65	6099	1.35
0B3/VR90	.73	5J2S	9.95	878	.48	5692	5.10	6101	1.45
0C3/VR105	.68	5LP1	7.40	884	.95	5693	4.65	6113	1.25
0D3/VR150	.68	5NP1	4.95	885	.95	5696	.90	6146	4.75
1B22	1.25	6AC7W	1.45	902	2.45	5702	1.95	6161	69.50
1B23	2.68	6AK5W	1.45	918	1.65	5703	.95	6187	3.95
1B24	4.85	6AL5W	.95	923	1.25	5704	1.85	6189	2.25
1B27	12.95	6AQ5W	1.70	925	1.50	5718	2.75	6263	11.45
1B35	3.45	6AS6W	2.69	927	.95	5718A	4.75	6264	11.45
1B38	33.50	6BF7W	3.45	930	1.19	5719	2.15	6539	2.95
1B40	3.45	6C4W	6.75	931A	2.95	5725	1.45	8005	4.75
1B41	3.75	6C21	14.95	954	.25	5726	.60	8008	3.95
1C21	1.89	6F4	2.65	955	.35	5727	1.25	8012	.98
1N21	.39	6J4WA	4.45	956	.35	5732	2.95	8013	2.65
1N21B	1.45	6J6WGT	3.95	957	.35	5744	1.75	8013A	3.75
1N23	.68	6J6W	2.20	958A	.35	5751	1.45	8014	67.50
1N23B	1.40	6J6WA	3.90	959	1.32	5762	99.50	8020	1.28
1N34	.42	6K4	2.20	991	.29	5763	1.25	8025	1.45
1N34A	.48	6N7WGT	1.85	1603	2.95	5783	4.45	9001	.82
1P21	29.50	6K4W	1.20	1616	.50	5787CK	4.05	9002	.60
1P22	13.25	6K5W	1.25	1619	.30	5794	5.95	9003	1.20
1P23	1.85	7BP7	4.45	1622	1.45	5812	2.70	9004	.35
1P24	1.45	12DP7	14.95	1624	.95	5814	.95	9005	1.39
1P25	64.50	15E	1.45	1625	.29	5819	32.50	9006	.25
1P28	8.95	15R	.49	1626	.19	5820	495.00	C1JA	10.95
1P30	1.95	28D7	.95	1633	.85	5823	1.35	C6J	7.95
1P32	.95	100TH	6.25	1635	1.48	5829	1.35	CK1005	.32
1P35	1.45	100TL	8.25	1641	1.35	5840	4.40	CK1006	3.45
1P40	1.25	211	.45	1654	1.75	5841	7.40	CK1007	.65
1P41	2.45	249B	2.95	2050	1.25	5844	.95	CK1038	4.70
1P42	2.35	249C	1.95	2051	.65	5851	3.45	CK1039	4.95
2AP1	4.95	250TH	18.95	5516	6.45	5876	12.50	F123A	2.75
2B22	1.95	250TL	14.75	5517	1.65	5879	1.25	F127A	22.50
2C22	2.95	262A	8.25	5634	6.95	5881	2.95	F128A	14.95
2C34	.25	274A	3.45	5636	2.90	5886	3.25	FC17	4.95
2C36	21.50	274B	.85	5637	4.95	5894	15.95	FC27A	10.90
2C39A	10.95	304TH	7.95	5638	7.45	5896	4.45	FC32	3.95
2C40	9.45	304TL	9.95	5639	8.95	5899	3.95	FC95	17.50
2C43	10.25	307A	1.10	5641	5.95	5902	5.95	FG105	12.95
2C52	2.95	350A	2.65	5642	6.95	5905	8.75	FG172	17.95
2C53	10.75	350B	2.35	5643	5.95	5906	14.95	FG172	17.95
2D21	.65	371B	.85	5647	3.95	5908	7.85	HF100	6.95
2D21W	1.95	393A	4.50	5651	1.35	5932	3.95	HF200	9.95
2E22	3.15	WL417A	2.95	5654	1.25	5933	2.25	HF300	17.50
2E24	2.40	417A/5842	12.45	5656	7.90	5963	5.45	WL616	47.50
2E25	14.00	434A	2.95	5670	1.10	6021	4.45	RK65	7.50
2E30	1.55	434A	2.95	5675	10.95	6080WA	7.95	RK72	.50
2G21	2.45	450TH	47.50	5676	1.25	6096	1.45	RX21	5.50
2J31	14.00	450TL	35.00	5678	1.25	6097	1.45	TZ40	3.50
2J32	12.50	575A	9.95	5686	1.95	6098	1.85		
2J33	14.00	705A	.68						
2J34	14.00	707A	4.95						
2J36	14.95	707B	3.95						
2J51	97.50	715B							

you can't match **TRIPLETT** model 630 VOM



**SPEED
ACCURACY
DURABILITY
CONVENIENCE!**

heavy molded case
—1/4" thick for high impact.
Fully insulated.

sure grip battery contacts
Balanced double-spring tension grip assures permanent contact

"this wide-range model
tests AC-DC Volts (DC at 20,000 O/V); DC Microamperes, Milliamperes, and Amperes; Ohms (to 100 Megohms); Decibel and Output. Its easy-to-read scales are the longest in this type tester."

streamlined design
No protruding knobs on switch or ohms control—both are flush with the panel.

king size recessed knob
—Only one switch; (fully enclosed) selects both circuit and range. Just turn the switch and make your reading.

for most efficient meter use
—With every Model 630 you receive complete, simplified instructions on how to use and maintain most efficiently.

for quick positive connections
—Banana jacks and plugs on test leads are best. Alligator clips are provided to slip on test prods for extra convenience.

for convenience in reading
—Available as an extra (only 50c), this special stand tilts meter at best angle for easy reading

no slip feature
Four rubber feet furnished as standard equipment fit in back of the case to prevent slipping on smooth surfaces.

advanced engineering
—Molded mounting for resistors and shunts allow direct connections without cabling. No chance for shorts. Longer life and easy-to-replace resistors in their marked positions.

TRIPLETT ELECTRICAL INSTRUMENT CO.
Bluffton, Ohio

MODEL 630 | \$39⁵⁰



THE MIGHTY NINE VOM LINE

- 631**
Combination V.O.M.—VTVM
- 630-NA**
For Best Testing Around The Lab, Production Line or Bench
- 630**
The Popular All-Purpose V.O.M.
- 630-A**
A Good Lab and Production Line V.O.M.
- 310**
The Smallest Complete V.O.M. With Switch
- 630-T**
For Telephone Service
- 666-NH**
Medium Size For Field Testing
- 625-NA**
The First V.O.M. With 10,000 Ohms/Volt AC
- 666-R**
Medium Size With 630 Features

... another
MALLORY
service-engineered
product

watch out for
shrinking
capacitance

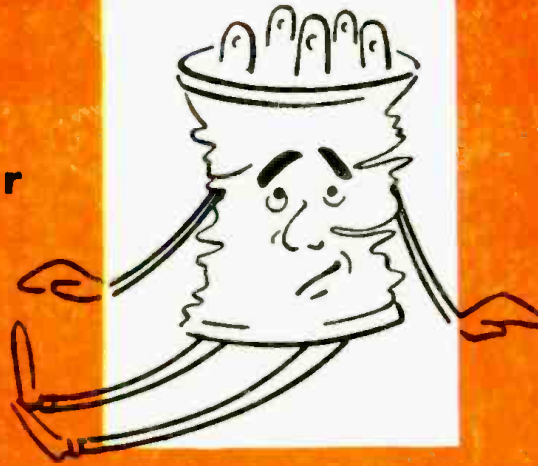

—insist on

Etched Cathode

Ever notice how some capacitors fail before their time? In just a few weeks, especially in a high ripple circuit, they begin to develop hum.

This is due to loss of capacitance, and it's a common ailment of capacitors with plain foil cathodes.

You'll never have this trouble with Mallory FP's and popular Mallory tubular electrolytics . . . because they have *etched cathode* construction. It's a standard feature of Mallory electrolytics that insures against "missing microfarads."

See your local Mallory distributor for full facts on why etched cathode is important to you— and to your customers!

P. R. MALLORY & CO. Inc.
MALLORY

P. R. MALLORY & CO. Inc., INDIANAPOLIS 6, INDIANA

• Capacitors • Vibrators • Resistors • Controls • Switches • Filters
• Rectifiers • Power Supplies • Mercury and Zinc-Carbon Batteries