

RADIO NEWS

JULY
1948
35¢



NEW
SPEED

RN-58-J84822-49
JOHN R NELSON
1100 CRESCENT N E
GRAND RAPIDS 3 MICH

PAGE 44

Now—
 a new way to
 sell batteries...
 a handy way to
 buy them...



RCA Battery Carry-Kit and Display Card work together to boost your sales.

The unique RCA Carry-Kit Package of eight sealed-in-steel "A" batteries

BECAUSE RCA sealed-in-steel Radio "A" Batteries *stay fresh for years*, you can sell them easily—and with confidence—in this new RCA Carry-Kit package of eight cells.

The new RCA Carry-Kit stimulates large unit-of-sales purchases . . . assures an ample supply of RCA

VS-036's *when* they're needed. It's one of the ways RCA is helping you get your share of what has been predicted *the greatest portable year in history*.

You'll need a good supply of RCA Carry-Kits to meet the demand. Order your stock today from your local RCA Distributor and be prepared for the business.

SELL RCA BATTERIES—THE COMPLETE LINE FOR THE RADIO AND ELECTRONIC TRADE

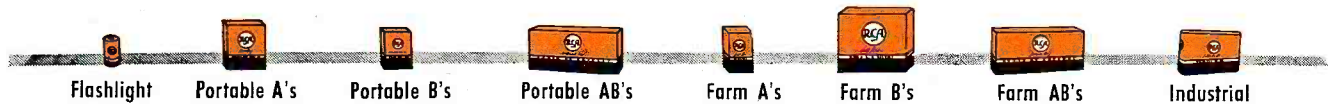

TUBE DEPARTMENT

RADIO CORPORATION of AMERICA

HARRISON, N. J.

LEARN RADIO

BY PRACTICING IN SPARE TIME

As part of my Course I send you the speaker, tubes, chassis, transformer, loop antenna, etc. . . . EVERYTHING you need to build this modern, powerful Radio Receiver! In addition, I send you parts to build many other real Radio circuits, like the Radio Tester, Frequency Modulation (FM) Signal Generator, and Superheterodyne Receiver pictured below. You use this material to get practical Radio experience and to make EXTRA money fixing neighbors' Radios in spare time. Mail coupon below for complete information!

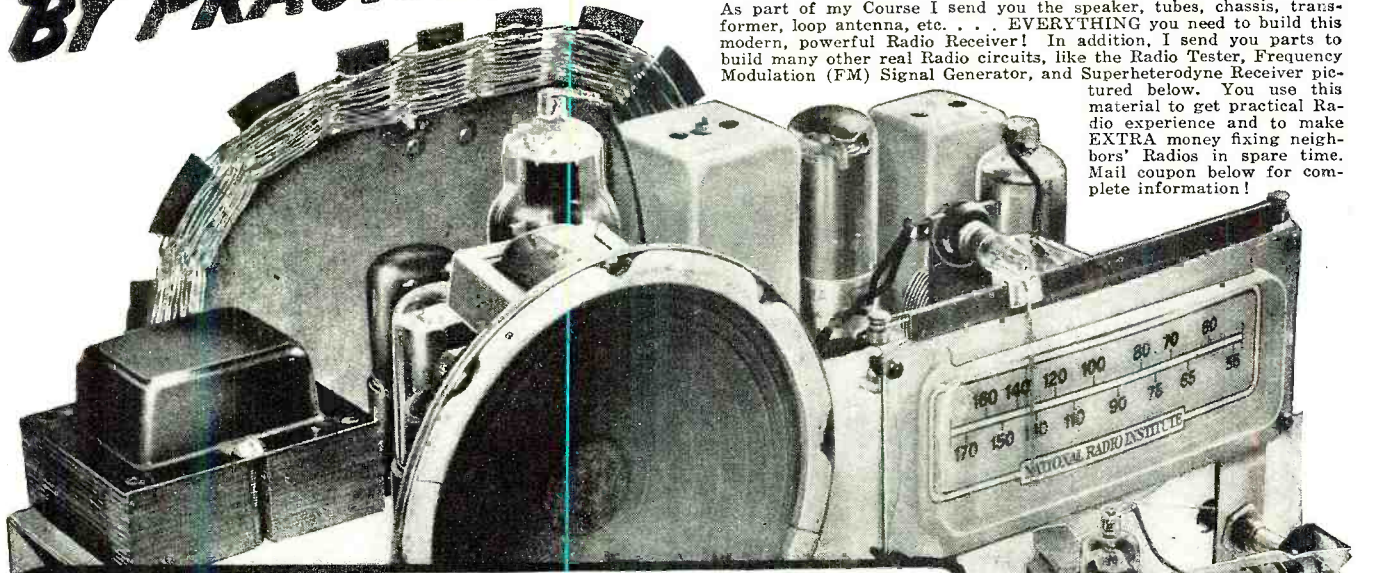

I SEND YOU BIG KITS OF PARTS
You Build and Experiment
With this MODERN RADIO
AND MANY OTHER CIRCUITS



J. E. SMITH, President
National Radio Institute

I TRAINED THESE MEN

Makes \$60 A Week Plus Bonus
 "I am Radio Serviceman for The Adams Appliance Co. Am now getting \$60 a week, plus bonus and overtime."—W. A. ANGEL, Blythesville, Arkansas.

Knew Nothing About Radio
 "I knew nothing about Radio when I enrolled. I am doing spare time work. I have more than paid for my Course and about \$200 worth of equipment."—RAYMOND HOLT CAMP, Vandalia, Illinois.

Do you want a good-pay job in the fast-growing Radio Industry—or your own money-making Radio Shop? My train-at-home method has helped hundreds of men with *no previous experience* become qualified Radio Technicians. Mail the Coupon and you'll get a Sample Lesson and my 64-page book, "How to Be a Success in RADIO-Television-Electronics," both FREE. See how you get practical Radio experience at home, building, testing Radio circuits with BIG KITS OF PARTS I send!

Many Beginners Soon Make EXTRA Money in Spare Time While Learning

The day you enroll I start sending EXTRA MONEY manuals. You learn Radio principles from my easy-to-understand, illustrated lessons—PRACTICE what you learn with parts I send—USE your knowledge to make EXTRA money fixing neighbors' Radios in spare time while still learning! From here it's a short step to your own full-time Radio Shop or a good Radio job!

Future for Trained Men is Bright in Radio, Television, Electronics

It's probably easier to get started in Radio now than ever before, because the Radio Repair Business is booming. Trained Radio Technicians also find profitable opportunities in Police, Aviation, Marine Radio, Broadcasting, Radio Manufacturing, Public Address work. Think of even greater opportunities as public demand for Television, FM, Electronic devices continues to grow. Get the facts on all these opportunities. Send for FREE books now!

Find Out What NRI Can Do For You

Mail Coupon for Sample Lesson, "Getting Acquainted With Receiver Servicing," and my FREE 64-page book. It's packed with facts about Radio's opportunities for you. Read the details about my Course. Read letters from men I trained, telling what they are doing, earning. See how quickly, easily you can get started. No obligation. Just MAIL COUPON NOW in an envelope or paste it on a penny postal. J. E. SMITH, Pres., Dept. 8GR, National Radio Institute, Pioneer Home Study Radio School, Washington 9, D. C.

VETERANS

You can get this training under G. I. Bill. Mail coupon.

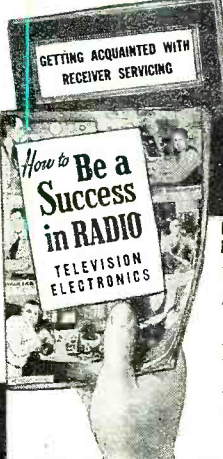

Good for Both—FREE

MR. J. E. SMITH, President, Dept. 8GR
National Radio Institute, Washington 9, D. C.

Mail me FREE Sample Lesson and 64-page book. (No salesman will call. Please write plainly.)

Age.....
 Name.....
 Address.....
 City..... Zone..... State.....
 Check if Veteran

My Course Includes Training in
TELEVISION • ELECTRONICS
FREQUENCY MODULATION

July, 1948

Editor
OLIVER READ, W9ETI
 Managing Editor
WM. A. STOCKLIN
 Technical Editor
H. S. RENNE, EX-W8PTS
 Associate Editors
RAY FRANK, W9JU
P. B. HOEFER
E. HITZEL
S. KRUMBACH
 Staff Photographer
ARTHUR E. HAUG
 Staff Artist
R. S. KUPJACK

Advertising Manager
L. L. OSTEN
 Midwestern Advertising Manager
JOHN A. RONAN, JR.

Art Director
HERMAN R. BOLLIN

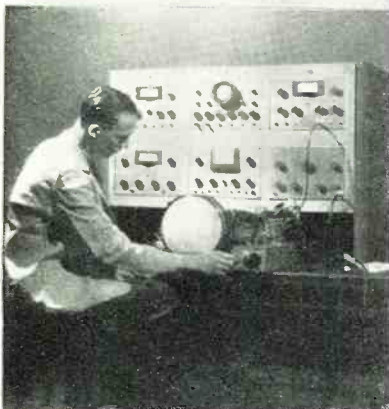

COVER PHOTO: Modern television servicing setup including an audio oscillator, oscilloscope, television calibrator, test oscillator, television sweep generator and "Volt-Ohmyst. All equipment made by RCA. (Photo by Radio Corporation of America)

Chairman of the Board and Publisher
WILLIAM B. ZIFF

President
B. G. DAVIS

Secretary-Treasurer
ARTHUR T. PULLEN

Vice-Presidents
GEORGE BERNER
 Advertising and Sales Director

MICHAEL H. FROELICH
 Dir. Eastern Div.

H. J. MORGANROTH
 Production Director

H. G. STRONG
 Circulation Director

BRANCH OFFICES
 NEW YORK (11)
 Empire State Bldg., WI 7-0400

LOS ANGELES (14)
 815 S. Hill St., TUcker 9213
 Manager, WILLIAM L. PINNEY

TORONTO
 21 King Street, East

ASSOCIATED WITH
 Ziff Davis, Ltd., Grampians Bldg.,
 Western Gate, London, England



First in radio-electronics

Average Paid Circulation over 175,000

Trade Mark Registered U.S. Patent Office No. 378427

CONTENTS

JULY, 1948

Marine Radio Installation.....	Max Alth	35
New Trends in Receiver Design.....	W. William Hensler	38
A Compact Linear Diode V.T.V.M.....	Rufus P. Turner, WIAY	40
Make a Test Unit for Your Service Kit.....	H. Leeper	41
A Compact Medium Power C. W. Transmitter.....	Charles S. Mayeda, W0GMR	42
New Test Equipment Speeds Video Servicing.....	Arthur Liebscher	44
Television on Wheels.....	R. P. Wakeman and T. T. Goldsmith, Jr.	46
Equalizing the G.E. Pickup.....	John F. Gruber	48
A Low Frequency Converter.....	R. C. Amundsen, WIHYF	49
10 db. Volume Compression Without Splatter.....	R. M. Crottinger, W0GUY	50
The Recording and Reproduction of Sound (Part 17).....	Oliver Read	52
Mac's Radio Service Shop.....	John T. Frye	54
Radio Seeks Black Gold.....	T. A. Patterson, Jr.	55
A Simple Shutter Speed Meter.....	Vernon B. Westburg	58
Putting the 826 to Work.....	Richard L. Parmenter, WIJXF and C. E. Clark, WIKLS	61
Low Cost All-Wave Signal Generator.....	Harold Gould	64
Modern Television Receivers. (Part 4).....	Milton S. Kiver	66
Again—Danger, High Voltage.....	Guy Dexter	78

DEPARTMENTS

For the Record.....	The Editor	8	RN Circuit Page.....	84
Spot Radio News.....		18	What's New in Radio.....	88
Within the Industry.....		26	New Receivers.....	134
Short-Wave.....	K. R. Boord	60	Manufacturers' Literature.....	152
Technical Books.....			159	



COPYRIGHT 1948
 ZIFF-DAVIS PUBLISHING COMPANY
 185 North Wabash Ave., Chicago 1, Ill.
 VOLUME 40 • NUMBER 1



Member
 Audit Bureau of
 Circulations

RADIO NEWS is published monthly by the Ziff-Davis Publishing Company, 185 N. Wabash Ave., Chicago 1, Ill. Subscription Rates: in U. S. and Canada \$4.00 (12 issues), single copies 35 cents; in Mexico, South and Central America, and U.S. Possessions, \$4.00 (12 issues); in British Empire, \$5.00 (12 issues)—all other foreign countries \$5.00 (12 issues). Subscribers should allow at least 2 weeks for change of address. All communications about subscriptions should be addressed to: Director of Circulation, 185 N. Wabash Ave., Chicago 1, Ill. Entered as second class matter March 9, 1938, at the Post Office, Chicago, Illinois, under the Act of March 3, 1879. Entered as second class matter at the Post Office Dept., Ottawa, Canada. Contributors should retain a copy of contributions and include return postage. Contributions will be handled with reasonable care but this magazine assumes no responsibility for their safety. Accepted material is subject to whatever revisions and by-line changes that are necessary. Payment made at our current rates, covers all authors', contributors', or contestants' rights, title, and interest in and to accepted material, including photographs and drawings.



**EVERYTHING
YOU WANT..... in a high quality
low cost receiver *Model*
hallicrafters NEW S-53**

- Coverage: 540 kc to 54.5 Mc
- Five bands
- Accurately calibrated slide rule dials
- Full electrical bandspread
- Series noise limiter
- Universal antenna input
- Built-in PM speaker
- Beat oscillator
- 2.5 watt audio output

Hallicrafters Model S-53 takes an important position in the Hallicrafters line of high quality communications receivers. Completely modern. Superbly engineered for top flight performance at remarkably low price. All the Hallicrafters built-in quality features amateurs expect and demand in a good receiver. Extended frequency range from 540 kc to 54.5 Mc in five bands. Uses two Mc IF which positively eliminates all amateur station images or repeat points within the ham bands. The strikingly designed, edge lighted dial is precisely calibrated. A separate bandspread control provides full electrical bandspread on all frequency bands. Latest series type noise limiter circuit; voltage stabilized oscillator; iron core IF's; built-in PM dynamic speaker. Rich satin-black steel cabinet with satin chrome trim. Complete with seven tubes and rectifier. 105-125 volts, 50-60 cycles AC. **\$79.50**

Overall tuning range: 540 kc to 54.5 Mc. Band 1: 540-1630 Kc; Band 2: 2.5-6.3 Mc; Band 3: 6.3-1.6 Mc; Band 4: 14-31 Mc; Band 5: 48-54.5 Mc.

Controls: main tuning, bandspread, band-switch, RF gain, audio volume, tone control, noise limiter, standby-receive, phone-code switch, speaker-headphone switch and phone jack on rear

panel. Input jack for record player pickup connection.

New superhet circuit uses: 1-6C4 oscillator; 1-6BA6 mixer; 2-6BA6 IF's; 6H6 detector-AVC-noise limiter; 6SC7 BFO-1st audio; 6K6GT audio output and SY3 rectifier.

Size: 12⁷/₈" x 6⁷/₈" x 7⁷/₈".

Copyright 1948, The Hallicrafters Co.

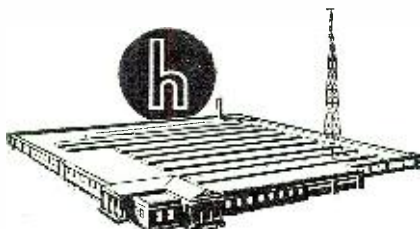

**hallicrafters
RADIO**

THE HALLICRAFTERS CO.
4401 W. Fifth Ave., Chicago 24, Illinois
MANUFACTURERS OF RADIO AND ELECTRONIC EQUIPMENT

RUBBER RECIPE

Rubber compounds to the tune of some 35 million pounds a year go into Bell System plant. Each compound must meet many requirements for resistance to humidity, oxygen, ozone, light and abrasion. The right properties depend on skillful selection and compounding of ingredients; this is one of the jobs of Bell Laboratories.

Sulphur, one essential ingredient of rubber, can also be corrosive. That seemed to rule out rubber on telephone cords. But Bell chemists found that if they held sulphur to the bare minimum, corrosion ceased. Now your handset cord has long life, is less susceptible to moisture as, for example, from a wet umbrella.

Connecting your home to the telephone wire on the street is a "drop" — one hundred feet or more of rubber-insulated wire. Once this wire was protected from ozone, light and abrasion by an impregnated cotton braid; but water leached the impregnant, and the braid rotted. Bell chemists tested scores of synthetics, and selected neoprene as an exterior covering with many times the life of braid.

Rubber is only one of many types of insulation developed by the Laboratories for the Bell System; insulation is only one of the Laboratories' problems in providing a quick, economical path for your voice.

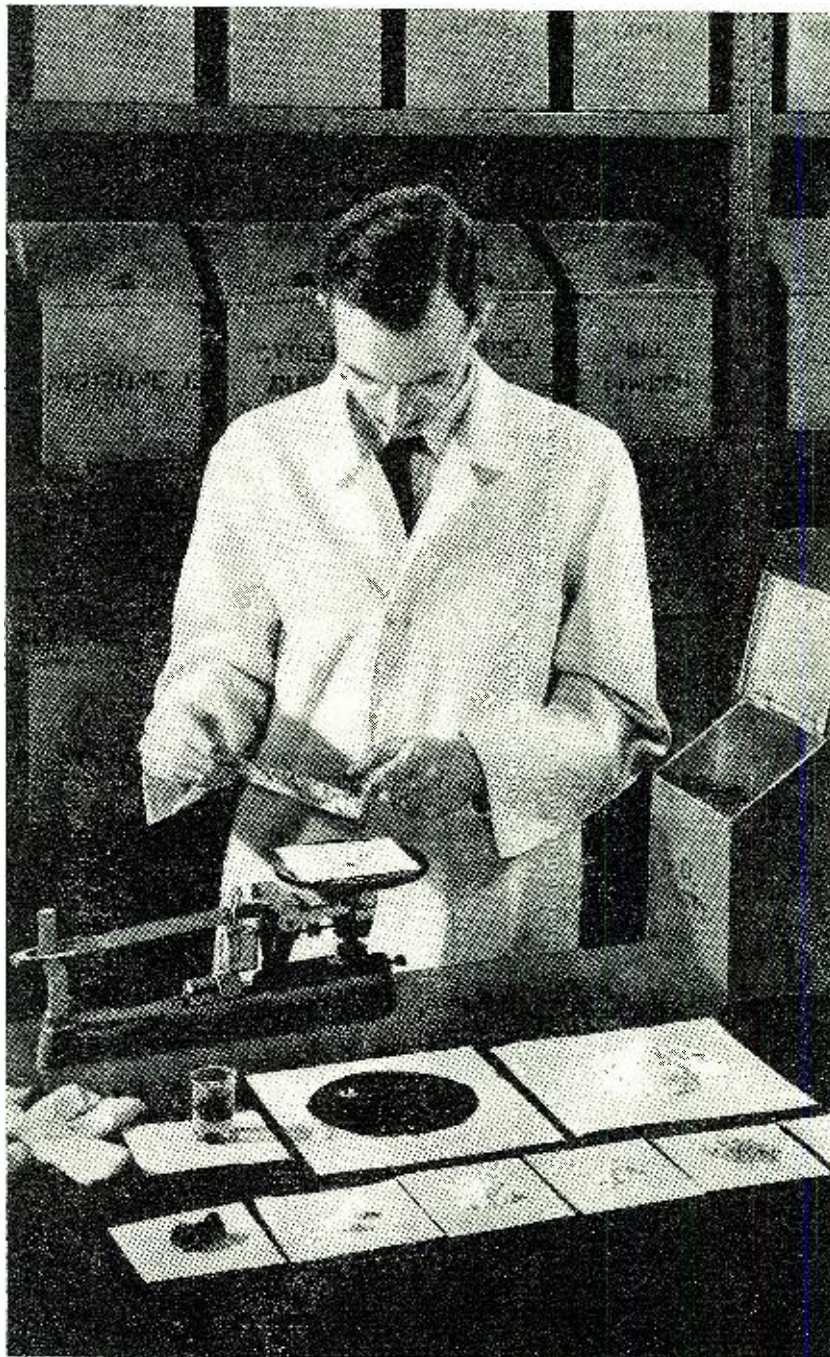

BELL TELEPHONE LABORATORIES

EXPLORING AND INVENTING, DEVISING AND PERFECTING FOR CONTINUED IMPROVEMENTS AND ECONOMIES IN TELEPHONE SERVICE.



HERE'S
THE
*Complete
Sprayberry
Course!*

LEARN
RADIO
ELECTRONICS-
TELEVISION!



*I SEND YOU
8 BIG KITS OF
RADIO
PARTS!*

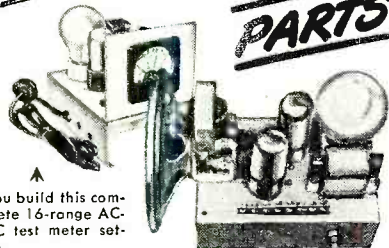

↑ You build this complete 16-range AC-DC test meter set-up.

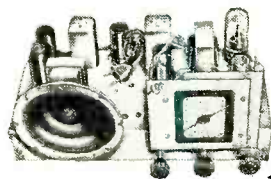

↑ I show you how to build this speaker tester and many other instruments.

↑ You build, test and trouble-shoot this powerful 6-tube superhet Radio.

I'LL TRAIN YOU AT HOME—BETTER—FASTER
by Putting You to Work with Your Hands

In this picture I show you exactly what you'll get from me during your Sprayberry Radio Training. This actual photograph speaks for itself! Sprayberry Radio Training is *really COMPLETE*—I start you with interesting, easily understood basic knowledge and I keep the mailman busy bringing you valuable Service Manuals, profitable Business Builders, extra helps and books—and *8 Big Kits of Actual Radio Equipment!* My course is practical and down-to-earth. You get my personal help every step of the way. My method is *BEST* for you—because you train largely by working with your hands—building, testing, trouble-shooting with parts I supply. With these kits you build a powerful 6-tube superhet Radio, a big 16-range test meter and perform over 175 other fascinating practical experiments.

EARN WHILE LEARNING

Shortly after you enroll I send you my famous **BUSINESS BUILDERS** that help you get and do profitable neighborhood Radio Service jobs while learning. These jobs pay well, and pave the way for a Radio Service Business of your own.

All branches of Radio, Television and Electronics are booming! Trained men are needed **NOW!** I'll prepare you for your own profitable Radio Service Business or a big pay radio job in double quick time. You learn at home in spare time—you keep your present job while getting set for the future.

My course is so perfectly planned—so easy to grasp and understand—you need no previous knowledge or experience of Radio or Electricity. Get the facts now—find out what Sprayberry Radio Training can do for you. Mail the coupon below and by return mail I'll rush my big book, "How To

Make Money In Radio, Electronics and Television" that tells all about Sprayberry Training. I'll also send you a Sample Lesson, "How To Read Radio Diagrams and Symbols"—all **FREE**. You'll read many letters from successful Radio men I've trained—and you can decide for yourself what Sprayberry Training holds in store for you.

LOW COST COMPLETE TRAINING

Sprayberry Training is surprisingly Low In Cost—and if you desire, convenient monthly payments can be arranged. This is **COMPLETE**, Up-to-Date training—covering Radio Repairing, Television and F.M., Industrial Electronics and many other new developments. Sprayberry Trained men really know Radio. This is training that sticks with you and makes money for you.

FREE SAMPLE LESSON AND BIG CATALOG

See how quickly and easily you can get your start in Radio, Electronics, Television with Sprayberry Training. Just fill out, clip and mail the coupon **NOW** for my big **FREE** book and **FREE** Sample Lesson. No obligation. No salesman will call. Read all the facts about Sprayberry Training—then decide. Take the first step **TODAY**—rush the coupon to me.

VETERANS: Approved for G. I. Training under Public Laws 16 and 346. Check coupon and mail today for complete facts.

SPRAYBERRY ACADEMY OF RADIO

Frank L. Sprayberry, President

ROOM 2578, SPRAYBERRY BUILDING, PUEBLO, COLORADO

July, 1948



Mail COUPON Today!

FRANK L. SPRAYBERRY, President
SPRAYBERRY ACADEMY OF RADIO,
2578 Sprayberry Building, Pueblo, Colorado

Rush my **FREE** copies of "How To Make Money In Radio, Electronics and Television" and "How To Read Radio Diagrams and Symbols."

NAME.....

ADDRESS..... AGE.....

CITY..... ZONE..... STATE.....

Check here if a Veteran

New!
JOHNSON INDUCTORS

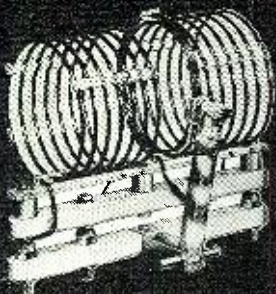

MATCH { **COIL TO TUBE**
LINK TO LINE

JOHNSON'S new and comprehensive line of inductors and "plug-in" swinging link assemblies bring to the amateur the same efficiency achieved in commercial and broadcast components.

This efficiency is secured by the use of two fundamental types of inductors for each band — inductors for use with either high voltage low current tubes or inductors for use with low voltage high current tubes. Each of these models is available in 150, 500 and 1,000 watt ratings.

Another great feature is the matching of "plug-in" link to feed line. The new JOHNSON Inductor Catalog provides the information necessary to select the "plug-in" link that will best match a particular inductor to any feed line ranging from 50 to 600 ohms impedance.

A complete line of semi-fixed link inductors is also available.

All inductor components, including hardware, are spaced to fit conventional, present day jack and plug assemblies in their respective ratings and can be purchased individually.

You'll find that the new matched JOHNSON coils and "plug-in" links will put substantially more RF in your antenna.



See them at your dealer or write for new JOHNSON AMATEUR INDUCTOR CATALOG.



JOHNSON
a famous name in Radio

E. F. JOHNSON • WASECA, MINN.

For the **RECORD.**

BY THE EDITOR

ONCE a year the Editorial Staff of RADIO NEWS deviates from its normal routine of getting out its monthly issue of RN and moves itself over to the Stevens Hotel in Chicago, to publish its "Radio News Daily."

This "daily newspaper" was first introduced by RADIO NEWS at the 1946 Trade Show as a service to our Industry. Each year it is distributed to all member-exhibitors, their distributors and representatives. Copies were distributed each morning, containing news and photos of current events and exhibits.

As you probably know, your Radio Industry gets together every year to work on problems of distribution, prices, and many others that all help to make your job in radio-electronics more profitable and secure.

Rated as one of the largest of all Industry Conventions, the Trade Show is not just a gathering of manufacturers to show off their new products to the end-users. Rather the Show is designed as a focal point for matters of common interest to the Manufacturers, their Representatives and their Distributors and, in turn, to you.

Attendance at the 1948 Show, once again, broke all records in spite of the threatened rail strike that loomed on its opening day. A total of 13,346 persons, after passing the "screening committee", were admitted to the Exhibition Hall. This figure included 1958 Exhibiting Manufacturers, 1239 Non-Exhibiting Manufacturers, 983 members of NEDA (National Electronic Distributors Association) 1075 non-NEDA members, 1557 Representatives, 82 Industrial Buyers, 236 Executive Engineers, 71 Guest Exhibitors, 180 Press, 690 Amateurs, Servicemen and Guests, and 5175 Students. Together with miscellaneous entrants, this represents by far the largest attendance for this yearly Convention and Show.

Most of the students admitted on "All Industry Day" came from Television Schools. Without exception they were keenly interested in the many new television products on display. In fact, for the first time television components were seen in large quantity throughout the Exhibition Hall.

Another "first" in Show history was TV cameras, strategically placed in the Exhibition Hall, to scan many of the exhibits in a preview of the Show. Receivers were set up in another part of the hotel and the telecast was witnessed by members of the various sponsoring groups. Among the more familiar personalities to appear before the television lenses were Howard W. Sams, John Rider and U. A. Sanabria, all well-known to radiomen.

In the past many of our readers have written, asking whether or not they would qualify to be admitted to the annual Parts Show, and many servicemen, amateurs and engineers, after identifying themselves at the Stevens, were admitted to view the exhibits on "All Industry Day" or "Open House Day." It is hoped that next year's program will offer the same opportunity to this group of radiomen.

One of the major problems facing the Industry is the general retailing situation of many radio and television set Dealers. Our Industry is producing more units than ever before in its entire history. In fact, production is about three times that of 1942. Many new manufacturers have come into the market, bearing names unknown to the public. They are seeking their fortunes in our Industry. They are competing with the "well known" national brands. As a result, many retailers feel that the Industry is approaching a chaotic condition, similar to the one that existed in the 30's. Dog-eat-dog practices of price cutting, heavy trade-ins, etc., are concerning many dealers, some of which are stocking as many as 38 brands. With sets piling up on their shelves, dealers are beginning to cut prices in order to cut down on their inventory. Leaders of the Industry, accordingly, held many meetings with the hope that groundwork could be laid to set up a workable plan and policy which would help remedy the situation which could otherwise reach alarming proportions.

All in all the 1948 Show was an outstanding success. All of the new products displayed will soon be available in quantity and many of the new television components will soon be gracing the homes of your customers.O.R.

NEW! hallicrafters Projection Television!

16" x 12" PICTURE—192 SQ. INCHES

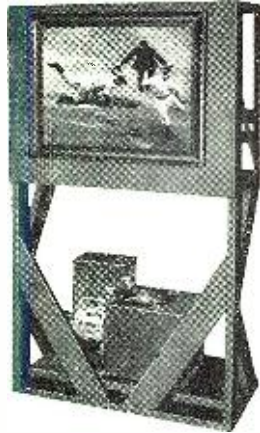

MODEL T-60 RACK TYPE PROJECTION UNIT FOR CUSTOM INSTALLATIONS

A brilliant new Hallicrafters development! A Television Projection System which consists of: an optical unit which magnifies, projects, and reflects a beautiful 16" x 12" picture; the receiver chassis; a high voltage unit which sustains brilliance and stability, and the viewing screen. Complete for custom installation in any desired location. Delivers a brilliant, sharp, flat-faced 192 square-inch picture, comfortable at close range, perfect for distant viewing. Optically correct picture provides excellent day or night viewing. Rack arrangement provides proper throw; stable optical system stays in adjustment. Ideal for custom installations in homes; in wide demand for taverns, clubs, halls, schools and for similar applications.

97-801. Hallicrafters T-60 TV Projection System. NET, f.o.b. Chicago **\$595.00**



hallicrafters' FAMOUS T-54 TELEVISION TABLE MODEL

The immensely popular direct-viewing TV Receiver at low cost! Provides a brilliant picture 5¾" long, 4" high—full 23 square-inch area. Easy to operate. Clear, sharp, bright image. Excellent sound.

97-800. Hallicrafters' T-54 Receiver. NET, f.o.b. Chicago **\$169.50**
Terms: \$33.90 down, \$11.98 monthly for 12 months

ALLIED has Everything NEW IN RADIO!

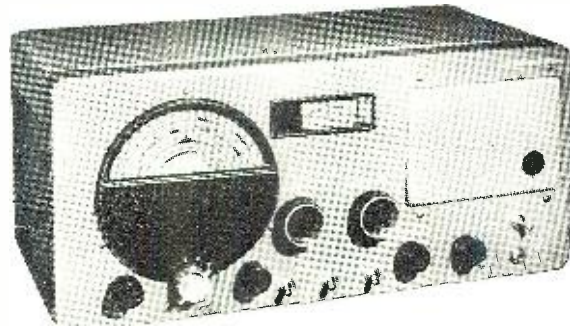

NEW! hallicrafters S-52 Receiver!

A popularly-priced new Hallicrafters communications receiver, packed with exceptionally fine features. Designed for AC-DC operation. Tunes 550 kc to 43 mc in 4 bands. Highlights include: full electrical bandspread; inertia flywheel tuning; calibrated main dial; automatic noise limiter; adjustable pitch BFO; standby switch; code-phone switch; headphone jack; shock-mounted speaker; separate sensitivity and volume controls; 3-position tone control. Includes 7 tubes, plus rectifier and ballast; for 117 volts AC/DC operation. In handsome all-steel cabinet, 18½" x 9¾" x 8½". Shipping weight, 25 lbs.

97-588. S-52 Receiver. NET, f.o.b. Chicago **\$995.00**
\$19.90 down, \$7.03 monthly for 12 months

There's Only ONE COMPLETE Radio Buying Guide—It's ALLIED'S CATALOG!

Get the Radio Buying Guide that's used by thousands of expert servicemen, engineers, soundmen, Amateurs, builders and experimenters! Radio's biggest catalog brings you the widest selections of the newest and finest equipment, at money-saving low prices. Get every buying advantage at ALLIED—speedy, expert shipment, the personal attention of seasoned radio experts—complete satisfaction on every order. Get your ALLIED Catalog today!



**172 VALUE-PACKED
PAGES. SEND FOR IT!**

FREE

**THE WORLD'S
LARGEST
RADIO
SUPPLY
HOUSE.**

**★ ALLIED
RADIO**

*Everything in Radio
and Electronics*

ALLIED RADIO CORP.
833 W. Jackson Blvd., Dept. 1-G-8
Chicago 7, Illinois

- Send FREE 172-Page ALLIED Catalog.
- Enter order for Hallicrafters Model.....
- Enclosed \$..... Full Payment
- Part Payment (Balance C.O.D.)
- Send ALLIED Easy Payment Plan details and order blank.

Name.....

Address.....

City..... Zone..... State.....

NEW

OHMITE DUMMY ANTENNA RESISTORS

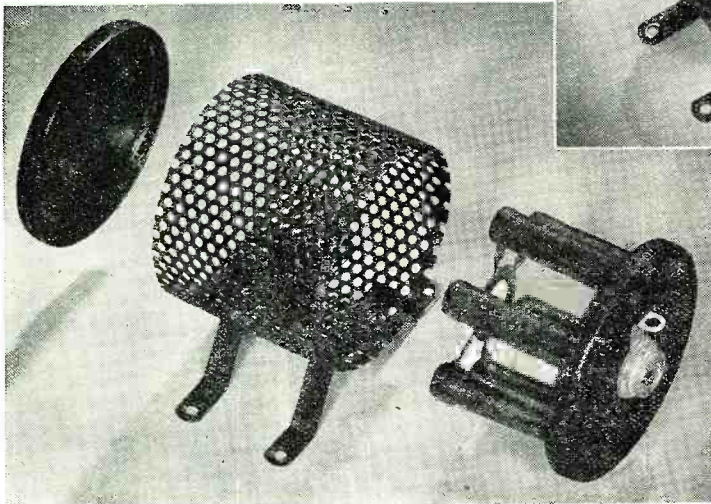
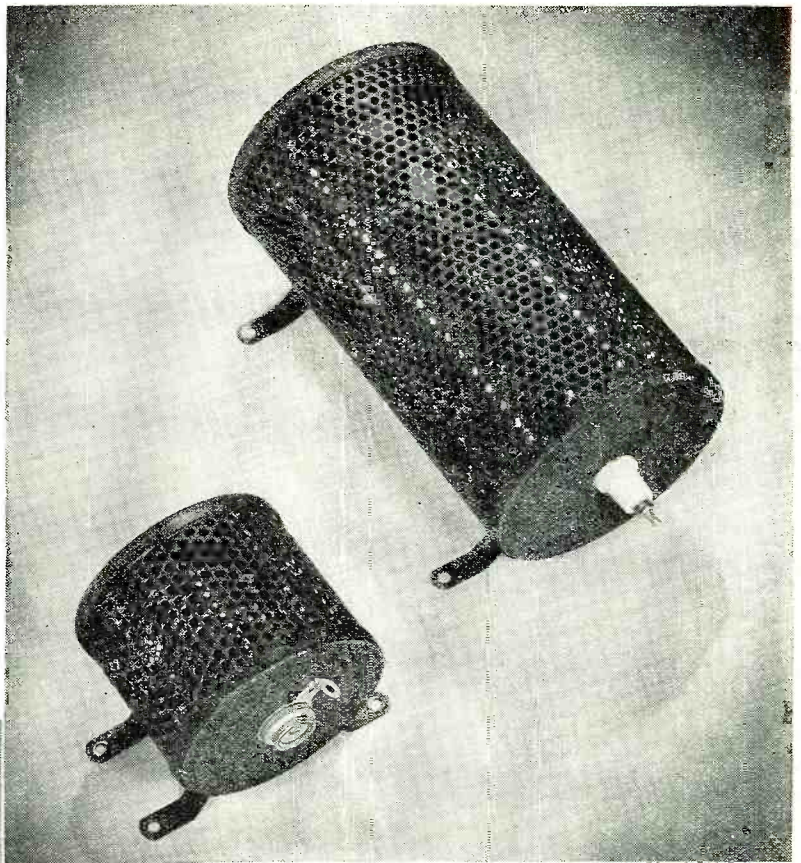

Rugged new Ohmite units consist of special non-inductively wound, vitreous-enameled resistors connected in parallel and mounted inside a sturdy, perforated steel cage.

- IMPROVED FREQUENCY CHARACTERISTICS
- RUGGED VITREOUS-ENAMELED CONSTRUCTION

Two new dummy antenna resistors, designed by Ohmite, for loading radio transmitters or other radio frequency sources, now offer improved frequency characteristics. This results from more effective proportionment of the d-c resistance, residual inductance, and distributed capacitance.

In the new units, residual inductance and distributed capacitance are kept to a minimum, making the natural resonant frequency as high as possible. For all practical purposes, these dummy antenna resistors may be considered "non-reactive" within their recommended operating frequency ranges. To make electrical connections, two types of terminations are provided, depending

upon whether the unit is intended to be used in conjunction with a coaxial cable or with a parallel transmission line.

Type D-101, 100-watt unit, is stocked in 52, 73, 300, 400, 500, and 600-ohm values; Type D-251, 250-watt unit, in 52, 73, 300, and 600 ohms. Tol. $\pm 5\%$. Get complete information on the new Ohmite Dummy Antenna Resistors.

WRITE FOR BULLETIN 136 TODAY!

OHMITE MANUFACTURING CO.
4883 Flournoy Street Chicago 44, Ill.



Be Right with

OHMITE

RHEOSTATS • RESISTORS • TAP SWITCHES • CHOKES • ATTENUATORS

DESIGNED FOR THE BETTER SERVICE SHOP...

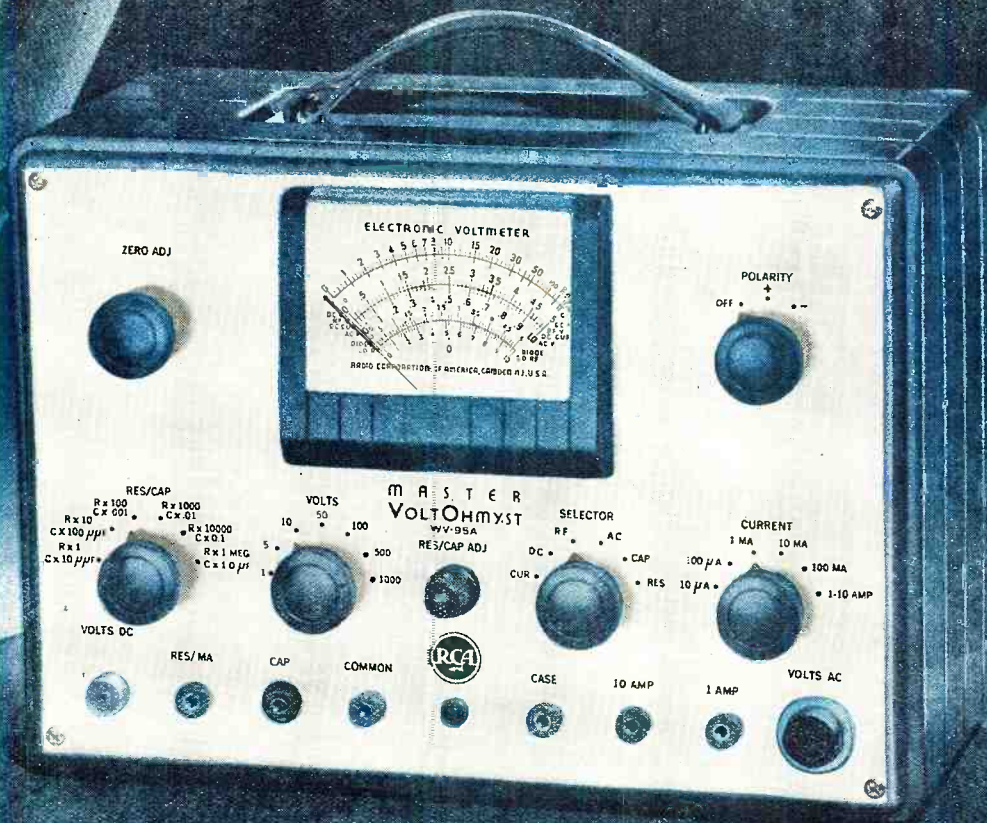

RCA's NEW MASTER VOLTOHMYST* ELECTRONIC METER
... fourth unit of a revolutionary new line of test equipment

Measures capacitance, current, voltage, and resistance

OUTSTANDING NEW FEATURES

- Measures Capacitance—from 5 mmfd. to 1000 mfd.
- Measures dc current—from 1 micro-amp to 10 amps
- Has measuring circuits isolated from case
- Accessory crystal probe available—for routine measurements up to 100 Mc.
- Accessory diode probe available—for peak-to-peak measurements up to 250 Mc.
- Provides extra ac sensitivity—1 volt rms, full scale

In addition, the RCA Master VoltOhmyst Electronic Meter includes all features of the regular VoltOhmyst Electronic Meter. It's a dc voltmeter ... a dc current meter ... an ohmmeter ... an ac voltmeter ... an af voltmeter ... and an rf voltmeter.

*"VoltOhmyst" is a registered trade mark of the Radio Corporation of America

Use the Master VoltOhmyst Electronic Meter to save time and increase profit on every radio or television job. It's the only single instrument capable of so many varied tests and measurements. It will give accurate readings despite line voltage fluctuations. Its million-to-one current range makes it useful as an electronic galvanometer. You can use it with the accessory crystal probe for rms readings to 100 Mc. or with the accessory diode probe for peak-to-peak readings to 250 Mc. The Master VoltOhmyst Electronic Meter is the most versatile VTVM available.

A new bulletin containing complete specifications on the Type WV-95A Master VoltOhmyst Electronic Meter is yours for the asking. See your RCA Test Equipment Distributor, or write RCA, Commercial Engineering, Section GX60, Harrison, N. J.

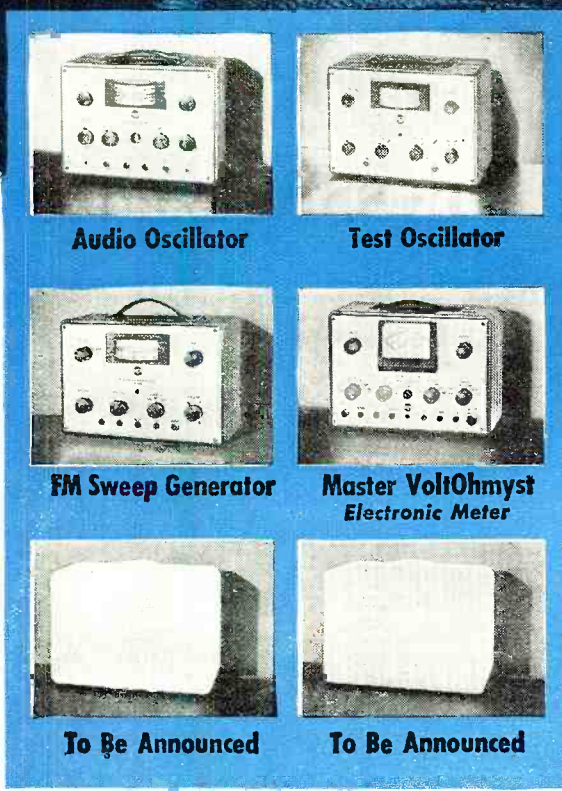

Audio Oscillator

Test Oscillator

FM Sweep Generator

Master VoltOhmyst Electronic Meter

To Be Announced

To Be Announced



RADIO CORPORATION of AMERICA
TEST AND MEASURING EQUIPMENT
HARRISON, N. J.

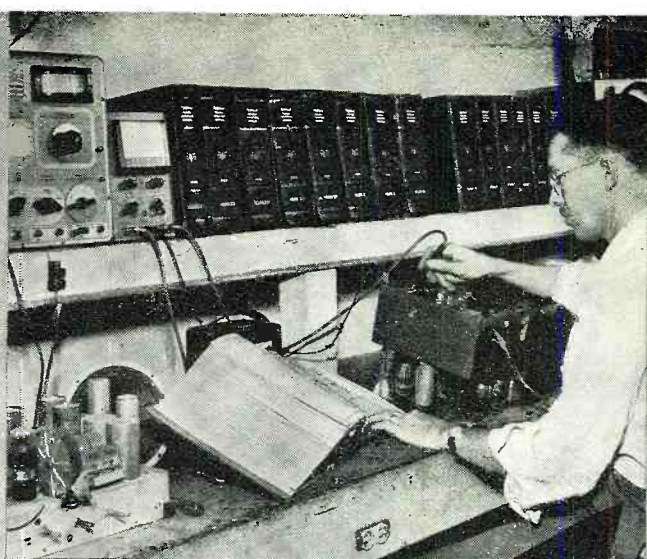
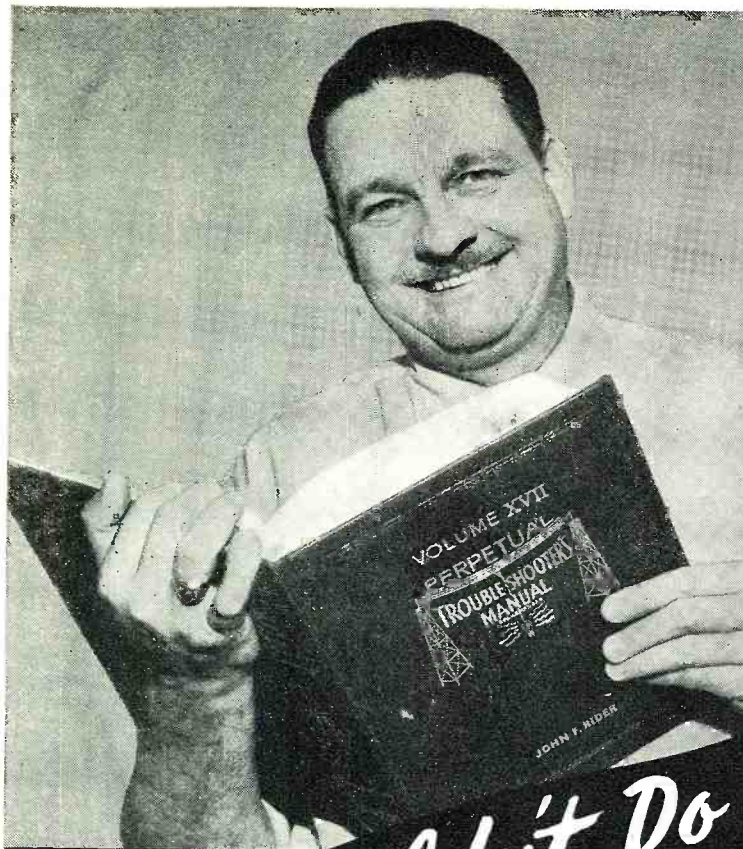

"We Couldn't Do Without Them"

Says: K. E. KRENZLER

of Krenzler Radio Service, Houston, Texas.

"The specialized radio servicing background of the Rider organization shows in their publications, which are built to meet the exact needs of the serviceman.

"They are practical, money-making—and offered at a reasonable investment. We couldn't do without them."

RIDER MANUALS GIVE Coverage!

During our "Eighteen Years of Continuing Service To The Servicing Industry" we have learned your needs. We have built—will continue to maintain Rider Manuals as—The World's Greatest Compilation of radio servicing data. No other source gives you so much! In the 17 volumes of Rider Manuals there are 23,800 pages, covering 13,120 chassis and 25,495 models!

Here is a further example of the Coverage provided by Rider Manuals:

SINCE THE END OF THE WAR, IN VOLS. XV, XVI AND XVII (3 VOLUMES ONLY), YOU WILL FIND:

- | | |
|------------------------|-------------------------------|
| 1415— ONE BAND MODELS | 15 —SEVEN BAND MODELS |
| 387 — TWO BAND MODELS | Plus—approximately 1000 |
| 172 —THREE BAND MODELS | "clarified schematics" of the |
| 41 — FOUR BAND MODELS | multi-band receivers. |
| 61 — FIVE BAND MODELS | 71 —RECORD CHANGERS |
| 27 — SIX BAND MODELS | 81 —FM RECEIVERS |

KRENZLER HAS ALL 17 VOLUMES

Give Your Shop the Sign of Successful Servicing—
All 17 Rider Manuals

Volume XVII	\$15.00	Abridged Manuals I to V	
Volume XVI	8.40	(one vol.)	\$17.50
Volume XV	18.00	Record Changers and	
Volume XIV to VII		Recorders	9.00
(ea. Vol.)	15.00	Master Index, covering	
Volume VI	11.00	Manuals, Vols. I to XV	1.50

RIDER ANTICIPATES YOUR NEEDS

Not content to merely supply those radio servicing data upon which you have come to depend, Rider is constantly alert anticipating your needs, enabling you to cash-in at the earliest date, on new and profitable servicing opportunities.

This month, we add to the list of Rider "firsts" with the publication of Volume 1—Rider Television Manual.

We also announce another Rider first which will be out soon, the Rider PA Manual. (Publication date this summer.)

Thus, Rider provides not only the most complete Coverage of American-made receivers, but the most comprehensive and up-to-date compilation of all kinds of circuit data available from any single source.

RIDER

JOHN F. RIDER PUBLISHER, Inc.,

JUST OUT

RIDER

Television

VOL. I

MANUAL

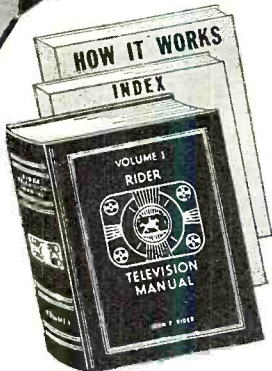

OVER 1400 PAGES
(approximating 2000 Regular Pages)
Plus 200 PAGE
"HOW IT WORKS"
and Separate Index
Complete .. \$15.00

Covers complete receivers as well as kits, on 1946-1947 television production of 34 manufacturers.

The Manual provides television servicing data based upon each *Manufacturer's Recommended Procedures* for his own sets. Circuit descriptions, adjustment of various trimmers, traps, transformers, etc.—voltage and resistance readings, complete alignment instructions, parts lists—schematics, patterns, chassis views, wave forms—everything to simplify your work.

Due to the many component parts in some of the receivers, more than 35 schematics are reproduced on new Rider **GIANT** pages of 440 square inches! These and 55 *Double Spreads* assure clear, easily read schematics.

THE TELEVISION "HOW IT WORKS" BOOK Gives You the Underlying Theories You Need!

Gives a clear overall picture of television transmission and reception. Deals with frequency standards and antennas. Describes various portions of a television receiver, the r-f, oscillator, converter circuits in the front end, the sound channel, the video i-f system and detector, the video amplifier and d-c restorer, the sync and sweep circuits, picture tubes, power supplies. The conclusion covers alignment and servicing problems. Shows when you do something, why you are doing it.

Index covers every particular portion of each model.

TELEVISION "HOW IT WORKS"

Available Separately

Even if television is not yet in your area, it will be in the near future. Start learning now what is in television receivers, and how each part works. This book covers the essential underlying theory you should be ^{\$270} familiar with.

OUT SOON

(Summer Publication)

ANOTHER RIDER "FIRST"

... AND STILL ANOTHER!

"Do you want a Rider PA Manual?" was the essence of our questionnaire in a survey just completed.

"Yes" came the replies—5 to 1 in favor of it.

So, this latest addition to the great Rider Manual library of circuit data is now in production; its publication date will be announced next month.

It will contain the amplifier production of all the American manufacturers starting with 1938, to date.

Following our usual system, an accompanying "How It Works" book will explain the theory of the various designs employed in different types of amplifier systems. The various types of mixing, degenerative feed back circuits, systems of sound distribution, impedance matching, etc. The servicing of PA systems using sine wave and square wave means of checking, the methods of rapidly locating faults—in general all the things you want to know about such equipment.

Order it from your jobber today.

Place Your Order With Your Jobber Today!

RIDER PA MANUAL

APPROX. 2000 PAGES
(Regular Rider Manual Binding)

SEPARATE "HOW IT WORKS" BOOK AND INDEX... COMPLETE \$18.00

If You Install and Service PA Systems You Will Find This New Rider Manual Profitable!

MANUALS *Mean* SUCCESSFUL SERVICING

404 Fourth Avenue, New York 16, N. Y.

Export Agent: Rocke International Corp., 13 E. 40th St., N.Y.C. Cable ARLAB

NOTE: The Mallory Radio Service Encyclopedia, 6th Edition, makes reference to only one source of Radio Receiver Schematics—Rider Manuals.
July, 1948



**A standard by
which all tubes
may be measured**

GENERAL  ELECTRIC

174-GA9-0850

FIRST AND GREATEST NAME IN ELECTRONICS

McMurdo
SILVER



Laboratory Caliber Electronic Test Instruments

McMurdo Silver Co., Inc.
1240 MAIN STREET HARTFORD, CONNECTICUT
CABLE ADDRESS: SILVERADIO, U.S.A.

New "VOMAX", new "SPARX" signal tracer, universal test speaker, AM, FM and TV sweep and signal generators, laboratory C/R bridge, multi-frequency standard, wavemeter, universal test speaker, sine/square wave audio oscillator. Buy them from your favorite jobber.

IN OUR NEW CATALOG you will find completely described ten instruments, each of which is in a special class . . . *Laboratory Caliber Electronic Test Instruments* at prices every technician can afford. Each is the product of the exclusive McMurdo Silver LCETI plan . . . the modern plan which makes available to every service technician the same instruments used by the big manufacturers who design and test the very radios you must service.

Instruments of advanced design . . . practical application "know-how" translated into simple *pictorial instruction manuals* . . . backed by over 37 years of world-famous radio engineering leadership . . . have increased LCETI production over

500% in 3 years and continue its growth.

We are proud that our efforts to bring fine instruments to the service professional and the research engineer have earned such overwhelming acceptance. Without our tens of thousands of customers we could never keep prices down while continuously increasing quality, accuracy and all-around "usability".

We are ever ready to help you turn your shop into a modern, efficiently-equipped service laboratory with Laboratory Caliber Electronic Test Instruments. Our new catalog will show you how easy this is . . . how each of these new instruments can amazingly increase your earning-power and efficiency. Send for 1948-49 LCETI catalog.

**LABORATORY
CALIBER
ELECTRONIC
TEST
INSTRUMENTS**

OVER 37 YEARS OF RADIO ENGINEERING ACHIEVEMENT

McMurdo Silver Co., Inc.

EXECUTIVE OFFICES: 1240 MAIN ST., HARTFORD 3, CONN.
FACTORY OFFICE: 1249 MAIN ST., HARTFORD 3, CONN.

GREATEST ADVANCE

NOTE... THESE SENSATIONAL

A COMPLETELY NEW
VOLT-OHM-MIL-AM-
METER that does more
... has proved compo-
nents ... and will give
a lifetime of satisfaction.

1 Beautiful Stream-lined Instrument.

2 Large 5 1/2" Meter In Special Molded Case Under Panel.

3 Resistance Scale Markings From .2 Ohm To 100 Megohms ... Zero Ohms Control Flush With Panel.

4 Only one Switch ... Has Extra Large Knob 2 1/2" Long ... Easy To Turn ... Flush With Panel Surface.



Precision first... to Last



TRIPLET ELECTRICAL INSTRUMENT CO.

In Canada: Triplet Instruments of Canada, Georgetown, Ontario.

IN V.O.M. HISTORY

IMPROVEMENTS

Inside view
cover removed . . . inverted

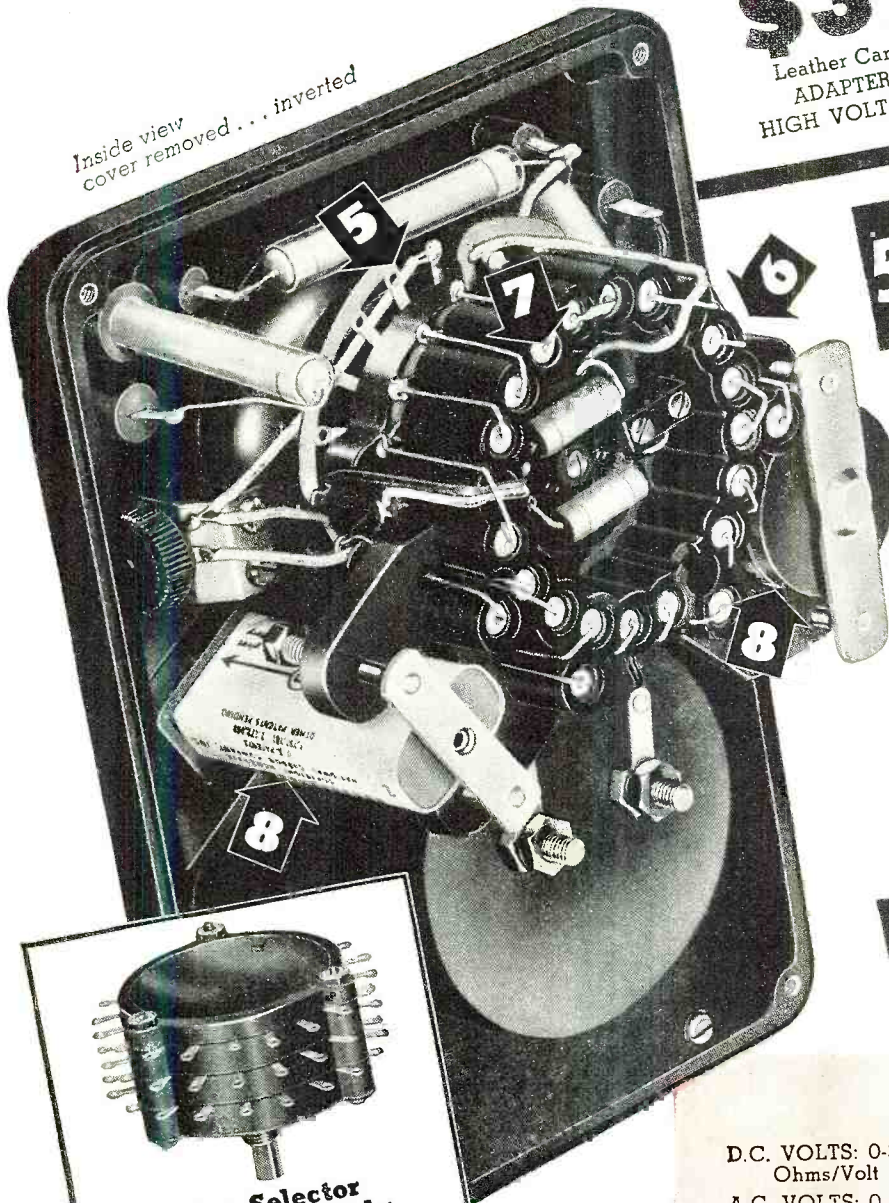

MODEL 630
\$37.50
U.S.A. Dealer Net

Leather Carrying Case \$5.75
ADAPTER PROD FOR TV
HIGH VOLTAGE TESTS EXTRA

5 **New Molded Selector Switch . . .**
Contacts Are Fully Enclosed.

6 **Unit Construction . . .** Resistors, Shunts, Rectifier, Batteries All Are Housed In A Molded Base Built Right Over The Switch . . . Provides Direct Connections Without Cabling . . . No Chance For Shorts.

7 **All Resistors Are** Precision Film Or Wire Wound Types . . . For Permanent Accuracy.

8 **Batteries Easily Replaced . . .** New Double Suspended Contacts.

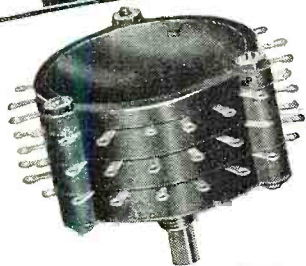

New Selector Switch Assembly

Note entire enclose of contacts . . . for the first time in any radio service test equipment . . . will retain lubrication without dust contamination.

TECH DATA

D.C. VOLTS: 0-3-12-60-300-1200-6000, at 20,000 Ohms/Volt
A.C. VOLTS: 0-3-12-60-300-1200-6000, at 5,000 Ohms/Volt
D.C. MICROAMPERES: 0-60, at 250 Millivolts
D.C. MILLIAMPERES: 0-1.2-12-120, at 250 Millivolts
D.C. AMPERES: 0-12, at 250 Millivolts
OHMS: 0-1000-10,000; 4.4 Ohms at center scale on 1000 scale; 44 Ohms center scale on 10,000 range.
MEGOHMS: 0-1-100 (4400-440,000 at center scale)
DECIBELS: -30 to +4, +16, +30, +44, +56; +70
OUTPUT: Condenser in series with A.C. Volt ranges

BLUFFTON, OHIO

HARVEY

has BEST BUYS

FM TRANSLATOR General Electric Model XFM-1



Post-war version of the old G.E. J.F.M-90 Translator which was used and enjoyed by tens of thousands of discriminating radio listeners.

Covers 88-108 mc range, dial 12 inches long, uses guillotine tuning for highest efficiency, high stability. Designed for export, has power inputs for 110 to 250 volts, 50/60 cy. Used in conjunction with good audio section or separate amplifier will provide best FM listening you ever heard. In attractive natural walnut cabinet - 10 3/4" high x 15 3/4" wide x 11 3/4" deep, complete with 8 tubes. Tragic-proof construction. Quantity limited, no more available. Get your order in while they last!

Special price \$49.50

For use with the FM tuner we recommend any of the following:

Altec-Lansing A-323 B Amplifier.....	\$125.00
Altec-Lansing 600 Speaker.....	45.00
Altec-Lansing 603 Speaker.....	63.00
Altec-Lansing 604 Speaker.....	157.50
Crossover for 604.....	30.00
Stephens Tru-Sonic P52A Speaker with crossover.....	123.00
Stephens Tru-Sonic P52FR Co-Spiral Speaker.....	48.00



Tech-Master TV Chassis

Complete kit of parts, including all hardware, pre-wired and aligned RCA front end, condensers, resistors, punched chassis, all tubes including kine, complete manual with service notes, all RCA..... \$198.50

NOTE: All prices are Net, F.O.B. N.Y.C. and are subject to change without notice.

Telephone: 7-1000 IO. 3-1800

HARVEY
RADIO COMPANY INC
103 West 43rd St., New York 18, N. Y.

Spot Radio News

* Presenting latest information on the Radio Industry.

By RADIO NEWS
WASHINGTON EDITOR

AMATEUR RADIO, one of the world's best good-will ambassadors, has now given its world-girdling, friend-winning talents to the United Nations at Lake Success, New York. With a one-kilowatt transmitter, and the last word in receiving equipment, including a scope setup, contact to the four corners of the earth has become a daily practice.

The spirited interest of ARRL's prexy George W. Bailey and the U.N.'s Chief Communications Officer, Brigadier-General Frank E. Stoner, made this unique international ham link possible.

For many, many months, hams had been serving as world-wide United Nations communications agents, relaying messages and bringing important informal information to amateurs abroad. In some instances, it was found possible to disseminate valuable U.N. gospel through ham channels. When the British left Palestine and took all their commercial communications facilities too, amateur radio came to the rescue, setting up contacts with hams in the main centers of the new State.

Gen. Stoner became more and more enthusiastic over the effectiveness of ham work and believed that the U.N. should have its own rig to perform a wider and more complete world service. Conferring with George Bailey, he found his ideas had the hearty approval of the ham fraternity, and it was decided to make a bid for funds for the station. Gen. Stoner's plea was a winning one, and \$10,000 was set aside for the purchase of a complete transmitting and receiving system.

While the equipment was being made, hams were notified of the new station, and plans were set up for quite a coverage program. The big night came a few weeks ago, with George Bailey, Gen. Stoner, quite a few hams and several U.N. dignitaries, including Ben Cohen, U.N. Assistant Secretary-General, in charge of information, in attendance. On-the-air time was 6:00 p.m., and a roaring thunderstorm broke at that moment. George Bailey paled, but the raging storm just had to be overlooked and a schedule kept. George pushed the mike button and prayed. U.N. ham station K2UN was on the air.

After a few CQ's, an Italian ham came in reporting K2UN as R5 S9. George beamed and asked Ben Cohen if he would speak to the Italian in his native tongue. Commenting on this incident, George said that all evening long Ben Cohen had not shown much interest in the ceremonies. But he was determined to overcome this listlessness. Aware that Mr. Cohen is quite a linguist, speaking about eight languages, George said that he hoped someone speaking a language familiar to Mr. Cohen would answer his CQ. The Italian rang the gong and Ben Cohen spoke with zest to this ham some 5000 miles away.

Subsequent CQ's brought in French, German, and Spanish hams, and each time Ben Cohen began chewing the rag in a native tongue.

At the conclusion of the test period, Ben Cohen smiled at George Bailey and said: "George, I want a station like this. How soon can I get delivery?"

That, said George Bailey, was the quickest ham conversion he had ever seen.

Since K2UN (Come To The United Nations) is on U.N. land, it does not come under the jurisdiction of the FCC or any nation. However Gen. Stoner is operating the station under the standard ham rules of the FCC.

A FIVE-YEAR USAF industrial mobilization plan, in which radio and electronics will play a major role, was disclosed by members of the procurement division at the recent Wright Field meeting of the Armed Forces Communications Association. Over \$55,000,000 will be spent this year for ground-controlled airborne radar, surveillance and other types of aviation control systems, around \$4,000,000 has been set aside for a civilian technical personnel payroll.

Wright Field research and development groups will be a key factor in the mobilization program. Describing the facilities of the field, Major General F. O. Carroll said that the engineering division as a whole has approximately 3000 projects under development at present, and they are trying to keep

RADIO NEWS

2 METHODS

Learn RADIO-ELECTRONICS

at HOME... or in our LABORATORIES

TAKE YOUR CHOICE!

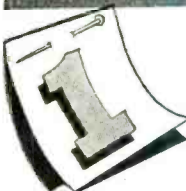

LEARN IN CHICAGO IN ONE OF NATION'S FINEST TRAINING LABORATORIES

36 weeks — that's all the time you need to get one of today's finest practical trainings in **RADIO** and **ELECTRONICS**. That's all the time required to prepare yourself for America's great opportunity field that offers so many thrilling possibilities for a **GOOD JOB** with a **REAL FUTURE** — or a profitable **RADIO SERVICE BUSINESS OF YOUR OWN**.



MODERN TELEVISION TRAINING calls for ample equipment. In our modern Chicago training laboratories, you will find some of the finest Television equipment available for training purposes.

Now you can enjoy outstanding training advantages in the large, entirely **NEW** postwar laboratories of DeForest's Training, Inc. in Chicago. You get **ALL** of your instruction amid a large staff of highly skilled instructors and loads of modern, costly commercial Radio-Electronic and Television equipment.

We secure comfortable living quarters for you. Get complete facts about this remarkably effective way to qualify yourself **QUICKLY** for a **GOOD PAYING FUTURE** — and about our **EMPLOYMENT SERVICE** that helps our graduates **GET STARTED**. **MAIL COUPON BELOW FOR COMPLETE DETAILS.**



*D.T.I.'s Home Study Course Includes the use of a 16 mm. Motion Picture projector and Movie Film to help you learn important fundamentals **FASTER**... **EASIER**. Get vivid — **LASTING** impressions by means of the modern **MOVIE-WAY** method of instruction.*



GET "SHOP METHOD" TRAINING AT HOME — IN YOUR SPARE TIME

Look around you! What other field embraces so many exciting, fast-moving activities as **F. M. Radio**, **2-Way Train Radio**, **Aviation Radio**, **Broadcast Radio**, **Radio Manufacturing**, **2-Way Bus, Truck and Cab Radio**, **Police Radio** and other branches?

DeForest's Training, Inc. makes it possible for **YOU** to train in the privacy of your own home for this bright field of **Radio and Electronics** — and without interfering with your present job.

You get a long-tested, **PROVED** combination of home study advantages — plus **EMPLOYMENT SERVICE** — which helps you get started toward a real future in **Radio and Electronics**.

3-Way Method Gets Results!

No previous **RADIO** or **ELECTRONIC** experience is necessary. Our effective **A-B-C Home Study Method** includes (A) "**Learn-By-Doing**" Home Laboratory of many Radio parts enabling you to work out **133** fascinating experiments at home, including **7** different **Radio Receiving Circuits**; (B) a **16 mm. Movie Projector** and **12** reels of "**Learn-By-Seeing**" **Movie Film** that speed your progress; and (C) well-illustrated lessons. **MAIL COUPON BELOW FOR COMPLETE DETAILS.**



ABOVE: You work out **133** intriguing experiments from this equipment to get valuable, practical experience **AT HOME**.

TELEVISION
Now you can work with modern television training equipment, and actually build a commercial-type **18 TUBE TELEVISION RECEIVING SET** in your Chicago Laboratory.

DeFOREST'S TRAINING, Inc.

Chicago, Illinois
Associated with the DeVry Corporation
Builders of Electronic and Movie Equipment

DeForest's Training, Inc.
2533 N. Ashland Ave., Dept. RN-E7
Chicago 14, Illinois

Send me complete details showing how I may make my start in Radio-Electronics-Television. No obligation.

Name _____ Age _____

Address _____ Apt. _____

City _____ Zone _____ State _____

If under 16, check here for special information.

If a discharged veteran of World War II, check here.

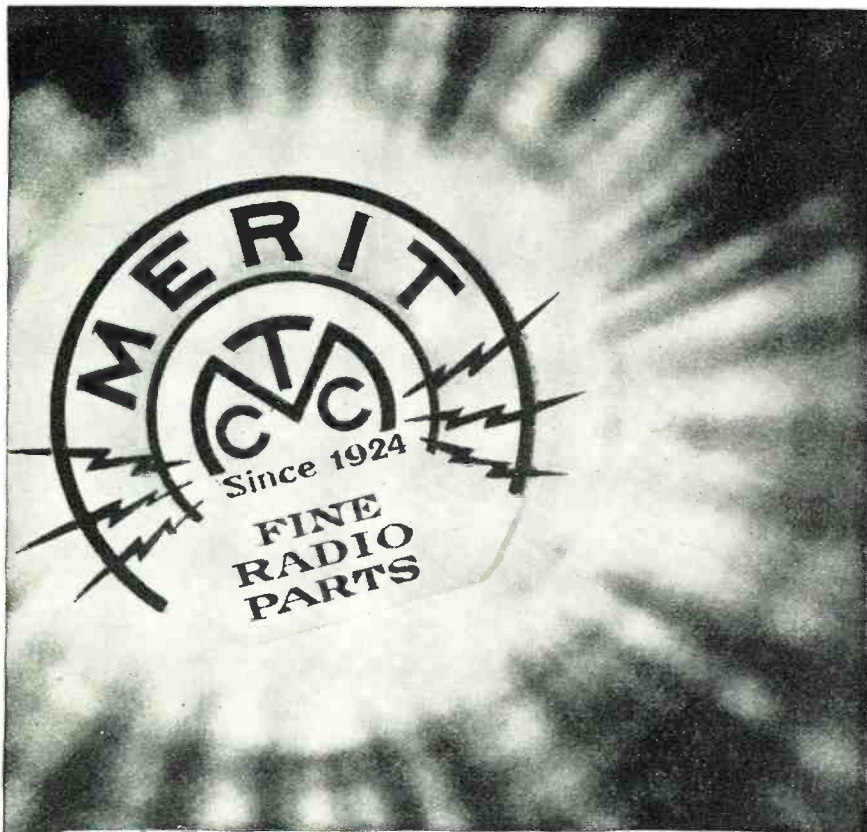

Merit EXPANDS ITS CATALOG

Showing many new transformers now available for amateur and industrial use. Your local distributor has them in stock. Ask to see these outstanding new models and get your copy of the new Merit catalog.



MERIT COIL & TRANSFORMER CORP.
TELEPHONE
4427 North Clark St. Long Beach 6311 CHICAGO 40 ILL.

about four or five years ahead of production equipment.

"Most items," he said, "and even the apparently simplest items, require three to four years before they are ready for production and subsequent issue to the military."

Analyzing the activities of the engineering division, Gen. Carroll said that the research, development and testing functions are accomplished by integrating its studies and experiments through a wide field of industrial, technical and educational organizations. The division is the go-between agency between the tactical and strategic air forces on the one hand, and science and industry on the other. The engineering unit now holds 226 research contracts with 57 leading universities and scientific agencies throughout the country.

General Carroll reported that approximately eighty per-cent of the Wright Field research and development appropriation is spent on contracts with industry for development.

Pacing the mobilization program, RMA president Max F. Balcom recently appointed a government liaison committee to secure information on government industry mobilization and military production plans from the National Security Resources Board, Munitions Board, Army, Navy and other allied agencies. Fred R. Lack, who served as chairman of an industry coordinating agency during World War II, is chairman of this new group. Other members of the committee include Frank M. Folsom and W. A. MacDonald.

TV HAS LOST channel 1, the 44 to 50-mc. channel, to the fixed and mobile services. The low-band frequency-modulation stations will be allowed to operate on this band until the end of the year, unless a Congressional ruling intervenes. The passage of the Lemke bill would introduce that situation and provide for a sub-allocation. This bill, shelved several times, has been re-activated and all-out efforts are now in force to route the bill through both houses before Congress adjourns.

In defending his bill Representative Lemke said that farmers and rural people want frequency modulation and are deprived of it under the present setup. He noted that both Brown of *Zenith* and Major Armstrong strongly supported his views.

The television channel change has resulted in an expanded allocation plan, almost tripling the present trading area setup. Under the new scheme, about 460 areas would be covered by more than 900 stations. The existing allocation schedule provides for 140 major markets and only 400 TV stations.

Application of the 475 to 890-mc.

(Continued on page 141)

PHOTOFACT Publications Help You to Success!

Have more practical, useful, complete data than you can get anywhere else...

READY NOW!

PHOTOFACT VOLUME 4

Includes First Three TV Course Installments!

Latest companion to popular Volumes 1, 2 and 3 — brings your file of post-war receiver service data right up to July 1948! Most accurate and complete radio data ever compiled... an absolute **MUST** for all Servicemen. Everything you need to know for faster, more profitable servicing, in handy, unified form. Includes: Exclusive Standard Notation schematics; photo views keyed to parts lists and alignment data; complete parts listings and proper replacements; alignment, stage gain, circuit voltage and resistance analysis; coil resistances; dial cord stringing; disassembly instructions; record changer repair instructions. Order Volume 4 today — it's the *only* service data that meets your *actual* needs!

- Vol. 4. Models from Jan. 1, 1948 to July 1, 1948
- Vol. 3. Models from July 1, 1947 to Jan. 1, 1948
- Vol. 2. Models from Jan. 1, 1947 to July 1, 1947
- Vol. 1. All post-war models up to Jan. 1, 1947

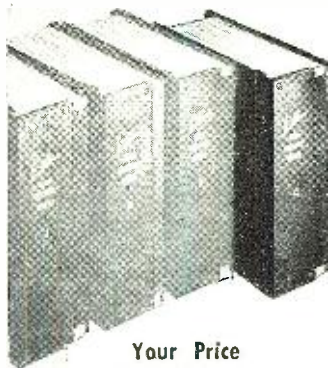

Your Price
Each Volume,
in DeLuxe Binder
\$18.39

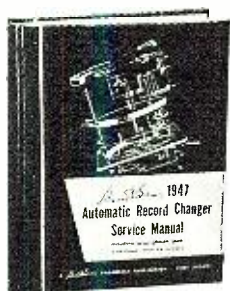

1947 Automatic Record Changer Manual

Nothing like it! Covers more than 40 different post-war models. Absolutely accurate, complete, authoritative — based on actual analysis of the equipment. Shows exclusive "exploded" views, photos from all angles. Gives full change cycle data, adjustment data, service hints and kinks, complete parts lists. Shows you how to overcome any kind of changer trouble. **PLUS** — for the first time — complete, accurate data on leading Wire, Ribbon, Tape, and Paper Disc Recorders. 400 pages; 8½" x 11"; hard cover; opens flat. Don't be without this manual. **ONLY \$4.95**



Radio Receiver Tube Placement Guide

The book that shows you exactly where to replace each tube in 5500 radio receiver models. Covers receivers from 1938 to 1947. Each tube layout is illustrated by a clear, accurate diagram. Saves time — eliminates risky hit-and-miss methods, especially when the customer has removed tubes from the set. A handy pocket-sized 192-page book, indexed for quick reference. You'll use it profitably every single day. Order several copies for your bench and outside calls! **ONLY \$1.25**

**FAMOUS \$500.00
TELEVISION COURSE
At No Extra Cost to You!**

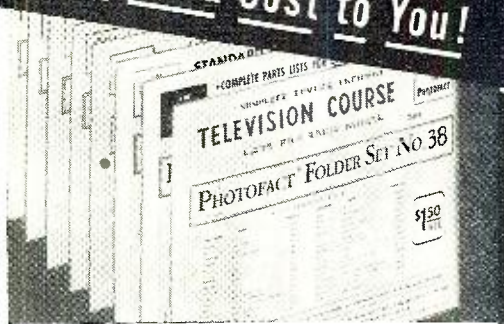

NOW RUNNING IN CURRENT PHOTOFACT FOLDER SETS

Here's the first practical, successfully proved Television instruction for the Service Technician! Now — at no extra cost to you — you can prepare for profitable Television servicing without taking time off from your business. If you can service a Superheterodyne, the PHOTOFACT Course will teach you clearly and simply how to service a Television Receiver. Telegrams, letters and phone calls by the hundred acclaim the first installment of the \$500 Television Course which appeared in PHOTOFACT Folder Set No. 38. If you haven't started the Course (which is running in current PHOTOFACT Folder issues) — be sure to get PHOTOFACT Sets No. 38, 39 and 40 today! Stay ahead of the game with PHOTOFACT!

Don't Miss a Single Installment!

Dial Cord Stringing Guide

The book that shows you the one *right* way to string a dial cord. Here, for the first time, in one handy pocket-sized book, are all available dial cord diagrams covering over 2300 receivers, 1938 through 1946. Makes dial cord restringing quick and simple. Pays for itself in time saved on a single dial cord repair job. A "must" for every service bench and tool kit. Order today! **ONLY \$1.00**



BOOST YOUR EARNING POWER!

Mail This Order Form
to HOWARD W. SAMS & CO., INC.
2924 E. Washington St., Indianapolis 7, Indiana

My (check) (money order) for \$.....enclosed.

- Send Photofact Sets 38, 39, 40. (\$1.50 per Set).
- Send Photofact Volume 4 (including Sets Nos. 31 through 40) in DeLuxe Binder, 18.39.
- Vol. 3. Vol. 2. Vol. 1 (\$18.39 each).
- Automatic Record Changer Manual, \$4.95.
- Tube Placement Guide, \$1.25.
- Dial Cord Stringing Guide, \$1.00.
- Send FREE Photofact Cumulative Index.

Name _____

Address _____

City _____ State _____

HOWARD W. SAMS & CO., INC.
INDIANAPOLIS 7, INDIANA

Export—Ad. Auricma—89 Broad St., New York 4, N. Y.—U. S. of America
Canada—A. C. Simmonds & Sons, 301 King St., East—Toronto, Ontario

PHOTOFACT SERVICE

"The Service that pays for itself over and over again"

20,000 OHMS PER VOLT.. TUBE and SET TESTER \$59⁹⁵ FOR ONLY— \$59⁹⁵ NET

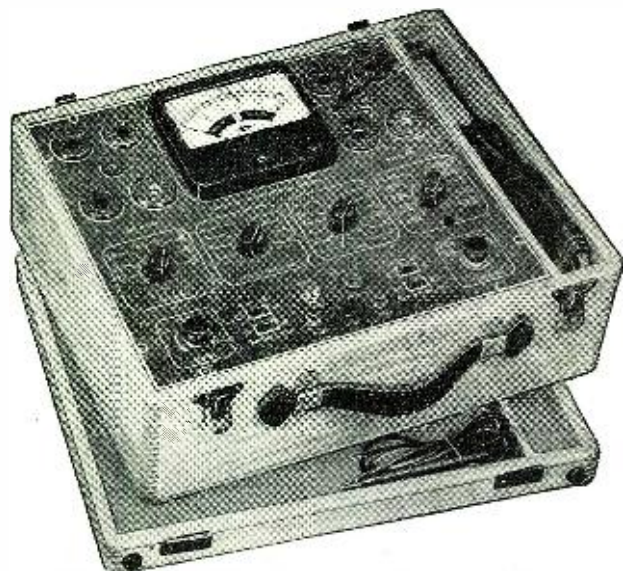

TUBE TESTER SPECIFICATIONS:

- Tests all tubes including 4, 5, 6, 7, 7L, Octals, Loctals, Television, Magic Eye, Thyratrons, Single Ended, Floating Filament, Mercury Vapor Rectifiers, New Miniatures, etc. Also Pilot Lights.
- Tests by the well-established emission method for tube quality, directly read on the scale of the meter.
- Tests leakages and shorts of any one element against all elements in all tubes.
- Tests both plates in rectifiers.
- Tests individual sections such as diodes, triodes, pentodes, etc., in multi-purpose tubes.
- New type line voltage adjuster.

V.O.M. SPECIFICATIONS:

- D.C. VOLTS: (at 20,000 Ohms Per Volt)
0 to 7.5/15/75/150/750/1,500 Volts
- A.C. VOLTS: (At 10,000 Ohms Per Volt)
0 to 15/30/150/300/1,500/3,000 Volts
- D.C. CURRENT:
0 to 1.5/15/150 Ma. 0 to 1.5 Amperes
- RESISTANCE:
0 to 5,000/50,000/500,000 Ohms 0 to 50 Megohms
- DECIBELS: (Based on zero decibels equals .006 Watts into a 500-ohm line.)
-10 to + 18 db., + 10 to + 38 db., + 30 to + 58 db.

Model 777 operates on 90-120 Volts 60 cycles A. C. Housed in beautiful hand-rubbed cabinet. Complete with test leads, tubes, charts and detailed operating instructions. Size 13" x 12 1/2" x 6".

\$59⁹⁵
NET PRICE

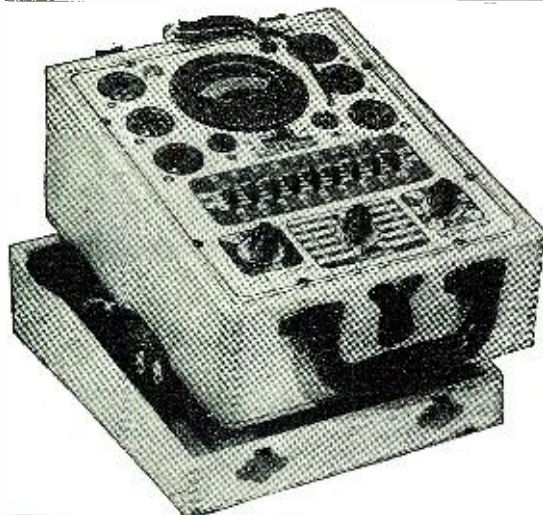

THE NEW MODEL 247

← TUBE TESTER

Checks octals, loctals, bantam jr., peanuts, television miniatures, magic eye, hearing aids, thyratrons, the new type H.F. miniatures, etc.

Features:

- ★ A newly designed element selector switch reduces the possibility of obsolescence to an absolute minimum.
- ★ When checking Diode, Triode and Pentode sections of multi-purpose tubes, sections can be tested individually. A special isolating circuit allows each section to be tested as if it were in a separate envelope.
- ★ The Model 247 provides a super sensitive method of checking for shorts and leakages up to 5 Megohms between any and all of the terminals.
- ★ One of the most important improvements, we believe, is the fact that the 4 position fast-action snap switches are all numbered in exact accordance with the standard R. M. A. numbering system. Thus, if the element terminating in pin No. 7 of a tube is under test, button No. 7 is used for that test.

Model 247 comes complete with new speed-read chart. Comes housed in handsome, hand-rubbed oak cabinet sloped for bench use. A slip-on portable hinged cover is included for outside use. Size: 10 3/4" x 8 3/4" x 5 3/4".

ONLY
\$29⁹⁰
NET

THE MODEL 650—AN A.C. OPERATED

SIGNAL GENERATOR →

RANGE: 100 KILOCYCLES TO 105 MEGACYCLES

- ★ RF obtainable separately or modulated by the Audio Frequency.
- ★ Audio Modulating Frequency—400 cycles pure sine wave—less than 2% distortion.
- ★ Attenuation—3-step ladder type of attenuator (T pad).
- ★ Uses a Hartley Excited Oscillator with a Buffer Amplifier.
- ★ Tubes: 6J5 as R.F. Oscillator; 6SA7 as modulated buffer and Mixer; 6SL7 as audio oscillator and rectifier.

Model 650 comes complete with coaxial cable, test leads and instructions. Housed in heavy gauge grey crystalline cabinet with beautiful two tone etched front panel. Size 9 1/2" x 10" x 6".....NET PRICE:

\$39⁹⁵

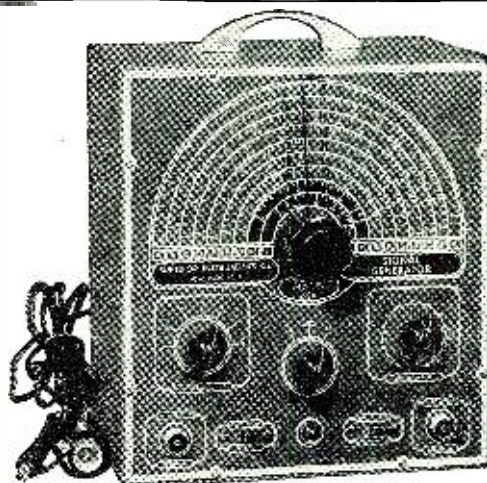

OUR POLICY • ALL MODELS DESCRIBED ABOVE ARE OFFERED ON MONEY-BACK-IF-NOT-SATISFIED BASIS. • ALL ITEMS AVAILABLE FOR IMMEDIATE SHIPMENT FROM STOCK. • ALL MERCHANDISE GUARANTEED TO BE EXACTLY AS DESCRIBED—ALL BRAND NEW—NO SURPLUS.

20% Deposit Required on all C.O.D. Orders

MOSS ELECTRONIC DISTRIBUTING CO.

DEPT. RN-7 229 FULTON STREET
NEW YORK 7, N. Y.
RADIO NEWS

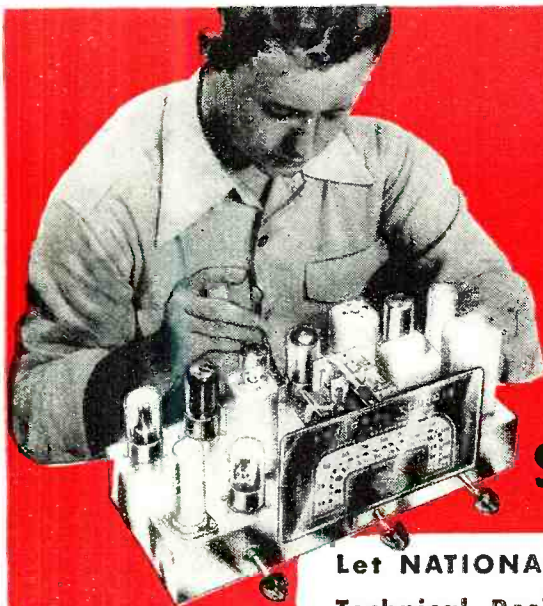

Learn RADIO TELEVISION, ELECTRONICS *by* SHOP METHOD HOME TRAINING

Let NATIONAL SCHOOLS, of Los Angeles, a practical Technical Resident Trade School for almost 50 years, train you for today's unlimited opportunities in Radio

You receive all parts, including tubes, for building this fine, modern Superheterodyne Receiver. This and other valuable standard equipment becomes your property.

these two FREE books will tell you how



Good Jobs Await the Trained Radio Technician

You are needed in the great, modern Radio, Television and Electronics industry! Trained Radio technicians are in constant and growing demand at excellent pay—in Broadcasting, Communications, Television, Radar, Research Laboratories, Home Radio Service, etc. National Schools Master Shop Method Home Study Course, with newly added lessons and equipment, can train you in your spare time, right in your own home, for these exciting opportunities. Our method has been proved by the remarkable success of National Schools-trained men all over the world.

You Learn by Building Equipment with Standard Radio Parts We Send You

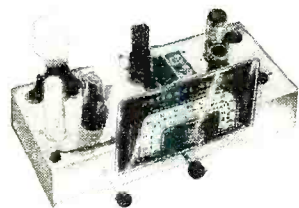

Your National Schools Course includes not only basic theory, but practical training as well—you learn by doing. We send you complete standard equipment of professional quality for building various experimental and test units. You advance step by step until you are able to build the modern superheterodyne receiver shown above, which is yours to keep and enjoy. You perform more than 100 experiments—build many types of circuits, signal generator, low power radio transmitter, audio oscillator, and other units. The Free Books shown above tell you more about it—send for them today!

NOW! New Professional Multitester Included!



This versatile testing instrument is portable and complete with test leads and batteries. Simple to operate, accurate and dependable. You will be able to quickly locate trouble and adjust the most delicate circuits. You can use the Multitester at home or on service calls. It is designed to measure AC and DC volts, current, resistance and decibels. You will be proud to own and use this valuable professional instrument.

Lessons

and Instruction

Material Are Up-to-date, Practical, Interesting.

National Schools Master Shop Method Home Training gives you basic and advanced instruction in all phases of Radio, Television and Electronics. Each lesson is made easy to understand by numerous illustrations and diagrams. All instruction material has been developed and tested in our own shops and laboratories, under the supervision of our own engineers and instructors. A free sample lesson is yours upon request—use the coupon below.

Here's Just a Few of the Interesting Facts you Learn with the

FREE MANUAL

1. Routine for diagnosing Radio Troubles.
2. Preliminary inspection of Receivers.
3. How to Test and Measure Voltages.
4. How to Test Speaker in Audio Stages.
5. How to Trace the Circuit and Prepare Skeleton Diagram.
6. Complete Reference Table for Quickly Locating Receiver Troubles.

Both Home Study and Resident Training Offered

APPROVED FOR VETERANS

Check Coupon Below

G. I. APPROVED

NATIONAL SCHOOLS

LOS ANGELES 37, CALIFORNIA EST. 1905



MAIL OPPORTUNITY COUPON FOR QUICK ACTION

National Schools, Dept. RN-8
4000 S. Figueroa, Los Angeles 37, Calif.

Mail me FREE the books mentioned in your ad including a sample lesson of your course. I understand no salesman will call on me.

NAME.....AGE.....

ADDRESS.....

CITY.....ZONE.....STATE.....

Check here if Veteran of World War II

GET THE DETAILS—SEND THE COUPON →

New 1948 and F.M. Manuals

BIGGEST BARGAIN IN RADIO DIAGRAM

Make these two new mammoth volumes your money-saving source for data on all recently released receivers. Learn about modern circuit developments, be ready to repair any new radio no matter how complex. You pay only \$2 for each of these large manuals. With these two volumes on your workbench there is nothing else to buy, nothing else to pay—a whole year of radio diagrams and service data yours for a couple of dollars total. Again Supreme Publications beats all competition and gives radio servicemen greatest bargains in service information. Other volumes for previous years described below. **No-risk** examination granted to servicemen.

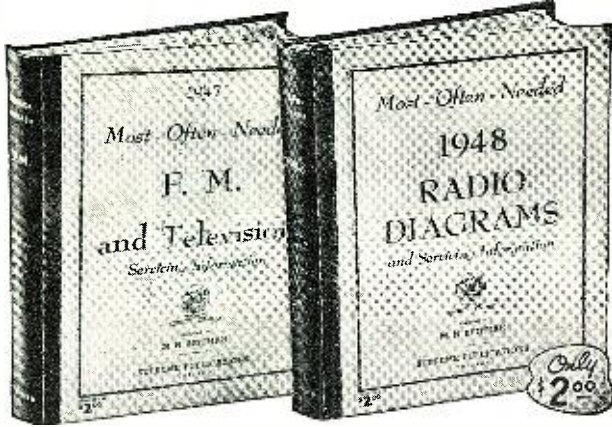

F.M. and Television

Use this new giant manual of factory instructions for troubleshooting, repairing, and alignment of any 1947-1948 F.M. and Television set. Every popular make, including new F.M. tuners, AM-FM combinations, and all types of television receivers. Detail circuit diagrams, theory of operation, test hints, alignment data, including both meter and oscilloscope methods. This is the material you need to fix any modern F.M. or Television set. Don't turn this profitable work away for lack of knowledge and information. Use this newest Supreme manual to save time and money on your very next F.M. job. Data presented on 192 large pages, 8½x11 in. Sturdy, manual-style binding. Just published. Special price.. **\$2.00**

New 1948 Manual

Be prepared to repair quickly all new 1948 receivers. In this big single volume you have clearly-printed, large schematics, needed alignment data, replacement parts lists, voltage values, and information on stage gain, location of trimmers, and dial stringing, for almost all recently released sets. Makes toughest jobs amazingly easy. Find faults in a jiffy. Speed-up all repairs. The time saved on your next job will pay the \$2 bargain price for the complete manual—after that you use it FREE. A worthy companion to the 7 previous volumes used by over 120,000 shrewd radio servicemen. New manual covers models of 42 different manufacturers. Giant size: 8½x11", 192 pages + index. Manual-style binding. Price, only.. **\$2.00**

FIND ALL RADIO FAULTS DOUBLE-QUICK

You can speed-up and simplify radio repairs with SUPREME PUBLICATIONS Manuals. Service all radios faster, better, easier, save time and money, use these most-often-needed diagram manuals to get ahead, earn more per hour. For the remarkable bargain price (only \$2 for most volumes) you are assured of having in your shop and on the job, needed diagrams and other essential repair data on 4 out of 5 sets you will ever service. Every popular radio of all makes from old-timers to new 1948 sets, including F.M., and Television, is covered. Clearly printed circuits, parts lists, alignment data, and helpful service hints are the facts you need to improve

your servicing ability. Save hours each day, every day, begin to earn more by making repairs in minutes instead of hours. Let these manuals furnish you with diagrams for 80% of all sets. There is no need to spend large sums for bulky, space-wasting manuals, or to buy additional drawings every few weeks; be wise, use SUPREME Manuals to get the most in diagrams and service data for the smallest cost. Act today and be money ahead with Supreme Publications.

Models Made by:
R.C.A., Zenith, Philco, Sears, Fada, Emerson, Belmont, Detrola, Crosley, G.E., Westinghouse, Arvin, Majestic, Admiral, Delco, Stromberg-Carlson, Wards, West'n Auto, Sparton, Motorola, and many others.

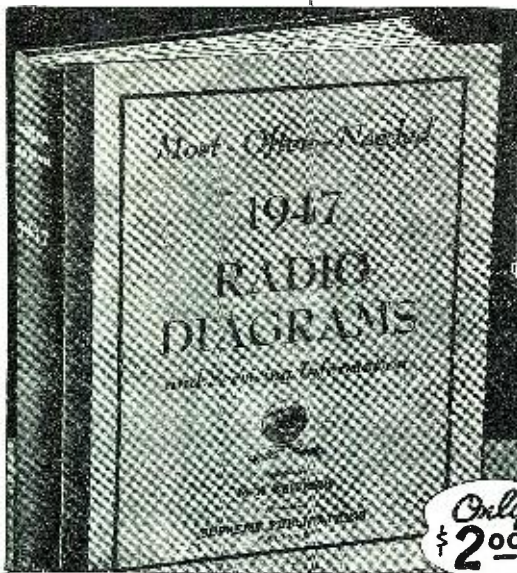

Only \$2.00

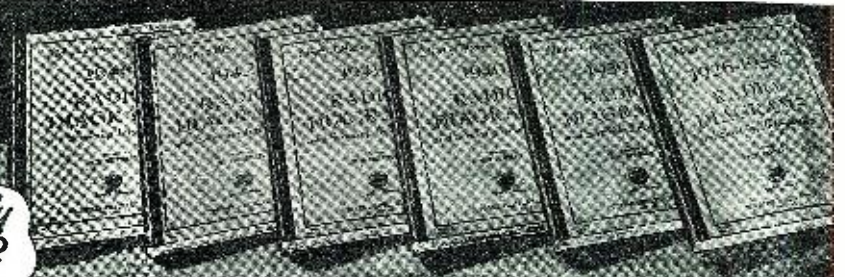

Use coupon to order manuals for examination
Include all popular sets from 1926 to 1948.

Select Supreme Diagram Manuals and Record Changer Books you want to examine. Send the convenient no-risk trial coupon. Use the manuals in your own home or shop for 10 days at our risk. Decide for yourself that Supreme Publications are the greatest values in service data. You must be completely satisfied, or return manuals and receive your money back.

Record Changers Manuals

Post-War Models

Service expertly all modern (1945-1948) record changers. Just follow simplified factory instructions to make needed adjustments and repairs. Hundreds of photographs and exploded views. Large size: 8½ x 11 inches. 144 fact-filled pages. Price only \$1.50, postpaid.

Pre-War Models

Just what you need to repair quickly thousands of pre-war (before 1942) automatic record changers, manual units, pickups, wireless oscillators, recorders, and combinations. Hundreds of mechanical and electrical diagrams. 128 large pages; size 8½ x 11 inches. Price, only \$1.50.

See Your Radio Jobber or Send Coupon →

NO RISK TRIAL ORDER COUPON

SUPREME PUBLICATIONS, 9 S. Kedzie Ave., Chicago 12, ILL.

Ship the following manuals on trial under your guarantee of satisfaction or money-back.

- New F.M. and Television Manual.. \$2.00
- Post-War Record Changers..... 1.50
- Pre-War Record Players & Recorders 1.50

PRICED AT ONLY \$2 EACH

1948
 1947
 1946
 1942
 1941
 1940
 1939
 1926-1938 — \$2.50

I am enclosing \$....., send postpaid.

Send C.O.D. I am enclosing \$..... deposit.

Name:

Address:

Supreme Publications

PUBLISHERS OF RADIO BOOKS, MANUALS, AND DIAGRAMS

9 South Kedzie Ave.

Chicago 12, Illinois

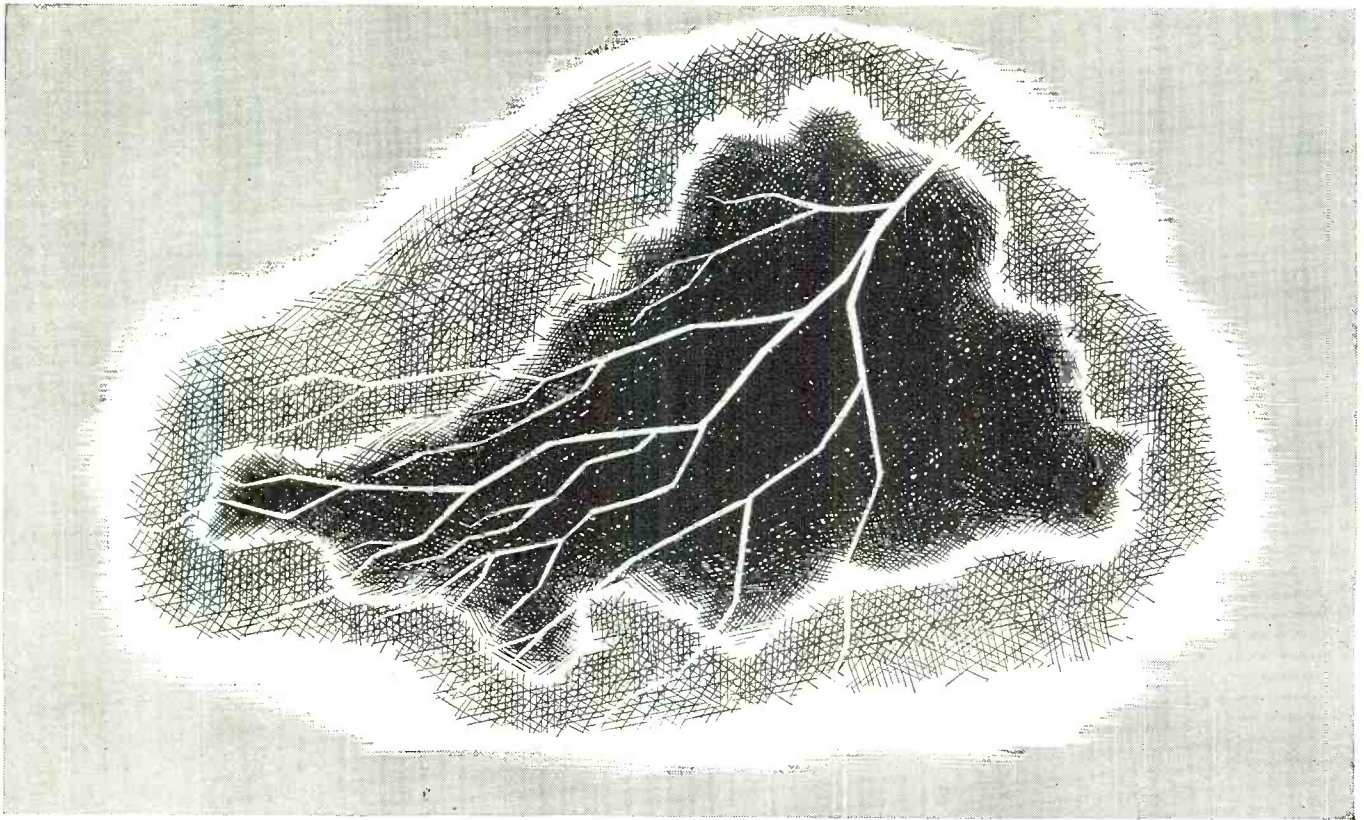

lightning

Lightning flashes that blaze across an otherwise peaceful sky hold no greater threat to man, proportionately . . . than uncontrolled voltage peaks that threaten the life of ordinary transformers. Man has controlled to a large degree lightning damage . . . and Radiart engineers have shackled flash damage in the RADIART VIBRATOR! The more expensive detail of mica construction insures longer life because stack breakdown is practically eliminated that ordinarily results from high voltage flashes. Carbonized stacks that mean efficiency loss are simultaneously eliminated. This . . . and many other features have built Radiart leadership. That is why your customers prefer RADIART VIBRATORS.

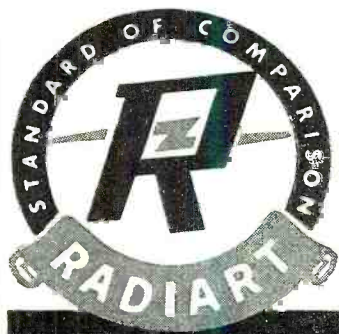
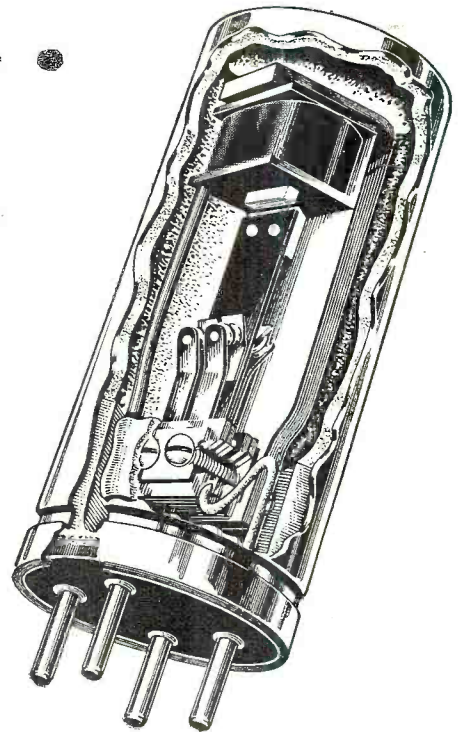

The Radiart Corp.
CLEVELAND 2, OHIO

PLEASE TEAR OUT THIS ADV. AS REMINDER

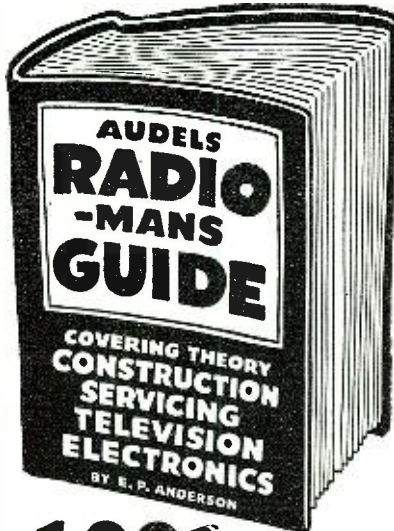

1001 RADIO FACTS AND FIGURES

AUDELS RADIOMANS GUIDE—914 Pages, 633 Illustrations, Photos, Wiring Diagrams, 38 Big Chapters, covering Radio Theory, Construction, Servicing, including Important Data on Developments in Television, Electronics and Frequency Modulation, Review, Questions and Answers, Calculations & Testing. Highly Endorsed—Indispensable for Ready Reference and Home Study.

\$4 COMPLETE • PAY ONLY \$1 A MONTH Step up your own skill with the facts and figures of your trade. Audels Mechanics Guides contain Practical Inside Trade Information in a handy form. Fully illustrated and Easy to Understand. Highly Endorsed. Check the book you want for 7 days' Free Examination.

Send No Money. Nothing to pay postman.

CUT HERE
MAIL ORDER

AUDEL, Publishers, 49 W. 23 St., NEW YORK 10, N. Y.

Please send me postpaid for FREE EXAMINATION books marked (*) below. If I decide to keep them I agree to mail \$4 in 7 Days on each book ordered and further mail \$1 monthly on each book until I have paid price—otherwise, I will return them.

- RADIOMANS GUIDE, 914 Pages . . . \$4
- ELECTRICIANS EXAMINATIONS, 250 Pages . . . 1
- WIRING DIAGRAMS, 210 Pages . . . 1
- ELECTRIC MOTOR GUIDE, 1000 Pages . . . 4
- ELECTRICAL DICTIONARY, 9000 Terms . . . 2
- ELECTRICAL POWER CALCULATIONS, 425 Pgs. . . 2
- HANDY BOOK OF ELECTRICITY, 1440 Pages . . . 4
- ELECTRONIC DEVICES, 216 Pages . . . 2
- ELECTRIC LIBRARY, 12 vol., 7000 Pgs., \$1.50/vol. . . 1
- OIL BURNER GUIDE, 384 Pages . . . 1
- REFRIGERATION & Air Conditioning, 1280 Pgs. . . 4
- POWER PLANT ENGINEERS Guide, 1500 Pages. . . 4
- PUMPS, Hydraulics & Air Compressors, 1658 Pgs. . . 4
- WELDERS GUIDE, 400 Pages . . . 1
- BLUE PRINT READING, 416 Pages . . . 2
- SHEET METAL WORKERS Handy Book, 388 Pgs. . . 1
- SHEET METAL PATTERN LAYOUTS, 1100 Pgs. . . 4
- AIRCRAFT WORKER, 240 Pages . . . 1
- MATHEMATICS & CALCULATIONS, 700 Pgs. . . 4
- MACHINISTS Handy Book, 1600 Pages . . . 4
- MECHANICAL Dictionary, 968 Pages . . . 4
- AUTOMOBILE GUIDE, 1700 Pages . . . 4
- DIESEL ENGINE MANUAL, 400 Pages . . . 2
- MARINE ENGINEERS Handy Book, 1280 Pages . . . 4
- MECHANICAL DRAWING GUIDE, 160 Pages . . . 1
- MECHANICAL DRAWING & DESIGN, 420 Pgs. . . 2
- MILLWRIGHTS & Mechanics Guide, 1200 Pgs. . . 4
- CARPENTERS & Builders Guides (4 vols.) . . . 6
- PLUMBERS & Steamfitters Guides (4 vols.) . . . 6
- MASONS & Builders Guides (4 vols.) . . . 6
- MASTER PAINTER & DECORATOR, 320 Pgs. . . 6
- GARDENERS & GROWERS GUIDES (4 vols.) . . . 6
- ENGINEERS and Mechanics Guides . . . 12
- Nos. 1, 2, 3, 4, 5, 6, 7 and 8 complete . . . 1
- Answers on Practical ENGINEERING . . . 1
- ENGINEERS & FIREMANS EXAMINATIONS . . . 1

Name _____

Address _____

Occupation _____

Employed by _____ RN



JAMES C. SARAYIOTES has been named Advertising Manager of *J.F.D. Manufacturing Co., Inc.* of Brooklyn.

Formerly associated with *Thoma & Gill* and *Reiss Advertising*, Mr. Sarayiotos served as a radar engineering aide to the War Department and as radar maintenance section chief for the U. S. Army Signal Corps.



In his new position he will be in charge of all direct mail advertising, sales promotion, and public relations for *J.F.D.*

* * *

WESTINGHOUSE AND PHILCO are establishing a Radio and Television Center in Philadelphia which will house all radio and television broadcasting activities of the two companies in that area.

The respective operations will occupy the present *Westinghouse-KYW* Building at 1619 Walnut Street, which will be known as the *Westinghouse-Philco* Radio and Television Center. Alterations on the structure are now under way.

* * *

SIGMA INSTRUMENTS, INC. has appointed Forrest C. Valentine to represent the company in Ohio, Indiana, and Kentucky.

Associated with Mr. Valentine in the Fort Wayne, Indiana office will be Walter Bieberich, while John Seelie will assist in the company's Cleveland, Ohio office.

* * *

G. ROBERT WANNEN, manager of *Sylvania Electric's* eastern radio tube sales division, passed away recently after suffering a heart attack while at work.



Mr. Wannan had been associated with the company in radio tube sales activities for fifteen years, working closely with jobbers, jobber's salesmen, service dealers, and servicemen.

He was connected with the radio industry since 1923 when he joined *Eastern Hardware & Radio Supply Co.*

* * *

BURLINGTON INSTRUMENT COMPANY has appointed *J-H Electronic Sales Company* to act as its representatives in the State of Maryland and Fairfax County, Vir-

ginia. The offices of the new representative are located in Towson, Maryland.

The company also announced that the offices of the representative for the West Virginia and western Pennsylvania territory have been moved. The new address is Sam J. Shaw, Avalon Bank Building, 604 California Avenue, Pittsburgh 2, Pennsylvania.

* * *

RADIO CORPORATION OF AMERICA has awarded the contract for a new building to be erected at the Lancaster plant of the *RCA Tube Department*.

The new building will provide an additional 40,000 square feet of space and will aid materially in stepping up the production of cathode-ray television picture tubes. Company officials estimate that production at the plant will be almost doubled upon completion of the new million-dollar expansion program now under way at the Lancaster plant.

* * *

WALTER F. MARSH, Sales Manager of *Allied Radio Corporation* for the past ten years, has resigned his post to become associated with *Leroy W. Beier Company*, Chicago Manufacturers' Representatives.



Well-known in the radio industry, Mr. Marsh has been associated with *American Phenolic Corporation* and *Meissner Manufacturing Company* in addition to his connection with *Allied Radio Corporation*. He is a member of the Veterans Wireless Operators Association and the Radio Old Timers.

* * *

NOBLITT-SPARKS INDUSTRIES, makers of *Arvin* Radios, has appointed Galen Freise to the post of assistant district manager in the Texas and Southwest territory.

Mr. Freise has been connected with *Arvin's* advertising department since his graduation from college in 1947. He was an ensign in the Air Communications office during the war and served for three years in the Aleutian Islands.

* * *

H. SILBERMANN, until recently Senior Engineer and Works Manager for *S. A. Philips (Pty) Ltd.* has joined *Continental Radio & Electrical Engineers (Pty) Ltd.* of Johannesburg, South Africa as Senior Engineer and Technical Director.

Mr. Silbermann is well-known both in this country and abroad. He is a

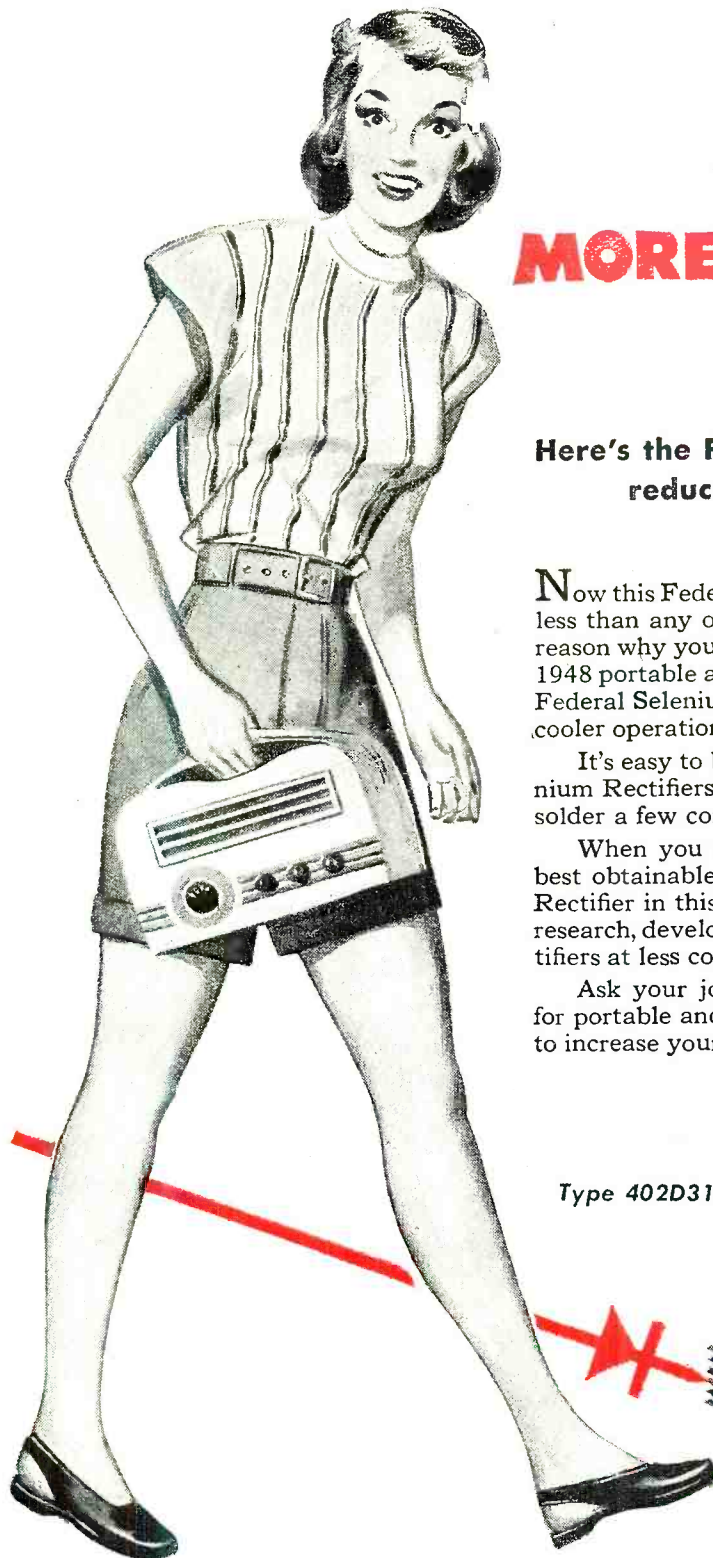

How to Make **MORE WALK-IN PROFIT** per Portable

Here's the Federal Miniature Selenium Rectifier that reduces your cost and does a better job

Now this Federal Miniature Selenium Rectifier actually costs much less than any of the rectifier tubes it replaces. That's the economic reason why you will find this modern power supply in so many of the 1948 portable and personal radios. The performance reasons are that Federal Selenium Rectifiers assure instant starting . . . longer life . . . cooler operation.

It's easy to bring most small radios up to date with Federal Selenium Rectifiers. Circuit changes are minor. All you have to do is to solder a few connections.

When you use Federal Selenium Rectifiers, you're sure of the best obtainable. It was Federal that first introduced the Selenium Rectifier in this country nine years ago. And Federal has led in the research, development and manufacture of ever-better Selenium Rectifiers at less cost.

Ask your jobber about Federal Miniature Selenium Rectifiers for portable and personal radio repairs. For full information on how to increase your profits by their use, write to Department F-959.

Type 402D3150A-75 ma

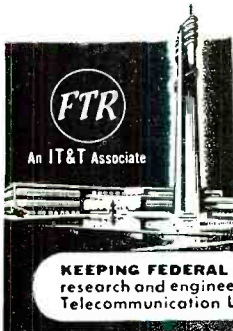
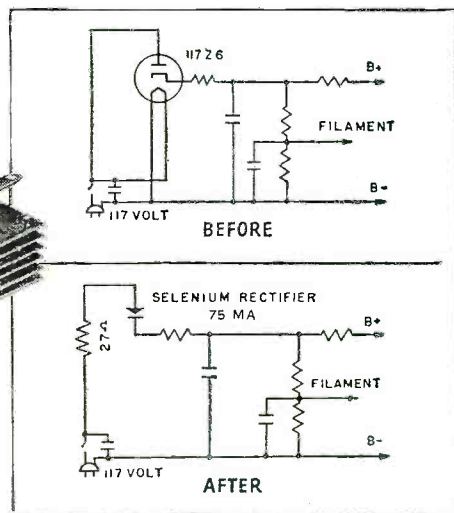
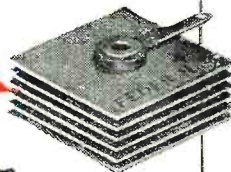

Federal Telephone and Radio Corporation

SELENIUM and INTELIN DIVISION, 900 Passaic Ave., East Newark, New Jersey

In Canada: Federal Electric Manufacturing Company, Ltd., Montreal, P. Q.
Export Distributors: International Standard Electric Corp. 67 Broad St., N. Y.

KEEPING FEDERAL YEARS AHEAD... is IT&T's world-wide research and engineering organization, of which the Federal Telecommunication Laboratories, Nutley, N. J., is a unit.

TELEVISION INDUSTRIES Co.

PICTURE IF & SOUND IF STRIP and FRONT END. This sensational picture If & Sound If Strip developed by our engineering staff enables you to build a 10"-12"-15"-20" direct view or projection type receiver with FM sound. Supplied with a

13 channel RF front end unit. The front end covers channels from 44 to 88 mc/s and 174 to 216 mc/s (13 channels). Matched antenna input for 300 ohm line. Tubes: 1-6J6 RF amplifier 1-6J6 converter 1-6J6 oscillator.

\$119.50

DEALERS NET

● PICTURE IF — 5 picture IF stages of amplification and second detector. SOUND IF STAGES 2 IF stages with limiter and discriminator. VIDEO amplifiers — 2 stages video with a frequency response of 4.5 mc/s. ONE DC RESTORER. IF FREQUENCY audio 21.25 — picture 25.75.

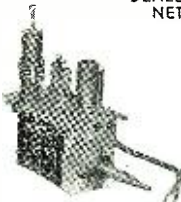

Picture IF band width 4.5 mc/s. All the above circuits and tubes are contained on one chassis. Front end unit on separate chassis. Both picture IF and sound IF delivered completely wired, tested, tubed, and matched ready for use.

DUMONT INPUTUNER

The Dumont Inputuner tunes continuously from 44 to 216 megacycles without a break—covers all 13 television channels as well as FM, amateur, and aviation channels. For ease and convenience of operation no band switching of any kind is required when tuning from channel to channel with the inputuner system. Just one simple operation to reach any desired station.

\$97.90

LIST



Deflection Yoke similar to RCA part # 20 IDI

\$13.75

LIST

BAUSCH & LOMB TELEVISION PROJECTION LENS



Television Industries Co. is proud to announce that they have been appointed national wholesale distributors for the Bausch & Lomb f: 1.9 Television Projection Lens. Sample orders filled immediately.

\$125.00

DEALERS NET



R. F. POWER SUPPLY

27 — 30 K.V.

for

Projection Television

\$125.00

DEALERS NET

Contact Us for your Local Distributor

TELEVISION INDUSTRIES Co.

540 BUSHWICK AVE.
BROOKLYN 6, N. Y.

member of the I.R.E. and a graduate of the University of Munich.

Continental Radio serves as manufacturers' representatives for several lines of radio, electronic, and electrical equipment.

* * *

SANFORD H. LEVEY has been appointed Sales Manager of *Allied Radio Corporation* of Chicago succeeding Walter F. Marsh who resigned recently.



Mr. Levey is well-known in the radio industry and has been associated with *Allied Radio* in various merchandising and sales positions.

He will make his headquarters at the company's offices at 833 West Jackson Boulevard, Chicago, Illinois.

* * *

SNC MANUFACTURING CO., INC. has combined its Glenview, Illinois plant with its Oshkosh, Wisconsin plant in order to effect operating economies which it hopes to be able to pass on to the trade.

The Oshkosh facilities have been expanded to house the additional machinery and inventories. The company manufactures a line of transformers.

* * *

HENRY O. BERMAN of Baltimore, Maryland has been appointed distributor for *Remington Radio Corporation's* "Rembrandt" television receivers in the Baltimore district, while *Mattson's Radio* in Richmond will handle the company's line in that city.

* * *

DR. ROBERT A. MILLIKAN will be the principal speaker at the banquet to be held in connection with the West Coast Convention of the I.R.E., September 29th through October 2nd.



Dr. Millikan, retired director of the California Institute of Technology, renowned physicist, author, lecturer, and winner of the Nobel Prize for Physics in 1923, will speak on "The Release and Utilization of Atomic Energy."

The I.R.E. Convention will be held in conjunction with the West Coast Electronic Manufacturers Association convention in Los Angeles.

* * *

THE ILLINOIS CONDENSER COMPANY has appointed Irving W. Rose, 314 North Michigan Avenue, Chicago as its Mid-western representative.

Mr. Rose will cover the jobber and manufacturer trade in Wisconsin, Illinois, and Indiana. Formerly associated with *Hallicrafters*, he has a wide and varied background in sales engineering.

-50-

RADIO NEWS

A Sensational Announcement to the "Top Third" of the Servicing Field!

Now, after two years of preparation, CREI introduces its new home study course in

TELEVISION AND FM SERVICING

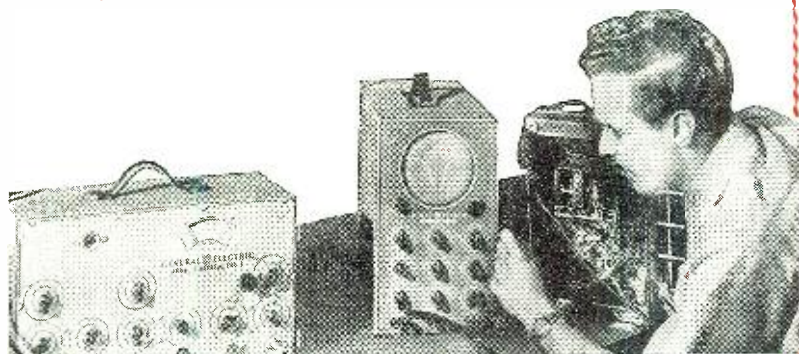

G. E. PHOTO

100% Practical "On-the-Job" Course That Equips You to Install and Service ALL Types of Television and FM Receivers

1948 is the big changeover year—from radio to television.

It is the year for you and all servicemen to make the big decision. Either you are going to catch up with the new developments in the industry, or you are going to be passed by. There are new techniques—entirely new methods of technical "know how" to be learned and mastered, if you are going to be in a position to handle good-paying Television and FM business.

This new course was prepared by CREI at the request of several large manufacturers, distributors and dealers who said, "We must have more servicemen trained to handle the approximately 800,000 television sets and 4,000,000 FM sets to be produced this year alone!" CREI knows exactly what you need and every effort has been made to keep this course practical and to the point. If you are now in service work you will be able to thoroughly understand and apply each lesson. It has been reviewed and checked by qualified service experts who know what *you must know* to get ahead in this booming field.

Radio Service Division of

CAPITOL RADIO ENGINEERING INSTITUTE

An Accredited Technical Institute

Dept. 478, 16th & Park Rd., N. W., Washington 10, D. C.

Branch Offices: New York (7) 170 Broadway • San Francisco (2) 760 Market St.

July, 1948

CREI has never attempted "high pressure" selling of any kind. In introducing this course, we believe honestly that it can provide you with the ability you must have to hold your job—qualify for a better one—or start your own business.

To such familiar service terms as "tone, selectivity, circuit noise, AVC, feedback, etc.," must be added such terms as, "dipole, rasters, clippers, clamping circuits, synch pulses, blanking pedestals, etc." Do you understand this new language? Are you qualified to install and service all types of Television and FM Receivers?



TV and FM will make more progress in the next 10 months than they have in the past 10 years. Just think of the extraordinary opportunities this opens up for you. Here in one practical course at a popular price, CREI offers you security and more money.

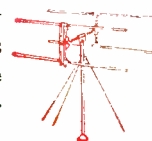

Don't put it off. Get going now and get in on the big money that is going to be made by those men who have equipped themselves to handle the "sets of tomorrow."

Start your training now and you start applying your new-found knowledge immediately. Every lesson in this course can be helpful in your daily work. As you progress in your training you will find yourself equipped to handle complicated Television and FM work that only a few months ago looked "impossible". The time to start is now.

It costs you nothing but a few minutes time to read the interesting facts and the complete lesson-by-lesson outline. So practical, so simple to understand. Mail the coupon now for complete information.



**MAIL
TODAY**

CAPITOL RADIO ENGINEERING INSTITUTE
16th & Park Road, N. W., Dept. 478, Washington 10, D. C.

Gentlemen:
Please send me complete details of your new home study course in Television and FM Servicing. I am attaching a brief resume of my experience, education and present position.

NAME _____

STREET _____

CITY _____ ZONE _____ STATE _____

I AM ENTITLED TO TRAINING UNDER G. I. BILL.

See how Cen ra ab

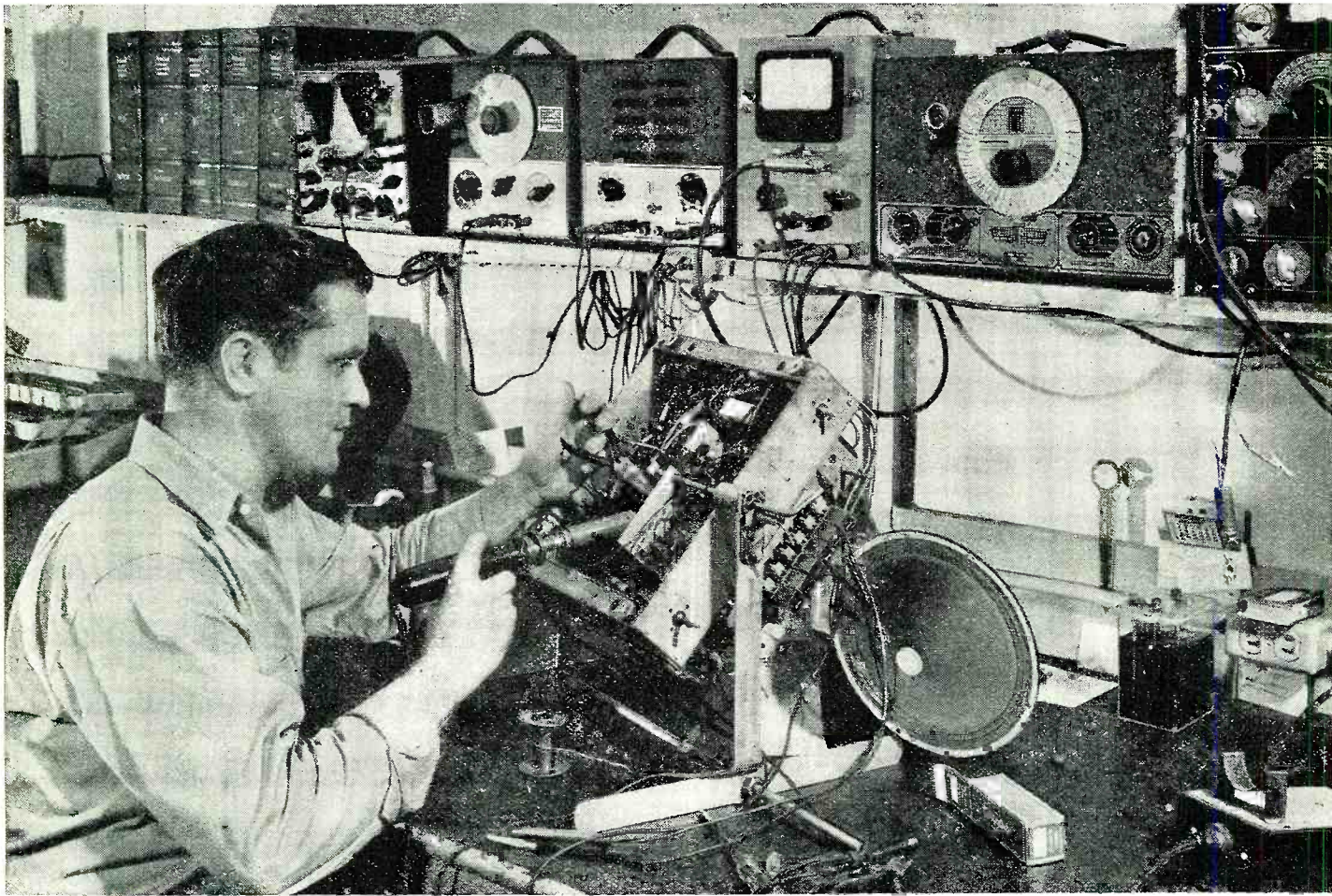

Capacitors: CRL line of ceramic By-pass and Coupling Capacitors gives you ceramic dependability and permanence at a new low price! Packaged in a convenient envelope, *Hi-Kaps* are clean, easy to stock and handle. Wide range from .000050 to .010000 mfd. Rating — 600 WVDC, 1000 V. flash tested. Just out! New ceramic *Hi-Vo-Kaps* for television and high voltage use!

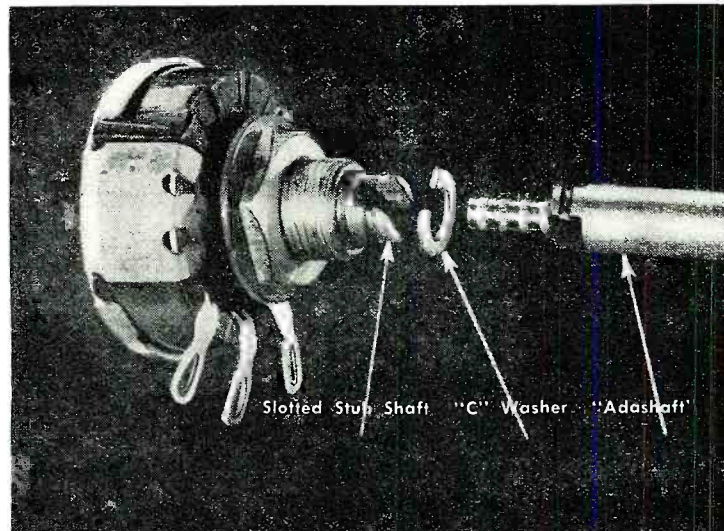

Controls: With CRL's improved *Adashaff* Radioshms you can carry a small stock of controls, yet be ready to handle almost any kind of control replacement problem. No wiggle, no wobble, no slip. Just insert shaft pilot in hole provided in control stub shaft, and slip "C" washer into place. Available in all sizes for all Model "M" volume control applications. Six types of shafts.

RADIO NEWS

serves your needs

Want to speed up service and repairs? Want to simplify inventory and draw more customers? One look at Centralab's line of service components gives you the key to these important service problems. Compare quality . . . compare performance . . . compare price, and you'll see why radio servicemen everywhere use CRL parts to increase the efficiency of their shops and give their customers fast, dependable service. Yes, new Centralab research and development points the way to easier, faster service and repair . . . improved customer satisfaction! For the complete story on the Centralab line, get in touch with your Centralab Distributor.

— "Centralab's ceramic *Hi-Kap* capacitors are way ahead on performance and cost", says Earl Meyers, service manager at Erv's Radio & Appliance Store, Milwaukee. "They're easy to stock, easy to use, and you can be sure they won't let you down."

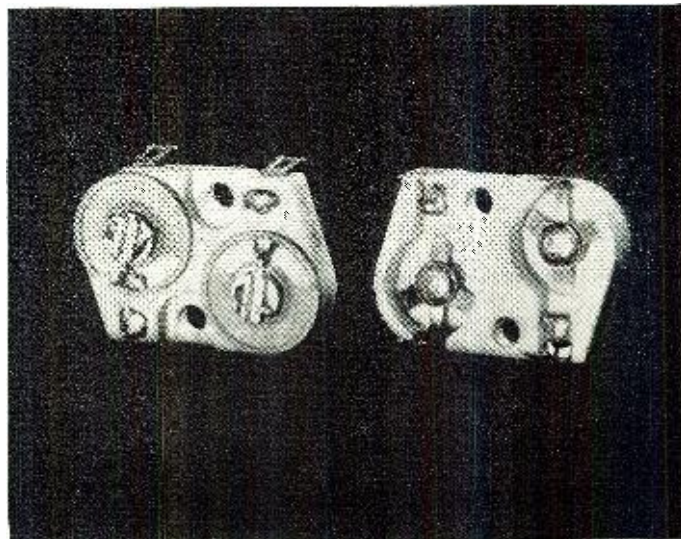
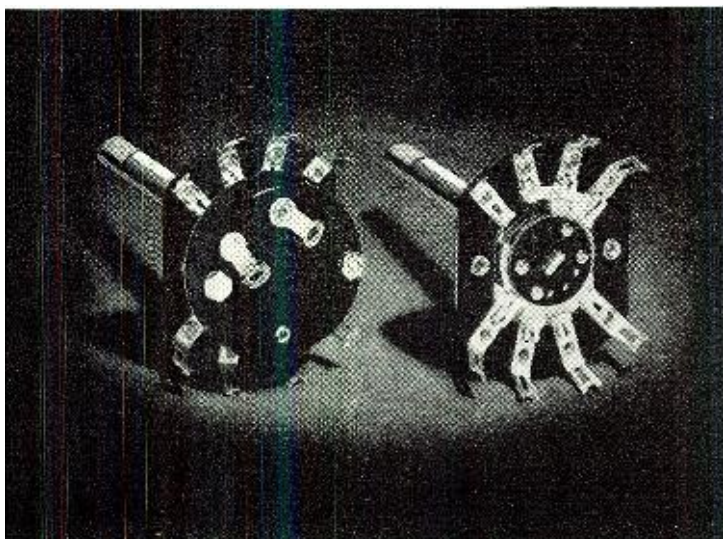

Switches: Centralab offers you a complete line of Tone, Rotary Selector, Lever Action and Medium Duty Power Switches, which features a wide variety in both laminated phenolic and steatite insulation. Available with shorting or non-shorting contacts. See your Centralab Distributor for further information, or write direct for Catalog 722.
July, 1948

Trimmers: CRL's Ceramic Trimmers are made in four basic types with full capacity change within 120° rotation. Working voltages, 500 DC. Flash test, 1100 volts DC. Type 820—3 ranges from 2.6 to 35 mmf. Type 822—7 ranges from 2 to 50 mmf. Type 823—8 ranges from 5 to 125 mmf. Type 824—5 ranges from 1½ to 35 mmf. Spring pressure maintains constant rotor balance.

No reason now to put off buying that new Test or Communication equipment you want and need. Never before in Walter Ashe history have allowances on used, factory-built instruments been so generous. So this is the time to trade and save yourself some real money. Simply tell us on the coupon what you have to trade. List your choice of new equipment. Slip the coupon in the mail (mounted on penny postal). Back will come our big, new "Surprise" offer. Don't delay. Send the coupon today!

All the big-name makes and models of brand new test and communication equipment . . . in stock, ready for delivery the day you write, wire or phone.

Order now for immediate shipment.

Walter Ashe Announces

"BIGGER-THAN-EVER

"SURPRISE"

TRADE-IN ALLOWANCES

ON YOUR USED TEST & COMMUNICATION EQUIPMENT



Also—Smash Values in Reconditioned, "Good-as-New" Test and Communication Equipment. Write for complete list.



No. 8056—8 HY x 500 MA. 55 ohm DC. Res. Shpg. Wt. 28 lbs.

Only... **\$11.85**

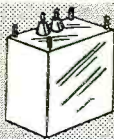

No. 8783—2.6 HY x 500 MA Swinging Choke. Shpg. Wt. 28 lbs.

Only... **\$11.85**



No. 6317—4 HY x 300 MA. 40 ohms DC RES. Shpg. Wt. 13 lbs.

Only... **\$4.95**

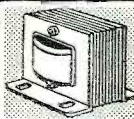

No. 4205-E—2.5 HY x 280 MA. 43 ohm DC Res. Shpg. Wt. 5 lbs.

Only... **\$1.49**

SPECIAL! FILTER CHOKE CLEARANCE

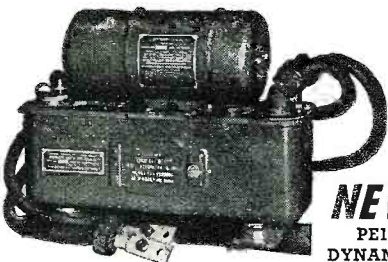

NEW!
PE103A
DYNAMOTOR

6 or 12 VDC input, 500 VDC at 160 MA output. In original overseas crating. Shpg. wt. 81 lbs.

ONLY \$995

No. 10062—10 HY x 250 MA. 110 ohms DC Res. Shpg. Wt. 13 lbs.

Only... **\$3.49**

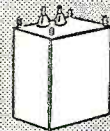

No. 0122—10 HY x 250 MA. 164 ohm DC Res. Shpg. Wt. 13 lbs.

Only... **\$3.95**



No. 2785—Dual 12 HY x 250 MA. 150 ohm DC Res. per section. Shpg. Wt. 17 lbs.

Only... **\$4.95**



No. 5269—4.5 HY x 150 MA. 79 ohms DC Res. Shpg. Wt. 6 lbs.

Two for... **79c ea.**
One only... **99c**

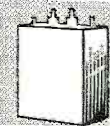

Use the Coupon to Prove That YOUR TRADE-IN'S WORTH MORE AT THE WALTER ASHE STORE RN-7

WALTER ASHE RADIO CO.
1125 Pine St., St. Louis 1, Missouri

Gentlemen:

Rush bigger-than-ever "surprise" trade-in allowance on my _____ for _____ (describe used equipment)

(show make, model of new equipment desired)

Send bargain list of reconditioned, good-as-new
 Test Instruments, Communication Equipment.
(check one or both)
 Mail my free copy of the new 1948 Walter Ashe catalog.

NAME.....

ADDRESS.....

CITY.....ZONE.....STATE.....

GET YOUR FREE COPY OF OUR LATEST CATALOG PHONE Chestnut 1125

ALL PRICES F. O. B. ST. LOUIS

TIME PAYMENTS AVAILABLE

Remember . . . Your trade-in's worth more at the Walter Ashe Store. Get Walter Ashe's offer before you make that trade!

WOWTM W9NRF WOCQI WOWJ
WOPGI WOQDF

Walter Ashe RADIO CO.
1125 PINE ST. • ST. LOUIS 1, MO.

RADIO NEWS

TUBES ARE KNOWN BY THE COMPANY THEY KEEP



McMurdo
SILVER

Farnsworth

Remler

TRIPLET



Rauland

hallicrafters

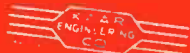

Harvey WELLS



BENDIX RADIO

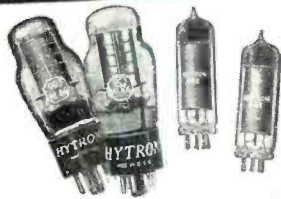

**"WHEN WE THINK OF V-R TUBES,
WE THINK OF HYTRON."**

When leaders automatically order their gaseous voltage-regulator tubes from Hytron, there must be a reason. Companies with top names can afford to select only top quality components. To have sold over 2,500,000, these Hytron OA2, OB2, OC3/VR105, and OD3/VR150 tubes must offer something special. They do! Better performance. Their advanced engineering—rigidly controlled processing and assembly—and tougher-than-JAN factory tests make these apparently simple tubes actually easy to make—better.

Yes, you are in good company if you instinctively associate V-R tubes with Hytron. Army, Navy, Air Force, AEC, famous university research laboratories—as well as industrial leaders—repeatedly order Hytron V-R tubes. Pick either the standard OC3/VR105 and OD3/VR150 or the space-saving OB2 and OA2; you, too, will prefer Hytron. That goes double, if you're "from Missouri." Find out for yourself why so many turn automatically to Hytron.



Motorola

DUMONT



COLLINS



The Fisher



SET-HELL CAPS IN INC.



General Communication Company



CONGRATULATIONS RADIO SERVICEMEN!

Hats off to you servicemen! Entries in your Hytron Contest are pouring in—and are they ingenious and practicable! You have really started something worth while to all. We are proud of you. Keep it up. Don't stop at one entry. Double-triple your chances to win. Watch for results of May contest.

Not received an entry blank yet? See your Hytron jobber, or write us. Briefly, six monthly contests—May through October—seek ideas for shop tools from bona fide radio servicemen. Many prizes still left. *Right now* you may have a winning idea at work in your shop. It's easy. Get an official entry blank today.

MANY PRIZES STILL AVAILABLE

First Prizes

- JUNE Radio City Products Model 665-A, the "Billionaire," V-T Volt-Ohm-Capacity Meter, Insulation Tester; and Model 705-A Signal Generator.
- JULY Hickok Model 156A Indicating Traceometer.
- AUG. McMurdo Silver Model 900A "Vomax" Electronic Volt-Ohm-Milliammeter; Model 904 Condenser/Resistor Tester; and Model 905A "Sparx" Dynamic Signal Tracer/Test Speaker.

- SEPT. Jackson Model 641 Universal Signal Generator.
- OCT. Weston Model 769 High Frequency Electronic Analyzer.

- Second Prize—Each Month \$50 U. S. Savings Bond
- Third Prize—Each Month \$25 U. S. Savings Bond

Grand Prize

\$200 U. S. Savings Bond—to contestant whose idea is judged to be best of the 6 winning monthly first prizes.

SPECIALISTS IN RADIO RECEIVING TUBES SINCE 1921



HYTRON
RADIO AND ELECTRONICS CORP.



MAIN OFFICE: SALEM, MASSACHUSETTS

Which Do You Want?



Better Pay



A Nice Home



A New Car



Greater Security



Happy Vacations and Travel

Jobs worth \$3000 to \$7500 are opening up right now for FCC Licensed Radiomen

How to Pass FCC Commercial Radio Operator LICENSE EXAMS



GET YOUR FCC TICKET IN A FEW SHORT WEEKS

Get your license easily and quickly and be ready for the \$3000 to \$7500 jobs that are open to ticket holders. CIRE training is the only planned course of coaching and training that leads directly to an FCC license.

IT'S EASY WITH CIRE COACHING AND TRAINING

Your FCC ticket is recognized in all radio fields as proof of your technical ability. Employers often give preference to license holders, even though a license is not required for the job. Hold an FCC "ticket" and the job is yours!

Look what these students say:

"Thanks to this course, I now have a very good job in a local power plant's test department. I couldn't have obtained this job without the math and basic electrical theories in the first part of Section I of this course." Stud. No. 2893N12

"I have been working for Police Radio Station WPFS in Asheville for five months since getting my second-class ticket." Stud. No. 2858N12

"You may be interested to know that I am employed at the local broadcast station, where I am a transmitter operator. I took and passed the FCC examinations last February." Stud. No. 2754N12

CLEVELAND INSTITUTE OF RADIO ELECTRONICS
RN-7 Terminal Tower Cleveland, 13, Ohio

Approved for Training under "G. I. Bill of Rights"



Get All 3 FREE Send Coupon Now!

I can train you to pass your FCC License Exams in a few short weeks if you've had any practical radio experience — amateur, Army, Navy, radio servicing or other. My time-proven training plan can help put you, too, on the road to success.

Let me send you FREE the entire story

Just fill out the coupon and mail it. I will send you, free of charge, a copy of "How to Pass FCC License Exams," plus a sample FCC-type Exam and Catalog A, describing opportunities for you in Radio-Electronics.

CLEVELAND INSTITUTE OF RADIO ELECTRONICS

RN-7 Terminal Tower, Cleveland 13, Ohio

I want to know how I can get my FCC ticket in a few short weeks. Send me your FREE booklet "How to Pass FCC License Examinations" (does not cover exams for Amateur License) as well as a sample FCC-type exam and Catalog A, describing opportunities in Radio-Electronics.

NAME.....

ADDRESS.....

CITY.....ZONE.....STATE.....

Veterans check for enrollment information under G.I. Bill.

NO OBLIGATION — NO SALESMEN.

RADIO NEWS

MARINE RADIO INSTALLATION

By MAX ALTH

Here is a fertile field for the radio serviceman who has a service shop near a lake or river summer resort area.



THERE will be more pleasure boats afloat this summer than ever before in the history of the sport. There will be a greater number and variety of electronic devices used aboard these ships than ever before, and the radio repairman who lives near a body of water, and complains of summer slack, has no one but himself to blame.

The installation and repair of marine radio equipment varies little in essentials from the installation and repair of ground based, or even airborne equipment. In particulars, of course, the practices do vary, the greatest difference being, perhaps, the emphasis placed on safety in marine work, as compared to home radio work.

Boats and their equipment roll, pitch, and yaw, while the home receiver is usually rather permanently situated. Marine installations have to be physically rugged.

When the console howls, and gives up the ghost, you can always walk in on Junior and force him to give up his "Mickey Mouse" radio. When a marine receiver, or direction finder, conks out, you're out of luck. You may be in thick fog; in the path of an oncoming storm; or you may be trying to navigate by broadcast time ticks.

When a home receiver starts to burn because of an internal short, you can always call in the local fire laddies. When a marine set starts to burn, you either put the fire out yourself, or your family is busy the next day strewing the waves with lilies in a funeral ceremony.

Backing up the need for marine

safety are the insurance companies who send their men around every once in awhile to examine every boat they insure, and right after reported accidents. They will tell whether or not they consider your installation safe, and if not, how to correct the job. If you don't follow their instructions, you find the premium rates have been boosted.

Front view of the twenty-five watt RCA Radiomarine radio-telephone unit.

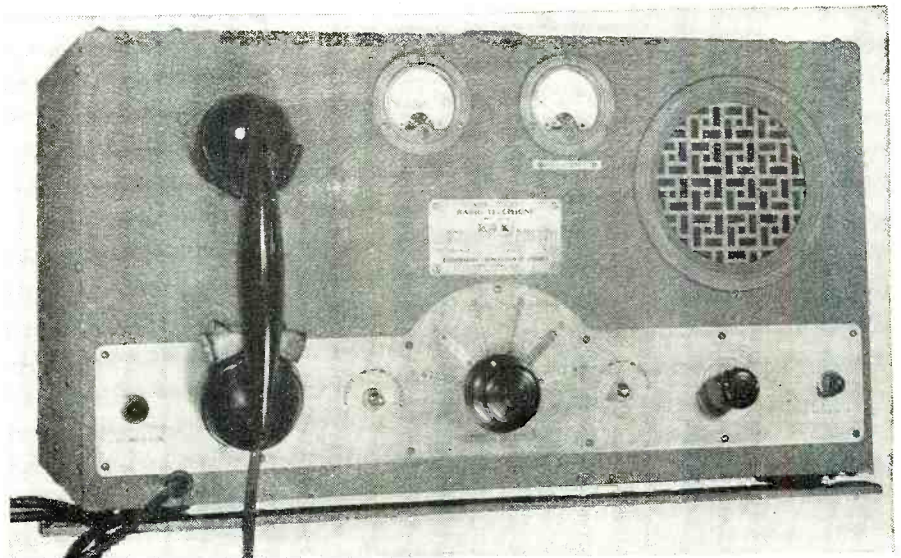



Another view of the RCA Radiomarine radiotelephone shown on page 35.

third class license. The new ruling on this class eliminates the need for taking an examination. The would-be licensee secures his license through the mail by declaring his knowledge of marine radio operating laws.

A non-license holder may use the radiophone by having the license holder make the contact.

The radio station is licensed by means of a simple application which only requires filling out a form.

Forms may be secured by writing to the Federal Communications Commission, Washington 25, D.C.

The problems you will encounter when installing radio equipment aboard a boat will depend upon two basic factors.

1. The means by which the boat is powered, i.e., muscle power, and wind, diesel, steam, and gasoline.

2. And the means by which your equipment is powered, internal or external.

Assuming that your customer owns a rowboat, or a small sailboat with no electrical equipment aboard, your problems are all solved. You can bring an ordinary portable radio aboard, and get fairly good results.

However, the regular, land grown re-

If your job happens to be on a commercial boat, one which carries passengers for hire, or can be hired, your work will also be inspected by the Federal Maritime Commission.

The U. S. Department of Commerce puts out a booklet on "Safety Rules for Radio Installations," the gist of which is

simply common sense. Ten cents.

No license is required to install and service marine radio equipment. However, a second class commercial radiotelephone operator's license is required to tune up the transmitter on the air. A ham license does not apply. The transmitter's operator must have a

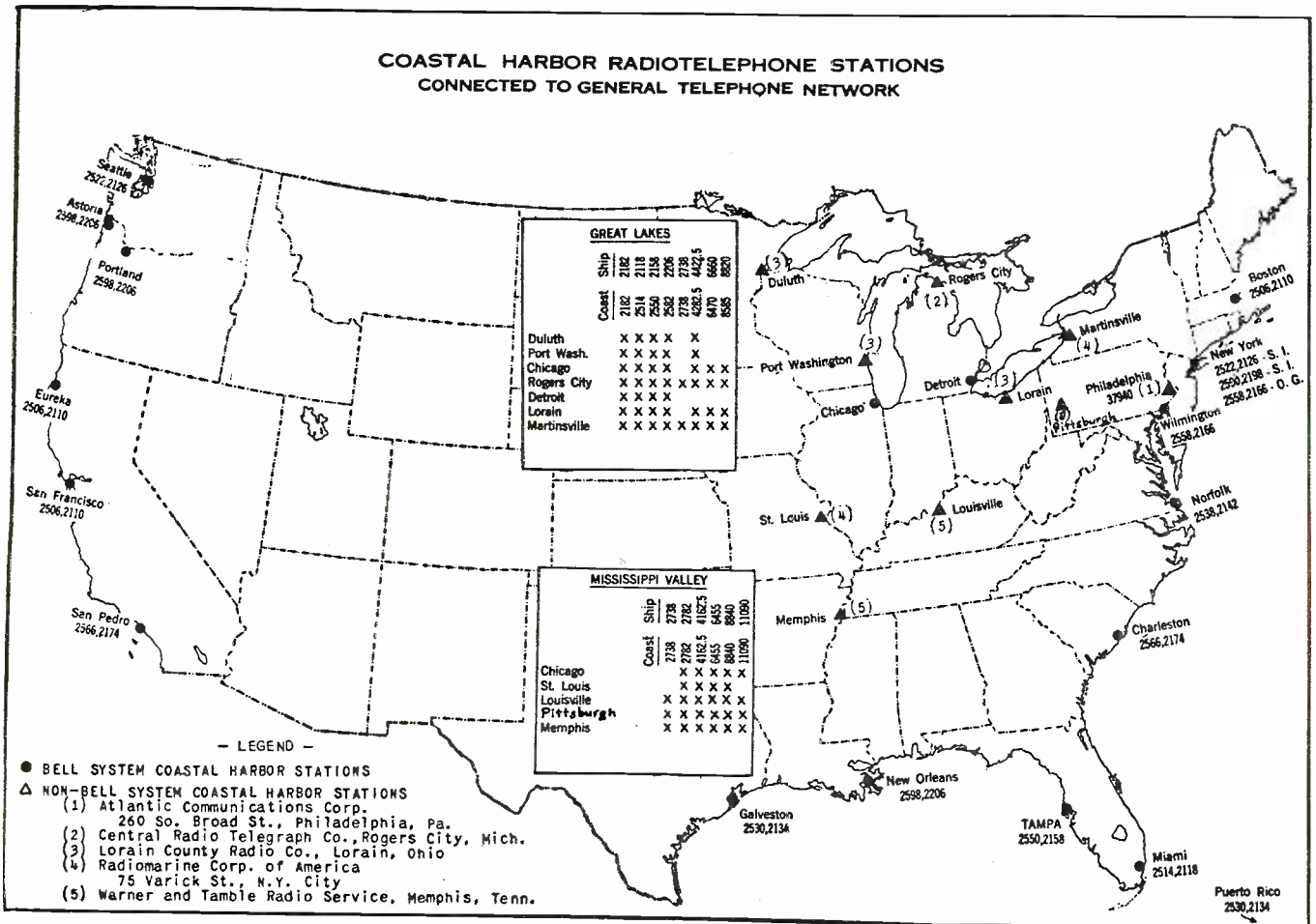

ceiver has several inherent drawbacks. Unless the set has been "tropicalized", it isn't going to last very long when exposed to salt air. Portable sets, because of their loop antennas, are highly directional, which means the set will have to be re-positioned every time the boat turns. Also, the loop is not the best type of antenna for the reception of vertically polarized radio signals that are broadcast by seaside, and sea-going transmitters. In addition, the smaller portables do not have very large battery compartments, which means the bother of carrying spare batteries.

Most important, the "landlubber" portable does not have a marine band, 16,000, to 46,000 kc., on which band you can receive time ticks, weather reports, Coast Guard warnings, etc.

While it is too much work to install a marine band in a regular receiver, you can "tropicalize" the set by dipping all the coils in hot sealing compound, replacing all the paper condensers with metal bathtub or bakelite units. The metal chassis and the solder joints will have to be painted with a coat of protective lacquer.

The directivity and low response of the loop can be cured by coupling an external antenna to it.

The battery compartment can be enlarged, or a battery pack can be kept aboard ship, and the set connected to this pack by means of plugs, when it is brought aboard.

The simplest arrangement is to purchase a marine portable which has all of these features, in addition to covering the marine band.

For those who desire a receiver that can be fastened to the boat so that it won't "walk around" during a heavy sea, there are commercially manufactured self-powered jobs that can be bolted to a bulkhead.

So far we have been concerned with the self, or internally powered, receiver installed in a boat without electrical power.

Connecting your equipment to a diesel or steam-driven electric power system, as differentiated from a gasoline-powered job, brings up the following problem—storage battery capacity versus the additional current drain of the radio receiver.

A marine radio is not used in the same fashion as a car radio. Few people ever sit in their cars for two days and listen to their radio. People on boats do it all the time. A car owner rarely uses his radio when his car is not in motion. A boat owner will often cruise for a few hours, drop anchor and remain in one spot for the weekend, using the radio for many hours when the generator is motionless.

This adds up to a considerable drain on the battery.

This means that the storage battery capacity must be considered before additional equipment is hooked to the circuit. A boat has winches, pumps, running and anchorage lights. In some cases there may be ample reserve capacity, while in other cases, the limit may have already been reached. Remember, if you play it too close, and the engine happens to be sulky that morning—it's a *tiny* marine engine that can be turned over by hand—if the battery is weak, and the engine doesn't start, your boat owner may have to pay several hundred dollars in towing charges, in addition to being inconvenienced.

The solution is not the simple addition of storage capacity. Weight is an important consideration in a small boat. A boat can only carry a limited load with safety and, the deeper she sits, the more power is needed to move her.

You may have to disconnect other equipment in order to connect your radio, or you may have to leave something or someone ashore.

The connection of the radio equipment to the boat's powerline will possibly introduce line noise produced by the generator, and other equipment on the same line.

Electrical interference aboard ship is no different than electrical interference anywhere else. The process of locating, and eliminating this interference is exactly the same as that used with non-marine equipment. Simply turn on each piece of equipment in rotation, first disconnecting the antenna from the receiver to make certain the noise is not being picked up by the antenna.

When you have located the offending unit, check it to see whether it is

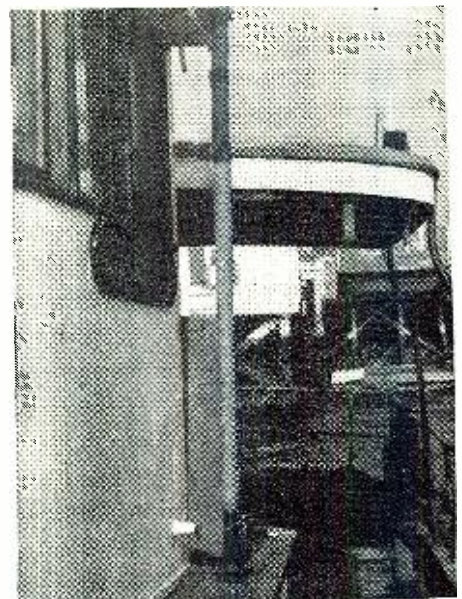

Bamboo pole used as a spiral antenna. Tape wrapping is not recommended.

working properly, and that the trouble is not due to a worn brush, or loose connection. Then suppress, if necessary, by using a condenser across the line, and/or a line choke.

A word about the wire used. Large boats, ships, use a special marine cable consisting of a layer of lead covered by a layer of tape, covered by a wire mesh. Connections are made in cast iron, or brass boxes, through water tight fittings, and covered with water tight covers.

The smaller boats use a lighter weight metal braid, and cambric loom over the wires. This type of installation is not absolutely required and, generally

(Continued on page 142)

Side view of a package shielding installation. All metal shielding is bonded; even the bypass condenser on generator housing is metal enclosed.

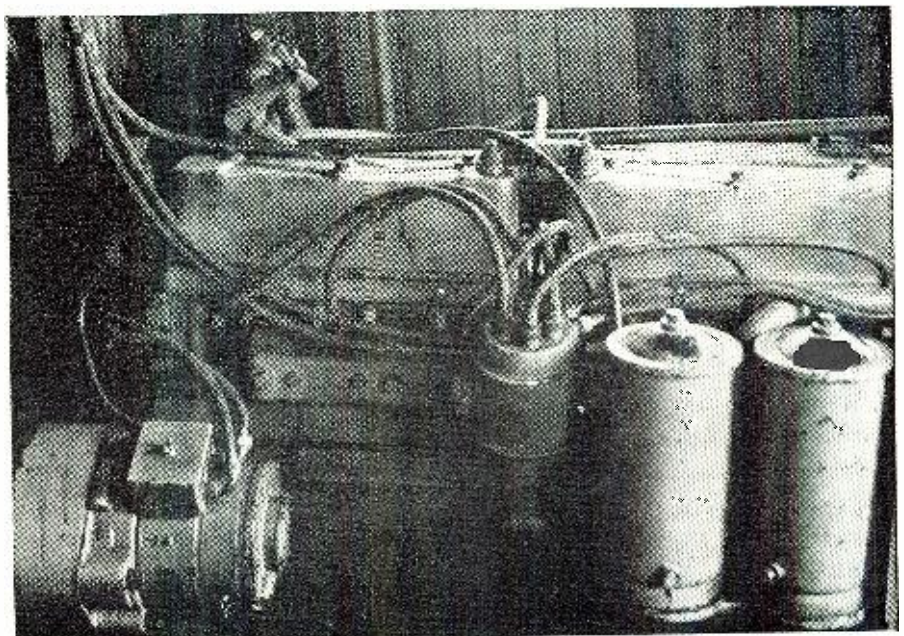

New Trends in RECEIVER DESIGN

By **W. WILLIAM HENSLER**

Staff Eng., Howard W. Sams & Co., Inc.

Part 2. The design of various FM tuning and input systems used in present-day receivers.

THE TYPES of FM tuning and input systems to be discussed in this article are the permeability tuned, the tuned transmission line, and the parallel tuned lines. Although the permeability tuned system is conventional, the new manufacturing techniques employed for making the coils are of special interest. The use of tuned transmission lines and parallel tuned lines is also unusual since it departs from the conventional tuning systems widely used in broadcast receivers.

Permeability Tuned

Small, low-loss coils for use in the FM band have been made possible by the recent developments in high-permeability powdered iron cores. Techniques in printed circuits developed during the war have also been employed for the manufacture of high Q coils. We have recently processed receivers having the FM coils printed on glass tubes. The glass tubes make good forms

for the insertion of the powdered iron cores. The tube, being very smooth, offers little resistance and friction to the movement of the core. This makes possible smooth tuning that is free from binding and backlash.

The maximum inductance which can be produced with the printed circuit is limited only by the surface available. If only a small area is available, the circuit may be printed in layers to obtain the desired inductance. This is accomplished by painting an insulating layer between each of the printed coils. These may then be connected in series to assist in securing the desired inductance. This method is restricted due to the high distributed capacitance of the coil. Also the multiple layer coil causes an increase in flux in the coil form material, a dielectric, with a resulting decrease in Q . At the FM band frequencies a single layer coil will provide enough inductance, usually about five turns are required.

Several methods have been developed for making these coils. One is to paint the surface through a stencil with silver paint and then plate with silver or copper. The thickness of silver plating is dependent on the desired Q of the coil. Another method is to fire the metal directly on the base material using a suitable flux. This method is especially effective when firing silver on ceramics.

A view of a receiver using glass coil forms with printed coils is shown in Fig. 1. The receiver is the *Truetone* Model D1752. The antenna and r.f. coils are of this type while the oscillator is wound with silver plated wire. Connections are made to the printed coils with flat straps of copper to keep the lead inductance at a minimum. These straps are soldered directly to the printed coil. The trimmers are mounted close to their respective coils as are the tubes. A shield is placed between the antenna and r.f. stages to prevent feedback. The coil at the left of the oscillator coil is the oscillator shunt coil. It has an adjustable slug for tracking purposes.

The permeability tuner does not vary greatly from the condenser tuned type except in the method of tuning. The oscillator is usually of the Colpitts type instead of the more frequently used Hartley type in other tuners. This is

Fig 1. View of Truetone Model D1752 receiver which uses printed coils on glass forms for antenna and r.f. coils.

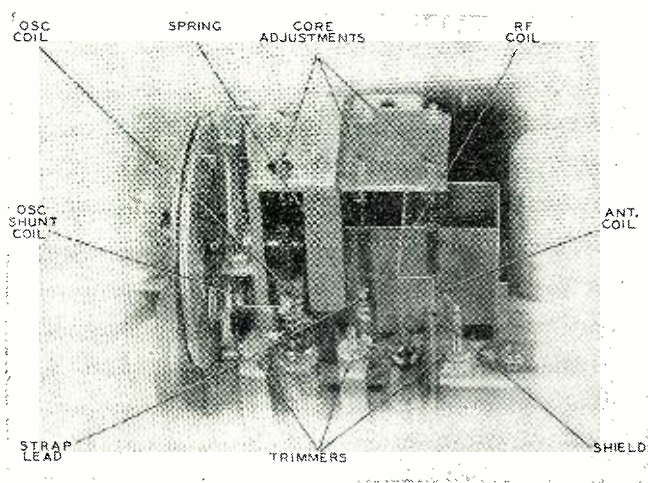
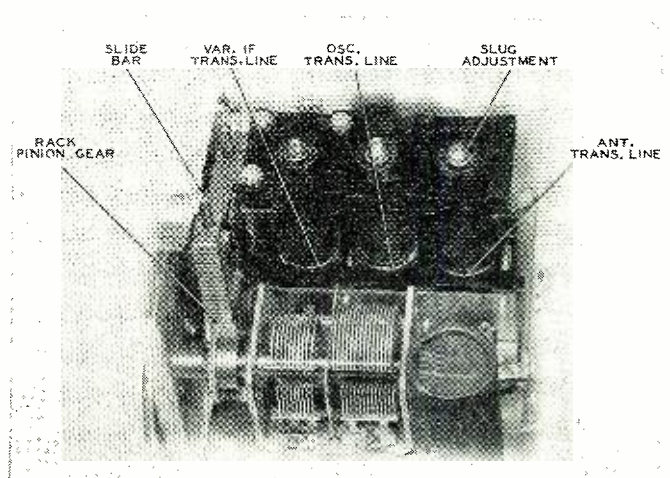

Fig. 2. This Motorola FM tuner uses short-circuited coaxial transmission line sections as the tuning elements.



due to the fact that a tap is not required on the oscillator coil.

Tuning is usually accomplished by the use of a platform which can be raised and lowered, as is the case in this receiver. A spring is connected to the platform to lower it and to provide the correct tension. The tension keeps slack out of the line and reduces backlash. A form of windlass is used to raise the platform.

Tuned Transmission Line

This type tuning system has been employed in all *Motorola* FM receivers we have processed to date. It is a double superheterodyne with a single oscillator. It was designed to be used with a 4.3 mc. i.f. amplifier and with good oscillator stability to permit push-button tuning.

The 4.3 mc. i.f. frequency was chosen so that more gain could be realized than that obtained in the 10.7 mc. i.f. amplifier, which is more frequently used. The ratio of stable gain obtainable is equal to the ratio of the square roots of these frequencies, in this case, approximately 1.57. Although the use of the lower frequency makes possible an increase of about 50% in gain it does present an image rejection problem. Two tuned circuits, in addition to the oscillator, are used. According to figures released from *Motorola* it was found that the image rejection should be around 60 db. for satisfactory operation. The Q per circuit, using a 10.7 mc. i.f. amplifier, should be approximately 75 for proper image attenuation. Using a 4.3 mc. i.f. amplifier the Q per circuit needs be approximately 200 for proper attenuation. Thus it can be seen that extremely high Q tuning elements are required. This is further evidenced by the fact that the input resistance of the tube and the antenna loading further reduces the Q of the circuit.

Tubes available for r.f. amplifiers have a fairly low input resistance. By

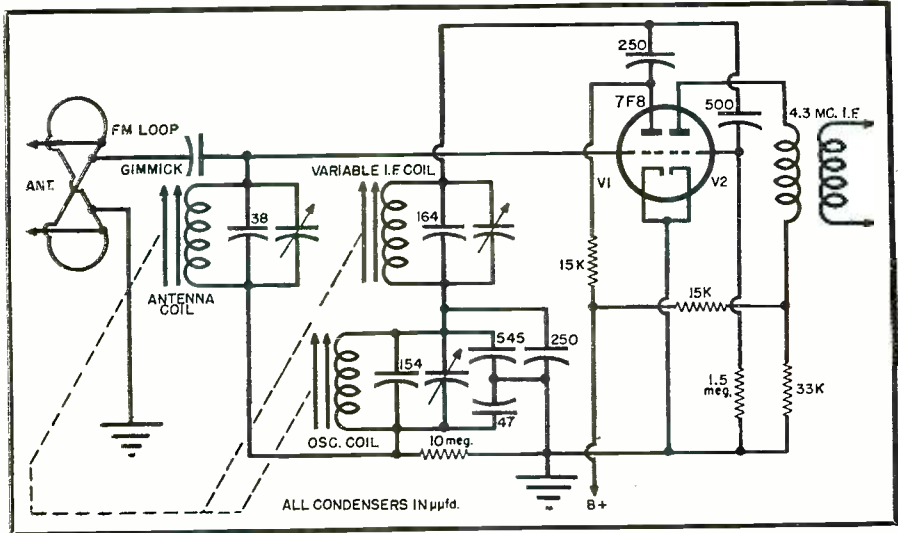

Fig. 3. Schematic diagram of the Motorola FM tuner unit.

using converters this input resistance may be as high as 7000 to 12,000 ohms, thus the reason for the double-super design.

Short-circuited coaxial transmission lines were selected to give the desired high Q tuning elements. According to Terman* the maximum antiresonant impedance of a coaxial line calls for an outer-to-inner diameter ratio of 9.2 to 1. According to information available from *Motorola* a 10 to 1 ratio is used in these elements. The desired inductance is obtained by selecting the proper length line. The formula for determining the length of line having a 10 to 1 ratio is:

$$A = L/0.0117$$

A is the length of line in inches and L is the inductance in microhenrys. Using this formula it is found that the length of line required to give an inductance of 0.031 microhenrys, which resonates

with 60 mmfd. at 115 mc., is 2.65 inches. Permeability tuning was selected for tuning this low inductance. Gang condenser tuning, with its series inductance in leads and chassis impedance paths would eliminate the benefit of the high Q elements. The tuned transmission line unit can be made as a mechanical assembly having very close tolerances. It has been found that the change of inductance caused by slight variation of inner and outer diameters of materials with commercial tolerances is negligible.

In order that the tuned circuit may be complete in one unit, a special concentric condenser which would be made as a part of the unit was developed for use in the Colpitts oscillator circuit. The condenser is of silver on mica construction. With both the inductance and capacitance of the tuned circuit constructed in one unit there are no connecting leads or chassis paths in series with the tuned circuit. Thus, chassis pickup and undesired antenna effects

(Continued on page 165)

Fig. 4. A Motorola FM tuner, showing coaxial line elements. Specially constructed concentric condensers are employed.

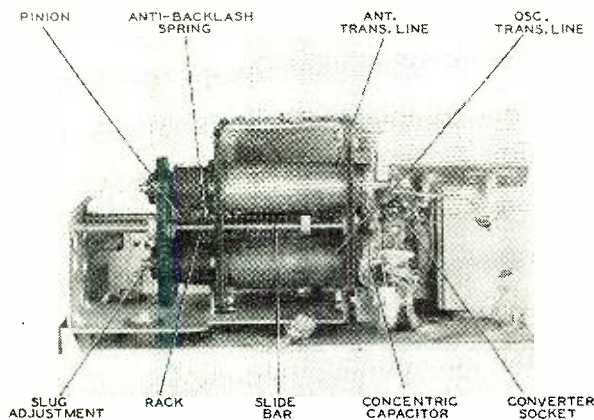
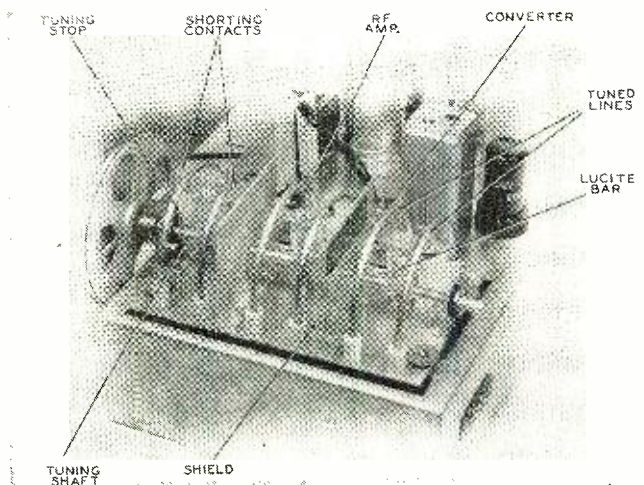

Fig. 5. Parallel tuned line type of FM tuner. Actual tuning is accomplished by moving a shorting bar assembly.



A simple, foolproof instrument which is of value to hams, servicemen, and experimenters.

**By RUFUS P. TURNER
WT4Y**

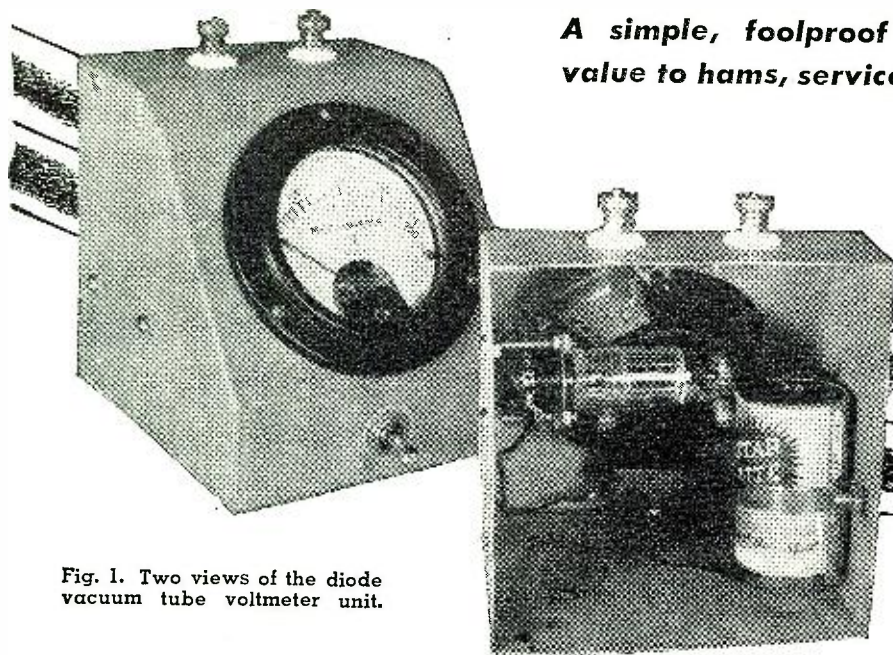

Fig. 1. Two views of the diode vacuum tube voltmeter unit.

A Compact Linear Diode V.T.V.M.

IN a few certain tests in both experimental and maintenance categories, the conventional vacuum-tube voltmeter is not entirely satisfactory for a number of reasons, and simpler crystal diode voltmeters are unsuitable for the chief reason that the latter are unable to handle high forward voltages. As an illustration, a number of measurements require an a. c. vacuum-tube voltmeter which is isolated from the power line and in which both of the signal input terminals are above ground. In transmitter work, such measurements include the checking of r. f. voltage across ungrounded coaxial, twisted pair, or open-type transmission lines, measuring r. f. voltage in antenna sections, and checking r. f. excitation or output in exciter or amplifier stages. In audio amplifier and modulator work, such voltage checks include all measurements of a. f. voltage between points which are above ground. A voltmeter which is satisfactory for these purposes must, in addition to being self-powered, be small-sized, light in weight, and simple to operate. Furthermore, it must have a wide frequency response.

The instrument to be described in this article was designed to satisfy the above requirements. Entirely electronic in operation, this meter is built in a standard "3-inch" sloping-front meter box. It is powered entirely by a single

1½-volt flashlight cell. No zero adjustment is required, the scale is linear, frequency range of the instrument is wide (the range extends from power-line frequencies into the u. h. f. spectrum), reasonably high input impedance is afforded, and the circuit is extremely simple. Servicemen, radio operators, and experimenters will find this v. t. v. m. useful in many phases of their work. In addition to serving the specific functions listed in the first paragraph, this instrument may be employed also as a general purpose a. c. voltmeter having a wide frequency range not afforded by oxide rectifier meters.

Circuit

The instrument employs the well-known shunt diode circuit. This circuit has the advantages of complete isola-

Fig. 2. Complete circuit of the v.t.v.m.

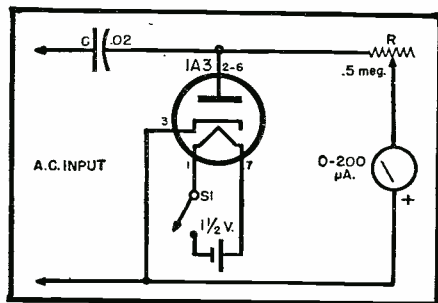

tion from any d. c. voltage in the circuit under test, ability to check voltages in circuits which provide no d. c. return for the diode tube, and linear meter response. The complete circuit schematic is given in Fig. 2.

The tube used is a Type 1A3 high-frequency diode, which has a resonant frequency of approximately 1000 megacycles. This tube is especially interesting for this application, since it is a cathode-type dry cell tube.

The coupling condenser, C, serves also to block d. c. voltages which otherwise might damage the meter or tube. R is the calibration control rheostat which is adjusted during the initial calibration and need not be touched afterward, except to compensate for an aging tube or for tube replacement. Heater power is derived from the 1½-volt flashlight cell, in series with which is connected the "On-Off" toggle switch, S1. The indicating meter is a 0-200 d. c. microammeter.

Polarity of the filament-heating cell is unimportant, since the heater element of the tube is not included in the instrument circuit proper. Meter polarity is consequential, however, upward deflection being obtained only if the positive terminal of the meter is connected to the tube cathode, as shown in Fig. 2.

Input impedance of the voltmeter is approximately one-half the value corresponding to 0.02 microfarad and approximately 500,000 ohms in series, at the operating frequency.

If voltage measurements are to be made exclusively at very low frequencies, that is at less than 100 cycles, somewhat better accuracy will be secured by raising the capacitance of coupling condenser C to 1 or 2 microfarads. Likewise, when the instrument is intended for use exclusively at high frequencies (10 mc. and higher), capacitance C should be reduced permanently to 100 mmfd. The capacitance 0.02 mfd., given in Fig. 2, is a good com-

(Continued on page 156)

Make a Test Unit for Your Service Kit

By H. LEEPER

THE usefulness of your service kit, when making service calls in the home, may be greatly increased by the installation of the test unit illustrated in Fig. 1.

Such a unit, which fits in the top tray of the service kit or case, contains a three-inch permanent magnet speaker, a tapped 25 watt resistor, six test condensers, and a triplex outlet for plugging in a soldering iron, tube tester, and like equipment.

The paralleling of suspected condensers, or certain resistors, is much safer and more simple with such a unit. The test condensers and tapped resistor may be varied in value to suit the operator, from the values shown in Fig. 2.

A test speaker is available and the draping of extension cords over the customer's room is eliminated, to a considerable degree, with the unit shown.

The equipment is mounted on a wood panel, measuring $12\frac{1}{2} \times 6\frac{1}{2}$ inches, which is fitted with feet or bottom strips to keep the top of the panel about flush with the top edge of the kit tray.

The wood panel was given two coats of clear varnish before the test equipment was mounted.

Fig. 1 shows the construction of the unit with the triplex outlet mounted on the side of one of the bottom strips and with the control switch nearby.

A rear view of the wood panel with all parts in place is seen in Fig. 4. Clamps such as used for electric cables were used to hold the condensers in place. Also shown is the PM speaker and the .01 mfd. condenser permanently con-

(Continued on page 173)

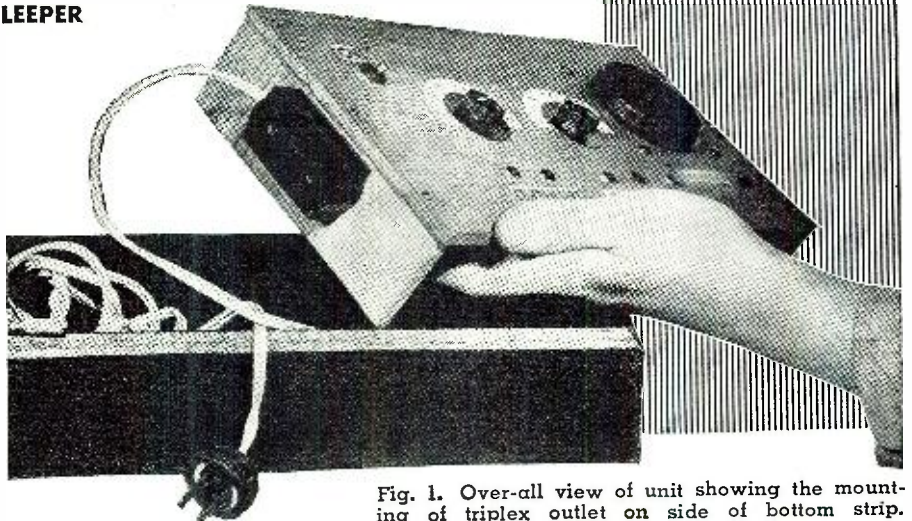

Fig. 1. Over-all view of unit showing the mounting of triplex outlet on side of bottom strip.

This simple test unit permits easy substitution of a speaker, bleeder resistor, or condenser in radio receivers or other equipment under test.

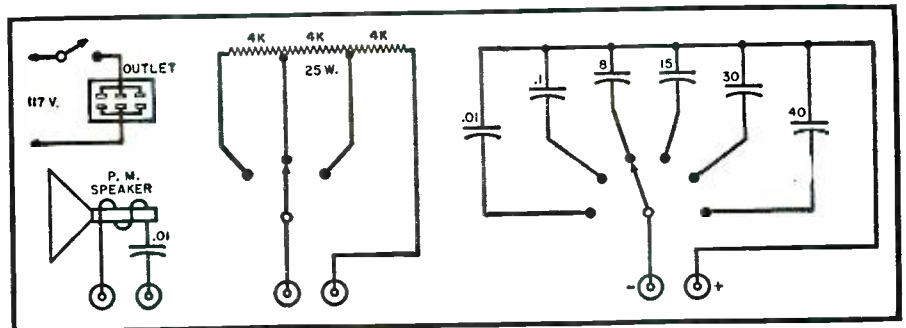

Fig. 2. Wiring diagram of the tester. Condenser values are in microfarads. The four higher values are electrolytics with a rating of 450 w.v., while the two lower values are paper condensers with a rating of at least 600 volts d.c.

Fig. 3. Top view of unit showing how the wood panel may be left in the tray during operation if so desired.

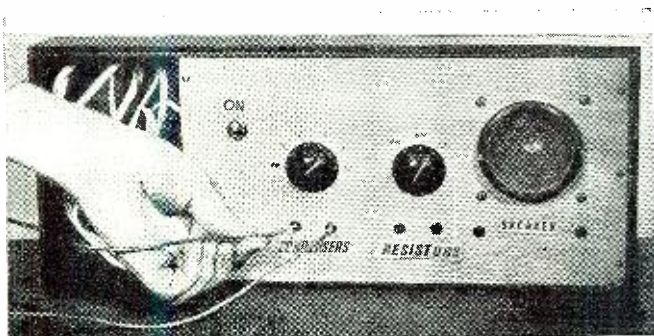
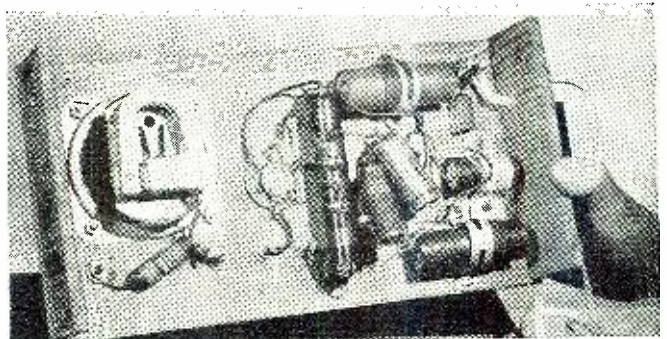

Fig. 4. Rear view of the wood panel showing all parts in place. The speaker coupling condenser is at lower left.



A COMPACT MEDIUM POWER C.W. TRANSMITTER

By
CHARLES S. MAYEDA,
WOGMR

Controls, left to right are: high voltage switch, S_1 ; crystal switch, S_2 ; buffer tuning, C_{11} ; band switch, S_3 ; meter switch, S_4 ; antenna tuning, C_{10} ; and low voltage switch, S_5 . Final tank tuning, C_8 is above the antenna tuning dial.

**C.W. operation on 80,
40, and 20 meters at
200 w. output is easy
with this compact rig.**

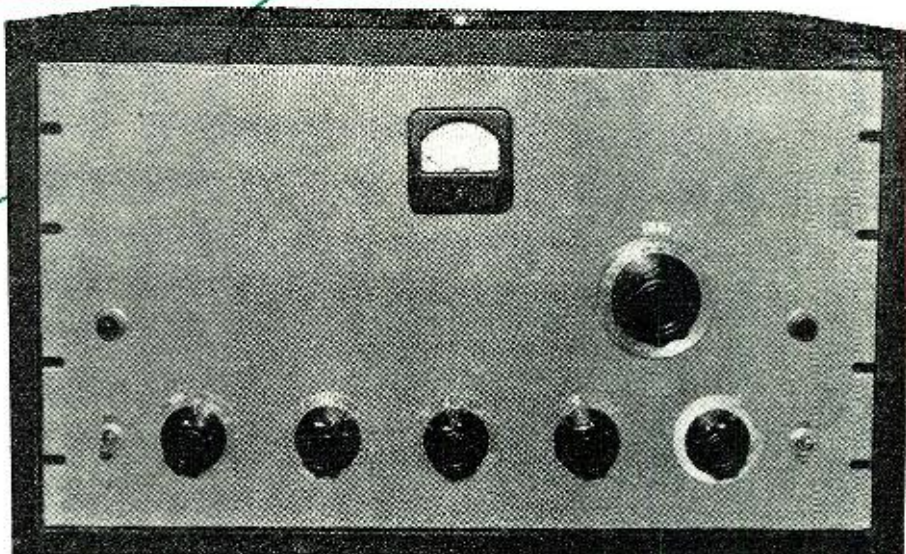

THE transmitter described in this article, while not of the "super deluxe" variety, was designed primarily for c.w. operation, with simplicity of adjustment and compactness of construction heading the list of its desirable design features.

The completely self-contained transmitter, with its minimum of "extras," features moderate power with simple band changing, best keying characteristic for c.w. break-in work, and the antenna coupling unit housed in the transmitter cabinet.

Circuit Details

A Pierce type of crystal oscillator was chosen because of its better keying characteristics and because it does not require a tuned circuit. By keeping the plate and screen voltages low, the crystal current can thus be kept to a low value. While this operating technique serves to limit the output, it is still sufficient to drive a beam power buffer or doubler.

Because only moderate power was required for this rig, a war surplus 813 tube was chosen for the final. The drive requirements for this tube are very modest and its low price is an attractive inducement. Because of the low grid

drive required, a receiving-type beam tube will function satisfactorily as a buffer or doubler. However, since the 807 tube was readily available at low cost it was incorporated in the design of this rig. The 807 has the further advantage of being able to withstand more abuse than the 6L6 or 6V6.

The buffer-doubler is fed with 400 volts from the low voltage supply which also furnishes the 300 or less volts needed for the screen. Bias is obtained by means of a 500 ohm cathode resistor. This allows from 40 to 50 milliamperes plate current to flow under no-drive conditions, thus stabilizing the low voltage while serving still another purpose which will be described later. The static current flow is such that little change will be noticed either with or without grid drive. Plate current with no drive is well under the plate dissipation rating of the 807 as is the case when detuning off-resonance with grid drive. The huskier beam tube was chosen in preference to the receiving type tubes as detuning off-resonance was desired to allow for small adjustments of the grid drive to the 813. The 807's are more rugged and can stand this type of abuse.

The 6V6-807 combination, while offering about the same drive as a 6L6

tri-tet oscillator, requires one less tuned circuit. In addition, the combination provides the better keying characteristics of the Pierce circuit. Disadvantages of the combination include insufficient output when quadrupling in the 807 stage because of the limited crystal output. Operation on 20 meters takes a 40 meter crystal. While 20 meter operation can be obtained with 80 meter crystals, the oscillator must be operated at a high plate and screen voltage which results in an increase in crystal current. Since crystals may be obtained quite inexpensively it was decided to limit the 807 to doubling. A second disadvantage is that operation on 10 meters is not possible as this would require a 20 meter fundamental crystal. The usual 20 meter harmonic cut crystals will not operate properly in a Pierce circuit. This latter disadvantage was not considered too important as 10 meter c.w. held no particular interest for me.

To limit the need for changing coils, bandswitching is provided in the buffer plate circuit. Because only small coils are required, shielding is no problem. The plate circuit is shunt fed thus simplifying the mounting of the tuning condenser and coils. The bandswitch in-

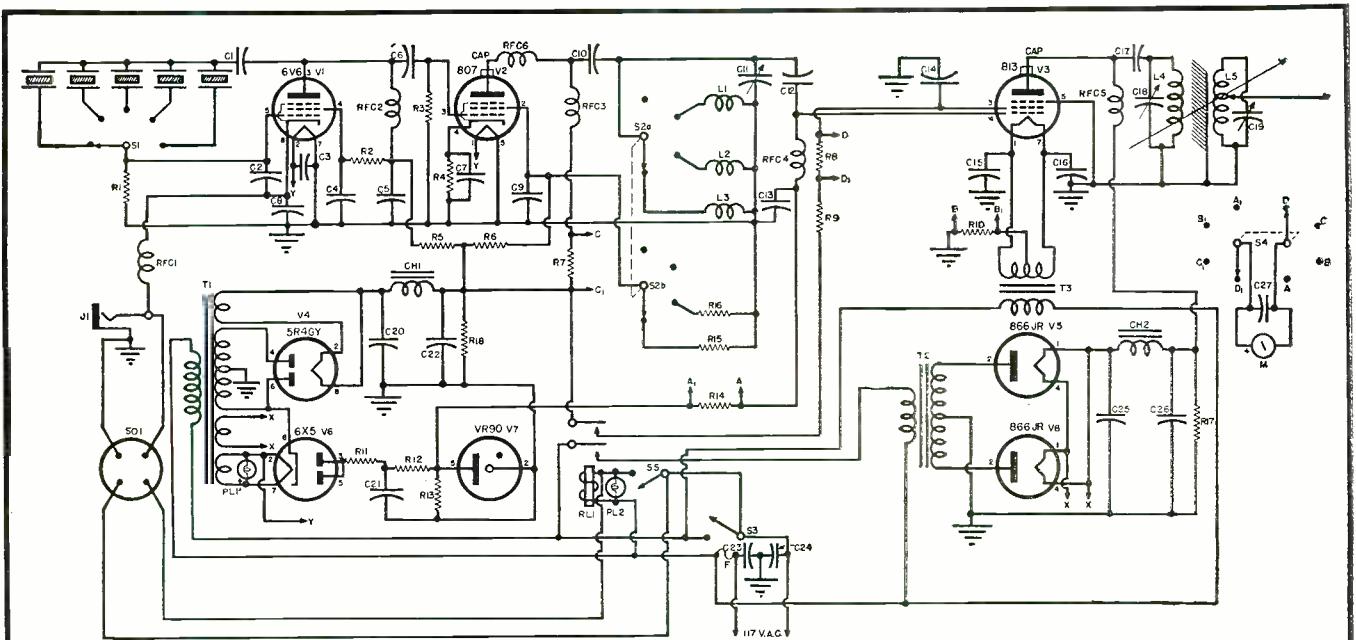

- R1—50,000 ohm, 1/2 w. res.
- R2—100,000 ohm, 1 w. res.
- R3—50,000 ohm, 1 w. res.
- R4—500 ohm, 10 w. res.
- R5—25,000 ohm, 10 w. res.
- R6—50,000 ohm, 10 w. res.
- R7, R8, R9, R10, R14—See text
- R9—3500 ohm, 10 w. res.
- R11—25,000 ohm, 10 w. res.
- R12—20,000 ohm, 2 w. res.
- R13—100,000 ohm, 1/2 w. res.
- R15, R14—15,000 to 25,000 ohm 10 w. res. (See text)
- R17—60,000 ohm (total), 100 w. res.
- R18—50,000 ohm, 25 w. res.
- C1—.002 mfd. mica cond.
- C2—.00005 mfd. mica cond.
- C3, C4, C5, C7, C9, C13—.01 mfd. 600 v. cond.
- C6, C12—.0001 mfd. mica cond.
- C8—.004 mfd. mica cond.
- C10—.002 mfd. mica cond.
- C11—150 mmfd. midget var. cond.

- C14, C15, C16, C23, C24—.01 mfd. mica cond.
- C17—.0015 mfd., 2500 v. mica cond.
- C18, C19—100 mmfd. var. cond. (.09 spacing)
- C20—4 mfd., 600 v. cond.
- C21—16 mfd., 450 v. cond.
- C22—10 mfd., 600 v. cond.
- C25, C26—2 mfd., 2000 v. cond.
- C27—.001 mfd. mica cond.
- RFC1, RFC2, RFC3, RFC4—2.5 millihenry, 125 milliampere r.f. choke
- RFC5—1 millihenry, 600 milliampere r.f. choke
- RFC6—10 t. #16 wire, 3/8 inch diam.
- CH1—10 henry, 150 milliampere choke
- CH2—10 henry, 250 milliampere choke
- S1—S.p. 6-pos. sw.
- S2—2-gang, s.p. 4-pos. sw.
- S3—S.p.s.t. toggle sw. (6 amperes at 250 v.)
- S4—D.p. 4-pos. sw.
- S5—S.p.s.t. toggle sw. (3 amperes at 250 v.; 2 amperes; 6.3 v. at 5 amperes; 2.5 v. at 5 amperes.)
- T1—800 v. c.t. at 150 milliamperes; 5 v. at 2 amperes; 6.3 v. at 5 amperes; 2.5 v. at 5 amperes.

- T2—2400 v. c.t. at 350 milliamperes
- T3—10 v. at 5 amperes
- J1—Open circuit phone jack (for key)
- M—1 to 10 milliampere d.c. meter
- PL1—6.3 v. pilot lamp (green)
- PL2—6 watt, 110 v. pilot lamp (red)
- SO1—Socket for remote operation
- F—10 ampere, 110 v. fuse
- RL1—D.p.s.t., 5 ampere, 110 v. a.c. coil
- L1—80 meter—35 t. #22 en., closewound on 1 inch diam. form, 1 1/2 inch long
- L2—40 meter—22 t. #22 en., spaced total 1 inch, wound on 1 inch diam. form, 1 1/2 inch long.
- L3—20 meter—12 t. #22 en., spaced total 1 inch, wound on 1 inch diam. form, 1 1/2 inch long.
- L4, L5—80 meter—25 t. #12 en., 2 1/2 inch diam. (approx. 4 inch section of ready-wound coil—see text)
- 40 meter—13 t. #12 en., 2 1/2 inch diam. (approx. 2 1/2 sections of ready wound coil—see text)
- 20 meter—8 t. #12 en., 2 1/2 inch diam., spaced 3 inch total length.

Circuit diagram of the c.w. transmitter. Cathode keying of the Pierce crystal oscillator provides excellent results.

incorporates an extra section in order to switch in resistors across the screen, thereby adjusting the grid drive to the finals for each band.

The 813 is operated with 1500 volts on the plate and 300 volts on the screen. A fixed grid bias of 90 volts is provided. The grid is capacity-coupled

to the buffer and the plate circuit is shunt-fed to eliminate the d.c. voltage from the tank circuit. In order to pro-

(Continued on page 128)

Side view of the transmitter shows how the final tank coil, its associated condenser, and coupling coil should be mounted.

Top view shows proper placement of the various above-chassis components. Faraday shield between coils is shown in place.

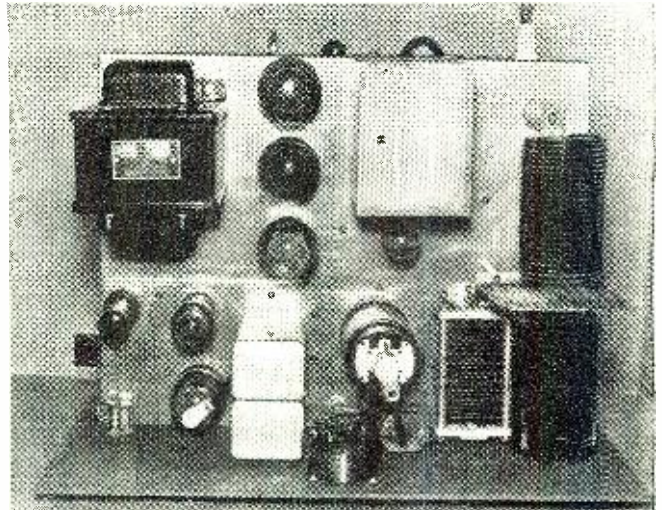
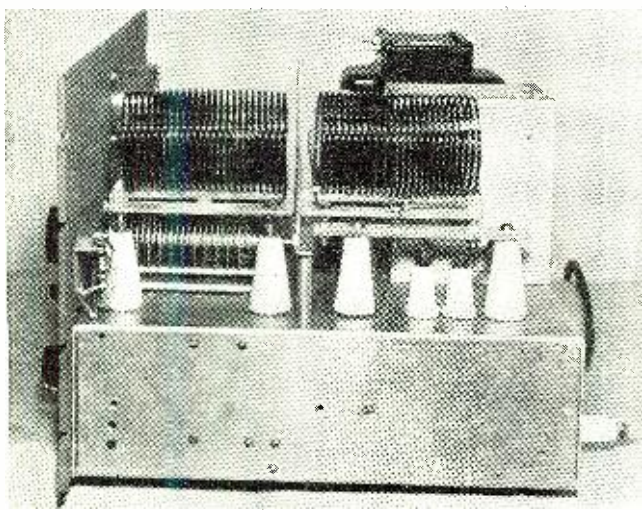

NEW TEST EQUIPMENT

Speeds Video Servicing

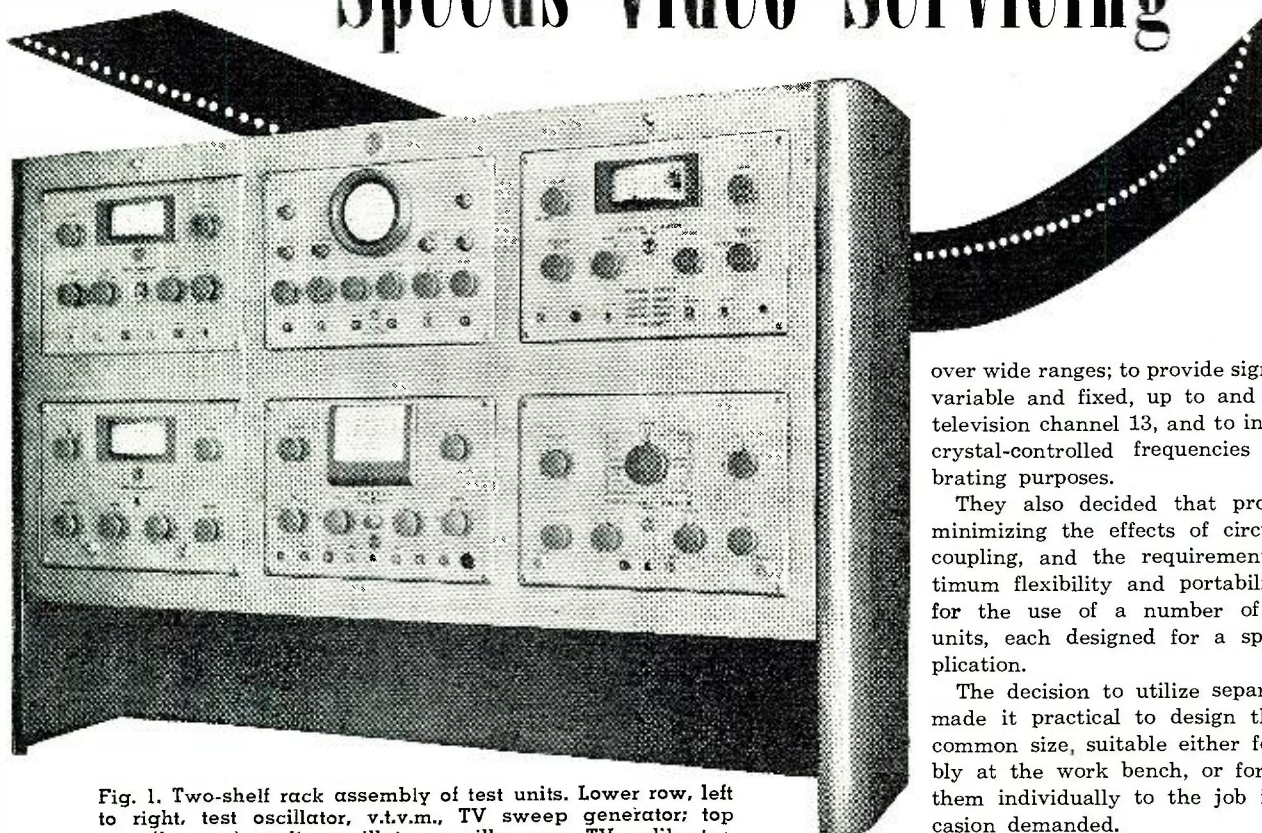

Fig. 1. Two-shelf rack assembly of test units. Lower row, left to right, test oscillator, v.t.v.m., TV sweep generator; top row (l. to r.) audio oscillator, oscilloscope, TV calibrator.

By **ARTHUR LIEBSCHER**

Test & Meas. Equip. Section
Radio Corporation of America

AM, FM, and TV receiver servicing is simplified by the use of proper equipment, conveniently arranged.

THE expansion of the radio industry to include FM and television receivers is having a marked effect on servicing activities and requirements. Television receivers, in particular, being more complex than AM receivers, require the use of additional and more elaborate test facilities than those needed for servicing AM receivers.

Recognizing the inevitability of these new servicing requirements, RCA engineers have developed a group of new test instruments and an assembly rack to provide service technicians with equipment suitable for servicing all classes of receivers efficiently.

Customers expect their sets to be serviced in accordance with original design specifications. In the case of television receivers, a service technician must have and know how to use most effectively new test equipment capable

of measuring the performance of the better receivers.

It is important that technicians duplicate the intermediate-frequency and video response curves recommended by receiver manufacturers, because these matters are as important to good sound and picture reproduction as are all the efforts of broadcasters in obtaining high-quality signals. The measurement of peak-to-peak voltages of various waveforms, and of small capacitance values, will soon become common practice.

In anticipating and analyzing the problems encountered in television and frequency-modulation servicing, company engineers decided that complete servicing efficiency required test equipment designed to measure current and voltage, including peak-to-peak values; resistance, capacitance, and frequency,

over wide ranges; to provide signals, both variable and fixed, up to and including television channel 13, and to incorporate crystal-controlled frequencies for calibrating purposes.

They also decided that problems of minimizing the effects of circuit inter-coupling, and the requirements of optimum flexibility and portability called for the use of a number of separate units, each designed for a specific application.

The decision to utilize separate units made it practical to design them to a common size, suitable either for assembly at the work bench, or for carrying them individually to the job if the occasion demanded.

This type of standardization also makes possible the construction of a rack for the work bench in which the units can be located to suit the individual requirements of the service technician and to provide extensive testing facilities, all within easy arm's reach. Fig. 1 illustrates the arrangement of the units in a two-shelf rack. In this arrangement, all of the equipment can be reached easily by the technician whether he is sitting on a bench stool or standing at the job.

Because of the importance of making it as easy as possible to take readings on the vacuum-tube voltmeter, it is suggested that this instrument be located in the center of the bottom row. This brings the scale of the v.t.v.m. into direct line-of-sight. For a similar reason, it is desirable to locate the oscilloscope in the center of the second row.

Two instruments, namely the audio oscillator and the test oscillator, can be grouped together on either side of the rack. In addition to their usual use in servicing AM receivers, these instruments are important in signal-tracing FM and television i.f. circuits and television video circuits.

The two final instruments of those described in this article are companion

RADIO NEWS

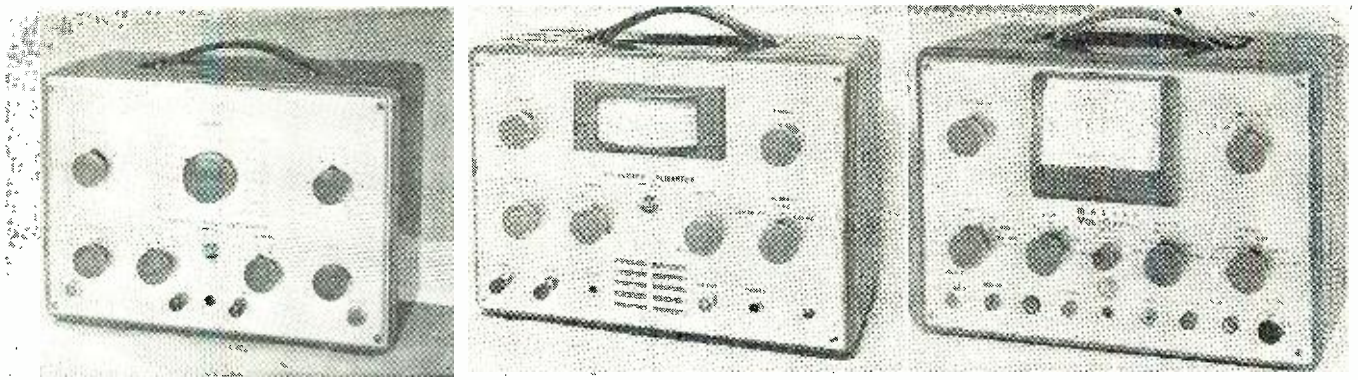

Fig. 2. (Left) Instant channel selection is a feature of this television sweep generator. (Center) Television calibrator for the precision alignment of wide-band amplifiers. (Right) The vacuum tube voltmeter is practically a universal test instrument applicable to all types of radio and electronic servicing.

units designed for the alignment of both television and FM receivers. The television sweep generator is conveniently placed below the television calibrator.

Versatile Instrument Assembly

In considering the individual functions of each instrument mentioned, it is also logical to think of the added advantage of their combined facilities. In television servicing, many dual uses for the six instruments are practical. For example, the audio oscillator is handy for signal tracing by the signal-injection method in video as well as in audio circuits.

The test oscillator, particularly designed for high-speed servicing of AM radios, can, with its signal-injection probe and step attenuator, do an equally fast job of signal-tracing picture-i.f. and FM-i.f. trouble. Picture-i.f. stages can be traced with a signal from the test oscillator by viewing horizontal modulation bars on the picture tube, or by an ingenious trick of capacitance-coupling the output of the picture detector to the television set's audio input and listening to the results. (See Fig. 5).

Grouping instruments makes it easy to use the vacuum-tube voltmeter for calibrating the scope, thus obtaining quick peak-voltage reading of any waveform visible on the cathode-ray tube. When these instruments are used in combination, the peak voltage of the saw-

tooth waveform of television deflection circuits can be measured on the oscilloscope at the same time that the associated d.c. voltage is measured on the vacuum-tube voltmeter.

Separate housing of the television calibrator and the television sweep generator serves to eliminate troublesome problems of leakage and intercoupling. In applying signals from either or both units to a television receiver, complete control of the independent signals is possible. Since sweep and marker frequencies can heterodyne only in the detector of the set being aligned, little or nothing would be gained by trying to mix the signals in one or the other of the instruments.

In passing, one important fact becomes obvious, and that is that problems of troubleshooting should be solved with signal tracing and voltage indications, including observation of deflection and synchronizing waveforms, before time is spent on alignment procedures. Analogous to this is the application of a prime coat of paint and its drying before a finish coat is applied.

New Features

Starting with new streamline styling and taking advantage of developments of modern plastics for meter cases and bezels, all six instruments shown in the test rack of Fig. 1 have been designed with many features in common. As mentioned before, the units are uni-

form in size and are therefore interchangeable in the rack. This feature provides a further advantage in that any of the six instruments can fit into one standard-size luggage-type carrying case.

All six instruments have standard binding-jacks for unshielded test leads, and employ standard microphone connectors for shielded leads. With few exceptions, this makes interchange of test leads practical and convenient, and helps solve the problem of what to do with inactive leads. Fig. 1 shows all instruments less leads, the proper condition when the bench is not in use.

Since test leads have a habit of getting badly snarled, it is good practice to work with as few as are needed for any one job, and to store the rest where they can be conveniently located, and in a manner that keeps them ready for instant use. For their proper care and maximum life, test leads are best stored in a straight hanging position along a wall or beside a storage cabinet. (See Fig. 4).

While on the subject of connectors, it should be noted that the binding jacks can be used with either a removable binding post or a locking-pin plug. The binding posts are essential in high-current or low-capacitance measurements. Having a straight shank, the binding post can also be used as a pin plug if desired.

(Continued on page 137)

Fig. 3. (Left) The oscilloscope is a useful tool in visual alignment procedures and for observing waveforms. (Center) The r.f. test oscillator is a basic AM servicing instrument. (Right) The audio oscillator is valuable in the service shop and may be used to locate performance difficulties in video amplifiers.

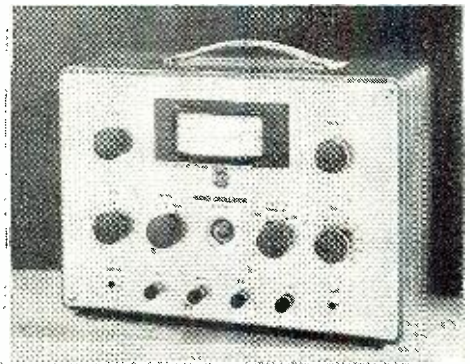
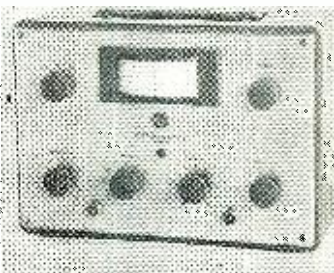
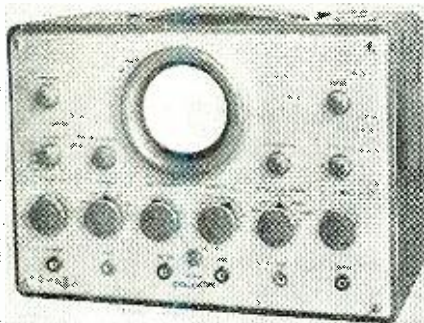

TELEVISION ON WHEELS

*The purpose of this traveling showroom
is to stimulate television interest in
localities where there are no TV
transmitters in operation.*



Fig. 1. Vehicle and equipment set up for local operation. Picture tube shield and speaker can be seen at left.

By R. P. WAKEMAN and T. T. GOLDSMITH, Jr.

Research Div., Allen B. DuMont Labs., Inc.

THE traveling showroom was originally intended to be a medium for the introduction of "television" into new communities. This was to take the form of a very simple pickup with the camera atop the vehicle and a 20-inch direct view picture tube to be exposed for viewing on the curb side.

As early plans were developed and even after construction was actually under way, new ideas for its ultimate use were advanced. These schemes included the direct merchandising of television receivers, the recruiting of new talent at remote points, the operation of the camera and receivers at several hundred feet from the showroom and promotional work in cities where television stations had just come on the air for the first time.

It is probable that a fair sized train would be required to transport the equipment and personnel necessary to

carry out, ideally, all of the suggestions for the use of the showroom. The fact that it was finally decided to incorporate facilities to accomplish to some degree, all of the above listed schemes gives an idea of the magnitude of the packaging problem.

Fig. 1 is an external view of the completed vehicle. The original body, a conventional school bus, with no windows, was modified in the following manner:

A houdah (platform surrounded by a low parapet) was built into the bus top. This provides a convenient and advantageous location for the camera and microphone for local demonstrations, i.e., where none of the equipment is removed from the vehicle and operated at a remote point. The sloping parapet also helps to relieve the severity of the original lines. On the curb side of the vehicle, at the rear, and as high as

possible, the housing for the 20" tube was constructed. As can be seen from Fig. 1, this housing takes the form of a gable standing out from the natural rear and top curves of the bus. This construction has the dual advantage of providing adequate height and viewing angle for the external audience and occupying a minimum of space within the vehicle. The traveling cover for the 12" dynamic speaker can be seen at the lower right corner of the tube housing.

In order to meet all requirements most adequately, it was decided to divide the bus interior into two "rooms" with a sound insulating partition, part of which was readily removable. This latter section was removed when the photographs of Figs. 2 and 3 were taken. The room at the rear of the bus is used to house all the permanently installed equipment. The front room can be used to transport several receivers in the event that remote operation of receivers is desired, or it can be transformed to simulate a well draped and

RADIO NEWS

carpeted living room, complete with floor lamps, six comfortable chairs and a 15" console type television receiver.

The rear wheel wells provided a convenient approximate location for the partition. A dais about 12" high, and extending clear across the bus, was constructed to cover the wells. The actual partition was built on this dais and contains an alcove approximately 20" deep and wide enough to hold the console receiver. This construction permits the receiver (which is in the front room) to be located a reasonable distance from the audience and at the same time provides two very handy storage wells in the rear room. As previously noted, the rear wall of the alcove is removable and is not in position in the pictures.

The final major body work consisted of the installation of a PE-197 generator. This is a 115 volt, 60 cycle, gasoline-driven generator rated at 6.5 kva. and weighing approximately 800 lbs. The entire unit is rigidly mounted on a steel base, this base being isolated from the bus body with two shear-type rubber shock mounts each about four feet long. On the outside of the vehicle appropriate vents and louvres are provided for the circulation of air through the equipment. Within the bus an acoustically treated housing completely encloses it. Access is provided to the control panel, distribution panel, and all necessary parts of the gasoline engine through convenient doors and hinged covers.

In addition to the above major body conversions, other work consisted in the installation of side bumpers, rear wheel covers, spare tire rack, etc.

Power Requirements

At certain locations, and especially when the camera chain is being used, it is desirable to operate the entire equipment from a remote power source, e.g., the standard commercial a.c. line. Also in some cases it may be necessary to operate receivers and other equipment at a remote point using power from the local source. The first condition requires the transfer of power from an external source to the vehicle, while the second condition requires power transmission in the opposite direction. In order to obviate the use of a second cable, and at the same time insure that the local and external sources would not be applied to the distribution panel at the same time, a special switch was made up. This consists of two double-pole, single-throw switches having double break contacts. The two levers are mechanically linked together in such a manner that the closed switch always operates before the open one. This arrangement permits the distribution panel to



Fig. 2. Front interior view shows traveling accommodations for driver and the two operating personnel. TV receivers are at right, camera at left.

be supplied from either the local or remote power source. In the event that power must be supplied from the local generator to the local equipment and at the same time the remote receivers, the link may be easily removed and both switches closed. The various circuit breakers provide additional protection and a voltmeter is permanently connected to the external source side of the switch so that the external voltage may be monitored before connecting it to the distribution panel and equipment. From this master switch, power is fed to the distribution panel. This consists of ten 20-ampere circuit breakers which, in turn, feed all of

the showroom equipment. Two of the circuits supply service outlets which are conveniently placed throughout the vehicle.

Camera Chain

A complete *Du Mont* single camera, image orthicon chain is included in the permanent showroom equipment. For local operation, i.e., using the camera to televise the audience watching the 20" picture tube or receivers within the showroom, the camera, tripod, and camera auxiliary are operated from the houdah as shown in Fig. 1.

Fig. 4 shows the permanent location
(Continued on page 103)

Fig. 3. View of remote position showing camera and receiver operating.



EQUALIZING

THE G. E.

PICKUP

By JOHN F. GRUBER

A desirable increase in bass response can be obtained with this equalizer.

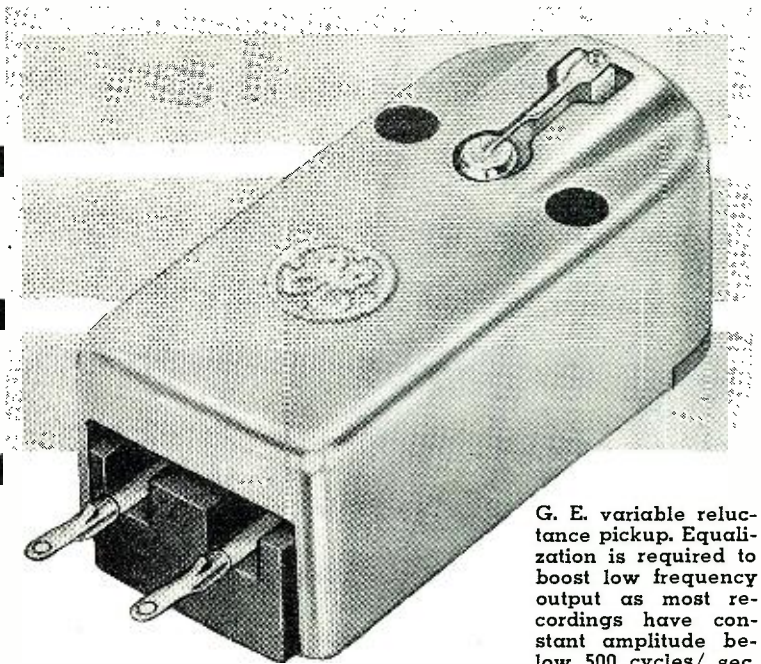

G. E. variable reluctance pickup. Equalization is required to boost low frequency output as most recordings have constant amplitude below 500 cycles/sec.

THE postwar market has been notable for the variety of new and improved phonograph pickup devices which have been offered. Crystal pickups have been improved and a wide variety of dynamic and magnetic devices have made their appearance. Among these latter, possibly none has elicited more interest and favorable comment than the variable reluctance pickup manufactured by General Electric.

This device combines sturdy construction with low cost; further it offers excellent high frequency response, little or no scratch, and low pressure. Details of its construction, etc. may be found in the article "The Recording and Reproduction of Sound" (Part 9) by Oliver Read, in November, 1947 issue of RADIO NEWS.

One drawback to this pickup is the lack of low frequencies supplied when used with ordinary commercial records. This is due to the fact that we have a constant velocity device operating in the constant amplitude region of the recording. Using the pickup with a good audio amplifier results in reproduction which is extremely brilliant and rich in overtones, but lacking in "body."

This difficulty was recognized by the manufacturer who endeavored to overcome it with a preamplifier and equalizer, the circuit of which was published in the aforementioned RADIO NEWS article, but the degree of equalization obtained is quite insufficient to the needs of the situation, as may readily be discovered with a frequency response record, particularly in the range below fifty cycles.

It may be argued that response in this range is unimportant in the home

set, and this argument is justifiable to some extent. Some customers, however, will complain that "somehow it doesn't

Fig. 1. (A) Ordinary output transformer with primary connected across pickup and a condenser connected across the secondary. (B) Resistor connected in series with transformer primary to give better high frequency response. (C) Shunting the pickup to reduce high frequency response.

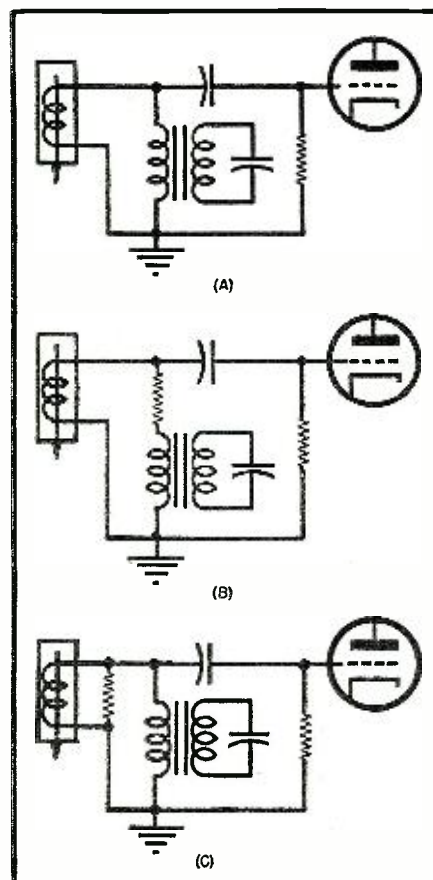

sound just right and natural." In this case the customer is partially correct. Some of the "unnaturalness" comes from the customer's hearing high frequencies previously attenuated in older phonographs. The remaining "unnaturalness" is the result of taper inherent in using a constant velocity device in a constant amplitude region.

Despite its fancy name (variable reluctance) this pickup is a magnetic device and first cousin to the heavy magnetic reproducers so common fifteen years ago. As such, the voltage generated is proportional to the rate of change of magnetic flux. At 200 cycles the cantilever is vibrated at only half the periodicity occurring at 400 cycles. This means only half the voltage generated at the 400 cycle rate is available at the 200 cycle rate. Power being proportional to the square of the voltage when divided by the resistance of the grid load at the input to the first tube, we find we have only one quarter the power available for each octave drop in frequency. This represents a loss of approximately 6 db. per octave.

This rate of taper is extremely severe in symphonic music and is noticeably severe even in dance bands. Let us see for a moment just what it amounts to. Present practice puts the crossover point from constant velocity to constant amplitude somewhere between 400 and 500 cycles. Let us arbitrarily assume it to be 440 cycles, this being the standard pitch for "A."

This pitch is also "the" high note of tenors. While singing it he will sound natural, but suppose he sings the "A" on an octave below. In this case his

(Continued on page 163)

A LOW FREQUENCY CONVERTER

By R. C. AMUNDSEN, WIHYF

A simple converter which will permit reception on the 100-500 kc. band with your regular receiver.

NOST communication receivers today do not cover the low frequency range, i.e., the frequencies between 100 and 500 kilocycles. An orthodox type of converter for these frequencies is cumbersome, as it is almost impossible to cover the entire range without switching.

The oscillator of this converter, using an intermediate frequency of 1500 kc., has only to cover from 1600 to 2000 kc. A bandpass mixer circuit proves entirely adequate to receive the strong signals in the marine and aircraft beacon bands. It effectively attenuates the image frequency signals which lie in the range of 3100 to 3500 kc., a portion of the spectrum which is practically free of high power signals. Due to the small range of the oscillator, a single 50 mmfd. variable condenser is all that is required in the way of a tuning gang. A type 6SA7 tube is used and its total drain is so small that it may be supplied by the receiver's power supply. The circuit of this converter is simple, straightforward and its adjustment is far from difficult. It can be built in a few hours' time and will provide many hours of enjoyment for those who like to listen to the merchant marine operators on 500 kc. and below.

Proceeding from the antenna terminal, a double-pole double-throw switch serves to connect the antenna either to the converter or direct to the receiver and also energizes the heater of the 6SA7 when it is to be used. No switch was found necessary in the plate voltage circuit as the tube will not draw current with its heater cold. From the antenna the signal proceeds through a low pass filter composed of RFC₁, RFC₂ and RFC₃ in series and then to the mixer grid through a 500 mmfd. mica condenser. A 30 mmfd. mica trimmer across RFC₁ acts as a wave-trap for the high frequency signals and two 25 mmfd. mica condensers either side of RFC₂ further bypass the undesired high

frequency signals to ground. The 500 mmfd. mica condenser attenuates the undesired very low frequency signals below a hundred kilocycles and a 4700 ohm resistor from grid to ground broadens this entire input circuit. The oscillator portion is an ordinary Hartley circuit and coupling to the mixer circuit is through the electron stream of the tube. The plate circuit of the mixer is tuned to 1500 kilocycles by means of the i.f. transformer. The secondary of this transformer could be decreased in inductance to better match the antenna coil of the receiver. However, sufficient signal strength was received without any changes in this winding. A shielded lead must be used to the receiver's antenna connection. This prevents 1500 kc. signals from interfering



Front view of converter.

with the converter's operation. After the circuit has been constructed the range of the oscillator should be adjusted to cover 1600 to 2000 kc. This may be done by listening to a receiver that covers this range and tuning the

(Continued on page 169)

Circuit diagram of the converter. Output frequency is 1500 kc.

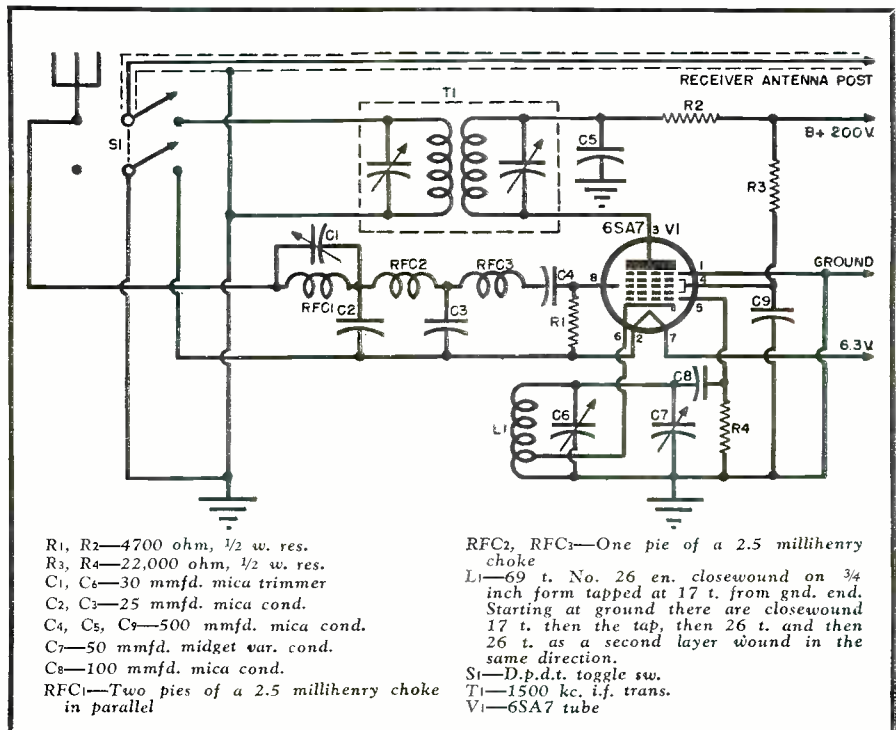

10 db. Volume Compression Without Splatter

By R. M. CROTINGER, WOGUY

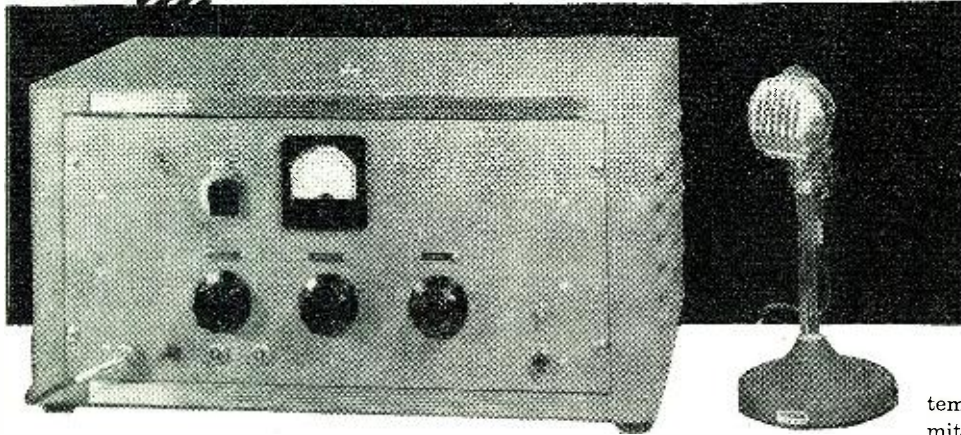

Front view of the complete amplifier. It may also be used as a high-quality public address installation.

Continuous high-level modulation without danger of overmodulation becomes feasible with this unit.

THE amateur trend toward beam antennas has emphasized the fact that more decibels can be produced at the distant receiver by working on the antenna system than by pouring more watts to the final. This practice has not only benefited the two stations in contact, but also benefited anyone trying to use the same or an adjacent channel for a different direction of propagation.

There is still another method by which the signal can be raised in the other fellow's speaker, other than pouring more watts into the final. This is known as volume compression. It consists of automatically decreasing the magnitude of the heavy peaks, thus permitting the lower levels to modulate the transmitter more fully. However, the compression must be accomplished without unduly increasing the distortion of the stage to which it is applied. This is a common fault of compressors and has led to a certain amount of ill-feeling toward some stations using compression. The splatter can come only from audio harmonics modulating the carrier, which, in turn, come from the stage accomplishing the compression. Of course a splatter choke may be used to eliminate the harmonics, but this is essentially a correc-

tive measure and does not help the distortion which is passed, or the overloading of tubes preceding it. By using a compressor stage which will not increase distortion with an increase in input level, and operating the other stages within their capabilities, the need for such correction is eliminated and the advantages of compression realized.

Ten decibel available compression is sufficient to handle the variations in level of the average ham working into a mike and is obtainable without utilizing an expensive number of tubes and components. When it is considered that increasing the level of input to the final from 250 watts to 1000 watts represents a received signal increase of six decibels, and is quite an expensive project, it can be realized that the same increase with a compressor is well worth the while.

The compressor to be described was designed to maintain a minimum distortion with full compression. Since the compression is accomplished by feedback variation the distortion actually decreases with increased compression. Thus the danger of splatter is eliminated and a clear intelligible signal still maintained.

Since it is necessary to build the equivalent of a good public address sys-

tem in order to modulate a ham transmitter anyway, the unit was designed so that it could conveniently be used for this purpose. When used as a public address amplifier the unit has a flat response from 50 to 12,000 cycles with less than 4% distortion at full output. It provides two microphone inputs and one phonograph input with an electronic mixer stage which eliminates interaction.

When using it as a ham modulator or driver, a tone control circuit is provided to eliminate any high frequencies which might be picked up by the microphone and modulate the transmitter. The tone control circuit was placed ahead of the compressor stage in order that any high frequencies thus picked up would not drive the compressor before they were eliminated. The distortion in the stages following the compressor is below three per-cent at full output and thus causes no splatter. Voltage regulation of the 2A3 bias and balancing of the currents in these tubes helps keep the distortion in these stages down.

If desired the phono channel can be connected to an FM converter or receiver and the real benefits of FM appreciated, if one uses a good speaker, properly baffled. Two 12-inch speakers are used with the unit described. These are mounted in two of the popular sloping front baffles and the inside of the baffles lined with felt or sound absorbing material. A masonite back was put on the baffles, the inside of which was also lined. This prevents spurious resonances and permits more volume to be realized for a given p.a. setup before

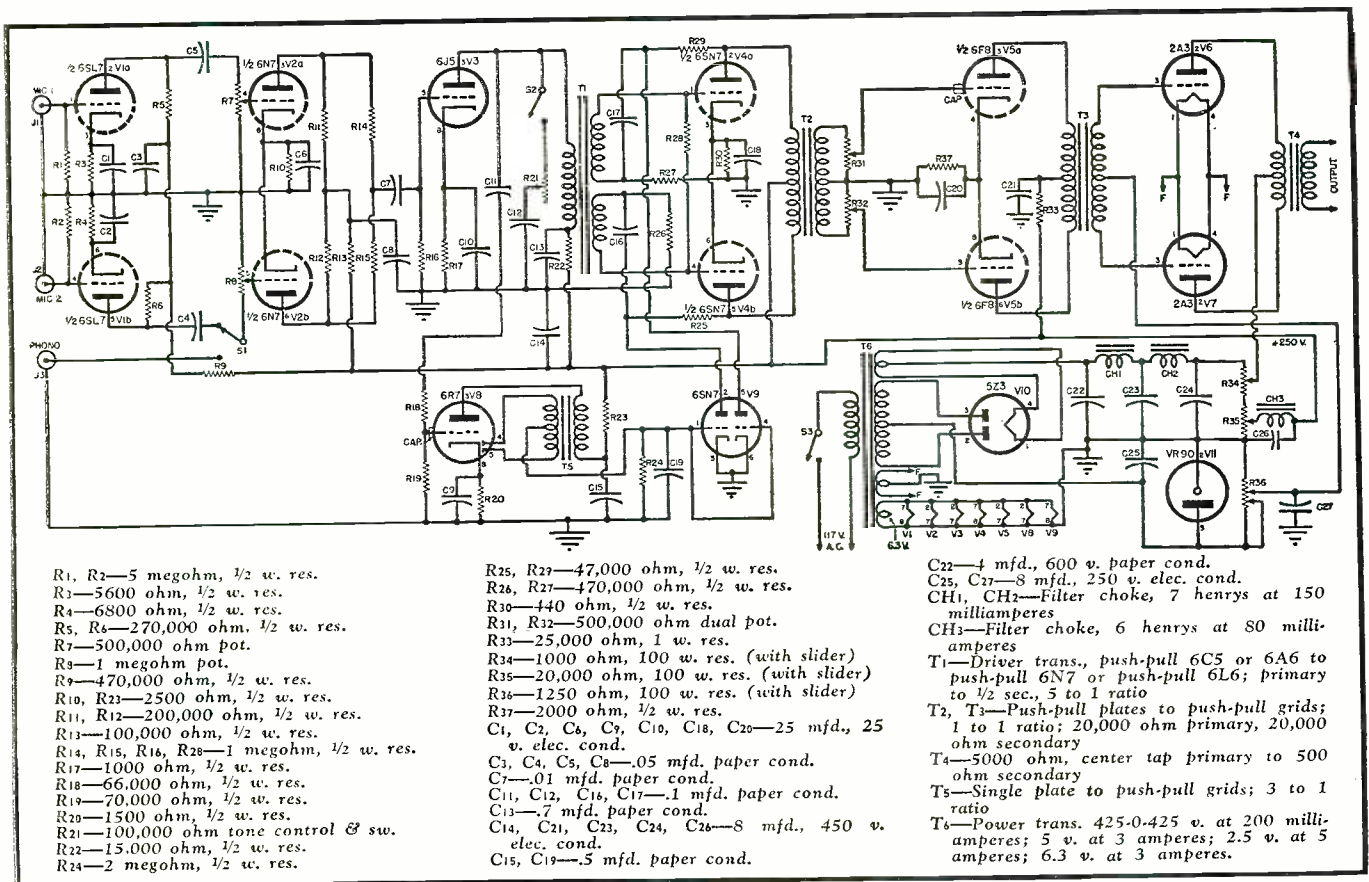

Circuit diagram and parts list for the complete volume compressor amplifier.

the system breaks into oscillation, by directing the sound where it is desired.

Of course the design may be changed to suit any preference. If the high fidelity is not desired cheaper transformers can be employed and a band-pass system used. If only one channel is desired the electronic mixer can be eliminated along with one of the preamplifiers. If just the compressor circuit is wanted perhaps it can be incorporated in your present equipment.

This would represent but a small part of the cost of the system shown. However, with the availability of parts on the surplus market the entire setup shown can be built amazingly cheap and if one has the opportunity, renting out the p.a. system will provide some extra cash for your hobby.

Circuit Description

The microphone preamplifier employs a 6SL7 dual-section, high mu

triode driving a 6N7 electronic mixer tube. The phono pickup is switched into one section of the 6N7 when using the record player. This permits the use of two microphones and one pickup for public address purposes.

The mixer stage drives a 6J5 triode which, in turn, drives the compressor stage and side amplifier. The side amplifier, triode section of a 6R7, is tapped off the plate of the 6J5 stage. The sig-

(Continued on page 98)

Wide spacing of the various components in this amplifier reduces possibility of interstage coupling.

The cabling of wires and careful placement of parts below the chassis makes construction of this compressor amplifier easier and quicker.

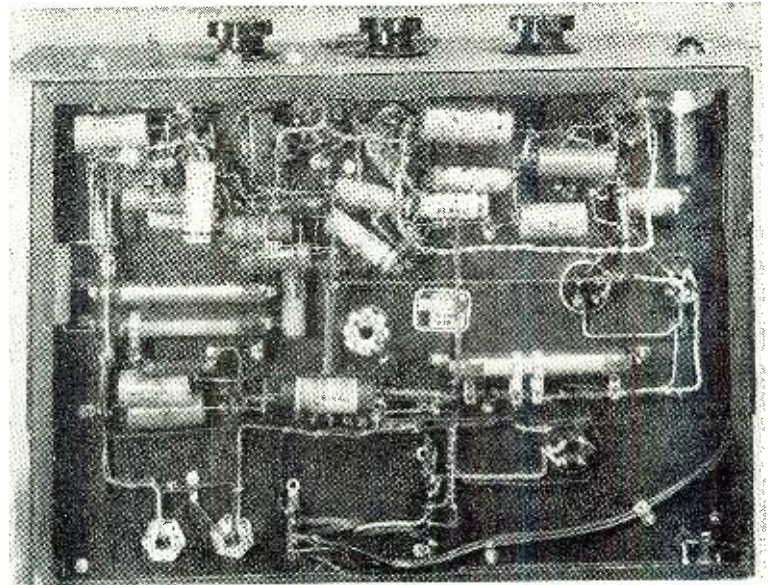

THE RECORDING and REPRODUCTION of SOUND



A commercially-built decibel meter primarily used in industry.

By OLIVER READ
Editor, RADIO NEWS

Part 17. A study of the decibel — its definition, how used, and how calculated.

THE measurement of gain in an amplifier or loss in a transmission line or attenuator circuit is usually expressed in db. (decibels) rather than in watts or volts. The reason for this is the fact that the human ear responds to intensities of sound logarithmically rather than linearly.

A sound having 10 watts of power is 10 times as loud to the ear as a sound of 1 watt and a sound of 100 watts is 10 times as loud as a sound of 10 watts but only 20 times as loud as a sound of 1 watt.

A sound of 1000 watts (1 kilowatt) is 20 times as loud as a sound of 10 watts or 30 times as loud as a sound of 1 watt. We must, therefore, use a "mental yardstick" having a logarithmic scale and not the usual rule.

The standard transmission unit is the decibel (abbreviated db.) and is equal to one-tenth of a bel. Nominally, it supersedes the TU (transmission unit), although specifying exactly the

same thing as the latter term. The bel, named in honor of Alexander Graham Bell, was adopted by an international convention of telephone engineers.

The decibel is a logarithmic expression of a ratio between two quantities. As a unit of measurement, it specifies no definite amount of current, voltage, power, or sound but represents merely a ratio between two magnitudes. It is therefore a relative unit. Since the db. is a logarithmic unit, successive gains or losses expressed by it may be added algebraically.

The db. may express a ratio between two values of either current, voltage, power, or sound energy. It thus becomes possible to determine the db. gain for a given amplifier from ratios that express either voltage, current, or power amplification. Gain is expressed as *plus* db., loss as *minus* db.

While the decibel may show gain or

loss with respect to the power at some point in a system, it properly has no regard for the finite value of any reference power. However, it is accepted practice in some radio and telephone measurements to designate the power level of 0.006 watt (6 milliwatts) as *zero* db. and to express any other value of power as a certain number of db. above or below this reference level. Hence, the expressions "db. up" and "db. down." (See table, Part 1, March, 1947, issue Page 54).

Determination of Ratios

Ratios are common to everyday scientific ratings. They express relative superiority or inferiority, gains or losses in a concise and readily understandable manner. We state that a certain transformer permits a voltage step-up of 2 to 1, etc. Such simple ratios might easily be converted into convenient statements of db. gain and db. loss.

The ratio of two values of power, for example, P_1 and P_2 is represented as:

$$P_1/P_2 \dots \dots \dots (1)$$

Or, the larger power is divided by the smaller. It is easily seen that the actual instantaneous magnitudes of P_1 and P_2 might extend over a wide range of values but would be of no concern to the quotient as long as they remained in the same proportion.

The number of decibels represented by such a ratio is obtained by multiplying the logarithm of the indicated quotient by 10:

$$no. \text{ db.} = 10 \log_{10} (P_1/P_2) \dots \dots \dots (2)$$

Observe that the common logarithm of the quotient (ratio) is employed, i.e., the logarithm to the base 10. Hence the form, \log_{10} . From equation (2) the following rule may be stated:

Rule A: The number of db. is numerically equal to 10 times the common logarithm of a power ratio.

Voltage and current ratios may also be expressed in terms of decibels. If the two values of voltage E_1 and E_2 are measured across the same or identical impedances, or if the two values of current (I_1 and I_2) are taken through the same or identical impedances:

$$\text{no. db} = 20 \log_{10}(E_1/E_2) = 20 \log_{10}(I_1/I_2)$$

Observe that in equation (3) the logarithm of the ratio is multiplied by 20 instead of 10. This is because power varies directly as the square of the voltage or the square of the current, and a logarithmic expression obtained in the manner of equation (2) needs to be multiplied again by 2, since doubling a logarithm is equivalent to squaring the number.

If, as is occasionally the case, the current or voltage values in the ratio are not associated with the same or identical impedances, our decibel computation must take into consideration the absolute magnitudes of the corresponding impedances and power factors of the impedances:

$$\text{no. db} = 20 \log_{10}(E_1/E_2) + 10 \log_{10}(Z_2/Z_1) + 10 \log_{10}(f_1/f_2) \dots \dots \dots (4)$$

$$\text{no. db} = 20 \log_{10}(I_1/I_2) + 10 \log_{10}(Z_1/Z_2) + 10 \log_{10}(f_1/f_2) \dots \dots \dots (5)$$

Z_1 and Z_2 are the impedances in which the voltages and currents operate, and f_1 and f_2 are the values of the corresponding power factors of the impedances.

From equations (3), (4), and (5) the following rules may be stated:

Rule B: When a voltage or current ratio shows values associated with the same or identical impedances, the number of db. is numerically equal to 20 times the common logarithm of the ratio.

Rule C: When a voltage ratio shows values associated with unequal impedances, the number of db. is numerically equal to a sum of three logarithmic expressions: 20 times the log of the voltage ratio plus 10 times the log of the impedance ratio plus 10 times the log of the power factor ratio.

Rule D: When a current ratio shows values associated with unequal impedances, the number of db. is numerically equal to the sum of three logarithmic expressions; 20 times the log of the current ratio plus 10 times the log of the impedance ratio plus 10 times the log of the power factor ratio.

Relationships

By definition, the common logarithm of a number is the exponent denoting the power to which 10 must be raised to equal the given number. Thus, 3 is the common log of 1000 since 10 must be raised to the third power to equal 1000. 5 is the common log of 100,000; 6 of 1,000,000.

Column 2 of Table 1 lists common logs corresponding to a few of the even-numbered ratios frequently encountered in radio work. The ratios are given in column 1. These logs are multiplied by 10 (in column 3) to give db. for power ratios, and by 20 (in column 4) to give decibels for current or voltage ratios.

It is readily seen from the chart that a power ratio of 100 to 1 corresponds to 20 db., while a current or voltage ratio of the same magnitude corresponds to 40 db. A ratio of 1,000,000 is equivalent to 60 db. for power, but 120 db. for current or voltage. It is also seen that a power, voltage, or current ratio must be squared in order to double the number of decibels; and that increasing a power ratio to 10 times its original value is equivalent to adding 10 db., while the same increase in a current or voltage ratio is equivalent to adding 20 db.

It should be apparent to the reader that the same number of db. may be obtained from each of a number of ratios with widely divergent numerator and denominator values, as long as the same proportion exists between the two terms. A clear understanding of this condition not only explains why an extremely low-powered system can show the same number of db. gain as one of high power, but at the same time also places illustrative emphasis upon the relativity of the transmission unit.

Consider, for example, three a.f. amplifiers—one delivering 1 watt output with 0.1 milliwatt input; the second delivering 10 volts output for 100 millivolts input, both input and output circuits operating into 500 ohms impedance; and the third delivering 50 watts output for 5 milliwatts input. The gain in each case is 40 db.

Applications

1. **Amplifier Power Gain or Loss.** (a) Measure a.f. or r.f. input watts, (b) measure a.f. or r.f. output watts, (c) apply equation (2) and **Rule A**.

2. **Amplifier Voltage Gain or Loss.** Input and Output Impedances Equal. (a) Measure a.f. or r.f. input voltage, (b) measure a.f. or r.f. output voltage, (c) apply voltage equation (3) and **Rule B**.

3. **Amplifier Current Gain or Loss.** Input and Output Impedances Equal. (a) Measure a.f. or r.f. input current, (b) measure a.f. or r.f. output current, (c) apply current equation (3) and **Rule B**.

4. **Amplifier Current or Voltage Gain or Loss.** Unequal Input and Output Impedances. (a) Measure a.f. or r.f. input voltage or current, (b) measure a.f. or r.f. output voltage or current, (c) determine absolute values of input and output impedances, (d) determine absolute values of power factor for the two impedances, (e) apply voltage equation (4) and **Rule C** or current equation (5) and **Rule D**.

Note:—Any of the foregoing amplifier characteristics may be taken for the entire amplifier (over-all), a single stage (per stage) or any cascaded group of stages. A *plus db.* rating indicates gain; *minus db.* loss.

5. **Amplifier Output Level, or A. F.**

(1) RATIO	(2) LOG OF RATIO	(3) DB FOR POWER RATIO	(4) DB FOR CURRENT OR VOLTAGE RATIO
1	0	0	0
10	1	10	20
100	2	20	40
1000	3	30	60
10,000	4	40	80
100,000	5	50	100
1,000,000	6	60	120

Table 1. Relationship between voltage, current, and power ratios and decibels.

Line Level. This is stated by engineers and manufacturers as so many db., the number of decibels above or below 6 milliwatts (zero db.) being assumed. Apply the equation:

$$P \text{ in watts} = .006 \times \text{antilog} (\text{db.}/10) \dots \dots \dots (6)$$

The term db. is the figure stated for amplifier or line. An *antilog* is the figure or number which corresponds to a certain log. (Looking up an antilog in the log tables is the reverse of the process of looking up a log.)

6. **Microphone, Hum, Input Signal or Noise Level.** This is generally stated as so many negative db., or "db. down," and like Example 5 refers to zero db.

(Continued on page 125)

Table 2. Chart showing the relationship between watts and decibels based on the standard zero level of six milliwatts.

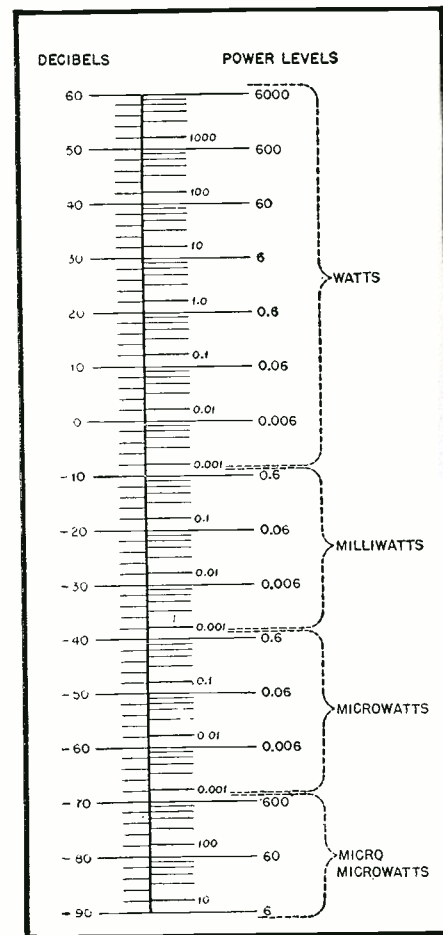

Mac's RADIO SERVICE SHOP

By JOHN T. FRYE



A LITTLE LIGHTNING

THE static crashes in the receivers Mac and his red-headed assistant, Barney, were working on had been growing steadily louder and closer together; and when there came a sudden sharp peal of thunder, Mac laid aside his test prods.

"Let's take a break, Red," he suggested as he started closing the switches that grounded the AM antenna, the FM dipole, and the TV three-element beam; "that is, if you think you can tear yourself away from your work."

"W-e-l-l-l, boss, if you insist—" Red said with a very phoney-sounding reluctance.

Mac tripped the circuit-breaker that opened both power leads going to the receiver outlets and the test equipment and settled himself comfortably on the end of the bench. Just then there was a brilliant flash of light accompanied by the vicious "sn-a-a-a-p!" of a near stroke of lightning, and Miss Perkins, the office force of Mac's Radio Service Shop, sailed through the door of the service department with rather unladylike haste.

"I just happened to think you boys might like some of these chocolates I picked up during lunch hour," she said holding out the open box in hands that were noticeably shaking.

Barney hopped off the stool on which he had been sitting and offered it to her with a sweeping bow.

"You feed us candy, and we will protect you from the thunder," he promised as he stretched his lanky frame on the floor and began to open and

close his mouth suggestively like a three-day-old robin.

"I don't think we need expect any customers for a few minutes," Miss Perkins said as she looked through the door at the rain slashing down across the plate glass windows of the shop; "and as for you, Mr. Smarty," she explained as she seated herself primly on the stool and dropped a chocolate into Barney's gaping jaws, "I am not afraid of lightning; I just don't like it."

"Anyway, you had better save your strength for answering the 'phone when this is over," Mac told her as he helped himself liberally to the candy.

"How's that?" Barney asked.

"The lightning," Miss Perkins explained. "It always knocks out several sets."

"How, Mac?" Barney inquired.

Before answering, Mac lazily sketched with his left hand—it was the one with no candy in it—the diagram of Fig. 3 on the little wall blackboard at the end of the bench.

"There you have the two circuits by

which lightning can get into a radio—excepting, of course, the remote possibility of a direct stroke, which is a fate that I wouldn't even wish on a three-tube midget. You will recognize 'A' as the antenna circuit; 'B,' the 110 volt input circuit."

"Let's talk about 'A' first. If lightning strikes near the antenna, it induces a voltage in the antenna wire which flows down through the lead-in, the antenna coil, the chassis, and the ground lead to the earth. If the current is high enough, it will burn out the antenna coil; if the voltage is sufficient, it will jump to other parts of the receiver and may damage them."

"How much voltage and current does a stroke of lightning have?" Barney wanted to know.

"That varies, of course, with different strokes. It is estimated, though, that the voltage is around 100,000 volts per foot. That means that if the discharge leaps from a mile-high cloud to the earth, the voltage is equal to 5280 times 100,000, or more than five hundred million volts. The current varies from a few thousand amperes to a few hundred thousand amperes."

Barney whistled. "If lightning strikes the antenna, then, about all you can do is pick up the pieces—if there are any pieces."

Mac nodded agreement. "Yes, the things to protect against are static charges and induced voltages. Even these are pretty hefty. It has been figured that the voltage induced in a clothesline six and a half feet off the ground by a stroke of lightning three miles away is often around 30,000 volts, and this voltage would be increased by 4600 volts for every foot you raised the line. In an antenna with considerable capacity, this induced current can become high enough to do great damage."

"What is the best protection against these induced voltages?"

"Grounding switches would probably be best if they were always closed during electrical storms, but people either forget or are not around when the storm comes up; so lightning arresters are the best bet. You have probably noticed that I keep the shop key in that slot so I cannot get it out until the antenna grounding switches are all closed. I forget, too!"

Barney waited until a window-rattling growl of thunder had subsided before asking, "How are lightning arresters made?"

"There are dozens of different types. Resistor, horn gap, carbon pile, electrolytic, coated pellet, oxide disc, neon gas—these are a few; but the important thing is what they do. A lightning arrester is simply a device that has a high resistance to the passage of cur-

(Continued on page 168)

Fig. 1. General Electric lightning arrester for use with FM antennas.

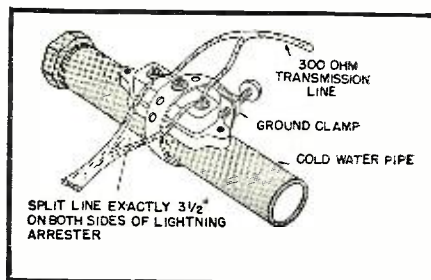

RADIO SEEKS BLACK GOLD

By
T. A. PATTERSON, JR.

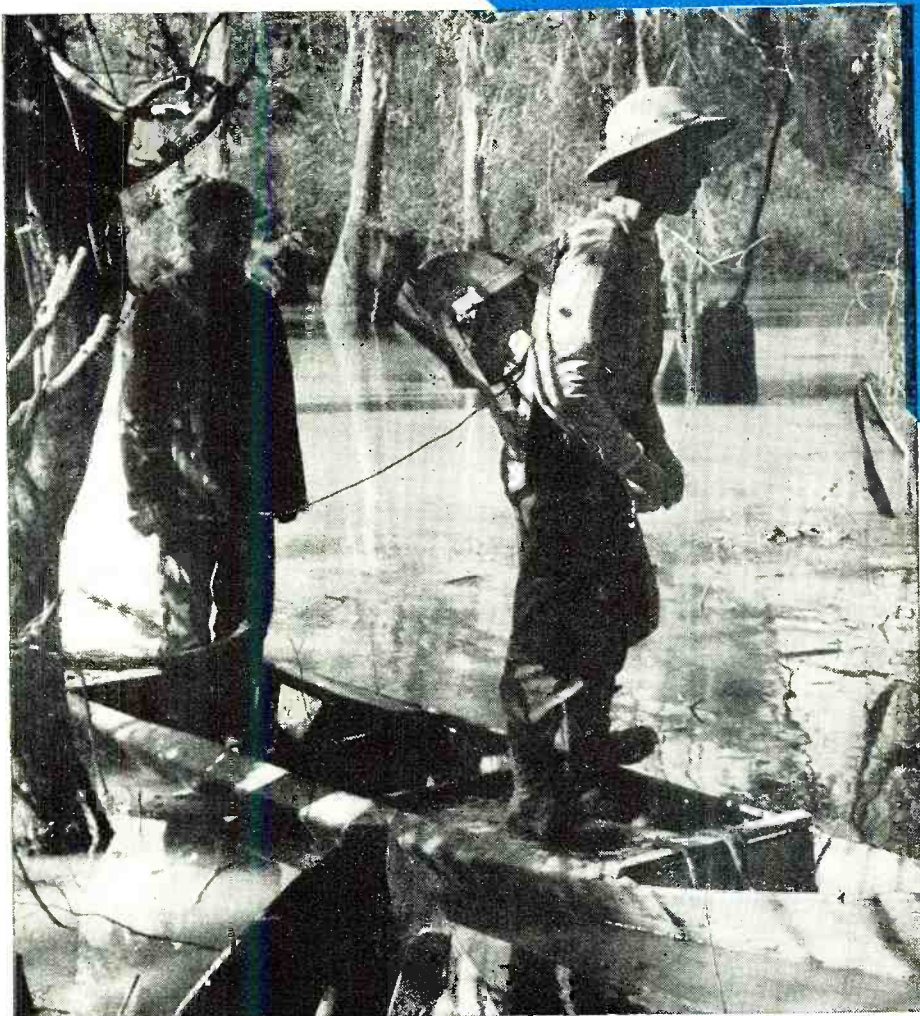

Fig. 1. Flat bottomed boat is used for stringing pickup cable in swamp areas.

Oil—the life blood of industrialization—is now being located by modern electronic equipment.

EEP in our Southwest territory which, roughly, comprises the states of Louisiana, Texas, Oklahoma, and New Mexico, the sensitive fingers of radio inspired equipment are probing the vast subterranean areas for new deposits of one of our most valuable resources. Even those who have heard the names geophysics, doodle-bugging, or seismograph survey seldom realize the all-important part electronics has played in the search for one of earth's richest treasures—OIL—truly a black gold, a bonanza, without which the wheels of industry would be paralyzed.

The many complex activities of the petroleum industry, which include scouting, leasing, royalties and mineral rights, drilling, spacing, producing, wildcat ventures, and the like, have become heavily dependent on this comparatively new super-sleuth of the deep, for on the shoulders of the modern geophysicist has fallen the burden of predetermination of substructure formations.

Before delving into the applications of electronics in petroleum's realm, we should first study very briefly the term "geophysics" and the relation of oil bearing structures to the earth's conformities. Webster defines the term

"geophysics" as "The physics of the earth, or the science treating of the agencies which modify the earth." The earth, over its span of life, has been built up of a multitude of composite layers of various materials, and, by structural changes, has exposed certain layers, hidden others, and in some places shifted the strata until they no longer match. This resultant configuration is known basically as a fault, of which there are many kinds and types. Fig. 4A illustrates various types of structures of the substrata and shows possible points where oil may be found. The structures in which the

Fig. 2. Part of seismograph crew on typical swamp operation. Where work is performed in part dry and part submerged country, all equipment must be back-packed.



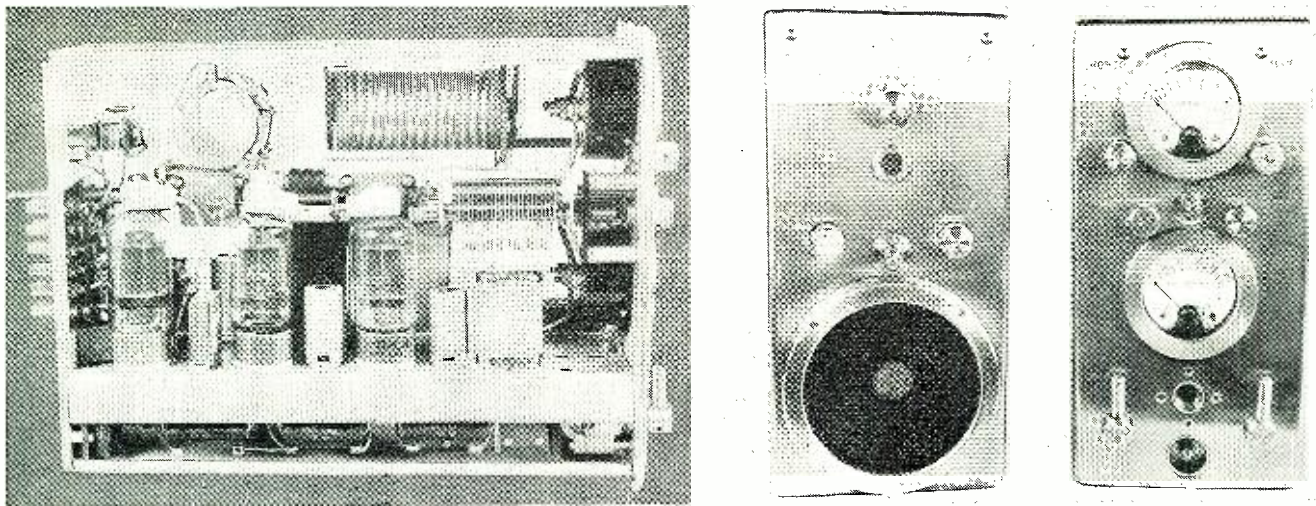

Fig. 3. Front view of typical two-way radio equipment and an open side view of the transmitter portion. This communications link plays an important role in coordinating operations and relaying the shot break marker.

porous stratum is shaped like an inverted bowl are called *anticlines*. Much of the world's known oil lies in such reservoirs.

Using the above data as a rough guide, we can now take up the process of seismograph survey as applied to the science of geophysics. First let us go over the entire process of obtaining a record of the earth's variation, then the theory can be broken down into its component parts and studied individually to determine the electronic era's part in the technique.

Using Fig. 4B as a reference guide, the setup or spread is made as follows: In a straight line, predetermined and marked by civil surveys and maps, the shot point and recording truck with its geophones are set up. A charge of dynamite is set off at the shot point with the resulting waves reverberating downward to the hard rock or limestone base beds, then returning to the surface as an echo wave to be picked up by the geophones and

recorded photographically. The milli-second time constants are the fundamental keynotes in determining the information being sought. Fig. 4B also shows a corresponding section of the seismic record showing the relative "kicks" from various rock strata. To an untrained eye, these "wriggly snakes" are so much hash, but, to the eye of an old hand in the game, the hieroglyphics immediately become a language of the earth, with syllables and punctuations as plain as our own native tongue.

With a slight background of the general field, we can now explore the component parts for a study of the role radio plays in this dramatic search for hidden wealth. To prove a point, it might be mentioned that the recording truck uses upward of 150 tubes in actual circuit functions. As mentioned before, the split second timing must be perfectly accurate, so communication between the shot point (where the dynamite charge is set off),

and the recording instruments is an absolute necessity. This is done in one of two ways, depending upon the location and type of area being surveyed. Communication is established between the two points by telephone or by radio (see Fig. 3), and, by either system, a contact is made for transmission of the exact time marker or "shot break" as it is called. One manner of obtaining this marker is by tying a piece of light wire about the dynamite cap used to set off the blast and, by long leads, connecting this wire in series with the transmitter keying circuit or the telephone line. When the charge is shot off, the radio or the phone is killed, thereby removing the voltage at the other end and producing a resultant kick.

Another system for handling this necessity calls for a modification of the blasting box. It is rebuilt in such a manner that the current generated by the magneto is not at once applied to the dynamite-cap, but only when

Fig. 4. (A) Cross-section of earth structure to a depth of approximately 5000 feet and a width of 2 miles. Darkened areas are gas pockets, usually under considerable pressure, lying above the oil pools. (B) Artist's sketch showing cross-section of earth with relative location of geophones to shot hole, and a record superimposed to show subsurface strata kicks on the record. Numbers 1 and 6 show relative pickup to the corresponding record trace; T is the timing trace and X is the shot break point. Note the additional time required for the signal to reach phone 6 (Y).

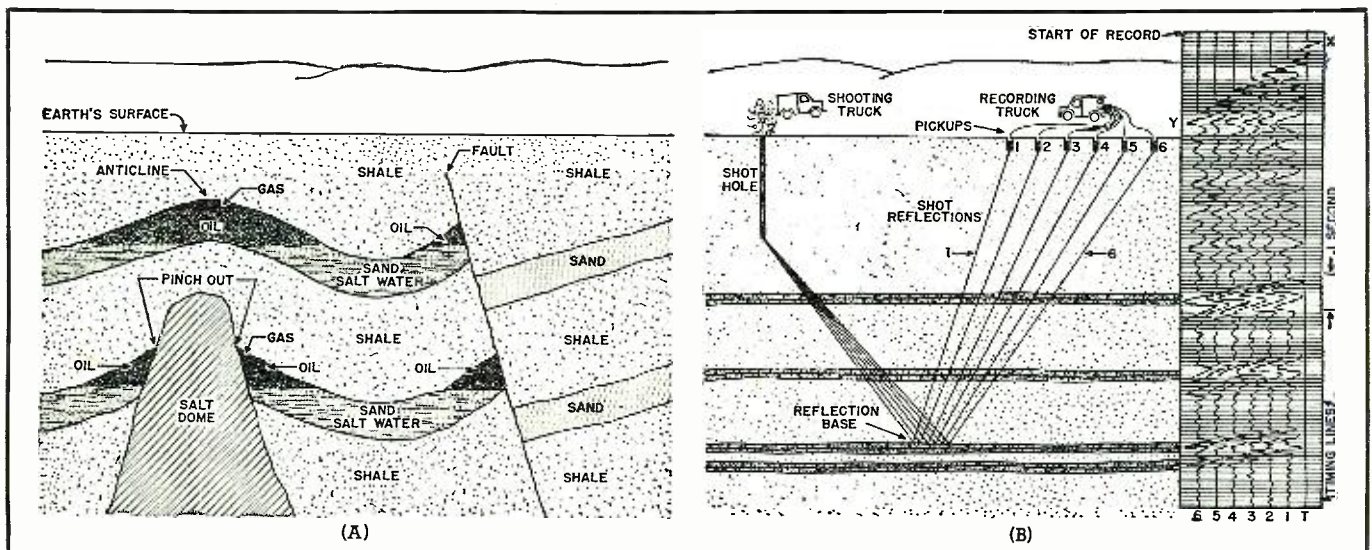

the handle reaches the bottom and hits a micro-switch. One side of the firing line runs through a small transformer, the secondary of which is in series with the phone line or modulation transformer of the radio. The sudden pulse gives a clean sharp break point, readily discernible on the final record.

The instrument picking up these reverberations from the earth is known as a geophone, and is most simply identified by describing it as a moving case microphone as seen in Fig. 6. There may be from 6 to 36 of these used, depending on general conditions such as the type of spread, penetration desired, etc. The average recording unit uses 12 or 18, though at times when ground conditions are bad, two are used at each location to provide a stronger signal. There are several types of "jugs" used, usually of the individual company's own design, incorporating various types of movements, impedances, and systems for damping.

The typical geophone has a natural frequency of from 10 to 40 cycles. It is nearly critically damped and may have an internal impedance of from 10 to 1000 ohms. The output voltage of a "jug" having 100 ohms impedance ranges from 20 to 100 volts per inch amplitude of motion. Since this apparently large output rating is in terms of measurement units, it must be emphatically pointed out that average movement for a weak reflected signal is in the order of 1 *microinch*.

The output of each unit is carried to the recording equipment over a two conductor cable which is generally a heavily sheathed copper and steel type (Fig. 6) to withstand the rough treatment of field work. These cables are stored, when not in use, on large reels on the back of the recording truck. These reels are powered by electric starter type motors or a power take-off gear box on the truck's transmission such as the one mounted on the rear of the truck in Fig. 7. In many portions of Louisiana and

Florida, nearly impenetrable swamps (Fig. 1) require all gear to be carried on the crew's backs (Fig. 2) to some of the locations. This necessitates a very lightweight waterproof cable, which, of course, gains in weight and space saving, but at a sacrifice of longevity.

The geophone signals are fed into the instrument panel junction box and thence to the control panel, where, by multiple controls, they are balanced to each other for equal deflection of the camera mechanisms. These units are neatly and compactly grouped on the instrument panel in the recording cab. Light tight, this cab also serves as a dark room for developing the records on the spot. A time delay mechanism and circuit is incorporated in this control panel to reduce the signal level until the ground wave shock has passed the truck. This is the rolling motion of the earth near its surface produced by the initial shock of the explosion. The trick of the operation is to set this delay so this ground wave may be bypassed, yet the actual signal sought after is passed freely. This involves timing in the order of a few milliseconds duration.

The amplifiers generally have three or four stages of voltage amplification with bandpass filters to eliminate unwanted noises and interference. Dependent upon the type of amplifier in use, from 5 to 100 different frequency response curves may be selected by varying the upper and lower frequency limits. An automatic volume control keeps the output level approximately constant for input signal amplitude variations up to 1000 to 1. Maximum gain of these amplifiers is from 80 to 90 db.

Such oddities as ants crawling over a geophone or wild game coming close can create enough signal intensity on the recording mechanism to render a record useless. Cars driving down a nearby highway, or in the case of an underwater job, a large school of fish

(Continued on page 76)

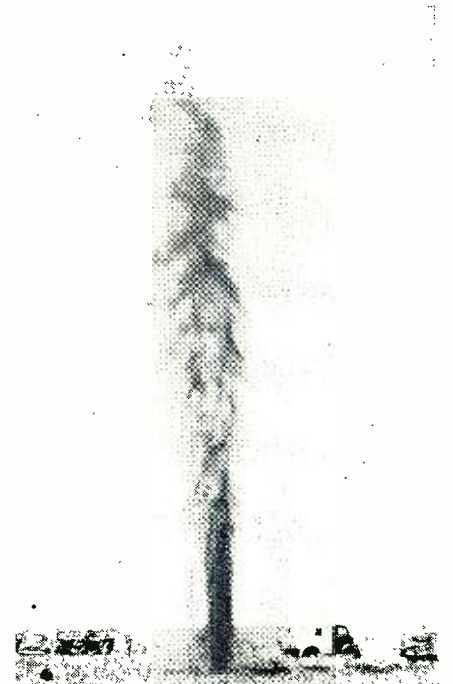

Fig. 5. Typical seismograph shot showing blowout when hole is left uncovered. Such blowouts are controlled when they are located near highways or buildings.



Fig. 6. Close-up of geophone and the method of planting it. Interval taps are provided for proper spacing of pickups.

Fig. 7. Recording and shooting truck showing cable reels in rear and instrument panel inside truck. Operators are shown studying the location record before moving their equipment to next point.

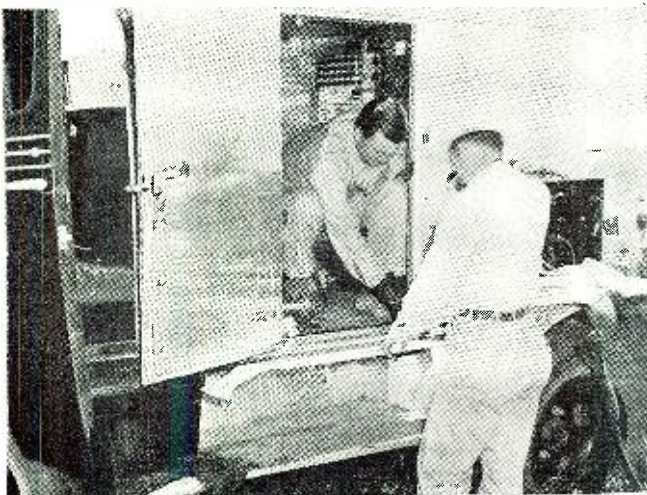
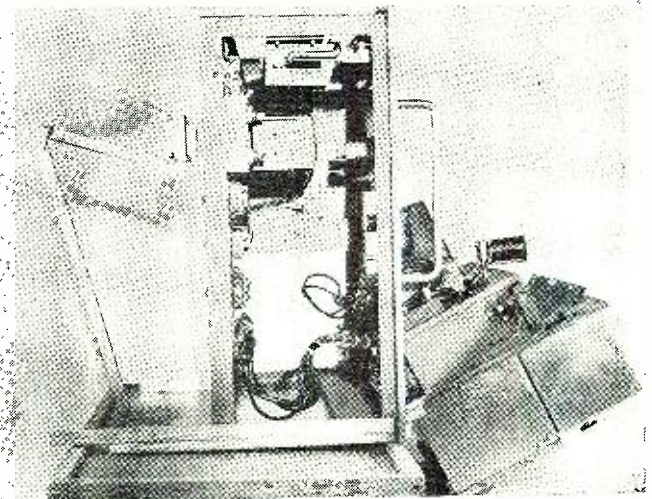

Fig. 8. Side view of a geophysical recording camera which has been opened for inspection and servicing. This instrument is of the mirror galvanometer type and is widely used in oil location.



A Simple Shutter SPEED METER

By
VERNON B. WESTBURG

IN these days of color film, exposure meters, range finders and high speed lenses, photography has developed into a specialized exacting science. The amateur photographer is anxious to make each shot count because he usually doesn't get a "second try" with the subject, and the professional likewise is anxious to avoid expensive retakes.

Electronics has been the great helper in the advance of photography. We have electronic synchronization, photoelectric aids to development, and photoelectric exposure meters. But there is still one notably weak link in the chain of photographic technique. It is the camera shutter. This is especially true with color work, where the latitude of the film is not great and the exposure must be exact for good results. The problem is this: How can we reliably measure shutter speed; for if we can measure it, we can either correct it or allow for it in making the exposure. Well, the obvious alternative is for us once more to rub the magic vacuum tube with the palm of our hand to summon our genie, Electronics.

Unfortunately, the answer is not as simple as that, for there are already devices designed for the job of measur-

Fig. 2. Desired shutter interval plotted against the ratio of actual to desired shutter interval for two camera shutters.

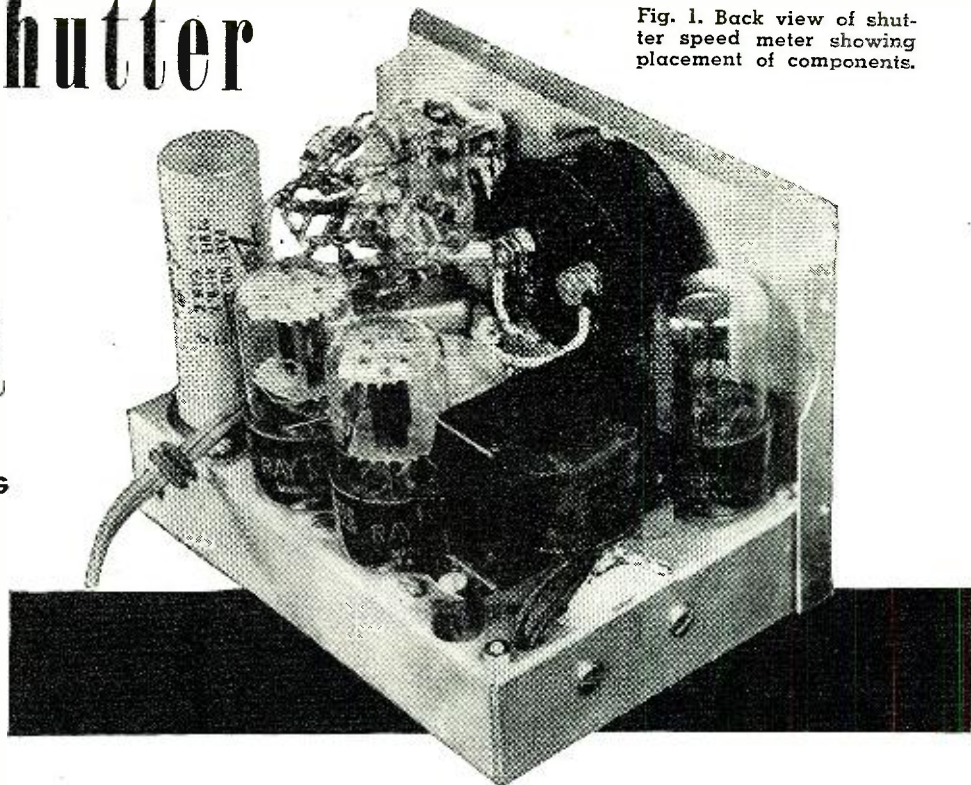
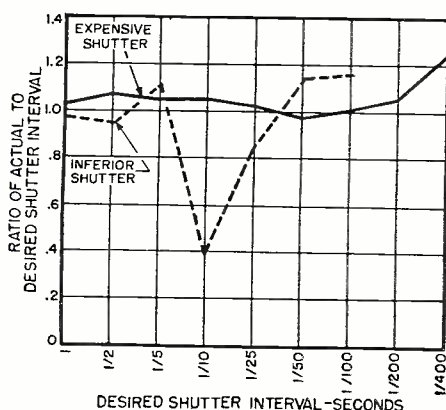

Fig. 1. Back view of shutter speed meter showing placement of components.

A useful device which should appeal to the serious camera enthusiast handicapped by a limited budget.

ing shutter speed. However, the price of these devices is out of line as far as the amateur photographer's pocketbook is concerned and are usually too expensive even for the local camera shop. Most of them are complicated and really require a trained operator.

The purpose of this article is to give a simple, cheap means of measuring shutter speed which may be adapted by anyone who has an interest in electronics.

The shutter speed meter described in this article is small and compact, measuring a mere 6½x4½x4 inches. It can be built for just a few dollars—using a phototube, two simple vacuum tubes, and a two-inch milliammeter. It is a.c. operated and can be used with any ordinary 100 watt light bulb as a light source. It is used in the following manner: The camera is opened and the light bulb is placed on one side of the lens at a distance of 3 or 4 inches. The shutter speed meter is placed within two or three inches of the lens on the opposite side and the shutter is tripped. The meter needle then moves up scale to read directly whether the shutter speed is correct, too slow, or too fast, and falls back again slowly to zero and is ready for another test.

It is important to mention that the shutter speed meter is a limiting device, and hence the indication on the meter is determined solely by the length of

time the shutter is open and does not depend on the exact intensity of light, as long as it is above a specified minimum value.

The shutter speed meter is shown in Fig. 3. On the front of the meter case we have the milliammeter which indicates the shutter speed under test, and the a.c. power (on-off) switch. On the left side of the case is the aperture for the phototube, with a removable window. Fig. 1 is the back view of the chassis. The meter was designed to be compact, but there is no undue crowding of parts. The circuit diagram is shown in Fig. 4.

Description of Circuit

Briefly, the operation of the circuit is as follows:

1. The light pulse which has passed through the shutter strikes the phototube and is converted into a voltage pulse of constant amplitude, regardless of the light intensity.
2. This voltage pulse is applied to an RC circuit, so that the final voltage on the condenser depends on the length of the pulse.
3. A meter is used to give an indication of this final voltage, which is a measure of the length of the pulse.

A phototube well suited for the purpose is the 929, because it has good

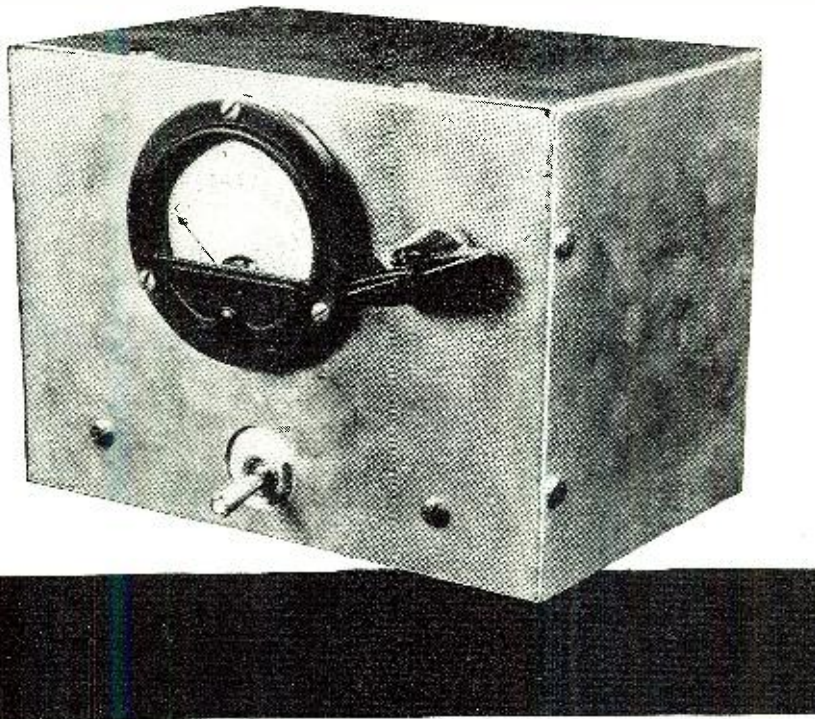

Fig. 3. Front view of shutter speed meter showing simplicity of controls.

sensitivity and because it is a vacuum type which will withstand rough treatment. A 925 or almost any other type might also be used, provided that sufficient light from the source is used to make up for reduced sensitivity. Both the 929 and the 6SN7's use octal tube sockets. Referring to the circuit diagram, Fig. 4, the load resistance, R_2 , R_3 and R_1 for the phototube is 30 megohms. To realize the required sensitivity it is necessary to use this high resistance, which means that this circuit should be shielded by braid (as shown on the circuit diagram) from 60-cycle pickup, unless the meter is operated on batteries. This high load resistance, however, allows us to use the output of the phototube directly—thus eliminating the stability problems of high gain amplifiers used in photoelectric applications of this type. Since the following stages are direct coupled throughout, leakage and charging problems of coupling condensers have also been eliminated.

The voltage pulse from the phototube is limited to a constant amplitude when the light flux which strikes it is above the minimum value of about two-tenths of a lumen. The voltage pulse is then fed to the first cathode follower, which acts as a buffer stage, since the phototube can only supply negligible power and cannot possibly drive the detector stage, which draws appreciable grid current.

The 1/4 watt, 105-125 volt neon bulb in the plate circuit of the phototube is to stabilize the plate voltage and therefore the limiting level of the phototube,

which would otherwise change with variations in line voltage and might affect the meter calibration. A neon bulb of this type (available in either bayonet or screw base) can be used as a

voltage regulator at about 60 volts where the current drain is slight.

The second cathode follower is a detector and it allows charging of the RC timing circuit (R_{11} through R_{21} and C_2) in the interval during which the shutter is open. The discharge of the same circuit is very slow because the tube is cut-off in the following interval and the only return path for the stored charge is through the very large cathode resistor, R_6 . Because of this slow discharge, energy is stored long enough to allow a peak indication to be read on the milliammeter. The voltage across the condenser, C_2 , of the RC timing circuit (which is a measure of the period of time the shutter is open) is applied to the grid of a third cathode follower, which acts as a power amplifier to deliver sufficient power to operate the milliammeter. The resistor, R_{23} , and condenser, C_3 , are for the purpose of over-damping, since most meters are slightly under-damped.

Now if the shutter is not open long enough, the condenser in the RC circuit will not have time enough to charge to the proper voltage and the milliammeter reading will be too low. If the shutter is open too long, the condenser will have time to charge beyond the proper voltage and the milliammeter reading will be too high. The proper constants in the timing circuit for the

(Continued on page 155)

Fig. 4. Complete circuit diagram for constructing the shutter speed unit.

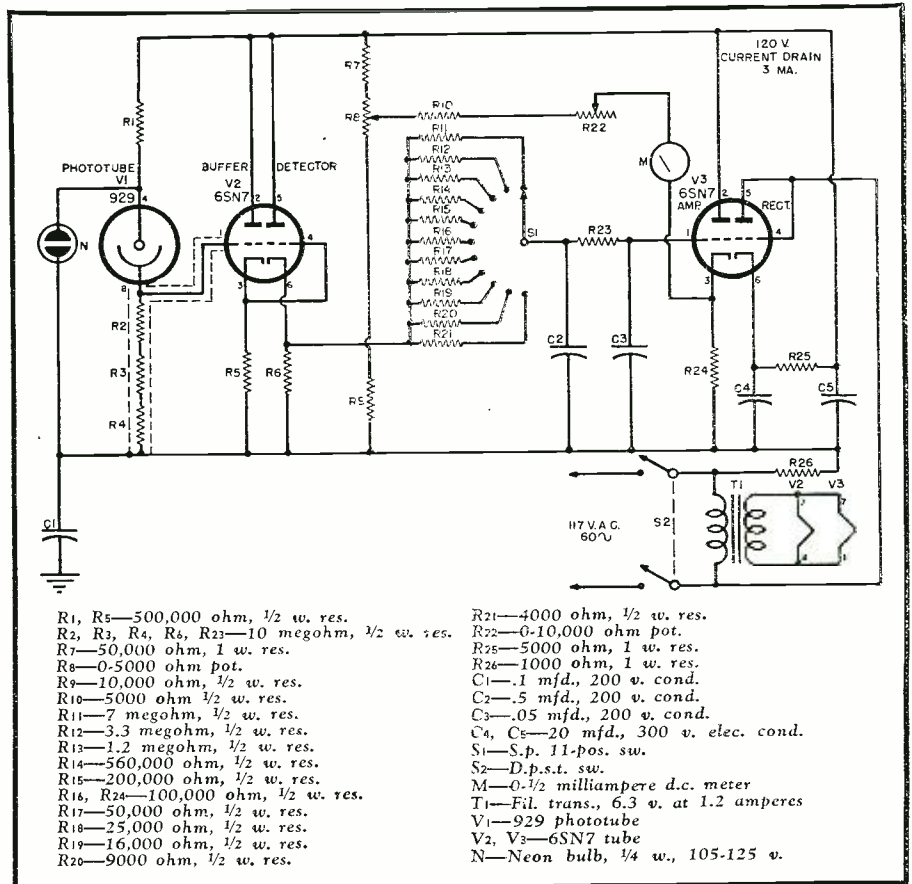



International SHORT-WAVE

Compiled by **KENNETH R. BOORD**

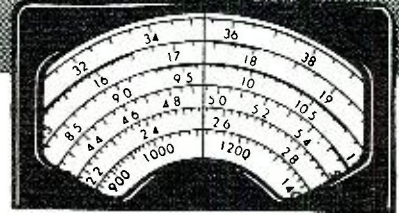

THIS month we are pleased to dedicate the *ISW Department* to radio in the Soviet Union. We are grateful to the *USSR Information Bulletin*, Washington, D. C., for the following material taken from an article in a recent issue of the *Bulletin*, entitled "Radio Broadcasts in the USSR," by P. Korzinkin and Georgi Kazakov:

"This is Moscow!" Broadcasting of more than 250 radio programs from the Soviet capital begins with these words. Moscow radio stations now transmit up to one hundred hours of various programs every day for listeners in the Soviet Union and abroad. The growth in volume of broadcasting from Moscow is seen from the following figures:

The number of hours of programs broadcast from Moscow stations amounted to seven thousand in 1930; 12 thousand hours in 1935; 23 thousand hours five years later, and exceeded 35 thousand hours in 1947.

Every day Moscow broadcasts 30 to 40 concerts, totaling more than 20 hours. Besides music, the amount of textual material which is transmitted from the Soviet capital's stations in different languages daily is sufficient to

fill 30 issues of a six-page newspaper.

Leading Soviet actors, composers, and writers participate in Moscow's radio programs. Sound recordings of noted singers of the past—such as Chaliapin and Sobinov—are included in the programs heard from Moscow. The All-Union Radio Committee has a collection of 25 thousand musical recordings.

The three main daily programs for Soviet listeners are broadcast from Moscow on 18 different wavelengths, and are well heard in all parts of the vast country. In addition to these programs, there are special programs for listeners in the Far East, Siberia, Central Asia and other regions where there is a considerable discrepancy between Moscow standard time and local time.

Moscow broadcasts are picked up in all countries of Europe, are heard in North and South America, in Africa, Australia, India, and China. Moscow radio stations transmit special programs (on short-wave) for foreign listeners. A special one-hour concert program is arranged for them daily.

Great progress has been made in the Soviet Union in developing radio, in building up a large-scale radio industry, and constructing new broadcasting sta-

tions. Millions of persons in the Soviet Union and beyond its boundaries hear the voice of Moscow. The entire listening world knows the call signals of the Soviet capital, bells playing the opening notes of the popular Soviet song, "Soviet Land, So Dear to Every Worker."

In addition to the broadcasts from the capital, there are many programs which originate and are broadcast locally.

As many as 1600 cities throughout the Soviet Union have their own local radio broadcasts.

Local broadcasts are directed by republican, territorial, and regional radio committees, whose task is to see that local programs reflect the life of the given republic or region.

Local radio broadcasts are conducted in as many as 70 different languages. Even such numerically small nationalities as the Tungus or Chukchi—who until Soviet times had no written language of their own—can now hear broadcasts in their native tongue. And these are not mere episodic programs, but regular well-produced daily broadcasts.

One distinguishing feature of local programs is the extensive participation of the public at large. Each republic and region has hundreds of its own radio correspondents. These are workers, collective farmers, intelligentsia. Thousands of persons take part in the daily programs.

Local programs are noted for their great variety. They include, first and foremost, news of life in the given republic or area. In big cities and capitals of the Union Republics, the local news bulletins are given over the air several times during the course of a day. Republics having a multi-national population give these bulletins in several languages. Local scientists, engineers, teachers, and physicians often speak over the air. Much time is given to popularizing the latest achievements of agriculture. These programs naturally concentrate on the principal branches of farming. The main subject in the agricultural programs of the Uzbek SSR is cotton; in Kursk Region, sugar beets; in Smolensk Region, flax. Among the

(Continued on page 106)

Besides giving its own concerts, the All Union Radio Committee broadcasts operas and plays direct from the best theaters in Moscow. Announcer E. Yemelyanova (left) beginning to announce Dargomyzhsky's opera, "The Mermaid", from the Bolshoi Theater. The sound is regulated by K. Barskova, shown seated next to the announcer in the broadcast booth.



Putting the 826 to Work



Fig. 1. Rear view of the three-tube transmitter, capable of operation on all bands from 10 through 80 meters, which uses an 826 as the final amplifier.

By **RICHARD L. PARMENTER, W1JXF**
and
C. E. CLARK, W1KLS

Construction details covering two and three tube rigs which use a popular surplus tube.

WHILE the tube bargains on the war surplus markets are far from being a novelty or surprise to the amateur, occasionally a type will be announced which seems to be quite worthwhile. One large distributor of war surplus items has featured the 826 tube in his advertising in two different issues of this magazine for the very nominal sum of 49 cents each. Other prices range from 75 cents to \$2.00, any of which are far below the regular amateur net price of about \$9.00.

Designed primarily as a very high frequency tube (80 watts output up to 250 megacycles) it performs very well on the lower frequency bands as may be seen by its use in the following transmitters. Since it is rated at 1000 volts on the plate it makes a nice tube to use in a final when stepping up from the commonly used 807. It is not touchy like the beam type tubes and the all too frequent problem of parasitics is avoided. It is easy to load and it will be found stable in operation and the excitation requirements are easily met. Neutralization is necessary, of course, but this presents no great problem to the builder who is tired of the tricky beam tubes.

If phone operation is desired for 10

and 11 meters, it will be realized that the modulation requirements of this tube are easily met. The overwhelming popularity of commercially-built transmitters in the 50 to 75 watt class would seem to indicate that more amateurs are able and willing to set up an outfit in this economical range than in the higher power brackets. This amount of power on 10 meters is sufficient to work plenty of DX as any ham who has been

on the band with an 807 will verify. Very satisfactory results can be had on 40 and 80 meter c.w. and if it is desired to operate on the v.h.f. a pair of these tubes in a grounded-grid final would provide a very respectable amount of power for 2 meters.

With the foregoing concepts in mind regarding the requirements of many amateur builders and the advantages of the 826 tube, the authors have built up the two rigs described herein for use in their own stations for frequencies up to and including the 28 mc. band. Each has advantages of its own and while both are far from being high power, both realize very closely the capabilities of the 826. The simpler outfit should have appeal as an easy-to-build project, requiring a minimum of parts and being

Fig. 2. Bottom view of the three-tube version showing placement of components.

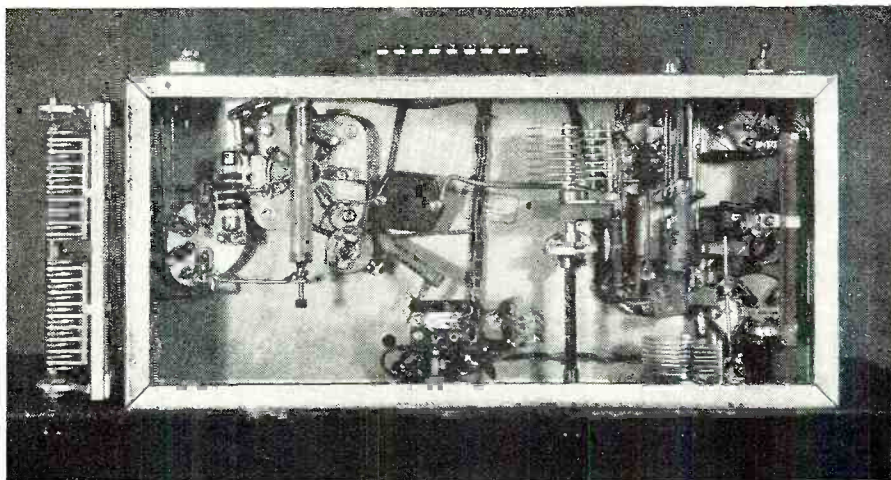

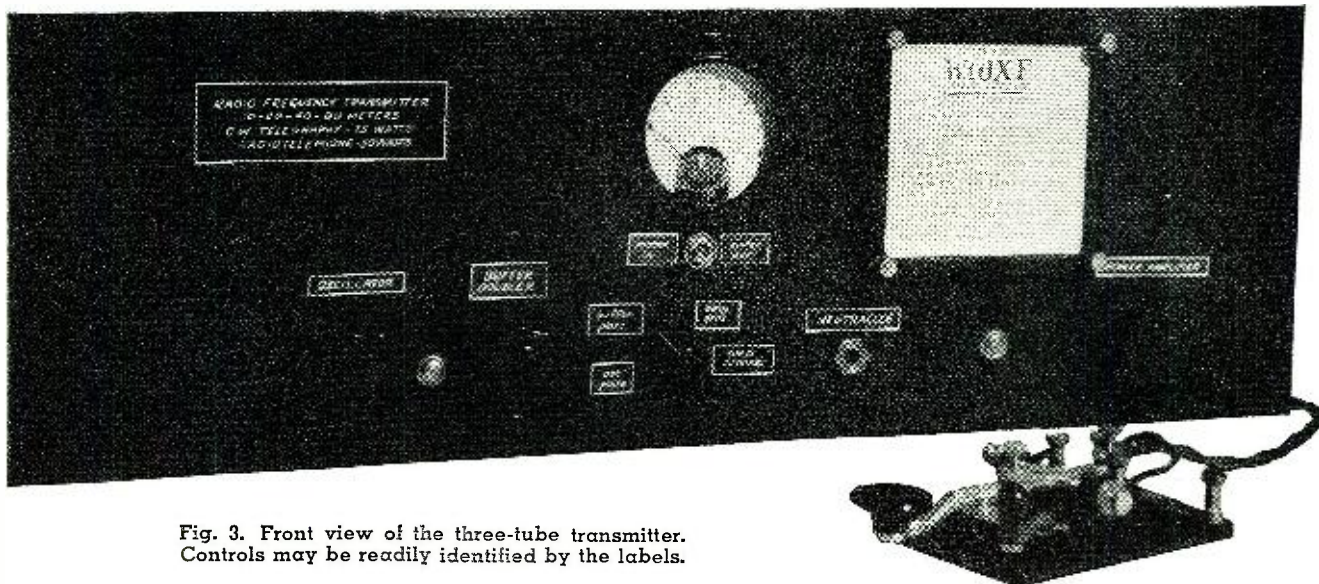

Fig. 3. Front view of the three-tube transmitter. Controls may be readily identified by the labels.

relatively foolproof in its operation. It makes an excellent beginner's rig and would also serve as a standby transmitter for an already established station undergoing modification. Using 40 and 80 meter crystals it provides output on three bands. The three-tube rig has incorporated an extra tube to act as buffer-doubler and by use of this extra stage will provide output on 80, 40, 20 and 10 and 11 meters, also being able to accommodate the 15 meter band when that is released to the hams. At present these rigs are on c.w. only and are described as such, however, a modulator for the three-tube outfit is coming up in the near future.

Two-Tube Transmitter

This transmitter, as built by W1KLS, comprises two stages with a crystal-controlled harmonic oscillator with output on either the fundamental or second harmonic. This circuit is familiar to many as one developed in recent years

primarily for doubling. It uses a minimum of parts and its efficiency is high on both fundamental and second harmonic with ample excitation for the final obtainable in either case. Keying is accomplished in the oscillator stage by the use of J_1 in the cathode circuit. If key clicks are troublesome a simple filter may be used here such as is described in the *ARRL* handbook. At the point marked X in the circuit diagram (Fig. 4) a 60 milliamperes pilot lamp may be inserted for crystal protection if desired. To maintain the screen voltage of the 6L6 at a reasonable figure under key-up conditions a voltage divider is used, consisting of R_2 and R_3 . The plate supply voltage for this stage should be in the neighborhood of 350 volts.

The final amplifier stage of this transmitter is a conventional form of class C triode being biased to somewhat beyond cut-off by a combination of grid-leak and battery methods. No current is drawn by this tube when idling and

good over-all efficiency is thus achieved. The plate circuit uses a split-stator type of tuning condenser to facilitate the neutralizing arrangement. The coils for L_1 are homewound, (data for which is given in Table 1 (oscillator section)). The coils for L_2 are commercially made and the data for these is also given in Table 1. Since the capacity of the final tank is rather low, on 40 and 80 meters the next lower frequency band coil will have to be used. This provides for a rather high L/C ratio and improves the output somewhat which is, of course, desirable as well as allowing for proper coverage on twenty meters.

Construction

The construction of this little transmitter is easy and few parts are used so no great detail will be given. The chassis used is 5" x 10" x 3" and is just about large enough to house all the parts without undue crowding. The layout of parts is shown pretty well in the photos and in order to get all the components in, this layout should be followed fairly closely. The oscillator section is mounted in one end of the chassis and the placement of the parts, as shown, allows for very short leads. The octal socket for the crystal is mounted on the back panel and the 6L6 socket and coil socket are in line on the top chassis. The tuning condenser C_3 is in line on the front panel. The 826 socket is mounted about mid-chassis and is sunk below the top about $\frac{1}{2}$ inch, the hole needed for clearance of the tube being 2" diameter. The final tuning condenser C_6 is mounted below chassis and this unit just fits into the chassis lengthwise. The coil, L_2 , uses a five-prong socket which is raised above the chassis about $\frac{3}{4}$ inch to allow for connections to be brought below. The link connections for this coil are brought out to two standoff insulators.

Fig. 4. Diagram of the two-tube version which operates on 80, 40, and 20 meter.

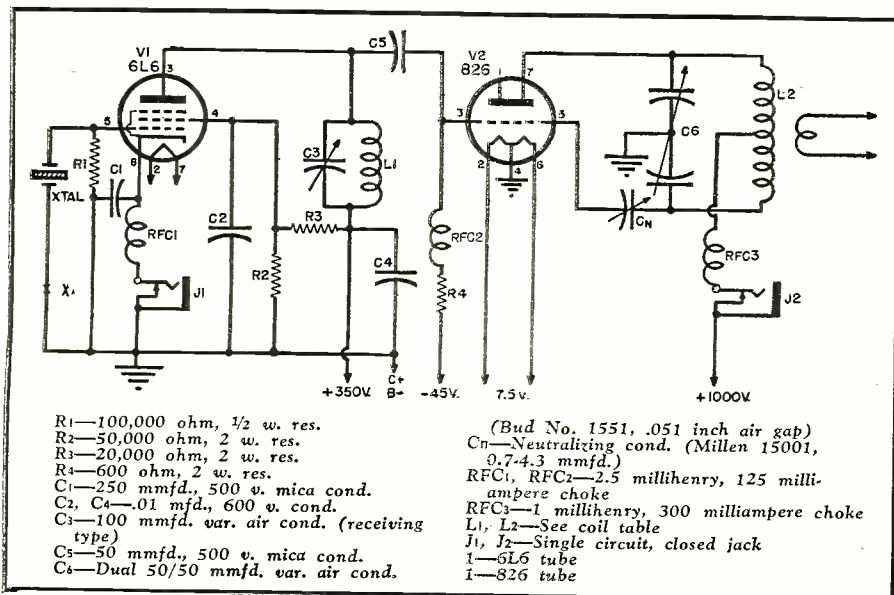

To keep expenses down and retain simplicity in keeping with reasonable ease of adjustment, no meters were incorporated in this outfit. A portable 0-200 milliammeter is used for tuning of the final amplifier, being plugged into J_2 . Metering for the oscillator plate and final grid is done by temporarily inserting a 0-100 milliammeter in these circuits externally. Afterwards tuning of the oscillator is done by a pickup loop and a Christmas tree bulb. The point of condenser setting which provides for maximum r.f. output, as indicated by this tuning lamp, will be very close to that indicated by the dip in plate current milliamperes on a meter and is sufficiently accurate for ordinary use.

Tune-Up and Operation

With all construction work done and power supplies connected as shown in the circuit diagram and with the bias battery connected, plug a key into J_1 . Assuming 80 meter operation is desired, insert an 80 meter crystal in its socket and an 80 meter coil in its place. Put a 0-100 milliammeter in the oscillator "B plus" lead, depress key for short intervals meanwhile tuning condenser C_3 across its range. The key should not be kept closed when the circuit is out of resonance since the current is high. At some place in the range of C_3 a pronounced dip will be observed in the oscillator plate current. Tune for maximum dip and then detune slightly on the low capacitance side of the dip to improve the keying qualities. (Some crystals do not start oscillating as readily as others and this adjustment is necessary for them). Consistent keying operation is improved by this slight detuning. If a 60 milliammeter pilot lamp was installed at point X in the circuit diagram the r.f. crystal current is indicated by a glow of varying brilliance in this bulb. Tuning of C_3 should be done for maximum r.f. output at the plate coil, consistent with a fairly low value of crystal current as indicated by the pilot lamp.

Now the 826 may be inserted in its socket and filament power only, 7.5 volts at 4 amperes, applied to this tube. Insert a 0-50 or 0-100 milliammeter in the 826 grid circuit, connecting plus on the meter to the proper terminal (-45 volts) on the transmitter and negative of the meter to the negative terminal of the 45 volt "B" battery. Now with the power on the oscillator retune C_3 for maximum grid current and r.f. output at L_1 using a tuning loop with bulb for indicator. It will be observed that maximum is the same point on both indicators showing that tuning in the future may be done with the tuning loop coupled loosely to L_1 . The grid current of the 826 should be at least 35 milliamperes and if not up to this value

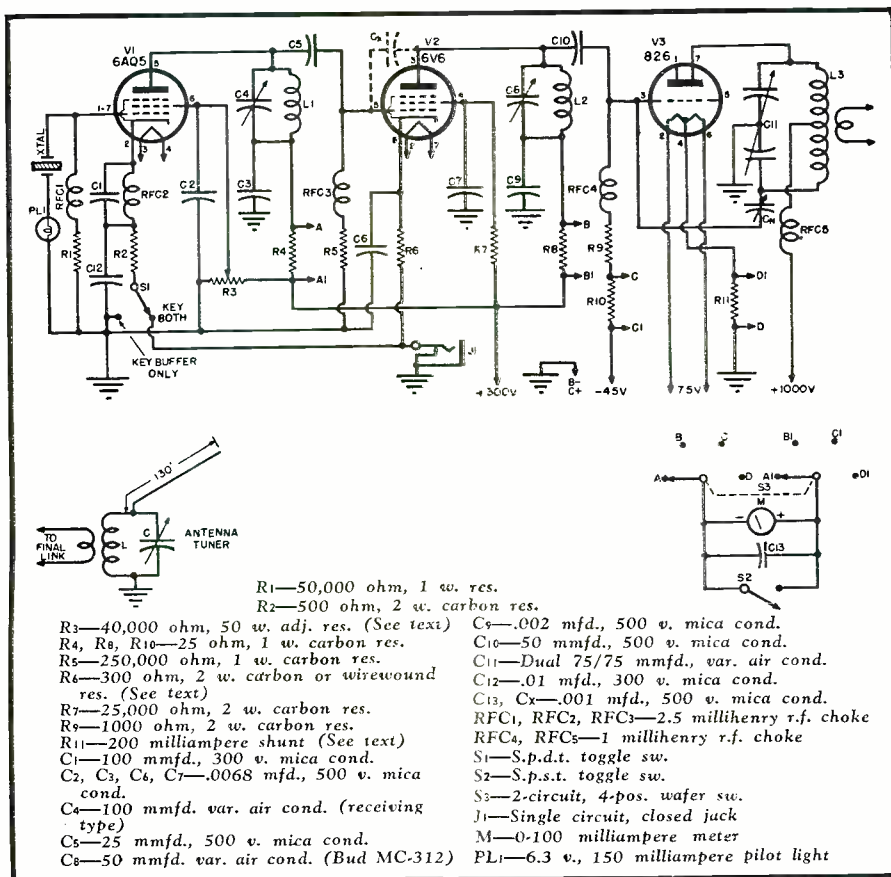

Fig. 5. Circuit diagram of the three-tube rig using a buffer stage.

readjustment of the plate and screen voltages of the oscillator are in order. The output of the oscillator may be increased somewhat by raising the screen voltage but this should be done with discretion since the r.f. crystal current will rise appreciably. Under load, the r.f. crystal current will decrease with this type of oscillator and if the oscillator is kept in a loaded condition, as it would normally be, a crystal current of damaging proportions may be avoided. It is well to be on the safe side here and avoid the possibility of ruining a good crystal.

Neutralization

The neutralizing procedure for a conventional triode is fully described in the various amateur handbooks but since it is simple it will be gone over briefly for the beginner. The oscillator should be in operating condition and the 826 in its socket with filament power applied but no plate voltage on the final. Tune the oscillator for maximum output as indicated by the grid meter. Now with a coil in L_2 of the same band of operation as the oscillator, tune the final tank condenser, C_8 , across its range with the

(Continued on page 145)

Fig. 6. The simplicity of the two-tube rig may be seen from this photo.

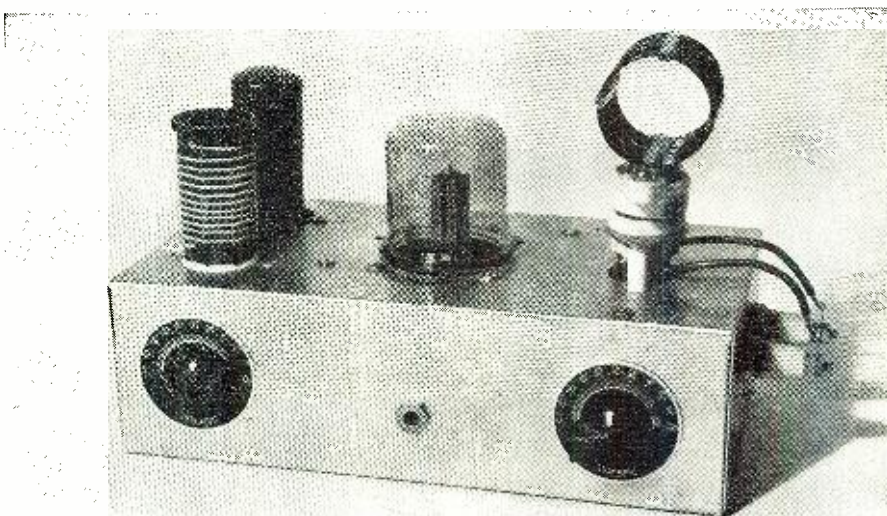

Low Cost All-Wave SIGNAL GENERATOR



This simple, easily-constructed unit covers 300 kc. to 24 mc., modulated or unmodulated, and provides for a 400 cycle audio output.

Fig. 1. Front view of complete signal generator. Four bands are used to cover r.f. range.

By HAROLD GOULD

SOONER or later in the career of the radio experimenter or amateur a stage is reached at which he needs a fairly reliable source of radio frequency voltage covering at least the range of the conventional all-wave spectrum. At such a stage his mind is apt to dwell on visions of that large chrome-trimmed model he saw in the radio dealer's window with the impressive array of dials and gadgets on its panel. The recollection of the sadly attenuated state of his finances is usually enough to bring him down to earth again. Realizing that it will be a considerable time before he can afford the deluxe job, he faces the fact that if in the meantime he is to acquire a signal generator, it must be one of his own making.

The writer, having experienced these primary frustrations, passes on this account of the results of his efforts with the hope that they will perhaps be of use to those of his fellow experimenters who are confronted by the same problems as he was. It should be stated at the outset that the instrument here described has been in use for over a year, and has fully demonstrated its usefulness.

After taking a mental inventory of

the junk box and having in mind a fairly clear idea of what was wanted, numerous back issues of radio magazines were consulted in hopes of finding a likely circuit. A great many of these circuits showed good possibilities, but in none of them could be found quite what was wanted. The plan of combining the desired features of several circuits was adopted, and after considerable experimenting and a few preliminary adjustments, the circuit to be discussed finally took shape.

In choosing the r.f. oscillator it was decided to utilize the electron-coupled type for reasons of its inherent stability and trouble-free qualities. A 12SK7 pentode fulfills this function, its plate circuit being coupled to the output cable by C_s and RFC_1 . The full r.f. voltage thus appears between the rotor of R_0 and ground. This method of connecting the output control was used because of the fact that a more constant impedance is presented at the output terminals. Condensers C_7 and C_8 were used to prevent the power line a.c. from shorting or burning out the potentiometer should either cable clip be accidentally touched to a "hot" chassis or wire. Their values are such that they present negligible reactance to the r.f.

current and a very high reactance to currents of the power line frequency.

In the actual wiring of the r.f. circuit the usual precautions should be taken to ensure that all connections are made as short as possible. To facilitate this, a strip of copper was used for all ground connections in the r.f. section. It was connected at one end to the point where the bandswitch's sub-panel is bolted to the chassis. This keeps the resistance of the ground connections at a small value.

The r.f. oscillator covers a range of from 300 kc. to 24 mc., approximately, in four steps or bands. A two-circuit, four-position rotary switch S_1 , selects any one of the four coils L_1 , L_2 , L_3 , or L_4 . The coils are tuned by a 365 mmfd. variable condenser of the midget broadcast type. Specifications for the winding of the coils are given in Table 1.

In the photograph of the sub-chassis wiring the relative position of the three highest frequency tuning inductances can be seen. They are so oriented as to offer a minimum of coupling between each other; this placing helps to prevent dead spots from appearing in the tuning range. Coil L_3 , being wound with thin wire, showed a tendency to shift around; to eliminate this a piece of heavy wire was soldered to an unused terminal nearby and the other end clamped onto the loose coil form, thus anchoring it firmly. The other coils are held rigidly and require no support. The

lowest frequency coil. L_1 , is mounted on the top side of the chassis by a metal angle.

A fifth coil, covering the lower frequency range of from 100 kc. to 300 kc., may be included in the instrument should the constructor think it necessary. In the writer's case, due to space limitations of the particular 8"x8"x8" cabinet available, the idea of including a coil of the size required for this seldom-used range had to be abandoned. In case the constructor has need for this range and the cabinet space to accommodate it, the specifications for the coil required are as follows: 500 turns of No. 32 enamelled wire, closewound on a form 2½ inches in diameter. The cathode tap would be made at 170 turns from the ground end. The band switch, S_1 , would require extra taps to handle this additional band. The particular switch available in the author's shack happened to have five positions, as the photograph of Fig. 1 shows. He hopes in the future to incorporate another range to make use of this extra tap; in the meantime range A , as marked on the panel, is unused, and the parts list specifies a four position switch.

The audio oscillator circuit, a version of the transitron oscillator using a pentagrid tube, is straightforward enough except for the frequency-determining inductance CH_1 , where a few words of explanation may be of assistance to the constructor. To bring the frequency to a value near 400 cycles, an inductance of between 1 and 2 henrys is required. This is a rather odd value but is easily provided in this case by simply removing the iron core of a

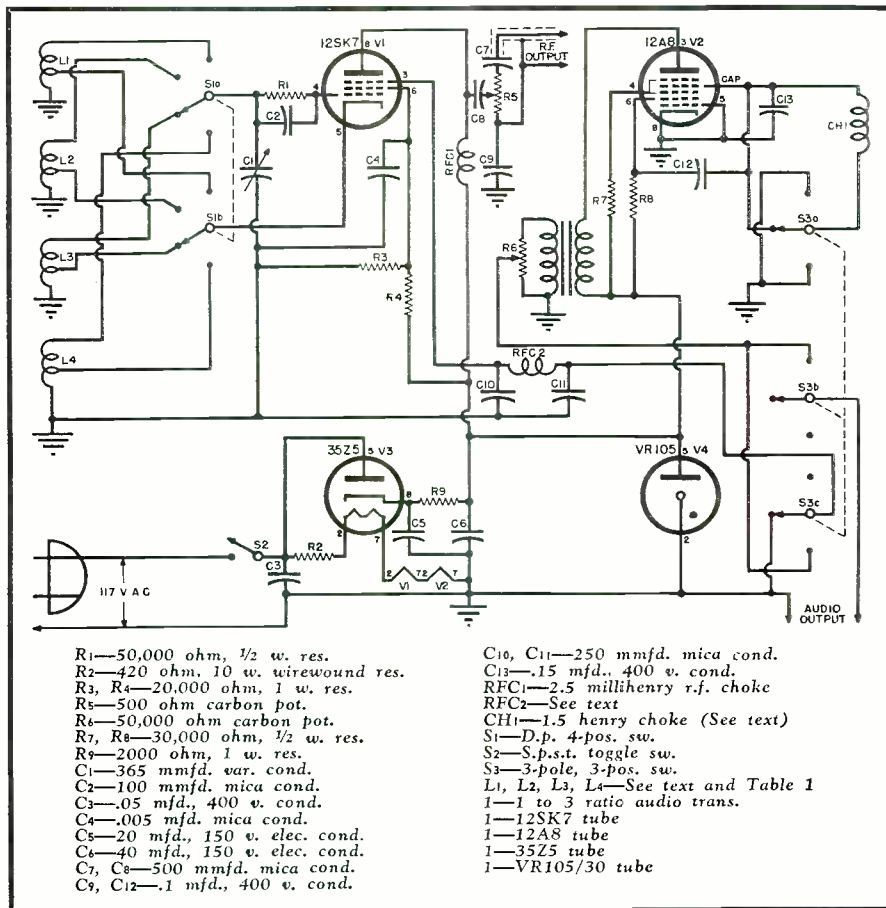

Complete circuit diagram and parts list covering the signal generator.

7 henry, 40 milliampere midget filter choke. To simplify the mounting of this coreless choke, a few bits of wood can be cut of the same cross-section measurements as the removed iron core. Then the original mounting strap can be used to fasten the altered choke.

The constructor may have to do a little experimenting to get the audio circuit to oscillate at the right frequency; this of course will depend on the particular inductance he uses. If the frequency is found to be too high it can

(Continued on page 160)

Top rear view of chassis showing location of component parts.

Under chassis view shows compactness of layout.

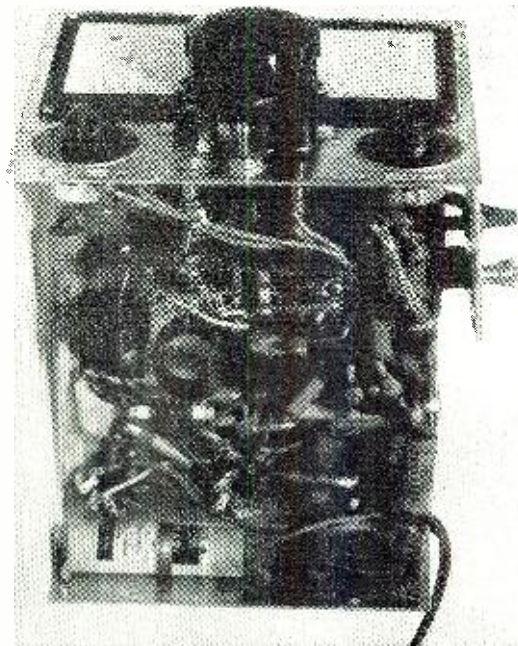
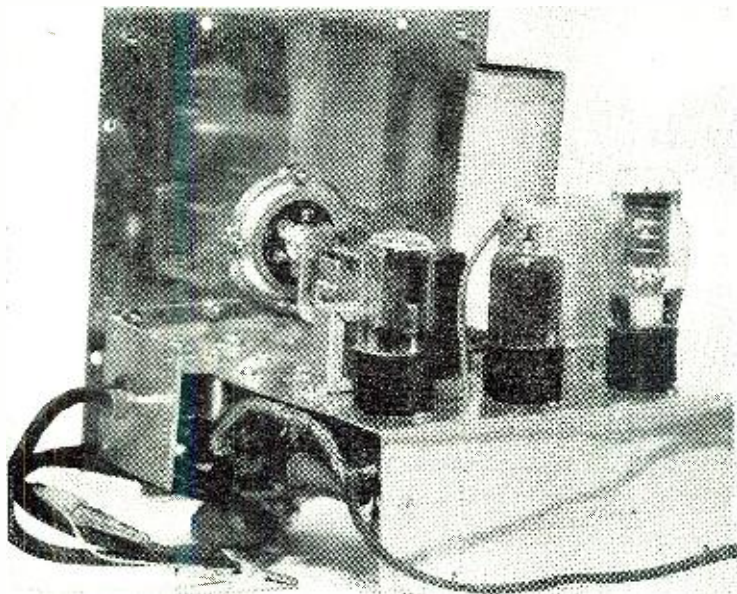

The chassis layout for
General Electric Models
801 and 802 TV receivers

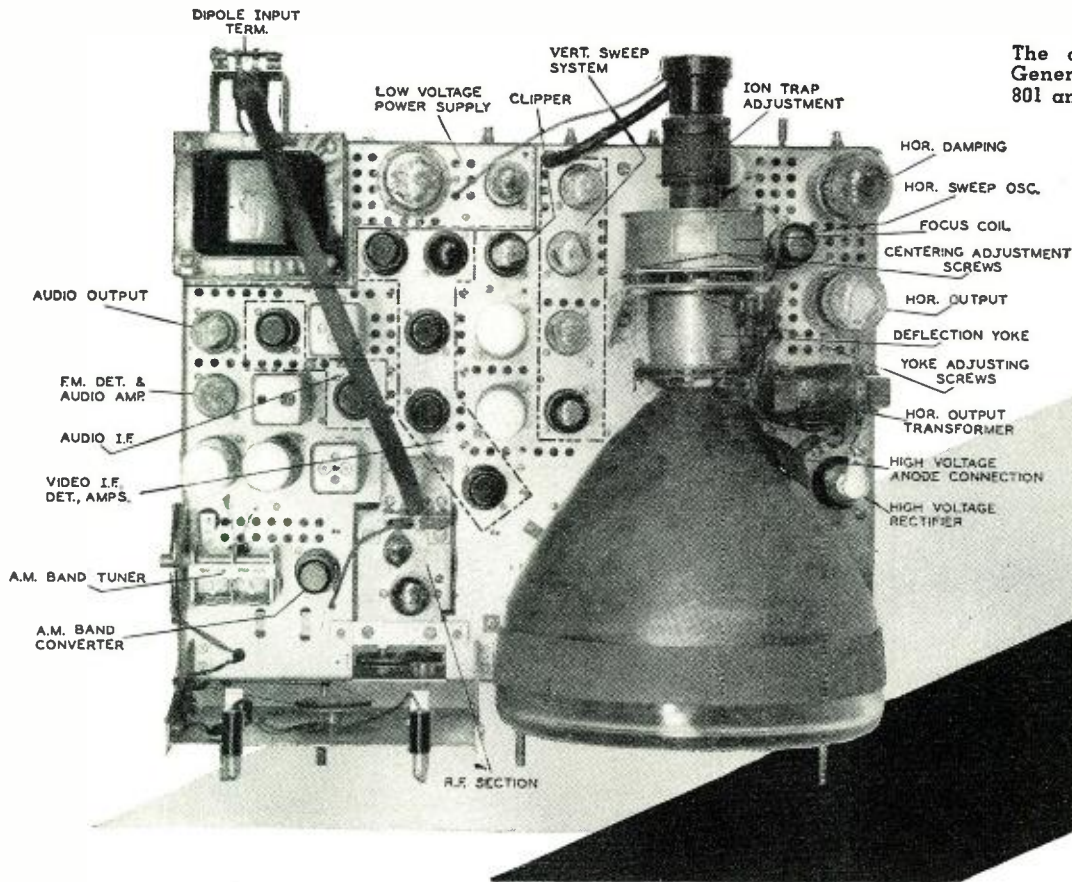

MODERN *Television* RECEIVERS

By MILTON S. KIVER

Part 4. A discussion of the various sound and video i.f. systems, and how the sound is separated from the video.

THE television signal, at the output of the mixer, has been reduced to its i.f. frequencies. In a typical receiver, the audio carrier would be at 21.25 mc. and the video carrier, 4.5 mc. above this, or at 25.75 mc. Between 25.75 mc. and 21.75 mc., we have the full 4.0 mc. of the video picture modulation. The problem now facing the set designer is the separation of these two signals in order that each may be applied to its respective system. The video signal is amplitude-modulated and contains the blanking and synchronizing pulses together with the picture information. The audio signal, on the other hand, is frequency modulated. If the audio carrier and its modulation are permitted to reach the video second detector, slope detection will occur, producing an equivalent audio signal at the detector output. The path will then be unobstructed for this audio signal to reach the control-grid of the cathode-

ray tube, and horizontal black and white bars will be visible on the screen. To prevent this, the FM sound signal is separated from the video signal at some point after the mixer, but before the video second detector. Furthermore, special trap circuits are placed at various points in the video system to

doubly insure that no audio voltage reaches the cathode-ray tube.

The foregoing method is followed by nearly all television receiver manufacturers. Recently, however, a system has been developed which permits the sound and video carriers to remain together until the stage preceding the cathode-ray tube, without adversely affecting the image. This system, known as the "Inter-carrier System," possesses several advantages over the current system. Chief among these is economy, due to a reduction in the number of stages required for successful set operation. Currently, the *Motorola* Model VT-71 receiver is the only set in quantity production which utilizes the "Inter-carrier System." However, many additional receivers employing the "Inter-carrier System" are contemplated, and a complete discussion of the operation of this system will be given in a subsequent article. Since only one such receiver is

Fig. 1. The separation network in RCA television receivers.

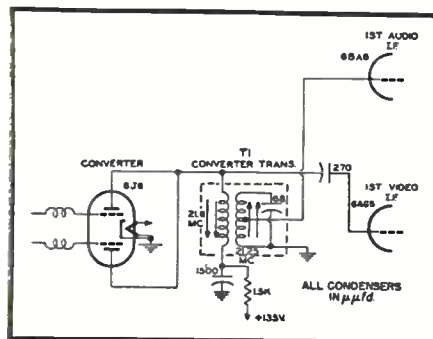

on the market now, little will be lost if we disregard it, for the moment, and turn our attention to the remaining receivers, all of which operate along similar lines.

Separation of the video and audio signals can be accomplished by several methods. In *RCA* receivers, the converter transformer (T_1 in Fig. 1) is a combination video i.f. transformer, sound trap, and sound i.f. transformer. The primary winding of T_1 is peaked at 21.8 mc., but since the frequency response is fairly wide, all of the video and sound frequencies appear across it. The secondary of T_1 is a high Q resonant circuit, sharply peaked to 21.25 mc., the audio i.f. carrier value. The resonant circuit absorbs the audio i.f. component from the primary, transferring it to the grid of the first audio i.f. amplifier. The rest of the signal on the primary of T_1 is unaffected by the trap and continues on into the video i.f. system.

It should be noted that the secondary of T_1 , although it absorbs a considerable portion of the audio i.f. voltage appearing across the primary, does not absorb all of it. Hence, a second, and sometimes a third audio trap will be found at a subsequent point in the video system.

Admiral sets employ the same type of separation circuit because their r.f. tuner is similar to the *RCA* tuner. Quite similar is the *Andrea* method of separation, although its r.f. tuner differs appreciably from that of *RCA*.

In *DuMont* receivers, we find several different methods of signal separation. In the RA-101 model, the signal separation circuit shown in Fig. 6 is employed. The tuned circuit in the plate of the mixer tube is designed to pass signals having frequencies between 21.5 and 26.4 mc. The sound i.f. frequency, together with a portion of the video signal, is picked off prior to the tuned circuit and applied to the grid of the

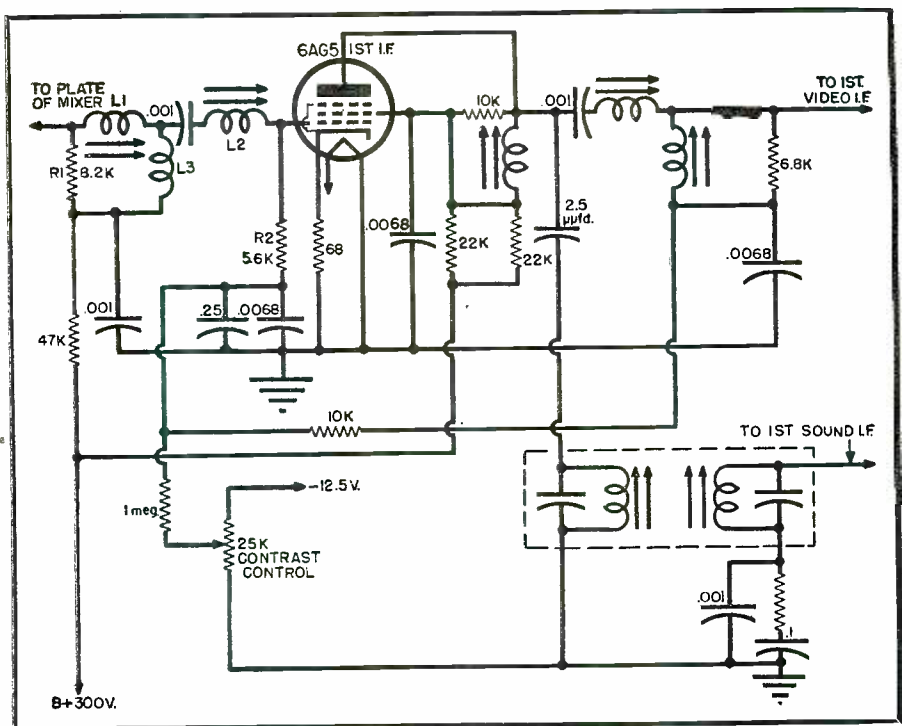

Fig. 2. Signal separation in the DuMont Model RA-103 occurs at the plate circuit of the first i.f. amplifier. A series resonant circuit is used.

first audio i.f. amplifier. Although the full signal (audio and video) is applied to the audio system, only the FM audio portion is effective because of the limiter stage which precedes the FM detector. The limiter removes all amplitude modulation, permitting only the frequency variations or modulation to pass. *Industrial Television* has the same type of signal separation circuit.

In the *DuMont* model RA-102 receiver, signal separation is accomplished as shown in Fig. 3. C_1 , in conjunction with the parallel combination C_2 and L_1 form a series resonant path from the plate of the mixer to ground at the sound i.f. frequency. In any series resonant circuit, the opposition offered to an applied voltage is low when its frequency is equal to the resonant frequency.

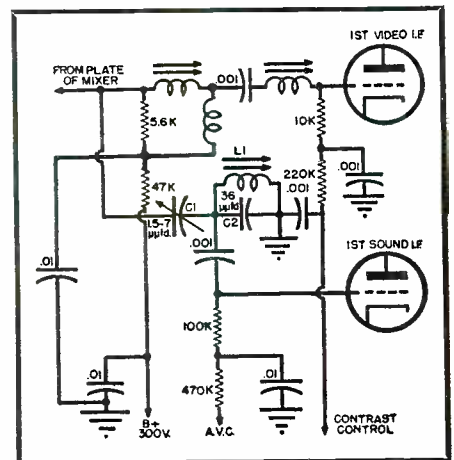

Fig. 3. The series resonant circuit, C_1 , L_1 , and C_2 , used to separate the audio and video intermediate frequencies in the DuMont Model RA-102.

Fig. 4. The audio intermediate frequency system used in *RCA* television receivers.

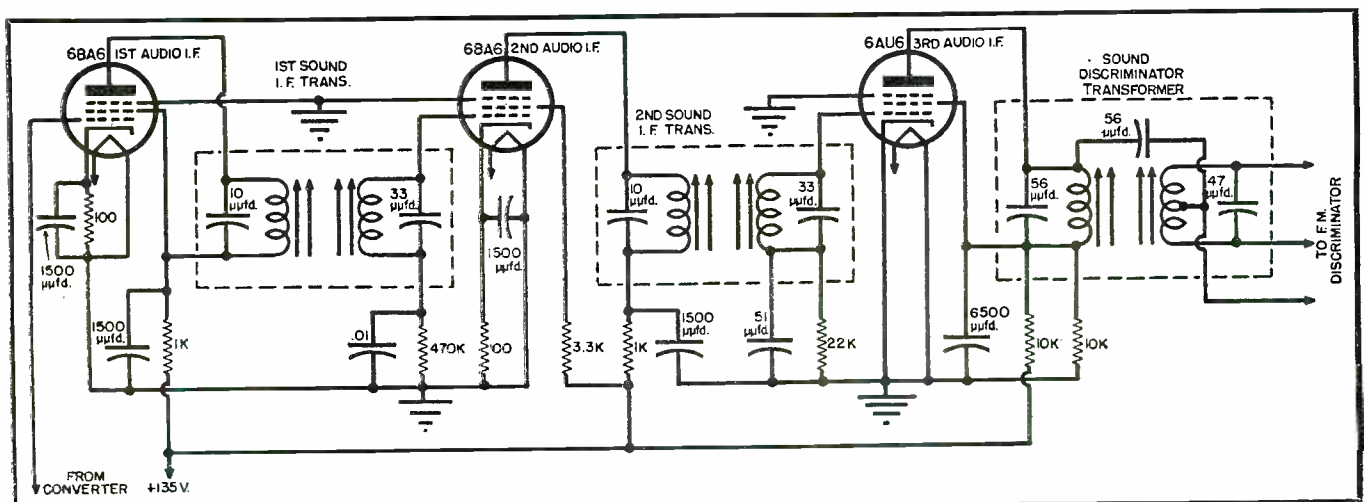

Table 1. A comparison of present-day television receivers. The chart below includes only those models which are on the market and which have been discussed in the articles thus far. As new models become available, they will be added to chart and adequate explanation of their operation given.

Manufacturer	Model No.	Picture Type		Tube Size Diam.	Screen Size	Model Type		Tuning Method		R. F. Amp.	R. F. Osc.	Mixer	Intermediate Frequencies		Composite I. F. Stages	Sound I. F. System
		Direct	Proj.			Table	Console	Continuous	Selector Switch				Sound	Video		
Admiral	30A14	X		10	6 x 8		X		X	6J6 ⁶	6J6 ⁶	6J6 ⁶	21.25	25.75	None	2-6AU6 Amplifiers—No Limiters.
	30A15	X		10	6 x 8		X		X	Same as Model 30A14						
	30A16	X		10	6 x 8		X		X	Same as Model 30A14						
Andrea	T-VJ12	X		12	7½x10	X		X ¹		6J6	6J6	6AG5	21.70	26.20	None	4-6BA6 Amplifiers—No Limiters.
	C-VJ12	X		12	7½x10		X		X ¹	Same as Model T-VJ12						
	CO-VJ12	X		12	7½x10		X		X ¹	Same as Model T-VJ12						
Belmont	21A21	X		7	5½x 4¼	X		X		6AK5	6C4	6AK5	22.25	26.75	6AH6	2-6BA6 I. F. No Limiters. 2-6BA6 No Limiters.
	22A21 22AX21	X		7	5½x 4¼	X		X		6AK5	6C4	6AK5	22.25	26.75	6AH6	
	22AX22	X		10	6¼x 8¼		X	X		Same as Model 22A21 except for C.R.T.						
Du Mont	RA-101	X		See Note 4			X	X		6J6	6J6	6AK5	21.90	26.40	None	3-6BA6 I. F. 2-6AU6 Lim. 2-6BA6 I. F. 1-6AU6 Lim. 1-6AU6 I. F. 1-6AU6 Lim.
	RA-102	X		See Note 8			X	X		6J6	6J6	6AK5	21.90	26.40	None	
	RA-103	X		12	7½x10	Note 5	X		X	6J6	6J6	6AK5	21.90	26.40	6AG5	
Farnsworth	GV-260	X		10	6 x 8	X		X		6BA6	½-6J6	6AG5	21.75	26.25	2-6AC7	No I. F. 1-6AC7 Lim.
General Electric	801	X		10	6 x 8		X	X		6AU6	½-7F8	½-7F8	21.90	26.40	6AC7	1-6SG7 I. F. 1-6SV7 Lim.
	802	X		10	6 x 8		X	X		Same as Model 801						
Industrial Television Inc.	IT3R	X		See Note 3			X ⁷			6J6	6J6	6AK5	21.90	26.40	None	2-6SH7 I. F. 1-6AC7 Lim.
Motorola	VT71	X		7	4½x 6	X		X		½-7F8	½-7F8	½-7F8	See Note 9		Note 10	1-6AU6 Partial Lim.
	VT101	X		10	6½x 8½		X	X		6AG5	½-6J6	½-6J6	21.90	26.40	6AG5	2-6BA6 I. F. 1-6AU6 Lim.
Philco	48-1000	X		10	6 x 8	X		X		6AG5	6J6	6AG5	22.10	26.60	6AG5	2-7W7 I. F. No Limiter
	48-1050	X		10	6 x 8		X	X		Same as Model 48-1000						
	48-2500	X		5	15 x20		X	X		6AG5	6J6	6AG5	22.10	26.60	6AG5	2-7W7 I. F. No Limiter
RCA	621TS	X		7	4½x 5½	X		X		6J6	6J6	6J6	21.25	25.75	None	1-6BA6 I. F. 1-6AU6 Lim.
	630TS	X		10	6½x 8½	X		X		6J6	6J6	6J6	21.25	25.75	None	2-6BA6 I. F. 1-6AU6 Lim.
	721TS	X		10	6½x 8½	X		X		6J6	6J6	6J6	21.25	25.75	None	1-6BA6 I. F. 1-6AU6 Lim.
	630TCS	X		10	6½x 8½		X	X		Same as Model 630TS						
	721TCS	X		10	6½x 8½		X	X		Same as Model 721TS						
	730TV1	X		10	6½x 8½		X	X		Same as Model 721TS						
	730TV2	X		10	6½x 8½		X	X		Same as Model 721TS						
	641TV	X		10	6½x 8½	X		X		6J6	6J6	6J6	21.25	25.75	None	2-6BA6 I. F. 1-6AU6 Lim.
	8TS80	X		10	6½x 8½	X		X		Same as Model 630TS						
	648PTK	X		5	15 x20		X	X		6J6	6J6	6J6	21.25	25.75	None	2-6BA6 I. F. 1-6AU6 Lim.
Stromberg-Carlson (See Note 11)	TV10L Series 10	X		10	6½x 8 11/16	X		X		6AK6 ¹²	6C4 ¹²	6AK5 ¹²	21.60	26.10	3-6AG5	1-6AG5 I. F. 1-6AG5 Lim.
	TV10L Series 11	X		10	6½x 8 11/16	X		X		6AK6 ¹²	6C4 ¹²	6AK5 ¹²	21.60	26.10	3-6AG5	1-6AG5 I. F. 1-6AG5 Lim.
	TV10P Series 11	X		10	6½x 8 11/16	X		X		Same as Model TV10L (Series 11)						
United States Television	T-502	X		10	6 x 8		X	X ²		6AG5	6AK5	6AK5	10.7	15.2	None	2-6AC7 I. F. 1-6S7 Lim.
	T-507	X		5	21 x16		X	X ²		6AG5	6AK5	6AK5	10.7	15.2	None	2-6AC7 I. F. 1-6S7 Lim.
	T-525	X		5	25 x19		X	X ²		Same as Model T-507						
	T-530	X		5	30 x22½		X	X ²		Same as Model T-507						
	T-621	X		5	22¼x16¼		X	X ²		Same as Model T-507						
	T-10823	X		10	6 x 8	X		X		6J6 ¹³	6J6 ¹³	6J6 ¹³	21.25	25.75	None	2-6BA6 I. F. 1-6AU6 Lim.
T-15823	X		15	9 x12	X		X		Same as Model T-10823 except for C.R.T.							

¹The Andrea receivers employ a tuner "turret" which is somewhat similar to the Philco except that all 13 channels are wired into position. The r.f., mixer, and oscillator tubes, with their circuit components, are also contained within the copperplated steel case. This reduces reradiation and protects the circuits from external fields.

²The r.f. tuning circuits of U.S.T. receivers closely resemble those employed in G.E. receivers. See explanation in Part 1 of this series.

³Industrial Television receivers are designed solely for commercial use. The picture tube is housed separately and controlled by a control unit located some distance away. Picture sizes can range from 6x8 inches for a 10-inch diameter tube to 13¼x17¼ inches for a 20-inch diameter tube.

⁴The set appears in six different style cabinets: Hampshire, Sherwood, Westminster, Revere, Plymouth, and Devonshire. Differences between models are in the size of the cathode-ray tube. The Hampshire and Westminster use a 20-inch tube; the other four models use a 15-inch diameter tube.

⁵This model receiver is available in three types of cabinets, two of which are table models and one is a console.

⁶Models 30A14, 30A15, and 30A16 employ an r.f. end section which is very similar to the RCA front end system.

⁷Industrial Television employs the "Inductuner" in an arrangement similar to that found in DuMont receivers.

⁸The set is housed in either the Clifton style cabinet, employing a 12-inch diameter cathode-ray tube (12JP4), or the Club style cabinet, employing a 15-inch tube (15AP4).

⁹For channels 1-6 video i.f. is 26.4 mc. and audio i.f. is 21.9 mc. For channels 7-13, video i.f. is 22.5 mc. and audio i.f. is 27.0.

¹⁰Uses Inter-carrier System.

¹¹Series 11 receivers have automatic frequency control of the horizontal frequency; Series 10 do not.

¹²The r.f. coils are mounted on a small bakelite strip which is then fastened to a motor driven rotating drum. Space is provided for 13 strips to cover all channels. The coils cannot be realigned but must be returned to factory if trouble develops.

¹³The r.f. stages are very similar to the RCA front end system.



SURVIVAL OF THE FITTEST

PUSHOUT: No push-over for speakers is this magnet test which checks the strength of the combination of seal and cement up to 1500 pounds.

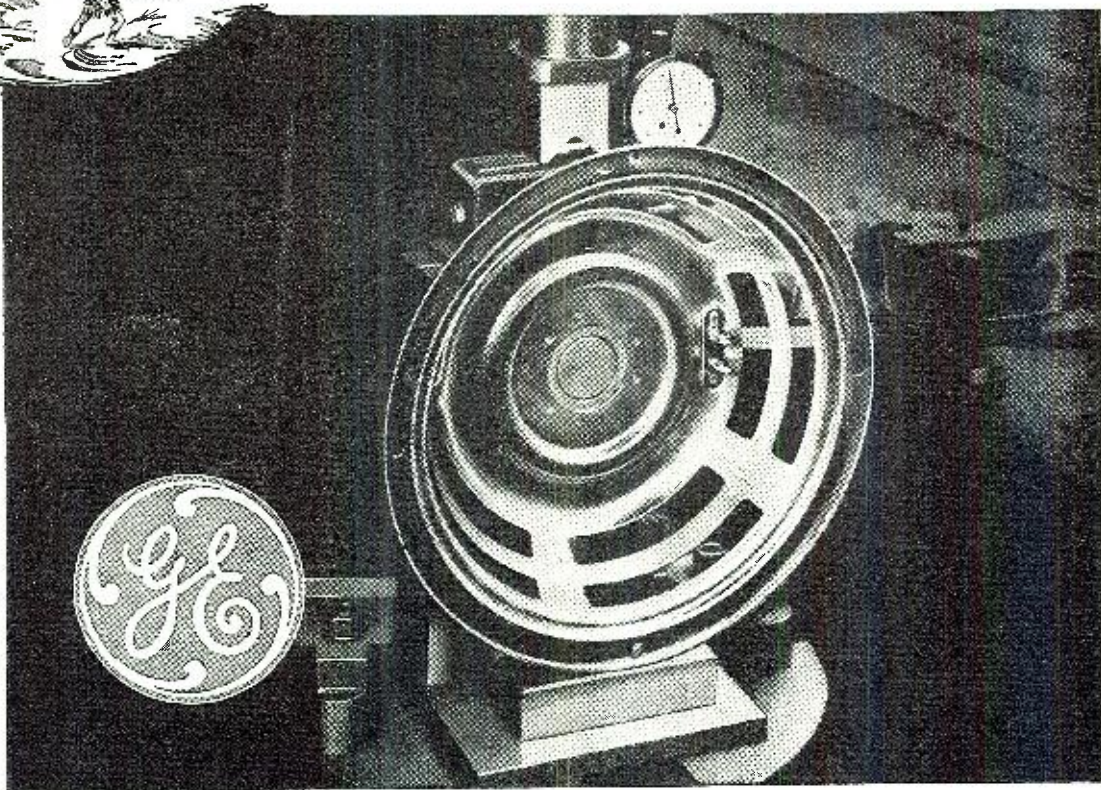

MEANS FINER SPEAKERS FOR YOU

ONLY the fit survive the stern tests our G-E speakers meet on the production lines. At frequent intervals speakers are picked from the lines and subjected to rigid tests to assure the maintenance of high standards in the manufacturing process.

Test after test is applied

to single elements, combinations of elements and to the final, completed units. The test shown here is only one of the many that General Electric speakers face as they roll down the production lines. This unceasing care in building speakers of quality builds confidence and customer satisfaction.



Write today for information on General Electric quality speakers to:
General Electric Company, Electronics Park, Syracuse, N. Y.

GENERAL  **ELECTR C**

HAMS! EXPERIMENTERS! Look at these EXCLUSIVE "G & G" BUYS!

JUST RELEASED! B-29 BOMB SIGHT ASSEMBLED BY SPERRY GYROSCOPE CO.

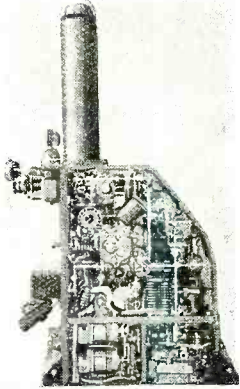

**HUNDREDS
OF USES
THOUSANDS
OF VALUABLE
PARTS**

**Cost to
U. S. Govt.
\$21,000
Cost to
You**

\$16900

Recently declared a war surplus item, this bomb-sight is now selling at a ridiculously low price! As parts or as precision units, this P-4 Computer can be used to make instrument and machinery repairs, in manufacturing and assembling, in home and industrial workshops. It can be used in teaching aeronautics, engineering, navigation, physics, optics, mechanics, etc. An invaluable machine for
**EXPERIMENTERS
PHYSICISTS
SCHOOLS
RESEARCH MEN
MECHANICS
OPTICIANS**

**LABORATORIES
TECH INSTITUTES
ENGINEERS
REPAIRMEN
MANUFACTURERS
ELECTRICIANS**

Comes in three units—the main body and two attachable periscopes, 22 and 68 inches high, alternate parts of an intricate optical system made by Eastman-Kodak Co. Main body is 35x25x14 inches. Contains at least 8 27 VDC motors, electric heater and temp. control, precision sextant, dozens of switches and controls, hundreds of fine gears and driving rods all types. Shipping wt. 250 lbs.

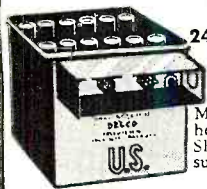

TERRIFIC VALUE! 24-VOLT STORAGE BATTERY, BRAND NEW! 17 AMP. HRS.

Made by Delco. 12 cells, heavy duty, very rugged. Shipped dry, uses standard sulphuric acid electrolyte.

**VERY SPECIAL . . .
\$16.95**

SPECIAL! 24 VOLT DELCO 12-CELL STORAGE BATTERY 11 ampere-hours. Only a few left at **\$14.95**

Down Come Prices! CATHODE RAY TUBES

All Brand New, in
Original Cartons



5BP1 Lots of 4, each \$1.79
5BP4 Lots of 4, each 1.95
3FP7 Lots of 4, each 1.49

304TL Eimac, each \$1.88
GE-211 Each 1.22

McElroy Automatic KEYER



Suitable for keying transmitter, or for code practice. Has photoelectric cell and sensitive relay. Variable speed motor operates on 110 volts 60 cycles AC. or DC. complete with 2-11726 and 1-11717 tubes, **\$14.95** your cost

BRAND NEW GE THYRATRON FG-105



MERCURY VAPOR RECTIFIER

**One of the most
Sensational Values
we've ever offered!**

**INDIVIDUALLY BOXED
in factory sealed cartons.**

List Price \$40.00

Your Cost

\$11.95 While they
last
each

For industrial electronics shops, and experimenters, here's a tube of a hundred uses!

One of the best tubes ever designed for continuous service and welder control service. Selling at far below the usual price, the FG-105 has a wide variety of industrial, commercial, and domestic applications. Now's the time to stock up. **YOU SAVE PLENTY!** Rugged, long life, flexible! **ORDER NOW!** SPECIFICATIONS: Tetrode, indirectly heated cathode. Peak voltage—10,000v. Inverse peak—10,000v. Average max. current: 6.4 amps on continuous service; 2.4 amps to 4 amps on welder-control service.

DC AMMETER 0-15 Amps



Terrific buy at this price! Has $3\frac{1}{2}$ " easy-reading scale with 75 divisions. Two binding posts. Black plastic case $4\frac{1}{2}$ " x $5\frac{1}{4}$ " x $2\frac{1}{4}$ ". Rubber covered test clip leads included, all in black metal carrying case

with hinged cover. **BRAND NEW.** Wonderful for automotive, battery charging, and general test work. Value \$25.

All yours for only **\$3.99**

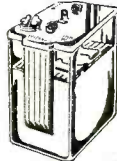

WILLARD 2-VOLT STORAGE BATTERY 20 Ampere-Hours

Exact replacement for GE portables — brand new. Each **\$1.49**

WILLARD 6-VOLT STORAGE BATTERY 27 amp. hrs.

3-cell battery, transparent plastic case, very specially priced. **\$4.50**

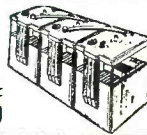

1-QUART BOTTLE BATTERY ELECTROLYTE Made by Willard, for above storage batteries. 1 qt. sufficient for two 2-volt cells. Hermetically sealed. **SPECIAL. per qt. bot. 95c**

7-PRONG 2-VOLT RADIO VIBRATOR for Portable and Farm Sets Replacement for GE LB 530. **\$1.65**

GOULD 6-VOLT STORAGE BATTERY Navy Standard, Black Rubber Case. **BRAND NEW.** 15 Amp. Hour Rating **\$4.95**

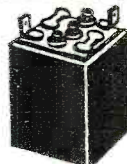

WILLARD 6-VOLT STORAGE BATTERY Similar to above but in transparent plastic case. Real value at **\$4.95**

QUANTITY PRICES

Inquiries welcomed from institutions, wholesalers, dealers, large users . . . Phone, write, wire for quantity prices.

Please include 25% Deposit with order — Balance C.O.D. Minimum order \$3.00. All Shipments F.O.B. Our Warehouse N.Y.C.

G & G GENUINE MAJESTIC
RADIO PARTS SERVICE
53 VESEY STREET · NEW YORK 7, N.Y.

SENSATIONAL Smash Value!

COMPLETE I.F.F. Equipment RC-188-A

Bargain opportunity of a lifetime! This I.F.F. equipment originally cost about \$20,000 . . . now buy it for a tiny fraction of cost! Easily converted for Television. Complete assembly consists of Control unit with 5" C.R. Tube, transmitter and receiver assembly (157 to 185 Mc). Indicator unit, and Power Supply (450 watts) operating on 110 volts, 60 cycles AC. All assembled, ready to operate. 62 Tubes included: 8-6V6GT, 9-6SL7GT, 14-6SN7GT, 1-5CP1, 2-9006, 1-6Y6G, 2-6E5, 1-100TH, 2-6J5, 2-2C26, 1-3E29, 1-6H6, 7-6AG5, 3-6AK5, 1-6C4, 3-2X2, 1-6X5GT, 3-5U4GT. Overall size 55" high, 28" wide, 20 1/2" deep. Shpg. weight 855 lbs. Your cost, complete, **BRAND NEW, in original packing. . . \$195.00**

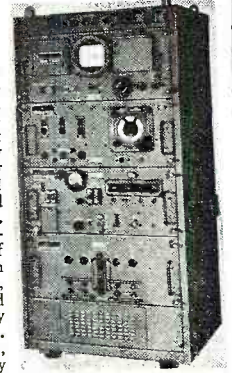

BC-645 XMTR RECEIVER 15 Tubes 435 To 500 MC



BRAND NEW!

\$9.75

2 FOR \$18.95

The electronic equipment that saved many lives in the war. Set can be modified to use for 2-way communication, voice or code, on following bands; ham band 420-450 mc, citizens radio 460-470 mc, fixed and mobile 450-460 mc, television experimental 470-500 mc. 15 tubes (tubes alone worth more than sale price!): 4—7E7, 4—7H7, 2—7E6, 2—6F6, 2—955 and 1—WE316A. Now covers 460 to 490 mc. Brand new BC-645 with tubes, less power supply in factory carton. Shipping weight 25 lbs.

PE-101C DYNAMOTOR FOR ABOVE BC645 **\$2.95**

UHF ANTENNA ASSEMBLY

A rare bargain for UHF experimenters! Consists of 7 aluminum rods, in calibrated lengths as follows:

3 rods 12" long for 200-247 Mc
1 rod 9 1/2" long for 248-313 Mc
1 rod 7 1/2" long for 312-400 Mc
1 rod 5 1/2" long for 402-517 Mc
1 rod 4 1/2" long for 512-667 Mc
All rods in handy fabric pouch. Two UHF coaxial coupling insulators included.

All **BRAND
NEW**, in original carton, set of 7 rods, only **\$2.45**

*2 of these rods suitable for BC-645 Transceiver

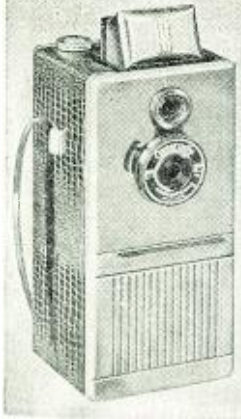

The Hottest Combination in Years!

Sensational New . . .

PORTABLE RADIO AND CAMERA COMBINATION

It's here . . . the Cameradio, indispensable for trips, hikes, ball games, every outdoor and vacation activity. Combines a fine Reflex Camera and a powerful Radio into one easy-to-carry unit. Order now . . . you'll double the enjoyment of every weekend!

TOM THUMB CAMERA-RADIO Combination

- Precision Built
- Excellent Tone Quality
- Full Vision Slide-Rule Dial
- The Ideal Vacation Companion
- Portable Radio, Battery Operated
- Reflex Camera, Standard # 127 Films

ONLY
\$28⁷⁵
Less Batteries

ANOTHER PROGRESSIVE SPECIAL!
AUTOMATIC

AUTO RADIO

Tops in car radios, now at a new low price! Six-tube superheterodyne, with steady, full-toned reception. Mounting brackets included for easy installation in your car. Don't miss this big bargain!

- Six Tube Superheterodyne • Three Gang Condenser
- Powerful Long Distance Reception • Fits All Cars, Easy Installation
- Mounting Brackets Included

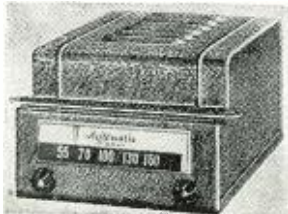

\$29⁹⁷
ONLY . . .



EICO MODEL 315
SIGNAL GENERATOR
with micro-cycle band spread vernier tuning

Vitality important for tuning and aligning FM and Television receivers where tuning is very sharp and critical. The extreme wide range and accuracy afforded by the micro-cycle band spread dial assures accurate frequency adjustment for test or alignment of broadcast FM or Television receivers. Vernier dial divided into 100 divisions. Any frequency can be tuned and repeated within .02% accuracy. Spring loaded split gears eliminate back lash and play providing smooth accurate tuning. Window casing encloses and protects the lighted dial and its fine pointer from accidents and jarring out of calibration. Range 75 KC to 150 MC • Complete broadcast band from 550 KC to 1700 KC covered on one range without switching • Unused coils are automatically shorted out to eliminate dead spots and absorption • Linear dial calibration. DOES NOT CROWD UP on high frequency end of dial • Accuracy better than .5% throughout the broadcast band and 1% on the higher frequencies • Just as accurate at high end of dial as at low end. **\$64.50**

VACUUM TUBE VOLTMETER

MODEL 221

A completely new and different vacuum tube voltmeter at an unusually low price. Its amazing performance sets standards of accuracy, linearity, and stability not usually found in this type of instrument. Electronic AC range is more linear and accurate than was ever possible with a copper oxide rectifier. Completely electronic so meter can not be burned out. AC and DC ranges: 0-5, 10, 100, 500 and 1000 volts. Ohmmeter measures from .2 ohm to 1,000 megohms in 5 ranges. Each instrument is **\$49.95** individually calibrated.



We pay postage on prepaid orders. All C.O.D. orders shipped collect.
PROGRESSIVE ELECTRONICS CO.
Dept. RN-31 497 UNION AVE. • BROOKLYN 11, NEW YORK

compromise between ease of signal separation after detection and freedom from spurious response, on the one hand, and gain, on the other. Briefly, the higher the value of the i.f., the easier it is to separate the video frequencies (0-4 mc.) from the i.f. frequencies at the detector output. In addition, interference of image signals from within the same band, or from other services, decreases with increase in i.f. Counterbalancing this is the inverse variation of gain with frequency. In 1939, the mass manufacture of high-gain, high-frequency amplifiers was not fully developed and, consequently, i.f. values were kept as low as possible. With the evolution of production "know-how," occasioned by the war, the RMA has recommended that the video i.f. be raised above 20 mc., and this has been current practice. •

Philco receivers (Fig. 9) employ essentially the same method of separation, with the exception that the signal from the mixer is first passed through an intermediate stage of amplification. The tuned circuit between the mixer and the input i.f. amplifier has a spread of 4.5 mc., obtained by peaking the primary and secondary windings to different frequencies and then adjusting C₁ until the proper bandsread is achieved. Sound trap circuits are contained in the video i.f. stages that follow the input i.f. amplifier, but none in the circuits that precede it.

Belmont, General Electric and Motorola (VT-101) receivers each delay the separation until the output of the first i.f. amplifier. Belmont and General Electric both use essentially the same system, coupling a third winding to the inter-stage transformer, and feeding its energy to the control grid of the first audio i.f. amplifier. See Fig. 11. Motorola (for Model VT-101 only) simply bridges a 10 mfd. condenser from the plate of the first i.f. amplifier to the control grid of the audio i.f. stage. No attempt is made here to restrict the signal voltages transferred solely to desired audio frequencies. Actually, this is not necessary because subsequent tuned circuits within the audio i.f. system will remove all but the desired signals.

Most receiver designers effect the video and sound i.f. separation at the output of the first i.f. stage. However, there are a few receivers which delay this operation until the second i.f. (Farnsworth) or even the third i.f. (Stromberg-Carlson) amplifier. By delaying the separation, the advantages of additional amplification are gained, which can be employed to reduce the number of audio i.f. amplifier stages. On the other hand, there is danger that enough sound FM voltage will reach the video second detector to produce

(Continued on page 170)

BRAND NEW SELSYNS

Bendix
No.
78411



6.95
Per
Pair

Synchro transmitter operates as transmitter and receiver. These are NEW IN ORIGINAL PACKING, supported in airtight can with dehydrator. Body dia. 3 1/4 in., length 4 1/2 in. 25% with order. Rating of 50 volts 50 cycles makes them ideal for series connection directly to 115 VOLT 60 CYCLE line per pair, with diagram \$6.95

F. HUMESTON, 9 Ash Lane
Valley Stream, New York

TELEPHONES



DESK MODEL

with wire, power supply and instructions. Ready to Hook Up. Special Prices—
3 Phones \$20.50
4 Phones \$25.50
25% deposit required on C.O.D. orders

DUNN-WRIGHT
ELECTRIC CO.
667 6th Avenue
Brooklyn, N. Y.

WALL MODEL



**Don't let others
put you out of
the picture!**

**Here's how CREI
Home Study Training
prepares you NOW
for a BETTER Job
and a Secure Career
in Radio-Electronics**

***CREI plus Your Present
Experience keeps you ahead
of Competition—Earns you more money!***

Never before have so many men like you had the opportunity to step ahead into better-paying jobs and enjoy lasting success. Why? Just look at the more than 3000 FM and standard broadcast stations predicted by the FCC by the end of the year—the scores of applications and permits for Television stations—the new applications radio-electronics is finding daily in every type of industry—the mobile communications systems now being utilized everywhere from backwoods logging operations to metropolitan taxicabs—the new high in overall radio-electronics manufacturing.

No wonder men with modern, technical training are needed in every branch of radio-electronics. Don't let others put you out of this picture. NOW is the time for *you* to take the time to prepare yourself for the important career jobs this great industry expansion is making possible. CREI home study training can show you the way by providing you with the "tools" with which to build a firm foundation of ability based on a planned program of modern technical training.

In our proved method of instruction you learn not only *how*, but *why!* This is real, honest-to-goodness practical training that leads to better jobs and more rapid promotions . . . the type of training for which many thousands of radio technicians have enrolled during the past 21 years.

It costs you nothing to read the interesting facts. There is no obligation. Send the coupon now.

VETERANS! CREI TRAINING AVAILABLE UNDER G. I. BILL

**CAPITOL RADIO
ENGINEERING INSTITUTE**

An Accredited Technical Institute

Dept. RN-7, 16th and Park Road, N. W., Washington 10, D. C.
Branch Offices: New York (7) 170 Broadway • San Francisco (2) 760 Market St.

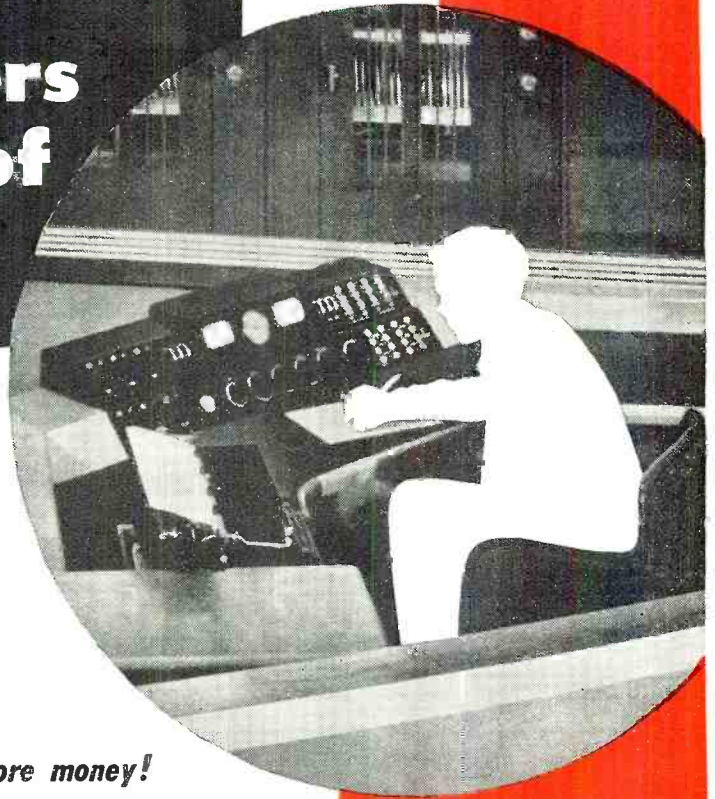

**Mail Coupon for
FREE Booklet**



CAPITOL RADIO ENGINEERING INSTITUTE
16th & Park Road, N.W., Dept. RN-7, Washington 10, D.C.

Gentlemen: Please send your free booklet, "CREI training for your better job in Radio-Electronics," together with full details of your home-study training. I am attaching a brief resume of my experience, education and present position.

- PRACTICAL RADIO-ELECTRONICS Practical Television
 Broadcasting Aeronautical Radio Engineering
 Receiver Servicing Industrial Electronics

NAME.....

STREET.....

CITY..... ZONE..... STATE.....

I am entitled to training under G. I. Bill.

Personal

PORTABLE RADIO KIT MAKES A \$32.50 RADIO

Complete with Batteries

\$14.95



Size: 6 1/2" x 3 1/4" x 4 1/8"

Weights Only 3 1/2 lbs.

- Two-Tone Ivory, Red Plastic Cab.
- Loop Aerial, Built-in Lid
- 4-Tube Superhet
- AVC.
- Looks like and is a Commercial Radio Kit
- Two-Gang Cond., Lucite Dial
- Simple Assembly and Wiring Instructions

This kit is ready for immediate delivery. The same nationally known factory that manufactures tens of thousands of this radio, is line-producing this radio kit for us. Every part, from the cabinet down to the last resistor, is matched. The chassis is ready-punched; all you do, is mount the parts and wire. This radio kit will assemble into a beautiful personal radio for you, just the same as it does for the factory. We furnish you a diagram, photograph of the completed chassis and full assembly instructions so that those with a minimum knowledge of radio may wire this kit. The beautiful case is made of metal with plastic hinged lid and snap on back. The lucite face of the receiver has an inlaid gold design. The circuit is the conventional two gang superhet type, with A.V.C. Receives the broadcast band, 540 to 1650 KC. Uses miniature tubes: 1R5 converter, 1S5 detector A.V.C., 1T4 amplifier and 3N4 power amplifier. Alnico V PM speaker. The loop antenna is built in the lid. Radio comes on automatically when lid opens. Operates on self-contained batteries. Priced complete with tubes and 6 7/8 volt "B" battery and flash cell (Not AC-DC). Nothing else to buy. Model X-45, Price \$14.95. Include Postage for 6 lbs.

SCOOP MODEL X-45 PERSONAL PORTABLE KIT WIRED AND TESTED WITH BATTERIES. NET \$17.95

8-TUBE RADIO KIT WITH COAXIAL SPEAKER, \$37.95



A COMBINED BROADCAST SUPERHET RADIO CHASSIS AND 15 WATT P. A. SYSTEM
HEAVY DUTY 12" P.M. SPEAKER
CROW 8" SLIDE RULE DIAL, 2 GANG COND.
REC. BROAD, 550 TO 1700 KC AND 19 TO 49 METERS

PUSH PULL 6V6-TONE CONTROLS
INPUTS FOR CRYSTAL OR DYN. MIKES AND PHONO-PICKUP. WE FURNISH EVERYTHING TO BUILD THIS DELUXE CHASSIS

- WHY NOT ORDER THE ARMCHAIR CABINET WITH THIS KIT
- HAS INPUT GAIN FOR THE G.E. VARIABLE RELUCTANCE PICKUP
- CHASSIS SIZE 9 1/2" x 11 1/2" x 8" HIGH

Here is something new in radio. A real 15 watt power amplifier with bass and treble controls. Has extra gain stage for crystal or dynamic mikes. And on the same chassis, a standard superhet radio receiver. We furnish all parts, knobs, escutcheon plate and tubes: 6SA7, 6SK7, 6SR7, 6SN7, 6SJ7, two 6V6 and 5Y3. No cabinet. Extra care in designing the power supply section assures low hum level, making this unit ideal for recording as well as P.A. use. We furnish everything as well as schematic diagram and photos of the completed chassis. Weight 35 lbs.

PRK-24 Radio-Amp. Kit with 12" P.M. speaker With tubesNet

\$29.95

CPR-15. Exactly the same kit as the PRK-24 kit, except it is furnished with a 12" Cineludograph wide range speaker. (Has built-in high frequency tweeter.) This is our finest kitNet

\$37.95

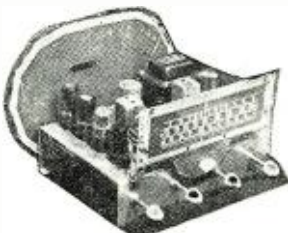

ARMCHAIR CABINET \$29.95

Will House PRK-24 or CPR-15

Beautifully made walnut armchair cabinet. Outside dimensions 24" high, 16 1/2" deep, and 27" wide. Ample room for radio receiver 14" long, 9" high and 10" deep. Will hold a changer up to 14" square. Will accommodate speaker up to 12". Has record album storage compartment. Hinged lid covers changer compartment. Cabinet Ar-15 Net \$29.95. Detrola automatic changer \$12.95 extra.

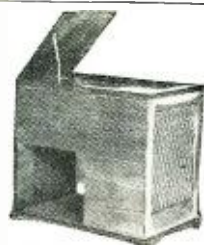

WIRE RECORDER \$69.95

Portable Wire Recorder Model GN-11

Has ready wired and tested 5 tube AC type amplifier with push-pull 6V6 tubes. Built-in eraser circuit. Input for crystal mike or phono pickup. Diagrams show how you can record from any radio receiver. 3 position switch enables you to quickly change from record to playback or conventional P. A. system. This amp delivers 12 watts of good clean audio. Here is what you get: Webster 79 recording mechanism, with 15 minute spool of wire, attractive leatherette covered case. 6" heavy duty PM speaker and wired and tested 12 watt AC wire recording amplifier. All you do is mount the amp, recording mechanism and speaker. Simple instructions furnished. Portable Recorder Model GN-11 Net \$69.95. Crystal mike \$4.95 extra.



BLOND ARMCHAIR CABINET \$34.95

3-WAY PORTABLE KIT \$16.95

- 4 Tubes Plus Disc Rectifier
- 300 Hour Battery Pack Included
- Beautifully Built Portable Case

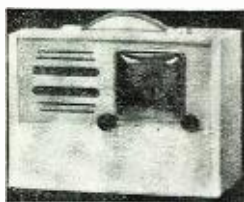

Build this powerful, 4-tube, 3-way portable kit. Operates on 110 volts AC or DC or self contained batteries. Receives broadcast 550 to 1650 K.C. Incorporates a standard superhet circuit with AVC and loop Ant. Has Alnico 5 PM Speaker, 2 gang condenser. All parts and batteries are furnished including tubes. Disc Rectifier, 1R5, 1T4, 1S5 and 3S4. Has attractive leatherette portable cabinet size 7x9x9. Weight 14 lbs. Kit Model 3-ZA. Net \$16.95

SMALL PORTABLE KIT, \$10.95

- 4-Tube Broadcast Superhet
- Priced Complete with Batteries
- Dynamic Speaker
- Slide Rule Dial



complete with batteries, pictorial diagram and tubes 1R5, 1S5, 1T4 and 3S4. Not AC DC, but straight battery operated. Has 2 gang cond. Everyone should have one of these personal portables. Everything furnished. Kit K-PXNet \$10.95

PORTABLE KIT MODEL K-PX. Small size leatherette covered case 8x5 1/2x5. Easy to build. Operates on self contained B and A batteries, etc. Broadcast 550 to 1600 K.C. Incorporates a standard superhet circuit with avc. Has 3 inch Alnico five PM speaker, 2 r t c e d



Heavy Duty Vibrator—Made for 6-110 volt amplifiers. Freq. 60 CPS. Scoop price. \$1.99 135 ma 6-110 volt conventional power transformer, with all windings; will run phono motor. \$5.95 (Use with above vibrator)

DELUXE WIRE RECORDER, \$79.95

Deluxe Wire Recorder Model GN-12. Incorporates the same wired and tested amplifier and recording mechanism as Model GN-11. Has larger leatherette covered, portable case, with 10" PM speaker, housed in removable lid. GN-12 Deluxe Wire Recorder kit \$79.95. Crystal mike \$4.95 extra.

6-110 VOLT POWER SUPPLY KIT MAKES ANY AMP. WORK ON \$14.95 A STORAGE BATTERY

New Power Supply Kit adapts any amplifier to 6-110 volt operation. Kit includes all parts, tubes, transformer, vibrator, ready-punched chassis and diagrams necessary for you to build this 6 volt DC or 110 volt AC power supply. The average radloman should wire this unit, in an hour or less. Supply furnishes from 110 volts 60 cycle, 350 volts DC at 135 mills, 6.3 volts AC. Also, from 6 volts DC it produces 110 volts 60 cycle AC to run a phono motor, record changer, or small AC-DC radio; 350 volts DC at 135 Mills. Instructions are furnished, to show you how this supply can be adapted to make any P.A. systems, up to 25 watts; operate on 6 volts DC or 110 volts AC. Switching is done in the power supply. Everything complete, including 2-6X5 rectifiers. Kit: 6-110KR. Net \$14.95. Spare heavy duty vibrator \$1.95. extra.



6-110 VOLT AMPLIFIER KIT, \$29.95

Model 22-KR—A complete kit of parts to build a 25 watt, 6 volt DC and 110 volt AC amplifier, utilizing the above power supply. Has push-pull 6L6 output tubes, with universal output transformer, 4-8-16-500 ohm line to voice coil winding, dual tone controls, inputs for crystal or dynamic mike and phono pick-up. Every part and tube, as well as diagrams and ready punched chassis furnished. You get the above 6-110 volt power supply kit and the amplifier kit pictured. Net \$29.95.

6-110 VOLT AMP. KIT FOR WIRE RECORDING, \$32.95

This amplifier kit is similar to kit 22-KR, except has oscillator and switching feature for wire recording and play back. Operates on 20 watts. Kit 34-KR net \$32.95. WEBSTER WIRE RECORDING MECHANISM, \$4.10

BUILD A RADIO Like you would buy 5-TUBE KIT ONLY \$9.95

Made from Detrola Components

Attractive 13" blond cabinet AC-DC kit, with illuminated slide rule dial. Incorporates a standard 2 gang superhet circuit. Loop antenna, ready-punched chassis. This is another one of our line production radio kits. Every part is furnished. Includes tubes: 12SA7, 12SK7, 14A4, 35Z5 and 50L6. Diagram, photos and instructions are included. Has full 5" Alnico 5 PM speaker. Receives broadcast 550 to 1650 KC. Shipping weight 9 lbs. Model TF-6. Net \$9.95. Model TF-6 wired and tested. \$14.95



1949 MODEL AC-DC KIT \$12.95



This is our latest and finest AC-DC radio kit. Receives Broadcast, 540 to 1650 KC. Has full length illuminated slide rule dial. Choice of Ivory or Walnut plastic cabinet. Full high efficiency 2 gang superhet circuit, with loop antenna. Ready punched chassis, full 5" PM speaker. Every parts fits. Everything furnished, including tubes, 12SA7, 12SK7, 12SQ7, 35Z5 and 50L6. This kit will go together just like it would on the production line. Diagram, photos and instructions are furnished. Shipping weight 9 lbs. Kit model XA-49. Net \$12.95.

AMERICAN AND FOREIGN KIT \$14.95

550 to 1600 KC and 6 to 18 MC



This radio kit is housed in an attractive grey opalescent finished metal cabinet, incorporates a standard 2 gang superhet circuit. Receives Broadcast (550 to 1600 KC) and foreign short wave (6 to 18 Megacycles). This kit is complete, nothing else to buy; just as all our kits. Ready-punched chassis. It will go together just as it would down a production line. Has full 5" PM speaker. Complete with tubes: 12SA7, 12SK7, 12SQ7, 35Z5, 50L6. Diagram, photos and instructions are furnished. Shipping weight 10 lbs. Kit model DT-5. Net \$14.95

12 WATT AMPLIFIER KIT, \$10.95

Push Pull 6V6's Gain for Mike

KIT MODEL AC-12. 12 watt amplifier kit. Ideal for high quality record player as well as public address or recording amplifier. Matched component parts, ready punched chassis pan. One control fader from phono to microphone. Gain enough for crystal or dynamic microphone. 100 mill power transformer, for 110 volt AC 60 cycle operation. Priced complete with tubes: 2-6V6, 6SN7, 6SH7 and rectifier. Diagrams and photos furnished. Kit AC-12. Net \$10.95. 12" Alnico 5 PM speaker \$6.95 extra; crystal microphone and desk stand \$4.95 extra. The above AC-12 amplifier wired and tested ready to operate net \$14.95 Specify stock No. AC-1125. 12 inch Alnico V PM speaker \$5.95 extra. Crystal mike and desk stand \$4.95.

20-WATT UTILITY AMP. KIT, \$17.95

Build this 20 watt utility 110 volt AC, 20 Watt power amplifier. Ready punched chassis, size 12 x 6 x 2 1/2 inches. Has two input circuits, one mike and one phono. Mike stage has 135 dB gain, for crystal or dynamic mike. Has bass and treble controls. Designed for use with PM speakers; has 8-16 ohm output transformer. All parts and easy-to-follow diagram furnished, including tubes: 2-6SN7, 6J5, 2-6L6GA, 5Z3. Kit Model 20-TX.Net \$17.95



POWERFUL SINGLE RECORD PLAYER KIT Z-26

Housed in an attractive leatherette covered cabinet. Latest 78 RPM rim drive motor and light weight pick-up. Ready wired and tested 70L7 type tube amplifier. Tone and volume control, 5" PM speaker (Alnico V). This kit easily slips together. Priced complete with tubes and hook-up instructions. Kit Z-26.Net \$9.95





★ ★ SALE ★ ★ COAXIAL 12" P.M. SPEAKER

A \$27.50 VALUE FOR
\$12.95 TWO FOR **\$25.00**

EACH

- ★ BRAND NEW NETWORK
- ★ FACTORY CARTONED ALNICO V MAGNET VALUE IN AMERICA
- ★ BUILT IN MATCHING BEST SPEAKER

Designed by one of America's finest speaker builders, for FM high fidelity radios, record players and P.A. systems. This speaker is incorporated in radios selling in the \$500.00 bracket. It is a specially designed 12" Alnico V magnet P.M. with built in 4" Alnico V tweeter. The high-pass filter is concealed under the dot cover. Just hook to any 8 ohm output transformer. (Will hook in place of any house radio speaker, as most speakers have 8 ohm voice coils), only two wires to connect. Will handle approximately 18 watts. This co-axial P.M. speaker should sell for \$35.00. Why buy an ordinary speaker, when we are offering a co-axial Alnico V P.M. for only \$12.95? Latest 1948 production, not surplus, fully guaranteed, Stock No. 4-12X, Weight 8 lbs.

100 ASSORTED CARTONED TUBES \$35

Individually Cartonned — Full Replacement —
Branded HYVAC — You Pick the Types from
List Below — 39c EACH — 100 for \$35.00

117P7GT	607 GT	1S5
32L7GT	6V6 GT	304
12A8GT	6X5 GT	3S4
12K7 GT	6SA7 GT	1B4
25Z6 GT	6SD7 GT	12K8
6A7	6SK7 GT	12A6
47	6SN7 GT	12SF7
12F5 GT	6X4 GT	6F5
658 GT	25L6 GT	6J5
6P5 GT	7017 GT	6SJ7
3V4	117L7 GT	12SJ7
6C5	117Z3	6AJ5
12SA7 GT	12AT6	6AV5
12SK7 GT	12BA6	6BA6
12SQ7 GT	12BE6	6BE6
35L6 GT	35W4	6AT6
35Z5 GT	35B5	6X4
50L6 GT	50B5	6EJ6
6K7 GT	1T4	6L7
6A8 GT	1L4	6BH6
5Y3 GT	1U4	80
6K6 GT	1R5	

75% OF ALL THE TUBES YOU USE 49c EACH

Guaranteed Standard Brands Cartoned and Uncartoned

12A4H7	6K7	6SL7	12SG7	12SQ7
27	9001	6SN7	12SH7	12SR7
26	9002	6SG7	12SJ7	50L6
78	9003	6SR7	12SA7	12SK7
76	1625	6V6 GT	12SL7	25L6 GT
3S4	6SA7	6X5 GT	12SC7	35L6 GT
5U4G	6SC7	6AB7	1T4	35Z5 GT
5Y3G	6SF7	12AT6	1R5	35W4
6AC7	6SQ7	12BA6	1S5	50B5
6C5	6SH7	12BE6	6R7	
6H6	6SJ7	12H6	6L7	
6J5	6SK7	12J5 GT	7Z4	

59c each 1/2 Volt Octal—1N5 GT, 1H5 GT, 1A7 GT, 1A5 GT, 69c each Loctal Tubes—50A5, 35A5, 7A7, 7B7, 7E7, 7F7, 7N7, 7C5, 7Y4, 0Z4, 35Y4, 14A7, 14A7, 14B6, 14Q7, 7E5, 79c each 1/2 Volt Loctal Tubes—1LN5, 1LC6, 1LH4, 1LD5.

ARC 4 TRANSMITTER and RECEIVER
For operation VHF frequencies in range of 140-144 mc. Four channel crystal controlled, manufactured by Western Electric—24V operation. Complete with crystal and dynamotor. Used.
Good condition..... **\$14.95**

BC-733 D LOCALIZER RECEIVER
Freq. 108-110 Mc; Tube complement: 16 tubes—1—12RQ7, 2—12SR7, 1—12A6, 1—1A7GT, 2—12SG7, 3—717A. New.
NOW ONLY..... **\$7.95**

15" 1000 OHM FIELD \$13.95
Nationally known make—15" 1000 ohm speaker. 1 1/2" 16 ohm voice coil. Will take 25 watts. Factory cartonned, fully guaranteed. Stock No. 15UZZ
NET \$13.95, Two for..... \$26.50

RELAY SCOOP \$2.95
Auto pilot amplifier salvage scoop. Has 6 high resistance relays that operate in tube plate circuits on less than 8 mills. Also 4 controls. Choke cond., etc. Less tubes. Used but in good condition. Weight 12 lbs. Stock No. C-1T. Net \$2.95; two for \$5.50.

BRAND NEW BC-645 9.95 TWO FOR \$19.00
A small complete Transmitter and superhet receiver, for the 450 megacycle band. Diagrams for building AC power supply and conversion furnished. Ideal for MCV, CW or phone. The tubes (4-7F7, 4-7H7, 2-7E6, 2-6F6, 2-955 and WB-816A) are worth more than our sale price. BC-645 T.E.P. unit \$9.95 each. Two for \$19.00. Extra WB-316A tube 99c. 12 volt DC dynamotor (furnished all power) \$2.95. BC-645 shipping weight 25 lbs.

SAVE ON FIELD SPEAKERS

4 in. Dynamic. 450 ohm field.....	\$1.69
5 in. Dynamic. 450 ohm field.....	1.89
5 in. Dynamic. 1000 ohm field.....	1.89
8 in. 2 ohm field for heavy duty auto radio use.....	2.95
8 in. Dynamic. 1000 ohm field.....	2.95
12 in. Dynamic. 1000 ohm field.....	4.95
12 in. RCA 450 Reg. 10.00 net 1 1/4" Voice Coil.....	4.95

Scop Price.....

SPEAKERS WITH OUTPUT ATTACHED

5 in. P.M. 1.47 oz. Alnico V. mag. with 50L6 output.....	Special \$1.49
5 in. P.M. 1.47 oz. Alnico V. mag. with Push-Pull output trans.....	Scop \$1.69
5 1/2 in. G.E. P.M. Square with 50L6 output trans.....	mounts in place of regular 6 in. speaker..... \$1.95
6 in. P.M. 1.47 Alnico V. magnet with 7000 ohm output trans.....	Special \$2.25
Heavy Duty 8" 450 Ohm Speaker with 6V6 output.....	\$2.95

POPULAR OVAL SPEAKERS

4x6 in. P.M. 1.47 oz. Alnico V. mag.....	\$1.49
5x7 in. P.M. 2.15 oz. Alnico V. mag.....	1.95
4x6 Dynamic. 450 ohm field.....	1.95

5 tube BC-1206 Beacon Receiver. 195-420 KC. New. factory cartonned.....	\$5.95
SCR-518 Altimeter complete, New factory cartonned.....	\$29.50
AM-61A 15 tube Indicator amplifier. New with tubes.....	9.95
Carbon hand mike, with push switch 99c. 10 for L-81-A 3" Selby indicator \$2.45. 2 for.....	4.45
BC-654 Transmitter-receiver, good condition.....	12.95
BC-458, 5 to 7 MC Command transmitter, new in factory cartons.....	6.95
BC-454, 3 to 6 MC Command receiver, with tubes. New factory cartons.....	5.95
New BC-456 Modulator, with tubes, less dynamotor.....	2.95
Used BC-456 Modulator, with tubes and dynamotor.....	2.90
Command set Antenna current meters. Used \$1.95. 2 for \$3.50; New \$2.95, 2 for.....	5.50

\$59.50 VALUE MUSICAL AMPLIFIER WHILE THEY LAST \$19.95

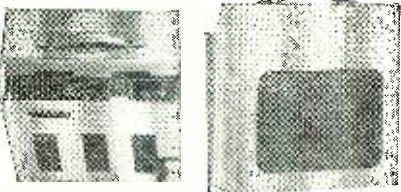

8 watt musical amplifier. 4 tube AC type. Inputs for crystal or dynamic mike and phono or instrument pick-up. 2 gain controls and tone control. Has heavy duty built-in 8" speaker. Attractive leatherette covered case. Made by a large manufacture to sell at \$79.95. Brand new, fully guaranteed. For 110 volt AC operation. Our scoop price, \$19.95. Stock No. C-1X. Contact instrument pick-up, \$6.95 extra. Deluxe instrument pick-up; with volume control, \$8.95 extra. Crystal mike and desk stand \$4.95. Shipping weight, 20 lbs.



Brand New ELECTRONIC MEGAPHONE
SCOOP PRICE \$39.95

Only 109 of these Brand New Electronic Megaphones to sell. You may see these listed at a lower price, but ours are new and guaranteed to work. Amplifier straps on shoulder, then just hold megaphone and speak into mike, mounted on rear of projector. Pull switch to turn on four battery operated amplifier.

WRITE FOR CATALOG
Prices F.O.B. K.C.

MAGNAVOX P.M. SPEAKER SALE!

Genuine Magnavox P.M. speakers. Brand new, fresh from factory. Heavy Alnico 3 magnets, no bad cones. Every speaker guaranteed. Save up to 75% on these unbeatable values. Order a good supply now.

12" Magnavox 20 cz. Magnet 6-8 Ohm V.C.....	\$5.95
10" Magnavox 20 cz. Magnet 6-8 Ohm V.C.....	4.79
8" Magnavox 12 cz. Magnet (Square) 6-8 Ohm V.C.....	2.95
6" Magnavox 12 cz. Magnet (Square) 6-8 Ohm V.C.....	2.49
5" Magnavox 8 cz. Magnet 4.5 Ohm V.C.....	1.79

15 IN. JUKE BOX ALNICO V P.M. SPEAKER \$19.95

JUKE BOX TYPE JUMBO 15" P.M. speaker, with 1 1/2" 8 ohm voice coil. Has 21.5 oz. of Alnico V magnet. (Equal to 110 oz. of ordinary magnet material). This speaker is so finely tuned, it should sell for \$100.00. Designed for full base response, such as required of juke boxes, etc. Will take 20 watts average, 30 watts peak audio power. Made by a nationally known speaker builder. Latest 1948 production. Individually cartonned. Weight 12 lbs. Stock No. M2. Net \$19.95, 2 for \$38.60.

12 IN. 25 WATT ALNICO V P.M. SPEAKER \$9.95

Heavy duty 12" P.M. speaker, with 12.1 oz. of Alnico V magnet. (Equal to 60 oz. of ordinary magnet material). Has 8 ohm voice coil. Will take 15 watts average or 22 watts peak audio power. Made by a nationally known speaker manufacturer. This is a fine speaker for any type of public address and radio set use. Good base and tunable response. Latest 1948 production, individually cartonned. Weight 10 lbs. Retail price \$25.00. Net \$9.95 each. Stock No. 2K1.

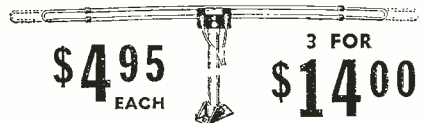

Super value. Folded Di-pole antenna, for FM and Television. Completes with 60 feet of twin 300 ohm line and 4 low-loss stand-off insulators. This folded di-pole covers frequencies 42 through 108 megacycles. Titanium action makes exact tuning to any one weak station. Furnished with adjustable mounting bracket. Has 5 foot mast. Made for Stromberg-Carlson. Stock No. M-300—Net \$4.95. Weight 4 lbs. Individually packed.

DETROLA CHANGER \$12.95 2 for \$25.00

Detrola Changer. Base size 11 1/2x12 inches, \$12.95. Two for \$25.00. Aero Changer. Base size 12x13 inches, \$12.95. VM-500 Changer. Base size 13x14 inches, \$14.95.



General Instrument changer, base size 10 1/2x12", \$16.95. Seelburg, triple spot, World's best, base size 14x14 inches, \$37.95. Made to fit leatherette bases for above changers, \$1.95. Specify type of changer for base.

REPLACEMENT MOTOR FOR CHANGER.....\$1.49

1948 MODEL—MIKE-BROADCASTER ONLY \$7.95

Broadcasts 800 to 1500 KC from either a phonograph pick-up or a crystal or dynamic mike. Makes any radio receiver a P.A. system, record player or recording amplifier. Gives broadcast quality. Has fader control from mike to record, simulating a regular broadcast station. This is a powerful model; using 2-35L6, 12S17 and 35Z5 tubes. Priced with tubes and connecting instructions. Works on 110 volts AC-DC. Crystal mike and desk stand \$4.95 extra. Model DE-5 truly a de-luxe mike-phonograph oscillator.



3-TUBE PHONO. OSC. ONLY \$4.95

Model DE-4—Phonograph oscillator. Broadcasts from 800 to 1500 KC. Gain for any crystal pick-up. A new powerful circuit is used to assure plenty of power. Has variable gain control for proper modulation. Priced with tubes ready to operate, two 50L5 and 34W1. Model DE-4 Net..... \$4.95

SUPERHET BROADCAST TUNER for connection to phono amp. or P.A. system. Compact chassis 5x3 1/2x3 inches. May be mounted inside the record player cabinet. Requires only three connections to amplifier. Uses 6SA7 or 12SA7; 6SK7 or 12SK7 and crystal diode. Complete with tubes, loop antenna, dial and instructions for connecting to any amplifier. Net \$7.95. Specify if tuner is to be used with AC or AC-DC type amplifier.

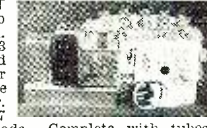

G.E. VARIABLE RELUCTANCE PICK-UP \$4.69

Scoop—Pre-amplifier for General Electric Variable Reluctance pick-up. Easily connected to any AC or AC-DC amplifier. Wired and Tested with 6SK7 or 12SK7 tube. Diagram for connections is furnished. Specify whether you want pre-amplifier for AC or AC-DC use. Net price, Pre-amp. with Tube and G.E. Pick-up—\$6.95. G.E. Variable reluctance pick-up cartridge with permanent needle. Net \$4.69.



McGEE RADIO COMPANY

July, 1948

SEND 25% DEPOSIT—BALANCE C. O. D.
1225 McGEE ST., KANSAS CITY, MISSOURI

HAMS... TECHNICIANS... SERVICE MEN... ORDER BY MAIL AND POCKET THE DIFFERENCE

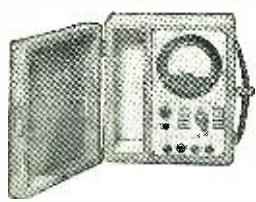

\$13.50 MULTITESTER KIT IN PORTABLE CASE
 Here's an item that will more than pay for itself many times over! 1000 ohms/volt 3 1/2-inch round meter for radio and servicing work. Measures up to 1500 volts AC or DC, to 150 MA DC and up to 200,000 ohms resistance. Complete with portable case, size 5 1/4 x 7 x 3 1/2". It's a compact unit considered a vital necessity in most radio work. And here again is an example of how you can SAVE when you buy by mail from CONCORD.
 AD2-24458\$13.50

SATISFACTION GUARANTEED OR YOUR MONEY BACK

3-TUBE, LOW COST PHONO AMPLIFIER

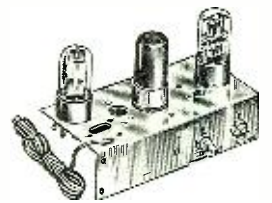

Now you can build your own fidelity record player or record changer at a rock bottom minimum cost! Built-in continuously variable tone control for deep throated bass or clear toned treble output. Uses efficient 50L6, 12SQ7 audio amplifiers and 35Z5 rectifier. For 110 volt, AC-DC. Phono motor connects directly to amplifier. Complete with tubes but less output transformer.
 AD3-5B9584 — Less Tubes \$2.98
 AD3-5B9583 — With Tubes \$4.95

PILOT LIGHT ASSEMBLY

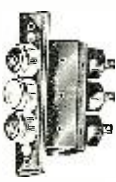

Three pilot lights, red, green, white, with frosted glass lenses and chrome plated rim, black finish. Sockets insulated and spring loaded. Size 3" long, 7/8" wide, 2 1/4" deep. Two mounting holes on 2 1/4" centers.
 AD3-5B698798c

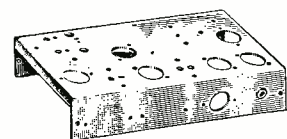

PUNCHED ALUMINUM CHASSIS — Punched and drilled for 5 or 6 tube permeability tuned receiver. Size 5"x10"x2". All corners smoothly machined. Precision punched for accurate placement.
 AD3-5B957929c



PERMEABILITY TUNER — To replace variable gang condenser in standard broadcast receivers. 4"x2 1/4"x2 1/4", dial drum is 2 1/2" in. With antenna coil, oscillator coil, oscillator padder coil and Plans for 5 and 6 tube AC-DC superhet receiver.
 AD3-5B3574\$1.29



LOOP ANTENNA — For use with Permeability Tuner Cat. No. AD3-5B3574. Matches input circuit. Compact, rugged.
 AD3-5B357519c

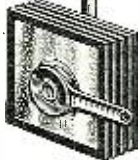

SELENIUM RECTIFIER — Costs less than tube and socket it eliminates. 1 1/4"x1 1/4"x1 1/16", 100 mil. rating construction. Two rectifiers can be connected as a voltage doubler.
 AD3-1056075c



LIGHT DUTY RECORD CHANGER MOTOR — For most standard record changers and phono players. Speed 2500 r.p.m.; idler wheel 350 r.p.m. Size 4 1/2" long, 3 1/2" wide, 2 1/2" high. 22" insulated leads.
 AD3-5B7083\$1.69



HEAVY DUTY RECORD CHANGER MOTOR — Replacement for Seeburg Model L changer. Speed 1700 r.p.m.; idler wheel 318 r.p.m. Flange holes for mounting. 12" insulated leads. Size 5 1/2" long, 3 1/2" wide, 3" high.
 AD3-5B7082 ...\$2.25

TUBULAR ELECTROLYTIC CONDENSERS

Stock No.	Cap. Mfd.	Wkg. Volts	Size Ins.	EACH
AD3-3156	10	450	1 1/2" x 2 3/8"	19c

AUTO GENERATOR CONDENSERS

AD3-5B3244	.5	19c
AD3-5B3245	1.0	29c

ORDER NOW Just send name and address with Stock Number of item wanted. Your order will be given immediate attention.

FREE CATALOG
 Absolutely no charge. 160 pages crammed with radio, TV and related electronic items. Get your FREE copy NOW.



CONCORD RADIO CORPORATION Dept. 522J — 901 W. Jackson Blvd., Chicago 7, Ill.

SELSYN MOTOR VALUE

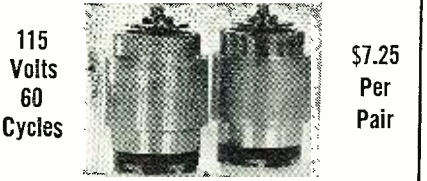

115 Volts 60 Cycles
 \$7.25 Per Pair
 From NEW gun directional control units. Excellent for rotary beam directional control and indication. Operate in pairs as transmitter and receiver. Diameter 3/4", length 4 1/4". Designed to connect direct to your 115 volt, 60 cycle, A.C. line.
 Pair (2 units), with diagram....\$7.25
 Quantity Discount available
WEBER ELECTRIC
 150 Maple Ave., Dept. 4, Hershey, Penna.

RCA Institutes, Inc.
 Offer thorough training courses in all technical phases of Radio and Television
WEEKLY RATES **DAYS—EVENINGS**
VETERANS: RCA Institutes is approved under G. I. Bill of Rights
 For Free Catalog write Dept. EN-48
RCA INSTITUTES, Inc.
 A Service of Radio Corporation of America
 350 West 4th St., New York 14, N. Y.

TELEVISION RECEIVER—\$1.00
 Complete instructions for building your own television receiver. 16 pages—11"x17" of pictures, pictorial diagrams, clarified schematics, 17"x22" complete schematic diagram and chassis layout. Also booklet of alignment instructions, voltage and resistance tables and trouble-shooting hints.—All for \$1.00.
CERTIFIED TELEVISION LABORATORIES
 5507-13th Ave., Brooklyn 19, N. Y.

Radio Seeks Black Gold
 (Continued from page 57)

or nearby motor boats, can accomplish this same ruinous effect on the records.

From the amplifiers the signal is fed into the recording units of the camera, which may be one of two types; mirror galvanometer with moving coil deflection, or a string harp unit. The galvanometer, which is in general use in the modern equipment, has a natural frequency of 60 to 400 cycles and is nearly critically damped. The internal impedance ranges from 5 to 200 ohms and normal full scale deflection in either direction may require from 5 to 40 millivolts.

Each of the aforementioned types of signal indicating systems requires its own individual system of optics in order to transcribe the intelligence into a permanent record form. The mirror galvanometers have a tiny mirror suspended on the meter movement staff which swings with deflection of the coil. A light beam focused on this reflecting surface is directed through a converging prismatic lens, through a restricting horizontal slit, and onto the photographically sensitive paper which records the galvanometer's horizontal movements as the paper strip passes the slit vertically. An open view of such a camera is shown in Fig. 8, but constructional methods hide the more complex details referred to in this text. A squirrel cage rotor, used to print the timing lines on the photosensitive paper, is synchronously controlled with a tuning fork, therefore permitting the photo paper to record at an even rate of speed without detailing such work as highly accurate constant speed non-slip paper mechanisms. The string harp system prints shadow traces, white lines on a black background, while the mirror system produces black traces on white background.

So in today's streamlined world of electronics, one of mankind's youngest achievements has found a permanent home in the petroleum industry. Radar, too, has found another peacetime application in the form of the Pathfinder marine navigation system, where water operations in the Gulf of Mexico are made safer and work can be started without being hindered by troublesome fog. Delays have proven costly in the past, and now with the aid of radar, operation costs are reduced.

More rugged component parts allow portable swamp operations in native bayou flat boats, or rough terrain by back pack, and in all sorts of fields in the ton and a half trucks especially designed and built for this purpose. The greater percentage of the new oil reserves now accurately charted have been located by such methods, one more modern magic act for which we credit electronics and radio for top-notch assistance.



note the New Look in Power Transformers

With *CT's* Famous
Sealed in Steel Construction

The clean, streamlined appearance and compactness of CT's new *Sealed in Steel* construction contribute immeasurably to the trim, precision-like effect of any electronic equipment.

In addition, CT Transformers provide "steel wall" protection against atmospheric moisture, efficient magnetic and electro-static shielding, unsurpassed strength and rigidity to withstand shock and vibration, and unusual convenience of mounting.

Two base styles are available for most of the units in this catalog line, one with clearly identified solder lugs in a phenolic terminal board, the other with RMA color coded leads, stripped and tinned for easy soldering.

The design of these new power transformers assures maximum performance with minimum physical size and minimum temperature rise in accordance with RMA standards.

The wide range of carefully selected ratings achieves maximum flexibility of application, close matching with today's preferred types of tubes, and conformance with all industry standards.

Write direct for catalog illustrating, describing and listing the complete line, or contact your nearest radio parts jobber at once.

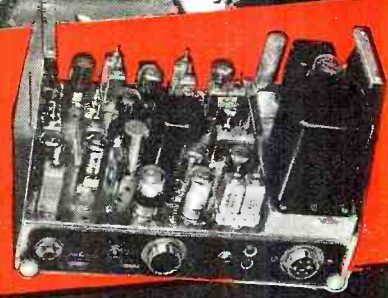

Typical Motorola FM two-way radiotelephone receiver utilizing Sealed in Steel Chicago Transformers.

PLATE AND FILAMENT SUPPLY TRANSFORMERS Primary 117 Volts, 50-60 Cycles

Catalog Number	For CAPACITOR INPUT SYSTEMS					
	HIGH VOLTAGE SECONDARY			FILAMENTS		
	A.C. Volts	D.C. Ma.	D.C. Volts Output	Rectifier Volts Amps.	No. 1 Volts Amps.	No. 2 Volts Amps.
PC-55	270-0-270	55	260	5 2	6.3CT 2
PC-70	335-0-335	70	320	5 2	6.3CT 3
PC-85	330-0-330	85	320	5 2	6.3CT 3
PC-105	345-0-345	105	320	5 2	6.3CT 3.5
PC-120	375-0-375	120	380	5 3	6.3CT 4
PC-150	370-0-370	150	390	5 3	6.3CT 4	6.3CT 1
PC-200	385-0-385	200	390	5 3	6.3CT 4.5	6.3CT 1
For REACTOR INPUT SYSTEMS						
PR-55	350-0-350	55	260	5 2	6.3CT 2
PR-70	425-0-425	70	320	5 2	6.3CT 3
PR-85	440-0-440	85	325	5 2	6.3CT 3
PR-105	445-0-445	105	325	5 2	6.3CT 3.5
PR-120	500-0-500	120	400	5 3	6.3CT 4
PR-150	505-0-505	150	400	5 3	6.3CT 4	6.3CT 1
PR-200	520-0-520	200	410	5 3	6.3CT 4.5	6.3CT 1
PR-300	550-370-75-0			5 6	6.3CT 5	6.3CT 1
	-75-370-550	300	425			

Also available in the *Sealed in Steel* constructions:
FILTER REACTORS with current ratings to match power transformers above.
FILAMENT TRANSFORMERS to meet a wide range of modern tube requirements.

AUDIO TRANSFORMERS—Input, Output, Driver, and Modulation—that provide uniformly high fidelity response in three frequency ranges: 30-15,000 cycles, 50-10,000 cycles, and 200-3,500 cycles.

CHICAGO TRANSFORMER

DIVISION OF ESSEX WIRE CORPORATION

3501 ADDISON STREET • CHICAGO 18, ILLINOIS



Have YOU
been
STUNG?



DON'T Put Your Money Into Junk! Buy BRAND NEW Surplus - In Original Factory-Sealed Cartons . . . For the Price of Used Equipment. Be Safe - Buy from One of the Nation's Largest Suppliers - OFFENBACH & REIMUS C

SPECIALS FOR JULY PE-103 DYNAMOTORS

LAST LOT! Brand New - In moisture-proof sealed packing. 6 or 12v input; 500v, 160ma output. Complete with filters, circuit breakers, etc. GET THE FINEST IN UNOPENED CASES, \$10.95.

FL-8A FILTER

LISTEN ONLY to the Signal You WANT to Hear



Improves ANY receiver! 1020 cps Filter, connects between output of receiver and phones or speaker. Hear only ONE signal at a time. Cuts-out interference and background noise. AMAZING PERFORMANCE! Complete with cords, phone plug and extension connector. BRAND NEW, made by UTC. War Surplus item. Original cartons. \$2.95 POSTPAID.

Brand New!

TS-13 HANDSETS



Cradle-Type Black Bakelite Telephone Handset, with low-impedance carbon mike and 3,000-ohm earphone, 6-ft. cord and two plugs. Butterfly push-talk switch. Brand New, in Original Sealed Cartons. LOWEST PRICE IN U.S.A. . . . Only \$2.85 net.

POWER SUPPLY FOR ANY 274-N RECEIVER



Here it is—at last! Just plug it into the rear of your 274-N RECEIVER . . . any model! Complete kit, and black metal case, with ALL parts and diagrams. Simple and easy to build in a jiffy. Designed especially for the 274-N receiver (Resistance-filter KIT \$6.95). Standard model has choke filter. . . . \$7.95

OTHER SPECIALS FOR JULY All Items BRAND NEW— GUARANTEED!

- Eimac VT-127A Tubes . . . \$2.85 each.
- Power Supply Kit for 8C-221 Frequency Meter . . . \$5.85.
- 12" PM Alnico-5 Speaker. \$7.85.
- Finest Headphones. 3000-ohms, with SIX-FOOT CORD and adjustable headband. Amazing Bargain . . . \$1.95.
- Beautiful Hand Mike with W.E. Unit and W.E. Plug, a 30-day special for July only . . . \$1.95.

WRITE FOR FREE CATALOG 89-R

- 4-Hour Mail Order Service.
- Send 25% Deposit, Balance C.O.D.

OFFENBACH & REIMUS CO.

372 Ellis St. • San Francisco 2, Calif.

AGAIN--

Danger, High Voltage

By GUY DEXTER

Even power line voltages are dangerous under certain conditions. Take these necessary precautions against possible serious injury.

THERE is a maxim "We need to be reminded more than we need to be educated." This applies strikingly to the danger of high voltage. All radiomen have learned at some time that high voltages are bad medicine; but without constant reminders, the lesson fades as experience gives way to risk, and risk clears the road for death. This is no indictment of radiomen alone, however. The situation is no less grave nor human than that of playing with fire—we forget easily that one match can start a whole town burning. And so it is with electricity; we forget how dangerous the stuff can be.

Perhaps at no other time in recent radio history than now do we need to be reminded of the death dealing and crippling effects of electricity. High-voltage television and electronic circuits now are enjoying wide distribution. Also, low-priced equipment in the surplus market has brought high-voltage transmitters to a large number of hams inexperienced in handling such apparatus. With this increased availability of dangerous equipment, we need to sound the alarm, lest soon we have the job of writing epitaphs.

With the foregoing thoughts driving us, we direct the following remarks to the amateur fraternity with the hope that they may serve to forestall disaster during the coming active months.

High Voltage Hazard

Kilovolts are killer volts! Few persons have survived contact with potentials of several thousand volts. Even when death does not ensue, severe physical injury and/or nervous or mental derangement are certain to result from high-voltage shock.

Many amateur transmitters have power supplies with voltage outputs higher than those used in the electric chair. This ought to be the source of much concern in homes where these rigs are operated.

There are a few simple rules which every transmitting amateur should observe. They have been restated by a score of authors, but can stand reiteration. For example: no "live" portion of a transmitter should be exposed. The material used to enclose the apparatus must not be loosely woven screen or perforated sheet metal, both

of which allow fingers or metallic objects to be poked through. True, heat runs high in solid boxes, but it is better to lose a little electrical efficiency through overheating than to expose the unsuspecting members of one's family to a top-flight hazard.

The chassis, framework, and negative terminal of every high-voltage power supply should be grounded by actual connection through heavy wire to a pipe driven deep into moist earth or to the cold water piping (not to the radiator system or gas piping) of the building. All of the other chassis in the transmitter, and the "B-minuses," should likewise be grounded.

Every power supply should be equipped with a high-wattage bleeder resistor connected directly between the positive and negative terminals. This bleeder should have the lowest value of resistance that can be tolerated in the circuit, in order that it can drain the filter condensers *quickly* when the voltage has been switched off.

The bleeder is a good safety device, but it must not be trusted blindly. Whenever it becomes necessary to do work in the power supply unit, the filter condensers first should be short-circuited temporarily by means of a heavy wire jumper, the "held" portion of which is heavily insulated to protect the operator. If the bleeder has opened, without the operator's knowledge, this operation will expose the deadly charge from the condensers.

High-voltage power supplies should be individually metered *and* provided with pilot lights in order that the operator may know definitely when they are in operation. Furthermore, they should be fused. For maximum safety, the pilot lamps should be replaced long before their burnout point—say, at the end of each 100 hours of operation.

Meters should be mounted behind thick plate glass. All wiring should be done with high-voltage-insulated cable and, when carried between chassis, should be run in metal conduit or raceways.

One or more interlock switches should be employed on each transmitter cabinet, so that the line voltage automatically will be removed from *all* power supplies before the

RADIO NEWS

Hyper

guarantees that the
projectors on your
job are the best . . .
. . . 6 new designs

Jensen
6601 So. Laramie Ave., Chicago 38

Designers and Manufacturers of Fine Acoustic Equipment

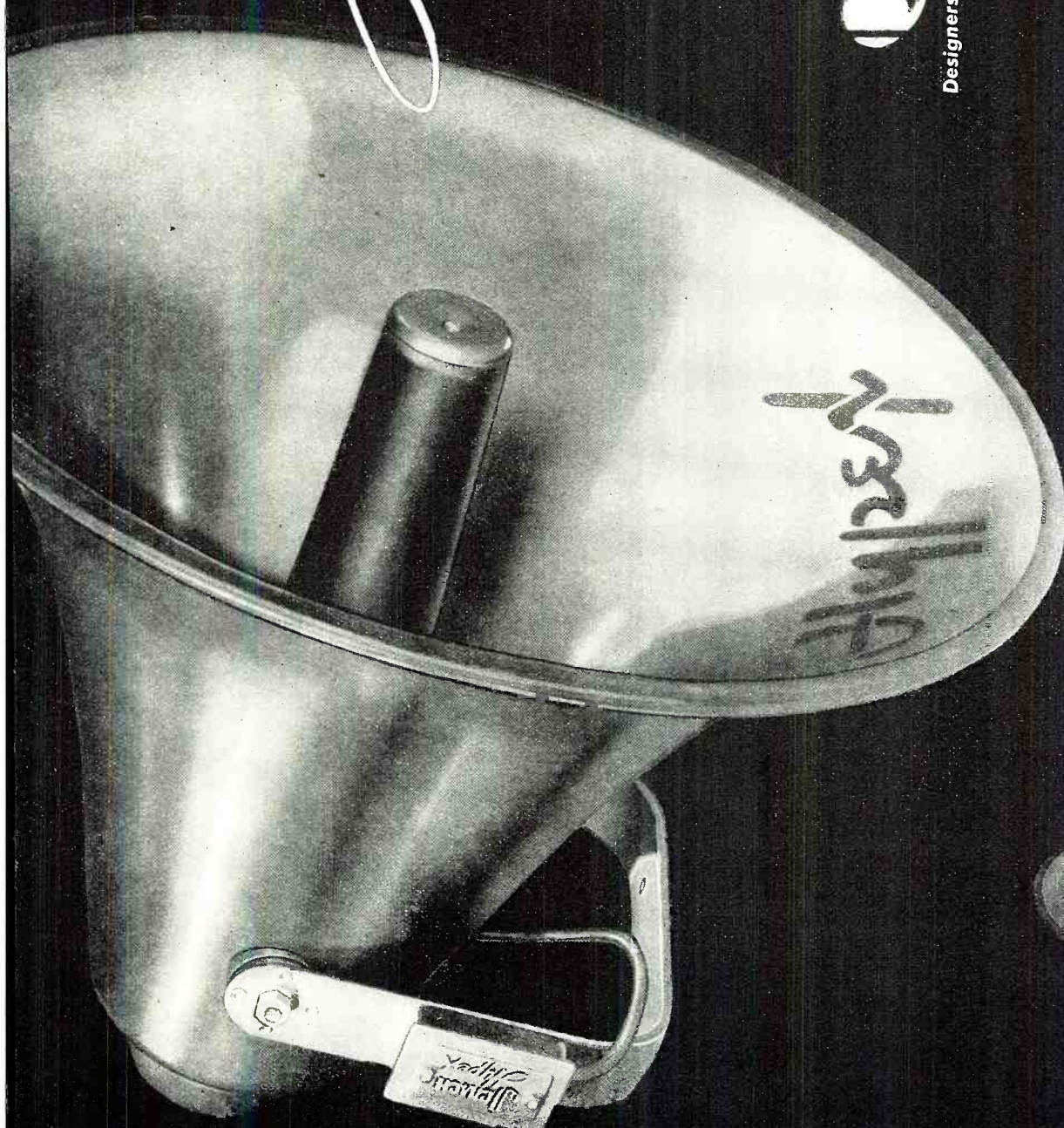

24 inch
Reflex
Radial

10 inch
Reflex
Radial

9 inch
Reflex

15 inch
Reflex

20 inch
Reflex

24 inch
Reflex

SUPER VALUES from MID-AMERICA!

Stromberg-Carlson DYNATENNA

This famous-make FM antenna has been advertised and sold for many times the low price MID-AMERICA asks! Covers both FM bands. Delivers FM reception at its best. Complete with 60 ft. of 300-ohm twin lead-in. Line is standard approved flat-type, solid dielectric with weather-resisting insulation. Mounts anywhere easily . . . vertically or horizontally to match polarization of trans-

mitting station. Illustrated instructions and all necessary hardware. A screwdriver is only tool needed for assembly. Dynatenna is seamless, heat-treated, all aluminum . . . will withstand severest weather.

\$4.95
each

\$4.45 each
in lots of 3



PERMEABILITY TUNER

Build a really HOT 5 or 6-tube AC-DC superhet receiver! Takes place of old-style gang condenser, of antenna coils; regular 455 KC intermediate frequency. **MA-2167**
Complete with permeability tuned oscillator coil. 4" x 2 1/2" x 2 1/4"; 2 1/2" diameter dial drum. Complete with diagrams for building 5 and 6 tube sets. **\$124**
Order **MA-2169** Loop Antenna 15c
Order **MA-2914** Drilled, punched Chassis 39c

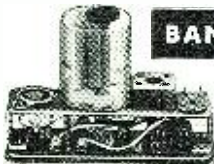

BANTAM 1-WATER

BCR-746-A tuning unit used as foundation for Bantam 1-Water described in Jan. 1948 QST. Makes tiny crystal-controlled CW xmitter. Measures only 3 3/4" long, 2 1/2" high, 1 1/2" wide. Requires only 1 1/2 volts "A", 30 to 90 volts "B". Draws 8 to 15 ma under load. Supplied less crystal, 1S4 tube and plug-in coil **MA-907** **24c**

SPECIAL AUDIO TRANSFORMERS

Exceptionally high-quality universal output transformer for up to 12" speakers. Rated at 12 watts. Matches any single, push-pull or parallel tubes to 6-8 ohm voice coil. 12" color-coded leads, 2" high with 2 1/4" mounting centers for installation on chassis or speaker. Complete with instructions for matching tube impedances. **MA-1205** **\$1.19**

Hermetically sealed 200 ohm CT to 50,000 ohm grid. Uses microphone transformer, line-to-grid, etc. 2 1/2" x 1 3/4" x 1 1/2". **MA-1262** **69c**

Single 3000-ohm to 4-ohm voice coil output for 50L6, 35L6, etc. 1 3/8" high on 2 1/4" mounting centers. **MA-1255** **49c**

Heavy Duty Noise Filters

Rated on 10 amps, 115-volt AC. Measures only 1" x 1 1/2" square. Install right in amplifiers, receivers and other equipment where line noises must be kept at a minimum. Nationally-known manufacturer. **MA-2164** **79c**

Filter for mobile power supplies. Rated 10 amps, 6-30 VDC. Has additional 2 mfd, 100 VDC condenser. 2" high, 2" square. **MA-2165** **59c**

SPEAKER SPECIALS

All with Heavy ALNICO 5 Slugs

3 1/2" PM MA-2062 . . . \$1.39 4x6 Oval PM MA-2187 \$1.39
5" PM MA-2071 . . \$1.39 6" PM MA-2189 . . . \$1.95

ORDER FROM THIS AD!

Quantities are limited, so get your order in now! Minimum order shipped, \$2.50. Send 25% deposit, balance C. O. D. Get on MID-AMERICA's mailing list to receive BIG BARGAIN BULLETINS that list latest, greatest buys in radio parts, electronic equipment. Send orders to Desk E-78

MID-AMERICA CO. Inc.
2412 S. Michigan Avenue
Chicago 16, Ill.

80

cabinet may be entered. Interlock switches are cheap, ridiculously so when stacked against a human life.

Meter-insertion jacks should not be used in high-voltage stages of transmitters, not even when they are mounted behind the panel. It is far better to employ separate meters or, at least, a meter switch and keep all of the "hot works" inside the transmitter.

Before prying into the "innards" of any radio equipment, make sure you study the circuit carefully beforehand and that you know what's what. This applies particularly to cathode-ray equipment in which, invariably, expected low-potential points turn out to be high-voltage.

Whenever working around high voltages—or where high voltages are suspected—it is standard practice to keep one hand behind you, or in your pocket. Your chances are much better if you don't get the jolt through both hands, and never knowingly work on a hot circuit. Let the other guy laugh if he wants to. Few situations are really so urgent that apparatus can't be shut down long enough for repair. When the floor is damp (as concrete cellar floors always are, even when they look their driest), it is a good idea to wear a good pair of rubbers (your shoe soles are damp too. If you don't believe it, check their insulation resistance sometime) or to stand on a dry wooden platform, or both. A heavy pair of rubber gloves is an added precaution.

Never work on high-voltage equipment when you are alone. Have another qualified person in the room. And never, never do this work when you are tired, sick, or intoxicated, however slightly. Your reflexes and judgment at their best will have to work pretty fast to beat a crippling electric shock; and when your faculties are dulled for any reason, your chances are mighty slim.

No person who knows that he is going to be exposed regularly to high voltages, nor his assistants or members of his family, should forego a knowledge of what to do in case of electric shock. This is plain sense. The radio handbooks, electrician's handbooks, first aid manuals, and similar books give practical information on artificial respiration. An excellent move is to take a Red Cross course.

Separated Transmitters

A separated transmitter is one which has its power supply in one part of the house (or room) and its r. f. and audio sections in another.

Some hams employ this arrangement because they like to have nothing transmitter-wise showing on the operating desk but a neat, little, receiver-sized cabinet. This keeps all of the ugly and noisy parts of the rig down cellar or in some closet. This method of operation calls for the running of high-voltage-insulated cable in conduits through the floors or walls of the house. It also calls for the installation of some pretty reliable kind

of signal-light system to warn the operator when the hot stuff is switched on.

Aesthetically, the separated transmitter has much in its favor. But it reminds us of a volcano. Signals, switches, and meters notwithstanding, we never could bring ourself to changing coils in a rig like that without first running downstairs to see if the rectifier filaments were off. Otherwise, we would make out our will first. With a separated rig, there is always the chance, even if you escape electrocution, that you will burn the house down.

A separated high-voltage power supply never should be exposed to trespass by persons other than the operator. It should be locked up, not merely shoved into a dark corner. Furthermore, the walls of its enclosure should be solid, to prevent accidental or intentional poking into it with wires, metal rods, wet sticks, and the like.

The "Safe Low Voltage" Fallacy

Radio amateurs and some electricians are inclined to look with scorn upon all voltages up to and including 500. They call these potentials harmless, although disturbing. This is a matter of record that several hams have been killed by their speech amplifiers (and these units operate at somewhat less than 500 volts!). Several times this year, the newspapers have carried stories about persons who have been killed by the 110 powerline voltage.

Line voltage is nothing to play with. A lot of people have been killed by it. While worrying about kilovolts, we come to sneer at 110. If you really want to keep out of trouble with line voltage, however, avoid a.c.-d.c. equipment as you would the plague. If you must use this kind of apparatus, insert your plug into the 110-volt receptacle in the right direction that will enable you to connect the chassis to earth.

Make no mistake that electricity is to be played with. More forcibly than in many other instances, the rule that familiarity breeds contempt applies here. But the contempt is the prerogative of electricity—not yours.

-50-



RADIO NEWS

FOR THE NEWEST IN TV AERIALS

Watch
WARD

GREATER TV
EFFICIENCY WITH
NEW "HIGH-LOW"
ARRAY BY WARD

All major parts pre-
assembled.
Saves costly installa-
tion time.

Here's another "first" by Ward in the rapidly expanding field of television reception. Advanced Ward design and engineering makes receivers work to their highest degree of efficiency.

That's the opinion of satisfied set owners, service installers, and major set manufacturers, who are all directly interested in the improved performance of television.

As a result of months of exhaustive scientific research and field testing, Ward now makes available a high band TV array which can be stacked above the standard television elements, and independently oriented! Also new is a kit for stacking two of Wards finest television assemblies into a two-bay array for a greater gain than ever before.

Sure, there have been other multiple antennas, but none with the scientifically measured spacing and complete adaptability of the new Ward models. You can see the difference yourself on the television screen when a "Magic Wand" aerial is connected to the set.

Send in coupon today for free copy of new Ward catalog.

ORIENTING AND GAIN. Each bay tilts in any plane, can be oriented in any direction to give sharpest focus possible. Eliminates awkward or tricky installations. Permits hairline adjustments for utmost gain on both the high and low band stations.

ADAPTABILITY. Ease of combination of assemblies in basic kits makes "Magic Wand" Aerials more adaptable than ever to the varying requirements of each installation. This superior flexibility means a highly specialized Ward TV aerial for each purpose, with fewer models in stock, no obsolescence, and greater profits! Write today for free catalog!

Please send me free copy of your new catalog showing latest developments in television aerials.

NAME _____

ADDRESS _____

STATE _____ CITY _____

IF JOBBER OR DEALER
COMPANY NAME _____

THE WARD PRODUCTS CORPORATION
DIVISION OF THE GABRIEL COMPANY
1524 E. 45th STREET, CLEVELAND 3, OHIO
IN CANADA: ATLAS RADIO CORP. LTD., TORONTO, CANADA

WARD
Magic Wand
AERIALS

WORLD'S LARGEST PRODUCER OF AERIALS FOR CAR AND HOME

Build YOUR OWN TEST EQUIPMENT

\$39.50

Nothing ELSE TO BUY

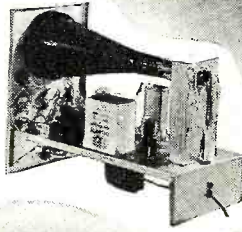
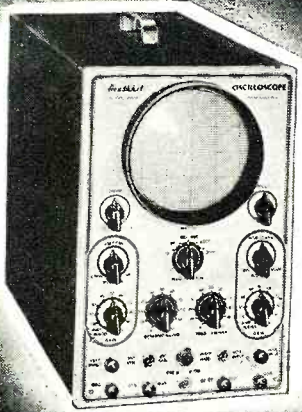

NEW 1948 HEATHKIT 5" OSCILLOSCOPE KIT

A necessity for the newer servicing technique in FM and television at a price you can afford. The Heathkit is complete, beautiful two color panel, all metal parts punched, formed and plated and every part supplied. A pleasant evening's work and you have the most interesting piece of laboratory equipment available.

Check the features — large 5" 5B1 tube, compensated vertical and horizontal amplifiers using 6SJ7's, 15 cycle to 30 M cycle sweep generator using 884 gas triode, 110V 60 cycle power transformer gives 1100 volts negative and 350 volts positive.

Convenient size 8½" x 13" high, 17" deep, weight only 26 pounds.

All controls on front panel with test voltage and ext. syn post. Complete with all tubes and detailed instructions. Shipping weight 35 pounds.

Order today while surplus tubes make the price possible.

HEATHKIT SINE AND SQUARE WAVE AUDIO GENERATOR KIT

The ideal companion instrument to the Heathkit Oscilloscope. An Audio Generator with less than 1% distortion, high calibration accuracy, covering 20 to 20,000 cycles. Circuit is highly stable resistance capacity tuned circuit. Five tubes are used, a 6SJ7 and 6K6 in the oscillator circuit, a 6SL7 square wave clipper, a 6SN7 as a cathode follower output and 5Y3 as transformer power supply rectifier.

The square wave is of excellent shape between 100 and 5,000 cycles giving adequate range for all audio, FM and television amplifier testing.

Either sine or square waves available instantly at a toggle switch. Approximately 25V of sine AC available at 50,000 ohm output impedance. Output—1 db. from 20 to 20,000 cycles. Nothing else to buy. All metal parts are punched, formed and cadmium plated. Complete with tubes, all parts, detailed blueprints and instructions.

HEATHKIT SIGNAL TRACER KIT

Reduces service time and greatly increases profits of any service shop. Uses crystal diode to follow signal from antenna to speaker. Locates faults immediately. Internal amplifier available for speaker testing and internal speaker available for amplifier testing. Connection for VTVM on panel allows visual tracing and gain measurements. Also tests phonograph pickups, microphones, PA systems, etc. Frequency range to 200 Mc. Complete ready to assemble. 110V 60 cycle transformer operated. Supplied with 3 tubes, diode probe, 2 color panel, all other parts. Easy to assemble, detailed blueprints and instructions.

Small portable 9" x 6" x 4¾". Wt. 6 pounds. Ideal for taking on service calls. Complete your service shop with this instrument.

HEATHKIT SIGNAL GENERATOR KIT

Every shop needs a good signal generator. The Heathkit fulfills every servicing need, fundamentals from 150 Kc. to 30 megacycles with strong harmonics over 100 megacycles covering the new television and FM bands. 110V 60 cycle transformer operated power supply.

400 cycle audio available for 30% modulation or audio testing. Uses 6SN7 as RF oscillator and audio amplifier. Complete kit has every part necessary and detailed blueprints and instructions enable the builder to assemble it in a few hours. Large easy to read calibration. Convenient size 9" x 6" x 4¾". Weight 4½ pounds.



\$24.50
Nothing ELSE TO BUY

THE NEW HEATHKIT VACUUM TUBE VOLTMETER KIT

The most essential tool a radio man can have, now within the reach of his pocketbook. The Heathkit VTVM is equal in quality to instruments selling for \$75.00 or more. Features 500 microamp meter, transformer power supply, 1% glass enclosed divider resistors, ceramic selector switches, 11 megohms input resistance, linear AC and DC scale, electronic AC reading RMS. Circuit uses 6SN7 in balanced bridge circuit, a 6H6 as AC rectifier and 6 x 5 as transformer power supply rectifier. Included is means of calibrating without standards. Average assembly time less than four pleasant hours and you have the most useful test instrument you will ever own. Ranges 0-3, 30, 100, 300, 1000 volts AC and DC. Ohmmeter has ranges of scale times 1, 100, 1000, 10M and 1 megohm, giving range .1 ohm to 1000 megohms. Weight 8 lbs.

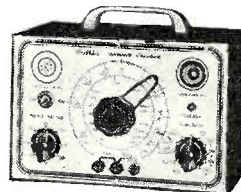

\$19.50

HEATHKIT CONDENSER CHECKER KIT

A condenser checker anyone can afford to own. Measures capacity and leakage from .00001 to 100 MFD on calibrated scales with test voltage up to 500 volts. No need for tables or multipliers. Reads resistance 500 ohms to 2 megohms. 110V 60 cycle transformer operated complete with rectifier and magic eye indicator tubes.

Easy quick assembly with clear detailed blueprints and instructions. Small convenient size 9" x 6" x 4¾". Weight 4 pounds. This is one of the handiest instruments in any service shop.

\$34.50

Shipping Wt., 13 lbs.

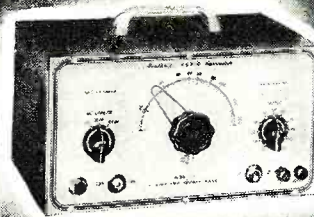

\$19.50

Nothing ELSE TO BUY

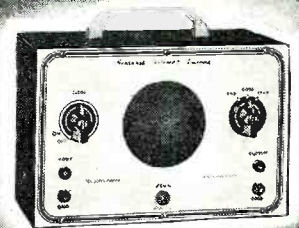

\$19.50

Nothing ELSE TO BUY

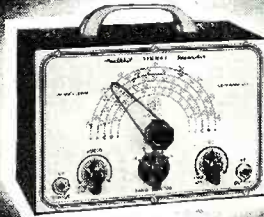

The **HEATH COMPANY**

DEPT. N . . . BENTON HARBOR, MICHIGAN

COMMAND SET ACCESSORIES

BEST OF KITS

POWER TRANSFORMER *Specials*

TRANSMITTER POWER SUPPLY KIT

For BC-645, 223, 522, 274N's, etc. Ideal for powering military transmitters. Supplies 500 to 600 Volts at 150 to 200 MA plate, 6.3 C.T. at 4 Amps, 6.3 at 4 Amps and 12V at 4 Amps. Can be combined to supply 3-6-9-12 or 24 Volts at 4 Amperes. Kit supplied complete with husky 110V 60 cycle power transformer, 5U4 rectifier, oil filled condensers, cased choke, punched chassis, and all other parts, including detailed instructions. Complete - nothing else to buy.

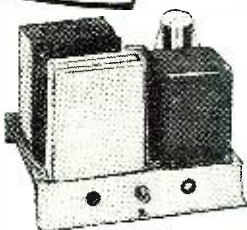

TRANSFORMER ONLY \$9.50

\$14.50

110V RECEIVER POWER SUPPLY KIT

With 24 volt filament, no wiring changes inside set, punched chassis and volume control

\$5.95

5" PM SPEAKER

With output transformer, matching headphone output.....

\$2.80

Dual receiver rack FT277A with connecting plugs.....

\$1.00

Single transmitter rack FT234A.....

\$1.00

MILITARY CONVERSION POWER TRANSFORMERS

Convert your military receivers without rewiring the filament. "A" type supplies 500 VCT at 50 MA, 5V at 2A and 24V at 1/2A. "B" type supplies 500 VCT at 50 MA, 5V at 2A and 12V at 1 amp. State whether A or B type desired.....

\$2.95

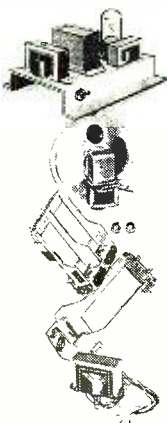

A wonderful buy in a new production heavy duty power transformer. Primary 117V 60 cycle. Secondaries supply 746 V.C.T at 220 MA, 6.3V. at 4.5 A., and 5V at 4 A. An ideal transformer for high quality amplifier modulator, small transmitter or quality radio. Will handle 13 tube radio receivers. Supply is limited, order early.

\$3.95 . . . 3 FOR \$9.95

INPUT AND OUTPUT TRANSFORMER



Two units in one case carbon microphone input and output from 155 to 150 ohm load used in Hartie Talkie No. 744 special 4 for.....

\$1.00



Filter Choke 15 henries at 60 MA cased type hermetically sealed No. 643, each.....

\$1.00



OUTPUT TRANSFORMER Push pull 6V6's to 6-8 ohm voice coil excellent characteristics No. 800. 3 for.....

\$1.95



OUTPUT TRANSFORMER Couples, 6C4, 6J5, etc. to 500 or 5,000 ohm line No. 716. 2 for

\$1.00

MIDGET AMATEUR TRANSMITTER KIT

Complete kit to assemble a 1 Watt battery operated amateur 80 meter transmitter, including tube and crystal. Range up to 500 miles. Only accessories needed are sending key and batteries. Complete instructions supplied. Add postage for 2 lbs.

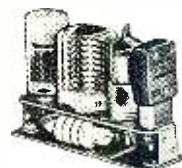

\$3.95

ACCESSORIES

Key (add postage for 2 lbs.).....\$1.00
Kit of batteries (add postage for 4 lbs.)..... 3.25

AN/APN1 RADIO ALTIMETERS

Brand new, complete with tubes, dynamotor, antennae, indicator, switch, plugs and instruction manual. Consists of 420 MC transmitter and receiver. Converts into excellent boat radar indicating in feet, or amateur 420 MC rig. In original crate.



\$34.95



T32 TABLE MICROPHONE

One of the Army's best. Built by Kellogg, ideal for factory call system, public address, amateur use. Brand new in original cartons, add postage for 5 lbs.....

\$2.95

DYNAMOTORS

Consists of electric motor operating generator on same shaft. Many applications—operating radios from storage battery—using as motor.

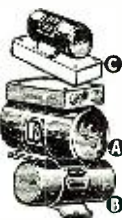

Dynamotor C—Input 28 volts, output 220 volts at 60 MA. Shipping Weight 6 pounds.....

\$1.50

Dynamotor A—Input 12 volts, output 1000 volts at 350 MA. Shipping Weight 72 pounds.....

\$5.95

Dynamotor B—Input 6 or 12 volts, output 500 volts, 160 MA. Shipping Weight 30 pounds.....

\$5.95



METER *Special*

Brand new DeJur Model 312 0-800 M.A. D.C. Square 3" 0-10 M.A. basic meter with built in shunt. Probably the best buy ever offered in a surplus meter. Shipping weight 1 lb.

\$2.95

HEARING AID HEADPHONES

The Army's best—eliminate flat ears and outside noise. Complete with transformer for conversion from low to high impedance. With cord and plug complete. Add postage for 1 lb.

\$1.00



HEATHKIT 3-TUBE ALL-WAVE RADIO

110-volt AC operation

\$8.75

An ideal way to learn radio. This kit is complete ready to assemble, with tubes and all other parts. Operates from AC. Simple, clear detailed instructions make this a good radio training course. Covers regular broadcasts and short wave bands. Plug-in coils. Regenerative circuit. Operates loud speaker. Battery model for use where no AC house current is available. Add postage for 3 lbs.



Heathkit Beginners' Radio 110-volt type.....

\$8.75

Heathkit Beginners' Radio, battery type (2 tubes, no rectifiers).....

\$8.75

Headphones for either type HS 30 per set.....

\$1.00

2 1/2" permanent magnet loudspeaker for either type.....

\$1.95

Batteries, complete kit for battery type set.....

\$3.25

INTERPHONE 2-WAY CALL SYSTEM KIT

Ideal call and communication system for homes, offices, factories, stores, etc. Makes excellent electronic baby watcher, easy to assemble with every part supplied including simple instructions. Distance up to 1/5 mile. Operates from 110 V.A.C. 3 tubes, one master and one remote speaker. Shipping Weight 5 pounds.

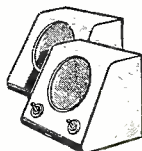

\$14.50

LOOK AT THE PARTS IN A GENERAL ELECTRIC BC-375 TUNING KIT

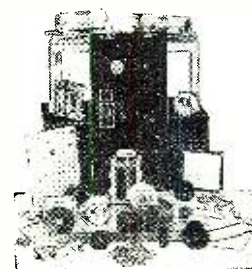

FOR *Only* **\$2.49**

A beautiful aluminum case ideal for building a receiver or transmitter. Three variable condensers, transmitting coils, transmitting mica condensers, ceramic switches, National Velvet Vernier dial, ceramic insulated couplings, 10 banana jacks, RF chokes, etc. The parts in this unit will be useful for years.

This is truly the greatest buy in surplus—better order one while still available. We include plans for converting to an 80 meter transmitter receiver all for \$2.49. Specify TU26B (200-500 KC.) or TU10B (10 to 12.5 MC.) Shipping weight 20 lbs.



**HERE IT IS!
JUST PUBLISHED!**

The Practical Aspect
of the Future of Radio

Television AND F-M RECEIVER SERVICING

By Milton S. Kiver
Registered Professional Engineer

As every radio man knows, the limitless possibilities of radio in the fields of F-M and television broadcasting are no longer "just talk"—the future of radio has arrived! With more and more F-M and television sets on the market and in operation, no student or service man can afford to be without the wealth of up-to-the-minute, practical information in Television and F-M Receiver Servicing. Written by the author of U.H.F. Simplified, F-M Simplified and Television Simplified, this simple, well-organized text contains enough theory to make crystal-clear all types of servicing problems, and gives specific directions for diagnosing, locating and repairing the common troubles which may occur in an F-M or television receiver. The book is profusely illustrated with valuable schematic diagrams and photographs.

CONTENTS

The Antenna System, Operation and Installation; Television Receiver Installation; Television Test Equipment; The Television Receiver, Operation and Servicing (4 chapters); Television Receiver Alignment; Trouble Shooting Television Receivers; F-M Fundamentals; Commercial F-M Receiver Circuits; F-M Receiver Alignment; F-M Receiver Servicing.

**EXAMINE THIS BRAND
NEW BOOK FREE!**

MAIL THIS COUPON

D. Van Nostrand Company, Inc.
250 Fourth Ave., New York 3, N. Y.

Please send me a copy of TELEVISION and F-M RECEIVER SERVICING for examination. Within 10 days I will return the book to you or send you \$2.95 plus a few cents postage.

Name _____
Address _____
City _____ State _____

RN-July '48



CIRCUIT PAGE

(FOR PARTS LISTS SEE PAGE 94)

RADIO NEWS, JULY, 1948

WESTINGHOUSE MODELS H-161, H-168, H-168A

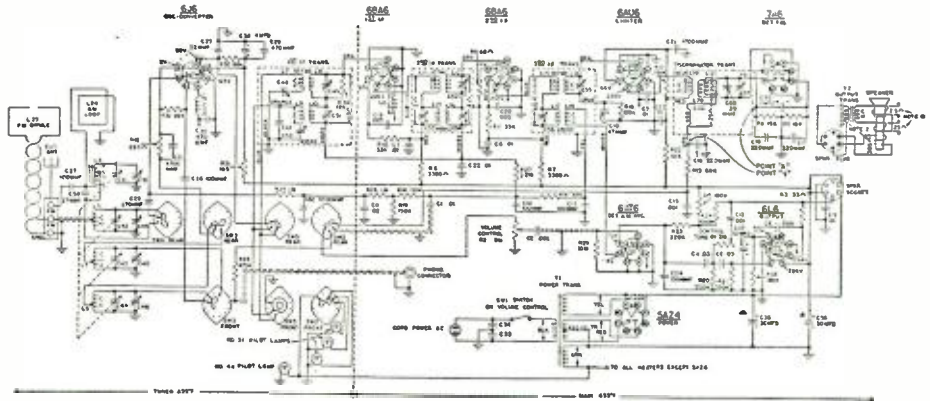

RADIO NEWS, JULY, 1948

GAROD MODEL 5A4

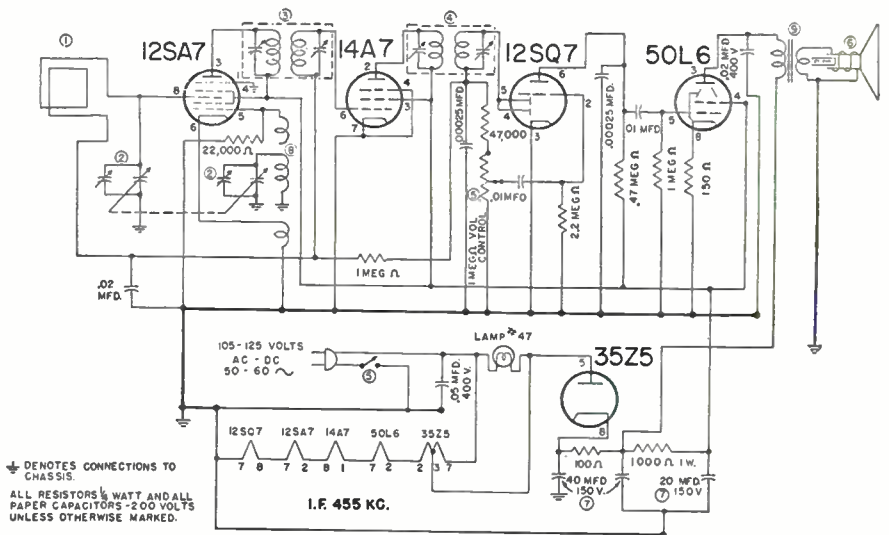

RADIO NEWS, JULY, 1948

ARVIN MODELS 152T, 153T

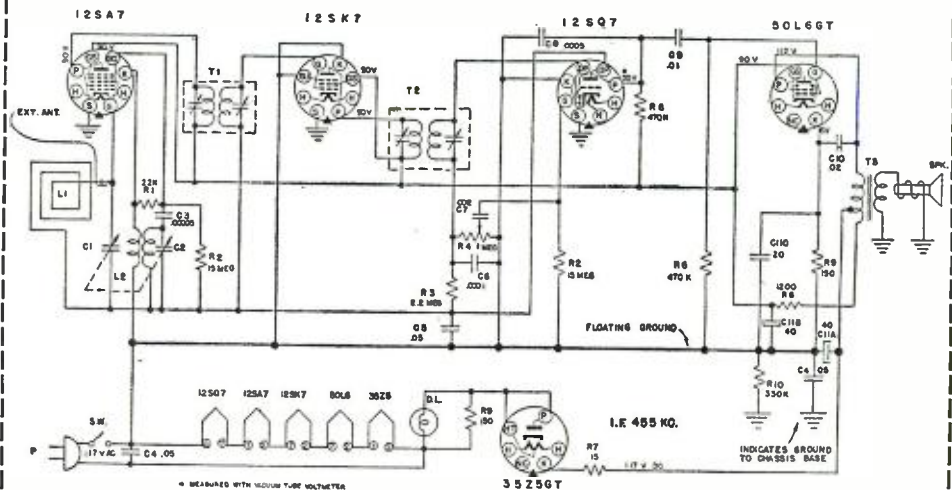

Here, and on following pages, are circuit diagrams and parts lists of many new postwar radio receivers. Radio News will bring to you other circuits as quickly as possible after we receive them from manufacturers.

RADIO NEWS, JULY, 1948

BELMONT MODEL 5240

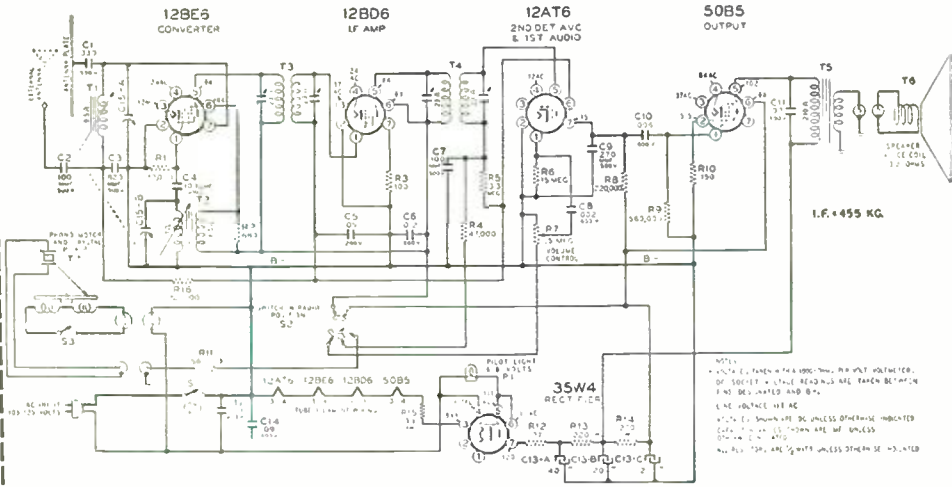

RADIO NEWS, JULY, 1948

MANTOLA MODELS 92505, 92506

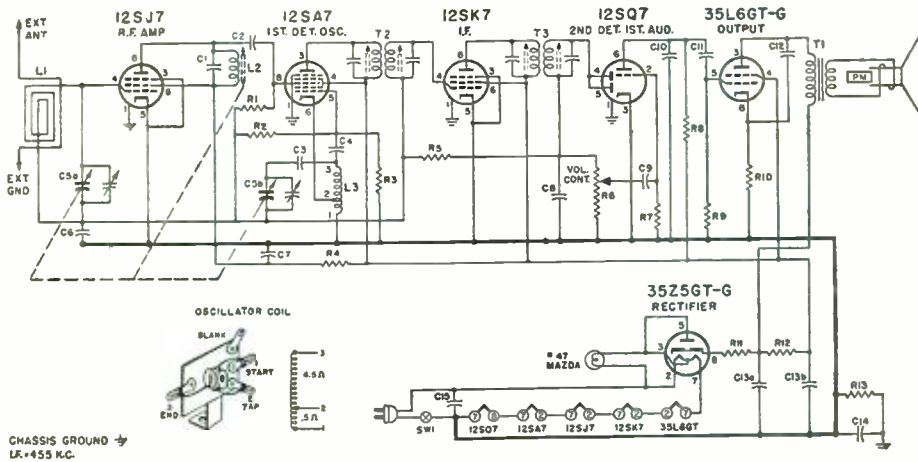

RADIO NEWS, JULY, 1948

GENERAL ELECTRIC MODELS 102, 102W, 107, 107W, 114, 114W, 115, 115W

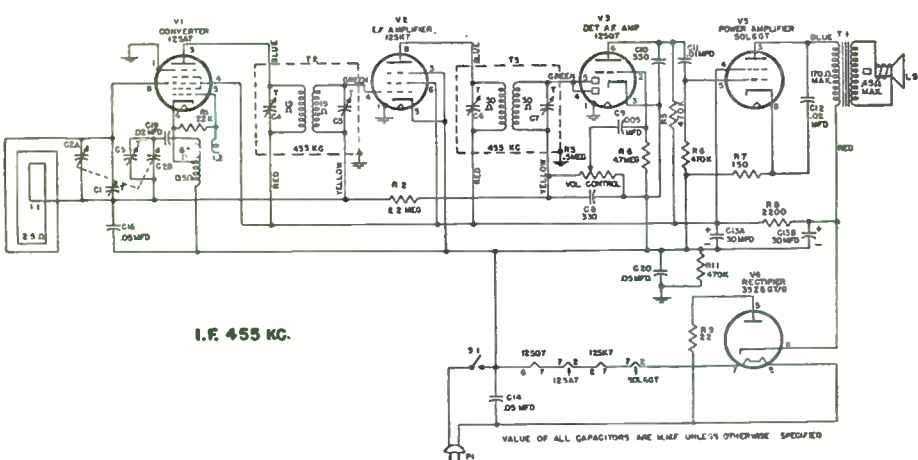

50,000
Wanted: DEALER NAMES
Your Name
IS NEEDED
TO COMPLETE OUR LIST!

To Get Your Name, Your Address, RSE Offers

CONDENSERS
NATIONALLY ADVERTISED
8-450-VOLT or
40-150-VOLT
Choice of 10 **\$2.90**



LIMIT
1 Deal to
A Customer

Over 70% off on top quality, nationally advertised, name brand condensers. Check them any way you want—for capacity, leakage, power factor—if they're not the best you can buy, you get your money back!



VOLUME CONTROLS

Our own private brand—made by a nationally known manufacturer. The same kind that net for \$1.09. Noise-free carbon construction, standard shaft and bushing. Individually boxed in our colorful cartons carrying the RSE quality seal of approval. Complete with switch, full range of sizes.

10 M ohms	100 M ohms	each	59c
15 M ohms	250 M ohms	per 10	\$5.50
25 M ohms	500 M ohms	ass'd.	
50 M ohms	1 Meg ohms		
2 Meg ohms			

500 M ohms less switch, 39c each, 100 for \$35.00

CLOSING OUT

PHILCO CELLS
PHILCO LAMPS

We can no longer ship our famous "Philco Reconditioning Kits." We've sold out of needles and can't replace them. Here's your chance to "steal" the other two items. Until they are gone we offer Philco Selenium cells only, post paid (no holder)..... **\$1.19**
Philco "Beam of Light" Lamps..... **25c**

OZ4's
at **73% OFF!**

Until sold out—RSE offers 15000 new guaranteed OZ4 tubes. You know who made them—You can't go wrong at **59c**



PANEL METERS

You fellows wanted them—So here's another of our famous meter specials! Made by the same company—all new, boxed, popular types—your chance to get those meters you've always wanted!

Model 341—0-500 Ma. R. F. thermo couple—3 inch bakelite case	\$3.95 each
Model 222—0-500 micro amps D. C.—2 inch brass case	
Model 322—1-0-1 (zero center) D. C. Mills—3 inch bakelite case	

ORDER INSTRUCTIONS
Minimum order—\$2.00. 25% deposit with order required for all C.O.D. shipments. Be sure to include sufficient postage—excess will be refunded. Orders received without postage will be shipped express collect. All prices F.O.B. Detroit.

DEMAND THIS SEAL OF QUALITY

RADIO SUPPLY & ENGINEERING CO., Inc.
129 SELDON AVE. DETROIT 1, MICH.

**IT'S SATISFACTION—
or YOUR MONEY BACK at—**

R & M RADIO

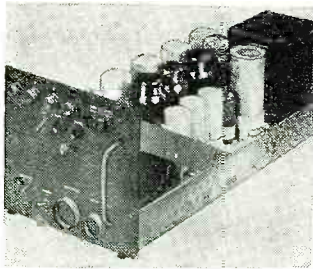

**APN-4 RCVR — 'SCOPE
POWER SUPPLY**

4 switch-selected screw-driver tuned RF channels; IF freq. 1050 kc, band-width 45-60 kc; RF freq. 16 2000 kc. Tubes: (2) 2Y2, (3) 6B4, (4) 6SK7, (1) ea. 5U4, 6SU7, 6SA7, 6H6, VR150. Makes fixed tuner for med. freq. police calls or PA system. Has power supply for 5" scope, with 400 cycle trans. Electronic-controlled low v. supply; delivers 260 vdc. 150 mils reg. to .01%. Power supply alone worth **\$12.50** more than price.

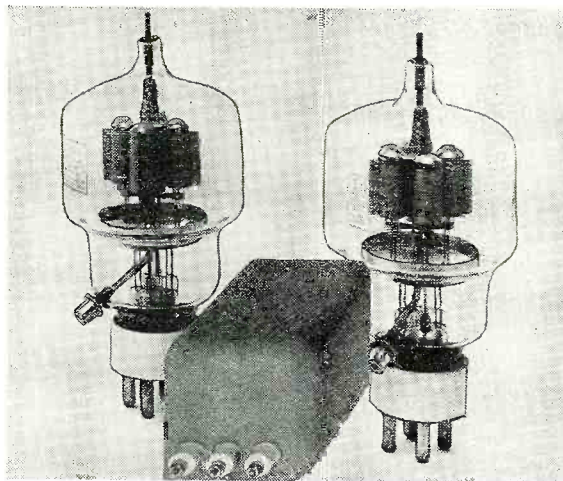

GOOD FOR 2 KW.

**SPECIAL
COMBINATION
\$14.50**

Two 304-TL's; 1 filament transformer, primary 115 VAC, secondary No. 1, 5 v. at 12 amps; secondary No. 2, 5 v. at 12 amps. Use filaments in series or parallel.

<i>Individual Price:</i>	ALL FOR
304-TL	\$14.50
304-TL	
Fil. Transformer.....	

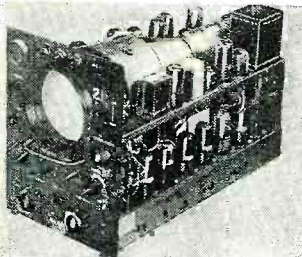

**APN-4 INDICATOR
Precision OSCILLOSCOPE**

Special for amateurs, experimenters and repairmen; can be converted into the following: 5-inch panoramic set with marker pips at 100 kc—20 kc—2 kc to enable you to observe crystal and V.F.O. drift and width of frequency deviation of FM; a precision sweep scope that is accurate with electronic switch for observing two signals simultaneously, and 100 kc lab. type crystal with TPTB oscillator circuit feeding six frequency divider stages. Tube line-up: (1) 5CP1, (3) 6SL7, (14) 6SN7, (6) 6H6 and (1) 6SJ7, Only **\$19.50**

TRANSMITTERS & RECEIVERS FOR 10 Meter Mobile Rig

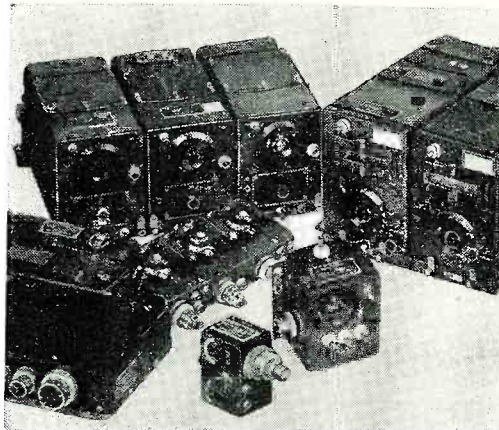

WAR SURPLUS SCR-274-N COMPLETE FOR ONLY

Conversion Book gives details for low-cost, easy conversion to
• 10 METER MOBILE RIG
• 20 - 40 - 80 METER BANDS

\$24.50

This sensation of all surplus is not only an ideal 10 Meter Mobile Rig! It's a complete amateur radio station! Here are a few more ways to use the equipment included in this Command Set. The transmitter VFO driver stage gives your BC-375-E higher RF output—as high as 150 watts. Make swell standby receivers with the BC-348 on round-table "rag chews." You get all this equipment: 3 Receivers—190-550 kc, 3-6 and 6-9.1 mc; two transmitters, 4-5.3 mc, 5.3-7 mc; four dynamotors—28 volts DC input; 1 modulator with carbon mike input; two tuning control boxes; one antenna coupling box with r-f ammeter; antenna relay and 5000 volt 50 mmfd. WE vacuum condenser (antenna relay can be used with most rigs); and a complete set of tubes for each unit—29 POPULAR TUBES in all. Mechanical cables for remote tuning of receivers supplied for \$1.00 extra.

COST GOVT OVER \$600.00 TUNING KNOBS for local control for receivers, 50c ea. Three for \$1.25

**WAR SURPLUS BC-375-E TRANSMITTER
WITH THOUSANDS OF USABLE STANDARD RADIO PARTS**

(Gov't cost,
\$1800)

\$24.50
complete

It's been written about and talked about—just the thing for beginner or old-timer; has five tubes, five tuning units. Xmtr. designed to operate from 200 kc. to 12 mc. (less BC band). Equipped with antenna tuning unit BC-306-A—variometer and tap switch. Dynamotor (PE-73-C) complete with relay, fuses and filter. Weight: approx. 275 lbs. Shipment from our nearest warehouse, East, Mid-West or West Coast

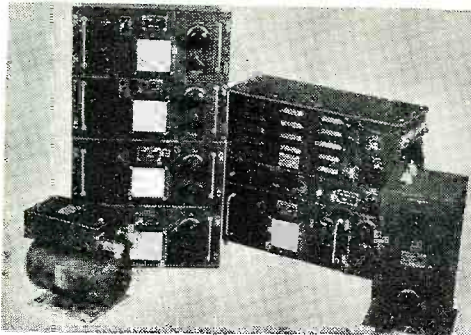

Two Meter Mobile or Ground Station

SCR-522, designed to operate from 100-156 mc. makes an ideal two-meter rig for two-way mobile radio; has one of the finest two-meter receivers ever designed. Complete trans. and rec., remote control Dynamotor PE-94 and all plugs.

\$24.50

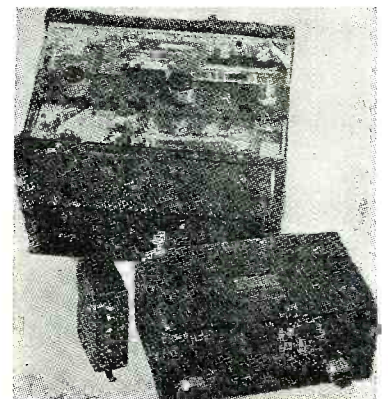

PE-98 Dynamotor, 12 v. input, for use with SCR-522 **\$12.50**

PE-94 Dynamotor, 24 v. input **\$3.95**

RADIO NEWS

COMBINATION BROADCAST RECEIVER & INTERCOM SYSTEM

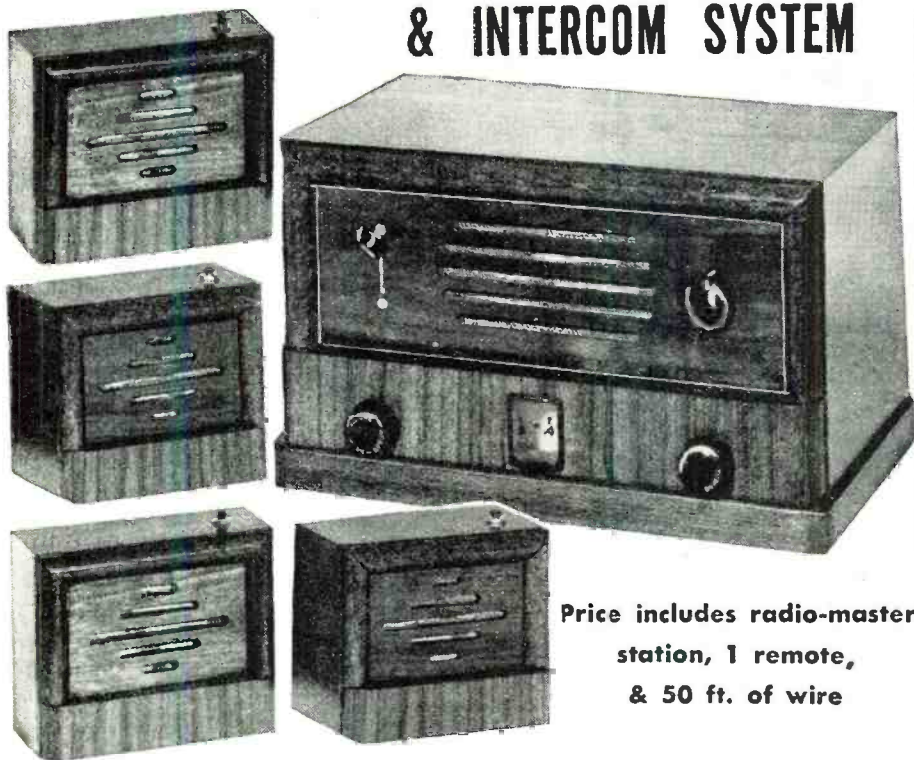

Price includes radio-master station, 1 remote, & 50 ft. of wire

Standard broadcast (6 tube superhet) receiver, plus home or office *intercommunication system*, walnut finish, modern design table model; high quality components; uses one to four remote stations. Any station can call the master while radio is playing; call can be returned to any remote. 115 v. AC; original list was \$84.50 (with 4 remotes). Additional remote stations, \$3.95 each.

BRAND NEW
\$29.95
 LIMITED QUANTITY

BEAM ROTOR & SELSYN INDICATOR

FOR 2 or 6 METER... **\$12.95**
 both for

Plenty of torque for 2 or 6 meter beam; 360 degree indication with selsyn ind.; slip rings and loop assembly to connect feed line for 360 degree rotation; instructions for wiring and parts list FREE with each set.

LP-21 loop only, \$8.95 I-82 selsyn indicator, \$4.90

• SAVE C.O.D. CHARGES and speed your order by remitting in full. Please don't send money for postage; we ship "transportation charges collect". These prices supersede all previous prices.

ALL EQUIPMENT F.O.B.

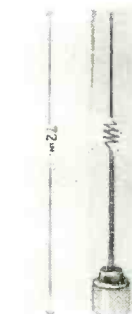
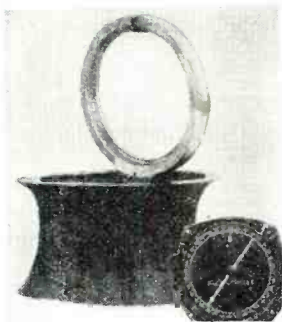

MOBILE WHIP ANTENNA

(or dipole) **\$2.89**

Solid spring steel; nickel plated; has broad response, antenna matching base. TWO for **\$4.50**

25 WATT FM-TRANSMITTER-RECEIVER

\$29.50 for special combination

For mobile or fixed station use; easy conversion to 10 and 11 meters. Schematic diagram and information—how to convert to 110 v. AC and amateur use.

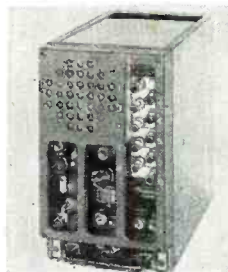

BC-603 RECEIVER (alone)

\$14.95

10 tube, superhet FM receiver; Loster Seely discriminator, 10 channel; pre-tuned, push-button selector; optional manual tuning; adjustable squelch control; speaker mounted in receiver; freq. range 20 to 27.0 mc. Few small changes in RF patterns will cover 10 & 11 meter bands. **POWER REQUIREMENTS** — Receiver 260-280 v. at .08 amps DC, 14 v. at 3.5 amps. AC.

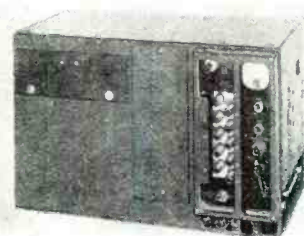

BC-604 TRANSMITTER (alone) **\$19.50**

10 channel, crystal controlled, selected by push button. Xmtr. has 7 1619 (2.5v 6L6's) for exciter and FM modulator; 1 1624 (2.5v. 807); final amplified 35 watts; crystal oven for 10 crystals, freq. range 20—27.9 mc. 1 0-100 MA meter measures grid, plate, & ant. current. Price excludes crystals. **POWER REQUIREMENTS** — Transmitter 500 VDC at .22 amps. DC, 14 VAC at 4 amps. AC.

12 v. Dynamotor for receiver **\$9.95**
 12 v. Dynamotor for Xmtr. **\$12.50**

1 box of 80 crystals for above, when purchased with trans., \$10.00 per set.

TRANSFORMERS

for conversion of SCR-274-N trans. & Rec. to 115v. AC

#1 POWER XMTR: Pri—115v 60 cycle; sec—500 CT @ .06 amp.; 24v @ 1/2 amp. Your cost only.....\$3.90
 #2 FILAMENT: Pri—115v 60 cycle; Sec. 1—14v @ 7 1/2 amp.; sec.2—14v @ 7 1/2 amp. Series 28v @ 7 1/2 v.; parallel 14v @ 15 amp. Your cost only.....\$4.60
 #3 FILAMENT: Pri—115v 60 cycle; Sec. 24v. @ 2 amp. Your cost only.....\$2.25

WRITE FOR BARGAIN BULLETIN

Name.....
 Address.....
 City.....
 Zone..... State.....

R & M RADIO COMPANY

1426 N. QUINCY ST. DEPT. RN-78 ARLINGTON, VIRGINIA

July, 1948

What's New in Radio

LIGHTNING ARRESTER

A new lightning arrester, designed to fit quickly and easily into television and FM receiver installations, is now being marketed by the *Tube Department of Radio Corporation of America*.

An inexpensive, simple plastic and metal device, the new unit is designed

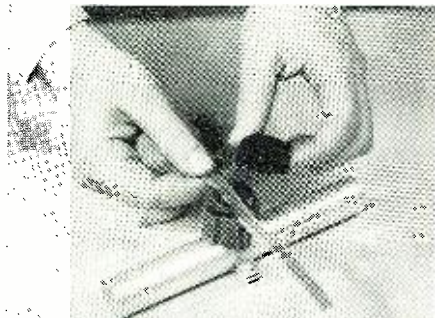

to fit 300 ohm transmission lines. The device features a foolproof method of attaching the transmission line which avoids cutting and splicing.

The arrester may be easily mounted on any indoor water pipe by means of its flexible metal ground strap. No separate ground wire is required.

Distribution of this new unit is being handled by *RCA Tube Distributors*.

MOUNTING ENCLOSURES

Two new wall mounting enclosures, one for 8 inch speakers and the other for 6 inch speakers, have just been announced by *Jensen Manufacturing Company* of Chicago.

The Model H-81 Bass Reflex Sector Cabinet is designed to fit anywhere—90 degree corners, flat on walls, or at

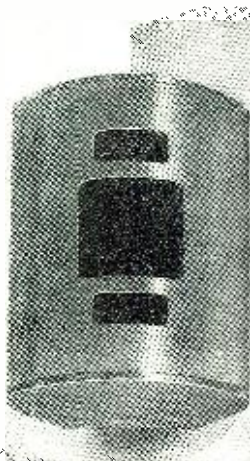

intersections of walls and ceilings. The units may be mounted singly, in pairs,

or in clusters of four around a post to attain wide-angle distribution of sound.

This model may be used with any 8 inch speaker. The cabinet is of formed wood composition around a frame of hard wood. Finish is of brown opaque lacquer with chrome trim. It can be covered with color to match the color scheme of the room in which it is used. The enclosure measures 22½ inches high, 17¾ inches wide, and 8½ inches deep.

A companion model, the Model J-61, is a Peri-dynamic enclosure designed to house 6 inch speakers. The cabinet is finished in brown simulated leather with grained effect and chrome trim. It is 16¾ inches high, 12¾ inches wide, and 5¼ inches deep.

Full details on either or both of these models may be secured from *Jensen Manufacturing Company*, 6617 S. Laramie Avenue, Chicago 38, Illinois.

G.E. PANEL INSTRUMENTS

The *Meter and Instrument Divisions* of *General Electric Company* have announced the availability of a new line of 3½ inch panel instruments of internal-pivot design, suitable for use in radios, power supplies, transmitters, amplifiers, and aircraft.

Designated Type DO-71, these new instruments have been especially designed for better readability. The elimination of arc lines and distracting printing from the scale and the use of a lance-type pointer and large, clear numerals assure accurate readings.

The internal-pivot construction of the instruments reduces their depth behind the panel thereby increasing their suitability for radio, communications, and other apparatus in which compactness is essential.

A high strength Alnico magnet provides high torque which makes for quick response and good damping so that the moving system follows changes in current or voltage rapidly and accurately, according to the company.

For further data on the Type DO-71 line, write to the *Meter and Instrument Divisions, General Electric Company*, Schenectady 5, New York.

D.C. MICROAMMETER

The *Tube Department of Radio Corporation of America* has announced the availability of a new ultra-sensitive electronic microammeter which is capable of measuring d.c. currents down to one-billionth of an ampere.

The new unit is a portable, battery-operated vacuum tube meter which may

be used in the chemical, medical, mechanical, electronic, and radiation fields wherever the measurement of extremely small currents is involved. The microammeter is expected to be of particular value in television, atomic research, facsimile, and similar projects. Applications in these fields include weak-current measurements in iconoscopes, image orthicons, and electron multipliers and such critical measurements as vacuum tube grid currents and anode currents of phototubes.

Current ranging from .001 microampere to 1000 microamperes, representing a range of 1,000,000 to one, can be measured with the new instrument which has six range settings permitting

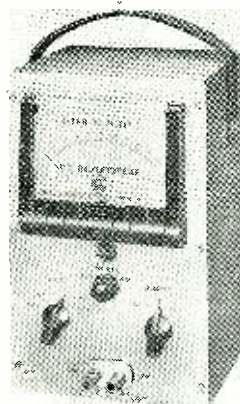

a choice of the most convenient range.

If additional information is required on this new Type WV-84A d.c. microammeter, write direct to the *RCA Tube Department, Radio Corporation of America*, Camden, New Jersey.

SIGNAL TRACER

Two new electronic test instruments have been added to the "Sparx" line of equipment manufactured by *McMurdo Silver Co., Inc.* of Hartford, Conn.

The first is the Model 905A, a super-sensitive aural dynamic signal tracer incorporating an 18 watt universal output transformer and test speaker which may be used separately.

Employing a new vacuum tube, hand-size probe on a four foot cable, the probe is provided with a switchable tip to permit either r.f., i.f., or a.f. signal tracing without the usual single probe distortion. The frequency range of the probe and two-stage a.f. amplifier is 20 cycles through 200 mc. for AM, FM, and TV signal tracing. Undistorted power output is 3.4 watts. The power supply employs a mains-insulating power transformer. Two panel switches and chart

MINIATURE TUBE SOCKET
 7 Prong. Bakelite. Furnished with retainer ring.
 10 for \$1.60
 20 for \$1.61

MINIATURE TUBE SOCKET
 7 Prong. Bakelite. With shield mounting base.
 10 for \$2.50
 20 for \$2.51

OIL FILLED CONDENSERS
 .25-600V
 Choice .5-600V
 1 mfd-400V
 4 for \$2.00
 8 for \$2.01

LOOP ANTENNA
 for Portable and AC-DC Sets.
 48c each
 2 for 49c

TWIN TIP JACK
 10 for 80c
 20 for 81c

GROMMETS
 100 Assorted. 1/8" I.D. to 1 3/8" I.D. Will cover most requirements.
 100 ass't. \$2.00
 200 ass't'd \$2.01

COAXIAL CONNECTOR
 Right Angle type.
 10 for \$2.50
 20 for \$2.51

CONDENSER
 Molded Paper. 500 mmfd - 600V. Half Postage Stamp type. Well known mfr.
 10 for \$1.00
 20 for \$1.01

CONDENSER
 Ceramic. 1000 mmfd. 3/8" Dia. x 5/8" Long.
 10 for \$1.00
 20 for \$1.01

TANK COIL
 Type C-447. 14 Turns. Freq. Range 8-11 MC. With fixed coupling link. 5 Banana Plug mounting.
 \$2.00 each
 2 for \$2.01

TANK COIL
 Type C-449. 8 Turns. Freq. Range 14-18 MC. With fixed coupling link. 5 Banana Plug mounting.
 \$2.00 each
 2 for \$2.01

TANK COIL
 Type C-449B. 6 turns. Freq. range 14-18 mc. With Rotary 1/2 turn coupling link wound inside tank coil. 5 banana plug mounting.
 \$2.00 each 2 for \$2.01

SLIDE SWITCH
 DPDT—1/8" mounting ctr.
 10 for \$2.00
 20 for \$2.01

STOCK-UP-NOW!
Summer Clearance
ONE CENT SALE
PRICES CUT IN HALF

OCTAL SOCKET
 1 1/2" mtg. ctr. Black bakelite. Fits 1/8" hole.
 50 for \$4.00
 100 for \$4.01

CABLE CLAMP
 AN3057-6, 3/4"
 AN3057-4, 1/2"
 Choice
 10 for \$1.50
 20 for \$1.51

STOCK-UP-NOW!
Summer Clearance
ONE CENT SALE
PRICES CUT IN HALF

CONTROL
 1/4 meg. 1 1/8" O.D.
 1/4" Shaft, 1 1/2" long.
 10 for \$3.90
 20 for \$3.91

LOW IMPEDANCE PHONES
 Used, perfect condition. Very sensitive. Less headband.
 10 for \$5.00
 20 for \$5.01

STOCK-UP-NOW!
Summer Clearance
ONE CENT SALE
PRICES CUT IN HALF

VARIABLE CONDENSER
 Single Gang. 8.5-370.3 mmfd. Complete with Vernier gear drive. 1 5/8" x 1 1/8" x 3/8". 1/4" Shaft.
 \$1.00 each
 2 for \$1.01

DIAL PULLEY
 Fits 1/4" Shaft. 7/8" Outside Dia.
 10 for \$1.50
 20 for \$1.51

RESISTOR
 1 ohm, 10W Wire Wound
 10 for \$1.00
 20 for \$1.01

PAPER ELECTROLYTIC CONDENSER
 20-20 mfd. 400WVDC. Popular Brand.
 10 for \$7.50
 20 for \$7.51

HOOK-UP WIRE
 Choice of Stranded or Solid. Please specify. Choice of No. 22 gauge or 24 gauge.
 \$3.75 for 500 ft.
 \$3.76 for 1000 ft.

PILOT LITE ASSEMBLY
 1/2" White Frosted Bead For Bayonet type bulb.
 10 for \$2.50
 20 for \$2.51

RELAY
 S.P.S.T. 110V A.C.
 \$2.00 ea.
 2 for \$2.01

PHONE JACK
 Type JK-34A. Fits PL-55, etc. Plug.
 10 for \$1.50
 20 for \$1.51

SHAFT COUPLING
 Ceramic. 1/4" to 1/4"
 10 for \$3.50
 20 for \$3.51
 Less set screws.

PANEL BEARING AND SHAFT EXTENSION
 1/4" x 1 1/4" Shaft fits 3/8" hole.
 10 for \$2.40
 20 for \$2.41

MAGIC EYE TUBE ASSEMBLY
 Can be used with 6AF6
 1 for \$1.00
 2 for \$1.01

PL-68 PLUG
 Fits Army-Navy JK33A; Mallory 5CA-2B, XP2B. 3 cond.
 10 for \$2.50 20 for \$2.51

PL-540 PLUG
 Midnet plug. Fits JK-26 2 Conductor
 10 for \$2.50 20 for \$2.51

OCTAL TUBE SOCKETS
 10 for \$1.70
 20 for \$1.71

HI-VOLTAGE INSULATED PLATE CAPS
 for Xmitting tubes.
 5 for \$2.00 10 for \$2.01

SHIELDED LEAD-IN WIRE
 No. 20 Stranded, 1/32" rubber covered, copper shielded.
 \$2.50 per 100'!
 \$2.51 per 200'!

SHIELDED MIKE CABLE
 2 Conductor—1/4" O. D.
 \$5.50 per 100'! \$5.51 per 200'!

BAKELITE BINDING POST
 5/8" Dia. Non Removable Screw Tap. With 10-32 x 3/4" Screw.
 10 for \$1.50
 20 for \$1.51!

BANANA PLUG JACK
 1/8" Dia. Hole. 1 1/2" O.D. x 1/8". Choice of red or black.
 10 for \$1.00
 20 for \$1.01

FLEXIBLE SHAFT COUPLING
 1/4" to 1/4". Bakelite. With four set screws.
 10 for \$2.50
 20 for \$2.51

SHOCK MOUNT
 2 3/8 square x 1 1/8".
 10 for \$2.00
 20 for \$2.01

POTENTIOMETERS
 300 ohm—tapped 50 ohm each side. Screw driver shaft.
 300 ohm—screw driver shaft.
 500 ohm—screw driver shaft.
 1000 ohm—screw driver shaft.
 3000 ohm—screw driver shaft.
 5000 ohm—1/2" shaft—1/4" dia.
 10000 ohm—3/4" shaft.
 50000 ohm—1/2" shaft.
 Any 10 for \$2.90
 20 for \$2.91

POLYSTYRENE WALKIE-TALKIE ANTENNA PLUG-IN COILS
 Choice of
 4225-4425 KC.
 4425-4625 KC.
 4845 KC.
 5305 KC.
 5300-5500 KC.
 10 for \$1.50
 20 for \$1.51

POLYSTYRENE SOCKETS FOR WALKIE-TALKIE ANTENNA COILS
 10 for \$1.00
 20 for \$1.01

TUNING SLUG
 Powdered Iron Core used for varying inductance of coils. Choice of 3/8" x 3/4" or 1/2" x 3/8".
 20 for \$1.00
 40 for \$1.01

All items listed on this ad subject to prior sale. Quantities Limited. Rush your order in! TERMS: All orders shipped P.O.B. Chicago. 25¢ deposit on all C.O.D. shipments.

IRVING JOSEPH 220 S. Halsted St., Chicago 6, Ill.

**For the Finest
Phonograph Performance Ever Achieved . . .**

Newcomb

ANNOUNCES 2 GREAT NEW PHONOGRAPH AMPLIFIERS

with the **MAGIC RED KNOB**

LOGICAL culmination of years of electronic research and engineering development continuously carried on in Newcomb laboratories, these new phonograph amplifiers, used in conjunction with suitable accessories, will produce unbelievable realism from recorded music or from AM-FM radio tuners connected to them. Their improved response at low volume, their beautifully clear, undistorted treble tones and the exclusive new "Magic Red Knob" control, which virtually eliminates surface noise and distortion from records in any condition, make these two amplifiers the best possible choice for those custom phonograph installations.

MODEL KXLP-30: Its ample power permits use of the famous Newcomb KX-Series dual tone control circuit, which provides tonal range and balance unattainable in less costly circuits. This circuit allows controlled emphasis of the desirable but power-consuming fundamental bass tones, avoiding emphasis of harmonic bass, so unacceptable to discriminating listeners.



MODEL HLP-14: Brings to music lovers an entirely new listening pleasure in a somewhat less expensive unit than the superb KXLP-30. Exceptional tonal balance at whisper volumes is a feature of the HLP-14. Its adaptability to use with the new AM-FM tuners, wide range loudspeakers and new phonograph pickups make it an ideal starting point for those increasingly popular custom installations.



Both include inputs for G.E. type pickups.

establish any one of 30 desired transformer primary impedances from 325 through 70,000 ohms, single and push-pull.

The Model 910 is identical to the 905A in its universal test speaker func-

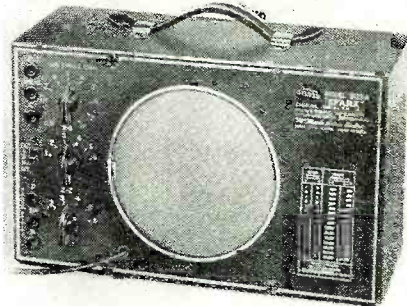

tions and applications, differing only in that it does not include signal tracing functions.

Complete details on these two new "Sparx" test instruments may be secured from *McMurdo Silver Co., Inc.*, 1249 Main Street, Hartford 3, Conn.

NEW SPEAKER LINE

Altec Lansing Corporation of New York City has announced a new and improved line of general purpose speakers.

Four models are included in the improved line and are designated by the code letter B. These include the Model 604B Duplex, 603B Multicell Diacone, 600B Diacone, and a new 8" unit, the 400B Diacone.

Among the interesting features of the new 604B Duplex is a reduction of the crossover frequency to 1000 cycles to assure that the low frequency cone will

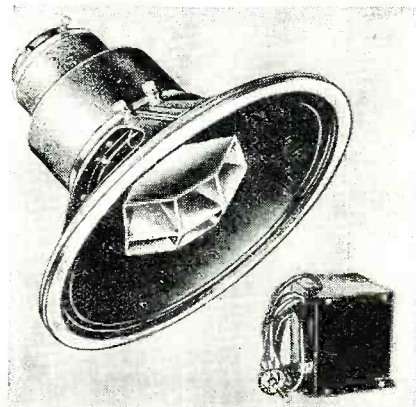

operate as a stiff piston and not "break up" in its operating range. This low crossover has been made possible by the company's recent development in the field of metal high frequency diaphragms which not only permits large diaphragm excursion without distortion or damage but also smooths the frequency response in the 1000 to 16,000 cycle range to eliminate characteristic harshness and fatiguing brilliance.

(Continued on page 124)

RADIO NEWS

Newcomb
AUDIO PRODUCTS CO.

Send for Specifications

Dept. F, 6824 Lexington Avenue • Hollywood 38, California

LOOK! METER SALE!

0-1 Milliammeter

Basic movement for all test equipment. 2% accuracy. 4 1/2" wide, large scale knife edge pointer. Nationally known make. Slightly used but guaranteed electrically perfect.

Order now while limited quantity lasts! A great buy!

\$2.75 ea.

only \$5.00
for two

SPECIAL KITS

- (1) 100 asstd. mica condensers; pigtail and lug types .000005 to .01 mfd. \$1.95
 - (2) 40 asstd. push-on knobs for knurled shafts. Red, green, walnut, ivory. \$1.29
- Orders shipped postpaid when accompanied by remittance in full. 25% deposit required on C.O.D.

NATION WIDE RADIO

(The Serviceman's Supply House)
572 W. Randolph St., Chicago 6, Illinois

SHORT CUT CODE SPEED Be an Expert

Learn to be a Telegraph or Radio Operator. Thousands of men need. Intensely interesting work — good pay. Learn at home or wherever you are, quickly, easily, with the famous Candler Code Speed System. Qualify for Amateur or Commercial License. Book of particulars Free.
CANDLER SYSTEM CO.
Dept. 2-H, Box 928, Denver 1, Colo.

In
Indiana
IT'S
Stanton Radio Supply
521 State St.
HAMMOND, INDIANA

VETERANS...

Act Now!

AN EDUCATION IS ONE THING THAT CAN'T WAIT

- FREE TO VETERANS

All veterans, entitled to training under "G. I. Bill," can take this course free of charge to them and also receive all books, equipment and tools. Mail coupon today.

If You Would Like to Learn RADIO

ELECTRONICS, TELEVISION, RADAR

TAKE ADVANTAGE OF THIS AMAZING RADIO OFFER FROM A RESIDENT SCHOOL THAT SPECIALIZES IN RADIO, ELECTRONICS, TELEVISION AND RADAR.

SUCCESS AWAITS YOU IN RADIO

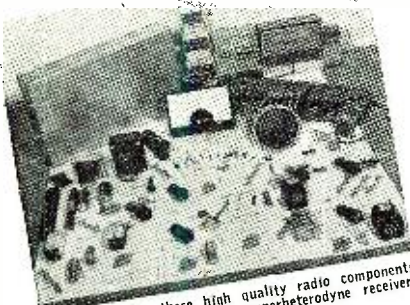

You will receive these high quality radio components with which you build your superheterodyne receiver.

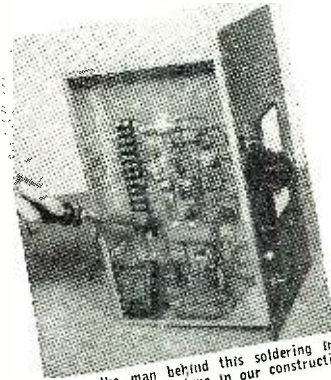

You can be the man behind this soldering iron and build this complete superheterodyne in our construction laboratory.



You will receive all this professional equipment in your training. It becomes yours at completion of the course.

RADIO OFFERS JOBS WITH A FUTURE

Radio provides jobs with real future and now, more than ever before, is the time to take advantage of this amazing school offer. The Tyler Commercial College of Tyler, Texas, a school specializing in Radio Training for over 25 years, now offers a Complete General Radio Course which provides a most comprehensive and successful preparation for employment in Radio.

COURSE REVISED AND EXPANDED

This course of Complete General Radio has been revised and expanded to include the latest instruction in Electronics, Television, F-M and Radar. Full attention is given to all matters included in the various elements of the FCC examinations for Radio Operator's Licenses, with emphasis on fundamental principles and practice, rather than the superficial "Question and Answer" method of preparation. As license examinations become more complex, students appreciate the "extra" value of Tyler Commercial College radio training.

THEORY AND ACTUAL PRACTICE COMBINED

The Tyler Commercial College Construction Laboratories provide familiarity with radio tools, parts, and equipment to complement the extensive training in radio theory, laws, etc. Shop work begins early in the course, and ranges from the construction of power supplies and filter circuits to the building of such electronic devices as photo timers and light-operated relays. All work is under the guidance of qualified laboratory instructors who encourage the student to develop his ability and self-reliance in the field of radio construction.

STUDENTS BUILD EQUIPMENT THEMSELVES



VACUUM TUBE VOLT-OHMMETER

At Tyler Commercial College, you will build, align and calibrate your own AC-operated superheterodyne receiver. You build phase inverters, phono amplifiers, experiment with impedance matching, and plot frequency response curves on the equipment you have built. Using precision parts, you build your own Vacuum Tube Volt-ohmmeter, making all calibrating adjustments upon completion. You start with unmarked metal chassis, making your own layout and performing all assembly work in accordance with good commercial practice. We do not use pre-fabricated receiver kits, or snap-button assemblies which rob the student of valuable experience in layout and installation of components. You learn the proper use of drill press, circle cutters, socket punches, soldering iron and other radio shop equipment. In addition, you have the use of a wide variety of professional test equipment such as signal generators, cathode-ray oscilloscopes, vacuum-tube voltmeters of various makes, together with radio transmitting and receiving apparatus, direction finder, and radar equipment valued at more than \$500,000.00.

INSTRUCTIONAL AIDS - OTHER SUPPLIES

The student in the Complete General Radio Course is furnished a complete set of carefully selected textbooks and reference manuals, written by the leading authorities, and chosen for this course on the basis of accuracy and understandability. Upon completion of his training, the graduate student will find that these books constitute a valuable reference library as he continues his career in Radio. A ten inch slide rule, and three-ring binder are among the other supplies furnished. For his shop work, each student receives a 15 piece tool kit, composed of essential radio tools such as long-nose pliers, diagonals, neutralizing tool and socket wrench set.



This Is Your Personal Library

OUTSTANDING SCHOOL - EXPERIENCED INSTRUCTORS

Each phase of the Radio training at Tyler Commercial College is under the supervision of men who are fully qualified by reason of training and actual experience in the field. Their background of experience in training hundreds of others in Radio makes it possible for them to give you the maximum assistance in mastering the work as it is presented. Our graduates are widely employed in Broadcasting, Marine Radio, Airline Radio, and Geophysical Exploration, as well as in operation of their own Radio businesses. We believe that their success constitutes our best advertisement. Approved by following institutions: Southwestern Private Commercial Schools Association, Texas State Department of Education, The Veterans Administration, National Association of Accredited Commercial Schools, American Association of Junior Colleges, Southern Association of Junior Colleges.

FREE IF YOU ACT NOW.

Fill in coupon below — mail today and receive absolutely free our new 1948-1949 catalogue showing of-

ficers, directors, faculty, offices and classrooms, graduates and students.
Tyler Commercial College
Tyler, Texas:

MAIL COUPON TODAY

Tyler Commercial College, Tyler, Texas
MR. HENRY RAMSEY
I am interested in learning more about your complete General Radio Course. I understand that there is no obligation.

Name.....
Address.....
City.....
..... Please send me your Free Catalogue.

TYLER COMMERCIAL COLLEGE

A school of Accounting, Business Administration, Secretarial Science, Radio, Television, Electronics, and Radar.

"ARROW" leads with Better Buys!

COMMAND SET SCR-274 MEDIUM FREQUENCY

Excellent condition \$24.95
Complete installation with 2 transmitters, 3 receivers, racks, tubes, crystals control box and plugs.

BLOWER MOTOR

24V, small portable with fan, ideal for defroster or ventilator unit, 17,000 RPM, BRAND NEW..... \$1.95

BRAND NEW SCR-625

Mine Detectors—complete in original packing container \$49.50
F.O.B. Shipping Point

THE LAZIEST Q-5'er

FL-8-A, used when flying radio range. RANGE-VOICE-BOTH switch selects 1020 pass ONLY, or voice freq. minus 1020 cps, or by-passes filter completely. Put in series with hi-impedance headset when listening to 1 kc MCW..... 95c

AUTOMATIC FREQUENCY CONTROL UNIT

Western Electric type used for controlling frequency for teletype and telephone work, complete with 3-6S7J and 2-6H6 tubes. Complete unit, brand new in original box..... \$4.95

BC-604 FM 35 WATT TRANSMITTER

A-1 condition, complete with tubes, 10 channel push buttons, less crystals and power supply, 19.6-27.6 Mc \$10.95

BC-788 FOR 420 MC

Complete with tubes. Excellent cond. Complete transmitter-receiver, 14 tubes including 9-6B6; 9-6AG5; 1-6L6; 1-5Y3. Six wide band IF stages. Has 98.356 KC crystal. Details on page 53 of "QST", Nov. 1947. ONLY..... \$10.95

PE-151 INVERTER

12V DC input; 115V AC output; 150 watts; ideal power supply for mobile work and sound systems, BRAND NEW \$12.95

FILTER CHOKES—All Fully Enclosed

3.7 H. @ 145 MA. DC, 125 ohms DC. Res. 59c
4 MTG. Studs, each 59c
100 mi 10H..... 59c

APN-1 RADIO ALTIMETER

Complete 420 MC transmitter-receiver unit, complete with all plugs, indicators. BRAND NEW \$34.50

AN/PRS-1 MINE DETECTOR—BRAND NEW

PE-103 DYNAMOTOR used..... 5.95

BC-929-A

Contains power supply 110 V, 400 cycles, has 7 tubes such as 3CP1, brand new, complete with tubes. Each \$17.95; Used, ea..... \$14.95

R-78/APS-15

Has 45 tubes, one 5" scope tube, one 2" scope tube, has 3 meters, 4 power supply units 110V 400 cycles, complete with tubes. Each \$39.50

COMPASS RECEIVER MN-26

Remote control commercial type navigational receiver. Indicates direction of any desired transmitting station. 3 bands—frequency range: 150 Kc to 1500 Kc; has 12-6 V. type tubes. Brand new, original cost \$600. Now \$24.95

Accessories for Above:

Loop MN-20 \$9.25
MN-28 Control Box 7.25
MN-52 Loop Control Unit 4.45
Loop Transmission cable—163" long 9.95
MC-124 Flexible Shaft 2.45
IN-40 Left-right Indicator 9.95
Set of 3 plugs 4.60
MN-40 Navigators Indicator 12.95

T-17B HAND MIKE

BRAND NEW perfect carbon hand mikes, light wt., 200 ohms, single button, press to talk switch, 5 ft. rubber cord, plug, dust cover. ONLY 89c

COMMAND RECEIVERS and TRANSMITTERS

(274N Series)—Complete with Tubes NEW

BC-454A; 3 to 6 MC (Receivers) \$5.95
BC-458; 5.3 to 7 MC 5.95
BC457; 4 to 5.3 MC 5.95
T-20/ARC-5 same Freq. BC-457 5.95
BC-456 MODULATOR, Brand New 2.95

RECEIVER

Low impedance, magnetic type receiver, ideal unit for pillow receiver or small microphone, NEW..... 39c

HEADSET BUY

HS-33 (Red plug), low impedance. Used, almost like new. With rubber cushions..... 95c
4' Extension Cord for above..... 65c

AN18/APT-10

Pre-amplifier Model K-1, designed to raise output level of magnetic type microphone, complete with 2 tubes 6SL7GT and 28D7 and hand switch, brand new in original cartons. Each \$1.95 3 for \$5.00

RCA AVT-112A—AIRCRAFT TRANSMITTER

For radio-telephone communication; for 6, 12 or 24 volt source freq. range from 2,500 to 6,500 Kc. Small in size and wt. (wt. 6 lbs.). Complete with 6 tubes, oscillator circuit, power amplifier modulators, dual tuning indicator and amplifier, with instruction manual, less crystal. BRAND NEW in ORIGINAL CARTONS— ONLY. Each \$12.95

ALTIMETER TRANSCIEVER RT-7/APN-1

Frequency 418-462 Mc FM, with 14 tubes: 3-12S7J; 4-12SH7; 2-12H6; 1-VR150; 2-955; 2-9004; 27 V. Dynamotor, used in working condition \$7.95

RECEIVER-POWER SUPPLY UNIT

For the APN-4 indicator; complete with 16 tubes; 110 V, 400 cycles. BRAND NEW \$10.95

MONTHLY SPECIALS

40-80 METER XMITTER

New equipment: Transmitter-Modulator and coil sets to cover 2.5-7.7 mc, transmitter tubes 2 No. 10 special and 2 No. 45 special, receiver (less the receiver coil sets), receiver tubes 1-37, 1-38, 4-39/44, shock mounts, dynamotor, antenna switching relay, receiver control box, transmitter control box, charts, dials, and instruction book. What a sweet buy! Only..... \$9.95

SMALL PORTABLE MOTORS

No. 1—Universal type .24 volts DC shunt with two leads, 1 1/2" diameter by 2 1/2" long with 1/4" shaft, 3/4" long. New. Ea..... \$1.49
No. 2—Delco motor .24 volts DC shunt type. 4 leads. 6000 R.P.M. 1 1/2" diameter by 2 1/2" long. 1/4" shaft one inch long. NEW. Ea. \$1.49
No. 3—Pincor motor. 24 volts DC shunt type. 4 leads. 5000 R.P.M. 1 1/2" diameter by 2 1/2" long. 1/4" shaft, 3/4" long. NEW. Ea. \$1.49

Above motors are ideal for small hand-driven portable applications. Set of 3 \$3.95

All shipments F.O.B. Chicago—20% Deposit Required on all orders. Minimum order accepted \$5.00.

REMOTE CONTROL BOX

BC-450—Triple receiver control box, can be modified to a FT-260 local control for command receivers, NEW..... \$1.95

RADIO RECEIVER

Designed to receive A-N beam signals, 24-28 VDC 21.6 watts. Tube complement: 14H7 or 14A7, RF amplifier; 14H7 or 14J7, mixer; 14A7 or 14H7, IF amplifier; 14R7, detector and 1st audio amplifier, 28D7, output amplifier, 195 to 420 kc, 4" high x 4" wide x 6 1/2" long—wt. 3 lbs., 4 oz. BRAND NEW in original carton..... \$5.95

ANTENNA THERMO-COUPLE METER

BC-442; 0-10 amps, with extra relay and 50 MALLFD 5000 Volt condenser... used with command transmitters. BRAND NEW..... \$1.95

ARB AIRCRAFT RADIO RECEIVER

The ARB is a six tube, four band, superheterodyne Aircraft Radio Receiver with built-in dynamotor, designed for the reception of MCW (tone or voice) or CW within the frequency range 195 Kc to 9.05 megacycles. Used..... \$15.95

R-89/ARN-5A

Glide path receiver. Crystal control of local oscillator, 332-335 mc, complete with relays, 7-6AJ5, 1-12SN7, 2-12SN7, 1-28D7, and 3 crystals: 6497 kc, 6522 kc, 6547 kc, 90-cycle band-pass and 150-cycle band-pass filters, excellent for making an intermodulation checker. Beautiful cabinet and chassis as foundation for many interesting experimental and construction projects. Broad pass band on 20.7 mc IF's ideal for television. Schematic furnished. Used, excellent. Only..... \$6.95

BC-733-D

Localizer receiver of the blind landing system. Companion to the glide path receiver. Also contains 90 and 150 cycle band-pass filters. 10S.3 to 110.3 mc, by relay selection of crystals in the local oscillator. Wide pass-band on 6.9 mc IF's ideal for FM. Has a wonderful AVC system using rectified output of an RF oscillator as power supply for 100 volt DC bias. With relays, crystals, and 10 tubes: 3-717A, 2-12SG7, 1-12SQ7, 1-12A6, 1-12-AL7, 2-12SN7. Schematic furnished! Condition: Used, excellent, only..... \$6.95

VEEDER-ROOT METER AND CASE

Counts up to 1000. Each 59c

HAND-TYPE MICROPHONE RS-38

Carbon type, with PL-68 plug, brand new... \$1.95
Used 1.00

BC-645 TRANSMITTER-RECEIVER

BRAND NEW... 15 tubes interrogator-transmitter designed for airborne use, 455 to 500MC frequency range. With some modifications the set can be used for 2-way communication, voice or code, on the following bands: ham band: 420-450mc; fixed and mobile: 450-460mc; citizens radio band: 460-470mc; television experimental: 470-500mc; complete with all tubes, including W8 Doorknob tube. Size 10 1/2 x 13 1/2 x 4 1/2". Net wt. only 25 lbs. Your cost..... \$9.95

DYNAMOTOR FOR ABOVE Model PE-101-C \$2.75

RADIO PARTS

100 Resistors 1/2 to 1 watt..... 95c
Electrolytic condensers 50-30, 150 Volt..... 10 for \$2.89
1/2 Meg. Volume Controls 1" shaft with switch, 10 for..... \$3.00
1/2 Meg. Volume Controls 1" shaft without switch, 10 for..... 1.95
Crystal Pick-up, new light wt..... each 1.79

400 CYCLE AUTOSYN MOTOR

Ideal for indicating direction of antenna systems—BRAND NEW..... each \$2.95

HEADPHONES

Signal Corps, 5000 ohms or 200 ohms, each..... used 79c

ARROW SALES, INC.

MAIN OFFICE

SOUTH SIDE BRANCH
8310 SOUTH HALSTED ST.

59 WEST HUBBARD ST., CHICAGO 10, ILL.
Telephone SUPERior 5575

NORTH SIDE BRANCH
1802 NORTH HUMBOLDT BLVD.

"ARROW" leads with Better Buys!



BIAS METER Brand New

Originally used for measuring voltages and telephone equipment. Can be used for measuring DC voltages and bias voltages also checking polarity of DC voltages. Complete with a d apt or plug and schematic enclosed in metal carrying case. Requires no batteries for operation\$5.95 ea.

T-26/APT-2

Radar jamming transmitter, 450-710 mc. Heising amp.-mod. by noise from 931A photo-tube. Output 3 to 7 watts. All controls on front panel. 2-6AG7 and 1-6AG7 video circuit supply random noise, with pass band of 20 kc. to 4 mc. to the 807 mod. 2-368AS tubes in a push-pull 1/4-wave transmission-line osc. circuit supply the RF. Power furnished by 2-5R4GY and 1-2X2 tube. Contains 27dc blower. Input 27vdc and 75-85v ac. 115-125v. 400 to 2600 cy. Brand new in original export case, with all tubes and handbook. Don't let this get away from you—Order today! **\$9.95**
At only

T-27/APT-3

Another noise-modulated radar jamming transmitter, companion to the APT-2. 85-135 mc. Power Output 9 to 12 watts. M.O.P.A. type transmitter. Built with 4 demountable sub-chassis: R.F. Osc.; R.F. Amp.; photoelectric noise source; video amp. limiter and modulator; power supply. Tubes are: 1-829B RF Amp., 1-829 RF Osc., 1-931A photo-tube, 2-6AG7 video amp., 1-6AG7 mod., 1-5R4GY rectifier. Brand new, in original export case, with all tubes **\$10.95**
and handbook

ANTENNA EQUIPMENT BUYS

AN-109-A. 62" long solid whip antenna, very flexible, made of cad. plated steel vanadium steel, 1/4" dia. at threaded end, tapering to 0.1" at tip end. A dandy antenna, a dandy fishing rod, a dandy price. **\$2.69**
4 to carton, per carton

Doublet Antenna Kit, used with the famous Halli-crafters RC-610, consisting of 7 steel-alloy mast sections in a handy canvas bag. Each section is 5'6" long, 1 1/2" OD with the last 6" rolled to a smaller OD to telescope into the end of the preceding section. No taper. Assemble into mast up to 35' high or shorter by any multiple of 5'. Finished in weatherproof olive drab. Ideal for erection of FM and Television Beams! Drop your coaxial cable right through the center! Brand New, export packed, **\$8.95**
Kit of 7 and bag

COAXIAL CABLE BUYS

RG-8/U: 52 ohm coax. cable, brand new, cut to length, min. quant. 100 ft. **\$2.95**

SCR-522 VHF COMMAND UNIT

2-Way Radio; freq. range 100-156 MC.; complete with crystals, tubes, plugs, dynamotor **\$24.95**
... used, in excellent condition

ARC 4 TRANSMITTER AND RECEIVER

For operation VLF frequencies in range of 140-144 mc. Four channel crystal controlled, manufactured by Western Electric—24V operation. Complete with crystal and dynamotor. Used. **\$19.95**
Good condition

PE-117 UNIVERSAL POWER SUPPLY

6 or 12 volt input; output 145 volts and 90 volts; less vibrator, voltage regulator and rectifier tube; ideal mobile power supply unit; excellent condition, each **\$2.95**

DYNAMOTORS AND INVERTERS

BD-77, Dyn. Unit 14v in, 100v, 350 ma out, with relay fuse box and filters.\$5.75
DM-21 Dynamotor; Part of RC-312 and BC-314, 14v in, 235v, 100 ma out.\$2.47
DM-34 Dyn: 12v in, 220v, 80 ma out.\$2.29
DM-35 Dyn: 12v in, 225v, 225 ma out.\$7.95
PE-101-C Dyn. Unit: 12 or 24v in, outputs 800v, 30 ma, 400v, 135 ma, 9v, 1.1A.\$2.75
PE-55Dyn. Unit: 12v or 24v in, either 16 or 25 amp, 500v out, either 200 or 400 ma.\$3.75
PE-206 Inverter Unit; rotary converter, 28v in, 80v at 500 VA, 800 cy. out.3.95
PE-103 Dynamotor, used\$6.95
DM32A—each95c 3 for\$2.00

OUTPUT TRANSFORMER

Hi-Fi; used is Scott-made Navy receiver. Fully potted, Pri. 5000 ohms, output secondary 600 ohms CT, inverse-feedback secondary **\$1.49**
60 ohms CT, ONLY

TUBES

BRAND NEW!	BRAND NEW!
2J32\$19.95	832A\$2.95
869B 19.95	837 1.95
872A95	838 2.95
6G679	839 2.95
304TL 1.95	5BP4 1.95
2C26A69	5BP1 1.39
84159	5FP7 1.39
6AK569	12SF749
1N5GT69	86449
6AT669	95449
6H649	RK3439
6J549	35W439
6J649	162539
6SJ759	162939
6SF739	20S139
3639	900149
10Y49	900249
12A639	900349
12C849	900449
12H639	900549
12J539	900649
12K869	719339
12SJ759	110 VAC Neon
12SR759	Light39
12AT649	Amperite 10T139

Write for lot prices!

C-1 AUTO PILOT AMPLIFIER

The complete amplifier includes one rect. 7Y4, 3-17T's for amplification and control, 3-7N7's for signal discrimination, 1 power transformer, 6 relays, 4 control pots, chokes, condensers, etc. Convert for use on radio controlled models, doors, etc. Operates from 24 V. DC. Size: 9 1/4 x 6 1/4 x 7 5/8". Complete, Used—good condition **\$4.95**
ONLY

SELSYN METER TO INDICATE POSITION C-71A/APQ-13

Contains 2" meter, FS-100uA, Weston 506, 0-300 V, 0-30 MA, with 6 precision resistors, as external multipliers and shunts; toggle switches, push switches, rotary switch, pots, knobs, etc. **\$4.95**
GOOD CONDITION

TORQUE AMPLIFIER AM 19/APA-14

Provides amplification of information from Flux Gate Compass to drive torque unit and differential gear of azimuth differential unit CN-4/APA-14. Input 26 VDC and 115 V; 400 cy. Part of stabilization assembly AN/APA-14. With plugs, 3-6SN7GT; 2-6L6, transformer, oil-filled condensers, pots, etc. **\$2.95**
EXCELLENT CONDITION

MEGAPHONE—Brand New

Only 40 of these to sell. Amplifier straps on shoulder, then just hold megaphone and speak in mike mounted on rear of projector. Amplifier is conventional type, shipped with tubes. Amplifier-cry battery operated less battery **\$29.95**
ONLY

SELSYN INDICATORS

For use with beam rotators for indication of direction of beam. Operate from 15-24V, 60 cycle AC supply. Small model, 3 inch diam **\$2.45**
eter, only

Large model, 5 inch diameter, only **2.95**

GE METER

0-10 amps., DCeach **\$2.29**

PHANTOM ANTENNA Brand New



Used with any 80 meter transmitter as a dummy load for adjusting transmitter for maximum output before going on air. Freq. range: 2MC to 4.5MC, with instruction manual enclosed in metal case with cover.....\$1.95 ea.

SCR-518-A

Radar altimeter 515 mc. Fast screen CR tube, hi-voltage power supply, connectors, cables, 29 tubes: 1-SK7, 2-8012, 2-6S7, 1-6R8, 1-6SN7GT, 1-6P8G, 1-23D4, 1-6Y6G, 1-6V6GT, 10-6AG7, 3-2X2, 1-954, 1-955, 1-956, 1-6J5, 1-180SP1 cathode ray tube. (With schematics). **24.50**
Brand new

SCR-522 CONTROL UNIT

BC-602-B, brand new, export packed, 1 "off" push-button switch, 4 channel-selecting push-button switches, 5 pilot lamp assemblies with pilot bulbs and film dimmer and lever switch with locking control. With Schematic **98c**

80 and 40 METERS

7-tube Superhet RA-10, Bendix DF and communications receiver, 200-1100 kc and 2-10 mc. In excellent condition, inside like brand new. Complete with tubes and dynamotors. Easily converted to 110V. Schematic furnished. **\$14.95**
Only

R-5/ARN-7 COMPASS RECEIVER

Very late model ADF receiver. Includes broadcast band. Frequency 100 to 1750 kc. in 4 bands. 5-gang tuning capacitor. With 15 tubes: 4-6K7, 1-6L7, 1-6J5, 2-6B8, 2-6P6, 1-6X4, 1-6SC7, 2-2051, 1-524. SCHEMATIC FURNISHED.
Like new, **\$19.95**
SPECIAL

BC-433-G COMPASS RECEIVER

SCR-269-G ADF receiver, similar to the R-5/ARN-7 described above and uses same tubes. Frequency 200-1750 kc in 3 bands. SCHEMATIC FURNISHED. **\$14.95**
Like new, SPECIAL

RECEIVER-TRANSMITTER BC-620

FM Mobile Transmitter-Receiver operates from 6 volt vibrapack, 20.0 to 27.9 Mc; easily converted to 10-meter freq. 28-29.7 Mc.\$14.95
New 9.95
Used

OUTPUT TRANSFORMER: 10 assorted ouncers for\$1.89

2-METER TRANSMITTER SCOOP!

The famous AN/ARC-5 VHF Transmitter (T-23/ARC-5), brand new 100-156 mc but less tubes, crystals, and the holders for the 832A tubes. Furnished with complete schematic, 4 Xtal-controlled channels selected by 3 motor-driven ferris. Motor can be spun by hand for manual band switching or driven by low-power rectifier power pack. Tubes required are 2-1625 and 2-832A. Don't pass **\$4.95**
this up at ONLY.....

POWER SUPPLY FOR BC-223

PE-125 VIBRATOR TYPE
12 or 24 volt input DC; output 475 volts-200 ma, 8 volts DC at 4.5 amps. BRAND NEW **\$8.95**
with schematic diagram.....

SPRAGUE PULSE FORMING NETWORKS

Used in small radar modulators, available in 3 sizes, 67 ohms impedance. 7.5 Kilowatt rating. H-603, one micro second, 200 pulses per second **\$1.95**
H-601, 3 micro seconds, 200 pulses per second **2.95**
H-602, 16 micro seconds, 60 pulses per second **3.95**
ALL THREE ABOVE FOR ONLY... **4.95**

OIL-FILLED CONDENSERS

25 MFD at 1500 VDC 59c
2 MFD 220 VAC 29c
25 MFD at 6000V DC\$1.49
.5 MFD at 750V AC29
2 X .25 at 2000V DC29
3000 MFD at 3V DC (electrolytic)19

ARROW SALES, INC.

MAIN OFFICE

59 WEST HUBBARD ST., CHICAGO 10, ILL.

Telephone SUPERior 5575

NORTH SIDE BRANCH

1802 NORTH HUMBOLDT BLVD.

SOUTH SIDE BRANCH

8310 SOUTH HALSTED ST.

THOUSANDS

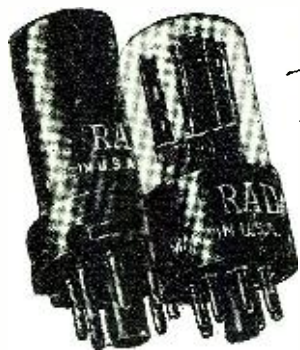

OF
TUBES!
TUBES!
TUBES!

Brand new!
Perfect!
Standard Brands
Only!

1B3/8016	\$ 1.79	12BE679
1L4	.49	12H639
1T4	.56	12J5GT39
1LN5	.99	12SA7GT69
2D21	.81	12SH749
2X2	.59	12SJ7GT69
2X2A	.69	12SN7GT69
3B7	.69	14A779
3B24	.79	14B679
5R4GY	.99	3059
5Y3GT	.49	35Y479
6AC7	.89	35W463
6AG5	.89	35Z5GT59
6A15	.90	50L6GT69
6AL5	.90	11Z6GT89
6BQ6G	3.29	723A/B	4.95
6C4	.49	861	29.00
6H6	.49	872A	1.59
6J5	.49	95749
6J6	.59	958A49
6N7	.89	95949
6SA7GT	.69	99129
6S67	.59	CK100529
6S17	.63	161929
6SL7GT	.79	162541
6SN7GT	.72	205069
6SQ7GT	.59	900149
6SR7	.69	900249
6E5	.79	900349
6Y6G	.89	900449
6Y7G	.79	900645
6X5GT	.69	VR15069
12A6	.39	5BP4	3.95
12AT6	.79	7DP4	12.00
12BA6	.79	10BP4	35.00

The following are Television Kinescopes with welded-on unusually wide angle Dupont Plastic Lenses. For replacement in your television set to give you 2 to 3 times larger picture. The lens is scientifically made to compensate for usual diffraction.

RCA 70P4 with lens.....	\$ 60.00
RCA 10BP4 with lens.....	115.00
Dumont 12TP4 with lens.....	180.00
Dumont 15AP4 with lens.....	315.00
Zetka 15CP4 with lens.....	320.00

MINIMUM ORDER \$10.00

Send 50¢ for catalog including diagrams for RCA, Belmont, G.E., Dumont, Andrea and Viewtone Television Receivers and Transvision Kits.

World's First Specialized House in Television

ELECTRONICS SERVICE AND SUPPLY CORP.

264 W. 40th ST. NEW YORK CITY 18, N. Y.
Phone PE-nnsylvania 6-8730

91

Parts Lists

(FOR CIRCUIT DIAGRAMS APPEARING ON PAGES 84 AND 85)

GAROD MODEL 5A4

Part No.	Code and Description
1.469	1—Loop assembly
2.163	2—2-gang var. cond.
1.259	3—First i.f. trans.
1.409	4—Second i.f. trans.
8.201-3	5—Vol. control & sw.
30.318	6—5" PM speaker
5.400-8	7—40/40/20 mfd. elec. cond.
1.402-1	8—Osc. coil
0.219	9—Output trans.

BELMONT MODEL 5240

Part No.	Code and Description
C-9B1-78	R1—22,000 ohm, 1/2 w. res.
C-9B1-60	R2—680 ohm, 1/2 w. res.
C-9B1-50	R3—100 ohm, 1/2 w. res.
C-9B1-82	R4—47,000 ohm, 1/2 w. res.
C-9B1-34	R5—3.3 megohm, 1/2 w. res.
C-9B1-302	R6—15 megohm, 1/2 w. res.
A-10A-10720	R7, S1—500,000 ohm vol. control & sw.
C-9B1-90	R8, R16—220,000 ohm, 1/2 w. res.
C-9B1-95	R9, R11—560,000 ohm, 1/2 w. res.
C-9B1-52	R10—150 ohm, 1/2 w. res.
C-9B1-43	R12—27 ohm, 1/2 w. res.
C-9B2-54	R13—220 ohm, 1 w. res.
C-9B2-63	R14—1200 ohm, 1 w. res.
C-9B2-44	R15—33 ohm, 1 w. res.
C-8F3-119	C1—330 mmfd., 500 v. cond.
C-8F3-113	C2, C4, C7—100 mmfd., 500 v. cond.
C-8F3-247	C3—820 mmfd., 500 v. cond.
C-8D-10770	C5—.05 mfd., 200 v. cond.
C-8D-10942	C6—.2 mfd., 400 v. cond.
C-8D-10789	C8—.002 mfd., 600 v. cond.
C-8F3-118	C9—270 mmfd., 500 v. cond.
C-8D-10785	C10—.006 mfd., 600 v. cond.
C-8D-10774	C11—.02 mfd., 400 v. cond.
C-8D-10760	C12—.1 mfd., 400 v. cond.
A-8C-10077	C13A, C13B, C13C—40/20/20 mfd., 150/150/150 v. elec. cond.
C-8D-11251	C14—.09 mfd., 400 v. cond.
A-8E-10723	C15A, C15B—Dual ant. & osc. trimmer
C-211-10171	T1, T2—Ant. & osc. coil tuner unit
B-13A-10728	T3—Input i.f. trans.
B-13B-10729	T4—Output i.f. trans.
B-12C-10074-1	T5—Output speaker trans.
B-18A-11089	T6—4"x6" oval speaker
B-201-12262-1	T7, S3—60 cycle a.c. record changer
A-20A-10722	S2—Radio-Phono sw.

ARVIN MODELS 152T, 153T

Part No.	Code and Description
C20060-223	R1—22,000 ohm, 1/4 w. res.
C20060-156	R2—15 megohm, 1/4 w. res.
C20060-225	R3—2.2 megohm, 1/4 w. res.
C21511	R4—1 megohm vol. control & sw.
C20060-474	R6—470,000 ohm, 1/4 w. res.
C20060-150	R7—15 ohm, 1/4 w. res.
C20070-122	R8—1200 ohm, 1 w. res.
C20060-151	R9—150 ohm, 1/4 w. res.
C20060-334	R10—330,000 ohm, 1/4 w. res.
C21481	C1, C2—Var. cond. & pulley assembly
A21643	C3—.00005 mfd., 350 v. cond.
C20068-503	C4—.05 mfd., 400 v. cond.
C20067-503	C5—.05 mfd., 200 v. cond.
C20065-101	C6—.0001 mfd., 500 v. cond.
C20068-202	C7—.002 mfd., 600 v. cond.
C20065-501	C8—.0005 mfd., 500 v. cond.
C20068-103	C9—.01 mfd., 400 v. cond.
C20068-203	C10—.02 mfd., 400 v. cond.
A21499	C11—40/20/20 mfd., 150/150/25 v. elec. cond.
A21521-1	L1—Antenna loop assembly
AC21492-1	L2—Osc. coil assembly
AC21495-1	T1—First i.f. coil assembly
AC21496-1	T2—Second i.f. coil assembly
AC21497-1	T3—Output trans. assembly

MANTOLA MODELS 92505, 92506

Part No.	Code and Description
60B8-103	R1—10,000 ohm, 1/2 w. res.
60B8-106	R2—10 megohm, 1/2 w. res.
60B8-223	R3—22,000 ohm, 1/2 w. res.
60B8-101	R4—100 ohm, 1/2 w. res.
60B8-105	R5—1 megohm, 1/2 w. res.
75B1-6	R6—.5 megohm vol. control & sw.
60B8-475	R7—4.7 megohm, 1/2 w. res.
60B8-274	R8—270,000 ohm, 1/2 w. res.
60B8-474	R9—470,000 ohm, 1/2 w. res.
60B8-151	R10—150 ohm, 1/2 w. res.
60B28-3	R11—33 ohm, 1 w. res.

60B28-2	R12—1000 ohm, 1 w. res.
60B8-154	R13—150,000 ohm, 1/2 w. res.
65B1-8	C1—785 mmfd., silver mica cond.
65B7-22	C2, C3—250 mmfd. mica cond.
64B1-24	C3, C12—.02 mfd., 400 v. cond.
65B7-11	C4—50 mmfd., mica cond.
68A18	C5A, C2B—2-gang cond. (0-420 and 0-108 mmfd.)
64B1-30	C6—1 mfd., 200 v. cond.
64B1-22	C7, C15—.05 mfd., 400 v. cond.
64B1-25	C8, C11—.01 mfd., 400 v. cond.
65B7-27	C10—500 mmfd., mica cond.
67A10	C13A, C13B—50/30 mfd., 150/150 v. elec. cond.
64A2-2	C14—.18 mfd., 200 v. cond.
69C44	L1—Loop antenna
A1052	L2—R.f. coil
69A43	L3—Osc. coil
98A4	T1—Output trans.
72B50	T2—First i.f. trans.
72B51	T3—Second i.f. trans.

GENERAL ELECTRIC MODELS 102, 102W, 107, 107W, 114, 114W, 115, 115W

Part No.	Code and Description
URD-081	R1—22,000 ohm, 1/2 w. res.
URD-129	R2—2.2 megohm, 1/2 w. res.
RRC-077	R3, S1—Vol. control & sw.
URD-137	R4—4.7 megohm, 1/2 w. res.
URD-113	R5, R6, R11—470,000 ohm, 1/2 w. res.
URD-029	R7—150 ohm, 1/2 w. res.
URF-037	R8—2200 ohm, 2 w. res.
URD-009	R9—22 ohm, 1/2 w. res.
RCT-029	C1, C2A, C2B, C3—2-section tuning cond.
UCU-040	C8, C10—330 mmfd. mica cond.
UCC-625	C9—.005 mfd., 600 v. cond.
UCC-630	C11, C17—.01 mfd., 600 v. cond.
UCC-631	C12, C19—.02 mfd., 600 v. cond.
SCE-001	C13A, C13B—30/30 mfd., 150/150 v. elec. cond.
UCC-635	C14, C16, C20—.05 mfd., 600 v. cond.
STO-005	T1—Output trans.
STL-007	T2—First i.f. trans.
STL-008	T3—Second i.f. trans.

WESTINGHOUSE MODELS H-161, H-168, H-168A

Part No.	Code and Description
V-4639	R1—2 megohm tone control
V-4640	R2, SW1—.5 megohm vol. control & sw.
RC10AE330K	R3—33 ohm, 1/4 w. res.
RC10AE680K	R5—68 ohm, 1/4 w. res.
RC30AE332K	R6, R7—3300 ohm, 1 w. res.
RC10AE153J	R8, R9—15,000 ohm, 1/4 w. res.
RC30AE333K	R10, R11—33,000 ohm, 1 w. res.
RC10AE221K	R12—220 ohm, 1/4 w. res.
RC10AE683M	R13—68,000 ohm, 1/4 w. res.
RC10AE473M	R14—47,000 ohm, 1/4 w. res.
RC10AE104K	R15, R16—100,000 ohm, 1/4 w. res.
RC20AE154K	R17—150,000 ohm, 1/2 w. res.
RC10AE154M	R18, R19—150,000 ohm, 1/4 w. res.
RC10AE334K	R20, R21—330,000 ohm, 1/4 w. res.
RC30AE103K	R22—10,000 ohm, 1 w. res.
RC10AE224K	R23—220,000 ohm, 1/4 w. res.
RC10AE684K	R24—680,000 ohm, 1/4 w. res.
RC10AE105M	R25, R26—1 megohm, 1/4 w. res.
RC10AE225M	R27—2.2 megohm, 1/4 w. res.
RC10AE474M	R28—470,000 ohm, 1/4 w. res.
RC10AE106M	R29—10 megohm, 1/4 w. res.
RC20AE683K	R30—68,000 ohm, 1/2 w. res.
RC30AE183K	R31—18,000 ohm, 1 w. res.
RC10AE223K	R32—22,000 ohm, 1/4 w. res.
V-4648	R33—180 ohm, 2 w. res.
RCPI0W4103A	C1—.01 mfd., 400 v. cond.
RCPI0W6202A	C2—.002 mfd., 600 v. cond.
V-5040-13	C3—.01 mfd., 200 v. cond.
RCPI0W4303A	C4, C5—.03 mfd., 400 v. cond.
RCPI0M6502A	C6—.005 mfd., 600 v. cond.
V-5040-15	C7, C8, C9—.01 mfd., 600 v. cond.
RCM20A470M	C10—47 mmfd., mica cond.
RCPI0W4203A	C11—.02 mfd., 400 v. cond.
RCPI0W6102A	C12, C13—.001 mfd., 600 v. cond.
RCM20A101M	C14, C15—100 mmfd. mica cond.
RCM20A221K	C16, C17, C18—220 mmfd. mica cond.
V-5040-11	C19, C20—.005 mfd., 600 v. cond.
RCM30A472M	C21—4700 mmfd. mica cond.
RCM30A103M	C22 C23—.01 mfd. mica cond.
RCM20A151M	C24—150 mmfd. mica cond.
RCM20B220K	C25—22 mmfd. mica cond.
R3CC32CG101K	C26—100 mmfd. ceramic cond.
R3CC26SL101M	C27—100 mmfd. ceramic cond.

**WE HAVE THE SENSATIONAL NEW MODEL 770
AVAILABLE FOR IMMEDIATE SHIPMENT FROM STOCK!**

**THE MODEL 770—AN ACCURATE POCKET-SIZE
VOLT-OHM-MILLIAMMETER**

(SENSITIVITY: 1000 OHMS PER VOLT)

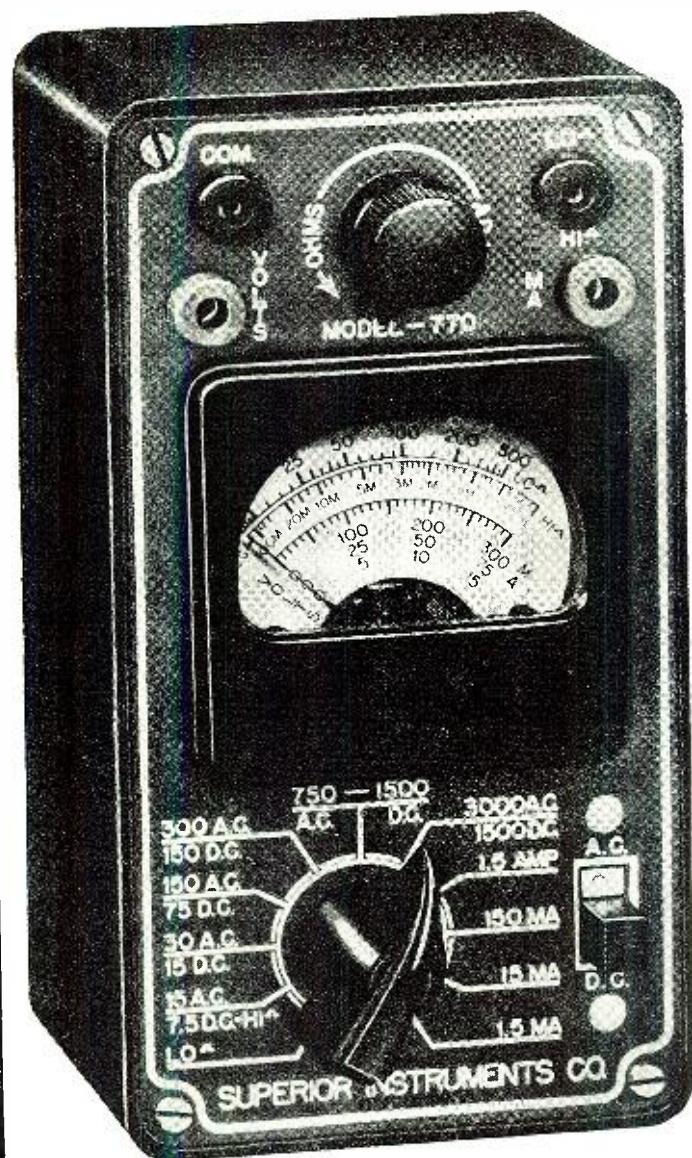

Features:

- ★ Compact—measures 3 1/8" x 5 7/8" x 2 1/4".
- ★ Uses latest design 2% accurate 1 Mil. D'Arsonval type meter.
- ★ Same zero adjustment holds for both resistance ranges. It is not necessary to readjust when switching from one resistance range to another. This is an important time-saving feature never before included in a V.O.M. in this price range.
- ★ Housed in round-cornered, molded case.
- ★ Beautiful black etched panel. Depressed letters filled with permanent white, insures long-life even with constant use.

Specifications:

- 6 A. C. VOLTAGE RANGES:
0—15/30/150/300/1500/3000 VOLTS
- 6 D. C. VOLTAGE RANGES:
0—7.5/15/75/150/750/1500 VOLTS
- 4 D. C. CURRENT RANGES:
0—1.5/15/150 MA. 0—1.5 AMPS.
- 2 RESISTANCE RANGES:
0—500 OHMS 0—1 MEGOHM

**\$13⁹⁰
NET**

The Model 770 comes complete with self-contained batteries, test leads and all operating instructions.

20% DEPOSIT REQUIRED ON ALL C.O.D. ORDERS

GENERAL ELECTRONIC DISTRIBUTING CO.

Dept. RN-7, 98 Park Place
New York 7, N. Y.

Proved in Millions
of Applications!



RELAYS
RESISTORS
RHEOSTATS

Vast Variety of Stock Units
ANSWERS EVERYDAY NEEDS ECONOMICALLY

Relays are available from stock in general-purpose, industrial, and radio amateur types for continuous or intermittent duty.

Vitrohm wire-wound Fixed Resistors are available in 8 stock sizes from 5 to 200 watts. Adjustohms in 7 stock sizes from 10 to 200 watts. Plaque Resistors in 3 sizes from 20 to 125 watts. Discohms in 18 watts. Stripohm in 5 stock sizes from 30 watts to 75 watts. Ring-type close control Rheostats in 4 stock sizes from 25 to 150 watts. (Plate Type Rheostats recommended for larger sizes.) Wide variety of Resistance Values.

AUTHORIZED DISTRIBUTORS EVERYWHERE
WARD LEONARD ELECTRIC COMPANY
Radio & Electronic Distributor Division
53-N West Jackson Blvd., Chicago 4, U.S.A.

SEND FOR HELPFUL CATALOGS
Catalog D-30 gives complete data and listings on stock units available in Resistors, Rheostats and Radio Amateur Relays. Catalog D-20 lists Industrial and General-Purpose Relays. Write for them today!

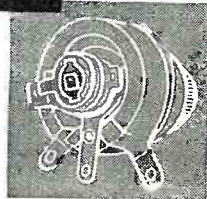
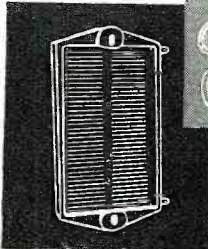
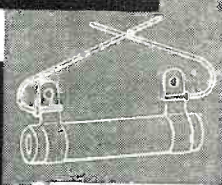
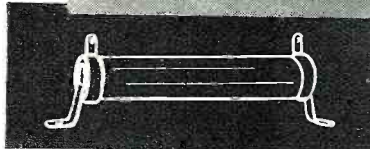
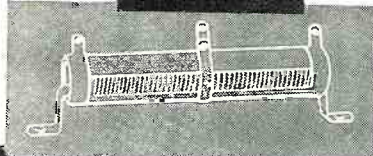
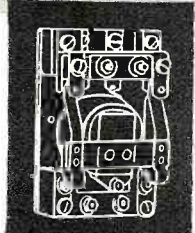

WARD LEONARD
Basic 3R's in Current Control



STEADY PROFITS

YOUR OWN BUSINESS

with **CORADIO**
THE COIN OPERATED RADIO

Place these specially built radios that play 1 or 2 hours for 25c in the thousands of available hotel rooms, tourists courts, etc. They yield immediate profits and steady income. Install Coradio, the finest made.

Limited capital required. Send for further information. Write today.

CORADIO Coin Operated Radio
Dept. R. N. New York 7, N. Y.
212 Broadway Phone: Beekman 3-0038-9

TUNING CONTROL KNOBS For Command Set Receivers
69c ea. 3 for \$2. Postpaid in CONTINENTAL U.S.A.

BC 454, etc. series with locking sleeve. Brand new, not surplus. Makes tuning simple for fixed or mobile use.

Send for Latest Bulletin
ALVARADIO, Dept. RN7
903 S. Alvarado, Los Angeles 6, Cal.



CORRESPONDENCE COURSES IN RADIO and ELECTRICAL ENGINEERING

ELECTRICAL ENGINEERING Get good grasp of wide electrical field. Prepare yourself at Low Cost, for secure future. Modern course. So simplified anyone can understand quickly.

RADIO ENGINEERING Extra fine course in radio, public address, photo-electric work. Trains you to be super-service man, real vacuum-tube technician. Servicemen needed badly. Diploma on completion. Many graduates earning big pay.

WRITE Send postcard for Free Copies of \$25 Course about deferred payment plan, experimental kits, etc.
LINCOLN ENGINEERING SCHOOL, BOX 931-R115 LINCOLN 2; NEBR.

- RCM20A471M C28—470 mmfd. mica cond.
- R5CC20ZY471M C29, C30—470 mmfd. ceramic cond.
- R5CC36ZY472M C31, C32—4700 mmfd. ceramic cond.
- V-4634 C33, C34—Dual .01 mfd., 600 v. line filter cond.
- V-4635 C35, C36—30/30 mfd., 450/450 v. elec. filter cond.
- V-4636 C37—50 mfd., 25 v. elec. cond.
- V-4885 C38, C39—4 mfd., 450 v. elec. cond.
- V-4671 C39—AM antenna trimmer
- V-4672 C40—AM osc. trimmer
- V-4673 C41, C42, C43, C44, C45, C46—2-gang var. cond.
- V-4627 C47, C48, C49, C50, C51, L7, L8, L9, L10, R34—First i.f. trans.
- V-4628 C52, C53, C54, L11, L12, L13, L14—Second i.f. trans.
- V-4629 C55, C56, L15, L16, L17, L18—Third i.f. trans.
- V-4630 C57, C58, L19, L20, L21, L22—Disc. trans.
- R3CC25CG270J C58—27 mmfd. ceramic cond.
- V-4638 L1, L2—1.1 microhenry filament choke
- V-4883 L3—FM antenna coil
- V-4675 L4—Antenna loading coil
- V-4676 L5—AM osc. coil
- V-4882 L6—FM osc. coil
- V-4653 T1—Power trans.
- V-4682 SW2, SW3, SW4, SW5—Selector sw.

-[30]-

DUAL TANK SYSTEM

By CLINTON E. CLARK, WIKLS

THIS kink may be of help to any ham who has tried to make both ends (frequency) meet. Although this system is a compromise it is one that is easily made.

On 80, 40, and 20 meters, plug-in coils are used whereas on 10 and 11 meters the coil is self-supporting and permanently attached to the low capacity tank condenser. The rig at WIKLS, built for 10-11, incorporates this system and it works very well. Another switch, not shown, is used to cut out the modulation section when operating on c.w.

When all-band coverage is desired with a single-ended final, such as the 807, the system shown in Fig. 1 provides a flexible and convenient means of obtaining correct L-C ratios on both the high and low frequency bands. The high frequency tank may be used to cover the 10 and 11 meter band and the low frequency tank will take care of 80, 40, and 20 meters. Quick changeover is possible with this system.

The procedure for using the high frequency tank would be as follows: First, check to be sure the plate power is off. Place the cap on the 807 and insert P₁ into J₁, and P₂ (a dummy plug) into J₂. For low frequency operation, reverse the procedure.

(Editor's Note: Be sure to use only an insulated plate cap connector in this circuit.)

—30—

Fig. 1.

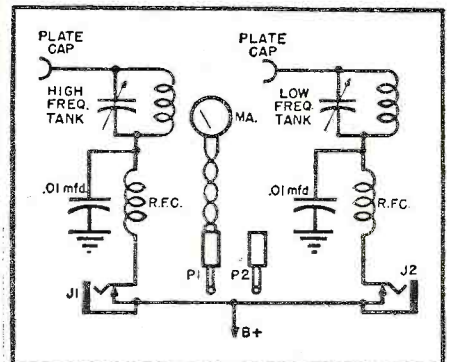

TUNING METER 5ma/2 1/2" AN BKLT	\$1.98
WESTON GE RF METER 0-1AMP 2 1/2" RD BKLT	3.95
CSD GE RF METER 0-5AMP 2 1/2" RD BKLT	3.95
GE GALVOMTR 2.5 & 25ma-0-ctr/3 1/2"	3.95
B' Csd GE 2000V mtr/1000ohms V & Resistors	5.95
WSTGHSE 0-100 & 100-0-100microamp/DUAL	2.95
GE ONE MA METER 3 1/2" B' Cased LN	3.95
DEJOUR ONE MA METER 2 1/2" B' CSD & STD Scale	3.95
WESTON 0-750ma RFMTR/2 1/2" & Thermo-couple	3.49
WESTON TWIN Galvonomtr 4"/10 & 40ma/5%	12.95
WSTGHSE 0-150VAC/2 1/2" B' Cased	3.95
WE 0-500VDC/3 1/2" B' Cased 1000ohms V	4.95
WESTON 0-15VAC/±476/3 1/2" SQ B' Cased	4.95
WE 0-200VDC/3 1/2" B' Cased 1000ohms V	3.95
HICKOCK 4" Illuminated MTR Tube Chkr	7.95
WSTGHSE 2AMP/3 1/2" Bklt CSD	4.50
GE 0-10KV/1000ohms V 3 1/2" B' C & REST'S	10.95
DEFLECTION YOKE 2000ohm TELV	5.95
DEFLECTION YOKE 4000ohm TELV	5.95
DEF YOKE SAME AS RCA 201DI TELV	7.95
GE PULSE TRANSF HORIZ & VERT BTO	1.49
RAYTHON PULSE TR HORIZ & VERT BTO	1.49
UTAH PULSE TR HORIZ & VERT BTO	1.49
TEST LEADS 8 ft & 1ins/dt 20AMP ellips. PR	4.99
PILOTLIGHT enclosed type min bulb	1.00
PILOTLIGHT & S6 bulb 1 1/2" type	2 for 1.00



Precision Resistors for Meters Bridges, Amplifiers All Standard Makes

SEE PREVIOUS RADIO NEWS AD'S or WRITE for PRECISION RESISTOR LIST

5 & 10% 2000 to 95000ohms	10 for \$1.98
1% from .116 to 95000ohms	10 for 3.00
1% from 0.1 to 0.95MEGohms	10 for 5.00
1% from 1 to 20MEGohms	10 for 6.95
VICTOREN VACUUM PRECISION RESTRS 0.83, 1, 1.5, 2, 3, 3.75MEG	
ACCY % of % HiVolts	10 for 7.50
IRC NAVY WW Caged 2Meg 1/5 of 1%	4.95
SPRAGUE 10 or 12Meg/10K Hiacy	ea. .98
IRC MVZ 30Meg/20Watt/25KV	@ \$1.89
GE 2Meg WW 0.2% acy caged	10 for 15.00
IRC MFB WW/1Meg/5% acy	1.69
HOYT 15AMPDC/2 1/2" Cased meter Int shunt	2.49
WSTGHSE RA35/7.5 mxd 6.3VAC/3 1/2" SQ B' C	4.50
STORAGE BATTERY 2V/BB54	2 for 3.98
STORAGE BATTERY 2V/BB206	@ \$1.75
STORAGE BATTERY 4V/50AH nonspill	2 for 3.00
STORAGE BATTERY 36V/BB52 WILLARD BR18/3-1/16X1-7/16x29/32" Wt. 6 oz ideal for portable use @ \$3.95	3 for 10.00
BAT 3V/F2BP BURGESS 1947 NEW	5 for \$1.00
BUZZER HIFRQ adjust 6V operation	.98
BELL AC/DC 48 to 115V telephone type	1.29
NAVY NOISE FILTER 30AMP/250V 40 & DC filters from 15 to 100mc's min 44DB & from 18 to 30mc's/60DB filters line noises & RF for RCVRs, XMTRs, OIL BURNERS, REFRIG, MCH TOOLS, SIGNS, C'Cost @ \$39. Excellent SCREEN BOOTH FILTER, includes data cnctng. SPECIAL @ \$4.50;	2 for \$8
NAVY NOISE LINE FILTER 10AMP 150VAC & DC filter from 1 to 1000mc's min 25DB & from 1 to 1000mc's/55DB @ \$1.20	2 for 2.20
IN34 X'DIODES @ \$1.08; 2 for \$2.10; 10 for \$12.14, 22, 23A, 25 G'insp boxed @ \$1.12	10 for 10.00
IN21, IN23 G'insp boxed	3 for 1.00
IN23B, IN26 G'insp boxed	3 for 17.50
THERMISTOR BEAD BULB W.E.	3 for 2.50
THERMISTOR D168391 for 10 & 3cm @ \$2	3 for 5.00

FUSES

TYPE 3AG-1/32, 1/8, 1/4, 1/2 Amp @ 06c	20 for 1.00
3AG-1, 3, 4, 5, 10, 15, 20Amp @ 03c	40 for 1.00
4AG-5, 10, 15Amp @ 05c	20 for 1.00
4AG-SLOBLO 1, 3, 5, 10, 15, 20Amp @ 12c	10 for 1.00
5AG-SLOBLO 1, 3, 5, 6, 35Amp @ 20c	6 for 1.00
5AB-800ma, 4, 10Amp @ 09c	12 for 1.00
7AG-200ma @ 10c	12 for 1.00
8AG-1/32, 1Amp @ 09c	12 for 1.00
Little Fuse 1000V-3/8, 1/2, 1Amp @ 30c	4 for 1.00
BUSS 4000V-1/2 Amp @ 75c	4 for 2.25
CARTRIDGE 2 1/2"x 1/2"/3, 5, 6, 35Amp @ 12c	10 for 1.00
Renewable 2 1/2"x 1/2"/3, 6, 10, 15, 20Amp @ 30c	4 for 1.00

TELEPHONE GRASSHOPPER WE 3A @ 09c 12 for 1.00
FOLDERS LF #1075 for 3AG @ 25c 5 for 1.00
FOLDERS LF #442001 for 4AG @ 30c 4 for 1.00
3AG-4AG CLIP MTG-single Fuse 10 for 1.00
3AG, 4AG Dual mtg @ 20c 6 for 1.00
DUAL mtg for 2 1/2"x 1/2" Cartridges @ 35c 5 for 1.50
CITAB for FUSES, CLIPS, HOLDERS & prices in Quantity. Can meet AIA & JAN specs.

CIRCUIT BREAKERS

HEINEMAN MAGNETIC BKRS 3, 5, 10 & 15, 20, 30, 40, 80, 100, 180Amp, 10ma @ \$1.95	10 for \$18.00
HEINEMAN DUAL 10AMP @ \$2.95	2 for 5.50
KLIXON BREAKER 60AMP @ 89c	4 for 3.00
SQ'D KLIXON & CH 5, 10, 20, 25 & 33, 35, 60 70Amps each 98c	10 for 8.00

That's A Buy

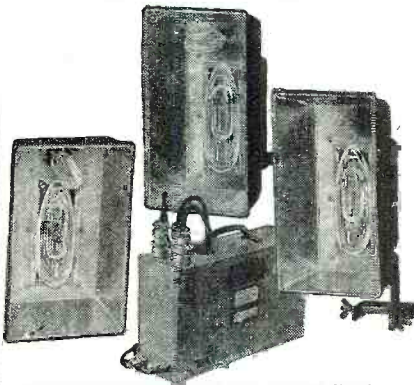

STROBOFLASH KI 1503 AIR CORPS NEW COMPLETE POWER SUPPLY TRANSFORMERS RECTIFIERS, RELAY, 2 STROBOLAMPS 12000000 Lumens light output/15000 flashes Plastic sealed for Colors & B.W. film. Condensers 50mf/2000V & ACCESSORIES REFLECTORS, CONNECTORS CABLE CORDS, DIAGRAM & INSTRUCTIONS Converting Unit for 110VAC OPERATION BRAND NEW GUARANTEED

SPECIAL TAB BUY.....\$59.95
SAME KIT for STORAGE BATS
OPR\$69.95
SAME KIT BATTERY & 115VAC \$79.95

ADJUSTABLE 54" TELESCOPIC Stands for MTG STROBOFLASH LAMPS \$7.95 @ 3 for \$18.00
 STROBOFLASH COMPLETE 115VAC @ .105.00
 COMMERCIAL STROBOFLASH & Stands for 115VAC operation295.00
 PORTABLE HI POWER STROBOFLASH 149.50
 STROBOLAMP X400 in plastic sealed protected case & reflector with built-in Xformer, 12000000 Lumens/15000 flashes SPECIAL \$10.95 ea.2 for 21.00

STROBOCONDSRS GE PYRANOL
 8mf/660VAC/2000WVDC/3000Vint11.95
 8mf/660VAC/2000WVDC/3000Vint3.95
 16mf/660VAC/2000WVDC/3000Vint7.95
 15mf/330VAC/1000WVDC/2000Vint4.50
 25mf/330VAC/1000WVDC/2000Vint7.95

SPECIAL "TAB" SPECIAL
 .16mm FILM PAN SPEED 50 REVERSIBLE or NEGATIVE 25 ft each roll. Outdated JULY 1946, sensitive all colors ANSCO-USN PACKED 54 rolls to sealed drum. Supplied with simple instructions for loading your own magazine.
54 rolls total 1350 ft.....\$19.95

HIPOWER VARIABLE ANTENNA MATCHING NETWORK ±100IA BRAND NEW 1500 to 7000 KC IKW-RF easily converted to hf/freqs. PINetwork adjustable in & output. CASED 15"x15"x23" Relay Rack mfg. Contains hv edge wise Ribbon coil & 250mmf/7000V variable Condnsr Johnson & RF mtr thermocouple 0-8AMP/3" Sq. With TECH manual, Will match & load majority ANTENNAS. STURDY CONSTRUCTION. Wgt. 45 lbs. Excellent for Police, Airport, Broadcast & Amateur stations.

TAB SPECIAL\$12.95
 SAME UNIT LESS ANTENNA COIL includes Housing, VAR CONDNR RF meter, Insulators, dials TECH manual, NEW.
TAB SPECIAL 8.95



*LN-Like New Used GOOD GUARANTEED.
 * PRICES SUBJECT TO CHANGE *
 * MONEY BACK GUARANTEE. \$2 MIN. ORDER F.O.B. N.Y.C. ADD SHIPPING CHARGES & 25% DEPOSIT. \$2 MIN. ORDER.

ART13 SPEECH AMP CLIPPER KIT.....	\$8.25
DYNMTR 28Vin/out 540V/250ma used LN*	2.50
DYN 12 & 24Vin/275V/110ma P'magnet.....	1.95
DYN 6Vin/out 240V/100ma or 12 & 24Vin/500V	3.49
DYNAMOTOR 28Vin/out 250V/60mc..... 2 for	1.98
DYN 12 & 24Vin/220V/100ma & 440V/200ma	5.95
DYN 24Vin/300V/260ma/150V/10ma & SCR522	4.95
PE94/522 COMPLETE filters & Start.....	9.95
VIBRAPAK 6Vin/out 400V/100ma.....	12.95
KEYING MOTOR 6Vinpt & SOS cams LN*	5.95
BC457, 458 Xmitter used LN* ea.....	5.95
BC456 Modulator less tubes & Dyn LN	1.69
BC191/375 & TU & TUBES used \$12.95 LN*	14.95
BALLOON 4 ft & Gas \$4.95; BOX KITE.....	2.95
BC1162 UHF WYVTR, FREQ MTR & CONTROL	24.95
DAK RCVR & 60cy PWR used LN*	34.95
866A COMBINATION TRANSF & TUBES.....	5.95
872A COMBINATION TRANSF & TUBES.....	12.95
OSCILOSCOPE 3" KIT Tubes & pwr.....	15.95
167B XMTR/2-24mc's/150-200W/NEW.....	149.50
ANTENNA TELESCOPIC 12" to 9 ft @ \$1.49	2 for \$2.49
ANTENNA AN30B/30-3/4" & loading coil @ 98c	2 for 1.49
ANTENNA 16 ft ins base & gnd mtr MS49-53	3.95
ANTENNA 20 ft ins base & gnd mtr MS49-54	4.95
ANTENNA VARIABLE DUMMY LOAD.....	1.49
ANTENNA 30CM/AT5 with COAX PL259 plug	.98
ANTENNA ent HF Insulator 2-1/2" D & ROD	.98
ANTENNA feedthru HF ins 1 1/2" x 8 ROD	.49
FOXBORO GRAPHIC ELECT RECORDER.....	39.50
CINCH DUAL XTAL SOCKET HF BKLT	10 for 1.00
EBY FOUR XTAL SOCKET 1/2 & 3/4" Sp	10 for 1.00
AIR BLOWER 100CM & Transformer.....	5.95
AIR BLOWER 125CM & BRCKT 115V ACDC	6.95
CLOCK MOTOR SYNCHRONOUS 10V/60c/24RPM	2 for .98
V'REGULATOR 198-242Vinpt/50-60cy output 220V/500Watts/5% Reptn	35.00
V'REG 95-130V/60c, Output 115V/60Watt.....	10.95
SOLA CONSTANT V'TRANSF 95-220V 50-60cy/2000W/17.4Amp LN*	149.50

"TAB" FOR TUBES

0A4G	\$.90	6D6	.74	450TL	29.95
0Z4	1.20	6E5	.98	527/60Z1	75.00
1B3/8016	2.00	6F8/1613	2.00	631PI/SN4	3.75
1B24	2.95	6F8	1.09	703A	4.95
1B27	2.95	6G5/6U5	.95	707B/2K28	9.95
1E7G	.98	6G6	1.08	710A/8011	2.90
1L4	.88	6HG6	.88	717A	.69
1LC6	1.25	6HM6	.68	722/287A	9.95
1LH4	1.25	6J4	2.99	723A/B	4.95
1LN5	1.25	6J5	.49	728A	6.95
1P5	.79	6J6	.49	802	1.49
1P24	2.95	6J7	.88	803	7.95
1R4/1294	1.25	6K5G	1.10	804	6.70
2A1A	3.95	6K6	.49	805	3.74
2C26	.39	6K6G	.49	807	1.24
2C34/RK34	.49	6K7	.59	808	1.95
2C40/446	.73	6K8	.73	812A	5.95
2D21	.73	6L6	1.24	811	1.94
2E22	1.50	6L6G	1.20	813	5.94
2J21/725	12.49	6L7	.98	814	2.98
2J26	14.95	6N7	.88	815	2.25
2J32	16.95	6S7	1.20	816	1.15
2J49	33.00	6SA7	.89	826	.49
2J55	24.95	6SC7	.79	827A/B	10.00
2J61A	39.95	6S7	.79	829B/3E29	4.90
2K25/7	.95	6SH7	.98	832	2.25
723AB	5.95	6S17	.79	836	1.10
2K29	6.95	6S17G	.69	837	2.25
2V3G	.98	6S17	.79	W632A	12.95
2X2	.49	6S17	.89	845	3.74
3A4	.49	6SN7	.91	860	2.00
3A7	1.95	6N7GT	.89	824B	14.95
3B7/1291	.95	6S7	.89	864	1.00
3B24	.95	6S7	.74	865	1.00
3BP1	1.90	6V6GT	.98	866A	1.00
3BP1A	2.95	6U7G	.78	868	1.00
3C23	4.95	6X4	.98	872A	2.20
3D6/1299	.88	6X5	.88	884	.75
3DP1	2.75	6Y6G	.89	818	5.75
3E27	2.98	6Z8/84	.74	922	1.49
3GP1	3.95	7BP7/1813	2.90	923	.49
3JP12	3.95	9JP1	3.95	931A	3.49
3S4	.55	10Y	.59	954	.45
4J47	35.00	12A6	.89	955	.45
5A1P	2.75	12A7	1.00	956	.49
5B1P	3.75	12A7	.95	957	.49
5BP4	3.75	12C7	.79	958A	.45
5CP1	3.75	12P7	.79	958	.69
5D21	19.00	12SA7	.79	1614	1.50
5FP7	3.95	12SH7	.88	1616	1.39
5HP1	3.95	12SK7	.69	1619	.39
5R4G	1.00	12SQ7	.80	1622	1.49
5T4	1.53	12X3	1.10	1624	.70
5U4G	.69	15E	.49	1624	.39
5W4	.98	25Z5	.70	1626	.45
5W4	.98	35L6	.74	1629	.58
5Y3G	.53	35Z5	.61	1635	1.90
5Z3	.88	37	.68	1641	.75
5Z4	.88	41	.68	2050	.90
6AB7	.98	50L6	.72	2051	.49
6AC7	.2	60	.52	2193	.49
6AC7	.88	83V	.89	8005	3.25
6AG7	.98	205B	3.95	8012	3.95
6AJ5	.98	211	.79	8013A	4.95
6AK5	.69	215	2.95	8020	4.95
6AL5	.98	250TH	1.74	9001	.49
6B4G	1.25	250TL	1.80	9002	.58
6BR6	.98	304TH	3.95	9003	.49
6C4	.98	304TL	2.49	9004	.49
6C5	.51	307A	3.75	9006	.49
6C6	.73	388	9.95	906J	4.95
6C8G	.98	393	5.95	CE206	3.95
6D4	.89	450TH	25.00	CE215	5.95

TUBESGT D except open Fil & Breakage Write Qty Prices

"TAB" • Dept. 7RN, Six Church Street, New York 6, N. Y., U.S.A. • "TAB"
 NEW GUARANTEED • CORNER CHURCH & LIBERTY STS., ROOM 200 • ELECTRONIC PARTS



**WUXTRY!
GET THE XL-347!**

**THE CONNECTORS WITH
TECHNICAL SUPERIORITY...**

favorite of sound technicians in night clubs, radio stations, motion picture studios—and also used extensively by "hams". Cannon Connectors require



XL-3-12 PLUG
LIST \$1.20

XL-3-11 PLUG
LIST \$1.25

a minimum of servicing—that's why sound men prefer Cannon.

Latch-lock keeps plug *positively* connected—no scratchy connections with loose coupling nuts. It stays connected!

Available from more than 300 distributors: In NEW YORK, Harvey and Newark Radio. In CHICAGO, Allied, Newark and Walker-Jimieson.

We'll send the XL-347 and the RJC-2 for the asking. Address Department G-228.

CANNON
ELECTRIC

Development Company

3209 HUMBOLDT ST., LOS ANGELES 31, CALIF.

IN CANADA & BRITISH EMPIRE:
CANNON ELECTRIC CO., LTD., TORONTO 13, ONT.

WORLD EXPORT (Excepting British Empire):
FRAZAR & HANSEN, 301 CLAY ST., SAN FRANCISCO

10 db. Compression

(Continued from page 51)

nal taken off at this point by the triode section is used for biasing purposes in the compression circuit which operates as follows:

The 6SN7 amplifier stage driven by the 6J5 utilizes a split secondary input transformer. A feedback voltage out-of-phase with the input signal voltage is fed back from each plate and applied in the lower leg of each half of the grid winding. The feedback voltage is fed back through the 47,000 ohm resistors and .1 mfd. condensers to each 470,000 ohm resistor in the grid circuit. However, across each of these 470,000 ohm resistors is the plate resistance of a second 6SN7. It is now that the 6R7 serves its function. The bias of this second 6SN7 comes from the rectified current from the diodes of the 6R7. It is seen that the diodes of the 6R7 are naturally at the same bias as the triode section and hence can pass no rectified current until the bias is overcome by the signal fed from the triode section. This is the point at which compression begins, or the threshold of compression. Consequently, below the threshold of compression, the equivalent resistance, across which the feedback voltage is developed in the bottom legs of the split secondary input transformer, is approximately equal to the plate resistance of the second 6SN7, or about 13,000 ohms.

However, when the signal level into the 6J5 drives the diodes in the 6R7 positive, a bias voltage is developed across R_{21} . This bias is applied to the second 6SN7, decreases the plate current of that tube and consequently increases its equivalent plate resistance. This increases the equivalent resistance in the lower legs of the first 6SN7 input transformer and consequently increases the feedback voltage developed here. Thus the gain of the stage is reduced in proportion with the level in the 6J5 driver.

This arrangement gives 10 decibels available compression, which is all that will be desired. It can be seen how much this increases the effectiveness of the transmitter as compared to a more costly increase in r.f. power output. The volume compressor in conjunction with a beam antenna represents the optimum in a ham station set-up. However, distortion must be avoided, and for this reason the tubes were operated conservatively and 2A3's were used in the output. Also, the bias for the 2A3's was voltage regulated with a consequent reduction in distortion. The distortion can be as low as 3 per-cent at full output if perfectly balanced tubes are used. If perfectly balanced 2A3's

**CUT ACCURATE HOLES
IN RADIO CHASSIS**

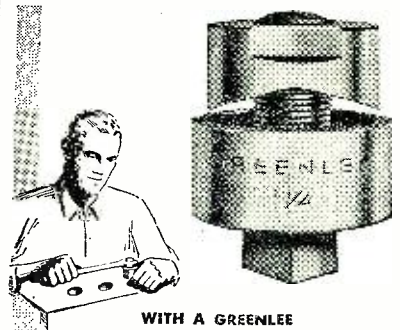

WITH A GREENLEE
RADIO CHASSIS PUNCH

• Make smooth, true holes quickly this easy way. Just turn GREENLEE punch with an ordinary wrench and have an accurately-sized opening for plugs, sockets, and other receptacles. No reaming or filing. A GREENLEE Punch for each of these sizes: 1/2"; 5/8"; 3/4"; 7/8"; 1"; 1 1/16"; 1 1/8"; 1 1/4"; 1 3/8"; 1 1/2"; 1 5/8"; 1 3/4"; 1 7/8"; 2 1/4". Also GREENLEE Knockout Punches and Cutters for conduit and meter holes up to 3 1/2". Get facts now. Write Greenlee Tool Co., 1887 Columbia Avenue, Rockford, Illinois.

TOOLS FOR CRAFTSMEN

GREENLEE

ORDER NOW

- 304 TL (New in Cartons), bargain..... \$.90
- 300 ohm Amphenol.....per C **\$2.91**
- 150 ohm Amphenol.....per C **\$2.62**
- 75 ohm Amphenol (small).....per C **\$2.01**
- 75 ohm Amphenol (heavy duty)....per C **\$7.20**
- Kilowatt 75 ohm Amphenol
- Twin Lead, per 100 ft.....**\$7.20**
- SCR 522 Dynamotors PE94C, New.....**\$3.95**
- SCR 522 Receiver Conversion Kit
- and Instructions (Less Dial).....**\$3.50**
- ACN Dial For Above.....**\$3.00**
- 3 Gang 410 Mmfd. Per Sect. Cond.
- Excellent quality**\$2.95**
- Four Gang—150 Mmfd. Variable..... **.95**
- 4 Mfd. @ 600V—Oil—Round Can..... **.69**
- PL 55A Phone Plugs..... **.18**
- 375E Tuning Units.....**\$1.95**
- 807—New—Boxed.....**\$1.49**
- 2C40 Lighthouse Tube..... **.95**
- 2" PM Speaker (Bakelite Cased)
- Used in Walkie Talkie.....**\$1.95**
- SIREN, Commercial type hand
- operated, very loud noise, gov't
- cost \$21.00. Spec..... **\$4.95**
- TRANSMITTING CONDENSER,
- 2 mfd. @ 2500 W. V. each.....**\$2.95**
- Vibrator, Heavy Duty 100 MA 6 Volt,
- 4 prong Universal.....**\$1.05**
- Relay Leach, 115 V-AC DPST.....**\$1.50**
- 872A—GE Surplus, New, Boxed, 2 for.....**\$2.50**
- Phosphor Bronze dial cable, 42 strand,
- 250 ft. spool..... **.69**
- 2051—Tube Thyatron..... **.39**
- New Surplus Jones 6 and 8 prong plugs
- Toggle Switches SPST plus spring return **.24**

Send For Our Special Bulletin of
Government Surplus Items

DOW RADIO

1759 E. COLORADO ST., PASADENA 4, CALIF.
Pasadena Phone—SYcamore 3-1196
Los Angeles Phone—RYan 16683



ESSE Specials!

In this July issue of Radio News magazine, we are omitting our ads except for this page. Esse Radio Company, having been one of the first companies to enter the surplus sales field, has accumulated, over the past few years, odds and ends of all different kinds of electronic surplus gear and now, during the month of July, is going to hold its retail store open Monday through Friday from 9 A.M. to 5 P.M. and on Saturday from 9 A.M. to 3 P.M. and we cordially invite anyone to our store and will promise that, if you do come, you will see the most sensational bargains ever offered anywhere. We suggest that, if you have never been in our store, that you should come alone or invite your friends and all of you come as a group. Esse will go through all of its warehouses and bring to the sales floor, the largest assortment of electronic gear that has ever been assembled in one sales room. We want to clear our shelves of small quantity lots, obsolete equipment, too large of stock items and we want to become personally acquainted with our mail-order customers so we are putting prices "Down", "Down", "Down" until our customers will hardly be able to believe what they see when they enter our door.

On this sale, you will find radio hardware, parts, receivers, transmitters, modulators, power supplies, and all the vast array of things that are yet unsold that you have seen in previous Esse ads. You will find hundreds of aircraft parts, controls, and instruments. There will be radar gear galore. We are going to cram into every shelf, corner and nook of this sales floor, all the way to the ceiling, tens of thousands of items.

Please use this as an open invitation to visit our store and believe us when we state that, if there is an item that you desire that's on the surplus electronic market, that we probably have it and the prices that we quote you will amaze you. Even if you have no intentions of buying and don't buy while visiting our store, it's almost an education to come here and examine the vast array of war surplus devices that we have. Meet and talk to some of your friends, whom you have talked to over the air here in Indianapolis, and get together and exchange ideas on radio.

We want to meet and become better acquainted with customers from all over the United States and Canada and from anywhere else, so please take our word for it — "It will be interesting" — Come in!

ESSE RADIO COMPANY
140 W. New York Street
INDIANAPOLIS 4, INDIANA

ESSE

Radio Co
130 W. New York St.
Indianapolis 4, Ind.

Unless Otherwise Stated, All of
This Equipment Is Sold As Used
CASH REQUIRED
WITH ALL ORDERS
Orders Shipped F.O.B. Collect

**INCREASE PROFITS!
BUILD GOOD WILL!**

**... SELL SEEBURG
RECORD CHANGERS**

FOR REPLACEMENT



Model DS-1. Single-post construction. High or low output cartridge. Size: 12 x 13 $\frac{3}{8}$ inches.

**FOR PLAYING
THROUGH EXISTING RADIOS**



Model DS-101. Same chassis as DS-1 with walnut finish wood base. Size: 12 $\frac{1}{2}$ x 14 $\frac{1}{8}$ inches.

● These are the same quality mechanisms—now available for retail sale—that are standard equipment on so many of today's leading radio-phonograph combinations. And there's good reason for this preference. For Seeburg Changers assure simple, dependable operation . . . constant sustained speed . . . quiet performance . . . the last word in listening pleasure.

Plan now to sell and install Seeburg Changers for every purpose. Mail the coupon.



J. P. SEEBURG CORPORATION
1500 N. Dayton St., Chicago 22

Seeburg Home Record Changers are available through our nation-wide distributing organization—located in all principal cities.

MAIL THE
COUPON
FOR FULL
INFORMATION

J. P. Seeburg Corporation RN-7
1500 N. Dayton St., Chicago 22, Ill.
Gentlemen: Please send complete information on Seeburg Home Record Changers.

Name.....
Company.....
Address.....
City.....State.....



**RADIO ENGINEERING
TELEVISION
ELECTRONICS**

Thorough training in all phases of radio and electronics, open to high school and junior college graduates. Old established school specializing in Radio training exclusively. Modern laboratories and courses. Enrollments limited. Approved veteran training.

VALPARAISO TECHNICAL INSTITUTE
Dept. RD Valparaiso, Ind.

**There ain't no difference
IN ELECTRICAL CHARACTERISTICS OF
RG 58/U and RG 29/U
BUT—A BIG DIFFERENCE IN PRICE.
RG 29/U CO-AX \$3.00 PER 100 FT.
LIMIT 300 FEET SATISFACTION GUARANTEED
HARRY H. VAN DICK
Route 23 LITTLE FALLS, N. J. Box 236**

**SPEAKER RECONING
ALL WORK GUARANTEED**

3"—\$1.40	7"—\$1.95	15"—\$4.00
4"—1.40	8"—2.20	4x6—1.90
5"—1.50	10"—2.70	5x7—2.20
6"—1.65	12"—3.00	6x9—2.50

OXFORD RECONING SERVICE
1039 Selby Ave. St. Paul, Minn.

are not available, it may be advisable to use a system of independent bias for each 2A3 and adjust each until the plate currents are equal. This is very easily accomplished by using two sliders on the bias bleeder and a bleeder which is physically long enough to permit getting the sliders physically close together.

In adjusting the amplifier, the input preamplifier controls are adjusted until the compression meter indicates the desired amount of compression, which will probably be around seven or eight decibels for voice work. The meter is not indicated on the circuit diagram but is shown in the photographs. It is a 0-10 d.c. ma. meter connected between the cathodes of tube V_3 and ground. It should read the total cathode current of both sections of the tube V_3 . The following figures may be used to calibrate the compression meter: 0 ma., 10 db.; 1 ma., 8 db.; 2 ma., 6 db.; 3 ma., 4 db.; 4 ma., 3 db.; 5 ma., 2 db.; 6 ma., 1 db.; 7 ma., 0 db.

The unit is constructed on a 12x17x2 inch steel chassis base. The panel is a standard 8 $\frac{3}{4}$ inch rack panel.

The parts layout was made with the purpose of placing the mike preamplifiers as far from the output transformer as possible. It is desirable to shield the plate and grid leads in the mixer and preamplifier stages. This tends to reduce the noise level, and if one has the time and patience to shield the wires and ground the shield, the result will be an extremely stable amplifier with a very low noise level. The measured noise level on the amplifier shown is minus 50 decibels below 5 watts output at 1000 cycles-per-second.

A symmetrical layout was attempted insofar as was practical. The most critical stage is the 6SN7 compressor stage and its associated variable resistance tube (also 6SN7). It is desirable to shield all plate and grid leads in this stage and keep same as short as possible. The lead from the variable resistance tube to the meter should be shielded and the shield well grounded. This stage should be watched for possible oscillation with minimum feedback which may not appear with maximum feedback. In this event, try reversing the transformer leads, as this may phase the transformers properly to stop oscillation. If not, the transformers, either or both input and output, might have to be oriented differently. The transformers in the photograph are oriented for minimum pickup; the input transformer for the stage is the critical one. If desired a *Stancor* A-4772 transformer can be used here. However, since

Our 26th Year



Quality - Price - Dependability

SELSYN MOTORS



115 Volt AC 60 cycles. Transmitters only. Can be used to turn small beam antenna or as indicators only. 3 1/2" Diameter x 5 1/2" High. Shipping Weight 10 lbs. Per Pair. Special Per Pair —

\$5.95



Selsyn Type 2J1G1 and 2J1H1. 57.5 Volts AC, 400 cycle. Make excellent beam indicators when used on 6 to 12 Volts AC, 60 cycles. **95c**

A Real Buy at Each.....

POWERSTAT VARIABLE TRANSFORMERS

- Type 20: 115 V. input, 0-135 V. output @ 3.0 amps. 0.4 KVA. **\$12.50**
- Type 116: mounted; 115 V. input, 0-135 V. output @ 7.5 amps. 1.0 KVA. **23.00**
- Type 116U: unmounted; 115 V. input, 0-135 V. output @ 7.5 amps. 1.0 KVA. **19.00**
- Type 1126: 115 V. input, 0-135 V. output @ 15.0 amps. 2.0 KVA. **46.00**
- Type 1226: 230 V. input, taped at 115 V. 0-270 V. output @ 9.0 amps. 2.4 KVA. **46.00**
- Type 1156: 115 V. input, 0-135 V. output @ 45.0 amps. 6.1 KVA. **118.00**

WIRE WOUND POTENTIOMETER

100,000 ohm, precision made. G.R. type, 25 watt, 6" diameter. Brand New **\$1.95**



FILAMENT TRANSFORMERS

- 2.5 Volt @ 5 Amps. 7500 Volt RMS. **\$2.10**
- 2.5 Volt @ 10 Amps. 7500 Volt RMS. **2.40**

WIRE

- No. 10, Copper Enamel, 100 Ft. Lengths. Each **\$1.75**
- No. 12, Copper Enamel, 100 Ft. Lengths. Each **1.25**
- No. 14, Copper Enamel, 100 Ft. Lengths. Each **.83**
- 300 Ohm, Twin Lead Plastic covered, per 100 Ft. **1.95**
- RG-59U, 72 Ohm Coaxial Cable. 7¢ per Ft., per 100 Ft. **6.75**

CORNELL-DUBILIER CONDENSERS

Oil Filled 2 Mfd.—10,000 Volt D.C. Pfd. 1001-23. Height 1 1/2", width 1 1/4", depth 3/4". Connecting insulators are 3 inch high. 2 inch in diameter. Net weight 36 lbs. New. If you can use them rush your order, they wont last long at this special **\$13.95** price of

INSULATOR

Porcelain Beehive type stand off insulator. Type 4451-J, stands 4 1/2" high, with 2 1/4" square metal base for mounting, with jumbo banana jack in top.

Each 24c; 10 for \$2

NATIONAL COMPANY COMPONENTS

Direct Calibration Dials—5:1 Drive Ratio

- ACN— 7 1/4" W. x 5" H. **\$3.00**
- ICN— 7 1/4" W. x 5" H. with illuminated scale **6.00**
- SCN— 6 1/4" W. x 4-7/16" H. **3.00**
- MCN— 3 3/4" W. x 2 1/4" H. **2.70**
- NPW0 Gear Drive 20:1 Ratio: Shaft perpendicular to panel with Micrometer Dial **7.20**
- PW0 Gear Drive 20:1 Ratio: Shaft parallel to panel with Micrometer Dial. **9.00**

We Carry a Complete Line of National Parts and Receivers

RELAYS

G.E.; 2500 Ohm, 4 Ma SPDT, 5 prong plug in type, hermetically sealed. Brand New **95c**



Multiple Contact

telephone type

relays high resistance. Extra special **49c**

CS Differential

Dual coil with amature pivoted between calls. All contacts normally open. Operates 220-250 Volts; 8000 Ohms each coil; contacts S.P.D.T. Controls rated 2 amps. at 110 VAC. Ideally suited for balanced or bridge type circuits where limited current or power is available. Will withstand 12 G Vibration up to 60 cycles at 35,000 feet altitude. Special low price **95c**



5B1P1 CATHODE RAY TUBES

5" Green Screen in original Cartons. Each **95c**

METERS

- 100 amp—6 volt D.C., 3" scale, 4 1/2" square, Grey finish, supplied with 100 amp. shunt. Brand New Each **\$2.95**
- 0-100 Ma 2" Rnd McClintock **1.95**
- 0-1 amp. RF 2" Round G.E. **2.45**
- 5-0-5 amp. Charge & Discharge 2" Round **.69**

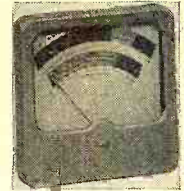

DYNAMOTOR — 5047-D.C.

Input 27 volts @ 1.75 amps. Output 285 volts @ 0.75 amps. continuous duty rating. Brand New **95c**

DM — 43A DYNAMOTOR

Manufactured by G.E. New. Input 24 V. @ 23 amps. 7500 RPM; output 515/1030 2/3 V. @ 215/260 milliamps; filtered. Special **\$2.95**



VARIABLE CONDENSER

6 Gang; 1 section of .00025 Mmfd, 4 sections .000035 Mmfd, 1 section of .00005 Mmfd; with 5 air trimmers of 15 to 25 Mmfd capacity. This condenser is all silver plated. Each, only..... **95c**

COAXIAL Cable Connector

PL-259 low loss connector for RG-8/U and RG-11/U silver plated with low loss mica inserts. Each 19¢ — 100 for..... **\$15.00**

PLATE TRANSFORMER

For Small Transmitters. DC Voltage Ratings are Approx. Values Obtained at Output of a 2 Section Choke Input Filter, Using Mercury Vapor Rectifier Tubes. Pri. is for 115V. 60 cy.

Type No.	Sec. Rms. Volts	Sec. DC Volts	DC Sec. M.A.	Dimensions			Price
				H.	W.	D.	
P 57	{ 660-660 } † { 550-550 }	{ 500 } { 400 }	250	4 3/8"	3-13/16"	4 3/8"	Each \$ 5.55
P 58	{ 1080-1080 } { 500-500 }	{ 1000* } { 400 }	125 150	4 3/8"	3-13/16"	5"	Each 7.20
P 59	{ 900-900 } { 800-800 }	{ 750 } { 600 }	225	4 3/8"	3-13/16"	5 1/8"	Each 6.00
P 67	{ 1450-1450 } { 1175-1175 }	{ 1200 } { 1000 }	300	5 3/8"	6 1/8"	4"	Each 17.85

*For dual operation with simultaneous use of both sec. ratings. †Has 40-volt bias tap.

If not rated 25% with order, balance C.O.D. All prices F.O.B. our warehouse New York. No order under \$2.00. We ship to any part of the globe.

LEEDS RADIO CO.

Dept. RN7

75 VESEY STREET

Corlandt 7-2612 New York City 7

H&H Wire Wound Rheostat

150 watts, 5.0 Ohms @ 5.48 amps, in approx 67 steps. Resistance Wire Wound toroidally around refractory core and embedded in vitreous enamel, 4" diameter. Depth behind panel 1 3/4". Makes excellent control for Toy Trains. A Buy at **\$1.95**



YOU'VE TRIED THE REST — NOW TRY THE BEST



10 WATT MERCURY HI FI AMPLIFIER

The H F 10 Amplifier is a general-purpose amplifier (only 6" x 8" x 6") designed for highest quality reproduction of sound, music and speech. It is engineered and manufactured to meet the highest quality standards required when used in conjunction with the new High Fidelity Pickups, FM, AM, Tuners and Mikes.

- 10 Watts undistorted 17 Watt peak.
- Inputs for new low level pick-ups, tuners and mikes.
- Selector switch for rapid changeover to input circuits.
- Hum level—below audibility (85 db. below 10 watts).
- Separate base and treble controls.
- Treble . . . from plus 7 db. to minus 12 db. at 15000 CPS.
- Base . . . from plus 11 db. to minus 4 db. at 40 CPS.
- 4, 8, 16 and 500 ohm output.
- Hermetically sealed components used throughout.

Complete with tubes and cover. **\$26.46**

FM & AM RADIO CHASSIS MODEL T5

9 tubes including rectifier, Super-Het Am-FM radio receiver designed to operate on 105/125V AC, 50/60 cycles. Power consumption approximately 75 watts. Contains the following tubes: 2 6BA6, 2 6AU6, 12AT7, 6BE6, 6T8, 6K6, 5Y3GT. 10" Auditorium type Dynamic Speaker provides the tonal balance for the finest recordings and symphonic music. Advanced FM and "Tonalizer" circuit for a new standard of quality and reception. On-Off and Automatic volume control; Band selector and phono switch; Tuning control. Built-in "FM-Tenna" — specially designed FM Di-Pole antenna for excellent FM reception. Complete with tubes. **\$69.95**

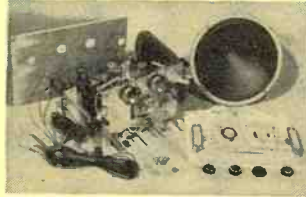

G.E. VARIABLE RELUCTANCE CARTRIDGE



A wonderful new magnetic cartridge that provides excellent high fidelity reproduction. Practically eliminates needle noise. Fits almost any pickup. Requires preamplifier. List Each **\$4.67**

Net, Each **\$7.95**

PREAMPLIFIER FOR G.E. VARIABLE RELUCTANCE CARTRIDGE

3" x 3" x 4 1/2". Increases output and equalizes cartridge for flat response. Attaches easily. Complete with tube and diagram. Made for following models: 1 - General Electric; 2 - Clarkstan; 3 - Pickering; 4 - Lear. Order by number. List, Each **\$9.00** Net, Each **\$4.82**

NEW HERMES HI FI PHONO OSCILLATOR



With built in preamplifier for low level magneto or reluctance type cartridges. Will also use regular cartridges. Covers entire broadcast band. Complete with tubes. **\$7.35**

"ULTRA MIKE" WIRELESS MICROPHONE

Light — Economical operation. Completely self contained. No connections to power lines. Complete with batteries, tubes, etc. Retail at **\$18.00**
Your price, Each **\$6.63**



RECORD PLAYER CASE

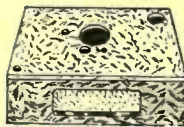

Simulated Leather Cover. 11"x13"x5". All holes punched. A real buy Each **\$9c**

Write for our new, FREE 1948 Catalog Terms: 25% Deposit with order Balance C.O.D. F.O.B. Chicago.

Mort's Radio Shack

630 W. RANDOLPH STREET

CHICAGO 6, ILL.

this transformer is not shielded, it will definitely have to be oriented properly. Therefore, it is advisable to leave the leads long and rotate the transformer until no oscillation is possible and hum pickup is minimum before drilling and mounting the part. The best procedure in wiring is to assemble and wire the output stage first. Then, when completed, apply voltages to the stage and check for oscillation. Reversing the plate leads will stop the oscillation, since it will be due to the lack of data available as to the start and stop of the windings. The oscillation should be located by using an a.c. voltmeter across the output winding which should be loaded with the proper resistor depending on the type output transformer employed.

Proceeding back from this stage, stage-by-stage, will save time in the long run. Watch for oscillation beyond audibility. This can be located with an a.c. voltmeter and is easily stopped by reversing transformer leads or rotating the transformer.

When the unit is wired, the bias on the final stage should be adjusted and the plate voltages on all stages checked.

It is possible to set the threshold of compression at any point desired by effectively tapping the grid of the 6R7 down on R_{18} and R_{19} . However, the input to the 6F8 in the compression range should be checked in order not to overdrive it with maximum setting of the output control. If desired, a variable pot could be installed in place of R_{19} . The values of R_{18} and R_{19} shown will give the maximum possible input to the 6F8 under full compression, without overdriving it. With this arrangement properly set, it is impossible to overdrive the 6F8 and 2A3 stages. The compression level can be set lower with a reduction in available power output. The arrangement shown will permit approximately 13 watts output with negligible distortion.

-30-

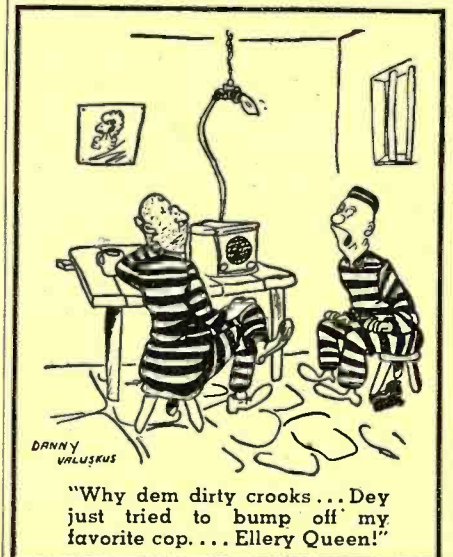

DANNY VELUSKY

"Why dem dirty crooks... Dey just tried to bump off my favorite cop... Ellery Queen!"

RADIO NEWS

RADIO MEN
WRITE FOR
BARGAIN CATALOG OF RADIO PARTS
BUYERS SYNDICATE
30 TAYLOR STREET, SPRINGFIELD 3, MASS.

RADIO COURSES
Preparatory, Broadcast, Marine Operating, Servicing, Aeronautical, Television, Frequency Modulation, Radar.
Classes forming for fall term Oct. 1. Entrance examination Sept. 20.
Veteran Training. Literature.
COMMERCIAL RADIO INSTITUTE
(Founded 1920)
38 W. Biddle St. Baltimore 1, Md.

Television on Wheels
(Continued from page 47)

of the other three units of the chain. This view was taken through the rear door of the showroom. Beneath the table is located the low voltage power supply. The bracket at the lower right normally holds this unit in position. However, removal of two screws permits the power supply to be rolled out for servicing. Above the power supply at the right is a sync generator and the camera control unit is located immediately to the left of the latter. These three pieces remain in this position both when the showroom is traveling and when the exhibition is in progress. The camera, microphone, and accessories are stored within the vehicle during transit.

Fig. 2 illustrates the front room with all equipment stored for traveling. The large cable in the foreground is used to couple the camera to the low voltage power supply and camera control unit in the bus thus permitting operation of the camera up to a distance of 250 ft. from the vehicle. This cable is coiled on a large reel having a vertical spindle. This permits the cable to be unrolled without having to carry the heavy reel around. At the left center is shown the camera head strapped in position for transit. As shown in the photograph, two comfortable chairs are provided for operating personnel in addition to the driver. During operation, one of these chairs is moved to the operating position before the camera control unit.

20-Inch Custom Receiver

Referring again to Fig. 4 the *Du Mont* custom receiver can be seen in the recess near the center of the photograph. The control panel is at the top just behind the cathode-ray oscilloscope with the sweep circuits and power supply beneath it. At the top of the photograph, the rear part of the 20-inch tube housing is shown.

Remote Set-Up

Fig. 3 illustrates a remote setup such as might be arranged in a store, theater lobby, or similar public place. For this type of demonstration, the front room of the showroom is employed to carry the receivers, stands, and auxiliary equipment. Such a receiver and stand is shown in the center of the photograph. In a larger room up to four of these units can be placed at appropriate spots. The camera is shown being operated at the right of the photo and the subject-audience at the left, seated before the microphone. At the time this photograph was taken, the operation was as follows:

The subject is viewed through the electronic viewfinder, the image orthicon converts the received image to a
July, 1948

Revolutionary Record Reproduction!



With This



High Fidelity
Variable Reluctance

Magnetic Phono Pick-up

"Knee-Action" Steps Over Surface Noise

PICK-UP PROFIT FOR SERVICEMEN . . . Daily service calls turn into profitable sales with this new LEAR magnetic phonograph pick-up. Profit for you and new improved revolutionary record reproduction for your customers. Its flawless performance has set a new standard for pick-up quality . . . actually transforms old style record reproduction into full rich mellow tones.

In this variable reluctance pick-up, LEAR engineering has developed the "knee action" permanent sapphire stylus which assures minimum surface noise and full tonal beauty of sound on all installations.

Turn this fast selling LEAR magnetic phonograph pick-up into profit for you. Don't wait! Write today for complete discount price list.

**To Complete Your LEAR Sound Installation
LEAR PRE-AMPLIFIER, List Price — \$9.90**

The new improved LEAR pre-amplifier provides additional amplification when used with MP-103 LEAR magnetic pick-up. Can be connected directly to old crystal cartridge input. Leads of convenient length are provided for connection into existing equipment. Two position switch permits High fidelity response to recordings.

FACTORY REPRESENTATIVES — DISTRIBUTORS: A few choice territories are still available for these and other fine LEAR electronic products. Write today giving full details.

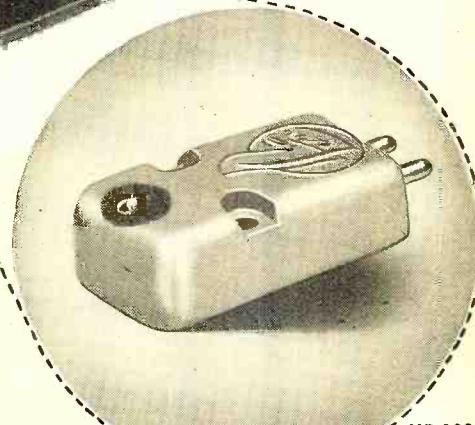

MP-103

List Price
\$12.00



A-172



110 Ionia Ave. N. W.

Grand Rapids 2, Mich.

LOOK AT THESE SENSATIONAL VALUES IN PORTABLES . . .



G 411 — NEWEST PERSONAL PORTABLE

- 4 tubes, self powered
- Uses standard flashlight cell and 67½ v battery
- Tunes entire broadcast band
- Super heterodyne circuit
- Built in loop antenna
- Ivory carrying handle
- Available in deluxe finish

LIST \$14.95

(Deluxe slightly higher)

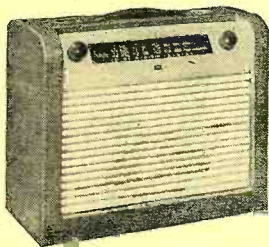

G 612 — TEMPLE AC, DC, BATTERY

- Completely self contained
- Six tubes — Auto. Vol. Control
- Full vision slide rule dial
- Uses longer life batteries

We Carry Temple, Minerva and DeWald Radio & Television

New! TEMPLE 3 WAY PERSONAL PORTABLE

AC, DC, Battery operated

List Less Battery

\$24.95

- 4 tubes plus rectifier
- Full 4" speaker
- Weight 5 lbs. incl. batteries
- New superhet circuit
- Choice of finishes from \$24.95 to \$29.95
- 8" high, 4½" wide 4¼" deep



WRITE FOR
COMPLETE TUBE
AND PARTS LIST

**LIST \$49.95
NET \$21.95**

PARTS SPECIALS FOR THIS MONTH ONLY

TUBES — all new, perfect. No cathode shorts. Guaranteed for three months
1R5, 1V, 1U4, 3V4, 6F6GT, 6G5GT, 6BA6, 6BE6, 6BD6, 6AT6, 7X7, 12BA6, 12BE6, 12J5GT, 12J7GT, 12SJ7GT, 12Q7GT, 26, 27, 35W4, 35L6GT, 50L6GT
43c each
1C7G, 1H4G, 1J6G, 32, 34 Standard Brands 89c each

(NO TUBE OR PART ORDERS FOR LESS THAN \$10 ACCEPTED)

ENCLOSE 20% DEPOSIT WITH ALL COD ORDERS

STANDARD BRAND CONDENSERS
.002, .003, .01, .02 at 600 volts \$6.25 per 100

40-40 MFD at 150 volts 49c ea. 10 for \$4.50

.25 meg, .5 meg, 1 meg Volume controls 39c ea. 10 for \$3.50

4 inch PM speaker 1 oz Alnico 5 magnet \$1.29 ea. 10 for \$12.50

5 inch PM speaker 1 oz Alnico 5 magnet \$1.39 ea. 10 for \$13.50

RAD — EL — CO TV Antenna

54-88 Mc band \$5.97 ea.



Fig. 4. Rear right interior view shows camera control equipment and synchronizing generator on table; camera low voltage supply is shown beneath table.

video signal, this signal being transmitted to the showroom outside the building via the 300 ft. camera chain cable. At this point the blanking and synchronizing information is incorporated into the video signal and the operator observes the composite video signal and the reproduced picture on the camera control unit (see Fig. 4). Manipulation of the various controls on this unit provides proper sync level, focus, beam current, target voltage, pedestal level, and video gain for the picture being delivered from the camera chain. Additional controls permit the operator to adjust his own picture and signal monitors for optimum operation. The composite video signal is fed to the distribution amplifier and after amplification, through coaxial cable back to the receiver shown in the photo. It should be noted that the distribution amplifier is equipped with eight outputs, four of which provide a sync negative signal and four, a sync positive signal. This permits operation of a picture monitor receiving either positive or negative input.

Television Antenna

The antenna used for picking up signals from neighboring television stations is the *Du Mont* type 72 duo-band receiving antenna. The supporting mast is hinged at the rear of the bus using an offset hinge so that it is in stable equilibrium when either in a vertical or horizontal position. As an additional precaution, clamps are provided at these two extreme positions. The mast is enclosed in a sleeve approximately four feet long at the hinge. A hand wheel is secured to the lower end of the mast to permit orientation of the antenna. With the mast in a vertical position, a normally closed switch

RADIO NEWS

WARREN DISTRIBUTORS 3145 WASHINGTON ST. JAMAICA PLAIN 30, MASS.

FOR BEST FM PERFORMANCE TROUGH-LINE FRONT END Tuned RF Amp.—Mixer—Oscillator

- High Gain
- Image Rejection 100 to 1
- Low Noise Factor
- A Quality Product
- Tunes from 75 to 120 MC

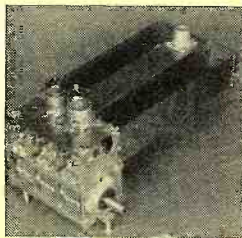

For use with any IF amp. Operating between 3 - 12 MC

Unwired.....\$15.95 Wired.....\$18.95

WARDELL SMITH
65 Glenwood Rd. Upper Montclair, N. J.

WALKIE-TALKIES

Operate on 28 to 52 mc., up to 25 miles in open country. Transmitter and receiver with regular hand set. Each unit comes complete, ready to operate. \$45.00 F.O.B., Chicago. Additional Battery \$4.75 each.

HARRIS SUPPLY CO.

1336 Chase Ave. Chicago 26, Illinois

RADIO COURSES

- RADIO OPERATING • CODE
- RADIO SERVICING
- F. M. TELEVISION
- REFRIGERATION SERVICING

Write for Catalog and Picture Brochure Personal Counseling Service for Veterans
Y.M.C.A. TRADE & TECHNICAL SCHOOLS
15 W. 63rd St. (Nr. B'way) New York City

TERRIFIC BARGAINS TERRIFIC WAR SURPLUS MATERIAL

S.O.S. DISTRESS SIGNALLING EQUIPMENT



Transmitter BC 578 which automatically emits S.O.S. signal which can be heard 500 miles, complete with tubes, 300' reel copper wire. Generator (hand driven),

Lights—handles, etc. **\$9.95**

Parachute 72 sq. ft. orange nylon material, 192 ft. white nylon braid 3/16 in. 15 ft. of 11/4 in. webbing—3 safety buckles, etc.\$4.95
 Balloon, rubber ... inflates to 4' Diam. 1.95
 Hydrogen Generator95
 Inflating tube25
 Knapsack, 3 cu. ft. Water & Moisture repellent95
 Box Kite, collapsible, 17 in. sq. x 34 in. high 1.49
 Reel of braided copper antenna wire (300') 1.49
 Save \$3.03 ... Take Everything for ... **\$18.95**

RADIO COMPASS RECEIVER R/5ARN-7 or BC 433
 Just a few hundred left. No tubes. Parts worth hundred of dollars ... Your price.....**\$6.95**

ANTENNA

Type AS-89/ART ... Adaptable for 37-50M. C. Ideal for U.H.F. work, "Sterba Array", and High Angle Radiation systems. Coaxial cable in base ... Brand New ... Value of \$35 for only **\$2.45**

Snap Out Whip Antenna AN-131/A—Half Wave 40-80CMC. Excellent for mobile or fixed station. 125" fully extended and only 13" collapsed. Can also be used as fishing pole. Costs \$15 ... Your price, brand new **\$1.49**

BC357 RECEIVER complete with tubes, highly sensitive relay. Operates on 4/10 mil. can be converted to 2 1/2 to 6 and 10 meter receiver.....Price**\$3.50**

RADIO RECEIVER BC-1023A CQ

Ultra High Frequency covering 62 to 80 mc range. An extremely sensitive relay, works on 4/10 of mil. Contains 4 tubes—12SH7—65Q7—65C7—6U6TG. Brand New



\$3.50

BC-456B MODULATOR UNIT complete with tubes, 3 relays; parts worth more than our low price of...**\$3.50**

Microphone 3 circuit plunger type switch; 2 1/2" long diameter; push button make and break, press to signal. Screw type, can be used with or without case. Good for interoffice buzzer, closet lights, doorbells, phonograph recorder. Can be mounted or used by hand. Each ... **20c**



100 lots 15c each
 Rated at 110V 3 AMPS

HEADSETS

P19-24,000 Ohm Impedance, receivers and 2 rubber cushions, 8' cord, PL 55, Special \$1.89; HS 23 8,000 Ohm Impedance PL54 \$7.99; HS 33 600 Ohm Impedance PL354

\$7.99



Receivers R 14 Telephone, high Impedance, light weight watch case type, double magnet, black bakelite cap **.25**

Telephone Microphone Kellogg PBX T28 with 10' cord & plug-swivel bracket.....**\$3.95**

BC 733 D LOCALIZER ... Receiver 108-120MC ... Operates on any of its crystal freq. Buy it for parts. Costs hundreds of dollars ... Your Price.....**\$5.95**

T-28/ABT-1—12 Tube UHF Trans. Freq. Range 93 to 212 Mc. Includes 2-21 V.D.C. Blowers. Power output varies from 7 to 22.1 watts. Tubes: 2/832 2/5R4GY 1/6V6 3/6AC7 1/931A 1/6X5 2/6C4 Fifty on hand **\$18.95**

T-9/APQ-2 UHF Trans. Freq. Range 200 to 250MC. Tubes 2/807 3/6AC7 1/931 2/388A 80/115 V 400-2600 cycles ... New**\$29.95**

TRANSFORMER and cord assembly for matching low impedance headsets to high impedance output circuit, 6" cord, PL 540 plug. Brand New**25c**

G. E. 50 WATT ceramic tube sockets: for 211-838, 250T.H. and other type tubes. New, each.....**35c**

POWER UNIT ASSEMBLY COMPLETE POWER PLANT

Includes gear case and gear train, governor for gear train assembly which operates generator. 6 1/8" long x 5 1/2" wide x 6" deep. Unit consists of gear train, 2-28v bulbs, A28 relay, A-8 MFD Condenser. This unit can be used as a portable power unit for receiver—transmitter, etc. Voltage supply ... 28VDC at .175 amps, and 300VDC at .040 amps. Motor 5000 RPM, also has keyer for automatic transmission. Real Bargain at **\$4.50**

FIELD TELEPHONE RM-29 with handset generator, ringer &c., in strong steel case.**\$12.95**

RECEIVER AN/CRW2 high freq., 6 tubes and 2 sensitive relays. Can be used for controlling purposes. Complete with tubes & dynamotor. New**\$5.50**

RECEIVER AN/CRW 2A high freq.; 5 tubes and 3 sensitive relays. Used for controlling purposes. Complete with tubes & dynamotor. New**\$5.50**

RADIO ALTIMETER—Transmitter Receiver RT/APN1—complete with 14 tubes; 418 to 456 meg. 27v dynamotor. Certified by CAA; cost Govt. \$2,000. Bargain**\$9.95**

BC-906—Frequency meter absorption type, mfg. by Philco. Battery operated. Frequency 14.5-23.5M harmonics go into high frequency spectrum coaxial tank. Complete with tube, chart, antenna meter 500 amps. **\$14.95**

Signal generator long lines contains 955 acorn oscillator, tubes 400-450 MC approx. Range can be converted to receiver for citizen band. Complete with carrying case, canvas bag E compartment for batteries. Schematic included.**\$9.95**

BC 1066B RECEIVER—Tunes to approx. 400-450 MC range complete with 2 oscillators. 955 acorn 1P8GT audio. Can be converted to transmitter-receiver for citizen band, room for batteries. Complete with tubes & carrying case, schematic included**\$12.95**

HANDETS TS 13, TS 15—Both these handsets 200 OHM carbon mike, 2000 OHM earphone, 6 ft. rubber cord, 2 plugs PL 55, PL 68. Price. \$2.25 ea.

TS 9 Magnetic phone 1000 OHM Impedance, single carbon mike rated at 200 OHM, 6 ft. rubber covered cable. Brand new**\$2.50**

Motor Driven GEAR BOX; two 24v DC shunt wound motors; can be used as low voltage AC motor from 3 2 1/2 24v input; complete with micro switch, 50 gears and control box, Brand new**\$3.50**
 2 motors will operate directly from 110V. AC for short periods without overheating making them useful in coin operating devices.

TBX2-5-6 Navy model transmitter receiver. Versatile because of freq. range of 2 Mc to 4.5 Mc for transmitter and 2 Mc to 8 Mc for receiver. It's adaptable for various types of power supplies, such as 6r-12v-24v dynamotor and 110v AC powerpacks. This unit is excellent for ship to shore and ship to ship communication. Range 30 miles CW and 15 miles phone. Complete with tubes and crystals**\$29.95**

THIGH CLAMP TRANSMITTING KEY

Limited quantity. General purpose transmitting key—heavy die-case metal base; all mounted on a swinging bracket thigh clamp. Key can be removed by unscrewing from clamp, 1/8" silver contacts, Well insulated. Adjustable bearings. Supplied with 5-foot cable and plug P1-55 Shpg. wt. 4 lbs. Brand New**65c**

All Merchandise is War Surplus and is Sold as used unless otherwise specified.

Write for Quantity Discounts

Prompt Delivery—Write Dept. RNJ
 25% Deposit Required on C.O.D. Orders
 Shipped F.O.B. New York Minimum Order \$2.00

Battery Charging control panel. Army type BD-LT-61 ... can be arranged for charging 1-3 batteries **\$25.00**

R 4/arr 2 Receiver & Dynamotor ... Parts alone are worth much more than our price ... Like New **\$7.95**

Receiver R 57/ARN6 330 340MG ... 24-28 Volts DC Crystal Controlled ... Never used**\$19.50**

Test Oscillator I-225 ... Freq. range 150-225 Mc. Can easily be modified for 60 cycle operation ... New**\$25.00**

BC-221 Freq. Meter ... Covers 125-20,000 Ke. Battery operated. Beautiful equipment ... never used **\$33.50**

Inverters ... ATR-2SB Type 110 ... input 115 VDC & 1.1 Amps ... out 115 VAC 150 W Cont. 250 W intermittent**\$12.95**

Converters Electronic 110 VDC to 110 VAC ... 250 W **\$12.95**

Magnetic Microphone T-44C ... Used with SCR-522 magnetic type complete with K 26 and PL 179 plug. Instructions Incl. Brand New**\$.95**

Mackay Receiver 128A ... 4 Bands ... 15Kc—650 Kc ... never used**\$5.00**

RBL 3 Receiver ... 15Kc-600Kc...Never used **\$50.00**

Auto Alarms AR 8601 and Alarm Signal Keyer AR 8651. Mfg. by Radio Marine Corp.....**\$125.00** each

Tuning Units for BC 375-191.....**\$249.00** each

Tube Kits For ... BC 433 ... R5/ARN7 ... R53/ARN7 ... RT7/APN1 ... BC7333 ... Complete Set **\$10.00**

Mining Machine Cable ... 3/4" diam. ... single conductor 7 strand No. 10 gage..... **\$55.00 MI**

Flare Guns ... with 3 flares ... for distress signalling purposes New**\$19.50**

RT 7/APN 1 Altimeter Transceiver ... complete with 14 tubes Only**\$7.95**

Portable Electric Megaphone ... Trigger operated Unit 1 ... Megaphone assembly weight 4 1/2 lbs. ... Unit 2 ... Compact Amplifier, set weight 8 lbs. Complete with batteries**\$37.50**

Jensen or Taybren 12 inch speaker high fidelity volume control pad for voice coil silencing 600 OHM input. Encased in metal housing.....**\$7.95**

Throat mike brand new with PL 291 instructions **19c**

Lip mike with PL 291 instructions. Brand New **19c**

FULL WAVE BRIDGE TYPE SELENIUM RECTIFIERS. Type P.C. 10 18 to 23 Volts Input (A.C.). Output 12 to 14 Bolts D.C. at one ampere. Our Price**\$1.00** each

G.E. 50 Watt Ceramic tube socket for 211-838-250 T.H. and other tubes. Brand New**35c**

Field telephone WE and Kellogg. Used but good. Complete with singer-operator, Handset—carrying case**\$9.95**

Taybren portable lifeboat radio transmitter includes Antenna and instructions. Cost Govt. \$195 ... Price **\$12.95**

Mackay Automatic SOS lifeboat transmitter. Built in suitcase type 168D includes antenna and instructions. Cost Govt. \$225.00 Price **\$15.95**

EDWARDS SINGLE STROKE (Solenoid type) SINGLE TONE CHIME—Has 4" Resonating Chamber. Mechanically Sturdy, designed for indoor and outdoor use. Brand new in original packing. Operates on A.C. or D.C. 110/115 Volts OUR BARGAIN PRICE**\$2.50**

HANDMIKE T-178— 200ohm, single button carbon mike, push button switch. Ideal for home transmitter or portable rig; 5 ft. rubber cord. PL-68 plug and dust cover. Brand New **59c**



TOM A LEN CO. 564 ATLANTIC AVENUE BROOKLYN 17, N. Y. — TR 5-8241

TELEMARINE'S SELECTED ELECTRONIC SURPLUS



5-Meter Walkie-Talkie

Model BC-322 Transceiver—simple, popular communications unit. Freq range 52-65 mc. Uses only two tubes, types 33 and 30. Includes a 5 MC crystal in a crystal callibrator circuit. Range 5 to 50 miles, depending upon location and altitude. Operates from single battery block (not supplied) available from mfr., or other sources. Supplied with handset, less antenna, battery. Excellent condition.

PRICE, EACH \$20.95

SCR-536 HANDY-TALKIES



We have just a few of these popular Handy-Talkies, and they won't last long. All are in very excellent condition, and complete with crystals (receiving and transmitting) and batteries. All are in top operating condition, and preset at various operating frequencies ranging from 3.5 to 6.0 mc. Some available for operation in 80 meter ham band. We will supply units with matched frequencies as long as quantity permits. First come, first served!

PRICE, EACH \$50.00
Extra Set Batteries (A&B)..... \$3.00



FREQUENCY METER TS-69/AP

Frequency range 400 mc to 1,000 mc, continuous. Ideal for labs, schools, or for hams experimenting with eqpt. for civilian phone band. Black-crackle finished metal case, dim: 6"x8"x2 1/2", contains variable length coax resonating cavity with crystal rectifiers and 0-200 microammeter. Veeder-Root counter and calibration charts insure extreme precision. Telescopic antenna, and coax line probe, with metal carrying case for entire equipment. New equipment.

COMPLETE, EACH \$42.50



32 VDC 110 AC CONVERTER

Mfd. by Kato Engineering, for marine or farm installation. Rotary type, compact and ruggedly built for continuous duty. Rubber shock mounting on filter case, with complete input and output filtering. Output-110 volts, 60 cycles AC, .225 KVA, but, will operate efficiently on loads up to 300 watts. New units only.

PRICE, EACH \$39.95
Quantities, 10 or more, Each... \$34.95

All Prices F.O.B. N.Y.C.

All Material Offered Subject to Prior Sale

Prices Quoted Supersede Previous Advertised Prices, and Effective Until Next Issue Only. Quantity Buyers Write For Complete Listing

TELEMARINE COMMUNICATIONS COMPANY

Phone—Watkins 4-7021 /

533 W. 24th St., N. Y. 11, N. Y.

causes a red light to appear on the dash board and another in the rear compartment of the showroom. Lowering and latching the mast in its horizontal position causes this switch to open, the absence of the red light indicating that the vehicle may be moved.

Preliminary Tour

During the first two weeks in February, the showroom was shown in several small Pennsylvania and Ohio cities. The general nature of these demonstrations was as follows:

The vehicle was parked outside a local theater with the camera and four table model receivers strategically placed in the theater lobby. This permitted the persons entering the theater to see themselves on the several receivers or to observe the lobby activity at any one of the receivers. The trick of showing people their own faces on a television receiver still proves to be an excellent interest creating stunt. Most of these people had never seen television of any kind and the tour was extremely successful in arousing enthusiasm. In addition to the theater demonstrations, receivers were set up in prominent show windows. These demonstrations also were highly successful in attracting the public.

-30-

International Short-Wave

(Continued from page 60)

speakers are scientists and noted agronomists as well as collective farmers who have raised large crops.

Amateur art looms large in local programs. One can often hear Tchaikovsky's music rendered by collective farmers or workers, members of amateur music circles.

Listeners maintain close contact with the local studios which arrange special all-request programs and regularly carry answers to listeners' inquiries.

The content of local programs—as well as of all Soviet broadcasts—is in no way dictated by commercial or advertising interests of various departments, organizations, enterprises, or private persons.

The interests of the people are the guiding principle in Soviet radio broadcasting. The extensive development of local broadcasting reflects the striving of the Soviet State to meet the most diverse interests of the people at large.

Radio programs in English are beamed via short-wave from Radio Moscow to the United States as follows:

Half-hour daily morning programs of news and commentary, from 0745* to

* (Note: Unless otherwise stated, time herein is expressed in American EST on a 24-hour clock basis; add 5 hours for GCT. "News" means in the English language.)

Prepare For A Good Job Now in

RADIO SOUND and TELEVISION

LEARN QUICKLY IN THE GREAT SHOPS OF COYNE

NOT A "HOME STUDY" COURSE

Get ready for a better job, bigger pay NOW in Radio. Cash in with "All-around" knowledge of Radio—Sound—Television. Train on actual equipment not by "Home-study". You learn quickest at COYNE because it's a real SHOP course!

G. I. APPROVED... also Finance Plan for NON-VETERANS. Don't let lack of cash hold you back. Many earn while learning. FREE Employment Service to graduates. Get facts today!

SEND COUPON FOR FREE BOOK

Send at once for Big Free Book on Radio, Sound and Television, and facts about our Finance Plan.

MAIL THIS COUPON TODAY

B.W. COOKE, Pres., Coyne Electrical and Radio School, 500 S. Paulina St., Dept. B8-1K, Chicago 12, Ill. Please send Big FREE Book and complete details.

NAME
STREET
CITY STATE

TUBE SPECIALS
AC-DC five—50L6GT, 35Z5GT, 12SA7, K7, Q1GT, \$1.90
Miniature five—50B5, 35W4, 12AT6, BA6, BE6, \$1.90
TWO JUMBO ASSORTMENTS
40-35Z5, 20-50L6, 10 ea. 35L6, 12SA7, K7, Q7, 100 tubes.
40-35W4, 30-50B5, 10 ea. 12AT6, BA6, BE6, 100 tubes.
Either of the above specials at only \$34.00
Every tube new and perfect. Guaranteed 100%.
Selenium rectifiers 100MA — ten for \$7.20
Postage extra. 20% deposit on C.O.D. orders.
Send for our new bargain list.
HALLMARK ELECTRONIC CORPORATION
592 COMMUNIPAW AVENUE, JERSEY CITY 4, N. J.

WAR SURPLUS AND OTHER BARGAINS

POWER DRIVEN ANTENNA REEL
1/4 HP, G. E. Motor—12.24V. Removable 6" Reel. Cam worm gears, bevel gear. Solenoid clutch. In gear only when current on. Operates clockwise or counter clockwise. Ideal for power fish line, opening or closing doors, auxiliary power take-off. Can be used as buffing machine or for dozen of other uses. New. Weight 6 lbs. \$4.50 each.

MICROMETER
Chrome plated, precision engineered and carefully toolled to give long life
all new. 0-1" capacity, \$2.25. 1-2" capacity, \$3.50 Each.

TRANSFORMER
Jefferson Electric step up or step down transformer. Input, primary 110-117 Volts A.C. Output, from 5 Volts to 650 Volts. Suitable for use with war surplus gadgets, heater relays, radio test filaments, electric trains, house chimes, etc. Weight 10 lbs. New \$7.95 Each
Send check, money order or cash. 25% Deposit required on C. O. D. orders. All prices F. O. B. Culver City, Calif.

AIRBORNE SALES CO., INC. DEPT. RN 7-8 CULVER CITY, CALIF.

VACUUM CAPACITOR \$2.98
50 MMF—5KV
Brand New—



TUNE YOUR BEAM
with an R. F. AMMETER
 Basic 0-3ma. movement. 2 1/2" meter.
Special—\$2.25

1 K.W. POWER SUPPLY KIT

- 2500—O—2500v @ 500 MA
 or
 2000—O—2000v @ 500 MA
 (Oil filled Xformer from BC 610)
 1 Swinging Choke
 1 Smoothing Choke
 1 Filament Xformer
 2—2 Mid.—3000v Condenser
 2—872 A Tubes
 2—Plate Caps for 872A
 2—Sockets for 872A

Special! All Parts New! \$99.50

STEP DOWN TRANSFORMER

PRIMARY 440/220 VOLTS
SECONDARY 230/115 VOLTS . . . \$14.95
.600 KVA

SELENIUM RECTIFIERS

Full Wave Bridge Type

INPUT		OUTPUT		
up to 18v AC	up to 12v DC	1/2 Amp.	\$.98	
up to 18v AC	up to 12v DC	1 Amp.	1.95	
up to 18v AC	up to 12v DC	5 Amp.	4.45	
up to 18v AC	up to 12v DC	10 Amp.	7.45	
up to 18v AC	up to 12v DC	*15 Amp.	9.95	
up to 18v AC	up to 12v DC	*30 Amp.	14.95	
up to 36v AC	up to 28v DC	1 Amp.	3.45	
up to 36v AC	up to 28v DC	5 Amp.	7.45	
up to 36v AC	up to 28v DC	10 Amp.	12.45	
up to 36v AC	up to 28v DC	15 Amp.	18.95	
up to 54v AC	up to 36v DC	.25 Amp.	.98	
up to 54v AC	up to 36v DC	.25 Amp.	2.95	
up to 115v AC	up to 100v DC	6 Amp.	6.95	
up to 115v AC	up to 100v DC	5 Amp.	19.95	
up to 115v AC	up to 100v DC	3 Amp.	12.95	

OIL CONDENSERS

NATIONALLY ADVERTISED BRANDS
 All Ratings, D. C.

2x.1mfd.	600v	\$0.35	1mfd.	2000v	\$0.95
.25mfd.	600v	.35	3mfd.	2000v	2.75
.5mfd.	600v	.35	4mfd.	2000v	3.75
1mfd.	600v	.35	15mfd.	2000v	4.95
2mfd.	600v	.35	2mfd.	2500v	2.49
4mfd.	600v	.60	1mfd.	2500v	1.25
8mfd.	600v	1.10	.25mfd.	2500v	1.45
10mfd.	600v	1.15	.5mfd.	2500v	1.75
3x.1mfd.	1000v	.45	.05mfd.	3000v	1.95
.25mfd.	1000v	.45	1mfd.	3000v	2.25
1mfd.	1000v	.60	.25mfd.	3000v	2.65
2mfd.	1000v	.70	.5mfd.	3000v	2.85
4mfd.	1000v	.90	1mfd.	3000v	3.50
8mfd.	1000v	1.95	12mfd.	3000v	6.95
10mfd.	1000v	2.10	2mfd.	4000v	5.95
15mfd.	1000v	2.25	1mfd.	5000v	4.95
20mfd.	1000v	2.95	.1mfd.	7000v	2.95
24mfd.	1500v	6.95	3mfd.	4000v	6.95
.25mfd.	2000v	1.05	2mfd.	3000v	3.45
.5mfd.	2000v	1.15	2x.1mfd.	7000v	3.25

HIGH CAPACITY CONDENSERS

2x3500 mfd.—25 WVDC	\$3.45
2500 mfd.—3 VDC	.39
2x1250 mfd.—10 VDC	1.25
1000 mfd.—15 WVDC	.99
200 mfd.—35 VDC	.59
100 mfd.—50 WVDC	.49
4x10 mfd.—400VDC	.89

TUBES (Brand New)

Standard Brands		
1N21	\$.039	F-127A
2AP1	2.25	371B
2C40	1.19	450TH
2D21	.89	703A
2V3G	1.25	715B/C
2X2	.69	721A
3AP1	3.00	723A/B
3BP1	2.95	726A/B
3E29	2.95	801
3GP1	3.95	802
5BP4	4.94	803
6CP1	3.95	804
5JP1	11.95	805
5LP1	11.95	806
5R4G	.98	807
5Y3	.39	808
6AB7	1.20	809
6AC7	1.20	810
6AG5	1.20	811
6AG7	.99	812
6AJ5	.99	813
6AK5	.90	814
6AL5	.81	815
6AQ6	.81	29-A-B
6AR6	1.29	832
6B4G	1.20	833A
6C4	.49	836
6C5	.67	837
6D4	.99	838
6F6	.81	861
6J4	3.95	866
6J5	.62	872A
6J6	.89	884
6L6G	1.20	885
6L7	.98	902P1
6N7	.99	954
6SH7	.81	955
6SL7	.91	956
6SN7	.91	957
6SR7	.67	958
7A4/XXL	.81	959
7F7	.99	1005
7L7	.99	1616
10Y	.98	1619
15R	1.50	1622
HK24G	1.75	1624
28D7	.98	1625
30	.81	1626
VR75	.99	8001
VR90	.75	8005
VR105	.75	8011
VR150	.75	8016
100TH	12.95	8025A
100TS	3.00	1654
211	.98	9001
75T	2.95	9002
250TH	17.50	9003
257B	7.95	9004
304TH	9.95	9005
HY615	.89	9006
706CY	22.50	F-128A
717A	.65	

PERMALLOY SHIELDS
 for CATHODE RAY TUBES

3" Shield	\$1.49
5" Shield	1.98

SCR-518 ALTIMETER

Famous SCR 518A Altimeter. Brand new factory cartoned. Worth over \$900.00. Made by RCA. Has 29 tubes. Works in the 500 MC region. This is the complete unit. Transmitter, receiver, power supply and 3" scope indicator. Reads altitude up to 30,000 ft. Operates on 28 volts. D.C. Complete with tubes. 6SK7, 2 8012, 2 6SJ7, 6C8, 6SN7, 6F8, 23D4, 6Y6, 6V6, 10 6AC7, 3 2X2, 954, 955, 956, 6J5, and 3 in. CR tube 1308P. A RED hot scoop at only \$69.50

TRANSFORMER—115 V 60 Cyc.
HI-VOLTAGE INSULATION

3710v @ 10 ma.; 2x2 1/2v @ 3A	\$9.95
2500v @ 15 ma.	6.50
2500v @ 4 ma.; 2 1/2v @ 2A. 6.3v @ 1 amp	7.95
2150v @ 15 ma.	5.50
1750v @ 4 ma.; 6.3v @ 3A	6.50
1600v @ 4 ma.; 700v CT @ 150 ma.; 6.3v @ 9A	7.95
1200v CT @ 400 ma.; 10v CT @ 10A	9.95
550-0-550 @ 150 ma.; 5v @ 3A; 2x6.3v @ 5A CT	7.95
525-0-525v @ 60 ma.; 925v @ 10 ma.; 2x5v @ 3A; 6.3v @ 3.6A; 6.3v @ 2A; 6.3v @ 1A	7.95
500-0-500v @ 25 ma.; 262-0-262v @ 55 ma.; 6.3v @ 1A; 2x5v @ 2A	4.49
500-0-500v @ 100 ma.; 5v CT @ 3A	4.95
400-315-0-100-315v @ 200 ma.; 2.5v @ 2A; 5v @ 3A; 6.3v @ 9A; 6.3v @ 9A	6.50
400-0-400v @ 200 ma.; 5v @ 3A	4.95
350-0-350v @ 150 ma.; 5v @ 3A; 6.3v @ 6A; 78v @ 1A	4.95
350-0-350v @ 45 ma.; 675v @ 5 ma.; 2 1/2v @ 2A; 2x6.3v @ 1A; 6.3v @ 2 1/2A	4.95
350-0-350v @ 80ma.; 6.3v @ .6A; 6.3v @ 3.75A; 2x5v @ 3A	3.98
385-0-385-550v @ 200ma. 2 1/2v @ 2A; 5v @ 3A; 3x6.3v @ 6A—PRI. 110/220	7.95
350-0-350v @ 150 ma.; 5v @ 3A; 6.3v @ 7.5A; 6.3v @ 3A	4.95
350-0-350v @ 35 ma.	1.49
340-0-340v @ 300 ma.; 1540v @ 5 ma.	5.95
335-0-335v @ 60 ma.; 5v @ 3A; 6.3v @ 2A; 0-13-17-21-23v @ 70 ma.—PRI. 110/220	4.95
325-0-325v @ 120 ma.; 10v @ 5A; 5v @ 7A	3.49
300-0-300v @ 65 ma.; 2x5v @ 2A; 6.3v @ 2 1/2A; 6.3v @ 1A	3.49
250-0-250v @ 100 ma.; 2x6.3v @ 4A; 6.3v @ 5A; 6.3v @ 1A	4.95
120-0-120v @ 50 ma.	.98
80-0-80v @ 225 ma.; 5v @ 2A; 5v @ 4A	3.95
24v @ 6A	3.50
13.5v CT @ 3.25A	2.95
3x10.3v @ 7A; CT	9.95
12.6v CT @ 10A; 11v CT @ 6.5A	7.95
6.3v @ 10A; 6.3v @ 1A	3.50
6.3v @ 1A; 2 1/2v @ 2A	3.45
6.3v @ 2 1/2A; 6.3v @ 2A; 2 1/2v @ 2A	5.95
6.3v @ .25A; 6.3v @ 3A; 5v @ 12A; 6.3v CT @ 9A	4.95
5v—190A	17.50
6.3v @ 1A	98
5v—115A	14.95
8v CT 1A	98
6.3v CT @ 3A; 5v CT @ 4A	4.25

TELEGRAPH KEY J37

Fully adjustable, 1/3" silver contacts and 5 ft. rubber cable, with PL-55 plug.
 Brand New 69c each

2 SPEED PLANETARY DRIVE

Fits condenser shaft back of panel, or dial knob shaft. 5 to 1 and 1 to 1 ratios. For any 1/4" shaft.
 Special 79c ea. 2 for \$1.50

FILTER CHOKES

HI-VOLTAGE INSULATION

10 hy @ 400ma	\$4.95	325 hy @ 3ma	.49
8 hy @ 300ma	3.95	1 hy @ 800 ma	14.95
25 hy @ 160ma	3.49	10 hy @ 250ma	2.49
12 hy @ 150 ma	2.25	10 hy @ 200ma	1.98
12 hy @ 100ma	1.39	10/20 @ 85ma	1.59
30 hy @ 70ma	1.39	15 hy @ 125ma	1.49
.05 hy @ 15 amps	7.95	15 hy @ 100ma	1.39
.1 hy @ 5 amps	6.95	3 hy @ 60ma	.29
4 hy @ 600ma	5.95	30 hy Dual @ 20ma	1.49
200 hy @ 10ma	3.49	8/30 hy @ 250ma	3.50
600 hy @ 3ma	3.49	10 hy @ 100ma	1.29

ALL PRICES SUBJECT TO CHANGE WITHOUT NOTICE
All merchandise guaranteed. Mail orders promptly filled.
All prices F.O.B. New York City. Send money order or check.
Shipping charges sent C.O.D. Minimum order \$5.00
20% Deposit required with all orders

ATTENTION!

INDUSTRIALS — LABS — SCHOOLS — AMATEURS

Let us quote on components and equipment that you require. We have too many items to be listed on this page. Place your name on our mailing list now for new catalog.

RADIO HAM SHACK Inc.
63 DEY STREET • NEW YORK 7, N. Y.

0815 on 15.41, 15.39, 15.23, 11.96, 11.88, and 11.87.

A daily evening program—one and one-half hours of news, political commentary, and sidelights on Soviet life features—from 1820 to 1930 on 15.39, 15.31, 15.23, 11.96, 11.88, and 11.87, and from 1930 to 1950 on 15.31 and 11.96.

Typical of the broadcasts to the United States were these items listed for the first two weeks of May: May Day Holiday Programs; weekly news review, sports talk, and replies to letters from listeners; concerts and talks on literature; programs for youth; Soviet press and radio; public health program;

Victory Day Program; economic affairs, and cultural programs.

(NOTE: It is regreted that we have been unable to secure technical details concerning the short-wave services of *Radio Moscow*; if at any time such material is made available to us by *Radio Centre*, it will appear in this department. —K.R.B.)

* * *

New Danish Station

We are indebted to an *ISW* monitor in Denmark, Per Friis, for information on the new, powerful Danish short-wave outlet which by this time should be on regular schedule. Here are highlights translated from an illustrated

article that appeared in the Copenhagen *Nationaltidende* concerning the "new short-wave station which is to broadcast to the Danish people in foreign countries, to sailors on the seas, and to foreign countries."

The transmitter is located at Hertedvester and cost approximately \$600,000 to construct. It is estimated it will cost in the neighborhood of \$100,000 a year to operate and maintain this overseas station and its services. Danish radio owners "will foot the bill" through license revenues, it was explained.

One of the first voices to have been heard at the dedication was that of King Frederiks. Prime Minister Hans Hedtoft was also to take part in the opening ceremonies which were scheduled for April.

The article pointed out that "for listeners at home, this station will not mean a great deal. Its activities are primarily to be directed to the outside world. It is such a big affair that it is a complete organization unit within the Danish radio. It will have *FOUR* different programs and will broadcast 24 hours a day on *FOUR* different frequencies. It is hoped that this station will be heard over great parts of the world. It will beam to North America and Greenland, to South America, to China, Japan, and Australia, as well as to Danish sailors on the high seas."

Purpose of the station was cited as two-fold. It will be used to send propaganda about Denmark to countries around the world, in such languages as *English*, French, and Spanish, in addition to Danish. There will be *English* directed to North America for second-generation folks of Danish extraction, Spanish to the same group in South America. Programs will follow two chief lines—in Danish to foreign countries so Danes abroad will know what is going on in Denmark and so they can follow Danish culture, and to foreign listeners so they will get some Danish culture from programs of that character.

On the announcing staff will be "speakers" of French, *English*, and Spanish; Greenlanders will also be used for broadcasts directed to Greenland. The staff will be quite large.

The article declares that "the station is as modern as can be made. It will have five tall, wood masts (towers) which already have been built. Fifteen acres of ground were acquired for the antenna installation and transmitting facilities. It will use eight transmitting tubes costing approximately \$2500 each. These will be cooled continuously with distilled water. Three masts are about 330 feet in height and the other two are about 190 feet in height. The station was constructed primarily of Danish materials, although certain parts were imported from Italy."

make **henry**
your **hallicrafters**
headquarters



S-38 Biggest little buy on the market. Frequency range: 540 kc to 32 Mc in 4 bands. Self-contained PM dynamic speaker..... **\$47.50**

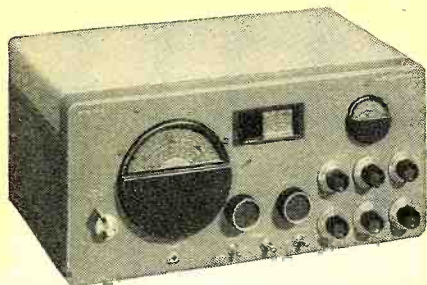

SX-43 All essential ham frequencies from 540 kc to 108 Mc. In the band of 44 to 55 Mc, wide band FM or narrow band AM, just right for narrow band FM reception is provided. **\$169.50**

COMPLETE STOCKS . . . Henry has everything in the ham field.

QUICK DELIVERY . . . Shipments 4 hours after receipt of order.

EASY TERMS . . . I have the World's Best Terms because I finance the terms myself and cooperate with you. I save you time and money. Write for details.

TEN DAY FREE TRIAL . . . Try any receiver ten days. Return it for full refund if not satisfied.

FREE NINETY DAY SERVICE . . . I service everything I sell free for 90 days. At a reasonable price after 90 days.

TRADE-INS . . . Trade-ins solicited. Big allowances made. Other jobbers say we allow too much. Write, wire, or phone. Tell me what you want and what you have to trade.

BUTLER
MISSOURI

HENRY RADIO STORES

11240 Olympic Blvd.
LOS ANGELES 25
CALIF.

"World's Largest Distributor of Short Wave Receivers"

12 BOOKS IN 1

IN THE

RADIO DATA BOOK

THE ONLY RADIO HANDBOOK OF ITS KIND! . . .
1148 PAGES, 12 SECTIONS, EACH A COMPLETE COVER-
AGE OF ONE RADIO SUBJECT.

TOGETHER THE 12 SECTIONS FORM THE MOST COM-
PLETE RADIO HANDBOOK YOU CAN BUY! EASY TO
READ . . . A QUICK REFERENCE!

Plan every operation in radio and electronics with the Radio Data Book. This new radio bible will be your lifelong tool . . . you will use it every day, on the board, at the bench, in the field! Use it for engineering, construction, trouble-shooting and testing. The RADIO DATA BOOK will be your invaluable aid in design, experiment and in layout. It will help make your production better, faster and easier. In any and every operation in radio and electronics, you will use the RADIO DATA BOOK!

The RADIO DATA BOOK is a work of complete author-ity, prepared by engineers with many years of practical experience. They have been assisted by the Boland & Boyce staff of editors skilled in preparing electronics manuals for the U. S. Signal Corps for many years. These men have worked for several years gathering material for this book . . . all the knowledge of radio principles and operation . . . all the statistics . . . all the newest developments in electronics . . . every possible angle and detail. Eighteen months were spent digesting this material into the most concise, the clearest, and the most readable form. The result is this in- valuable manual . . . The RADIO DATA BOOK. Whether you use this book for general reference, for scientific instruction, or for education, one thing is certain—the practical help, the daily usefulness you will derive from it will prove to be worth many, many times its astonishingly low price!

Here's a description of just ONE section—Section 5, Sound Systems:

This section covers the planning, selection of components, and assembly of complete P. A. installations. Every type of unit and material used in a sound system is described and analyzed. Components are classed as to size and type of P. A. installations in which they should be used. Tables and charts are given from which to determine power and ratings. Micro- phone and speaker construction are described and illustrated in detail . . . placement in auditoriums, etc., for proper acous- tical results is explained and illustrated. Patterns of the different types of microphones are illustrated as are the proper methods of wiring up the various units, etc.

The above is just one of the twelve big sections in the RADIO DATA BOOK. We wish we had room here to de- scribe all twelve in detail, but just look over the list of sec- tions, and you will see why this is the best radio handbook money can buy. Send in your order for the RADIO DATA BOOK today!

Coming Soon!

THE VIDEO HANDBOOK

Everything in Television in one Complete Textbook.

OVER 500 PAGES COMPLETELY ILLUSTRATED

This new handbook will be invaluable to everyone concerned with the technical aspect of Television. Everything from the basic theory of television through the design and characteristics of receivers to final installation, operation, and maintenance is covered. This is a completely new book that includes all of the latest developments in the field—the components discussed are of the newest design—the practical maintenance described is a result of intensive study of the equipment placed in operation during the past few months.

There are five completely illustrated sections in the VIDEO HANDBOOK, each over a hundred pages long. Each section completely covers.

The VIDEO HANDBOOK will be out October 15th, but we have received a flood of orders already. To insure your getting a copy in the first printing— mail your order now.

The VIDEO HANDBOOK is \$5.00 alone, or you can order it with the RADIO DATA BOOK and get both books at the special price of \$9.00. Send in the coupon today.

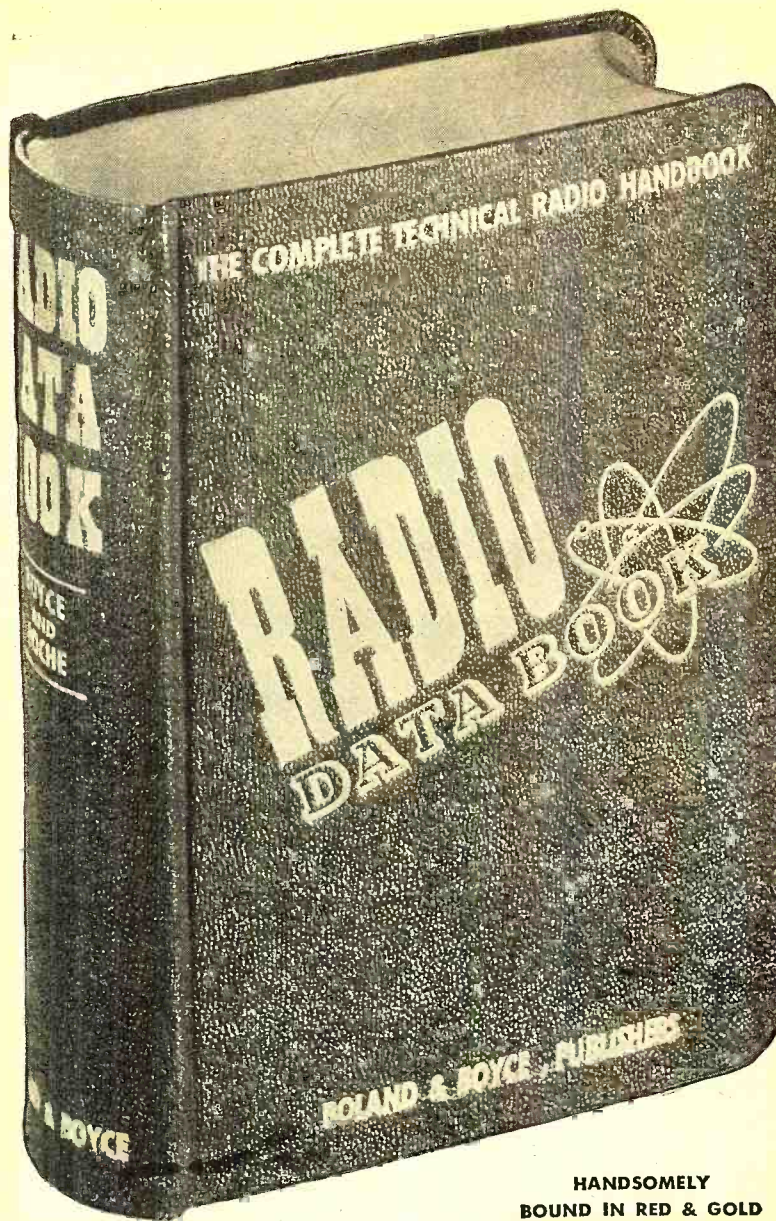

**HANDSOMELY
BOUND IN RED & GOLD**

12 sections . . . 1148 pages . . . Completely Illustrated

- | | |
|--|--|
| Section 1. THE 150 BASIC CIRCUITS IN RADIO. | Section 8. CHARTS, GRAPHS AND CURVES. |
| Section 2. COMPLETE TEST EQUIPMENT DATA. | Section 9. CODES, SYMBOLS AND STANDARDS. |
| Section 3. TESTING, MEASURING AND ALIGNMENT. | Section 10. 50 TESTED CIRCUITS DESIGNED FOR OPTIMUM PERFORMANCE. |
| Section 4. ALL ABOUT ANTENNAS. | Section 11. DICTIONARY OF RADIO AND ELECTRONIC TERMS. |
| Section 5. SOUND SYSTEMS. | Section 12. RADIO BOOK BIBLIOGRAPHY. |
| Section 6. RECORDING. | |
| Section 7. COMPLETE TUBE MANUAL. | |

12 complete books in one only \$5.00! Less than 42c per book!

MAIL THIS COUPON TO YOUR JOBBER—OR DIRECT TO: RN-7

BOLAND & BOYCE Inc., PUBLISHERS
460 BLOOMFIELD AVE., MONTCLAIR, N. J.

PLEASE SEND ME:

THE RADIO DATA BOOK AT \$5.00 (Foreign \$5.50)

THE VIDEO HANDBOOK AT \$5.00 (Foreign \$5.50)

BOTH BOOKS AT THE SPECIAL PRICE OF \$9.00 (Foreign \$10.00)

I ENCLOSE FULL PAYMENT

I ENCLOSE \$1.00 AND WILL PAY BALANCE TO POSTMAN ON DELIVERY (IN U. S. ONLY)

NAME

ADDRESS

CITY

STATE

ZONE

BOLAND & BOYCE INC., PUBLISHERS

Chicago

INSTRUMENTS

Quality at Low Cost!

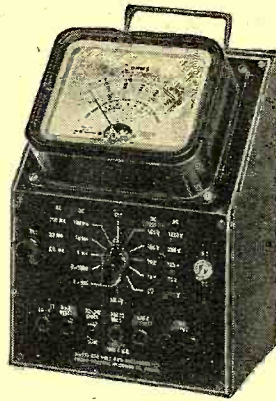

For years, Chicago Instruments have given radio men accurate, dependable service. And because of simplicity of design and freedom from "gadgets" we have been able to hold down prices to a fraction of what you would normally pay for instruments of similar quality.

Chicago Instruments are available in a variety of ranges and sensitivities. You may see them at your Suppliers or get the complete details by writing for Bulletin No. 10.

POCKET VOLT-OHM-MILLIAMETERS FOR ONLY \$5.25

Anyone can now own a good volt-ohm-milliameter. There is a Chicago V.O.M.A. priced at only \$5.25. Chicago "Featherweights" that slip easily into the pocket are the original miniature radio test instruments. They are popular throughout the world.

CHICAGO INDUSTRIAL INSTRUMENT CO., 536 W. ELM ST., CHICAGO 10, ILL.

LAKE SPECIALS

	Each	Per 10
Natl. Brand Phono Pickup.....	1.95	\$17.00
Natl. Brand Phono Motors.....	3.65	35.00
Gen. Ins. Record Changers		
12" X11".....	13.95	130.00
Alfig. Port Cab. for any changer		
17 1/2 x 17 1/2 x 10" Cutout for		
6" Spkr.	7.95	75.00

SPEAKERS

3" 450 Ohm	1.49	14.00
4" 450 Ohm	1.49	14.00
5" 2750 Ohm or 450 Ohm.....	1.69	16.00
5" PM with 50L6 Transformer...	1.39	13.00
6" PM	1.59	15.00
8" PM-1000 or 1800 Ohm field.....	3.50	32.00
5" Permatic Speaker-Special.....	.49	4.50
12" PM Heavy Duty Alnico-5.....	5.95	55.00
12" Dynamic 450 or 1000 Ohm.....	5.65	53.00

PARTS

500M Ohm Chgo. Tol. Vol. cont. & switch.....	.39	3.50
50x30 Mfd. 150 V Natl. Brand Cond.....	.42	3.90
40x40 Mfd. 150 V Natl. Brand Cond.....	.42	3.90
40x40 Mfd. 150 V 20 Mfd.....	.39	3.75
25 V-F.P.....	.50	4.75
Universal AC DC Line Cords.....	.45	4.25
All other Sizes from 135-350 Ohms.....	.22	1.95
100' 7x26 Bare Aerial Wire.....	1.95	17.50
70 Mil. Power Transf. 6 Volt.....	.85	8.00
40 Mil. 2 1/2 V. Power Transf.....		

AUTO AERIALS AND SUPPLIES

68" 3 Sec. Side Cowl Aerial.....	1.75	16.50
96" 3 Sec. Side Cowl Aerial.....	2.50	22.50
3 Section Univ. Mount.....	2.25	20.00
Spark Plug Suppressors.....	.10	.95
Distributor Suppressors.....	.10	.95
Generator Condensers 1/2 Mfd.....	3.65	35.00
7" Auto 6 Volt Speaker.....	3.65	33.00
7" Auto PM Dyn. Spkr. Heavy Duty.....	1.39	13.50
4 Prong Std. Oak Vibrator.....		

Sale on Tubes—For Limited Time Only—50-100% Discount on List Prices of National Brand Tubes! 25% Deposit required on all orders Write for our new 1948 illustrated catalog!

Lake Radio Sales Co.
615 W. Randolph Street
DEPT. A
Chicago 6, Ill.

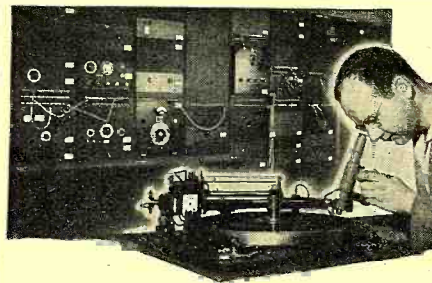

School of SOUND RECORDING, TRANSMISSION ENGINEERING, RADIO-TELEVISION

Learn sound recording and transmission engineering techniques of the professionals, as used in Motion Picture, Broadcast, F-M, Television, and Commercial Recording Studios.

A practical engineering course devoted to the technique of sound recording and transmission measurements. Well equipped studios, professional recorders and circuit laboratory containing latest model test equipment installed for student training. A portion of our laboratory is pictured above.



H.M. Tremaine
Director

WRITE FOR LITERATURE

HOLLYWOOD SOUND INSTITUTE, Inc.
1040-N No. Kenmore, Hollywood 27, Calif.

Although power was not given, it is believed to be 100 kw.

Frequencies to be used, according to the article, will be between wave lengths of 13.8 and 50 meters.

The writer commented that "it is hoped the station will be heard far away, but this will remain to be seen." It was suggested that the Danes will make an effort at the International Radio Conference in Mexico City this autumn to get assignment of at least comparatively clear channels.

(NOTE: At the time this data was compiled, no reports had been received that the new Danish outlet is on the air yet. Your ISW editor would appreciate any further details, including frequencies and schedules, when this material becomes available.)

* * *

Trondheim Experiments

H. Horgersen, radio engineer at Fysisk Institutt, Trondheim, Norway, who was technical director of the Trondheim experimental stations, informs me that these stations are no longer on the air, except for amateur work on the amateur bands, using the call LH2A. "But, of course," he adds, "we do hope to be on again soon with broadcast programs." Details are promised.

Last autumn, the Students' Society at the Technical University went on the air with their own short-wave broadcasting station, LH2A. The occasion was the "Studententer-uka," or Students' Week, although the actual celebrations spread over several weeks. During this period, the Students' Society Club House was transformed into a great entertainment center—with "bodega," or dance halls each with their own bars.

Permission was given by the Norwegian G.P.O. for the students to operate their own broadcasts from their own short-wave transmitter. Two transmitters were used, both of the same type, each putting about 600 watts into the antenna. They could be tuned to wavelengths between 17 and 55 meters. One of the transmitters was owned by the Norwegian Technical University itself and was located there. The other belonged to the Norwegian G.P.O. and was installed at the regional broadcasting station in a suburb of Trondheim. The frequencies 6.130, 9.540, 11.735, and 15.175 were allocated to these transmissions.

Two different studios were used for the programs, each working in cooperation with the other. Each could be connected to both or either transmitter and a comprehensive system of inter-studio and studio-transmitter inter-communication channels was installed. Among the technicians in charge were LA9J, LA3UA, LA3ZA, and LA9QA. LA9J is the director of the regional

RADIO NEWS

SLASHED PRICES DOWN

SELSYN MOTORS 110 V 60 CYCLE INPUT



No. S for indicating direction of your beam or actually driving it. Made in two popular sizes. Type 11-5 are heavy duty brass motors which will drive. **\$12.95** per pair
No. S2 Type 1—Light duty for use as indicators **\$9.95** per pair

No. BM 601 BEAM ROTATING MOTOR



3 R.P.M. with built in reduction gears — weather proof—reversible-AC or DC. This motor will drive any type of array — small, compact and strong. Requires 30 volts which can be obtained by the simple use of a lamp bulk in series with the line. A wonderful value at **\$12.95**



No. C 3002 BUTTERFLY CONDENSER

This cond. has the tank circuit built in—just plug in a tube. (Designed for V.E. 368-AS) Operates from 200 to 1000 mc. Can be used with any high frequency triode. **\$1.98**

No. C-641

R.F. UNITS FROM THE BC-312

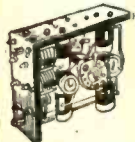

Contains six coils which cover from 1500 KC to 18 Mc. Has a ceramic band switch to change from any coil. Each coil is tuned with an air padder. Build your own receiver or signal generator with this assembly. A marvelous Buy at **\$1.98**

No. M-462

3 1/2 INCH "S" METER



Used in a Bridge Circuit, will give you accurate readings on your surplus receiver or receiver not equipped with meter. Uses light for lighting meter face. **\$4.95**

No. SH 414

SHOCK MOUNT

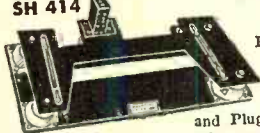

For The Popular BC-348 Complete With Plug For Set and Plug on bottom of shock mount for cable. Going very quickly **\$3.00** complete



BRAND NEW HF 100

A perfect tube for Class A amplifiers or Class B modulators—Can be run at maximum of 1750 volts, 150 ma each up to 30 mc. Will deliver conservatively 110 watts output on phone or 350 watts of audio. A Wonderful Value at **\$4.95**

KITS!

TUBE KITS

Complete set of tubes for SCR-522.... **\$17.95**
Complete set of tubes for BC-348..... **\$7.95**
Complete set of tubes for BC-312..... **\$7.95**
Specify Model Numbers

BC-348 Owners

CONVERTER for BROADCAST BAND

Convert that BC-348 without any alteration in your circuit. Our special converter takes power from receiver. Just tune your set to 450 kc. and forget it. All tuning is done on a converted panel covering 550 to 1600 kc.—double conversion means High Sensitivity. Excellent Fidelity and Higher Selectivity—complete basic kit with schematic and full instructions—less chassis dial and tuning knobs. **\$6.50**
Terrific Buy at

Model 200-EA. 5-ELEMENT 2 METER BEAM KIT. Folded di-pole driven element. All-aluminum construction. Feed with low impedance coaxial cable. Amateur net price **\$8.40**

DO YOU OWN AN SCR-522?

We have a complete power supply, including a separate voltage regulated bias supply chassis and schematic—all in kit form. This kit will supply all voltage necessary for operation of the set. All parts guaranteed. Complete at the amazingly low price of **\$14.95**

IT'S SENSATIONAL!

Hottest Item Out! Make your SCR-522 Receiver operate on 144 to 148 MC with ONE DIAL control, in less than 1 hour! Parts and instructions..... **\$3.00**

DESIGNED FOR THE 522 TRANSMITTER



A Four Band Selector Unit Which replaces the selector motor allowing you to change frequency from the front panel quickly. Can be installed in 10 minutes. **\$3.00 each**

No. T 500

FILAMENT TRANSFORMER



115 v. primary 60 cy. two secondaries, both 2.5 volts @ 10 amps—each may be used in series to deliver 5 volts @ 10 amps c.t. or as two 866 fl. windings insulated at 10,000 volts. A steal at..... **\$4.35**

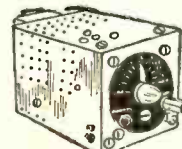

"Q 5'er"

Here is a little unit that covers 200 to 400 KC. has 135 KC I.F.—complete with tubes—has a tuned stage of R.F.—it is a natural for the aircraft beacon frequencies—The tube line up is: 2-25L6; 1-6SQ7; 1-6SK7; 1-6SA7; 1-6K7; This set is perfect for Rand's article "The Man's Q 5'er" Special **\$4.95**

No. TV-1403 TELEVISION COIL GROUP



Here is an inexpensive coil group complete with schematic includes I.-F. trans. peaking coils, discriminator coil for FM sound and sound traps. 3.5 MC wide..... **\$8.50** complete
Will give you a good picture with plenty of gain.

No. TV-4116 TELEVISION COIL KIT

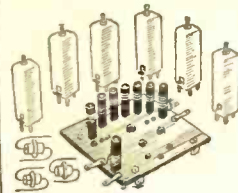

For the construction of a 20 tube television receiver. Kit consists of 5-shielded video I. F. coils. 1-RF tuner assembly consisting of 1 ant. coil 6 IF tuning coils, and one oscillator tank coil mounted on bakelite switch mounting plate. 1-shielded discriminator coil for FM sound. 3-video peaking coils. 1-complete instruction manual with detailed information on how to construct a 6 channel 20 tube receiver. **\$23.50**
Instruction Manual Alone **\$1.25**

No. FC-22 FOCUS COILS



300 Ohms. For television or scope tubes in two sizes—low resistance for use in series with power supply—high resistance for use across power supply. **\$5.25**

No. FC-20—15000 ohms **\$6.20**

No. H 1412 SOCKET AND BRACKET

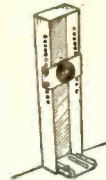

For 5" or 7" Cathode or Television Tube. Adjustable for Height. Easily Mounted on Chassis. **\$1.95**

SARKES TARZIAN

13 CHANNEL TUNER FOR TELEVISION

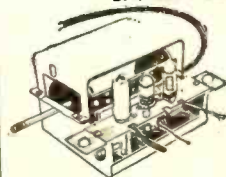

A front end designed to go into 27.5 I. F. Has a stage of tuned RF—comes complete with 7 fixed channels—answers the "front end" problem in that set you are building. **\$31.75**

No. H4110

THE WELLER SOLDERING GUN

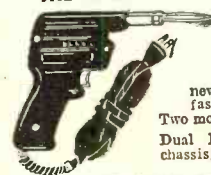

Heats instantly—cools instantly, carry one in your tool box—no wasted time—once you have used this iron you will never go back to an old fashioned soldering iron. Two models. Standard **\$12.95**
Dual Heat (for soldering to chassis) **\$14.95**

1948 SURPLUS RADIO CONVERSION MANUAL



Here is the latest manual on conversion of surplus equipment. Complete articles including schematics "before & after" on such units as the BC 221, 342, 312, 348, 412, 645, 946, SCR 274, 522, TBY Transceiver, PE 103A, BC 1068A/1161. Electronic Surplus Index. Cross Index of A/N Vac. tubes and many others. **Only \$2.50**

20% DEPOSIT WITH ORDERS UNLESS RATED

NIAGARA RADIO SUPPLY CORP.

160 GREENWICH STREET

NEW YORK 6, N. Y.

ALL PRICES F. O. B., N. Y. C.

WE ER SOLDERING GUN

Time Saving-Money Making Features

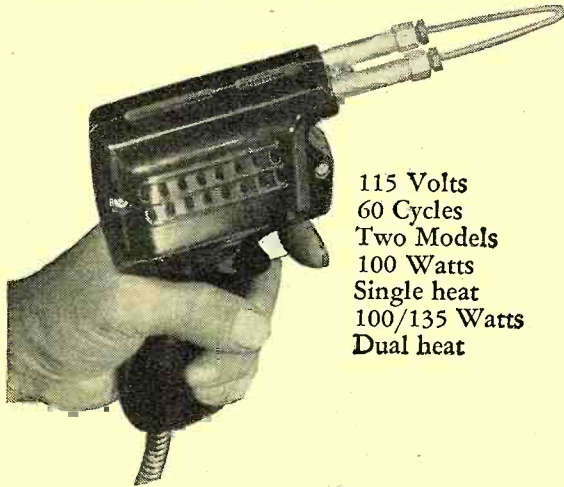

115 Volts
60 Cycles
Two Models
100 Watts
Single heat
100/135 Watts
Dual heat

See your radio parts distributor or electrical wholesaler. Or write direct for bulletin.

WELLER Mfg. Co.
810 Packer St. • Easton, Pa.

5 SECOND HEATING

ADJUSTABLE TIP

BUILT-IN SPOTLIGHT

LONG REACH

DUAL HEAT

broadcasting station, LKT, the others being students at the University.

A separate monitoring station was set up in the Club House and the studio equipment included a tape recorder and a disc recorder. The programs were produced and presented by students from the University.

Best Bets

For the benefit of Eastern DX-ers, here is a list of "Best Bets for Beginners," compiled by Charles S. Southhall, Philadelphia, Pennsylvania:

Australia—VLB, 9.54, VLC7, 11.81, 0700-0845; VLA8, 11.76, 1645-1815. *Belgian Congo*—OTC-2, 9.768, Leopoldville, 2100-2300. *Colombia*—HJDE, 6.145, in Spanish only, around 1730-1800, announces irregularly; not complete schedule, heard at various other times also. *Ecuador*—HCJB, 9.958 (may be as high as 9.964), and 12.455, best 2130-0000. *French Equatorial Africa*—Radio Brazzaville, 11.970, afternoons and evenings to 2010 closedown. *Guatemala*—T G W A, 9.76, 2100-2330; TGWB, 15.170, 0900-1100. *Hawaii*—KRHO, 15.25, Honolulu, news 0800. *Holland*—PCJ, 9.59, Sundays and Wednesdays with "Happy Station Programs," 2200-2330. *India*—A I R, Delhi, 15.16 and 15.19, news 2130, 2230. *Portugal*—CSW7, 9.73, Lisbon, 1900-2030. *Switzerland*—HER4, 9.535, and HER5, 11.815, 2030-2230; HER5 also at 1730-1815. *Turkey*—TAP, 9.465, Ankara, best Sundays, Mondays, Thursdays around 1630-1645; news daily 1245. Charles comments that all these stations will verify correct, detailed reports. In most cases an IRC should be enclosed.

* * *

World Radio Handbook

By this time, the Summer Edition of *World Radio Handbook (English)*, edited by O. Lund-Johansen, Copenhagen, Denmark, should be ready for delivery. Those wishing a copy of this valuable guide to world radio may send \$1.25 to Mr. Lund-Johansen's American agent—Ben E. Wilbur, 80 S. Oraton Parkway, East Orange, New Jersey, U.S.A.

* * *

Club Notes

United States—Through the courtesy of Director and Mrs. Harold Robinson, the NNRC Summer Convention will again be held at Mapine Farm, Lansdale, Pennsylvania, on Sunday, July 18. Members of the Convention committee are Richard Daneker, Lansdale, chairman; Vincent C. Stasen, Philadelphia, and Howard Sellers, Lansdale. The NNRC (Newark News Radio Club) has just effected this organization for 1948—Irving R. Potts, president; Peter J. McKenna, executive secretary; Robert S. Knox, assistant executive secretary; Walter L. Townley, treasurer; John H. De Rosa, Louis Hahn, M. F. Williams,

RADIO NEWS

Basic Scope Or TELEVISION KIT

Item 1—Transformer—4½x3½x3
PRI: 115V-60 cycle
Sec: 2.5V-1.75 Amp (for 2x2)
6.3V-0.6 Amp (for C.R. Tube)
3800 VDC-Condenser input with load

Item 2—Steatite Magnal socket for C.R. Tube 5BP1, 5BP4, 7EP4, 7BP4.

Item 3—Steatite 4 prong socket for 2x2 Rect.

Item 4—H.V. Filter Cond.—103-7500 VDC-oil Schematic for 11V Pow. Supply included.

Complete \$6.95

SPECIAL!!! Small 6.3-1 Amp Filament Transformer individually boxed, 1x2x1 ¾" 3 for \$2.00

Famous Make FILAMENT TRANSFORMER Hypersil Core



Extremely light weight—8 lbs.
5x4½x4½
PRI-115V-60 cycle
Sec. #1—6.3V-22.0 amp.
#2—6.3V-2.4 amp.
#3—6.3V-2.25 amp.
#4—6.3V-0.6 amp.

The 22 amp. winding consists of 2—6.3V at 11 amp. windings in parallel. Case is easily removed. Windings can be re-arranged in series, for 12 volt at 11 amps. Also connect for 18 or 24 volts. An extremely versatile transformer at a REAL GIVEAWAY PRICE. New—Each \$2.95

New Bulletin off press—write
GREENWICH SALES CO.
59 Cortland St.
New York 7, N. Y.

ERECO BEAM ROTATOR

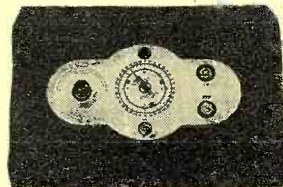

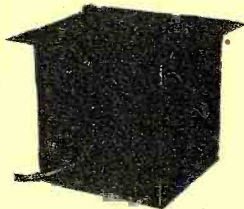

COMPLETE—Ready to plug into 110 volts 60 cycle line Selsyn Indicators variable speed control indicator: blue-gray crackle finish sloping panel cabinet with chrome trim louvers.



Three tone (silver-red-black) control panel. Push button reversing switches. On-off switch fused. Red panel light fused. Complete with 6 foot line cord and plug.

ROTATOR—Will support and rotate the weight up to 250 pounds. Heavy duty ball bearing construction ¾" pipe thread output shaft. Weather-proofed. All instructions and diagrams for mounting and installing furnished. Control cable 14c per foot extra. 90 day

FACTORY GUARANTEE\$69.95 Net
FOB Everett, Wash.
Dealers Inquiries Invited

12" Antenna Insulator	Selsyn's Model No. 2J
	
No. 112 800 lb. test factory carton of 100 for \$8.95.	Operates from 25 to 30 volts 60 cycle.
NEW10c each	BRAND NEW 69c each

Satisfaction Guaranteed or Your Money Back
Hundreds of Surplus Bargains In Our Free Illustrated List

DICK ROSE **ERECO**
2912 HEWITT AVENUE EVERETT 20, WASH.

Lester W. Kraemer, Roger C. Legge, Arnold E. Gerrard, Eugene S. Allen, Kenneth Albrecht, vice-presidents; William H. Stone, Canadian vice-president. Mr. Potts is editor of NNRC's house organ; Carroll H. Weyrich and Bernard L. Ahman Jr. are in charge of the broadcast band section; James J. Hart is short-wave editor; Earl Roberts and Gail Beyer compile the amateur division, while Carleton Lord is in charge of special features. Known as the "pioneer of DX clubs," having been founded in December 1927, this organization maintains headquarters at 215 Market Street, Newark, New Jersey.

The Short-Wave Listeners Registry, a prewar group, has been reorganized and now has members again all over the world; details on membership can be had from Short-Wave Listeners Registry and Hobby Exchange, 1042 Water Street, Moosic 7, Pennsylvania, U.S.A. Officials of this group are Bill Camp, president; Elwin Gleason, vice-president; Russ Beringer, secretary, and Bob Camp (W3NJL), SWL-"ham" editor. The club issues an attractive monthly house organ; there are sections for write-ups about members and their hobbies, items of interest to SWL's, and to amateurs. The DX section is quite interesting. (Cooley, Pa.)

Last Minute Tips

Latest summer schedules of Canada's International Service are: To Europe—weekdays, 0800-1735 (Saturdays to 1705 only), CKNC, 17.82; 0914-1100, CKCX, 15.19; 0800-0912, 1105-1135 (Saturdays to 1705 only), CKCS, 15.19. Sundays, 0930-1705, CKNC, 17.82; 0930-1100, CKCX, 15.19; 1105-1705, CKCS, 15.32. To the Caribbean (*English*), 1820-1920, CKCX, 15.19, CHOL, 11.72. To Latin America (Portuguese and Spanish), 1920-2105, CKCX, 15.19; 1935-2105, CKNC, 17.82. To Australia and New Zealand (*English*), 0345-0535 (may be Sundays only), CHOL, 11.72, CHLS, 9.61; *English* official commentaries from the United Nations, 2200-2235 (daily except Sundays), CKNC, 17.82, CKCS, 15.32.

Leipzig's 9.728 now signs on at 2200. (Balbi, Calif.)

PMA, 19.345, Batavia, Java, has *English* daily 1200-1230. (NNRC)

Radio Clube da Huila, Caisca Postal No. 111, Sa Da Bandeira, Angola, has informed Mervyn P. Laubscher, ISW monitor in South Africa, that its call is CR6RH; is scheduled weekdays 1230-1400, Sundays 0630-0745 and 1200-1330; although station listed frequency of 9.500, it is actually operating on 9.235; power was given as 100 watts. Mr. Laubscher says a call of CR6RJ is also given over the air, which may be that of a medium-wave outlet in parallel.

July, 1948

TRANSVISION

**NEW... Sensational TRANSVISION Development now offers
LARGE-IMAGE DIRECT-VIEW TELEVISION at low cost!**

BIGGEST VALUE in TELEVISION

Model 10BL TELEVISION KIT with FM Radio
... Features Beautiful CABINET with
BUILT-IN LENS ... Gives LARGE 120 Sq. In.
Picture

Roto-picture effect: Picture "rotates," giving the appearance of being in focus and clearly visible from every angle! Uses 10" Electromagnetic Direct-view Picture Tube. Features new-type cabinet with built-in lens which magnifies, clarifies and heightens contrast of the picture. The lens also creates the effect of apparent rotation of the picture, so that when the observer moves, the picture still seems to be in focus and clearly visible from any angle.



MODEL 10BL

ECONOMICAL KIT, EASY TO ASSEMBLE. In point of value, this Television KIT provides the opportunity of acquiring a LARGE-IMAGE direct-view television set at a VERY LOW PRICE; also very economical from a tube replacement angle. This model is available in KIT FORM, for easy assembly; no technical knowledge required. Simple step-by-step instructions are included. Saves as much as 50% over the cost of receivers with similar picture magnitude.

TECHNICAL DATA: Model 10BL uses a 10" Electromagnetic Direct-view Picture Tube; has complete F.M. Radio which comes completely factory-wired; receives all channels in any area; supplied complete with antenna and lead-in wire. The LENS is 15" x 11", giving a picture size of approx. 10" x 12" or 120sq. in.; the highly-styled cabinet measures 26" wide x 17" high x 19" deep, available in Mahogany, Walnut, or Blonde finishes.

PRICES: Transvision MODEL 10BL Television Kit, with FM, 10" tube, cabinet with built-in lens, antenna, 60 ft. lead-in wire. **NET \$299.95**

Scoop! New Revolutionary MODEL 7BL Television Kit with Specially Designed CABINET with BUILT-IN LENS



MODEL 7BL

- Uses 7" Electrostatic Picture Tube
- Gives 50 square inch picture of superior quality

FEATURES: Though it has a 7" tube, the effect is equivalent to a 10" set because the built-in lens magnifies the picture. Also picture performance is superior because the lens clarifies and heightens contrast of the image. Picture "rotates" apparently, as the observer moves, giving the effect of always facing the observer. This is effective to a very wide angle. Pre-tuned for 5 channels.

PRICE: Including cabinet with built-in lens, antenna, 60 ft. of lead-in wire **NET \$189.00**

TRANSVISION "SERVICE NOTES"

Transvision's "Service Notes" is a compilation of confidential Television Notes and Information, the product of experience with over 20,000 television receivers, now made available to the public. The "Service Notes" is a most valuable compilation of instructions and data on Magnetic and Electrostatic Television Receivers. Though compiled in the course of servicing Transvision Kits, the information is applicable to any type of television receiver.

"Service Notes" is complete with photographs and diagrams. The information is worth a small fortune. The cost is low. **NET \$1.95**

The Key to Successful Television Servicing



All prices 5% higher west of Mississippi; all prices fair traded.
For further information see your distributor, or write to:

TRANSVISION, INC. Dept R.N. NEW ROCHELLE, N. Y.
In Calif.: Transvision of California, 85-72 Santa Monica Blvd., Los Angeles

HER6, 15.305, Berne, has replaced HER3, 6.165, in the North American beam, 2030-2230. (Balbi, Calif.) Frequencies of 9.535 and 11.815 are in parallel. (Worris, N.Y.)

Brazzaville, Fr. Equatorial Africa, is heard on 15.595 with news 0715. (Ferguson, N.C.)

KZFM, Manila, Philippines, appears to have dropped 9.62; is heard in California only on 11.840, news 0900. (Balbi)

Since May 2, PCJ, "The Happy Station," Hilversum, Holland, has been using its new 100 kw. station on 21.480 on Sundays and Wednesdays at 1030-1200 and on Tuesdays at 0330-0500 for

"The Happy Station Programs" produced and presented by Eddie Startz. (*This may not be complete schedule for this channel.*) (Callahan, Pa.) Is beamed to the Netherlands East Indies, the Pacific, and the Far East. Is reported to be using only 10 kw. to 40 kw. for the present.

A station heard announcing as "Ici Radio Collaise" has been identified as located at Elizabethville, Belgian Congo; call sounds like OQ2AC; frequency is about 7.195 and schedule appears 1130 to 1210 or 1215. (Laubscher, Sou. Africa)

The Finnish Radio has announced that its projected 100 kw. short-wave trans-

mitter—now under construction at Pori—will be completed to go on the air soon—probably by mid-July or earlier; it hopes to provide good reception to North America, a dispatch from Helsinki declared. (Anderson, Calif.)

Swedes report *Radio Splendid*, Buenos Aires, has moved LRS2 from 11.970 to 11.840 where it is heard "rather well" in Sweden after 1700. (Stockholm Radio)

A new Angola station reported by Laubscher, Sou. Africa, is *Radio Clube da Nova Lisboa*, about 7.165; call sounds CR6RI or CR6RY; first heard at 1330 and heard signing off at 1430; may not be complete schedule.

Recently, the daily program for Norwegians abroad (some *English*) has been radiated on 6.185 (8 kw.), 9.610 (8 kw.), and 11.735 (100 kw.) at 2000-2100. (Anderson, Calif.)

As of May 1, Stockholm replaced SBU, 9.535, with SBT, 15.155, in the daily 1900-2000 transmission for Swedes abroad; news is shortly after start of broadcast, and on Saturdays the weekly DX program is radiated at 2000-2015. (Anderson, Calif.)

Block, Belgium, reports the United Nations Radio, Geneva, Switzerland, has been heard 0900-1000 on 6.672 and 9.655, with programs in *English* at 0930-0945 and in *French* at 0945-1000 and on 17.770 at 0500. Asked for reports from listeners to Radio des Nations Unies, Geneva, Switzerland. (Stockholm Radio)

Radio Italiana's summer schedule to North America appears to be daily 1900-1955, news 1930, on 15.120 and 11.810. (Anderson, Calif.)

Denmark's 15.175 outlet is heard in California, irregularly, around 0130-0400, fair level. (Balbi)

An Indonesian station on 7.55 has news 0900. One on 11.60 is heard irregularly to 0130 (*not on daily*). (Balbi, Calif.)

Radio Tananarive, Madagascar, is scheduled at 2255-2315 in *French*; 2315-2330 in *Malgash*; 0320-0330 in *Comoran*; 0330-0415 in *Malgash*; 0415-0545 in *French*; 0900-0930 in *Comoran*; 0930-1030 in *Malgash*, and 1030-1345 in *French*; 6.063, 9.693, 10.615 are used in parallel. (Bluman, Eritrea, via Stockholm Radio)

Radio Australia's summer schedules include to West Coast, 2330-0045, VLA7, 17.80, VLC4, 15.32, VLG10, 11.76 (off Sats.); news 0015 DX session Sundays 0025. To West Coast, 1000-1115, VLC3, 11.76, VLB9, 9.615, news 1030. To South Africa, 2330-0045, VLB5, 21.54, news 0015, DX session Sundays 0025; 1015-1115, VLA6, 15.20, VLG4, 11.810 (off Sats.), news 1030. To Britain, 0200-0315, VLC10, 21.68, VLA6, 15.20, VLB3, 11.76; 0900-1000, VLA6, 15.20, VLC4, 15.32, VLG10, 11.76 (VLB9, 9.615, is

2 out of 3

ESPEY

need it!

The Custom-Built Chassis



According to the RMA over 18 million consoles were built BEFORE '44!

That's right! The newest are four years old, and there are more than 11 million of them that are ten years old. Of the 18 million owners, 51%, or over 9 million LIKE their cabinets—in spite of the fact that the vast majority of receivers are hopelessly obsolete, lacking such present-day essentials as FM.

Furthermore, over 90% of the console owners WANT FM, but less than 6% HAVE it. What a replacement market!

It was to fill this tremendous need that ESPEY designed its line of top-quality custom-built chassis, supplied complete and ready to operate in your customers' cabinets.

For further details about the ESPEY replacement chassis, and the opportunities in the replacement industry, we urge you to write today to Dept. A-7.

ESPEY MANUFACTURING COMPANY, INC.

528 EAST 72ND STREET-NEW YORK 21, N.Y.

"ESTABLISHED—1928"

War Surplus Bargains Sold As Used Unless Otherwise Specified!



TELRAD 18-A FREQUENCY STANDARD

Checks signals in the range of 100 Kc. to 45 Mc. with a high degree of accuracy. Self-contained power supply is 110, 130, 150, 220, and 250 V. 25-60 cycle AC. Complete with tubes, dual crystal, and instruction book. Brand new.

Price

\$24.95



AIR COMPRESSOR

Will pump pressure up to 1500 lbs. per sq. in. 3-stage type—air-cooled, powered by a 24 V. DC motor. Ideal in shop for use with airgun, small paint sprayer, and numerous other applications. Small, compact, precision-built.

Only **\$12.95**

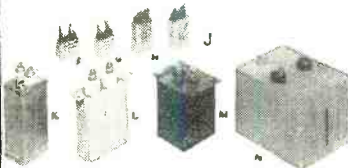

F—Cond., .25 Mfd. 400 V. (New) \$.10
 G—Cond., .125 Mfd. 400 V. (metal cased) (dual condenser) (New)15
 H—Cond., 1.75 Mfd. 50 V. (New)15
 J—Cond., (GE Pyranol) 2 Mfd. 600 V. (New)50
 L—Cond., 4 Mfd. 600 V. DC (GE Pyranol) (New)50
 M—Cond., 4 Mfd. 300 V. (New)35
 N—Cond., 30 Mfd. 330 V. AC (GE Pyranol) (New) 3.00



B—Cond. (GE Pyranol) 8 Mfd. 1000 V. DC (New) 1.75
 C—Cond. (Chi. Ind. Cond. Corp.) 4 Mfd. 2000 V. (New) 2.50
 D—Cond. (Cornell-Dubilier) 1 Mfd. 4000 V. (New) 3.00

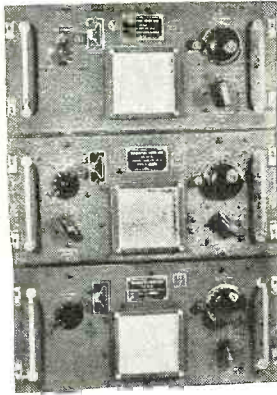

BC-375 GE MOPA TRANSMITTER

The most famous of all surplus transmitters. Was used by the Army bombers and ground stations during the War. Frequency range is covered by means of plug-in tuning units as shown below. Each tuning unit has its own oscillator and power amplifier coils and condensers, and antenna tuning circuits all designed to operate at top efficiency within its particular frequency range. Transmitter and accessories are finished in black crackle, and the milliammeter, voltmeter, and RF ammeter are mounted on the front panel. Frequency Range: 209-500 Kc. and 1500-12,500 Kc. (Will operate on 10 and 20 meter band with slight modification.) Oscillator: self-excited, thermo-compensated, and hand calibrated. Power Amplifier: neutralized class "C" stage, using 211 tube, and equipped with antenna coupling circuit which matches practically any length antenna. Modulator: Class "B"—uses two 211 tubes. Power Supply: Dynamotor which furnishes 1000 V. at 350 Ma. Conversion instructions and diagram for 110 V. AC furnished upon request for \$1.00.

PRICES: As follows—
 Transmitter only \$12.50
 Tuning units TU-5B, TU-6B, TU-7B, TU-8B, TU-9B, TU-10B, TU-26B, choice 2.50
 Dynamotor PE-73C 3.95
 Antenna tuning unit (BC-306A) 4.95

BC-645 ULTRA HI-FREQUENCY TRANSMITTER-RECEIVER



You read about it recently in QST! Originally operated in the 450 to 500 Mc. Can be converted to 420 Mc. amateur band. Consists of complete transmitter and modulator system, a n d receiver.

Complete with 15 tubes \$11.95

BRAND NEW

SCR-625 MINE DETECTOR

ATTENTION: PROSPECTORS, MINERS, OIL COMPANIES, PLUMBERS, ETC.

Used by the Army to detect buried metallic mines. Its private use suggests the location of underground or underwater pipes, cables and ore-bearing rock, the location of metallic fragments in scrap materials, logs, etc., and the screening of personnel in plants for carrying of metallic objects. New, complete in original overseas packing container. Originally sold by War Assets for \$166.00. The U. S. Forestry Service has recommended procedure for using the SCR-625 Mine Detector to find concealed metal in tree logs and other timber products.

PRICE \$69.50

Batteries \$4.50 extra

TERMS: CASH WITH ORDER

AMERICAN SURPLUS PRODUCTS CO.

537 N. CAPITOL AVE.
INDIANAPOLIS, IND.

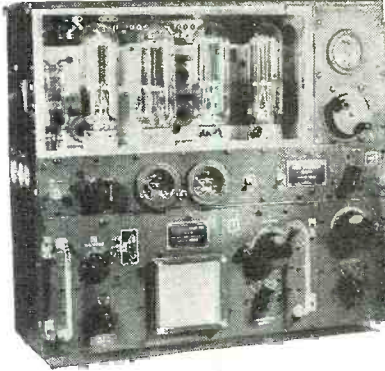

MARKER-BEACON RECEIVER

Can be adapted to radio controlled devices. Was used by pilots to flash a signal lamp on aircraft instrument panel when in range of a beacon transmitter. Responds to modulated signals over a variable range of 62 to 80 Mc. Tube plates and filaments operate directly from 24 V. DC. Can be adapted for radio control of experimental apparatus, opening garage doors, etc. Circuit diagram and parts list included on either model shown below:

BC-357—contains 12C8 and 12SQ7 tubes and sensitive relay (size 5 3/4" x 5 1/4" x 3 1/4").
 Price \$2.95

BC-1033—contains 6SH7, 6SL7 and 12SN7 tubes, sensitive relay (size 5 3/4" x 5 1/4" x 3 1/4").
 Price \$3.50

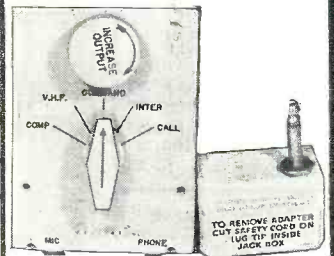

JACK BOX BC-1366

Contains 2-pole 5-position switch, rheostat, two phone jacks, etc. In aluminum case 3 1/4" x 4 3/8" x 2 1/4". Complete with headphone set adapter to match high to low impedance.

Price \$1.25

Willard
Lead
Acid
Cells

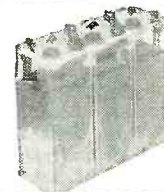
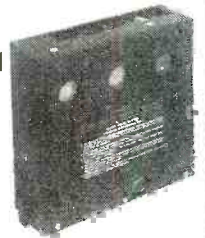

6 V. (New) (Dry-charged) \$3.00
 6 V. (In metal carrying case) (Add electrolyte specific gravity 1.265) (Drug-store) \$4.00

beamed to Far East in parallel); DX session Sundays 0902. To Fiji Islands, 0100-0145, VLG6, 15.24, VLC3, 11.76; on Saturdays, VLA6, 15.200, is used instead of VLG6. To New Caledonia, 0245-0345, VLC4, 15.32, VLG3, 11.71. (Balbi, Calif.) East Coast morning transmission is at 0700-0845, VLB, 9.54, VLC7, 11.810, news 0700, 0815, DX session Sundays 0827, evening beam 1645-1815, VLA8, 11.76, news 1645, 1800; this beam also is radiated 1645-1815 to Forces in Pacific, to Asia, the Pacific and for relay by Kure (6.105), on VLB11, 15.16; from 1710 to the British Isles and Europe on VLG6, 15.230, and

to South America on VLC, 15.200. Finland's OIX4, 15.19, is heard in California, irregularly, around 0000 and also at 0230, good signal. (Balbi) *Radio Congo Belge*, Belgian Congo, was heard testing some time ago at 1100-1500 on 11.720; *Radio Congolia* carries a program in French at 1200-1300, and at 1300-1330 has a "native type" broadcast; frequencies are 6.010 and 15.325, while 9.210 is also used after 1300. (Bluman, Eritrea, via Stockholm Radio) VE9AI, 9.54, Edmonton, Alberta, Canada, appears to be using this channel only now. (Balbi, Calif.) The USSR uses 11.75, 11.885, 9.72,

9.565 to the Orient early mornings, irregularly, to 0900 or later, replacing 6.06, 6.115, 9.545. (Balbi, Calif.) Sanderson, Australia, reports a Chinese station on 9.553 as XOPD, at 0500 with news in Chinese and music; had modulation. Also reports HS8PD, 5.99, Bangkok, Siam, with news 0615, fair signal; a "Free Indonesian" on 11.88 at 0445 with program for local listeners; YCN3, 8.09, at 0715 with Dutch news and Western music from Biak; HYP5, 7.41, at 0630 with music and news in Dutch.

Sbarq-al-Adna, the Near-East Arab Broadcasting Station, Jaffa, Palestine, has ceased transmission on 6.135 and is now using only 6.790 and 11.720; the latter transmitter is so weak, however, it is doubtful that it is really the old 7.5 kw. station. (Bluman, Eritrea, via Stockholm Radio)

JVW, 15.225, and JVW3, 15.325, Tokyo, have replaced JVW2, 9.505, and JVW4, 9.56, in the Japanese Home Service, 0300-0900. (Balbi, Calif.)

Denmark's 11.78 outlet is heard in Australia at 0100. (Sanderson) Block, Belgium, reports Praia, Cape Verde Islands, 5.890, at 1530-1700, through heavy CWQRM; closes with Portuguese National Anthem. (Stockholm Radio)

Tips airmailed to ISW by Cushen, New Zealand, include—"Forces Broadcasting Station," 6.070, Jerusalem, Palestine, is heard daily to 1600. (NOTE: With the British leaving Palestine, it is possible that this station may have closed down by this time.—K.R. B.) KZBU, 6.100, Cebu City, Philippines, verified with card, wants more reports, QRA is Philippines Broadcasting Corporation, Gotiaoco Building, Comercio Street, Cebu City, Philippines operates on 1250 kcs. and 6.100. Placido L. Mapa, Secretary of Commerce and Industry, Manila, verified a 1941 report on Cushen's reception of KZND, "National Defense Station," on 9.505 and 8.790; power was 1 kw.; station is now KZFM, 710 kc., 9.620, 11.840, 5 kw. on medium-wave and 400 watts on short-wave; QRA is Managing Director, Government Broadcasting Station KZFM, City Hall, Manila, Philippines. A new Chinese station on 12.100 seems to have call of XGAE, good signal, leaves the air usually at 0615. XEBT, 9.625, Mexico, is heard with news 2230. A "mystery" station has been identified on 10.230 as the French Home Service, heard testing at 0200 and 0300; also heard testing on 6.200 at 0600; schedule on 10.230 appears 1100-1815. Incidentally, Cushen has won the Australasian Championship in a contest conducted by "Radio Hobbies" magazine of Sydney, Australia; in the senior section, he scored 3554 points, more than 2000 ahead of the second place winner; the

NO ONE IS "ABLE" TO BEAT "ABELL" SURPLUS VALUES

ORDER BY MAIL

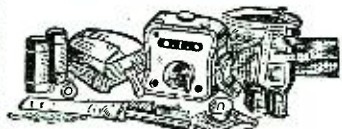

500 KC SOS XMITTER
\$24.95

New mdse. in original pack. Rugged, emergency transmission. Operates from life raft, boat, or vehicles. Provides 20 seconds automatic code transmission of SOS or alarm signals, then, 20 seconds of 1000 cycle tone. Can be keyed manually for other messages. Hand crank powered. No batteries required. Speed indicator lamp and tuning control lamp included. Tubes are a 12SC7 (Audio Oscillator and Amplifier) and 12A6 (RF Oscillator). Radio antenna wire furnished. Spares; 2 Balloons; two hydrogen generators, Box Kite; Parachute, signal lamp, spare antenna wire and instructions, included in shockproof, wetproof bag. No experience required, any person can operate. Weight; 38 or 42 lbs. depending on hydrogen generators furnished.

BC-325 TRANSMITTER
400 Watt Federal 1.5-18 mc. Parallel 803's RF final. All tubes and 3" cathode ray modulation monitor tube furnished. Eleven 3" meters for all circuits. 110/220 Volt 60 cycle Single Phase. Enclosed rack. Top-notch... **\$495.00**

ANTENNA TRIPOD
13 ft. high; strong. Weather-proofed head rotates on ball bearings. Will clamp two inch tube or shaft. Legs are 2" phenolic tubing, with fool proof lock joints for assembly. Fine business for rotating beams. TV. No guying or RF insulation needed. Weight, 75 lb. Brand New **\$10.95**

ANTENNA SWITCHING RELAY UNIT BC-442.
0-10 Amp. R.F. meter. 50 mmf. 5 KV vacuum capacitor. 24 Volt Relay **\$1.95**

SCR-522 VHF TRANSCEIVER
100-156 MC. 17 Tubes; Good Condition... **\$22.95**

AUTO SPARK PLUG SUPPRESSORS
Box of 50..... **\$2.25**

3 COND. CABLE #18 STRANDED
400 V. insulation. Heavy Duty RC. 250 Feet long. 1 Cond. Shielded. Plug each end **\$6.95**

ROTARY BEAM GEAR BOX
Gear train, motormounts, enclosed in a waterproof housing. Excellent for use in constructing your new beam. Brass gears, bearings, useful hardware. Plenty of room for meter, solen, and controls. 11 1/2 x 14 x 9". Two waterproof junction boxes also included. NEW, ridiculously low **\$7.95**

RG8 U COAX 52 OHM
Price per foot (25' or more) **.05**
Reel of 1200 ft. **\$54.95**

SOUND POWERED HANDSET
No batteries required. **\$12.95**

DESK STAND MICROPHONE
With switch, 6 ft. cord and plug. 200 ohm carbon button **\$2.95**

SCR 284 CONNECTING CABLE
7 Cond. with connectors, for use between PE103 and BC654..... **\$1.95**

100 WATT AM TRANSMITTER BC 375

Self-contained oscillator, modulator, and P.A. Uses 4-211's and 1-10. Meters—0-350 MA, 0-6 amp RF, and 0-15 V. Fine business for your medium power rig. Use as is or take apart for hundreds of top quality X-mitter parts. Less tubes and tuning unit **\$10.95** With tubes and tuning unit..... **\$15.95**

BC 191 TRANSMITTER 100 WATT
Frequency Range 200-500 KC and 1500-18,000 KC. Can be modified to operate on 10 and 20 meters. Self-excited oscillator, temperature controlled. P. A. neutralized 211 operating Class "C". Pair of 211's as Class "B" modulator. Versatile antenna matching network built in. Has 12 V. Dynamotor Power Supply, connecting plugs, tubes, and two tuning units. (Tuning Units do not cover complete range above). Wt. 150 lb. Similar to BC 375, but Dynamotor operates on 12 V. DC, not 24..... **\$24.95**

GAS ENGINE ELECTRIC GENERATING PLANTS
32-110 Volt AC or DC. 350 Watts to 35 KW. Write for full particulars.
3 KW 115 VOLT AC 60 CYCLE 26.1 AMP ONAN (Reconditioned) **\$289.00**

Write Our Ham Department
Lou Brenne, W3LE, in charge. Nationally known DX'er and Winner 1939 DX Marathon (Phone Section).

Satisfaction guaranteed Order By Mail. We ship C.O.D. Order to-day.

Send for Special Value Bulletin on our large stock of Radio and Photo Supplies. Tell us your wants.

24 FT. ANTENNA WHIP
3 Screw-in sections, tubular copper-plated steel, with insulated mounting base. Our price **\$9.95**

ANTENNA TOWER BASE INSULATOR
Safe compression load 25 tons. 15" of porcelain insul. Rain and snow cap. Galv. iron hardware **\$29.95**

ANTENNA INSULATOR ASSORTMENT
Consists of antenna strain insulators, transmission line spreaders, stand-off insulators, and antenna insulators. Assmt. worth \$50.00 for..... **\$4.95**

LINEMAN'S SAFETY BELT AND STRAP
State Belt Size **\$5.75**

LINEMAN'S POLE CLIMBERS AND STRAPS
\$4.50

7 CONDUCTOR CABLE #14 STRANDED
600 V insulation. Heavy duty RC. 65 feet long. Russell-Stoll plug #3880 at each end. 3/4" OD. **\$4.95**

AUTO TRANSFORMERS 300 WATT—FULLY ENCLOSED
115/160/170/180 Volts or 115-/140/150/160 Volts, State Voltage Range **\$2.95**

MINE DETECTOR SCR 625
\$49.50 Ideal for locating buried metal, pipes, treasure, metallic fragments in lumber. Approximate depth of detection 6 feet depending on soil conditions. Supplied with batteries and tubes. Tested before shipment. Shipping weight, 70 lbs.





ABELL
Distributing Company
15 E. BIDDLE ST.—BALTIMORE 2, MD.

116

RADIO NEWS

www.americanradiohistory.com

NEW GUARANTEED SURPLUS!!

SYNCHROS

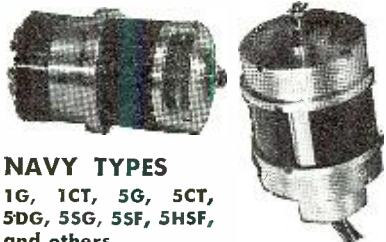

NAVY TYPES

1G, 1CT, 5G, 5CT, 5DG, 5SG, 5SF, 5HSF, and others.

Pioneer Autosyns—AY-1, AY-14, AY-20, AY-30, AY-54, AY-101D, 851, etc.

Kollsman—775-01

G. E. — 2J1F1, 2J1G1, 2J1H1, 2J5HA1, 2J5FB1, 2J6F3, etc.

Size 5 Synchro Generator

Similar to Navy Ordnance type 5G with shaft detail per Army Ordnance Dwg. C-78414. 115 v. 60 cy. Stock #SD-43.

Price \$9.50 ea.

NULL TYPE SYNCHRO INDICATOR



Precision position indicator. Uses Bendix size 5 Selsyn, rectifier tube, transformer, magic eye tube and illuminated 360° dial. Ideal for Hams, labs and experimenters. May be used with SD-43 Synchro Generator. Stock #SD-119. Price \$6.95 each.

Minneapolis - Honeywell Stabilized Aerial Camera Mount. Complete with amplifier, inverter, and carrying case. Stock #SD-9. Price \$125.00 ea.

DC Selsyn System—24 V. DC transmitter and indicator. Indicator calibrated for flap position. 360° dial easily added. Stock #SD-129. Price \$9.50 per system.

Pioneer Magnetic Amplifier Assembly. Saturable core type output transformer. 400 cycle. Operates from plates of 6SN7 to supply 1 phase of servo motor. Stock #SD-44. Price \$8.75 ea.



Remote Position Indicating System



Idle for Ham Beam Position Indicator or industrial uses. 6-12 volts 60 cycles. 5-inch indicator with 0-360° dial. Heavy duty transmitter. Stock #SD-115. Price \$9.95 per system.

SERVO MOTORS

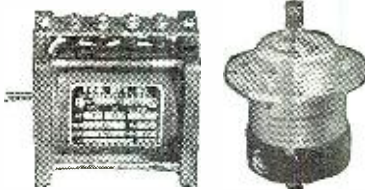

Pioneer—CK-2 and 10047-2-A for 400 cycles.

Diehl—FP-25-3, FPE-25-11 (CDA-211052) and ZP-105-8 (CDA-211-377) for 60 cycles.

400 CYCLE MOTORS

E.A.D. J83. 115 V. 3 phase. Synchronous. 8000 rpm. 2" x 3". Stock #SD-59. Price \$6.75 ea.

E.A.D. J-72B. 115 V. 2 phase induction motor. 4700 rpm. Stock #SD-140. Price \$9.75 ea.



WESTINGHOUSE Type FL Blower

115 V. 400 cy.
17 C.F.M. Includes capacitor.

Stock #SD-144 Price \$6.75 ea.

DC MOTORS

John Oster. Series wound. 27 V. 7,000 rpm. 1/100 H.P. Stock #SD-30. Price \$3.75 ea.

Westinghouse 1171391. 27 V. 6.5 amps. Series-fan cooled. 3" diam. 4½" lg. ⅛ H.P. Cont. Duty. Stock #SD-156. Price \$6.75 ea.

Delco 5069370. 27.5 V. Alnico field. 10,000 rpm. Has straight shaft extension. Stock #SD-16. Price \$4.75 ea.

DC Timing Motor—Haydon ½ rpm. 29 volts, 100 mills. Stock #SD-157. Price \$3.75 ea.

Constant Speed D.C. Motor—G. E. 5BA25MJ24. 24 V. D.C. 7100 rpm. RC noise filter. Stock #SD-100. Price \$8.50 ea.

G.E. 5BC26AC134. 1/20 H.P. Cont. Duty. Reversible. 24 V. @ 3.4 amps. Explosion proof housing. 4½" diam. x 6½" lg. ⅜" shaft, 1¼" lg. Stock #SD-143. Price \$12.50 each.

110 RPM AIRCRAFT MOTOR

G.E. 5BA10AJ18D. 27 V. @ 0.7 amps. 1 oz/ft torque. 1½" diam. x 3½" lg. Operates on AC or DC Stock #SD-98.



Price \$2.95 ea.
Include 15¢ for P.P. and handling

ALL PRICES F.O.B. CLIFTON, N. J.

INVERTERS



Pioneer—12116-5-A, 12117-2-A, 12123-1-A.

Holtzer Cabot—MG-149F, MG-149H, MG-153F.

General Electric—5D21NJ3A.

Leland—10563, PE-218.

Wincharger—PU-7/AP.

Radio Compass Loop LP-21-LM. Stock #SA-99. Price \$9.50 ea.

Phase Shift Capacitor—4 stator single rotor. 0-360° phase shift. Stock #SD-114. Price \$4.75 ea.

Magnesyn—Pioneer CL-3. 6 power. Transmitter or receiver. Stock #SD-6. Price \$3.75 ea.



ACUATOR

Footo Bros. 10801. 1/6th H.P. 24 V. @ 11.5 amps. 5 inch linear travel. Limit Switches.

Stock #SD-161.

Price \$12.50 ea.

60 CYCLE AC MOTORS

G.E. Reversible. 1/150 H.P. Shunt wound. 40 volts 5000 rpm. Split field. Stock #SD-18. Price \$4.75 ea.

Stock #SD-19. Similar to above but not split field. Price \$2.75 ea.

Barber-Colman. 0.001 H.P. wound shaded pole type. Reversible by relay or s.p.d.t. switch. Stock #SD-27. Price \$3.75 ea.

Timing Motor—Haydon 1 rpm. 115 V. A.C. Stock #SD-133. Price \$2.85 ea.

AMPLIDYNES

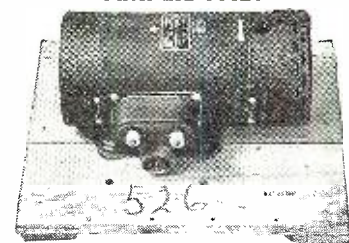

G.E. Aircraft 5AM31-NJ18A. Input 27 V. D.C. @ 44 amps. Output 60 V. DC @ 8.8 amps. max. 530 watts. Stock #SD-111. Price \$14.50 ea.

60 cy. G. E. Amplidyne—5AM45-DB15. Input 115 v. Output 250 v. DC at 0.6 amps. Cont. Duty. Stock #SD-147. Price on request.

Write or call for complete listing.

SERVO-TEK PRODUCTS Co.

INCORPORATED
Surplus Division

ARMory 4-2677

Open account shipments to rated concerns, others may order C.O.D.

PATERSON, N. J.

4 GODWIN AVE.

Something NEW and Different!

LOOP LP-21 RADIO COMPASS INDICATOR ANTENNA



Can be used for small beam rotor. Loop rotated by selsyn motor, also has selsyn indicator trans. for remote indication. Slip ring assy (3). Contacts and rings made of silver. Loop is enclosed in tear drop housing. Wiring diagram for AC operation is included. Used, but tested..... **\$3.95**

SELSYN INDICATOR AND MOTOR

Part of LP-21 Loop. 0-360 calibration on selsyn. Wiring schematic included. Used (tested)..... **\$2.95**



1-82 5" INDICATOR

Radio compass indicator used with selsyns for remote indication. Used (tested) at..... **\$2.95**
New at..... **\$4.95**



SELSYN 2J1G1

Suggested wiring for 110 volt, 60 cycle included. Normally operates from 57 1/2 volts, 400 cycle. Used (tested) Only **\$3.50** per pair

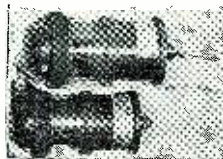

DYNAMOTORS MOBILE USE

9 Volt input; Output 405 volts 85 MA. Also will operate from 6 Volt input; Output 230 Volts 95 MA. Size: **\$3.95**
3"x7" DM 635x...

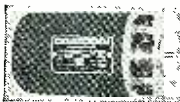

FM TRANSMITTER AND RECEIVER

SCR 608 RADIOSET • FREQ. 27 to 38.9 Mc.
BC 684 Crystal control transmitter. 10 channel preselection, w/10 crystals (one for 10 meters) 30 Watt output.
BC 683 Receiver, 10 tube, 10 preselected channels and manual tuning.
FM 237 Base for mounting trans. & rec. on common base. (Easy for remote operation). Units complete w/ tubes, dynamotors—ready for 12 volt operation. Used and tested.
Transmitter—One Receiver and Mounting..... **\$54.50**
Transmitter—Two Receivers and Mounting..... **\$69.50**

MINIMUM ORDER—\$2.00
Prices are F.O.B., Lima, Ohio
25% DEPOSIT ON C.O.D. ORDERS

ALUMINUM TUBING for Antennas

1 1/4" Dia.	.058 wall	\$.20 per ft.
2" Dia.	.049 wall	.20 per ft.
3/4" Dia.	(3/4")	.13 per ft.
5/8" Dia.	(Telescopes 5/8")	.14 per ft.

Sold in lengths of 12 feet only.
GUY WIRE. Stainless Steel, Stranded
3/32"02 per ft.

WALKIE-TALKIE

BC-222 Frequency Range 25 to 52 Mc. Portable Radiotelephone transmits and receives anywhere in the 28 to 52 Mc. Bank which includes 6 and 10 Meters. Ready to operate. Complete with Handset, Tubes, Schematic, Antenna, and Batteries. Check it before shipped. Reconditioned by Gov't. and Guaranteed... **\$39.50**
New—Guaranteed... **\$49.50**



BC221A* FREQUENCY METERS (*Later Models) Crystal Calibrated

Can be used as signal generator and V.F.O. Crystal calibration. Ranges: 125 K.C. to 20,000 K.C. Complete with Tubes, Crystal, Original Calibration Charts. Every meter tested and guaranteed. Slightly used, but in excellent condition. Stock No. EN 4221—**\$39.50**
Price:.....



COMMAND RECEIVER COMP.

BC 454—3-6 Mc. With Schematic. New..... **\$5.95**
Dual Receiver **\$1.00**
Tack—New.....
Turning Control **.50**
Knobs.....

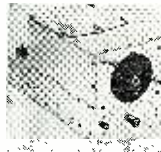

MG-149F 400 CYCLE INVERTER

Used to operate Radio Compasses. Input 24 volt DC; Output 26 volts 400 cycle 250 VA or 115 volt 500 VA. 400 cycle. Used, reconditioned and tested..... **\$9.95**

FAIR RADIO SALES
223 S. MAIN ST. • LIMA, OHIO

competition covered two months of listening during which Art wrote to 160 stations in 70 countries, and at the end of the contest he had verified 87 stations in 70 countries. His veries now total more than 1300.

Radio Nacional Lisboa, Lisbon, Portugal, is reported on a new channel of 11.845 at 1600-1700; heard well in Antwerp, Belgium, but fades badly. (Block, via Stockholm Radio)

Radio SEAC, 15.120, Colombo, Ceylon, has been relaying *Radio Newsreel* from London's BBC 0900. (Foerster, Ill.)

Chinese stations of the National Government are now on Summer Time, making programs *one hour earlier* than in winter and early spring. For example, XGOY's new periods are now at 0600 on 15.170; and at 0800, 1000 on 11.913 and 7.152. The Communist-Controlled outlets still have news 0740 and sign off 0800; use 7.495, 6.580, 6.096, 5.870; also announce 6.050-6.070 but this one has not been heard since XHSR took the air on about 5.870; they do not announce the latter; frequencies actually vary a great deal from those announced. (Bilg, Calif.)

By this time, the British Far East-ern Broadcasting Service, Thomson Road Studios, P.O. Box No. 434, Singapore, Malaya, will probably have been taken over by the BBC, London, according to word received direct from the stations. Heretofore, this service was operated by the British Foreign Office. Two new 100 kw. transmitters are to be erected. An official stated that "since we broadcast so many BBC programs for the Far East, the taking over by BBC will make no difference in our schedules." It was stated the 21.72 channel was dropped because it was unsatisfactory. Schedules were given as 6.77, 0400-1130; 9.69, 0530-1130; 11.73, 0400-1130; 15.30, 0400-1130. News is scheduled for 0405 (headlines), 0450, 0645, 0915, 1100, 1110 (analysis). Takes relays from BBC's Far Eastern, Eastern, and General Overseas Services. Stations are located latitude 1°20'20" North and longitude 103°50' East. The 6.77 transmitter is used to Sumatra, Java, East Indies. Archipelago, 9.69 to Siam, Indo-China, Southern China, 11.73 to Burma, Siam, Indo-China, Southern China, and 15.30 to India, Burma, and East China.

BBC's summer scedules for the Western Hemisphere are listed:

Special Regional Programs—Canada, Newfoundland, United States, Mexico, 0800-0900, GSP, 15.31; 0915-1115, GST, 21.55; 1200-1600, GST, 21.55; 1400-1615, GWG, 15.11; 1745-1815, GWH, 11.80; 1745-1815, GWG, 15.11. North America (West Coast), 1745-1815, GWH, 11.80. West Indies, 1815-1845, GVW, 11.70, and GSO, 15.18.

General Overseas Service—West In-

RADAR TECHNICIANS—WANTED

FOR OVERSEAS ASSIGNMENTS:

Technical Qualifications:

- At least 3 years practical experience installation and maintenance.
- Navy veterans ETM 1/c or higher.
- Army veterans TECH/SGT or higher.

Personal Qualifications:

- Age over 22—Must pass physical examination.
- Ability to assume responsibility.
- Must stand thorough character investigation.
- Willing to go overseas for 1 year.

Base pay, bonus, living allowance, vacation, add up to \$7,000.00 per year.
Permanent connection with company possible.

APPLY BY WRITING TO
R-45 P.O. BOX 3495 PHILADELPHIA 22, PA.

Give complete history of your experience, particularly in radar maintenance. Interview will be arranged for successful applicants.

dies, Central America, South America (North of Amazon), 1215-1600, GVR, 21.675; 1600-1815, GVW, 11.70; 1600-1815, GSO, 15.18; 1845-1915, GSO, 15.18; 1845-2215, GVW, 11.70; 1930-2215, GSC, 9.58. South America (South of Amazon), 0600-0615, GVT, 21.75; 1100-1615, GVS, 21.71; 1615-1915, GSF, 15.14; 1615-2215, GSD, 11.75; 1930-2215, GSC, 9.58. Canada, Newfoundland, United States, Mexico, 0600-0800, GSP, 15.31; 1615-1745, GWH, 11.80; 16-15-1745, GWG, 15.11; 1815-1915, GWG, 15.11; 1815-2215, GWH, 11.80; 1930-2215, GRH, 9.825. North America (West Coast), 1615-1745, GWH, 11.80; 1815-2145, GWH, 11.80; 1930-2215, GSB, 9.51.

BBC's Latin-American Service in Portuguese is scheduled for the region South of Amazon at 1700-2030, GSN, 11.82, GSP, 15.31; in Spanish, 1700-2100, GRD, 15.45, at 1700-2230, GSE, 11.86, and 2100-2245, GRY, 9.60. For region North of Amazon, in Portuguese, 1700-2030, GSN, 11.82, GSP, 15.31; in Spanish, 1800-2100, GRD, 15.45; 1800-2230, GRF, 12.095, and 2100-2245, GVZ, 9.64.

Stockholm's SBT, 15.155, is noted in California with fine signal, 0140-0400. (Balbi)

Chile's CE1185, listed 11.850 but may be as high as 11.865 at times, recently has been signing off 2100; formerly ran to 2300. (Stark, Texas)

On weekdays, Sweden's SBT, 15.155, and SDB-2, 10.780, have news bulletins in *English*, French, and German, beginning at 1230. (Stockholm Radio) Usually, SBT sends a good signal to Eastern North America. The period to North America on these stations is currently at 0900-1000, with news shortly after beginning of the transmission; the program for Swedes abroad is now 1900-2000 on these outlets, news near start of period.

According to Skoog, Sweden, *Radio Sumatra* lately has been "strolling along the 41-m. band," around 7.260; sometimes they open at 1830, but have been heard earlier at times.

Block, Belgium, reports "*Radio Venezia Guiglia*," location appears unknown, on 6.430 around 1615 with musical selections. (Stockholm Radio) This station was reported to *ISW* sometime ago by Peddle, Newfoundland, and others.

The Santa Cruz de Tenerife station, Canary Islands, can be heard on 7.275, at times badly jammed; reported around 1800 to 1820 or 1830. (Stockholm, Radio)

YHN, listed 10.842 but actually approximately 10.851, "Voice of Free Indonesia," is heard in Texas in a transmission around 1715-1930; has *English* at 1800, 1900. (Stark)

SVW, 15.905, Athens, Greece, is a new Cable and Wireless outlet heard July, 1948

PROJECTION TELEVISION!

CONVERT YOUR RCA 630 OR CROSELY 307 TO THIS AMAZING TELEVISION CONVERSION OF 1948!

The gigantic picture this set projects must be seen to be believed! One set converted by a Los Angeles company was demonstrated at the Shriner's Temple during the Rose Bowl game. It was seen by 4800 people at one sitting! A 12 x 16 foot rear projection plastic screen of our type was used.

The complete kit for RCA 630 or Crosley 307 conversion—less chassis—includes necessary condensers, resistors, RF power supply, kinescope tube, lens, stand, front plate, ring for mounting lens and full instructions.

\$336⁹⁵

Net Price, Complete

F 1.9 TELEVISION PROJECTION LENS

Dimensions: Length 7", Diameter 4 1/4"

F 1.9 EF. 5 in. (127.0 mm). This lens incorporates in barrel a corrective lens for use with a 5TP4 projection tube. It is easily removable for use with flat type tubes. Lens can be utilized to project picture sizes from several inches to 7 x 9 feet. Made by Bausch & Lomb Optical Co.

Net Price

Mounting ring available for above lens



G. E., Philco, Transvision, etc. — practically any set using electro-magnetic deflection can be converted to Projection Television.



5TP4 PROJECTION KINESCOPE TUBE

Features a metal backed white fluorescent screen having high brightness and contrast. Net Price

\$67.50



30 KV RF POWER SUPPLY

Dimensions: Length 14", Width 11", Height 11 1/4"

New improved unit of exceptional regulation. Has a focus control pot built in for use with 5TP4 Tube. Voltage variable from 27 to 30 KV. Supply utilizes 6 tubes. Net Price, including DC Power Supply

\$99.50

Also available with voltages up to 60 KV. Write for information, stating your requirements.

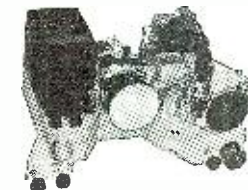

PROJECTION TELEVISION CHASSIS

This outstanding set using famous 630 circuit is a modified version to accommodate 5TP4 Projection Tube. The intense source of light on the face of the projection tube enables set to project pictures onto screens of sufficient size to be utilized by auditoriums and small theaters. FEATURES: Set, less 30 KV RF Power Supply, contains 30 tubes. Full 13 channel coverage; FM sound system; A-F-C horizontal hold; stabilized vertical hold; 2 stages of video amplification voice saturation circuits; three stage sync separator and clipper; four mc. band width for picture channel. Exclusive Cutout Relay to protect projection kinescope in the event of sweep failures!

Net Price—Chassis Only (Includes all tubes less projection tube shown above)

\$340.00

Chassis as above, but designed for 10" or 15" tube use, relay circuit not included. Set complete less kinescope ready to operate—

Net Price **\$298.00**



HIGH VOLTAGE COIL

Complete with diagram for 10 KV and 30 KV tripler circuit. Same type used in our power supply.

Net Price **\$7.75**



HIGH VOLTAGE METER—0 to 30 KV

An accurate High Voltage Meter that's a necessity for television service men, laboratory technicians and experimenters. An absolute must for projection television work!

A precision-made instrument with range from 0 to 30 KV, has 4" scale and only draws 20 microamps. Bakelite meter panel housed in solid oak cabinet. Meter has jack connector for convenient connection to oscilloscope in checking voltage wave forms. Net price

\$67.50

Send for FREE complete technical information and details.

STAND FOR PROJECTION TELEVISION SETS
Dimensions: Height 23", Width 25", Depth 18 1/2".
For use with RCA 630 chassis or Crosley table model sets. Unit mounted on ball bearing soft tread wheels. Depth is designed to accommodate RF Power Supply. Open grill allows free circulation of air. This stand a natural for mounting scopes and other lab. equipment for easy mobility. Specify whether for Television use or shop. Stand as shown in top photo.
Net Price **\$31.50**

NEW REAR PROJECTION PLASTIC TELEVISION SCREENS
The screen surface consists of a conglomerate arrangement of microscopic plastic crystals that "Pin Point" the projected image providing unexcelled angular viewing with a minimum loss of projected light. It is estimated that there is a loss of approximately 10% of light viewing the image at 45 degrees off center.
Light transmission percentages are controlled to obtain the maximum efficiency of the television optical projection system.
The percentage of 80% of transmission has been determined as that providing maximum efficiency. Stock sheets are available from 3x4 feet down. Specify inside dimensions of screen desired. If larger sizes are required, they can be made to order.
Net price of Rear Projection Screen, per sq. foot **\$3.00**

FRONT PROJECTION SCREENS	
High Efficiency, Crystal Beaded Roll-up Type.	
Size	Price
30"x40"	\$10.00
37"x50"	14.00
45"x60"	20.00
52"x72"	25.00
5'x7'	40.00
6'x8'	62.00
7'x9'	78.00

RCA PROJECTION TELEVISION COMPONENTS
Send for FREE Catalog "A" of complete line—including diagrams of major television sets.

Include 25% Deposit With Order, Balance C.O.D.

PIONEERS IN PROJECTION TELEVISION
SPELLMAN TELEVISION CO., INC.
DEPT. A, 130 WEST 24th STREET, NEW YORK 11, N. Y. • WAtkins 4-3721

For added sales
(and profits!)



demonstrate

the amazing Shockproof

nylon needle*

by

DUOTONE

Actually b-o-u-n-c-e the whole
tone arm on a record without
effect. A spring steel shaft and
nylon elbow—that is the secret!

\$2.50

LIST

*pat. pending



Just off the Press!
1948 Radolek RADIO PROFIT GUIDE



NEW
COMPLETE
RADIO
PROFIT
GUIDE
FREE

Radio Repair Parts • Tools
Sound Systems • Tubes
Phono Equipment & Supplies
Test Instruments • Etc.

Big, new ENLARGED complete catalog
showing thousands of Radio Bargains sent
to you immediately. Helpful, money-sav-
ing buying information. Send coupon today!

BIG VALUES, LARGE STOCKS,
FAST, DEPENDABLE SERVICE.

FREE...SEND TODAY

RADOLEK CO., Dept. B-078
501 W. Randolph St., Chicago 6, Ill.
Please send your Free Profit Guide Catalog and
regular Supplements.

Name
Address
City Zone State

SAVE AT RADOLEK

around 1645-1720 in parallel with SVR,
13.670, with reports to American net-
works; strong signal. (Kary, Pa.) •

A letter from the manager of *Radio Monte-Carlo*, Monaco, confirms that the new 25 kw. station is operating on 6.035 (49.71 m.) at 0130-0300, 0600-0800, 1300-1715. Reception reports desired. It was stated that by July a second short-wave station of 25 kw. will be put into operation in either the 25 or 31-m. band. The medium-wave outlet on 731 kc. (410 m.) will increase power from 10 kw. to 120 kw. about the same time, officials stated.

Laubscher, Sou. Africa, flashes that Lourenco Marques, Mozambique, has changed schedules recently. *English* programs are now radiated weekdays 0700-1000, CR7BE, 9.715; 1100-1700, CR7BV, 4.915, and CR7AB, 3.490; Sundays, 0400-1000, CR7BE; 1000-1600, CR7BV, CR7AB. The Portuguese program on 4.825 was off for some days early this spring but appears to have been resumed now; is scheduled 1100-1500 on 4.825 and 9.645; on Thursdays usually runs later, to around 1530.

Radio Dakar, on new frequency of 15.624, has been heard in California as late as 1800 sign-off. (Dilg)

A station heard in French on approximately 6.035 (not *Radio Monte Carlo*) to 0700 sign-off may be *Radio Cambode*, French Indo-China; does not play "La Marseillaise" at close; plays some Western recordings, rather old ones. (Dilg, Calif.)

Bandoeng's 7.997 and 10.060 (approx.) have been heard recently in California on Monday (mornings). Just below the 7.997 channel is a Soviet station (about 7.995) that has been identified as Ulan-Ude, which is in dual with 5.265; the 7.995 Soviet has a strong signal, mornings. (Dilg, Calif.) Ulan-Ude is in Buryat Monol S.S.R.

At times, *Radio SEAC's* 9.520 and 15.120 appear to have separate programs; both carry same news at 0900, however. (Dilg, Calif.) The 9.520 outlet is heard at times here in West Virginia, peaking around 0630; the 15.120 outlet is normally best.

Radio El Mundo, Buenos Aires, Argentina, informs that LRU is "back on the air after a silence of several years," broadcasting on 15.280 (19.62 m.) daily 1400-1800 Argentine time (probably 1300-1700 EST).

Prague's OLR5B, 15.320, is good opening 0945 with a few trumpet notes from Josef Suk's "New Life," and then relaying Prague II; appears to run to 1020 or 1030 sign-off; all Czech-Slovak.

Late tips airmailed from Britain by Pearce include—*Omdurman Calling*, 13.320, Anglo-Egyptian Sudan, heard with *English* programs on Fridays only, 1230-1300; opens with theme, "Col. Bogey's March." LKJ, 9.54. Oslo, Nor-

way, heard from 1000 on Sundays; also heard Sunday mornings at 0245 with *English* lesson. Warsaw has been heard testing on approximately 11.710 to 0800; generally closes at 0720, however no *English* but has frequent interval signal. Station wrote Pearce these are technical tests by Warsaw III. Late schedules received from *Danske Brigade Radio*, 6.225, Germany, are 0700-0800, 1000-1200, and 1400-1500; say is still experimental. *Emissora Nacional*, Lisbon, noted with program for Brazil, Cape Verde Islands (in Portuguese), signing on at 1600 on new frequency of approximately 11.840. *Radio Dacia Romana*, 9.253, Bucharest, Roumania, is scheduled with a program in *English* at 1400-1430 in parallel with *Radio Romana Libera* on approximately 6.200; announces 48.3 m. and asks for reports. The new Paris transmitter on 10.230 is in parallel with 6.200 at 0615-0920. *Radio Innsbruck*, Austria, is heard in Britain on approximately 6.000, mostly in German, but carries French news, relayed from Paris, daily 0200. Tashkent, 6.820, is heard on Sundays to India at 1200-1230, at least partly in *English* (news, commentaries); announces that the Tashkent Radio Broadcasting Committee presents programs three times a week—Sundays, Wednesdays, Fridays 2230 Indian Standard Time (1200 EST). Warsaw's 6.215 outlet now has news daily 1430-1500. Prague's *English* programs are now at 1245 on 11.760; 1445 and 1645 on 9.553. *Radio Tirana*, 7.852, ZAA, Albania, has again changed time of news, to 1515. Leopoldville's beam to Britain and British Colonies in Africa is now 1430-1530, news at start; frequency is 9.768. Berlin's 6.072 outlet is heard afternoons (in Britain, would be mornings in America). Belgrade's 6.107 outlet still has news 1530. The Broadcasting Corporation of Japan, Tokyo, verified by letter; stated they do not have verification cards "because of the present limited purposes of our short-wave transmissions." *Radio Italiana* now has an *English* broadcast for Sou. Africa at 1600-1615 on 9.630, 6.085.

Late tips broadcast by *Radio Australia* include these—*Radio Noumea*, New Caledonia, appears to have moved to about 6.000, runs to 0500 closedown; *Radio Malaya*, Singapore, 7.200 (or 6.120?), and *Radio Kuala Lumpur*, 6.025, run weekdays 2330-0130, 0530-1100, Saturdays and Sundays continuously 2330-1100; the 4.825 outlet in Singapore is used from 0530 to around 1030. PCJ's new 21.480 outlet has been heard in Australia at 0545. *Radio Cambode*, approximately 6.035, French Indo-China, is being heard in Australia by Sander-son from 0600; news in French at 0600 then Asiatic-type music to around 0630, when plays Western music.

CATHODE RAY TUBES
5BP1 . . . 1.20



3BP1—\$1.25 5FP2—\$1.75
3BP7—\$1.20 5JP2—\$4.00
5" CR tube viewing hoods, leather. . . . \$1.79

POWER TRANSFORMERS

Plato Transformer. Pri: 220 v, 60 cy, 3 Phase, 30 KVA. Sec: 6130, 5620, 5050, 4500 volts. Oil filled, 89 gal. Size: 34"x32"x23". Amertran. Approx. wt. 1500 lbs. \$250.00
#5108: Pri: 117 v, 60 cy, Sec: 50 or 46 v, 200 ma, 5 v, @ 2.4 amps, 5 v @ 1.2 amps. . . \$2.50
#5111: Pri: 117 v, 60 cy, Sec: 300 v @ 42 ma, 55 v @ 125 ma, 45 v @ 35 ma. \$2.45
Plate Xfmr: Pri: 230 vac, 50-60 cy, 1 Phase, 8.5 KVA. Sec: 5450 v, 1.4 amp, Amertran. Size: 15 1/2"x16 1/2"x25". Composition filled. Wt. 500 lbs. \$125.00
Plato Transformer, Amertran. Pri: 117 v, 60 cy, 1 Phase. Sec: 17,000 v, 144 ma. oil immersed. With choke, 250 h, 100 ma. 4000 hy @ 0 ma. 26"x29"x13". \$65.00
Step-Down or Isolation Xfmr, Amertran. Pri: 440/220/110 v.a.c., 60 cycles, 3 KVA. Sec: 115 volts, 2500 volt insulation. Size: 12"x12"x7". \$40.00
Auto-Xfmr: Input 115 v, 60 cy. Sec: 78 v, .0075 KVA. GE67G997 3"x3"x2". \$2.00

FILAMENT TRANSFORMERS

#5058: Pri: 117 v, 60 cy, Sec: 6.3 vet, 2 amps, 6.3 vet, 2 amps. \$2.25
Pri: 115 v, 50 to 60 cy (Sec: 6.3 v, 6.6 amp CT \$2.65
Pri: 117 v, 60 cy, sec: 4v, 16 amps, 2.5 v, 1.75 amps \$3.50
Fil. Xfmr for 872, with socket mounted atop. Pri: 115 v, 60 cy, sec: 5 v, 10 amps, 25KV test. \$12.00
Plate Xfmr: Pri: 115/230 v, 50-60 cy. Sec: 21,000 v, 100 ma. \$145.00
Plate Xfmr: Pri: 115 v, 400 cy. Sec: 9800 v, or 8600 v, @ 32 ma, d.c. \$12.50

REGULATORS

Line Voltage Reg 2 KW Saturable reactor type Pri 95-130 v 60 cy Sec 115 v 60 cy, 17.4 A 2 Kw 100% PF \$160.00
Line Voltage Reg Pri 92-138v 57/63 cy 16H15A Sec 115 v 7.15A .32 Kw 96% PF. . . . \$135.00

POWER CHOKES

6 Hy @ 150 ma \$1.50
1 Hy @ 800 Ma 7.5 Ohms \$8.95
Dual Choke: 2-2 Hy @ 100 ma. \$.75
Dual Choke: 7 Hy @ 75 Ma, 11 Hy @ 60 Ma. \$1.50
8.5 h @ 125 ma. \$1.50
25 h @ 65 ma. \$1.10
5 hy, 40 ma, 312 ohms, 2,000 v test. 2"x2"x 1 1/2" \$.65
2 hy, 200 ma, 102 ohms 2500 v test. . . . \$.85
Dual 2.5 hy, 130 ma. \$1.15

OIL CAPACITORS

.1 mfd, 10 KVDC, GEPR #14F101. . . \$15.00
.06 mfd, 15 KVDC, GEPR 25F53-GT. \$ 8.70
1.5 mfd, 6000 vdc, Acrovox \$12.50
.25 mfd, 20,000 vdc \$17.50
.5 mfd, 2000 vac, 180 cy, GEPR 25F649. \$ 5.50
10 mfd, 1,000 VDC \$ 1.79
3x10 mfd, delta connected synchro-capacitor, 90 v, 60 cycles, GE. \$ 4.95
2x.1 mfd, 4800 vdc, GEPR 25F813. . . . \$ 2.95
.1 mfd, 6000 vdc, GEPR 25F509G2. . . . \$ 3.85

MICA

STANDARD BRAND

.08 mf @ 1500 VDC, MX 60 \$11.50
.03 mf @ 2000 VDC, 551A-50 \$12.75
.045 mf @ 2000 VDC, G1 \$12.75
.00015 mf @ 20 KV, 1970-404 \$25.00
.0001 mf @ 20 KV, G3 \$25.00
.006 mf @ 10 KV, G3 \$17.50
Isolating Capacitor, PL 1417, 406-110 mmf @ 10 KV AC (peak) Each \$ 3.50

CROSS POINTER INDICATOR

Two 0-200 microampere movements, 3" case, many applications \$2.50



All merchandise guaranteed. Mail orders promptly filled. All prices, F.O.B. New York City. Send Money Order or Check. Shipping charges sent C.O.D.

COMMUNICATIONS EQUIPMENT CO.

131 "N" Liberty St., New York City 7, N. Y.

Digby 9-4124

THERMISTORS
(\$.95 ea.)

Western Electric
D-167332 (Bead)
D-170296 (Bead)
D-168392 (Button)
D-168391 (Bead)

GREATEST VALUES



LOWEST PRICES

ARC-5 ACCESSORIES
CONVERSION COILS FOR ARC-5 TRANSMITTERS

M.O. Coils	P.A. Coils	Antenna Loading Coils	Freq. Range
\$1.00 each	\$1.00 each	\$.85 each	
#6029	#7247	#6033	3-4 Mc.
#6030	#9293	#6034	4-5.3 Mc.
#6032		#6035	7-9.1 Mc.

CONVERSION KIT, consisting of 1-M-O coil, 1-P.A. coil, 1-ANTENNA COIL, in any one particular frequency range \$2.00
Dual mtg. racks (retr.) \$1.50
ARC No. 6558 variable receiving capacitor, 62 mmf/section, 3 sections, .03" spacing, 8 rotors. Worm drive ratio 33:1 \$1.75
ARC No. 4990, variable xmtg capacitor, 22.4-145 mmf, .05" spacing, 11 rotors. Each \$1.00
ARC 5632 Var. Xmtg. capacitor, 29.2-117 mmf, .06" spacing, 16 rotors, worm drive: 96:1 \$1.00
Single rrvr. mtg. racks \$1.00
Dual mtg. racks (retr.) \$1.50
Single Shock mounts for rack \$1.50
DUAL CONTROL BOXES FOR RCVRs. \$.50
Modulation Trans, ARC #9466, push pull 807's to Plates and screens of 2 807's in parallel. \$1.65
Screen Mod. Xfmr for SCR 274-N modulators. . . . \$1.00

THIS MONTH'S SPECIALS

24 VOLT AUTO-TRANSFORMER. Input: 117 v, 60 cy. Output: 24 volts, 5 amps. Size: 5"x5"x4 1/2". Hermetically sealed \$3.25
UNIVERSAL PLATE XFMR: Input: (Using vibrator) 6, 12, 24, 110 v. OR 110/230 v, 60 cy. Sec: 420 vct, 30 ma, 6.3 v, 0.9 amp. 4"x4 1/2"x3". Completely shielded. . . \$2.50
POWER PAIR: Trans and choke. Xfmr. pri: 117 v, 50-60 cy. Output: 470 vct @ 60 ma, 6.3 v @ 1.65 amp, 5 v @ 2 amp. PLUS a 6 hy @ 50 ma. choke. \$1.75

MICROWAVE TUBES

Tube	(Magnetrons)	Freq. Range	Pk. Pwr. Out.	Price
2J31		2820-2860 mc	285 Kw	\$15.00
2J31-A (725-A)		9345-9405 mc	50 Kw	\$25.00
2J32		3267-3333 mc	265 Kw	\$15.00
2J36		2992-3019 mc	275 Kw	\$15.00
2J37		2965-2992 mc	275 Kw	\$15.00
2J31		2820-2860 mc	285 Kw	\$15.00
2J32		2780-2820 mc	285 Kw	\$15.00
2J38	PKG.	3249-3263 mc	5 Kw	\$25.00
2J39	PKG.	3267-3333 mc	8.7 Kw	\$25.00
2J55	PKG.	9345-9405 mc	50 Kw	\$25.00
3J31		24,000 mc	35 Kw	\$17.50
W.E. 700-A		680-710 mc	100 Kw	\$30.00
W.E. 720-BY		2800	1000 Kw	\$25.00

MAGNETS for 2J31-A (725-A), 2J32, 2J36, 2J37, 2J31, 2J32 and 3J31, each \$8.00
Field Strength Distance Between Pole Faces Pole Diameter Price
(Gauss) (inches) (inches)
4850 5/8" 3/4" \$8.00
1500 1 1/2" 1 1/2" \$8.00
1000 Adjustable 2 1/2" \$12.00
(Electromagnet) 2 3/8" to 3" \$7.75
Klystron—2K25-725A/B \$20.00
Klystron, 707-B \$20.00

MICROWAVE TEST EQUIPMENT

10 cm. waveguide switching unit, switches 1 input to any of 3 outputs. Standard 1 1/2"x3 1/2" guide with square flanges. Complete with 115 vac or dc arranged switching motor. Mfg. Eastheon. New and complete \$135.00
10 CM. WAVEMETER. Model "SL". Micrometer adjust cavity with microammeter resonance indicator. Includes 115 VAC operation converter section. In grey metal carrying case, complete with cables & spares. Made by Western Electric \$135.00
W.E. I 138 A. Signal generator, 2700-2900 Mc. range. Light-house tube oscillator with attenuator & output meter. 115 VAC input, reg. Pwr. supply. With circuit diagram. \$50.00
10 cm oscillator cavity for 2C40 lighthouse tube, with attenuator, thermistor, pickup loop. Heavy silver-plated casting \$50.00
TS-238 GP. 10 cm. Echo box with resonance indicator and micrometer adjust cavity \$85.00
3 cm. absorption type wavemeter, micrometer head, mounted on, but removable from, "Bell" guide \$65.00
3 cm. wavemeter; transmission type 9200-11000 mc with square flanges \$15.00
3 cm. stabilizer cavity, transmission type \$20.00
3 cm. wavemeter. Micrometer head mounted on "X" Band guide. Freq. range approx. 7900 to 10,000 mc. \$75.00
Direct reading VSWR meter. Complete with amplifier, holo-meter input-AC crystal-dc crystal connections. \$45.00
A COMPLETE LINE OF 10 CM, 3 CM, 1.25 CM EQUIPMENT IN STOCK. SEND FOR MICROWAVE FLYER.

DYNAMOTORS

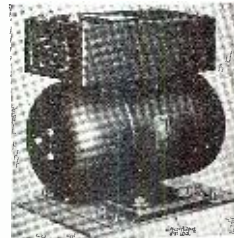

PE 73 CM (G.E.) Power supply for BC 375 Input: 28 VDC Output: 1000 VDC @ 350 Ma. New \$4.95
BD 77KM Power Supply for BC 191 with spare fuse links, etc. Input 14 v.d.c. Output 1000 v @ 350 ma. New \$9.95
Used, excellent condition \$5.95
MFRS: Write for quantity prices and discounts on above items.
PE 101-C input 13/26 VDC @ 12.6/6.3 A. Output: 400 VDC @ 135 Ma., 800 VDC @ 20 Ma. 9 VAC @ 1.12 A. new \$3.49
PE 86 N. Input: 28 VDC, Output: 250 VDC @ 60 ma. \$1.95
DAG 33A Input: 18 VDC @ 3.2 A. Output: 450 VDC @ 60 Ma. \$2.45
DM 33: Input 28 VDC @ 7 a. Output: 540 VDC @ 250 Ma. Power supply for SCR 274 modulator \$3.95
DM 23350: Input: 27VDC @ 1.75 A. Output: 285 VDC @ 75 Ma. \$3.50
DM 21: Input: 14 VDC. Output 235 VDC @ 90 Ma. Power supply for BC 312 \$2.49
PE 55. Input: 12 vdc @ 25 amp. Output 500 vdc @ 400 ma. (slightly used) ex. cond. \$4.95
MP 10 G Power supply, using 2 dynamotors. Input: 24-28 vdc. Output: 1000 vdc @ 400 ma. 250 vdc @ 100 ma. New, complete with relays, filters, etc. BENDIX \$40.00
B-19 power pack (dynamotor). Input: 12 vdc @ 9.4 amp. Output: 275 vdc @ 110 ma. 300 vdc @ 50 ma. New, complete in metal case with 2 plugs, filters, etc. \$6.95
DM 28-R. Input: 28 v.d.c. @ 1.25 amp. Output: 270 v.d.c. @ 70 ma. New, with enclosed terminal box. \$3.25
ZA/USA .0515. Input 12/24 v.d.c. @ 4/2 amp. Output: 500 v.d.c. @ 50 ma. Compact square shape, size: 7 1/2"x4 1/2"x3" \$3.95
ZA/USA .0518. Input: 12/24 v.d.c. @ 8/4 amp. Output: 275 v.d.c. @ 110 ma. 12 v.d.c. @ 3 amp. Compact Square, size: 7 1/2"x4 1/2"x3" \$4.25
DM-25: In 12VDC 2.3A Out 250VDC 60 ma. . . . \$2.49
DM-42: In 14VDC. Out 515/1030 VDC 215/260 ma. and 2/8VDC \$9.95

INVERTERS
PE 206-A. Input: 28 v.d.c. @ 38 Amp. Output: 80 volts @ 500 volt-amp, 800 cy. Leland Electric. New, complete with instruction book, relays, filters, etc. \$12.50
PE 218—Input: 25-28 v.d.c. @ 92 amp. Output: 115 volts, 1500 volt-amps, 380/500 cy. Leland Electric. Used, good condition. \$20.00

HAND GENERATORS
GN 35: Output: 350 v, 60 ma, 8 v, 2.5 amp. less hand crank \$3.50
Gn 45: Output: 500 v, 100 ma, 6 v, 3 amp. less hand crank \$4.15
Selsyns, 115 v, 60 cy, size 5 Per pair \$7.75

RELAYS

Keofing Relay: Leach 107, high speed keying relay, 4-12 vdc SPST contacts 500 watts \$2.15
SD #TD97-1, SPDT, Contacts 12 v, 1 amp, 30 sec. thermal delay, 12 volt coil \$1.45
DPST, (normally open), 5-7.3 vac, 60 cycles, contacts 110 v, 60 cy, 10 amps Wheelock . . . \$2.35
4PST (normally open), 75 VDC, contacts: 115 vdc, 4 amp. SD #3DXX108 \$1.75
SPDT, 21 vdc, 9,000 ohms. Contacts 115 v, 1 amp. Balanced armature type, Allied Control . . \$1.15
SPDT, 115 v, 60 cycles, 4000 ohms DCR, contacts: 5 amp, 50 v Kurman #2221-90 . . . \$1.95
SPST, 24-28 vdc, Heavy duty contactor, 400 amps, Leach 7220-24 \$1.20
DPDT, 24 vdc, antenna changeover, Leach 1077-BF \$1.15

MINIATURE RELAYS
4PDT, 22-28 vdc, 350 ohms DCR. \$.65
4PST, 22-28 vdc, 300 ohms DCR. \$.55
DPDT, 22-28 vdc, 300 ohms. \$.45
SPDT, 24-28 vdc, 300 ohms \$.45
SPST, 22-28 vdc \$.40
6PST, 22-28 vdc \$.60
SEND FOR COMPLETE LISTING OF W. E. TELEPHONE RELAYS IN STOCK.



Better Products for the Radio Industry

NEW G-C STATIC CHASER INJECTOR and POWDER

Tire static powder kits — improve auto radio reception. Eliminates wheel static interference.

New powder is blown into all inner tubes — easy to use. For every car owner!

- No. 5604 Injector for G-C Static Powder—List \$1.50
- No. 5605—G-C Static Powder Packet for 5 tires—List \$1.00
- No. 5606—Kit—One Powder Packet and Injector—List \$2.50

NEW G-C MINIATURE TUBE PIN STRAIGHTENER

Every Radio Man needs a tube pin straightener for the new miniature glass tubes. Each man should have 2 for 3—one to carry with him and several fastened to his bench.

- No. 5191—List \$1.00



Have you seen the new G-C "Speedex" Wire Strippers . . . write for illustrated literature.

RADIO DIVISION, DEPT. H

NEW G-C TUBE PULLER

Makes it easy to remove or insert miniature tubes — simple to operate. Inserts or extracts tubes where fingers will not reach — into hard-to-reach places. Saves time and money. Ends tube breakage. Prevents burnt fingers.

- No. 5093—Miniature Puller . . . List \$ 1.65
- No. 5093-D—Display of 12 . . . List 19.80

NEW G-C FIELD CHASS EZ

Holds almost any radio chassis in position! Has special reversible hooks for flanged type chassis or, to tilt chassis back if necessary. Made with slide adjustment—takes only 5 seconds to install. No parts to lose—will never wear out. A real convenience for the radio serviceman!

- No. 5207—Chass Ez . . . List \$3.65

G-C Products are available at leading distributors. Write for your copy of our new illustrated catalog.

GENERAL CEMENT Mfg. Co., Rockford, Ill., U.S.A.

Manufacturers of over 3,000 products • Sales offices in principal cities



"Highly Satisfactory"

Says FM Broadcast Station

Eliminates Noise In Reception. Low Cost V Dipole Type Proving Popular In Installations

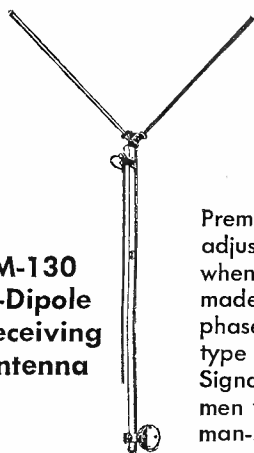

FM-130 V-Dipole Receiving Antenna

A Chief Engineer reports: "... set up several unfavorable locations where man-made electrical noises abounded, and we found that the 3d dimensional adjustment in the dipole arms helped considerably to reduce noises . . ."

Premax V Dipole Antennas are designed to permit adjustment of the angle for strongest reception and, when the proper vertical or horizontal adjustments are made the "direct" and "reflected" signals combine in phase, thereby increasing the received signal. This type of Antenna will insure proper reception of FM Signals and is being adopted by dealers and service men who have been seeking some way to counteract man-made electrical noise in receiving sets.

Write for special Bulletin FMT-148, telling why an Adjustable V Antenna is best for FM and TV.

Premax Products

Div. Chisholm-Ryder Co., Inc.

4813 Highland Ave. Niagara Falls, N. Y.

The *Broadcaster*, Perth, Western Australia, describes the long-awaited New Zealand overseas transmitters as follows: "They use a high-level modulated final amplifier. Each transmitter radiates at 7.5 kw.; antenna system has four horizontal three-wire Kraus radiators with reflectors." At deadline, these stations have not been reported as on the air yet, although tests many months ago were quite successful.

Bucharest, Roumania, appears to now be using 11.900 in addition to other channels. (Bostedt, Norway)

Prague verified its 11.840 recently for Kary, Pa., for report sent after change in Government was effected in Czechoslovakia; stated call as OLR₅A although 11.840 is listed as OLR₄A.

Tips just in from Peddle, Newfoundland, include those below:

CR6RN, 9.475, CR6RL, 15.895V, Angola, are heard 1330-1600; CSX2, 4.845, Azores, heard 1800-1900; Omdurman, 13.320, Anglo-Egyptian Sudan, heard around 1200-1430 sign off; Sofia, Bulgaria, heard on 9.350 with *English*, 1515-1535; Brussels, 17.845, heard in French, 0800-0815; schedules received from Brussels are listed on 17.845 for 1100-1200, 1600-1700; FIA, 7.950, Douala, Cameroons, heard 1330-1500 sign-off; Rabat, Morocco, heard on 9.082 at 1415-1730, on 16.666 at 0745-0815 or later, and on 6.01, very poor, late afternoons; OZI, 5.942, Godthaab, Greenland, through bad CWQRM, 1700-1745; Batavia outlets in *English* at 1200-1230 on 17.630 and 19.345; Beirut, Lebanon, 8.020V, 0000-0100 and 1345-1600 or sometimes to 1630; Luxembourg, 6.090, 1415-1445; Fort-de-France, 9.705, Martinique, is heard only occasionally evenings through heavy QRM from a U.S. outlet; latest schedules of VONH, 5.970, St. John's, Newfoundland, are Sundays 1030-1615, 1700-2200, Thursdays 0830-1300, 1615-2200, other days 0830-1230, 1615-2200.

Radio Makassar, 9.55, Celebes, was heard in California recently on a Wednesday ending an *English* period at 0730. (Dilg)

-50-



"White man says Congo static terrific . . . would we relay traffic!"

CRYSTALS

In the greatest purchase of radio transmitting crystals ever made by one wholesaler in the history of the Radio Parts Industry, Sun Radio acquired title to over a half million dollars (\$500,000.00) of Army Surplus, precision built, exactly tooled crystals in moisture proof holders which are shock mounted. Please note that crystal shipments of 6 or less are packed in cloth containers to expedite handling. . . . No worry because all crystals are shock mounted and guaranteed delivered perfect. All crystals have Army MC harmonic ratings but Sun encloses directions for deriving the correct fundamental frequency in kilocycles.

CRYSTALS WITH A MILLION USES

Fractions Omitted											
kc	kc	kc	kc	kc	kc	kc	kc	kc	kc	kc	kc
412	420	429	437	445	462	469	479	490	497	506	516
413	422	430	438	446	463	470	481	491	498	507	518
414	423	431	440	447	466	472	483	492	501	508	519
415	424	433	441	448	468	473	484	493	502	509	522
416	425	434	442	451	474	485	494	503	511	523	
418	426	435	443	453	475	487	495	504	512		
419	427	436	444		477	488	496	505	515		

49¢ each

I.F. Frequency Standards			Crystal Frequency Standards			For Crystal Controlled Signal Generators		
kc	kc	kc	kc	kc	kc	525kc	525kc	525kc
450	454,166	461,111	98,356kc			526,388	531,944	536,111
451,388	455,556	464,815	Easily altered for 100 kc Standard, Mounted in low loss 3 prong hldr.			527,777	533,333	537,509
452,777	459,259	465,277				529,166	534,722	538,888
						530,555		

99¢ each **\$3.89 each** **99¢ each**

ASSORTED MISCELLANEOUS CRYSTALS						FOR HAM AND GENERAL USE					
Fractions Omitted						Fractions Omitted					
370kc	376kc	381kc	384kc	387kc	390kc	390kc	395kc	402kc	405kc	408kc	408kc
372	377	383	386	388	391	392	397	404	407	411	411
374	379				393	393	398				
375	380				394	401					

39¢ each 79¢ each

Priced at a fraction of the cost of their holders alone.

CRYSTALS FOR SCR 522		Crystals from BC 6 10	
5/8" Spacing - 2 Banana Plugs			
5910kc	7350	2045	2258
6370	7480	2105	2260
6450	7580	2125	2282
6610	7810	2145	2300
	7930	2155	2305
		2220	2320
			2442
			3250
			3257
			3580
			3945
			3955
			3995

\$1.29 each \$1.29 each

• Payments must accompany order. Enclose 20¢ for postage and handling. Minimum order—\$2.00 plus postage.
• Crystals are shipped packed in cloth bags inasmuch as they are shock mounted. All shipments guaranteed.

Hot Radio Values AT SUN RADIO



RADAR RECEIVER BC-106A

Guaranteed excellent condition. It is a "Hot" receiver for the "Ham" and short wave experimenter covering the 174 to 210 MC television band. Has individually slug tuned antenna R.F., Detector and oscillator circuits resulting in maximum sensitivity; contains 2 R.F. and 5 I.F. stages detector and video amplifier. Complete with 170 volt AC power supply and 14 tubes. **\$39.95**



Build Your own LABORATORY TYPE DYNAMIC MUTUAL CONDUCTANCE TUBE TESTER

You've been waiting for this chance to get one of these brand new 3" round foundation meters calibrated in microhms with Good-Bad Scale. Complete with schematic only. **\$9.50**



SCR-522 VHF TRANSCEIVER

Tunes 100-156 MC. Don't confuse these with other incomplete and abused 522s. Sun Radio offers electronically perfect and guaranteed 522s . . . AND COMPLETE with tubes, remote control box, 28 volt dynamotor (can be converted to 110 V operation), 4 crystals and ALL CABLE CONNECTORS but less cable. **\$39.95**

ATTENTION! CLOSEOUT SPECIALS ON PARTS KITS

- KIT #1 Asstd Mica Condensers—Unmarked 100 for **\$1.50**
- KIT #2 Asstd Resistors 1/2W-1W 100 for **1.00**
- KIT #3 Asstd Condensers—Tubular Bypass 25 for **1.00**
- KIT #4 Asstd Condensers—Electrolitic 25 for **2.00**
- KIT #5 Asstd Potentiometers—with & without Switch 10 for **1.00**
- KIT #6 Asstd Ballast Tubes & Line Ballasts 10 for **1.00**
- KIT #7 Asstd Hardware—Screws, Rivets, Nuts, etc. 10 lb. for **1.00**
- KIT #8 Octal Sockets—Wafer 25 for **1.00**
- KIT #9 Octal Sockets—Plastic with Flange 20 for **1.00**

Special!! All 9 Kits for \$9.00



PANEL METERS All Meters Brand New and Guaranteed

GE	2" Round	0-500 D.C.-M.A.	2.97
Simpson	2" Round	0-15 D.C.-V.	2.97
Triplet	2" Square	0-40 D.C.-V.	2.97
Sun	2" Round	0-300 D.C.-V.	2.97
GE	3" Square	0-150 A.C.-V.	3.49



MAGNETIC HEADPHONES

2000 ohms, 8' Cords with Army plug. All unused; show slight handling. **\$1.98**



VHF TRANSMITTER

Here is one of the greatest offerings in war surplus! Hundreds sold at \$20 and now closed out at an amazingly low price. Brand new, Battery operated (67 1/2 v B and 1 1/2 v A). Frequency 80 to 105 mc. Complete with 2-1 G4 tubes and full instruction manual. Ready to go on the air. **\$6.95**
Less batteries.

WALKIE TALKIE

SCR195 Walkie Talkies, brand new, weight 27 1/2 pounds including knapsack, 52.8 to 65.8 MC. Complete with spare parts.

\$69.95 Each

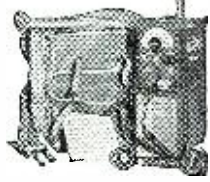

TUNING UNIT . . \$1.29

A wealth of expensive parts. Contains: 6-A.P.C. Condensers, 6-coils, 3 or more mica condensers and resistors, 1-porcelain and two gang wafer switch and dozens of other useful units.

•TERMS: All items F.O.B., Washington, D.C. All orders \$30 or less, cash with order. Above \$30, 25 per cent with order, balance C.O.D. Foreign orders cash with orders, plus exchange.

100 WATT

Bendix Transmitter separate E.C.O.



These can be easily converted to 20-40-80 meters. Crystal required for 10 meters. Each electronic coupled oscillator dial has 3000 divisions enabling quick precision shifting. This transmitter was constructed of the highest quality of precision parts, with laboratory precision. Four separate output tanks; one 4-position selector channel switch having seven sections which changes the ECO, IPA and output tanks simultaneously.—
BRAND NEW, complete with tubes. **\$49.95**

SUN RADIO

OF WASHINGTON, D. C.

938 F STREET, N. W. WASH. 4, D. C.

NECORP ELECTRONICS Presents

PLUGS and CONNECTORS-Your choice for Only 49c each

For the SCR-522..... PLQ-167 For the SCR-274-N..... PL-147, 148, 151.
 PL-172 152, 154A, 156, 253
 For the BC-733..... PLQ-254 For the RT-375..... PL-59 DT, 61 PL-64
 For your 269-F Radio Compass..... PL-147, 148, 151, 152, 154A, 156, 253
 Inverter..... PL-3108-22-4S Coax Fittings..... PL-258 (83-14)—PL-259A
 (83-15P)—UG-21U—UG-22U

BC-454
 3-6MC COMMAND RECEIV-
 ER with tubes and dyna-
 motor, used, excel-
 lent condition, ea. **\$4.95**

TU-10B or TU-5
 Tuning unit for BC-375
 a terrific parts value with a
 metal case. **\$2.10**

Brand New ONLY \$2.10
 6" PM SPEAKER
 Beautiful new stock, Alnico
 magnet **\$1.95**

Each.
AN/CRW-2 V.H.F.
RECEIVER

6 tubes; 3 6SL7, 1-6SN7, 1-
 6SG7, 1-6J5. Dynamo motor,
 plug-in coils and sensitive re-
 lays. This was one of the
 Army's "Secret" V.H.F. re-
 mote control receivers. A
 thousand and one uses. Like
 new in a metal **\$5.95**
 case. Each

SOLDER

One pound spool, highest
 grade compound of tin and
 lead, rosin core, on metal
 spool, Brand New, **69c**
A REAL BUY, Ea., \$3.95

BC-306
 Antenna loading unit for BC-
 375. Brand New. Another
 parts value **\$1.50**

BC-733D
 A 10-tube superhet receiver
 for lateral blind landing guid-
 ance (CAA type certificate)
 (TU-1045) Excellent condition
 10S-110MC. Tube complement:
 1-12SQ7; 2-12SR7; 1-12A6;
 1-AH7GT; 2-12SG7; 3-717A—
 tubes alone worth more than
 this low price of **\$4.95**
 EACH

RM-29
 An Ideal portable field tele-
 phone. Complete in a rugged
 steel case for years of wear.
 Ringer circuit and TS-13
 handset. No leather case to
 deteriorate. Compact 5/8"x-
 9"—also used as remote con-
 trol on SCR-284. If wt 12
 lbs Excellent **\$9.95**
 condition only ea. **\$18.95**
 2 for

5BPI SCOPE TUBE
 Extra special **\$1.19**
 Each.

SHOCK MOUNTS
 4 each of 3 sizes—small, me-
 dium and large. New,
 ALL FOR **99c**
 ONLY

BC-453
 200-500 Kc; with tubes and
 dynamotor, used, **\$5.95**
 excellent cond. ea.

1625 TUBE
 Army-Navy Standard
 This is a 12 V. filament 807
 tube. A tremendous **29c**
 buy at Ea. **\$1.00**
 4 for

WILLARD
 2 Volt Storage Battery
 Brand new, spill-proof, use
 standard electrolyte. Suitable
 for all farm sets and port-
 ables. Built-in hydrometer.
SPECIAL 98c
 EACH

ANTENNA RELAY UNIT
BC-442
 0-10 Weston Meter and
 50KMF 5000 V. vacuum con-
 denser change over unit, with
 mounting FT-229.
 Brand New **\$1.95**
 Ea. ONLY

Visit Our New Retail Store

20% Deposit required on all C.O.D. Orders.

division of

NATIONAL EQUIPMENT & SUPPLY CO., INC.
 806-810 W. Jackson Blvd., Chicago 7, Ill., Franklin 8629

JULY BARGAINS! SATISFACTION GUARANTEED!

TRANSFORMERS—115V. AC 50-60 CYCLES

Fil. trans. Sec. No. 1, 312 v. D.C. C.T.—Sec.
 No. 2, 8.3v. 2 amp. Sec. No. 3, 5v. 3 amps.
 use with 5U4G..... \$3.25
 Scope Plate Trans. Sec. No. 1, 680V. C.T. @
 225 MA.—Sec. No. 2, 1540V. @ 20 MA..... 4.75
 Fil. Trans. 6.4v. @ 8.5 amps..... 2.55
 Fil. Trans. Sec. No. 1, 6.4v., 21.5 amps.—Sec.
 No. 2, 2.1v., 2.0 amps. Sec. No. 3, 6.4v.,
 1.0 amp..... 3.95
 Fil. Trans. 7V. @ 1.5 amp. (15,000v. Insul.)... 1.95
 Output Trans. Ratio 3000:100, max. 50W. max.
 current 300 MA..... 1.00
 Output Trans. Ratio 5000:70 ohm..... .85
 Output Trans. Ratio 9:1, works out of 6S17... .85
 Output Trans. Ratio P.P. match 616's into 50
 ohm load input, ratio 15,000:50..... 1.10
 Input Trans. Ratio 3650:2500 ohm..... .85

CONDENSERS—OIL-FILLED—MICA

2X.1 mfd 600v. 1 mfd 600v. **.35**
 Bathub.....\$.30 Bathub.....
 3X.1 mfd 600v. 2 mfd 600v. **.45**
 Bathub..... .40 Bathub.....
 1 mfd 2000v. 1.15 10 mfd 1000v. **2.15**
 .5 mfd 2000v. 1.00 4 mfd 2000v. **2.60**
 .005 mfd 3000v. 1.00 .0008 mfd 5000v. **2.60**
 D.C.W. Mica .45 D.C.W. Mica **.75**
 BT-14, 0.012 mfd 25,000v. D.C.W. oil filled... 5.25

RELAYS

Dunco 115v. 60 cycle, A.C., contacts 115v.
 A.C., 30 amps..... \$3.15
 Dunco 125v. D.C. V. coil, 125V. D.C. 3 amp.
 contacts..... 2.95
 Dunco 115V. A.C. 60 cycles, 30 amps. W. Coil
 3 amps..... 2.95
 G. E. 115V. A.C. contacts 50/20A. coil 10V.
 D.C..... 1.40
 Allied Control 28V. D.C. DPDT..... .60
 Cramer Time Delay Adjustable one minute... 3.95

TUBES — GUARANTEED!

705A ... \$3.95 715A ... \$3.95 2X289
 708A ... 2.15 717A ... 1.55 6Y670
 713A ... 2.15 718EY ... 4.25 83695

METERS

G.E. 3" 0-150V. G.E. 3" 0-50 MA. \$4.15
 A.C. 3" 0-15KV. \$3.95 G.E. 3" 0-250 MA. 4.15
 G.E. 3" 0-1.5KV. 4.15 Weston 0-1.0 RF
 G.E. 3" 0-20 MA. 4.15 Amp **3.95**

Toggle Switches—BAT HANDLE

S.P.S.T. \$2.24 D.P.D.T. \$3.30
 S.P.D.T. .24 D.P.S.T. .30
 500 ohm 50W. Ohmite-I.R.C. rheostat. .95
 3000 ohm 100W. Ohmite-I.R.C. rheostat. 1.15
 Selsyn motor—Bendix type I-I 115V. 60 cycle
 TWO FOR **6.25**

WALMAR DISTRIBUTING CO.
 3002 Virginia Ave.
 BALTIMORE 15, MARYLAND

LARGE-SCREEN TELEVISION is here!



**CORTLEY MODEL
 #720**

It's been dreamed about — experimented with — intensively tested and now **CORTLEY** brings it to you! A Projection Television Set that throws a bright, sharp picture from several inches way up to 6 x 8 feet onto a screen — just like a home movie projector!

The clarity of the picture is so outstanding that it must be seen to be believed. Preliminary installations in New York have been proven and accepted for almost two years. Yes, people demand television wherever they go — but they want to SEE IT!

UNLIMITED SALES OPPORTUNITIES
 Your sales possibilities with this **CORTLEY PROJECTION TELEVISION SET** are absolutely unlimited. Bars, Restaurants, Homes, Schools, Clubs, Churches, Hospitals, Hotels, Resorts — these are but a FEW prospects! They have been clamoring for television that can be seen by several hundred people at one sitting — and now you can supply them.
 Get in on this new, easy-to-sell market. Be the first in your community to fill the need. Send for full information, details and price today!
CORTLEY TELEVISION CORPORATION
 Dept. A, 15 West 27th Street
 New York 1, New York
 Telephone — MU 3-3624

What's New in Radio (Continued from page 90)

Further details on the 604B Duplex or any of the other speakers in the new line may be secured by writing *Altec Lansing Corporation*, 250 West 57th Street, New York 19, New York.

BATTERIES FOR PORTABLES

The *Electrical Division of Olin Industries, Inc.* has introduced a miniature dry cell battery which features a radically



new interlocking construction and is especially designed for portable radios and hearing aids.

The new battery is made up of multiples of tiny plastic cells which, when assembled, interlock automatically to make the electrical connection between cells. This new technique eliminates 91 per-cent of the soldered connections which are said to be the major cause of battery failure.

These batteries, which are available in several different sizes, are being marketed under the tradenames of "Bond-Olin" and "Winchester-Olin."

Further technical and application data is available on request. Write to *Electrical Division, Olin Industries, Inc.*, New Haven, Conn.

LEAR PHONO PICKUP

Lear, Incorporated has added the Model MP-103 "Leartron" phono pickup to its line of equipment.

This new unit is of the magnetic variable reluctance type and has an output of approximately 80 millivolts at .001 inch double amplitude at 1000

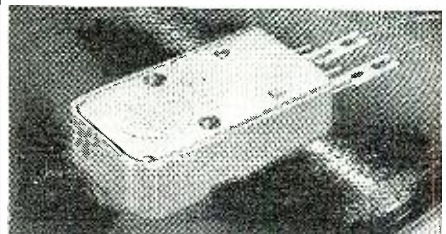

cycles-per-second. Its response at other frequencies from 50 to above 10,000 c.p.s. is substantially proportional to the velocity of motion of the stylus point.

A data sheet giving performance characteristics as well as a circuit dia-

gram of the compensating network is available on request from *Lear Incorporated*, 110 Ionia Avenue, N.W., Grand Rapids 2, Michigan. -30-

Recording of Sound

(Continued from page 53)

as 6 milliwatts. Since we are dealing with ratios only, we can work out the problem assuming a positive db. level to get the power ratio, then divide the reference level, 6 milliwatts, by this ratio to get the actual level. For example, a level of -19 db. will be assumed for the purposes of calculation. Taking the antilog of (19/10) or 1.9 gives 79.4. The actual power level represented by -19 db. would then be .006 divided by 79.4 or .000076 watts, or .076 milliwatts. This method simplifies calculation somewhat as it avoids the necessity of dealing with negative logarithms.

Use of the Slide Rule

Problems involving decibels are easily solved on the slide rule, making use of the *L* logarithm scale. Converting a power ratio to decibels is accomplished by setting the indicator to the power ratio on the *D* scale and reading the number of db. on the *L* scale. Example: the power ratio corresponding to 5 is 6.99 db. When the power ratio is higher than 10, divide by 10, 100, etc. until the quotient is less than 10. Find the corresponding db. and add 10 decibels for each place the decimal point had to be moved in order to bring the ratio within the range 1-10. Example: What is the db. gain corresponding to a power gain of 5530? Moving the decimal point three places to the left, we obtain 5.53. Set the indicator to 5.53 on the *D* scale and read 7.42 on *L*. Add 30 db. to the result, which gives 37.42 db.

If the power ratio is less than 1, the *CI* and *L* scales should be employed. Finding the db. gain corresponding to voltage ratios—if the impedances and power factors are the same in each case—proceed as described in the foregoing but multiply the result by 2.

The "log-log" slide rule offers an alternative method of finding decibels. Set the index on the slide to 10 on *LL3*. Opposite the power ratio on *LL2* and *LL3* find the gain in db. on *C*. If the power ratio was greater than 10, all values found on *C* are between 10 and 100. If it was less than 10, the *C* scale may be read directly.

Finding decibels from the voltage ratio is accomplished by setting 2 on the *C* scale to 10 on *LL3*. Opposite the voltage ratio on *LL2* or *LL3*, the db. may be read on *C*. If the voltage or current ratio is between 1 and π , the db. gain is between 1 and 10. If the

July, 1948

as convenient to use as
a fountain-pen desk-set.

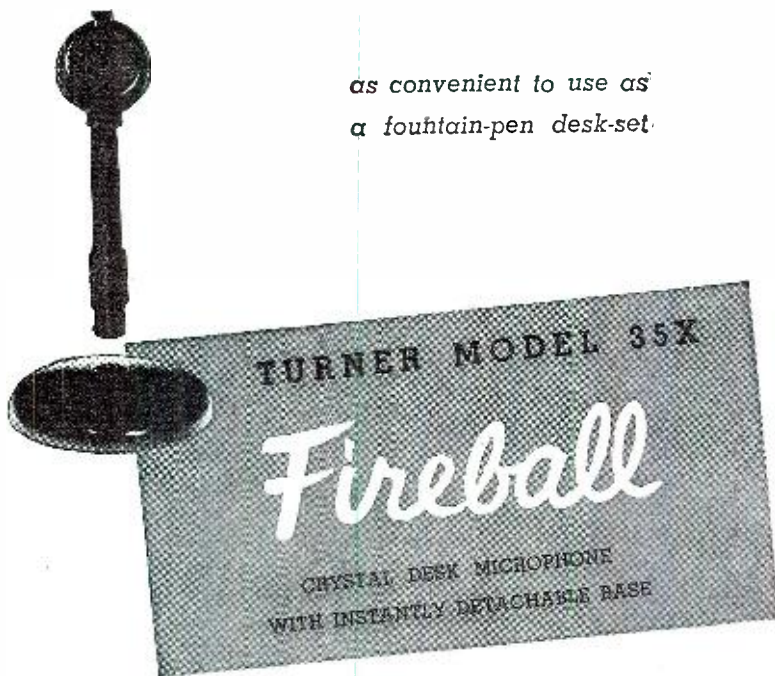

HANDSOME and handy . . . and low priced too! It's a desk mike, it's a hand mike. The Turner Model 35X brings high convenience to amateur communications, home recording, paging and call systems. A quarter-turn releases handle from base or locks it securely. Turner precision engineering assures smooth response to both voice and music pickups. Complete unit includes microphone with handle, base, and 7 ft. cable. Ask for Bulletin. Sent on request.

THE TURNER COMPANY

900 17th Street N.E.

Cedar Rapids, Iowa,



Licensed under patents of the
Brush Development Company

HERBACH & RADEMAN

presents

OUTSTANDING VALUES FROM THE PAGES OF

"THIS MONTH"

Shown here are just a few of the hundreds of values listed every month in our bulletin "THIS MONTH". In "THIS MONTH" we bring you the outstanding "buys" from the surplus market as well as an up-to-the-minute listing of new products, gadgets and devices from scores of nationally known manufacturers. In effect "THIS MONTH" is a perpetual radio and electronic-parts guide.

RADIO NEWS READERS are invited to be put on our mailing list — free — by merely filling out the coupon below.

ALNICO MAGNETRON MAGNETS



Horseshoe shaped magnet, originally designed for use in microwave radar equipment. Field strength 4800-4900 gauss. Size 5 1/4" W. x 5 1/2" H. x 2" thick. Mts. on base 3" x 2 1/4". Airgap 19/32". Wht.—8 lbs. Lifts more than 5 times its own weight. With Keeper. No. RN-1056. **\$4.95**

PRECISION APPARATUS 844P VOLT-OHM-MILLIAMMETER

All purpose AC-DC Multimeter in hardwood hinged cover case with a 4 3/8" 1000 ohm per volt meter.

RANGES

AC and DC Volts 0/12/60/300/600/1200/6000
Milliamperes D.C. 0/1.2/12/300/600/1200
Amperes D.C. 0/12
Ohms 0/400/100,000/1 meg/10meg
Decibels 6 Ranges from - 12 to / 70 D.B.
Output Volts 0/12/60/300/600/1200/6000
Case has tool compartment. With test leads less batteries. (Batteries \$1.40 additional)
Regular Price \$34.20. **\$24.95**
No. RN-844P

REVERSIBLE MOTOR



Built like a fine watch. Continuous duty 1/50 H.P. Capacitor start reversible motor for operation on 115V, 60 cycle. Speed 3300 r.p.m. Size 3 1/2" x 3 1/2". Shaft 5/16" diam. x 1-3/16" long. With capacitor. No. RN-1002. **\$7.95**

ALL METAL SPEAKER BAFFLE

Enclosed all metal, sloping front, black crackle finish wall baffle. Takes a 12" speaker. Front entirely hinged. 14" H. x 14" W. x 9" D. Wht.—16 lbs. No. RN-4711. **\$2.95**

NO SUPERLATIVES

No, we're not "the biggest," "the oldest" nor "the greatest" parts house in the world; we do guarantee complete satisfaction on every purchase. We also guarantee speedy delivery on all orders. Order direct from the page and be sure you send us your name for our mailing list. Quantities Limited. Minimum order \$2.00.

Terms 20% deposit, balance C.O.D.
All prices are quoted F. O. B. warehouse Phila., Pa.

HERBACH & RADEMAN, Inc.

Electronics Specialists

522 MARKET ST., PHILADELPHIA 6, PA.

Yes indeed, send me your monthly Bulletins.

Name

Address

City..... Zone..... State.....

ratio exceeded 3.14, multiply the C indication by 10.

When converting power ratios less than 1 to decibels, set 1 (middle of B scale) to 0.10 on the LLO scale. The loss is then found on B opposite the power ratio on LLO. For current or voltage ratios, set 2 on the B scale to 0.10 on the LLO scale and proceed as before.

To find the gain in db. directly from two values of current, voltage, or power, set the larger of the two on C to the smaller on D. Opposite the index of C, find db. on L.

Ready-Reference Charts

For the reader's convenience, two charts have been made up from calculations involving equations (2), (3), and (6).

By referring to Table 2, the number of decibels corresponding to any power level between 6 micromicrowatts and 6 kilowatts may be found quickly, the necessity for performing equation (6) computations being eliminated in most practical instances. From Table 3, the number of decibels corresponding to any current, voltage, or power ratio may be quickly located.

Particular notice should be taken of the subdivisions in the power column of Table 2. These graduations are uniformly spaced (as regards numerical value) except that the lowermost subdivision in each power group has not the same value as each of the upper five in the group. For this reason, we have numbered the lowermost subdivision in each group. Thus, the numbered line, 10 micromicrowatts is only 4 micromicrowatts removed from the 6 micromicrowatt major division, while each other subdivision up to 60 micromicrowatts is exactly 10 micromicrowatts higher than the previous one. Thus, we read, 10, 20, 30, 40, and 50 micromicrowatts between 6 and 60 micromicrowatts. Similarly, we read, 100, 200, 300, 400 and 500 micromicrowatts in the next highest power group, between 60 and 600 micromicrowatts.

To illustrate the use of Table 2, locate the db. output rating of a 6L6 amplifier, the audio output of which is 60 watts. Opposite the 60 watt line in the power column will be found the 40 line in the decibel column. On the basis of 6 milliwatts as zero db., a power level of 60 watts is 40 db.

The power output of a high quality microphone rated at minus 45 db. may be found in the same manner. Read 0.2 microwatt directly opposite the "minus 45 db." in Table 2.

A current, voltage, or power ratio is located in the ratio column of Table 3 and the number of decibels read directly opposite in the power column or current-voltage column, depending upon

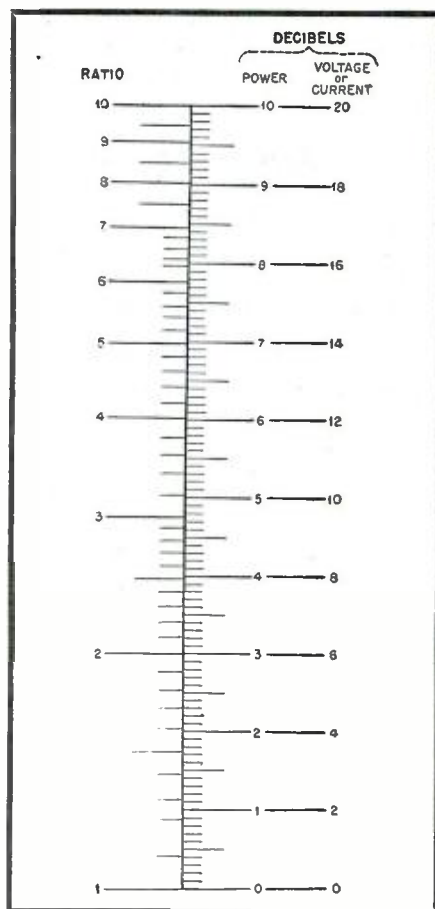

Table 3. The number of decibels corresponding to any voltage, current, or power ratio between the values one and ten.

the nature of the ratio. For example: a power ratio of 4 is seen to correspond to 6 db. while a current or voltage ratio of the same value equals 12 db.

The use of Table 3 can be extended beyond the current or voltage ratio of 10 by adding 20 db. for each place the decimal point has been moved to the right to make the figures in the ratio column correspond to those in the ratio desired. For example: to find the db. equivalent to a current or voltage ratio of 44, locate 4.4 in the ratio column of Table 3. Read the equivalent 12.8 db. in the current-voltage db. column. The decimal point was moved one place in 4.4 to convert it into the ratio, 44. Therefore, add 20 db. to the result. 12.8 plus 20 equals 32.8 db.

The use of Table 3 may similarly be extended beyond the power ratio of 10 by adding 10 db. for each place the decimal point is moved to the right. For example: look up the power ratio 160 as 1.6 in the ratio column. This would correspond to 2 db. But the decimal point was shifted two places to change 1.6 to 160 and 10 db. must be added for each place. The result, therefore, is 2 plus 20, or 22 db.

Reference

The Aerovox Research Worker, Vol 13, No. 7; July, 1941

(To be continued)

TUBES TUBES TUBES

MANUFACTURERS • INDUSTRIAL • AMATEURS

Never Before at These **LOW PRICES!**

Receiving, Transmitting, Special Purpose. All Brand New, in Original Factory Cartons. Over 1,000,000 Tubes in Stock for

IMMEDIATE SHIPMENT

RECEIVING, TRANSMITTING & SPECIAL PURPOSE TUBES

10 SPEC.	.30	434A	3.95	851	60.00	1A7GT	.99
10 Y	.49	450TH	12.75	CG801	40.00	1B24	2.19
15 F	.95	WL468	5.50	864	.59	1B29	.99
30 SPEC.	.75	527	1.95	865	.95	1B32	.99
35 SPEC.	.49	550	29.50	866	.75	1P24	.25
120	5.95	531	20.00	876	.69	1S21	.99
123A	7.50	575A	10.00	884	.75	1U4	.89
VT127A	3.95	615	.95	933B	12.00	1Y4	.89
204A	25.50	WLG32A	5.00	954	.39	1H5	.89
205B	3.50	703A	5.95	955	.39	1N5	.99
211	.70	707B	12.50	956	.49	2C21	.49
215A	1.95	713A	1.25	957	.39	2C22	.39
221A	1.95	714AY	8.00	1616	.85	2C26	.39
222A	75.00	720CY	12.00	1619	.49	2C26A	.35
242C	4.95	721A	3.25	1625	.16	2C34	.39
249C	1.95	724A	3.95	1629	.29	2C44	1.50
250TH	14.00	728A	10.00	1638	1.00	3C22	15.00
250TL	8.00	800	1.95	1641	.59	3C23	4.50
256A	12.00	801A	.95	1665	.79	3B22	3.95
268A	1.00	802	1.25	2050	.75	3B24	.75
274B	1.95	803	6.95	2051	.19	3C30	.65
285A	1.45	805	3.50	8001	3.90	2K25	5.90
286A	1.25	806	9.95	8005	2.95	2X2	.69
304TL	8.00	807	2.75	8011	1.50	23D4	.69
304TH	8.00	808	1.50	8012	2.95	28D7	1.75
305A	5.95	809	4.50	8012A	3.50	SD535	8.00
307A	4.95	810	1.75	8013A	2.95	CW93	4.95
316A	.85	811	2.95	8025	2.50	C100E	.79
313CD	1.95	812	5.50	9001	.49	FG105	5.00
331A	9.00	813	1.95	9002	.49	EF50	.50
345A	5.95	814	1.45	9003	.39	RK59	3.50
350	2.75	815	2.50	9004	.39	RK73	5.75
350A	5.75	826	29.50	9005	.49	RW30	39.95
350B	7.75	829A	1.75	9006	.39	RK21	1.50
353A	1.95	833A	.69	1A3GT	.79	RK25	3.50
363AS	7.50	837	.69				
371B	3.50	841	.69				
383A	4.25	843	.69				

KLYSTRON & MAGNETRON TUBES

STANDARD NATIONALLY ADVERTISED BRANDS

ALL NEW — SOME WITH MAGNETS

2T21A	2J36	2T55	} Special Limited Quantities \$10.95 ea. net.
2T22	2J38	4T26	
2T26	2J39	4T28	
2T32	2T40	4T29	
2J33	2J51		
417A	6.95	726A	4.25
723AB	2.95	725A	8.95

COMPLETE STOCK — YOUR INQUIRIES INVITED

CATHODE RAY TUBES

ALL STANDARD BRANDS—
BRAND NEW—IN ORIGINAL
MANUFACTURER'S CARTONS

905	1.75	7BP7	2.75
2AP1	1.75	7DP4	12.95
3AP1	1.75	7EP4	17.50
3BP1	1.75	10DP4	34.50
3CP1	1.75	10FP4	39.99
5AP1	1.75	12GP7	9.95
5BP4	1.75	12JP4	55.00
3DP1	2.95	15AP4	109.50
4AP10	3.50		

SEND FOR OUR COMPLETE LISTING
OTHER TYPES TOO NUMEROUS TO MENTION

SEND FOR SPECIAL QUANTITY PRICES

DEDUCT 10% ON ORDERS OVER \$50.00

MINIMUM ORDER \$3.00

SEND 20% DEPOSIT WITH ORDER F.O.B. N. Y.

AMERICAN RADIO SUPPLY CO.

120 CEDAR STREET, NEW YORK 6, N. Y.

Phone: BArcly 7-2685-6

WRITE — CABLE

★ STAHL'S ★

★ Star ★ Studded ★

★ SPECIALS ★



TRIODE 24G/3C24

24G/3C24—Triode—100 W output. Fil 6.3V-3A-Plate Dis. 25 W Max Plate Volts 2,000. Max Ma 75. Here is a real bargain in surplus tubes. One of these tubes will give 100 watts output. Two of them will take ¼ kw. input. Stock No. 3C24—Each **\$3.99**
10 for \$33.50

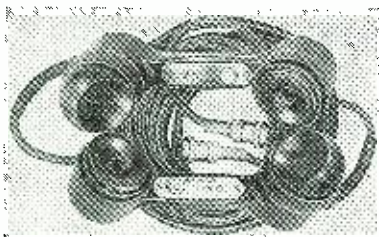

RCA-CRV-51019 Hand Sets self contained battery operated. Uses 4 Pen light batteries excellent for Television Antenna installation. Sold in pairs only Pair **\$15.00**

Blank Calibration Books

For BC 221-Frequency from 125KC to 20000 KC printed in 10 divisions—68 pages, aluminum cover, spiral bound.

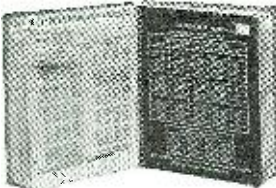

\$1.50



General Electric Magnetic Recording Wire

General Electric magnetic Recording Wire—Brand New; about 12,000 ft. on bakelite spool—can be used on any wire recorder; good for 2 hours, in sealed cans. Each **\$3.45**

- 1N21 & 1N23 Western Electric Crystals 35 each
- Hi-power quartz. Crystal units, type CF5, 5000 KC. complete with holder 3 for \$1.00
- Jefferson step down (or step up) power circuit transformer double wound 230V input 50-60 cycle, to 115V output, 250KVA. Weight 17 lbs. \$7.95
- Standard rack cabinets heavy gauge steel, gray crackle finish; panel opening 19" wide, 27" high \$12.95
- Parallel No. 18 Zip wire; 10 feet lengths, with lugs on each end. Each10
- Hammerlund variable APC210 micro microfarad .50

METERS

- 2" Round Westinghouse Bakelite Case 0-30 Milliamps D.C. \$2.25
 - 3" Round Western Electric 0-1000 Mill D.C. Bakelite Case 2.25
 - 3" Round Beede 0-1000 Mill D.C. Bakelite Case 1.95
 - 3" Round Westinghouse 0-15 Mill D.C. Bakelite Case 3.45
 - 4½" Weston Panel Board flush metal case 0-5 amp. A.C. with a 0-200 amp. scale 3.95
- Prompt Delivery—25% deposit required on C.O.D. order. Shipped F.O.B. New York—Write Dept. RN7.

MICHAEL STAHL, INC.
39 VESEY ST.
New York 7, N. Y., WO 4-2882

C.W. Transmitter

(Continued from page 43)

vide a completely self-contained unit, the antenna coupling unit was included on the chassis. Since this coupler was to feed a simple antenna system, a piece of wire hung on a tree and run into the room, a simple voltage feed tuned circuit, inductively coupled to the plate tank, was provided. To reduce harmonic radiation a Faraday shield was placed between the two coils. While this antenna coupler limits the antenna to the less efficient types, it was advantageous in this particular case because of its simplicity. Operation at 80,40, and 20 meters was obtained while using a piece of wire 132 feet long.

Power supply requirements for this rig are 400 volts at 120 milliamperes, 1500 volts at 200 milliamperes, and 90 volts negative bias in addition to the various filament and heater voltages. The writer was able to obtain a high quality, 400 volt, 200 milliamperes war surplus transformer which incorporated the required filament voltage. The 2.5 volt winding on the transformer was used for the high voltage rectifier tube filaments. This technique should not be used, however, unless the transformer employed has high insulation between the windings and the case. In order to obtain 90 volts negative bias, the a.c. voltage is taken off one side of the low voltage transformer. The rectified voltage through the 6X5 is dropped by

means of resistors and fed to the VR90 tube. Resistor values are such that the regulator tube will just ignite as the grid current flow will increase the current flow through the tube.

In order to obtain 1500 volts at 200 milliamperes for the final without using a larger transformer, it was decided to use condenser input filtering. The particular transformer used in the rig gave 1300 volts a.c., each side of center, at 350 milliamperes. While regulation, as compared to choke input, is not good and a bit harder on the mercury vapor rectifiers, the advantage gained offset the drawbacks. The bleeders are of comparatively high value to reduce heat dissipation below chassis and are used mainly to discharge the filter condensers when the power is turned off. Screen voltage to the 813 final is taken from the low voltage supply and dropped through a resistor. This was considered to be more desirable than dropping the high voltage through large resistors with the consequent heat radiation. In addition, under key-up conditions, the voltage would soar above the rated value. A switch is used to break the screen voltage.

Since the unit is intended to be used with one of the more simple antenna systems, it is advantageous to place the rig as close to the antenna lead-in as possible. Since this point may not necessarily be near the operating table, an a.c. relay was included to turn on the high voltage power supply in addition to breaking and making the screen voltage from a remote point. The remote

The recently-elected Board of Directors of the West Coast Electronic Manufacturers Association includes; front row, Ed Grigsby, Altec-Lansing Corp.; Wallace Walgren, Electro Engineering Works; James L. Fouch, Universal Microphone Co.; Noel Eldred, Packard-Hewlett Co., and William Hewlett. Second row; Robert Newcomb, Newcomb Audio Products Co.; Jack McCullough, Eitel-McCullough, Inc.; John Kaar, Kaar Engineering Co.; O. H. Brown, Eitel-McCullough, Inc.; Herb Balderson, Thermador Electrical Mfg. Co.; Fred Falck, Jr., Advance Electric & Relay Co.; and Jim Hopkins, Girard-Hopkins Co., shown in the usual left-to-right order.



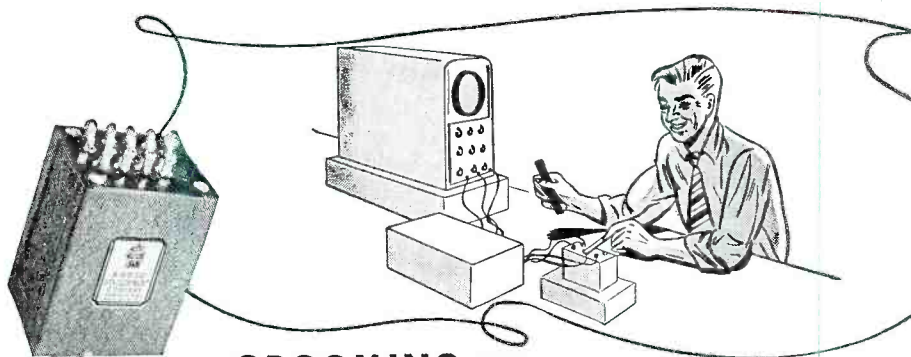

Features

- $\pm 1/2$ db 30-15,000 cps for—Quality Plus Series.
- $\pm 1 1/2$ db 50-10,000 cps for—Industrial Series.
- Low transmission loss.
- Excellent balance on all "balanced" windings.
- Power ratings taken at 30 cps for Quality Plus Series, at 50 cps for Industrial Series.
- Either top or bottom mounting.
- Extremely low hum pickup.

GROOMING an

ADC AUDIO TRANSFORMER for FAULTLESS PERFORMANCE

3 Complete Tests to Meet Rigid ADC Specifications.

Strict electrical tests are given each and every ADC Audio Transformer at three different stages of production. In order to give you faultless performance on the job, every transformer must come within catalog specifications on all tests. (Custom specifications on special transformers.)

1st TEST. After assembly of coil and laminations, each component must perform within ADC specifications on frequency response, impedance ratio, phasing, breakdown and balance tests. Any unit failing to meet all requirements is rejected.

2nd TEST. After impregnation, baking and casing, each transformer is re-checked for continuity breakdown and other requirements of the particular unit. This guarantees correct wiring, perfect insulation—no "shorts" or "opens."

3rd TEST. After cleaning, labeling, etc., a final continuity, breakdown and thorough visual check is made. This quality control test—plus the finest materials and workmanship available—assures you of faultless ADC performance on the job.

Consult your jobber about ADC Audio Transformers and other Components. Ask for Catalog 46-T.

Other ADC Components: JACKS • JACK PANELS • PLUGS • PATCH CORDS



Audio Development Co.

2833-13th Avenue So., Minneapolis, Minn.

Audio Develops the Finest

OUTSTANDING VALUES NOW AVAILABLE

AUTOMATIC CAR RADIO

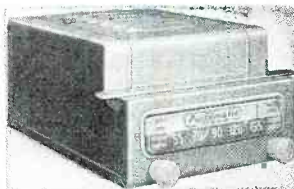

The Best Buy on the Market

Six tube superheterodyne. Two dual purpose tubes, giving 8 tube performance. Equipped with G.E. 5" Speaker.

FITS ANY CAR FEATURES:

- 3 gang tuning condenser
- Beautifully finished case
- Hearing this fine radio is a thrill

Only \$27⁹⁷

CROWE HEADS for AUTOMOBILE RADIOS

A dial to fit any radio and car 1940 thru 1948 Custom Dash Mounting Dials

Under 1940—Universal Underdash Mounting Dials. Dealers Price.....\$3.82
 Tuning Units 706-T1 up thru 720-T1. Dealers Price.....\$1.71
 Tuning Units with switch 706-T2 up thru 720-T2. Dealers Price.....\$2.40
 Volume control units 700-V1. Dealers Price.....\$0.73
 Volume control units with switch. 700-V2. Dealers Price.....\$1.80
 Cable kits to fit Delco-Arvin-Philco. Dealers Price.....\$1.74
 When ordering, specify Make, and Model of car and make and model of radio. Complete dial kit consists of "Head, Tuning Unit, and Volume Control Unit. We carry a complete line of all auto radio equipment and accessories.

F M TUNER

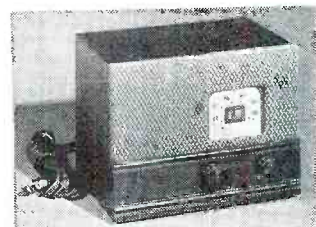

- Attractively styled—Mahogany Cabinet
 - Compact
 - of Highest Quality
 - Easily attached to any radio or amplifier
 - AC operation
 - 88 to 108 megacycles operation
- Priced at\$20.59**

AUTO RADIO IGNITION SUPPRESSORS

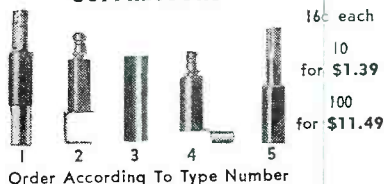

Order According To Type Number

16¢ each
 10 for \$1.39
 100 for \$11.49

BUFFER CONDENSERS

Standard Brands, They are Built To Stand Up At High Voltages.

.005	2000V	10 for \$1.90
.008	1600V	10 for \$1.50
.01	2000V	10 for \$1.90

ANTI-NOISE GENERATOR CONDENSERS FOR AUTO GENERATOR INTERFERENCE SUPPRESSION29¢ each
 10 for\$2.50

Radio Parts Company, 614 RANDOLPH ST., CHICAGO 6, ILL.

switch shunts the switch on the panel that controls operation of the relay. Two pilot signal lamps are included as a safety precaution. By placing the low voltage indicator (green pilot lamp) above the high voltage supply switch, it will serve to indicate that the rectifier filaments are on and the high voltage may now be applied. The high voltage indicator is wired across the relay coil and indicates that the relay is closed. Since the high voltage indicator is above the low voltage supply switch this serves as a warning that the switch should not be turned on as voltage would then be applied without the

rectifier filaments getting a chance to heat up. The low voltage switch is wired to also serve as a main switch. Turning it off shuts off the high voltage but the relay will continue to be energized, along with the pilot lamp, if the high voltage switch is on, either on the panel or at the remote position. 866JR tubes were chosen as the high voltage rectifiers in order to eliminate the necessity for hot leads above the chassis.

Constructional Details

The chassis is of hard aluminum and measures 17 by 14 by 4 inches. The depth of the chassis permits most of the

components to be placed below deck. As can be readily seen in the photographs some of the parts are larger than would be required but they were used as they were on hand or were easily obtained at favorable prices from war surplus.

Crystals are placed on the side of the chassis as far away from the heat of the tubes as possible. To reduce grid and plate leads of the crystal oscillator, the crystal selector switch is mounted on a bracket and an extension shaft used. The 807 socket is mounted on two rods thus lowering its height above the chassis. The plate coils are wound on one inch by one-and-a-half inch forms. The 20 and 40 meter coils are placed in the same shield, at right angles to each other. The shield cans measure 1 7/8 by 2 1/2 inches and are placed side-by-side and bolted to the chassis with spade lugs. The shield cans were placed in such a manner that they effectively shield the coils as well as the 807 tube and its plate lead from the final. The other side of each coil is grounded directly to the chassis and leads from the other run to the four-position band-switch.

The 813 tube must have its plate circuit carefully shielded and spaced from its grid and associated circuit to avoid self-oscillation troubles. The socket is mounted on a bracket that lowers the tube to a point where the shield in the tube is at the same level as the chassis. Spacing in the plate tuning as well as the antenna tuning condenser is greater than absolutely required, however this increased spacing insures against arc-over under any condition. All r.f. plate circuit components and leads should be above-chassis. While the antenna tuning condenser is mounted below the chassis, it is sufficiently removed from the grid circuit so as to eliminate trouble.

Coils for the 40 and 80 meter bands were made from sections cut from ready-wound ones which are available on the market in 10 inch lengths. Commercially available coils could not be used without extensive alteration, for inductive coupling requires that the coils be closely coupled. Plate and antenna coils are identical except for the tap on the antenna coil. Coils should be mounted on plug strips and the jack so placed as to allow close coupling between the two. The exact spacing should be adjustable and maximum coupling should be such that the two meet the Faraday shield as closely as possible. The antenna coil, as the side view photograph of the unit shows, is mounted on a jack strip made of 3/4 by 3/16 inch polystyrene. The strip is slotted at the two points where it is held down by the screws to the outer standoff insulators. This construction al-

Summer Surplus Specials

- **I.F.F. VHF**
11 tube Receiver-Transmitter; Dynamotor, Bays and many useful parts. Shipping wt. approx. 30 lbs.\$5.95
- **BC-645 VHF TRANS.-REC.**
420-500 Mc. Ideal for citizens band. Conversion Diagram included. New in cartons. Wt. approx. 40 lbs.\$9.75
- **AIRCRAFT HOMING RECEIVER, ZB-1**
A T.R.F. Receiver unit covering 234 to 258 Mc. Beautifully built and calibrated. Uses 4-954 tubes. Complete with Relay and one control box. Wt. approx. 15 lbs. New.\$9.75
- **SWITCHBOARDS-BD 57A**
Student training. 20 duplicate circuits with patch cords. Wt. approx. 35 lbs. While they last\$12.50
- **CATHODE-RAY TUBES (Brand New)**
5BP1....\$1.25 5CP1....\$1.25 5FP7....\$1.19
- **RECEIVER-TUNING UNIT MC 125-A**
Black wrinkle finish with 3 V. miniature pilot lite. New49c
- **REMOTE CONTROL UNIT**
Model MN-28Y, 3 bands. 150-325 Kc.; 325-695 Kc.; 3.4-7.0 Mc. With pilot lite. New.\$1.69
- **POTENTIOMETER**
2 Ohms, 3 Amps. slotted shaft for screwdriver adjustment. Panel mounting centers. 1 3/4" for two 6-32 screws. Overall dia. 2". Grounded rotor. New4 for 98c
- **PUSH-BUTTON TUNING ASSEMBLY FOR 728-A RECEIVER**
2 to 6 Mc., 4 P.B., 12 coils for RF mixer and Osc. One assembly. Completely wired and aligned. New. In overseas cartons.\$1.95
- **AZIMUTH CONTROL, TYPE MN-52H**
Dial: Zero to 360 degrees. With pilot lite and coax connector. New in cartons.79c
- **OSCILLATOR COIL FOR SCR-528 and SCR-608**
Range: 20-28 Mc. Shielded. Temp. compensated, moisture treated, ceramic form wound with silver wire. New.59c
- **CONNECTORS**
For many units such as SCR-522. APN/1, APN/4, 274-N, etc. Kindly specify connector number and unit number. Each.49c
- **METER MULTIPLIERS (within 2% accuracy)**
IRC 10,000 Ohms.29c
IRC 150,000 Ohms.29c
- **PHANTOM ANTENNA UNIT**
Mounted in round metal can, size 3" D., 6 3/4" L. Contains air trimmer, jewel lite, 2-20 W. resistors, amphenol mate connector, iron slug tuned coil and 2 metal binding posts. Ideal as dummy ant. on 10 M. and 20 M. for low-power rigs. Just69c
- ★ **Special—SURPRISE ELECTRONICS "PACKAGE"**\$1.49
More than 10 lbs. of assorted electronic units and parts.
- Quantities are limited—Order now! Prices subject to change without notice.
- Minimum order—\$2.00; 25% Deposit Required. Balance C.O.D. All orders shipped f.o.b. Chicago. All Foreign Shipments, minimum order—\$50.00.
- **FILTER STRIPS**
Two 8 Mfd, 450 V. Aerovox PRS type condensers and one 6000 Ohms 20 W. Resistor mounted on a bakelite sub-assembly. New. Only.55c
- **HEARING AID SUBMINIATURES**
Triode tubes. New. Each.39c
- **TIME DELAY RELAY**
Klixon—Thermal. 7 W control. Handles 110 V. 30 Amp. 30 second delay. New. Each.49c
- **CORDS**
6 1/2' two conductor. Rubber covered. Two colored conductors. Lugs on both ends. Each.7c; 15 for \$1.00
- **PATCH CORD**
Red fabric covered cable with 2-PL-47 standard plugs. Approx. 34" long. 39c; 12 for \$4.49
- **TOGGLE SWITCHES**
Bat-handle or Standard S.P.S.T. Each.25c
- **COIL FORMS**
Glazed porcelain. Ribbed and grooved for winding. Vertical mounting, with four 8/32 screws. Dia.: 2 3/8". Lgth.: 4 5/16".17c
- **SELENIUM RECTIFIERS**
Dual. Input: 7.1 V. A.C. 115 cyc. Output: 1.7 V. D.C. @ 2-4 Amps. Ideal for converting battery sets to A.C. Each.49c
- **LIP MICROPHONE UNITS**
Carbon Mc-419 (less leads and band). 3 for 59c
- **LIP & THROAT MIKE CORD and SWITCH**
CD-318 and SW-141-E. With PL-68 plug. Slightly used. Each.49c
- **VOLTAGE REGULATOR**
32 Volts. For PE-HA-43 carburetor. New.29c
- **CARBON RESISTORS**
Various sizes to 2 W. New. Assortment of 100\$1.79
- **JEWEL LITES**
Miniature Bayonet socket. In amber, red or green. (Specify color.) New. Each.21c
Aircraft Type. Red facet with dimming provision. New19c
- **POWER PANEL SWITCH**
G.E. type. SB-1, 8 P.D.T. 115 V. 10 Amp. Positive lever action. New. Each.\$2.98
- **HOO-K-UP WIRE**
Plastic covered. Stranded #20 brown or black, or solid black. 100 feet.79c
Fabric covered. Stranded #20. Red or orange. 100 feet79c
- **SOLDERING IRONS**
Vulcan. 100 W. 110 V. New, in cartons. A beauty\$1.79
- **MICA CONDENSERS (Silver and Ruby) (100 V. to 500 V.)**
150 to 600 V. D.C. Brand new.3 for 10c
Assortment of 100\$2.98
- **CERAMIC CONDENSERS (100 V. to 500 V.)**
(Silver) 3 for 10c; assortment of 100 for \$2.98
Insulated Erie. 5.6; 15; 50 mmfd. 500 V. D.C. Each5c

★ Write for free copy of UNITED SURPLUS new Flyer!

UNITED SURPLUS MATERIALS

3313-19 W. OGDEN AVE.

CHICAGO 23, ILL.

lows a small amount of coupling adjustment. Copper strips are used to make contact to the feedthrough insulators and the antenna condenser below, as well as to the ground lead. The antenna tap is also fed through a feedthrough insulator, through a flexible lead from the jack strip, and to another feedthrough insulator and out the back of the chassis for the antenna connection.

The Faraday shield is made from a ½ inch strip of brass angle, 4 inches long. This piece is drilled along its inner edge with a series of holes the diameter of No. 16 wire and spaced just less than the diameter of the wire. Pieces of No. 16 wire, 4 inches long, should be cut. These are inserted in the holes and soldered to the side of the brass angle. With a little care it should be possible to solder these wires so that no two of the pieces make contact. After the wires are spaced correctly, the unit can be placed on a piece of celluloid and then heavily doped with thick polystyrene cement. Later when the cement dries, the celluloid can be peeled off leaving the shield self-supporting with the cement filling in all the spaces between the wires. The Faraday shield is then mounted between the two coils on tapped rods.

To provide metering for the circuits, a 1 milliamper unit is used, together with a double-circuit, four-position wafer switch. No values for the shunt resistors have been included in the parts list as these will vary with the meter used. The shunts are made from short lengths of resistance wire salvaged from an old rheostat. By using a low voltage battery with a rheostat to adjust the current, together with a calibrated meter, the length of resistance wire can be determined. The meter should read 100 milliamperes for the buffer plate and final screen current, 50 milliamperes for the final grid, and 500 milliamperes for the plate. Plate current reading to the final will also include grid and screen current and this should be taken into consideration when making the measurements. As the meter is inserted near the final plate circuit, a grounding ring was placed around the case of the meter to reduce any danger from high r.f. potentials. In addition, a bypass condenser is used across the meter.

Brackets were constructed to hold the filter condensers as the war surplus units used were not equipped with brackets. The high voltage bleeder resistors were made up of smaller units placed in series, which permitted easy mounting in the available space. Mica bypass condensers were used wherever possible. Above chassis, plate cap insulators were used for both the 807 and

813 tubes. Leads should be insulated with high voltage spaghetti and all exposed connections should be carefully taped and doped.

The panel is a piece of masonite, cut 10½ by 19 inches to fit a standard relay rack. The panel is not very sturdy and if the unit is to be moved around a lot, the chassis should be fastened to the cabinet. The photograph of the front panel indicates the proper location of the various controls. Discs were cut from sheet aluminum and used as washers to mount the condensers, switches, etc. to the panel. In addition to reinforcing the masonite panel at the

mounting point, these discs dress up the panel to match the final tuning dial. The cabinet measures 21 by 12 inches by 14½ inches deep. This cabinet is sufficiently large to eliminate excessive heating of the rig.

Tests and Operation

With the indicated low voltage supply, plate voltage to the oscillator will be around 150 volts with 90 volts on the screen. Crystal current, as checked with a 2 volt, 60 milliamper bulb, indicated the current to be well below the maximum allowed. Keying characteristic, with a good crystal, is excellent.

UNITED'S "Mighty-Mite" TRANSMITTER-RECEIVER (80M) KIT

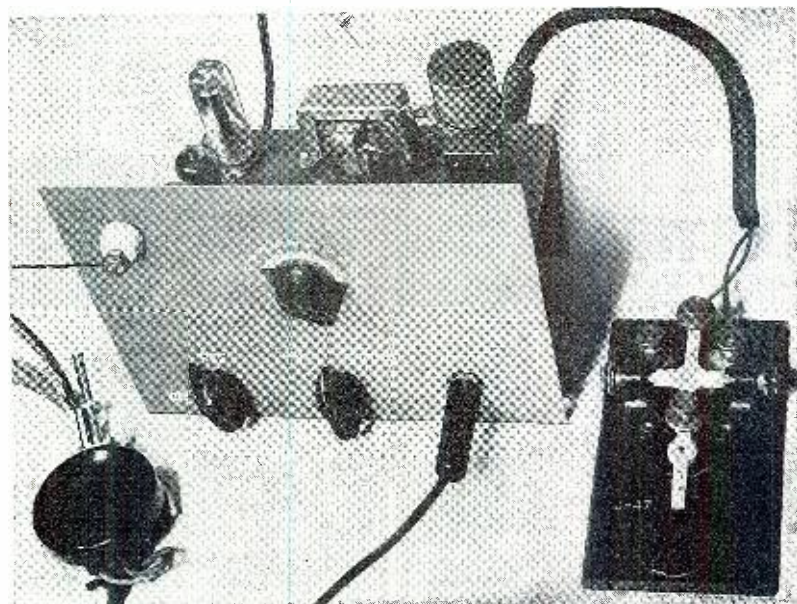

• It's Tiny!

• It's Thrilling!

• It's Terrific!

- ✓ 3 latest multi-purpose tubes.
- ✓ Complete 3.5-4.0 Mc. crystal controlled CW transmitter.
- ✓ Improved high gain regenerative receiver.
- ✓ 110 V. AC-DC power supply.
- ✓ All high quality parts furnished.
- ✓ Simple step-by-step instructions assure ease of rapid assembly.
- ✓ Plug-in coil for rapid receiver frequency change.
- ✓ Same antenna for transmitting or receiving.
- ✓ Single control operates transmitter or receiver.

MITEY-MITE is a "nifty" for beginning amateurs or as an auxiliary rig for the Old Timer. Exhaustive operating air tests conclusively proved performance of MITEY-MITE to surpass that of more powerful sets under similar conditions!

Operation is smooth and dependable. All reports were T9X. By winding additional coils, the receiver will cover all bands with equal efficiency and highly gratifying results. Tube line-up: 1-12BA6 Reg. Det., 1-50B5 Xtal Osc.-Aud. Amp., 1-35W4 Rect.

IMMEDIATE DELIVERY!

• Special Introductory Offer!

MITEY-MITE
KIT Complete

\$14.95

(less key and headset)

UNITED SURPLUS MATERIALS

3313-19 W. OGDEN AVE.

CHICAGO 23, ILL.

LEOTONE WIRE & TAPE RECORDING COMPONENTS

Essential "Hard-to-Get" basic parts for constructing units described in Radio News, Feb., '48. **RM-4 RECORDING MOTOR.** Heavy duty 110V, 60 cycle shaded pole induction type. Silent operating for WIRE, TAPE or DISC RECORDING, fans, etc. 5/16" O.D. shaft, 3 3/8" sq. x 2 3/4". Less turntable, mtg. plate & reduction drive wheel. Shpg. weight 6 lbs. **WHILE THEY LAST—ONLY 4.95**



PERMALLOY OUNCER LAMINATIONS. Hydrogen annealed. Specifically for use in constructing TAPE RECORD-PLAYBACK HEADS. Per ounce contg. laminations .40
"HYFLUX" RECORDING TAPE. Recommended for highest fidelity and permanency. Standard 1/2 hour spool 2.98

WIRE RECORD-PLAYBACK HEAD. Precision-built Triple-Coil (record, playback erase), 4 pin plug-in type. Moulded bakelite housing (1 1/4"x1"x3/8"), accurately "Y" grooved for maximum fidelity & sensitivity. For replacement or new applications **SPECIAL 6.95**

WEBSTER RECORDING WIRE. Finest reproductive quality; REPLAYS INDEFINITELY. Standard spools: 1/2 hour 1.98. 1/2 hour 2.98. 1 hour 4.95.
WIRE SPOOL HUB. Polished aluminum. Takes standard recording spool. 1/4" shaft hole, 3/8" deep. .39

ALNICO ERASE MAGNET for TAPE or WIRE. "U" shape; polished poles, 3/8" x 3/8" x 5/8", 3/16" gap .39
WRITE FOR LATEST ILLUSTRATED "ALNICO MAGNET" SUPPLEMENT.
MAGNET WIRE—Sufficient to wind complete TAPE RECORD-PLAYBACK HEAD. #22 P.E. .35. #28 P.E. .59. #30 SCC Enam. .45. Kit of 3 1.25

GET ON OUR MAILING LIST
ALWAYS SOMETHING NEW
A BETTER CONE—BUY LEOTONE
FACTORY REPAIR SERVICE ON ALL
SPEAKERS
 Min. Order \$2.00—20% deposit required on COD's
 Please add sufficient postage

LEOTONE RADIO CO.
 65-67 DEY ST., NEW YORK 7, N. Y.

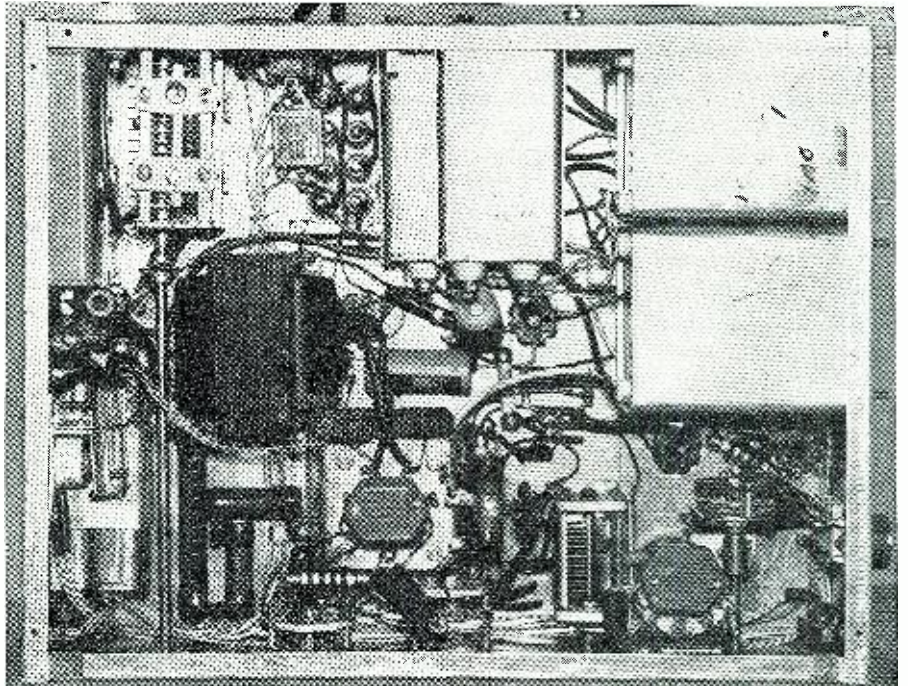

This underchassis view of the complete transmitter shows the location of such components as the buffer and antenna tuning condensers, filter condensers, high voltage power transformer, and other associated parts.

As checked with an oscilloscope, and with the oscillator keyed at several hundred words a minute with a motor rigged up for the purpose, keying was clean.

The buffer operates with 400 volts on the plate and 300 volts on the screen for 20 meter operation. Screen voltage is dropped by switching in bleeder resistors for the 40 and 80 meter bands to reduce the output proportionally. The only difficulty encountered with the 807 was with parasitics. The addition of a small choke in the plate lead cured this trouble.

While self-oscillation seems to be a common difficulty with the 813, no trouble was experienced with the tube in this unit. By reducing the fixed bias so that plate current begins to flow and with the plate circuit unloaded, the tube can be made to oscillate. However when the tank circuit is loaded, oscillation ceases. Aside from carefully shielding the input and output circuits of the 813 and bypassing the screen to ground with a good mica condenser, the grid circuit should be investigated if self-oscillation persists. Loading the grid circuit will reduce the tendency toward self-oscillation. This loading can be done in a number of ways. Shunting the buffer tank circuit with a carbon resistor is effective although it minimizes the advantages gained in the low drive requirements of the 813. Utilizing a low impedance buffer stage by operating it at low plate voltage and comparatively high plate current will hold the grid impedance to a low value. A series resistor can be placed in the grid lead to introduce some loss at this

point, thus discouraging self-oscillation. In this particular unit self-bias is used for the 807 stage. Plate current continues to flow during key-up condition thus effectively shunting the tank circuit by means of the plate resistance of the tube. Bias is such that the plate current flow during key-up condition does not exceed the dissipation rating. This proved to be sufficient to prevent the final from taking off when the key is released.

With plate voltage at 1500 and 180 milliamperes plate current, grid drive should be adjusted so that screen current is 30 milliamperes at 300 volts. Grid current, under these conditions, will be around 10 milliamperes. Increasing grid drive increases the screen current rapidly and this can be used as an indication of the proper amount of drive. Loading of the tank circuit, however, greatly affects the screen current so that loading and grid drive should be adjusted together to provide proper current reading. With a good 40 meter crystal and doubling in the 807, more than sufficient drive can be obtained on 20 meters. The slight excess to allow for variation in crystal activity can be reduced by detuning the 807 plate circuit. Screen bleeder resistors that are switched in on 40 and 80 meters should be of such a value as to allow a little more than the required excitation. Excessive grid drive can damage the 813, therefore cutting down the over-all drive beforehand would be advantageous. In tuning up the plate circuit of the 813 final, in order to avoid excessive off-resonance plate current, the

Columbia

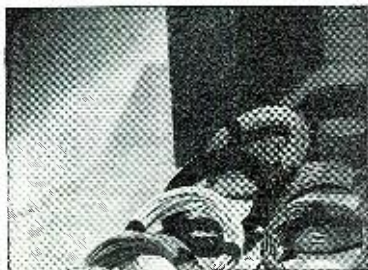

KIT OF ASSORTED WIRE

Ten 100 foot coils of wire, assorted colors and sizes No. 18 to No. 24. Lead-in, push-back and hook-up wire.

\$4.50

A REAL BUY

Jobbers: Write for quantity prices.

TELEPHONE WIRE

Two 19 ga. solid conductors, twisted, with waxed black cotton braid overall, ideal for inside telephone use and intercom installations. Stock up at this low price while limited quantity lasts.

100 foot coil, ea. \$1.95
 500 foot spool, ea. 9.25
 1000 foot spool, ea. 18.00

OUR NEW CATALOG IS NOW AVAILABLE FOR DISTRIBUTION
 Write for your copy today!

COLUMBIA WIRE & SUPPLY CO.
 5734 ELSTON AVE.
 CHICAGO 30, ILLINOIS

grid drive can be reduced to a low value. This will be sufficient to indicate resonance without the tank circuit loaded and then afterwards the grid current can be increased to the rated value. With the antenna cut to proper length, the tap on the antenna coil should be placed and the coupling adjusted to permit proper loading. In the writer's case, tuning the plate condenser to exact resonance with the antenna condenser detuned rather than tuning up the antenna condenser; the resonance setting of the plate condenser does not change for all three bands, using the same antenna.

In operating the unit from a remote position with extended control and keying leads, it may be advisable to shield the hot lead to the key. To avoid introduction of r.f. to the oscillator, RFC₁ was added after it was discovered that the transmitter continued to operate with the key-up due to the r.f. which was getting back into the oscillator and exciting the crystal. Adding the choke eliminated this difficulty but shielding is desirable if leads are of considerable length.

Operating the final with 1500 volts and the recommended 180 milliamperes plate current with 300 volts and 30 milliamperes for the screen, a 200 watt bulb tapped across a few turns of either the antenna or the plate coil lighted to full brilliancy with an input of 270 watts on all three bands. Adding an r.f. choke at the key terminal removed the key click interference in nearby receivers. Despite the inferior supply regulation, no trouble was experienced from key thumps or other interference and so far reports have been excellent.

-30-

The first in a series of nation-wide forums on television antenna installation sponsored by J.F.D. Manufacturing Co., Inc. of Brooklyn and R.A.D.A. of Northern New Jersey brought out 350 radio parts distributors and servicemen. This eager group asked questions and examined television antennas to their heart's content. The company has planned several other forums to be held in the near future.



ACORN SCORES AGAIN WITH MORE FOR YOUR MONEY ON LOW-PRICED BRAND-NEW MATERIAL

ANTENNA BEAM ROTATOR 300 Degrees Rotation

1/25 HP motor, operates on 6VDC or 18VAC. Has 10,000 ohm potentiometer position indicator to operate 0-1 millimeter. Made of aluminum and magnesium; motors enclosed in waterproof housing. Excellent for FM and Television dipoles. Standard Army & Navy equipment; a real Ham's and radio experimenter's delight. Instruction sheets included. Shipping wt. 19 lbs.

Sensationally
Low Priced
\$12⁹⁵
ea.



DC CONVERTER

110 volt 60 cycle, single phase AC to 6 volts DC at 4 amps. Consists of fully enclosed, heavy duty transformer, and selenium rectifier. Shipping wt. 10 lb. Available in 12 and 14 volts DC at slightly higher prices.

\$11⁴⁵
ea.



TUNING CONDENSER

Terrific Value
\$1⁴⁵
ea.
3 for \$4
driven. Shaft 2 1/2", h. 2 1/2", w. 1 1/2", d. 4 1/2". Shipping wt. 2 lbs.

FM Tuning Condenser

\$1¹⁰
ea.
3 for \$3
w. 1 1/2", h. 2 3/4", d. 3 1/4". Shipping wt. 1 lb.

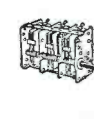

IF TRANSFORMERS

456 KC. Made for high quality sets.
39c ea. 3 for \$1

HEAVY DUTY POWER TRANSFORMER

PRIMARY 110/220 volts 60 cycle
SECONDARY No. 1—110-0-110 at 400 mils
No. 2—3.3 volts at 3 amps
No. 3—6.9 volts at 13.5 amps
No. 4—5 volts at 3 amps
No. 5—2.5 volts at 1.7 amps
Dimensions H 6 1/2", W 6 1/2", D 5 1/2". Shipping Wt. 30 lbs.
Made by G.E. for the U.S. Army.



Tremendous Value
\$7⁹⁵
ea.
3 for \$21

POWER TRANSFORMER

SPECIAL PRIMARY 115 volts 60 cycles
SECONDARY 600 ct. at 100 mils. 6.3 v at 3 amps; 5 v at 2 amps half shell mtg. Mtg. centers 2-5/16" x 2 3/4". Made by Thordarson. Shipping wt. 5 lbs.



Special
\$3²⁵
ea.
3 for \$9⁵⁰

10 STATION INTERCOM

BRAND NEW
Only
\$79⁵⁰

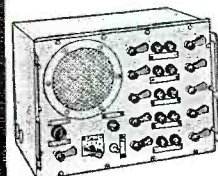

110 volt—60 cycle AC; 16 watt push-pull output. Standard 3 wire control system. Includes all tubes and 3 metal-housed substations as shown. Instruction sheets included. Shipping wt. 60 lbs.

Brand New AMERTRAN TRANSTATS VOLTAGE REGULATORS

130/230 volts, 50/60 cycles. Max. output .65 KVA. Single phase, 0-260V Commutator Range. 2 1/2" Amps. Max. shipping wt. 23 lbs. **\$19⁹⁵**
115 volts, 60 cycle. Max. output .25 KVA. Single phase. 103-106V Commutator Range. Max. Amps. 2.17. Shipping wt. 15 lbs. **9⁹⁵**
115 volts, 400 cycles. Load KVA output .72. Output 75-120 volts. 6 Amps. Max. shipping wt. 14 lbs. **6⁹⁵**

OUTPUT TRANSFORMER

Single tube to voice coil. Primary 6000 ohms, secondary 8 ohms. Hermetically sealed. Made by Chicago Transformer Co. for the Signal Corps. Mtg. centers 1-1/16" by 1-5/16". Shipping wt. 2 lbs. A real bargain at 69c ea. 5 for \$3.00

6L6 OUTPUT TRANSFORMER

Push pull, 25 watts. 6600 ohms per plate to 4-8-15 ohm voice coil. Upright mounting. Mounting centers 3 3/4". Shipping wt. 4 lbs. **\$2.45 ea. 3 for \$7.00**

METER PANEL LIGHTS

Mazda No. 323—3 volts at .19 amps. 12c ea. 100 for \$10.00

TRANSMITTING MICAS

up to 7500 TV. **.49c ea. 10 for \$4.50**

SHIELDED CABLE

with glass insulation and copper braid overall 22 gauge single conductor
500 ft. **\$.15** 1000 ft. **\$.25**
20 gauge double conductor
500 ft. **\$.25** 1000 ft. **\$.45**
20 gauge triple conductor
500 ft. **\$.35** 1000 ft. **\$.60**

ELECTROLYTIC FP TYPE

10 @ 350v **\$.49**
30 @ 300v
20-20 @ 25v
30 @ 450v
20 @ 450v
10 @ 450v **1.19**
20 @ 25v
20-20 @ 450v **.89**
20-20 @ 400v-250v **.59**
10-10 @ 350v
20 @ 25v **.59**
30-30 @ 450v **.94**
100 @ 50v **.57**
1000 @ 25v **1.09**

TOGGLE SWITCHES each

SPST—Ball Handle **.17**
SPDT—Bat Handle **.23**
DPST—Bat Handle **.29**
DPDT—Bat Handle **.49**
Comb. SPDT & DPST Bat Handle **.45**
Momentary reversing switch with PE Knob, black or red, one side open, one closed **.39**

OIL CONDENSERS

2 x .02 Mfd 1500v **\$.69**
.1 Mfd 3500v **.79**
.1 Mfd 7500v **1.79**
.25 Mfd 3000v **1.19**
.15 Mfd 4000v **1.39**
.5 Mfd 5000v **1.89**
1.0 Mfd 2000v **1.29**
1.0 Mfd 1200v **.99**
4.0 Mfd 1000v **.89**
4.0 Mfd 600v **.45**
3 + 3 Mfd 600v **.79**
6.0 Mfd 600v **.79**
8 + 1 Mfd 1000v **1.39**
1.0 Mfd 600v **.89**
15 Mfd 1000v **1.89**
1.0 Mfd 330v AC/1000 DC **.39**
1.5 Mfd 330v AC/1000 DC **.39**

TLA OIL FILLED

4.0 Mfd 600v **\$1.49**
2.0 Mfd 1000v **1.39**

BATHTUB

2.0 Mfd 600v side terminals **.44**

ACORN ELECTRONICS CORP.
Dept. B-80 Vesey St., New York 7, N.Y.

TERMS: 20% cash with order. Balance C.O.D. All prices F.O.B. our warehouse in New York City. No orders under \$2.50.

NEW RECEIVERS

----- on the Market

THREE-WAY PORTABLE

Noblitt-Sparks Industries, Inc. of Columbus, Indiana, are in full-scale production on the new *Arvin* three-way portable, the Model 250P.

Selling in the moderate price class, the new portable features a scuff-proof



carrying case of unbreakable laminated plastic wraparound with light steel top and bottom, and a luggage type carrying handle. The new unit has five miniature tubes plus a selenium rectifier and is equipped with a special antenna hookup for clear reception in mountainous areas. It has a 5 inch Alnico V magnet speaker and specially designed i.f. transformers for higher sensitivity.

For further information on the *Arvin* Model 250P, write to *Noblitt-Sparks Industries, Inc.* Columbus, Indiana.

RCA TABLE MODEL

A small-sized table model receiver, housed in a hardwood cabinet, is the newest addition to the *RCA Victor* line of home radios.

The streamlined walnut-finish cabinet is only 7 $\frac{5}{8}$ inches high, 11 $\frac{3}{4}$ inches wide and 6 $\frac{7}{8}$ inches deep. The "Golden



Throat Tone System" includes a super-sensitive PM electrodynamic speaker measuring 6 by 4 inches. Automatic volume control and a built-in Magic

Loop antenna are added features of this receiver.

The Model 8X53 has four tubes and a rectifier and will operate on either a.c. or d.c.

The *Home Instrument Department, Radio Corporation of America*, Camden, New Jersey, has additional details available on request.

OLYMPIC "GEMS"

Olympic Radio & Television, Inc. of Long Island City is in volume production on a personal portable "Gems," the Model 8-451.

The receiver weighs only slightly over two pounds and fits easily into a coat pocket or handbag. The set measures 8-11/16 by 4-5/16 inches, and is available in maroon, ebony, or ivory with a slide-rule dial.

The portable shuts off automatically as soon as the lid is closed thus assuring that the battery is not subject to unnecessary drain. The set uses four

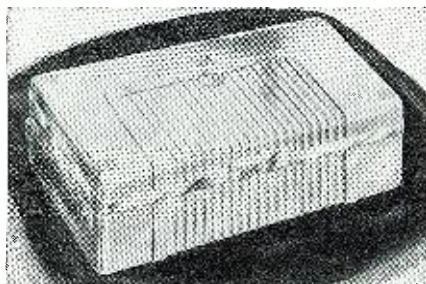

miniature tubes, a 3 $\frac{1}{2}$ inch Alnico speaker and iron core coils.

For further information on "Gems" and data on distributor or dealer openings, write to *Olympic Radio & Television, Inc.*, 34-01 Thirty Eighth Avenue, Long Island City 1, New York.

PROJECTION TV

United States Television Mfg. Corp. is now manufacturing a television set which projects a picture three feet by four feet under normal lighting conditions.

The new model uses a special metal screen developed by the company. This three by four foot screen is placed approximately twelve feet from the set at a height of six feet from the floor. The unit is particularly adapted for clubs, group meetings, schools, institutions, and other places where regular theater controlled lighting is not available.

The television unit is compact and takes up very little room. It is 34 inches high, 20 $\frac{1}{2}$ inches wide and 30 $\frac{1}{2}$

inches long. The unit uses the company's refractive projection television system with certain mechanical advancements to provide this new type of television picture quality.

Additional information on the T3X4836 may be secured by writing *United States Television Mfg. Corp.*, 3 West 61 Street, New York 23, New York.

AIR KING VIDEO SET

The new Model A-1000 table television receiver being marketed by *Air*

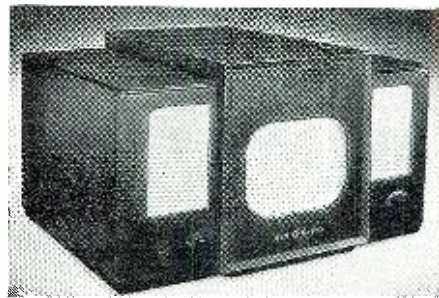

King Products Co., Inc. will retail in the moderate price class.

This 30-tube receiver incorporates a 10 inch direct view tube and provides full 13 channel coverage. The set uses seven front-panel controls including a.f.c., horizontal hold, and stabilized vertical hold. Two stages of video amplification are provided and the set uses a 4 mc. bandwidth for video amplification.

The cabinet is of mahogany veneer which measures 26 by 14 $\frac{1}{2}$ by 19 inches. *Air King Products Co., Inc.*, Brooklyn 2, New York will supply full details on request.

TABLE MODEL RECEIVER

One of the three new table model receivers being introduced by *Packard-Bell Company* of Los Angeles is the Model 682.

This receiver is a six tube set (including rectifier) and is housed in a wooden cabinet and features a metal

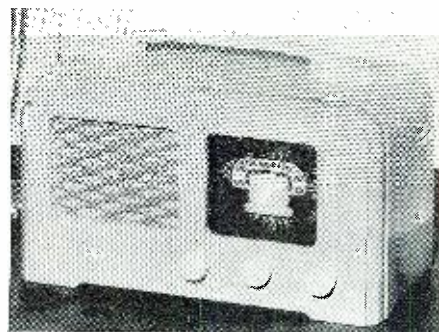

grille, large handle, and tone control. The receiver has the company's "Stationized Dial," continuous tone control, built-in Hi-Q loop, edge-lighted dial, and is designed to provide excellent performance and tone at a moderate price.

NOW **COLLINS** introduces...

**THE "Super 20" TUBE
FM RECEIVER**

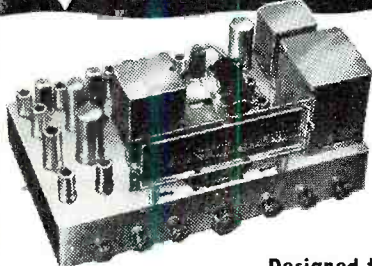

**Unexcelled in
PERFORMANCE**
•
**Remarkably
LOW IN COST**

Designed to satisfy the most critical professional or amateur, the Collins "Super 20" offers unsurpassed value in an FM RECEIVER. The advanced 20-Tube circuit features: Armstrong FM, built-in stabilized power supply and audio amplifier capable of 10-watt output; new 6AL7GT tuning eye, connections for 2 types of phono pick-up, output impedances to match 4 to 20 ohm voice coils and 500 ohm line, and variable bass and treble tone controls with attenuation and boost for upper and lower registers.

Write Today for Complete Details

COLLINS Audio Products Co., Inc.
P. O. BOX 368 • WESTFIELD, N. J. • WE-2-4390

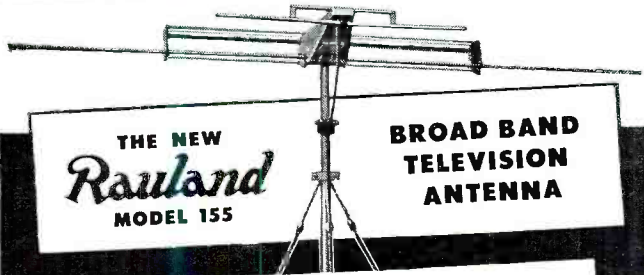

**THE NEW
Rauland
MODEL 155**

**BROAD BAND
TELEVISION
ANTENNA**

**CHECK THESE
SUPERIOR
FEATURES!**

- High Sensitivity on All Channels
- Low Standing Wave Ratio
- Ingenious Dual-Section Design
- All-Aluminum Construction

For Clear, Brilliant Reception on All Channels

Here's a better Television Antenna, engineered and built in the famous RAULAND quality tradition! The Model 155 demonstrates exceptional coverage and high-efficiency on all channels. Features dual-section design; low band section covers Channels 2 through 6 and FM band. High band section covers Channels 7 through 13. Unusually low standing wave ratio is maintained throughout all channels, and a highly efficient built-in coupling network contributes to maximum efficiency on all bands. Lightweight aluminum construction throughout withstands 80-mile wind with 1/2" sleet or ice load. With threaded flange for coupling to 1" pipe. Has lucite low-loss insulators. Special MT-500 heavy steel base available optional; fully adjustable from horizontal to vertical. Antenna can be permanently grounded for protection against lightning. Direct match to standard 300 ohm input. From every angle, the RAULAND Model 155 Television Antenna demonstrates superior performing advantages!

AVAILABLE AT YOUR DEALER NOW!

Electronizing is our business

SOUND TELEVISION **Rauland** **INTER-COMMUNICATION**

THE RAULAND CORP. • 4267 N. KNOX AVE. • CHICAGO 41, ILL.

July, 1948

*Everybody agrees
ATR AUTO RADIO VIBRATORS
are TOPS*



AUTO RADIO VIBRATORS
have Ceramic Stack Spacers.



New 34 page
VIBRATOR
GUIDE
FREE



A Complete Line of Vibrators . . .
Designed for Use in Standard Vibrator-Operated Auto Radio Receivers. Built with Precision Construction, featuring Ceramic Stack Spacers for Longer Lasting Life.
Backed by more than 17 years of experience in Vibrator Design, Development, and Manufacturing--
ATR PIONEERED IN THE VIBRATOR FIELD.

New Models



**"A" BATTERY
ELIMINATORS**
For DEMONSTRATING AND TESTING
AUTO RADIOS

New Models . . . Designed for Testing D. C. Electrical Apparatus on Regular A. C. Lines. Equipped with Full-Wave Dry Disc Type Rectifier, Assuring Noiseless, Interference-Free Operation and Extreme Long Life and Reliability.

New Models



**STANDARD AND
HEAVY DUTY
INVERTERS**

For Inverting D. C. to A. C. . .
Specially Designed for operating A. C. Radios, Television Sets, Amplifiers, Address Systems, and Radio Test Equipment from D. C. Voltages in Vehicles, Ships, Trains, Planes and in D. C. Districts.

**NEW MODELS
NEW DESIGNS
NEW LITERATURE**
*See your jobber
or write factory*

AMERICAN TELEVISION & RADIO Co.
Quality Products Since 1931
SAINT PAUL 1, MINNESOTA-U. S. A.

AMPERITE MICROPHONES

The ultimate in microphone quality, the new *Amperite Velocity* has proven in actual practice to give the highest type of reproduction in Broadcasting, Recording, and Public Address.

The major disadvantage of pre-war velocities has been eliminated — namely "boominess" on close talking.

- *Shout* right into the new *Amperite Velocity*—or stand 2 feet away—the quality of reproduction is always excellent.
- Harmonic distortion is less than 1%. (Note: best studio diaphragm mike is 500% higher.)
- Practically no angle discrimination . . . 120° front and back. (Best studio diaphragm microphones . . . discrimination 800% higher.)
- One *Amperite Velocity* Microphone will pick up an entire symphony orchestra.



P. G. Dynamic Models PGH, PGL List \$32.00

STUDIO VELOCITY, finest in quality; ideal for Broadcasting and Recording.

Models R80H-R80L — List \$80.00
There is an *Amperite Microphone* for every requirement.

WRITE FOR ILLUSTRATED 4-PAGE FOLDER giving full information and prices.



Amperite Velocity Microphones for Public Address Models RBHG, RBLG List \$42.00

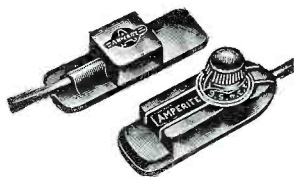

"Kontak" Mikes Model SKH, list \$12.00 Model KKH, list \$18.00

Address inquiry attention Dept. RN

AMPERITE Company
561 BROADWAY NEW YORK

In Canada: Atlas Radio Corp. 560 King St. W. Toronto, Ont.

Additional details on the Model 682 and other receivers in the company's line are available from *Packard-Bell Company*, Los Angeles, California.

"POLICALARM"

For the police call fans *Radio Apparatus Company's* announcement of the availability of their "Policalarm" FM receiver will be welcome news.

The new receiver tunes from 152 to 162 mc. which includes taxi and other mobile receivers in addition to the police band. The receiver is housed in a walnut veneer cabinet and operates on 115 volts a.c. or d.c.

It is a straight superheterodyne, 5 tube circuit with two stages of high gain i.f.'s at 10.7 mc.

Radio Apparatus Company, Indianapolis, Indiana will supply prices and other pertinent data on request.

GENERAL ELECTRIC TV

General Electric Company has started shipment of the Model 810 television receiver, the lowest priced model in the company's line.

This table model receiver features a 10 inch direct view tube with an alumi-



num-backed fluorescent screen. This aluminum backing acts as a mirror which prevents loss of light and stray reflections inside the tube thus improving picture brilliance.

Complete information on the Model 810 table model TV receiver can be secured from *General Electric Company*, Electronics Park, Syracuse, New York.

HOFFMAN'S "MALIBU"

Hoffman Radio Corp. of Los Angeles is now in production on the "Malibu," the first television receiver to come off the company's production lines.

Features of the set include the 12 inch acoustically treated speaker. The television unit is entirely independent and no plug-ins are needed. All visible glass, except the picture area, is sand blasted for glare protection. The cabinet

Miller
BUILDERS OF QUALITY RADIO INDUCTANCES SINCE 1924

NOW AVAILABLE TO THE SERVICEMAN AND EXPERIMENTER THE FAMOUS

K-TRAN

• THE FINEST MINIATURE I. F. TRANSFORMER EVER

MANUFACTURED!

• ONLY 2 1/8" HIGH BY 3/4" SQUARE

• SHELL CORE PERMEABILITY TUNED. STABLE SILVER MICA FIXED CONDENSERS — NOT MICA COMPRESSION TUNED.

• UNIQUE SNAP CLIP MOUNTING FOR ROUND HOLES IN CHASSIS.

455 KC input transformer gain 50. Band width at 2 times 16 KC; at 10 times 40 KC.

455 KC output transformer gain 110. Band width at 2 times 18 KC; at 10 times 50 KC.

262 KC input transformer gain 65. Band width at 2 times 9 KC; at 10 times 23 KC.

262 KC output transformer gain 130. Band width at 2 times 10 KC; at 10 times 27 KC.

CAT. No	ITEM	NET PRICE
12-H1	262 KC Input I. F. Trans.	1.35
12-H2	262 KC Output I. F. Trans.	1.35
12-C1	455 KC Input I. F. Trans.	1.20
12-C2	455 KC Output I. F. Trans.	1.20

The "K-TRAN" is distributed nationally to the jobber only by *J. W. Miller Company*.

*Manufactured under "K-TRANS" Patent Numbers 2435630 and 2429468 of Automatic Manufacturing Corp.



J. W. MILLER COMPANY
5917 S. MAIN ST. LOS ANGELES, CALIF.

IT'S NEW!
IT'S DIFFERENT!

RADIO DOR-A-FONE

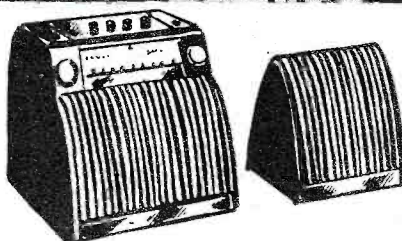

A Combination Radio and Inter-Com System

For use in office—home—factory and warehouse! Use as regular radio—channel the radio reception to the remote speak if you wish. Or use as inter-com system for instant 2-way communication!

- Push-button selector switch for radio and inter-call
- 5" Alnico V Dynamic Speaker in master and sub station
- Sensitive super-het circuit; built-in loop antenna

MODEL 458RD
MASTER AND SUB-STATION with 50-ft. wire
Extra Sub-Station4.95 List

3995
List

Radio Electric
SERVICE CO. OF PENNA., INC.

7TH AND ARCH STREETS, PHILA. 6, PENNA.
Branches: 5930 Market St. & 3145 N. Broad St., Phila.
Also in Wilmington, Del., Easton, Pa., Allentown, Pa., Camden, N.J.

doors can be adjusted to block side reflection by partially hooding the screen.



The "Malibu" is available in blonde or mahogany finish.

Further details will be supplied by Hoffman Radio Corp., 3761 S. Hill, Los Angeles 7, California.

-30-

Video Test Equipment

(Continued from page 45)

A safety factor is provided in the locking-pin plug, in that a single turn will prevent the test lead from pulling out of its panel connection. This is rather important when it is necessary to depend on a good ground connection during high-voltage measurements.

Television Sweep Generator

The television sweep generator shown in Fig. 2 (left) incorporates many new design features. While it employs the usual heterodyne system for the video and all i.f. sweeps, only the fundamental of a single frequency-modulated oscillator is used on any of the r.f. channels. This method avoids r.f. coupling between the desired sweep and any other signals present in the equipment.

The channel selector provides for choice of any one of the pretuned 13 channel positions for choice of i.f. or video sweep voltages. Although a sweep-width control is a part of the equipment, the maximum sweep is preset to approximately 20 per-cent over-ride for each channel requirement. In becoming accustomed to the sweep-width control, it will be noticed that the normal action is the reverse of that of a scope gain control. In other words, increasing the sweep width makes more of the over-all curve visible, while decreasing the sweep width enlarges a portion of the curve.

The 60-cycle sine-wave sweep rate used will produce two identical images on the scope screen and so it is necessary to have a phase control to bring these two images together. When blanking is chosen, however, one of the im-

July, 1948



Federated Celebrates New ALLENTOWN, PA Branch Opening

with this **BLAST** of Values

18-DRAWER EQUIPTO



STEEL SHOP CABINETS

Remarkably useful assembly, contains 18 drawers, each with 4 removable adjustable compartments. Olive green baked enamel finish. Width 34", height 133/4", depth 12". Cabinets may be stacked or used individually. **YOUR COST... \$24.50**

12". Cabinets may be stacked or used individually. **YOUR COST... \$24.50**

8-DRAWER EQUIPTO

Similar to above, but eight drawers. Overall width 25 1/2", height 10", depth 12". **YOUR COST... \$14.50**

SENSATIONAL CRYSTAL MIKE VALUE

Never before offered at this low price! High quality crystal hand-mike, unidirectional, wide range response. Massive one-piece construction, 2 1/4" diam. by 1 1/2" thick. Complete with attached 100-ft. shielded mike cable. A truly wonderful buy, for only **\$5.95**



150 MIL POWER TRANSFORMER

Fully shielded, with internal electrostatic shield. High quality unit, latest type construction, suitable for P.A., general replacement, construction of power supplies, etc. Primary: 115 v 60 cycles. Secondary: 700 V C.T. @ 150 Ma; 5 V @ 3 Amps; 6.3 V @ 3.2 Amps. Long flexible color-coded leads. Height 4 3/4", Mtg. Ctrs. 2 5/8" x 3". **SPECIALLY PRICED. Each \$3.39**

115 MIL POWER TRANSFORMER

Fully shielded, made by well-known mfr., all BRAND NEW. 115 volt 60 cycle primary. Secondary: 700 V C.T. @ 115 ma; 5 V @ 3 Amps; 6.3 V @ 3.2 Amps C.T. Long tinned color-coded leads. Mtg. Ctrs. 3-3/16" x 2-9/16". **VERY LOW PRICE. Each... \$2.95**

Famous Make RF Choke

2.5 Milhenrys 500 Ma. DC

Brand New

Six thin universal pies, isolantite core, insulated mounting brackets. Sensational value at our low price of... **59c**



HERE'S A TERRIFIC VALUE!

TUBULAR ELECTROLYTIC
30-25 MFD 300 V DC
20 MFD 25 V DC
ONLY 24¢ EACH

Compact cardboard tubular. Long insulated color-coded leads. Made by foremost mfr. (we can't mention name—price is SO LOW!) Special quantity price:

TEN FOR \$2.00

2 VOLT WILLARD STORAGE BATTERY

Lightweight plastic case. Rechargeable, spillproof. Portable type. Another big value! **EACH ONLY \$1.25**

Quart Bottle Battery Electrolyte

For above or similar storage batteries. Enough for two 2-volt cells. Limited quantity at this **SPECIAL LOW PRICE. \$1.25**
Per qt. bottle... **\$1.25**

MAIL ORDERS TO NY OFFICE DEPT. 28-J

Please include 25% Deposit with order, Balance C.O.D. Minimum C.O.D. order **\$5.00**

Federated Purchaser
INCORPORATED
distributors of **RADIO - ELECTRONIC and SOUND EQUIPMENT**
80 PARK PLACE, N. Y. 7
Phone: Dighy 9-3050

NEW BRANCH Just Opened
115 HAMILTON ST. ALLENTOWN, PA.
Completely stocked warehouse and showrooms.

12" Heavy Duty PM

Well-known make 12" heavy duty PM speaker, complete with output transformer for PP 6L6s. Latest type construction. Ideal for P.A. work. Each... **\$8.95**



12" PM SPEAKER

Fine for replacement and medium duty P.A. use. Latest type construction. Made by nationally known mfr. Alnico V slug. Less transformer. Each... **\$5.95**

WALL BAFFLE for 12" Speaker

Well made, reinforced walnut wood speaker baffle, suitable for 12" speakers. Lustrous finish, handsome grille, ideal for all indoor P.A. use. Limited quantity, **sensationally LOW PRICE. Each... \$2.95**

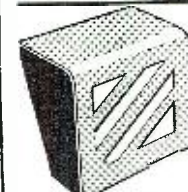

FAMOUS MAKE CRYSTAL MIKE SPECIAL

An exceptional buy! This crystal mike (30-10,000 c.p.s.) can be used for ham work, home recordings, public address, etc. Detachable base. May be used as desk stand, hand mike, or on a floor stand. Complete with 15 foot cable. All yours for **\$4.95 ONLY**



VOLUME CONTROL BONANZA!

YOUR CHOICE TEN FOR \$4.90

Standard replacement volume controls, complete with switches. Well-known make. 3" aluminum shaft with flat, easy cutting. Available in these ohmagest:

10,000 ohms	250,000 ohms
25,000 ohms	1/2 megohm
50,000 ohms	1 megohm
100,000 ohms	2 megohms

SOCKET WRENCH KIT

Another necessary tool for every ham, repairman, experimenter. Consists of right-angle ball-bearing wrench with six interchangeable sockets from 1/2" down to 3/16". In handy metal container. A **REAL BARGAIN AT... 35c**



SPECIAL ALIGNMENT TOOL

39¢ each

Cleverly designed one-piece combination insulated screwdriver and 5/16" hex wrench. Screwdriver recessed when not in use. 1 3/4" diam. futed bakelite knob with etched pointer.

WONDERFUL VALUE, ONLY 39c

APRON TOOL

Very useful for every radio serviceman, ham, experimenter. Heavy canvas, 21 1/2" x 18". Has five pouches for standard tools, can be worn as apron, or rolled up as tool kit. Has strap with clasp. Only a few left at this **LOW PRICE. Each... 19¢**

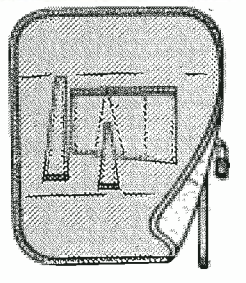

PEAK POWERFUL BUYS!



A BRUTE
A hefty filter choke with an honest-to-goodness rating of 6 henry at 550 mills. We emphasize "at," 28 ohms DC resistance. Built to Signal Corps specs, and beautifully cased as illustrated. Size 5 x 4 1/4 x 5 7/8. Net weight 14 lbs.
ONLY \$4.95 EA.
2 FOR \$8.90

FOR FILAMENTS

Conservatively rated, this transformer delivers 5 volts at 15 amps running "ice cold." Has two separate 115 volt primaries 25 to 60 cycles, 110 or 220 volt input. Ideal for tubes such as 35T, HK254, 100TH, 250TH, H4257, etc. Cased as illustrated above. Size 5 x 4 1/4 x 5 7/8. Weight 10 lbs.
\$3.75 EA. 2 FOR \$6.80

A HUSKY BABY

This rugged plate transformer was designed for good regulation. It has two separate 115 volt, 25 to 60 cycle primary windings. (115 or 230 volt input.) Output 820 volts center tapped at 775 mills. Excellent regulation even under 900 mill load. Makes a wonderful plate supply for running lots of equipment simultaneously. Built to rigid government specs. Size 6 1/2 x 6 1/2 x 7 mounting holes on top and bottom. Fully shielded as illustrated above. Net weight—36 lbs.
ONLY \$7.95 EA. 2 FOR \$14.50

VERSATILE POWER

These transformers built to Signal Corps specs. All have two separate 115 volt primaries, 25-60 cycles (115/250 V. input) They have many uses—Filament Isolation, Bias, Stepdown, etc. 3 choices of secondary windings.

Type T54—115 volts—500 ma, 6.3 V. @ 5 amps
Type T55—115 volts—900 ma, 6.3 V. @ 2 amps
Type T52—0-70-75 Volts, 2 1/2 amps (0-35-37 with Pri. in series)

Your Choice of Any Type
\$1.95 EA. 2 FOR \$3.50

SPERTI RF

VACUUM SWITCH

9200 volts peak, 8 amps. Used as antenna switch in Collins ART 13. BRAND new.....
\$1.75



SCOPE TRANSFORMER

Hermetically sealed 1800 volts, 4 ma, 6.3 volts, 9 amp. 2 1/2 volts, 2.5 amps., 5 x 3 1/4 x 3 3/4.....
\$5.95

We Have Just Purchased A New Batch of Standard "METERS" Brand

1 1/2" 0-1 ma Basic	\$3.95
2" 0-5 ma Basic	1.95
2" 0-12 ma	2.49
2" 0-120 ma	4.55
2" 150-0-150 Micro Amp	3.49
2" 0-30 amp DC	2.95
2" 0-1 ma Basic	2.95
3" 0-50 amp AC	4.95
3" -10 to +4 DB	3.95
3" 0-80 ma	2.95
3" 500-0-500 Microamp	4.50
3" 0-75 amp AC	4.95
3" 0-2 ma DC	3.55
3" 200-0-200 V. DC	2.95
3" 0-1 ma DC	3.95
3" 0-20 ma DC	3.95
3" 0-15 ma DC	3.95
3" 0-150 V. AC	3.95
3" 0-50 Microamp	9.95
4" 1-0-1 ma	3.95

STEPPDOWN TRANSFORMER

220 to 110 volts, 50 to 60 cycle, 100 watts. \$2.49 ea.

FEDERAL SELENIUM RECTIFIER

Full wave, 36 volts input, 28 volts output at 6.1 amps. Brand new.....
\$7.95

OIL CONDENSERS

11 mfd 250 vac.....	\$0.85	vdc.....	\$1.95
5 mfd 150 vac.....	.49	1 mfd 7500 vdc.....	1.95
1 mfd 600 vdc.....	.29	.15/.15 mfd 8 kv	
2 mfd 600 vdc.....	.31	dc	2.75
4 mfd 600 vdc.....	.59	4 mfd 8 kv dc.....	19.95
3/3 mfd 600 vdc.....	.79	.01/.01 mfd 12 kv	
10 mfd 600 vdc.....	.95	dc	5.75
14 mfd 600 vdc.....	1.35	.005/.01 mfd 12 kv	
2 mfd 1000 vdc.....	.79	dc	5.50
4 mfd 1000 vdc.....	.95	.03 mfd 16 kv dc.....	5.75
15 mfd 1000 vdc.....	2.95	.65 mfd 12500	
2 mfd 1500 vdc.....	1.25	vdc	12.95
1 mfd 2000 vdc.....	1.45	.75/.35 8/16 kv	
3 mfd 3000 vdc.....	3.45	dc	12.95
1 mfd 5000 vdc.....	4.50	.02 mfd 20 kv	7.95
.15/.15 mfd 6000		1 mfd 25 kv dc.....	17.50

MISCELLANEOUS SPECIALS

Vibroplex's	\$6.95
2-11 mmf Butterfly with ball bearings.....	.99
G.E. SPDT Relay 10,000 ohm coil.....	.99
Heinemann Circuit Breaker, 110 V. AC 5 amp	.89
G.E. Solenoid with microswitch.....	.69
Ohmite 25 ohm 25 W. rheostat.....	.39
Microswitch (interlock) 13 amps.....	.59
W.E. Choke 4.3 hy 620 ma 42 ohms.....	4.95
4 Quadrant phasing cond.....	1.95
Trimm Commercial Phones.....	4.50
Veeder Root Counter.....	.95
Choke 8 hy 160 ma 140 ohms.....	1.99
TPDT Antenna Relay-110 V. AC Isolantite.....	1.95
C-H Switch DPST 1/2 H.P. Bat handle.....	.95
CD.002 Mica 7500 Volts test.....	.99
CD 16 mfd 450 V Can with leads.....	.69

If not rated, 25% with order, balance C.O.D.—Minimum order \$3.00.

PEAK ELECTRONICS CO.
188 WASHINGTON STREET, DEPT. MR
NEW YORK 7, N. Y.

ages is blanked out and the return trace appears as a base line. This line provides a convenient means for measuring the amplitude of various parts of the remaining trace. With the help of the graph screen on the scope it becomes an easy matter to locate the 70 per-cent point on an i.f. or r.f. curve.

Television Calibrator

The television calibrator illustrated in Fig. 2 (center) produces c.w. signals which show as heterodyne markers on the scope screen when both its signal and the sweep signal are applied to a television receiver for curve observation. The marker indicates the definite frequency of any one point on a curve. In the adjustment of r.f. oscillators and trap circuits or in the alignment of stagger-tuned i.f. strips, the calibrator can be used as a signal generator with inherent crystal-controlled accuracy.

The television calibrator itself contains a tunable oscillator which produces a dial-indicated signal from 19 mc. to 110 mc. and from 170 mc. to 240 mc. An internal crystal-controlled oscillator is used to check the accuracy of the dial. Heterodyning signals are detected and reproduced audibly by a small built-in speaker. Applying the crystal-controlled oscillator harmonics in this way facilitates checking and accurately resetting the dial to any 2.5-mc. point within its range.

A second crystal can be switched in to add its 0.25-mc. signal frequency by modulating the 2.5-mc. oscillator. This, in turn, makes it possible to divide the 2.5-mc. harmonic points on the dial into 0.25-mc. calibrations. Once a 2.5-mc. point is established, it is easy to count the added 0.25-mc. in between steps and thus arrive at a precise calibration for television receiver requirements.

Having such facilities available, plus the signal from one television station, makes a truly scientific alignment job a reality, for with crystal accuracy and properly reproduced curves, a receiver can be adjusted for maximum dependable service on all 13 television channels.

Vacuum-Tube Voltmeter

The new vacuum-tube voltmeter seen in Fig. 2 (right), designated commercially as the "RCA Master VoltOhmyst VTVM" is quite a universal testing instrument in itself. As normally found on electronic voltmeters, d.c. ranges up to 1000 volts, and resistance ranges to 1000 megohms, (and a.c. ranges flat to 20 kc. reading to 1000 volts) are provided with increased sensitivity. For r.f. voltages, an accessory crystal probe can be used to read r.m.s. values to 100 mc., or an accessory diode probe will read peak, or peak-to-peak voltages, to 250 mc. This makes the instru-

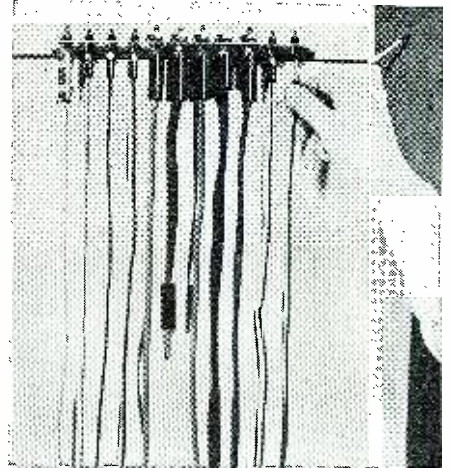

Fig. 4. This handy rack keeps the test leads straight and readily available.

ment useful for checking v.h.f. oscillator voltages and peak values of deflection voltages regardless of waveform.

Six capacitance ranges enable the meter to indicate directly on one scale, any value between 5 micromicrofarads and 1000 microfarads. With this new feature, tuning condensers, r.f. and i.f. bypass condensers, audio-, video-, power-supply, and deflection-circuit condensers can all be accurately tested.

Oscilloscope

The oscilloscope shown in Fig. 3 (left), besides taking its rightful place in the test rack, is small and light enough to carry to the job when the job can't come to the bench. This instrument has the new feature of calibrated vertical deflection which enables direct reading of peak-to-peak voltages regardless of waveform. A removable graph screen, once calibrated on a 10-division basis, reads voltages throughout the deflection range.

When the sweep selector is set to "line" position, a small sine wave voltage at power line frequency is applied to the horizontal amplifier. This feature provides a time-base deflection for sweep alignment since it eliminates the need for connecting the sweep generator to the scope. Both instruments can be synchronized to the power line and thus to each other.

While wide-band response is essential for the observation of synchronizing and

Fig. 5. Method of listening to interference on picture i.f. channel. The sound i.f. tube is removed from circuit.

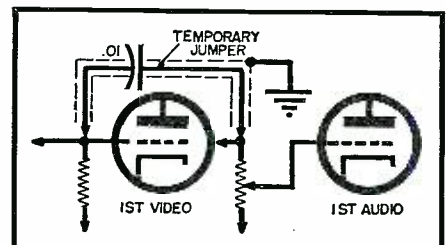

New UNGAR SOLDING PENCIL!

No. 538
Tellurium
1/8" Chisel tip

No. 537
Tellurium
1/8" Pencil tip

No. 539
Tellurium
3/8" Chisel tip

No. 536
Tellurium
3/8" Pyramid
Tips \$1.00 each

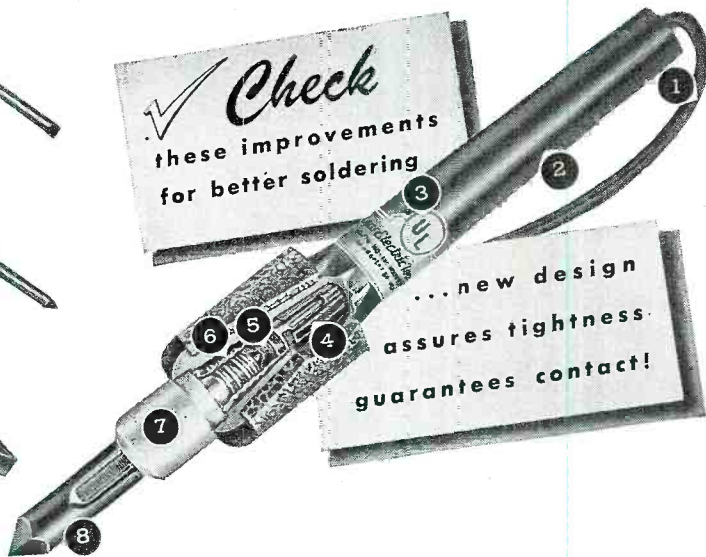

Feather-light FOR HARD-TO-REACH JOBS
Heavy-Rugged FOR ALL STANDARD SOLDERING

8 New Features

1. Full Length CORD
65 strand Extra Flexible
2. New, Cooler HANDLE
of Durable Molded Plastic
(Patent applied for)
3. UNDERWRITERS'
Listed
Seal on Complete Pencil Set
4. Ceramic SEPARATORS
for DOUBLE Safety
5. Spring Action Rivet
Assures positive contact at
all times
6. Extra Length Brass
Shell
Firmly engages all threads
Keeps Heating Unit Tight
7. 20 watt ELEMENT
1,000 hours operation 56¢
110-120 volt A. C.—D. C.
8. 4 INTERCHANGEABLE
TIPS • ample copper
heats to 600° in 90 sec.

No. 776
Handle & Cord
Set \$100

UNGAR *Electric Tool Co., INC.*

★ ★ ★ LOS ANGELES ★ ★ ★

Sold only through
Radio Parts, Hobby,
& Hardware Dealers

Telephones!

**MAGNETO RINGING
SELF CONTAINED
No External Power Required**



- Simple installation - 2 wires or one wire and ground. Fence wire makes satisfactory circuit.
- Works and rings up to 50 miles.
- No external power required.
- Use as many units as you need on one pair of wires.
- Housed in rugged steel cabinet for mounting on wall or post.
- BRAND NEW French style handset.

APPLICATIONS

- x Broadcast remotes.
- x Construction projects - Highway - Building - Bridge Construction, etc.
- x Farm house to out-buildings.
- x Farm to farm.
- x Extension phones.
- x Store to warehouse to yard.
- x Summer camps, lodges, etc.
- x Trailer camps.
- x Athletic stadiums.
- x Independent telephone companies.
- x Ships.
- x Office intercommunicating.
- x Install your own private telephone system.

These telephones are Army surplus - slightly used, checked and inspected. Guaranteed to be in excellent condition. Dimensions - 5 1/4" x 6 1/4" x 9 1/4". Shipping weight - 16 lb.

SREPCO

STANDARD RADIO & ELECTRONIC PRODUCTS CO.
135 E. Second St. - DAYTON 2, OHIO. - Tel. Fullton 2174
Cable Address "SREPCO"

Stock No. B-588R
PRICE PER UNIT
Complete with
BRAND NEW HANDSET

\$12.95

Write, wire or phone your order Today!!

MAIL ORDERS SHIPPED WITHIN 24 HOURS
20% DEPOSIT REQUIRED

All prices are net, f.o.b. Dayton, O.

RESISTOR EQUIPPED

for 115 V. Neon Lamps

5/8" DIA.



Ask for the Johnson-Gothard Catalog, illustrating and describing a complete line of Indicator Light assemblies of varied sizes and duties.

JOHNSON-GOTHARD INDICATOR LIGHTS

Models 147-1143 and 147-1144

You have a choice of Model No. 147-1143 (with 200,000 ohm, built-in resistor) for dim glow; Model No. 147-1144 (with 100,000 ohm built-in resistor) for bright glow; or Model No. 147-1142 (without resistor) for Nos. 42, 313 and 1815 Mazda lamps. All models are equipped with a colored lucite protecting cap which encloses the lamp. All metal parts are ruggedly precision made. This Johnson-Gothard Indicator Light assembly radiates a quality appearance that will be a definite asset to any product you have in mind—and it is the last word in utility and economy.



E. F. JOHNSON CO.
WASECA, MINN.

JOHNSON
a famous name in Radio

Surplus Accessories

45" Tuning Cable for SCR274N. ea. \$.65
MC211A R/Angle for SCR274N. ea. .75
TU7, 9, 10, 26 w/case, used. ea. 1.95

Plugs & Connectors

PLQ-103 for BC348. ea. \$.75
AN/APN1 plugs. ea. .35
R89/ARN5 plugs. ea. .55
PLQ62, PL65, PL76, PL104,
PL126, PL152, PL172, PL179,
PL256. ea. .75

BC732A Control Head w/plug, new \$1.85
M299 Mike Adapter w/plug, new. 2.95
4 foot cable for BC375 w/PL61
plugs. 2.00
Spark plug suppressors. ea. .05

Mountings & Racks

FT222, FT228. ea. \$1.00
FT107, FT142, FT151, FT221,
FT225, FT226, FT227, FT229,
FT234, FT247, FT248. ea. 2.00
FT154, FT293, FT488. ea. 3.00
FT224, MT14, MT28. ea. 3.50
FT331A. ea. 7.50

SPECIAL—C97/AIC2 Remote Gain Control
includes single pole 4-position rotary switch
and knob. 3 for \$.69

Radio Compass Special

1—PL112 Plug
1—PL118 Plug
1—PL122 Plug
1—Tuning Cable 13' 8"
1—R/angle Drive MC136
Total Cost \$11.65

Minimum order \$2.00—FOB Flushing, N. Y.

LONG ISLAND RADIO CO.

36-23 164th St., Flushing, N. Y.
Flushing 9-3918

ONLY A FEW LEFT !

RA20 Powerpack
converts BC312 receiver to
AC operation. Fits in
dynamotor compartment.
Also for external use with
BC348, 314, 224, and used
with BC636 and 459 as
ECO. Input 110-120 VAC,
60 cycles. Output 250 VDC
@ 95 MA, 12V @ .6 A.
12V CT @ 3A.



Shipping weight, 12 lbs. **\$7.95**

BC610 Components. Modulator Decks less mod-
ulation transformer. Completely wired. \$14.95
11Hy. .600 amp. Chokes. \$7.95

VIBRATOR POWER SUPPLY KIT

150 VDC at 40 MA. Use with portable receivers.
Consists of power trans., synch. vib. and socket,
two 8 mfd at 450 V. condensers, resistor. Value
\$8.50. Price only \$4.25

SENSITIVE RELAY—10,000 ohm coil—SPDT. \$1.25

FILTER CONDENSERS

8 mfd—1000 VDC. \$1.45
8 mfd—2500 VDC. 4.50

NARROW BAND FM ADAPTOR

Noise Free Reception!

Only adaptor for BC-348 receiver using 915 KC IF.
Also made in 455-465 KC Model 33x4 1/2".
Completely Chromium Plated. Easily mounted. Uses
6A15 limiter and 6A15 discriminator. Instructions
supplied. **\$10.95**

Price (less tubes)
6A15 tubes. 90c ea. 6A15 tubes. 90c ea.

MICA CONDENSERS

50 mmf—8000 VDC. Can be used in parallel with
tuning condenser to extend frequency range of
transmitters. Sangamo type F3L. \$2.50
100 mmf 5000 VDC Sangamo type F2L. \$1.50

2 1/2 Volt 10 Amp. 866 filament transformer for
BC610. \$3.50

50 Watt tube stockets similar to National XM50 60c

Write for FREE Merit Catalog listing all
transformers and chokes

TERMS: 30% with order. Balance C.O.D. Shipt. F.O.B. Chicago

SCHUH'S RADIO PARTS

1253 Loyola Avenue • Chicago 26, Illinois

blanking-pulse shapes, it is well to point out here that a scope, such as described, having a response flat within plus or minus 10 per-cent to 40 kc. is ample for all sweep-alignment work on television or FM sets. The sweep curve observed is not r.f., but is derived from the frequency-modulated r.f. or i.f. signal by detection, and so it is actually well within the audio range. When it is desired to check a video curve, an additional detector such as the 1N34 crystal is required to demodulate the video sweep.

Test Oscillator

The test oscillator illustrated in Fig. 3 (center) can be considered an old friend, since most users are familiar with its basic function of providing a tunable c.w. signal from 100 kc. to 30 mc. Troubleshooting i.f. circuits in FM and TV sets now adds to its usefulness. Due to its superior r.f. waveshape, harmonic content of the test oscillator output is considerably lower than usual and second-harmonic signals above the fundamental maximum of 30 mc. are therefore not usable. Supplying higher-frequency signals is a job that belongs to the television calibrator.

Audio Oscillator

With the audio oscillator seen in Fig. 3 (right), video signal tracing can be accomplished in the same manner as audio signal tracing since only one frequency is needed at a time to run down the usual causes of failure in video circuits. After a video circuit has been repaired, it can be tested for characteristic response with the television sweep generator and oscilloscope, but because the low-frequency end of the curve is difficult to interpret, it is often advantageous to use audio oscillator signals for low-frequency determinations.

The audio oscillator can also be used advantageously to produce bar-like patterns on the screen of a television picture tube, and thus furnish a means of testing television receiver sweep circuits for linearity.



Spot Radio News
(Continued from page 20)

channels for video work was cited in a second TV ruling by FCC, which called for hearings on the state of development of black and white and color for these bands. The sessions, which will begin on September 20 in Washington, will also be concerned with interference problems which now prevail on channels two to thirteen, and are caused by adjacent-channel operation, harmonic radiations, or manmade noise.

Appears as if there'll be plenty of TV-allocation activity before the year is out.

THE FIRST CASE of illegal two-way radio cab operation, reported recently by the FCC, has been sent over to the Attorney-General's office. According to the complaint two unlicensed transmitters of a cab company in Oklahoma had been on the air and interfered with licensed equipment. Should the cab company officials be found guilty, they may be fined up to \$10,000 or imprisoned for two years, or both, as violators of section 301 of the Communications Act which forbids unlicensed transmissions.

THE OFFICE OF NAVAL RESEARCH is seeking many electronic and radio engineers for a variety of posts throughout the country. One opening requires an engineer with experience in telemetering systems, recorders, remote radio control and communications equipment. Another specialist is wanted for the design and development of antenna and reflector systems. Experience in acoustic measuring and recording equipment for up to 5 megacycles is a requirement of another opening. In another spot, the Navy requires an engineer who is familiar with magnetometer circuits, low-drift direct current amplifiers, and sub-audible techniques.

Complete data on these openings is available from the Scientific Personnel Division, Office of Naval Research, Washington 25, D. C.

A HIGH-SPEED FACSIMILE receiver which is capable of reproducing a ten-page paper in eight minutes, sixty times faster than current facsimile systems, was demonstrated during the recent United Nations Conference on Freedom of Information and Radio Communications in Geneva, Switzerland, in the Palais des Nations.

OVER 1200 SERVICEMEN attended an unusually interesting meeting in New York City, recently, to listen to a forum of four papers on television and public-address systems, presented under the auspices of the Associated Radio Serv-

July, 1948



HAS THE VALUES!



HERE ARE A FEW TYPICAL OF WHAT IS TO BE FOUND IN THE BIG NEW B-A CATALOG #481

116 BIG PAGES PACKED WITH THE LATEST DEVELOPMENTS IN RADIO AND ELECTRONICS, Sets, Supplies and Apparatus For Trade—Industry—Communications—Public Utility—Experimental and Hobby Applications.

A Bargain Section Packed With OUTSTANDING VALUES in desirable WAR Surplus and other SPECIAL VALUES.

Write For Your Copy of Catalog #481 If You Did Not Receive It.

Only \$13.88 for this Quality RECORD CHANGER



A fortunate purchase from an overstocked manufacturer enables us to offer these popular UTAH Model 650 Record Changers AT A BIG SAVING.

Features: Single post, gearless construction. Quiet and fast during change cycle. Plays 10 twelve-inch or 12 ten-inch records. Rejects any record desired. Light weight balanced tone arm with quality crystal cartridge for any standard needle.

Has heavy, die cast base plate 10 3/4" x 12 1/8". Mounting size approx. 12 1/4" x 13 5/8", extends 5 3/4" above and 2" below mounting. Operates from 110 volts, 60 cycle.

No. 40A1000 Bargain Priced, Each \$13.88 Two in Factory carton, for only \$25.00

BIG VALUE—AC-DC Superhet

Graceful design, dependable performance anywhere. An outstanding value! Proven Superhet circuit, 5 dependable tubes (including rectifier). Full size 5" Alnico "V" PM speaker for wonderful tone. Airplane dial. Modern Plastic cabinet. Ivory finish size 10 5/8" x 5 1/2" x 6 5/8". No. 31A224, SPECIAL EACH.....

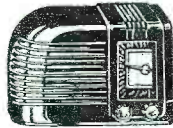

\$15.94

3 WAY "PERSONAL" AC.-DC. and BATTERY OPERATED PORTABLE

Superhet circuit, 4 tubes plus Selenium rectifier. 5" Alnico PM speaker. Iron core I.F. Safety switch for operation from 110 volt AC or DC electric current or from self contained batteries (1-746 "A" and 1-467 "B") available anywhere. Beautiful dual colored Polystyrene Shatter-proof molded cabinet with plastic easy grip handle. Large slide rule dial. Vernier Hi-ratio tuning. Small: only 4" wide, 8 3/4" long, 7 1/4" high. Weight only 5 1/2 lbs. with batteries. A "Honey" for in the home or "on the go." No. 36A66 Less Batteries, ONLY \$21.95 Set of batteries (1-746 and 1-467) \$2.40

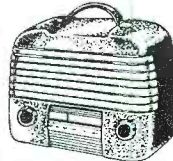

"Re-Mote" REAR SEAT

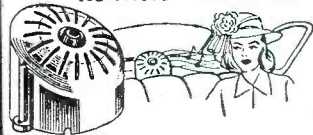

Car Radio Speaker

Easy to install in a few minutes—no cutting of holes required. Furnished complete with 17 ft. wire, fittings, resistor to match speaker to any standard Auto Radio and complete instructions. Consist of 5" quality PM speaker in beautiful marbled french gray plastic case, volume control built in. No. 14A650 Your Cost Each..... \$6.37

80, 75 and 40 Meter CRYSTALS, 10 for..... \$3.95

IN FT 243 holders, cut from highest quality quartz, accurately ground and acid etched. Frequency marked on each with-in 2 KC. Sorry we must sell them in ass'ts. our pick of frequencies—but you can't go wrong! There are plenty of choice frequencies for 80, 75 and 40 meters or for doubling to 20 and 10 meters in each ass't. Every one guaranteed to be an active oscillator. Stock No. 21T 3991 Assortment of TEN — ONLY..... \$3.95

Order direct from this ad. Our Terms: Cash With Order or C. O. D. with 20% deposit please. Radio Sets Shipped Via. Express Only.

ALUMINUM UTILITY CASE

LIGHTWEIGHT DURABLE EYE APPEALING IDEAL FOR

- Radio Servicemen's parts and tool kit
- Tube carrying case
- P.A. accessory case
- Camping, Fishing, Picnics, all family use

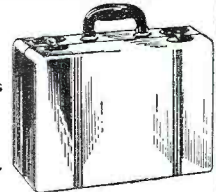

Life time aluminum case with bakelite handle, lock and key. Size 15" long, 11" wide, 5" deep. Weight only 3 lbs. Shipping weight approx. 5 lbs. No. 36A75—Very Handy For Everyone, NET EACH..... \$3.65

1000 V.—200 Ma. Power Supply FILTER KIT



Consist of Two 4 mfd. 1000 volt DC oil filled condensers size 2 1/2" x 1 1/2" x 5 1/2" high overall and One Thordarson 10 Hy.-200 Ma. filter choke fully enclosed metal case size 3 3/8" sq. x 4 5/8" H.

21T3983 ONLY..... \$3.65

2 MFD. 2500 VOLT OIL FILLED CONDENSER

Well known brand. Ceramic pillar terminals, in hermetically sealed metal case, size overall 1 3/4" x 3 3/4" x 5 1/2" high. Comes with handy removable mtg. bracket and solder lug terminals.



No. 21T3990, Special, Each \$2.95

12 1/2 FOOT ANTENNA TELESCOPES DOWN TO 1 FOOT 4"

"Just it" for mobile equipment, portable receivers, and transmitters. Solid Brass—Ruggedly constructed—smooth telescopic action. Base is 7/8" dia. No. 38A39, Special Each..... \$1.95

WEATHERPROOF WIRE at GIVE AWAY PRICES



Stranded tinned conductors (3 copper, 4 steel) flexible, yet unusually strong to stand long runs. Conductor is rubber covered with overall weather-proof saturated braid; OD 5/32".

Perfect for lead-ins, telephone, intercoms, etc. BRAND NEW in original factory wound coils.

No. 4A503, Three Conductor Per 550 Foot Coil, ONLY..... \$4.95

No. 4A502, As above except Single Cond. Per 900 Foot Coil, ONLY..... \$2.95

WRITE FOR YOUR COPY OF CATALOG No. 481 IF YOU DID NOT RECEIVE IT.



BURSTEIN-APPLEBEE

company

1012 MCGEE, KANSAS CITY 6, MO.

A WHOLE CARLOAD OF FM RECEIVERS AND TRANSMITTERS

This may be your last chance at these desirable items.



FAMOUS BC-659 PORTABLE FM RECEIVER, 27 to 38.9 Mc, xtal controlled; ideal for "hams," police, seismograph crews, park service, etc. Battery operated power supply 6, 12 or 24 volt. As shown, with all tubes, meter, less speaker, diagram and handset & xtals.

Like new, with power supply.....\$17.95
 Like new, less power supply..... 12.95
 Used, good, with power supply..... 12.95
 Used, good, less power supply..... 7.95
 Used, fair, less power supply; some need minor repairs..... 4.95
 Choice of xtal for any channel, each... 1.00
 Set of 120 xtals in case..... 35.00
 Battery BA-41 when purchased with BC-659 .50

27 to 38 Mc FM RECEIVER BC-683 for police, park service, seismograph, "hams." Superhet, BFO, squelch; 10 pushbuttons & manual tuning; with 10 tubes, speaker, case; 12 or 24 volt dynamotor; diagram.

Used, excellent\$23.95
 Used, good 18.95
 Used, fair 13.95

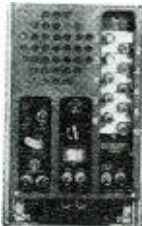

27 to 38 Mc FM TRANSMITTER

BC-684, 30 watt, 10 channel pushbutton xtal controlled; with covers, all tubes, meter, diagram, less xtals. Some with dynamotors.

Used, excellent\$23.95
 Used, good 18.95
 BC-683 and BC-684, used, excel. both...\$45.00
 BC-683 and BC-684, used, good, both for. 35.00
 Set of 80 xtals in drawer for BC-684 (when purchased with xmtr) 14.95

20 to 27.9 Mc FM RECEIVER BC-603 for 11 meters: looks just like BC-683 above; superhet, BFO, squelch; 10 pushbuttons & manual tuning. Makes fine 10 meter converter or IF strip for 88 to 108 Mc wide-band FM; with 10 tubes, speaker, diagram; 12 or 24 volt.....\$11.95

FREE CONVERSION INSTRUCTIONS: simple, easy change to 115 v AC. Converter diagram furnished. Complete conversion (power supply & converter) costs less than \$7 to build.

20 to 30 Mc FM TRANSMITTER BC-604 for 10 & 11 meters can be extended to 30 Mc (10 meters) with proper xtals looks just like BC-684 above; 10 channel pushbutton xtal controlled; with all tubes, meter, diagram, case & covers, less xtals; 12 or 24 volt. Used, good.....\$11.95

COMB. OFFER: BC-603 & BC-604.....\$22.95
 Set of 80 xtals in drawer for BC-604 (when bought with xmtr).....\$10.95

(BC-603 & BC-604 F.O.B. Tulsa, Okla. or Oakland, Calif.)

27 to 38 Mc FM RECEIVER BC-923; similar to BC-683 above, but 4-channel band-switch instead of push-button tuning. With all tubes, less xtal. Used, cases fair, OK inside.....\$11.95

27 to 38 Mc FM TRANSMITTER BC-924, companion to BC-923. Similar to BC-684; used, with all tubes, cases fair, OK inside.....\$11.95

COMB. OFFER: BC-923 & BC-924.....\$22.50

TERMS:

Check with order, or 25% deposit on C.O.D.'s Shipped express collect, unless otherwise requested. **FREE LIST**

ELECTRONIC SUPPLIES

Stores in Tulsa, Okla. & Oakland, Calif.

1032 12th St. Oakland, Calif

icemen of New York and conducted by John F. Rider. The p.a. talk was given by C.A. Tuthill, who was in charge of sound system installations at the United Nations site in Lake Success. He covered acoustic feedback, speech equalization, microphone baffles and speaker locations. Three phases of television were covered in talks by Seymour D. Uslan, M. Plotkin, and John Meagher....L.W.

-30-

Marine Radio

(Continued from page 37)

speaking, you can play it safe by using the same type of wire for your work as is used in the already existing circuits. Flexible wire is preferred. Plan your runs so that you make your connections in existing junction boxes.

If the boat you are working on is driven by a gasoline engine, you have an expensive and complicated problem of ignition interference on your hands.

Do not use suppressors.

Suppressors will ruin a marine gas engine, while they will not harm most auto engines. This is the reason.

In order to *double* the speed of a boat, you have to *square* the power pushing it. This means that a marine engine is usually run at its full rated horsepower. This is why they seem so big for so little horsepower.

The only time a car engine is opened up is when its driver is pushing ninety or so. Most of the time the engine in a car is not even "breathing hard."

Suppressors will not prevent complete combustion in an unloaded engine. They will prevent complete combustion in a fully loaded engine. The unburnt gasoline will accumulate in the crankcase, dilute the oil, and thereby injure the bearing surfaces.

The most practical approach to the suppression of ignition interference is the installation of a commercially manufactured ignition shield set. This costs about \$150.00. It consists, in effect, of a metal wall that goes around all the high tension, and most of the low tension, circuits of the engine. These package shields are easily installed, but each job still requires a certain amount of cut and try. No two ships ever respond exactly the same.

This shield can be fabricated by the serviceman, but it is not an easy task. Merely slipping metal loom over the high tension wires will get you nowhere. Grounding the engine to the sea by means of a plate on the outside of the hull is a waste of time as far as noise suppression is concerned.

The distributor, the ignition coil, etc., all have to be metal enclosed. Ventilation has to be provided for the points and rotor so that the ozone gas that is generated will be dispersed before it corrodes the metal parts. Also the ignition coil must be kept cool by ventilation.

Plenty of insulation must be provided between the metal shield and the high tension leads, and the shields must be firmly bonded to the engine block, and to parts of itself.

Complete marine radio installation which covers the bands for ship-to-ship, Coast Guard, telephone, and standard broadcast. Direction finder loop antenna is shown mounted on top of cabinet. The conventional antenna is connected to the binding post located on the side of cabinet.



RADIO NEWS

Fixing Radios the Old Hard Way?



The Feiler Stethoscope does everything but make the actual repair. And the Stethoscope does it faster, better and much easier. Thousands of radio men, many with little experience, are already fixing radios and other electronic equipment this new way.

You will find that just this one low priced unit and a few basic hand tools are all you need to fix practically any radio.

Here is the new Model TS-5 "Pocket Stethoscope" built to take out on the job. It's light, compact and rugged yet performs like the bench models. Stethoscopes are available in 4 types ranging from \$9.85 to \$34.95.



The "Inside Story" of the STETHOSCOPE—how it works—how it instantly locates trouble in any circuit—is yours for the asking. The "Inside Story," a 24 page illustrated booklet, is full of practical tips and hints on radio servicing. To get your free copy, send your name and address on a penny post card today.

tical tips and hints on radio servicing. To get your free copy, send your name and address on a penny post card today.



"MAKES RADIO REPAIRS AUTOMATIC"

Available for Export—Choice Territories Still Open

FEILER ENGINEERING COMPANY

945 George St. Dept. 7H8 Chicago 14, Illinois

12 NEW METERED VARIABLE TRANSFORMERS



Staco has done it again . . . 4 new metered isolation transformers . . . 8 new metered auto-transformers. @ Fuse protected. Pilot light indicator. Hi-accuracy, magnetically shielded meter. @ Write for catalog. Model LRL-5 . . . 500 V.A., metered variable isolation transformer . . . \$41.50.

STANDARD ELECTRICAL PRODUCTS CO.
407 Linden Ave., Dayton 3, Ohio

Adjust-A-Volt
VARIABLE TRANSFORMERS

July, 1948



TRIPLE BONUS

the **GREATEST**

Yes! the **GREATEST**

TEST EQUIPMENT

Story Ever Told

1000 pieces of LATEST MODEL, Standard Brand Test Equipment to be sold this month. TUBE CHECKERS, SIGNAL GENERATORS, OSCILLOSCOPES, VTVM's, MULTI-TESTERS, etc.

LABORATORIES, SCHOOLS, RADIO DEALERS, SERVICE MEN, HAMS, EXPERIMENTERS, STUDENTS:

Get a TRIPLE BONUS on EACH piece of equipment valued at \$40.00 or more. Just fill out the coupon below. Act now!

Radiomart

INC.

Store
149 Riverdale Ave.
Yonkers
New York

Store & Warehouse
143 West End Ave.
New York 23
New York

RADIOMART

Dept. RN-7

149 Riverdale Ave., Yonkers, New York

I am interested in learning more about the greatest test equipment story ever told. Please send details of your great triple-bonus plan. I am particularly interested in buying the following equipment:

Name

Address

- | | |
|---------------------------------------|---------------------------------------|
| <input type="checkbox"/> Laboratory | <input type="checkbox"/> Service Man |
| <input type="checkbox"/> School | <input type="checkbox"/> Ham |
| <input type="checkbox"/> Radio Dealer | <input type="checkbox"/> Experimenter |

Special for Engineers, Technicians, Experimenters, and All Enthusiasts of Magnetic Recording

BUILD YOUR OWN MAGNETIC TAPE RECORDER

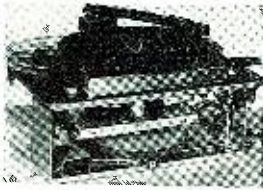

Illustration shows Pickup mounted on arm bracket.)

Experimenter's
NET PRICE \$89.50

Send your order today for prompt delivery.

- Optional Accessories
- Turntable and Pickup Arm Bracket (Less pickup) \$1.75
 - Scotch Sound Recording (Paper Base) Tape, Per one hour reel 3.00
 - Scotch Sound Recording (Plastic Base) Tape, Per one hour reel 4.50
 - Brush (Paper Base) Tape, Per one hour reel 2.50

COMING! Complete factory built recording chassis with self-contained recording amplifier, playback amplifier, superasonic erase and bias oscillator and amplifier, plus cabinet, microphone and loud speaker. Priced from \$225.00. A postal card will get your name on our Track mailing list so that you will be among the first to know about our exciting new line of Magnetic Tape Recorders built around this revolutionary Twin-Track Recorder Chassis.

WITH THIS DUAL-CHANNEL TWIN-TRACK RECORDER TWO-WAY CHASSIS

Now you can get a full hour's high-fidelity recording on a single 7 inch standard reel of Scotch Sound Recording or Brush Tape. This ultra-modern, precision-built tape recorder mechanism actually utilizes two sound tracks on a standard 1/4 inch tape. One track records in the forward direction, and the other during reverse. Eliminates the necessity for rewinding.

You can use this chassis with any amplifier for recording or playback. Or you can construct an amplifier from any one of the special designs which are furnished with the unit. Circuit features include superasonic or DC erase, phono-radio-microphone input circuits, and provision for mixing microphone and radio-phonograph inputs. Advanced design principles provide for unbelievably quiet operation. Overheating is a thing of the past with this dynamically and electrically-balanced heavy-duty recording motor. Optional built-in turntable and phono-pickup enable you to use the unit for disc record playback, and to copy your records onto tape with or without self-accompaniment.

For matchless quality of magnetic recording and reproduction, and for exclusive built-in design features, the Twin-Track Recorder Chassis leads the field.

Supplied with 32 page instruction book containing circuit diagrams and construction data.

Check these Exclusive Features

1. ONE HOUR continuous play on standard 7" reel at tape speed of 7 1/2" per second.
2. Attainable Frequency Response 50 to 9,000 cycles \pm 3 db.
3. Cuts tape cost in half. No other recorder matches this economy.
4. Easy to thread. Threads directly from one reel to the other.
5. Heavy Duty Recording Motor prevents overheating.
6. High traction between capstan and tape. No tape slippage.
7. Twin Electronic Erase Heads for complete superasonic or DC erasure.
8. Constant tape speed precision drive. Reduces flutter and wow to a minimum.
9. Can be used for twin-channel stereophonic recording.
10. No rewinding necessary. Plays continuously during forward and reverse.
11. Unique design prevents development of eccentricities in capstan drive.
12. One tape channel can be used for compression-expansion control.
13. No belts to loosen or pulleys to slip.
14. Automatic switch and solenoid instantaneously reverses direction of tape travel.

Magnephone Division **AMPLIFIER CORP. OF AMERICA**

398-2 BROADWAY • NEW YORK 13, N. Y.

The most practical approach, next to buying a manufactured package, is the installation of a metal screen around the engine. This screen may be fastened to the wall of the engine compartment, and made solid by soldering the various sections together. In effect, it is a metal wall around the entire engine, instead of the high tension leads.

Another approach to the problem is the use of a set with a noise-bucking circuit. These commercially manufactured sets have provision for picking up ignition noise in the engine compartment by means of a noise antenna, then feeding this noise into the antenna circuit, where it bucks, and cancels the noise coming down the regular antenna. Again, the placement of the noise antenna, and the regular antenna is a cut and try procedure.

This is an adaptation of an old idea which was formerly used in auto radio and later discarded. The opponents of this system claim that it is impossible to achieve the same degree of quietness possible with shielding, while its advocates claim satisfactory reception proven by the widespread customer acceptance.

Still another approach is the return to the self-powered receiver. By placing the receiver out of the area of ignition interference, it is sometimes possible to achieve satisfactory reception without touching the engine. Sometimes it will be found necessary to erect one or more metal screening walls.

This brings us back to the good old days when auto bodies were of wood, and sets would play fine until the driver got behind the wheel and started the motor. Then, ignition noise would drown out the program.

You may have to ground all the metal rods leading out of the engine compartment. You may have to place bypass condensers across the lines going from the engine compartment to some light or pump in another part of the ship. It all depends upon the type of boat, placement of the set, etc.

The installation of a transmitter presents only one additional problem to those already mentioned, i.e., the antenna.

Since it is usually impossible to string up (not a nautical term) a full length quarter-wave antenna, some compromise has to be made, and the most satisfactory solution seems to be the spiral antenna. This consists of a long vertical pole on which the antenna is wound spiral fashion. There are no set figures on pole size, wire size, etc., but the longer the pole, the better the results. Simply use the longest bamboo pole practical, and more wire than you think necessary. Tune and cut as needed. In a straight line, your antenna would be between thirty and fifty yards.

It is best not to wrap your pole with

RADIO NEWS

WAR SURPLUS BARGAIN KIT

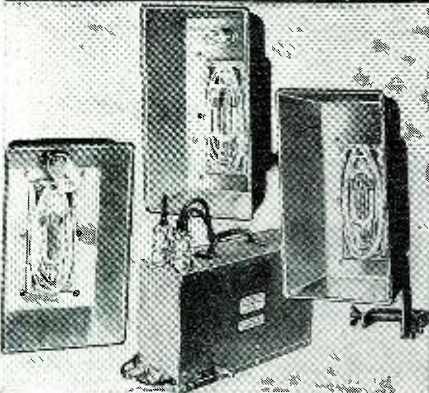

4 LAMPS ELECTRONIC PHOTO FLASH EQUIPMENT, THE FAMOUS "MODEL 1503" AIRCRAFT FLASH UNIT.

This powerful high quality equipment was made for the U.S. Air Corps and will be shipped to you brand new in original boxes.

- **THE POWER SUPPLY** is built into a beautiful gray finished case, with all connectors, relay control, 2 condensers each 2000 Volts, 50 M.F.D. light output 110 Watt seconds, can be used with any 12 Watt battery as a professional studio flash equipment. The power pack alone is worth more than the price we are asking for the complete unit.
- **THE FOUR HIGH SPEED FLASH TUBES** are plastic sealed, unbreakable, 12 million peak lumens light output for more than 15,000 flashes.
- **IN ADDITION TO THIS WE SUPPLY:** aluminum reflectors, transformer, connectors, connecting cords, spare parts, diagram and instructions on how to use it for battery or on how to convert the unit for 110 Volt A.C.

• **IT IS THE BEST VALUE IN WAR SURPLUS MATERIAL. WHILE THEY LAST.**

PRICE complete **\$68.00**

CINEX INC. Dept. N.R.
165 West 46th St. New York 19, N. Y.

SICK OF BACK ORDERS ?????

Marco Gives Immediate Delivery

TUBES			
1B24	\$2.25	VR105/30	\$.75
5R4GY90	VT127A	2.35
6AK559	725A	6.50
6C435	807	1.25
6Y680	829B	2.95
12DP7	5.50	900350

OIL FILLED CONDENSERS

5 Mfd. 220 VAC.	\$1.50	2 Mfd. 1000 VDC.	\$.70
7.5 Mfd. 330 VAC.	1.95	10 Mfd. 1000 VDC.	1.95
4 Mfd. 400 VDC.	.45	15 Mfd. 1000 VDC.	2.25
2 Mfd. 600 VDC.	.35	8 Mfd. 2000 VDC.	3.95
4 Mfd. 600 VDC.	.60	12 Mfd. 2500 VDC.	4.95
7 Mfd. 600 VDC.	.75	3x2 Mfd. 4000 VDC.	1.75
8 Mfd. 600 VDC.	.85	2 Mfd. 4000 VDC.	4.50
2x8 Mfd. 600 VDC.	1.25	4 Mfd. 4000 VDC.	8.50
10 Mfd. 600 VDC.	.90	1 Mfd. 7500 VDC.	1.60
5 Mfd. 660 VAC.	2.25	.25 Mfd. 20K VDC.	24.50

VARIABLE CONDENSERS

170 Mmfd. 1000 V.	\$1.20
Dual 75 Mmfd. 1000 V.	1.85
Dual 110 Mmfd. 3000 V.	4.80

FILAMENT TRANSFORMERS & CHOKES

10 Hy., 110 Ma.	\$1.80
15 Hy., 150 Ma.	2.25
Pri. 115V 60 Cyc.-Sec: 6.3VCT @ 1A; 7.5VCT @ 3A; 11VCT @ 10A.	3.95
Pri. 115V 60 Cyc.-Sec: 5VCT @ 3A; 5VCT @ 5A.	2.40
Pri. 115V 60 Cyc.-Sec: 5V @ 6.5A (34 K.V. Test)	4.95

MISCELLANEOUS

Swinging Choke 9-38 Hy. @ 75/.075A.	\$14.95
Relay 115 VAC DPDT	1.25
24 Volt, 5 Amp. Copper Oxide Rectifier.	7.50
Volt-Ohm-Ma. Meter (Portable W/Test Probes)	12.50
New	3.25
24 Volt D.C. Motor, 6000 R.P.M., .96 Amp.	3.25

AN CONNECTORS Large Selection Catalog for Industrials

Min. Mail Order \$2.00—25% Dep. with order. Bal. COD

WRITE YOUR NEEDS

MARCO ELECTRONICS, INC.

513-515 W. Franklin St. Baltimore 1, Md.
Lexington 0198

tape as tape gets waterlogged. Use solid wire, and wrap as tightly as you can.

For those customers who think more of the appearance of their boat than the radiation of their antenna, you can install a whip. This is of course very inefficient. The longer the whip, the better the results, but at best, radiation from a fifteen or twenty foot whip is poor compared to the spiral.

The only power requirements you need consider when installing the transmitter is the peak current requirement. This is because you won't be using the transmitter for more than a few minutes at a time. Simply make certain the feed leads are heavy enough to supply the current required without excessive voltage drop. Bear in mind that some of the units operate on 6, 12, and 32 volts.

It is very important that a good ground be provided for the transmitter. On a wooden ship, a metal plate will have to be installed below the water line. On a metal ship you can ground directly to the hull.

Putting The 826 to Work

(Continued from page 63)

neutralizing condenser set for minimum capacity. At some point in the tuning range of C_0 there should be a pronounced dip in grid current and at this point it will be likely that there will be an indication of r.f. voltage on L_2 by using a neon bulb of 1/2 or 1 watt size. This indicates that the stage is not neutralized. Now gradually increase the capacity of C_n in small steps tuning C_0 across its range after each adjustment of C_n , until a point of setting of C_n is reached where there will be no dip in grid current. This is the point of neutralization and no r.f. indications should be obtainable at L_2 . If the adjustment of C_n is carried further in the same direction this point will be passed and the stage will be out of neutralization again. This same neutralization procedure is used on all single-ended amplifiers and the same procedure is used in the three-tube transmitter excepting that the buffer is tuned for maximum output instead of the oscillator.

Now a 0-200 milliammeter should be inserted into the final plate circuit by means of jack J_2 and plate voltage applied to this stage using a value of 400-500 volts at first if this is possible. No current should be indicated on the meter with the key up. Now key the oscillator in short intervals, tuning C_0 meanwhile until a point of pronounced dip in plate current is found. This is the point of resonance at which the final amplifier is tuned to the same frequency as the oscillator and maximum output should be realized. No-load cur-

July, 1948

SAVE \$ ON RADIO SURPLUS

U.S. SIGNAL CORPS 5 METER SHORT WAVE XMTRS.

(72.2Mc) XMTRS and TUBE only, less mike, batteries and antenna. One 1 1/2 volt dry cell and 67 1/2 volts of B operates it. Just attach di-pole, key or mike, connect the batteries and it's ready to use. Signal Corps spec. wired with silvered wire, mica condensers, and precision resistors. Highly stable circuit with Lo-Loss silvered inductance. (Adjustable padding) Schematic supplied. Converts easily to walkie-talkie and Ham bands \$3.25



GENUINE SIGNAL CORPS FEATHER-WEIGHT HEADPHONES WITH CORD AND PLUG 2000 OHMS—8000 OHMS IMPEDANCE \$1.00

NATIONALLY KNOWN OIL FILLED FILTER CONDENSERS

1.—MFD—1000 working volts. 4 for..... \$1.00

FAMOUS BRAND RECORD CUTTING HEAD

These units are all Brand new and were made for a nationally advertised manufacturer to be in their quality Home Recording Radios. Size 1 1/2x2 1/2 ready to fit your cutting arm or bracket. SPECIAL..... \$2.95

3 BAND ALL-WAVE DIAL 6" DIAMETER..... 75c

AMPLIFIER CHASSIS, SIZE 18"x8"x2 1/2". BLUE CRACKLE FINISH DRILLED FOR CONDENSERS—TRANSFORMERS AND SOCKETS..... 65c

8 OR 9 GANG PUSH BUTTON TUNING UNIT (PLEASE SPECIFY). COMPLETE WITH BUTTONS 29c

U.S. AIR FORCE RESISTOR ASST. 1/4-1/2-1 WATT—100 PIECES 95c

U.S. AIR FORCE MICA COND. ASST. 25 PCS. 50M-100M MFD 49c

Low-Loss-Short Wave Variable Condensers 1/4" Shaft Type	
3 Plate—12-15 MMFD.	15c
5 Plate—20 MMFD.	20c
9 Plate—35-40 MMFD.	25c
14 Plate—55-60 MMFD.	27c
27 Plate—100-110 MMFD.	45c
37 Plate—150 MMFD.	50c
38 Plate—150-155 MMFD.	55c
53 Plate—210-21 MMFD.	60c

Lock Type Air Trimmer Variable Condensers	
3 Plate—12-15 MMFD.	10c
5 Plate—20 MMFD.	11c
8 Plate—30-35 MMFD.	13c
10 Plate—40 MMFD.	14c
13 Plate—50 MMFD.	17c
14 Plate—55 MMFD.	20c
20 Plate—80-100 MMFD.	25c
27 Plate—100-110 MMFD.	35c

SIGNAL CORPS TRANS. KEYS..... 39c

4 PRONG WAFER SOCKETS—\$1.49 per C; 3c each

ISOLANTITE OCTAL WAFER SOCKETS—\$4.25 per C..... 6c each

ISOLANTITE UNDER PANEL CLAMP SOCKETS—\$4.50 per C..... 5c each

PHILCO 4 MF—300 V—1% CAN CONDENSER—\$8.00 per C..... 10c each

W-L—10 W. 1,000 OHM POWER RHEOSTAT 29c ea.

5-6 PRONG WAFER BAKELITE SOCKETS—\$2.50 per C

100 ASST. SOCKETS—4-5-6-7—OCTAL \$3.50 per C

1,000 OHM WIRE WOUND POTENT..... 15c

30 HY-FILTER CHOKE SHIELDED..... 49c

UNSHIELDED..... 7c

100 ALLEN BRADLEY—1 WATT—1/2 MEG RESIS..... \$1.25

100 ERIC—1 WATT—2,000 OHM RESIS..... \$1.15

10 WIRE WOUND RES. KIT—5-50 W. ASST..... 49c

2 METER RF CHOKE..... 7c

phone PICK-UP REST. RUBBER—1 HOLE MTG. 6c

2,000 OHM WIRE WOUND RHEOSTATS \$1 per doz.

RCA-VICTOR NEEDLE CUPS—2 PIECE 10c ea.

CARTER WIRE WOUND C.T. VARIABLE 20 OHM RECTIFIERS \$1.00 per doz.

G. E. TAPPED VOLTAGE DIVIDER—200 WATT—230 OHM—MOUNTED ON ASBESTOS BASE—TAPPED AT 180-205 ohms..... 25c

RCA 6 OHM POWER RHEOSTATS..... 39c

RCA RUNNING BOARD AUTO AERIAL..... 49c

PHILCO AUTO SUPPRESSORS—\$5.00 per C; 7c ea.

Signal Corps Flex, hook-up wire asst. contains approx. 150 ft. asst. colors, glass insulation. 1 lb..... 25c

GENERAL ELECTRIC 60 CYCLE WATT HOUR METERS, slightly used, perfect condition, same as used in your home, 110-125 volts. 5 Ampere..... \$3.50

10 Amps..... \$4.50

3 GANG T.R.F. VARIABLE CONDENSERS .000365 Cap 95c

D. P. D. T. SLIDE T O G G L E SWITCH 23c

Walkie-Talkie Telescoping Aerials—extends 36" 75c

2 piece 4-pole . . . Male and Female Separable plug. Male is for panel mount. Female for Flex. cord. A steel. at only . . . 35c per pr.

PHILCO MAGNETIC RELAY TAP SWITCH. Operates on 6 V DC—15 V AC. When contact is made relay operates rotary contacts switch to 20 different contacts. Brand new 89c



Philco rotary tap tone control, 3 position, including condensers. Only 1 wire to connect to grid of audio tube. 1/4" shaft 25c

I. C. A. 30 MH RF choke..... 25c

Grind your own crystals—Pure Brazilian Quartz, all sizes and thicknesses—1/2 lb. package..... \$1.00

National Velvet Vernier Dial Attachment—1/4" shaft—converts any dial to slow motion vernier..... 75c

340 degree dial with 10 push button attachment—1/4" shaft—ideal for Xmitters—Sig Gen. or Osc..... 49c

RCA Band Switches—3 gang 3 posit. 3 band..... 30c HIGH FREQUENCY BUZZER..... 39c

Trimmer-Padder Asst.—all isolantite—singles, dual triples—100 asst. pieces..... \$2.25

Signal Corps V. T. I receiving tubes—\$1.00 per doz.

5" 5M OHM RCA SPEAKER..... \$1.00

MAGNAVOX—12"—1,000 ohm Dynamic speakers..... \$3.95

8"—10,000 ohm Dynamic speakers..... 1.35

Spaghetti Assortment—Approx. 75 ft..... 75c

30-WATT—6L6 BEAM POWER AMPLIFIER KIT. Complete kit of parts with all necessary parts—Tube. Ready to assemble and wire. Plate supply—is provided by an oversize extra heavy transformer—(1) Filament supplied by an extra heavy transformer filter, by pass and filter condensers. Sockets all ready mounted on chassis. Volume and tone controls with separate AC switch are provided. Circuit is the latest type of phase inverter system using 1-5U4, 2-6L6, 1-6C5, 1-6S17, 1-6N7. Chassis has ample room to work on or add more tubes-terminal strips for mounting resistors, etc., are included, and all parts are Signal Corps spec. brand new, never used before. A large diagram is provided so that a novice may be able to assemble this kit with ease, merely by following the point to point connections that are outlined on the print. Complete 6L6 kit, less sepaker and output trans. \$17.95

TUBES—6SN7—45c; 54—39c; 2A7—39c; 55—39c; 117L7—59c; 27—25c; 15, same as #24—20c.

DRY ELEC. FILTER COND. ASST. CONTAINS 10 PIECES ALL BRAND NEW 150-450V..... \$1.10

6 ASST. WET ELECTROLYTIC CONDENSERS 59c

RADIO EXPERIMENTER'S SURPRISE PACKAGE—CONTAINS BY PASS & FILTER CONDENSERS, SHORT WAVE TUNING UNITS, POWER AND AUDIO TRANSFORMERS, SOCKETS, RESISTORS, CHASSIS HARDWARE, OVER 15 LBS. OF VALUABLE PARTS \$4.95

THEY'RE HERE!!! THE NEW 1948 CROP OF GENUINE EVEREADY BATTERIES

ORDER NOW THE FOLLOWING TYPES USED IN MOST PORTABLES:

Type No.	Voltage	Approx. Size	Cost
482	45V. "B"	3 1/2"x1 3/4"x5 1/2"	\$1.50
	"Min-Max"		
467	67 1/2 V. "A"	2 3/4"x1 1/4"x3 5/8"	1.71
	"Min-Max"		
741	1 1/2 V. "A"	3 3/4"x2 5/8"x5 3/8"	1.12
742	1 1/2 V. "A"	2 1/2"x2 1/2"x4"	.63
743	1 1/2 V. "A"	3 3/4"x2 1/2"x4"	.87
745	1 1/2 V. "A"	1 3/8"x3 7/8"x1 3/8"	1.18
746	4 1/2 V. "A"	3 7/8"x1 3/8"x4 3/8"	.52
747	6V. "A"	1 1/2"x3 7/8"x1 3/8"	1.26
718	6V. "A"	3 3/4"x2 5/8"x5 3/8"	1.19
744	6V. "A"	2 5/8"x2 3/8"x4"	.66
915	"A" Penlite 1 1/2 V. Dry Cell (12 to Pkg.)		.05 ea.
935	"C" Medium 1 1/2 V. Dry Cell (12 to Pkg.)		.06 1/2 ea.
950	"D" Standard 1 1/2 V. Dry Cell (48 to Ctn.)		.06 1/2 ea.

"A-B" PACK FOR 1.4 V. PORTABLES

752	9 "A", 90 "B"		
752W	9 1/2 "A", 90 "B"		
753	7 1/2 & 9 "A", 90 "B"		
754	7 1/2 & 9 "A", 90 "B"		
758	1 1/2 "A", 90 "B" (Farm)		

MINIMUM ORDER \$2.00—NO C.O.D. SHIPMENTS—PLEASE INCLUDE POSTAGE
NEWARK SURPLUS MATERIALS CO. 324 Plane Street Dept. P Newark 1, N. J.



D61B CONSTANT VELOCITY FREQUENCY RECORD

Here's an indispensable guide for fast, accurate, direct checking of phono pick-ups and indirect checking of recording heads, loud speakers, p. a. equipment, etc. 12", double-faced Vinylite record, 78 RPM—recorded in 3 sections, 50-10,000 cps, 600 cps, 1,000 cps. Lists \$3.50 ea.—see your distributor or write:

UNIVERSAL MICROPHONE CO. INGLEWOOD, CALIFORNIA.

Radio Technician and Announcers

A practical 15-month course in First Class Radiotelephone Operation and Announcing is offered by Don Martin School of Radio Arts. Most stations these days require combination men. We specialize in this type of training and maintain a placement bureau for our graduates. Serving the industry for 15 years, the School of Radio Arts can train you. Write for our catalogue outlining the courses offered. Classes can be arranged so you can do part time work on the side.

APPROVED FOR VETERANS
DON MARTIN SCHOOL OF RADIO ARTS
1655 North Cherokee St. Hollywood 28, Calif.

ONE OF A SERIES

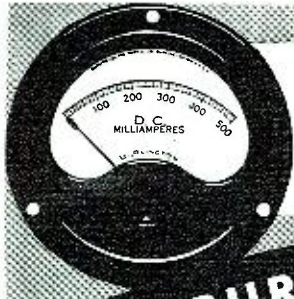

CERAMIC POINTER STOPS

WHY BURLINGTON PANEL INSTRUMENTS PROVIDE UTMOST RELIABILITY...

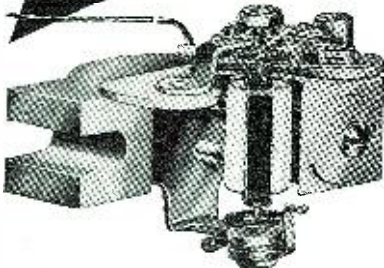

CERAMIC POINTER STOPS are used to prevent damage to the pointer due to accidental application of sudden overloads. All ranges AC and DC available in 2 1/2", 3 1/2", 4 1/2" rectangular or round case styles and are fully guaranteed for one year against defects in workmanship or material. Refer inquiries to Dept. K78.

Burlington INSTRUMENT COMPANY
BURLINGTON, IOWA

Industrial Teleceivers



For Public Viewing in
TAVERNS - HOTELS
HOSPITALS - SCHOOLS
INSTITUTIONS - CLUBS
Featuring
SIMPLIFIED
CENTRAL CONTROL
with any number of
viewing screens

INDUSTRIAL TELEVISION, INC.

359 LEXINGTON AVE., CLIFTON, N. J. · GREGORY 3-0900

CONVERSIONS and SCHEMATICS

SCR-274-N Receivers
BC-453, BC-454, BC-455: Explanation of control and power circuits and plug terminals. Conversion of the front plug to a local control adapter with volume control, on-off and CW-MCW switch. Schematic for AC power pack. Alignment instructions. Top and bottom views showing parts location. Voltage and resistance readings. Schematic of 3-unit rack, control box, adapters and interconnection. Price \$2.00
Conversion of BC-946-B Broadcast-Band Receiver BFO replaced by AF driver, delayed AVC added, AC power supply, speaker operation. Includes 106 step-by-step instructions, alignment, practical wiring diagram, and parts locations pictures. Price \$2.00
12 8 1/2 x 11" pages.
ID-6A/APN-4 Loran Indicator, schematic, \$2.00
SCR-518-A Hi-Altitude Altimeter, 6 schematics with explanatory notes and complete reprint, 2.00
IF data, etc. 1.00
BC-375, conversion to AC, step-by-step 1.00
BC-645, original and conversion, fixed or mobile 1.00

SCHEMATICS: \$1.00 each

SCR-274-N Transmitters, Modulator, etc.
AN/ARC-5 Transmitters (less the VHF), Push-Pull Modulator, Relay, Switching, etc.
T-23/ARC-5, the VHF transmitter.
ARB (CRV 46151), Alignment, etc.
AN/ART-13A Transmitter, Control Box, etc.
SCR-522 Receiver, Transmitter, etc.
BC-348-J, N, or Q, plus AC Power Pack
BC-348-H, K, L, or R, plus AC Power Pack.
R-89/ARN-5 Glide Path Receiver, RC-103-A, (includes BC-733-D)
AN/APN-1, (includes RT-7/APN-1)
MN-26-C Bendix Radio Compass Receiver.
MN-26, MN-28, IN-4, interconnection of components, etc.
R-65/APN-9 Loran Receiver-Indicator.
R-5/ARN-7 AN/APT-2 RA-10
AN/ARC-4
T-85/APT-5, power unit, 60 cy. AC power supply information, freq. and mod. adjustments and chart of counter settings, operation instructions, etc. \$1.00
DZ-1 BC-1206-C
SCR-269-G (Includes BC-433-G)

PLEASE SPECIFY which you want. Remit with order. Print your name and complete address in the upper-left corner of the envelope.

R. E. GOODHEART
345 1/2 N. Palm Drive Beverly Hills, Calif.
Note New Address

rent (i. e. without antenna connected) should be below 20 milliamperes.

Now the output terminals of the two turn loop of L_2 may be inductively coupled to an antenna coupling unit suitable for the antenna to be used. Since many different antenna systems are suitable for an outfit of this type no suggestions will be made on a definite type. A diagram is shown in Fig. 5 for a simple tuner which has been used with good success and is easy to rig up. The coil and condenser combination L and C should have approximately the same dimensions as the final tank assembly except that no center tap on the coil is required. The center link, preferably adjustable, is needed however. The tuning condenser C should have at least 100 mmfd. maximum for the two lower frequency bands of operation. Now tune this assembly for loading as indicated by a rise in final plate current and also by a drop in r.f. voltage in the final tank using a tuning loop. An r.f. ammeter in series with the antenna is handy when tuning up here but good results may be had by observing r.f. indications and the final plate current. At maximum loading a check should be made of the quality of the note by tuning to some harmonic of the frequency of operation since it is possible to load too heavily and reflect back the load to the power supply resulting in "whoops" and chirps in the note. The maximum rated plate current of the 826 is 125 milliamperes so this value of current should be respected when tuning the antenna circuit.

A few precautions should be observed, especially by the beginner, in the tune-up and use of this transmitter. Use a means of checking your frequency! *Don't* guess. A wavemeter is almost a virtual necessity in tuning up a transmitter where it is possible to pick off harmonics of nearly as much amplitude as the fundamental. Also it is quite possible to double in the final with a sizeable amount of r.f. so be sure to check this stage well before attaching the antenna. When changing frequency be sure to check for complete neutralization although if this outfit is neutralized at the highest frequency to be used, it will usually hold sufficiently close for the lower frequency bands. Remember, if not correctly neutralized, the emission of spurious frequencies is quite possible and probable, besides contributing nothing to the quality of the note on the correct frequency.

Three-Tube Transmitter

The three-tube transmitter as built by W1JXF, is a somewhat more ambitious project including some refinements which enable greater ease in operation as well as affording better coverage of the lower frequency amateur bands. A

buffer-doubler stage has been added between oscillator and final amplifier. This added stage enables the operator to use any band from 10 through 80 meters, inclusive, by the use of proper crystals and coils. The new 15 meter band, when released, will be available to this outfit, of course. Briefly the tube lineup is as follows: a 6AQ5 as grid-plate crystal oscillator, a 6V6GT as buffer-doubler and an 826 as power amplifier. The 6AQ5 is an efficient oscillator and delivers quite an amazing amount of power for the size of the bottle. The output on the second harmonic is nearly as much as at the fundamental and is quite sufficient to drive the 6V6. The 6V6GT performs very well as a doubler. It will quadruple very nicely too, but there is insufficient excitation for the final when used in this manner. The 826 is a conventional class C amplifier using plate neutralization.

The grid-plate type of oscillator was decided upon as the best for our use after some experimentation on various types of harmonic oscillators which have been brought out of late. Many of these have advantages, admittedly, especially for operation only on harmonics. Since we wanted good performance on the fundamental as well and since it is easy to run into difficulties with the harmonic type of oscillator, such as parasitic troubles and high crystal current, the grid-plate was finally used. The tri-tet would have given better output on second harmonic, as we well know, but for efficient operation as a doubler on several bands, another tuned circuit would have been in order, so this was ruled out. If the individual builder, for instance, desires operation only on 10 and 11 meters one of the harmonic types could have been used to better advantage perhaps, as we demonstrated to ourselves when setting up the outfit for 10 meters. Excellent data has been published on this type of circuit from time to time and if the reader is interested it is suggested that some of this material be perused. The circuit (see Fig. 5) for

**ADD A
NOTE OF
Quality...**

**HEARD
THROUGHOUT
THE WORLD**

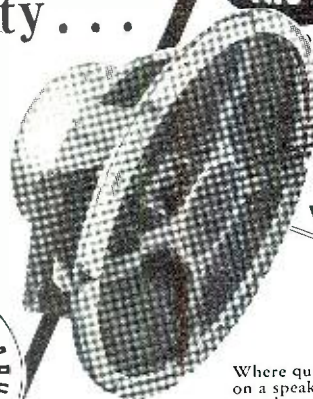

**WORLD'S
FINEST**



Where quality counts, insist on a speaker noted for fine sound reproduction... and built for high frequency clarity. CINAUDAGRAPH Speakers, the world's most complete line, insure superior performance on any job.

Shown above, the CINAXIAL Speaker, designed especially for F.M. and television use... consists of a 12" low frequency speaker, and 3" high frequency speaker mounted within the cone of the 12" unit. Together they cover the range from 50 to 15,000 c. p. s., and will handle the output of a 10-watt wide range amplifier.

To be sure of the best, be sure to specify CINAUDAGRAPH.

Write today for the new CINAUDAGRAPH catalog - Dept. 149D

Cinaudagraph Speakers

DIVISION OF AIREON MFG. CORP.

SALES OFFICE and FACTORY 1401 FAIRFAX TRAFFICWAY KANSAS CITY-KANSAS

JULY SPECIALS

ARB RECEIVER 195-9050KC, 28VDC, tubes, remote control, tuning head, manual, less cables and plugs. New...\$49.50

GN58 HAND CRANKED GENERATOR 425V, 115 ma; 105V, 32ma; 6.3V, 2.45amp; 1.4V, 450ma with cranks and stand...\$5.95

IDEAL MOBILE POWER SUPPLY PE237 heavy duty vibrator power supply, 6, 12, or 24V input. 525V, 95ma; 105V, 42ma; 6.5V, 2amp; 6V, 500 ma; 1.3V, 450 ma; small supply 100V, 17ma; 1.35-450ma with spare vibrators, tubes, shock mounted -brand new...\$29.50

7 FT. CORD CD 1086 for PE237, GN58...\$1.95

BC-1306 SMALL COMPACT TRANSMITTER 3800-6500KC, 3A4, 2E22, less cover. Can be used with PE237, GN58. New...\$9.95

K-7 GUN MOUNT ASSEMBLY, ideal mount for beam antenna, cable control. New...\$6.95
50 Ft. RG34U with connector NEW...\$3.95
250 Ft. PHOSPHOR BRONZE stranded transmitting antenna wire NEW...\$3.95
100 Ft. STEEL MEASURING TAPE NEW...\$5.95
65 Ft. GUY ROPE, pulley ring and snap...\$.45
FT-167 FEDERAL TRANSMITTER, 200 watts, 2 to 18 MC, tubes less power, NEW...\$195.00
WESTON MODEL 45 AMMETER, 0-15-150 D. C. amps. New...\$59.00
DYNAMIC HEADSET and mike. NEW...\$1.95
DYNAMOTOR - SCR 522, N-1 \$3.95; Plugs for SCR 522 N-1, \$4.00 per set.
BC602 CONTROL BOX, N-1...\$1.00
BC1206-C SETCHELL CARLSON RECEIVER, 28 volts D.C., 195-420 KC, 5 tubes, NEW...\$54.95
BC1206A-DETROLA, NEW...\$4.95

BC464 TARGET RECEIVER, 5 channel remote control, battery case and ant. 68-73 MC-NI...\$14.95

BC357J BEACON Receiver, 75 MC, tubes N-1...\$34.45
G.E. BATTERY CHARGER: Tungar 6RB617, 12 battery, 12 amp; 24 battery, 6 amp. N-1 \$67.50
MN26 RADIO COMPASS RECEIVER, tubes 150-1500 KC, U-1...\$18.95; U-2...\$14.95
SIGNAL BOX KITE, N-1...\$2.00

EE-8 TELEPHONE FIELD SETS with handset and ringer, N-1, \$15.00 ea. \$28.00 pr; U-2 \$10.00 ea., \$18.00 pr.; U-3 \$7.00 ea., \$13.00 pr.

TUBE SPECIALS
5BP1...\$1.15 726...4.95 6L6G...1.10
3AP1...2.25 75TL...2.50 12A6...\$.29
2X2...\$.75 5BP4...2.50 4 for...1.00
9002...\$.75 717-A...\$.69 VRI50...\$.90

GIBSON GIRL SCR 578B transmitter for sending distress signals from boats. Trans., complete with balloons, hydrogen gens., kite and instal. manuals. N-1 Export packed...\$25.00
Transmitter only, tubes...\$6.75

EXTENSION CORDS, PL55 plug incl. N-1 \$.40
HS-30 Ear Plug head set N-1, \$.95; U-1...\$.50
MATCHING TRANSFORMER, HS-30...\$.50

APN-1 ALTIMETER INDICATOR - Basic movement 0-1 m.a. 5 m.a. shunt 270° scale. An excellent basic G. E. movement for constructing your own meters. N-1...\$1.95
METER RECTIFIER, full wave midjet Selenium, 10 volts, 30 MA, N-1...\$.29

PL-55 PLUG, N-1, \$.29; 4 for...\$1.00
AN-160 ANTENNA, N-1, 2,000-6,000 KC; 9 insulators and jumpers 100 ft. long...\$1.00
BC733D GLIDEPATH RECEIVER, NEW...\$14.95
T-17 MIKE, NEW \$1.50; Used...\$.75
SCR-274 Remote tuning head, 3 crank...\$1.50

PE-103A DYNAMOTOR N-1...\$12.95
CD-501 A CABLE for PE-103A-BC654A 1.95
FRAME MOUNTING BC654A-103A...4.95

THROAT MIKE, \$.50; HAND KEY, N-1 \$.50

BC-348 MOUNTING BASE Postpaid...\$2.50
BC-348 OUTLET PLUG Postpaid...\$.80
BC-348 MNTG. BASE and Outlet Plug, Postpaid...\$3.00

\$1.00 TUBE SPECIALS
872A-1616-304TL-211; Minimum order: four tubes. NEW & CLEAN.

.25 MFD.-20,000V. G.E. Pyranol Cap.N-1, \$9.95
12 In. CERAMIC insulator 1 In. Diam. N-1, .25
12 In. CERAMIC spacer N-1...\$.20

PHOTOCON SALES
1062 North Allen Avenue Pasadena 7, Calif.

ALLEN BRADLEY B-400 4 pole relay, 10 amps., 600 V.A.C., contacts, 110V-60 cycle coil N-1...\$4.95

T-32 DESK MIKE-N-1, \$3.50; U-1...\$1.95
3 FT. DIAM. SIGNAL BALLOON N-1...\$1.50
AN73, 7' ANT. TELESCOPES to 12" N-1...\$2.50
U-1...\$1.50
AUDIO CHOKE-I Henry 800 M.A. 15,000 V. Test U-1...\$12.50
5 VOLT-115 Amp. Transformer 115 V.A.C., U-1...\$9.95
5 VOLT-190 Amp. Transformer 115 V.A.C., U-1...\$9.95

SOUND POWERED CHEST SET, N-1...\$5.95
SOUND POWERED HANDSET, TS-10, N-1, each...\$15.00 per pair...\$25.00
CRANK FOR 274N RECEIVERS...\$.60

PHOTOFLASH CAPACITOR, 25 mfd., 2000 V; N-1...\$10.00
6 COND. PLASTIC CABLE for Photo-flash, N-1 per foot...\$.35

FL-8 RANGE FILTER, \$1.95; with cord and plugs...\$9.95
ANTENNA KNIFE switch, S.P.D.T.,...\$2.50
PEERLESS A-4233Q line matching transformer -50/125/200/500 ohms, NEW...\$1.50

BC-222 WALKIE TALKIE transmitter-receiver 28-52 MC less tubes, batt., handset & antenna, USED...\$6.50
BC-222 with tubes and handset-Used \$11.50

HS-23 8000 Ohm Headset, New \$2.25; Used, .89
OVERLOAD RELAY-Potter-Brumfield, 10 MA, 5000ohm D C trip; 115 V.A.C. 60 cy. reset-NEW...\$3.95
TRANSFORMER, CASED: 200-0-200 at 50 M.A. 6.3 @ 3 amps., 115 V. A. C. 60 cycles NEW...\$2.50

RM-13 REMOTE CONTROL UNIT contains EEB, handset, 1 stage amplifier, Weston DB motor, Used, 115 V.A.C. \$25.00
Pre-amplifier FROM BC610, modulation limiter, etc. tubes, DB meter, USED \$39.00
Less Meter...\$34.00

CODE: N-1-NEW; USED LIKE NEW; U-1-USED EXCELLENT COND.; U-2-USED GOOD.
TERMS: F.O.B. Pasadena, unless postpaid. No C.O.D.'s under \$5.00. 25% deposit on ALL orders. All C.O.D. shipped by Rail Express. Send full price with order and we will ship by fast truck, transportation collect. Minimum order \$2.00. Californians include 2 1/2% sales tax.

GUARANTEED SURPLUS ELECTRONIC MATERIAL

Only a few of the many special buys to be found in our latest catalog.

TUBES

(New surplus priced for quick sale)

Type	Price	Type	Price
HY114B	.45	954	.45
3B24	.55	9003	.18
3B25	.55	9006	.35
6AC7	.65	1629	.25
388A	4.95	1632	.25
23D4	.35	RK72	.75
45	.55	RK73	.45
RK60	2.95		

RADIO NOISE FILTERS

These line noise filters are available in large quantities and priced for quick sale.

Mallory NF 12-6EG—Housed in a bathtub type container and rated at 7 amps, 50 volts D.C. Solder lug terminals	Price \$.35
Mallory NF7-3A—Housed in silver-plated rectangular case 3 3/4" x 1 1/2" x 2 1/2" with male and female amphenol AN3108 plugs	Price \$.95
Mallory NF7-4—Housed in rectangular case 3" x 1 1/2" x 7 1/2". Internal screw terminals. Rated at 13 amperes—35 V.D.C.	Price \$.95
Mallory NF2-2—Housed in square case 3 3/4" x 2 1/2" high—Rated at 50 amperes 35 volts	Price \$.95
General Electric Noise Filter—Housed in square case 1 1/4" x 3" high. Rated at 200 amperes at 50 volts	Price \$.95
Mallory NF2-1—100 amps. 35 volts—Housed in shielded container 3 3/4" square x 2 1/2" high screw terminals	Price \$.95
Solar Elim-O-Stat—Type EA105—50 amps at 50 Volts—\$.95 Type EA109—50 amps at 35 volts. Both units are housed in container similar to Mallory NF2	Price \$.95
Bendix—model 3937—Generator Filter—50 amps. 120 Volts D.C.—Housed in shielded containers 4" x 3 3/4" x 8"	Price \$1.25
Line Noise Filter—Unshielded and mounted on a bracket suitable for use on power lines—Consists of two .01 molded condensers and 140 turn solenoid choke coil	Price only \$.10

RELAYS

Telephone type RBM 556-881—Double contacts, double-pole, double-throw—Coil 14000 ohms	Price \$.65
Telephone type RBM 556-882—Double contacts, double-pole, double-throw, plus single-pole, single-throw normally open—Dual winding coil, each winding 170 ohms	Price \$.65
Telephone type RBM 556-883—Double contacts D.P.-D.T. plus 2 S.P.S.T., one normally open, other normally closed. Dual winding coil, each winding 170 ohms	Price \$.65
Telephone type RBM 556-884—Double contacts 2-S.P.S.T., one normally open, other normally closed. Dual winding coil, each winding 170 ohms	Price \$.65
Miniature Relay D4913 S.P.D.T. Coil 300 ohms 24 V. D.C.	Price \$.55
Aircraft-type Starter Relay Hermetically sealed coil 12 Volts 18 ohms. Very heavy contacts	Price \$.65
Aircraft-Type Starter Relay Leach type 7220-3-24. Coil 24 Volts D.C. Res. 132 Ohms. Very Heavy Contacts	Price \$.65

TRANSTAT VOLTAGE REGULATORS

Model 29144 Fixed Winding 115 Volts—60 cycles Commutator range 103-126 Volts Maximum output .25 KVA Housed in shielded case 5" x 6" x 6"	Price \$6.95
Type RH Fixed Winding 115 Volts—100 cycles Commutator range 75-120 Volts Load—.72 KVA Housed in shielded case 5 1/2" x 6" x 6 1/2"	Price \$1.95

Write for free descriptive catalog R-7 listing a large variety of electronic components.

EDLIE ELECTRONICS, INC.

131 Liberty Street, New York 6, N. Y.
Telephone: WOrth 4-1169

the oscillator is quite straightforward and will present no trouble for the builder. The screen voltage is taken off the voltage divider R_3 so that it could be adjusted for best operation but this could be replaced by two resistors of 15,000 ohms and 25,000 ohms, 2 watts if desired. Switch S_1 has been incorporated to enable keying of the buffer stage only or both oscillator and buffer simultaneously. This is an advantage when using some crystals which don't start well, such as some 14 mc. types.

The 6V6GT buffer-doubler stage is capacitively coupled to the oscillator by a 25 mmfd. mica condenser of 500 volt rating. This stage doubles very efficiently and with the voltages indicated provides ample excitation to the final. When working straight through, that is, with output from the final at the crystal frequency, the 6AQ5 will provide enough excitation for the 826 and the buffer stage may be bypassed by the use of a jumper plug inserted in the 6V6GT socket and the coil for this stage removed. This jumper plug is made from the base of a discarded octal tube with a .001 mfd. mica, 500 volt condenser soldered in across pins 3 and 5 thus applying the output from the oscillator to the grid of the final. This is indicated on the diagram by the dotted line from grid to plate of the 6V6GT and condenser C_x . We expected that if the 6V6GT was employed as a buffer, self-oscillation in this stage would be bothersome, involving the necessity of neutralization. We made many checks along this line using various values of inductance with various crystals but under no conditions could this stage be made to take off by itself. Presumably there was enough circuit capacitance added by wiring to act as a neutralizing condenser. However, if the individual desires to use this stage as a buffer it is well to take precautions and make sure that self-oscillation is not present.

The 826 final amplifier is a conventional triode acting as a class C ampli-

CHARACTERISTICS OF THE 826

Filament voltage	7.5 v.
Filament current	4.0 amps
Socket - Special	7 pin

Typical Operation

Plate voltage	1000
Grid voltage	-70
Plate current	125 milliamps.
Grid current	35 milliamps.
Grid driving power	5.8 watts
Power output	86 watts (class C telegraphy)

Operating characteristics of the 826.

fier. Bias is obtained by use of a combination of grid leak and battery and by these means a value considerably beyond cut-off secured. This was a compromise value so that this stage could be plate modulated by a suitable modulator at some later time. At this writing it would seem that merely adding another 45 volt battery in series with the one indicated, would provide sufficient bias for plate modulated operation.

Neutralization in this stage is accomplished by the use of the homemade condenser which is similar to the *Millen* type used in the two-tube transmitter. The procedure of neutralization has been gone over briefly in the discussion of the smaller outfit and many handbooks give data on this so it will not be repeated here. Conventional procedure is used and no difficulties were experienced in this adjustment.

The metering arrangement for the entire outfit is one that has been used many times and makes use of a two-section wafer switch having at least four positions and preferably using cera-

Fig. 7. Underchassis view of the two-tube transmitter.

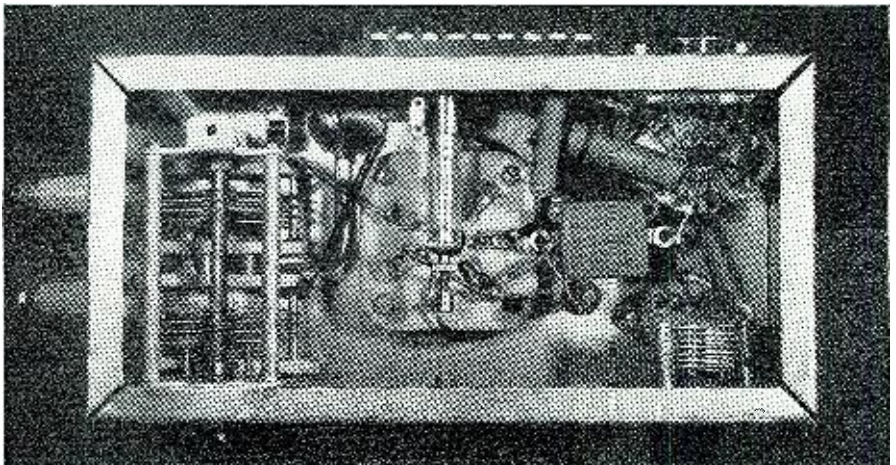

mic insulation. By the use of the switching arrangement shown the meter may be switched into the oscillator plate, the buffer plate, the amplifier grid and the amplifier cathode circuits at will. The meter is a 0-100 milliammeter and is bypassed for r.f. with a .001 mfd. mica across the contacts just in case there is any r.f. left in the particular lead switched in. Installed on the front panel is a s.p.s.t. toggle switch, S_2 , to cut the meter when using c.w. Resistor R_{11} is a homemade 200 milliampere shunt so that full scale deflection in this position of the switch is 200 milliamperes. Incidentally, remember when reading the total current for the final stage in this switch position, the value includes both grid and plate currents and is fairly high. The plate current is determined by checking the grid current then subtracting this from the total reading. The meter was inserted into this circuit in order to avoid bringing the lead up to the front panel.

Nameplates were used quite profusely on the front panel to identify all controls clearly. These were made photographically and the method has been described before. While many builders might feel that the trouble of making these is hardly worthwhile they do help the operator avoid mistakes as well as dressing up a panel quite professionally and economically as well.

Notes on Construction

Since the photographs show fairly clearly the placement of parts and the controls are identified on the front panel, elementary details of construction will be avoided. The chassis is a standard, 7" x 15" x 3" unit, cadmium plated. The panel is homemade of masonite being finished off by two coats of flat black enamel, rubbed lightly with steel wool between coats. The terminal strip is a war surplus item, but any strip having the desired number of terminals may be used. Since the insulation of this item was excellent the high voltage lead was brought into the chassis by its means, but a special feed-through insulator is to be recommended here. The neutralization condenser C_n was fabricated from a piece of 1/2" o.d. polystyrene tubing, 3" long. A 3/4" band of copper foil is attached to one end of this condenser in the manner of a hose clamp with a soldering lug placed on the screw for connections. A 6-32 machine screw 2 1/2" long is used to provide the variable element and has a small cup, 3/4" long, made of copper foil soldered to one end, this being of correct diameter to fit loosely inside the poly tube. A 6-32 barrel nut is cemented into the poly tube at the other end and the long 6-32 screw is passed through this. The 6-32 screw may be slotted to facilitate its adjustment with a neutralization

July, 1948

TUBES

GREATEST SELECTION IN COUNTRY LOWEST PRICES

NEW - STANDARD BRAND - MIN. ORDER \$5.00
QUANTITY PRICES ON REQUEST

0A4G	1.06	3C24	.69	6P5GT	.88	12F5GT	.59	50	1.56	830B	.525
0Y	.50	3D6	.89	6Q5G	.98	12H6	.59	50A5	.88	832A	2.95
004	.88	3E29	2.95	6Q6G/6T7G	1.06	12J5GT	.54	50B5	.72	833A	39.50
01-A	.50	3L4	1.06	6Q7	.72	12J7GT	.72	50L6GT	.59	836	1.15
024	.88	30F4	.72	6R7	.88	12J8GT	.60	50M6	.39	839	2.95
IA3	.72	30S5GT	.88	6S7	.88	12K7GT	.59	50V6GT	.59	838	4.95
IA4	1.28	35A	.72	6S8GT	.88	12K8GT	.59	50V7GT	.59	841	.69
IA4P	1.28	4-125A	.27	6S9GT	.59	12Q7GT	.59	55	.72	843	.69
IA4T	1.28	4-250A	.37	6S7	.72	12SA7	.59	56	.59	845	4.95
IA5G	1.28	5B5P1	1.49	6S7F	.59	12SC7	.72	57	.72	860	3.00
IA6G	1.28	5B5P2	1.49	6S7F	.59	12SF5	.59	58	.72	861	50.00
IA85	1.06	5B4P	4.95	6S7F	.72	12SF7	.72	59	.72	864	.69
IB4	1.28	50P1	3.95	6S7G	.72	12SG7	.72	70L7GT	1.06	866A	.89
IB5/25S.	1.06	51P7	3.95	6S7H	.59	12S7	.72	71-A	.72	868	1.95
IB7G	.72	5R4GY	1.29	6SK7	.59	12SJ7	.72	75	.59	872A	1.95
IB25A	4.95	5T4	1.29	6SL7GT	.88	12SK7	.59	75TL	2.95	874	1.95
IA7G	.88	5TP4	20.00	6SN7GT	.88	12SL7GT	.88	76	.88	876	4.95
IB27	4.95	5U4G	.54	6X4	.54	12SN7GT	.88	77	.59	884	.98
IB38	4.95	5U4G	.54	6X4	.54	12SQ7	.59	78	.59	902	4.95
IC5G	.88	5V4G	.88	6SR7	.59	12SR7	.72	80	.72	904	2.95
IC6	1.06	5W4	.88	6SS7	.72	12S7	.88	81	1.28	950	1.06
IC7G	1.06	5Y3GT	.38	6T7	1.06	14A4	1.06	82	.88	955	.49
ID5GT	1.28	5Y4G	.50	6U5	.72	14A5	1.06	83	.88	956	.75
ID7G	1.06	5Z3	.60	6U6GT	.72	14A7	.88	83V	.88	957	.49
IE2P	1.50	5Z4	.88	6U7G	.59	14B7	.88	84/6Z4	.59	958A	.69
IE7G	1.28	6A3	1.06	6V6	1.06	14B7	1.10	85	.72	991	.49
IF4	.88	6A5G	1.56	6V6GT	.72	14B6	.88	85	.88	99V	1.56
IF5G	.88	6A7	.72	6V6G	.72	14C7	.88	89V	1.56	1614	1.75
IF6	1.28	6A8	.72	6X4	.88	14C7	.88	89X	1.56	1616	1.39
IG4GT	.88	6AB5/6N5	.88	6X5	.54	14E6	.72	100TH	12.95	1616	.29
IG6GT	.88	6AB7	1.06	6Y6G	.88	14E7	.88	114A	.69	1619	.98
IH27	1.28	6AC5GT	.88	6Z7G	1.28	14F7	.88	117L7GT	1.28	1622	1.95
IH3GT	.60	6AC7G	1.06	6Z7G	1.28	14H7	1.06	117M7GT	1.28	1625	.49
IH6G	1.06	6AD7G	1.06	7A4	.72	14J7	1.06	117N7GT	1.28	1625	.49
IJ6G	1.06	6AF6G	.88	7A6	.72	14K7	1.06	117P7GT	1.28	1626	7.95
IL4	.72	6AF8	.88	7A6	.72	14Q7	.88	117ZGT	.72	1627	.59
IL4A	1.06	6AG5	1.06	7A7	.72	14S7	1.06	117Z6GT	.88	1629	4.95
IL4B	1.06	6AG7	1.06	7A8	.72	14R7	.88	120A	12.95	1642	1.25
IL4C	1.06	6AJ5	.99	7AE7	.72	14W7	1.06	121A	2.65	1851	1.95
IL6C	1.06	6AK5	.99	7AF7	.72	14X7	1.06	205B	4.50	8011	.49
IL6E	1.06	6AK6	.88	7B4	.72	14Y4	.88	215A	3.00	2051	4.95
IL6S	1.06	6AL7GT	1.06	7B7	.72	14Z4	110.50	215A	3.00	5514	3.95
IL6T	1.06	6AL7GT	1.06	7B7	.72	15E	1.50	217C	7.50	5516	5.95
IL6U	1.06	6A05	.72	7B8	.72	19	1.06	250R	7.95	5562	10.00
IL6V	1.06	6A06	.72	7B8P7	2.95	20	1.56	250TH	19.50	7193	.39
IN5G	.88	6AT6	.60	7C4	1.06	20AP4	270.00	252A	4.95	8005	4.95
IP5GT	1.50	6A06	.72	7C5	.72	22	1.28	259A	4.95	8011	2.95
IQ4	.88	6B4G	1.06	7C6	.72	23D4	.88	304TL	4.95	8016	1.95
IR5T	1.06	6B7	1.06	7C7	.72	23D6	.88	310	4.95	8016	5.95
IT4	.72	6B8	1.06	7E6	.72	24G	.88	307A	6.25	8020	3.95
IT5GT	.88	6BA6	.72	7E7	.72	24G	.88	310	.88	8025	.89
IU4	.72	6BE6	.72	7E7P4	1.75	25A6	1.06	316A	.89	9001	.89
IU5	.88	6BE6	2.40	7F7	.88	25A7GT	.88	350B	4.95	9002	.49
2A3	1.06	6C4	.60	7F8	1.06	25C6G	1.06	394A	4.50	9003	.49
2A5	.72	6C5	.60	7G7	1.06	25L6GT	.59	417A	19.95	9004	.49
2A6	.88	6C8G	1.06	7H7	1.94	25Z6	.72	450TL	24.95	9005	.98
2A7	.88	6D4	1.95	7J7	1.06	26	.59	701A	49.50	9006	.49
2A8	.88	6D6	.60	7K7	1.06	28D7	.75	707A	24.95	EF50	.39
2B2	.88	6E5	.72	7L7	.88	30	.72	709A	9.95	EL225	1.95
2C27	.75	6F5	.60	7N7	.88	31	.88	715A	1.85	FM-1000	1.56
2C26A	.98	6F6	.72	7O7	.72	32	1.06	718B	19.95	GL434	4.95
2C34	.98	6F6	.72	7R7	.88	32L7GT	1.28	719A	1.65	KL46A	2.60
2C40	2.60	6F7	1.06	7R7	1.06	33	1.06	721A	3.95	HF100	3.95
2C43	2.60	6F8G	1.06	7V7	1.06	34	1.06	723AB	5.95	HY69	2.95
2C44	1.75	6G6G	.88	7W7	1.06	35/51	.72	725A	12.50	HY75	1.25
2D21	1.89	6H6	.60	7X7	1.06	35A5	.72	750TL	49.50	HY615	1.25
2E5	.88	6H6GT	.60	7Y4	.72	35L6GT	.46	800	2.25	IEY1148	1.25
2E22	1.50	6J4	3.95	7Z4	.72	35W4	.46	801A	2.95	RK12	1.95
2E24	4.37	6J5G	.54	10BP4	34.95	35Z3	.72	803	8.95	RK60	.79
2E25	3.95	6J5GT	.54	10CP4	42.20	35Z4GT	.50	805	4.95	RK72	3.50
2E30	2.25	6J6	1.06	10HP4	49.50	35Z5GT	.46	807	1.25	RK73	9.95
2IB51	4.95	6J7	.72	10P4	.89	36	.88	808	2.95	T20	1.95
2V3G	1.10	6J7GT	.72	12A6	.89	37	.59	809	1.95	V700	6.95
2X2	.69	6J8G	1.06	12A7	1.06	38	.72	810	7.95	VR75	.98
3A4	.72	6K5GT	.88	12A8GT	.72	39/44	.59	811	2.95	VR78	.75
3AP1	2.95	6K7	.60	12A8GT	.88	41	.59	812	6.50	VR90	.75
3B7	1.06	6K8	.88	12AT6	.59	42	.59	812H	7.95	VR105	.75
3B22	4.95	6L5G	.88	12AU7	.72	43	.59	813	5.95	VR150	.75
3B23	4.95	6L6	1.29	12AU7	.88	45	.59	814	2.50	VT127A	3.00
3B24	1.95	6L6G	1.06	12BA6	.72	45Z5GT	.88	815	1.25	W532A	1.50
3B25	.88	6L7	.88	12BE6	.72	48	.88	826	1.25	W532A	4.95
3BP1	2.95	6N7	.88	12C8	.89	47	.88	829B	4.95	Z225	1.95
3C6	1.28	6N7GT	.88	12DP7	14.95	49	.88	829B	4.95	Z225	1.95

20% DEPOSIT WITH ALL ORDERS UNLESS RATED

ALL TYPES LISTED ABOVE IN STOCK NOW BUT SUBJECT TO PRIOR SALE

NIAGARA RADIO SUPPLY CORP.

160 GREENWICH ST.
NEW YORK 6, N. Y.

WANTED—Western Electric Carrier Telephone and Telegraph Equipment and Components. Filters, repeating coils, transformers, equalizers. Types CFI, CF2, H, C, and other carrier equipment. Telephone and telegraph repeaters.

Box 450, Radio News, 185 N. Wabash
Chicago, Illinois

Mr. Radio Service Dealer "Speed is our Motto"

One day service on all orders. None too small. Only Nationally Advertised Merchandise (No Surplus Handled). TUBES—Any quantity 50% off list.

Mail us your orders.
Illustrated list on request.

Bill Sutton's

Wholesale
Electronics
Fort Worth, Texas

Fifth at Commerce

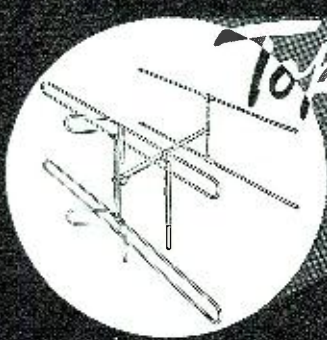

*Top Performance**
with **JFD**

F-M and TELEVISION ANTENNAS and Accessories

Here is the last word in television antennas. This double stacked folded dipole with high frequency lobes and reflectors gives full reception on both TV bands and on the FM band. Frequency Range is from 44 to 216 mc. JFD's exclusive "ROTO-LOCK" insulator, molded of a special modified polystyrene, guarantees maximum insulation efficiency and TOP PERFORMANCE on upper television channels. Heat and cold resistant in extreme temperatures.

This lightweight, durable antenna is precision engineered of heavy wall 1/2" aluminum tubing and is completely adjustable in both horizontal and vertical planes. Mast and supporting members are the heaviest in use today — 1" diameter and 1/16" wall thickness. Assembly can be completed in a few minutes — all pre-assembled. Every screw, nut, and bolt is right in place — no need for a hardware bag.

Cat. No. TA105 List Price **\$35.00**
Cat. No. TA105L (No. TA105 with 60' or 300 ohm Twin Lead). List Price \$37.50

ASK YOUR JOBBER FOR FREE LITERATURE DESCRIBING OTHER JFD TELEVISION AND FM ANTENNAS OR SEND DIRECT TO US.
WRITE FOR JFD FOLDER 248-S

"Pioneering in F-M and Television Antennas Since 1939"

JFD MANUFACTURING CO., Inc.

4111 FORT HAMILTON PARKWAY, BROOKLYN 19, NEW YORK, U.S.A.

L ₁ *	80 m.-- 28 t. #18 en. closewound 1-1/4 inch form
	40 m.-- 17 t. #18 en. closewound 1-1/4 inch form
	20 m.-- 11 t. #18 en. wound 1-3/8 inch long on 1-1/4 inch form
L ₂	80 m.--30 t. #18 en. closewound on 1-1/2 inch form
	40 m.-- 19 t. #18 en. closewound on 1-1/2 inch form
	20 m.-- 11 t. #18 en. wound 1-1/2 inch long on 1-1/2 inch form
L ₃ **	80 m.-- OLS - 160 (160 m. size)
	40 m.-- OLS - 80 (80 m. size)
	20 m.-- OLS - 20 (20 m. size)
	10 m.-- OLS - 10 (10 m. size)

Use Bud 75-watt adjustable center-linked coils. Due to the rather low C in final it is necessary to use the next lower frequency size on 80 and 40 m.

* Use this data for L1 in Fig. 4
** Use this data for L2 in Fig. 4

Table 1. Coil data for both transmitters.

tool which is inserted through the panel bearing on the front panel, labeled "Neutralize."

The placement of the 826 socket seems to be out of line but it was purposely installed thus in order to provide for short r.f. leads. The keying selector switch is placed at the rear of the chassis and is shown clearly in the rear view of the chassis. The final tuning condenser, C₁₁, is mounted outboard to allow for short r.f. leads. The two small feedthrough insulators on the rear of the chassis are for connections to a coupling link to the antenna tuner. A square escutcheon plate which was removed from a surplus tuning unit was mounted on the front panel to house the instruction plate.

Tune-Up and Operation

Not a great deal of detail will be given here since the average builder is already familiar with the general procedures. Briefly, with the proper crystal and coil in the oscillator stage, the filaments of all stages being turned on, "B plus" for the oscillator and buffer is applied. With the meter switched to oscillator plate, tune the oscillator for minimum current consistent with low crystal current as indicated by the panel lamp. (Detune slightly on the low capacity side of resonance for better keying qualities.) Now repeat this procedure in the buffer-doubler stage using the proper coil for the band of operation desired, keeping in mind that if either stage is doubling, the plate current will be higher and the dip in current at resonance will be less. Now switch the meter to the grid circuit of the final and neutralize this stage using the grid meter as an indicator (no plate voltage applied). Now the high voltage may be applied to the final and the final tuned up in the same manner as the other stages keeping in mind the fact that the no-load current will be quite high because it includes the grid excitation current as well as the plate current. Finally the

"AMERICA'S BEST BUYS"

N
E
W



N
E
W

The PREPRO Jr. TRANSMITTER

50 Watt C.W.-40 Watt Phone. Covers 10-20-40-80 Bands through bandswitching Pi network. Operates on 115 Volt, 60 Cycle. Crystal Controlled. Light weight; 30 lbs. Small size; 10"x10"x8". Can be supplied adapted for commercial use at additional charge.

\$17750

NEW PANAM CRYSTALS

NOT WAR SURPLUS

Your frequency plus or minus 1 KC. Fundamentals from 3500 KC. to 8500 KC. in new "PA43" holders. (Same as FT-243).

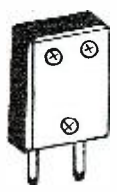

\$169
EACH

(Guaranteed by manufacturer)
Postage extra 20% deposit on COD.
Write for latest bargain list featuring "America's Best Buys."

POTTER RADIO CO.
1314 McGee St., Kansas City 6, Mo.

RADIO TUBES

For immediate shipment
R.M.A. Guaranteed
Below Distributor Costs
Individually Sealed Cartons

Type	Price
6K6GT	.40
6K5GT	.46
6V6GT	.46
6SA7GT	.46
6SJ7GT	.46
6SK7GT	.46
6SQ7GT	.46
6X5GT	.40
12SA7GT	.46
12SQ7GT	.46
12SK7GT	.46
12SJ7GT	.46
35L6GT	.40
35Z5GT	.32
50L6GT	.46

POPULAR MINIATURE TYPES NOW AVAILABLE
25% DEPOSIT REQUIRED ON C.O.D.
10% DISCOUNT ON LOTS OF 50 OR MORE
2% C.O.D.

RAVAC ELECTRONICS CORP.
432-4th Avenue
New York 16, N. Y.

antenna may be coupled to the transmitter through a suitable device and the outfit put on the air. In lining-up a transmitter such as this it will be found that some sort of a frequency measuring device is a necessity and a wavemeter, either homemade or commercially built, should be used in checking each stage so as to avoid the possibility of the emission of signals which are outside the amateur bands. It is better to be safe and take a little more time in being so, than to hurry and guess and to receive one of those nice pink tickets.

Conclusion

The primary purpose of this article has not been to extol the merits of the 826 tube just because it has sold on the surplus market for a very nominal price. Rather it is to point out to the prospective builder the possibilities of rather decent bargains in worthwhile tubes. While the initial cost of the tubes used is a far cry from the cost of the finished transmitter, it does nevertheless figure in as an item to be considered. The use of tubes designed for the very high frequencies does not necessarily recommend them for the lower frequencies, but there are many which do perform well on both and the 826 would seem to be one of these. It would appear to be more economical, other things being equal, to buy a tube whose characteristics make it more versatile in this respect than to use a tube which is limited in its capabilities.

The two transmitters described in this article have performed very satisfactorily for the authors. Since a power supply which delivers 1000 volts at 250 milliamperes is a common size to use after the 400 to 500 volt size that is the usual one for the beginner, it would seem that these two rigs offer definite advantages in this voltage and power range. The subject of the relative merits of triodes over beam power pentodes is a debatable one but we think that there are many hams who will go along with us and be content to use a triode in the final and eliminate some of the unpredictable headaches that seem to be inherent qualities of the beam type tubes.

EDITOR'S NOTE: Further experiments have shown that the output of the 6V6 buffer in the three-tube unit may be increased somewhat by changing R_3 to 50,000 ohms and eliminating R_4 .

REFERENCES

- Whitaker, James N.; "Deluxe Amateur Transmitter," RADIO NEWS, April and May, 1947.
- Smith, Tom; "Medium Power Table Top Transmitter," CQ, November, 1947.
- Jones, Frank C.; "Plate Modulated 60 Watt Transmitter," CQ, January, 1947.
- Parmenter, R. L.; "Simplified RC Bridge," RADIO NEWS, March, 1948.

-30-

July, 1948

**YOU'RE SAFE
at HOME!
for every ball game..**

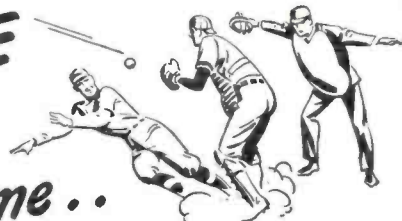

**with the
HIGHEST QUALITY**

MEISSNER FM RECEPTOR

• The thrill and incomparable beauty of FM reception is available to all with the Meissner model 8C FM receptor. A simple connection to any present AM radio . . . and the full scale fidelity of FM reception, unbelievably free from static, interference or fading, is brought to the listener as only the quality of Meissner skill can produce it. See and hear the new MEISSNER — there is nothing like it! Retail Price . . . \$57.50.

- New FM Band, 88 to 108 Mc.
- Audio Fidelity, flat within plus or minus 2 db. from 50 to 15,000 CPS
- Audio Output, 3 volts R. M. S. at minimum useable signal input, 30% modulation.
- For greater signal inputs, output voltages as high as 15 volts R. M. S. obtained without distortion.
- Power Supply, 105 to 125 volts, 50 or 60 cycle AC. Consumption, 35 watts
- Tube Complement, 2 type 6AG5, 2 type 6BA6, 2 type 6C4, 1 type 6AL5 and 1 type 6X5GT/G

M **ISSNER MANUFACTURING**
DIVISION OF MAGUIRE INDUSTRIES, INC.
MT. CARMEL, ILL., U. S. A.

QUANTITY SURPLUS BUYERS

We Offer Quick Delivery On Your Largest Orders.

Our large inventory of electronic equipment and parts includes many of those hard-to-get items. Much of our stock is stored in Eastern warehouses, affording quick, low-cost delivery of large orders. Send for latest inventory lists (use your business letterhead, please). Phone and telegraph inquiries invited.

Liberal quantity discounts allowed.

**WE HAVE A LARGE STOCK OF RUBBER COVERED
MULTI-CONDUCTOR CABLES - ALL WIRE GAUGES -
ANY NUMBER OF CONDUCTORS - SHIELDED, UNSHIELDED**

G. & M. EQUIPMENT CO., Inc.

4505 VAN NUYS BOULEVARD • VAN NUYS, CALIFORNIA • STATE 4-3233



RIDER'S *New*

Television "HOW IT WORKS"

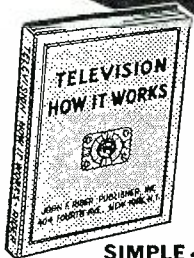

**STOP
"Wondering
About"
Television**

SIMPLE—BASIC EXPLANATION

Television is in the eye of the public and the radio man alike. Knowledge of its underlying theories is a must for anyone who hopes for a future in radio work.

Rider, famous for his practical, easy-to-understand style of presentation has just published this new book with its easy-to-apply explanations on the biggest development since the very introduction of radio.

A GOLD MINE OF PRACTICAL FACTS

Here is practical theory. The first chapter deals with the transmission and reception of television signals in general, giving you a clear overall picture. The second chapter deals with frequency standards, the next with antennas. Television "How It Works," then goes into descriptions of the various portions of a television receiver: the r-f, oscillator, converter circuits in the front end, the sound channel, the video i-f system and detector, the video amplifier and d-c restorer, the sync and sweep circuits, picture tubes, power supplies. The conclusion covers alignment and servicing problems. The entire book carries the practical right along with the theoretical, ending up with the when and why of certain operations in television receiver maintenance.

The information in this book will be part of Vol. 1 Rider Television Manual, therefore if ordering the Manual (priced at \$15.00) you will automatically get this book.

A VALUABLE BOOK—YOU NEED NOW!

Though television may not now be in your area, it will be soon. You need the knowledge this book provides, now. Send handy coupon below, today.

**Over 200 Pages—Illustrated . . . \$2.70
ORDER FROM YOUR JOBBER OR SEND COUPON DIRECT**

COUPON

JOHN F. RIDER PUB. INC., 404 4th Ave., New York 16
Enclosed \$2.70 for Television "How It Works."
If I send it back within 10 days you will return my money.

Name _____
Address _____
City _____ (Zone No.) _____
State _____ RN

RADIO ENGINEERING I

COMPLETE Radio Engineering Course. Bachelor of Science Degree. Courses also in Civil, Electrical, Mechanical, Chemical, Aeronautical Engineering, Business Administration, Accounting, Secretarial, Science. Graduates successful. 65th year. Enter Sept., Jan., March, June. Write for catalog.

TRI-STATE COLLEGE 1678 College Ave., ANGOLA, INDIANA

SELSYN DRIVE MOTORS

Heavy Duty, Type C 78248—Built for Directional Gun Control—Perfect for Rotary Beam Control and Direction. Dia. 3 1/4", length 4 1/2". Mfd. by Bendix, Hobart. Operate in Pairs as Transmitter and Receiver on 115V, 60 Cycle A.C., Per pair (two units).....\$6.50
Synchro-Differential, Type C78249, same make, size, 115V, 60 Cycle A.C., each.....\$3.50
McCoy Sales Co., P.O. Box 335, Berea, O.

Manufacturers' Literature

Readers are asked to write directly to the manufacturer for the literature. By mentioning RADIO NEWS, the issue and page, and enclosing the proper amount, when indicated, delay will be prevented.

"STETHOSCOPE SERVICING"

Supreme Publications have prepared a booklet "The Inside Story of Stethoscope Servicing" for the Feiler Engineering Company which they are offering free of charge to RADIO NEWS readers as long as the supply lasts.

The little 24-page booklet describes the advantages of radio servicing with the Feiler "Stethoscope" and outlines the methods to be used. Instructions are clear and complete and servicemen should derive much benefit from studying the booklet.

Requests for copies should be addressed to Supreme Publications, 9 South Kedzie Avenue, Chicago 12, Illinois.

TRANSFORMER DATA

Standard Electrical Products Co. is now making available a catalogue sheet describing a new line of metered variable transformers being manufactured by the company.

Described in this four-page, two-colored sheet are isolated primary transformers with secondary voltages from zero to 140 volts and auto type transformers with the same output voltage.

Electrical specifications, dimensions, and prices for all "Adjust-A-Volt" transformers are also included in the catalogue sheet.

A copy of Form 12475 may be secured by writing Standard Electrical Products Co., 400 Linden Avenue, Dayton 3, Ohio.

HAM EQUIPMENT

Amateurs will be particularly interested in the catalogue sheet currently being distributed by Dick Rose, (Ereco) Everett, Washington.

Among the equipment described are beam rotators, antenna relays, u.h.f. tuner assemblies, generators, storage batteries, ohmmeters, ammeters, dynamos, microswitches, etc.

A copy of this sheet will be forwarded on request. Address Dick Rose (Ereco), 2912 Hewitt Avenue, Everett, Washington.

TV ANTENNAS

La Pointe-Plascomold Corporation of Unionville, Connecticut is now offering three new data sheets covering the "Vee-D-X" television antenna and the "Vee-D-X" lightning arrester for television and FM.

The two data sheets on the television

antenna contain complete instructions for assembling the unit while the lightning arrester is described and pictured on the third sheet.

Any or all of these data sheets are available upon request to La Pointe-Plascomold Corporation, Unionville, Connecticut.

CHIMNEY MOUNT

South River Metal Products Company has released a new flyer covering the company's unique "Chimney Mount" antenna base.

The unit, which is designed especially to facilitate the installation of television, FM, and amateur antennas, is fully described in the data sheet. According to the flyer, the new antenna base may be installed in ten minutes without the use of special tools or requiring any special skills. The unit weighs about three pounds.

A copy of this catalogue sheet may be secured by writing South River Metal Products Company, South River, New Jersey.

TIPS ON TELEVISION

A brochure of interest to restaurant and tavern owners planning to install television is currently available through the RCA Victor Home Instrument Department.

The booklet describes major points to be considered by owners of public places planning on television and is the result of 15 months of study of the use of television in such establishments.

Vital points to be covered are listed and fully discussed. A copy of this brochure is available from the Home Instrument Department, Radio Corporation of America, Camden, New Jersey.

JOBBER CATALOGUE

General Catalog Publishers, Inc. of Chicago has assembled a syndicated catalogue which will be made available to radio jobbers.

The new listing comes complete with individualized cover and specialized message within along with jobber resale prices.

Each page carries the merchandise of a different manufacturer, the items have been chosen as the result of a survey among the jobbers themselves. Each jobber may have a wide choice of pages from the 180 pages already printed. More units are now in preparation.

Officers of the newly organized firm responsible for the publication include William O. Schoning, Karl A. Kopetzky, and Jacqueline J. Silver.

Further details on the new jobber catalogue may be secured from *General Catalog Publishers, Inc.*, 188 West Randolph Street, Chicago, Illinois.

TEST EQUIPMENT

Radio City Products Company, Inc. of New York now has available Bulletin No. 132 which has been designed to assist servicemen in selecting suitable test equipment.

Four of the company's test units are described and pictured in the bulletin; the Model 720 FM Signal Generator, the Serviceshop Model 8073, the new Servicette (Models 4410, 4420, and 4712), and the Modernization Unit for the Models 120 and 125 tube testers.

A copy of the bulletin will be forwarded upon request. Write to *Radio City Products Company, Inc.*, 152 West 25th Street, New York 1, New York.

MALLORY ENCYCLOPEDIA

P. R. Mallory & Co., Inc., have announced the 6th edition of the "Mallory Radio Service Encyclopedia." The encyclopedia includes detailed replacement information on volume and tone controls, capacitors, and vibrators, circuit information, service hints, installation notes, i.f. peaks, tube complements and number of plates, and in addition, shows a reference to *Rider's Manual*, volume and page number for each receiver.

This latest edition of the encyclopedia provides information on all pre-war and postwar receivers in one volume, containing 25% more listings than in the previous volume.

All Mallory distributors have this latest edition, at a net price of \$2.00

REPLACEMENT GUIDE

In time for this summer's portable radio season, *Burgess Battery Company* has announced the availability of their new "1948 Replacement Guide to Battery Operated Radios."

This guide contains up-to-the-minute replacement battery information, listing over 1600 sets made by 100 radio manufacturers along with the correct replacement battery for each set.

Free copies of the guide may be secured by writing *Burgess Battery Company*, Dept. RG, Freeport, Illinois.

TV AND FM ANTENNAS

A copy of the new *J.F.D.* catalogue covering the company's line of "Super-Beam" antennas for television and FM is now available for the asking.

Included in the catalogue are details on over 27 arrays ranging from Model No. TA100, a straight dipole, to Model No. TA118, a double-section, multi-dipole, all-channel array. The catalogue also describes and illustrates a wide as-

July, 1948

SELENIUM RECTIFIERS

And Specialized Electronic Components

FULL WAVE BRIDGE TYPES

Input 0-18VAC	Output 0-13*VDC	Type#	Current	Price
B1-250	250 MA.		8.98	
B1-500	500 MA.		1.95	
B1-1	1 AMP.		2.49	
B1-1X5	1.5 AMP.		2.95	
B1-3	3 AMP.		3.49	
B1-5	5 AMP.		3.95	
B1-7X5	7.5 AMP.		7.95	
B1-10	10 AMP.		9.95	
B1-15	15 AMP.		13.95	
B1-20	20 AMP.		15.95	
B1-25	25 AMP.		20.95	
B1-30	30 AMP.		24.95	
B1-40	40 AMP.		27.95	
B1-50	50 AMP.		32.95	
B1-60	60 AMP.		36.95	

Three Phase Bridge Types

Input 0-126VAC	Output 0-130*VDC	Type#	Current	Price
3B7-4	4 AMP.		\$32.95	
3B7-6	6 AMP.		48.90	
3B7-11	11 AMP.		65.00	

0-234VAC

Input 0-234VAC	Output 0-250*VDC	Type#	Current	Price
3B13-4	4 AMP.		\$56.00	
3B13-6	6 AMP.		81.50	
3B13-11	11 AMP.		110.00	

FULL WAVE BRIDGE TYPES

Input 0-54VAC	Output 0-40*VDC	Type#	Current	Price
B3-150	150 MA.		\$1.25	
B3-250	250 MA.		1.95	
B3-600	600 MA.		3.25	

0-72VAC

Input 0-72VAC	Output 0-54*VDC	Type#	Current	Price
B4-1X2	1.2 AMP.		\$7.95	
B4-3X5	3.5 AMP.		15.95	
B4-5	5 AMP.		17.95	

0-115VAC

Input 0-115VAC	Output 0-110*VDC	Type#	Current	Price
B6-150	150 MA.		\$1.95	
B6-250	250 MA.		2.95	
B6-400	400 MA.		4.95	
B6-600	600 MA.		5.95	
B6-800	800 MA.		7.95	
B6-1X2	1.2 AMP.		9.95	
B6-2	2 AMP.		12.95	
B6-3X5	3.5 AMP.		21.95	
B6-5	5 AMP.		24.95	
B6-7X5	7.5 AMP.		32.95	
B6-10	10 AMP.		36.95	

0-180*VAC

Input 0-180*VAC	Output 0-180*VDC	Type#	Current	Price
B13-4	4 AMP.		\$54.95	
B13-7X5	7.5 AMP.		63.95	
B13-10	10 AMP.		69.95	

FULL WAVE BRIDGE TYPES

Input 0-36VAC	Output 0-26*VDC	Type#	Current	Price
B2-150	150 MA.		\$1.98	
B2-220	220 MA.		1.25	
B2-300	300 MA.		1.50	
B2-450	450 MA.		2.25	
B2-600	600 MA.		2.95	
B2-1	1 AMP.		3.95	
B2-2	2 AMP.		4.95	
B2-3	3 AMP.		6.95	
B2-5	5 AMP.		9.95	
B2-6	6 AMP.		10.95	
B2-7X5	7.5 AMP.		13.95	
B2-10	10 AMP.		15.95	
B2-15	15 AMP.		24.95	
B2-20	20 AMP.		27.95	
B2-30	30 AMP.		36.95	

CENTER TAPPED TYPES

Input 12-12VAC	Output 0-8*VDC	Type#	Current	Price
C1-10	10 AMP.		\$7.95	
C1-20	20 AMP.		12.95	
C1-30	30 AMP.		17.95	
C1-40	40 AMP.		21.95	
C1-50	50 AMP.		25.95	
C1-80	80 AMP.		34.95	
C1-120	120 AMP.		46.95	

*SELECT PROPER CAPACITOR FROM LIST SHOWN BELOW, TO OBTAIN HIGHER D.C. VOLTAGES THAN INDICATED.

Rectifier Transformers

All Primaries 115VAC

50/60 Cycles

Type#	Secondary Volts	Amps.	Price
XF10-18	10	18	\$3.95
XF15-12	15	12	3.95
TXF36-2	36	2	2.95
TXF36-5	36	5	4.95
TXF36-10	36	10	7.95
TXF36-15	36	15	11.95
TXF36-20	36	20	17.95

All TXF Types are Tapped to Deliver 32, 34, 36 Volts.

RECTIFIER CHOKES

Type#	Inductance	Amps.	Price
HY2	.03 Hy	2	\$2.25
HY3	.03 Hy	3	2.95
HY5	.03 Hy	5	3.25
HY8X5	.02 Hy	8.5	7.95
HV10	.02 Hy	10	9.95
HV12	.125Hy	12	12.95
HV15	.015Hy	15	13.95

RECTIFIER CAPACITORS

Type#	Value	Voltage	Price
CF-1	1000 MFD	15VDC	\$.98
CF-2	2000 MFD	15VDC	1.69
CF-3	1000 MFD	25VDC	1.69
CF-4	2X3500 MFD	25VDC	3.45
CF-5	1500 MFD	30VDC	2.49
CF-6	4000 MFD	30VDC	3.25
CF-7	3000 MFD	35VDC	3.25
CF-8	100 MFD	50VDC	.98
CF-9	200 MFD	150VDC	1.69
CF-10	500 MFD	200VDC	3.25
CF-11	100 MFD	350VDC	2.25
CF-12	125 MFD	350VDC	2.49

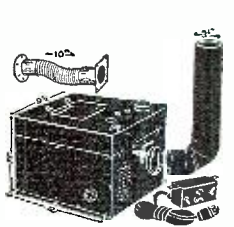

Motorola Heaters

Ideal for boats, aircraft, photo-dark-rooms, trailers, cabins, trucks, etc.

The GN-3-24A Heater is of the int. combustion type using gasoline as fuel. The unit operates on 24 volts and is thermo-controlled to use min. electrical power. Self-contained tank holds fuel for 6-7 hrs. of operation with heat output of 15,000

B.T.U. The blower, which supplies 125 cubic ft./min. of heated air, can be used as a cool air circulator during warmer weather. Supplied with remote control unit, flex. stainless steel exhaust, air duct elbow, and spare parts.

With instr. and maintenance manual.

Specially priced \$49.50

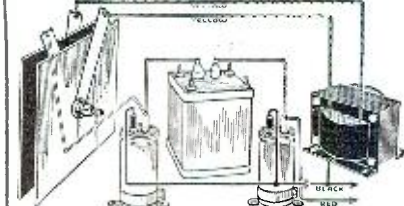

"A" ELIMINATOR KIT!

A well engineered six volt direct current power unit, for Auto-Radio and similar service work, has always been in the high priced range. Now, for the first time, we are presenting a fine quality unit, in kit form, embodying the essential components necessary to easily construct an "A" eliminator at a price that will meet with the approval of the most thrifty. We feel sure that this unit will fulfil a long-standing need of every serviceman and technician. This kit is designed to operate from a 115 V.A.C. 50/60 cycle source, and delivers 6 V.D.C., well filtered, at eight amperes, with a peak rating of ten amperes. Complete with pictorial diagram Price \$19.50

TO AVOID SHIPPING ERRORS, KINDLY ORDER BY TYPE # ALL PRICES SUBJECT TO CHANGE WITHOUT NOTICE

It would be impossible to give a complete listing of all our rectifier types. Our engineering staff is at your service to help you work out the application of selenium rectifiers to your specific problems. Minimum Order \$25.00. Deposit Required on All C.O.D. Shipments. No C.O.D. Orders Accepted Under \$25.00. Add 10% for Parcel Post.

OPAD-GREEN COMPANY

71 Warren St.

Dept. 2

New York 7, N. Y.

Phone: BEekman 3-7385

RADIO TUBES

at the lowest prices ever offered 70% OFF

at current list prices

(25% deposit required on C.O.D. orders)

HARRIS SUPPLY CO.

1336 Chase Ave. Chicago 26, Illinois

ELECTRICAL TRAINING

Intensive 32 weeks' residence course in fundamentals of industrial electrical engineering, including radio, electronics. Prepares for technician, engineering aides. Approved for veteran training. 5th year. Enter July 26, Nov. 22. Catalog.

BLISS ELECTRICAL SCHOOL
7698 Takoma Avenue,
Washington 12, D. C.

SURPLUS SAVINGS!

Brand New! In Original Cartons!

LP21-A RFE LOOP for SCR 269G. and other compass sets. Low impedance loop, good for direction finder; 1-Sclyn motor, 1-Sclyn transmitter; frequency range of loop, 200 KC to 1750 KC, streamlined, tear-drop design. Postpaid anywhere in U. S.\$6.95 ea.
J37 HAND KEY—ruggedly built 1/4" silver contacts. Bakelite base. Brand new in original cartons, postpaid in U. S. ea.\$5.00
9-Inch CATHODE RAY TUBE — 91P1/1809/P1 RCA, brand new, original cartons, postpaid anywhere in U. S. only.\$2.95

Send Check or Money Order—No C.O.D.

E. M. JOHNSON COMPANY

Distributors, Radio Electronic Products
W. 615 First Ave. Spokane 8, Wash.
(Reference, Wash. Trust Bank)

for QUALITY of Reproduction . . .

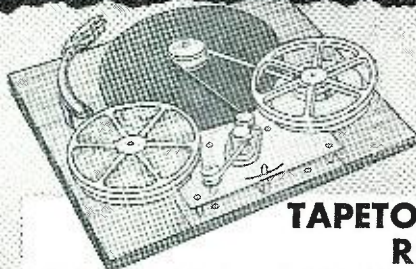

tapetone
is TOPS!

TAPETONE MAGNETIC TAPE RECORDING KIT

For Homes, Schools, Studios . . . Set Builders, Hams, Radio Engineers are all enthusiastic about the newly developed TAPETONE Magnetic Tape Recorder. • Records voice and music on tape. • Plays up to 12" platter records and reproduces from the records on to the tape. • Records radio reception on tape. Tape can be played back and re-recorded hundreds of times.

THE RECORDING-PLAYBACK MECHANISM

(Illustrated above) comprises heavy duty General Industries motor mounted on rubber, and 10" 3 lb. turntable. Complete tape drive mechanism of exclusive TAPETONE design. Precision tooled with bronze bearings throughout for marvelously smooth quiet operation. Lever has Record-Play, Neutral, and rewind positions. Crystal pickup with permanent stylus. Separate Record-Play and Erase Heads, plug-in type TAPETONE exclusive design. Recording magnetic paper tape is simple to thread and can be edited more easily than home movie film. TAPETONE MAGNETIC TAPE RECORDING MECHANISM, NOW AVAILABLE SEPARATELY, includes; Recording-Playback mechanism illustrated and described above, for 115 Volt 60 cycle AC only; completely assembled plus mounting board; Amplifier wiring diagram; one 1/2 hour roll (1225 ft.) of new SCOTCH HIGH FIDELITY MAGNETIC RECORDING TAPE. Shpg. Wt. 22 lbs.

Your net cost **\$62.50**

THE EQUALIZED AMPLIFIER

This specially-designed 6-tube recording and playback amplifier is equipped with exciter circuit for operation with mechanism above. Has high impedance microphone and phono-radio inputs with separate gain controls, permits mixing. Output connects to 4 or 8 ohm speaker voice coil. Supplied in kit form, with all components, tubes, drilled chassis, wire connectors, plugs, cables, nothing else needed — no special knowledge required to construct it. For 115 Volt 60 cycle AC only.



COMPLETE TAPETONE MAGNETIC TAPE RECORDING KIT

Includes Recording-Playback Mechanism and Amplifier Kit described above, plus one 1/2 hour roll (1225 ft.) of new SCOTCH HIGH FIDELITY MAGNETIC RECORDING TAPE. Shpg. wt. 30 lbs. Express collect.

\$98.50

Your net cost, Complete Please include 20% deposit with C.O.D. Orders
OPTIONAL ACCESSORIES: Crystal Desk Mike with removable base and 7-ft. cable . . . List \$12.20. 8-inch Heavy Duty PM Speaker . . . List \$8.85. Additional 1/2 hour rolls Scotch Recording Tape, per roll. \$3.06 (Plus 1% postage when ordered separately)

TAPETONE MFG. CORP.

37-06 36th St. Long Island City 1, N.Y.
Phone: 5711well 4-8380

SAVE AT R. P. D.

G. E. Pyronol Capacitors 2B47 - 2 mfd 4000 Volt DC . . . Each \$4.79; 5 for \$22.50
G. E. type 2B435 Dual .15-.15 mfd 6000 Volt DC . . . Each \$5.35; 5 for \$23.00
G. E. 1 - 7500 Volt DC . . . Each \$4.79
4-4-4 Mfd 600-1000-2000 Volt. . . Each \$2.39

HEINEMANN CIRCUIT BREAKERS

Type 0322 8-25 amperes - Curve D 230 Volts . . . Each \$1.85; 3 for \$5.25

JEFFERSON ELECT. SEALED FILTER CHOKE

40 Ma-20 Henry, Size 2 x 2 1/2 x 2 1/4 . . . Each 79c

SLIDE SWITCHES DPDT

Each 18c. Lots of 100 \$15.00.

Tobe Oilmite (RaL-300) 5-5 mfd 400 Volt D.C. . . . Each 79c; 5 for \$3.75

Micamold Paper Molded Condenser .01-600 Volt . . . 50 for \$2.00; 100 for \$3.50

Solar .1 mfd 400 volt paper cond. . . . Each 12c; 100 for \$10.00

Spaghetti tubing 25 foot lengths White Rubber 1/4" inside diam. . . . per roll 25c; 5 for \$1.00

FRACTIONAL MOTORS

Compound Wound 115 V DC Input 3/16 H.P. 3450 R.P.M. Oil Impregnated Ball Bearings . . . Each \$3.69; 4 to case \$14.00

110 Volt Female Receptacles with mtg plate (2 pole universal) Mounting 1 3/32 Hole . . . 10 for \$1.00

2 Prong AC Cap Small (Hard Baked Rubber) to fit receptacles . . . 10 for 85c; 100 for \$7.00

2 Prong (Alden 449) Miniature Metal Seal Socket Mounts in 1/2" Dia. Hole Center dist. of holes 1 1/2" . . . 10 for \$1.00

2 Prong Plugs to fit Socket (Alden 122P) . . . 10 for 50c

Porcelain Cleat Receptacles No. 50715 Med Base . . . Each 15c; 10 for \$1.25

5-Watt 1000 ohm adj W. W. Power res. . . . Each 69c; 10 for \$6.00

Jeff. Elect. Dual Filter Choke 9.5-9.5 Henry 60 ma size 6 x 3 x 2 1/4" . . . Each \$1.39

Fluted Black 1 1/2" transm-knobs (Metal Insert) . . . Each 12c; 10 for \$1.00

FREE! Write for R.P.D.'s latest bulletin.

Terms: Remittance with order PLUS POSTAGE or 25% deposit. Balance C.O.D.

RADIO PARTS DISTRIBUTORS

925 E. 55th St., Chicago 15, Ill.
Butterfield 1611-12

SURPLUS TRANSMITTERS

B.C. 459-7—9.1 mc (new) . . . \$9.95

ARC/5-7—9.1 mc (40m) . . . \$6.95

ARC/5-4—5.3 mc (80m) . . . \$5.95

Special both ARC/5's for . . . \$10.95

RECEIVERS

B.C. 454-3—6 mc (new) . . . \$6.95

MODULATOR UNITS

B.C. 456 (274N series) . . . \$3.95

ARC/5 (push-pull plate mod.) . . . \$7.95

FL8 Audio Filters Nat. Adv. . . . \$1.39

OIL FILLED CONDENSERS

2 ufd-4000V . . . \$4.95

3 ufd-4000V . . . \$5.95

2 ufd-5000V . . . \$6.95

TUBES

810 triode . . . \$5.95

860 tetrode . . . \$4.95

861 tetrode . . . \$9.95

872 rectifier . . . \$1.19

TRANSFORMERS

12/24V 2 amp. filament (115V Pri) . . . \$2.95

5V @ 3 amp, 5V @ 6 amp, 33V @ .15 amp (115V Pri) . . . \$2.95

Modulation. Push pull 807 to modulate two 807's parallel . . . \$4.49

Prices subject to change without notice.

ESEGE SALES CO. LTD.

Distributors of

Surplus Radio and Electronic Parts

1306 BOND STREET

LOS ANGELES 15 • CALIFORNIA

sortment of television and FM antenna accessories, brackets, and wire in addition to a line of antenna conversion kits.

The catalogue is available from J.F.D. Manufacturing Co., Inc., 4117 Fort Hamilton Parkway, Brooklyn 19, New York upon request.

"LEARECORDER"

Lear Incorporated has just released a four-page data sheet containing full information on the "Learecorder."

The data sheet points out several of the instrument's outstanding and exclusive advantages in addition to providing application data on its use.

A copy of this flyer is available upon request. Write to Lear Incorporated, Home Radio Division, Grand Rapids 2, Michigan.

ALTEC BOOKLET

Of special interest to persons concerned with providing loudspeaker systems for use with 16 mm. films, the Altec Lansing Corporation has reprinted a paper, "Portable and Semi-portable Loudspeaker Systems for Reproducing 16 mm. Sound on Film" in booklet form.

The paper, originally presented by John K. Hilliard, Chief Engineer of the company, before the Society of Motion Picture Engineers, details Altec equipment designed for this purpose.

Copies of the booklet are available from Altec Lansing Corporation, 250 West 57th Street, New York 19, New York or from the company's West Coast office at 1161 North Vine Street, Hollywood 38, California.

CONCORD SUPPLEMENT

Concord Radio Corporation's new 1948 "Spring Supplement" has just been released for the trade.

Included in this 48-page catalogue are receivers, radio-phono combinations, amplifiers and p.a. systems, intercoms, microphones and accessories, radio components for the amateur and the serviceman, tubes, test equipment, tools and accessories, tuners and antennas, ham receivers, etc.

A copy of the "Spring Supplement" may be secured by writing to Concord Radio Corporation, 901-11 West Jackson Boulevard, Chicago 7, Illinois.

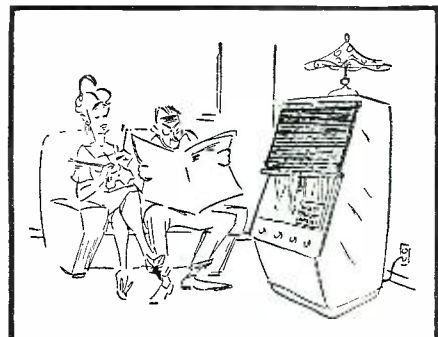

Shutter Speed Meter

(Continued from page 59)

various shutter speeds to be tested are obtained by switching the resistors R_{11} through R_{21} . These resistors may be mounted directly on a wafer-type band-switch. They have been chosen so as to compensate for the internal resistance of the detector at the high speeds and the effect of the overdamping circuit (R_{23} and C_3) at low speeds. The shutter speeds obtained with these resistors are, respectively: 1, 1/2, 1/5, 1/10, 1/25, 1/50, 1/100, 1/200, 1/300, 1/500, and 1/1000 of a second. Intermediate speeds can be estimated by interpolation of meter readings; for instance, the time interval of 1/400 second is 75% of the interval of 1/300 second, and 125% of the time interval of 1/500 second.

Using the remaining section of the 6SN7 as a half-wave rectifier, the shutter meter is operated directly from the 115-volt a.c. line. A small 6.3-volt filament transformer is used to supply the heater drain of 1.2 amperes. If desired, however, the meter can be battery operated, since the "B" supply drain is only three milliamperes. If it is more convenient to use a one milliampere meter rather than the one-half milliampere meter, the values of resistors R_7 , R_8 , R_9 , R_{10} , and R_{22} must be cut in half, and the total current drain will then be about five milliamperes. It might be mentioned that in either case, the milliammeter is protected from damage by the limiting level referred to previously.

Calibration and Operation

The calibration of the phototube depends on certain voltages and elements in the circuit, and so an initial adjustment must be made to insure working accuracy. The most satisfactory way is to operate the shutter speed meter in the usual manner, measuring the shutter times of several good shutters on the one-second speed. Most shutters are fairly reliable on the one-second speed and, as a matter of fact, any wide differences can be heard as the shutter trips, or can even be seen by looking through the shutter on this slow speed. The average of several good shutters should furnish a sufficiently good degree of calibration, unless some really precise timing device is available.

To calibrate the shutter speed meter initially, allow the circuit to warm up and adjust R_8 for zero reading of the milliammeter with no direct light on the phototube. Let us establish 0.8 of full scale as the designated value for the correct shutter interval reading. Now set up the light source (100 watt

July, 1948



NOW! BUILD 15 RADIOS \$14⁷⁵

COMPLETE KIT ONLY...

ABSOLUTELY NO KNOWLEDGE OF RADIO NECESSARY YOU NEED NO ADDITIONAL PARTS!

THE PROGRESSIVE RADIO KIT is the ONLY COMPLETE KIT

Operates on 110-120 volts AC/DC. Contains everything you need. Instruction Book, Metal Chassis, Tubes, Condensers, Resistors and all other necessary radio parts. The 36-page Instruction Book written by expert radio instructors and engineers teaches you to build radios in a professional manner. The first circuit built is a simple one-tube detector receiver. Each succeeding circuit incorporates new arrangements of detectors, RF and AF amplifiers. This kit is excellent for learning the principles of receiver, transmitter and amplifier design. It is used in many radio schools and colleges. All of the commonly-used detectors are used, including diode, grid leak, plate and infinite-impedance. The transmitters are designed with Hartley and Armstrong oscillators, using screen-grid and control-grid modulation. Both vacuum tube and selenium rectification are employed in these circuits. The circuits are designed to provide excellent performance. Altogether, fifteen circuits are constructed, including 11 receivers, 1 audio amplifier, fifteen circuits are designed to provide excellent performance. Altogether, fifteen circuits are constructed, including 11 receivers, 1 audio amplifier, and 3 transmitters. The sets start with simple circuits of 1 tube plus rectifier, gradually grow more complex, and finish with several examples of radio sets using three tubes plus rectifier.

PROGRESSIVE RADIO KIT . . . ONLY \$14.75

SPECIAL FREE OFFER

Electrical and Radio Tester sent absolutely FREE with each Progressive Radio Kit. PLUS FREE membership in Progressive Radio Club. Entitles you to free expert advice and consultation service with licensed radio technicians. Write for further information or ORDER your KIT NOW!

PROGRESSIVE SCOOPS!

FM COIL & CONDENSER KIT

Designed for operation on 88-108 MC (new band), contains 2 IF transformers, 1 Limiter Transformer, 1 Discriminator Transformer, 1 RF coil, 1 Variable condenser, Schematic and wiring instructions. Excellent for schools, experimenters and Radio Hobbyists. **\$4.95**

Price only

CONDENSER KIT

50 Paper Tubular Condensers. Values from .002 mfd to .1 mfd. 400 V. DC to 600 V. DC. **Only \$1.95**

RESISTOR KIT

100 Carbon Resistors, 1/2 Watt., RMA color-coded. Values from 120 ohms to 2.2 megohms **\$1.50**

10-10 MFD. 450 W.V. DC Electrolytic Condensers 65c

20-20 MFD. 150 W.V. DC Electrolytic Condensers 30c

40-40 MFD. 150 W.V. DC Electrolytic Condensers 45c

Antenna and RF Coil Set (Broadcast Band) 59c

6" Alnico Slug Speaker \$1.69

Selenium Rectifiers 79c

Midget Soldering Iron 35 Watts 110/120 volts UL approved 69c

55 Watt Soldering Iron UL approved \$1.90

75 Watt Soldering Iron UL approved \$2.40

Long Nose Pliers and Cutters \$1.45

PROGRESSIVE AMPLIFIER KIT \$15⁷⁵

HIGH FIDELITY, HUMLESS, AMPLIFIER. SEVEN TUBE PERFORMANCE.

This newest Progressive Kit will enable you to build a newly-designed, high fidelity, humless amplifier. Beautiful aluminum custom-punched chassis. Rich tone and volume control plates. Designed by former Western Electric engineer. Total amplifier for television kit or set, FM tuner, AM tuner, microphone. Electrify your musical instruments by connecting them to the Progressive Amplifier by means of a contact mike. Amplifier can be readily modified to match the GE reluctance pick-up. Separate mike and phono input. Regulated power supply maintains constant voltage supply. DC heater supply, which amplifier is used on AC or DC provides humless operation by eliminating cathode-heater leakage hum. Contains degenerative feedback for improved frequency response, balanced phase inversion and push-pull beam power output. Every stage thoroughly decoupled to improve low-frequency response and to prevent motor-boating. Tone and volume controls completely variable. Seven-tube performance. Uses 2 selenium rectifiers, 2 beam power amplifiers, 1 high- μ pentode mike amplifier, 1 twin-triode phase inverter, and 1 voltage regulator tube. **Progressive AMPLIFIER KIT (less Tubes and Speaker) only \$15.75**

TUBES for Progressive Amplifier Kit 1-12SL7, 1-12SJ7, 1-VR75, 2-12A6's. Complete Set **Only \$3.00**

BUILD A 5 TUBE AMPLIFIER—ONLY \$5.95

Ideal for phonograph, FM tuner or microphone. Has 5 tubes including rectifier. Kit is complete with tubes, chassis, volume control, tone control, radio parts, hook-up wire, solder and instructions. We can provide a 3-inch FM speaker with mounted output transformer to fit on chassis, priced at \$1.95. Or use this kit with your own speaker. It has 5 watts output, more than enough to drive a 12-inch speaker. **Only \$5.95**

ESPEY CUSTOM-BUILT AM-FM HIGH FIDELITY RECEIVERS—Model No. 7-BC

<ol style="list-style-type: none"> 1. AC Superhet AM-FM receiver. 2. Frequency Modulation Circuit. 3. 11 finest quality tubes, including rectifier. 4. 4 dual purpose tubes give 15 tube performance. 5. Automatic volume control. 6. Full-range volume control. <p style="text-align: center;">Your Price \$84.00</p>	<ol style="list-style-type: none"> 7. High Fidelity AM-FM reception. 8. Full-range combination bass-treble tone control. 9. 13 watt (maximum) Push-Pull Audio Output. 10. 10 inch PM speaker with Alnico V magnet. 11. Indirectly illuminated "slide-rule" dial. 12. Loop antenna for AM and Folded Dipole antenna for FM reception supplied. 13. Provisions for external antennas. 14. Wired for phonograph operation. 15. Licensed under RCA and Hazeltine patents. 16. RMA listed. <p style="text-align: center;">\$25.00 deposit required with C.O.D. orders</p>
---	---

WRITE FOR PROGRESSIVE ELECTRONICS CO., Dept. RN-11
PRECISE QUANTITIES PRICES 497 UNION AVE. • BROOKLYN 11, NEW YORK

We pay Postage on Prepaid Orders. All C.O.D. Orders Shipped Collect.

HOW TO GET THE MOST

from only

\$

BASIC TEST EQUIPMENT

Servicing by Signal Substitution

The Simple, Modern, Dynamic Speed approach to receiver alignment and adjustment problems, FM-AM-TV.

- Nothing complex to learn
- No extra equipment to purchase
- Universal — non-obsolete
- Employs only Basic Test Equipment



S-S-S tells NOW — in simple, direct language.

New 9th edition now off the press. 100 pages of valuable information.

Available from all leading radio parts and equipment distributors or directly from factory at only 40c per copy.

PRECISION APPARATUS COMPANY, Inc. • 92-27 Horace Harding Blvd., Elmhurst 9, N. Y.

ARE YOU CONFUSED?

LET US SET YOU STRAIGHT

Cross-reference tube list—Army VT Numbers to commercial types. Price50c
Schematic diagrams for SCR274N; ART-13; BC375; BC221B, J, O, or R; BC348; SCR289G (BC433G radio compass); SC652; BC721 Handi-Talkie; R19A /ARC-1; T14A/ARC-1; RT/ARC-1; ARC-1; RA34; BC611 Handi-Talkie; BC-312N or NX; BC342N; BC-314G; BC344D; BC659; BC603; BC604; BC683; BC-684; Super-Pro, Army types BC779, BC791, BC1004; RT-19/ARC-4; BC653;4 for \$3.00
Each\$1.00

CRYSTALS, fit FT-243 holder or octal socket; any freq. 5675 to 8650 kc (except 7025 & 7050) in steps of 25 Kc; 6 for \$5; each.....\$1.00
COMPLETE SET of 120 xtals covering 5675 to 8650 kc in metal cabinet.....35.00
ALSO: 3010, 3465, 3525, 3735, 3825, 3980, 3995, 5300, 5500 or 6335 kc, choice.....1.00
CRYSTAL STANDARDS: 400kc, 450kc or 455.5kc.....1.95
500.000kc.....2.50
Get our free list for other freqs. Priced at......49

BAND SWITCHES; S.P. 5 pos. 1-gang...5 for \$1.85
S.P. 12-pos. 4-gang.....1.25

HERE'S YOUR 2-METER RIG AND RECEIVER!!

RT-19/ARC-4, 140 to 144 mc; 4 xtal controlled channels. Super-het receiver has 13 tubes, xmitter has 7 tubes including 4 6L6's, 832A final. With all tubes, xtals, shock mount, dynamotor, control box, diagram, orig. crates,
BRAND NEW\$19.95

RF METER, 0-1 amps with couple in 2" case.
NEW\$2.95

TRANSFORMER BARGAINS

B. 4v @ 16a. 2.5v. @ 1.75a\$1.88
D. Power, 315 VDC 85 ma; 5v 3a, 6.3v 2.1a No. 1159\$2.15
E. Power, 250 VDC 150 ma., 5v 3a, 6.3 5a. No. 1188 similar to "D".....\$2.65
CHOKE, 5h 225 ma 112 ohms GE, slick.....\$1.95

PRECISION METER

0 to 10 amps DC W'house PX-14 mirror scale\$10.95

VARIABLE MIDGET

215 mmf double-bearing in shield can 1 1/4" dia. micarta shaft, as used in BC-312, BC-342, etc. \$1.25

POTENTIOMETER

500 ohm lin. WW, 3/4" shaft, 10 for.....\$2.00

WRITE FOR FREE LIST

Postage extra. Minimum order \$2.00
TERMS: Net Cash, 25% deposit on C.O.D.'s

ELECTRONIC SUPPLIES

Stores in Tulsa, Okla. and Oakland, Calif.
317-R East 2nd St. Tulsa 3, Oklahoma

bulb) about six inches from the phototube window with the shutter between. This will be sufficient to insure ample light if the light beam through the shutter is accurately lined-up to fall on the phototube. This minimum intensity of light can be checked by placing a *Weston* exposure meter in the position of the phototube. The minimum intensity of light for satisfactory operation is shown by a reading of 25 (candles per sq. ft.) on the meter, as read through the shutter. Of course, it is desirable to open the shutter aperture to its widest position if any difficulty is encountered in obtaining this minimum intensity of light. The shutter speed meter is operated in the usual manner; the shutter is placed between the light bulb and the phototube window, the shutter is tripped, and the peak meter reading is noted. Now adjust R_{22} until the meter needle reads the designated value of 0.8 of full scale for the shutter time of one second. The selecting switch for shutter speed should, of course, be set at "one second." The controls R_5 and R_{22} are screwdriver adjustments.

When calibrated at one second, the higher speeds are automatically correct. A red line can be marked on the milliammeter at 0.8 of full scale to indicate the proper shutter interval. Limits of minus and plus 25% of the correct time interval can also be red-lined on the scale at 0.6 and 1.0 of full scale, if desired.

When using the shutter speed meter it is desirable that the shutter aperture be open to its widest position, and it is necessary to carefully align the light source and the lens so that all the light traveling through the lens will enter the window to finally fall on the phototube plate. The distance between a 100-watt light source and the phototube should be approximately 6 inches. Another point which must be remembered is that the phototube must be shielded from stray light, if it is appreciable, but usually there is not enough stray light to give any trouble.

Probably one of the first reactions in using the shutter speed meter will be amazement at how far off some shutters actually become. A plot of the values of the actual shutter time interval versus the desired shutter time interval for two cameras is shown in Fig. 2. The dotted curve, an average shutter, shows the degree to which an ordinary shutter may be inaccurate, while the solid curve, on a superior type, shows that even expensive shutters are sometimes subject to discrepancies.

The shutter speed meter has been used with good success by the writer and several of his friends interested in photography. The original calibration of the meter was done point by point with a larger, more intricate and pre-

cise instrument. The accuracy of the shutter speed meter is independent of the exact amount of light which is used (if it is above the minimum value already specified) and it is more than sufficient for all normal photographic use.

The shutter speed meter will find repeated chances for use in any camera shop or club, and many of the features and principles mentioned have other applications to a wide field of electronic devices.

—50—

Compact V.T.V.M.

(Continued from page 40)

promise value when the instrument is to be operated over a wide range including both audio and radio frequencies.

No zero adjustment is required. Elimination of this control is a distinct advantage, since one manual operation thus is removed from the voltage measuring procedure. Any deflection of the meter due to contact potential of the diode is not discernible on the microammeter scale.

Voltage Range

Basically, the circuit is a peak-reading voltmeter. However, an r.m.s. calibration may be made (See Fig. 4), provided the operator remembers that the r.m.s. values hold only for sine-wave signal voltages. Peak voltage values may be obtained by multiplying the r.m.s. voltages by 1.414.

The author has provided a single voltage range, 0-100 volts r.m.s. This has proved to be a widely useful range. Each meter division of the *Weston* Model 301 0-200 d. c. microammeter is 2 1/2 volts. Maximum input voltage which may be handled by the 1A3 tube is 117 volts r.m.s. (165.4 volts peak).

Lower voltage ranges may be provided by reducing the value of calibra-

Fig. 3. Calibration curve for the diode v.t. voltmeter. Peak values for a sine wave may be obtained by multiplying the r.m.s. value by 1.414.

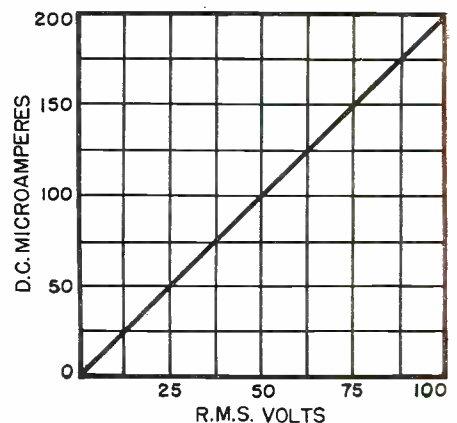

R.M.S. VOLTS

RADIO NEWS

RADIOMEN! ELECTRICIANS!

Get this Valuable Book

FREE for Merely Examining
Coyne's NEW Pay-Raising
5 VOLUME APPLIED PRACTICAL RADIO SET

Here's a PRACTICAL set of radio books just off the press! Gives you "know how" on everything in Radio today. Basic principles to newest in Television and F.M.—how to construct, install, service. Latest trouble-shooting methods. 1000 illustrations, over 1500 pages. Ideal for reference or home training. To prove how valuable these great books can be to you, Coyne will give you a FREE copy of our new, helpful "150 New Radio Diagrams Explained" for looking over the 5 Vol. Set. OFFER LIMITED—ACT NOW! We will send you 5 vol. set APPLIED PRACTICAL RADIO for 7 days FREE examination, together with Radio Diagrams. Look set over for 7 days. If you like it send \$15 cash, or \$3 after 7 days and \$3 monthly until \$16.75 is paid. If you don't want the set, return it and you owe NOTHING. Either way you keep Diagrams Book Free. SEND NO MONEY! Coupon asks to see books free and get your gift book for doing it! Send coupon NOW!

FREE BOOK COUPON
Educational Book Publishing Division
COYNE ELECTRICAL & RADIO SCHOOL, Dept. B8-T3
500 South Paulina St., Chicago 12, Illinois
OK. Send me, postpaid, Coyne's new 5 volume set, "APPLIED PRACTICAL RADIO" for 7 Days FREE TRIAL per your offer. Also send, absolutely FREE, "150 New Radio Diagrams Explained" as a gift.
NAME.....AGE.....
ADDRESS.....
TOWN.....ZONE.....STATE.....

tion rheostat R (approximately 500,000 ohms for the 100-volt range). As this resistance is reduced, however, contact potential effects become more pronounced and a zero adjustment may be required for bucking out the initial no-signal current. It is not advisable to increase the voltage range much above 110 volts by increasing the size of resistance R , since the 1A3 characteristics will be exceeded after passing 117 v. Instead, for higher voltages, a capacitive-type input voltage divider should be used ahead of the instrument.

Reducing the resistance of R exactly to half the value indicated for 100 volts will not provide a full-scale deflection of 50 volts. Nor will a 25 percent reduction of resistance give a 0-25-volt range. This is because the rectification efficiency of the diode (d. c. output voltage vs. a. c. input voltage) decreases as the load resistance is lowered. The correct value of the load (calibration) resistor required for a desired low-voltage range must be determined experimentally by adjustment of rheostat R , since rectification efficiency is not a constant but varies from tube to tube of the same type.

The calibration curve, Fig. 3, reveals the excellent linearity of the instrument. This feature permits the operator, if he so desires, to calibrate only one point on the meter scale against an accurately-known a. c. voltage. When the 0-100-volt range is employed, it is necessary only to divide the 0-200 microammeter readings mentally by 2 to obtain the corresponding voltages.

Construction

The diode v. t. voltmeter is built into a standard, metal, sloping-front meter case, 4½" high 4¼" wide, and 4¼" deep (at the base). This construction is clearly shown in the photographs of Fig. 1.

The "On-Off" toggle switch, S_1 , is mounted directly under the meter (See Fig. 1), and the ceramic-insulated input terminals pass through clearance holes in the top of the case. The tube socket is mounted on the ends of two ¾-inch-long 6-32 screws which pass through one side of the case (See Fig. 1). The flashlight cell is held by a thin brass strap to the opposite side. The shaft of the calibration control rheostat, R , is sawed off and provided with a slot for screwdriver adjustment, and this component is also mounted on one side of the instrument case.

To provide short, direct leads, the parallel-grouped condenser, C , is connected by means of its own pigtailed directly between one input terminal and the No. 2 or No. 6 terminal of the tube socket. All other connections are made with solid, insulated hookup wire. Leads are soldered directly to the flashlight

July, 1948

Now! BE THE FIRST TO OFFER Custom-Built TELEVISION

TELEVISION
ASSEMBLY CO.

TO THE CUSTOMERS IN YOUR COMMUNITY

51 SQ. IN.



75 SQ. IN.



120 sq in



Yes, you can be the first in your community to offer custom-built television. Simply wire and install a Television Assembly, Champion or Standard model, of the picture size desired by your customer. You can supply the individual requirements of the most fastidious television customer.

NO INVENTORY — NO TIE-INS

Order from your local National Parts Distributor. He can supply you with 10", 12" or 15" Champion or Standard Model Television Assemblies. It is not necessary to purchase anything but the model you need. Wire one, install it, order another.

CHECK THESE EXCLUSIVE FEATURES

30 Tubes • 12" High Fidelity Speaker • Di-Pole Antenna
4.5 MC Band Width • Pre-Wired Tuned IF (Pat. Pend.)

Both Champion and Standard Models are supplied with 13 tube Picture IF and Sound IF (Pat. Pend.) completely wired, tested, aligned, and tubed, mounted on a separate chassis ready for use. Champion models are supplied with the Dumont Inputuner giving continuous tuning for all 13 channels plus FM Radio. Standard Models are supplied with a standard tuner which will handle 13 channels, completely wired ready for use with above unit. All Television Assemblies are complete with all components, schematics, and pictorial diagrams supplied.

SEE YOUR LOCAL NATIONAL PARTS DISTRIBUTOR

TELEVISION
ASSEMBLY CO.

ONLY THE FINEST STANDARD BRAND
COMPONENTS USED THROUGHOUT

540 BUSHWICK AVENUE
BROOKLYN 6, NEW YORK

Police CALL FANS

HERE
IT IS

TUNES 152-162 MEGACYCLES

6 Tube (miniatures) True F.M. Superhetrodyne including rectifier. 115 Volts, A.C.-D.C. 3 Inch speaker. Clear vision dial. 9½ x 6¼ x 5¼ deep, walnut veneer cabinet. Shipping weight 5½ lbs. Highest quality components. Schematic inside back cover. 2 stages high gain 10.7 Megacycle I.F.s. High Selectivity. Discriminator Detector. Guaranteed reception from your local F.M. Transmitters with attached antenna, from cabs, police and others. Ready to plug in and use.

\$39⁹⁵

Excise Tax Included F.O.B. Indianapolis \$10.00 Cash With Order Rest C.O.D.

RAC

POLICALARM
RECEIVER

RADIO APPARATUS CO.
729 NORTH BANCROFT ST.
INDIANAPOLIS (1), INDIANA

SOME CHOICE DEALERSHIPS
STILL AVAILABLE — BE FIRST — WRITE

QUAM *Adjust-a-Cone* SPEAKERS

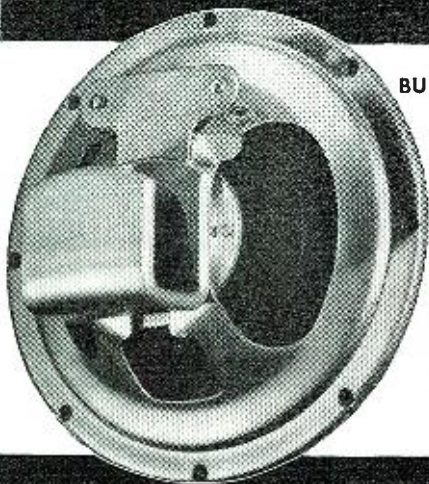

BUILDERS OF FINE SPEAKERS SINCE 1923



Electro Dynamic and P. M. Speakers in the following sizes: 3 1/2", 4", 4"x6", 5", 5 1/4", 6 1/2", 6"x9", 7", 8", 10" and 12".

Write for Catalog...

QUAM-NICHOLS COMPANY, 522 East 33rd Place, Chicago 16, Ill.

cell, since this jumbo-sized unit does not require frequent replacement.

Calibration

Initial calibration of the instrument is very simple. The following step-by-step procedure is recommended:

1. Switch-on instrument and allow about 5 minutes for tube warm-up.
2. Set rheostat *R* to maximum resistance position.
3. Apply accurately-known a. c. voltage to input terminals of instrument. Meter should read up-scale.
4. Adjust *R* to bring meter pointer to proper scale graduation corresponding to applied a. c. voltage. Refer to calibration curve of Fig. 3 to determine proper meter reading—for example; 25 v. should give 50-microampere deflection; 75 v., 150 microampere; 100 v., 200 microampere, etc. Best accuracy will be obtained when applied a. c. voltage is 50 or higher (r.m.s.), since upper half of microammeter scale then will be used.

5. Ordinarily, only one voltage point need be calibrated, as in Step 4. However; to verify linear operation of instrument, apply a number of other accurately-known a. c. voltages to input terminals and check corresponding meter deflections. Compare with curve of Fig. 3.

6. Inspect calibration occasionally during life of tube, readjusting rheostat *R* to correct for aging of tube and components.

An outstanding advantage of the linear diode v. t. voltmeter is the simplicity of operation it affords. Except for switching the instrument on before using, its operation is no different from that of an ordinary a. c. voltmeter. The following steps corroborate the author's claims for simplicity:

1. Switch-on instrument and allow about 2 minutes for tube warm-up.
2. Connect input terminals to unknown voltage source.
3. Read voltage from microammeter deflection.
4. When checking r. f. voltages, always use shortest possible leads between voltage source and input terminals of instrument.
5. To conserve dry cell, always switch-off instrument as soon as measurements are completed.

-30-

APCO CONFERENCE

THE Associated Police Communication Officers, Inc. have invited all mobile communication men to attend the National Convention the organization is holding September 20, 21, 22, and 23 in Houston.

Reservations should be made with Paul Franklin, APCO Conference chairman and Radio Supervisor of Houston police.

-30-

RADIO NEWS

AMSCO SERVICE KIT

- Kit includes assortment of:
- | | |
|--|---|
| 1 pr. head-phones or lip mike. | 10 Wire Wound Resistors, 10 & 25 watt. |
| 100 Resistors, 1/2 and 1-watt. | 25 Connectors, Plugs, Ties |
| 100 Condensers, paper, mica, electrolytic & can. | 10 Jacks (Phone) & Tip |
| 10 Switches, Toggle, Gang & Rotary. | 12 Padder Condensers |
| 100 ft. Spaghetti, various sizes. | 12 Terminal Boards. |
| 12 Knobs, round and bar. | 25 Ceramic Insulators. |
| 2 lbs. Hookup wire. | 2 Panel Lights (1.neon). |
| 20 Fuses. | 1 Screw Driver |
| 6 Volume Controls. | 1 Tube Puller |
| 10 Tube Sockets. | 2 Allen Wrenches. |
| 1 lb. Hardware (screws, nuts, lugs, etc.) | 2 Panel Fuse Holders. |
| | 4 Binding Post Strips, and many other valuable items. |

Bought individually would cost \$80.00—Now! Yours for only **\$9.95** complete

Available 1948 CATALOG Write Today

AMERICAN SALES CO.

1811 W. 47th St. Chicago 9, Ill.

GREYLOCK

A Dependable Name in RADIO TUBES

GT, Glass, and Miniature Types
ALL TUBES IN INDIVIDUAL CARTONS

12SA7, 12SK7, 12SQ7, 50L6, 12AT6,	
12BA6, 12BE6, 35W4, 50B5, each	39c
1R5, 1S5, 1T4, 3S4, 3Q4, 6AK5, 6AC5,	
6AQ5, 6BE6, 6BA6, 6AU6, 6BJ6,	
6X4, 117Z3, each	49c
32L7, 70L7, 117L7, each	59c

All Tubes Carry RMA 90-Day Guarantee

PM SPEAKERS

4" Alnico No. 5, each	\$1.19
5" Alnico No. 5, each	1.29

TERMS: Net C.O.D. No order accepted for less than \$5.00

Write for Bargain Catalog N-7

GREYLOCK ELECTRONIC SUPPLY CO.
30 Church Street New York 7, N. Y.



RADIO INSTITUTE

Outstanding PRE-WAR Technical

Training Center for

TELEVISION & RADIO

Under the personal direction of Frank Melville, former Airlines, Merchant Marine, and Broadcast technician, you may soon qualify as:

- RADIO TECHNICIAN
- AIRLINES RADIO OFFICER
- PT. TO PT. TELEGRAPHER
- RADIO AMATEUR
- MERCHANT-MARINE RADIO OFFICER
- TELEVISION TECHNICIAN
- HOME RECEIVER REPAIRMAN
- VISUAL TELEGRAPH OPR. (SLIP TAPE)

MELVILLE RADIO INSTITUTE believes vocational training means vocational training. Thus we, like many radio schools, teach ample theory. But, unlike most schools, two-thirds of our technical students' time is spent in laboratories and shops, where, with superior equipment, they learn by doing — not memorizing.

FREE employment service is available to all MELVILLE graduates.

Visit the 10-story MELVILLE Building today as our guest and observe the school in operation.

Day and evening classes approved for veterans. Licensed by the State of New York.

MELVILLE RADIO INSTITUTE
Melville Building
15 West 46th St., N. Y. 19 • LOngacre 4-0340

MAIL THIS COUPON NOW!

MELVILLE RADIO INSTITUTE R N
Melville Building
15 West 46th St., New York 19, N. Y.

Gentlemen: Send me Free information about your school.

Name _____

Address _____

Technical BOOKS

"THE RADIO AMATEUR'S BEAM POINTER GUIDE" by John F. Rider. Published by John F. Rider Publisher, Inc., New York. 30 pages. Price \$1.00.

For the amateur operator interested in working DX, knowledge of the location of distant stations is essential to permit setting of the antenna to the proper direction. In the past it has been the practice to use regular maps or special great circle maps for this purpose. In some cases, grammar school geographies have had to be depended upon for this important function.

This booklet has eliminated all guesswork by giving the setting in degrees from true north for all the prefixes used by amateurs. A separate table is provided for all the major U.S. cities as well as tables for Buenos Aires, London, and Mexico City. Each prefix is followed by a reading in clockwise degrees from true north. In addition, a table of magnetic compass deviation from true north is given for all major cities.

* * *

"FREQUENCY MODULATION (VOLUME 1)" edited by Alfred N. Goldsmith, Arthur F. Van Dyck, Robert S. Burnap, Edward T. Dickey, and George M. K. Baker. Published by Radio Corporation of America, RCA Laboratories Division, Princeton, New Jersey, 515 pages. Price \$2.50.

Like previous books in the RCA Technical Book Series, this newest volume is a compilation of technical papers written by RCA engineers on the subject of frequency modulation.

This first volume covers the period 1936 to 1947 and is divided into four major sections dealing with general papers. Two appendices, one including a FM bibliography and the other listing papers dealing with FM station placement and field survey techniques, are additions to the text material.

The material presented has been written for the engineer and covers such topics as FM noise characteristics, bandwidth and readability in FM, variation of bandwidth and modulation index in FM, FM propagation characteristics, generation and detection of FM waves, characteristics of the Pylon FM antenna, the service range of FM, impulse noise in FM reception, intermediate frequency values for FM receivers, duplex transmission of FM sound and facsimile, etc.

Engineers will find this new book a valuable addition to their technical libraries both as a reference and as a springboard for further research on frequency modulation.

-30-

July, 1948

DON'T FAIL TO GET RADIONIC'S FREE CATALOG

ROGERS RQ33 TEL-ADJUST



A genuine boon to television equipment. Eliminates, permanently, the shifting of contrast and brightness controls with change of stations. Equalizes signal strength and provides proper matching of antenna, line, and receiver. Once installed, the TEL-ADJUST needs no further attention or servicing. The TELE-PAD tells you the constants required for perfect matching. These components (furnished) are quickly installed in the TEL-ADJUST. Price.....\$4.77

ROGERS RQ30 TELE-PAD



A You'll find it an absolute necessity for rapid installation of television equipment. Tells, in a matter of seconds, whether: Tearing pictures are caused by overloading signals • Ghosts are caused by transmission line standing waves • A dipole is mismatched to receiver • An attenuation pad is needed, and also • The exact constants to use. Sturdily constructed for rough tool-box handling. Price.....\$8.95

A PERFECT BUYER'S GUIDE

RADIO & TELEVISION PARTS • KITS • PUBLIC ADDRESS • INTER-COMMUNICATORS • RECORDERS • RECORD CHANGERS • TEST INSTRUMENTS • TUBES • AMATEUR EQUIPMENT • CHANCELLOR RADIOS • HARDWARE • TECHNICAL BOOKS

RADIONIC EQUIPMENT COMPANY

TRIBUNE THEATRE ENTRANCE
DEPT. 170 NASSAU ST., N. Y. 7, N. Y. WORTH 2-0421
CABLE "CHANSLOZ"

DAZOR FLOATING FLUORESCENT LAMPS

A splendid all purpose fluorescent. Can be clamped or screwed to any surface — horizontal, vertical or sloping. Cushion on underside of footing prevents scarring of surface. Color smooth brown tone finish. For 110 Volt 60 Cycles A.C. Complete with hardware.

Single 15 Watt Model less bulb\$14.17

Double 15 Watt Model less bulb\$17.55

15 Watt Fluorescent Bulb for above Lamp—White or Daylight.....\$6.00

ROGERS PHONO PRE-AMPLIFIER



Completely self-contained high gain amplifier for use with Pickering G.E. and other low output pick-ups. Excellent response characteristics. Well equalized. Small, compact, easily mounted. Provides ample output for all conventional power amplifiers, radio audio systems, etc. Contains own power supply with excellent regulation, eliminating necessity for external power connections. Price.....\$10.50

GARRARD RC70 RECORD CHANGER



Simplicity combined with well known Garrard reliability keynote this newest changer. 10 twelve or ten inch records at one loading. Automatic stop. 110 or 220 Volts, 60 cycles A.C. (also available for 50 cycles). Removable spindle. Specify magnetic, crystal, G.E. Variable Reluctance or any Astatic desired. Price.....\$47.95

PICKERING PICK-UP

Famous Pickering 120-M cartridge. Fits practically all pick-up arms with aid of "Keystone Clip". High impedance. Output 70 millivolts. Built in sapphire stylus. 1/2 oz. pressure. Price.....\$15.00

G-E PRE-AMPLIFIER

Designed specifically for use with the famous G.E. Variable Reluctance Pick-up, this quality pre-amp may be used with other low output pick-ups. Requires A and B voltages from external power supply. Price.....\$5.82

MAIL THIS COUPON TODAY

A MUST for All • Service Dealers
Amateurs • Experimentors • Industri-
als • Institutions • Govt. Agencies

Radionic Equipment Co., Dept. 57
170 Nassau Street, New York 7, N. Y.

Send at once your free catalogs, supplements and Bargain lists as published—listing products of leading manufacturers of radio—electronic parts and equipment.

NAME.....

P.O. BOX or STREET.....

TOWN.....STATE.....

NEW BUSINESS

Multiple coin mechanism, timer clocks for power or utility outlets, revamp any new or old A.C. radio, Washing-machine, Iron, Fans, Air-conditioning, Refrigerators, Heaters, Ice-makers, etc., for coin machine operation.

TIMER MECHANISM, LIGHT-CORD AND FITTINGS
5c for 10 minutes\$4.95

TIMER MECHANISM, LIGHT-CORD AND FITTINGS
25c for 1 hour or 2 hours each\$4.95

Quantity Lots Write F.O.B. Los Angeles
RADIO-COIN-MATIC 1110 S. Normandie, Los Angeles 6, Cal.

PEN-OSCIL-LITE

Extremely convenient test oscillator for all radio servicing; alignment • Small as a pen • Self powered • Range from 700 cycles audio to over 600 megacycles u.h.f. • Output from zero to 125 v. • Low in cost • Used by Signal Corps • Write for information.

GENERAL TEST EQUIPMENT
38 Argyle Buffalo 9, N. Y.

RADIO ENGINEERING 27 MONTHS DEGREE IN 27 MONTHS

Intensive, specialized course, including strong basis in mathematics and electrical engineering, advanced Radio Theory and Design, Modern laboratory. Low tuition. Self-help opportunities. Also 27-month courses in Aeronautical, Chemical, Civil, Electrical and Mechanical Engineering. Gov't approved for G.I.'s. Enter Sept., Dec., March, June Catalogue.

INDIANA TECHNICAL COLLEGE
978 E. Washington Blvd., Fort Wayne 2, Indiana

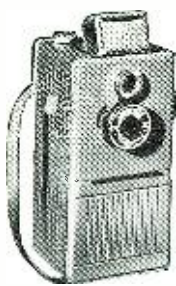

TOM THUMB CAMERA RADIO

- Precision Built
- Excellent Tone Quality
- Full Vision Slide-Rule Dial
- The Ideal Vacation Companion
- A Portable Radio for Battery Operation
- A High Grade Camera with Reflex Lens
- Using Standard 127 Film
- 16 Pictures. Net
- Less Batteries

\$28.75



\$21.62
Less Batteries

FAMOUS MAKE 3 WAY PORTABLE

- Superb Styling
- Non Breakable Cabinet
- Plays Anywhere, AC, DC or Battery
- Top Notch Performance. Net—

\$21.62
Less Batteries

FAST SELLING BATTERIES

	Each
67 1/2 VOLT, 3 1/4" x 2 3/4" x 1 1/8"	\$1.88
In lots of 6 or over	1.71
45 VOLT, 5 1/2" x 3 1/2" x 1 1/2"	1.65
In lots of 6 or over	1.50
4 1/2 VOLT, 4 1/4" x 3 1/2" x 1 1/8"	.57
In lots of 6 or over	.52

BARGAIN SPECIALS

CO-AX-CABLE, 72 Ohms, 100 feet	5.25
CO-AX-CABLE, 72 Ohms, 500 feet	24.75
TWIN-LEAD-IN, 300 Ohms, 100 feet	1.95
TWIN-LEAD-IN, 300 Ohms, 500 feet	7.50
TWIN-LEAD-IN, 300 Ohms, 1000 feet	13.75
ZIP CORD, 20 gauge, 500 feet	6.75
LINE CORD, 6 foot with plug	.14
PUSH BACK WIRE, 500 feet	4.75
4" PM SPEAKER, alnico #5	1.19
5" PM SPEAKER, alnico #5	1.39
6" PM SPEAKER, alnico #5	1.75
8" PM SPEAKER, heavy alnico #5	3.95
10" PM SPEAKER, heavy alnico #5	4.95
OUTPUT TRANSFORMER, match 50 L6	.39
VOL. CONTROLS, with switches, 50K, 1/2 or 1 meg	.39
CATHODE RAY TUBE, #7BP7	1.19
CONDENSERS, .001 to .01, 100 assorted	3.95
CONDENSER, 20/20-150 V	.26
TOGGLE SWITCH, SPST	.15
FM, Condenser & Coil Kit	4.95
PHONO AMPLIFIER, with 3 tubes	3.95
PHONO MOTOR, with turntable	2.95
CRYSTAL PICK-UP, with hardware	1.95
SOLDERING IRON, 100 watts	2.36
BROOKS INVERTER, D.C. to A.C.	8.95

BROOKS RADIO DIST. CORP.

80 Vesey St., Dept. B., New York 7, N. Y.

Signal Generator

(Continued from page 65)

be lowered by inserting one or more of the laminations in the choke, along with its new wooden core. If the frequency is too low, a smaller value of C_{13} should be tried. Using the choke and condenser specified, the frequency, when compared with an accurate source, was found to be slightly on the high side of 400 cycles; this was thought to be close enough for most work.

The audio oscillator circuit described has plenty of output (30 volts), which renders it especially useful in making tests of audio equipment. It has even served as an emergency code practice oscillator in the writer's shack. The use of an output control in the audio stage permits the operator to vary the modulation percentage of the signal output to suit his requirements.

The a.f. oscillator is suppressor-grid modulated, as can be seen from an examination of the circuit diagram. The choke, RFC_2 , in the suppressor lead is used to prevent r.f. from passing into the other parts of the circuit. This choke may be of any inductance from 20 to 80 millihenrys; or perhaps there is an old low frequency i.f. transformer gathering dust in the junk box, in which case one of its windings could be pressed into service. The mode-of-operation switch, S_3 , grounds this suppressor lead when an unmodulated r.f. output is required.

It was found in the original experimental set-up that when S_3 was switched to the "unmodulated r.f." position, trouble was experienced due to audio voltage leaking into the r.f. circuit. Even though liberal use was made of shielded wire in the a.f. circuit, this unwanted modulation of the r.f. signal persisted. To overcome the condition, the switch S_3 was wired so that when it is in the "unmodulated" position, the audio inductance CH_1 is short-circuited.

Employing a type 35Z5 tube as its rectifier, the power supply is of the half-wave type; its filtering components consist of a 2000 ohm resistor and two high capacity, dry electrolytic condensers. Due to the low current requirements, the usual filtering choke was dispensed with, thus cutting down both the size and cost of the instrument. The combination of high capacity filter condensers and low current drain results in a smooth voltage output. A VR-105/30 gas-filled voltage regulator tube serves to stabilize the output and help to smooth out the filtering.

Voltage for the tube heaters is provided by voltage-dropping resistor R_2 . A line cord resistor or ballast tube may be used by those having a preference

WAR SURPLUS BARGAIN SPECIAL!

Brand New BEAM ANTENNA ROTATOR MOTOR



\$5.95

Postpaid in Continental U.S.A.

- OPERATES DIRECTLY ON 110V AC, 60 CYCLES (Requires only 12 MFD Condenser)
- NO STEP-DOWN TRANS. NEEDED
- NO LINE RESISTOR NEEDED
- HIGH TORQUE — NO FREE SWING
- APPROX. 3/4 R.P.M.
- REVERSIBLE — ONLY THREE WIRES NEEDED
- ELECTRICALLY & MECHANICALLY QUIET
- LIGHTWEIGHT, RUGGED, QUIET
- MOTOR & GEARS OIL SEALED
- NO EXPENSIVE CONVERSIONS
- FLAT MOUNTING SURFACE — FOUR TAPPED HOLES
- FB. FOR 2-6-10-LITE 20 BEAMS

ALVARADO RADIO SUPPLY CO.

Dept. RN6, 903 So. Alvarado
Los Angeles 6, California

ARC-5 TRAN. 7 to 9 .1 meg. with tubes and xtal, new comp.....\$7.95

ARC-5 2-sect rcvr xmitter racks, used.....\$2.49

TBY xmitter or rcvr w/tubes 27-80m, used \$14.95

4-SECT OIL COND. 8-8-8-8 mfd 600v, new, w/ clamps. A real buy.....\$1.95

ARC-5 REC. 6 to 9 .1 meg. with tubes & dyn. New\$4.95

FIL xformer 6. 3V. 5A 1-10V. 60 cyc Input .,1.95

RL-42 Ant real excellent beam rotator wks on 8-24vac reversible, new\$2.95

SUPERIOR MODEL 670 SUPER-METER tests volts, ohm, milliams, capacity, reactance plus decibel measurements w/leads\$28.40

25% deposit FOB LA send full amount, save COD charge. All items subject to prior sale, Rush your order.

V & H RADIO SUPPLY

2033 W. VENICE BLVD. LOS ANGELES, CALIF.

SAVE 50% ON KITS!

25 WATT P.P. 6L6 Hi Gain AMP. KIT

Separately controlled Mike & Phono Inputs. All parts, including drilled chassis, hardware, solder, circuit diagram, etc.

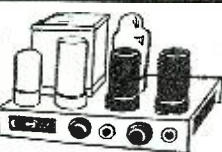

LESS TUBES **\$11.95**

PHONO OSCILLATOR 2 TUBE KIT

Hi-gain with microphone jack and all parts including Tubes\$2.95

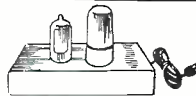

UNIVERSAL TROUBLE SHOOTER

Locates every service trouble. All parts including case, test leads, plug, 2 1/4" x 8" x 3"\$3.95

PHONO-AMPLIFIER KITS—All Parts Incl. Tubes

3 Tube Kit\$4.25—2 Tube Kit\$2.95
Pwr trans 1500v c.t., 150 ma, 6.3v 2.5a, 6.3v 1.6a, 5v3a; 115v 50-60 c. pri.\$5.95 ea.
Fil trans 6.3v 8a, 115v, 50-60 c pri.\$2.29 ea.

Write for free data, circuits designed by ROBT. G. HERZOG.

Universal general corp.

365 CANAL STREET DEPT. N
N. Y. 13, N. Y. WALKER 5-7642

BC-348

SHOCK MOUNT BASE

Dress up your "348" with a new base—fits all models—brand new in original cartons.

\$1.65

Shipped Anywhere In U.S. for 35c. Enclose \$2.00 for Each Base Wanted! Money Back Guaranteed.

ELECTRONIC SALES CO.

5559 W. Adams Blvd. Los Angeles 16, Calif.
GET ON OUR MAILING LIST

NOW AVAILABLE POKETRACER UNIVERSAL SIGNAL GENERATOR



Carry in your pocket like a fountain pen. Excellent for all types of trouble shooting. Fastest known means of obtaining accurate B.C. Dialer adjustment. Uses single penlite battery obtainable everywhere. Insert battery and it's ready for use. Send for yours today. Drop us a card and we will send it C.O.D. or send cash in advance and save postal charges. Price \$4.50 each.

HOWARD MACHINE PRODUCTS CO.
2754 Diversey Blvd., Dept. RN7 Chicago 47, Ill.

RADIO NEWS

for different methods of voltage-dropping. R_2 is mounted in a vertical position, and is kept as close to the back of the chassis as possible, so that the heat developed in it will be dissipated by the rear wall of the metal cabinet.

Condenser C_3 discourages any r.f. which may have been induced, or otherwise leaked into the power circuit, from entering the line cord and radiating therefrom. Any leakage or radiation of r.f. from the connecting wires is liable to cause faulty indications in alignment work. The only place where r.f. voltage is wanted is at the business end of the output cable. By making use of a cable of the concentric type with the outer braid at r.f. ground, the inner "hot" lead is shielded, and unwanted radiation eliminated.

A glance at the circuit diagram will show that use is made of only one wire and one prong of the line cord and plug, the return for the power being made by connecting the binding post, which grounds the instrument, to a ground common with the mains supply, i.e., a cold water pipe. The binding post may be seen in the photographs; it is located next to the output cable. This arrangement was adopted for the purpose of enabling the user to keep the instrument's case at ground, and is merely a safeguard. An alternate method would be to connect the ground points of the circuit together on an insulated lug, and then ground the lug through a high capacity paper condenser to the chassis. There is one serious objection to the latter method of grounding; if the condenser used to connect the lug to the chassis should become shorted, the metal case *could* be "hot," and the operator might suffer an unpleasant, and possibly serious, shock. The writer prefers to play safe and not depend on condensers any more than necessary.

Of course, this particular method of connecting the line cord was based on the assumption that wherever there is a power line, the system is grounded to the cold-water pipe. In cases where this is not so, the constructor can make the minor changes necessary to adapt the unit to the circumstances. And for those preferring a conventional two-wire line cord, or any other arrangement, their preferences may be incorporated without affecting the signal generator circuit proper.

As the circuit stands—with ground connections made, and a.c. cord plugged in—when the switch is turned on the instrument will either warm up or else nothing will happen, depending on the polarity of the plug. To make it easy to tell whether or not the plug is in the correct way, a pair of headphones or an indicating device such as an a.c. voltmeter can be connected to the audio output pin-jacks. Make sure that

the mode-of-operation switch is turned to the "audio" position. Once the tone or indication is observed, one side of the a.c. outlet can be marked with white adhesive tape or paint, thus making sure of the correct polarity at future times.

In place of the power supply described, batteries could be used by those constructors located in districts where power is not available. A "B" supply of from 90 to 135 volts would suffice for the plate supply, while a 6 volt storage battery could be used for the heaters. If no source of voltage is available for 6 volt tubes, a 1A7-G and 1N5-G could probably be worked into

the circuit, in which case the filament supply would have to be 1.4 volts.

The completed instrument may be calibrated by using a receiver and a secondary frequency standard giving markers at every 10 or 100 kc. as described in most radio handbooks. For those not so fortunate as to have access to equipment of this type, the signal generator may be calibrated by zero-beating it with local broadcast stations. The accurate transmissions of station WWV offer an excellent standard from which to calibrate the high frequency ranges. It is advisable, before beginning the actual calibrating, to allow sufficient time for the unit to reach its

Modern Hams Junk Old-Style "Cans"!

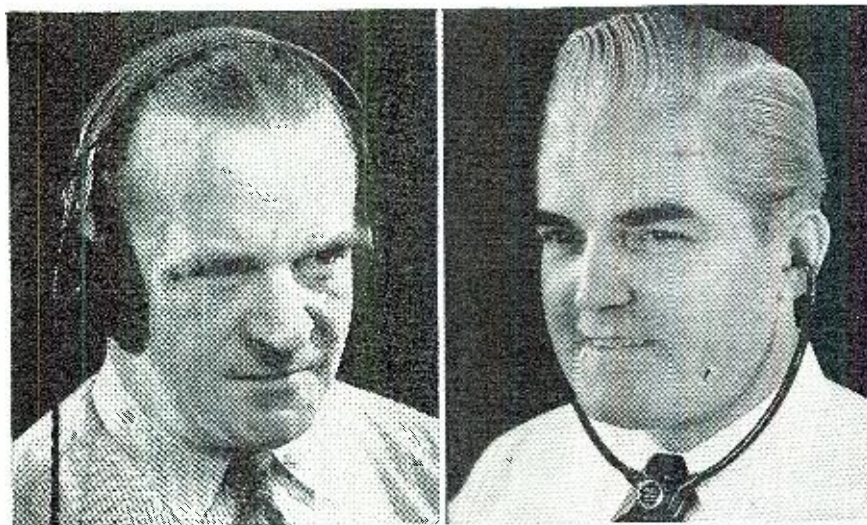

First basic improvement in headset design in 50 years

TELEX MONOSET

- Gives clear, crisp "near as here" reception
- Blocks outside noise
- Eliminates that "top-heavy" feeling
- Ends headachy ear pressure

Man, what relief to get rid of those pressure headaches from old-style earphones!

The TELEX MONOSET swings lightly under the chin like a stethoscope—never gets in your hair! The TELEX MONOSET delivers the signal into the ears, excludes all room noise automatically. The TELEX MONOSET gives undistorted output at maximum volume... plenty of "sock" easily adjusted with the built-in volume control.

Modernize your rig with a MONOSET
—successor to the earphone! Write
Department BT for information.



Canadian Distributors
Sono Film, Ltd., Winnipeg

BOOST YOUR TV SIGNAL

on all
13 CHANNELS



VIDEAMP
VIDEO BOOSTER
**A 13 channel, self-powered,
2 stage TV signal preamplifier**
Pretuned selector system.

Non oscillating original circuit combination with easy matching for any antenna impedance to any tele-set input impedance.

See Your Local Jobber

WRITE FOR INFORMATION

List Price \$30

CRYSTAL DEVICES CO. Dept. B
1819 BROADWAY NEW YORK 23, NEW YORK

L1	—226 t. #32 d.c.c. closewound 1 1/2 inch coil form, tapped 75 t. (300-900 kc.)
L2	—46 t. #32 en. closewound 1 1/4 inch coil form tapped 5 t. (900-2700 kc.)
L3	—17 t. #20 en. wound 1 1/4 inch coil form, tapped 15 t. 1 1/4 inch long (2700-8100 kc.)
L4	—5.2 t. #14 en. wound 1 1/4 inch coil form, tapped 1.4 t. 1 1/4 inch long (8100-24,000 kc.)

Table 1. Coil winding data.

operating temperature so that inaccuracies will not result from thermal drift.

The only available cabinet was a cadmium-plated steel box of war surplus stock. The tuning dial represents the most expensive item, and justified this expense by simplifying the calibration of the instrument. Besides its utilitarian value this type of dial dresses up the appearance of the unit.

In conclusion it should be mentioned that the finished instrument held its calibration remarkably well. With the signal generator set at 500 kc., the signal was picked up on a high quality receiver; using b.f.o. on the receiver, the two were zero-beated. During this test, the frequency never varied more than a few hundred cycles over a period of two weeks, the length of the test. There was, of course, quite a difference between the two until the unit had passed its warm-up period, but this was only to be expected when a simple, uncompensated circuit was employed.

—30—

Sonotone Corporation of Elmsford, New York has announced the discovery of a synthetic material which possesses piezoelectric properties. The new material involves the use of specially prepared, chemically treated ceramic for converting mechanical energy into electrical impulses. First application was a new ceramic pickup for phonographs. Photo illustrates this pickup immersed in a glass of boiling water from which it emerged unharmed. The new material may be used for mikes, and telephone receiver units.



RADIO NEWS

Below Wholesale Cost!!!
WESTERN ELECTRIC
BRAND NEW

2495
35 watts will handle up to 55

A sensational buy in quality Reflex speakers. Blasting and blaring completely eliminated by a heavy gauge metal main trumpet section. The Western Electric Driver Unit, rated at 35 Watts will handle 55 watts safely without blasting. A new plastic diaphragm replaces the standard metal type and is unconditionally impervious to climatic changes and free from atmospheric corrosion. Min. power. Max. coverage, reduces cost of installation. Full frequency response driver unit complete with projector. Excellent for concessions, ball parks, mobile, P.A. work. 20% dep. with order, balance C.O.D. MANUEL KLEIN, 74 Cortlandt St., N. Y. 7, N. Y.

Guaranteed Radio Tubes
All types for Immediate Delivery
Send For List
Territories Still Open for DISTRIBUTORS

Attention Manufacturers—Large Quantities of 117L7-32L7-6F6-6K6-6SK7-70L7-1-Volt Miniature and 12-Volt Miniatures

•
LE-HI ELECTRICAL COMPANY
660 Broadway Newark 4, N. J.
Humboldt 5-3530 Humboldt 5-3531

U. S. SIGNAL CORPS 2-WAY TALKING SYSTEM
Dressed in a piano finish wooden cabinet.

Talk to any one station, privately or all 5 at once. Any sub-station can originate a call to the master. Ready to plug into 110 volt, AC or DC. Tube line-up 12J5, 12J5, 50L6 and 3Z5. The 45 Ohm voice coil permits tremendously long transmission lines, amazing fidelity on voice. All equipment guaranteed perfect.

Master station with one sub-station and 100 ft. of wire.....\$59.95
Sub-stations, ea. 6.95
Wire per 100 ft. 4.00

KITS
Broadcast Band Converter for BC-342, BC-348, BC-312, NC-100, etc. uses 6SA7 fixed oscillator. Nothing extra to buy.....\$5.00
10 Meter Converter Kit for BC-342, BC-348, BC-312, etc. Read article in Oct. '47 Radio Craft. Complete kit. Nothing else to buy..... 7.95
Home Broadcast Microphone consists of D.B. carbon microphone, matching transformer, batteries and a detailed sketch to hook to your radio. 1.98

FM-IF COIL KIT
4-1F Transformers, 20.7 megs, slug tuned including one diode trans. 1.49

SURPLUS SPECIALS
All aluminum utility case, 3-3/16 x 4-7/16 x 2 1/4 has 4 drilled holes 3/8" diam. Just right for that crystal set or 1 tube converter..... .18
JK 35A fits PL55 phone plug..... .11
JK 35A fits PL68 phone plug..... .11
11 Prong Male & Female Plug. Just right for that 11 wire cable. Each contact will carry 20 amps. .24
12 Volt Relay 70 Ohm Coil. SPST 20 Amp contacts19
100,000-Ohm Pot. 3/8" shank 3/8" shaft..... .15
100 Millihenry Choke, variable slug tuned..... .29

Pushbutton Momentary Switch, DPDT one side normally closed49
Telephone type lever switch, DPDT one side normally closed49
800 Ohm, 35 Mil choke..... .15
14 Ohm, 20 Watt Resistor..... .05
100 Resistors ass't. not color coded..... 1.00
3500 Ohm, 100 Watt variable resistor..... .69
HS-30 Headset with 8000 Ohm Trans. new..... .69
DM-32 Dynamotor, 28 Volts input, New..... .79
Interlock Safety Switch—complete..... .69

SURPLUS TUBE SPECIAL
12A624
161909

SERVICE SPECIALS
4 inch PM Speaker 45 Ohm impedance voice coil. Put this in your inter-com and note the difference 2.99
Metal cabinet for above 1.29
Fuse for panel mounting18
100 Ass't. Knobs 1.65
2 MFD Oil Filled Cond. 600 V..... .16
8 MFD 600 Volt Bathub..... .39
Handy Hardware Ass't. over 500 pieces..... .89

All Merchandise Guaranteed
Terms—25% with order
Balance C.O.D.
Prices F.O.B. Chicago

THOR ELECTRONICS
5051 N. Clark St., Chicago 40, Ill.

20 Lb. Radio Parts—
Assortment
\$2.00

G.E. Pickup
(Continued from page 48)

fundamental pitch will be six shades softer (6 db.) while all the overtones in his voice (which begin exactly an octave higher) will be reproduced in their proper intensity. The result is to make him sound thin and "reedy." And this effect is noticeable to a critical ear, only one octave below crossover. A bass singer sings roughly an octave below a tenor and the loss of "body" in his voice, as reproduced, is even more severe.

Now let us consider the "bull fiddle." Two varieties of this instrument exist, one found in all dance bands with four strings, and one met in symphony orchestras with five. The four stringed bass has a low note of 41.25 vibrations per second, while the five stringed bass can grumble away as low as 34.375 cycles. At 44 cycles only one-tenth of the voltage or one-hundredth of the power at 440 cycles is generated, equivalent to a 20 db. loss. Pianos can produce a low of 27.5 cycles and large pipe organs a low approximating 16.25 cycles. The piano may thus be attenuated 24 db. and the organ even more.

Obviously, some form of equalization must be employed, and the standard G.E. preamplifier and equalizer endeavors to do this task. However, it does not succeed, although to a non-critical listener it may be satisfactory. Actually this circuit amplifies the output of the pickup in one triode of a 6SC7. The amplified output is then impressed across an equalizing network which progressively attenuates highs but does not boost lows. A portion of this attenuated voltage is then applied to the second grid of the 6SC7 and the plate is coupled to an ordinary amplifier input.

Measured at this input, the response curve from this preamplifier and equalizer shows a "hump" at crossover frequency with a rapid taper on the low frequency side and a gradual loss on the high frequency side of the "hump." Since the highs are attenuated, they sound more in balance with the lows, and the effect is passable if not precisely flat.

The G.E. preamplifier will probably suit most needs and applications, and it has the added advantage of being obtainable in a completely assembled unit ready for use. However, where greater bass response is desired, or for use with a public address system or similar installation not incorporating this preamplifier, something different must be employed. In the case of a p.a. system it would be highly advantageous if the equalization could be accomplished

without additional tubes, either external or internal, and the equalized voltage applied to the input of a high-gain microphone stage.

Accordingly, the following system of equalization is offered, together with such pertinent information as may be needed to make the system susceptible to variation both in response and the choice of parts which may be utilized, all of which will probably be found kicking around in the junk box.

To begin with, the pickup is inductive in nature and for best power match throughout its range should face an inductive, rather than a resistive load. Referring to Fig. 1A it will be seen that

we have impressed the output of the pickup across the primary of a transformer. This transformer is an ordinary cheap output variety, designed to match 25L6 or 50L6, etc. tubes to a voice coil. With the secondary shorted it proved to have an inductance of about 370 millihenrys.

According to the literature published by G.E. the pickup has an inductance of 100 millihenrys, but check of three pickups by the author gave an average of 201.6 millihenrys, checks being made at frequencies of 50, 100, 500, 1000, and 10,000 cycles on each one. Individual results varied from 189 to 214 millihenrys. If the average is about 200 as

BIGGEST SAVINGS IN HISTORY!
USE THE BEST SURPLUS

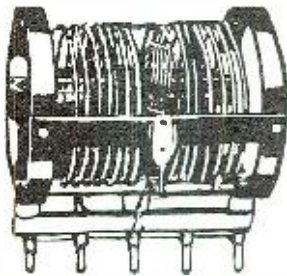

BRAND NEW! RUGGEDLY BUILT!



ATTENTION!!!
ALL SCR-522 OWNERS
Remote Control Boxes for SCR 522's. Brand New in Original Packing; Consists of 5 push button switches, 5 Western Electric Pilot Assemblies, with Pilot Bulbs and Dimmer, and Lever Switch all finished in Black Crackle. Order yours Today.

Your Cost, **79c EA**

SCOOP!
110 M.C. REC. BARGAIN
BC-733 D Localizer Receiver
Freq. 108-110 Mc; Tube complement: 10 tubes—1-12SQ7, 2-12SR7, 1-12A6, 1-AH7GT, 2-12SG7, 3-717A. NEAR NEW CONDITION. Companion to the glide path receiver. Also

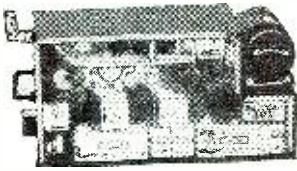

contains 90 and 150 cycle band-pass filters. Has the best AVC system yet developed; can use parts or use as a model for construction. 10 tubes, crystals, relays, etc. Schematic included. Don't pass this up! At only.....**\$3.95**
2 for **\$7.50**

MORE FOR YOUR MONEY
BARGAINS GALORE—SEND FOR OUR BIG SPECIAL BULLETIN

500 WATT TRANSMITTING COILS
B & W 3400 SERIES INDUCTORS

Frequency Range in (MC)	No. of Turns Adjustable Link		
2.0 - 3.5	6.5	14 COILS PER SET \$5.	
3.5 - 4.5	4.5		
4.5 - 5.7	4.5		
5.7 - 8.0	4.5		
8.0 - 11.0	4.5		
11.0 - 14.0	2.5		
14.0 - 18.0	1.5		
SOUND POWERED			
PHONES & CHEST			
SET WITH MIKE \$4.95			

MATCHING UP TO 100 OHMS.

POWER!! POWER!!

EIMAC
304TL
BRAND NEW JAN. INSPECTED
SUPER VALUE
BETTER ORDER 4 OR MORE
TODAY
90c EA
WHILE THEY LAST—ANY QUANTITY

SUPER SPECIAL BRAND NEW \$3.95 EIMAC 304TH EA
JAN. INSPECTED

Vertical Antenna MAST KITS COMPLETE
\$9.95

Fully Adj.
5 to 35 Feet
Easy to Set-up
FOR FM, TELEVISION AND ROTARY BEAM

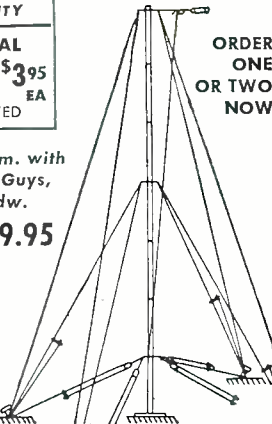

ORDER ONE OR TWO NOW

Doublet Antenna Kit, Com. with used with the famous Hallicrafters BC-610, consisting of 7 steel-alloy mast sections in a handy canvas bag. Each section is 5' 6" long, 1 1/2" OD with the last 6" rolled to a smaller OD to telescope into the end of the preceding section. No taper. Assemble into mast up to 35' high or shorter by any multiple of 5'. Finished in weatherproof olive drab. **Ideal for erection of FM and Television Beams!** Drop your coaxial cable right through the center! Brand new, export packed.

\$9.95
Guys, Hdw.

TERMS: F.O.B. Pasadena unless postpaid. No C.O.D.'s under \$2.00. 25% deposit on ALL orders. All C.O.D.'s shipped by Rail Express. Save freight and C.O.D. fees by sending full price with order and we will ship by fast truck, transportation collect. Minimum order \$2.00. Californians include 2 1/2% sales tax.

BE SURE TO ASK FOR OUR BIG SPECIAL BULLETIN

DOW RADIO

1759 EAST COLORADO BLVD.
PASADENA 4, CALIFORNIA

www.americanradiohistory.com

163

NOW—A REALLY HIGH-POWERED— Radio Engineering Library

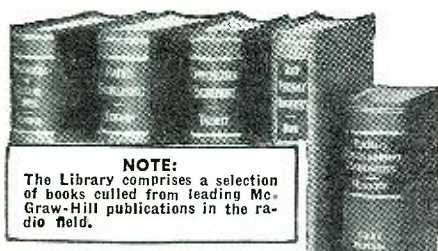

NOTE:

The Library comprises a selection of books culled from leading Mc-Graw-Hill publications in the radio field.

- especially selected by radio specialists of McGraw-Hill publications.
- to give most complete, dependable coverage of facts needed by all whose fields are grounded on radio fundamentals.
- available at a special price and on easy terms.

THESE books cover circuit phenomena, tube theory, networks, measurements, and other subjects—give specialized treatments of all fields of practical design and application. They are books of recognized position in the literature—books you will refer to and be referred to often. If you are a practical designer, researcher or engineer in any field based on radio, you want these books for the help they give on hundreds of problems throughout the whole field of radio engineering.

5 VOLUMES, 3559 PAGES; 2558 ILLUSTRATIONS
1. Eastman's FUNDAMENTALS OF VACUUM TUBES

2. Terman's RADIO ENGINEERING
3. Everitt's COMMUNICATION ENGINEERING
4. Hundt's HIGH FREQUENCY MEASUREMENTS
5. Henney's RADIO ENGINEERING HANDBOOK

10 days' examination. Easy terms. Special price under this offer less than books bought separately. Add these standard works to your library now; pay small monthly installments, while you use the books.

10 DAYS' FREE EXAMINATION—SEND COUPON

McGRAW-HILL BOOK CO., INC.
330 W. 42nd Street, New York 18, N. Y.

Send me Radio Engineering Library, 5 vols., for 10 days' examination on approval. In 10 days I will send \$2.50 plus few cents postage, and \$5.00 monthly till \$27.50 is paid, or return books postpaid. (We pay postage on orders accompanied by remittance of first installment.)

Name

Address

City and State.....

Company

Position..... RN-7-48

**NEW
LOW
PRICE**

9.45



TRANSMITTER-RECEIVER BC 645

BC-645 ultra-high frequency transmitter receiver can be converted to operate on the 420 Mc band with few changes. It's surplus, brand new, packed in original carton—complete transmitter, modulator system and receiver. Comes complete with fifteen tubes. Well worth the price for parts and tubes.

Send us your name to receive FREE *Almo* Broadcaster magazine.

10%
Cash
with
Orders



Phone
LO
3-9255

509 ARCH ST., PHILA., PENN.

would seem to be indicated, the resultant mismatch loss is less than 1/2 db. Various makes and models of output transformers were tried, but they presented greater mismatch losses due to higher inductances, and the little cheap one was finally employed.

Referring again to Fig. 1A we find that the secondary side is connected to a condenser. Due to the low inductance of the secondary, resonance of this LC network at audio frequencies is remote with any size condenser readily obtainable. Choice of size will depend to some extent on the transformer employed, the degree of bass boost wanted, and the location of crossover frequency if non-commercial recordings are to be reproduced.

Actually it should be of such size as to offer negligible reactance at the crossover frequency, thereby offering a practically shorted secondary for frequencies above this point. (This accounts for determining the inductance of the primary with the secondary shorted). In practice, anything from 100 to 1000 mfd. may prove best with chances being that about 200 or 300 mfd. will prove most desirable. Such a condenser may readily be made by paralleling two or three 100 mfd. cathode condensers. No. d.c. will be applied so insulation qualities are not important. The a.c. volts will be less than .001. If cathode condensers aren't available, a motor starting condenser will also do.

At low frequencies this condenser will reflect an added impedance on the primary side, equal to the reactance of the condenser multiplied by the square of the turns ratio. In transformers of this sort the turns ratio is about 20-1 and the multiplying factor is thus 400. The turns ratio will thus become of more importance than the size of the condenser. Both, however, are mutually interdependent.

At 50 cycles a 200 mfd. condenser offers a 15 ohm load which is reflected as 6000 additional ohms added to approximately 90 ohms presented by the inductance of the primary. Similarly, at 100 cycles the condenser offers a load of 7.5 ohms and reflects an additional 2850 ohms to the primary whose impedance alone would now represent about 230 ohms. In other words the reactance of the load to which the pickup is connected approximately doubles for each descending octave.

This will not compensate 6 db. per octave, but it will compensate about 3 db. so far as the voltage impressed on the control grid of the first tube is concerned. Incidentally, since the grid resistor of this tube is effectively in parallel with the transformer primary, as far as a.c. is concerned, it should be large enough so that it will not ma-

terially reduce the reactance of the network at high frequencies. Choice of 1 megohm or more will obviate this possible difficulty.

At 500 cycles assumed crossover, the condenser reflects an additional 600 ohms to the 1200 ohm impedance of the primary, and at 10,000 cycles it adds about 3 ohms to 25,000 ohms. This does give some taper above crossover, but since commercial records are pre-emphasized from about 700 cycles upward, the resultant final output is reasonably flat.

Should more highs be desired, a resistor in the vicinity of 5000 ohms should be inserted between the top of the transformer and the "hot" lead from the pickup. The grid of the first tube should be coupled to the junction of this "hot lead" and resistor as shown in Fig. 1B.

Conversely, if greater treble attenuation is desired, the primary of the transformer should be shunted by a resistor, as shown in Fig. 1C. Size will be determined by personal taste but will probably range downward from 40,000 ohms.

This network has the advantage of being small and readily incorporated in either the amplifier chassis or at some external point. Care must be taken, however, to keep it away from any magnetic fields such as chokes, motors, power transformers, etc., since its impedance at 60 cycles is low and hum pickup will be very severe.

Another advantage of the network is that since its over-all attenuation is low, a single triode, such as the one in a 6SQ7 will provide sufficient gain for use with an ordinary amplifier, or the equalized output may be plugged directly into a mike input on a p.a. system, without any changes in the interior of the amplifier or the need for filament, plate, or screen voltages.

—50—

TV PASSES 300,000

A TOTAL of 118,027 television receivers were manufactured by RMA member-companies during the first quarter of 1948 to bring the total number of TV receivers manufactured since the end of the war to more than 300,000.

The new production rate was almost three times the rate for the corresponding quarter last year and 66 per-cent of the total TV set output during 1947.

FM-AM sets for the first quarter totaled 437,829 or two and a half times the number manufactured in the first quarter of 1947.

Total set production aggregated 4,352,296 during the first quarter as against 4,321,406 for the corresponding period in 1947.

—50—

Receiver Design

(Continued from page 39)

are eliminated. This is evidenced by the fact that removal of the FM antenna completely eliminates any response.

A photo of this tuner is shown in Fig. 4. The inductors are held in place with bakelite pieces which are mounted to the tuner sub-chassis. The cores are mounted to a bakelite piece with adjusting screws to permit adjustment. The antenna and oscillator inductors are shown. The variable i.f. inductor is directly behind the oscillator inductor and is almost identical in appearance. Two slide bars are provided for movement of the cores. These are seen at the center of the picture. A rack and pinion gear is used to transmit power to the sliding mechanism. The rack is seen directly below the slide bar. The pinion, with its anti-backlash spring, is at the left center of the picture. The concentric condensers are at the extreme right end of the inductors. The dual triode converter is mounted on the tuner sub-chassis in a position which makes possible the use of very short connection leads to the tuned circuits. Heavy braided straps are used to bond the sub-chassis to the main chassis. This photo was taken with the shield removed.

A view of another *Motorola* tuner is given in Fig. 2. Electrically these tuners are the same, the difference being in the physical placement of the parts. The drive mechanism can be seen more clearly than in the other *Motorola* tuner.

A 7F8 twin-triode tube is used as the converter. One section of the tube is used as the first converter and the oscillator. The other section is used as the second converter. A complete schematic of the tuner is given in Fig. 3. The pickup system of this tuner is unique in that it does not use a dipole for pickup. Instead it employs a figure 8 loop. The loop is tapped at the proper impedance point to match the input of the tuner. The loop is also tapped to provide for an external antenna connection. These taps are in the form of sliding clips so that the external antenna impedance can be matched. The pickup from this loop is good and seems less directional than that of the dipole mounted in the cabinet.

In order to fully understand the theory of operation of this tuner it is necessary to note the relationship of the frequencies present in the tuner. Let us assume the tuner is tuned to receive a 100 mc. signal. The oscillator is operating at one-half the incoming signal minus one-half the i.f. frequency, in this case one-half of 100 mc., or 50 mc., minus one-half the 4.3 mc. i.f. frequency which is 2.15 mc. Thus the oscillator is operating at 47.85 mc. Referring

SENCO DECLARES ANOTHER BUYER'S DIVIDEND!



POWER TRANSFORMERS—

All Fully Shielded, Flush Mount
 100 Mfd — 6.3V @ 3 amps —
 5V @ 2 amps 750V C.T. ... \$2.95
 150 mil — 6.3V @ 4 amps —
 5V @ 3 amps 750V C.T. ... 3.39
 200 mil — 6.3V @ 3.3 amps —
 5V @ 3 amps 815V C.T. ... 4.45

SALE! PUSH PULL OUTPUT TRANSFORMERS

6L6 P.P. Output Transformer fully shielded, upright mount—25 Watts Tapped at 4 ohms, 8 ohms, 15 ohms, 250 ohms, 500 ohms \$2.95
 6L6 Parallel P.P. Output Transformer for 4—6L6 tubes —50 Watts Tapped at 4 ohms, 8 ohms, 250 ohms, 500 ohms—upright mount \$3.49

Special! CHOKE

93 mil choke 5 Henries strap mounting..... 53c

STANDARD BRAND VOLUME CONTROLS— Nationally Advertised

10,000 ohms V.C. with switch, 3" shaft
 25,000 ohms V.C. with switch, 3" shaft
 50,000 ohms V.C. with switch, 3" shaft
 100,000 ohms V.C. with switch, 3" shaft
 250,000 ohms V.C. with switch, 3" shaft—Tapped
 500,000 ohms V.C. with switch, 3" shaft—Tapped
 1 meg ohms V.C. with switch, 3" shaft—Tapped
 2 meg ohms V.C. with switch, 3" shaft—Tapped
 44c each



CARTRIDGES — Brand New Stock

L70 Astatic Crystal Cartridge \$1.49
 N7 Webster Crystal Cartridge 1.49
 Astatic Nylon Cartridge 2.95

FP CONDENSERS—Standard Brand, Fresh Stock

10 Mfd @ 450V 31c
 20 Mfd @ 450V 36c
 30 Mfd @ 450V 42c
 40 Mfd @ 450V 49c
 40 x 40 Mfd @ 150V 44c

Brand New Willard # 27-2 2 Volt Storage Battery and 2 Volt Vibrator Used in General Electric model #530 charge A PACK portables. Suitable for all farm radio sets. Individually boxed. Both for \$2.69
 Battery alone 1.79
 Vibrator alone .99



NATIONALLY ADVERTISED SPEAKERS— ALL TERRIFIC BUYS!

3" P.M.—.68 oz Alnico V \$.99 ea.
 3" P.M.—1.47 oz Alnico V 1.15
 4" P.M.—1 oz Alnico V99
 5" P.M.—1 oz Alnico V99
 5" P.M.—1.47 oz Alnico V 1.15
 6" P.M.—2.15 oz Alnico V 1.55
 6" P.M.—2.15 oz Alnico V 2.75
 8" P.M.—.8 oz Alnico V 3.69
 10" P.M.—.8 oz Alnico V 4.39
 12" P.M.—3.2 oz Alnico V 4.95
 12" P.M.—6.8 oz Alnico V 5.95
 Output \$7.95 complete
 8" Dynamic 680 ohms field with 6V6 P.P. 3.95 complete
 12" Dynamic 680 ohms field with 6V6 P.P. 6.95 complete
 Output 5.95
 12" Dynamic 1000 ohms field 5.95

YOU JUST CAN'T BEAT THESE PRICES!

Every Tube In Carton R.M.A. Guarantee

Type	Each	Each 10	Type	Each	Each 10
024	69c	59c	6U7G	35	25
1A3	45	39	6V5G	59c	49c
1A5GT/G	59	49	6V6GT/G	45	39
1A7GT/G	55	45	6X3GT/G	49	39
1H5GT/G	39	49	7A4	53	43
1L4	49	45	7A7	59	49
1LH4	69	59	7B6	44	35
1LN5	69	59	7F7	49	44
1N5GT/G	59	49	7N7	49	44
1S5	59	55	7X7		
1T4	69	55	(XXFM)	44	35
1U5	36	30	7Y4	44	35
1V	45	39	12A6	29	25
2A5	54	43	12A8GT	35	28
2A6	45	35	12A16	50	45
2A7	49	39	12BA6	50	45
2X2/879	35	29	12BE6	50	45
3A4	49	39	12J5GT	25	19
354	55	45	12J7GT	45	39
514G	59	49	12K7GT	45	39
5W4GT/G	39	34	12K8Y	35	25
5X4G	39	35	12Q7GT	45	39
5Y3G	42	37	12SA7GT/G	40	32
5Y3GT/G	40	33	12SF7	35	32
5Y4G	39	32	12SJ7GT	35	49
5Z4	59	49	12SK7GT/G	45	39
6A7	59	49	12SQ7GT/G	40	32
6A8GT	49	39	12SR7	35	32
6AC5	69	59	14A7	65	55
6AC7/1852	65	50	14B6	59	49
6AG7/6AK7	89	79	24A	49	39
6AK5	74	69	25L6GT/G	49	39
6B7	55	49	25Z5	45	39
6C4	29	25	25Z6GT/G	45	39
6C5GT	40	35	26	45	32
6C5MG	89	79	27	49	44
6C6	45	32	32L7GT	52	48
6C8G	37	29	35/51	42	32
6D6	49	45	35L6GT/G	45	39
6F5	55	45	35W4	43	40
6F6GT	45	39	35Y4	43	40
6H6GT/G	45	39	35Z3	44	35
6J5GT/G	45	39	35Z5GT/G	43	39
6J6	59	49	36	35	29
6J7GT	42	38	39/44	35	29
6K6GT/G	45	39	41	49	45
6K7G	50	41	47	49	39
6K8GT/G	49	39	50A5	60	55
6K8G	55	49	50B5	42	32
6L6G	79	69	50L6GT	50	45
6Q7GT	47	39	56	55	45
6R7	55	45	57	45	39
6R7GT	59	49	58	45	39
6SA7	49	39	59	50	39
6SA7GT/G	44	37	76	49	45
6SB7	55	45	77	35	27
6SD7GT	39	34	80	40	38
6SG7	44	39	83V	79	69
6SH7GT	40	32	85	49	45
6SJ7GT	44	37	99V	35	25
6SK7GT/G	49	39	99X	35	25
6SL7GT	49	47	11Z76GT/G	89	76
6SN7GT	49	47	182B	99	89
6SQ7GT/G	44	37	1231	39	29
6SD7	49	39	1644	39	29
6U6	49	39			

Standard Brand AC phono Motor & Pickup

60 cycle, 115 volts, with Turntable, Complete

\$4.35

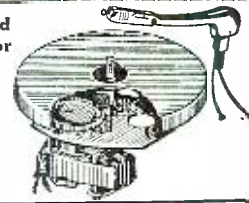

829 PUSH PULL TWIN-UNIT

Beam Power Amplifier Tube \$1.49 ea.

25% deposit on all orders, balance C.O.D. F.O.B. New York

SENCO RADIO, Inc.

71 WEST BROADWAY, N.Y. 7, N.Y.
 TELEPHONE — BEKMAN 3-6498

Stock Reduction Closeouts • Last Time Offered Terrific Savings! Buy at Distributor Cost!

	Your Cost
637 Jackson Tube Tester	\$67.50
640 Jackson Tube Tester	40.00
642 Jackson Tube Tester	50.00
643 Jackson Tube Tester	50.00
645 Jackson Tube Tester	60.00
650A Jackson Tube Tester	40.00
2413 Triplett Tube Tester	12.00
3212 Triplett Tube Tester	32.75
625N Triplett Volt OHM Milliammeter	15.00
2450 Triplett Volt OHM Milliammeter	80.00
A200 Oscillators	42.00

Also Mikes, Audio Amplifiers, Aerovox Condensers and Resistors at Extremely Low Prices. Prior orders will get preference.
 All shipments 25% deposit with order, balance C.O.D. F.O.B. St. Louis, Missouri.
CREST CORP. Dept. B-2, 3949 Forest Park Bl., St. Louis 8, Mo.
 Write for complete catalog on Radio Parts & Equipment.

LEARN TELEVISION ELECTRONICS RADIO

Modern Completely Equipped Laboratories

DAY AND EVENING CLASSES

G.I. Approved—Veterans Receive Subsistence

ENROLL NOW!

ELECTRONICS INSTITUTE, INC.

21 Henry, Detroit 1, Mich.

HIGH FIDELITY AMPLIFIER KIT

MODEL "CONCERTO"

This kit is a unit of highly advanced design which will meet the exacting requirements of the most discriminating music lover.

This famous reproducer uses eight tubes in a new circuit design, and the first kit available to the public using the Cathode Follower output circuit. This circuit provides remarkable transient response and improves the performance of the loudspeaker itself by heavily damping its resonances.

A very carefully designed tone control system permits separate control of treble and extreme bass registers and while bass boost is substantially greater than with conventional circuits, it does not affect the middle register.

This amplifier accommodates both high and low gain pickups. Incorporates special circuits for G.E. reluctance pickups. Can be used with any microphone or tuner, complete with tubes.



Kit Model 210
A Three Way
Portable Receiver
Operating on either
AC or DC or self-
contained batteries

... power switch
conveniently located
on front of set so
that "battery" or
"AC-DC" may be
selected without
opening case. Five-

inch Alnico 5 permanent magnet dynamic speaker, and case covered with beautifully grained leatherette.



Multitester Kit
Model M-3C

A versatile, compact multitester 4" x 7" x 3" using a 3 1/2" rd. meter of 1000 ohms per volt sensitivity. Employs the following ranges: Volts AC or DC 0/5/50/150/500/1500. Milliampers DC 0/5/50/150. Ohms

0/2000/20,000/200,000.

All kits accompanied by a detailed, illustrated instruction sheet. Many other kit models available. Write for Catalog K.

RADIO KITS COMPANY
120 Cedar Street New York 6, N. Y.

Follow MILT KIVER'S Series On
The Design and Operation of
"MODERN TELEVISION RECEIVERS"
Each Month in RADIO NEWS

PRACTICAL TECHNICAL TRAINING FOR YOU

SPECIALIZE In 6 Months to 3 Years

COURSES

- SERVICE**
6 to 12 Months
- Electricity
 - Welding
 - Refrigeration
 - Heating
- TECHNICIAN**
1 to 2 Years
- Electricity
 - Radio
 - Electronics
 - Refrigeration, Heating and Air Conditioning
- PROFESSIONAL**
3 Years
- Electrical Engineering
 - Bachelor of Science Degree
 - Major in Machinery or Electronics

Train for a substantial career in industry—or a business of your own. Each 6-month course is complete in itself, yet prepares you for advanced courses. More than 35,000 former students in industries the world over. 1,538 students now enrolled from 48 states and 13 overseas countries. Faculty of 72 specialists. Four terms a year.

Write for booklet "Career Building" and mention course interested in.

MILWAUKEE SCHOOL OF ENGINEERING
A Technical Institute Founded 1903

RN-748, N. Broadway and E. State, Milwaukee, Wis.

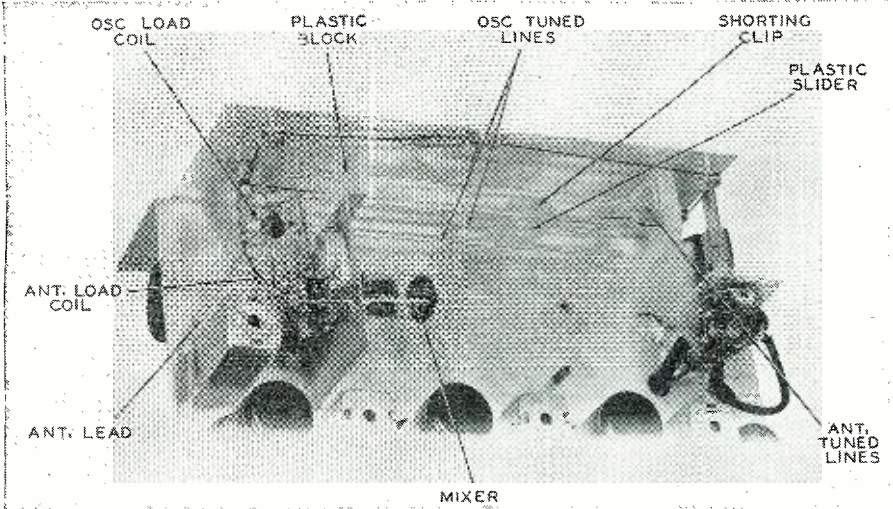

Fig. 6. Another tuner using transmission lines with shorting bar for tuning. This unit is manufactured by Edwards F-M Radio Corporation.

again to Fig. 3, it will be noted that the 100 mc. signal and the 47.85 mc. oscillator frequency will be beat together in the first converter. The difference frequency is 52.15 mc. and is shunt fed to the variable i.f. coil. This variable i.f. frequency is again beat with the same oscillator frequency in the second converter to give the i.f. frequency of 4.3 megacycles.

Since the oscillator operates at a much lower frequency than the incoming signal, the oscillator transmission line must be resonated with a high capacitance, which in this case is approximately 250 mmfd. The use of a high C/L ratio is one of the reasons for the stability of this tuner. A negative temperature coefficient condenser is shunted across the oscillator coil to counteract the change in capacitance in

the tube during warm-up. The temperature coefficients of the powdered iron core and the coaxial line differ, giving further cause for the use of the compensating condenser. Motorola tests for frequency drift show that after forty minutes the maximum drift of approximately 7.5 kc. was reached. This is well within tolerance for push-button tuning. Some of these units employ a synchronous motor for automatic tuning.

At the center of the FM band approximate stage gain values released by Motorola are as follows; antenna—4.2, 1st converter—4.0, second converter—25.4 and the sensitivity in microvolts was 1.0 for fifty milliwatts output using only one 4.3 mc. i.f. stage operating into a ratio detector. No limiters are used. Image attenuation across the entire band was found to be about 60 db.

Fig. 7. Schematic diagram of the Approved Electronic Instrument Corp. tuner.

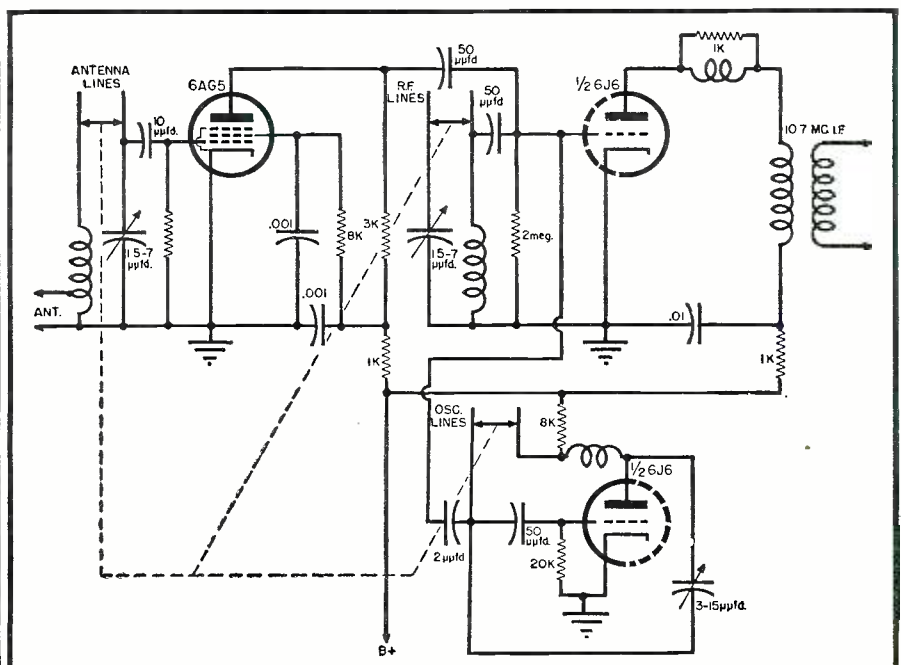

In aligning the tuner, the trimmers are adjusted at 90 mc. and the slugs are adjusted at 105 mc. This insures proper tracking and calibration across the band.

Parallel Tuned Lines

Another type tuner which has been introduced on the market is the parallel tuned lines. To date we have processed receivers from the *Approved Electronic Instrument Corporation* and the *Edwards F-M Radio Corporation* using this type tuner. The lines are tuned by means of a sliding shorting bar which is moved along the lines. A photo of the *Approved* tuner is given in Fig. 5.

The tuning lines in the *Approved* tuner are constructed of 5/32 inch brass tubing with a silver overlay .0005 inch thick. The silver overlay was used because of its wearing qualities and smooth contact surface. The lines are formed in arcs so that a circular motion may be used in tuning. Clear plastic bars, centered between each pair of lines, are attached to the tuning shaft. Upon these plastic bars are attached the shorting contacts. These contacts are formed from .007 inch thick phosphor bronze stock. They also have a silver overlay .0005 inch thick. A shield is placed between each pair of lines to prevent coupling between them. Note the tuning stop at the left end of the tuning shaft. This is to limit the tuning shaft to 180 degrees of rotation. The tuned lines, the r.f. and converter tubes, and all the component parts of the tuner are mounted on a separate chassis. This sub-chassis is shock mounted to the main chassis to reduce any tendency for microphonism. It is then bonded to the main chassis.

Each of the pairs of tuned lines is terminated in small series inductances to give the desired tuning range. These coils are mounted on the under side of the sub-chassis. A schematic of this tuner is given in Fig. 7. The antenna is coupled into the end inductance coil at the proper impedance point. The signal is capacitively coupled to the grid of the r.f. amplifier. A 6AG5 miniature tube used for this purpose has a fairly high input resistance and affords minimum loading of the tuned circuit. The output of this stage is shunt fed to the r.f. tuned circuit where it is coupled to the grid of the mixer. The oscillator voltage is also coupled to the same grid to get mixing action. The difference frequency is then fed to the i.f. amplifier. It is interesting to note that the oscillator operates 10.7 mc. below the incoming signal instead of above as is usually the case. Semi-fixed, temperature compensating, silver ceramic condensers are used across the tuned circuits to obtain maximum stability.

According to the manufacturer life July, 1948

tests on these sliding contacts have shown that after many thousands of sweeps, no apparent roughness developed on the tuned lines, which would cause noisy tuning.

Another tuner of similar design is the *Edwards* unit. A view of this tuner is given in Fig. 6. Instead of the lines being formed in arcs, they are straight. They are held in place with plastic blocks which are seen at each end of the lines. A plastic block is cut so that it makes a snug fit when placed in the center of the four lines. Clips with spring tension at the top and bottom of the block short the line as the block is moved along it.

This tuner employs a 6J6 miniature tube as a converter. No r.f. stage is

used. As was the case in the *Approved* tuner, series inductances are used to obtain the desired inductance. These are seen at the left of the picture. These inductances may be compressed or expanded, whichever is required, to give proper calibration and tracking.

The use of these tuned lines has been extended to television work, although in a slightly different form. Since continuous tuning is not required, a switch is used to short out the required amount of the line. The possibility of using frequencies much higher than those being utilized at present seems likely. This will probably bring developments in tuners more unique than those described in this article.

(To be continued)

IT PAYS To Buy Hallicrafters

From The Worlds Most Personalized

RADIO SUPPLY HOUSE

LARGE STOCKS

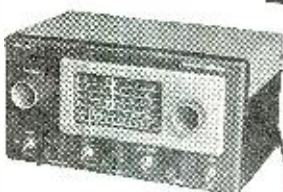

Hallicrafters S-53
\$79.50
\$15.90 Down

PROFESSIONAL PERFORMANCE

World wide domestic and short wave reception. It's sensitive, powerful, completely dependable. SIMPLIFIED control—anyone can operate the S-53. 540KC to 54.5MC—5 Tuning ranges. Electrical Band Spread-Series Noise Limiter. 2.5 watt audio output. Complete with 7 tubes and built-in speaker.



Hallicrafters SX-43
\$169.50
\$33.90 Down

PREFERRED BY AMATEURS

Hallicrafters SX-43 is designed for the discriminating amateur and short wave fans who demand the finest reception of standard A.M., F.M., Broadcasts, AM 540 KC—55MC.—FM. 44-55 MC; 88-108MC. 6 Frequency Bands—tuned RF stage—High fidelity audio—Automatic Noise Limiter.



Get Acquainted Offer
New up to date
Radio Reference Map
Just right for your control room wall. Approximately 28"x42". Contains time zones, amateur zones, leading shortwave stations, monitoring stations. Mail coupon today & 25c.

Bigger Trade-In Allowances

Fellows—BIGGER TRADE INS—let me know what you have to trade—use as down payment on my personalized payment plan to fit your budget. Get acquainted with me. I have a WORLD REPUTATION for square dealing and hosts of satisfied customers and friends. Ask anyone who has dealt with me—write me today for a PROMPT PERSONAL REPLY.

WRL Guarantees Fast, Personal Service

- Liberal Trade Ins
- Complete Parts Stock
- Orders Filled Same Day
- Ham Gear Our Specialty

Get this 68 Page Bargain Catalogue FREE!

WRITE—WIRE
PHONE 7795

WORLD RADIO LABORATORIES
744 West Broadway
Council Bluffs, Iowa

Please send me: Radio Map Free
 Parts Catalogue Send Hallicrafters illustrated catalog

Name.....Call Letters.....

Address.....

City.....Zone..... State.....



**ANOTHER ACA-100 AMPLIFIER EXCLUSIVE FEATURE
PUSH-PULL VARIABLE-SPEED DYNAMIC VOLUME EXPANDER**

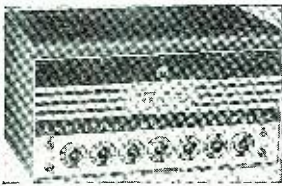

- Normal Response 20 to 20,000 cycles \pm 1 db
- Rated Power Output 23 Watts at less than 1% Total Distortion
- Independent Push-Pull High and Low Frequency Controls
- Non-Frequency Discriminating Noise Suppressor
- Push-Pull Dynamic Volume Expander with Variable Timing

Models available to accommodate GE and Pickering Phono-Cartridges

Send today for our literature, which lists complete specifications of the ACA-100 Amplifier.

AMPLIFIER CORP. of AMERICA

398-2 BROADWAY • NEW YORK 13, N. Y.

Musical recordings and transmitted programs are generally easily distinguishable from live renditions by a "flattening" effect, which robs the finest musical programs of their realism! This results from compression of the dynamic range of the original sound intensities; that is, high levels are reduced and low levels increased, because of inability of the recording and radio transmittal media to reproduce the full original dynamic range!

The ACA-100 Amplifier Series actually undoes this compressing effect! The exclusive built-in push-pull variable-speed non-overloading dynamic volume expander compensates for monitoring at broadcast and recording studios, actually recreating original dynamic ranges for all types of programs, without introducing noticeable distortion at peak levels!

Add to this feature such other "exclusives" as the non-frequency discriminating scratch and noise suppressor, an Unconditional 5-Year guarantee, and a higher fidelity circuit than has ever been built into any super-fidelity amplifier — and you have the reasons why the ACA-100 has become the standard by which all other amplifiers are judged.

TOOLRAK SAVES TIME & TOOLS

You always have the right tool at your fingertips when you equip your shop with Toolrak. Because the selected hardwood blocks are interchangeable in the extruded aluminum backstrip, you arrange them any way you want, rearrange as often as you wish. Get Toolrak in factory-assembled sets or buy individual blocks and strips to fit your special needs. Send for free folder.

Set No. 8-7, 8" long, holds 7 tools, \$1.25

Set No. 12-10, 12" long, holds 10 tools, \$1.90

Set No. 18-14, 18" long, holds 14 tools, \$2.55

If your jobber can't supply you, order direct.

Mail orders add 10c per set to cover packing and mailing.

DAVIS DEVELOPMENT CO. 348-2 First National Bank Bldg.
Colorado Springs, Colorado

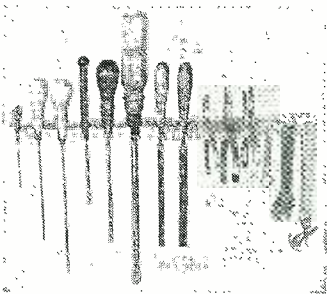

LARGEST WAR SURPLUS STORE IN AMERICA



**METERS
AT GREAT
SAVINGS!**

- Dejur model 210 0-2MADC 2 1/2" rd. \$2.95
- Westing. RX-33 0-1 MADC 3" sq. 4.95
- Weston 476 0-150 VAC 3 1/2" 4.95
- Roller-Smith MR34V 0-150 VAC 3- 1/2" round 4.95
- Weston 506 (blk. face) 0-200 MADC 2 1/2" round 2.95
- Dejur 210 0-50-0 MADC 2 1/2" 2.95



**DYNAMOTORS
BD77C**

- Input 14 volts, output 1000V at 350 mils. Comp. with mounting bracket, hash filter, & solenoid starting relay \$6.95
- PE 73 C-Input 28 volts, output 1000 V at 350 mils. Comp. with mounting bracket, hash filter, & solenoid starting relay \$4.95
- BD-AR—Input 28 VDC, output 375 volts, 150 mils with hash filter & mounting bracket \$1.95
- DM-28—For 'BC' 348 Receiver 95c
- DM32—For 274 N Receiver. Input 28 VDC, output 250 VDC at 60 mils. 95c
- DM33 A—28 volts output 575 V, 160 mils. For 274 N modulator \$1.95



**SURPLUS
SCOOP!**

TUNING UNITS

BC 375

- TU-5B, TU-6B, TU-7B, TU-8B, TU-9B, TU-10B, TU-26B.

Will ship no. indicated 'til sold out, then nearest no. sent.

REDUCED TO ONLY

\$1.25 without case
5 for \$5.75

\$1.55 with case
5 for \$7.25

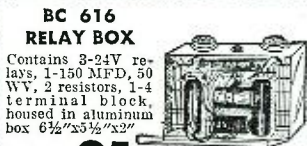

**BC 616
RELAY BOX**

Contains 3-24V relays, 1-150 MFD, 50 W, 2 resistors, 1-4 terminal block, housed in aluminum box 6 1/2"x5 1/2"x2"

95c

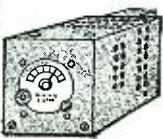

**BEACON
RECEIVER
1206 B**

Six tube superhet, 200 to 400 kilocycles.

3.95

- INVERTER PE 218C**
Input 28 volts. Exciting voltage 28v. Output 115 VAC at 1500 watts. 1 phase, 400 cycles, complete with starting relays, filter, mounting bracket. \$19.95
- 5 Asst. Dynamotors less filters **3.00**
- RESISTOR KITS**
50 resistors, 1/4 to 2 watts, assorted useable values. **77c**

JOHNSO'S FAIR

No orders filled for less than \$2.00 • 8th & Allegheny, Philadelphia 40, Pa. F.O.B. Phila.

rent until a certain critical voltage is reached, at which time it develops a low resistance that allows the high voltage to go to ground. After this is done, it returns to its former condition. It is placed between the lead-in and the ground, usually just where the lead-in enters the house."

"Most sets have built-in antennas now, though, don't they?" Miss Perkins asked.

"Outside of FM and TV sets, yes," Mac said. "But since these came along, people are once again trying to get their antennas as high and as in the clear as possible—right where the lightning likes to have them."

"I'd think a lightning arrester would upset the balance of a twin-lead lead-in," Barney offered.

"Ordinary ones would, but the engineers are bringing out new ones that don't," Mac opened a drawer and tossed a couple of objects to Barney. "That long arrester is made by G.E. and the round one is RCA. Both are made to clamp on a water-pipe, and both are especially designed for use with twin-lead lead-ins from FM and TV antennas. Some antennas of the folded dipole type are arranged so that grounding the supporting mast also grounds the antenna itself at a voltage node and so affords lightning protection without impairing the efficiency of the antenna."

"How about the damage done by lightning coming in over the line?"

"That is much more common in my experience than antenna damage," Mac said. "What happens is that high voltages are induced into the power lines, sometimes at a point some distance from the receiver, and it is piped right into the set by way of the line cord. Once inside, it may raise all kinds of hob, such as arcing the line switch, blowing condensers, burning out tubes, breaking down the insulation of the power transformer—and I once saw

Fig. 2. RCA lightning arrester for use with FM and television antennas.

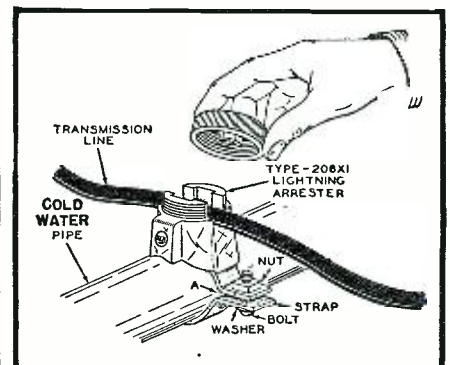

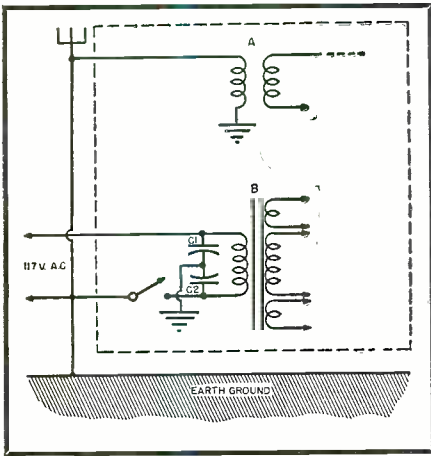

Fig. 3. If antenna terminal is connected to an external ground, lightning surge may break down C_1 , thus shorting line through the primary of the antenna coil.

where it had welded the tuning condenser plates into a solid mass."

"Does it usually do all that?" Barney asked in awe.

"Fortunately, no. The most common damages are the blowing of line-filter condensers, ruining of line switches and associated tone or volume controls, and burning out of antenna coils."

"Wup! Wait a minute there!" Barney exclaimed. "How is lightning that comes in over the power line going to hurt the antenna coil?"

Mac grinned approvingly at the boy's alertness and pointed at the diagram on the blackboard. "Remembering that half the sets in town have the antenna posts attached to the ground because the owners are too lazy to put up antennas, suppose a voltage surge comes in on the ungrounded light wire and breaks through the insulation of C_1 to the chassis and proceeds through the chassis and the antenna coil to the ground. The surge does not have to do all the work. All it has to do is break down the insulation of C_1 , and then the line current will follow this path and burn the fine wire of the antenna coil primary to a crisp."

"Tell him about the sets that turn themselves on," suggested Miss Perkins, who was taking more interest in the conversation now that the thunder had subsided to a distant growling.

"Well," Mac said, "suppose the surge does not puncture C_1 but does cause the insulation of C_2 to break down. Then the line current can flow right through the transformer primary, C_2 , the chassis, the ground lead, and the ground back to the grounded side of the pole transformer, effectively bypassing the receiver switch. People get pretty excited when their sets turn themselves on during a thunderstorm and they cannot turn them off.

"What is the best protection against these line surges?"

"The best protection is for the customer to pull the plug out of the wall socket during thunderstorms, and I warn all my customers to do that. One thing I have found helpful is to put in d.p.s.t. switches in place of the usual s.p.s.t. type used in receivers. By breaking both sides of the line, you increase the arc path, and you remove the vulnerable line-filter condensers from the line except when the set is turned on."

He was cut short by the shrilling of the telephone, and Miss Perkins ran to answer it.

"Mac's Radio Service Shop; good afternoon!"

"You say the receiver started playing without anyone's touching it, and now you can't turn it off? Well just pull the plug out of the wall socket and leave it out. Do not try to plug it back in or you may blow a fuse. We will pick it up in a few minutes."

Barney looked first at Mac's teasing grin and then at Miss Perkin's satisfied smile.

"How smug can two people look?" he asked in mock disgust.

-30-

L. F. Converter

(Continued from page 49)

trimmer across the oscillator coil. Next, with the shielded lead connected to the receiver's antenna post and the receiver tuned to approximately 1500 kc. the trimmers in the i.f. can should be tuned for maximum noise. Signals should then be heard by tuning the oscillator tuning condenser. Adjustment of the 50 mmfd. trimmer across RFC_1 can be made if any high frequency signals cause interference. Too long an antenna should not be used on the converter as strong signals will tend to block it. Most of the signals heard over the range of this converter are c.w. signals and a beat oscillator in the receiver will be necessary to hear them. Occasionally marine stations will use modulated c.w. and these can be received without a beat oscillator.

-30-



30,000 SUCCESSFUL RADIO SERVICE- TECHNICIANS READ



EVERY MONTH

RADIO MAINTENANCE today fills a breach that has existed in the radio field for a long time. Already 30,000 technicians read RADIO MAINTENANCE every month because it is devoted entirely to the radio servicemen.

The RADIO MAINTENANCE staff specializes in the preparation of articles on every phase of Radio Maintenance in series form which may be filed and used for reference. The leading articles cover everything for the radio servicemen on Television, FM and AM; Test Equipment; Electronic Appliances; Tools; Antennas; Alignment; Troubleshooting; Repair; Construction; Pick-Ups and Sound Amplification and Reproduction Equipment. Also, in RADIO MAINTENANCE each month there are departments on hints and kinks, the latest news of the trade, review of trade literature, radiomen's opinions, new products and news from the organizations. All articles are presented in a step-by-step precision style, clearly illustrated with schematics, accurate photographs, specially prepared drawings, white on black charts, color diagrams, isometric projection and exploded views.

Binders in beautiful green simulated leather are now available for your RADIO MAINTENANCE magazine. See the current issue for details. RADIO MAINTENANCE is not sold on newsstands.

RADIO MAINTENANCE
MAGAZINE

RN-7

460 Bloomfield Avenue,
Montclair, N. J.

Please send me RADIO MAINTENANCE for
() 2 years, \$5 () 1 year, \$3
() Payment enclosed () Bill me later

Name
Address
City—State
Occupation
Title
Employed by

* Independent Serviceman—Dealer Serviceman—Service Manager—Dealer—Distributor—Jobber.

BOLAND & BOYCE INC., PUBLISHERS

LIMITED SUPPLY!

**274-N or ARC/5
COMMAND SETS
FIRST COME FIRST SERVED!**

These have been used and removed from surplus aircraft and are guaranteed to work. Shipment is from Hawaii and your order will be sent from Seattle, but you may expect as much as 6 weeks delay from the day you order. Your money, (not credit slips) will be refunded if we do not have what you order.

RECEIVERS

- Except Broadcast \$4.25 each
- Broadcast \$12.00 each

TRANSMITTERS \$3.50 each

Please Specify Model or Frequency Desired

- BC348 Receiver (used)\$50.00
- BC522 Transceivers (used)\$20.00
- 24 Volt Dynamotors for 522 (new) \$4.00
- LP21A Radio Compass
- Loops (new)\$5.50

Write for our list of New and Used Aircraft Meters, Pumps, Tach. Gen. instruments at

BARGAIN PRICES

FARWEST TRADING CO., INC.

209 - 1st AVENUE, S.
SEATTLE 4, WASHINGTON
Cable Address "FARCO" Acme Code

Coming — Next Month's Issue
RADIO NEWS

"A Single Sideband Selector for
Amateur Communications Use."
By Jack Najork

**TELEVISION
ELECTRONICS**

LEARN RADIO THE
NORTHWESTERN WAY

- BASIC RADIO
- RADIO SERVICE
- COMMUNICATIONS
- INDUSTRIAL ELECTRONICS
- TELEVISION

Highly Trained Instructors
Modern Equipment
Spacious Building and Grounds

NORTHWESTERN VOCATIONAL INST.



745 Grand Ave.
ST. PAUL 5
MINN.

Television Receivers

(Continued from page 72)

interference across the video screen.

It is important to realize that the r.f. servicing procedure must be extended to include those i.f. stages through which both signals pass. Thus, whenever the sound output is distorted, or missing, and the same is true of the image, we know that some common component is defective. Obviously, if both signals are kept together through one or more i.f. stages, then these, too, must be inspected in order to locate the defective component. Whenever work is begun on an inoperative or faulty receiver, the serviceman should first inspect a block diagram of the receiver. This will indicate among other things, the point of signal separation. When one signal alone is affected, all stages prior to the separation point may be generally disregarded. On the other hand, if both signals show signs of distortion, attention should first be given to those stages up to the separation point. And if, as indicated above, one or more i.f. amplifiers are included, they must be grouped with the r.f. or front-end section of the receiver for trouble isolation purposes.

The Audio System

The sound signal, once it has been divorced from the video signal, is passed through one or more of its own i.f. amplifiers before it reaches the FM detector. At the detector output, the resultant audio voltage is further amplified until it is sufficiently strong to drive a loudspeaker. The elaborateness of the final audio system will, in large measure, be governed by the price of the receiver. In table model receivers, 12-inch speakers are rare, and the audio system is patterned closely after the current AM midget sets. When the unit is housed in a console cabinet, a larger speaker is used, with a subsequent rise in the quality of the audio output.

Servicemen who are not familiar with FM circuits may be inclined to believe that FM i.f. amplifiers differ, radi-

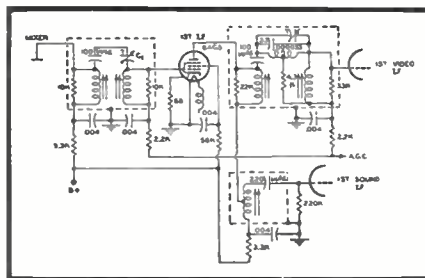
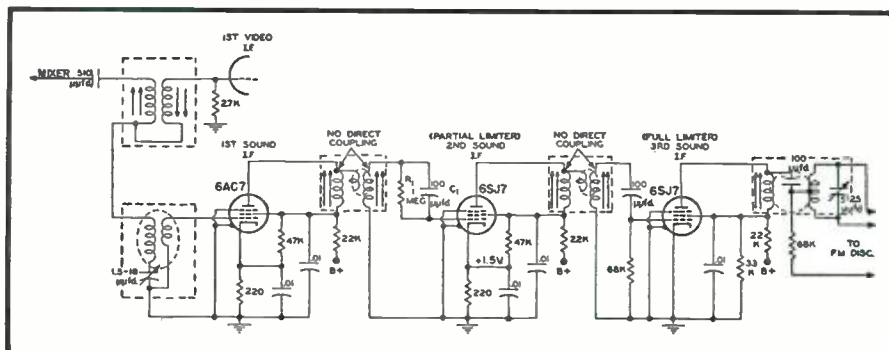

Fig. 9. Video and audio signal separation employed in Philco receivers.

cally, from AM i.f. stages. Actually, this is not so. From a servicing standpoint, the FM i.f. system of a television receiver differs in only two respects from its AM counterpart. It differs in the frequency of operation and in the bandpass of its tuned circuits. The center frequency is approximately 21 mc., and the bandpass is between 150 kc. and 350 kc. In all other respects AM and FM systems are similar, and knowledge of one system may be transferred to the other.

The television FM signal, when fully modulated, occupies a bandwidth of approximately 50 kc., (plus or minus 25 kc.) The audio bandpass, however, is designed for a greater frequency variation in order to minimize audio distortion when the mixing oscillator drifts in frequency. At 100 mc., a drift in frequency of 0.1 per-cent produces a change of 100 kc., which is more than sufficient to throw the audio signal completely out of the bandpass of the audio i.f. amplifiers. However, with normal frequency drift and a fine tuning control at the oscillator, the audio signal can be kept within the circuit frequency boundaries. In this respect, it is important for the serviceman to realize that the fine-tuning control is adjusted until the sound comes through, clear and undistorted. When this is accomplished, if detail does not appear as sharp as desired, little can be done to correct this except realignment of the video i.f. circuits. The fine-tuning control is incorporated specifically for the audio signal, and if its setting adversely affects the video signal, little can be done.

Fig. 10. The sound i.f. system used in United States Television receivers.



The number and type of audio i.f. amplifiers will depend upon the type of FM detectors in use; i.e., the Foster-Seeley discriminator, or the ratio detector. The latter further appears in two forms, balanced and unbalanced. The Foster-Seeley circuit, while essentially an FM demodulator, will, at the same time, also respond to AM. Consequently, one of the i.f. stages preceding this detector must be operated as a limiter. For the ratio detector, either in balanced or unbalanced form, such a stage is unnecessary because the detector is unresponsive to AM over wide ranges of signal amplitude. Consequently, in a system employing the latter detector, every i.f. stage will be an amplifier, although some small degree of limiting may be employed in order to reduce the amplitude of large interference pulses. Whenever the incoming disturbance possesses greater amplitude than the signal itself, noise will be heard in the loudspeaker. FM does reduce the effect of interference, but only when the signal is at least twice as strong as the interfering pulse.

The sound i.f. system of *Motorola* Model VT-101 receivers is shown in Fig. 5. The first and second stages have single iron-slug tuned coils, which resonate with a fixed condenser of 20 mmfd., and the tube capacities, to the audio i.f. frequency of 21.9 mc. Shunting resistors are not required for these coils because at 21.9 mc. several hundred kilocycles bandpass can be readily achieved by regulating the *Q* of the coil. The third stage is a limiter, required because this system feeds a Foster-Seeley discriminator. The limiting grid resistor, *R*, is kept small, so that the time constant of it and *C*₁ will be small. In this way, sharp pulses of interference (generally from ignition systems) are reduced or eliminated.

Examination of the limiter reveals that the grid resistor returns to a point which is slightly positive. Actually, the end of the grid resistor should be connected to a point of zero potential, usually ground. The foregoing circuit design reduces variations in the gain of limiter tubes, arising from differences in the contact potential. The slightly positive voltage, obtained from the "B+" drop across the 100-ohm resistor, neutralizes the negative contact potential and places the tube at actual zero bias. The operating bias voltage for the tube is then established by the grid-leak voltage developed across *C*₁ by the incoming signal.

In *RCA* television receivers, the number of i.f. stages in the audio system varies from two to three, depending upon whether the set is a console or table model. When two stages are employed, the first stage is a straight amplifier and the second is the limiter.

July, 1948

EVERY SERVICEMAN CAN afford SUPERIOR TEST-EQUIPMENT

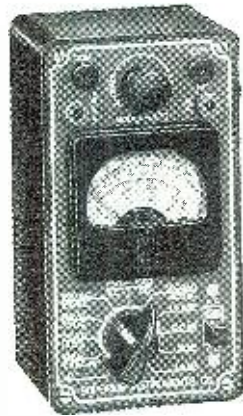

THE NEW MODEL 770 —
AN ACCURATE POCKET-SIZE

VOLT-OHM-MILLIAMMETER

(Sensitivity: 1000 ohms per volt)

Features: • Compact-measures 3 1/4" x 5 1/2" x 2 1/4". • Uses latest design 2% accurate 1 Mil. D'Arsonval type meter. • Same zero adjustment holds for both resistance ranges. It is not necessary to readjust when switching from one resistance range to another. This is an important time-saving feature never before included in a V.O.M. in this price range. • Housed in round-cornered, molded case. • Beautiful black etched panel. Depressed letters filled with permanent white, insures long-life even with constant use.

Specifications: 6 A.C. VOLTAGE RANGES: 0-15/30/150/300/1500/3000 volts. 6 D.C. VOLTAGE RANGES: 0-7 1/2/15/75/150/750/1500 volts. 4 D.C. CURRENT RANGES: 0-1 1/2/15/150 Ma. 0-1 1/2 Amps. 2 RESISTANCE RANGES: 0-500 ohms. 0-1 Megohm.

The Model 770 comes complete with self-contained batteries, test leads and all operating instructions.

13.90
NET

MFD. BY



Write Dept. RN for FREE catalog today!

SUPERIOR INSTRUMENTS CO.

227 Fulton Street

New York 7, N. Y.

at your regular jobber

TUBES! NATIONALLY ADVERTISED BRANDS TUBES!

RCA — Kenrad — Sylvania — Tung-Sol — National Union — Raytheon — Philco — Hytron
All new tubes. 100% guaranteed. Individually boxed.

TYPE	PRICE	TYPE	PRICE	TYPE	PRICE	TYPE	PRICE
0Z4	\$.80	6J7G	\$.65	6SN7GT	\$.80	7F7	\$.80
1A5GT	\$.54	6K6GT	\$.50	6SQ7	\$.54	7H7	\$.80
1A7GT	\$.65	6K7GT	\$.54	6SQ7GT	\$.54	7Q7	\$.65
1D8GT	1.15	6L6	\$.96	6SR7	\$.60	7Y4	\$.65
1F4	\$.80	6L6A	\$.96	6U5/6G5	\$.65	7Z4	\$.65
1G4GT	\$.80	6N7	\$.80	6U7G	\$.54	12A6	\$.54
1G6GT	\$.80	6R7G	\$.54	6V6GT	\$.65	12A8GT	\$.65
1H5GT	\$.54	6SA7GT	\$.54	6V7G	\$.95	12AT6	\$.54
1H6	\$.95	6SC7	\$.65	6X5GT	\$.45	12BA6	\$.65
1LC6	1.15	6SF5	\$.65	6Y7G	\$.80	12BE6	\$.65
1LD5	1.15	6SF7	\$.65	7A4	\$.65	12C8	\$.96
1LN5	1.10	6SH7GT	\$.54	7A7	\$.65	12J5GT	\$.60
1N5GT	\$.65	6SJ7	\$.54	7B5	\$.65	12H6	\$.54
1Q5GT	\$.80	6SJ7GT	\$.54	7B6	\$.65	12K8GT	\$.80
1R5	\$.65	6SK7GT	\$.54	7C5	\$.65	12SA7GT	\$.65
1S3	\$.65	6SL7GT	\$.80	7E6	\$.65	12S7	\$.65
1T4	\$.65					12SF5	\$.65
2A3	\$.96					12SG7	\$.65
3A4	\$.65					12SJ7	\$.65
3Q4	\$.65					12SJ7GT	\$.65
3S4	\$.65					12SK7GT	\$.54
3Q5GT	\$.80					12SL7GT	\$.80
3U4	\$.45					12SN7GT	\$.80
5Y3GT	\$.40					12SQ7GT	\$.54
5Y1G	\$.45					12SR7	\$.54
6A1	\$.95					14A7/12B7	\$.80
6A5	\$.80					14Q7	\$.80
6A7	\$.65					14R7	\$.80
6A8	\$.65					25L6GT	\$.54
6A7/1852	\$.65					25Z5	\$.54
6AG7	\$.95					25Z6GT	\$.50
6B4G	\$.95					26	\$.45
6R7	\$.95					27	\$.65
6U6G	\$.95					30	\$.65
6C4	\$.54					35A5	\$.65
6I5	\$.54					35L6GT	\$.54
6C8	\$.65					35Y4	\$.65
6C9G	\$.65					35Z5GT	\$.45
6F5GT	\$.65					35W4	\$.45
6F6GT	\$.54					39/44	\$.45
6F6	\$.65					30	\$.95
6F8G	\$.96					50A5	\$.80
6G8G	\$.80					50B5	\$.65
6H6	\$.54					50L6GT	\$.54
6H6GT	\$.54					53	\$.72
6I5	\$.50					77	\$.54
6J5G	\$.50					11Z76GT	\$.96
6J5GT	\$.50					VR90-30	1.15
6J7	\$.65					VR150-30	1.15



ELECTRIC PORTABLE PHONOGRAPH
Leatherette Covered, 2 Watt Amp-ifier. Plays 12 inch records with cover closed. 5 inch Alnico 5 Speaker. Rim drive constant speed. Self starting motor. High fidelity pickup. Size 17" x 13" x 7 1/2". List Price \$29.95.
NET PRICE \$15.95
LOTS OF THREE \$14.95

TERMS: 25% with Order—
Balance C.O.D.—F.O.B. Chicago
Prices Subject to Change
Without Notice

ORDER TODAY FROM

FRANKLIN-ELLIS CO. 1313 West Randolph St. Dept. R-7 Chicago 7, Ill.

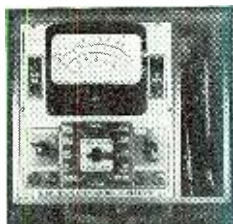

METERS & HAM RECEIVERS

Model 844 this Precision instrument 34 ranges AC DC Mils DB W/4% inch meter 5 ranges AC to 6000 V. 5 ranges DC to 6000 V. 4 ohm ranges 0-10 Meg. 6 ranges DB - 12 to +70 6 output ranges 0-6000 Wire wound shunts and metal DC multipliers both 1% accuracy. W/high Voltage Prods.

BRAND NEW IN ORIGINAL BOXES AT A BIG

SAVING IN HARDWOOD PORTABLE WALNUT FINISH CASE. OUR SPECIAL
 Natl. 100A 10 tube sup. Het. 2-4 KC to 30 Meg. \$79.00
 Super Pro 210 excellent condition like new... \$150.00
 Test set 1-236 for AC DC Capacity & Res. Spec. \$2.95
 Amplifier Facimile BC908-B 12 tube New, Spec. \$15.50
 Meter 0-25 Mils 3" square, new orig., box... \$3.50
 Meter R F 0-1 0-3 0-5 0-8 new, your choice, Spec. \$1.95
 Weston Mod. 155 Lab. meter 0-30 VAC, new \$25.00
 Weston Mod. 663 DC Volts & Ohms in orig. leather case, new, cost \$68.00, our price like new \$27.50
 Weston mod. 280 DC Volts 0-15 0-150 DC amps 0-3 0-15 0-30 in leather case, like new, special \$14.95
 DB meter 3" Rec. Type O level 6M. W. 600 ohm line \$4.50
 Voltmeter AC 0-150 round panel type new \$3.50
 T32 press to talk desk mic dose out special \$1.50
 T24 walkie talkie Mic w/cord plug & headset JK. \$1.00
 Hi imp. dual monitoring headset Reg. \$13.50 \$2.65
 Condensers 8-8 CD 450 V. Orig. pack. 50 ea. 3 for \$1.00
 Asso. 100 .1 .05 .5 .25 etc. National brands \$3.00
 Battery 103 1/2 VDC. F/Handle Mine Det. etc. \$1.35

INCLUDE POSTAGE WITH EACH ORDER
 3834 Germantown Ave. Phila., Pa. RA 5-6033

Send For These Specials ALL NEW MERCHANDISE

- 10.0 mfd., 600 V. Rectangle oil filled w/stand off insulators.....\$.95
- 2.0 mfd., 2,500 V. Rectangle oil filled w/stand off insulators..... 2.20
- 50 mmf., 32,000 V. Tubular Vacuum..... 5.95
- Telescoping antennae-AN75B, 1'-3" 7'-0" solid brass clamp on..... 1.25
- Thermo switch - Fenwall -50 +400° F. 110/220 V., 2500 watt contacts..... 1.60
- Sound Power Phones - Navy Type complete w/Microphone, Headset, 5'0' cord..... 4.95
- 3.5 V.A.C.-1.8 V.D.C. @ 1.0 amp. full wave bridge..... .75
- Fenwal -50 +400° F. 110/220 V., 2500 6.5 V.A.C.-2.2 V.D.C. @ 3.0 amp. full wave center tap..... 1.20
- Transat 115/230 V., 50/60 Cy. input, 0-260 V. @ 2 1/2 A..... 21.50
- K.V. Meter Multiplier Resistor, 1 meg., Type R-5, molded case, .1%, non-inductive, wire wound. Will provide I.K.V. indication on 0-1 M. A. meter SPECIAL 2D21 Miniature Thyatron..... .70

No Orders Under \$3.00 Please
 30% with Order - Balance C.O.D.

1527 E. Los Angeles
 Seventh Street California
EPCO

Learn and Earn! TELEVISION

RADIO F. M. COMMUNICATION

offer profitable occupation for both men and women. You learn by actual work, how to build and operate, and fit yourself for a higher pay job. Write for catalog.

Approved for Veterans
Hollywood Sound Institute, Inc.
 1040-A No. Kenmore Hollywood 27, Calif.

A CAREER WITH A FUTURE! TELEVISION

SHOP WORK • SHOP TECHNIQUES • THEORY • FULLY EQUIPPED LABORATORIES
 • RADIO SERVICE & REPAIR
 • F. M. & TELEVISION
 • TRANSMITTER COURSES
 Preparing for F.C.C. LICENSES
 • RADIO TECHNOLOGY
 MORNING • AFTERNOON • EVENING CLASSES • MODERATE RATES • INSTALLMENTS
 AVAILABLE UNDER G. I. BILL
DELEHANTY SCHOOL OF RADIO • ELECTRONICS • TELEVISION
 105 EAST 13th STREET, NEW YORK 3, N. Y. - DEPT. S
 LICENSED BY STATE OF NEW YORK

tional plate which serves as the second detector for the AM signals.

Belmont, Philco, Admiral and Andrea television receivers use FM ratio detectors and, as such, do not require a limiter. The audio i.f. systems of these sets are quite similar to the circuits already shown and need not be individually investigated. In the Andrea circuit, the third audio i.f. amplifier is made to operate as an AM i.f. amplifier by placing the two i.f. transformers in series with each other. With ratio detectors, we obtain a negative a.v.c. voltage automatically developed within the circuit, and this voltage may be utilized as a control voltage for any or all of the preceding i.f. amplifiers.

(To be continued)

Service Test Unit (Continued from page 41)

nected in series with the speaker and the pin jacks. As may be noted in Fig. 3, pin jacks are used for the speaker, resistor, and condenser terminals.

Suitable markings for these jacks were obtained by cutting the proper words from a catalog, such as "Condensers," etc., and using varnish to hold these paper labels in place.

Fig. 3 shows that the wood panel may be left in the tray when in operation if desired. Other photos show the panel removed entirely from the tray as it is not fastened by any screws to the tray. By making a fairly tight fit, no trouble is experienced.

Fig. 2 shows the circuits of the test unit as attached to the pin jacks.

If it is desired to parallel a condenser in the customer's radio, it is only necessary to plug in a couple of test leads in the jacks marked "Condensers" and turn the knob of the six point switch to any value from .01 to 40 mfd. as desired.

Polarity of the jacks for the condensers is identified with different colors on the heads of the jacks.

Likewise, values of resistance from four to twelve thousand ohms are available in three steps. Using a 25 watt tapped resistor it is often possible to close an open bleeder circuit with this arrangement.

With the triplex outlet line cord plugged into the customer's wall outlet, three points of attachment for test equipment are available, while using only one section of the home outlet.

To check a speaker, the test speaker may be attached from the plate of the radio output tube to the chassis directly with test leads, since a small condenser is installed in a series circuit on the panel.

free radio book

RADIOS HAM P.A.

Good coupon for buying guide to the best values in Radio, Ham and P.A. Equipment. Send too for the newest flyer jam-packed with bargains.

Spot-lite Values

performs PRE-AMP PHONO KIT



Build your own preamplifier kit for use with the new G. E. variable reluctance or Pickering pickup. This kit enables you to have a fine pre-amp and save money. Easy to build, with full instructions, all parts and 6SC7 tube. Complete with chassis, resistors, condensers, tube and all parts plus simple instructions and diagrams.

X248-Pre-Amp Kit—Your Cost..... \$3.95

3-Inch Nylon Tweeter

Makes a fine woofer-tweeter combination for any high-fidelity job. Heavy 7 oz. Alnico V magnet and a 3.2 ohm voice coil. Sturdy nylon one piece one for high frequency.

XPS 876 Wt. 2 lbs. \$1.89
 Your Cost.



from Lafayette

MAIL NOW

New York
 100 SIXTH AVE.
 110 Federal St. Boston 10
 24 Central Ave. Newark 2

Lafayette Radio

RADIO WIRE TELEVISION, INC.
 Dept. RG-8, 100 Sixth Avenue, N. Y. 13
 Send #X248 @ \$3.95 ea..... quantity
 #XPS876 @ \$1.89 ea..... quantity
 Enclosed: check money order
 Send catalog New Flyer C42

Name.....
 Address.....
 City.....Zone.....State.....

RISCO HAS IT

All Changers Brand New

V. M. MIXER CHANGER

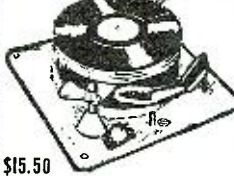

\$15.50

Above Easily Attached to Any Radio or CAN BE USED WITH AMPLIFIER BELOW

PLAYS 10" and 12" records at the same time \$15.50
2 for \$29.00
V.M. 400 \$28 prepaid

DETROLA, \$13.75

G. I. RECORDERS

Single Speed \$22
Dual Speed \$26
40% off on
Recording Recording
Seeburg Mixer \$32.50

SERVICEMEN'S SPECIALS

- 100-INSUL. RES. KIT 1/2, 1, 2W \$1.45
- 100 ma. Selenium Rectifiers 59c
- Astatic Cartridge Nylon 1-J \$3.45
- Astatic Cartridge L-70 3.45
- Astatic Cartridge MLD 1-2 3.45
- Eveready-Minimax 67 1/2 V. Batt. New
- I.F. Trans. -456 K.C. Shielded in or out 35c
- Meissner Osc. Coils, 456 K.C., 12SA7 12c
- 100 Ft. 300-ohm Lead-in wire \$1.65
- 7EP4-Television Tubes, New \$14.95
- 100 Ft. Phosphor Bronze Dial Cable 35c
- 100 Ft. Hookup Wire 49c
- Volume Controls, 500M, 19c, With Sw. 29c
- 50L6-Output Transformers 32c
- Variable Condensers, 365M, Superhet. 54c
- Antenna Loops 23c, 8 push button sw. 35c
- Condenser Specials, New Stock
- 20x20-150V. 29c
- 8 x 8-450V. 45c
- 8 x 4-0V. 25c
- 16 x 450V. 39c
- Bypass up to .02 5c
- 50x30-150V. 38c
- ALLIANCE PHONO MOTORS 2.30
- ASTATIC L-70 1.79

PHONO AMPLIFIER

3 TUBE AC-DC

Vol. & Tone Control \$2.75

Uses 12SQ7, 50L6, 35Z5.

Wired & Tested

Set of 3 Tubes \$1.75

Output Trans 39c

Alnico Spk 1.19

PHONO OSC-2-TUBE

Wired & Tested

2 Tubes-\$1.20 \$2.75

25% on C.O.D. orders. Orders Filled as Received

VISIT OUR NEW SHOW ROOM

Free Catalog "RJ" Just Out

We Specialize in Mail Orders

RISCO ELECTRONICS

WHOLESALE DISTRIBUTORS

25 West Broadway, N. Y. 7, N. Y.

STOP FUMBLING!

New radio special QUICK-WEDGE SCREW-HOLDING SCREWDRIVER HOLDS the screw, REACHES those impossible places, STARTS it and DRIVES it home!



6" BLADE, 8 1/2" OVERALL LENGTH

—DOUBLE BLADE FOR EXTRA STRENGTH! BUY AT YOUR DEALER'S OR WE WILL SHIP POSTPAID UPON RECEIPT OF \$1.00.

KEDMAN COMPANY
233 SO. 5TH WEST, SALT LAKE CITY 1, UTAH
ENCLOSED FIND \$1.00—SEND ME A QUICK-WEDGE "RADIO SPECIAL" SCREWDRIVER.

NAME _____

ADDRESS _____

CITY _____ STATE _____

RN6 _____

Mass. Radio School

273 Huntington Ave., Boston 15, Mass.

Offers Training Courses for Radio Technician (Pre-Television) and Licensed Radio Operator (All Types) including maintenance and operation of General Electronic Equipment. Over 20,000 Alumni and 28 years radio training EXPERIENCE. Courses approved for G. I. Training for Veterans.

Licensed by Commonwealth of Mass.
Department of Education

Classified

Rate 20c per word. Minimum 10 words.

RADIO ENGINEERING

RADIO Engineering Broadcasting, Aviation and Police Radio, Servicing, Marine Operating and Electronics taught thoroughly. Expenses low. Write for catalog. Valparaiso Technical Institute, Dept. N, Valparaiso, Ind.

FOR SALE

NEW and used Collins, Hallicrafters, National, Hammarlund, RME, Millen, Meissner, other receivers, transmitters, test equipment, amplifiers, speakers, parts, etc. Lowest prices. World's best terms. Shipped on approval. Write: Henry Radio, Butler, Missouri and 1240 West Olympic Blvd., Los Angeles, Calif.

RESISTORS, shunts and multipliers, precision wire-wound, 1/10th per cent accuracy. Assortment of 15 values, while they last \$1. McCoy Sales Company, P. O. Box 335, Berea, Ohio

COIN operated radios, save \$160. 20 new (still boxed) Coradios \$51.50 each. \$240 deposit balance COD. S. Lauchner, 6320 W. 84th Place, Los Angeles, California

LOOK ahead. Replace short-lived vibrators and rectifiers with these very reliable, long life P.M. Dynamos: Output; 240V @ 100MA., from 6.3V input. New surplus, ready to use. Full data supplied. F.O.B. only \$4.50 each, crates of 4, \$16. E.H. Pallme, 375 Oak Place, Mineola, N.Y.

8" PM SPEAKERS, with wall baffle and out-pump transformer, slightly used, \$2.39; 25mfd 400V Tubulars, 25 for 95¢; RG8/U Cable 35', 65', 100' lengths 4¢ foot; Throat Microphone 29¢; Prices F.O.B., Alco Electronics, Box 214, Lawrence, Mass.

JENSEN JAP60 Coax Speaker \$35. Excellent condition. James Miller, 2742 Catherine St., Shreveport, La.

NEW cartoned tubes 39¢ each. 100 assorted for \$35. 1R5, 1S5, 1T4, 3Q4, 3S4, 5Y3gt, 6A8gt, 6C5gt, 6F5gt, 6J5gt, 6Q7gt, 6SA7, 6SK7gt, 6KTgt, 6Q7gt, 6K6gt, 6V6gt, 6SN7gt, 12A7gt, 12SA7gt, 12SQ7gt, 12SK7gt, 25L6gt, 32L7gt, 35B5, 35W4, 35Z5, 47, 50B5, 50L6, 70L7gt, 117Z3, 117L7gt, 117P7gt. Write for bargain flyer. Henshaw Radio, Supply, 3313 Delavan, Kansas City 2, Kansas

AMPLIFIER ACA100DC 1947 model make offer. Elmer Seavey, 79 Chenango St., Buffalo, N.Y.

ACCURATELY align superheterodynes without signal generator. Complete instructions \$1. Satisfaction guaranteed. Norman, 527 Laird Boulevard, Montreal, Que.

SCHMATIC for BC-929A 3 inch Radar Indicator \$1; Oscilloscope conversion instructions, layout, parts list for above \$2. C.H. Prowse, 2310 Spokane St., Seattle 44, Washington

BUILD A Superonic Octometer; An ultra modern test instrument, incorporating a V.T. Voltmeter, V.T. Ohmmeter, Signal Tracer, Signal Generator, Amplifier, Auxiliary Power Supply, Speaker, Microphone and Pick-up tester, in one small portable cabinet. For complete Diagrams, Schematics, Panel Template, Chassis layout, Assembly and operating instructions, send \$2 and this ad to; Grand Federal Supply, Box 57, Argentine Branch, Kansas City 3, Kansas

SPECIFICATION & Prints of the First Successful Permanent Magnet Motor, \$10. Plus right to make model. Send ten cents for literature. George J. Altman, 150 Broadway, New York 7, N.Y.

COLLINS ART-13 complete \$127; Push-pull 250TH RF Amplifier; .002 Mica Condenser 2500 WV \$2.70 dozen; Johnson Steatite Sockets, seven or octal \$2 dozen; Ceramic Condensers, four units: 185, 200, 280, 400 MMF 60¢, single units 50 MMF 7500 PV \$2.80 dozen; Code Practice Tapes; etc. W9PPG, Mount Vernon, Iowa

HALLICRAFTER HT-9 transmitter excellent operating condition with all coils, etc. Make offer. 360 So. F. St., Oxnard, Calif.

F.M. CONVERTER units, old, band to new 88-108 Mc. band, with instructions \$5. Radio-electronics, 436 Cornelia St., Boonton, N.J.

NEW 6 Conductor #18 Color Code rubber covered cable 5¢ per foot. Wolverine Entertainers, Inc., 88 Newberry Street, Pontiac 18, Mich.

PANELS. Complete service. Inquiries invited. Gilpin, Box 638R4, Mt. Clemens, Mich.

GRILL Cloth. Celanese, light and dark pieces, 1000 sq. inches for \$1 bill. Write for list of lowest priced national brand parts in nation. Bursma Radio, Route 5, Grand Rapids, Mich.

NEW tubes: 802, \$1.25; GL8020, \$3.50; VR90, 81, 45, 884, 50¢. Variacs: 2KVA, \$25. 5KVA, \$45; Saturable Reactors 6KVA, \$75. Transformers: 110V to 3,000V, 3KVA \$25; 110 to 1500V, 3.4KVA, \$30; 30W Sola, \$8; 34 others. Thordarson T-15C46 Choke, \$8. Batteries: sealed, protected, Ray-O-Vac, Eveready, Burgess, 1 1/2-90V AB 2 1/4"x4 3/4"x10", \$1.50; 45V 4 3/8"x8"x8", \$1; 6V Hotshot 2 3/4"x1 1/2"x10 3/8", \$1; 6V or 1 1/2"x2 1/2"x4, 25¢; 45V 2 1/4"x4"x5" or 1 3/4"x4 5/8"x3", 75¢; others. Satisfaction guaranteed. Add postage. D.D. Smith, Box 74, Oak Ridge, Tenn.

RADIO Tubes, bargains, national advertised radios, test equipment, etc. Address Radio Tubes, Box 108, Elizabeth City, N.C.

YOU can accurately align Superheterodyne receivers without signal generator. Complete instructions, \$1. Moneyback guarantee. Chas. Gates, Pecos 1, Texas

LOWEST Prices, Radio Tubes, parts. Bargain lists, 3¢. Potter, 1314 McGee, Kansas City 6, Mo.

V.O.M. ASSEMBLY, consists of 18 wire-wound, non-inductive, precision resistors mounted and fully wired on low-loss, wafer-type, rotary switch, ready to connect to your meter to make highest grade instrument. While they last price, \$2.50. Radioco, 1110 Marshall Bldg., Cleveland, Ohio

TELEVISION components for assembly of a modern 52 square inch screen receiver using the newest circuits and tubes. The only kit on the market featuring an aluminumized cathode ray tube, A.F.C. on horizontal sync and a wired, pre-aligned r.f. tuner covering any combination from 1 to 13 television channels. Sound and Picture IP's are on one sub-chassis using new 6AH6 miniature tubes having a gm of 9000. The IP Strip and the 9000 volt RF Power Supply are sold in kit form. The main chassis is sold with all holes punched, with suggested chassis layout print. All components individually priced. Our catalog lists television components exclusively and shows parts and circuits of the "hard to find items" you have been looking for. Send for it today. It's free. Television Specialties Co., 315 Madison St., Oak Park, Ill.

BRAND new five inch 'Scope like Dumont 274 list \$127.50. Need cash. Sell for \$99.50. D. Shapiro, 118-45 Metropolitan Avenue, Kew Gardens 15, N.Y.

6V DYNAMOTOR from 12V surplus. No rewinding. Original output. Instructions 50¢. Satisfaction guaranteed. Paul Hawkins, 1306 E. 27th St., Kansas City 8, Mo.

DON'T waste time on FM, TV and other VHF alignment. Use the VHF Alignment Wand, 60¢. Save time and headaches. Free particulars. Hawkins Radio, Box 4632, Kansas City 3, Mo.

BARGAINS. DeJur 20,000 ohm pot, 50¢. Heavy duty rheostat, bronze contacts, metal box \$1.50. 1/6 hp 4500 rpm 12 volt motor \$3.50. High speed 24 volt motor for hand grinder \$1. 12 volt, 3 rpm motor for antenna beam \$5.50. Bronze flexible shaft, 24 inch 50¢. Large Selsyn Differential 3 1/2"x4 1/2" \$3.50. Thordarson transformer 110 volt primary, 6.3 volt, 12 ampere secondary, \$2.50. Plastic midget Cabinet \$1, chassis 50¢. Cabinet 6x7x10 1/2. chassis 50¢. Metal meter box 3x5x7, \$1. Carbon Pile voltage regulator 18.5 volts \$3.50. Micromatic Control boxes \$1. Ward-Leonard Ribblex 43.5 ohm 500 watt \$1. Veeder Electric Impulse counter \$2. Microphone, Interstage or Output audio transformers 40¢. 4635 KC Plastic antenna coil 40¢. 2MC I.F. Transformer, slug tuned 65¢. 456KC 1st and second stage I.F. Transformers, slug tuned \$1.50 pair. 20 asstd. terminal strips \$1. Antenna Change-over Switch, silver contact 50¢. Aerovox, 5 cond 400 vdc. 10¢. Radioco, 1110 Marshall Bldg., Cleveland, Ohio.

ACCURATELY align superheterodynes without signal generator. Complete instructions \$1. Satisfaction guaranteed. Norman, 527 Laird Boulevard, Montreal, Que.

WANTED

BENDIX MN-311 Loop Control units, Bendix RTA-1B communication units, ARC-3 VHF transmitter-receivers. Reeve Airways, Anchorage, Alaska

JAN inspected tubes: 6SA7, 12A6, etc. Exchange against things Chinese. McChang, Postbox 341, Shanghai, China

TYPE 101 B 1000/20 cycle rings manufactured by Federal. Type J68602 Ringer-Oscillators manufactured by Western Electric. Box No. 461, c/o Radio News, 185 N. Wabash Ave., Chicago 1, Ill.

WESTERN Electric Vacuum Tubes. Types 101F, 102F, 272A, 274A or B, 310A or B, 311A, 313C, 323A, 328A, 329A, 348A, 349A, 352A, 373A, 374A, 393A, 394A, 12L1 Ballast Lamps. Box No. 462, c/o Radio News, 185 N. Wabash, Chicago 1, Ill.

HELP WANTED

INSTRUCTORS in Electronics and Radio. Prefer former Navy Radio Technician instructors willing to locate in the Detroit, Mich. Area. Write to Box 452, c/o Radio News, 185 N. Wabash Ave., Chicago 1, Ill.

PATENT ATTORNEYS

LANCASTER, Allwine & Rommel, Registered Patent Attorneys. Patent Practice before U.S. Patent Office. Validity and Infringement Investigations and Opinions. Booklet and form "Evidence of Conception" forwarded upon request. Suite 414, 815 15th St., N.W. Washington 5, D.C.

CORRESPONDENCE COURSES

USED Correspondence Courses and Books bought, sold, rented and exchanged. Catalog free. Lee Mountain, Pisgah, Alabama

AMATEUR radio licenses. Complete code and theory preparation for passing amateur radio examinations. Home study courses. American Radio Institute, 101 W. 63rd St., New York 23, N.Y.

USED Correspondence Courses and Educational Books, bought, sold, rented, catalog free. Educational Exchange, Somerville, Georgia

MISCELLANEOUS

TELEVISION, self taught. \$1.50 book "TV Construction" by Liebscher, tells how to build, align, operate, trouble shoot TV set described in Sept. '47 Radio News. \$1 factory size blueprint of schematic with block diagram shows alignment frequencies. Special offer: send \$2 for both to Electronic Development Co., 7613 Fayette St., Philadelphia 38, Pa.

BC-454 OR 455 easily converted to hot ten meter receiver. Fixed or mobile. Instructions schematics, \$1. N. Brown, 3327 Geronimo, Tucson, Arizona

MAKE more money, easily. Become independent. We show you how. Eye-opening information free. Radio-men and beginners, write: Merit 216-32d 132nd Avenue, Springfield Gardens 13, N. Y.

26 YEARS experience radio repairing at your fingertips. I've repaired 45000 radios. Have perfected simple system you can follow step by step. No calculations or formulas. Total price, \$2 postpaid or C.O.D. Money back guarantee. Ross Radio, 14615-C Grand River, Detroit 27, Mich.

QSL'S SWLs samples. WSFAY Press, 6118 Goliad, Dallas, Texas.

ELECTRICAL, Electronic parts or products desired by manufacturer. Engineering, manufacturing, shipping facilities available. Box 464, c/o Radio News, 185 N. Wabash Ave., Chicago 1, Ill.

ERRATA

In the article "A Unique A.V.C. Amplifier" by J. T. Goode appearing on page 67 of the April, 1948 issue of Radio News, the circuit diagram of Fig. 2. (page 160) is in error. R₁ and C₂ should connect to the cathode of the 6SQ7 as shown in Fig. 1 on page 67.

In Part 15 "The Recording and Reproduction of Sound" (May, 1948) an error appears in the parts list of Fig. 2. C₃ should be 100 mfd. C₂ should be 100 mmfd. while C₄ should be 50 mmfd. instead of the values given.

The schematic diagram covering the article "A 2-Tube Phono Amplifier" appearing on page 45 of the May, 1948 issue should show the plate pin on V₁ as No. 2 instead of No. 4 as indicated.

Photo Credits

Page	Credit
35 (bottom), 36 (top), 44, 45, 138	Radio Corporation of America
36 (bottom)	American Telephone & Telegraph Co.
38, 39, 168	Howard W. Sams & Co., Inc.
43, 47, 104	Allen B. DuMont Labs., Inc.
48, 66	General Electric Company
52	General Radio Company
53, 128	Aerovox Corporation
55, 56, 57	Humble Oil & Refining Co.
60	A. Kapustynsky
128	West Coast Electronic Mfg. Assn.
133	J. P. D. Manufacturing Co.
142	Electronic Associates, Inc.
162	Acme



"Yeah Ed, I think that's a definite power hum!"

VEE-D-X means "VIDEO DISTANCE"

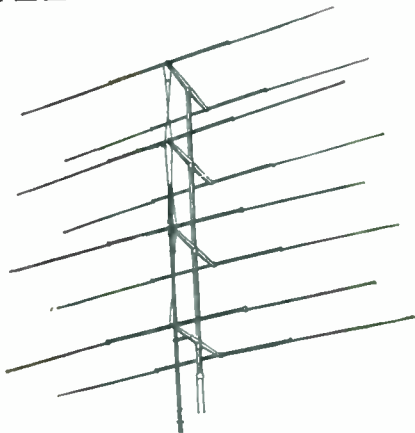

- Highest Gain of any Antenna on Market.
- Sharply Directional assuring maximum desired signal.
- Weighs less than 25 pounds—sturdily built of Duraluminum.
- Completely equipped with Matching Stubs.
- Broad Band—Model R.D.-6; for Channels 1 to 6; Model R.D. 13, for all 13 Channels.



2-STAGE PRE-SELECTOR Model R.C.-2

- Guaranteed 5 megacycle band width. (assures quality pictures)
- Gain 40 d. b.
- Matches Impedance of Transmission line to input of Receiver.



LIGHTNING ARRESTER High Frequency—Low Loss

- Designed Especially for Video and F.M.
- Unnecessary to cut Transmission line for installation.
- Unnecessary to change spacing of Transmission line.
- Does not vary impedance.
- High dielectric low loss Plastic material.

"THERE'S MORE VISION IN TELEVISION" See Your Nearest Jobber or write direct

La Pointe-Plascomold Corp.

UNIONVILLE, CONNECTICUT



... It's only a whisper!

Because Quantities are Limited. Get your orders in for these bargains, now. War surplus stocks are almost gone, and special values like these brand new items are scarce.

I-82A Selsyn Indicator

5" dial, calibrated in 360 degrees. Contains one selsyn motor that will operate from 6 to 10 volt, 60 cycle source. Ideal as rotating beam indicators. Brand New, in original cartons.



Each \$2.50

BC-645 Transmitter-Receiver

435 to 500 M.C. 15 tubes. Easily converted to 115 volt operation, and to 420 M.C. amateur or 465 M.C. citizens bands. Schematic and instructions included. Brand new, in original cartons.

Each \$9.00

TUBES—All brand new, J.A.N. in cartons

5BP-1\$1.15	1625seven for \$1.00
5BP-4\$1.55	211three for \$1.00
12K8\$.50	12SK7\$.50
12A6\$.19	RK-34\$.35
9003\$.19	9006\$.19
		954\$.19

Write for FREE Circular

All prices quoted are NET, F.O.B. our warehouse Chicago.

All items subject to prior sale. 10 days to rated firms and individuals, all others 20% minimum with order, balance C.O.D.

QUAD ELECTRICAL SUPPLY, INC
1650 North Damen Avenue, Chicago 47, Illinois



We use "revolutionary" advisedly. You'll agree when you add new "805" 100 kc. I.F. Amplifier to your present receiver that the phone/broadcast selectivity and noise reduction it gives are revolutionary. Less than this improvement has been described as "like nothing you've ever seen or heard before".



Added to any superhet having i.f. lying between 450 and 500 kc., Model 805 will cut dial-spread on even the strongest local station down by 75% . . . will reduce noise unbelievably. It gives your present set a selectivity curve of 2.4 kc. wide 2X down, falling almost vertically to only 7.2 kc. wide at 10,000X down—an engineering dream come true. 805 gives single-side-band selectivity, the ability to reject noises, heterodyne squeals and all QRM on one side of the signal or the other—yet get clear, crisp speech and music without deleterious side-band cutting.

Add Model 805 to your present set, and you have next year's new receiver today. Its selectivity gain-noise reduction is revolutionary.

Price, less 1 ea. 6BE6, 6BA6, 6C4 tubes \$18.90
Model 805K Kit with pictorial instructions \$15.90

OVER 37 YEARS OF RADIO ENGINEERING ACHIEVEMENT
McMurdo Silver Co., Inc.
EXECUTIVE OFFICE: 1248 MAIN ST., HARTFORD 3, CONN.
FACTORY OFFICE: 1249 MAIN ST., HARTFORD 3, CONN.

JULY SPECIAL

Wire Wound Resistors 450 ohm 10 watt, 15 watt and 25 watt . . . 10 for \$95 . . . in any combination.
RESISTOR KITS \$1.45 | **CONDENSER KITS \$1.75**
 100 assorted carbon and wire wound resistors . . . 50 assorted paper and mica condensers . . . all new . . . good value.

Wireless Phono Oscillator \$4.52

Operates as far as 100 ft. from radio and can be used with automatic record changer and players . . . complete with 2 tubes all wired and tested. Diagram.

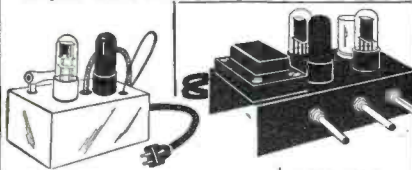

Phono Pre-Amplifier \$4.95

This unit is for G.E. Reluctance type cartridge. Completely wired, tested. Supplied with diagram, and tube 6SC7.



Mike and Phono Amplifiers \$12.95

This unit sold complete with power transformer, 3 tubes and 3 controls . . . all wired and tested. Diagrams supplied.

RADIO PARTS

G. E. Reluctance Cartridge. List \$7.95	\$4.54
4" PM Speakers	.95
5" PM Speakers	1.15
6" PM Speaker	1.55
5" 450 ohm dynamic Spk. with 50L6 output	1.95
Selenium Rectifiers—100 Ma Famous Make	.69
1/2 meg. Volume Control and Sw. long shaft	.35
Osc. Coil 128A7	.15
6 ft. line cord	.13
Nat'l famous Crystal Pickups	1.89
Nat'l adv. Crystal Cart. L-70A, L-26A, L-40	1.59
Nat'l famous Motor and Turntable	2.50

FAMOUS MAKE CONDENSERS

50x30 150V.	\$45	16 450V.	\$39
20x20 150V.	.38	400V or 600V	Per 10
20x20 (10) 150V. (25)	.39	.01, .02, .05	.49
8x8 450V.	.49	.001, .002, .005	.49
25 25V.	.29	.1	.59
25 50V.	.29		

All Prices F.O.B. N.Y.C. — On C.O.D. 25% Dep.

THE ROSE COMPANY

88 West Broadway, Dept. (N) N. Y. 7, N. Y.

SCR-536 HANDY TALKIES

Convenient hand carry transceiver. Popular with infantry. Present frequencies ranging from 3.5 to 6.0 MC. 5 miniature tubes. 384 HF output. Telescoping whip antenna 41" long. Top operating condition. Size 3 1/2 x 3 1/2 x 1 1/2. 7 lbs. Schematic. **\$34.95**

BC-221 FREQ. METER

125 KC to 20 MC popular precision heterodyne meter. Complete with crystals. Calibration book. Completely tested before shipment. Similar to Navy Type LM. Self contained battery compartment. Schematic. **\$37.95**

BC-342 RADIO RECEIVER

6 bands. 1.5 to 18 MC. Crystal phasing BFO. MVC/AVC. 110V 60 cycle. Extremely stable well built. All tubes. Operating. Schematic. **\$54.95**

JAN TUBES

6AC7 . . . \$.79	6AG5 . . . \$.89	9CA . . . \$.29
6AK589	6I669	95549
332229	3AP1 . . . 2.29	2X269

1" paper capacitor. 4 MFD 500 VW cased. . . . \$.24
 Filter Choke, 9H @ 400 MA 3KV insulation. . . . 4.95
 Weco
 Paper capacitor. 2 MFD 600 VW cased. . . . 1.19
 25% Deposit — Balance C.O.D.

EASTERN ELECTRONIC SALES

31-B Cedar Drive Baltimore 20, Maryland

LEARN RADIO!

IN ONLY 10 MONTHS
PREPARE FOR A GOOD JOB!
 COMMERCIAL OPERATOR (CODE)
 BROADCAST ENGINEER
 RADIO SERVICEMAN

Television Servicing—15 Months

Veterans get \$130.00 Equipment
 SEND FOR FREE LITERATURE
BALTIMORE TECHNICAL INSTITUTE
 1-125 EUTAW PL., DEPT. R, BALTO. 17, MD.

INDEX OF Advertisers

JULY 1948

While every precaution is taken to insure accuracy, we cannot guarantee against the possibility of an occasional change or omission in the preparation of this index.

ADVERTISER	PAGE NO.	ADVERTISER	PAGE NO.
Abell Distributing Co.	116	General Electronics Distributing Co.	95
Acorn Electronics Corp.	133	General Test Equipment.	159
Airborne Sales, Inc.	166	Goodheart, R. E.	146
Allen Corp., Tom.	105	Greenlee Tool Co.	98
Allied Radio Corp.	9	Greenwich Sales Co.	112
Almo Radio.	164	Greylock Electronic Supply Co.	158
Alvarado Supply Co.	96, 160		
American Radio Institute.	172		
American Radio Supply.	127		
American Sales Co.	158		
American Surplus Products Co.	115	Hallcrafters Radio.	5
American Television and Radio Co.	135	Hallmark Electronics Corp.	106
Amperite Co.	136	Harris Supply Co.	104, 153
Amplifier Corp. of America.	144, 168	Harvey Radio Company, Inc.	18
Arrow Sales, Inc.	92, 93	Heath Company.	82, 83
Ashe Radio Co., Walter.	32	Henry Radio Stores.	108
Audel Publishers.	26	Herbach & Radman.	126
Audio Development Co.	129	Hollywood Sound Institute.	110, 173
		Howard Machine Products Co.	160
		Humeston, F.	72
Baltimore Technical Institute.	176	Hytron Radio and Electronic Corp.	33
Bell Telephone Laboratories.	6		
Berman Co., Inc., Henry O.	177		
Bliss Electrical School.	153	Indiana Technical College.	159
Brooks Radio Distributing Corp.	160	Industrial Television, Inc.	146
Burlington Instrument Co.	146		
Burstein-Applebee Co.	141		
Buyers Syndicate.	102		
		JFD Mfg.	150
Candler System Co.	90	Jensen Mfg. Co.	79
Cannon Electric Development Co.	98	Johnson Company, E. F.	9, 140
Capitol Radio Engineering Institute.	29, 73	Johnson Company, E. M.	153
Centralab, Division of Globe Union, Inc.	30, 31	Johnson's Fair.	168
Certified Television Laboratories.	76	Joseph, Irving.	89
Chicago Industrial Instrument Co.	110		
Chicago Transformer, Division of Essex Wire Corporation	77	Kedman Co.	174
Cinaudagraph Speakers, Division of Aireon Mfg. Corp.	147	Klein, Manuel.	162
Cinex, Inc.	144		
Cleveland Institute of Radio Electronics.	34	Lake Radio Sales Co.	110
Collins Audio Products Co.	135	LaPointe Plascomold.	175
Columbia Wire & Supply Co.	132	Lear Radio Co.	103
Commercial Radio Institute.	102	Leeds Radio Co.	101
Communications Equipment Co.	121	Le-Hi Electrical Company	162
Concord Radio Corp.	76	Leontone Radio Co.	132
Coradio.	96	Lincoln Engineering School.	96
Cortley Television Corp.	124	Long Island Radio Co.	140
Coyne Electrical & Radio School.	106, 156		
Crest Corp.	165		
Crystal Devices Co.	162		
		Mallory & Co., Inc., P. R.	Third Cover
Davis Development Co.	168	Marco Electronics, Inc.	144
DeForest's Training, Inc.	19	Martin School of Radio Arts, Don.	145
Delehanty School of Television.	173	Mass. Radio School.	174
Dow Radio.	98, 163	Meissner Mfg.	151
Dunn-Wright Electric Co.	72	Melville Radio Institute.	158
Duotone Company.	120	Merit Coil & Transformer Corp.	20
		Mid-America.	80
Eastern Electronics Sales.	176	Miller Company, J. W.	136
Edlie Electronics.	146	Milwaukee School of Engineering.	166
Electr-Voice, Inc.	177	Morts Radio Shack.	102
Electronic Sales Co.	160	Moss Electronic Distributing Co.	22
Electronic Supplies.	142, 156	McConnell's.	173
Electronics Institute, Inc.	165	McCoy Sales Co.	152
Ellis Co., Franklin.	171	McGee Radio Company.	74, 75
EPCO.	173	McGraw-Hill Book Company.	164
Ereco (Dick Rose).	112	McMurdo Silver Company.	15, 175
Esege Sales.	154		
Espey Mfg. Company, Inc.	114	Nation Wide Radio.	90
Esse Radio Company	99	National Equipment & Supply Co.	124
		National Radio Institute.	3
Fair Radio Sales.	118	National Schools.	23
Farwest Trading Company.	170	New York YMCA.	104
Federal Telephone & Radio Corp.	27	Newark Surplus Materials Co.	145
Federated Purchaser, Inc.	137	Newcomb Audio Products Co.	90
Feller Engineering Company.	143	Niagara Radio Supply Co.	111, 149
		Northwestern Vocational Institute.	170
G. & G. Radio Parts Service.	71		
G. & M. Sales.	151	Offenbach & Reimus Co.	78
General Cement Mfg. Co.	122	Ohmite Manufacturing Company	10
General Electric Company.	14, 69	Opad & Green Company.	153
		Oxford Reconing Service.	100
		Peak Electronics.	138
		Photocon Sales.	147

ADVERTISER

PAGE NO.

Plastics & Electronics Company. 172
 Potter Radio Company. 150
 Precision Apparatus Co. 155
 Premax Products. 122
 Progressive Electronics Co. 72, 155

Quad Electrical Supply. 175
 QuamNichols Company. 158

RCA Institutes, Inc. 76
 R & M Radio Company. 86, 87
 Radiart Mfg. 25
 Radio Apparatus Co. 157
 Radio Coin-Matic. 159
 Radio Corporation of America 11, Second Cover
 Radio Electric Service Co. 136
 Radio Ham Shack. 107
 Radio Kits Company. 166
 Radio Maintenance. 109, 169
 Radio Parts Company. 129
 Radio Parts Distributors. 154
 Radio Supply & Engineering Co. 85
 Radio Wire Television, Inc. 173
 Radiomart, Inc. 143
 Radionic Equipment Co. 159
 Radolek Company. 120
 Rauland Corp., The. 135
 Ravac Electronics Corp. 150
 Rider Publisher, Inc., John. 12, 13, 152
 Risco Electronics Wholesale Distributors. 174
 Rose Company. 176

Sams Company, Howard W. 21
 Schuh's Radio Parts. 140
 Seeburg Corp., J.P.. 100
 Senco Radio, Inc. 165
 Servo-Tek Products Co. 117
 Smith, Wardell. 104
 Spellman Television. 119
 Sprayberry Academy of Radio. 7
 Stahl, Inc., Michael. 128
 Standard Electrical Products. 143
 Standard Radio & Electronic Products Co. 139
 Stanton Radio Supply. 90
 Sun Radio of Washington D.C. 123
 Superior Instruments. 171
 Supreme Publications. 24
 Surplex Retail Sales, Inc. 172
 Suttons Wholesale Electronics, Bill. 149
 Sylvania Electric Products, Inc. Fourth Cover

TAB. 97
 Tape Tone Mfg. Co. 154
 Technical Radio Parts Co. 177
 Teletronics Service & Supply. 94
 Telemarine Communications. 106
 Television Assembly Co. 157
 Television Industries. 28
 Telex, Inc. 161
 Thor Electronics. 162
 Transvision, Inc. 113
 Tri-State College. 152
 Triplett Electrical Instrument. 16, 17
 Turner Company, The. 125
 Tyler Commercial College. 91

Ungar Tools. 139
 United Surplus Materials. 130, 131
 Universal General Corp. 160
 Universal Microphone Company. 145

V & H Radio & Electronic Supply. 160
 Valparaiso Technical Institute. 100
 Van Dick, Harry H. 100
 Van Nostrand Company, Inc., D. 84

Walmar Distributing Co. 124
 Ward Leonard. 96
 Ward Products Corporation. 81
 Warren Distributors. 104
 Weber Electric. 76
 Weller Manufacturing Co. 112
 Wells Sales, Inc. 178
 World Radio Laboratories, Inc. 167

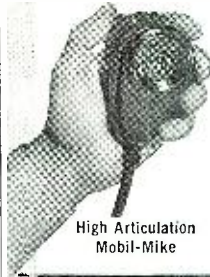

High Articulation Mobil-Mike



Century Crystal Dynamic or Carbon



Improved Cardyne Cardioid Dynamic

Only the **CARDAX** gives you all this!

- ★ Dual Frequency Response
 - 1— for High Fidelity Sound Pick-Up
 - 2— for Extra Crispness of Speech
- ★ High Output Level
- ★ E-V Mechanophase' Cardioid Wide-Angle Front Pick-Up Dead Zone at Rear
- ★ Enclosed Metal-Seal Crystal Greater Moisture Protection
- ★ On-Off Switch
- ★ Highest Purity Pressure-Cast Case
- ★ Satin Chromium Finish

Model 950. List Price \$39.50

Write for free Bulletin!

Authorized Distributors Everywhere

*E-V Pat. Pend. Licensed under Brush patents



NO FINER CHOICE THAN

Electro-Voice

ELECTRO-VOICE, INC., BUCHANAN, MICH.
 Export: 13 E. 40th St. New York 16, U.S.A. Cables: Arlab

TECHNICAL KO's

OIL FILLED CONDENSERS		TRANSMITTING MICAS	
.05 MFD 1000 V	\$0.35	.000025 2500 V	\$0.15
.05 500 V	.14	.00005 2500 V	.15
.1 2500 V	.75	.00005 3000 V	.35
.1 7000 V	1.65	.00005 5000 V	.85
2x.1 7000 V	4.10	.000067 2500 V	.20
.12 15000 V	7.95	.00007 2500 V	.20
.25 1000 V	.35	.00025 2500 V	.25
.25 4000 V	2.15	.00025 5000 V	.85
.25 6000 V	3.75	.0005 2500 V	.25
10x.25 600 V	1.05	.00072 5000 V	.85
.5 600 V	.28	.0008 5000 V	.85
.5 1000 V	.40	.001 2500 V	.25
.5 2000 V	.75	.0011 5000 V	.85
.75 2000 V	.60	.002 1200 V	.20
.77 330 VAC	.30	.0023 3000 V	.65
1.0 1000 V	.45	.00275 2000 V	.25
2.0 200 V	.20	.003 2500 V	.30
2.0 600 V	.40	.003 3000 V	.65
2.0 1000 V	.60	.004 2500 V	.35
4.0 600 V	.60	.005 1000 T.V.	.15
4.0 1000 V	1.00	.005 3000 V	.65
5.0 220 VAC	.55	.006 2000 V	.35
6.0 600 V	.70	.008 1200 V	.15
6.0 1000 V	1.45	.01 1200 T.V.	.15
8.0 600 V	.85		
8.0 1000 V	1.75		
10.0 600 V	1.00		
30.0 90 VAC	1.40		
30.0 330 VAC	3.75		
25.0 25 V	.40		
100.0 25 V	.50		

SHIELDED WIRE #22 50 Ft. for \$.65
 RESISTOR KIT ASSORTED 1/2 & 1W 100 for 1.49
 BATTERY KIT 3x1.5 10 for .58
 CONDENSER KIT .01-.00001 100 for 2.99
 MICAS .01, .002, .005, etc. ALL VALUES08
 .01 150V PAPER (MIDGET) 60 for 1.00
 0.1 600V PAPER 8 for 1.00

\$2.00 min. order F.O.B., N.Y.C. Add postage 50% deposit, balance C.O.D. with all orders. Manufacturers' inquiries invited. Send for Flyer. Prices are subject to change without notice.

TECHNICAL RADIO PARTS CO.

265 Greenwich St. Dept. RN-2 N. Y. 7, N. Y.



PANADAPTOR "Seeing Eye of Radio" Model PCA2 \$49.75
 Reg. N.P. \$99.75. Our Special Price

F. M. DIPOLE ANTENNA \$5.19
 Model 107-104. Regular \$10.55 list. Our Special Price

STANCOR Mod. 752 Battery Eliminator Input 110 V. AC-Output, 6 V.D.C. @ 12.5 amp. Your Cost \$43.90

300 OHM F.M. TELEVISION LEAD-IN \$19.95
 Reg. net per M'. \$29.00 Our Special Price Per M'

PHONO AMPLIFIER 3 TUBE WIRED \$3.49
 Regular Net \$4.95 less tubes. Our Special Price (less tubes)

CRYSTAL PHONO-PICKUP \$1.98
 Model J.-1. Regular net \$3.30. Our Special Price

Write for our Monthly Bulletins on Standard Radio Parts featuring Nationally Advertised Brands

HENRY O. BERMAN CO., Inc.

10-12 E. LOMBARD STREET
 Dept. R-8 BALTIMORE 2, MD.
 Electronic Equipment and Replacement Parts

WELLS

TUBES

Guaranteed

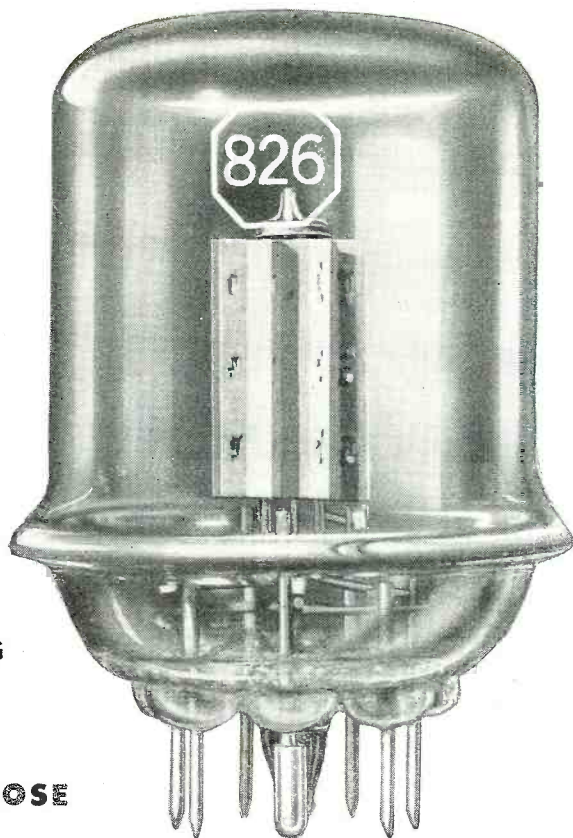

This is a Partial List of Tubes in Stock

TYPE No.	PRICE	TYPE No.	PRICE
2C26	.55	807	1.25
2C26A	.65	810	7.95
2X2/879	.80	813	7.85
3B25	3.00	814	4.25
3C24/24G	1.60	826	.49
5D21	6.00	10Y	.75
6AC7	1.10	829B/3E29	3.95
6AG5	.80	830B	2.25
6AK5	.80	832	2.75
6B4G	.95	832A	3.50
6C4	.75	836	1.75
6E5	.80	837	1.25
6SL7	.90	841	.85
6SN7	.90	864	.80
6V6	1.00	869B	29.50
12C8	.80	872A	2.45
12A6	.55	954	.65
VT33	1.00	955	.65
VT67	1.00	957	.65
RK34	1.00	1005	.70
VT52	.55	1148	.40
VR90	.75	1201	.40
VR105	.80	1616	1.95
VR150/30	.75	1625	.55
VT127	.25	1626	.65
211	1.15	1629	.50
304TH	7.25	2051	.90
304TL	3.75	7193	.35
GL471A	1.00	9001	.80
532A	3.50	9002	.80
559	1.25	9003	.80
801/801A	.95	9004	.85
803	8.75	9006	.80

Minimum Order \$500

Write or Wire Us for Quantity Prices

- TRANSMITTING
- RECEIVING
- INDUSTRIAL
- SPECIAL PURPOSE

**All Tubes Are Standard Make,
Brand New and Fully Guaranteed**

Prices Represent Tremendous Saving

The Type 826 UHF Transmitting Tube at 49c is a sensational example of Wells tube values. This all-purpose tube is capable of delivering 86 watts output as a class C amplifier!

AMATEURS

The new Wells Amateur Catalog H400C is now ready. Send for your free copy today. Hundreds of the highest quality radio items are listed at a fraction of their normal value.

**Ceramic Tube Sockets for the
826 and 829B . . . 50c each**

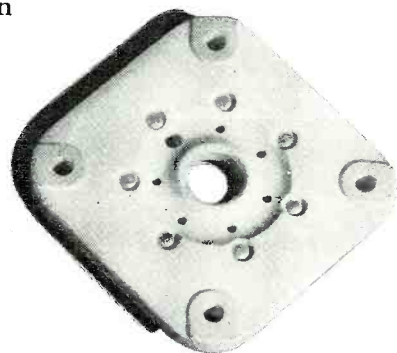

**Order Directly from this
Advertisement or Through
Your Local Parts Jobber**

WELLS
SALES, INC.

320 N. LA SALLE ST., DEPT. R-7, CHICAGO 10, ILL.

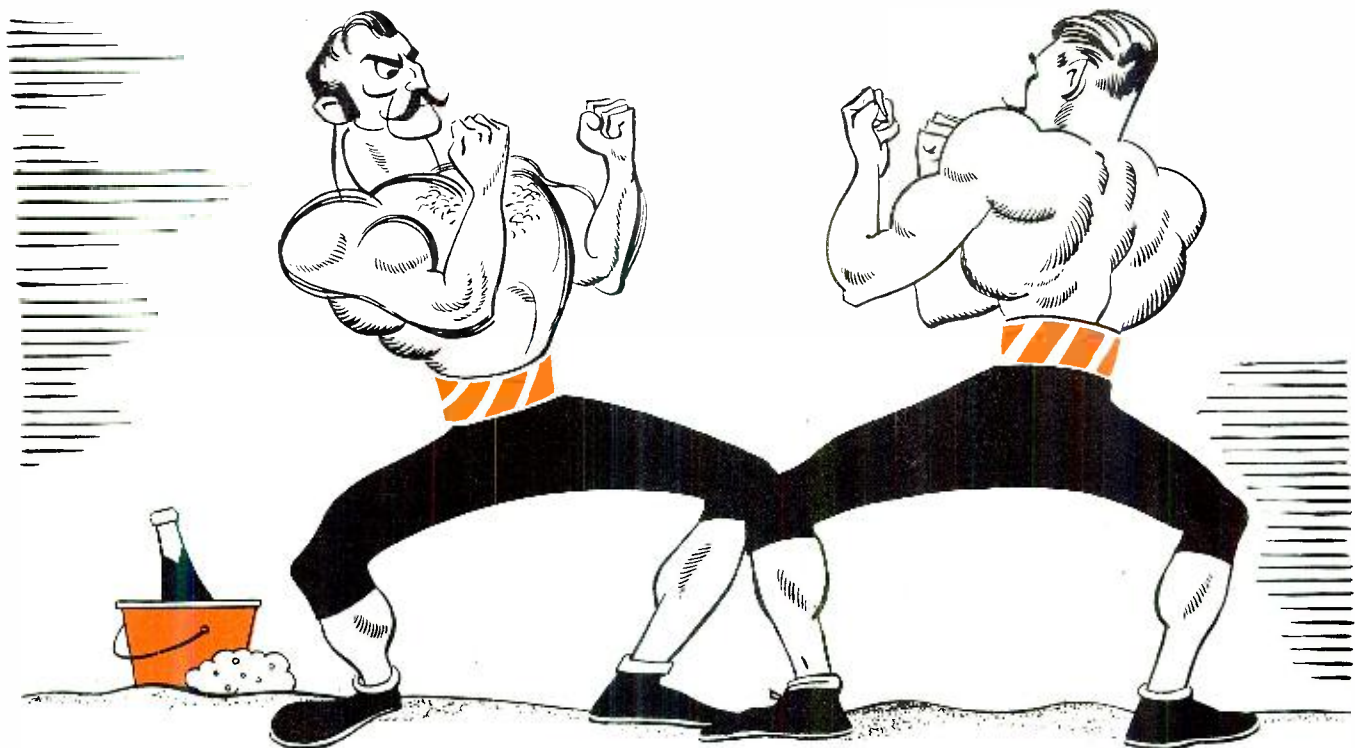

Equally Matched

There's no place for a "weight advantage" in the assembly of a vibrator. Unless every part is accurately matched to every other part the performance of the vibrator will be erratic.

Mallory vibrator parts are measured to a minute fraction of an inch and then assembled so that related parts match accurately. The reed matches the reed arms, the reed arms match each other, the weight matches the reed, and the contacts match the assembly. Even the finest scale could not register a significant difference.



The Mallory Replacement Vibrator Guide is free. The Vibrator Data Book is \$1.00—from your distributor or by mail.

Mallory Vibrators Make the Best Replacements

Careful manufacturing makes Mallory vibrators free of bounce and chatter, dependable in starting, and reliable in operation. More of them are used in original equipment

than all other makes combined. That's convincing proof they are the best replacement vibrators for you to stock.

In addition to assured quality, Mallory offers the most complete vibrator line in the business. Mallory standardization permits 12 basic vibrators to meet 90% of your replacement requirements. But a complete line of 52 vibrators is available to meet virtually every vibrator need.

The Mallory "Good Service for Good Business" Plan

will increase business and profits in your shop. A unique follow-up file makes it easy to keep customers.



You tie in with Mallory acceptance to develop new business—ask your distributor about it.

MORE MALLORY VIBRATORS ARE IN USE THAN ALL OTHER MAKES COMBINED

P. R. MALLORY & CO. Inc.
MALLORY

CAPACITORS . . . CONTROLS . . . VIBRATORS . . .
SWITCHES . . . RESISTORS . . . RECTIFIERS . . .
VIBRAPACK* POWER SUPPLIES . . . FILTERS

*Reg. U.S. Pat. Off.

APPROVED PRECISION PRODUCTS

P. R. MALLORY & CO., Inc., INDIANAPOLIS 6, INDIANA

In every type of home radio
SYLVANIA tubes speak for themselves

Admiral

ARVIN

Bendix
 THE REAL VOICE OF
Radio

CROSLEY

Emerson
Radio

ESPEY

FADA
Radio

Farnsworth

GLOBE

hallicrafters



Minatures, standard types, and famous Lock-Ins are all included in the Sylvania line.

In the leading makes of home radios—from portable models to console combinations—you'll find Sylvania tubes helping to assure fine reception and lasting service. The quality of Sylvania tubes has made them famous throughout the world.

For information on Sylvania tubes, see Sylvania Distributors, or write Radio Tube Division, Emporium, Pa.

SYLVANIA

ELECTRIC

MAKERS OF RADIO TUBES; CATHODE RAY TUBES; ELECTRONIC DEVICES;
 FLUORESCENT LAMPS, FIXTURES, WIRING DEVICES; ELECTRIC LIGHT BULBS

Motorola

Olympic
 Radio and Television

PHILCO

Regal

Silvertone

Spartan

STROMBERG-CARLSON

Temple

TRAV-LER

Westinghouse

ZENITH
 LONG DISTANCE RADIO