

RADIO NEWS

NSE

JUNE
1941
25c
In Canada 30c



Policeman of the Airwaves:-
The Piezo-Electric Crystal

BUILD YOUR OWN "PERSONALIZED" RADIO RECEIVER
PRIVATE PILOTS' PORTABLE TRANSMITTER
CONSTRUCT A STABILIZED PHONO-OSCILLATOR



YOU COULDN'T BEND IT WITH A HAMMER!

LOOK AT THAT SWITCH!

MY KID COULD WORK THOSE NEW PLUG-IN SHAFTS!

BOY! IS THAT SMOOTH!

WOW! IT WILL CUT INVENTORY IN HALF!

Completely NEW!
P. R. MALLORY & CO. Inc.
and ALL MALLORY

Next Month...
 at your Mallory Distributor's

The Greatest Advance
 Ever Made in Replacement
 Volume Controls
 Watch for Complete Announcement!



Also On The Way!

A COMPLETELY NEW Edition of MYE
 (Mallory-Yaxley Radio Service Encyclopedia)

Completely new—more information than ever—indispensable to the service engineer! *Keep on the watch for it.*



P. R. MALLORY & CO., Inc., INDIANAPOLIS, INDIANA • Cable Address—PELMALLO

More
 than ever
 —INSIST ON

P. R. MALLORY & CO. Inc.
MALLORY
 APPROVED
 PRECISION PRODUCTS

VIBRATORS • VIBRAPACKS • CONDENSERS •
 VOLUME CONTROLS • ROTARY SWITCHES •
 SINGLE AND MULTIPLE PUSH BUTTON SWITCHES
 • RESISTORS • RADIO HARDWARE

DAVEGA

AMATEUR DIVISION, 63 Cortlandt St., N. Y., N. Y.
World's Largest Radio Dealer

A Really Wonderful Value!

- Ten independent ranges—six general, four amateur bandspread
- Full vision velvet vernier dial—ratio 30 to 1
- Sensitivity—better than one microvolt
- Signal to noise ratio better than 30 db. at ten meters
- Stability—3 parts in 100,000 with a 20 volt line fluctuation
- Wide range crystal filter with rejection ratios as high as 10,000 to 1
- Low drift temperature compensation
- Series valve noise limiter
- Crystal clear tone with 8 watts undistorted output
- Amateur net price with speaker in cabinet—\$147.50



SENSATIONAL PRICE REDUCTIONS on RECORDERS

LEACH MODEL L

Wide range magnetic cutting head. Special G.E. split phase recording motor. Quadrant worm gear drive. 12½" aluminum die cast turntable.

REGULAR PRICE ... **\$59.50**

OUR PRICE

\$29.50

Get Our Low Price Quotations

Federal Symphonic 16" Recorders

Federal Little Pro 12" Recorders

Federal Portable 10" Recorders

Leach Recorders

We lead the field! Come in and choose from the largest stock of recording machines and recording accessories. Marvelous values. Write today for our list of recorder bargains.



- Crystal filter (four-position variable selectivity).
- Calibrated bandspread.
- Automatic noise limiter.
- Preselection on all bands.
- Two stage IF amplifier.
- Fly-wheel tuning.
- Separate 6-inch PM speaker.
- CW Monitor.

Never Before! ECHOPHONE

Commercial

- Preselection on all bands
 - Calibrated bandspread
 - Automatic noise limiter
- 8 Tubes, 3 bands, covers 545 to 2100 kc.—2.1 to 8.1 mc.—7.9 to 30.5 mc. 5" PM dynamic speaker mounted in cabinet. Calibrated bandspread scale on 80/40/20/10 meter amateur bands. Electrical bandspread at all frequencies in the tuning range. Operates on 115 volts alternate current or direct current. Available also for operation on higher voltages with resistance cord.

HALLICRAFTER SX-28



15 tubes—two stages pre-selection—calibrated bandspread—calibrated bandspread—micrometer scale tuning—inertia controlled—tone and AC on-off—beat frequency oscillator—AF gain—RF gain—crystal phasing—adjustable noise limiter—send-receive switch—AVC—BFO switch—bass boost switch—phono jack—80, 40, 20 and 10 meter amateur bands.

SMASHING LOW PRICE! McMURDO SILVER 15-17

New r.f. amplifier equalizes gain at all wave lengths and provides in single stage, selectivity and gain heretofore available only in best two stage r.f. amplifiers. Four bands. Special Jensen-Silver 15" Giant electro-dynamic speaker. 30 to 8000 cycles. Heavy welded one piece chassis, 20" by 12¾".

Regular Price, \$205.00

SALE PRICE **\$89.50**

You Save \$115.50

Demonstrator Models, good as new

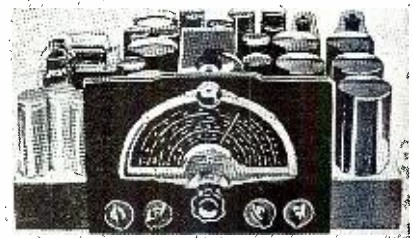

AMATEUR DIVISION
63 CORTLANDT STREET
NEW YORK, N. Y.

DAVEGA



by THE EDITOR

WE have been listening in on the ham bands occasionally during the last week or two and we find that our amateurs are getting very jittery.

Of course, the most "terrible" thing which could happen to them is that the F. C. C., in its infinite wisdom, would take them off the air. This is what they are afraid of; and as one listens across the bands, one hears various reasons when and why this should take place.

The feeling in the industry catering to the amateurs is *not as pessimistic*, however. In talking to one of the largest distributors in the Middle West, we were informed that he was buying as much equipment as he could get. When queried as to what would happen if the amateurs were to be taken off the bands, he said that he did not believe that this would happen. However, he explained to us that one of two things might occur. In the event that the United States actually went to war, of course, he did not doubt for a moment that the amateurs would be liquidated. In the event, however, that a national emergency was declared, without our going to war, he felt that the amateurs would be permitted to operate just as they are now.

He said a third condition might arise whereby a National Emergency would be declared and the amateurs might be restricted to the 2½ and 5 meter bands, but he claimed that this was hardly likely.

* * *

NATURALLY, if the United States should go to war, many of the amateurs who were between 18 and 40 years of age would probably be called to the Colors, and their interest in amateur radio will thereby cease, "for the duration." Those among the amateurs who were too old "to go," probably would find positions with the government as civilian employees, or would otherwise make use of their very valuable radio experience, and also would not find any time for amateur work. Those who were too young, as a great many of us were in the last war, would simply close up their shacks and that would be that.

In the event of a National Emergency being declared and the amateurs being forced down to 2½ to 5 meters, it would be a comparatively simple matter to cut antennae and coils to fit and to procure crystals to meet the new requirements. This would not mean a general liquidation of the amateurs; and one may reasonably suppose that as many amateurs will cloud the 5 and 2½ meter bands as are right now active on all the rest of the bands put together.

* * *

ALL in all, therefore, we see no reason for the amateur to become
(Continued on page 49)

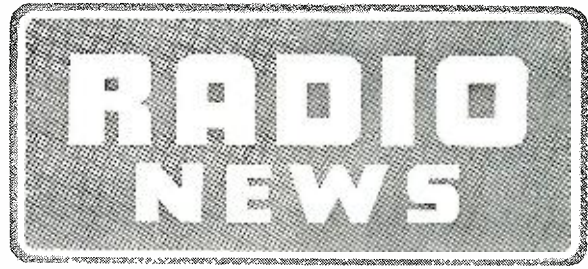

Trade-Mark Registered

Including Articles on POPULAR TELEVISION

The Magazine for the radio amateur
experimenter, serviceman & dealer

Vol. 25, No. 6

Contents for June, 1941

FEATURES

- Build Your Own Personalized Broadcast Receiver** John X. Utley **8**
A radio builder's puzzle: the manufacturers can,—can you?
- As I See It!** John F. Rider **11**
Interpretation of the U. S. Census figures on radio repair shops.
- Battery-Operated Private Pilot's Transmitter** A. B. Cavendish **13**
A 3-watt transmitter for the pilot radio-constructor to make himself.
- Stabilized Phono-Oscillator** Clark E. Jackson **17**
Something a little better than the average of this type of unit.
- The RADIO NEWS Super-Superheterodyne Receiver** Karl A. Kopetzky, W9QE A & Oliver Read, W9ETI **20**
Conclusion of the series. Lining up the various components.
- Build Your Own Recording Studio, Part 5** . . Oliver Read, W9ETI **25**
Playback theory and practice fully explained for the recordist.
- Profitable Customer Relations** J. C. Abernathy **36**
How to capitalize on yourself to make more money.
- "Jesse James Had a Gun"** E. H. Leftwich **37**
Adventures of a serviceman in the lush Florida boom times.
- Cover Picture: A comparison between an adult hand and a ground piezo-electric crystal used to keep transmitters on frequency.**

DEPARTMENTS

- | | | |
|--|---------------------------------------|---------------------------------------|
| What's New in Radio 28 | Bench Notes 31 | Police Radio 42 |
| Hamchatter 32 | Manufacturer's Literature 40 | Serviceman's Cases 66 |
| Serviceman's Legal Advice 40 | Aviation Radio 15 | The Video Reporter 43 |
| QRD? 35 | Washington Communication 12 | Ring the Bell 19 |
| | | Serviceman's Experiences 16 |

Copyright 1941,
ZIFF-DAVIS PUBLISHING COMPANY
Member of the Audit Bureau of Circulations

RADIO NEWS is published monthly by the Ziff-Davis Publishing Company at 608 S. Dearborn St., Chicago, Ill., William B. Ziff, Publisher; B. G. Davis, Editor; J. Fred Henry, Business Manager; Karl A. Kopetzky, W9QE A, Managing Editor; Oliver Read, W9ETI, Technical Editor; Raymond Frank, W9JU, Laboratory Technician; A. H. Erickson, W9TDT, Draftsman; Herman R. Bolin, Art Director; S. L. Cahn, Advertising Manager. New York Office, 270 Madison Ave. Subscription \$2.50 per year; single copies, 25 cents; foreign postage \$1.00 per year additional, Canada 50c additional. Subscribers should allow at least 2 weeks for change of address. All communications about subscriptions should be addressed to: Director of Circulation, 608 S. Dearborn St., Chicago, Ill. Entered as second class matter March 9, 1938, at the Post Office, Chicago, Illinois, under the Act of March 3, 1879. Contributors should retain a copy of contributions. All submitted material must contain return postage. Contributions will be handled with reasonable care, but this magazine assumes no responsibility for their safety. Accepted material is subject to whatever adaptations, and revisions, including "by-line" changes, necessary to meet requirements. Payment will be made at our current rates upon acceptance and, unless otherwise specified by contributor, all photographs and drawings will be considered as constituting a part of the manuscript in making payment.

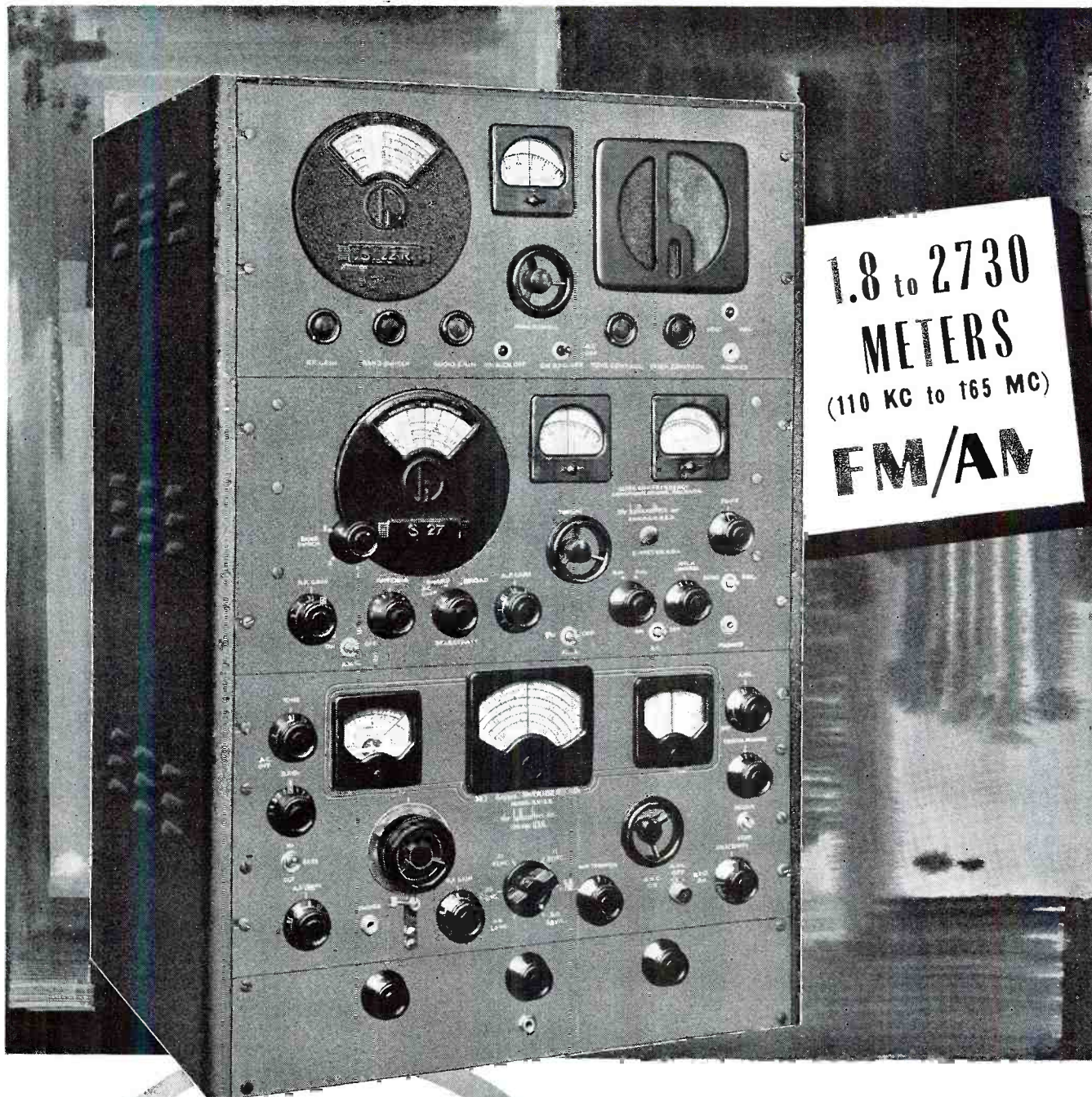

1.8 to 2730
METERS
 (110 KC to 165 MC)
FM/AN

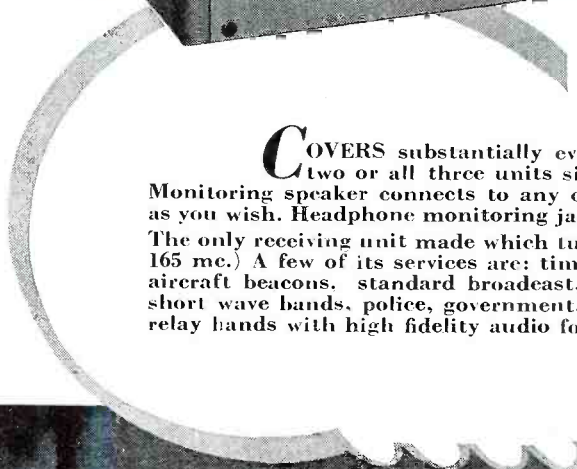

COVERS substantially everything in the radio spectrum. You can use one, two or all three units simultaneously through the separate antenna switch. Monitoring speaker connects to any one; in addition separate speakers can be connected as you wish. Headphone monitoring jack ties into output of any one of the three receivers. The only receiving unit made which tunes continuously from 1.82 to 2730 meters (110 kc. to 165 mc.) A few of its services are: time signals, coastal and ship telegraph and telephone, aircraft beacons, standard broadcast, relay broadcast, aviation, amateur, international short wave bands, police, government, press and educational channels. FM broadcast and relay bands with high fidelity audio for best FM reception.

Hallicrafters

USED BY 33 GOVERNMENTS... SOLD IN 89 COUNTRIES

*Super Skyrider SX-28
Tunes from 550 KC to 42 MC*

*Sky Traveler
Model S-29
Tunes from 550
KC to 30.5 MC*

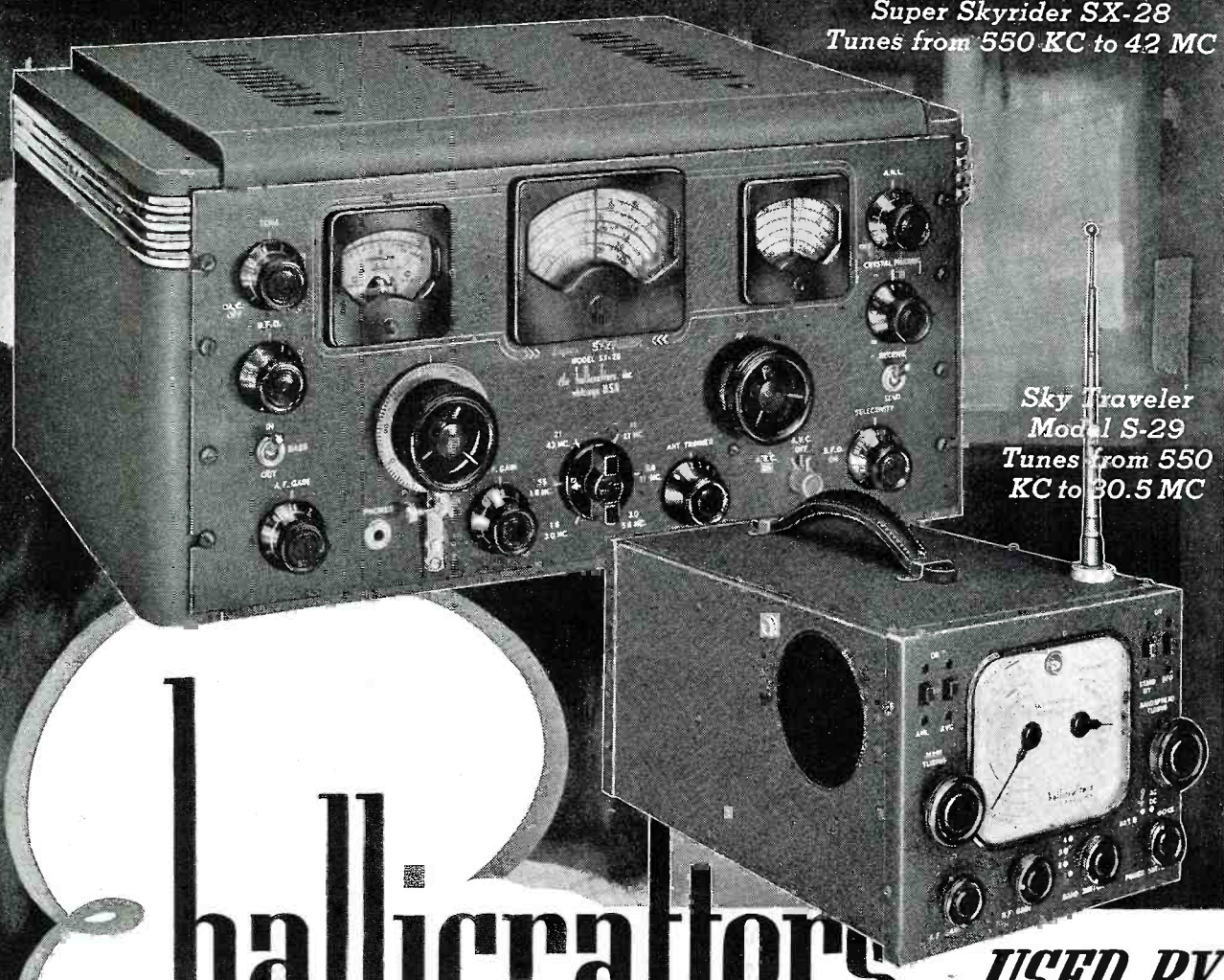

Hallicrafters ...USED BY

DISTRIBUTED BY

ALBANY, N. Y.
Uncle Dave's Radio Shack
356 Broadway

ANN ARBOR, MICH.
Wedemeyer Radio Co.
221 East Liberty

ATLANTIC CITY, N. J.
M & H Sporting Goods Co.
1709 Atlantic Ave.

BATTLE CREEK, MICH.
Wedemeyer Radio Co.
183 W. Michigan Ave.

BOSTON, MASS.
The Radio Shack Corp.
167 Washington St.

BRIDGEPORT, CONN.
Hatry and Young, Inc.

BUFFALO, N. Y.
Radio Equipment Corp.
326 Elm St.

BUTLER, MO.
Henry Radio Shop
Bob Henry, W9ARA

CHICAGO, ILL.
Allied Radio Corp.
833 W. Jackson Blvd.
Chicago Radio Apparatus
Co., Inc.

415 S. Dearborn St.
Newark Electric Co.
323 W. Madison St.
The Radolek Company
601 W. Randolph

CINCINNATI, OHIO
Steinberg's, Inc.
633 Walnut St.

CLEVELAND, OHIO
Radio Servicemen's Supply
Co.
519 Huron Rd.
628 Prospect Ave.

COLUMBUS, OHIO
The Hughes Peters Electric
Corp.
111-117 East Long St.

COUNCIL BLUFFS, IOWA
Wholesale Radio Laboratories
744 West Broadway

DALLAS, TEXAS
Wilkinson Brothers
2406 Ross Avenue
(Mailing Address P.O. Box
1169)

HARRISBURG, PA.
Radio Distributing Co.
1124-26 Market Street

HARTFORD, CONN.
Hatry and Young, Inc.
Radio Inspection Service Co.
227 Asylum St.

HOUSTON, TEXAS
R. C. & L. F. Hall
1021 Caroline

INDIANAPOLIS, IND.
Van Sickle Radio Supply Co.
34 West Ohio St.

KANSAS CITY, MO.
Burststein-Applebee Co.
1012-14 McGee St.

LANCASTER, PA.
George D. Barbey Co.
29 E. Vine St.

LIMA, OHIO
The Northwestern Radio Co.
116 W. Spring St.



Model SX-25
Tunes from 550 KC to 42 MC

FM/AM Model S-27
Tunes from 28 MC. to 142 MC

33 GOVERNMENTS • SOLD IN 89 COUNTRIES

DISTRIBUTED BY

LONG BEACH, CALIF.
Scott Radio Supply
344 East Fourth Street

MILWAUKEE, WIS.
Central Radio Parts Co.
1723 W. Fond du Lac Ave.
Radio Parts Co., Inc.
538 W. State St.

NEW HAVEN, CONN.
Hatry and Young, Inc.

NEW ORLEANS, LA.
Shuler Supply Company
902 Poydras Street

NEW YORK, N. Y.
Davega-City Radio
63 Cortlandt St.
Harrison Radio Co.
12 West Broadway

Harvey Radio Company
103 W. 43rd St.
Sun Radio Co.
212 Fulton Street
Terminal Radio Corp.
68 W. 45th St.
80 Cortlandt St.

NORFOLK, VA.
Radio Parts Distributing Co.
523 Boush Street

OAKLAND, CALIF.
W. D. Brill Co.
198 Tenth St.

E. C. Wenger Co.
15th and Harrison Sts.

OMAHA, NEBR.
All-State Distributing Co.
2855-57 Farnam St.

PHILADELPHIA, PA.
Consolidated Radio Corp.
612 Arch St.

M & H Sporting Goods Co.
113 S. 16th St.
512 Market St.

Radio Electric Service Co.
N. W. Cor. 7th and Arch Sts.

PITTSBURGH, PA.
Cameradio Co.
963 Liberty Ave.

READING, PA.
George D. Barbey Co.
432 Walnut St.

ST. PETERSBURG, FLA.
Cooper Radio Co.
648 Second Avenue So.

SAN FRANCISCO, CALIF.
Offenbach's
1452 Market St.
Pacific Wholesale Co.
116 9th St.
Zack Radio Supply Co.
1426 Market St.

SCRANTON, PA.
Scranton Radio & Television
Supply Co.

519-521 Mulberry St.
SHREVEPORT, LA.
Interstate Electric Company
616 Spring St.

SPOKANE, WASH.
Spokane Radio Co., Inc.
611 First Ave.

WASHINGTON, D. C.
Sun Radio
938 F St. N. W.

Build Your Own Personalized Broadcast Receiver

by **JOHN X. UTLEY**

Portland, Oregon

If you had to duplicate a manufacturer's miniature broadcast receiver with retail-purchased parts, could you do it? The author presents a solution which is interesting and clever.

This is the home-built personalized radio receiver. Illustration is $\frac{3}{4}$ full size.

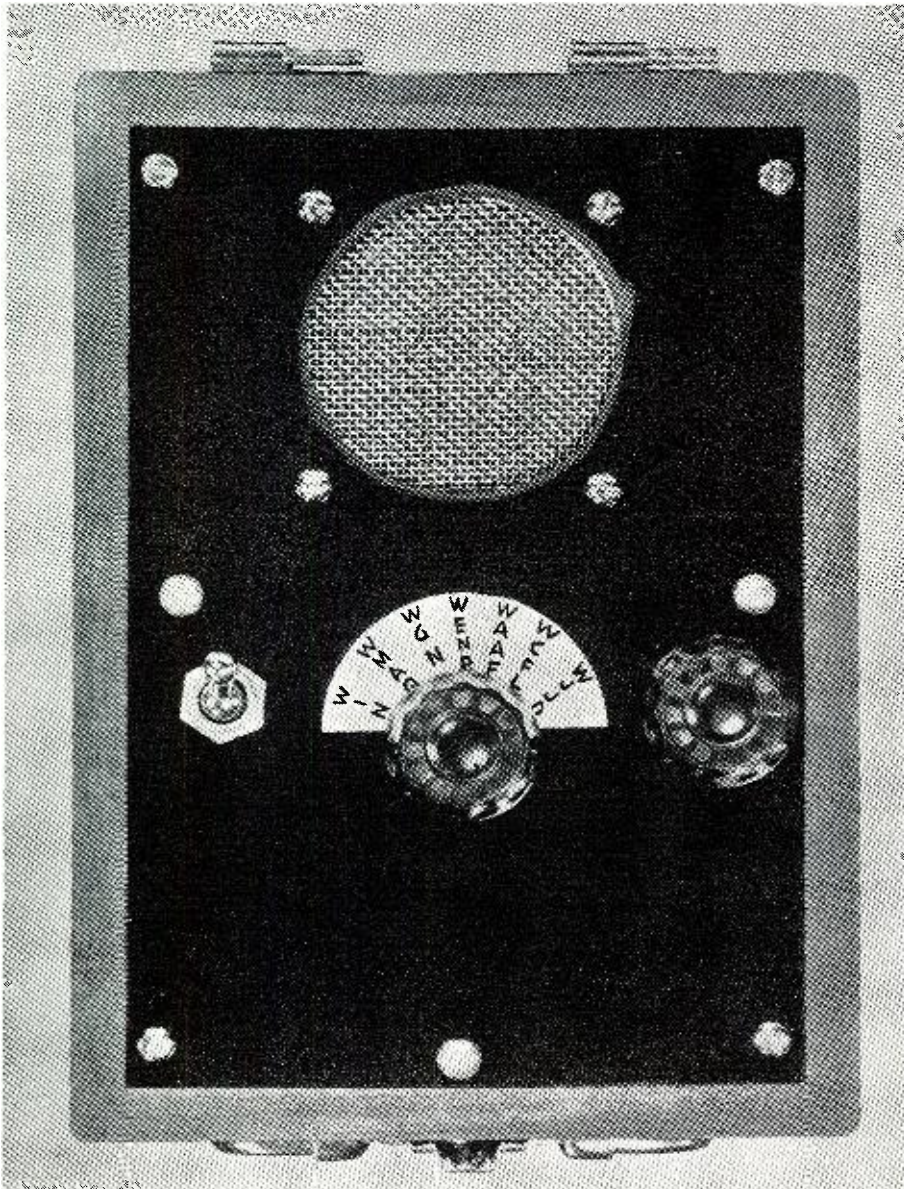

AS in almost every field, radio has its diversions. The technical radioist and the beginner can often meet on a common ground where the technical knowledge required of the latter is not too much, and the interest of the former can be held by the novelty the problem has to offer. Such a diversion is this little personalized radio receiver. There can be no doubt in anyone's mind that the finished manufactured product can be purchased cheaper than the cost of the parts as they can be bought over the radio store's counter. Prices are said to range from \$9.95 to \$20, and the parts cost nearly as much as the highest priced unit. But if the unit were purchased, where would be the fun of building it?

This particular unit has all the niceties of working an absorbing puzzle. The question is how to get all the parts into the small space. And that problem should interest the engineer as well as the beginner. Nothing which appears in the parts list has been home-manufactured; everything is standard and can be obtained from the average radio parts shop. Nor is the circuit tricky, although there may be some trouble in making it operate due to the differences between the tubes. Midget tubes give that trouble, and a duplicate set should be made available, to avoid countless hours' work when the sole difficulty lies with a defective tube. When completed the unit gives as good service as does the manufactured product, but it will not be contained in as attractive a case as the latter. However, among the readers there are doubtless some excellent cabinet makers whose efforts will be crowned with a better looking cabinet than that which the author used, which was an old portable meter case.

In constructing the unit, two methods can be employed depending on the individual's own radio knowledge and ingenuity. Either he can follow the instructions herein given, or he can start from scratch and do his own layout work. Full-size illustrations appear with this article which will be a material help to the constructor. No

actual layout has been attempted because of the fact that there may be a wide divergence in the respective parts used. The circuit, as has been said before, is standard for the type of receiver, and that in itself makes for flexibility in the choice of parts.

Construction

The tube lineup for the receiver is as follows: 1R5 mixer-oscillator; 1T4 i.f. amplifier; 1S5 diode detector-a.v.c.-audio; 1S4 output pentode. This follows the conventional tube lineup used by most manufacturers in the design of the now popular personalized portable. In order to add to the gain of the unit, the use of iron core transformers will add greatly to the performance. The maximum "B" voltage applied to the receiver is $67\frac{1}{2}$ v. and is supplied by an *Eveready Minimax* No. 467.

Note the dropping resistor, R13, placed between the negative "B" and ground. This places a fixed negative bias on the grid of the 1S4 so that maximum output with low current drain may be had.

The loop antenna is home-made and is wound on a piece of thin fibre which measures $4\frac{3}{4}$ "x7". Slots are cut into the fibre so that the wire may be wound in and out and will be self-supporting. The loop consists of 28 turns of No. 24 d.c.c. and the inside dimensions of the winding are 3 "x $5\frac{1}{2}$ ". Note that the slots are cut at the four corners and on the two long sides. One slot is cut in one end of the fibre piece. Connections are made to the receiver chassis through the two brass hinges on the case. The connections are soldered carefully to the hinges. A single-turn is wound around the loop winding so that an external antenna and ground may be used when a greater reception range is needed than that afforded by the self-contained loop.

A sub-panel is cut from a piece of *Evaydo* metal, or aluminum, which measures $3\frac{1}{2}$ "x $4\frac{1}{2}$ ". All of the parts and tubes, with the exception of the speaker, output transformer, and batteries, are mounted on this panel. Considerable care is required so that all of the parts may be fitted without undue crowding. These may be seen in the illustration. The space allowed between the coils is approximately 1". This will allow ample room for the mounting of the tubes.

The volume control, R8, is soldered directly to the sub-base and a shaft extension is used which passes through the bakelite panel so that complete assembly and wiring of this part may be done before the final assembly takes place. By keeping all of the parts in fact on the sub-panel, it is possible to wire nearly all of the receiver before the front panel is attached. This makes construction far easier than if one were to attempt to wire the chassis after it had been mounted to the panel.

The single $67\frac{1}{2}$ v. "B" battery and the two $1\frac{1}{2}$ v. cells are mounted directly in back of the speaker in the case. The two "A" cells are wired in parallel, which gives greatly added life to this supply. They are held in place by brass straps which are bent up from scrap. The speaker and its output transformer are mounted directly to the bakelite panel, which measures $4\frac{3}{4}$ "x7". It is important to match the speaker properly to the plate circuit

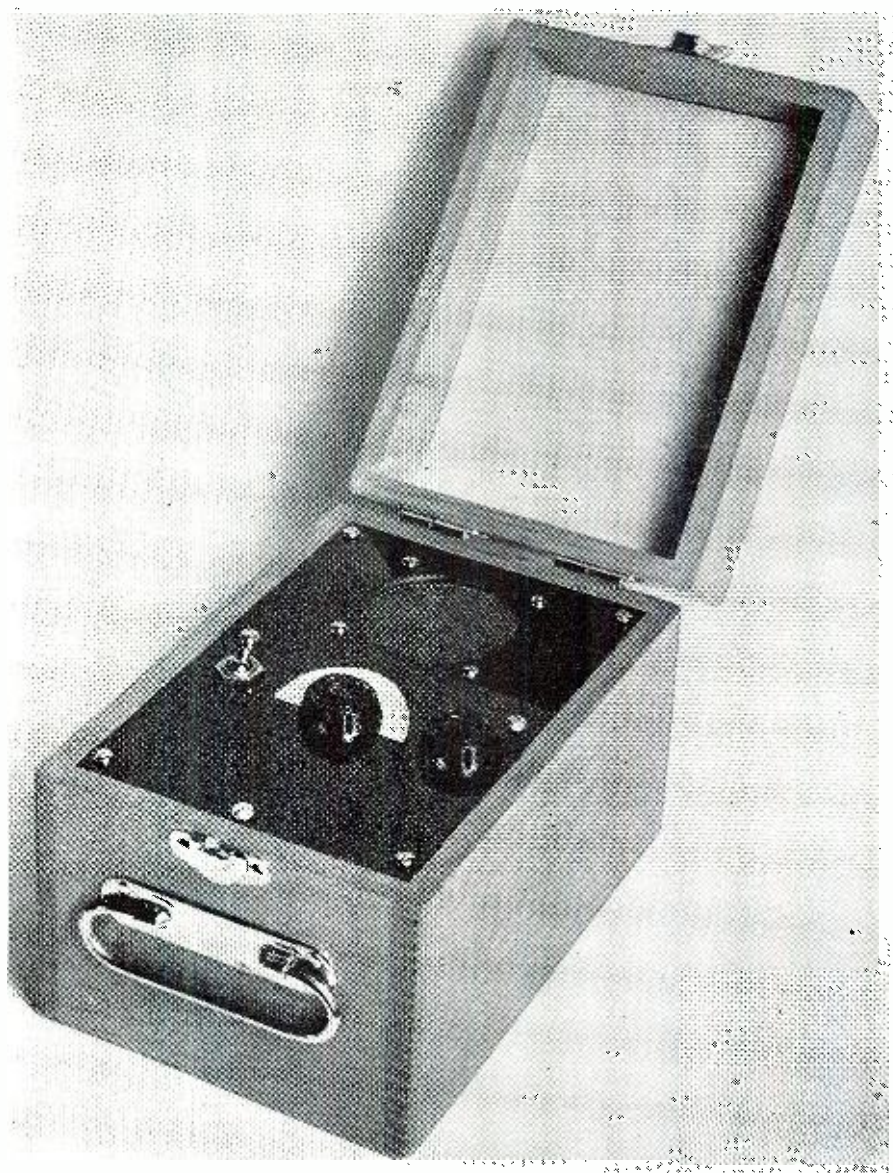

The loop antenna is mounted in the cover and fed to the unit through the hinges. The external antenna and ground connections are in behind.

of the 1S4 pentode. The correct load impedance is 8400 ohms. There are six taps provided on the output transformer secondary. The proper match to the speaker is obtained with numbers 2 and 5 if the same unit is used as contained in the parts list. A .002 midget mica condenser is placed directly across the primary winding. This improves the tone somewhat, and its inclusion is recommended.

This little receiver incorporates an automatic volume control system which aids materially in offsetting the characteristic fading encountered in some localities in certain stations. All of the resistors in this circuit need not be larger than $\frac{1}{4}$ w. rating. In fact, the user may use ultra compact parts wherever such units are obtainable. For example, several manufacturers are making condensers and resistors to a minimum physical size, and these may be used successfully if their ratings are not exceeded.

A rather unusual arrangement is used in obtaining oscillation from the oscillator section of the 1R5. Note that the primary of the oscillator

transformer is wired in series with the primary of the first i.f. transformer. No attempt should be made to include a by-pass condenser from the B+ side of the first i.f. transformer to ground as this will render the set inoperative.

A two-gang midget variable condenser is used for tuning. Each section has a maximum capacity of 370 mmf. A 400 mmf. padder is used so that the circuits will track properly over the range of the coil. After the sets have been completely wired, they may be tested for proper voltage throughout the circuit.

Proper alignment of the receiver will depend a great deal upon the skill of the individual and upon the equipment available. The signal generator will be found most valuable for proper circuit alignment. The i.f. section is first aligned by feeding a 455 kc. signal into the grid of the 1R5 and by adjusting the trimmers on T1 and T2 for maximum output of the set beginning at the diode, or secondary of T2 and working back toward the primary of T1. When these adjustments have been completed the r.f. section should

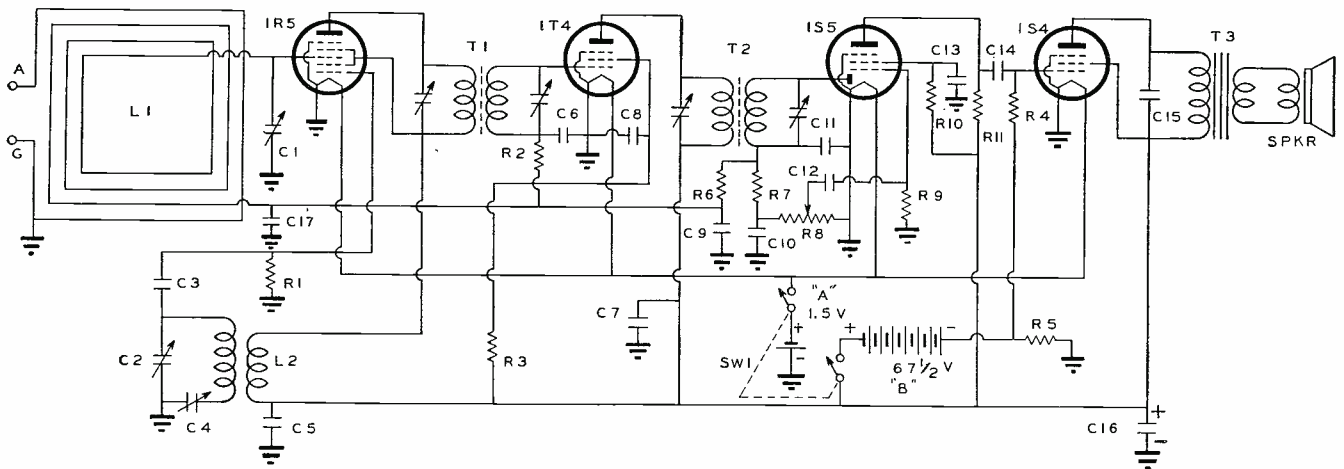

- R₁—100,000 ohms, 1/2 w. Aerovox
- R₂—100,000 ohms, 1/2 w. Aerovox
- R₃—2,000 ohms, 1/2 w. Aerovox
- R₄—3 megohm, 1/2 w. Aerovox
- R₅—500 ohms, 1/2 w. Aerovox
- R₆—2 megohms, 1/2 w. Aerovox
- R₇—50,000 ohms, 1/2 w. Aerovox
- R₈—1 megohm pot. Mallory
- R₉—10 megohms, 1/4 w. Aerovox
- R₁₀—3 megohms, 1/2 w. Aerovox
- R₁₁—1 megohm, 1/2 w. Aerovox
- C₁, C₂—370 mmfd. 2-gang, Allied B4140
- C₃—50 mmfd. midget mica. Aerovox
- C₄—325 to 1000 mmfd. padder, Allied B6676

- C₅—.1 mfd. 200 v. paper. Aerovox
- C₆—.05 mfd. 200 v. paper. Aerovox
- C₇—.1 mfd. 200 v. paper. Aerovox
- C₈—.02 mfd. 200 v. paper. Aerovox
- C₉—.05 mfd. 200 v. paper. Aerovox
- C₁₀—.0001 mfd. mica. Aerovox
- C₁₁—.0001 mfd. mica. Aerovox
- C₁₂—.0025 mfd. mica. Aerovox
- C₁₃—.1 mfd. 200 v. paper. Aerovox
- C₁₄—.0005 mfd. mica. Aerovox
- C₁₅—.002 mfd. 200 v. paper. Aerovox
- C₁₆—8 mfd. 150 v. electro. Aerovox
- C₁₇—.05 mfd. 200 v. paper. Aerovox

- SW₁—DPST toggle. Arrow, set on-off
- L₁—Loop antenna (see text)
- L₂—Oscillator coil. Miller 624C
- Speaker—Oxford-Tartak; or Allied B9715
- T₁—456 Kc. input i. j. Allied B4944
- T₂—456 Kc. output i. j. Allied B4945
- T₃—Univ. output trans. Allied 9715
- Tubes—RCA IR5, IT4, IS5, IS4
- Batteries—No. 467 Eveready } "B"
- Mini-max. 67 1/2 v. }
- Two Eveready Type D cells, } "A"
- 1 1/2 v. each }
- Sockets—Amphenol

be aligned. Alignment is important. This is done by feeding a 1400 kc. signal into the receiver by connecting the source to the antenna post on the loop coupling winding. The two-gang condenser should be open until the plates are nearly all the way out. The two trimmers, one on each section, are then adjusted for maximum output of this signal as heard through the speaker or as indicated on a suitable output meter. Condenser plates are then closed and a 550 kc. signal fed to the receiver. The padding condenser C4 should then be adjusted for maximum output. Then, return to the trimming procedure as a bit of returning will probably be required due to the upsetting

of the circuit caused by the change in capacity of C4. It may be necessary to add on, or remove, turns from the loop in individual cases. Some experimenting need be done in order to determine whether or not this is required. For example, if the trimmer condenser across C1 has to be completely closed, it will indicate that more turns are required on the loop. On the other hand, if the trimmer across C1 must be kept open while the one across C2 is closed, it would indicate that turns need be removed from L1. Some trouble with oscillation in the i.f. stage may be encountered. This is due to excessive coupling between the input and output circuits. One of two

remedies may be employed to relieve it. The first is to allow more spacing between component parts and the second is to employ shielded leads in the r.f. circuits. It will be virtually impossible to align the receiver properly if such oscillation is present and a great deal of care must be exercised in placing the parts in position to prevent this excessive coupling. If the builder will exercise care in the building of this little receiver, he will enjoy many hours of trouble-free service and will enjoy many hours of relaxation and entertainment at the beach, on hikes, picnics, etc. This receiver possesses a very satisfactory degree of performance and the quality of reproduction is excellent. —30—

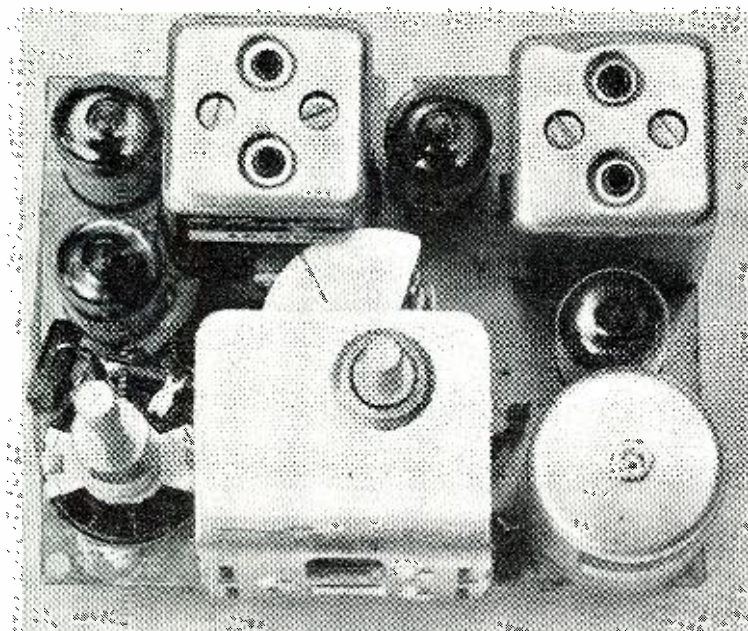

Top view of the sub-panel. Note the placement of the IF transformers and tubes. The volume control is soldered to panel.

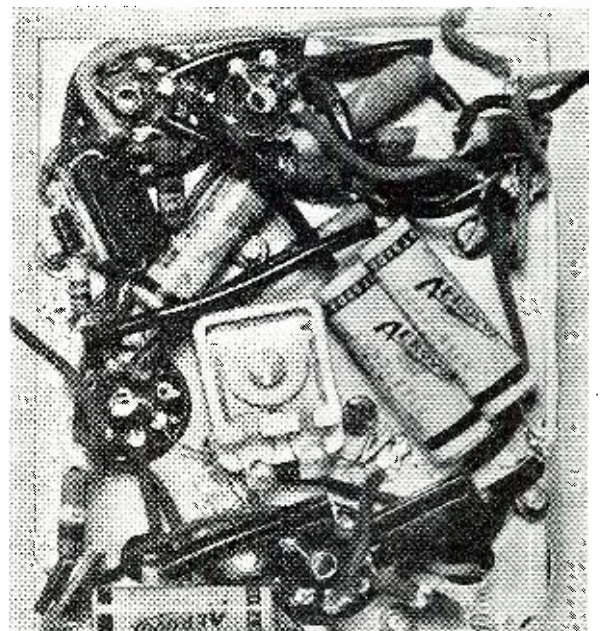

Under sub-panel view. Only smallest parts will fit.



AS I SEE IT!

By **JOHN F. RIDER**

Dean of the Servicemen

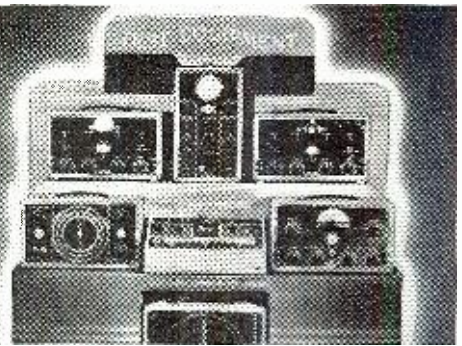

Low Serviceman Income

HAVE before me as I write these lines, a report, dated February 14th, 1941, from the *Bureau of Census of the U. S. Department of Commerce*. This report shows various facts relating to different kinds of businesses in the United States. My interest lies in those which are classified as "repair services," to quote from the circular. In this tabulation are to be found many different types of repair services, as for example, radio, shoes, watches, tires, electrical appliances, locksmiths, musical instruments, typewriters, upholstery and furniture and leather and many more, which need not be mentioned.

The list contains information about the number of shops in existence in the United States as of December 31, 1939, total revenue or receipts, number of employees and other data. What interests me is the total of establishments and the total receipts of these organizations.

Now it is possible that the total of slightly more than 10,700 radio service shops stated in this bulletin does not represent all of the service organizations which actually exist, but I am prone to believe—not having these exact facts, that this list represents shops—that is, service organizations with "store fronts." This seems to be the case inasmuch as the comparative figure of about 8,000 quoted for 1935, is, unless my memory fails me, the number of radio service shops with store fronts which were assumed to be in existence at that time.

However, that is not important, for whether or not these stated 10,700 radio service establishments have store fronts, the comparisons which I want to draw still hold. If, for example, we assume that the comparative repair concerns, say those who work on furniture and upholstery, leather and tires and the rest, have store fronts, then the radio shops also have store fronts. If, for example, we assume that any one particular condition, good or bad is associated with the radio shops which are dealt with in this list, that is, they are located mostly in small towns the same applies to the other types of organizations, for this census covered the nation. And if by chance, some of the financial data may have been secured from the *Treasury Department*, it is the same for all of the different shops. If by chance some mistake of some kind may have crept in as the consequence of confusion on the part of the radio service shop owners, the same possibility exists in the case of the other kinds of businesses which are covered in the report. I mention these conditions solely because I want to

discount any possibility of comment to the effect that the report errs as it relates to the radio service shops. So much for that. Let's get to the report.

It shows that the total receipts for the 10,732 radio repair shops during 1939 was roughly \$21,687,000.00. This is an average of about \$2,040.00 per establishment for the year of 1939. Now, before we say anything about these figures, let us quote a few other repair services. The same report cites 487 automobile brake repair shops and they had total receipts of \$4,876,000.00 or an average of \$10,000.00 per shop per year. Then the report cites 2,215 tire repair shops who had annual receipts of \$8,222,000.00 or an average of about \$3,700.00 per year per shop. Then there are figures for 2,073 battery and ignition repair shops with total annual receipts of \$10,228,000.00 or an average of about \$5,000.00 per year per shop.

Getting away from the automotive field, there are recorded 50,000 shoe repair shops with total annual receipts of \$106,737,000.00 or an average of about \$2,000.00 per shop. Contained in this report are 3,615 electrical appliance repair shops with a total annual income for 1939 of \$16,926,000.00 or an average of \$4,700.00 per shop. There are recorded 1,601 bicycle repair shops with total receipts of \$3,455,000.00 during 1939 for an average of slightly more than \$2,000.00 per shop. And to quote just one more there is shown upon this list a total of 9,685 upholstery and furniture repair shops with total receipts for 1939 of \$35,095,000.00 for an average of better than \$3,500.00 per shop.

So much for statistics. What do they mean? There is much more than meets the eye at first glance. Of all of the different kinds of services listed upon this list there is not a single one which requires the kind of education that is needed by a radio serviceman; the continual need for technical study; the rapid and continual changes with which he must keep abreast—yet average for average, the radio serviceman's total annual income is almost at the very bottom of the list.

To try to find a complete explanation for this condition is pretty difficult. At first glance some of us would be tempted to blame it upon the public by saying that the public refuses to pay a proper fee for a service job, hence the serviceman's income is limited. But this seems strange in the light of the fact that no single organization or group of organizations has ever attempted to educate the public to pay certain levels of prices for the repair of furniture, tires, batteries, brakes, etc. The public pays as it does because the vendor asks what he does.

It is, of course, true that in the radio service business, we have part time workers and much has been laid upon their doorstep. But investigation shows that these part time workers do but a small part of the total amount of repair work. I'd be tempted to say that not more than 20 percent if that much, of all of the radio receivers repaired in this country are handled by part time workers. Is it possible to say that work upon this 20 percent of the total number of receivers establishes the price that these part time workers influence the customer's reaction to price? That seems pretty far fetched, particularly during the past few years with its increase in the number of people employed and the gradual climb in wages, thus making it less and less imperative for the daytime worker to do work at night in order to augment his income. No, it appears difficult to blame the low average upon the part time worker and the same goes for the fringe servicemen—the experimenter who dabbles in service work to satisfy some whim or to do a friend a favor.

I think that an investigation among full time servicemen would be more fruitful of results. I think that there are many service shops operating in localities where there just are not enough people and enough radio receivers to enable the man to derive a satisfactory income from service operations upon radio receivers. In fact, one of the things that I have commented upon and which is still lacking in the servicing industry is some education upon the ways and means of

(Please turn the page)



determining potential income from radio service work in any one locality. In other words servicemen have never been shown how to investigate any area where they hope to operate in order to establish the fact that the number of receivers in that area is enough to give them the basic income they need for proper conduct of their business.

And assuming that such a check-up shows that there are not enough receivers, that does not mean that a repair shop cannot be opened. Such a shop can be started, but only if the operator or those whom he employs are capable of repairing electrical appliances and doing various kinds of electrical repair work. This census tabulation does not specifically state that those shops which are classified as radio repair shops do strictly radio service work, but one is tempted to imagine that they are in the majority, in view of a separate classification for electrical appliance repair shops. As to such electrical appliance repair work in radio service shop, many do this kind of work and those whom we have met who are within this category are far above the \$2,000 per annum receipt class. In fact I'd be tempted to say that they contributed much to raising the average annual receipt level to \$2,000. If more service shops saw their way clear to do service work upon all things electrical, the average gross income would be much higher.

If some of the readers of this page are certain that this low annual gross take is due to the refusal on the part of the public to pay a reasonable charge, there are many who will concur with me when I lay that blame right upon the window sill of the radio shop—that is, very many of them. Recognizing the fact that the public always wants the most for the least, no matter what it may be, unjustified competition; the lack of realization of what proper conduct of a business meant and the consistent refusal to accept a commercial slant in a business founded upon technical ability, has contributed more to the public's attitude than the natural instincts of the public as a buyer.

This is proved by the fact that the public pays the seller's price for what it wants when it cannot get it at the buyer's price. The incomes of other service businesses, the great number of stores where one price prevails, the fact that the public patronizes stores of various price range is mute testimony that the seller can get his price if he asks a fair and just figure.

But you can't blame the public if they refuse to pay for inspection when so many servicemen give it away for nothing—that is, do not incorporate that cost in their charge to the public. Witness what happened in a number of different cities, not small ones, during the few days after March 29th, the frequency change day. The average price for resetting a push-button radio receiver throughout the nation was \$1.00. Yet in many towns radio servicemen did this work for as low as 35 cents a set and up to 65 cents. It just does not make sense! Most certainly the public in that town were not educated to the fact that such work would be or could be done for 35 cents. I don't think there is a serviceman living who must bear the operating expense of a shop of even the smallest
(Continued on page 54)



by ALFRED TOOMBS

Special Washington Correspondent for RADIO NEWS

The Inside on the L. P's

AT this time, the United States and the other countries of the non-Hitler world, are being bombarded with propaganda broadcasts originating in the Axis territory. This *word-offensive* is a highly important part of the dictators' campaign because, as Hitler has said, "In war, words are acts."

All of the Axis propaganda is carefully planned. Every word, every exaggeration or understatement is made to achieve a definite purpose. The propaganda barrage is laid down as exactly as artillery preparation. By analyzing the barrage of words, it is possible to tell where the Axis is preparing to strike. In other words, Hitler is literally telegraphing his punches.

The discovery of this truth lies behind the creation of the new American "listening posts." A great deal has been written about the "listening posts"—on the basis of Government statements which cleverly obscured the real purpose of the new organization—but this column can now reveal for the first time the true function and method of operation of this modern "American Black Chamber."

Establishment of the listening posts was urged first by the Navy and, upon recommendation of the *Defense Communications Board*, was taken over by the F.C.C. It has been placed under direction of the F.C.C.'s defense unit, headed by keen, able, peppy G. E. Sterling. On its staff will be 350 translators, psychologists, propaganda analysts and experts on international politics.

The new unit will be modeled on the British "Secret Four," whose weekly reports are carefully studied by the members of Churchill's war cabinet. The English group has been little heard of, because even its existence was a secret until recently. But its amazing record in forecasting Hitler's strategy has won it the respect of the British Government.

The eleven primary monitoring stations which the United States has set up for other defense purposes will be used as part of the listening post work. Recordings will be made in some of these stations of every word which emanates from Axis stations—not only broadcasts directed at this hemisphere, but the broadcasts which go out to the Arabs, the Chinese and the Australians. One of the key stations will be the one which has been opened in Puerto Rico—right "on the beam" from Europe to South America. The recordings will be turned over to translators who will know, between them, every language on earth. They will brief the individual broadcasts and then the analysts and psychologists will study these summaries.

Their work will not be to counter-act this propaganda nor to black it out, as has generally been believed. They will study it to find clues to what Hitler is going to do next—and this information will be turned over to the high command of the military forces.

Full reports on the English experience with propaganda analysis are in the hands of Washington authorities. These reports show some remarkable successes, including forecasts which proved accurate on the date when the invasion of the Low Countries would begin, the development of the German magnetic mine, the date of the Italian entry in the war, the "peace offensive" of last summer, etc.

The "Secret Four" told the Government that Hitler was not going to try an invasion of England last fall nor during the winter.

The method by which they reached this conclusion offers an excellent example of the way in which the "listening posts" operate. The English picked up repeated Nazi radio boasts and threats, directed to all parts of the world, that an invasion of England was imminent. The constant repetition of these threats kept the English on guard—thus immobilizing on the besieged island strong army units. The "Secret Four" noticed one significant fact, however, in all this Nazi propaganda. Whereas all the rest of the world was being told that an invasion would be attempted, the German people were being told nothing about it. They knew, from study of Hitler's methods, that he never attempted any big military activity without a big propaganda campaign at home to whip the German people up to the necessary fervor. They reported to the cabinet that Hitler's strategy was to threaten invasion—so that British forces would be kept idle at home—but that he had no immediate intention of trying it.

They have been able to keep an "invasion schedule" by noting the changes in tone of Nazi broadcasts to countries which are about to die. There is close cooperation between the Germans and Russians. At the time Stalin and Hitler were getting ready to carve up Rumania, the "Secret Four" uncovered good evidence of this. The Russian radio began a campaign against the Rumanians—which fact alarmed the Hungarians. Almost immediately, the German radio began a campaign directed at Hungary, to get that country used to the idea of Russian occupation of part of Rumania. The English listeners have reported all along that the Russian-German tie was unbroken. One of their chief pieces of evidence is this: following conclusion of the Hitler-Stalin non-aggression pact, before the start of the war, all German propaganda broadcasts to Russia and all Russian broadcasts to Germany ceased. These two countries send their propaganda to every other corner of the earth—but as long as they keep their understanding not to interfere with each other by radio, that is good evidence that there is no split.

The propaganda broadcasts are cleverly
(Continued on page 46)

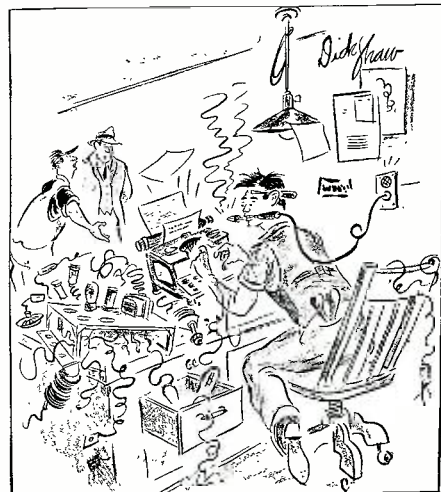

"Now! That's just the Managing Editor of RADIO NEWS hot on a story."



The complete unit ready for installation. Note size against 807 tube.

Battery Operated Private Pilot's Transmitter

by **A. B. CAVENDISH**
Savannah, Georgia

Flea-powered airplane transmitters are increasingly popular with private pilots. This one is very efficient at 3 watts.

NATIONAL DEFENSE has created schools which under the CAA is giving instruction to literally thousands of airplane pilots. Not all of these will end up in the military. Many have neither the physical stature nor the ability to become Army or Navy airmen. Therefore it is reasonable to suppose that the ranks of the private and amateur pilots will increase by leaps and bounds throughout the next five years.

This will mean that more and more will be flying and to take care of the increased air traffic, certain rules and regulations have been promulgated to reduce the hazards attendant to the increase of airplanes around the average airport. The most important aid to navigation has been the radio, and since a license is not required for the use of a receiver, and since the "beams" cannot be flown without one, almost every plane is today equipped with such a unit.

But further than that, most first class airports are requiring that the private pilot use a transmitter so that he can follow air traffic tower orders, ask directions, and for generally necessary communication with the ground. A special frequency has been set aside for the itinerant flyer. It is 3105 kc. He has other frequencies also, but for the purpose of this article we are only concerned with the one mentioned.

Most communication with the ground for the average flyer is confined to a *few minutes* transmission at the beginning and at the end of his flight just before landing. If the private flyer is not an inveterate cross-country man, he will little have need for the extensive and somewhat expensive higher powered rig which he would ordinarily use. Actual tests have revealed that an output power of 2 watts will generally fill the bill around the limits of the airport. Greater power, of course, will be necessary for the longer contacts.

Since the power required is so low, and since the channel is usually clear, except for other planes (and you await your turn—getting a clear channel, finally) a battery operated transmitter seems to be a logical answer.

Most radiomen are familiar with the fact that by the mere statement of "battery power," a multitude of "sins" can be covered. But when one adds to the battery powered specification the use of the "1" series of peanut tubes, then the unit automatically becomes a midget one, and the weight negligible. Of course, there will be some who will naturally find that they cannot extend the range of the little transmitter to be described and will, therefore, blame the author. So in fairness to himself, let it be said that 2 watts is not very much power, and

to get the best results there must be as little loss between the transmitter and the antenna as is possible. At 2 watts, one cannot afford to waste any with poor connections, an inefficient antenna, and, above all, run-down batteries. It is to be remembered that the batteries are of the midget type also, and their power curves have a precipitous drop-off, suddenly when they "run-down." So to use the unit fresh batteries should be used within a reasonable time. You cannot change batteries while flying, specially if you are doing the flying yourself.

The circuit is similar to that which was published in RADIO NEWS in the February, 1940 issue except that other tubes, as has been mentioned, have been used. There is nothing too tricky about the circuit, nor is the construction difficult. It will, however, tax the ingenuity of the builder if he wants to make it as compact as the author's. There is no necessity for this beyond the desires of the constructor coupled with the pride that he will have if the unit is as small as is possible without the sacrifice of parts and efficiency. No particular layout is shown, and the illustrations will suffice to give an idea of what goes where. Parts of equal electrical characteristics can be substituted, but to obtain the same compactness as that of the one that is illustrated, the identical components

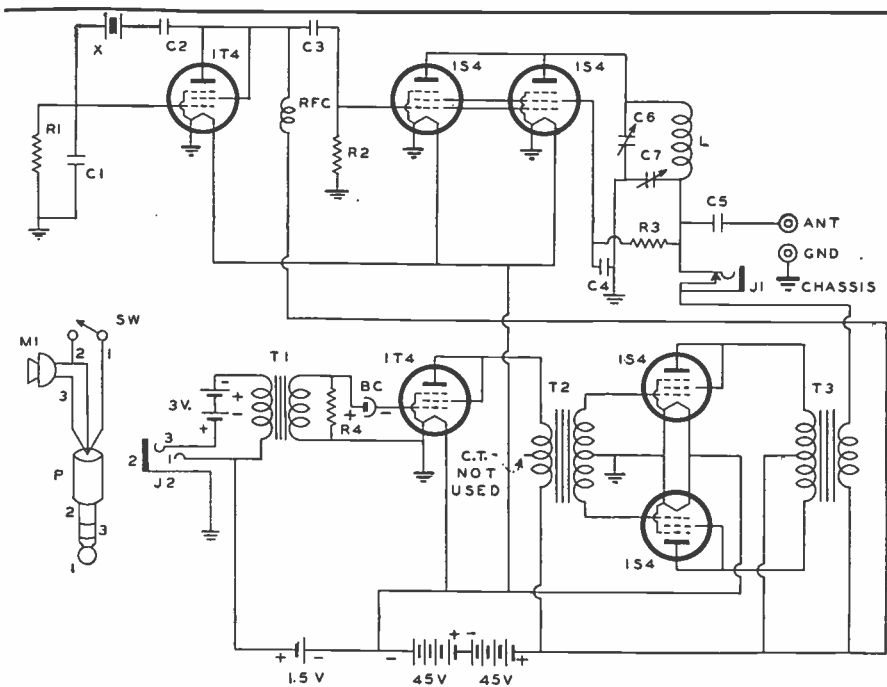

Circuit diagram of the Airplane Transmitter.

- R₁—50,000 ohms, 1/2 w. IRC
- R₂—10,000 ohms, 1/2 w. IRC
- R₃—15,000 ohms, 1/2 w. IRC
- R₄—1 megohm, 1/2 w. IRC
- C₁—50 mmfd. mica. Aerovox
- C₂—.006 mfd. mica Aerovox
- C₃—.002 mfd. mica Aerovox
- C₄—.002 mfd. mica Aerovox
- C₅—.002 mfd. mica Aerovox
- C₆—.002 mfd. mica Aerovox
- C₇—140 mmfd. var. Hammarlund APC140
- C₈—100-500 mmfd. padder Hammarlund
- BC—1 1/4 v. Mallory bias cell
- J₁—Single-closed circuit (see text)

- J₂—3-way mike jack (see text)
- T₁—mike-to-grid Stancor A-4705
- T₂—Driver trans. Stancor A-4712
- T₃—Modulation trans. Stancor A-3812
- X—3105 kc. crystal. Bliley (In Millen socket)
- Batteries—2 Minimax 482's, 1 Minimax 742, 2 Flash lite cells and 2 Eveready No. 2 cells
- P—3-way mike plug, Carter
- M₁—American carbon mike with sw.
- Tubes—2—RCA 1T4, 4—RCA 1S4
- Chassis—Par-Metal, or Bud
- Cabinet—Par-Metal or Bud
- RFC—2 1/2 mhy. Millen

should be used. Substitute cautiously. One thing more, a license from the Federal Communications Commission is absolutely necessary even to test the unit, and certainly to use it. For the frequency of 3105 kc. an amateur license will not do, but some crystal between 3900 and 4000 kc. can be used, if the tester has a Class A license, or one between 3500 and 3900 kc. if the tester has a Class B amateur license, provided that in the last case modulation is not attempted. In the case that amateur licensed testers make the tests, they must make them from the location of the licensed stations, and not in the field. The testing of airplane transmitters on airplane frequencies is covered by Rules and Regulations from the FCC, and information from that source should be sought before putting the transmitter through its paces.

The tube line-up for the transmitter

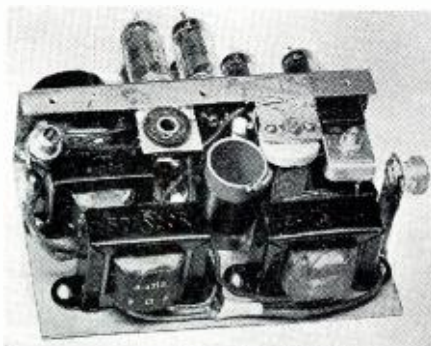

The chassis is of the open type.

is as follows: RCA 1T4 oscillator tube; two RCA 1S4's in parallel as modulated r.f. amplifiers; a 1T4 microphone and driver amplifier; and a pair of 1S4's as class "B" amplifiers. It was necessary to use two tubes connected in parallel in the r.f. amplifier stage in order to obtain, approximately, 2 watts output. These are connected as pentodes with a suitable screen dropping resistor, R3, connected as shown, to limit the screen voltage.

The crystal oscillator utilizes a simple Pierce hook-up, and the crystal is placed between the grid and plate

circuits as indicated. The blocking condenser, C2, is used to keep the d.c. plate voltage from being applied to the crystal.

The resistance of the oscillator grid leak is not critical, a suitable value being 50,000 ohms. A fixed shunt condenser is placed directly across this resistor, having a value of 50 mmfd. This is designated as C1. The plate choke r.f.c. is an ordinary 2 1/2 mhy. radio frequency choke. It is necessary that rather heavy loading be applied to the 1T4 oscillator tube. A .002 mfd. midget mica condenser was found to be optimum for this purpose. The amplifier grid leak resistor, R2, is 10,000 ohms, 1/2 w. No experience was encountered with self-oscillation with the two 1S4's when they were connected in parallel. This is probably due to the fact that a rather low frequency is used.

The output tank coil, L, is tuned at both ends by condensers C6 and C7. This circuit is known as a simplified Collins, and its main advantage lies in its ability to match most single wired antennae. The condenser, C5, is used to keep the d.c. plate voltage from being on the antenna in order to prevent accidental shock.

The closed circuit jack, J1, is added so that proper tuning can be done to the amplifier by means of a 0-50 dc. ma., and this meter later removed once tuning was set.

The audio section includes a 1T4 connected as a triode, which serves as a driver for the Class "B" modulator tube. These latter two tubes are also connected for triode operation by connecting the two screens direct to the plate as indicated. A small, inexpensive mike-to-grid transformer, T1, is used to match the single button carbon microphone to the grid of the input tube. This tube is operated in Class "A" and, therefore, a small amount of fixed bias is required so that proper operating point may be used for satisfactory quality and to keep the plate current at a safe value within the tube.

At first, we attempted to utilize the 1 1/2 v. "A" supply as a microphone source for its current. This did not permit the full output from the microphone and, as a result, we added two extra cells wired in series so that this gives 3 v. to the microphone button. A



Note the comparative size of the 807 tube and the "works" inside unit.

three-circuit jack is used so that push-to-talk operation may be had. It is necessary that the microphone be equipped with a switch suitable for this application. We use an *American Aircraft* type of microphone with a push-to-talk switch.

Complete control for the operation of the set was had from this push button. When it is depressed, the transmitter is placed into operation automatically. A three-way mike plug will be required. The cell in the grid circuit of the 1P4 is a *Mallory* 1.4 v. bias cell. It is necessary, of course, to connect the negative side of the cell, which is the shell, to the grid.

A small driver transformer is used, indicated as T2. Considerable experimenting was done before the one indicated was adopted. The two 1S4 modulator tubes are connected in push-pull and they operate at zero bias in class "B." The modulation transformer, T3, is a *Stancor* A-3812 and is correct size, physically, to fit nicely into the assembly.

The total applied "B" voltage is 90 v. This is obtained from two *Eveready Minimax* batteries, No. 482, wired in series. They should give approximately six to eight hours service for intermittent operation. They are easily replaced in the same manner as is used in regular broadcast portables. The entire transmitter is contained in a black metal *Par-Metal* box which measures 5" x 5 1/2" x 6". This includes the transmitter and all of the batteries required for its operation. The actual layout of parts must be determined by trial after they have been purchased. If substitutes are made, some revisions may be necessary.

The *Bliley* 3105 kc. crystal may be seen mounted in its holder at the top of the chassis next to the tube. This is mounted in a *Millen* crystal socket.

The coil, L, is wound on a 1" diameter form, and consists of 42 turns of No. 26 enamelled wire, close wound. The parts should be laid out in proper sequence as shown on the schematic diagram. It is impossible to show, pictorially, the exact positioning of these units, and the builder will have to use considerable forethought before a final decision is reached.

An oblong section is cut off from the front panel so that access may be had to the two tuning condensers. Note that C7 is of the compression type padder, and it is tuned with a screw driver. Another piece of metal is cut to serve as a cover for these cutouts so that the entire unit may be protected against dust. It also serves as a safeguard against one who may attempt to alter the tuning adjustment. The batteries fit snugly into the space left behind the chassis in the transmitter cabinet.

The unit will operate into most any type of aircraft antenna, and this may be a straight wire running the full length of the plane, or an antenna may be used which winds up on a reel which is known as a "trailing antenna." Theoretically, the antenna will perform the best when sufficient wire is used and this may be as long as 50 feet. The same length of wire should always be used on each flight so that the loading to the transmitter will be the same after the initial adjustments have been made for a given length of wire. This is approximately 35 ma.

The unit may be mounted in any

(Continued on page 46)



by CHARLES J. SCHAUERS

Radio Aid to Air Navigation

IN order for the modern day pilot to fly safely and efficiently, it is quite necessary that he use radio at one time or another. If we would but stop to consider those many factors that inherently affect the safety status of an aircraft in the air, we would readily realize the beneficial attributes of modern day radio helps as concerns aviation.

For many years, various research organizations and individual research workers have been attempting to break the "weather blockade." They have accomplished much toward providing pre-flight weather information for airman. However, even though modern day weather forecasting is accurate to a large degree, (as accurate as the forecaster and modern instruments will allow) there are times when an aircraft is caught in a weather shift which necessitates "flying blind" and using radio.

Our American air transportation agencies provide two-way radio for their aircraft, and it is seldom that a pilot of an airliner is "caught with his phones off." Weather information along the route of travel is provided frequently to the pilot of a scheduled aircraft used for transportation, and the ground operations office is kept posted of likely weather shifts. The inevitable result of keeping check on weather conditions along the air lanes, is of course, *safer flying*.

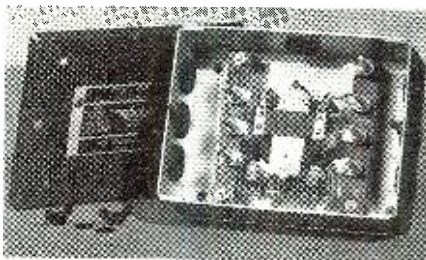

RCA's new antenna changeover relay.

Among the many radio aids to navigation, the radio range beacon has held the "spotlight" for quite some time. These radio range beacons, scattered throughout the United States at strategic positions afford the pilot flying a radio equipped aircraft, many radio beam paths. Too, weather information concerning specific areas is usually broadcast at :20; :43; :48; and :53 minutes after each hour. These weather broadcasts are "simultaneous" with beam transmission. That is, the beam is not usually interrupted for the voice broadcast; and in order to understand the voice broadcast fully, it is quite necessary in some aircraft radio installations to install an appropriate filter which filters out the 1020 cycle beam and allows the range of voice frequencies to be received. There are very few stations that do not now employ "simultaneous transmission."

The principles of operation of the radio range beacon are not too complex. However, in order to fly the range it is a "must" to know the "how and why" of the system now used extensively throughout the United States.

Very low frequencies are used as the "spot frequencies" for radio range beacons. These frequencies extend from approximately 200 kilocycles to 400 kilocycles.

If a loop antenna were fed by a radio transmitter, it is known that the resultant

pattern as transmitted by the loop will closely resemble a figure "8." Now if we were to take two loop antennae and place them at right angles to each other we would find that we now have two figure "8" loops. Too, we will find that there are four distinct places where the fields from the separate loops intersect each other. That is to say, that the signals from one loop will be found to be super-imposed on the signals from the other loop. The resultant is then due to the difference in field intersection of the two individual loops and it is found that a different signal is obtained.

Glancing at Figure 1, we see our transmission pattern approximating two figure eights at right angles to each other. The intersections of the lobes of both patterns is indicated by circled shading. In these shaded sections we find either the "N" or "A" predominating, but the oncourse or "T" signal predominates due to the superimposition of the two signals, as indicated by the unbroken shading.

When the aircraft is in a position that is common to both loops; that is, when signals from the two loops are received simultaneously and with equal signal strength, it is said to be oncourse and the letter "T" (a dash —) will be heard in the phones or indicated by lights. However, when the airplane is not in a position common to both loops,

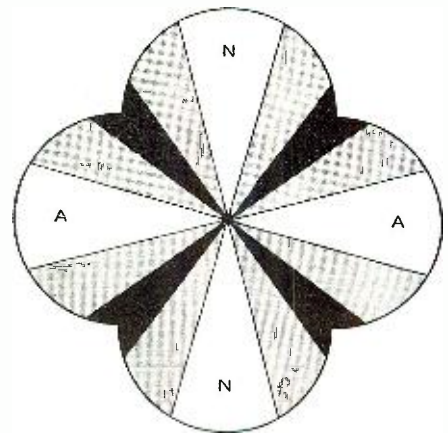

Figure 1.

the signal "A" (. —) or "N" (— .) will be heard in the phones or indicated.

The "equi-signal" or "T" zone is usually from 8 to 16 miles wide. That is, when the distance from beacon transmitter is between 100 and 120 miles.

It can readily be seen then, that it is quite possible for an aircraft to fly the beam path of one station to the beam path of another, and so on until it arrives at its destination. However, the actual orientation involved is not so simple as it seems.

When passing from the right or East quadrant to the lower or South quadrant of the range ("A" to "N"), the "A" will predominate until oncourse is reached; then the "N" will predominate until the second oncourse is reached, then the "A" will again predominate. It is to be remembered, however, that the oncourse signal "T" will be faintly heard when in either the "A" or "N" zones and will become stronger as the air-

(Continued on page 58)



SERVICEMAN'S EXPERIENCES

by LEE SHELDON

I AM willing to concede that into each life a little rain must fall, but that's no reason my partner—the old pickle-puss!—should demand I go on my appointed rounds acting like a Zombie whose mother-in-law is about to move in on him.

Last week, as I was picking up the chassis of an especially lucrative *Brunswick 21*, I experienced the minor unpleasantness that later developed into an argument between Al and me. I was walking from the empty console to the vestibule door, carrying the tuning chassis. Of course, I know I should have laid the thing down while I opened the door, but I'm always in a hurry to leave the customer's house after I get his job, so I tried to work the knob with my right hand while I held the sides of the chassis with both.

As a result of the juggling, the voltage regulator tube worked out of its socket and fell to the floor. I saw it and grabbed just as it rolled off; but I missed, and the chassis also crashed to the floor.

Mr. Croft—the customer—walked slowly into the hallway, smoking a pipe, and found me lying on the floor, with the set under my stomach.

"Stop work already?" he asked pleasantly. "It's only four o'clock!"

The big lug—it was all his fault. If he'd had any sense he would have opened the door for me, and the accident wouldn't have happened. Naturally, I was nervous and angry as he helped me to my feet, but I made up my mind to show my better nature.

"Many a slip, eh?" I laughed.

To look at the bits of glass on the floor, one would never believe the original regulator had been manufactured in one piece.

"Yes, indeed," Mr. Croft replied, baring his upper teeth and raising his eyebrows in a categorical smile. "Small world, isn't it?"

I propped the chassis against the wall, and we both noticed it had been bent at the point where the tuning and power sections were bolted together.

"No two-way stretch," I laughed, an octave too high, "but don't you worry—I'll straighten it out in the shop."

He just stood there, puffing his pipe and rubbing his toe over the dent I had made in the floor. His silent sarcasm piqued me, but I kept myself under control, and took the chassis down to the truck as if nothing had happened to offend me.

When I returned for the speaker, he was sweeping the glass into a dustpan. On the way out, humming affably to show I held nothing against him, and swinging the speaker by its cord, I stood over him for a moment. Then, to change the mood of our meeting, I asked:

"Jevver hear the one about the fellow in a restaurant who ordered radishes with shaved ice?" I began. "Seems that when the waiter brought them back, this fellow said: 'There's a hair on these radishes' and the waiter said: 'Yes—it landed there while the chef was shaving the ice!'"

Came a deep silence. Mr. Croft stopped sweeping, but he didn't answer or look up. I stood there awkwardly for a moment, and suddenly the speaker fell to the floor, leaving me with the cord and plug. It made an awful noise, spun on the floor, and then came to rest in a still deeper silence.

Still he said nothing. He picked up the speaker, put his other hand under my arm, and walked me all the way down-stairs and out to the curb. Then he opened the door of the truck, laid the speaker on the seat beside me, and pointed ahead.

"Go," he said, in a trembling voice, "but drive slowly!"

I noticed his pipe had gone out, but I knew he could have lighted it without a match. There was no use for me to say anything, so I started off. After all—what *can* a person do with such unreasonable customers?

I put the set on the bench when I got back to the shop, and went to the washroom to paint my fingers with iodine.

"Hey, Lee," Al called to me, watching the chassis rock back and forth, "why don't you *haul* these things into the store, instead of *dragging* them?"

I explained the whole affair to him, hoping against hope he would understand I wasn't to blame.

"Accidents will happen," Al conceded, "but you showed very bad judg-

ment in trying to wisecrack your way out of your clumsiness—especially when the customer was so decent about it!"

"What did you want me to do?" I snarled, "make the situation worse by wringing my hands and tearing my hair out? Here—tie this bandage for me."

"You should have apologized," Al replied, "and then you should have offered to make good any damage you had caused. You should have cleaned up the glass, too. The customer was mad because you were flip, not because you were clumsy, and you had no reason to cover up by telling jokes."

"Al, the whole sad world is looking for a laugh," I insisted. "Besides, my gay repartee has more than once taken a customer's mind off the amount of my bid. It's good technique!"

"You're wrong there," Al said. "Everyone who calls us expects you to be dignified. It's a serious business—this making a living. It's serious for the customer, too—after all, he's trusting you with the most important piece of furniture in the house—except one."

"Aw, nuts!" I said, so heatedly I felt my heartbeats in my bruised hand. "When a serviceman jokes as he works, the customer infers he is so competent he doesn't have to give the set his full attention. Such casualness can result only from great skill and experience! Why—even a doctor has a 'bedside manner!'"

"That's different," Al replied, with equal warmth. "When a repairman uses too much 'bedside manner', the job usually dies on him. Plain, old-fashion dignity is always best!"

"You have a negative personality," I growled, chucking the adhesive tape into the corner. "You should learn to be more cheerful and bright as you go about your business!"

"Maybe," Al said, turning away as the 'phone began to ring, "but don't forget—Pollyanna wasn't a pro!"

I went back into the washroom while Al talked at the desk. We had both cooled off somewhat when we resumed.

"What was it—a call?" I asked.

"It was your former friend, Mr. Croft," Al said, sighing as if his patience was being tried. "He asked me to deliver the *Brunswick*. Doesn't ever want you in the house again. Says he's been looking over his insurance policies, and finds no clause that will protect him against giddy servicemen. He also suggests you lay off those elevator jokes."

"Elevator jokes?" I asked, "what are they?"

"They let you down with a sinking feeling," Al explained. "Next time, let the *customer* do the wisecracking!"

—50—



Stabilized Phono- Oscillator

by

CLARK E. JACKSON

New York, N. Y.

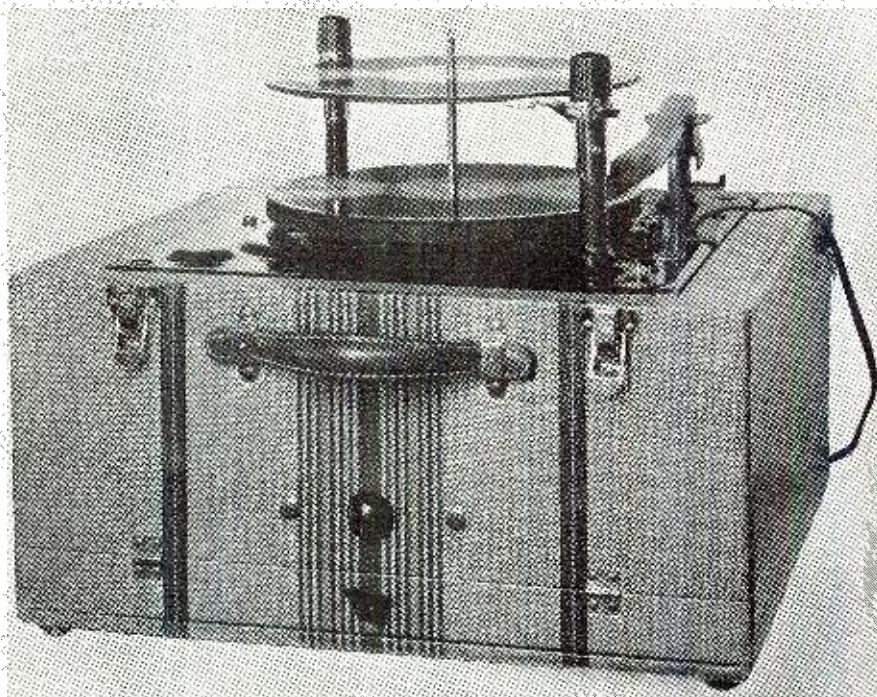

The unit has a record-changer and a small bottom shelf for keeping records.

NEW of us are not familiar with the phono-oscillator. It has been with us in ever increasing numbers for the past 18 months. Its main feature has been that we were spared the purchase of an entirely new unit to play records. We simply hooked up a turn-table, the oscillator and listened to the record through our radio receiver.

There were drawbacks to this arrangement, however. Firstly the oscillator had a definite tendency to drift. This necessitated the re-tuning of the receiver. That in itself was not serious, but more often than not, the drift was directly into some broadcasting station's carrier, and an unholy squeal resulted. We tried to retune the oscillator, and there again the disadvantage was with us. We were not at all sure where we would finally end up even after the unit had heated to its final temperature. In addition to the above, the quality of the modulated oscillator, for that is all that the units were, left much to be desired. Sometimes there were too many highs, and the next day, there would be too many lows. We had no definite way in which we could adjust the response (except at the radio receiver) to assure ourselves that we were getting all that was in the record.

The unit we have built gets away from nearly all of these difficulties. In the first place the drift problem is definitely licked after the unit has warmed up. And once set, in the warmed-up position, it will hold that setting indefinitely. Secondly by eliminating the modulated oscillator characteristic, we have a fair chance to get all that is in the record into our radio receiver where we can tailor it to suit our own demands.

The method used is as old as tube transmitters; it is that of the MOPA. While the unit is increased in price for the parts which are used, the compensations of the system more than override this inconvenience. The modula-

tion is applied to an amplifier, and so the signal carrier is constant, and the quality is undistorted.

The power is very, very low, and, we believe, well within the limits proscribed by the *Federal Communications Commission*. It is to avoid complications with that regulatory body that it must be insisted that the dimensions of the "antenna" of 6 inches be not surpassed or changed. Sufficient "soup" is at all times available for any legitimate and legal use.

The circuit is generally standard, and well-known to all radio engineers. No particular difficulties or "bugs" should be encountered by the constructor in building the unit, and the result will be worth the trouble and money expended.

No attempt was made to build the turn-table, and the one selected by the author does not have to be used by the builder. In fact a mechanical turn-table with the old-type side-winder will work equally as well. There were several reasons why the turn-table used by the author was picked, not the least of them being the permanent sapphire needle with which it comes equipped. Then again we felt that we wanted a table which would play more than one record at a time; and that, too, is a nicety which the home-builder may, if he chooses, eliminate, and save a few cents on the final costs.

Construction

The stabilized oscillator is built on a chassis which measures approximately 7"x4"x2". This allows plenty of room

A phono-oscillator built on the MOPA principle which gets away from the drifting and distortion encountered in the usual home-built unit.

to mount standard parts. Some of these may be on hand in the builder's shop and they may be used providing they are the equivalent of the parts used in our model. The two coils are shielded completely in metal cans. This prevents too much energy from being transmitted.

It is very important to limit the range of the phono-oscillator to just enough distance to reach the radio receiver.

There is nothing critical about laying out the various parts inasmuch as the circuit is of straightforward design. Many builders will already have parts which may be substituted for certain units, and these may be used providing they are of the same value as those specified in the parts list.

The circuit utilizes a 12SK7 ECO oscillator, a 50L6GT r.f. amplifier, a 50L6GT modulator, and a 117Z6GT rectifier.

Note the manner in which the tube heaters are connected. The first three tubes are all wired in series and receive their current supply direct from the line source. The 117X6GT rectifier is wired directly across the 120 v. line. By using the arrangement shown, it is possible to eliminate plate and filament transformers.

The rectifier is used for 50 to 60 cycle operation. Basically, the circuit utilizes a conventional a.c.-d.c. midget idea as far as the rectifier portion is concerned. The unit may be operated from 120 v. d.c. supply, but this will not permit operation of the record changer, and this feature is therefore

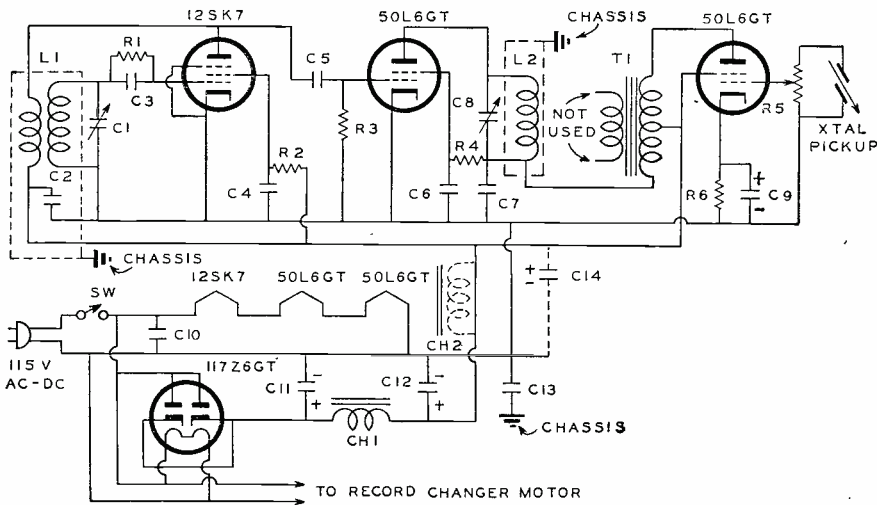

- R₁—1 megohm, ½ w. IRC
- R₂—15,000 ohms, ½ w. IRC
- R₃—100,000 ohms, ½ w. IRC
- R₄—15,000 ohms, ½ w. IRC
- R₅—250,000 ohms pot. Mallory
- R₆—150 ohms, ½ w. IRC
- C₁—100 mmfd. midget var. Hammarlund APC100
- C₂—.05 mfd. paper 200 v. Sprague
- C₃—.0001 mfd. mica. Sprague
- C₄—.002 mfd. mica. Sprague
- C₅—.0001 mfd. mica. Sprague
- C₆—.002 mfd. mica. Sprague
- C₇—.002 mfd. mica. Sprague
- C₈—.002 mfd. mica. Sprague
- C₉—100 mmfd. midget var. Hammarlund APC100
- C₁₀—20 mfd. 50 v. electro. Sprague
- C₁₁—16 mfd. 150 v. electro. Sprague
- C₁₂—16 mfd. 150 v. electro. Sprague
- C₁₃—1 mfd. 400 v. paper. Sprague
- C₁₄—16 mfd. 150 v. electro. Sprague (optional)
- L₁—Osc. coil Miller 624C
- L₂—R.F. coil Miller 624
- CH₁—Filter choke Allied B11635
- CH₂—Filter Choke, Allied B11635 (optional)
- T₁—Univ. output trans. Allied B11666 (see text)
- Tubes—one 12SK7, two 50L6GT, one 117Z6GT, Raytheon

- Record Changer—Webster-Chicago
- Case—Allied B16351
- Chassis—7½" x 3¾" x 2¼" (electralloy)
- SW—S.P.S.T. toggle; AC line switch

discarded. We found it necessary to add a rather complete filter system so that the unit would be free from any hum modulation which might be introduced into the amplifier stage.

Looking down on the chassis, we see the two small midget coils, the one mounted next to the 12SK7 is the oscillator coil, while the one mounted next to the output choke is the r.f. amplifier coil. These coils were originally used in midget superheterodyne receivers and are available from any radio jobber. Any equivalent units may be used providing they are designed for operation in the broadcast spectrum. These coils are normally tuned with a 270 mmf. condenser. This capacity is required to reach the low frequency end, or, approximately, 550 kc. By reducing the capacity to 100 mmf., we are able to keep the tuning toward the high frequency end of the band. These condensers are small

Hammarlund, or Bud units, which are mounted as indicated in the illustration. Once set, they will require no further tuning.

Note that a standard Universal output-to-voice coil transformer is used as a substitute for the conventional modulation transformer such as would be found in an amateur phone transmitter. This reduces the cost of the unit and provides fairly accurate match between the modulator and the r.f. amplifier. The quality of the signal is materially increased by the use of the high level modulating arrangement. The secondary of the transformer is not required and it is left alone. This unit may be seen mounted toward the center of the chassis on the top. The small filter choke may also be seen and this mounts between the oscillator and modulator tube. Only one variable control is required in order to vary the output of the phono-oscillator. This is

a conventional gain control and is placed across the phono pick-up so that the characteristics of the reproduced music, or selection, may be varied to suit the taste of the individual. This control is also provided with an on-off switch so that the unit may be disconnected, if desired.

An *Amphenol* chassis connector is mounted on the rear edge of the chassis. A shielded lead *must* be used between this connector and the gain control to prevent stray hum pick-up from the wiring. A 6" piece of insulated push-back wire is used as an antenna to transmit the signal from the oscillator to the receiver. It is important that this be kept as short as possible to limit the transmission range to but a few feet. This wire is soldered to the plate side of the amplifier coil circuit. 6" is *exactly* right and should not be exceeded.

All of the condensers used in the unit may be of the low voltage variety inasmuch as the maximum "B" voltage applied to any section will not exceed 125 v. We used paper condensers with a 200 v. rating and electrolytic condensers with 25 v. rating for the cathode, and 150 v. for those used in the filter supply section. The mica condensers are all of the postage stamp variety and their tolerances are not critical. In fact, none of the parts used in the circuit must be kept within close limits. The two variable condensers must be insulated from the chassis, which is one of the reasons why the types used were selected.

All of the small parts and resistors should be wired in first. This will make construction easy as by-pass condensers may be added later. This also applies to the filter section, where more room is required for the electrolytics.

Tuning Adjustments

After the wiring is completed and a voltage test is made in order to ascertain whether or not the wiring has been properly done, the unit may be tested with the following procedure.

Tune the home receiver to the vicinity of 1500 kc. at some point where no station may be heard. This can best be done in the evening hours as there is possibility for an outside station to be audible that might not be the case during the daylight hours.

(Continued on page 61)

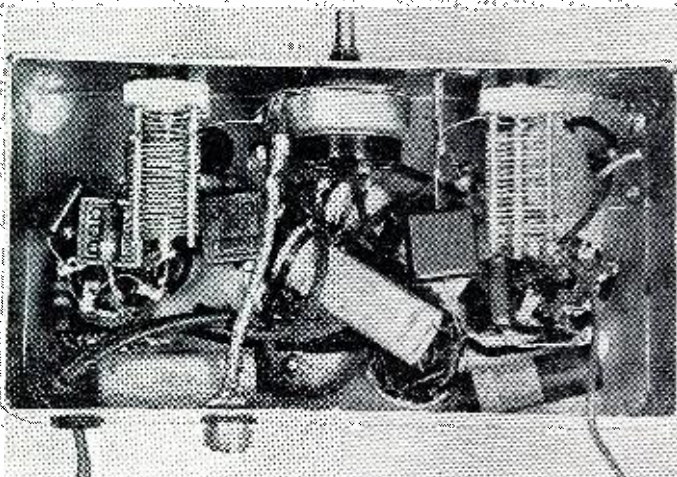

Under-chassis view. Note the shielding over the phono input.

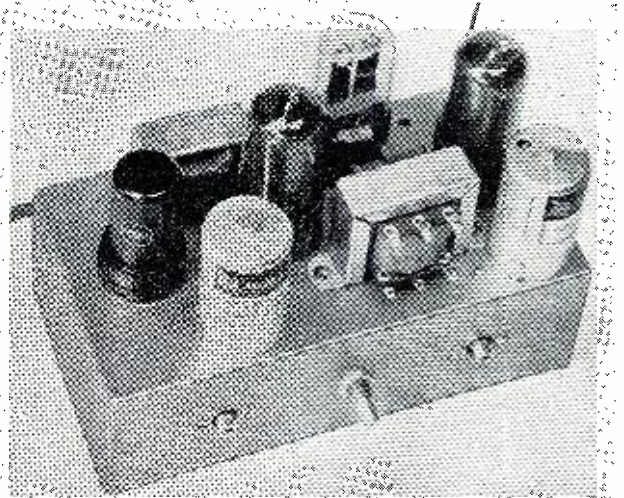

Top-chassis view. Tuning is with a screw-driver.

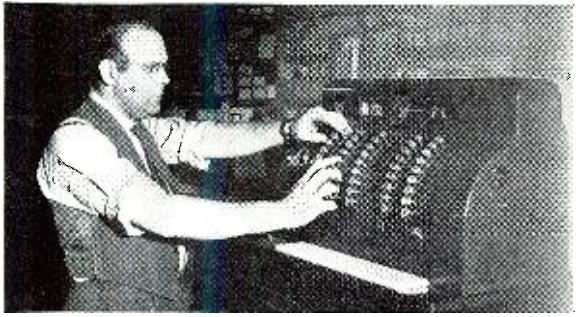

RINGING THE BELL

by

SAMUEL C. MILBOURNE

Credit

CREDIT is the most precious asset any radio service business can possess.

As explained by Mr. Ben Gruber, Credit Manager for *McGregor's Inc.* of Memphis, Tennessee, credit extension is based on three principles—*character, capacity and capital.*

Character refers to the personal character of the man who operates the business.

Capacity refers to the ability of the operator to run a successful business, and to keep his Accounts Payable in good shape.

Capital refers to the net worth of the business which is arrived at by comparing the assets to the liabilities.

Current assets produce the income necessary to take care of *current* liabilities and, while many other assets are considered in analyzing a financial statement and extending a line of credit, more consideration is given to such current assets as *cash on hand, cash in bank, accounts receivable, and merchandise*, for they furnish the means for paying current liabilities such as *accounts payable, notes payable* and any other obligations due in connection with the operation of a business.

Hence, it is important that when credit is desired, the serviceman can furnish a financial statement which will reflect favorably upon his business and himself.

It has been our experience that no business—including the radio service business—can continue long without some form of credit extension. All business is based on an easy flow of credit and our whole business structure would crash without it.

Yet, many servicemen continually abuse their credit standing with jobbers and manufacturers without giving any thought to the future consequences.

How can you establish a satisfactory credit rating? It's not too easy, because it requires the *capacity* to be successful and the *character* to meet your obligations as promised, as well as sufficient *capital* (in this case, "quick" assets such as cash and good accounts receivable) to keep your business operating normally.

Before you can obtain credit, in most instances, you must show an ability to pay cash for your goods. Let us suppose that you are in the plight of many servicemen—practically no cash, some accounts receivable and quite a few debts. Here again we must emphasize the need for an adequate bookkeeping system for every service shop, and its value in keeping the serviceman "posted" on the condition of his business.

Your first step in gaining a good credit footing is to analyze your busi-

ness worth. List all your assets (such as cash in the bank and on hand, accounts receivable, notes receivable, merchandise, equipment, etc.). Then list all your liabilities such as accounts payable, notes payable and any other business obligations. The difference between the two totals is your "business worth."

Now, make a determined effort to collect all accounts receivable (money that people owe you) and use it to pay all your accounts payable (money you owe other people). If necessary, buy as little as possible and reduce your stock inventory up to the point where you are clear of old accounts payable.

Next, for several months try to pay cash for all stock and other business expenses, building up your bank account by "cutting every corner" of business expense.

Then, when your business is "liquid," apply for a small credit extension from your jobber and others with whom you deal. Don't expect too much of a line of credit at first, even a \$5 or \$10 limit is a start. Talk with your local bank representative, explain what you are attempting to do and ask for a business loan of enough to tide you over each month so that you can pay your accounts payable promptly and not press your accounts receivable unduly. Assuming a \$100 loan, and a rate of interest at 6% per year, this means that you will have to pay \$6 per year interest. However, most jobbers allow a cash discount of 2% and, on their open accounts, extend this so that if the account is paid by the tenth of the following month, the 2% discount still applies. Therefore, by using bank credit, you can enjoy the advantages of cash purchasing power without pinching yourself each first of the month. In the above case, you could get your \$6.00 interest paid for you when you discounted \$300 worth of accounts payable (2% of \$300 is \$6). After that, for the balance of the year you actually make a *profit* on your loan when further discounts are taken up. Another saving you make is the amount of C.O.D. charges you will not have to pay when you deal on an open account basis.

One word of caution at this point. To make this work successfully, you *must* collect your accounts receivable during the month so that on the first of each month you will have an amount of cash on hand or in the bank *at least* equal to the amount of the loan. This does not include any amount you might want to draw for your salary or salaries of your employees.

By careful "nursing" of your credit and by prompt discounting of all bills, you can establish a small but very solid credit rating in as short a time as a year.

Now, of what value is a good credit rating other than the above reason?

Let us take a concrete case. You find it advisable to purchase \$100 worth of new test equipment. Under ordinary circumstances, you would apply for credit from the test instrument manufacturer. If he would allow you a year to pay, the carrying charges would (in most cases) equal about 15% of the net price of the item. You think not? Let us explain.

If you will check the difference in cost between the *cash* price and the *time* price of almost any line of test equipment, you will find that the time price runs about 10% higher. If the test instrument costs more than \$50, a year is usually allowed for full payment. If it cost less than \$50, the usual thing is to clean up the payments in some time less than a year.

Now, assuming that the manufacturer allows you one year in which to pay for your \$100 worth of test equipment, and assuming the usual carrying charge of 10% of the total, let's see what happens.

The total cost is \$110 which is divided into 13 equal payments (a down payment and 12 monthly payments) of about \$8.46 each. As you pay for your tester, you owe the manufacturer progressively less and less so that, if figured each month on the *unpaid balance*, you are actually paying about 15% for the loan of this money!

This is not meant as any discredit to the test instrument manufacturer because it is necessary for him to make this carrying charge to take care of bookkeeping, mailing costs, bad debts (which are quite high) and other expenses, not to mention the normal rate of interest he could receive on his money if he used it for other purposes.

(Continued on page 45)

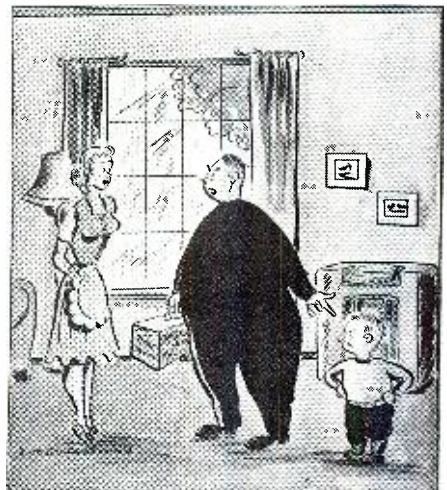

"There's nothing wrong with the set but him. Tell him to lay off of it!"

The Radio News Special Superheterodyne Receiver

*How to assemble the IF stages, align the whole receiver,
and a description of the use to which it can be placed.*

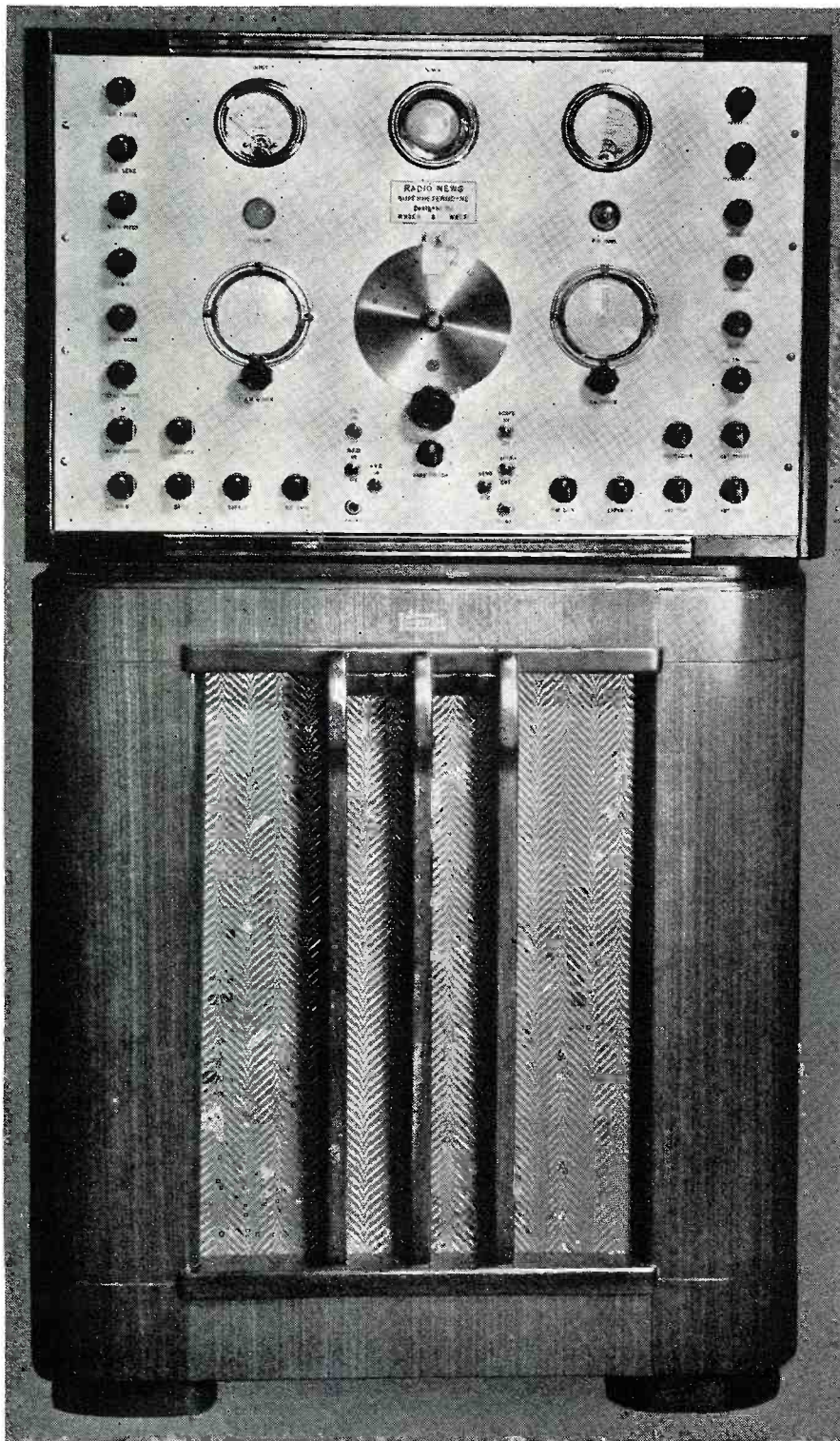

CONCLUSION

THOSE who have been following this series have noticed that we have broken up the construction into a number of different components—such as the f.m. tuner, the r.f. section of the a.f. tuner, the amplifier section, the squelch section, the oscilloscope modulation-meter section, the antenna noise-rejection circuit, the speaker circuit, the BFO circuit, and, finally, the relay circuit. There remains then only the hooking up of the i.f. stages in order to complete the *Super Superheterodyne*. Those who are building this unit will by now know that there is nothing to fear in the construction of a large unit if one remembers the well-taught lesson of short leads and adequate soldering.

The i.f. circuit is a standard one with the exception of the regeneration, which is inserted in the third i.f. stage. There are several types of regeneration, some of which date back a great many years. For instance, the "tickler" one. It was felt that if the tickler type of regeneration were used, the special i.f. transformers which it requires would not be so readily available in the parts store, and could not have been purchased. Likewise the r.f. choke-resistor circuit, which is sometimes used in commercial application, did not seem to be applicable to this unit because of the long leads carrying r.f. potentials, which would have to be used. So the old, reliable screen voltage variation type of regeneration was employed. As it is, all of the i.f. stages have got to be "kept down" in order to prevent oscillation, and if a potentiometer is placed in the screen circuit of the final i.f. stage, sufficient control of regeneration can be had to accomplish the desired results.

Under the heading of construction, the very pitfalls which you will encounter in wiring the i.f. stages, will be mentioned, and the constructor is cautioned to read that section carefully so that he may avoid the necessity of shooting "bugs" and trouble after the entire unit has been wired.

Construction

So far, we have covered the actual construction of the receiver as far as the mechanical requirements are concerned. The illustrations serve to indicate the positions for most of the parts and controls and will serve as a guide to the builder so that he may duplicate the model with little difficulty. The only part of the set that has not been discussed is the layout of the transformers in the a.m. intermediate section.

These are arranged so that the wir-

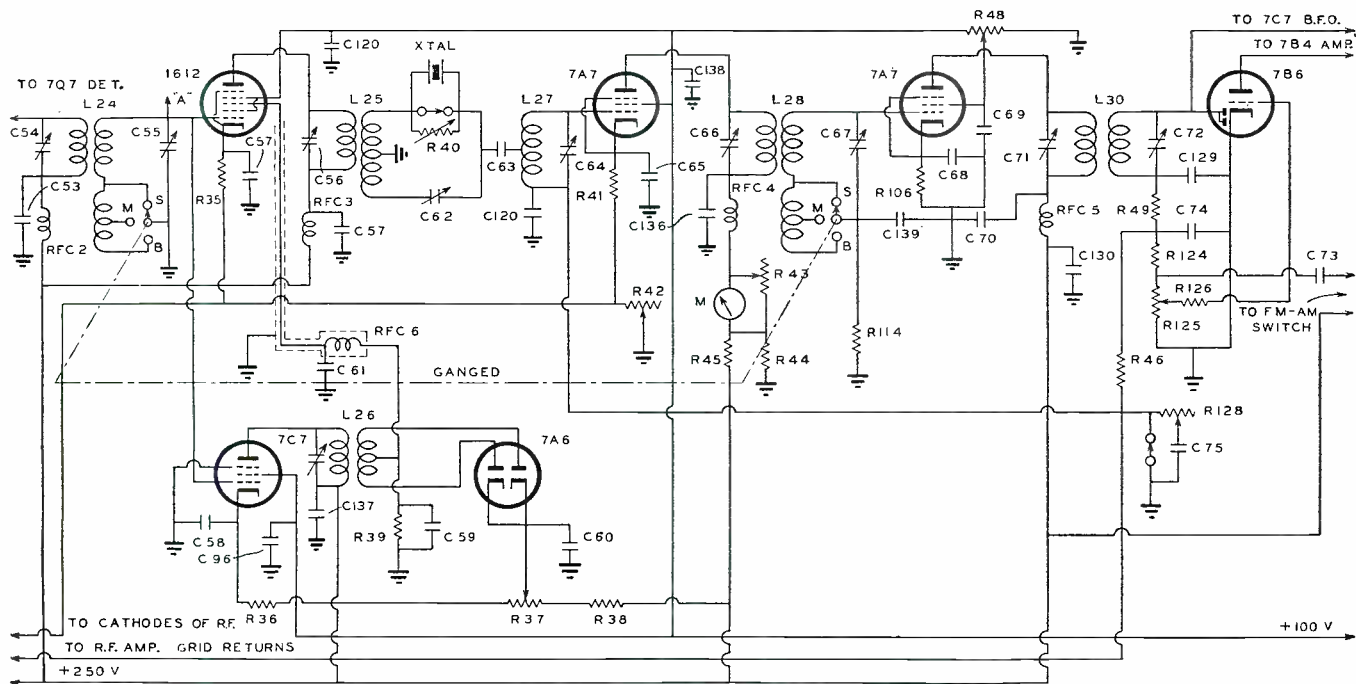

- C₅₁, C₅₅—In can with L₂₄
- C₅₂, C₅₃, C₅₄—In can with L₂₅
- C₅₆, C₅₇, C₅₈, C₆₀, C₆₂, C₆₃, C₆₄, C₆₅, C₆₆, C₆₇, C₆₈, C₆₉, C₇₀, C₇₁, C₇₂, C₇₃, C₇₄, C₇₅
- C₁₂₀, C₁₂₁, C₁₂₂, C₁₂₃, C₁₂₄, C₁₂₅, C₁₂₆, C₁₂₇, C₁₂₈, C₁₂₉, C₁₃₀, C₁₃₁, C₁₃₂, C₁₃₃, C₁₃₄, C₁₃₅, C₁₃₆, C₁₃₇, C₁₃₈, C₁₃₉, C₁₄₀, C₁₄₁, C₁₄₂, C₁₄₃, C₁₄₄, C₁₄₅, C₁₄₆, C₁₄₇, C₁₄₈, C₁₄₉, C₁₅₀—.05 mfd., 400 v. paper Mallory
- C₅₉, C₆₁—.00005 mfd. midget mica, Aerovox
- C₆₀, C₆₇—In can with L₂₈
- C₇₁, C₇₂—In can with L₃₀
- C₇₄, C₁₂₀—.0001 mfd. midget mica, Aerovox
- C₇₅—.5 mfd. Mallory
- R₃₅—1500 ohms, 1 w. Aerovox
- R₃₆, R₄₁—300 ohms, 1 w. Aerovox
- R₃₇—10,000 ohm pot. Mallory
- R₃₈—50,000 ohms, 1 w. Aerovox

- R₃₉—200,000 ohms, 1/2 w. Aerovox
- R₄₀, R₁₂₅—2 megohms pot. Mallory
- R₄₂—25,000 ohms pot. Mallory
- R₄₃—2,000 ohms pot. Mallory
- R₄₄, R₁₁₁—100,000 ohms, 1 w. Aerovox
- R₄₅—1,000 ohms, 1 w. Aerovox
- R₄₆—500,000 ohms, 1/2 w. Aerovox
- R₄₈—50,000 ohms pot. Mallory
- R₄₉—100,000 ohms, 1/2 w. Aerovox
- R₁₀₆—500 ohms, 1 w. Aerovox
- R₁₂₄—250,000 ohms, 1/2 w. Aerovox
- R₁₂₆—500,000 ohms pot. Mallory
- R₁₂₇—1 megohm, 1/2 w. Aerovox
- R₁₂₈—IF Transformer, Trutest 17-7416

- L₂₅, L₂₇—Xtal filter Transformer: Keystone 9-1005
 - L₂₈—Noise silencer IF Keystone 17-6869
 - L₃₀—IF Transformer Trutest 17-7416
 - L₃₁—Output IF Transformer Trutest 16-6645
 - RFC₁, RFC₂, RFC₃, RFC₄, RFC₅—RFC Millen 34225
 - RFC₆—RFC Keystone 19-5590
 - Xtal—Bliley 455 Kc. Filter
- Note: Keystone is trade-mark of Radolek Co., 601 W. Randolph St., Chicago. Knight is the trade-mark of Allied Radio Co., 833 West Jackson St., Chicago. Trutest is trade-mark of Lafayette Radio Co., 901 W. Jackson Blvd., Chicago.

ing may be done point-to-point, rather than to attempt to gain a pleasing arrangement. It is absolutely necessary to keep the connecting leads as short as possible to reduce the circuit coupling. There are many parts in this section, and care must be used if oscillation troubles are to be avoided. Certain leads must be shielded. These include the plate leads that connect to the i.f. transformers, to controls, and to any part of the circuit that acts as a coupling medium to other parts. The switch that is used to control the amount of i.f. band-width is mounted under the chassis between the two transformers equipped with the extra taps.

The front panel includes all of the controls for operation of the receiver. Some of these are only set once, others rarely used, and but a few are actually used during the procedure of operation. They are not as complicated as they appear.

Identification of the controls is as follows: reading from the top on the left hand side going down we find the Focus, Sensitivity (oscilloscope), B.F.O. pitch, A.V.C., Crystal sensitivity, Crystal phasing, Band width, A.N.S. The right hand side contains the following, top to bottom: Vertical adj. Horizontal adj. (oscilloscope), db. multiplier, R meter sw., Regeneration control, AM-FM-Phono, Antenna phase, Antenna tune.

The remaining four controls on the left hand side are the: Squelch, Bass, Treble and R.F. Gain controls. The four on the right are the: F.M. Gain, Expander, Antenna tune, and Audio Gain. The two jacks on the front of the panel are the phono and headphone

jacks. The six toggle switches are the Fil. on-off, B.F.O. on-off, A.V.C. on-off, Scope on-off, Speaker-Cutter, and Send-Receiver.

The selector switch for the a.m. coil assembly is controlled by the knob directly under the main bandspread dial.

Alignment

There is really only one proper way in which the receiver can be aligned, and that is by use of a signal generator and an output meter. Nothing else will do a suitable job; and if the constructor does not have a signal generator at hand, he is urged to go to his nearest serviceman and make use of that gentleman's equipment, even if he has to pay for such use.

Of course, it is advisable to have some form of signal tracing equipment available, then the "bugs," if any have developed due to oversights in wiring, can be easily traced and run down. The f.m. tuner is first aligned.

FM Tuner Alignment

[The following is quoted from Willard Moody's article on F.M. alignment—the best we have seen—which was published in the February, 1941 issue of RADIO NEWS.—Ed.]

"In aligning the f.m. receiver, work should start at the differential detector, which is no more or less than our old friend the discriminator used in automatic frequency control on the broadcast band. A signal of the correct intermediate frequency is fed into the grid circuit of the limiter tube, using a series capacitor of .1 mfd. About one volt or full signal generator output power is needed. The primary

of the detector transformer is tuned to resonance by observing the deflection obtained when the zero center micro-ammeter is connected in series with a one megohm resistor across the .1 meg. resistor of the diode load network.

"A 0-100 d.c. micro-ammeter is used for the adjustment of the detector transformer secondary. The micro-ammeter with one meg. series resistor is connected across the full diode load. Trimmer is then adjusted for zero center on the meter. Note that a good strong signal is used and not a weak one as in broadcast superheterodyne alignment. This is necessary, as otherwise the detector would not be in correct alignment when operating under normal conditions in the presence of received f.m. signals.

"The identical alignment frequency used for the detector tuning adjustments must be used for lining up the limiter and i.f. circuits. This means signal generator stability and careful usage of the generator. The generator is shifted to the grid circuit of the second i.f. tube, using a series capacity of .1 mfd. and disconnecting the lower side of the Limiter's grid resistor. A 0-200 micro-ammeter is inserted here to read limiter grid current. The third i.f. transformer secondary is tuned to the 3 mc. i.f. by watching the micro-ammeter, tuning for maximum grid current. The adjustment is similar, in some respects, to tuning of a Class C stage in a transmitter. The generator is now shifted to the first i.f. grid and the trimmer is peaked. Next, the signal is fed into the 6SA7 mixer grid and trimmers are tuned for maximum grid (Please turn to page 24)

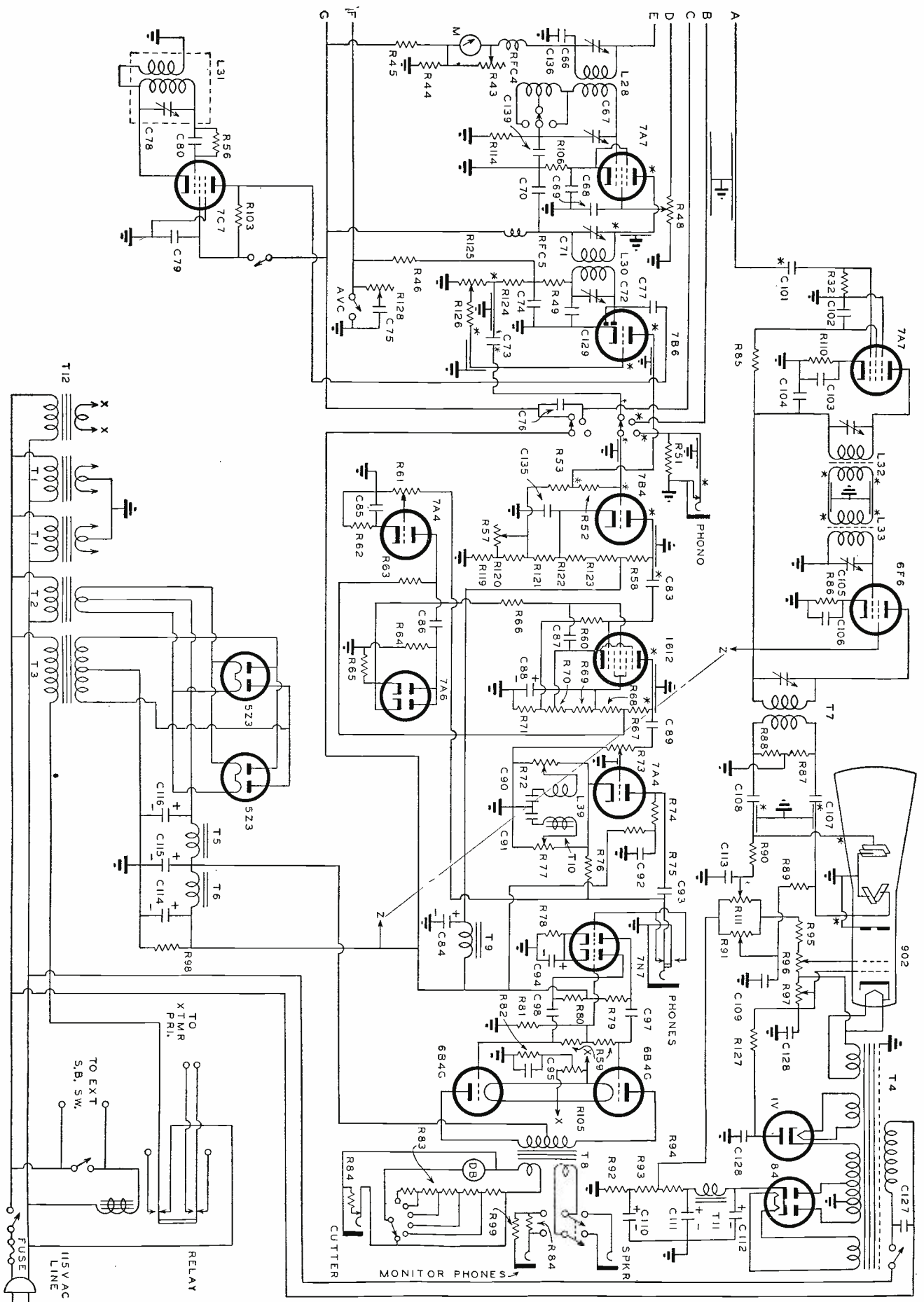

Circuit diagram of: Rest of IF, audio, oscilloscope modulation meter, B.F.O., power supplies and relay system.

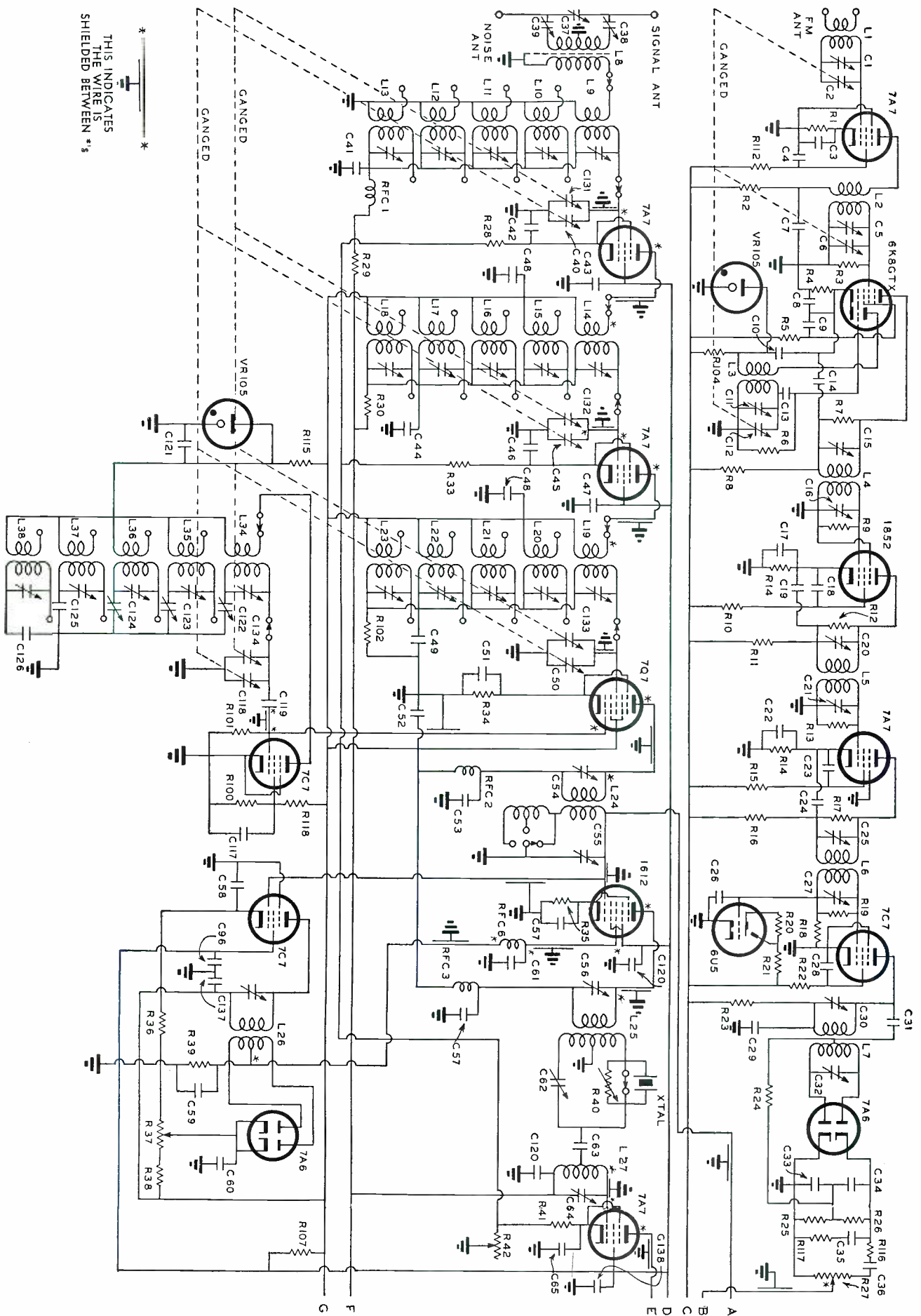

Circuit diagram of: FM tuner, AM tuner, 1st IF section, Antenna noise rejection and noise silencer circuits.

current as in all the preceding i.f. adjustments. No attempt should be made to "stagger" the i.f. circuits by slightly detuning one capacitor in one direction and a second capacitor in another. It won't work and will lead to negative results. The shunt resistor and coupling coefficient of the individual i.f. transformers assure a broad band-pass without the necessity for special alignment. Directions must be followed to the letter, as mentioned in manufacturer's data.

"Following i.f. alignment, the signal generator is connected to the proper input terminal of the receiver, through a 100-ohm resistor. If the receiver has a low frequency adjustment for the oscillator, the dial is first set at 40 mc. or whatever the specified frequency may be, such as 39 or 39.5 mc., and the oscillator is tuned to the signal generator output. If the generator does not have a fundamental output of 40 mc. as the *Weston 787* does have, then the harmonic frequency of the highest available frequency must be used. Usually, this will be 20 mc. and the second harmonic will be used. The generator should, of course, be as accurate as possible.

"The high frequency end of the band is next set by adjusting the shunt trimmer of the oscillator in the receiver to 43 mc. or whatever the alignment frequency of the particular set may be. Next, if an r.f. stage is used, adjust the 1st detector shunt trimmer, followed by the adjustment of the r.f. stage shunt trimmer. Some sets do not have an r.f. stage, but use only 1st detector tuning. The 0-200 micro-ammeter serves as resonance indicator during this alignment process, reading grid current maxima as in the case of tuning the i.f. circuits.

"Over-all response of the receiver tuned circuits may be checked by observing the grid current of the limiter while the signal generator is varied over the 150 kc. band-pass. This is done conveniently by tuning the generator to zero beat with a local frequency modulation station. The generator frequency is then varied plus or minus 50 to 75 kc. either side of the central frequency. The deviation of the value of grid current at plus 75 kc. should not be greater than the deviation at minus 5 kc. by more than 50%. In other words, symmetry of the response curve is sought about the station carrier axis, or equal side-band amplification in the receiver. If these side-bands suffer attenuation, there will be distortion of the wave due to nonlinear amplitude amplification. The flat-top curve is similar to high fidelity alignment in the broadcast band, with a sharp drop outside of the required pass-band. If this form of response is not obtained, the adjustments should all be repeated with pains-taking care and accuracy. If desired, before aligning the oscillator, 1st detector grid tuning and r.f. stages, the i.f. may be checked for symmetrical tuning by slowly varying the signal generator plus and minus 75 kc. about the 2100 kc. alignment frequency, or whatever i.f. may be used by a particular manufacturer.

"The limiter action of the receiver is of great importance in suppressing noise and has the job of ironing out variations in amplitude of the received wave. If the limiter does not work properly there may be weak reception, distortion or noise. To check the lim-

iter, connect the 0-200 micro-ammeter in the plate circuit with no signal input. Of course, it is assumed that the tube has been carefully checked. Now, feed a signal between 40 and 44 mc. into the receiver input. Gradually increase the generator output until the plate micro-ammeter shows an increase. Continue to advance the generator output until the meter shows maximum plate current and then begins to level off, which will be the starting point of limiting action. Leaving the generator untouched, shift the micro-ammeter to the limiter grid return, seeing to it that the plate circuit of the limiter is reconnected after the meter's removal.

"The grid voltage of the limiter will be indicated by the grid current multiplied by the grid resistance, usually about 25,000 ohms and 5 volts for 200 micro-amperes of current. If available, a vacuum tube voltmeter could be used to check the limiter input voltage across the high impedance grid circuit. In the manufacturer's data sheets, however, the normal plate voltage is given and may be checked with either a vacuum tube voltmeter or a high resistance meter. If the plate resistance is measured, that is the load resistor, a current meter will give the current which may be multiplied by the resistance to obtain the voltage. The plate voltage of the limiter will depend on the sensitivity of the receiver, and may vary between 50 and 100 volts, depending on the manufacturer.

"Service troubles are apt to involve defective tubes for the most part, as well as the usual run of difficulties common to all radios, whether f.m. or otherwise. The antenna plays a very important role in achieving satisfactory results, since the limiter action is dependent upon a strong signal in order to work properly. If a tube before the limiter does not give enough gain, or there is any other weak link in the chain, noise and distortion may result. If a condenser opens up, either partially or completely, trouble may be expected in the way of regeneration which will sharpen the i.f. selectivity curve, cutting side-bands and resulting

(Continued on page 52)

COMPLETE PARTS LIST

- C₁, C₂, C₃, C₆, C₁₁, C₁₂—in *Browning BL40TA Assembly*
 C₈, C₇, C₈₂, C₉, C₁₀, C₃₄, C₁₇, C₁₈, C₁₉, C₂₂, C₂₅, C₂₄, C₂₈, C₂₉, C₇₀, C₈₃, C₉₇, C₉₈, C₁₂₇—.01 mfd., 400 v. paper, Mallory
 C₄, C₄₈, C₈₉, C₉₂, C₁₀₃, C₁₀₄, C₁₀₆—.1 mfd., 400 v. paper, Mallory
 C₁₃, C₂₆, C₃₅, C₃₄, C₇₄, C₁₂₀—.0001 mfd. midjet mica Aerovox
 C₁₅, C₁₆—Included in can with L₄
 C₂₀, C₂₁—Included in can with L₅
 C₂₅, C₂₇—Included in can with L₁
 C₃₀, C₃₁, C₃₂—Included in can with L₇
 C₃₅—.001 mfd. midjet mica Aerovox
 C₃₆, C₄₁, C₄₂, C₄₃, C₄₄, C₁₀₅, C₁₇, C₄₉, C₅₁, C₅₂, C₅₃, C₅₇, C₅₈, C₉₀, C₈₅, C₈₈, C₆₀, C₇₀, C₇₃, C₉₉, C₁₀₂, C₁₁₇, C₁₂₀, C₁₂₁, C₁₉₈, C₁₈₇, C₁₈₈, C₁₃₀—.05 mfd., 400 v. paper, Mallory
 C₃₇—.140 mmfd. var. Millen 21140
 C₃₈, C₃₉—.100 mmfd. var. Millen 21100
 C₄₀, C₄₅, C₅₀, C₁₁₈—250 mmfd. var. Hammarlund MC250M
 C₅₄, C₅₅—In can with L₂₄
 C₅₆, C₅₂, C₆₃, C₆₄—In can with L₂₅
 C₆₀, C₆₁, C₁₀₁—.00005 mfd. midjet mica Aerovox
 C₉₆, C₉₄—In can with L₂₈
 C₇₁, C₇₂—In can with L₃₀
 C₇₅, C₇₆, C₈₅, C₈₇, C₉₁—.5 mfd., 400 v. paper, Mallory
 C₇₇—1/2" push back wire, twisted
 C₇₈—In can with L₃₁
 C₈₀, C₁₁₉—.00025 mfd. midjet mica Aerovox
 C₈₈, C₉₃—.8 mfd. 450 v. electro, Mallory
 C₈₄—.16 mfd. 450 v. electro, Mallory
 C₉₀—.02 mfd. 400 v. paper, Mallory
 C₉₄, C₉₅—.20 mfd., 50 v. electro., Mallory
 C₁₀₅—In can with L₃₃

- C₁₀₇, C₁₀₈, C₁₀₉, C₁₁₃, C₁₂₈—.25 mfd., 600 v. paper, Mallory
 C₁₃₀—.8 mfd., 600 v. electro., Mallory
 C₁₁₁, C₁₁₂—.4 mfd., 600 v. electro., Mallory
 C₁₁₄—.16 mfd., 600 v. electro., Mallory
 C₁₁₅, C₁₁₆—.8 mfd., 600 v. electro., Mallory
 C₁₂₂—22-7961 Knight, padder
 C₁₂₃—22-7733, Knight, padder
 C₁₂₄—22-7731, Knight, padder
 C₁₂₅, C₁₂₆—22-4137, Knight, padder
 R₁, R₄, R₁₄, R₄₃, R₈₈—400 ohms, 1 w. Aerovox
 R₂, R₉, R₁₁, R₁₀, R₁₅—1,000 ohms, 1 w. Aerovox
 R₃—Included in *Browning BL40TA assembly*
 R₅, R₅₈, R₇₄, R₅₅, R₁₂₅—20,000 ohms, 1 w. Aerovox
 R₆, R₁₅, R₂₃, R₂₄, R₃₈, R₆₉, R₁₁₂, R₁₁₆, R₁₁₇—50,000 ohms, 1 w. Aerovox
 R₇, R₁₂, R₁₇, R₁₀—40,000 ohms, 1/2 w. Aerovox
 R₉, R₁₃—15,000 ohms, 1/2 w. Aerovox
 R₁₀, R₁₀₁—50,000 ohms, 1/2 w. Aerovox
 R₁₈—10,000 ohms, 1/2 w. Aerovox
 R₂₀, R₂₁, R₂₂, R₉₉, R₁₂₈—1 megohm, 1/2 w. Aerovox
 R₂₂, R₂₉, R₄₄, R₄₃, R₆₇, R₇₀, R₉₀, R₁₁₄, R₁₂₅, R₉₉, R₃₀
 R₃₀, R₆₄, R₁₀₂—100,000 ohms, 1/2 w. Aerovox
 R₂₇, R₇₃, R₁₂₅—500,000 ohms, pot. Mallory
 R₂₈, R₃₃, R₇₆, R₁₁, R₁₁₀—300 ohms, 1 w. Aerovox
 R₃₂, R₅₁, R₉₉, R₁₀₀—2 megohms, 1/2 w. Aerovox
 R₃₅—1,500 ohms, 1 w. Aerovox
 R₃₇—10,000 ohms, pot. Aerovox
 R₃₉—200,000 ohms, 1/2 w. Aerovox
 R₄₀, R₁₃₈—2 megohms pot. Mallory
 R₄₂, R₇₉, R₇₇, R₉₈—25,000 ohms, pot. Mallory
 R₄₃—2,000 ohms, pot. Mallory
 R₄₆, R₆₆—500,000 ohms, 1/2 w. Aerovox
 R₄₈—50,000 ohms, pot. Mallory
 R₅₂—150,000 ohms, 1 w. Aerovox
 R₅₇—5,000 ohms, pot. Mallory
 R₅₉, R₁₂₄—250,000 ohms, 1/2 w. Aerovox
 R₆₁—1 megohm pot. Aerovox
 R₆₂, R₈₉, R₉₀, R₁₀₈—10,000 ohms, 1 w. Aerovox
 R₆₅, R₇₈, R₁₀₀—250,000 ohms, 1 w. Aerovox
 R₇₀—800 ohms, pot. Mallory
 R₇₁—200 ohms, 1 w. Aerovox
 R₉₁, R₁₁₁—250,000 ohms, pot. Mallory
 R₇₅, R₈₁—50,000 ohms, 1 w. Aerovox
 R₇₈—1,500 ohms, 1 w. Aerovox
 R₈₂—750 ohms, 10 w. Mallory
 R₈₃—DB Multiplier with meter by Triplett
 R₈₄—500 ohms, 10 w. Ohmite or Mallory
 R₈₇, R₈₈—500,000 ohms, 1 w. Aerovox
 R₉₂—15,000 ohms, 1 w. Aerovox
 R₉₃, R₉₄, R₉₅—22,000 ohms, 1 w. Aerovox
 R₉₇—20,000 ohms, pot. Mallory
 R₉₈—100,000 ohms, 50 w. Ohmite
 R₁₀₄, R₁₁₂—6,000 ohms, 10 w. Ohmite
 R₁₀₈—100 CT Ohmite
 R₁₀₆—500 ohms, 1 w. Aerovox
 R₁₀₇—10,000 ohms, 10 w. Ohmite
 R₁₁₈—25,000 ohms, 1 w. Aerovox
 R₁₁₉—2,000 ohms, 1 w. Aerovox
 R₁₂₀—8,000 ohms, 1 w. Aerovox
 R₁₂₁—150 ohms, 1 w. Aerovox
 R₁₂₃—30,000 ohms, 1 w. Aerovox
 R₁₂₇—40,000 ohms, 1 w. Aerovox
 L₁, L₂, L₃—Included in *Browning BL40TA assembly*
 L₄, L₅, L₆—*Browning BL3M IF Transformers*
 L₇—*Browning BL3D Discriminator Transformer*
 L₈—See Text, Faraday screen and coils
 L₉—Ant. coil (Band 1) Knight N-3380
 L₁₀—Ant. coil (Band 2) Knight N-3381
 L₁₁—Ant. coil (Band 3) Knight N-3382
 L₁₂—Ant. coil (Band 4) Knight N-3383
 L₁₃—Ant. coil (Band 5) Knight N-3384
 L₁₄, L₁₆—RF coils (Band 1) Knight N-3385
 L₁₅, L₂₀—RF coils (Band 2) Knight N-3386
 L₁₆, L₂₁—RF coils (Band 3) Knight N-3387
 L₁₇, L₂₂—RF coils (Band 4) Knight N-3388
 L₁₈, L₂₃—RF coils (Band 5) Knight N-3389
 L₂₄—IF transformer, Trutest 17-7416
 L₂₅—Xtal. filter, Keystone 9-1005
 L₂₆—Noise silencer, IF Keystone 17-6869
 L₂₇—In can with L₂₅
 L₂₈—IF transformer, Trutest 17-7416
 L₃₀—Output IF transformer, Trutest 16-6645
 L₃₁—BFO transformer, Knight N-3395
 L₃₂—Oscilloscope IF trans., RME 5775
 L₃₃—Oscilloscope IF trans., RME 5775
 L₃₄—Oscillator coil (Band 1), Knight N-3390
 L₃₅—Oscillator coil (Band 2), Knight N-3391
 L₃₆—Oscillator coil (Band 3), Knight N-3392
 L₃₇—Oscillator coil (Band 4), Knight N-3393
 L₃₈—Oscillator coil (Band 5), Knight N-3394
 L₃₉—25 mhy RFC Millen 34225
 RFC₁, RFC₂, RFC₃, RFC₄, RFC₅—25 mhy RFC Millen 34225
 RFC₆—RFC Keystone 19-5590
 M₁—"R" meter Triplett
 DB—10+6 DB meter Triplett
 Xtal Biley 455 Kc. filter
 T₁—6.3 v. @ 5.0 A. Thordarson T11F60
 T₂—5.0 v. @ 6A. Thordarson T19F84
 T₃—375-0-375 @ 250 MA Thordarson T15R07
 T₄—Oscilloscope power transformer, Thordarson T45066
 T₅, T₆—Filter choke, Thordarson T15C55
 T₇—Oscilloscope output transformer, RME 5.3
 T₈—Output transformer, Thordarson T15S90
 T₉—Filter choke, Thordarson T68C08
 T₁₀—Audio filter, Thordarson T14C61
 T₁₁—Filter choke, Thordarson T74C30
 T₁₂—6.3 v. @ 2.0 A. Thordarson T19F81

Note: Keystone is trade-mark of Radolek Co., 601 W. Randolph St., Chicago. Knight is the trade-mark of Allied Radio Co., 833 West Jackson St., Chicago. Truestest is trade-mark of Lafayette Radio Co., 901 W. Jackson Blvd., Chicago.

B... .. W... RECORDING STUDIO

— PLAYBACK THEORY AND PRACTICE —

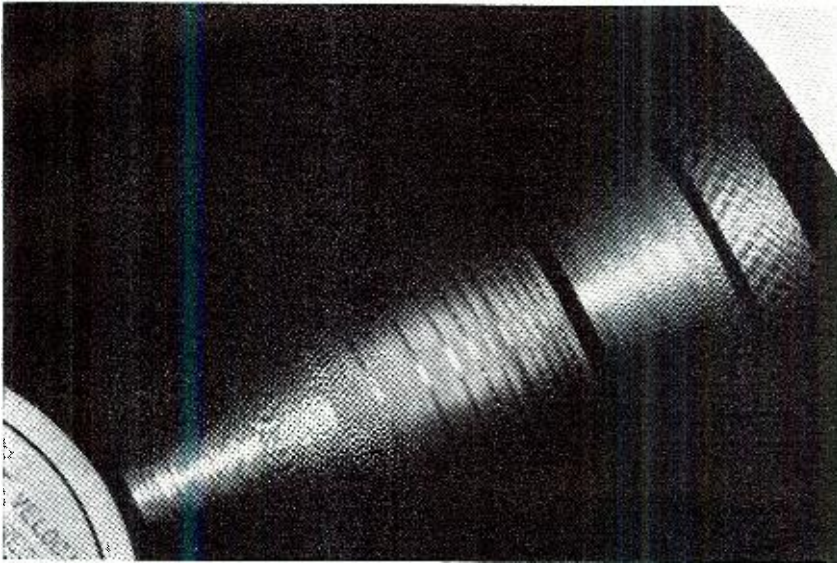

An excellent illustration of a light pattern taken from a *Universal* test record which was used as a standard. Note frequency gradations.

by

OLIVER READ

Technical Editor, RADIO NEWS

A careful attention to the playback medium pays dividends to the serious recordist. Many a good playback can be ruined by one unfamiliar with his tools.

Part 5

NE of the most interesting phases in the recording art is in the study of reproducing systems. The reproducing systems must be able to render distortionless voltage output from the revolving disc, or record, and must do so without introducing excessive wear. There has been much controversy in recording circles as to which type of reproducing system is best. Many arguments have been made both for and against the use of so-called "feather weight" pick-ups. Some manufacturers claim that they actually increase the wear to the record groove. It is the purpose of this article to present both sides of the problem and to attempt to analyze those factors which enter into the reproducing of both commercial pressings and instantaneous recording discs.

There are two general types of pick-ups in common use—the "crystal" and the "magnetic." Inasmuch as these two are most popular, we shall devote our attention to only these two types, although there are others, such as the dynamic, which might be mentioned as being similar in action to the better grade of magnetic unit.

Crystal pick-ups have been greatly improved during the past two years, and we have done considerable research with all types of records in order to attempt to find the type best suited for general recording work. One must first decide whether or not they will do *semi-professional* recording, or confine their efforts to making and reproducing of the *home-made* variety of records.

It is first necessary that the reader

understand what is meant by "overall frequency range." Some manufacturers give certain specifications for their pickups, which, to the reader, are often confusing. For example, one may state that the response of a certain head is from 30 to 6000 cycles. Others making a unit which is nearly identical may give a frequency range of from 40 to 8000 cycles. The discrepancy is due to the failure to specify the response when it is essentially of flat characteristic. Some of the most inexpensive pickups are capable of reproducing frequencies as high as 9000 or 10000 cycles, with but a slight drop in output at the high end past the normal specified rating of 6000, or 8000 cycles. In other words, it is possible, in some cases, to alter the circuit in the amplifier so that a slight rise will be effected at these high frequencies and, therefore, will tend to offset the initial loss.

Now, let us analyze the crystal cartridge as it is used in the modern vibratory system in a modern pickup. Some of these are equipped with a permanent sapphire stylus, while others use the older method of needle insertion by means of a tube and set screw. Crystal cartridges are made in two varieties. One of these is known as a "twister" element, and the other is known as a "bender" type. Each possesses certain characteristics which make them adaptable to specific use. The reader is not concerned with the selection of one type over the other as the manufacturer has the knowledge and facilities to use these in their most effective way. We will confine our re-

marks to the newer type of light-weight pickup that incorporates a permanent sapphire stylus for the reproducing needle. This stylus forms a permanent part of the vibratory system and is securely mounted in a short light-weight tube so that only the tip protrudes outside of this tubing. It actually forms a part of a resilient vibratory system and inasmuch as the protrusion does not exceed approximately $\frac{1}{16}$ " below the bottom of the pickup arm, considerable protection is afforded. This does not mean, however, that this assembly is a guarantee against damage to the sapphire tip. On the contrary, considerable care is required to prevent accidental dropping of the stylus or in jarring the stylus from either side.

The shape and other dimensions of the sapphire stylus play an important part in its capabilities to function properly when a low amount of pressure is applied to the stylus. A vibratory system of optimum stiffness and exceedingly low inertia results when such a permanent reproducing stylus is properly connected to the crystal element. The above features guarantee a much longer record life with considerable reduction in acoustic and background noises. The acoustic (needle scratch) noises are most familiar to the reader. The amount of this noise is determined by the hardness of the record material and by the weight of the reproducing needle or stylus as it travels in the groove of the record. Therefore, if the needle pressure is relieved and if the reproducing system possesses sufficiently low iner-

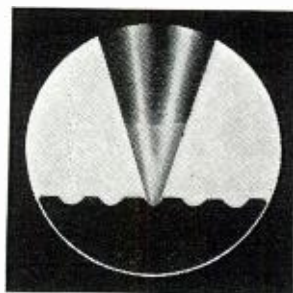

Figure A.

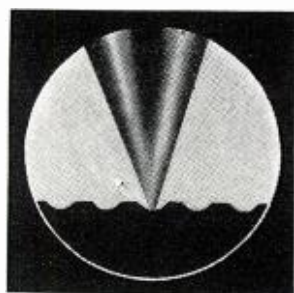

Figure B.

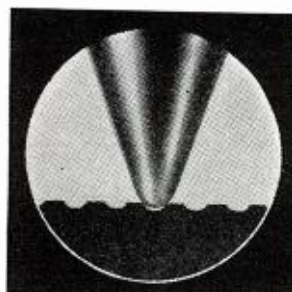

Figure C.

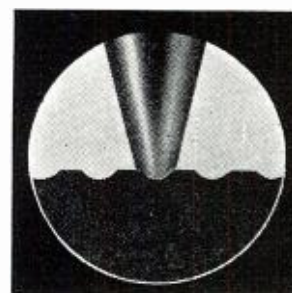

Figure D.

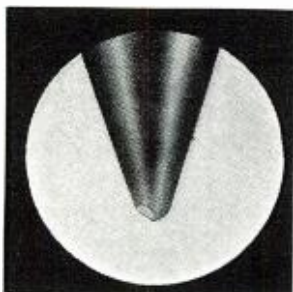

Figure E.

Microphotographs of reproducing styli showing several conditions as met in everyday practices and by the professional studio and by the home recordist. Fig. A illustrates a correctly seated stylus in a properly cut groove. Fig. B shows how a sharp point on the stylus can cut into the soft surface material. Fig. C indicates the condition when a too rounded stylus rests on the walls of the groove. Fig. D shows a worn stylus ground to fit into the groove. Fig. E shows a chipped or defective stylus point. Fig. F indicates a worn out or damaged needle point.

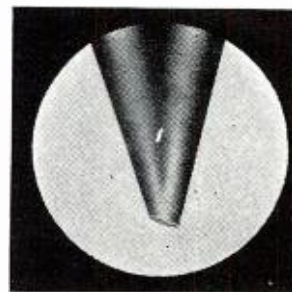

Figure F.

tia and maximum stiffness, considerable noise reduction may be had.

Next, we come to the subject of "needle pressure." Our own experience with various types of modern pickups has indicated that the optimum pressure which may be used between the reproducing stylus and record is, approximately, one ounce. This does not mean, however, that other pressures will not be suited to good reproduction. It is simply an average we have encountered with our own equipment which, by actual measurement, proved to be the most satisfactory for proper reproduction, and freedom from "groove skating." Some crystal pickups are designed to use considerable more pressure than one ounce. This becomes necessary in the lower priced units where optimum stiffness of the vibratory system is less than that used in most of the high grade units.

For maximum fidelity, we have found a pick-up such as the *Brush PL-20* and *PL-50* units to be highly satisfactory. They are capable of giving reproduction with true "high fidelity" characteristics, and the recordings are heard with a "fullness," and "brilliance," that are not present when cheaper units are used. The *PL-50* unit requires but half the stylus pressure of that used with the *PL-20* (15 grams). However, this unit is especially designed for reproduction of wax and soft nitrate records. If the system is improperly adjusted, "groove skating" will result.

"Groove skating" is illustrated in Fig. 8, and here we find three positions indicated on the drawing where the stylus may actually ride. Note that if too light a pressure is exerted to the stylus that, due to the velocity of the revolving disc, it may actually "ride up" on one side of the groove. The action is similar to that of a sled traveling down a winding toboggan slide. Obviously, true reproduction cannot result when this condition is present. It is highly important that the stylus

rest in the bottom of the groove and, furthermore, it is imperative that this stylus be ground to proper shape so that it will fit into the groove accurately. Proper seating of the stylus is indicated in the microphotographs appearing with this article which were prepared by the *Permo Products Corp.* This applies to all types of reproducing styli.

Certain characteristics are required in order that the styli fit the record groove properly. In general, the dimensions given in the drawing in Fig. 7 will be found most satisfactory. Note that the tip of the needle, or stylus, is rounded to a radius of .002 inch. We may see, therefore, that in order to obtain proper "tracking" it will be necessary that the radius of the stylus be similar to the bottom of the record groove in shape. Furthermore, when cutting instantaneous discs, it is good practice to use a cutting stylus which is capable of cutting the same type of groove. This is not as difficult to accomplish as one may believe. Much of the success possible in recording today is due to the maker of the cutting and playback styli. By adhering to close standards, and by applying other principles previously given in these articles, it is possible to consistently turn out records of good quality and texture.

We have already covered the theory involved for both "constant amplitude" and "constant velocity" recording. The very nature of the crystal pickup permits reproduction with either method. Several suitable input networks are illustrated. The simplest being that shown in Fig. 3 where a crystal pickup is connected directly across the input gain control to the amplifier. This connection is used where it is desired to reproduce records that have been cut "constant amplitude." Fig. 4 shows a similar arrangement that has, in addition, a filter network, or "equalizer," for the reproduction of "constant velocity" recordings. This is the proper circuit to

use when regular commercial pressings are used. These filters are available from the manufacturer of the particular pickup employed by the user and no specifications will be given as to their components inasmuch as they will depend entirely upon the characteristics of the pickup used. The same type of reproduction may be used for use with a push-pull amplifier. Reference to Fig. 5 will indicate the proper method for installing the equalizers between the crystal pickup and the push-pull input of the amplifier. Fig. 6 indicates a similar arrangement to that employed in Fig. 3 and one which is designed for operation into a push-pull amplifier when "constant amplitude" reproduction is required.

Now, let us consider the magnetic type of pickup. This type of unit has also received due attention, and the manufacturers have kept pace with those making the crystal units in perfecting units having excellent reproducing characteristics. The entire structure of the magnetic unit requires great care in manufacture in order that the reproducing stylus be centered between the magnetic poles of the magnet used in the assembly. One of their outstanding features is their immunity to moisture and heat, and they possess a certain ruggedness not found in all crystal units. If the magnetically powered pickup is properly designed, it will be capable of giving consistent distortionless performance and will possess sufficient stability for continuous recording. The better magnetic pickups are counterbalanced in preference to using the old spring-tension method which causes variation and affects the reproduction. Some pickups accentuate the scratch noise because of "peaks" which are inherent in the pickup. These often cause certain notes to reproduce much louder than others, causing highly objectionable harshness and shrillness. The better grade of units are free from these so-called "peaks." It must be

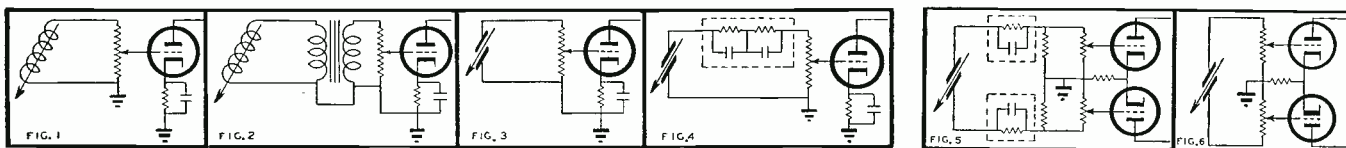

Some representative input networks for both crystal and magnetic units.

remembered that any pickup which is capable of reproducing over approximately 4200 cycles, will also reproduce whatever surface or scratch noise that may be present on the material. Reducing the stylus pressure will have little or no effect to overcome this condition. Furthermore, an amplifier that will not pass the scratch frequencies is considered to be inadequate for high fidelity work. In other words, one should hear the scratch if present on the record.

This is most noticeable, of course, on commercial records known as "shellac pressings." It is necessary for the maker of the record to incorporate an abrasive material. This is used so that the ordinary steel needle may be ground to fit the groove. Record wear is governed by two principal factors: "Vibratory Momentum," and "Groove Skating." Obviously the unit with the lowest "vibratory momentum" and proper stylus pressure will show the lowest harmonic distortion—all other things being equal.

One of the most popular of the magnetic units is known as the *Audak "Relay-Flux" Microdyne*. The moving mass ratio of this new unit is of the order of 1 to 80 and, great as this is, it does not represent the total improvement over older types. The inertia of the "exciter" is several hundred times less than that of the moving armature in the cheaper magnetic units. The mechanical structure is quite different from that employed previously and it incorporates a tiny vibrating reed for the vibratory medium.

Summing up, we find that both the crystal and the magnetic pickups have been perfected and both may be used with good success if properly applied. Fig. 1 indicates a simple arrangement for feeding a high impedance mechanism into a single-ended amplifier. This circuit may be used providing the pickup has a rated impedance of 2000 ohms, or more. Units having low impedance should be matched to the amplifier input by means of a transformer, as shown in Fig. 2. If the pickup has a 15 ohm impedance, it will be necessary to use a transformer that will match 15 ohms to the grid impedance, or approximately 50,000 ohms.

It is imperative that the turn-table lay perfectly flat in order to prevent excessive wear on the record. Furthermore, the reproducing tone arm must move freely from side to side and be free from binding for true reproduction. Many a record has been ruined by failure to observe the above rules. The proper needle pressure is stated by the manufacturer of whatever unit the purchaser is using, and his recommendations should be closely adhered to for best results.

Many home recordists have attempted to use various types of lubricants, either to improve the cutting of a disc, or as a preservative applied after a record has been cut. Many of our readers have written asking whether or not the use of such lubricants is recommended. Our answer is

definitely "no" under any conditions on high-fidelity recordings. A properly cut disc should be capable of being played back with little or no surface noise. If we attempt to add a liquid to the disc in order to preserve its texture, we invite trouble inasmuch as the moisture present will be a direct invitation to dust particles and lint to accumulate and to stick to the surface. For this reason, we do not recommend that they be used unless they are of the "home-recorded" type.

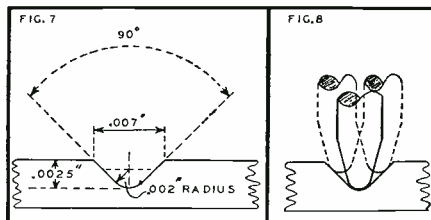

Relative dimensions of cut groove.

Recently various combinations of cutters and pickups have appeared on the market. These units are designed so that both cutting and play-back may be done with the same stylus. As yet, we have had no reason to become excited about this development and so far it has found little application. In fact, records were made many years ago using pre-grooved discs and a magnetic pickup was used as a cutting head by tying a suitable weight to the head to increase its pressure onto the disc. A properly cut record is actually etched, or chiseled out of the material and this may be properly termed "cutting," while the older method would be termed "indenting."

Another problem in the recording art is in "tracking error." This is the angle between the tangent to the groove at the stylus point, and the vertical projection upon the disc of the

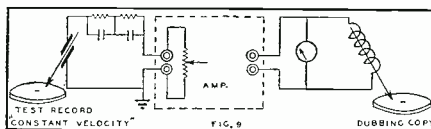

Simple setup to check pickup range.

axis of stylus vibration. Vast improvements have been made in the reduction of these errors in the design of the modern pickup. Certain losses may be encountered if this tracking is improperly done. A revolving flat disc presents problems which are not encountered with the early cylindrical phonographs or dictating machine. These older types possessed perfect tangency to the groove and this was maintained at every point on the record. When reproduction is done by means of a pivoted tone arm, such as a modern pickup, the locus of the needle point is the arc of a circle and perfect tangency to the groove is only possible at but a few points on the record blank. From this we see that the tracking error is the result of the

pivot and is an inverse function of the length of the tone arm. Other considerations are the radius of the groove and the location of the pivot with respect to the spindle, and the type of tone arm used. Manufacturers have dealt with the problem accordingly, with the result that the modern pickup offers considerable reduction to pickup tracking errors.

One of the most commonly asked questions is "What type of needle shall I use to reproduce my phono records?" Every now and then we hear of some new fangled idea which features a special material or shape for a reproducing needle and claims are often made that high fidelity results may be expected from their use. Common sense tells us that any good quality phono-needle may be used if it meets the following specifications. First, that it be free from burrs, or any imperfections which might distort or tear the groove material on the record. Second, the tip radius of the needle must never be less than .002 of an inch. Third, it must possess sufficient hardness so that it will maintain the proper shape for the playing of at least one complete disc. Fourth, it must be of proper length and diameter so that all of the frequencies may be reproduced properly. Fifth, it should be micro-inspected so that the consumer will not damage his records from a defective stylus.

A very popular type of reproducing needle is the "Permopoint." Record and needle wear is greatly reduced by using them in place of the ordinary steel needle. Only .002 to .0025 inch of the tip of the needle actually runs in the groove. This is smaller than the average human hair. The tip material at this point must support the weight of the pick-up and will be subjected to the grinding action of the record. It is obvious that the tip should be composed of only the finest materials and workmanship. Imperfections in the material and shape will result in excessive record wear and poor tone quality. This type of reproducing needle is more or less self-lubricating and they are manufactured with a uniform tip radius. The tip of this type of needle is plated with a precious metal of the platinum group, and the alloy used is applied to the tip of these needles after they have been micro-inspected for proper shape and other characteristics.

There are several methods which may be used to determine the characteristics and capabilities of a phono pickup. One method is to make use of *test records*. One of these is made by the *Universal Microphone Co.* and may be used as a standard for most practical purposes. The circuit illustrated in Fig. 9 is used in conjunction with this record, and a flat response amplifier, a db. level indicator, and a magnetic, or crystal cutter which has been properly chosen to cut "constant velocity." The copy is dubbed on a second turntable, as indicated, and the light pattern observed in the same

(Continued on page 44)

WHAT'S NEW IN RADIO



ECHOPHONE RECEIVER PROVIDES FOR CODE PRACTICE to budding hams, scouts and others desirous of learning the code the *Echophone Commercial* communications receiver, Model EC-1, will be of special interest. Not only does it provide for reception of both 'phone and code throughout its range of 545 kc. to 30.5 megacycles but in addition has self-contained facilities for keying and code-reading practice.

With a standard telegraph key connected in series with the headphone the output of the receiver to the headphones will be broken up into dots and dashes as the circuit is keyed. If the receiver is tuned to a broadcast or other steady carrier, and its beat-frequency oscillator turned on, this output will be in the form of a heterodyne whistle. When keyed the result is a perfect imitation of the sound of regular radio telegraph transmissions.



Group "copying" practice is possible if the headphones are placed on the table and the receiver volume turned up to make their sound audible over a reasonable range. Or by connecting two keys in parallel it is possible to carry on 2-way communication with either participant breaking in at will.

When some degree of speed has been achieved in code copying then the regular code transmissions of commercial stations can be tuned in for actual on-the-air practice.

In this receiver the headphone circuit is completely isolated from the line and high voltage supplies by an output transformer. Thus the possibility of shock while handling the key is completely avoided.

In addition to its code practice feature this 6-tube model, a product of the *Echophone Radio Corp.*, 201 E. 26th St., Chicago, provides many other advantages, not the least of which is its extremely modest cost. Among these are electrical bandspread; a.v.c. off-on switch, stand-by switch, headphone-speaker switch, built-in speaker, b.f.o. switch, b.f.o. pitch adjustment, tuning coverage of 545 kc. to 30.5 mc. in three bands each fully calibrated on the main dial, separate band-spread scale of the slide-rule type, AC/DC line operation, antenna connections for standard or doublet antennas, etc.

NEW C-D MOULDED BAKELITE MICA CAPACITORS A new addition to the *Cornell-Dubilier* line of mica dielectric capacitors is the Type 7 illustrated. This is a moulded bakel-

ite capacitor, similar to the existing Type 4 but with wider spacing between the insulated mounting holes to meet the 1½" standard called for in a number of applications.

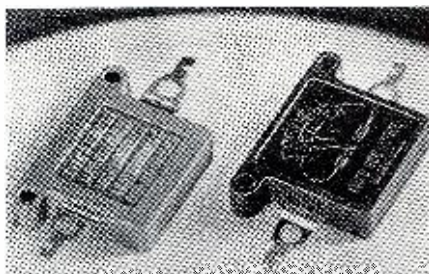

Standard units are moulded in brown bakelite and are available in capacities beginning at .00005 mfd. and running up to .03 for those rated at 600 volts (d.c. working), .01 for the 1200-volt rating, and .003 for the 2500-volt rating. Standard tolerance in capacity ratings is plus or minus 10%. Insulation resistance is 20,000 megohms. Each unit is clearly stamped with the capacity value, d.c. working voltage and d.c. test voltage.

While these standard units meet the requirements of the great majority of mica capacitor applications, the special features required for other application can be incorporated in the Type 7 on special order. The capacitors can be supplied moulded in low-loss bakelite (insulation resistance 40,000 megohms), for instance, with saltwater immersion seal against humidity; or temperature aged—multi-cycle for stabilizing capacity over extremely wide temperature changes, minus 40 degrees C. to plus 70 degrees C. Any or all of these special features can be combined in such special units.

Further data and specifications covering the Type 7 may be obtained from catalog supplement No. 160T (B) supplied on request to *Cornell-Dubilier Electric Corp.*, South Plainfield, New Jersey.

JOHN MECK ANNOUNCES NEW 25-WATT Audiograph AMPLIFIER. The 1941 *Audiograph* 25-watt amplifier, listing at only \$39.95, has just been announced by *John Meck Industries*, 1313 W. Randolph St., Chicago.

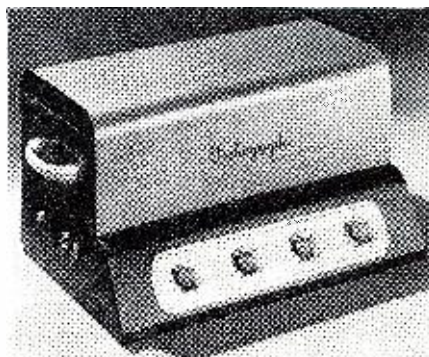

Three input channels are available to make

possible the use of a phonograph record player and two microphones simultaneously. Each channel is provided with individual volume control. Sturdy construction of this unit makes it suitable for 24-hour service in paging systems and other severe applications. It is also available with two speakers in a rawhide-finished carrying case for use as a dual speaker portable system. Both plug-in sockets and terminal board speaker connections are provided, with choice of 2, 4, 8, 166, 250, and 500 ohm impedance. Record player built into top shield is available at small extra cost.

ATLAS REFLEX PROJECTOR AND TRI-ANGLE CABINET. The new "Inter-mediate" 4½' "Morning Glory" reflexed projector, Model DR-54, has a bell opening of 25". Effective air column is 54"; dynamic reflex design reduces the overall length of the double reentrant trumpet to 23½". This new size projector is excellent for general p. a. application, such as sound truck use, where the overall length must be considered but where sufficient air column length is required for good reproduction of voice as well as music.



Finish is a battleship gray lacquer and crackle with red insignia on the inside throat section. Adjustable mounting bracket supplied. DR-54 lists at \$32.00; P. M. Driver Unit Model PM-23 shown is \$32.50 list. SO Rubber Rim for bell edge available on special order.

NEW LINE OF TRI-ANGLE ACOUSTIC ENCLOSURES excellent for corner mounting, side-wall hanging, and cluster arrangement in groups of two, three, and four. Distinctive finish in natural grain walnut with attractive musical motif and acousti-cloth grille. Infinite baffle with bass reflex design permits high quality music reproduction, and inner glue-block construction for sturdiness. Model TR-12 for all 12" cones has overall height of 22", width 19", depth 10". *Atlas Sound Corporation*, 1449 39th Street, Brooklyn, N. Y.

KNIGHT INDUSTRIAL PAGING SYSTEM. *Allied Radio Corporation*, Chicago, has recently placed on the market a new Industrial Paging System designed especially for use in factories, hotels, offices, warehouses, transportation terminals, etc., for making announcements of general interest, paging individuals, calling parked cars and many

similar services. Operation is from 110 volts, 60 cycles a.c., and the amplifier which delivers 30 watts of usable power will satisfactorily handle four or more 8" p.m. dynamic speakers with sufficient volume for simultaneous coverage of large areas or widely divergent locations. Controls are provided for regulation of output power and tone to meet a wide variety of installation requirements. The system comes ready for installation and consists of: 1 *Knight* 30-Watt Amplifier, with tubes and volume level meter; 1 *Shure* Crystal Microphone, with 25-foot cable and switch; 1 desk-type micro-

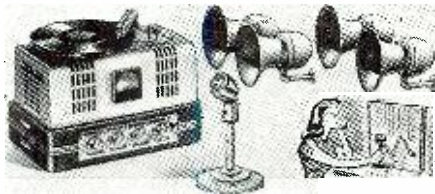

phone stand; 4 Jensen PM-8DS speakers, with transformers, each installed in a Kainer Steel Projector Baffle, with wall-mounting brackets. Additional accessories available include a phono-top, with turntable and crystal pickup for playing records, and a special PBX telephone arm for mounting microphone on switchboard.

A product of *Allied Radio Corporation*, 833 West Jackson Boulevard, Chicago, Illinois.

CLAROSTAT POWER RESISTOR DECADE BOX FINDS MANY USES. Introduced several months ago, the *Clarostat* power resistor decade box has already become indispensable equipment in many laboratories, engineering offices, plants, maintenance departments and schools. It is reported to be saving many hours, days and even weeks in national defense activities, because of the ease with which it solves practical resistance problems under actual working conditions. Some users report saving the cost of the instrument in a few weeks.

This instrument is something radically new in resistance decade boxes. Instead of a mere measurement or resistance value, it actually provides a precise power resistor of anywhere from 1 ohm to 999,000 ohms, for actual use in a given circuit. It provides a power resistor handling up to 225 watts per decade. Merely adjusting any or all of the six rotary decade switches provides any resistance value within the enormous range. The reading for the inserted resistance is read from the decade dials, duly observing the multiplying factors indicated.

The power resistor decade box does away with time-consuming and usually uncertain resistance calculations. Much time is saved in deciding upon the best resistance value to use, by actual practice. The instrument is especially valuable in determining parallel resistance values, in voltage-dropping requirements, and for other practical functions. Instead of having a large collection of power resistors on hand, or waiting days to obtain different units, this one instrument instantly provides any required value, known or unknown, for a circuit. The instrument is made by *Clarostat Mfg. Co., Inc.*, 285-7 North Sixth Street, Brooklyn, N. Y.

NEW WALCO SAPPHIRE NEEDLE FOR LOW-PRESSURE PICKUPS. *Electrovox Company*, 424 Madison Avenue, New York City, announce the WN-55 *Walco* Sapphire Needle for low-pressure pickups. This new genuine jewel stylus has been developed in conjunction with the engineers of several large radio-phonograph manufacturers who are adopting it as standard equipment on their

new model phonographs and combinations. The specifications of this new *Walco* needle include a genuine sapphire point mounted in a straight duralumin shank. The shank has two parallel in-cut flats ground near the tip to provide a lateral flexibility which eliminates "needle talk" and minimizes surface

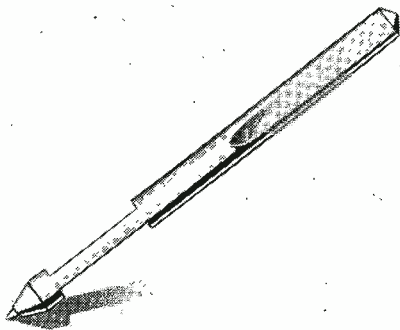

noise. The shank also has a flat on its upper extremity for the set screw. This automatically insures correct positioning in the pickup when used as a replacement. The needle is specifically designed for pickups having needle pressure of 2 ounces or less and at one ounce pressure will give approximately 12,000 playings before it must be replaced.

EMERSON ANNOUNCES ITS "POWER LINE" OF "3-WAY" PORTABLES. Super power—seven times greater sensitivity. This is the Advertising and Promotional theme that *Emerson* employs to launch its first group of new 1942 "3-Way" Portables. These three new Superheterodyne models are equipped with 3-Gang Tuning Condenser, and Tuned r.f. Amplifier.

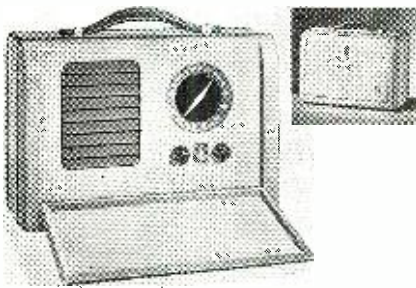

Priced at \$19.95, \$24.95 and \$29.95, respectively, they represent a combination of performance features never before found in a popular-priced line of "3-Way" Portables. 3-Gang Tuning and r.f. gives these sets seven times greater sensitivity, and makes possible the application of the statement "guaranteed to play everywhere."

Other outstanding features of these models include six tubes, completely automatic error-proof power shift, large p.m. dynamic speaker, inclosed super-loop, and automatic volume control. The models are handsomely styled in simulated leather and mark an important advance in portable design.

Emerson's chief engineer, Dorman Israel, points out that these models will amply satisfy the dealers' needs for popular priced "3-Way" Portables with greater selectivity and sensitivity features. He emphasizes especially the importance of 3-Gang Tuning, and goes on to state that this feature, coupled with r.f., represents a combination never before found in a "3-Way" Portable listing at \$19.95. *Emerson Radio & Phonograph Corp.*, 111 Eighth Ave., New York City.

OHMITE RESISTORS AVAILABLE IN LIVE BRACKET AND DEAD BRACKET TYPES. *Ohmite*

wire-wound vitreous-enamelled resistors are available in "Live" Bracket and "Dead" Bracket types for special applications.

The "Live" Bracket type resistors have flexible leads connected to tin-plated brass brackets. They are designed for mounting and making electrical connection by bolting the slotted brackets to panel terminals.

Ohmite "Dead" Bracket type resistors are mounted by bolting to the brackets. Electrical connections are made separately to the lugs. The brackets for one, two or three resistors are mounted to the resistors by means of through-bolts. The leakage distance from lug to bracket can be regulated by the use of mica washers or by having the lugs located as far in as required.

Both types of resistors are much used for signal circuits, electrical refrigeration controls, storage battery charging, switchboards, and other applications. They are available in a wide range of core sizes with diameters from $\frac{3}{16}$ " to $2\frac{1}{2}$ ".

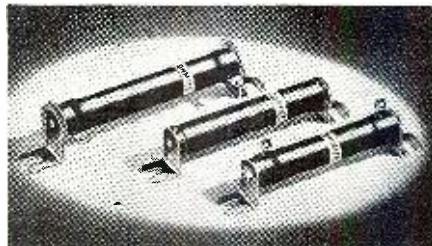

The resistors are accurately wire-wound, sealed tight and permanently protected by *Ohmite* vitreous enamel. They are promptly made-to-order according to specifications. *Ohmite Manufacturing Company*, Dept. 10, 4835 Flournoy Street, Chicago, Illinois.

RADEX ANNOUNCES NEW IMPEDANCE MATCHING BRIDGE AND CURVE TRACER. *The Radex Corporation*, Chicago, have just put on the market two new precision testing units—an Impedance Matching Bridge and an I. F. Visual Curve Tracer.

Many coils are required to have an inductance within a rather close tolerance of a standard value. Since it is usually not possible to wind the coil to the inductance due to certain limitations, it becomes necessary to make an inductance adjustment. This adjustment and checking of inductance presents a serious problem where coils are produced in large quantities. The Impedance Matching Bridge was developed to provide a very fast, as well as very accurate method, for adjusting and checking coil inductances in production work.

The Bridge set-up as supplied consists of an oscillator, an amplifier, a cathode ray indicator and the bridge proper. The set-up is complete and requires no auxiliary equipment, except for fixtures that the user may find advisable to add to simplify connecting different types of coils to the test terminals.

Coils having inductances between less than 1 microhenry and more than 10 millihenries may be compared to a standard with an accuracy of 1/100 of 1% if desired. Any other electrical elements, such as condensers, having impedances between $\frac{1}{2}$ ohm and 5,000 ohms at 100 kilocycles may be similarly compared.

The second item is a Visual Curve Tracer. There are many circuit elements used in electrical systems wherein knowledge of the amplitude variation with frequency is desired. Point by point analysis of the frequency-amplitude function is slow, often results in error and fails to convey the proper overall impression of the result being obtained. Such methods are particularly poor on production where speed is essential or accuracy in maintaining a number of critical characteristics is desired. A highly satisfactory solution to the problem is to pro-

duce on the screen of a cathode ray tube a frequency-amplitude function for visual observation. A proper screen, or limits otherwise indicated, will enable an immediate appraisal of the correctness or error of the observed curve.

The type of units to be tested by the Visual Curve Tracer are I. F. Transformers, Wave Traps, Discriminator Circuits and all forms of high, low or band-pass Filters. In short, almost any electrical network analysis as to frequency-amplitude can be made immediately and completely.

Frequency limits are 10 cycles to 30 megacycles. Band widths of 200 kilocycles up to 5 megacycles may be visually shown on the large cathode ray tube, the wider band widths being available at the higher frequencies.—*Radex Corporation, 1733 Milwaukee Ave., Chicago, Ill.*

NEW PHILCO RADIO. The sweeping rounded lines of the new *Philco Transitone* are executed in molded *Resinox, Monsanto* phenolic plastic. This strong, tough material has the color and lustrous finish molded in, making the cabinet durable and permanently attractive. Light weight, in addition to strength, is a further advantage of the molded plastic.



The cabinets are molded for *Philco Corporation* by *Associated Attleboro Manufacturers, Inc., Attleboro, Mass.* Plastics Division, *Monsanto Chemical Company*, supplies the material.

NEW AEROVOX PLUG-IN ELECTROLYTICS NOW STANDARD ITEMS. Originally made to order for military, aircraft, police radio, sound system, and other users of continuous-service equipment, the *Aerovox* plug-in electrolytics are now listed in the latest catalog and made available as standard jobber items.

These unique plug-in condensers, developed and manufactured by *Aerovox Corporation* of New Bedford, Mass., are provided with a specially-constructed octal base which fits into the standard octal socket. Such units are readily removable for substitution testing and checking and replacement, in much the same manner and ease as regular radio tubes. This feature is vitally important in continuous-service equipment, where in electrolytic condensers must be instantly replaceable when necessary. Auto radio sets and other assemblies are beginning to come through with plug-in condensers, hence the need for such replacements as standard items.

Aerovox plug-in electrolytics are now available in the 525 v. surge 450 v. d.c.w. rating, and in 10 to 80 mfd. single-section, 10-10 and 20-20 double-section, 10-10-10 triple-section, and the 10×10×450+20×25 combination.

HOWARD CHAIR-SIDE RECORDER. The new *Howard "Chum" Recorder* is a 7-tube radio that tunes 2 bands, standard broadcast and foreign short wave from 540 to 1700 kc. and 5.5 to 18 mc. Records radio programs direct from the air, through microphone, or

radio and microphone can be mixed. Magic eye acts as resonance indicator when radio is on "receive" position, and becomes output level indicator when switched to "record." Mute switch on speaker cuts volume to prevent feed-back, yet is sufficiently loud for monitoring. Record changer plays twelve 10" or ten 12" records. Cabinet available in three finishes, Walnut, Mahogany or Blonde Mahogany. Convenient place for storing records in side of cabinet. Has 12" *Jensen* electrodynamic speaker and *Astatic* Crystal Microphone. Same cabinet can be supplied with an 8-tube phono-radio without recorder.

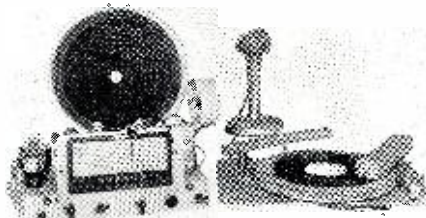

Another new addition to their line is an exceptionally versatile Chassis for the semi-professional recording studios, for installing in old or custom built cabinets, wherever great flexibility and good recordings are required. Radio has tuned radio frequency on all bands and two i.f. stages. Tunes three full bands to 13 meters. Records radio programs direct from the air, from microphone, or microphone and radio programs can be mixed and faded. A separate channel is provided for connecting an extra pickup and turntable, and records can be dubbed electrically so that singer can use a recording for musical accompaniment. Microphone can be mixed and faded while dubbing record. Supplied with 12" *Jensen* electrodynamic speaker, *Astatic* Crystal Microphone, cutting arm and pickup and all necessary hardware. Can also be used as a public address system. Maximum output, 11 watts.—*Howard Radio Co., 1731 Belmont Ave., Chicago.*

NEW PILOT SET. The newest addition to the famous *Pilot "Super-Challenger"* series possessing 3-gang condensers, tuned r.f. amplification on each band, and push-pull output. New features consist of self-contained loop aerial easy-reading dial and Gyro-Tuner. A new dual-purpose ballast resistor permits operation on 107-125 volts a.c./d.c. and 220-240 volts a.c./d.c. by merely turning a switch on the rear of the chassis.

Walnut cabinet is furnished with acoustical louvre grille, having rosewood inlays and hand-rubbed finish. Large, rectangular, well-illuminated dial. Station indications clearly printed on dial face. Shortwave bands indicated by fine line shading to aid in shortwave tuning. Separate band indicator controlled by band-antenna selector in front of cabinet. Live rubber mountings protect all vital parts. Improved superheterodyne with tuned r.f. amplifier on each band. Continuously variable tone control for use on radio or with phono attachment. Covers infinite steps from bass to treble. Automatic volume control to minimize fading or blasting. Built-in loop aerial for broadcast with provision for external aerial for use on broadcast and shortwave. Permeability tuned ironcore i.f. transformers and oscillator coils. Fine, smooth tuning given by momentum-spin. Quick scale coverage by fast spinning. 3-gang condenser, for extreme sensitivity and selectivity. Phono, television and Frequency Modulation jack in rear of set. These attachments may be plugged in and operated from band-antenna selector in front of cabinet without necessity of removing them to

operate radio. Push-pull output with parallel 25L6G's. Output—8 watts. Dual-purpose ballast tube permits operation on 107-125 volts a.c./d.c. and 220-240 volts a.c./d.c. without necessity of changing ballasts. Voltage switch on rear of set permits instant interchangeability of receiver to either of the above power supplies. Can also be equipped for use on 130 or 150 volts with corresponding line cord. One 6SA7, Two 6SK7, Two 6SQ7, Four 25L6G, Two 25Z6G, One 6U5/6G5 and one dual-purpose ballast resistor.—*Pilot Radio Corporation, 37-06 36th St., Long Island City, N. Y.*

TRIUMPH MODEL 131 SIGNAL GENERATOR has a large dual scale dial, calibrated 1/2 of 1% from 100 kc. to 96 mc. Multiplier-At-

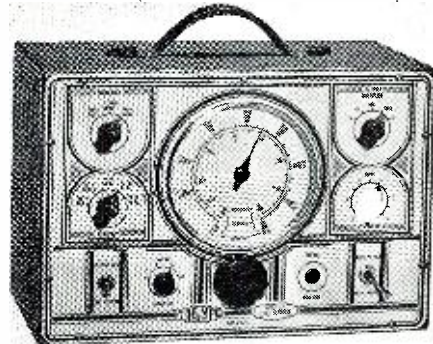

tenuator allows sensitivity, selectivity, A.F.C., A.V.C., and overload tests of receivers. Variable percentage modulation at 400 cycles or any other frequency 0 to 2 1/2 volts of 400 cycle at output cable. Ivory, green, and black panel on brown wrinkle case. Size 13" × 9" × 7". Shipping weight 22 lbs.

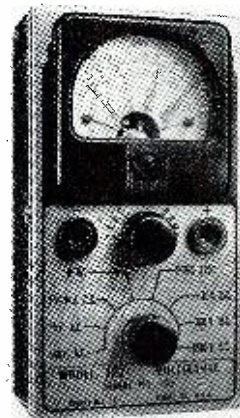

TRIUMPH MODEL 323 TEST SET is a pocket size, general purpose, high sensitivity, a.c./d.c. instrument for Radio and Electrical measurements. Stainless steel panel and welded steel case. Fully insulated. Ruggedly built. Dimensions 2 1/2" × 5 1/4" × 1 1/8". Shipping weight 2 lbs.—*Triumph Mfg. Co., 4017-19 W. Lake St., Chicago, Ill.*

—50—

BRUNO GOES TO SELECTAR

Selectar Mfg. Corporation, 30 West 15th Street, New York City, devoted in the past to the manufacture of high grade precision instruments in varied electro-mechanical fields, announces its entry into the Professional and Home Recording Market with a complete line of Recorder Microphones, Pick Ups and other accessories.

The new Selectar line is built around the well-known Bruno products and, to insure a continuous source of advanced design, *William A. Bruno* has been retained to direct the Manufacturing and Technical activities of the Corporation. The new, complete line will soon be ready for distribution, and will include, as well, the Bruno line. Further information available from manufacturer.

BENCH NOTES

by **ROBERT KENDALL**
Service Manager, Indianapolis, Indiana

Beginners' Charges

IN the May installment of *Bench Notes* a few of the young service man's common perplexities were given a quick once-over, including that most important question of proper service charges. Our advice to the beginner to charge "what the job was worth" was quite correct, as far as it went; but at the time we were quite aware that it was much too general in tone to be an adequate solution for the young man's problem. However, it was the best we could do at short notice, and after giving a little more thought to the matter we can offer something a little more specific in the way of a rule-of-thumb method that will serve as a rough guide, subject to whatever modifications conditions in the service man's territory may necessitate.

As a general rule it may be said, with some exceptions of course, that the amount of labor necessary to repair a receiver has a more or less direct relation to the parts required to make the repair, exclusive of tubes; so, for Rule No. 1 we should say: The labor cost should be approximately equivalent to the list price of the new parts installed. By checking up on a few common cases, most of the charges arrived at by this system will be found fairly equitable to the customer and the service man alike. For example, if a receiver requires a new power transformer with a list price of \$3.50, adding a labor charge of like amount would produce a total charge of \$7.00, which is not far from being a standard rate for this type of job. Likewise, a receiver that required three new filter condensers listing at 90c each, would be charged on this basis, \$5.40, which is about what the bill should be.

"Aha," you say with the sly air of having caught the old man with his nether habiliments down, "what about those jobs where only one or two small parts are used, costing say, 50c; are we to get only 50c for the sweat of our brow?" Not at all—simply apply *Professor Kendall's Rule No. 2*, that is: There should be a minimum labor charge fixed for all work. In a good many independent shops this minimum is often 75c or \$1.00, depending largely upon local conditions. A typical bill for a case of this kind would be:

1—.1 mfd. bypass condenser.....	\$0.25
1—15,000 ohm resistor.....	.20
Labor (minimum)	1.00
Total	\$1.45

There are, of course, certain services that do not fall in these classifications—such as the alignment of R.F. and I.F. channels, setting push-buttons, etc. To the competent repairman, with necessary equipment, these

are comparatively simple operations that require little time to complete. The average push-button set can be adjusted in fifteen minutes or less, and the minimum charge should cover that adequately, if no other work is done. When other work is being done on a receiver, the R.F. and I.F. alignment is usually checked and touched up as a matter of routine, with a nominal charge if any, as very little time is required for this as a rule.

It should be born in mind that these charger cover parts and labor in the shop only, and do not include pick-up and delivery charges, which will depend too much upon individual circumstances for this writer to attempt to estimate them at this time. In the absence of any more accurate knowledge of costs, pick-up and delivery charges may be calculated on a straight time basis—and as a suggestion only, we would say that the beginner in the average community might reasonably charge around 50c per hour for this service.

The charges arrived at by the application of the plan roughly outlined, will approximate closely the prevailing rates in this locality; but it is quite probable, of course, that such bills might be too high or too low for other communities. In that case, however, it would only be necessary to alter the ratio between the material and labor charges to conform to the requirements of any particular location. In any event, we would greatly appreciate an expression of opinion from service men in all sections of the country on the subject.

Condenser Pal Nuts

UR "Young Edison" blew in the other day, with a chassis under one arm, and an exceedingly worn-out expression on his pan, and bouncing the chassis with a fed-up air on the bench, demanded bitterly "How in that place of excessively high temperature do you get those vermin-infested illegitimate nuts off those no-good filter condensers?" A brief inquiry was sufficient to reveal that he had spent the last hour snapping at them with a pair of gas pliers, with no results other than breaking a few leads, and removing a quantity of skin from his knuckles—so perhaps we may be excused for our slight air of smugness, as we slid these nuts off in short order, using an ordinary double-end spark-plug wrench.

Of course you knew this all along, but it is possible that there are a few fellows that don't, so for their benefit let us say that these useful gadgets may be picked up at any auto supply store, and only cost 15 or 20c each. Two of these wrenches will suffice for

most purposes, and we note that the ones in use at *Super-Snappy S & S* are marked 1 1/32-29/32, and 31/32-15/32.

Those Push Buttons

NOW that the widely heralded "Moving Day" of radio has come and gone, the service man can return to his normal routine with a sigh of relief, and take stock of the actual results in the way of net business derived by him. We must confess that this department was somewhat perplexed by the fanfare and general hullabaloo that preceded this event, and at the same time more than a little skeptical of some of the optimistic estimates of the number of service jobs in view. We found that the majority of the local boys shared our more conservative views, and inclined to be more amused than otherwise at some of the estimates that ranged as high as four hundred odd jobs per man in some quarters.

After the event, a quick check-up was made among a number of representative service-dealer shops in this locality, which indicated that the actual number of jobs per man was considerably less than 20% of the theoretical 400 jobs estimated, and many of the calls received were taken care of on a no-charge basis, as the sets were ones only recently sold. There is a wide discrepancy between the estimated possibilities and the actual number of jobs, and this may be taken as a good example of the general unreliability of estimates based on figures alone without regard to other factors of more importance.

(Continued on page 44)





Ham Chatter

Courtesy W9LLX

\$\$\$ \$ \$ \$ \$ \$ \$ \$ \$ \$ \$ \$ \$ \$

WANT TO CATCH YOURSELF SOME OF THOSE \$\$\$?

Here's what you do!!

Surely you have some favorite transmitter receiver, antenna (beam or otherwise) that you believe different. Well, send the old Ham-chatter Editor an article on something like that,—anything up to 3500 words,—telling how you built it, so that some reader could duplicate your ideas. Include some good pictures of what you are writing about, and a pencil diagram of the hook-up giving all the parts' values, and the manufacturer's name, so that the reader can know whose part to buy.

For every one of those we publish we will pay up to 2c a word plus \$3 for every picture we use. For professional pictures, which we prefer, we will pay \$5 each, if we use them.

Want to get yourself some new gear, a new receiver, or a new transmitter, or even get the baby a new pair of shoes??? Well, get busy with the mill (all manuscripts must be typewritten, double spaced on one side of the paper only) and shoot it in! Back will come a check, if we use the article. Payment is on acceptance! Include return postage if you want your article back, if it is not published.

No waiting until the article appears in RADIO NEWS!

Come one, come all! The dough is waiting!

\$\$\$ \$ \$ \$ \$ \$ \$ \$ \$ \$ \$ \$ \$ \$

An Open Letter to the ARRL

Dear Ken:

As you no doubt know, the boys are chafing a bit because they have not very much in the way of dx to go after. Talking the matter over the air the other ayem, this idea was advanced as a suitable substitute. We offer it to you for whatever you think it worth.

Lots of hams are WAC, and quite a few are WAA. But in the majority of cases these were men with either high power (over 99 watts input) or with elaborate arrays. Now, of course, WAC is out of the question. So here's a swell substitute, and something that would be a real question of consistent operating and good antenna installations.

Why not give out four different forms of WAC? The first, termed *Class A*, would be for working all states on 160 meter phone with 1

(one) watt or less input to the final amplifier. *Class B WAC* would be for working all states with 10 watts or less (but not less than 1 watt) input to the final amplifier. For *Class B* either 160 or 80 meters could be used. *Class C WAC* would be for working all states, any band with 25 watts or less (but not less than 10 watts) input to the final amplifier. *Class D WAC* would be for working all states with anything over 25 watts input to the final amplifier.

We have been told that the flea-power boys can do things; that their antennae are better designed; that their rigs are more efficient. We firmly believe that that *Class A WAC* would be a toughie to make. In the case of *Class A*, an affidavit attesting to the power broken down to volts and amperes would be required.

What do you think?
Respectfully yours,

The Hamchatter Editor.

FROM W9DBO we hear:

On a Wednesday, a Jr. op arrived at W9NIU's. The following Wednesday, a Jr. op arrived at W9LNI's. Then the next Wednesday, a Jr. op arrived at W9QLZ's !!!??? These new arrivals' dads are members of the *Starved Rock Radio Club*.

Are there any hams in New Mexico?

That's something I would like to know.

I've worked the coasts, south, east and west.

I've worked world-wide dx.

I've worked all states in the U. S. A.

Except that one, New Mex! (Sgd.) W9DBO.

Will someone from New Mex come to the assistance of W9DBO so he can obtain his W. A. S. certificate?

W9CZB was recently called for training down at Camp Forrest, Tenn. He took his portable rig along and is now signing W9CZB/4.

W9QKL is located in a filling station, and from the way he has skywires strung around the place I'll bet the motorists usually mistake the gas station for a Broadcast Station. Hi!

The *Starved Rock Radio Club* now has a fine spot-frequency net on 1941 kcs. Their net meets every Sunday morning at 10:30. W9QLZ is the net control station.

W9JVC joined the Army.

W9JMG is a man of action. Skeds, skeds, skeds! He hops around 80 meters with his ECO, like a jumping-bean, or "sumpin'."

W9EBD joined the AARS.

NOVEZ is building a portable rig.

Does anyone want a game of checkers over the air? Give W9VD Ya call and challenge him to a game. He's a tough hombre.

W9MCW has been appointed *State Net Control* of the Illinois AARS, 3940 Kc. phone net.

W9LEM says:

W9ERR, "Chuck," has a new job and will be heard from a new location in the future. Being appointed *Deputy Special Officer* in the Indian Service you will probably work him as a w5 at his new QRA, Gallup, New Mexico.

W9NBX, ERR's Xyl, before joining her OM in New Mexico, will take over a position vacated by W9GNS of Minot, N. Dak. Louie is going to work for Uncle Sam and NBX is going to copy news for KLPW at the rate of 37 words per till the fore part of May.

W9ABQ is getting some wonderful reports out of a new antenna he is using. He ought to as it

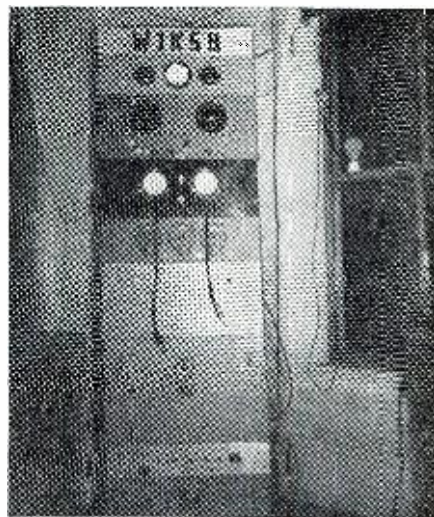

Ham-transmitter of w1k5h.

hangs way up in the air attached to a kite that will fly in a weak breeze and not become too unstable in a stiff wind. Dude really appreciates the wind as it keeps both his batteries and antenna up.

W9ABT is planning to move back out to the farm, just a half mile from his brother abq. Stub has been in town fixing BCL sets for four months but will be on the air at the farm from now on. He and abq have been doing some extensive experimenting on 5 meters.

W9DAO will possibly be heard on either 40 or 20 meters cw. Rumors have it that he may have a new 807 on the air soon. He has a new antenna up supported by the masts he bought from W9ERR.

W9HIG has a new rig. 6C5 xtal osc. and 6L6 final. About 20 watts on 80 meters. In my opinion is the youngest ham to work the Antarctic Expedition. Jerry is a yl. and a crack op, too!

W9HMC, Ole, formerly of Powers Lake, N. D., and cream tester over there, has moved to Stanley, N. D., where he will continue to test cream and do a little hamming in his spare time. Ole usually is found on the high end of the 160 m band or on 10 meters.

W9LEM has a new job now after being appointed Deputy Treasurer of Burke County. Having purchased a 1000 volt power supply and most of the rest of err's rig will probably be heard soon on 40 m with a pair of T 40's and 200 watts.

W9HHN, Willie, the Sage of Woburn, N. D., recently returned from an extended vacation spent in the western parts of the USA. Along the way he acquired an Xyl and is preparing an abode to live in over there. We hope he included a ham transmitter in his living room suite.

W9ZVW, Harold, of Lignite, N. D., and points near there, hasn't been heard on the ham bands much lately and probably won't be very active for a while now as the spring's work will keep him occupied. I think his Xyl should get her ticket then when he's busy she could keep us informed on the activities over there.

W9GZH, Dan, the hardware man at Powers Lake, N. D., is in the same boat as ZVW. Too much work and no time to ham. When on, Dan is found on the 160 meter band.

W9EEK, Stan, of the *Martag* store in Crosby, N. D., has moved to Minot, N. D., and will probably be heard from his new Qra now on 160 meters.

FROM the F. C. C.
March 12, 1941.

Order No. 73-D

At a meeting of the Federal Communications Commission, held in its offices in Washington,

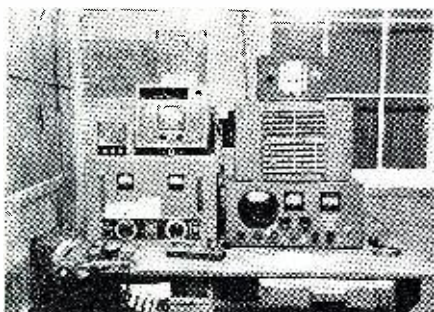

The beautiful layout of w9hzn.

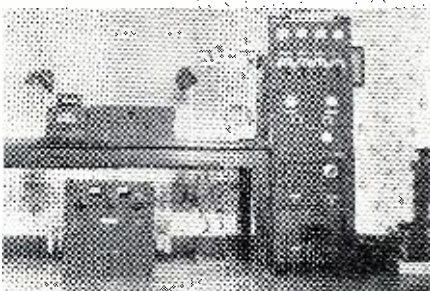

Hamstation of w8pak.



Compact rig of w2jb.



Hamop w1ubm es his rig.

D. C., on the 11th day of March, 1941, the Commission having under consideration its Order No. 73 prohibiting portable and portable mobile radio station operation by licensed amateur operators and stations; and

IT APPEARING, That the annual Field Day tests of the American Radio Relay League will be held beginning at 4:00 p.m., EST, June 7, 1941, and ending at 6:00 p.m., EST, June 8, 1941; and

IT APPEARING, That the public interest would be served by permitting portable and portable mobile operation during this period by amateur stations participating in such tests.

IT IS ORDERED, That during the period of the American Radio Relay League Field Day test from 4:00 p.m., EST, June 7, 1941, to 6:00 p.m., EST, June 8, 1941, the prohibitions contained in Commission Order No. 73 shall not apply to communications transmitted by licensed portable and portable mobile amateur stations participating in such tests.

This Order shall become effective immediately.
FEDERAL COMMUNICATIONS COMMISSION.

W7FOR blasts us wild:

W7DPU is doing a very worthwhile job of transmitting code practice on 160 from 5:30 P.M. to 6:30 P.M., daily except Sat. and Sun.

W7HTT is attending business college. Going to run his rig fine business like?

W9BTY has been jerked off a nice job with United Airlines for service with NCR.

It seems everyone in the American Legion Net pays very little attention to anything but the mention of their call at rollcall time. W7DPU, calling roll in his district, told the boys he had a high noise level and would have to have his listening posts stations report the fellows he could not hear. Well, you should have heard the bedlam that broke loose after about the fifth fellow was not recognized by DPU. It took the boys from 7:30 to 10:00 to talk that one over.

The "Nit-Wit Net," a gang of W7's on about 1990 Kc., are sure keeping that freq. open lately—all you need to become a member is a sharp tongue and a well oiled switch!

It is said W7HBC has worn out three switches on that freq. in the past six months.

W7FKQ just bought himself a new car—guess that puts the skids on any new bottles. Maybe he is trying to acquire a Y!

Wonder when W7FOR is going to discard those over-worked, worn out, flat and out of date 46's he has in the final? No foolin', that's what he's using.

W7EKA (the voice of moonshine valley) is a mail man, or should we say postman—maybe he is the one who has been getting your dx qsl cards.

Does your transmitter howl? Listen to this one—I swear it is the truth. Did any of you ever have a cat in your xmtr. instead of bugs? W7LR's XYL nearly lost one of her prized possessions the other night when it climbed, un-

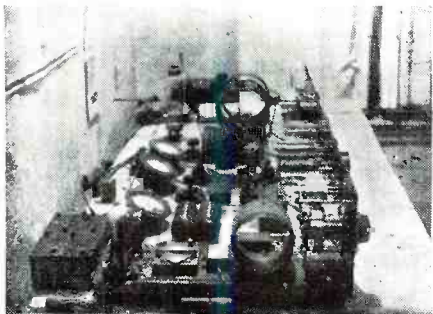

First xtal rig in Mass. It's w1bdm.



Hamstation w4bjw.

beknows to anyone, up on top of the power supply and went to sleep. When the rig was turned on you should have heard the howling that came out of that rig. No, that cat just lost one life; has 8 more left!

FROM the mail bag:

Hamchatter Editor,
Radio News.

Dear Ed.:

Here I am again, after some more of that bloodmoney you dish out for this W6 drive!

While listening in on the boys in the AEC hidden transmitter hunt a few days ago, we heard four or five of the boys agree that their bearings indicated it to be somewhere in the direction of Malibu Beach. I'll bet they were really a very unhappy bunch of boys when they learned it was over by Forest Lawn, which happens to be in the opposite direction.

W6QED is finally back on the air. He bribed one of his pals to climb a tree or two and hang the sky wire. Ted has a beautiful list and can make that old Speed-ee talk with the best of them. He has his revamped 60-P on forty and one-sixty.

"Bip," W6RDR, is going to be back on the air one of these days soon. He has the new rig practically finished and it is going to have a built-in eco, too. Rip used to be very active on 2 1/2.

Al, W6RVL of two and a half fame, has been chosen coordinator for the "flying squadron" of the AEC. It is to be a group of hams with mobile 2 1/2 meter equipment, who will be able to provide communications where they are needed and in a big hurry in case of disaster.

Quite a large number of the boys here in Los Angeles took part in the recent ARRL code proficiency tests and found that they had slipped a bit in the old code speed. Even a certain commercial operator, who is well known here in town, discovered he really had to hump at thirty per.

The voice of Lake Islinore is ripping a nasty hole in the old ether these days. Bill is feeding some 200 odd watts to W6RCF and nobody on the net has any trouble hearing him now.

W6QXL is back on the air again. Mimi has been among those not heard for a long time. She is one of those few female ops who don't get the receiver gummed up with their sugary gab. She is just plain pleasant.

Maybe the new freq. shifts help the bel's (who cares about them!! hi!!) but it sure hasn't done the one sixty gang any good. It has put a couple more broadcast harmonics in the band and also removed a couple of swell band edge markers in person of KHJ and KVVD whose harmonics fell at 1800 and 2000 Kc respectively.

Lath, W6OYV, doesn't have too much time for hamming these days. He is learning to be a biologist at USC and takes just enough time to check in on the MTN and work a couple of boys after net.

(Pse turn the page)



Chile's hamop & station ce3cb.



Hamop & station of w3hqk.



Andy Sannella, w2ad, (arrow), working.

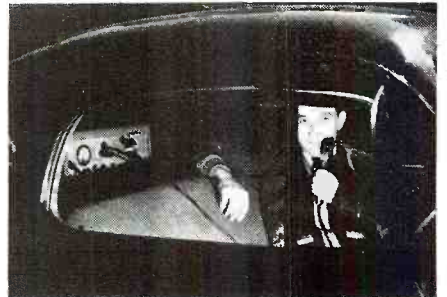

Hamop w1akd at the mike!

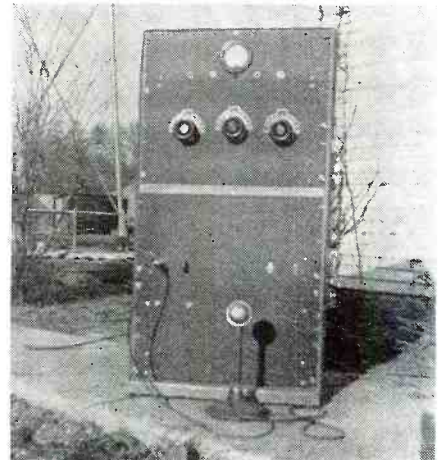

Ham transmitter of w9aez.



W5EHT
 Oklahoma City, Okla.
 2141 Eubanks ST.
 RADIO *W5EHT* UR SIGS
 QSA *RZ AF201A*
 ON *Jan 25, 1939*
 QRM *no* QSB *yes*
 73" *W J Russell*

Ham-QLS-card of w5eht.



w1fzx's yl.



yl-op w4gex.



Hamop w1ksb, the jr. op es yl.

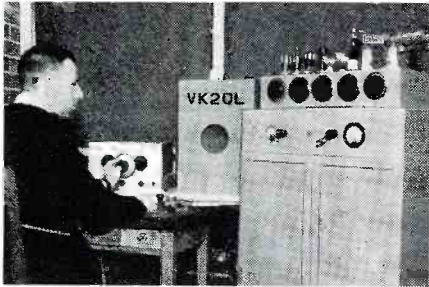

Pre-war hamop vk2ql.

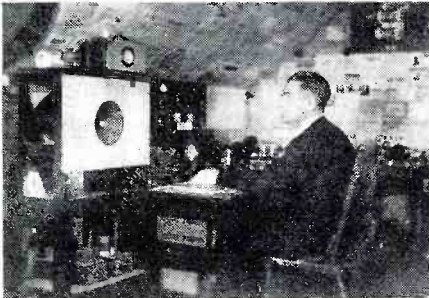

Hamop & station w1fks.

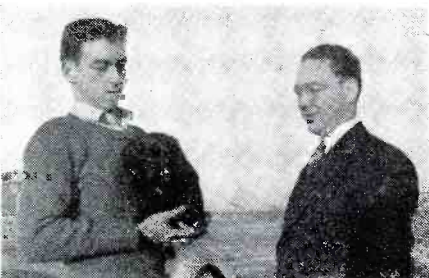

w9vzo (es pup) & w9yas.

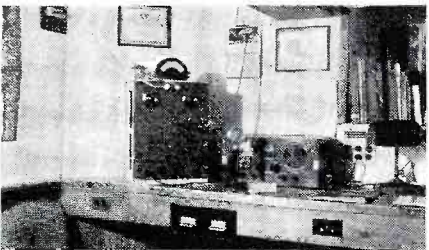

Hamrig of w2nku.

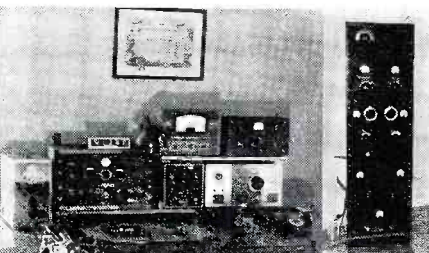

A beaut! Belongs to w1jrp.

W6QVV has acquired a mobile power supply. Ted got hold of one of those re-wound Dodge generators and a little gas engine, so he's fixed up for the finest emergency that old Jupe Pluvius can stir up in these parts.

Sam, W6ZM, is a busy little boy. Besides handling traffic on the Mission Trail and American Legion nets he also plays journalist by playing godfather to the "Mission Trail Blazer."

I guess Larry, W6RNL, won't go high power for a while. Poor guy just had a mouthful of molar repairs, setting him back the price of a good quarter kilowatt. Don't know why he would want high power anyhow, he's worked K6 twice in the last month on 160 fone with 40W.

Dot, W6QLM, had an unwelcome visitor during the recent electrical storm. A ball of lightning came wandering into the shack and made the lady very unhappy until it settled down somewhere in the rig.

Kay, W6SCS, has definitely the outstanding signal here in Los Angeles. He now has a full three hundred watts into that super top loaded vertical and recently proved its value by working some twenty states in as many minutes on one sixty fone.

Maury, W6RGK, is head of one of those crews that goes walking in your back door and yells "light man!" He sees to it that your light meter isn't chiseling you when the first of the month comes around. From the ragchew we had the other night he must run into some pretty lousy places; I mean that literally. Maury said he still had the bumps on his arms and legs to prove it.

Dud, W6TDW, is still engineering the Breakfast Club broadcast and having himself a good time installing aircraft transmitters at one of the big aviation companies.

W6RED has finally had his dream come true. Bob now has 400 watts to a pair of Gammy 54's and a half wave doublet on one sixty and is really getting east.

I'll bet it would interest the fellows here on the coast a lot to know how soon in the evening we are heard on one sixty, in the eastern part of the country; we begin to hear them at about 10:30 p.m. here in the West.

Max, W6DJJ, has finally retired the old F1 and is now sporting one of those new crystal mikes such as they are using on home recorders. It has a lot better quality than some of these expensive ones. Max can usually be found on twenty fone with a terrific wallop. Just listen for the Third Street busses in the background.

With that, W6SJK is going to say 73 to the gang and hit the feathers. Good night, boys, and don't work too much DX.

(Sgd.) Don Lively, W6SJK.

G O O F Y Gossip Given in Gobs by W51KP:

W51KV, Jake, has changed his QTH to Baton Rouge. Possibly he can show Windy Bill how to get that half kw into the antenna. He, Jake, puts into this shack such a terrific sig that it is hard to believe he is really 80 miles away. Comes in as well as a few of the locals. Hi Hi!

W5JNY is the new NYA station for New Orleans. They are working 160 meter fone nw with abt forty watts input but plans are being made for a higher powered rig. (Al asks, "Since when does the Gov't send out SWL reports?") Hi!

W5YT is another NYA station. He's located in south Houston, Texas, and runs abt 50 watts input to a vertical ant.

W5HQE is a model airplane enthusiast. The younger fellows in town (Madisonville) use Fred's radio shack for a club room. Fred has also just invested in a Meissner Sig Shifter.

W5LT, of Donaldsonville, can tell many a story about his experiences on the railroad and

they are all interesting, too. Hi!
 W5HEK, Fan, sure was missed during her visit to Florida on the Delta 160 A.A.R.S.

W5HHT, of Radio Parts, Inc. in New Orleans, has joined the gang on the Ultra Highs with a little rig that works 160 thru five fone running about five watts on either 110 or 6 volts. (Or JOLTS as they are sometimes called. Hi!)

W5EB called CQ on March 20 on 160 CW in the fone band. This resulted in a roundtable QSO that had W5EB, W51KP, W51GW, W5CQJ and another station all on the same freq. The



"I borrowed him from the carnival for Field Day."

fone stations probably didn't like this not only becuz it was CW in the fone band but we were all sending about thirty words per. (But then who cares?) Hi!

W5EGG, of Ged, La., won the T21 tube in the 160 A.A.R.S. contest. Oliver really knows his cryptography.

W5EWV is trying to get into the movies by whistling during his QSO's. He says that he hopes his signal is reaching Hollywood and some big producer will hear it and ask him to come

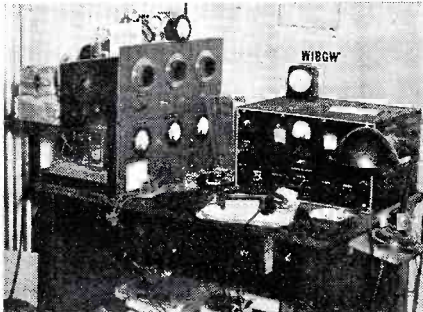

The layout at w1bgw.

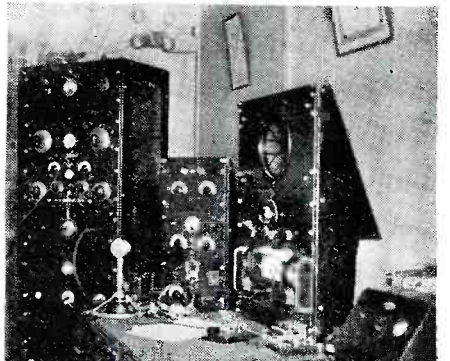

A lotta stuff! Pre-war vk2zc.

immediately and take a screen test. Then he could have that W6 call. Now we all know why Joe suddenly breaks out in a whistle during his QSO. Hi, Joe!

W8QDA/5 and W8URH/5 at Camp Shelby in Miss., are both really vy fb chaps to work, both on 160 and 40 meters. Bob says that he is willing to accept TFC for the camp but is unable to keep Skeeds.

W5IZC, W5HQC, W5JIP, W5IUJ, W5IKP(?) are all members of the *Royal Order of the Polecats*. Ask the *Chief Polecat*, W5IZC, abt it.

W5HIJ, Edith, of Alexandria, tells the one abt one of the hams in town who went into a drug store to purchase a R.N. mag. and the clerk asked him if he wanted to buy it or just "look." (It seems that quite a few of the fellows in town had received post cards from this mag telling them that their call was in print and had all gone to the drug store just to "see." The druggist soon got wise and wouldn't let anybody see the mag till he had seen their money. Hi hi!)

W5MO says that the population of Greensburg will vy shortly be increased. Gud Luk.

W5EKV is temporarily off the air due to a changed QTH.

W5EJ, Marc, says he is using 6L6 into 807 into T40 final with 125 watts input on forty meters. Also a Sky Buddy RX.

W5ISF, alias "Tarzan, The Handsome, two words a min., and alias Monk," is still putting out on forty meters. Hi there Howard!

K4OES is now located in Shreveport and will soon be on agn wid 125 wis to Thordarson transmitter. Nw is ur chance to wrk to K6.

I still say Patsy is more "like that" over me than she is over W5LX.

Well, so long, as being you next month.

GULF Coast Storm Net:

The *Gulf Coast Storm Net* is made up of 160 meter phone stations in Louisiana and Mississippi whose operators are interested in banding together for the purpose of establishing a form of communication to supplement the regular facilities within the two states.

This Net is only a branch of the Headquarters Net in Texas which has been in operation since 1933. The Net control station for the Hdq. Net is W5DIG of Galveston. The La. and Miss. branch was organized in January of this year by W5IKP who is now Net control station. W5HRX acting as alternate control station.

Seventeen stations are active each Sunday morning at 8:00 on the net frequency of 1980 kcs. Each member has or is now planning on some type of portable equipment that can be used in the event of an emergency, also each member is asked to keep up with his code practice.

The Net is constantly on the lookout for new stations around the coast of the Gulf that can be added to the list of member stations.

Any station in Louisiana or Mississippi who is interested is invited to write W5IKP, Metry, La., for further information.

The following stations are reporting into the net at present: W5IKP, W5BHQ, W5HHT, W5HRX, W5HKJ, W5DLA, W5JHS, W5ABY, W5GQW, W5FSX, W5IUG, W5EKV, W5HRW, W5INN, W5HAV, W5IUJ, W5JNY.

WORDS from W3IXH:

W3AZZ, chick of High Bridge, is active on 160 fone, but a new accordion takes up a great deal of his time.

W3BU of Glen Gardner, N. J., is active on 160 fone and holds regular schedules with his brother, Bud, W2BEY, of Paterson, N. J.

W3DGE, John Naughtright of Naughtright, N. J., is active on 160 fone and is also a school teacher in High Bridge High School, N. J.

W3IXH is occasionally heard working 160 fone but spends most of his time on 40 cw with a T240 running abt 80 watts input.

W3HSL of Flemington, N. J., is active on 80 cw and informs us that there are 3 hams in Flemington and vicinity.

W3IDZ of Somerville, N. J., can be heard regularly working 160 fone.

W3IDD/3 of Rosetta, Pa., is working 160 fone and seems to be doing nicely.

W3GCK of New Hope, Pa., is also a 160 fone man hi.

OUR Cordele, Ga., reporter, W4GFF, opines:

W4HFK, Walter Purcey, has changed his QTH. W4FDE is working portable at naval air base in Jacksonville, Fla. W5KJR in Swainsboro, Ga., is on 75m.

W4GBT in Valdosta, Ga., and W4GHU in Albany, Ga., is doing a fine job as net control stations for the South Ga. AARS.

W4GFF has also moved a coupla blocks, and getting up skywire for 160 meters is a job anybody can help me with. Hi.

W4GDU, Boles in Alabama and W4GDV, Matue Lee, his XYL are heard putting mighty good signals all over the Southeast. W4FOO is working 10 meters.

It has been reported that W4HAE in Valdosta has given up ham radio for the Army. (Pse QSY to page 61)



by JERRY COLBY

SOME columnists receive bon mots, others bullets, whilst we catch a blitzout. And rightly so! Here 'tis; *Re that squawk on Page 61 of your current issue asking that FCC do something about radio on the Great Lakes, what do you think this is? FCCordially, Signed GOGillingham (Information).* Well, after reading the weighty Report on *Special Study of Radio Safety Requirements for Great Lakes and Inland Waters Submitted to Congress*, we discovered that for the past two years an investigation has been in progress to determine whether vessels plying the Great Lakes and Inland Waters should be treated differently with respect to radio requirements than ships sailing the high seas.

Extensive observations and tests were made by the engineering staff of the *Commission* and coordinated with other pertinent data available to complete a comprehensive engineering analysis. This full report was presented to Congress on December 17, 1940, with recommendations that "under the circumstances the *Commission* finds that the routes and conditions of the Great Lakes voyages are such as to make the mandatory installation, maintenance, and use of radio equipment for safety purposes on board ships in those waters desirable or necessary."

We know there are many men who will be grateful for this information and we are thankful to Brother Gillingham for his communication, although action will be delayed on this matter until an agreement can be signed with Canada.

IN the meantime we understand that the *Lorraine Telephone Co.* of Lorraine, Ohio, is busy installing radiophone jobs on many of the Lake freighters. CB, our Great Lakes sleuth, advises us that the following fleets have been 100% equipped with radiophone installations: *Great Lakes S. S.; M. A. Hanna Co., Interlake, Wilson Transit, Pioneer, Reiss, Buckeye, Inland Steel, Shenango S. S., Lake Tankers, Brown & Co. and Paisley S. S.* These represent 214 vessels. Which makes CB moan, "Remember when the gang used to get the 'first six months' on a lower Laker? Them times is gone forever, I'm afraid."

But one can't stop ol' Debbil Progress. So the next best thing is a servicing and maintenance job. Even phone jobs get out of adjustment! Ament jobs, Brother Bolvin informs us that Capt. H. I. Marks, Skipper of the *18th Signal Service Company* at Fort Hayes, Ohio, has thirty-five (35) positions open for radio and telephone operators and he wishes to hear from any radiops interested in getting into some real Army operating work. For anyone who wants to know, the *Signal Service Companies* are the boys who hold down the real honest-to-gaw operating jobs in Forts, Recruiting Centers, Etc. Yousah, step this way, gentlemen, for shore billets with good, hard Mother Earth underfoot instead of a gallopin' deck.

WE learn from the papers that Mervyn Rathborne, former *ACA* prexy, who resigned from his post "due to ill health" has been cited for Secretary of the San Francisco *CIO* Council, a spot in which strong health, good judgment and quick thinking are prerequisites. Has former radiop Rathborne completely regained his health within 30 days or did he drop his *ACA* job for other than "due to ill health" reasons? This moot question demands an answer, for upon a logical excuse stand the reasons for the sud-

den resignations of other *ACA* officials.

OUR Northwest sleuth'ound tells us that Brother Leo Moen, brass pounder in the *Alaska S. S. Fleet*, '35-39, is now Ass't Business Agent for the *IBEW*, Broadcast Division. He has organized every BC station in the State of Washington and has brought the radio servicemen of Seattle into one organization, as well as the *Postal Telegraph* employees. Whataman, Moen! *ACA* is going to have a real fight on its hands if this man Moen assists the *CTU-Mardiv* in their organizational drive of this area, which has *ACA Local No. 6* in Seattle. So watch the fireworks since this town is definitely *AFL*. . . I bunked into I. P. Crowder, Chief of the *S. S. Cordova*, a little spit-kit of a passenger steamer that runs from Cordova to Dutch Harbor. This Ex-Navy 20 year retired Chief Radiop, is affectionately known to radiops as *IP*, but I call him the one-man-Army. During his Navy hitch he boxed and came close to winning a championship. And in spite of his added weight and years, he can still lick a couple of Bengal tigers. He's got some great radioping stories from the Far North and can reminisce a-pulently.

SEATTLE is another port into which all kinds of double bottoms are coming and going. "Tother eve we dropped around the waterfront to see what gives and noted the old Dimon Line freighter *S. S. Pacific Redwood* being groomed at Todds Drydock. Nine British Merchant Marine Officers, newly arrived via the *S. S. Georgic*, were standing by to take the *Redwood* back to jolly ol' England. In the group were three radiops, all young fellows. Two of them just out of radio school and the Chief had but one year's experience which goes to prove that radiops are scarcer than scarce "over there." Their courage for the job they've got ahead of them must be admired. Also a U.S.S.R. freighter was in for repairs and the ship and its crew looked dirtier than you could ever imagine. Their machinery is in bad shape and the interior of the boat is filthy. But they do carry a couple of women in the Steward's department which should make for good chow. Not the women, I mean the chow they cook, hi hi. If that's Joe Stalin's idea, the guy's human after all. But then again I've heard tell he doesn't care about chow; he's still on a diet of black bread, spuds and onions. Oh well (yawn) 73.

NORM UNDERWOOD blasts out from *WLO*, Mobile, with the announcement that radiops must "beware, beware" and not be asleep in the deep when visiting this fair city. He sez quote statistics now on hand indicate more ship ops get their legs broken in this port than in any other town. Of course, you can go broke in any port, but take particular care in this burg that your pedal extremities (nize word) don't get busted too. Last fall it was Brother Charlie Harn of the *S. S. Thermo*, and this time it's Brother Lester Gueldner of the *Tug Bas-cobel* whose broken leg is giving him an excuse for sparking the pretty nurses at the *Mobile Marine Hospital*. And it's always the other guy's fault, eh?

BALTIMORE is heard from through Brother A. MacDonald, *CTU-Mardiv* Rep. who reports 24 assignments for the first 15 days of last month. No members (Pse QSY to page 55)

Profitable Customer Relationships

by J. C. ABERNATHY

Flagstaff, Arizona

Technical ability is not everything. You must know how to get and hold customers.

AS surprising as it may seem to many service men, the most important factor in the success of a radio service business is *not* the ability to repair a radio. Believe it or not, there are any number of service men who are excellent technicians, but who make only a limited living because they do not have, or have not cultivated, the ability to deal successfully with their customers.

When a subject as broad as "Profitable Customer Relations" is consid-

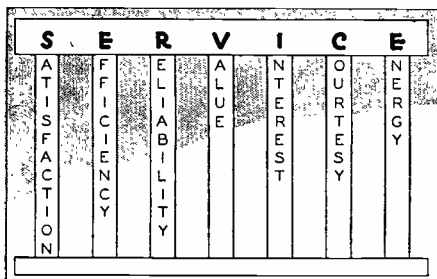

The seven pillars which underlie the word "SERVICE" must all be followed.

ered, it is necessary to tie down the discussion to certain main general classifications. To discuss the problem in terms of the large-city radio shop would put an entirely different slant on the subject from that which would result from a discussion of the problem of a shop located in the country (or a small town).

Therefore, let us form a basis on which both can operate.

Fig. 1 shows the word SERVICE and opposite each letter is a word. These seven words form the basis of proper customer relations. They are:

1. Satisfaction.
2. Efficiency.
3. Reliability.
4. Value.
5. Interest.
6. Courtesy.
7. Energy.

Without any one of these factors, customer relations are bound to fail.

Satisfaction

THE word "Satisfaction" completely sums up in any business every effort to be successful. *You must satisfy the customer.* If you do not do so, your business will not grow unless you have an unlimited "sucker" list. To satisfy customers but partially results in a bare business existence with little or no prospect of future growth. To satisfy almost all customers *completely* is the surest way to be successful and to develop a paying radio service business.

You will notice that I have qualified

the above statement by saying "almost every customer." This is done advisedly and in all frankness for there never was a business which or a business man who satisfied *every* customer on *every* transaction. (That is, outside the covers of a "Success" book.) It must be realized that the general public has a certain percentage of people who, according to organized society, are definitely insane. There is another group that is called "anti-social" (criminal), and in this classi-

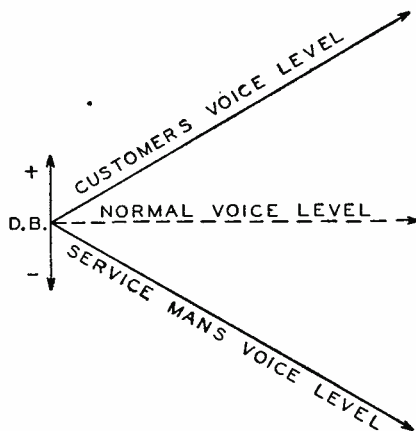

Let your voice match the customer's by dropping it while he raises his.

fication can be placed the "dead beats"—those people who intentionally do not pay their bills. It is patently impossible to satisfy such people and no set of rules on courtesy will help do so.

However, getting back to the main object—that of customer satisfaction—it must be realized that all of the succeeding factors which we will discuss lead back to the main objective of satisfying as many customers as possible.

Efficiency

UNDER the classification of *efficiency* we can group all of the technical knowledge, equipment and facilities of the service man for doing the best job in the shortest time.

Test equipment manufacturers have hammered for years on the value of modern service equipment as a means of increased shop efficiency. Manual publishers have tried to educate service men to the use of their manuals for greater service efficiency. (And there's no better way to increase shop efficiency than a set of *Rider's Manuals*—*J. R. please note the free plug!*) Replacement part manufacturers have issued dozens of catalogs listing proper replacement parts for increased order-

ing efficiency. Text book publishers offer the service man complete technical information from "afc" to "zero-bias"—all in the effort to speed up repair work.

You are not doing your best if you do not take advantage of every one of these helps to speed up your efficiency and cut down your "per-job" time.

Reliability

RELIABILITY is the rock upon which you build your business house. Beware of any business practice which would weaken this foundation. Reliability is *business character*. Business character demands respect from your customers and is an assurance to them that your every dealing is "on the square."

If you think that you can't build a business on honesty and reliability, read the life of John Wanamaker and learn how he "built upon a rock." Next

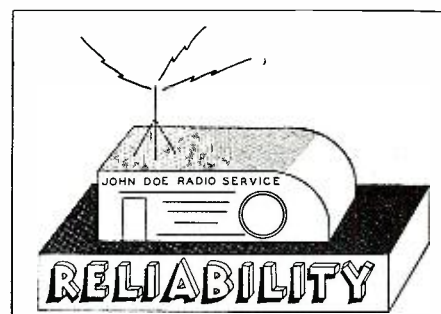

RELIABILITY is the foundation stone on which all good business is built.

time you visit New York or Philadelphia, wander down the aisles of either great John Wanamaker store and see for yourself the fruits of an honest, reliable business policy. Stand next to the great bronze eagle in the center space of the Philadelphia store and listen to the magnificent tones of the *Wanamaker organ* as its notes float down over this busy hive of business activity. No matter how calloused you may have become to the idea of "get the money, honestly if possible, but *get the money*," you cannot help but feel the air of sound, solid, conservative reliability that has paid dividends for many decades.

Reliability, truthfulness, honesty—there are no substitutes for these.

Value

FOR *value received!* This is a legal phrase but one upon which is based all business transactions.

Have you given "value received" in every repair job? Or, have you skimped on the quality or quantity of parts replaced in a customer's radio because you knew that he wouldn't know the difference?

I'll admit that it is a great temptation at times to "forget" to install that condenser or to replace a coil with another "just as good." It's a great temptation to run up an imposing list of items and services because you feel

(Continued on page 59)



The Author hard at work in those grand old days of serviceman's high prices.

'Esse James had a Gun'

by E. H. LEFTWICH

Nashville, Tenn.

"The Good Old Days,"—when servicemen built sets to sell for \$300, and did an odd repair job for a mere \$100! Would you want them now?

WHENEVER someone starts talking about the "good old days," someone else is always sure to pop up and ask, "What was good about 'em?"

Knowing that this question will be asked, I'm going to try to explain what was good about radio service in the "good old days" of 1925.

Yours truly, is the guy in the illustration who is yanking some leads off a *Radiola 28* catacomb. This was my shop in *The Big Store* in West Palm Beach, Florida, in late 1925 and early 1926.

At the extreme left is an amplifier using a 213 half-wave rectifier, and a 210 audio stage. Directly behind this is my long range oscillator panel. There was a two stage audio amplifier for speech and phono pickup and this modulated a single 210. Having no local stations, radios were placed on a rolling platform and pushed back a hundred feet or so, there to be aligned to the oscillator signal. (Broadcast only; we didn't align i.f. stages then.)

Next, in front, is a dismantled "tom-sat" or power unit from an *RCA 104* speaker (which incidentally sold for \$275.00). Directly behind this is a home-made portable oscillator, battery powered, for lining up sets in the home. Next in line, of all things you'd least expect is a *vacuum-tube voltmeter!* I'll confess that I didn't know what it was all about, but I could use it. I got the dope from RCA testing lab. in New York, and built the darn thing.

It had an exploring coil which was placed just inside the loop of the set to be "compensated," and a pickup plug with dummy UX-199 tube to plug into the respective stages. When resonance was attained, the needle of the 0-1½ milliammeter took a nose dive and all was well . . . maybe.

Just the other side of the wrecked chassis is my old standby a *Jewel* Test-set. This baby was not only a point-to-point checker and tube tester, but carried its own battery power supply (135 volts "B" and 6 volts "A").

At the far right is a spring-wound phono turntable. A *Bristol* pickup was used to scratch the records and I could feed these raspings into the oscillator.

There was romance, there were thrills and adventure in those early days of radio, some 17 years ago. It doesn't seem so long ago since my Dad and I sat at a little table in the attic, headphones hanging heavy on our ears, listening far into the night to WOS, Jefferson City, Missouri, enjoying the piano solos of "Harry Snodgrass, The King of the Ivories," thrilling to his rendition of "Three O'clock in the Morning." We listened with real enjoyment to WDAF broadcasting the "Kansas City Night Hawks" orchestra. Our radio was a Westinghouse *Aeriola Senior*, a one-tube regenerative set that set us back 75 bucks. I'll never forget how I once blew that tube and worked a whole week, jerking soda in the drug store earning the eight bucks for another one. This was in 1922.

A year later, I was "building" 8-tube *Remler* super-hets. I didn't know what it was all about, but I got the parts and the diagram. I built the blamed things and sold five or six of them for \$300.00 each, clearing over a hundred on each set.

Came the Florida "boom."

Here, I figured, was a real chance to get into radio service in a big way if I could land a job down there, and incidentally earn some real money. I sold a used *Somersset* 5-tube TRF job and took off for West Palm Beach on the money.

I arrived in May 1925, and failing to locate a job, I finally wound up in front of *The Big Store*. I had spent

the morning in Palm Beach, just across the Lake Worth bridge, looking at the big blue ocean in awe and amazement. Long stretches of shining white sand beach, Royal Palm trees, and the many other tropical beauties, seemed to radiate a new pleasant feeling of well-being which I had never before experienced. This was God's country, and I was going to make the most of it!

The native men wore knickers, and later, I learned that most of them had never swung a golf club. It was just the custom. Hundreds of people were buying and selling lots. Fifty dollar bills were as common as two-bit pieces. I almost bought a lot myself the first day I arrived. Activity was at the boiling point. (This is a good comparison, because boilers often burst, and that's exactly what happened there . . . later.)

I saw the millionaires' homes on the ocean front. The *Royal Ponciana Hotel* was pointed out to me as being the joint where the suites averaged \$250.00 per day. (They still do.)

Choking with Florida fever, I stood in front of *The Big Store*. It was big . . . and how. It covered half a block. They handled hardware, marine supplies, plumbing and electrical equipment, furniture and sporting goods. I went inside, and was directed to the third floor, where heavy machinery, mill and farm equipment was sold.

The manager, a tall middle-aged guy, with a kind look in his eyes, a heavy mustache and a black bow tie, gave me the once-over.

"I'll give you a trial," he said. "I can use a bright young fellow in my department, but we don't go in very

strong for radio. We've got one in stock. If you want to try selling it, go ahead, and if you do sell it, we'll buy another one."

I looked around, and there amid concrete-mixers, horse collars and chain-hoists, I saw *the* radio. It was resting on the crate of a 7-horse one-lung gas engine. It was a *Radiola* Semi-portable super-het, second-harmonic. It was to become the forerunner, the Daddy of all commercial supers.

Figure a heavy cabinet, coffin-shaped, about one foot by four and a half feet, by one foot deep; built in loop; 6-tube (UV-199s) chassis; a standard size 45 volt "B" and three dry cells in each end, and you'll wonder why they called it "portable." True, they called it *semi*-portable, and had a handle in the top, but it took two good men to shack it for any distance.

Now, let's jump ahead to 1926. I was still at The Big Store. I'd learned a lot in that year and I'd sold and serviced a lot of radios. On the heels of the semi-portable had come Radiolas 25 and 28 selling for \$225.00 and \$316.00 respectively. The UX-199 tubes and the UX-120s were used in these sets. I had a shop on the fourth floor and two helpers. *The Big Store* sent me to New York City to RCA testing lab to learn more about service. I also took a couple of good technical courses.

When I returned, I was made manager of a new department, the Radio Department on the *first* floor. It was a perfect set-up, a radio-man's dream come true. My pay had been jacked up from \$150.00 to \$180.00 per month, and shortly afterward to \$200.00 a month. In addition to this, because we had no local stations, and therefore had to wait until night to test all our repair jobs, I was paid labor at the rate of \$3.00 per hour for these tests as well as other jobs which I was too busy to handle during regular hours. I worked nearly every night for over three years.

Service calls were \$3.00, and labor \$3.00 per hour. Due to the salty air, corrosion played havoc with receivers. A.f. transformers opened right on the shelves, in stock. Magnetic speaker field coils gave up the ghost over night, and we replaced hundreds of them at \$5.00 the job. It only took a few months for the plates in variable condensers to turn green and all wiring became moldy in short order. We had a hot-air blower to dry out sets.

I stocked a complete supply of parts for set-builders, and the sales counter became the hang-out for these radio bugs. Every new circuit which appeared in *RADIO NEWS* was tried out, built and sold from our model set. Some of you old-timers will remember the "*Ultradyn*," the "*Hilcodyne*" and the 10-tube "*Infradyne*," which used a factory built high-frequency intermediate amplifier. All of the *Bremertully* and *Browning-Drake* circuits helped to sell parts and provided additional service work in ironing out the kinks the radio-bugs had built into their jobs.

One of my helpers wired up a job for a man who didn't pay the \$25.00 he charged him. So, this boy went out to the man's home when he was away, and on pretense of repairing the set, removed every wire from every part!

A set of dry cells (12) for *Radiola* 28
(Continued on page 51)

RECEIVER SELECTIVITY

THE selectivity of many modern receivers does not compare favorably with the "old timers" as you would at first think. The sharpness of tuning of modern superheterodynes is a function of the built-in selectivity due to the i.f. amplifier, which, usually, is pretty sharp. But, if you think that i.f. sharpness is the whole story, you are all wrong.

There is the very much neglected antenna input stage to be considered, and in the interest of economy many design engineers have yielded to the budget director and built radios to sell at a price, a low price. That they can be built right and still sell at a reasonable figure is my story and come hell or flood I'm going to stick to it. Oh for those good old days!—when every good set had a well designed stage of r.f. before the first detector, and the image response was negligible, the selectivity adequate.

What would you say if someone told you that a radio could be built to give good performance and have a certain amount of real selectivity with only one tuned circuit? Take a look at the curve, showing the selectivity of a parallel-resonant circuit for various coil efficiencies. For a high Q coil the tuning is relatively sharp, but the actual selectivity curve of the average commercial receiver is very broad for

The only answer, then, would seem to be that of adding a stage of r.f. tuning, with a gain in selectivity and no great loss of compactness in the receiver. For practical reasons it would be more feasible to add the r.f. stage, using small size components, than to attempt building a set with really sharp 1st detector tuning. The r.f. stage would also prevent, to some extent, the effect of impact excitation, which occurs when a very strong signal or static impulse hits the 1st detector grid, having passed through the capacity coupling of primary to secondary in the r.f. transformer. If an electro-static shield were used between the two windings this effect would be eliminated to a great extent, but the cost of manufacture of such a coil would be high.

Another point that generally is not very much referred to is that of the bypass condenser in the a.v.c. circuit, which allows the grid return lead to be at zero r.f. potential. That is, it should be at zero r.f. level if the impedance of the condenser is very low. Actually, unless a high grade condenser is used, the bypass will have a broadening effect upon the tuned circuit, since it introduces, in effect, a series resistance between the coil and the tuning condenser.

One way of getting rid of this ob-

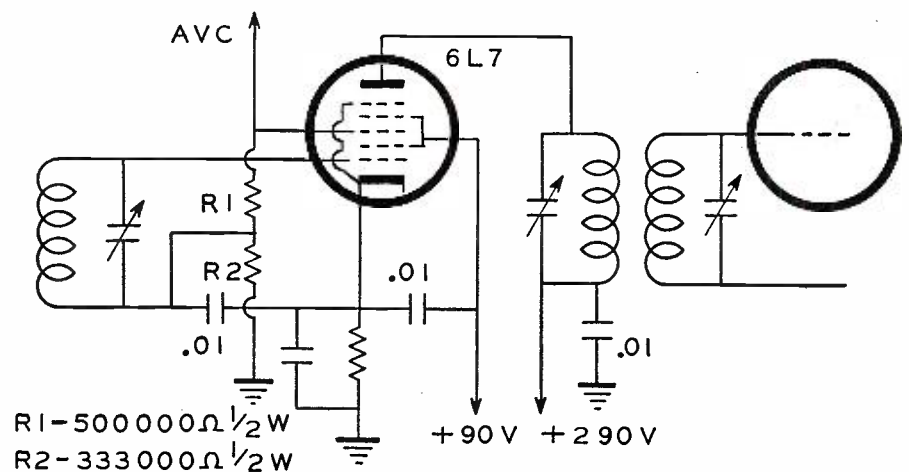

the resonant circuit of the 1st detector. As a result, a powerful local station may break through and cause cross talk or there may be a tendency for strong code stations operating near the receiver's i.f. to pass through the 1st tuned circuit stage. If the Q of the coil were made higher the sharpness of the receiver tuning would be greater, but space limitations usually dictate that a coil of small physical dimensions be employed. The Q of such a coil does not compare with that of the type coil used in an old *Atwater Kent* or *Majestic*. The coils used in those sets were of large diameter and wound with wire of low r.f. resistance.

jection would be to connect the coil and condenser combination directly together and bypass the low side to ground through a condenser of low impedance in comparison with the a.v.c. resistor, as shown. The disadvantage of this arrangement would be the necessity of insulating the tuning condenser from ground and also a tendency to a.v.c. hum because of the fact the tuning condenser would be connected to the high side of the audio circuit. As this is usually high impedance, precautions would have to be taken to insure against this particular trouble.

(Continued on page 56)

2 more of NATIONAL UNION'S *50,000 Reasons Why!

POPULAR CONDENSER
ASSORTMENT with
TOOL SUPPORTER

2.75

TAKES
BOTH

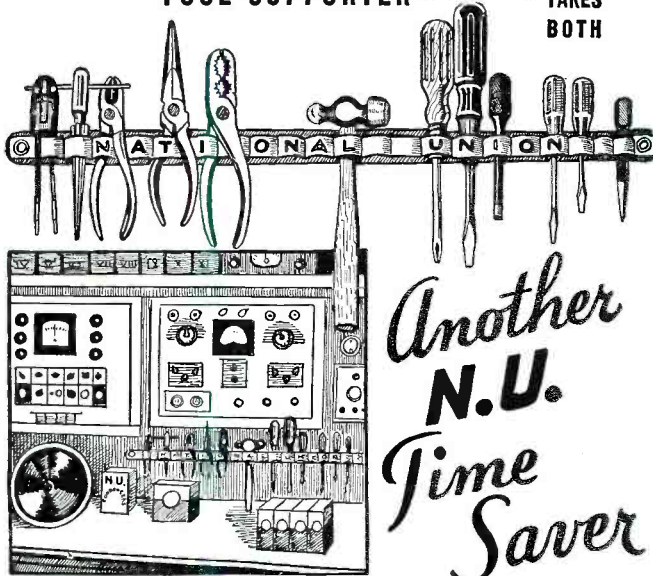

Another
N.U.
Time
Saver

Tool Supporter is 24" long,—holds 20 tools,—sturdily constructed.

THE basic tools of your profession always at your finger-tips — No more hunting — no more wasted time — your tools are where you want them — when you want them.

FOR A LIMITED TIME ONLY.

Get this POPULAR CONDENSER ASSORTMENT WITH TOOL SUPPORTER — \$5.25 LIST TOTAL VALUE \$6.10

This fine assortment of popular type N.U. Condensers will move fast, give you a good profit and insure the good will of your customers. If you're already using N.U. condensers, you'll be sure to snap up this offer in a hurry. If you don't know yet how really good N.U. condensers are, here's a great opportunity to try them! The assortment you get on this limited offer consists of:

1—AT1025 1—AT2015 2—AT8450 1—AT2215
2—T601 3—T605 3—T610 1—T625

See your N. U. Distributor or write

AND NOW

A BATTERY MERCHANDISER



Sells More Batteries
•
Lets Your Customer See



win trade from drug stores and filling stations

- Set Switch for Voltage
- Read condition of battery on percentage of useful life meter
- Made by TRIUMPH
- For Counter use or Can Be Mounted on Wall

Only \$9.00 Deposit

Delivery made at once on \$5.00 deposit and order for \$10.00 worth of batteries, dealer prices. Deposit refunded on purchase of 430 points. All purchases of N.U. tubes, condensers and batteries count as points.

MAKE MORE MONEY WITH N.U. BATTERIES

Sold Exclusively to Radio Service Dealers

The N.U. line of radio replacement batteries has been developed exclusively for radio service specialists. All popular types are included. Batteries are attractively packaged in rugged boxes incorporating the standard N.U. color scheme—black and two shades of green.

N.U. Batteries are carefully manufactured from the finest materials obtainable and are fully guaranteed against defects in workmanship and materials. All types equipped with standard plugs for quick and easy replacement installation.

Thoroughly moisture proof for satisfactory and reliable service under all climatic conditions.

Install N.U. replacement batteries for more hours of reliable service and satisfied customers.

N.U. brings you a line of replacement batteries on which you can

make your full radio service profit. It is not necessary now for you to test sets and install batteries without adequate compensation for your time and knowledge.

N.U. has been identified with the radio service dealer and his problems since the beginning. You can definitely make more money handling N.U. products.

★
SEE YOUR DISTRIBUTOR OR SEND COUPON

NATIONAL UNION RADIO CORPORATION
57 State Street, Newark, N. J.

I am interested in your new Battery Merchandiser calling for only \$8.00 deposit. Please send more information.

Please have salesman call. RN 4-41

Name

Street Address

City..... State.....



Over a 10 year period Servicemen have earned through their purchases of N. U. tubes, batteries and condensers, in excess of 50,000 pieces of high calibre test bench equipment.

© 1941 N.U.R. Corp.

NATIONAL UNION RADIO

57 STATE STREET, NEWARK, N. J.

Corp

*Proved Protection
against Breakdowns*

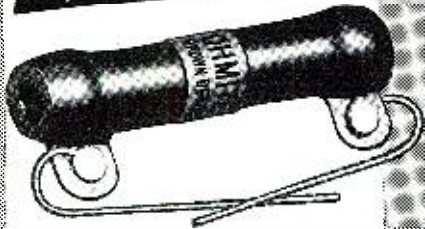

Brown Devils—Extra-sturdy vitreous enameled resistors for voltage dropping, bias units, bleeders, etc. 10 and 20 watt sizes. Many stock values.



Adjustable Dividohms—Handy for change of resistor value or quick replacement. Easily adjusted or tapped where needed. 7 sizes, 10 to 200 watts. Many stock resistances.

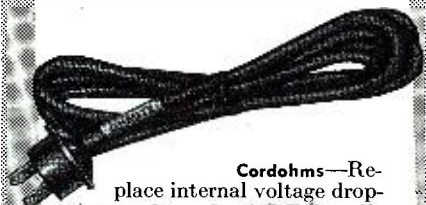

Cordohms—Replace internal voltage dropping resistor in AC-DC radio sets. Tapped cord for pilot light also available. Eliminates generated heat from set.



R. F. Power Line Chokes—Prevent R.F. currents going out over the power line and causing interference with radio receivers. 3 stock sizes, rated at 5, 10 and 20 amperes.

Send Coupon and 10c for New Ohmite Ohm's Law Calculator

OHMITE MANUFACTURING CO.
4885 Flournoy St., Chicago, Illinois
10c in Coin enclosed.
Send Ohm's Law Calculator

Name.....
Address.....
City.....State.....
Occupation.....
Radio News—June

OHMITE
RHEOSTATS RESISTORS TAP SWITCHES



SERVICEMEN'S LEGAL ADVICE

by **TIMOTHY J. HEALY**
Counselor-at-law, New York, N. Y.

ONE of the most frequently asked questions by servicemen is, "If the customer doesn't pay, then what?"

As a general proposition, the answer is divided into two parts. What you can do if you still have in your shop the set on which you did the repairs, and if you have delivered it to the customer.

Let us take the first case. In most states, there is such a thing as a "mechanic's lien." This is a lien, or *right* given to every worker, or repairer to collect what is coming to him by selling the article itself, if the owner will not pay. There are several things which must be done before you can usually acquire such a lien. In the first place you must have the article in your possession. As a general proposition, there is no such a thing as a mechanics lien on property which is in the hands of the owner. So to enforce your lien, even to *assert* it, you must not part with the physical possession of the receiver, appliance, or what have you.

Next you must have done some actual work on the set. It will not be enough to have estimated how much the repair will cost for the owner and have had him say, "I will return and let you know whether I want you to do the work."

There is a wide difference between the states as to what constitutes "work," but all agree that if repairs are actually made that will be determined as "work." Some states

even hold that the replacement of a defective tube is "work," but they are in the minority. You will have to find out what the law is in your particular state.

Next after you have done the "work," you must *assert* your lien. Different states have different laws on how this may be done. Much discussion arises on this question, but almost every state holds that you must notify the owner some way that you are "asserting" or "filing" your lien. The *notification* can be by mail, and in some places it can also be by phone or word-of-mouth. But the safest way is by registered mail. The statement need not be legal-like.

Just to say, "I have a mechanic's lien on your set left here for repair, and not heretofore paid for, and will sell the set in accordance with the law within the next — days to satisfy the lien" is usually enough. But here again, different localities have different laws. Some states require the filing of a statement in the County Court House on a form which usually costs a few cents plus the payment of some nominal fee to the clerk. You had better make yourself thoroughly familiar with the law in your particular state.

In any event, after complying with the law, and "asserting" your lien, you are privileged to sell the set, or have it sold to pay yourself off. You may generally protect your-

(Continued on page 57)

MANUFACTURERS' LITERATURE

Our readers are asked to write *directly* to the manufacturer for this literature. By mentioning **RADIO NEWS** and the issue and page, we are sure the reader will get fine service. Enclose the proper sum requested when it is indicated.

1940-1941 **SPRAGUE CONDENSER CATALOG**. Just off the press is this newest release put out by the *Sprague Products Co.*, North Adams, Massachusetts. Known as Form C-301, it gives a complete listing on all types of condensers manufactured by this concern. Many new items are to be found in its pages, and a most complete assortment is available to the serviceman or to those designing new equipment. Among the types described are: the *Sprague* Atoms, small units which are available either individually or in handy kits; a wide assortment of replacement condensers; famous *Sprague* Tubulars and Tiny Mikes; cardboard dry electrolytics; all types of can and cardboard dry electrolytics; paper condensers; auto radio condensers; transmitting units. Also, are listed fixed mica condensers in a wide assortment, silvered mica condensers, interference condensers and chokes, and several test instruments which include the famous *Sprague* Tel-Ohmike, and the deluxe Tel-Ohmike. New television condensers are listed and, finally, a *Sprague* capacity indicator designed to indicate the correct capacity in any circuit, which is a valuable time-saver to the serviceman.

Sprague Koolohm resistors are described in bulletin C-500, which it also available. Copies of these two sheets may be obtained

by writing to the *Sprague Products Co.*, North Adams, Mass.

ALLIED SPRING-SUMMER 1941 CATALOG. A new and up-to-date publication of the *Allied Radio Corporation*, 833 West Jackson Blvd., Chicago, Ill., is now off the press. This large radio parts supply house has a most complete assortment of parts for the serviceman, amateur, and home set builder. Within its pages will be found almost every conceivable item. *Allied* has always featured a wide assortment of P. A. equipment. This includes up-to-date amplifiers designed for specific applications. *Allied* has always enjoyed a fine reputation in the design of this equipment, and the new amplifiers incorporate several new features exclusive to this famous line of equipment. All *Knight* amplifiers are E.R.P.I. licensed. Many complete systems are available which include not only the amplifier but a wide assortment of microphones, speakers, and accessories. New recording equipment is also listed and *Allied* has always kept up-to-date in this fascinating field by providing a wide selection of recording discs and accessory items.

New test equipment finds its way into this new catalog and all of the well-known makes are listed. Fluorescent lighting, which has taken the American public by storm, is well

represented, and *Allied* has included an assortment of industrial and home fixtures which will cover practically any installation requirement. Other new items include new auto radios, home and farm receivers, and phono-combinations. Copies are available by writing direct to the *Allied Radio Corporation*, 833 West Jackson Blvd., Chicago, Illinois.

C-D 1941 CAPACITOR MANUAL. Hot off the presses is the *Cornell-Dubilier* "Capacitor Manual for Radio Servicing" for 1941. In its over 300 pages it presents concisely and completely all available data pertaining to capacitor replacements in standard receiver models, including even some advance information on receivers that have not as yet made their appearance on the market.

This new edition covers all models brought out within the last year, including older models on which data was not heretofore available. Thus it constitutes a complete replacement manual in one handy volume, and provides maximum speed and simplicity in determining the capacitor requirements of any of the thousands of receiver models listed.

Strongly bound to withstand constant handling, this new manual is now being mailed to all radio servicemen who made request during the past year for the first edition, including those on the regular servicemen's C-D house organ mailing list. *Cornell Dubilier Elect. Corp.*, South Plainfield, N. J.

RCA TRANSMITTING AND SPECIAL PURPOSE TUBES (Form TT-100/3-41) just off the press.

This booklet catalogues all RCA non-receiving types—Transmitting Tubes, Transmitting Rectifiers, Television Tubes, Oscillograph Tubes, Phototubes, Acorn Tubes, Gas Tubes, Voltage Regulators, and Special Amplifier Tubes. On pages 10-16, the charts of

phototubes and transmitting tubes facilitate selection of a tube type for a particular service or application.

Tube types especially suited for u-h-f uses at frequencies of 100 megacycles and above have been indicated in red for convenient reference. Similarly, types of special interest to radio amateurs have been indicated in bold face.

This new booklet, 8½" by 11" in size, is strikingly printed in red and black and is copiously illustrated with photographs of different tube types.

Our readers can obtain a copy of this new booklet from their nearest RCA distributor or by sending 10 cents to cover handling costs to *Commercial Engineering Section, RCA Manufacturing Co., Inc.*, Harrison, New Jersey.

P. A. GUIDE. New 1941 *Atlas* Sound Catalog F-41 just released by the *Atlas Sound Corporation*, 1449—39th Street, Brooklyn, N. Y., describes more than 100 types of P. A. speakers, microphone stands, connectors, and accessories; including: "Morning Glory" Reflexed Projectors and P. M. Drivers, "Peri-Conic" Baffles, "Chandelier" Baffles, "Marine" Horns, Parabolic Baffles, Wall Cabinets, Enclosures, Air Column Projectors, Microphone Floor and Desk Stands, "Hold-Tite" Shielded Connectors and Mike Switch, "Boom" Stands and "Boom" Extensions. 23 colorful action photos of actual sound installations are included to help the sound man in his selling work.—*Atlas Sound Corporation*, 1449—39th St., Brooklyn, N. Y.

NEW HOWARD LITERATURE. *Howard* announces two new folders.—No. 105 listing a complete line of replacement chassis, including Frequency Modulation and Home Recorders—No. 106 listing metal and paper base recording discs and needles.

(Continued on page 53)

COAST GUARD USES RADIO LIFEBOATS

FURIOUS storm is raging off the coast of Cape Hatteras, North Carolina. The Coast Guard station located on that dangerous shore has been warned to stand by for any possible marine disaster in the vicinity. The commanding officer and his 12 men manning the station are grouped around the radio loudspeaker, listening with strained ears to the reports coming in over the air. Amidst the crackling of static, the United States Weather Bureau is constantly sending out warnings to all craft to make for the nearest port.

Suddenly comes the dreaded announcement: "Calling Coast Guard station at Cape Hatteras! Attention, Coast Guard Station at Cape Hatteras! Freighter foundering 20 miles off coast. Stand by for exact location. Prepare to launch lifeboats. Cutter *Argo* setting out from Norfolk. Stand by for further directions!"

In a moment the precise location of the stricken steamer is broadcast to the Cape Hatteras station, and presently radio communication is established with the cutter *Argo* which is steaming to the rescue from Norfolk, 150 miles away.

Quickly and efficiently the Coast Guardsmen prepare and launch their lifeboats. These are motorized, sea-going craft, capable of bucking the roughest waves.

Equipped with watertight compartments of blocks of cork, (depending upon the type of craft) they are practically unsinkable, and even if turned completely over, will right themselves.

Courageously the Coast Guardsmen force their sturdy lifeboats into the roaring, inky blackness. Somewhere in the raging waters before them is a doomed vessel, fated to go down with all hands unless they can get to the rescue in time. In the forward compartment of each lifeboat crouches a trained radio operator twisting knobs and dials.

"What," you might say, "radios in lifeboats? Who ever heard of such a thing?"

But it's true, for today Uncle Sam is equipping the lifeboats of the U. S. Coast Guard with two-way short wave radio systems capable of accurate communication to distances up to 25 miles. Thus these craft can keep in constant touch with cutters, airplanes and shore stations all cooperating in a rescue at sea.

Building a radio set that would receive and transmit only 25 miles doesn't sound like much of an engineering feat these days, but when one considers what such a set must undergo when installed in a 50-foot open boat which is being violently

(Continued on page 42)

RECORD CHANGER

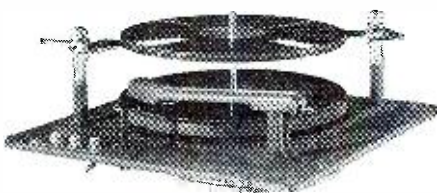

Plays 10 12" or 12 10" records. 14" by 14" by 5" high. Crystal pickup. Handles warped records. Will not chip or crack records. Reject switch—automatic or manual change—2 point record suspension. 115 V. 60 cycles. Only 7 seconds to change records.

\$12⁹⁵ F.O.B.

CHANGER-RECORDER

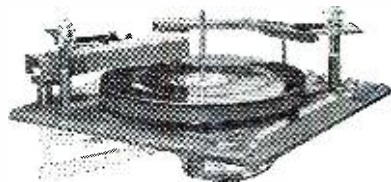

Records up to 12-in. record. Webster cutting head, 4 ohms at 400 cycles—cuts 112 lines per inch—cuts blank discs—under panel feed screw—powerful 110-volt 60-cycle motor. Changer features are the same as in the unit above. Simple to install.

EASY TO OPERATE!

\$25⁰⁰



OXFORD TYPE PD. A beautiful hand-rubbed, piano-finished cabinet. Made of five-eighths stock. Rose mahogany or walnut, \$19.50. Blonde maple, \$25.50. A real piece of furniture 33" high, 32" long, 17" deep. Phono compartment 31x15x6.

UNCUT CONSOLE CABINETS

Send for latest folder

LA E RADIO SALES CO.

618 W. RANDOLPH ST. CHICAGO

New EFFICIENCY

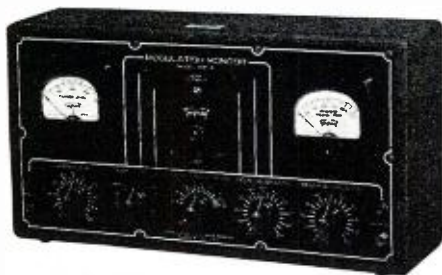

TRIPLET MODEL 1696-A

You've solved your problem of getting maximum efficiency from your transmitter when you invest in a Model 1696-A Modulation Monitor . . . A new monitor with improved shielding—just the unit for 10-meter bands. Plug it into your AC line—make simple coupling to the transmitter output and the monitor shows:

- Carrier Reference Level • Per Cent of Modulation • Instantaneous Neon Flasher (no inertia) indicates when per cent of modulation has exceeded your predetermined setting. Setting can be from 40 to 120 per cent. Helps comply with FCC regulations. Has two RED • DOT Lifetime Guaranteed Triplet Instruments. Modernistic metal case, 14½" x 7½" x 4½", with black suede electro enamel finish. . . . Black and white panel.

Model 1696-A . . . Amateur Net Price **\$34.84**

Also available as a rack panel mounting unit.

FOR MORE INFORMATION

WRITE SECTION 156 HARMON AVENUE

THE TRIPLETT ELECTRICAL INSTRUMENT CO.

Bluffton, Ohio



SAVE MONEY ON LAFAYETTE'S SUPER-VALUES!

Don't confuse this big book with any catalog you've seen before! When you get your free copy, you'll see why—it's complete. Whatever the wiring diagram or service job calls for, you'll reach for your Lafayette catalog—and find it! You'll be surprised at the low prices, too, 'till you remember that Lafayette is the largest radio supply house in the world today!

you'll be glad we suggested
MAIL THE COUPON TODAY!

Lafayette
FOR RADIO VALUE

- NEW YORK, N. Y., 100 Sixth Ave.
- CHICAGO, ILL., 901 W. Jackson Blvd.
- ATLANTA, GA., 245 Peachtree Street
- BOSTON, MASS., BRONX, N. Y., NEWARK, N. J., JAMAICA, L. I.

Lafayette Radio Corp., Dept. 2F1
901 W. Jackson Blvd., Chicago, Ill.
or 100 Sixth Avenue, New York, N. Y.

Please Rush FREE Catalog.

NAME.....
ADDRESS.....
CITY..... STATE.....

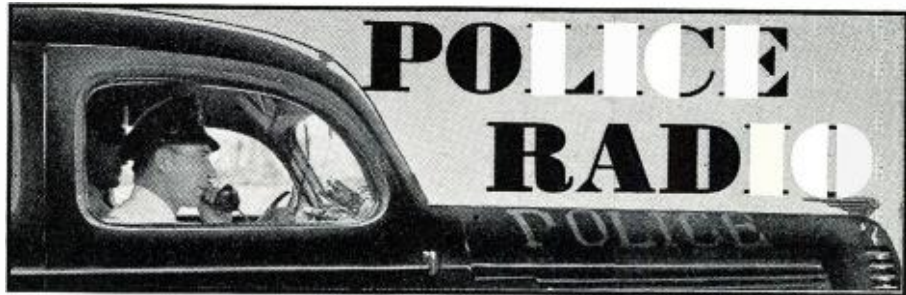

by **WILBERT T. PETERSON**
Illinois State Police Dept.

Plug-in Type Police Rigs

HOME-MADE equipment that really works beautifully and designed for optimum speed in serviceability was demonstrated to us by Harry Quandt, radio engineer for the Lake County, Illinois, police radio system.

All one has to do to change a receiver or transmitter in one of the Lake County cars is to lift it from its mounting. Both units merely plug into the base. Not one screw need be turned, or one cable loosened!

The strain is taken up by two half inch steel plugs, and the electrical connections are made by tube socket plugs. The base is one unit containing the shock mounting for the transmitter and the receiver, which are mounted on each end with the dynamotor in the center. This dynamotor is fastened permanently to the base.

The control panel on the dash of the squad car, which incidentally was made by the local tin-smith, contains the microphone, filament and plate switches, and two meters reading final amplifier and modulator plate currents. *As the push to talk switch is depressed, the meters light up from behind!* The entire installation is so simple, that four

cars can be equipped in one hour.

The Lake County transmitter is located in Waukegan, Illinois operating on 1714 kc. It has two remote operating positions, beside the main position in the police office. Sheriff Kennedy has a remote in his private office enabling him to contact one of his cars at any time. The other remote is located in the office of the North Chicago Police department.

Quandt has four remote receivers located at Grey's Lake, about 10 miles from Waukegan. Five other receivers are installed in the station, making a total of eight channels monitored, two of these receivers being set on the Lake County frequency, 33,220 kc.

The home-made rig lineup is a 76 Pierce oscillator, RK34 double doubler, and HY69 final running at 25 watts. The receiver is a conventional superhet, however, it has a delayed action squelch, which does not open until one and one half seconds after the carrier is received. Short duration noise pulses, therefore, will not open the receiver.

More Rigs Discussed

WE heard several ops inquire of each other the other night as to the legality
(Continued on page 48)

Coast Guard Life Boats

(Continued from page 41)

thrown about in a raging sea, some idea of the difficulties may be appreciated.

In the first place, the set must be able to withstand constant salt water wetting—it must function perfectly under any and all weather conditions—it must be able to withstand a terrific beating, and yet be able to receive and transmit messages that can be heard clearly over the howling wind, pounding waves and throbbing engines. In short, the construction of such a radio set is no cinch.

For some years officials of the Coast Guard have been dissatisfied with the performance of its lifeboat crews. Not that the personnel of the shore stations was not doing all that was humanly possible. It simply was a case of the equipment being at fault. Rescues were being attempted hit or miss fashion—the lifeboats often being completely out of touch with shore, as well as with cutters, airplanes and even the very ship whose crew and passengers they were trying to save. This was especially true at night and during fogs and heavy rains. Rescuing by lifeboat in those days was pretty much of a gamble.

Now let us have a first hand look at the new radio equipped lifeboats being built for Uncle Sam and learn for ourselves the evolution of this new radio set-up. First we consider these unique crafts themselves:

The more numerous type of lifeboats being installed in the 280 Coast Guard sta-

tions throughout the Atlantic and Pacific Coasts, as well as the Gulf of Mexico and the Great Lakes, is the standard 36 footer.

The general arrangements of these boats provide a forward self-bailing cockpit from which handling of lines during a rescue can be accomplished. The forward cabin is entirely inclosed and will provide protection for crew and passengers. Under ordinary circumstances 25 persons can be carried, but during an emergency, the number can be stepped up to 40.

Despite the advances of marine propelling engines today, each lifeboat is equipped with a sailing rig. However, so dependable is the 95 horsepower, six cylinder engine, that this rig is practically never used; in fact, no oars are provided, for as Coast Guard officials phrase it, "the efficiency of the power plant has demonstrated unfailling reliability."

Several new and interesting developments have been incorporated in this type of boat, of which the self-bailing properties, mentioned earlier, are outstanding. A watertight deck which is located about a foot above the water line extends the complete length of the craft. Below this deck, yet above the water line are scuppers which automatically conduct all water shipped aboard back into the sea.

A neat arrangement for controlling the power plant has been evolved, all engine control leading direct to a plate glass inclosed instrument board, located convenient to the wheelsman and arranged entirely for one-man operation, thus leaving the rest of the crew free to proceed.

(Continued on page 58)



by Samuel Kaufman

WHENEVER there's a television hearing going on before the FCC we always lend the event a very keen ear. And, now, the latest official video gabfest has gone its way and we're busily sifting through the data.

Best news of all is that the commercial "Go!" signal on telecasting is about to be turned on. And the little fellows (and some not so little) are primed for the launching of a new industry that may lead to big and consistent financial returns. But what was most surprising of all is that the staunch supporters of early commercialization of video transmissions took a somewhat about-face attitude and apparently were not *too* eager to see the commercial ball rolling.

It seems that the certain sight-and-sound men are a bit frightened by any commitment to a minimum program service schedule in the vicinity of thirty hours a week. True, the televisioners would like to see the iconoscope on a commercial status, but the cost and scope of a long program schedule without immediate revenue seems to have the eye-and-ear program producers a bit awed.

And reports from Washington showed that FCC chairman, James L. Fly, was a bit irked by this attitude after the previous championing of a "Television Now!" cause.

But on the face of the facts, the video-

mens' points can very easily be understood. After all, they are commercial organizations obviously doing everything with an eye on profit. With no deluge of television program sponsors in sight, it will be a considerable time before television programs will pay for themselves. But, with one firm's manufacturing and licensing set-up in the field of television receiver production and marketing, the cash registers of the firm should be quite busy ringing up new business—and plenty of it—long before the sale of television time by telecasters brings in a penny.

Ah! But won't other set makers benefit by the telecasts without necessarily providing programs of their own? Yes, that's true! But even there the manufacturer should benefit substantially through its license-fee collections from a great many—if not all—manufacturing competitors.

But, as the *Video Reporter* sees it, the claim to television channels should obligate the telecaster to a public service on its own part. There should be no link between what the telecaster will offer the public in program fare and what amount it will realize during the first year or so of commercial operation.

The telecaster and, in fact, the whole list of television channel applicants—must be expected to provide a substantial amount of program hours. And not drab offerings! That is their obligation when commercial licenses are granted!

There's little question that—in a reasonable period—the profits from the sale of television time will be big. A superficial glance at the progressive climb of broadcast time sales shows that. But to grant broadcasters public facilities on highly desirable ultra-short waves, and let them lie dormant until the broadcasters see immediate financial returns from providing an adequate program service, is a poor deal to Mr. and Mrs. Look-and-Listener.

THIS would be the right point, apparently, to let out a few squeaks and squawks about the so-called "experimental" programs

that have been hitting the New York area television channels in recent months.

It seems as if the lads in their desire to put on programs that have virtually no production expense, are catering to a capacity audience of standees. All of which sounds mighty encouraging from a merchandising angle until we add the fact that the standees are unseated merely because they prefer to sip their beers and whiskies-and-soda with an elbow on a bar and a foot on a rail.

In other words, bars and taverns galore are making the most out of the skeleton schedule of sports programs.

Now, before we sound like a blue-nose, we must hasten to explain that we think the ruddy-proboscis lads have every right to television entertainment they enjoy. But it's certain that such a type of audience would have limited advertising appeal to would-be television sponsors. And before we go on to fret that the telecasters won't stand to gain from building up this type of audience, we must make it clear that our one and only concern is about the program service the *average family* would get. Sports are fine television fare. But there must be other topics too. And by "other topics" we don't mean the Grade Z movie reels New York television fans have already suffered through.

We can't criticize the telecaster for the fact that its programs are being exploited by bars and taverns. And we'd even concede that a drink or two might be essential when glancing at some of the stuff on the cathode-ray screen. When a window streamer on a saloon window proclaims "TELEVISION TONIGHT . . . BASKETBALL MATCH . . . TRY BILLIE'S SPECIAL TORNADO BOOMERANG FLIP," there's nothing implied that's detrimental to the program producers. But compare such an instance with a telephone call from your next door neighbor to invite your family over for an evening's television entertainment.

Only when television gets to the "next door" stage—when your neighbor boasts of the excellent programs he received the night

(Continued on page 55)

ALL-PURPOSE P.A. SYSTEM

Ideal for sound truck or passenger car installations. Operates from either 6-volt DC or 110-volt 60-cycle AC power

A perfect system for rental service. Provides an unsurpassed medium for announcing and advertising new products and sales promotions of all kinds. Commands attention at fairs, carnivals, theatrical events, political rallies, patriotic demonstrations and community events.

Specifications: 7-tube, 30-watt amplifier, with inputs and volume controls for 1 crystal, velocity, or dynamic microphone, and one phonograph. Battery-saving stand-by switch which reduces battery drain during intermissions but keeps tube filaments at operating temperature ready for instant service. Phonograph has crystal pickup. High and low tone compensation and master gain control. Two-tone wrinkle baked-on enamel finish. Ruby bull's-eye on front panel. Shipping weight, 49 pounds.

57VT08903—Unit and tubes only \$49.95

Write for Details of Sears Easy Terms

SEARS, ROEBUCK and CO.

Chicago • Philadelphia • Boston • Kansas City
Minneapolis • Atlanta
Memphis • Dallas • Seattle • Los Angeles

TURNER MICROPHONES

Give You Sales That Stick!

Reliable Turner 99

There's no worry about returned goods when you sell Turner mikes! They're engineered to give absolutely natural reproduction of both voice and music. No tone distortions with a Turner. Model 99 is the toughest, most reliable of the entire Turner line of mikes and first choice of veterans. Demanded by internationally famous manufacturers for their finest equipment. Professional gunmetal finish. List.....\$29.50



44X Whips Feedback Problems

Crystal mike in modernistic design, with selective directional features. 13-15 DB differential between front and rear pick-up permits rear to be considered dead. Beautiful satin chrome finish. List.....\$27.50 With switch, add \$2 List.



Send for Free Mike Catalog
Crystals licensed under Patents
The Brush Development Co.



Turner Vibrator Manual—16 pages of information. Send for yours to

THE TURNER CO.
908 17th St. NE,
Cedar Rapids, Iowa

Streamline CABINET RACKS



Give your equipment the handsome appearance and rugged protection it deserves by housing it in a BUD Streamline Cabinet Rack. Made in five convenient sizes with panel space from 8 $\frac{3}{4}$ " to 35".

BUD Professional Cabinet Racks, Receiver Cabinets, Amplifier Foundations and Speaker Cases are also made in this modern Streamline style which combines attractiveness with sturdy construction. Your jobber will be pleased to assist you in making selections to fit your particular applications.

BUD
BUD RADIO, Inc.
CLEVELAND, OHIO

Bench Notes

(Continued from page 31)

In the meantime, we are curious about the remaining majority of push-button receivers for which no service man was called. It is likely, of course, that a small number of these may straggle in later, and some of the dealers interviewed thought that a large number of receivers, more than a year old, had been adjusted by the owners. In many cases this is true no doubt, but we do not believe it begins to account for the large number of unserviced jobs, or any considerable percentage of them. Allowing for a small number that have probably been junked, it seems probable that there are a considerable number of receivers whose push-buttons were not adjusted by the owner or the service man, which suggests that quite a few set owners have not found that feature worth the expense of a service job, and in many cases we cannot blame them.

We will admit freely that there is a prejudice against push-button jobs at *Super-Snappy Sales & Service*, and one of rather long standing at that. In 1928 or thereabouts, we retailed a popular receiver which had one of the first commercial push-button mechanisms. Oldtimers will easily remember this job as it had several levers resembling typewriter keys, behind a hinged panel at one side of the receiver. This was probably the forerunners of the rocker arm types in use today, and exhibited the same weakness, that is, it wouldn't stay put for more than a few days at a time. As active head of the service end of the business, this writer was quickly fed up with push buttons by the time a half-dozen of these jobs had been sold, as each of them required a free service call about once a week to restore the desired settings. Since a condition of this sort added nothing favorable to the reputation or cash balance of *Super-Snappy Sales*, we called a quick meeting of the salesmen (both of them) and advised them that the first guy that pulled open the panel and exposed the push buttons was fired. After that comparative peace returned to the service department, as the remaining sets were sold without any mention of this intriguing device to the customer.

But now again in recent years the push-button has returned in various forms, some of which—especially certain capacity and mechanical types—are notorious trouble-makers on account of their inability to retain a setting for any reasonable length of time. By no means do we wish to imply that all push-button systems are bad, but too high a percentage of them are, and from the serviceman's standpoint such business may prove to be more of a liability than an asset. Aside from being a fertile source of exasperation to the radio man that takes a skilled mechanic's pride in a job well done, there is also a financial angle to the matter, as some jobs often require one or more free adjustments, and even then the radio man may find it a difficult matter to satisfy the non-technical customer, who is too often inclined to take the view that the trouble is due more to the service man's incompetence than any

inherent weakness in the design of the push-button system.

While the actual setting up of the average push-button job is one of the easiest ways the service man has of picking up an extra dollar or so, there are just enough trouble-makers in the way of assemblies that are consistently unstable, that it behooves the service man with any regard for his reputation to adopt some method with a view to keeping his nose clean when these jobs bounce back in his lap. There is a policy here at *Super-Snappy S & S* that accomplishes this to a fairly satisfactory degree, which may be of interest to the man that has been "stuck" with a few of these jobs.

When a push-button job is encountered that is known or suspected from past experience to be a bad "drifter" it is by far best to tell the owner frankly that such is the case, and if it is at all possible the owner is then and there shown just how to make the necessary readjustment when the occasion arises. If for any reason the customer was not instructed at the time the first set-up was made, and the service man is called again in a few weeks, the customer should certainly be instructed at this time. The service man will lose nothing by this procedure, as his gains should more than offset the very small amount of business he may think he is losing as a certain number of free re-adjustments will be eliminated, and the grumbling complaints from customers that reflect against the service man's ability avoided. The majority of the receivers that are subject to excessive "drifting" are in the lower price brackets, and the customer is not going to spend much on them in the way of service in any event. If, after a customer has been given this instruction, and he finds himself unable to effect the proper adjustment, he will usually be more inclined to pay for this service than he would have otherwise.

Considering the results of the survey mentioned at the beginning, it seems quite likely that there are a considerable number of set owners who have not found the utility of the push-button worth its upkeep; but this is hardly any indication that the push-button is on its way out as yet; as we are advised by the manager of one of our largest local retail outlets that consoles without this feature are not moving at all. By taking a few precautions the serviceman can eliminate most of the annoying factors from this type of service, and enjoy whatever small change can be picked up along this line.

—30—

Recording Studio

(Continued from page 27)

manner as that shown in a preceding article on the subject. If the dubbed record is a replica of the test record, as viewed under a light source from the side, it is a fairly accurate indication that the reproduction has been properly accomplished. There are many other methods, of course, which can be used and which are more accurate, but they involve considerably more equipment and their use will not be discussed in this article. Other test records are available from *Columbia* and *RCA-Victor*. The *Columbia* rec-

ords are known as the "Audio-Tone" No. 1, No. 10003-M and No. 10002-M. These all have been cut for specific applications. The RCA-Victor record number is 84522. These records have been cut at various frequencies and these are identified by suitable voice announcements or tone signals. The Victor record has a response of from 30 to 10,000 cycles, which is continuously variable. Columbia record has a range of from 50 to 7000 cycles, with a 1000 cycles reference at the beginning and end of the record. Other suitable frequencies are included within the range of the record. These records are also handy to have for the testing of amplifier and speaker systems.

This concludes the fifth in the series of articles dealing with the construction of a "Recording Studio." The art of recording requires considerable understanding in the application of the various component units required to turn out consistently good records. We have attempted to cover each and every phase of the art in simple language so that the reader may apply the principles set forth not only for semi-professional recording but home-recording, as well. We have made no attempt to skip over any of these particular subjects as we feel that a thorough background will be required by those who are seriously interested in this new and fascinating hobby or profession.

We will, in later articles, cover the actual layout and construction of a modern acoustically treated studio, and suitable plans will be given that will enable the builder to have a flexible and efficient arrangement both for the recording equipment, as well as the studio proper. We shall cover the applications of various microphones suitable for recording and next month will deal further with semi-professional cutting and play-back procedure.

We are also designing a special recording and play-back amplifier which will meet any and all requirements for the professional recordist, or for the most exacting music lover. This amplifier will be featured in a forthcoming issue of RADIO NEWS. We have received many requests for a diagram and layout of what we would consider to be a later, and at the same time the finest recording amplifier that could be built and yet one which would not be excessively expensive. We believe that the reader will find the answer in the presentation of this forthcoming unit.

-50-

Ring the Bell

(Continued from page 19)

It can be safely said that no test instrument manufacturer would be unhappy if *all* his sales were on a cash basis. He is forced into the time payment plan because of necessity and he has no intention of doing other than breaking even on it.

Now, let's see what would happen if your credit were established. You could go to your local bank and borrow \$100 for one year at 6% which would cost you only \$6.00, or no doubt you could make out 4 notes for \$25 each, maturing at 90-day intervals. At 6%, this would cost you \$3.76. Each month you could lay aside about \$9.00 and this would give you additional

working capital, even though only a small amount. Compare this with the \$10 you would have to pay under a condition of poor local bank credit.

Another way to look at it is that, assuming the borrowing of \$100 at 6% for one year and further assuming a 2% cash discount on the test equipment, you actually pay only 4% or \$4 for this money, against \$10 as paid under a time payment plan. And, further, you have the use of the accumulating monthly payments to bolster your bank balance, although you show a Notes Payable for the full amount.

It is from just such savings in expense that successful businesses are built. Carrying the story one step further, if you used that \$6.25 you saved in interest for a small advertising campaign, you could easily profit many times more than the original.

Are you taking your cash discounts? Many servicemen are not aware of the usual cash discount of 2% and, thus, pass the opportunity of saving \$2.00 on every \$100 purchased. Some jobber's catalogs show the price of items after the 2% has been deducted, so that an item which has a price of \$50 in one catalog will show a price of \$49 in another catalog.

Don't be afraid to ask for your cash discount and see that you get it. This is another way to Ring the Bell for greater profits.

Watching the Pennies

WHILE we will no doubt take these matters up in greater detail in a later "Ringing the Bell," we want to point out, at this time, several

ways to watch the pennies without cheapening the quality of the parts or tubes used in repairing radios.

First, do you check every item on jobber's invoices, check the extensions and re-add the invoice? We doubt whether many servicemen take the trouble to do so, yet you will be surprised how often you will find an error, an error which you were slated to pay for. Don't for one moment think that we wish to imply that the errors are intentional, because they aren't, but human nature is human nature and we all make honest mistakes. Check and double check every bill you pay. It will be profitable to you.

Do you count your change? If you do not, you are the loser. Once more, there is no attempt to imply dishonesty among those with whom you deal, but it's merely good, sensible business to count your change whether it is received from the cashier at your jobber's or the cashier at your bank.

Do you watch the coins and paper money you receive in change? They may be counterfeit and if so, you are the loser if you try to re-pass them. More than one serviceman has learned this lesson the hard way. In a future issue of *Ring the Bell*, we will show you how to distinguish between "good" and "bad" money.

Do you follow the market trends and stock accordingly? That is, when there is a possible rise in the tube prices do you stock up, and when there is a possible lowering in tube prices do you cut down your tube inventory? This is important because every dollar

THORDARSON AMPLIFIERS PROVE THEIR QUALITY and FLEXIBILITY

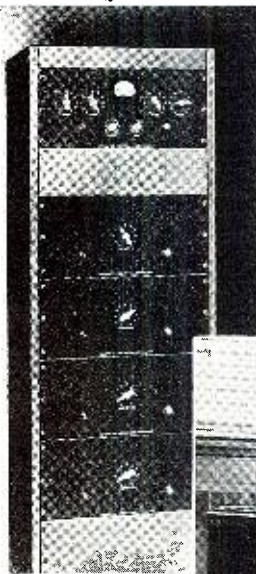

Amplifier panel of this 56 speaker installation.

An interesting example of Thordarson high quality and flexibility in industrial applications is the Aitken and Reed Public Address Installation in the offices and factory of the W. D. Gibson Spring Mfg. Co., Chicago.

One T30W04 Pre-Amplifier, one T30W25 Booster and three T30W50 Booster amplifiers were used to operate 56 speakers covering the offices and every section of the factory. The system is used for paging, and to send out music, and special announcements during recess periods.



Record Changer and Microphone in executive office.

Specify Thordarson in YOUR public address installations for more flexibility and for continuous quality operation. . . . Consult Thordarson Engineers; they are always at your service

500 W. HURON ST.

THORDARSON
ELEC. MFG. CO.

CHICAGO, U. S. A.

TRANSFORMER SPECIALISTS FOR 46 YEARS

rise in the cost of tubes or parts means a dollar you could have saved if you had bought earlier.

Do you investigate the discounts offered in various brands of tubes and take this into consideration when you establish the line you wish to handle? We do not mean that the tube deal with the longest discount is necessarily the best tube deal, but discounts do vary and it can be one way you can save money.

If you buy on a cash basis, do you send the money with the order or do you order the item C.O.D.? C.O.D. fees mount up to a sizeable item over the period of a year and it is much the wiser business policy to send the money with the order (include enough for transportation costs) and ask for

a refund if you are due to get a refund. These are but a few of the ways to *Watch The Pennies* and increase the monthly net profits without additional sales or advertising expense.

-30-

Airplane Transmitter

(Continued from page 15)

convenient spot available in the plane as it takes up very little room. The total weight of the transmitter, including batteries is 11 3/4 lbs. Many hours of constructive entertainment may be had in building this unit and the private flyer may duplicate the results had on the original with little effort. It should answer the problem of getting a transmitter in operation at the lowest possible cost.

-30-

Washington Communication

(Continued from page 12)

devised. By discovering that the Nazis are telling the Arabs one story, while they are telling the Spaniards another, the "listening posts" may be able to discover the German's motive and purpose.

This, then, is the work that the listeners in the United States will do. The English "Secret Four" got its name from the fact that four highly trained persons directed the work of the bureau. The American Government has been having trouble finding people to take over the organization of its bureau. Princeton University has a propaganda analysis staff and there is another at Stanford.

Note: Little has been heard of Japanese propaganda broadcasts, but they have become large scale in recent weeks. The Japanese are appealing to the people of Australia, the Philippines, Hawaii and the United States West Coast, to be "understanding." Army and Navy commanders in Hawaii, thoroughly alarmed by the Japanese broadcasts, have sent urgent appeals to Washington for counter-action. It was even suggested that we black-out the Japanese radio. Washington vetoed this idea, is making plans to answer Japanese radio with our own broadcasts.

Hot Water for Hams

SUDDEN, large-scale violation by hams in the last few weeks of Order 72—which forbids communication with stations outside of the U.S.—has brought the threat of stern action from the *Federal Communications Commission*.

No one at the *F.C.C.* is able to understand what suddenly prompted the hams to go

haywire. All they know is that for several weeks they have been intercepting foreign contacts at the rate of five or six a day. Apparently, one ham tries it, thinks he's getting away with it and others, who hear him, chime in. That seemed to be the case with one outbreak late in April when the interceptors began to pick up hams in all parts of the country contacting a station in Central America. *Some hams have even been caught in contact with German stations.* The *F.C.C.* says that some were tricked into talking with the German operators when the latter switched their prefixes around—but it was pointed out that the hams had no business talking to any foreigners.

One license has been revoked and there is likelihood that more will follow. If this doesn't stop it, sterner action will be taken. The operator whose license was revoked found out something about how hard it is to beat the *F.C.C.'s* air patrol. He had been talking with a foreign station, had entered the contact on his log and when he learned that the *F.C.C.* had picked him up—he altered his log. This didn't do a bit of good, for the *Federal Bureau of Investigation* sent its men around, picked up the log and examined it with infra-red photography. This revealed the entry which the ham had tried to eradicate—and showed him that the Government isn't fooling.

The seriousness of the violation of Order 72 cannot be exaggerated. This country is as good as at war and this kind of activity is a menace to our safety—which cannot be tolerated. If the hams can't abide by the regulations, the Government will take decisive action—and that means bye-bye to ham broadcasts for the duration.

F.C.C. Power Extension Being Planned

SINCE the shooting started getting close to our shores, there have been several attempts, from different sources and for different reasons, to jam legislation through Congress which would affect radio. There has been the *Hobbs Bill*, which would remove the sanctity of radio messages and allow the *F.B.I.* to intercept messages in cases where it believed espionage or other serious crimes were involved; there has been the *Dirksen Bill*, aimed at removing radicals from the radio rooms of merchant vessels; there has been the *Truman Investigation* into the filing of defense orders in the radio and other industries.

The whole approach to the problem of controlling radio in war-time has been piecemeal, helter-skelter and not entirely well thought out. There has been the danger that, in the hysteria of the moment, Congress might take drastic steps which the country would have cause to regret later.

With this in mind, Senator Truman of Missouri has introduced in the Senate a resolution which would call for hearings on possible amendments to the *Federal Communications Act* to incorporate, in orderly fashion and after careful consideration, all the changes which appear necessary for war-time.

The main points of the bill are in extension of *F.C.C.* power. They would give the *F.C.C.* power to tighten its control over domestic operators, to block fifth column activities; would provide for punishment of marine operators who betrayed the position of U. S. Navy vessels on the high seas (this provision on the suggestion of Admiral Hooper, whose testimony on this score was printed here last month); would include the *Hobbs Bill* for intercepting radio messages by *F.B.I.*, and would provide for an investigation of possible foreign control—through international cartels—of the manufacture of radio equipment in this country.

Senator Truman asked that hearings be held on these changes by the *Senate Interstate Commerce Committee*. Under ordinary procedure, the *Hobbs Bill* as now drawn would come before the *Senate Judiciary Committee*. Senator Truman's resolution would take it away from that committee and

★ Now, though faced with the most urgent demands industry has seen in years, GUARDIAN has set aside, as "sacred ground," a Special Production Department devoted to the requirements of RADIO AMATEURS and the jobbers who supply your relay needs. You've looked to Guardian for RADIO RELAYS for many a year . . . so, today we will not let you down. Prices? Right! Deliveries? Now!

Standard A-100 and A-100-C Antenna Relays AlSimag insulated operate on 110 V. 60 cycle A.C.

Amateur Net Prices:

A-100 Double Pole Double Throw Relay	\$4.11
A-100-C Single Pole Double Throw Relay	\$2.28
R-100-G Triple X insulated	\$3.45

Write for New Bulletin "N" and Free Circuit Diagrams. Order Today!

GUARDIAN ELECTRIC
1630 W. WALNUT ST. CHICAGO, ILL.

NEW Par-Metal Catalog

Our New Catalog No. 41 lists over 400 metal parts for both Amateur and Commercial applications. Relay racks, enclosed racks, transmitter racks, all-purpose cabinets, rack panels, speaker cabinets, many amplifier and other foundation chassis. *Standard and De-Luxe Models* for transmitters, amplifiers, public address systems, exciters, receivers, frequency meters, test equipment. **FEATURES include:** Streamlined units, Chromium trim, Grey or black ripple finish, Accurate machining for easy assembly.

Your copy FREE at your jobber or write us direct.

PAR-METAL PRODUCTS CORPORATION
3268 — 49th STREET • LONG ISLAND CITY, NEW YORK

put it before the *Interstate Commerce Committee*.

Best bet: The Truman plan will be adopted and, after due consideration, the *Communications Act* will be amended so as to give the Government adequate power to meet the war crisis.

Para-troops' Radio

THE Army has revealed that *R.C.A.* is manufacturing for its use a special "vest-pocket" radio. This device, the design of which is based upon similar sets developed for use of firemen who work in smoke-filled buildings, is worn like a life-preserver jacket.

The set weighs only 15 ounces, can receive and transmit messages over short distances. Troops can use it to keep in touch with each other and with their headquarters. All parachute troops in the U. S. forces will have these "vest-pocket" sets.

Army Day in Retrospect

ARMY DAY was a long time ago, but the *War Department* hasn't yet gotten over the amazing showing made by hams on two occasions in connection with that celebration.

The *Army Amateur Radio System* demonstrated most successfully how quickly ham stations can disseminate information. Secretary of War Stimson, from his office in the *War Department*, issued the following message to "All Amateurs;":

"Incident to the annual observance of Army Day, I am pleased to acknowledge the important work that American amateur radio operators, particularly those affiliated with the Army Amateur Radio System, are doing in building the national defense structure."

"Many amateur radio operators are in the military service at the present time. A large number also have volunteered their services as instructors to teach radio code and theory in their communities. Many are helping to train interested young men to qualify as radio operators for the expanding army."

"The ramifications of our armed forces require a host of skilled radio operators and technicians. I am confident that, as in the past, the amateur radio operator will do his part in building up an impregnable defense for our country."

This message was first transmitted from the *Army Amateur Net Control Station*, WLM-W3CXL in Washington on 3497.5 and 6990 kc. frequencies, with the request to other *ARRS* stations that they rebroadcast the message on the various amateur bands. Within a short time, the amateur frequency bands were almost completely covered by *ARRS* and other ham stations rebroadcasting the Secretary's message by both c. w. and phone!

The second demonstration of the day was staged under Red Cross auspices. The chairman of Red Cross Chapters in 3,700 towns were asked to file 15-word messages addressed to control stations in Washington, St. Louis and San Francisco. Operators were working in shifts at the control stations and handled all 3,700 of the messages with hardly a slip. Army alternate net control stations W3ZD-WLMD (Roy Corderman) and W3FZ-WLMP (Dean Young) in Washington handled some 1,200 messages.

The fine showing of the hams on this and other occasions has not gone unnoticed in the *War Department*. Maj. Gen. Mauborgne, chief of the Signal Corps, is at the present time considering a plan for reorganization and expansion of the Army amateur system which promises big things for the hams. The plans call for organization of an extensive amateur net, in which the hams would be enlisted as members of the Army reserve. This might possibly lead to pay for whatever active duty the hams performed and to some Government subsidy for the purchase of equipment by participants.

The hams are being included in plans for organization of the *Army's Aircraft Warning System*. More than 500,000 civilians will be enrolled in this system before the summer is over. They will be spotted throughout the country in a great grid system. From roof-tops, skyscrapers, church steeples they will watch for and listen for

approaching planes during raid drills. Their observations will be reported over special telephone communication systems to Air Corps headquarters, where are stationed intercepter planes.

It is planned to enroll amateur radiomen in this system for two chief purposes: first, to serve as an auxiliary means of communication in case telephone and telegraph lines are knocked out by bombs, sabotage, etc., second, to serve as a means of communication in areas where there are no telephones and telegraph lines.

The Division of State and Local Cooperation of the *Office for Emergency Management* has advised city officials organizing fire-fighting systems to include the hams. It was suggested that city officials make surveys of ham facilities in their towns. The hams could be used as a fire alarm system, to report fires and summon equipment, in case the regular systems were disrupted—as often happens in raids.

There is a big place for the hams in national defense. They are going to have a busy summer. The *ARRS*, which usually suspends its activities during the vacation season, will keep going full speed this summer. Now is the time for all good hams to come to the aid of the country!

FM-Newspaper Stations Held Up

INVESTIGATION of newspaper ownership of radio stations, long under consideration by the FCC, has been launched.

Lowell Mellett, member of the *Defense Communications Board*, has been assigned the fact finding job. Newspaper-station owners quickly went into action and formed a committee under the leadership of Mark Etheridge, publisher of the *Louisville Courier*, to present the case of the publishers.

The appointment of Mellett climaxes the recent action of the *FCC* in ordering applications of a number of newspapers for FM construction permits held up. Opposition of the newspapers was immediate and vigorous. The *FCC* relented, allowing temporary per-

mits, but announcing that it was going to have a good look into the whole newspaper-ownership of radio situation.

FCC action on FM applications is only part of the picture. The policy extends to all newspaper applications for new standard broadcast stations, as well as transfer of control of existing standard broadcast stations to press interests. Newspapers already licensed to operate broadcast stations will be permitted to improve facilities if changes conform to engineering requirements—and if the *FCC* decides that they are in the public interest.

Now that the long anticipated radio broadcasting monopoly and television reports have been released by the commission, a hearing date probably will be set in the near future.

More Radio Jobs

THE *Civil Service Commission* is scheduling examinations for a variety of radio jobs in the Government. Applications for the following jobs are now being accepted by the Commission: Junior Communications Officer, at \$1,620 a year, requires one year's experience—commercial or Government—and a speed of 30 wpm in transmission; principal engineer, \$5,600 a year, requires a college degree (or four year's experience in lieu) and seven years practical engineering experience; senior engineer, \$4,600 a year, degree or compensatory experience, and six years of engineering experience; engineer, \$3,800 a year, degree or experience, and five years experience; associate engineer, \$3,200 a year, degree or experience, and three years' experience; assistant engineer, \$2,600 a year, degree or experience, and two years' experience; senior radiophone technician, \$2,000 a year, requires four years' experience in installation, maintenance and repair of radio equipment, at least six months of which was with radiometeorograph equipment.

Note that the *Commission* will allow engineers to substitute, on a year for year basis, their practical engineering experience in

SPRAGUE and NATIONAL DEFENSE

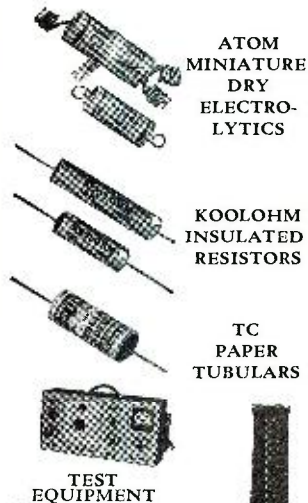

National defense needs come first!

Sprague is putting them first—fully and wholeheartedly. One of our two big factories in North Adams, Mass., is now devoted almost solely to defense work. Meanwhile, our other factory is turning out more Sprague Condensers, Koolohm Resistors and Test Equipment for the Radio trade than ever before. Deliveries are prompt. Full Sprague quality is being rigidly maintained. Development work continues as in the past.

Thus, thanks to Sprague's size and unique facilities, we are able to put defense first—and still not neglect our long-time-friends of the Radio profession.

SPRAGUE PRODUCTS COMPANY

North Adams, Massachusetts

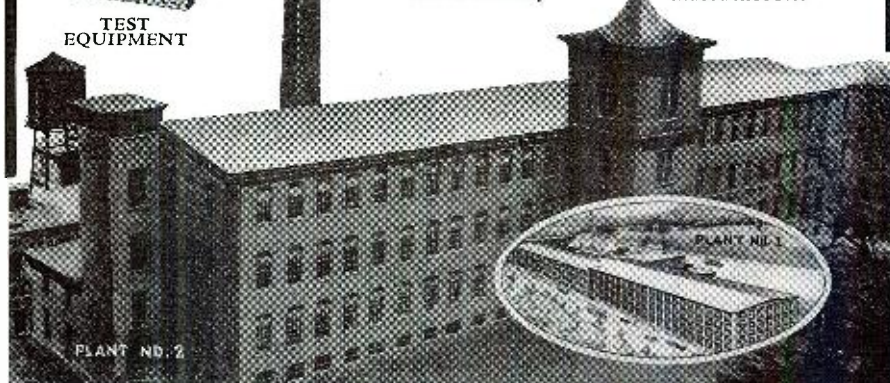

place of the four year college course. This is a move to include in Government service—especially in departments where defense work is being done—radio men of large practical experience whose formal education is not sufficient to allow them to add a degree after their names.

The shortage of radio engineers in Government service is at times acute. Civil Service records do not reveal how many positions have been filled in the last year, but the following applications were received—and in many cases were accepted—from January to September 1940:

Radio Inspector, 480; Assistant Radio Inspector, 739; Radio Monitoring Officer, 868; Assistant Radio Monitoring Officer, 645; Radio Operator, 3,059, and Radio Sonde Technician, 187.

Applications may be obtained from the *Civil Service Commission* in Washington.

The Navy is calling for experienced cable men and for radio operators for the *Merchant Marine Reserve*. The shortage of marine operators is causing concern in Washington. The *Department of Commerce* said serious shortages exist in Boston, Philadelphia and New Orleans and that the situation will grow worse.

Note: There is talk of classifying marine radio operators and workers in radio manufacturing industries as "necessary" men, giving them deferment under *Selective Service*.

Defense Orders

THE *Office of Production Management* is calling for more sub-contracting and when the new defense radio orders are placed, the smaller companies will get a better break. The *OPM* is urging expansion of sub-contractors' facilities, pointing out that it is better to use these plants, which are ready to work without re-tooling and experimenting, than to expand the big plants or build new ones.

In the radio manufacturing, sub-contracting has been largely confined to condenser parts, insulation material, etc.

The Kearny (N. J.) plant of *Western*

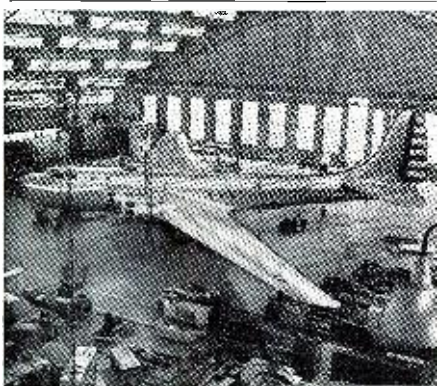

Uncle Sam's Newest SKY GIANT

Over 2,000,000 man-hours have gone into the creation of the new 82-ton Douglas B-19 . . . the largest plane in the world! Capable of flying non-stop from Los Angeles to London and back across the Atlantic to New York, the huge ship is scheduled for a test flight in July. Don't fail to read all about this long-range bomber and the other big multi-engine warplanes slated for Uncle Sam's air force . . . the answers to problems of hemisphere defense . . . in a revealing article

IN THIS MONTH'S

Fact-Filled • Picture-Packed

FLYING
AND POPULAR AVIATION

NOW ON SALE At All Newsstands

Electric reports that half its work has been sub-contracted to smaller manufacturers.

The following contracts for defense radio have been signed in recent weeks: *Bendix Radio Corp.*, Baltimore, \$74,477 for aircraft radio; *Higgins Industries, Inc.*, New Orleans, La., transmitting and receiving equipment for the Navy, \$86,525; *Allen D. Cardwell Corp.*, Brooklyn, antenna, \$725; *Radio Laboratories Inc.*, Seattle, Wash., \$11,135 for radiotelephones.

-30-

P.A. System Aids Tower Construction

DURING the construction of the vertical radiator of radio station WJBO in Baton Rouge, La., which is a 485-foot steel tower with a 20-foot base, much trouble was experienced with the cord and signal bell system of communication between the steel crew and the engineer operating the hoisting engine.

The customary two-wire telephone was tried, but that, too, was a bother rather than dependable, as both top and bottom men had to wear telephone sets to keep in contact with each other.

Finally a P.A. system was used. A double button carbon microphone was installed in a heavy wood case to prevent damage and short circuits when the mike came in contact with the steel tower. The frame of the mike was connected to a large battery clip with a three-foot lead wire, this clip was clipped to the steel and the mike hooked over a nearby beam. A twisted pair cable was run from the mike buttons to the P.A. amplifier and speaker located in the hoisting engine house on the ground below.

-30-

Police Radio (Continued from page 42)

of interzone stations operating between zones on the zone frequencies.

Upon putting this question up to the *F.C.C.*, the reply is as follows: "The 2800 kc. frequencies may be used only for zone communication; that is, by both zone and interzone stations for communication within a zone."

This definitely states that operating between zones on the 2800 band is illegal.

The much discussed question of phone stations working each other across states is also answered by the *F.C.C.* in which they state that this type of communication is permitted provided that no interference is caused to the mobile service, and that communication is limited to places between which, by reason of their close proximity, the use of police radio-telegraph stations is impracticable, and that under no circumstances shall these stations engage in point-to-point radio communication beyond the good service range of transmitting stations.

This interpretation leads us to believe that phone stations, having a service range extending into a phone station of a neighboring state, may engage in communication.

Point-to-point communication at night, when skip allows two stations separated by hundreds of miles across several states to work each other would be illegal, as this type

of communication exceeds the good service range of the stations.

Corona Discharge Attenuation

CORONA discharge, that ear splitting racket that reminds one of bacon and eggs frying on a griddle, has been greatly reduced by a little gadget worked out by A. C. Kadow, police radio engineer at Elgin, Illinois.

This type of interference is noticed whenever low hanging clouds pass over the receiving antenna. The antenna acts as a means of discharging the potential between the cloud and the earth.

Corona discharge produces a type of interference much like snow or rain static, which, of course, results from the snow flurries or rain drops releasing their static charge which they have picked up upon striking the antenna.

In his experiments, Kadow reasoned that if two electrodes of large area were subject to high potentials, a breakdown will eventually occur as the potential is increased. By replacing the large area electrodes with needle points, a much higher potential would be needed to cause a breakdown.

Since naturally the tip of the antenna is where the corona discharge takes place, Kadow placed several bronze wires about .008 inch diameter and 1¼ inches long on this tip. However, he also found that by placing a resistor between this wire cap and the antenna proper, a suppressor action would result, greatly diminishing the static voltage passing on through the antenna.

This resistor may be of any value between 100,000 ohms and 1 megohm. A 20-watt type is ideal, and it may be mounted on the antenna with short brass rods inserted into each end of the resistor and cemented to the porcelain tube.

This little device was designed mainly for an UHF antenna, as this type of interference is more predominant on ultra highs.

Chatter

WE wonder how Jake Spade, Dunes Park, Indiana, State Policecop, manages to get the upper hand over the Indiana Troopers. The other day we noticed one of these hearty troopers curled up beneath the dash of a squad car replacing a receiver while Jake stood by giving the instructions!

The police radio field has lost two more prominent men. John Weaver, former acting chief engineer of the Illinois State Police, is now with *RCA Mfg. Co.* Johnny will still be around, however, as he is connected with the police radio division of *RCA*. Jim Virden, the gentleman who handled the *Associated Police Communication Officers Convention* in Orlando last December, has also turned in his resignation to the Orlando, Fla., Police dept. to go commercial.

The *APCO* will hold their annual convention in Oakland, California, during the third week in August. Any person engaged in police radio may hold a class of membership into this organization. Most of the work undertaken by the association this year is centering upon obtaining more frequencies for police use. This is, indeed, the main problem now confronting police radio.

Many of the county police radio departments are taking advantage of the additional coverage afforded by an FM system. Several are changing over to FM for communication with their own cars, but still using AM for the other departments which they may serve. Only one transmitter is generally used, however, the two types of modulation are applied to the carrier by a switching arrangement.

We notice more radio supervisors are installing push button switches on their control boards for isolating one receiver from a group. They are also using lights to warn that only one receiver is working.

Counties to Get Aid

A BILL is up for its last reading in the house of legislature in the State of Illinois which will greatly benefit county police radio departments.

At present, all counties in the state are operating under an old time law approved in 1874 which states that county sheriff departments must manage on the fines and fees

that they must earn entirely by themselves. It has been proven impossible for these departments to progress by financing themselves in such a manner.

This bill will enable county boards to have power to make appropriations for the police radio department. Section 11 of the proposed amendment reads as follows:

"To purchase, lease, or otherwise acquire and maintain and operate, a radio broadcasting station, for police purposes only, in its county, or jointly with other counties, equipped to send messages to and receive messages from peace officers; and to purchase or otherwise acquire, radio receiving sets and equipment necessary for receiving messages from and sending messages to such broadcasting station and to furnish such receiving sets and equipment to peace officers under the jurisdiction of the county for use by such peace officers for police purposes only."

We believe this bill is almost certain to pass, and with it, police radio in our county departments will rise to new heights. This only proves that our lawmakers are getting wise to the fact that a good radio system is a vital necessity to all police departments, whether they are rural or metropolitan.

Because of the great efficiency achieved by our metropolitan police departments, crime has been more active in the rural areas of late. Robbing of farmhouses is becoming quite common. With revised legislature permitting sheriff departments to equip themselves, this situation may be remedied.

-50-

For the Record

(Continued from page 4)

jittery. Everything being equal, he will be permitted to operate as he is now. This does not mean that he should become careless, or that he should not be careful with whom he has a QSO. It means that the F.C.C. will permit the amateur to remain on the air only so long as the great majority of them obey its Rules and Regulations and make the monitoring of the amateur bands a comparatively simple and easy task.

In all fairness, therefore, to all concerned, we feel that we may tell the amateurs that at this writing they have nothing to fear, that they should go ahead and build their rigs as they had planned, and that they should buy the receivers which they were thinking of purchasing before the national case of "jitters" hit them.

And above all, they should not invite lightning to hit them by talking so much about it.

* * *

IN reality, we could call this our "miniature" issue. Starting with the first article on the "personalized" receiver, a three-quarter's size illustration of which appears on page 8, and finishing up with the "stabilized" phono-oscillator on page 17, three of the main features of this issue are of the "midget" type transmitter or receiver. We were agreeably surprised to see how many components could be placed in the small space that each of the three authors had allotted to his respective unit; and we were more amazed to discover that each unit actually worked. We know this to be true because in each of the three cases we requested the author to forward the unit to us for test.

Probably the most outstanding of all three was the little airplane transmitter with its six tubes looking for all the world like a miniature of a man-sized rig built about the year 1922. The similarity was the more striking because the "1"-series tubes do not

have flat dome ends, the bulb being finished off with a "tip" with which the radio engineer was so familiar about twenty years ago.

Mr. Utley, too, had his problems in trying to build a duplicate of the manufactured personalized receiver. The circuit itself was standard and Mr. Utley told us that the unit could be purchased far cheaper than it could be built. Building it, however, represented a challenge, not only to the beginner, but to the accomplished radio engineer to duplicate with ready-bought parts that which the manufacturer had built specialized equipment. The little receiver has remarkably fine quality, considering the small speaker it includes. We found it to be quite sensitive, also.

We are waiting for the day when some amateur will send us a complete 5-band communications receiver for amateur use built into the same size case and with the same type of components as Mr. Utley's. We have been informed that it can be done, but we would not care to believe it until we see it.

* * *

THE stabilized phono-oscillator represents a radical departure from the customary phono-oscillators with which the market has been flooded for the past two years. Mr. Jackson's design is somewhat unorthodox in that it represents a master-oscillator power-amplifier unit; however, when we tested it we found the reproduction far exceeds that of the usual phono-oscillator. To the uninitiated, the circuit seems somewhat complex; but the radio engineer and amateur will readily recognize an old friend. Actually, the little stabilized phono-oscillator is a miniature broadcast station, and the similarity goes further than that. The broadcast stations themselves, are a form of master-oscillator power-amplifier unit. The modulation is of the Heising, or constant current variety, and the unit can be used either on a.c. or d.c.

A word of warning: to those who build this unit, we suggest they follow the parts list carefully and do not vary from the electrical values of resistors, condensers and especially from the actual length of the "antenna" which is attached in the unit. A variation from these components may result in an increase in power, which would cause the constructor to violate the Rules and Regulations of the Federal Communications Commission. As it is, the unit has sufficient power to transmit a record across the average living room, which we believe to be ample for all legal and legitimate purposes.

Adjustment of the unit should be attempted only by those who understand a master-oscillator power-amplifier unit, or by a recognized serviceman. The beginner will have a great deal of trouble in tuning the unit if he does not have available a receiver which can be placed close to the stabilized-oscillator during the procedure. All of these troubles, however, are easily overcome and, in view of the fact that the summer months are hard upon us and that parties, with their dances and their phonograph records, will rapidly supplant the hot soldering iron and the technical relaxation, we believe Mr.

It's Meissner again

WITH A BRAND NEW

F-M ★ A-M

3-BAND COMBINATION



TABLE MODEL RECEIVER that has everything!

- ★ Two-tone, hand-rubbed walnut cabinet
- ★ 12¼" high — 22¾" wide — 11" deep
- ★ FM and AM in two separate channels
- ★ Covers Broadcast and Short Waves on AM
- ★ Full coverage of 42-50 mc FM band
- ★ Calibrated glass scale, edge-lighted
- ★ Tuning indicator, accurate adjustment
- ★ Includes seventeen latest type tubes
- ★ High-gain RF stage on all three bands
- ★ Wide-band I-F channel on both AM bands
- ★ 3-stage I-F channel on FM at 4.3 mc
- ★ Audio system common to both channels
- ★ Response flat from 30 to 15,000 cycles
- ★ Push-pull output, 6½ watts undistorted
- ★ Heavy-duty 8" PM Hi-Fidelity Speaker
- ★ Operates on 105-125 volts, 50-60 cycles

Complete Receiver as shown, with tubes,
Model 9-1053 List Price \$108.00

Chassis Only, with tubes
Model 9-1054 List Price \$95.00

See Your Jobber Today!

1941 INSTRUCTION MANUAL



Now Ready!
Contains complete instructions for all Meissner Kits
Circuit Diagrams
Parts Lists
Pictorial Diagrams
Charts and other useful data
ONLY 50c NET!

WRITE TODAY FOR FREE 48-PAGE COMPLETE CATALOG

Address Dept. N-6



RADIO made EASY

LEARN AT HOME - IN SPARE TIME!

36 VOLUMES in 1 Big Book!

1. Broadcasting System
2. O u n d Speech
3. E l e c t r o n Theory; Electric Current
4. Elec. Units; Ohm's Law
5. Electric Circuits; Batteries
6. Magnetism; Electromagnetism
7. Electromagnetic Induction
8. Inductance
9. Capacitance; Condensers
10. A.C. Circuits
11. Filters
12. Measuring Instruments
13. Broadcasting
14. Receiving
15. Vacuum Tube Principles
16. V. T. Characteristics
17. Vacuum Tube Construction
18. V. T. Detector and Amplifier Action
19. Radio Frequency Amplification
20. "Superhets"
21. R.F. Amplifiers; Tuning Coils
22. Audio Amplifiers
23. Loudspeakers
24. Battery Receivers
25. Power-Supply Units
26. Electric Receivers
27. Phonograph Pick-ups; Public Address
28. Short Waves
29. Photoelectric Cells; Cathode-Ray
30. Television
31. Antennas and Grounds
32. Testing; Servicing
33. Sound Pictures

Ghirardi's COMPLETE Course will train you QUICKLY

Here's your **BIG CHANCE** to get a thorough training in basic RADIO FUNDAMENTALS—quickly, easily. There are **BIG OPPORTUNITIES** and lots more jobs for men with radio training—in radio factories, in radio service shops—in all branches of the Army and Navy.

RADIO, SOUND, TELEVISION —MADE EASY AS A. B. C.

Ghirardi's famous RADIO PHYSICS COURSE is the cheapest, quickest radio training you can find. The whole science of Radio, Sound, & Television in a form completely intelligible even to beginners without any previous radio experience. Clear explanations and 836 self-testing Review Questions make it so easy to understand as a primer. Thousands of successful radio men got their start with this book, and are used by more radio schools and students than any other radio text in the world! Get this whole 972-page course today for only \$4—and get started on your own radio career!

Use it 5 Days —OUR RISK!

Your money back if not fully satisfied. Don't delay—get started now—mail this coupon at once!

972 Pages 508 Illus.

Only \$4

CLIP OUT — AND MAIL!

Radio & Tech. Publ. Co., Dept. RN-61, 45 Astor Pl., N. Y.

Enclosed find \$4 (\$4.50 foreign) for my copy of "RADIO PHYSICS COURSE" with your 5-day Money-Back Guarantee.

Name

Address

City

State

Send me free literature.

NEW! NO BATTERIES! 1941 MODEL Pocket Tubes Radio Plug-In

DURABLE PLASTIC CABINETS
Dual Bands—Magichenna—Microdial

Fits your pocket or purse. Wt. 6 ozs. Small cigarette package. Receives standard & some short wave. PATENTED POWER RECIPIER. No tubes, batteries, Hi-ratio easy tuning in. "MAGIC" DIAL. M.L. OF ILL. SAYS: "MIDGET RADIO WORKS FINE!" **ONE YEAR SERVICE GUARANTEE!**

Sent complete ready to listen with instructions & tiny phone for use in homes, offices, hotels, in bed, etc. **SIMPLE TO OPERATE—NO ELECTRICITY NEEDED!**

SEND NO MONEY! Pay postman only \$2.99 plus postage charges on arrival or send \$2.99 (Check, Cash or money order). **FREE!** "MAGIC-TENNA"—ELIMINATES OUTSIDE WIRES!

MIDGET RADIO CO. Dept. HG-6 Kearney, Nebr.

POWER AND LIGHT

ONAN A.C. ELECTRIC PLANTS supply current for Radios, Transmitters and Receivers, P. A. Systems, Motors, Sewing Machines, Truck Apparatus, Tools, Lights, All Appliances, Ue'das Stand-by Equipment in Schools, Hospitals, Theatres and Public Buildings in case of Power Line Failure due to Storms, Floods, etc. Available in 110 or 220 Volt A.C.—12, 32 and 110 Volt D.C.—Also Dual Voltage A.C.-D.C. Types. Manual, Full-Automatic & Self-Starting. \$89 and up. Shipped. Ready to Run.

D. W. ONAN & SONS
1456 Royalston Avenue, Minneapolis, Minn.

INTRODUCTORY TOBACCO KIT

WE ARE MAKING THIS USUAL ADVERTISING OFFER TO INTRODUCE THESE QUALITY TOBACCOES

HERE'S WHAT YOU GET

- A Half-oz. Trial Pack of OLD NAS-SAU, mild, slow-burning, mellow blend.
- A Half-oz. Trial Pack of HICKORY CURED (Blend No. 917) rich, fragrant, aromatic flavor.
- A Half-oz. Trial Pack of COLO-NEL ADAMS, Our mildest, natural leaf Pipe Mixture.
- A Package of 12 Pipe Cleaners.
- A FREE Subscription to PIPE LORE, the magazine for pipe collectors and tobacco connoisseurs. Many interesting features, bargains.
- Send 10¢ (coin or stamps to cover postage and handling) — for this Complete Kit. Act now before this offer expires. Send your dime to—

WALLY FRANK, Ltd., 10 E. 45 St. New York, N.Y. Dept. 79

Send only 10¢ for postage and handling

Jackson's article to be most timely and of wide general interest.

"PRIORITIES" continue to pile up in the radio industry. First it was aluminum, now affectionately called, "radio's gold." To that has been added copper, steel; and we freely predict the time when a great many of the crude products going into the manufacture of radio parts all will be on the "priority" list.

What does this mean to the constructor?

If you are planning any extensive experimenting; if you are planning to build a transmitter, or receiver, which requires considerable parts, or which requires meters, or for which you want some specialized type of cabinet, we urge you to place your order at your local jobber at once, while there is still a chance to obtain these parts without a rise in price on the stocks the manufacturer still has on hand. As soon as the "priorities" make themselves felt, and the experimenter is forced to buy things built under the very latest wage scales, he will find that he will have to pay a premium. To avoid: order now!

THE American Radio Relay League informs us that the Annual *Field Day* is again with us over the weekend of June 7 to 8. The *Federal Communications Commission*, in cooperation with the *League*, has opened those two days for portable operation of amateur transmitters in any band so long as the licensees participate in the *ARRL Field Day tests*. We cannot urge all amateurs too strongly to take part in the *National Field Day*. It makes little difference whether or not you have a score which is counted among those winning—it makes little difference whether or not you can get a group together or whether you do it by yourself. One of the greatest assets of the amateur has been his ability to organize emergency equipment and get it on the air with the least amount of time.

With the *F.C.C.* regulations prohibiting the usual low-frequency portable operation relaxed, the *Field Day* presents the only chance during this year in which the amateur will be able to test his ability to create emergency equipment, and to get it working. We believe that this *Field Day* will be the greatest that has ever been held in the United States, and we believe, also, that thousands, literally thousands of amateurs, will take part.

We of the *RADIO NEWS* technical staff will take our transmitters into the field to see what can be done. Naturally, we're not interested in winning a prize, nor will we particularly keep any score, but we are interested in testing out a number of theories we have had on portable and mobile operation. A full story of our exploits (?) will be told in the August issue.

So, you amateurs, if you have no emergency equipment, there is still time for you to build it. A number of hook-ups have appeared from time to time in *RADIO NEWS*, which would admirably serve your purpose. If you do have emergency equipment, get it in working order. See that nothing will break down during the short period which, in the 12 months, will be all that will be allowed you to use low-frequency portable gear. Any of you making pictures of your own rigs, or the rigs of others in operation on *Field*

Day are asked to send them to *RADIO NEWS*, where we will be most happy to publish them together with information in the *Ham Chatter* column.

We have arranged for attractive QSL cards which will be distributed to all whom we contact, and we promise something a little unusual from a rather unusual location. So, if you are in the *Field Day*, keep a sharp look-out for W9QEA-portable/mobile and the gang. We'll be seein' you!

All servicemen will be interested in John F. Rider's column, "As I See It!" this month. For the first time in the last five years, figures are available as to what the servicemen with store-front shops are earning; and Mr. Rider has taken great pains to break these figures down and interpret them. Are you making as much money in your servicing business as you would like to? Are you taking the fullest opportunity of your advantages? Are you really wide-awake, or do you just fancy yourself to be so? Where are their additional opportunities for income to the serviceman? These things are all discussed by the author in his enlightening article which appears in this issue.

Of interest to all radiomen, Mr. Rider takes to task the thousands of servicemen who are seeking to jump on the bandwagon of the National Defense radio technical man shortage, who offer their services to the manufacturers with apparently little or no results. The reason for these men not being used and the chances of those who stick at home at their radio shop benches, makes an enlightening conclusion to Mr. Rider's article. Serviceman, if you are interested in your business, by all means, don't fail to read "As I See It!" in this issue.

The other day we received a letter from the Honorable T. J. Slowie, Secretary of the *Federal Communication Commission*. Mr. Slowie asked us to call the attention of the amateur fraternity to the fact that in operating a transmitter remotely by radio (as differentiated from wired wireless), a special license is required. In the March issue of *RADIO NEWS* we ran a circuit showing how a transmitter could be controlled remotely by means of a radio circuit. While it is true that in these United States everyone is presumed to know the law (yet even lawyers always have large libraries in which to look it up), we wish to warn all amateurs who may be contemplating building a remotely radio controlled radio transmitter, or who have already done so, that they should make prompt application for the special license on the form which may be obtained from their local Radio Inspector's office.

A RECENT survey made by our Circulation Department reveals that the serviceman and the radio engineer is becoming more and more interested in sound-on-film. This is a comparatively new subject to us, and while we have already run one article showing how sound is put on film in Hollywood, we have not opened our columns to the general experimenter and the home-builder on this subject. In view of the demand from our readers, they can expect one or more articles showing how they can make and run their own sound-on-film. More,

and more, sound-on-film is getting popular, and RADIO NEWS would be indeed remiss (since sound-on-film is an offshoot of sound-on-acetate, which, in turn, is an offshoot of the public address system) were it not to give our readers the information that they seek.

At all times, the editors of RADIO NEWS are anxious to keep up with our readers' interests. It is our policy, well established over a period of the last three years, that the readers' wishes are our command. If you do not see it in RADIO NEWS over a short period of time, please do not hesitate to write to us and tell us what you would like to have us run. It is only from these letters that we are able to maintain a well-balanced technical magazine.

Actually, we cannot hope to please everyone, nor do we want to displease anyone, but we should like to be able to say that RADIO NEWS covers as much of the radio and allied fields as our readers want it to, so that in each issue, something of interest to every reader will be found, and none will be slighted.

* * *

SUMMER comes fast upon us, with the resulting static in our radio sets. The warm evenings are stiff competition for the hot soldering iron and the glaring test bench. Swimming, tennis, hiking, boating, and touring, in fact, all of the outdoor sports lead us further and further away from our radio. It takes real "stuff" to stick it out; but in all of our experiences in radio, which date back over 20 years, we still find that in the average summer months there are a sufficient number of cool evenings when nothing satisfied us better, or more completely, than to build up that unit which we have been "dreaming" about, or to turn on the receiver to hunt that elusive bit of dx. Most especially we like the summer because there seem to be a few hamfests and conventions which we might be able to attend and meet some of our readers personally.

* * *

AND that's about all we have on our chest at this time. Don't get downhearted at the news reports you read and hear over the radio. Remember, that from the last war, radio got a terrific impetus. Developments of this war cannot be evaluated.

But they certainly will be startling.

—KAK.

—50—

Jesse James Had a Gun

(Continued from page 38)

cost \$6.00 plus \$3.00 for the trip to install them. These had to be replaced every six to eight weeks until Philco came out with a wet "A" unit.

Grief? We had our share of that too, but we were in position to cut this undesirable feature down to a minimum. Here's what was printed on our service policy which went out with each repair job.

"We will repair your radio, and put it into first-class operating condition in our shop, but if after delivery to your home, the same day, the next day, or any day thereafter it suddenly goes dead, becomes noisy, doesn't get any distance, or is otherwise unsatisfactory we will not be held responsible.

Any additional labor which is necessary to put the radio into satisfactory working order will be charged for at our regular rate of \$3.00 per hour. \$3.00 minimum charge. (Parts extra.)"

Show me the radio man who wouldn't like to see that sort of policy in use today! Maybe, you won't ask "What was good about the old days," now. Because the salt air pulled continuous blitzkriegs on radios, we had to do this for our own protection. We, having no cut-throat competition, and being blessed with customers who were cognizant of conditions, were in position to enforce the above service policy . . . and we did it!

The first screen-grid tube came out, the UX222. RADIO NEWS had the dope on it, as well as a practical diagram for a TRF job. We built one, shielding each stage and running the grid and plate leads through copper tubing. The job looked like a model steam engine . . . but it worked! And we sold lots of screen-grid kits.

Most of our really big jobs came from the Palm Beach millionaires. We installed, maintained and serviced the big sets of such notables as the late Col. Samuel D. Lit (Station WLIT); Wm. H. Luden (The Cough-drop king); E. T. Stotesbury, John C. King, Sailing Barouche, H. B. Phipps, E. B. McLean and many others.

The Big Store operated on strictly cash basis to everybody and one Christmas Eve, we sold among many other sets, 15 Radiola 30's at \$575.00 per each. The Palm Beachers paid us \$25.00 for installing outside aeriels each season when they came down, and the same price for taking them down when they left for they were afraid that lightning would damage their homes if the aeriels were left up while they were away.

One of my helpers brought in a Radiola 17 from Palm Beach one afternoon for repair. When we lifted the lid of the cabinet we found that it was almost full of valuable jewelry, diamond and pearl necklaces, rings and brooches. We returned the stuff to the owner and he thanked us very politely . . . but no tip for the radio man. This was unusual as most of the Palm Beachers tipped us very liberally.

Another radio man who worked out of my shop told this one:

He had been called to a certain home in Palm Beach, and just as he'd finished sticking a tube in the radio and got it going, the owner came in.

"Is it okay?" he asked.

"Yes, sir. It's working fine, now."

"Well, I hope you've done a good job. Most of these cheap radio men from West Palm Beach come over here, work on my set and only charge me ten or twenty dollars. You don't look like that kind of a boy to me. I hope you're not one of those cheap radio men." He reached into his pocket. "How much do I owe you?"

"It'll be \$100.00 even."

The owner peeled off a hundred dollar bill from his roll, and added ten more for a tip.

"That's more like it," he said. "I'm tired of these cheap radio men."

We took care of many jobs on the big yachts anchored in Lake Worth. These were special installations, early AC consoles using converters, as practically all of the boats had DC generators. A complete set of tubes for one

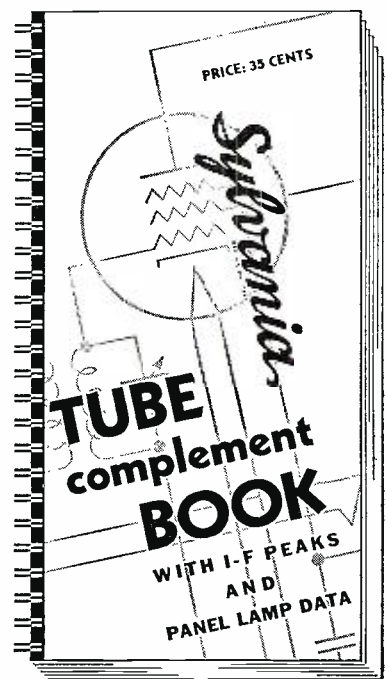

1941 EDITION

... including
the first collection of
PANEL LAMP NUMBERS
ever compiled
only 35c

272 Pages. 16,730 Radio Models shown—including data on '41 receivers. Tube replacement information for 100,380 Tubes or Sockets. 586 Trade Names of receivers.

Names and Business Addresses of 190 Receiver Manufacturers.

THE FIRST AND ONLY COMPILATION OF
PANEL LAMP NUMBERS

Every Radio Serviceman should own one of these Sylvania Tube Complement Books. All the information you'll need—from the oldest set to the latest '41 model—is packed into those 272 pages. And the book is bound by the WIRE-O process. It opens flat and there's no danger of it falling apart or of the pages pulling out.

This valuable compilation, the only book of its kind in the field, is one of the 125 silent salesmen Sylvania has created to help you build a sounder, more profitable business. Write today for Sylvania's Tube Complement Book, enclosing 35c in stamps or coins, and for a full list of the sure-fire, tested, dealer aids. Some are free, some cost you just what they cost us—all of them are designed to help you sell more, and *make more!* Sylvania Radio Tube Division, Hygrade Sylvania Corporation, Emporium, Penna., St. Marys, Pa., Towanda, Pa., Ipswich, Mass., Salem, Mass.

SYLVANIA

Set-Tested Radio Tubes

Also makers of Hygrade Lamp Bulbs, Hygrade Fluorescent Lamps and Miralume Fluorescent Light Fixtures

ASSURED STABILITY

WITH

BLILEY CRYSTAL UNITS

10-20-40-80-160
METER BANDS



TYPE B5—This highly active crystal unit for the 40 meter band has less than 4 cycles/mc/°C drift. Price \$4.80.

TYPE LD2—An efficient and powerful low drift crystal unit for the 80 or 160 meter band. Price \$4.80.

TYPE HF2—Simplifies the construction of 5- 10- and 20-meter transmitters. Drift, 20 meters, 20 C/mc/°C; 10 meters, 43 C/mc/°C. Price, 10 or 20 meters, \$5.75.

TYPE BC3—A moderately priced mounted crystal with unusual activity and power output. Drift 23 C/mc/°C. Price, 40, 80 or 160 meters, \$3.35.

BLILEY ELECTRIC CO. • ERIE, PA.

MODERN PARTS for MODERN CIRCUITS

THAT HAVE BEEN

*"Designed for
Application"*

CATALOG UPON REQUEST

JAMES MILLEN  MFG. CO. INC.
150 EXCHANGE ST. MALDEN, MASS.

COMMERCIAL RADIO INSTITUTE

A radio training center for over twenty years. Well equipped. Excellent faculty. Practical resident courses in Radio Telegraphy, Broadcast, Servicing, Industrial, Television, Aeronautical, Drafting, Mathematics and Studio Technique. Placement. Catalog upon request.

Dept. C, 38 West Biddle St., Baltimore, Md.

 **RED-CAPS**
Smaller Diameter Dry Electrolytics

SPEED
Servicing

Write for Catalog 

SOLAR MFG. CORP. Bayonne, New Jersey

CANADIAN SERVICEMEN

can now purchase SUPERIOR Test Equipment direct from Radio Parts Supply Co., R.N.6, 962 Bleury St., Montreal, Canada. They stock our complete line. See inside back cover in this issue.

SUPERIOR INSTRUMENTS CO.

The all-way radio magazine!

For the serviceman, dealer, amateur, and experimenter! Get the RADIO NEWS habit. 25c at all newsstands.

of those babies ran around \$50.00. I've thrown many a good set of tubes overboard because the owner "didn't want them in his set if they didn't test like brand new."

These incidents sound like fish stories, but they're true. You see, these people circulated their money very freely in order to cut down on income taxes.

"Yes . . . radio in the "good old days" was really good!

I was 20, in 1925, and making over \$250.00 per month. I'm 37 today, and although I have a good job, I'm making so little that I have taken up writing in order to help keep the wolf a little farther from the door.

But . . . FM and Television are on the way to wide-spread use, and who knows . . . maybe soon we'll return again to what fifteen years from now, we'll call the "good old days."

-30-

Super Superheterodyne

(Continued from page 24)

in only a portion of the 150 kc. band-pass being amplified, with resultant distortion. In the case of biased converter tubes, that is, automatic volume control bias, a certain amount of oscillator instability may result, which will show up in the need for retuning of the receiver. In such cases it may be advisable to use fixed bias of the mixer tube, removing the a.v.c. line. Where line voltage irregularities exist, incorporation of a VR-150 voltage regulator tube may be needed to stabilize the oscillator plate voltage.

"Under certain conditions, i.f. interferences due to strong local stations may necessitate the use of a wave trap tuned to the peak frequency of the i.f. and placed in the antenna input circuit. Ordinarily, this won't be encountered."

Alignment of the A.M. Tuner

An all-band signal generator is needed if the 5 a.m. frequency bands are to be calibrated and aligned accurately. The signal is first fed to the i.f. amplifier input at the grid to the mixer tube with the oscillator tube removed from its socket. The correct i.f. frequency is 456 kc. A proper dummy antenna must be used between the signal generator and the receiver. For the broadcast band, use a 200 mmf. condenser in series with the "hot" lead from the generator with a common ground connection between the two units.

Set the signal to 1400 kc. and adjust the trimmers for maximum output on that frequency. Then set the generator to 600 kc. and adjust the padding condenser for maximum output at that setting. An output meter should be used for all of these adjustments and the gain controls on the tuner set to "full-on." The strength of the signal may be controlled at the generator. Go back to the 1400 kc. setting and re-adjust the trimmers on all broadcast coils for maximum output.

The process is repeated on the 1.5 to 4.5 mc. band by trimming the coils at 4.0 mc. and by padding the coils at 1.7 mc. A 400 ohm resistor is substituted for the condenser on all of the bands below the broadcast. There is no necessity for a padding condenser on the

two high-frequency bands, so the alignment is simplified on those two bands. It is only necessary to trim at 10 mc. on the third band, and pad at 4.5 mc. The other two are trimmed at 16 mc. and at 29 mc.

The frequency range of the five bands are as follows: Band No. 1—540-1580, Band No. 2—4.0-1.7, Band No. 3—10.0-4.5, Band No. 4—7.3-18.8, and Band No. 5—11.2-31.6 mc. The band-spread condenser is set to maximum for all alignment process.

The tuner must now be adjusted to the particular antenna system used. A a.m. signal should be tuned-in on the receiver and the condenser located at the rear of the tuner adjusted for maximum signal strength. Some slight adjustment may be needed on the r.f. trimmer. Maximum signal strength will be indicated when this has been done properly.

Once the two r.f. tuners are operating satisfactorily the remaining parts of the receiver may be wired in in almost any order that is convenient. The mounting of the cathode-ray tube should be done last so that it will not interfere with the process of mounting or wiring of the other parts. Proper tuning of the set will result in rather startling performance. Improper tuning can completely ruin the performance that is possible.

Many of our readers have indicated that they are now actually building the receiver in its complete form. Some have requested full-scale drawings of the entire group of assemblies. We regret that it is impossible to supply this type of data due to space limitations and because of the vast amount of mechanical engineering that would have to be done to satisfy each and every request for various versions of the set, many which request layouts using some particular parts that happen to be available to some particular person. No trouble should be experienced in following the layout from the illustrations and diagrams. Naturally, because of its size, there will be no crowding of parts and this will allow much leeway in laying out whatever parts the builder may have on hand. *Substitutes should not be made unless they are the electrical equivalents of the original parts used.*

Use of the Receiver

To the engineer, the uses to which this receiver can be put will become immediately apparent from an examination of the controls with which it is equipped; but we should like to enumerate some of the more outstanding uses for those who are not as well informed.

The primary use, of course, of this receiver is as a communication unit, hence the regeneration and the three i.f. stages, not to mention some of the other refinements which are found in the a.m. tuner circuit. The receiver represents an extremely selective and, at once, a sensitive super heterodyne receiver for the reception of faint signals and, therefore, extreme dx.

Because of the inclusion of a rather extraordinarily fine audio amplifier section, the tone quality from local broadcast of musical action or as fed.

in from a phonograph pick-up will be better than usual. Part of this is due to the amplifier section, as has been said, and part is due to the extremely fine high-grade Jensen co-axial speaker which is used.

The addition of the oscilloscope modulation-meter has many uses in communication work. Not only is the user of the unit able to check the modulation of the broadcast station and, using such a setting as a "yard stick," measure the modulation of amateur transmitters; but the modulation meter can be used in making field strengths checks on transmitters to show the receptive effect of varying the percentage of modulation at the transmitter. For those who are engaged in engineering work, this is an extremely valuable adjunct.

The f.m. tuner is entirely standard, and coupled with the audio amplifier section, previously described, enables static-free reception of f.m. signals. With the continuing advance f.m. is making from day to day, the increase in number of f.m. stations from coast to coast, this feature alone makes the receiver a little unusual. When one considers the provision made for making recordings, by means of the f.m. tuner, high fidelity records can be turned out without the interference due to static.

You do not have to do your cutting "in the dark." A suitable volume indicator has been included so that your cutting level may at all times be exactly as you want it. To facilitate tuning, on the other hand, a suitable "R" meter has been included in the a.m. section, and a tuning eye in the f.m. section. Thus split-hair tuning and on-the-nose-resonance is wholly possible.

A small word of mention should be made on the noise-rejection circuit which was fully explained in the last month's issue. Too few receivers lack this feature, and too many receivers lacking this feature are being used in noisy locations. The claim is not made that by the addition of this feature that a noisy location will thereby afford noise-free reception. But we do say that the noise-rejection antenna system assists materially toward that goal; and that any such assistance should be gratefully received, especially by the man who uses his receiver for recording purposes.

Another feature is the variable band-width i.f. stages. In the reception of c. w. signals, a razor-sharp i.f. system is necessary. On the other hand, in order to pass the high and variable frequencies of phone transmission, such as broadcast, a wide band-width is equally necessary. Both have been included in this receiver and a "medium" setting has been included for communications work. The advantages of the wide, narrow, and medium band widths in the i.f. stages can only be appreciated after the constructor has made use of them.

Finally, there is the use of loktal tubes wherever possible. These tubes, with their short leads, their internal shield, microphonic-free construction, offer a material advance in receiver design over the older types of octal tubes. Of course, there are not loktal tubes available for all types, so some of the octal types had to be used. Even there we substituted, for instance, a 1612 for a 6L7. A 1612 is a hand-picked 6L7 and, correspondingly,

the very much better tube to use for this.

Conclusion

Those who have built the entire unit, we know, will be pleased with its results if they have followed the directions and the hook-ups carefully. Those who have built a piece, or a part of the unit, such as, for instance, the squelch circuit, or the oscilloscope modulation-meter, will find that whatever part they have built will be an adequate, highly satisfactory adjunct to the receiver they now already possess. As we said at the outset, the *Super Superheterodyne* contains that which the authors thought to be the best outstanding points contained and featured in commercial receivers, at all times considering that the parts to be used in the *Super Superheterodyne* would be those readily available from any radio parts store. Actual tests of the receiver revealed that it lives up to the authors' fondest expectations.

It may be said that this is not the time to build a large receiver, what with the *National Situation* being as it is. In answer to that, we may say we know of no plan of our Government, or any agency thereof, to limit radio receivers in any respect.

The builder may therefore go ahead in complete confidence. From the standpoint of enjoyment alone, not to mention the valuable experience which may be obtained by the construction of such a large unit, the *Super Superheterodyne* is without peer.

-30-

Manufacturers' Literature

(Continued from page 41)

Available to servicemen and dealers without charge. This firm also has a Folder 104 listing a complete line of communication receivers.—*Howard Radio Co.*, 1735 Belmont Ave., Chicago.

ENGINEERING DATA COVERING RESISTORS AND CONTROLS. New and revised engineering data sheets, some covering brand new items, have just come off the press and are made available to parties engaged in actual engineering, designing and production of radio, electronic and electrical assemblies, by *Clarostat Mfg. Co., Inc.*, 285-7 North Sixth St., Brooklyn, N. Y. These data sheets provide concise information on the many different types of Clarostat resistors, controls and resistance devices, and are gathered together in a loose-leaf binder. New sheets are sent to those who already have the binder, so as to keep the data up to date. It should be noted that this is engineering, not servicing, data, and is, therefore, confined solely to engineers, designers and manufacturers, requesting same on their business letterhead. Other data is available to servicemen, as well as to retailers and jobbers.—Write to *Clarostat Mfg. Co., Inc.*, 285 N. Sixth St., Brooklyn, N. Y.

NEWEST UNITED CATALOG READY. To the amateurs, dealers, servicemen and industrials in the vicinity of New Britain, Conn., it will be good news to know that *United Radio Supply*, have issued a 265 page 1941 Catalog. Chock full of vital information and prices of radio sound equipment this book will be extremely useful to all purchasers. Write today to *United Radio Supply*, 616 Main St., New Britain, Conn., and your copy will be sent to you promptly. The more you will use this book the more

LOOKING FOR VALUES? HERE'S WHAT YOU NEED!

EVERYTHING

ALLIED'S CATALOG
THE ONLY COMPLETE RADIO BOOK FOR 1941!

ALLIED RADIO CORPORATION
INCORPORATED IN ILLINOIS

Free!
180 PAGES SHOWING EVERYTHING NEW IN RADIO

A GREAT BOOK OF RADIO VALUES

Get ALLIED's complete 180-page Catalog—the only full-sized Radio book for 1941—cramped with smashing values from cover to cover! ALLIED offers you everything new in Radio, real savings and fast service. Dealer, Serviceman, Soundman, Builder, or Amateur—whatever your interest in Radio, you'll find the new ALLIED Catalog a necessity! Send for your FREE copy!

NEW RADIO SETS VALUES IN P. A.

More than 60 models—every one a Champion—new "Personal" three-way Portables; latest Recorders; Photo-Combinations; Plastic Sets; World-wide Models; new FM-AM receivers; Auto and Farm Radios; Amateur Sets—all at lowest prices that spell Savings and Profits!

25 New Sound Systems! For every Public Address application—7 to 75 watts. Widest selection in all P.A.; finest features. Easy Payment Plan and 15 Day Trial. Dollar for dollar, you get more when you buy 1941 KNIGHT Sound Equipment. Don't miss the big PA section!

FOR THE BUILDER 15,000 RADIO PARTS

Count on ALLIED for the latest low-cost kits and for help in building any type of radio circuit. Complete listings of the latest builders' and experimenters' supplies. New diagrams. Yes—ALLIED is the headquarters for Radio Builders!

The biggest selection of quality parts in all radio. Every leading make—complete listings for every radio building and servicing requirement. You need this reliable Guide to Everything in Radio at lowest prices! Mail coupon now!

ALLIED RADIO

833 W. Jackson Blvd., Dept. 1-F-1
Chicago, Illinois.

Send me your FREE 180 Page 1941 Spring Catalog.

NAME
ADDRESS
CITY STATE

FREE

★ NOW ★ IS THE TIME

to increase your code speed by the
easy, practical **CANDLER SYSTEM.**

The call of the U. S. NAVY Communication Reserve for 5,400 expert radio operators shows the growing need for trained operators in NATIONAL DEFENSE, as well as in the commercial radio field. For a promising future start training now under the Candler System of SPECIALIZED TRAINING—the system backed by over a quarter of a century of success.

WRITE TODAY FOR THIS FREE BOOK!

A penny post card brings you the most interesting book you have ever read. This 52-page **BOOK OF FACTS** is crammed full of information on—how the Naval Reserve speeds up its operators, how you can become a high speed expert by using the Candler System, and other vital information. Why not send for this free book today? No obligation, of course.



CANDLER SYSTEM COMPANY

Dept. N-6, Asheville, N. C., U. S. A.

FIX ANY RADIO

Amazing New Invention

Simplified
Radio
Servicing
by
Comparison
Method

Repair radios in minutes instead of hours. Revolutionary different Comparison technique permits you to do expert work immediately. Most repairs can be made without test equipment. Simple, point-to-point, cross-reference, circuit suggestions locate the fault instantly. Plain copyrighted. Covers every radio set—new and old. Easy to apply.

Complete
\$1
Training

1941 EDITION

In Manual form, 8½x11 in., 112 pages. Over 1,000 practical service hints, 19 large, trouble-shooting blueprints, 114 different tests using only a 5c resistor, invented by M. N. Beitman, noted engineer.

Results and Satisfaction Guaranteed. The complete simplified training is yours for only \$1.00, postpaid. Will pay for itself with time saved on the first job. Limited quantity. Money-back guarantee.

SUPREME PUBLICATIONS, Room 947
3727 West 13th St., Chicago, Illinois

LEARN Radio

**SERVICING—8 WEEKS
OPERATING—5 MONTHS
I'LL FINANCE
YOUR TRAINING**

Prepare for opportunities in Radio, Broadcast, Aircraft Radio, Police Radio, Commercial Radio Stations, Ships, Radio Shops, Radio Operators' Government License, Radio Service Opportunities, Sound and Television.

EARN BY DOING, not books or lessons. You don't need advanced education or experience to learn Radio by Coyne modern shop training methods, on real Radio Equipment. **FREE EMPLOYMENT SERVICE** for life. **EARN WHILE LEARNING.** Hundreds of Coyne graduates are holding good Radio Operating and Servicing jobs after completing Coyne practical training. **I'll finance your tuition.** Mail coupon today for free book and all details.

H. C. LEWIS, Pres., COYNE RADIO SCHOOL
Dept. A1-3M, 500 S. Paulina St., Chicago, Ill.

Send free book and full details of easy tuition payment plan.

NAME _____
ADDRESS _____
CITY _____ STATE _____

RADIO ENGINEERING

DEGREE IN 2 YEARS

Intensive, specialized course, including strong basis in mathematics and electrical engineering, advanced Radio Theory and Design, Modern Laboratory. Low tuition. Self-help opportunities. Also 2-year courses in Aeronautical, Chemical, Civil, Electrical and Mechanical Engineering. Participation in Civilian Pilot Training Program. Enter June, September, December, March. Catalog.

INDIANA TECHNICAL COLLEGE
761 E. Washington Blvd., Fort Wayne, Ind.

PATENTS, TRADE MARKS COPYRIGHTS

Protect Your Valuable Assets.
Expert Service.

LESTER L. SARGENT
Registered Patent Attorney, 1115 K St.
Washington, D. C.

necessary it will become for your everyday business. Be sure to get your **FREE** copy.

LATEST CROWE CATALOG NO. 242. *The Crowe Name Plate & Mfg. Co., 3701 Ravenswood Ave., Chicago,* have issued a Bulletin No. 242 covering items for Jobbers and Manufacturers in radio components including precision tuning devices, plates of all sorts for transmitters, radio receivers, phonographs, etc., in different metals and finishes. Knobs in bakelite and tenite for instruments, transmitter panels and other special uses, in various styles and colors and others specialties. Copies free for the asking.—*Crowe Name Plates & Mfg. Co., 3701 Ravenswood Ave., Chicago.*

NEW VERTROD CATALOG. The *Vertrod Manufacturing Co.* of 132 Nassau Street, New York City, announces the release of a new catalog for general distribution, describing a specialized list of 5 antennae.

The aeriels described are Broadcast; Broadcast-Short Wave; Broadcast-Short Wave-FM; a special Communications type; and a new type FM-AM combination.—*Vertrod Mfg. Co., 132 Nassau St., N. Y.*

ATR CATALOG RELEASED. The *American Television & Radio Co., 300 East Fourth Street, St. Paul, Minnesota,* announces the release of the ATR 1941 Catalog No. 141 covering the complete ATR line of Vibrator Operated and Rectifier Power Supplies including d.c.-a.c. Inverters, "A" Battery Eliminators, Battery Chargers, etc. This catalog is free upon request by writing direct to the manufacturer.

ILLINOIS CONDENSER CATALOG. The *Illinois Condenser Company, 1160 N. Howe Street, Chicago, Ill.,* announces that their latest catalogue is now off the press and ready for distribution. A complete listing of electrolytic and paper condensers for manufacturing and replacement use is yours upon request. Catalogues mailed promptly. There is no charge.—Address 1160 North Howe St., Chicago, Ill.

-30-

As I See It!
(Continued from page 12)

kind, who could afford to go out into the field and reset the push-buttons of a single simple receiver for 35 cents. Yet it was done, with the knowledge that the average price throughout the nation was \$1.00 per set and that the customer could not do a decent resetting job himself.

Some servicemen will say that low incomes are due to the fact that the public does not want to have its receivers serviced. With this I don't agree and neither do my friends with whom I have discussed such problems in order to get their reactions to various financial and economic problems. I have, during the last year, recommended numerous servicemen to friends of mine and they also have done work upon receivers in my own home. It is a selfish motive that I have when I call a serviceman to repair one of my receivers in my home. Incidentally there are seven (or is it eight) radio receivers in my house. By having someone outside come in and do the work I have an opportunity to see what is called a completed job.

At any rate, I have had work done upon my television receiver, but not once did the men ask if there were any

other receivers which required service; and as it happens, two of the portables aren't fit to live with. And the same applies to my mother's set and in this case, it's even more flagrant, for the small job is in the same room as the big one. And if the big set goes bad, my father is in a bad spot because he cannot understand which of the horses in his daily imaginary four horse parley ran out on him. Seriously speaking, the midget is bad and it will stay that way until a serviceman who calls at that house will have sufficient business acumen to ask if the small receiver which is in plain sight, is working properly. He will be surprised when he is told that it is not working well and he can take it away for service.

And what I have said goes for some of my friends. I don't know a single individual who does not own more than one receiver in his home and who does not have a radio set in his car. I made it my business to ask if ever the serviceman who called on them asked about the other receivers in their respective homes or about the car set. Every one had the same negative answer and the same experience that I had. So I am tempted to discount the statement that the public does not want to have its receivers serviced. I honestly feel that it is the average serviceman who does not think about soliciting business, and that's sad, when you realize that in ever so many instances, extra business is there for the asking.

Taking all these things into account and many more which have not been mentioned, as for example proper service charges, charges which would show a reasonable and fair margin of profit. Low average serviceman-income is attributable more to the serviceman than to John Q. Public.

National Defense Jobs

DIRECTLY after it has appeared in many monthly radio magazines, that there is a dearth of radio technicians in the industry, literally thousands of servicemen, dissatisfied with their stores, get out their typewriters and bombard the manufacturers with applications for positions. When they fail to get a job, they blame the editors of the various magazines, and finally subside into a grumbling state of semi-coma from which they had been aroused by the wishful thinking about big salaries and fine-feathered jobs.

Something is definitely wrong with that picture. In the first place, why did it take a National Defense Situation to create an idea in the minds of those servicemen? Good technical radio jobs have always been available in the industry for those who had "stuff on the ball," and it did not need the impetus given by National Defense to get the proper men hooked up into the proper jobs. If the serviceman had "what it takes" to get a job before National Defense, he could have gotten it. If he did not have the "stuff," the mere advent of a National Defense shortage in radiomen did not by itself act to give it to him. Nor is it to be supposed that because of the National Defense that the manufacturer is more anxious to give a job to some man who is not equipped to hold it, than he was before the shortage was apparent. If a serviceman was training himself to go into the industry, and only marking

time being a serviceman while he completed that training, well and good. He was the man who could logically suppose that he would find a job now that he had completed his training. But if the serviceman was dawdling at his bench for, lo, these many years, and not training himself to step into a responsible job in some plant, he cannot think, except erroneously, that he is going to get a job because of the shortage of men. That shortage, if it exists, is of trained, highly qualified, technical radio engineers, and similar types,—not in has-beens whose sole claim to the job is their desire to be so employed. There is never a shortage of lazy people, and the servicemen are no exception.

Then to those servicemen who are not lazy, who have kept abreast of the times, whose technical knowledge is on a higher plane than that of their competitors, I say that they should stay at their respective benches. As salaries rise, so will the cost of living. As the cost of living rises so will the fees they will collect for radio repairs rise. And when the pinch of priorities makes itself felt in the serviceman's trade, it will be the better trained, who can make a makeshift do a first-class job, who will cash in. Remember that the other man's yard always seems greener than yours. But unless you know his headaches also, you should not consider that he has all the best of it. . . . In fact, you may be much better off than he.

Again we stress the fact that the serviceman is in a position to really make his weight in "gold," if you will pardon the simile, by sticking it out. Look neither to the left, nor to the right, but hoe your own row. Do it carefully, do it completely, and above all, do it smartly. When the smoke of battle clears away, it will be the smart serviceman, who kept his training up to snuff, stuck to his job, who will find that the business has increased for him, that his profit-and-loss statement for the year will be much on the profit side. Not the least help towards getting that profit bigger will be the shaking out of the serviceman who has betaken himself to the industry, to try to get a responsible position and, having burned his bridges behind him by closing his shop, accepted a minor wiring job for the "duration" . . . which is not forever. Five years after the National Defense Situation has abated will find mostly well-established, even prosperous servicemen dominating the field. They are the stickers . . . smart men!

—50—

QRD? de Gy

(Continued from page 35)

on the beach and men with six months' experience scarce. Of the new ships building around these diggings, *Isthmian* has eight which when finished will go into the round-the-World service. *Seas shipping* is building six, *Alcoa S. S. Co.* ten, *Delta Line* three with the *Delbrasil*, *Delargentino* and *Delorleans* already delivered and in service between New Orleans and South American ports. *Bull Line's* three "C-3s" are getting the finishing touches and the *Ore S. S. Co.* has renamed the *Charles G. Black*, the *Venore*, and put her into the Chile-Baltimore run.

With such activity around Baltimore, one can imagine what's doing around other ports

of the U. S. A. We do definitely know that *CTU-Mardiv* are having a tough time filling billets, although they have a majority of licensed professional radiops on their membership rolls. Outside of the draft, radiomen are being snapped up by the *FCC* and *CAA*, the *Maritime Commission* and the War Department with *Bendix* and *Westinghouse* doing their share to deplete the number of seagoing radiops available to keep our communication channels open for traffic. For the past few months this columnist hasn't received a single request for information about job vacancies. So what do harried union officials squawk about now? Radiops and more radiops to fill "reliefs" and new vessel assignments. This problem can only be worked out by the influx of new radiop material and the recent bill introduced in Congress which will nullify the six months' experience law may open the door for the many "hams" who are capable, willing and ready to pound brass on the briny wavelets.

SO chins up and "isms" down in this grand and glorious country where Freedom of thought, of speech, of press and of worship is an accepted fact and not a privilege to be enjoyed by a few exalted fools. . . . And with 73 . . . ge . . . GY.

—50—

Video Reporter

(Continued from page 43)

before—will the new art really have achieved the merchandising impetus tantamount to terming television a "big business."

IT was predicted that some arbitrary standard of television picture definition would be struck between the high and low factions of the *National Television Systems Committee*. Hence, when Dr. W. R. G. Baker, of *General Electric*, who is *NTSC* chairman, presented the *FCC* with revised recommended standards, it was not surprising to find a 525-line picture suggested in place of the previously favored 441 lines.

Dr. Baker added a note of trade optimism when he declared that the defense preparations, going on in the U. S. A. would not stymie television development due to any material shortage. "Engineers," he declared, "would find ways and means to find new substitutes."

THERE have been many shifts among experimental television participants regarding promoting or delaying commercial television. Based on statements by company representatives, here's a box score on the commercial desires at the time this article is being written:

"Commercialization of television should be made effective as soon as practicable," said one telecaster. But, the hitch is in the word *practicable*. However, in the words of Dr. C. B. Jolliffe, chief engineer of *RCA Laboratories*, his firm means "when a number of broadcasters have been authorized and are ready to transmit programs on a regular basis and when a substantial number of receiving set manufacturers are ready to make available adequate receiving sets which can be purchased by the public."

A rival firm is against premature commercialization, citing shortage of man power and materials during the national defense program and small present revenue prospects. Favors adoption of *NTSC* standards, but would like provision therein for color television.

DuMont.—Immediate commercialization. Wants flexible standards of 375-800 lines and 15-60 frames, together with provision on synchronization for the *DuMont* waveform.

Zenith.—"Adequate flexibility to set a path for commercial development." Desires minimum program requirements of ten—or as low as five—hours weekly, holding that too-strict service requirements would permit only the largest participants to qualify for commercial operation.

Farnsworth.—Immediate commercialization with no obstacles due to defense pro-

"Bottleneck" IN YOUR BUSINESS..

BECAUSE OF INCOMPLETE SERVICING DATA?

Is your production choked up—are your operating costs per hour too high—do you find yourself late on promised delivery dates? Trouble shooting is a bottleneck in any service shop that tries to "get by" without complete servicing data.

In successful shops, where work flows through smoothly, where hour costs are low and profits are high, you will find *Rider Manuals*. Speed up your trouble shooting—eliminate bottlenecks in your production—get all twelve *Rider Manuals* . . . Today!

Other RIDER BOOKS YOU NEED NOW!

Servicing by Signal Tracing

Book explains this fundamental method of servicing that is free from every limiting factor heretofore encountered. 360 pages, 188 illus., \$2.00.

Frequency Modulation

Frequency Modulation is here! This book explains transmission of F-M signals as well as discussing the new F-M sets, 136 pages, illustrated, \$1.00.

The Oscillator

Protect your investment in oscillator equipment. Make any future investment in the light of the knowledge this book gives you. 256 pgs., 167 illus., \$1.50.

Meter at Work

If you want to get the most from your present meter or want to buy the proper one for your needs, you should have this informative book. Only \$1.25.

And . . .

Vacuum-Tube Voltmeters, 180 pages—\$1.50.

The Cathode Ray Tube at Work, 336 pages, over 450 illustrations, \$2.50.

Hour-A-Day-with-Rider Books on Resonance and Alignment—on Automatic Volume Control—on D-C Voltage Distribution in Radio Receivers—on Alternating Currents in Radio Receivers. Stiff covers—only 60c each.

JOHN F. RIDER PUBLISHER, Inc.

404 Fourth Avenue, New York City

Export Division: *Rocke-International Elec. Corp.*, 100 Varick St., New York City. Cable: ARLAB

For Complete Information
RIDER MANUALS
Now in 12 Volumes!

Volumes XII to VII—\$10. each
Volumes VI to I—\$7.50 each

RADIO DIAGRAMS

MOST - OFTEN - NEEDED

1926-1938 RADIO DIAGRAMS

In this one low priced manual you have all the circuits you really need. 427 diagrams and service data of the most-often serviced radios is \$1.95 the help you want for easier, faster, and better repairs. 244 pages. Special price

\$1.95

1939 DIAGRAM MANUAL

These popular diagrams, service hints, alignment data, test charts, and parts lists will prove time-savers and money-makers for you. The time saved in two days will more than pay for this manual. Large size, 8 1/2 x 11 inches. 196 pages. Limited quantity at

\$1.50

1940 POPULAR SCHEMATICS

This single manual will give you over 80% of all 1940 circuits ever needed, acquaint you with recent radio developments, and teach you how to service quickly millions of sets sold last year. Models of 43 manufacturers. 212 large pages. Order all three manuals today.

\$1.50

SUPREME PUBLICATIONS 3727 W. 13th St. Chicago, Illinois

RADIO ENGINEERING

DEGREE IN 2 1/2 YEARS

COMPLETE Radio Engineering Course in 2 1/2 years. Bachelor of Science Degree. Radio (television, talking pictures and the vast electronic field) offers unusual opportunities for trained radio engineers. Courses also in Civil, Electrical, Mechanical, Chemical, Aeronautical Engineering; Business Administration and Accounting. Tuition, living costs low. World famous for technical 2 1/2 year courses. Special preparatory department for those who lack required high school work. Students from all parts of the world. Enter Sept., Jan., March, June.



FOUNDED
IN
1884

Write for catalog.

1661 College Ave. Angola, Ind.

TRI-STATE COLLEGE

READ **CODE** LIKE AN EXPERT
SEND **CODE** LIKE AN EXPERT
Learn Quickly at Home—Get Real Speed

It's easy, fascinating, to become a good op. with the NEW ALL ELECTRIC MASTER TELEPLEX CODE TEACHER to help you. Only instrument ever produced which records your sending in visible dots and dashes—then sends back to you at any speed you desire. Also sends practice work, recorded by an expert. That is why so many schools teaching code prefer Master Teleplex, why thousands agree this method is surest and quickest—has taught more ops in the past few years than all other methods.

FREE BOOK

We furnish Complete Course, lend you Master Teleplex, give you personal instruction with a MONEY-BACK GUARANTEE. Low cost. Send today for booklet RN6. No obligation.



TELEPLEX CO., 107 HUDSON ST. JERSEY CITY, N. J.

Correspondence Courses in
RADIO and ELECTRICAL ENGINEERING
Get good grasp of wide electrical field. Prepare yourself at Low Cost, for secure future. Modern course. So simplified anyone can understand quickly.
RADIO ENGINEERING Extra fine course in radio, public address, photo-electric work. Trains you to be super-service man, real vacuum-tube technician. Experimental kits furnished. Diploma on completion.
Either course, only \$25. Deferred payment plan available. Write for free copies of school catalog, student magazines, full details.
LOW AS \$25
SEND NOW!
LINCOLN ENGINEERING SCHOOL, Box 931-R 30, LINCOLN, Neb.

gram. Recommends five program hours daily.

THERE are reports in television circles that the movie industry is getting more worried than ever over television. The FCC's move towards early commercialization have the cinema lads concerned. And the fact that there are considerable television interests backed by movie firms doesn't actually add a note of favor to Hollywood's views of video progress.

The movie industry may be powerful enough to bring adverse lobbying pressure to retard television's commercialization. But even a more powerful weapon is the reluctance of the film producers to release their better and newer productions to television stations. But, of course, it should be expected that the television firms should pay a fair rental for such privileges, especially since wide telecasting would cut down paid theatre admissions at showings of the same film. And, in these days of double features, pictures are revived so frequently in neighborhood movie houses that it's difficult to proclaim a date when they can be labelled "old."

And, if television producers think they can foist old films on their audiences after they've been shown in everything from cinema palaces to tenth-run nickelodeons, they've got another guess coming.

There must be some basis on which the Hollywood lads can work out an agreeable working arrangement with television stations. Just who will have to yield the most is questionable.

However, television needs films—good films. And it will have to invest in them in either of two ways: Pay enough to rent them for telecasting. Or produce them. And Hollywood is certain to be upset by the latter course. Because, if television companies form their own movie producing units, there's every reason to believe that they will seek additional revenue—after television usage—to rent the reels to theatres.

THERE have been so many reversals of recommendations and opinions regarding television's position that video executives in the New York area are in a quandary.

The vice-president of one firm told the *Video Reporter* that he was so bewildered by rapid-fire changes and switches in trends and decisions that he's decided not to count on anything until the FCC comes out with definite standards on commercialization.

During this period of indecision, many worker's jobs are in jeopardy. Just how long engineering and program production staffs will be maintained at present sizes cannot be ascertained until there's some definite inkling regarding the Government's view.

-30-

Receiver Selectivity

(Continued from page 38)

In the second modification shown, which is used in some sets made by RCA, the tuning circuit is isolated from the a.v.c. and detector grid circuits by a high grade blocking condenser. The tube's grid leak has the effect of producing an automatic bias which may result in the drawing of current from the tuned circuit, causing some detuning or broadening, dependent upon the signal strength. In the presence of a strong carrier or noise interference this circuit would not be very effective. If it were made partially regenerative, through some form of controlled oscillation, the selectivity might be materially improved.

As the selectivity of the parallel resonant circuit decreases with frequency, the image response at the high

end of the band will naturally be much greater and the cross talk effect heightened. An r.f. stage or a regenerative 1st detector would help to alleviate this condition. As the image would be twice the frequency of the i.f. away from resonance either a continuously variable wave trap might be used in the antenna circuit, or, as a shunt across the ant. primary circuit, as shown. An r.f. stage might eliminate the need for a wave trap tuned to the i.f. and placed in the antenna circuit, or for any special means as described for dealing with the image problem.

One means of simplifying coil requirements would be to eliminate the primary winding on the 1st detector coil, since the r.f. tube could be coupled electronically. If the screen voltage is made higher than usual and the plate circuit left open for d.c. the electrons within the tube will not stop at the screen grid because of their high velocity and will pass through to the plate where they will be able to affect the 1st detector grid circuit by virtue of the coupling condenser. The gain will not be as high as in an orthodox circuit, but the coil could be made simpler, requiring less space.

There is still another factor to be considered in any discussion of selectivity of tuned circuits where those circuits are connected with a.v.c. arrangements. As the a.v.c. is dependent upon the level of carrier intensity, there will be variations of the controlling voltage and these variations may affect the tuning, since, at high frequencies, or on the low wave end of the band, there is less shunt tuning condenser capacity across the coil. The effect of the controlling voltage variation is to influence the input capacity of the tube. This detuning, while slight, may at certain dial settings be important. Usually it is not, since the circuits of most receivers have a large amount of stray or distributed capacity, but if the circuit does have a high Q the a.v.c. will affect its tuning at resonance. In the case of an i.f. amplifier of high selectivity the same detuning effect will be present, sometimes causing distortion or overloading because of the difference between alignment with a.v.c. not operative and the same amplifier operating under actual conditions of home reception.

It has been found* that this difficulty may be met by using the 6L7 in a special circuit, feeding the control voltage to the number 3 and number 1 grids. For a cathode resistor of 2,000 ohms the ratio 2/5, as a voltage relation of the two grids, has been found satisfactory. With signals greater than .5 r.m.s. volts and if the control grid voltage is higher than —13 volts, the 6L7 may overload, which means the system must be used within a certain range of a.v.c. potentials.

The circuit is shown in the sketch.

* Compensating Tube Input Capacitance Variation, QST, p. 42, Feb., 1940. Also, R.M.A. Engineer, Nov., 1939, art. by Farrington.

Further reference: Regeneration in the Preselector, G. H. Browning, QST, p. 28, Jan., 1940.

-30-

Legal Advice
(Continued from page 40)

self by bidding on the article yourself, fixing the lowest figure at which you value your work. Sometimes you will then find yourself the owner of the set. If that comes to pass, you may later re-sell it at any price you care to, and keep the profit, if any.

If, however, the set is bid in above your figure, the amount you will receive will be equal to the sum owed you, plus your expenses in filing the lien, plus the expenses in selling the set. So it will behoove you to know what those expenses will be so as to start the bidding with that figure in mind. For should someone top your bid by a few cents and get the set, the seller (usually the marshal or sheriff) will take his fees out first, and then give you the rest, which may be less than what was owed you in the first place.

How long must you wait before you can assert your lien? Well, that depends again on the location. In some states it is 30 days, some have it at 6 months (like Maine, which just passed the law) and others have it at a year, even 18 months. But howsoever long you have to wait, you are under no obligation to return the set within that period if the customer tender you less than your bill and demand the set.

You may "assert" your lien at once; you may be able to sell the set only after a year. Your right to the lien attaches the moment that you do work on the set.

Suppose that the customer believes that you are over-charging and demands his set at the payment of what he thinks a fair price for the repairs. Then what?

Well, you can give it to him, remembering always that a bad payment is better than a good law suit!

Of you can refuse. Then the owner may get out a bond indemnifying you for your lien and have the set turned over to him. This bond we speak of, is a contract by a recognized surety company that they will pay your entire costs plus the price of the repairs, should a court decide that you are right, and the customer is wrong. It will not, however, include your attorney's fees, nor what you may have to pay expert witnesses.

On receipt of such a bond, usually in the sum of twice to four times what your price was, you must turn over the set to whomsoever the court in the accompanying papers says you must. Sometimes that is the sheriff, sometimes it might be the "finance company" (if the set was bought on time) and sometimes it is the owner. Together with the bond and the papers you will find a "summons" to go to court and explain to the judge, and perhaps a jury, why you are charging the price that you are. You must appear there, or your attorney must, and go through with the case. After the trial the judge or jury will "award" you what they think is a fair price (it may be what you asked and it may be less), and if the owner does not pay that sum within a certain time, then the surety company will pay you in cash.

How do you know "what your services are worth"? That is a question for the jury (if the case has one) or the judge. He or they will hear expert testimony from yours and the owner's experts and will decide what the reasonable value of the services are worth and award that sum.

So much for the first case. What, however, if you have given the set to the owner and he does not pay. Well, by parting with the physical ownership of the receiver on which you did your work, you destroyed your lien, and you have a simple collection case to be handled in the usual manner. So if you are scared of the chances of collection (1) get a substantial deposit in advance, or (2) refuse to let the set out of your shop without payment.

This brings up the matter of "in-between-cases." What where the customer tells you to go ahead and get that expensive transformer, and then comes in a day later and tells you "never mind"?

The law in different states is not too clear on that point. But here are some generalities which may help. If the transformer is

one which you would normally have in stock, but you are out of it at the time, you must give the set back to the customer, and he gets it without payment—providing that you have done no work on it, and even though you have already ordered the transformer. If, however, the transformer (and we are using the transformer as an example, only) is one that you would not ordinarily have in stock, and in fact might even be a "special," then the customer cannot "call you off," and must pay for the transformer even if you do not install it.

Suppose that the customer comes in and the following conversation, so common takes place:

"Mr. Jones, this radio doesn't play at all well. Please see what you can do to fix it."

You say, "Ok, Mrs. Doenagel. I'll see what's the matter and let you know."

Mrs. D., "How much will it be?"

You, "I don't know. I'll let you know as soon as I see what it needs."

Mrs. D goes out of the store, and you start checking the set. Then something interrupts your work (and who has not had this happen?), and you put it aside without knowing what is wrong, but still having spent maybe as much as an hour work on it. Suddenly the phone rings. You answer it. 'Tis Mrs. D.

"Never mind about the radio," she purrs. "I'll pick it up in the morning. I don't want it repaired. My husband just called me and said that the boys in his shop will fix it for nothing."

What can you do? Nothing, brother, just nothing! In the vernacular, she has you there, and your hour's work is for nix. That is unless you want to go into court and try and prove (1) that you worked an hour, (2) that you used the best possible method to locate the trouble, (3) that your price for the hour's work is reasonable and (4) that she knew that you were going to work on the set at once and took advantage of you. Naturally sometimes you can prove these things, but even if you do, and collect at the highest rate of National Defense pay, you stand to collect only about \$5.

That just isn't worth it. So swallow your chagrin, and let the old duck have her precious receiver.

How about this case? You look over a set and see that it has a burnt out condenser. You say in your best salesman manner, "I'll fix this perfectly for just \$3.50" (figuring mentally that the blamed condenser costs you about 89c and about two hours work removing the old one and installing the new one). When you get back to the shop you find that not only is the condenser shot, but the tubes are burnt out and the transformer is leaking so much wax that it just has no insulation left. What you thought was worth \$3.50 to fix and leave you a handsome profit, now tips the beam at \$17.68 your cost and that's without your labor or any profit. What can you do?

Nothing! Since you have made a contract (I will fix this perfectly for \$3.50), you are bound by it. You must pocket the loss, and the owner can take the set away from you, giving you \$3.50 and have another repair it and charge you the balance.

So be careful on what you say. The best way to do the job is as follows:

Have a little sales tag printed with the following sentence on it in BIG type:

"ALL ESTIMATES ON REPAIRS ARE SUBJECT TO EXACT CHECKING AT OUR SHOP AND PRICES QUOTED ARE TENTATIVE ONLY AND SUBJECT TO INCREASE OR DECREASE ACCORDING TO WHAT THE CHECKUP IN OUR SHOP REVEALS."

And don't forget to call the owner's attention to it either. Don't be afraid of such a statement. Auto repair shops have been doing it for years, and they are still in business.

One last hint. The successful serviceman is he who steers clear of law suits. The only one who makes any money, usually, on a law suit is the lawyer. So try and keep your customers happy. Give in to them when it seems advisable. The fellow who spends all his time in the courts, and is not a lawyer, is not out making money servicing radios.

And last but not least, don't be your own lawyer. Remember the old adage, "He who is his own lawyer, has a fool for a client, and an ass for an attorney."

How To Get The BETTER Job in Radio!

● Technical Training Backed by Your Own Radio Experience Should Prepare You for a BETTER Job in Radio!

Did you ever realize how much money the lack of modern advanced training is costing you? It's worth taking time right now to find out how CREI offers you a planned program for advancing yourself in radio. CREI courses in Practical Radio and Television Engineering equip you with the ability to go after and get the better engineering jobs.

THINK THIS OVER:

Actual Records Show—
● CREI graduates, as a group, are among the highest paid in radio! ● CREI men are in more than 350 broadcasting stations! ● More than 5,000 radiomen have taken this course of training! ● Employers are increasingly calling upon CREI for personnel replacements and additions.

WRITE TODAY! If you are a professional radioman and want to make more money, send for free booklet and factual information. To help us intelligently answer your inquiry—please state briefly your education, radio experience and present position.



CAPITOL RADIO ENGINEERING INSTITUTE

Dept. RN-6, 3224 16th St., N. W., Wash., D. C.

PUBLIC ADDRESS HEADQUARTERS



RADOLEK De Luxe Public Address Systems offer the most for your money in Styling—Hi-Fidelity Performance—Reserve Power—fast, convenient, easy installation. Offered in 15, 30, 50 and 100 watt sizes—for permanent, portable or mobile use. They feature from 2 to 6 input channels, built-in input and mixing controls, AVC, and the newly developed "feedback" tone control circuit. Wide choice of microphones and speakers. Mail coupon for complete information.

RADOLEK'S

NEW 1941 RADIO PROFIT GUIDE

FREE!

Indispensable to every serviceman, dealer and sound engineer. Send for big FREE Radolek Profit Guide now!



SEND TODAY! PASTE ON A PERMANENT POST CARD

RADOLEK CO., Dept. B-55
601 W. Randolph St., Chicago, Ill.

Please send information on Radolek Public Address equipment—also new 1941 Radio Profit Guide.

Name _____
Address _____
 DEALER SERVICEMAN EXPERIMENTER

Simplest WAY TO REPLACE BALLASTS

4 STANDARD TYPES of Amperite Regulators replace over 200 types of AC-DC Ballast Tubes now in use. . . Has patented automatic starting resistor. List \$1.00

WRITE FOR REPLACEMENT CHART "S" Amperite Co. 561 Broadway, N. Y. C.

AMPERITE

EASY TO LEARN CODE

It is easy to learn or increase speed with an Instructograph Code Teacher. Affords the quickest and most practical method yet developed. Available tapes from beginner's alphabet to special messages on all subjects. Speed range 5 to 40 WPM. Always ready on GRM.

MACHINES FOR RENT OR SALE

The Instructograph Code Teacher literally takes the place of an operator-instructor and enables anyone to learn and master code without further assistance. Thousands have used and endorse the Instructograph System. Write today for full particulars and convenient payment and rental plans.



INSTRUCTOGRAPH COMPANY
Dept. NR, 4701 Sheridan Rd., Chicago, Ill.
Representatives for Canada:
Radio College of Canada, 54 Bloor St. West., Toronto.

CHEST MICROPHONE

Breastplate "Dispatcher" type. Leaves hands free. Handsome dielectric black finish. Adj. fabric neck-band. Choice of single or double headset, high or low impedance. Available total of 12 dif. types and imp. incl. 7 1/2 ft. flex. cord. Wt. 8 oz. Most attractive, lightweight rugged, practical chest mike yet devised. At your dealer or jobber.

UNIVERSAL MICROPHONE CO., LTD.
INGLEWOOD, CAL., U. S. A.



RADIO COURSES
Start September

- RADIO OPERATING—BROADCASTING
- RADIO SERVICING—a practical course
- RADIO AMATEUR CODE • TELEVISION
- ELECTRONICS—1 yr. day course, 2 yrs. eve. Day and Evening Classes. Booklet Upon Request.

New York Y. M. C. A. Schools
7 W. 63rd St. New York City

RADIO-TELEVISION

Oldest, largest Radio-Television school in West trains you for good pay job. Complete instruction including Radio Construction and Service, Broadcast Operating, Sound, Talking Pictures, Television, Public Address, etc. Flexible plan to meet specific needs of those with or without jobs. Transportation allowed to L. A. Earn room and board while learning. Request Free Catalog.

NATIONAL SCHOOLS Dept. 6-RN
Los Angeles

RADIO TECHNOLOGY

RCA Institutes offer an intensive course of high standard embracing all phases of Radio and Television. Practical training with modern equipment at New York and Chicago schools. Also specialized courses in Aviation Communications, Radio Servicing and Commercial Operating. For Free Catalog Write Dept. RN-41.

RCA INSTITUTES, Inc.
A Radio Corporation of America Service
75 Variek St., New York 1154 Merchandise Mart, Chicago

RADIO ENGINEERING

broadcasting, aviation and police radio, servicing, marine radio telegraphy and telephony, Morse telegraphy and railway accounting taught thoroughly. 48 weeks' Engineering course equivalent to 3 years of college radio work. All expenses low. Catalog free. School established 1874. Dodge's Institute, Oak St., Valparaiso, Ind.

Full Washington Coverage & Latest News. Read RADIO NEWS. 25c at all newsstands.

Aviation Radio
(Continued from page 15)

craft approaches the oncourse zone proper. The pilot, in order to fly the range efficiently must not only use the range itself for position but he must also use his magnetic compass.

Many systems for flying the radio ranges have been promulgated and among the many used, this writer is in favor of the "True fadeout" system, and the "Parallel fadeout" system.

These systems must be used frequently in order to obtain accuracy, but without practice, nothing is perfect!

In order to identify the range station, identifying signals are transmitted in conjunction with the usual "A," "N," and "T" signals. These identifying signals are quite independent of the zone in which the aircraft is flying. They usually consist of two letter combinations, i.e., Chicago—"CG"; Portland—"PW," etc., and are transmitted at 24-second intervals.

When the aircraft flying the range passes over the station, the "over station" indication is usually given by a minimum signal in the earphones or minimum reading on a meter indicator. This minimum signal area (over the station) is called the "cone of silence."

At stations equipped with marker beacon transmitting installations, over station indication of the aircraft is usually indicated by a flashing light; if the aircraft has the proper marker receiver installed tuned to the correct frequency. (Usually 75 megacycles.)

Nearly all the low-frequency ranges now in use employ five vertical antennae. Four are used for the four-course range; the fifth being used for voice transmission.

At the present time, the *Civil Aeronautics Administration* is conducting research work on a four-course UHF radio range. Due to the freedom from static, usually atmospheric, at the UHF frequencies, first experiments show that the UHF range is feasible, practical from the navigational standpoints, and much lower in cost than the low-frequency installation.

The antennae systems of the UHF installation including transmission lines, etc., cost less than \$250.00, as compared to \$9,400.00, the cost of four 125-foot towers, etc., for the low-frequency installation. However, more money has been appropriated for the low-frequency installations for new installations, upkeep, etc., while the tests are being conducted.

So far, it has been found that 63 megacycles used as the UHF range frequency was not as susceptible to multiple courses, as was 125 megacycles, and that vertical polarization was more susceptible to the multiple course phenomenon.

In the *Civil Aeronautics Report Number 9*: "Preliminary Investigation of the Effects of Wave Polarization and Site Determination with the Portable Ultra-high Frequency Visual Radio Range," prepared by J. M. Lee and C. H. Jackson of the Radio Development Section, a description of the equipment used for the preliminary tests for site determination and for studying the effects of horizontal and vertical polarization on ultra-high frequency radio range transmission is given. This report tells of the conducted tests with the portable range obtained from the Washington Institute of Technology.

The courses as transmitted by the portable transmitter (125 megacycles) were excellent as long as the equipment was in an open field, and the radiated patterns were free from scalloping or any other irregularities. However, with the transmitter located near woods, less favorable results were obtained.

It was concluded, that from the point of view of multiple courses, horizontal polarization is far superior to vertical polarization for ultra-high frequency radio range applications, and that it is quite necessary that a site be chosen for the uhf range that is not surrounded with trees, etc., which would affect the radiated patterns.

It is believed, that after further tests are made, the ultra-high frequency radio range

will come to the "fore" as did the low-frequency radio range. As advances are made, this column will endeavor to obtain as much information as is available.

Adjustment of Antenna Change Relays

IN some aircraft radio installations a relay is employed to switch one antenna between receiver and transmitter. This relay is called the antenna change relay.

Due to vibration and usage, these relays have a tendency to go out of adjustment. That is, they will either stick or "hold" on one position. It has been found that various relays as manufactured by different manufacturers, are hard to adjust and present their own peculiar problems. Correct spring tension is hard to obtain because in some cases, no provision was made at the time of design for adjusting the armature, or due to the heat developed by the coil, the retaining tab loses its temper.

In adjusting the relay, caution should be exercised, because in some instances the final adjustment is just as critical as that encountered with the usual power vibrator, and much trouble will be experienced by the technician if the proper tools are not used.

Arcing contacts (chattering armature) may be relieved by dressing the points down with a fine grade of crocus cloth or a fine ignition file. After the dressing process has been accomplished, the length of the button contacts should be measured. In every case, they should be of equal length. This is **IMPORTANT**.

Improper contact is sometimes caused by warped insulating material. This should be replaced.

If an irregular or sporadic reading is obtained on the r.f. ammeter in the antenna circuit of the transmitter, with no modulation, look for r.f. arc-over. Sometimes the contact points of the receiver are too close to the main in-lead (antenna) connection; this results in arc-over. Proper adjustment will alleviate this condition.

Ultra High Frequency Airport Traffic Control

IT has been reported, that those airports seeking to renew their licenses after the first part of this year, must obtain the new ultra-high frequency airport transmitter and receiver combination. This will mean a cash out-lay of no little sum. The *Federal Communications Commission* promulgated this order.

Kink of the Month

HEADPHONES can be made "lighter" by attaching small square cut pieces of sponge rubber along the headband with ordinary adhesive tape.

—50—

Coast Guard Life Boats
(Continued from page 42)

And now for some idea of the new radio set-up now being installed in the boats:

To begin with all the Coast Guard stations of the nation are equipped with standard 76 ft. steel radio broadcasting towers and transmitters operating on 2670 kilocycles, equipped for telephone transmission and powered by 32-volt batteries. The standard Coast Guard receiver covers a range from 1600 kc. to 3000 kc. and this equipment is now used on both land stations and lifeboats.

The station transmitters are rated at 50 watts output while the lifeboat transmitters are weaker, being rated at only 15 watts output. A standard Coast Guard loudspeaker is located on both shore station and lifeboats.

The two main difficulties encountered

with the lifeboat radio set-up was evolving a set that was absolutely watertight, and would overcome interference of static caused by the ignition system of the engine. In previous sets, the motor had to be stopped when radio communication was established. The drawbacks to such a situation are obvious. Frequently the boats missed important messages for the motors could not be stopped due to heavy seas. The new sets have overcome this hazard by suppressing ignition interference.

Possibly the average person doesn't realize it, but over fifty percent of the distress and emergency calls heard on the air are sent directly to the Coast Guard. As an example of this, during the Ohio flood this Federal division maintained a joint emergency radio net of 240 stations in connection with the Naval Reserve, U. S. Army and the amateurs. In addition, 300 boats, ranging from 165-foot patrol vessels down to station lifeboats, over 1,800 men, 10 planes and 11 communication trucks were on duty.

Clearly pointing out the value of the new lifeboat radio communication system is an adventure shared by the crews of four Coast Guard stations in the Chesapeake Bay area recently. Here's what happened:

A seagoing tug was on its way from New York to Norfolk towing three decommissioned trawlers. While crossing Chesapeake Bay at night, the hawsers parted, and the three trawlers were adrift. The master of the tug immediately communicated with Coast Guard headquarters and the lifeboats at Smith Island, Cobb Island, Hog Island and Parramore Beach stations were ordered to the rescue.

Not only would the trawlers eventually be smashed on shore, but in the meantime they were a deadly menace to navigation in the crowded bay. The captain of the tug was unable to locate them.

The crew of the Cobb Island station located two of the trawlers within a few hours and immediately radioed their location. Shortly after that, the Smith Island station lifeboat crew found the remaining trawler. While the lifeboats stood by, tugs were dispatched to take the drifting vessels in tow. In the meantime, all the other lifeboats were radioed to return to their stations.

The reader can easily visualize what might have happened if these boats had not been radio equipped. They could easily have cruised around for days, all of them out of touch with one another, not to mention not having communication with the four land stations. The crew of one lifeboat could not have had any way of learning if and when other crews had found the vessels, and thus much valuable time would have been wasted.

Poignantly illustrating what Uncle Sam thinks of his new lifeboat equipment is the order recently issued by Admiral Wacsche, Commandant of the Coast Guard:

"It occasionally happens that a distress case occurs near enough to shore for the Coast Guard stations to utilize their lifeboats. They may be able to reach the scene much sooner than the larger vessels if promptly informed of the case. The possibility of utilizing their services should always be considered and district com-

manders kept fully informed (by radio) of distresses within their scope of operations."

-50-

Customer Relations

(Continued from page 36)

sure that you can "get away with it."

Let's look at the matter in "reverse English." What would you think of a man who overcharged you because he could take advantage of your lack of knowledge of values in his line? Aside from the unflattering terms with which you might describe him, he certainly would be a poor sort of man to betray your confidence, now wouldn't he? If you feel that way about a man who would "gyp" you, you should feel the same way toward the customers you serve.

Discard "shady" practices. This does not mean that you should allow yourself to fall prey to the wiles of those who would take unfair advantage of you, but learn to "size up" your customers and proceed accordingly. Remember that a man held for trial in the United States is deemed innocent until proven guilty. Treat your customers in the same manner. It's just good business and is another plank in the platform of correct customer relations.

Interest

DID you ever walk into a store with the idea of buying something and be met with such a stone wall of indifference that you finally decided to forget the whole thing? Have you ever dealt with people whom you felt sure didn't care whether you "lived or died" so long as they sold you something? What do you think of such people?

How do you react when a clerk seems interested in what you want, takes the time to explain the difference between two qualities, and acts as if your entrance were a visit, not an intrusion? If you are like other men (and there should be no reason either biological, or otherwise, to doubt this), you "expand" to this treatment and probably buy more than you had first expected to buy.

To be successful in any business you must first like people. You must take a vital, dynamic, living interest in your customers. You must study their likes and dislikes, and cater to them.

For instance, Mr. X is single, an enthusiastic golfer, but has no interest in baseball. Mr. Y likes baseball, has one child, and speaks rather disparagingly of golf. Mrs. Z has six children and a penchant for bridge.

Mr. X would consider you a terrible bore if you went into detail about what your baby did last night, or how poorly the local ball club was doing, but he would carry on quite a conversation with you regarding the last 18 holes he played.

Mr. Y, being an "only child" parent, will willingly swap baby experiences with you—particularly if you give him the impression that his child has a slight edge on yours. He will also discuss the ball club situation with you. Golf is taboo.

Mrs. Z is just the person to ask regarding sure-cures for thumb-sucking or diaper rash—even though you don't intend to use them—and she might be interested in telling you how she won

Read How These Men Got Good Pay Jobs in RADIO

HAS OWN RADIO BUSINESS EXTRA SPARE TIME PROFITS

I HAVE BEEN IN BUSINESS FOR MYSELF FOR TWO YEARS, MAKING BETWEEN \$200 AND \$300 A MONTH. BUSINESS HAS STEADILY INCREASED.

ARLIE J. FROEHRER
380 W. TEXAS AVE.
GOOSE CREEK, TEX.

I DO RADIO SERVICE WORK IN MY SPARE TIME ONLY, OPERATING FROM MY HOME, AND I NET ABOUT \$40.00 A MONTH.

Wm. J. CHERMAK
HOPKINS, MINN.

GOOD RADIO STORE JOB

AVIATION RADIO OPERATOR

I WAS WORKING IN A GARAGE WHEN I ENROLLED WITH N. R. I. I AM NOW RADIO SERVICE MANAGER FOR M. FURNITURE CO. FOR THEIR 4 STORES.

JAMES E. RYAN
119 DEEBLE CT.
FALL RIVER, MASS.

N. R. I. TRAINING HELPED ME GET AND HOLD MY JOB. I AM NOW IN CHARGE OF THE RADIO DEPARTMENT FOR THE AMERICAN AIRLINES AT CLEVELAND.

WALTER B. MURRAY
AMERICAN AIRLINES, NATIONAL AIRPORT, CLEVELAND, OHIO.

BROADCAST STATION OPERATOR

LOUD SPEAKER SYSTEM

AFTER COMPLETING THE COURSE I OBTAINED MY RADIO BROADCAST OPERATORS LICENCE AND JOINED STATION WMPG WHERE I AM NOW CHIEF OPERATOR.

MOLLIS F. HAYES
337 MADISON ST.
LAFAYETTE, MISS.

MY LOUDSPEAKER SYSTEM PAYS ME ABOUT \$35 A WEEK. IF IT HAD NOT BEEN FOR YOUR COURSE I WOULD STILL BE MAKING COMMON WAGES.

MILTON L. LEIBER, JR.
TORONTO, PA.

Be a RADIO Technician

Learn at Home—Make Good Money

Do you want to make more money — be successful like the men above? Then find out how you can train at home nights to be a Radio Technician.

MANY RADIO TECHNICIANS MAKE \$30, \$40, \$50 A WEEK

Radio Broadcasting Stations employ operators, technicians, Radio manufacturers employ testers, inspectors, servicemen in good-pay jobs. Radio jobbers and dealers employ installation and service men. Many Radio technicians open their own full-time Radio businesses and make \$30, \$40, \$50 a week. Some hold jobs in other lines and make \$5 to \$10 a week fixing Radios in spare time. Others make extra money fixing radios while learning. Automobile, Police, Aviation, Commercial Radio, Public Address Systems, Electronic Devices are other fields offering opportunities for Radio Technicians.

GET SAMPLE LESSON AND 64-PAGE BOOK FREE—MAIL COUPON

Act today. Mail the coupon now for Sample Lesson and 64-Page Book Free. They point out Radio's spare time and full time opportunities and those coming in Television; tell about my Course in Radio and Television; show more than 100 letters from men I have trained, telling what they are doing and earning. Find out What Radio offers YOU! MAIL COUPON in an envelope or paste on a penny postcard—NOW!

J. E. Smith, President
Dept. IFR, National Radio Institute
Washington, D. C.

Mail this Now FREE
Get 64-page Book

J. E. Smith, President
Dept. IFR
National Radio Institute
Washington, D. C.

Mail me sample lesson and 64-page book "Rich Rewards in Radio" FREE. No salesman will call. (Write Plainly.)

AGE.....

NAME.....

ADDRESS.....

CITY.....STATE.....

14X1



CAMERA FANS BEWARE!

TAKING PICTURES OF U. S. NAVY DEFENSE ESTABLISHMENTS AND EQUIPMENT NOW PROHIBITED!

It is important that all photographers learn about the regulations set forth in Bill HR2768 . . . rules that will be enforced to keep vital defense secrets from falling into the hands of foreign agents! Remember, camera fans, a year in the Federal "darkroom" is a long time, so don't fail to read all about the new laws governing camera activity in the neighborhood of U. S. Navy defense establishments and equipment in an exclusive and authoritative account by Rep. Carl Vinson, Chairman, House Naval Affairs Committee, in the

JUNE ISSUE

Popular Photography

NOW ON SALE AT ALL NEWSSTANDS!



the last weekly bridge prize (or what poor cards she has been receiving).

Thus, a knowledge of your customers and their interests will make them *your* interests. Always try to get a *common meeting ground* between you and each of your customers—it will pay dividends.

Courtesy

NO matter what your "make up" may be, you can learn to be courteous without too great an effort. Courtesy in a man is merely "being a gentleman." It is not necessary to be a Lord Chesterfield and use exaggerated gestures or talk. You need not be an authority on Emily Post and you don't have to wear "fancy" clothes.

Courtesy is aptly defined as *genuine and habitual politeness*. Courtesy is the logical step after interest because, if you are interested in people you cannot help but be polite to them and this is an act of courtesy.

It would be well to take a leaf from the South and cultivate the use of the terms "sir" and "ma'am." No man who is a man would hesitate to use the term "sir" in addressing another man. It is a conventional term of respectful address and does not imply any lack of inequality between service man and customer. Likewise, when addressing a woman, the term "ma'am," although a colloquialism, effects a nice shade of respect which any woman appreciates.

Another point which should be brought out under *courtesy* is *never to argue* with the customer. Also, *never* allow a customer to "*make you mad*." Remember that he is entitled to his opinion and even though you may

think he is sixteen kinds of a fool, you are bound, as a tradesman, to respect his attitude. I know of one service man who always makes a practice of *lowering* his voice as the voice of an irate customer *mounts*. He always wins his point because the difference in voice levels invariably reminds his customer that the customer's voice is pitched at entirely too high a level.

Energy

THE final word in our S-E-R-V-I-C-E set-up is "Energy." *Energy is the power by which anything acts effectively to move or change other things or accomplish any result.* (Funk and Wagnall's Dictionary.) Thus, the *energy* in service work is the effective effort and action which produces the resulting service.

Remember, the word "business" can be most readily defined as *busy-ness!* Busy-ness requires energy—unflagging and ever powerful.

You can't render service or hope to maintain satisfactory customer relations if you open shop at noon and take a day off every so often to go fishing. You must maintain normal office or shop hours and expect to be called out once in a while in the late evening or on a normal holiday. I am one who advocates a definite ten-hour day—8 a.m. to 6 p.m., 6 days a week, with other work done by appointment only. These sissies who advocate a 40-hour week should try running a service business (or any other shop) successfully on such short hours. It would be too, to divine if we could work 8 hours a day, 5 days a week, and make a comfortable living, but the plain

MR. SERVICEMAN:

Your Dollar Buys a Lot When You Use It to Join the RSA!



It entitles you to membership in the only national organization of servicemen that has the sponsorship of the RMA, the NAB, the Sales Managers Clubs, and the trade journals.

It entitles you to receive the house organ, the RSA membership certificate, and the RSA pocket membership card.

It gives access to the RSA Technical Helps Bureau, and enables you to participate in all functions and

benefits the RSA offers.

It enables you to exchange ideas with thousands of good servicemen who are already members of the RSA.

Protected territories will be established as rapidly as local chapters are formed. Applicants in present chapter areas will be referred to the local chapter. Fill out the coupon, attach a \$1.00 bill and mail it in today.

Don't Be the Last Man in Your Neighborhood to Join the RSA.

RADIO SERVICEMEN OF AMERICA, INC.

"Reliable Service Assured"

**JOE MARTY, JR., EXECUTIVE SECRETARY
304 S. DEARBORN ST., CHICAGO, ILLINOIS**

RADIO SERVICEMEN OF AMERICA, INC.
304 S. Dearborn Street, Chicago, Illinois

\$1.00 enclosed for 1941 National Dues in RSA.

Name.....

Address.....

City.....State.....

Radio News—June

facts of the case are that it *can't be done*.

Death and the time of radio breakdowns take no holidays!

Conclusion

If you find that you are not following these seven cardinal points of service and good customer-relations, resolve to incorporate them into your business life today!

Satisfy your customers so that they will return to you. Make your shop and yourself efficient so that you can turn out the work in a reasonable time and at a reasonable price. Found your business on the rock of reliability so that people whom you serve will have complete confidence in you. Give value for value received—don't cheat your customer if you expect not to be cheated. Develop an interest in your customers—make their interests yours so that they, in turn, will make your interest theirs. Be courteous by being genuinely and habitually polite. Lastly, put forth every bit of energy to make your business a success. *The lazy man cheats himself.*

-30-

Stabilized Phono-Oscillator

(Continued from page 18)

Tune the oscillator condenser so that the signal picks up on the receiver. Then tune the amplifier condenser until the tuning eye on the receiver shows maximum indication of the signal. The oscillator condenser may then be touched up for more accurate alignment.

Connect the phonograph pick-up leads to the connector on the back of the chassis and advance the gain control to the point where the music appears most pleasing. After satisfactory reception is had, the phono unit should be placed at some point approximately 50 feet away from the receiver and the antenna cut off, a bit at a time, until the signal disappears. In no case should the user attempt to cover any distance greater than that which may be heard between two adjacent rooms. *If the signal is allowed to be heard in neighboring homes, it is in direct violation of the law.* For that reason, the antenna must be cut as short as possible to limit the radiated signal.

Three holes are cut into the front of the carrying case so that the unit may be tuned without removing the chassis from the case. The center hole is used to accommodate the shaft on the gain control and switch, while the two outside holes provide access to the two tuning condensers. After all adjustments are made, these should be plugged up with small nickel plated plugs available for the purpose.

The quality of the reproduction will depend a great deal upon the pick-up used in the reproducing equipment. If this is not capable of wide frequency range, the reception as it is heard from the speaker will suffer. The Webster record changer used in the author's model utilizes one of the new feather-weight pickups which is equipment with a permanent sapphire stylus and is capable of reproducing with good quality. The carrying case was purchased from Allied Radio Corporation and is designed to accommodate the Webster record changer.

-30-

DEGENERATION

OLD MAN SPRING FEVER got us last month, and we regretfully report the following errors:

- p. 10—L5 thru L13 is a Browning 5P unit.
- L14—30 t. No. 28 DCC 1" dia. tapped 10, 20 & 30 t.
- C17, 18, 19 & 20 should read in MMFD not mfd.
- C21 is a 1500 mfd (honest!) 15 v. Mallory electro.
- C19 next to CH2 is a 0.5 mfd 200 v. Mallory paper.
- C19 next to L3 is included in the Browning unit.
- CH2 is a Meissner vibrator choke.
- p. 20—T1, 2 & 3 are 4.3 mc. i.f. transformers.
- p. 26—C135 is 0.1 mfd 400 v. Mallory paper.
- p. 27—Oscilloscope: C101 is MMFD not mfd.
- R32 is 1 to 2 megohms, Aerovox.
- C127 is 0.05 mfd 400 v. Mallory paper.

Ham Chatter

(Continued from page 35)

There are others wondering if they will have to do the same thing. If it comes to that we'll try radioing in the Uncle's Army Hi.

We were glad to notice that the largest newspapers in the nation carried several nice write-ups for Amateur Radio during the past month. W4GZW, Snooks Lewis, says that he is getting back on the air for good.

W4GAA, Tommy, in Tallahassee, Fla., is using three different RIGS. He has one that belongs to the Fla. National Guards, one of his own and one that belongs to a friend. The miracle is that they all seem to get out fb. W4FDDJ, at Lyons, Ga., is hard to find on 160 meters these days.

W4GOA in Jacksonville, Fla. Mr. Clayton Williams has downed forty meter CW and 160 meter fone for TEN meters. W4FFI his brother, hopes to join him soon. W4FJM and the gang in Panama City, Fla., are really going to town with their radio activities. W4GRP is also trying to get up a ski wire. W4FCW in Ft. Jackson, S. C., is on the air nightly but we can't seem to contact him. We believe that Guy White W4CCV in Macon, Ga. needs a new Receiver. We've called him constantly, but in vain. The W1's are as rare on 160 fone in Ga. But we did hear ONE the other night. 1's are as rare as do-ra-me in Cordele. W4FAH in Eastman, Ga. is working 160 meters FB with low power and that telephone mike does do a good job on the speech. All of you fellows around where there is to be a HAMFEST drop us a line so we can inform the fellows just where to go. There will be no hamfest in CORDELE this year. There are only two of the original Hamfests now in Cordele, they being W4FPI and W4GFF. We are sorry but maybe we will have one next year. Who knows? The frequency move that the commercials made, must have affected some of the amateurs, because there is a few we haven't heard since. Hi. It was reported that W4PDE and your reporter are heard R9 in Miami, Fla. We're sure glad to hear that.

DOW B. SUMMERS, W9KOH, reports:

The ham bands are very full of traffic to the different training camps and it is a good idea to check your frequency to be sure no one is trying to put through a message. I hope we all prove our worth during the Red Cross test. W9KSA is doing fine with only 8 watts while her big rig is being rebuilt.

W9OXS also is a new ham on 160 using only 5 watts input. Nice going there, Jerry. He's a Movie Op.

W9LMZ has one of the strongest signals out here coming from the Windy City. Maby it's the windy Op. Hi Ed.

W9SAS has up a new ant. and is laying a swell sig. from Wisc.

W9RNM is a new ham in Chicago with a mighty fine rig.

W9NIP moved his rig to the Engineers' Lab. during the annual St. Patrick's exhibition and used it for handling messages from the public. I had a very nice contact with the boys during the exhibition.

W9AEZ has built up a small 60 watt rig just to have something to keep him away from the blondes.

W9ROD, formerly of St. Paul, has recently moved to Burlington, Ia., and has his rig on with a fine sig.

W9FYO is a NYA station operating out of Muscatine, Iowa. Located at the airport they have some sig. Fine equipment, too.

W9PEF is a new ham using only 6 volt batteries on the farm, and boys, you should hear that sig.

W9BHW of Burlington is back on the air after a rest or sompin.

W9YTZ has moved from Chi. to 7 miles south of Rockford, Ill., town of Mohaven. Harold has got what it takes to cut QRM.

W9UVJ of Arian, Ia., is head of a big NYA project to build receivers to be placed on all snow plows in the vicinity, and a transmitter to be operated from the courthouse. This should (Pse qsy to page 63)

FOR THOSE WHO WANT THE BEST

You take no chances

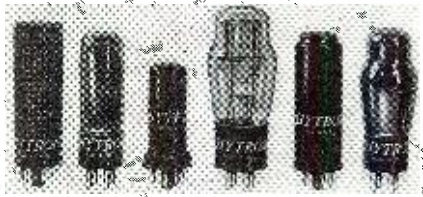

With Hytron EXACT-DUPLICATE ballast tubes (plug-in resistors).

There's no danger of burning out tubes or otherwise damaging or impairing the performance of the set for Hytron ballasts are designed for the particular circuit. And you can't make the error of cutting the wrong pins or taps since each Hytron ballast is an EXACT-DUPLICATE. Furthermore, you actually PAY LESS for them.

Then, too, Hytron, as a manufacturer of radio tubes fully understands the correlation between the ballasts and the radio tubes used in the set. Don't forget Hytron is the only manufacturer of radio tubes also making a complete line of ballasts.

Get your complete list of Hytron ballasts from your jobber or write direct.

Since 1921

HYTRON CORP. SALEM, MASS.

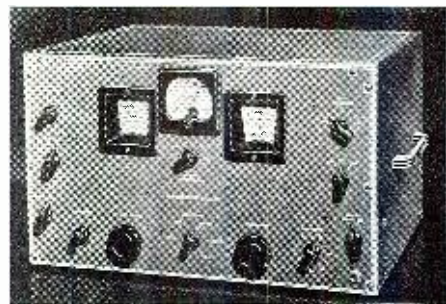

You owe it to yourself - TRY THE HQ-120-X

IF YOU are interested in fine performance at a reasonable cost, you owe it to yourself to try the "HQ-120-X," for in it you will find low background noise, high sensitivity and ease of operation. The "time test" has proved the "HQ" a superior product—for two years it has led the field. Its one stage of T.R.F. with the antenna compensator is so well designed that its image rejection is equal to, or better than, many two-stage receivers.

WRITE FOR "HQ" BOOKLET!

HAMMARLUND MFG. CO., Inc. IN-6
424 W. 33 St., N. Y. City
Please send 16-page "HQ" booklet

Name

Address

City

State

HAMMARLUND

EXPORT DEPT., 100 Varick St., New York City

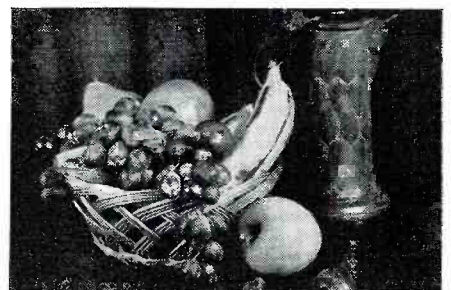

TAKE "PRIZE-WINNING" PICTURES WITH YOUR CAMERA ALL YEAR 'ROUND!

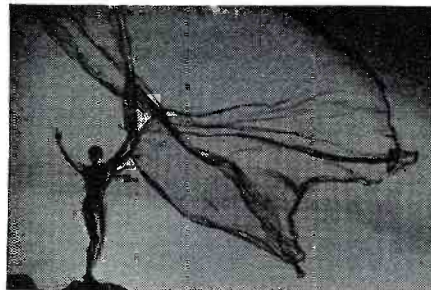

THESE TWENTY AUTHORITATIVE POCKET-SIZE PHOTOGRAPHIC TEXT BOOKS SHOW YOU HOW

No. 1—YOUR CAMERA AND HOW IT WORKS by W. E. Dobbs and Charles A. Savage. Selection, use, focusing, composing, lenses, shutters, making an exposure, filters, problems, etc.
No. 2—DEVELOPING, PRINTING, AND ENLARGING by Al and De Vera Bernsohn. Elementary, advanced developing, types of printing, elementary, advanced enlarging, etc.
No. 3—FILTERS AND THEIR USES by W. Bradford Shank. Light, film sensitivity, types of filters, polarizing screens, color separation, lens shade, problems, etc.
No. 4—COMPOSITION FOR THE AMATEUR by Kenneth Hellbron. Joining subject and picture, the picture as a whole, masses and accents, tone, lines, rhythm, etc.
No. 5—MOVIE MAKING FOR THE BEGINNER by Herbert C. McKay, F.R.P.S. Modern movies and cameras, using the camera, production, titling, projection, etc.
No. 6—COLOR IN PHOTOGRAPHY by Ivan Dmitri. Types of subjects, separation negatives, density scales, wash-off relief printing, chromatype printing, etc.
No. 7—CHILD PHOTOGRAPHY by Harold Lambert. Cameras and equipment, taking the shot, posing, finishing and processing, do's and don'ts, etc.
No. 8—HOME PORTRAITURE AND MAKE-UP by Maurice Seymour and Syd Symons. Part I: Tools, lighting, posing, background, etc. Part II: Restyling contour, eyes, eyebrows, lips; powdering, make-up, etc.
No. 9—TRICKS FOR CAMERA OWNERS. An outstanding collection of the latest and most valuable kinks and hints on every phase of amateur photography.

50¢ EACH

No. 10—A GLOSSARY FOR PHOTOGRAPHY. Compiled by Frank Fenner, Jr. Over 3,000 words having photographic significance are defined. They cover still and motion-picture photography in black-and-white and color.
No. 11—OUTDOOR PHOTOGRAPHY by Samuel Grierson. A comprehensive coverage of the picture possibilities found outdoors; landscape, pictorial, seascape, etc.
No. 12—INDOOR PHOTOGRAPHY by Hillary G. Easley, F.R.P.S. Posing, lighting, and exposure for portraiture, table-top, still-life, etc.
No. 13—FLASH PHOTOGRAPHY by Rus Arnold. Flash equipment, synchronization, exposure, indoor and outdoor work at night or in daytime, etc.
No. 14—PHOTOGRAPHING ACTION by Victor De Palma. Selecting shutter speed for motion. Special discussion of action photography outdoors and indoors.
No. 15—MANUAL OF ENLARGING by Stephen White, A.R.P.S. Complete guide to projection printing, printing technique, paper selection, etc.
No. 16—MINIATURE CAMERA TECHNIQUE by Fenwick G. Small. Discusses miniature cameras, special technique in shooting, finegrain developing, printing, etc.
No. 17—PHOTOGRAPHIC LENSES AND SHUTTERS by Richard W. St. Clair, A.R.P.S. Photographic optics; camera lenses; auxiliary lenses and shutters, etc.
No. 18—PHOTO TRICKS AND EFFECTS by Jacob Deschin, A.R.P.S. Montage, double exposure, solarization, and other odd effects obtained by photography.
No. 19—SELLING YOUR PICTURES by Kurt S. Saffranski. Markets, saleable material, legal aspects, and numerous hints on making money with your camera.
No. 20—DARKROOM HANDBOOK—AND FORMULARY by Morris Germain, A.R.P.S. Formulas for film and paper developers, fixing baths, intensifiers, reducers, toners; darkroom plans, equipment, technique, etc.

Are you getting your share of *good* pictures? . . . "prize-winning" shots that every camera owner deserves and has a right to expect? If you're not, you *need* the Little Technical Library PHOTOGRAPHIC SERIES! Here, in twenty informative and fascinating volumes, photography's foremost authorities show you the way to "prize-winning" pictures. Yes, camera fans, such noted photographers as Ivan Dmitri, Jacob Deschin, A.R.P.S. and Hillary G. Bailey, F.R.P.S., bring you the answers to every photographic problem. Each of these handy pocket-size text books is *complete* in itself, brilliantly illustrated, beautifully printed and richly bound. Get a set of these authoritative photographic books today, or a volume a week, and collect on fun, thrills and "prize-winning" pictures with your camera all year 'round!

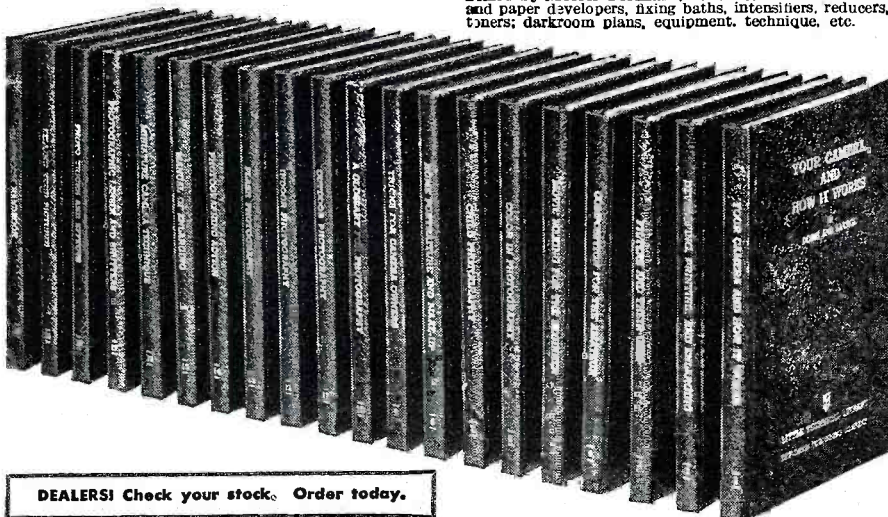

DEALERS! Check your stock. Order today.

Little Technical Library PHOTOGRAPHIC SERIES AT ALL LEADING BOOK AND CAMERA STORES

-----Or-Clip Convenient Coupon-----

LITTLE TECHNICAL LIBRARY, Dept. C641
608 South Dearborn Street, Chicago, Ill.

Please send me the books of the PHOTOGRAPHIC SERIES whose numbers I have circled below. If I am not completely satisfied, I have the privilege of returning them within five days for refund in full.

1 2 3 4 5 6 7 8 9 10
11 12 13 14 15 16 17 18 19 20

Send the complete set (20 volumes). Enclosed \$.....
 Send C.O.D. postage added. (C.O.D. in U.S.A. only)

NAME

ADDRESS

CITY & STATE

(60c each outside of U. S. A.—Payment with order)

be a fine thing to keep the highways open during the storms.

W9WML, the club station of the Ottumwa, Ia., hams, is on the air with several rigs on different bands.

W9VZQ and K6SDM held a fb contact on 40m. for 30 minutes, power on each end only 17 watts, both boys happy over it all.

W9NUY had a fine visit recently with W9OOL, and various hams in the Iowa territory.

W8UDP just about blocks things out here since he pulls in those new T 55's. Boy, what a sig. from Ohio!

10 meters is still a washout here in Missouri. Just once in a while I hear a K6 coming through. 160 meters has been in better shape though than it was during cold winter time.

Yours truly is starting a new home which will, of course, mean a new shack, and intentions are to have a real 1/2 wave zepp about 60 ft. up on 160 meters, so when you hear the *King of Happiness*, give us a call, boys; also send any photos you may have of yourself or the rig. Please. So Long.

W51RE says:
W5HYH has joined the AARS.
W5HQN has a kilowatt on 80.

W5JBL has a *Stancor* 10-P with 12 watts on 160 and 40.

W5JFH has a *Stancor* 60-P on 40 CW.

W5JUH is going on 160 fone.

W5ISV has been off the air for several weeks.

Willie has ECO. on 160 fone.

W5IRP has a *Stancor* 10-P on 160 fone.

W5IRP is the Emergency Coordinator for Lufkin and W5HQN is the Assistant Emergency Coordinator.

W5BIZ at Corrigan, Texas, is on 160 fone.

W5IRP also has 150 watts on 10 fone.

SARASOTA'S pride, W4CFP, qsp wid:
W4DZ of Tampa, Fla., evidently is a firm believer in the adage of better late than never. He recently got around to sending W4CFP of Sarasota a qsl confirming a 40 meter contact on July 17, 1933—nearly eight years ago!

Ham activity in the Sarasota area is on the upgrade. The *Sarasota Amateur Radio Club* has been organized and a bunch of would-be hams are attending weekly code and theory classes. Look for some new tickets around these parts.

W9GXG/4 plans to go up for a new W4 ticket soon—if he can find the time from his regular job of magazine cartoonist and his sideline of beauty contest judge. His rep as a judge of YL beauty spread to other towns after Linn's photo appeared on page one of a Sarasota newspaper with the winner of a bathing beauty event. Hi!

Mark Green, senior recording engineer with CBS in Chicago, discussed recording and its problems in a talk before the Sarasota club. Green was in Florida with Pat Flanagan, CBS sports commentator.

You can expect to hear W4DUI on 10 meter fone again soon. Joe, a newspaper printer, has been building a home on the side with only the aid of his brother and it's about ready for occupancy—including a new hamshack.

Latest call in this sector is WAHDO, Cecil Sills of South Carolina, who is radio op at the CCC camp near Sarasota.

HDO expects to go into the merchant marine or Uncle Sam's Navy when his CCC hitch is completed.

W4FZV of Nokomis, Fla., has resigned as principal of the Nokomis High School and reports he has picked a new QTH near Tallahassee, Fla.

Central Florida hams have a lakeside resort all their own. Incorporated as Ham Haven, the setup is near Eustis, Fla., and provides an ideal spot for hams to get together and chew the fat—not to mention the fishing, boating, etc.

W4GJO of Sarasota is now operating fixed portable from college at Winter Park, Fla. Grid plans to quit 10 meter fone for a whirl at 56 MC at intervals this summer and hopes to get some of the Sarasota gang on five also.

W4CFP handled the local test message in the *American Red Cross* test drill sponsored by the ARRL.

More Mail

DEAR Editor:
I was very much surprised in reading over the May issue of RADIO NEWS and finding out thru Mr. Sherman's letter that there might be a change in the Amateur Examination. As yet, I am not a ham, but I have been doing everything in my power to pass the test. I think I have the code down pat, but I just can't get the theory by myself.

Up to date, I would say that I've spent \$300 on equipment. I have a *Hammarlund HQ-120-X* and have built a thirteen tube transmitter under the supervision of a licensed amateur. I have lost complete contact with him, so here I am with a station near completion and no license. I am not going to finish the transmitter until I have the license.

I am sure you realize how hard it is to obtain the necessary knowledge without the aid of an experienced person. I am not going to offer any suggestions as to how the bar should be lowered because I am not familiar with the troubles that the amateurs might be having with inexperienced hams. I am sure that if a person has enough interest in the hobby, he can obtain the knowledge by contacts over the air. I would like to see the F.C.C. take a couple of thousand people interested in getting a license, but who have had trouble as in my case, and put them on the air and see what comes of it in about a year. I am sure that after the year they would have a pretty good understanding of Amateur Radio.

In conclusion I would suggest that if this idea was passed there would have to be some very strict rules to be enforced. I would say that every privileged amateur would have to have his rig examined by a licensed ham and would have to be instructed by a ham on the operation of his rig

Very truly,
Lewis Konecky
Yonkers, N. Y.

[Ed. Note: As reported by our Alfred Toombs, RADIO NEWS Washington Correspondent, the plan to lower ham entrance requirements is at present bogged down behind a mass of much more important legislation within the F.C.C. and will be that way for some time to come.]

ROM Ye Olde Beane Towne, your First District Reporter, W1JOM, reports the following:

Spring is here! And it is tough trying to bang this out with the temp. hitting it up to 79 degrees. Well hr goes—

WIDRL is experimenting with television. Woody has a revr perking fb.

W1MSS will leave for the West Coast sn. The New Eng. Ultra High Freq. Net meets on 5 meters every Thur. nite.

W1KSA worked W1COO at Brentwood, N. H., on 56mc. F.B. Joe.

W1JNK operates on a freq. of 28,725 and wud like the boys in Boston to look for him evenings.

W1AMK is now on ten fone using a Harvey UHX-10.

W1LLW of Rockland is with Harvey Radio in Cambridge.

W5CSU is working portable from Brighton. Witt is on 2 1/2 meters and as u know attends M.I.T.

W1MOR hails from Quebec, Canada. W1MOR is teaching at a local NYA radio center. Phil is on ten fone from his home QTH in Hyde Park. He runs 225 watts to 812's *Scop-Flow*. Air Romance. W5CSU and W1JDO's sister W1MPB were just betrothed and are honeymooning out West. Congratulations. Ann and Witt.

W1CIB & XYL recently pd a visit to W1BDM of Roxbury.

W1KLO is on 80 c.w. W1M works for a local B.C. station. Cliff is on 20 fone.

W1SS is also a teacher in the NYA radio training center. The grapevine informs that Art is in line for the job of supervisor of radio training for this district. We're pulling for u, Art.

W1HSB informs that his slogan "Heavy Swedish Boy" is vy much the truth.

W1BB is back on ten after abt a yrs. absence. He's running 250 watts to T55's into a vertical Johnson Q antenna.

W1LFD of South Boston is on 2 1/2 with a real potent signal.

W1KEF is secretary of the Brockton Radio Club. The club recently took part in the Red Cross Drills.

W1LGC & W1GOU r thinking of hiring an aeroplane and riding back and forth between their QTH's, to see if they can solve the problem of the rapid fade which occurs when one of those ding blasted flying machines flies over either the xmitting or receiving antenna when working ten meters. Well—it's a worth while project. Brainstorm—mebby they can get a gov't grant. Mite be just the thing for spotting planes now tt were all National Defense minded. C'n u imagine W1MZF sez quote "they're both nuts" unquote.

The following are active on 2 1/2 meter Army Net: (all W one's) EYR, MON, QD, MQH, BHL, MIE, MBS, MRS, NBT, MMY, MZF, AAR.

W1KRD & W1KSA recently paid a visit to W1JDD of Waltham. The five meter band opened up for short skip on March 30, at abt 4:30 p.m. The band was just loaded with 2's, 3's, 8's & 9's. Most of the sigs were on c.w. They were vy strong & had a deep note, & rapid fade. The band was open for abt an hour.

The BCL's have driven W1EPH off of 160 fone. He's gone dwn to 40 c.w. and 2 1/2 fone.

W1NBT is now located in Roxbury. Was located formerly in Jamaica Plain, so called by W1LPA, "the weird wide fantastic plains of Jamaica, the 'hams' paradise." Well, I won't argue abt tt point with u Wes cuz I don't know. I don't live there. But ** "a" is tt Polaroid?

W1JDE is experimenting with a vertical *Johnson O* beam.

W1JUZ of Allston is now with *General Electric*.

W1BB is using a nw *Hallcrafters 5&10* for reving on 5 meters. Wudn't it be nice if u cud get them in the aforementioned place. Yessiree.

W1NBM has a nw rig for 2 1/2 meters. Seems like everyone is gg dwn to 2 1/2. How abt five meters, fellows, it still belongs to us.

W1LBH is now up on 80 fone using a Meissner Signal Shifter into an 807 into HK54's. The mike is an xtal belonging to W1LPO. The revr is an RME-60. Wat with all the QRM on 80 Carter is getting interested in 2 1/2.

W1HSC of Hanton Beach is active on 160 fone. Warren is using 812's in final.

W1NHN, Norma of W1JLI, is doing fb on the 2 1/2 meter band. Certainly gets out even when the band seems dead.

Incidentally, have u taken the proficiency tests sent out by W1AW? Try them. This hobby may come in mighty handy some day. I sincerely hope it doesn't ever come to tt.

W1LZI, formerly of North Yarmouth, is planning on gg on five from the radio store which he operates. He will run the rig from batteries, and will operate during the daytime only. W1MPK has a fine five meter beam about 40 feet in the air.

(Please turn the page)

WANTED Radio Operators

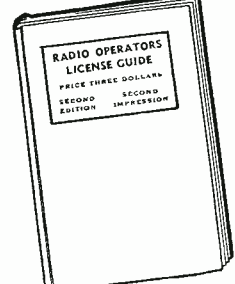

National Defense
Program Creating
Many Openings for
Radio Operators...

- ★ NOW is the time to capitalize on your radio training and experience by obtaining a commercial operator's license and taking advantage of the many opportunities presented!
- ★ The "RADIO OPERATORS' LICENSE GUIDE" has been especially prepared as a study and reference manual for those radiomen having considerable training and experience who are unfamiliar with the exact requirements for a commercial radio operator's license.
- ★ Containing over 1,250 questions and answers to the new type examinations, it will aid you to pass the tests. Purchase from your local parts distributor or order direct. Postpaid only.....\$3.00

WAYNE MILLER
The ENGINEERING Bldg. • • • Chicago, Ill.

**SPRAYBERRY TRAINS YOU
for
GOOD PAY!
STEADY WORK!
ADVANCEMENT!
in
RADIO and TELEVISION**

DON'T WAIT! START NOW!
You Can Make Money Almost At Once
You'll be quickly shown how to get and do neighborhood Radio Service jobs... for practice and profits. You easily learn Tele-Vision, Frequency Modulation, Signal Tracing, Mobile Radio (Auto-Tank), Aviation Radio, Electronics, Facsimile Radio, Radio Set Repair and Installation Work.
I'll Prepare You Quickly In Spare Time
... At Home Or At Camp

SPRAYBERRY Training does not interfere with your present work. You will receive personal coaching service all the way. You'll be fitted to hold down a good paying job in Radio or to have a Radio business of your own.

You Get Professional Test Equipment
... Plus Experimental Outfits
Includes 148 RADIO PARTS (to build complete Radio Receiver), RADIO TOOLS and a TESTER-ANALYZER. MY EXPERIMENTAL OUTFITS enable you to conduct actual experiments with your own hands.

NO EXPERIENCE NEEDED
It makes no difference what your education has been. I can fit you to become a real RADIO TECHNICIAN. Your success is my full responsibility.

THE SPRAYBERRY COURSE IS SOLD UNDER MONEY-BACK AGREEMENT

RUSH COUPON for BIG FREE BOOK

SPRAYBERRY ACADEMY OF RADIO
F. Sprayberry, President
425 F University Place, N. W.
Washington, D. C.

Please rush my FREE copy of "HOW TO MAKE MONEY IN RADIO."

Name..... AGE.....
Address.....
City..... State.....
(Mail in envelope or paste coupon on penny postcard)

W1UJ recently paid a visit to W1MZK. W1AP of Berlin, N. H. is putting thru a terrific sock from Ft. QTH on five fone.

W1AUC is Emergency Coordinator for Bar Harbor, Me.

W1KWD is giving up all other bands for 2 1/2. He has an Abbott MRT-3 powered from a Vibrapack in the car. He will operate a similar unit from the home location, and it also will be battery powered. Doc tells us that he is setting up & testing the equipment especially for emergency use. Which is something more of us should think about, especially the part about having it powered by other than the 110 volt line. Doc, in-

identally, as he is in radio since 1912 & still admires it. He has plenty to learn.

W1LWQ, who is on ten fone, is really an old timer at radio. As he tells the story, he was one of those boys who gave up the game for good. But one day, while he was in town looking for a b.c. set, he came across a new shiny ham receiver and the bug bit him again. So now Bob has himself one of those Hallicrafters 5 & 10.

W1MME built a super deluxe rotary beam complete with remote control, direction indicator, motor, etc., and the total cost was under five dollars. F. B. Rudy.

Have you noticed the tendency of many of the high powered stations on 160 fone to reduce their power? W1LMB is planning on getting an old B. C. set and using the audio for a modulator & the rest of the set for the R.F. Seems as if BCI is catching up with Al.

W1KQK of Canton is past Pres. of the Parkway Radio Club. The club meets every other Thursday evening. The club station is W1HOB. The xmt'r runs about a KW on 160 & 75 fone. The members r now constructing a new c.w. outfit. The receivers r an HRO & an All Star. The members of the club r gg up to N.H. again this yr for field day, which comes on the 7th & 8th of June. Last yr the club had one xmt'r, a kw. on fone. This yr they will operate strictly c.w. They have three 30 watt xmt'rs & 2 100 watt jobs. Last yr the club took top honors for strictly fone operation.

W1IIM who is very active at the above station and all club activities, works for the Mass. State Police at their station WMP.

W1KMN teaches Adult Education classes, Mon. & Wed. eve. at Fairfield.

W1MNC of Rhode Island is active on 2 1/2 mobile around these parts.

W1KLG, who is on ten fone, is also an aviation enthusiast. He is attending flying school at the East Boston Airport. George is running a pair of T55's in final & modulating with T240's. His receiver is an RME 69.

W1JIL is back on the air & experimenting as usual.

Now all you students gather 'round & we'll give you the monthly quiz. This month we'll give you only one question since it is a very serious problem. Question. Preamble. You know I spoke to some of the members of our community & mine r now in camps located throughout the country. I suppose you also know or r trying yourself to contact some of the stations which r being operated at these camps so that the friends & families of the boys down there can hear their voices. It means a lot to these folks to be able to speak a few words & hear an answer come back over the speaker. Question. Who is the station that "HOGGED" the QSO one Sunday so that half a dozen other stations who had schedules with the same camp he was working could not carry on their own schedules & he knowing all the time that these stations were standing by, many of them for four and five hours. He was responsible for the disappointment of two score friends and parents who were waiting at the other station and who traveled through one of the worst storms to be able to say a few words to the boys at camp. Joe Palooka would probably say, quote, "tsk, tsk," unquote. If we ever had an emergency, this guy would probably get on ten and try to work the DX that would probably come thru because of the increased activity. Well, spose snuff.

W1MRK is a member of the Waltham Radio Club. The club meets in the penthouse atop the Waltham Watch Co. plant. Some class.

W1JGZ is a Professor at Boston College. Some of the boys in his class tell me he is f.b. in the class room and a fine lecturer.

W1IAR went up on 80 cw using a couple of Edison cells. He worked Ohio with an R78 report. W1IAR is Emergency Coordinator for his district—Belmont, & he is checking up on the available emergency equipment.

See u next month.

W3IWF reports:

The Greater Camden Amateur Radio Assoc. is now reorganized as will be gng great gains by the time this is printed.

W3BYK is now on 10 M fone. Stan was up on 160 fone few awhile too.

W3SN is at it again—he has another class of beginners at the local YMCA—Joe has been helping fellas get their tickets since 1938—

W3ILN is also working 160 fone es experimenting wld recordings of his contacts—

W3IOF is gng to build a 40 M rig es 3CZN wld sn be on 40 wld abt 70 watt—

W3ASG, Doc Mikitarian, expects to be called to service in the Dental Corps sn—Gud Luck, Doc—

W3EIK is a cop in Philly—gud sig fm a 6L6 es 30 watts on 40—

W3HND is an old railway op—watch out fer those landline Morse characters, Bill Hi—

W3JBE is a nw op in Bethesda, Md., es Bob wrks out f b wld 6L6-6L6G es 45 watts—

Hrs sum dpe on W3IWF—6L6 xtal osc wld 18 watts input—V-C-44a rcvr es 40M end fed zepp—bn on the air since Jan. '41 es hve 34 states so far—hpe to wrk WAS before graduating to higher pwr, Hi—Where r all the Vt. stns?

W3SKJE been busy selling radio equipment for G. E. He sure is sold on the fm bug. W3GGA has license 40-CQ on his car; W3EFW has 41-CQ; W3QV has license 8-QV. Not bad, eh? W3BCH, former Cleveland and Detroit ham, is now working and living in Chicago.

W3LXT is working for The Aluminum Co. of America in Tennessee.

W3CPS and W3DKK, brothers-in-law, have both let their calls go. Bob, Ex-W3CPS works for TVA in Tennessee. Is married, and we

hope he will get back in ham game soon. Johnny, Ex-W3DRK, lives and works in Washington, D. C. and recently became a proud papa!

W3NIE has a nice Zepp antenna hanging over his house, but we think his yf keeps him off the air most of the time.

W3EFW, married now and settled in his own place, is back on the air. Wonder of wonders, he has shown up once in a while on 160 phone; and after swearing for 10 years he wouldn't be found dead on the band!

W3ADT is Ex-W3SIP with his long lost call restored to him again by the FCC.

W3DLI is very busy making equipment for manufacturing fluorescent lamps at Nela Park.

W3WV is one of the three men left of the local NCR. He is Lt. Commander of the local Naval Reserve Unit.

W3LXQ and W3IPU are working on the new equipment for BC station W3AR.

W3GCU is an engineer at WHK-WCLE. He also is married now, and last we heard liked it very much. He has been inactive on the ham bands for some time.

W3HFE has been a W2, W9, and W5 during his last three years as an airline radio operator. He is now stationed in Columbus, Ohio for American Airlines.

W3DQZ has taken appointment as Professor at University of Iowa. His XYL, W3TLE, is staying in Cleveland for a while, trying to sell the new house they had just built here. Too bad, and such a beautiful QTH etc.

Remember W3GPF? Well last we heard of Frank he was rumored to be Chief Radioman for a Florida airline. He also has joined the married ranks since leaving the Cleveland gang.

W3KPB is said to have given up an Army Air Corps career recently, and is back at Sun Valley as a Ski Instructor.

When the 107th Cavalry left Cleveland recently for Camp in Tennessee, it took a number of Cleveland hams with it, including the following: W3CPT, W3OQV, W3OPG, W3NGZ, and W3PMJ. Ex-hams W3EHO and W3LDD, also included.

W3EBY is working for Westinghouse in Lima, Ohio. Mish is too busy with yfs to put much time on radio.

W3NID is the latest addition to the ranks of the benedicts. Yep, and he married the daughter of one of the SWLs at his radio club! Club membership committee take note!

W3IEF puts in a nice signal on 160 from Independence, Ohio.

W3OIT has been working 75 phone of late. Spent busy with plans for last April 19th Hanifest of which he was Chairman.

W3GPB has fallen completely out of the picture since he got married last year. S'matter, Jim?

Remember Kelly, W3GXC? He used to tear the air up out in Bedford. We ran into him on 75 recently and he's now located in E. McKeesport, Pa. and has a job and everything. Wants to talk to the old Cleveland gang.

W3BUM is back in Bedford after being away for a while. He held the call W3ICB while in the east.

HAM news from northern NJ by W3LNT:

One Sunday afternoon a few SWLs came over to see what the rig looks like. One SWL stood outside the door and when invited inside the room he calmly pointed to his wrist-watch and his xtal mike and proudly displayed a clipping clipped from a local newspaper: "If you want the right time never ask a radio announcer for it. Their watches run slow because the magnets inside every microphone magnetize watches, causing them to run slow." Thus for the first time I found out that my xtal-mike emitted such a strong magnetic field hi!

Thus in our 60 ani extending as u will always find W2NHZ gassing away. George seems to be the most active ham on 160.

W2ESC can't seem to stay on one band for an length of time—must be his adventurous blood. He's always hopping around on 10, 20, 40 or 160.

W2NCA nw sports a xtal mike and it sure has improved his quality.

W2MQD's new pride and joy—a Super Sky Rider. He will be on 160 shortly with a 3A2 or 60P. His stn is located in a hospital where he wrks. With all the X-ray and short wave diathermy machines etc., we dnt knw hw he will be able to wrk anybody hi.

W2NRH is a new radio ham in Hasbrough Heights.

W2LPV has 1/2 wave ant on 160 and sez he don't care to put up a longer one since he is interested in local rag chews only.

W2NJW's quality sure has improved since he bought that double button mike with trans. es a couple condensers on 75.

W2IIT was called for a physical—if he passes es Unk Sammy calls him, I'm sure all hams (especially W2MHL es W2NFI) will miss his hearty laughter es chatter on 160.

W2FK staged a comeback. He hope Joe will be a little more active.

W2NIW, brother of W2NHZ, sure puts in a swell sig nw tt he graduated to higher pwr.

On 160 you will always find W2NGJ and W2NCQ gassing away, telling jokes or playing checkers.

W2NKN seems to be always looking for wood to keep the stove gg at the Clifton Radio Club. We expect W2MEW to come home this summer with a degree hi. He is attending Alabama and wants to become an Electrical Engineer.

W2MKT and W2IMG nw wrk in Western Electric.

Like to talk abt bowling? Then get in touch with either W2EMY or W2IMG on 160.

W2MRI es W2MOP the only boys who represent Passaic on 160 are quite inactive at present—must be the homework for Joe attends a Prep school es Nick planned to attend Casey Jones

EVERYTHING IN RADIO



Radio Handbook HAS ALL IT

This big book serves your entire needs. It includes sets, parts and supplies, public address, amateur equipment, test-ers, kits, fluorescent lighting. Nationally known favorites at lowest possible prices. Write today for your copy of this

BIG FREE CATALOG

BURSTEIN-APPLEBEE COMPANY
1012-14 McGEE STREET, KANSAS CITY, MISSOURI

New Fountain Pen Spark Self powered oscillator for



AR. AF. AP Signal Generator

- All alignment
- Trouble shooting
- PA systems ● Checking sensitivity ● AVC ● Antenas ● 10 second locating of auto set ignition pickup
- Host of other tests. Utterly simpler, faster, more accurate. Used by U.S. Army Signal Corps, hundreds of servicemen and organizations. Write now for leaflet.

GENERAL TEST EQUIPMENT CO.
213 N. CROSBY AVE., KENMORE, N. Y.

Classified

Rate 15c per word. Minimum, 10 words.

CORRESPONDENCE COURSES

AMATEUR Radio licenses, training in code and theory. Resident and home study courses. Hundreds of licensed students. American Radio Institute, 1123 Broadway, New York.

USED Correspondence Courses and Educational Books sold or rented. Inexpensive. Money-back guarantee. Write for Free Catalog listing 4000 bargains. (Courses Bought.) Lee Mountain, Pisgah, Alabama.

CORRESPONDENCE courses and educational books, slightly used. Sold, Rented, Exchanged. All subjects. Satisfaction guaranteed. Cash paid for used courses. Complete details and bargain catalog free. Nelson Company, 500 Sherman, Dept. F-237, Chicago.

LEARN Aviation Radio; get radioperator license; go to work. New field for servicemen. Combination home-resident training prepares for license examinations. Universal System, 404 Candler Building, Kansas City, Mo.

ELECTRICAL EQUIPMENT

SOME bargains on used light plants, AC generators & converters, 80 to 10,000 watts. Write Katolight, Mankato, Minn.

PATENT ATTORNEYS

PATENTS—Advice and booklet free. Highest references. Best results. Promptness assured. Watson E. Coleman, Patent Lawyer, 724 9th Street, Washington, D. C.

INVENTORS—Before disclosing your invention to any one send for Form "Evidence of Conception"; "Schedule of Government and Attorneys' Fees"; and instructions. Sent free. Lancaster, Allwine & Rommel, 414 Bowen Building, Washington, D. C.

PHOTO FINISHING

ROLLS DEVELOPED, two prints each and two free enlargement coupons, 25c, reprints, 2c each; 100 or more, 1c. Summers Studio, Unionville, Mo.

RADIO ENGINEERING

RADIO Engineering, broadcasting, aviation and police radio, servicing, marine and Morse telegraphy taught thoroughly. All expenses low. Catalog free. Dodge's Institute, Elm St., Valparaiso, Ind.

RADIO Kits—\$3.95 up. Single band; all wave. 5-10 tubes. Fluorescent lighting. Save 50%. Radio-parts catalog—FREE. McGee Radio, P-2075, K. C. Mo.

Aviation. Nick also observes quiet hrs nw tt he put up his great big ant hi.

For the past 2 weeks there seemed to be much pow wowing abt 2 1/2 mtrs. One of these days there will be a mad scramble for tt band, so if u think u will miss some of the boys on 160 then better build urself a 2 1/2 mtr rig.

NEWPORT, R. I., via W1JFF reports: In interest to ham radio, W1MMX, W1JFF, of Newport, R. I., has skeds with W1JTB Rt. 1, Wickford, R. I., W1BFB, W1CJH, East Greenwich, R. I., Mon., Tues., Thurs., and Fri. nites at 6:30 p.m. E.S.T. The gang are looking for newcomers on ground wave gang on 10 meters. This sked is done on 10 meters.

We hear W1DLY, Gilbertville, Mass. as our ground wave on 10 DX altho haven't worked him. We start at 6:30 but continue as late as 9 or 10 p.m.

W1LPO, "doc," has a new qth: Tiverton, R. I. He is also on the book for ground wave boys on 10.

W1JTB is also on 5. "Steam" originally comes from Boston way and has done considerable good work on 5.

W1JFF has a converter all set and working with a 65 ft. high 2 half-waves on 5 meters. Docs plenty of listening. Also, has a rig on 5.

W1HPE has new rebuilt rig with 2 finals, one for 10 other for 160. Expects to get on very shortly and will join the boys.

W1BVI old stand-by on 160 meters.

W1JNO working for the telephone company at their Green Harbour ship-to-shore station. Gets home week ends to fire up on 160 or 75 phone.

W1NED, Doc, is new in town. Works 20 mostly on phone, altho equipped to work all bands. Is Naval Reserve officer called to duty here.

W1NEC also new, expects to be on 10 M soon. W1NEG, Ed Miller used to be WSTGS fm N. Y. state.

W9DPU writes in: W9KDA is reported as doing well in his new defense job in California.

W9YNX is looking for someone to work 5 meters with him.

W9CPO finally got his rig on ten meters. He is using the famous beam of W9KDA.

W9QIF has almost finished his new rig which is running 500 watts to a pr of S12s on 160 and 10.

W9SZG has an xyl, a new bug es a new rig. All he lacks is a place to put up an ant.

W9HMH has much better quality now with his new dynamic mike.

W9LYH. With his studies in his national defense course and his xyl's, Lowell doesn't have much time for hamming.

W9WVR has moved to Crookston and joined the radio club there.

W9MJB has a new SX-24 and likes it very much.

W9BHI can see hundreds of partridges from his hamshack window almost every day.

B Y Bud Crawford, W9BDO:

Spring arriveth and this old young man's fancy turns to writing of the doin's of U ham brethren. Most of the hams are quite bizzie infants with all this defense activity, putting their best efforts into whatever might be their particular forte in this world of ours; and many are affiliating with this or that "net" as their idea of what-to-do for the U.S.A. with their ham radio knowledge and ability.

W9PQG was heard making dot'n-dashes recently.

W9RYV, the sugar beet sugar man of Minnatare, built a Wheatstone

Bridge to exhibit to those attending the Western Nebr. Radio Club meeting at W9MGV's—also showed it to an interested group in Denver a short while later. Roy now "slides" round the freqs with a composite VFO.

W9SRE, W9LXJ, W9RDY, W9FSX heard using 80 wiggulations for QSOs.

W9IIB "Bob" of Boulder, Colo. in on a 3-weight with W9GYB Gayle of Gunnison, and ol' Bern W9RGX of Brighton other noon on 75. First I had heard of that jovial "Real Good 'Xouse" on "our band" and sure a pleasure to anione's ears to hear such a good natured ham.

W9TVU Laken, Kan. an AARS 160 F netter bends his wrist on 80, too.

W9CYX "Pinky" of Tracy in Minnesota gave me a FB short QSO on 3.8 maggie-sicklez til his "supreme court" sed "Soup's on!" so

"Pinky" gave me the big hop es hurried to put his dogs under the table so he cud put sum "fill-tur" in his loading coil off the plate suppli.

W9URQ lil Cliffie in person hrd saying he es "Calamity Jane" the OW who pickt him up in Black Hills were gg QSY 2 another house thr in Watertown, S. Dak.—hard or soft aqua pura in ur burg, Cliff?

We used razz W9PDH abt it's bein' cheaper for Les 2 move than pay rent, so now the sun-uv-a-gun has went es bo't him.OWSN's infant a lil grey home in the east-side of the st. "Lete" sez.

W9OZL of Newton, I-weigh, beat QSZ at its own significance by a third repeat on QTH, rep't, etc. Still sig s'posed b Q5. Hi.

W6PLS—"poor lonesome sailor"—Gen in-

QUICK 4 HOUR SERVICE

HIGH VOLTAGE POWER TRANSFORMERS

One of America's largest transformer builders made these... and NEWARK's immense amateur radio business enabled us to get them for you at a price! We guarantee every one. Real "huskies" they are, and just the thing for your Ham rig!



Choice of Two Filament Types
 No. 4140 — 600-0-600 V. — 200 Ma. Filaments: 7.5 V.C.T.-3A. — 5.0 V.C.T.-3A.—2.5 V.C.T.-10 A. Wt. 8 1/2 lbs.
 No. 4240 — 600-0-600 V. — 200 M.A. Filaments: 6.3 V.-4 A. — 6.3 V.-3 A. — 5.0 V.-3 A. Wt. 8 1/2 lbs.

\$2.85
\$2.85

Echophone COMMERCIAL

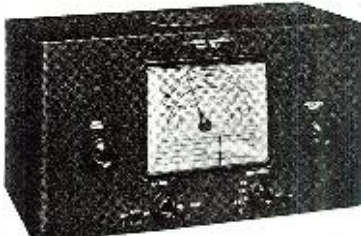

TERMS
 ON ECHOPHONE EC-2 OR EC-3
\$5 DOWN and \$5 PER MONTH
Order from Newark Now
 It's easy to buy an Echophone on our time payment plan. Send \$5.00 down payment and credit references with your order. We ship at once when credit is O. K. Pay balance, plus 6% carrying charge, at \$5.00 per month.

DISPLAY YOUR CALL LETTERS

Your call letters in GOLD on your ham shack door or auto window... will look mighty fine!

10c

Big, shadowed decalomania letters nearly 2" high. Send dime for yours today. Don't forget to give your call letters.

SEND FOR THIS FREE BOOK

Our latest issue, with illustrations, descriptions and lowest prices on thousands of bargains. Sets, parts, supplies and accessories of all the better makes. No ham should be without his NEWARK CATALOG. It's FREE!

WRITE TODAY!

ON EVERYTHING YOU ORDER FROM THIS AD!

CIVILIANS HAVE NO PRIORITY! SAVE BY BUYING NOW! PRICES GOING UP!

EC-1
A SENSATIONAL BUY
Only \$19.95 COMPLETE!



Try and beat all these amazing features at this sensationally low price. Tunes from 545 kc. to 30.5 mc. (550 to 9.85 meters) on 3 bands. Electrical bandspread on all bands. 6 tubes. Self-contained speaker. AC/DC-115-125 volts. (Model EC-1.) A real communications receiver.

EC-2 8 TUBES, DYNAMIC SPEAKER \$29.95

Up to the minute communications receiver performance. 8 tubes; 3 bands; covers 545 to 2100 kc. — 2.1 to 8.1 mc. — 7.9 to 30.5 mc.; self-contained 5" PM dynamic speaker; preselection on all bands; calibrated bandspread scale on 80/40/20/10 meter amateur bands; automatic noise limiter; electrical bandspread at all frequencies in the tuning range; operates on 115 volts AC/DC. (Model EC-2.) Never before have you been offered these outstanding communications features at a price so low.

EC-3
10 TUBES, FLYWHEEL TUNING \$49.95



Here's your opportunity to have all these communications features at this remarkably low price. Crystal filter (four position variable selectivity); calibrated bandspread; automatic noise limiter; preselection on all bands; 2 stage IF amplifier; fly-wheel tuning; separate 6" PM speaker; CW monitor; 10 tubes; 3 bands; covers 545 to 2100 kc. — 2.1 to 8.1 mc. — 7.9 to 30.5 mc.; electrical bandspread. Operates on 115 volts AC/DC.

LATEST CONDENSER BARGAIN LIST

Oil Filled—Oil Impregnated FILTER CONDENSERS



As low as 59c

Thousands now in use by "hams" who are still wondering how we can sell such dependable quality condensers at such low prices. No compromise with quality. Made by a leading manufacturer and GUARANTEED at rated voltages.

Mfd.	Volts DC	Size	Price
1	1000	5 x 3 3/8 x 1 1/2	\$.59
18.3	1000		2.15
4.4	1500	5 x 3 1/4 x 1 3/4	1.50
2	2000	4 7/8 x 3 3/4 x 1 3/4	1.50
8	2000	5 x 3 3/4 x 3 1/2	2.75
4	3000	5 x 3 3/8 x 3 3/8	3.75

NEWARK Electric Company

325 W. MADISON ST.
 Dept RN CHICAGO, ILL.



• It's easy to get the very latest condenser types. All you need do is look for the familiar yellow-and-black Aerovox cartons, and then spot those with *bright red labels* on front and sides (see above). Those labels denote *new items*. At a glance you can pick out the very latest things in condensers.

And then there's the Aerovox Catalog. Be sure you have a copy in your working library. It contains the most extensive choice of types, sizes, capacities, voltages, etc., and Aerovox is the one line on which you can standardize for ALL your condenser requirements.

Ask for Copy ...

The local Aerovox jobber will gladly give you a copy of the new 1941 Edition. Also ask about free subscription to the monthly Research Worker. Or write us direct.



ducing one of the airway stns to pay him in St. Lake spot, was tellin' me one morn on 75F he had had abt 7 OM's es 1 YL in shack one time es the guy they were QSOing had cracked "Pretty good OT but it ain't the way I've heard-d it abt Utah!" Hi.

W5HFV—his first wife—"Bill" of Ponca City, Okla. gave me nice chat and bits of info on their new AARS 75 F net they use to drill on 3920 Wed eves abt 7 CST.

W9RKM brand-newly licensed Johnnie from Lee Summit, near K.C., Mo. informed me I was his 2nd DX QSO wid his 850W xmr—had gotten his ticket day b4 es his OW was anticipating another of the same as she had bn examined but hrd Jawn saying other nite ND on a call for her as yet. Boys, Howdy! Will the lite co be happy wid two hams in the family to keep it near-RW hot!

W6PJ Dave didn't stutter wid his key on 40CW the midnite 1 QSOd him.

W9WRS Earle has bn messing wid a versatile monitor he has gotten well past the experimental stage which gives promises of being whing in duplicate by rest of us in future. His "supreme court" Francis blossoms forth with W9POI as her ham designation. Fb! But, pse b careful Francis es don't kid the radio-romeos too much.

W9GKX "Bob" in Faribault, Minn. sed 20 below during th terrible March storm up thr the noon I had radio visit wid him on 40.

W9LMY of Mitchell, S. Dak. was a new victim for me on 40 but he was keeping too much company with Miss Fadeaway so had th satisfaction arguing wid him th session. Btr luck next time OT.

One nite on 160 F I heard sum W7L?? whose exact call I hv forgotten at the moment wrking from "the coldest spot" in U.S.A. (it seems as Big Piney, Wyo. on the mountain top hits the low spots of the Thermometer most mornins on the w report.

W9EKP the printer man has concocted a neat certificate of membership for the "pair" newly inducted into their "Lil Homemakers' Club" which holds forth on 75F in late evenings cum Friday. Requires an OM and sumone of the "contrary sex" at each ham's place to get in on the verbal barrages of stuff and nonsense the gang jaw out.

W9HYR besides op'ing KFAB and KFOR also does a bit of early-morn "pronouncing" fm the latter stn.

W9OYB "Rolly" of the metropolis of the "white spot" wrks 80 c.w.

W9TVF Dick is nw wrking for Uncle Sam's radio in sum phase es op 's ham rig on 75F fm Aurora, Colo. Dick usta tell a certain ham YL wen he was oping BC xmr at Dodge City, Kan. th he es other OM kiddr were medical students thr. Hi.

W9FXN haywired up an un-married 201A in an xtal eret tk perks nicely off a vibrapak on 80 c.w. but won't get-out on 160 c.w.??

W9MJY mist army net sked on 75F one Sun. morn—heck Ken U shudn' let a lil thing like the newly-arrived Connie Jean 7 lb. interfere with keeping a net sked. Hi, FB! Milly, we'll forgive U if U will make Ken do the floor walkin' es also promise to join our AARS net when U get th ticket—W9AMY es W9TIF sed sarcastic things to me when comparing ur ability to wiggle a bug in a c.w. way es results thru the audio osc were btr than they rate mi c.w.!

-50-

SERVICEMAN'S CASE HISTORIES

Reprinted with permission, from RADIO Trouble Shooters Handbook. Copyright, 1939, Radio & Technical Publishing Co. Copyright in Canada and Great Britain, and all countries subscribing to the Berne Convention, by Radio & Technical Publishing Co. All rights reserved.

GRAYBAR GB-678

(Uses same chassis as RCA Radiola 48 receiver.) See the Case Histories listed for the RCA Radiola 48 receiver

GRAYBAR GB-700

(Uses same chassis as RCA Radiola 80 receiver.) See the Case Histories listed for the RCA Radiola 80 receiver

GRAYBAR GB-770

(Uses same chassis as RCA Radiola 82 receiver.) See the Case Histories listed for the RCA Radiola 82 receiver

GRAYBAR GB-900

(Uses same chassis as RCA Radiola 86 receiver.) See the Case Histories listed for the RCA Radiola 86 receiver

GRAYBAR GB-980

(Uses same chassis as RCA R-10 receiver.) See the Case Histories listed for the RCA R-10 receiver

GREBE HS-4

Oscillation 2) replace 8,500-ohm resistors in screen-feed circuit, using wire-wound 10-watt units
Intermittent re-1) remove entire 6-section

ception, metal-cased by-pass condenser. Replace the r-f and i-f cathode by-pass units with 0.1-mfd. condensers; the second detector tube by-pass units with 0.5-mfd. by-pass condensers; and the tone control condenser with a 0.02-mfd. unit. The capacity of the screen by-pass condensers is also 0.1-mfd.

GREBE M 3-4

Fading 1) leaky or intermittently open-circuiting condensers. Test each separately

GREBE NK-4 Synchrophase

Intermittent reception ... 1) broken pig-tail leads on gang condenser. Examine especially the first condenser of the gang which is in series with the antenna
2) "gassy" type '24 tube. Try several '24 tubes
Intermittent reception, fading, cuts out when "dx" switch is snapped ... 1) replace detector grid return by-pass
2) replace 3-meg. series resistor with a 1.5-meg. unit
3) clean contact of "phono" switch (this is operated by the condenser gang when in the high-frequency position)
4) "gassy" type '24 tube. Try several new '24 tubes
Low volume ... 1) check aligning condenser at extreme right of tuning gang for high-resistance "leak" changed value of 0.25-meg. resistor from center-tap of push-pull input. Replace faulty 0.1-mfd. condenser mounted at the detector tube. Replace with new unit O.K.)
Oscillation between 550 and 750 kc ... 1) clean the contacts of all wiper fingers on tuning condenser rotor shaft. Tighten the fingers down, without restricting condenser movement. Align

GREBE G-AC

Inoperative (no plate voltage on detector) ... 1) "open" 2,500-ohm detector plate resistor. Also check the det. plate by-pass condenser between the resistor and chassis for a "short"
Inoperative (no plate voltages on tubes) ... 1) "open" bias resistor. The '26 bias resistor has a value of 95 ohms while that for the '71A has a value of 695 ohms
Oscillation ... 1) any tubes drawing high plate current are "gassy." Try new tubes in these sockets
2) faulty 1-mfd. by-pass condenser between ground and the two filament bus bars of the '26 tubes
Motorboating ... 1) faulty 750-ohm resistor and condenser which form a resistance-capacity filter to prevent motorboating

GREBE 7-AC Synchrophase

Inoperative ... 1) "shorted" tuning condenser
2) faulty push-pull input transf.
Oscillation ... 1) any tubes which draw a high plate current are "gassy." Try several new tubes in these sockets
Motorboating ... 1) faulty by-pass condensers between the intermediate and detector voltage supply points and ground. These form part of a resistance-capacity filter for eliminating motorboating

GREBE 89

Volume and sensitivity insufficient ... 1) substitute a 0.01-mfd. condenser for the 0.00005-mfd. unit located between the antenna and first r-f coil

GRIFFITH 20

Inoperative, volume weak ... 1) check 40,000-ohm carbon resistor attached to one end of Candohm and wired between plate of '27 first a-f and grid of 47's. Replace with 5-watt unit. Also replace 0.5-mfd. by-pass unit in the condenser block (red wire) with external 0.5-mfd. 600-volt unit
Intermittent reception, "Fuzzy" tone ... 1) check 0.1-mfd. 600-volt and 0.05-mfd. by-pass condensers

GRIMES SERENADER 0

Oscillation at low frequencies (tubes and voltages test O.K.) ... 1) high-impedance r-f coil primary windings. Detune the plate coil in the first r-f stage by connecting a 0.00005-mfd. condenser across it

GRUNOW—(ALL MODELS)

Rumbling at low volume ... 1) faulty volume control. On some models, the end plate of the chassis must be removed to solder the a-c leads in place, when replacing the volume-control unit

GRUNOW—ALL 1937 MODELS

Inoperative on broadcast band ... 1) broadcast-band oscillator coil "open"
2) faulty 6K C r-f tube

-50-

BUY DIRECT FROM THE MANUFACTURER AND SAVE

WE KNOW OUR PRICES ARE VERY LOW and expect a certain amount of skepticism from servicemen who have never purchased the SUPERIOR way, but five years of sticking to our way of doing business has convinced us and many thousands of servicemen who have purchased from us that it is a practical and mutually profitable way of doing business. We know that the average income of the Radio Serviceman prohibits his purchasing high-priced equipment, and yet the very nature of his work makes it necessary for him to use accurate, dependable and up-to-date equipment. We know we have solved the problem for him and our continually expanding business proves that servicemen recognize this claim to be true.

BESIDES THE THOUSANDS OF SERVICEMEN AND TECHNICIANS, THE FOLLOWING WELL-KNOWN NAMES ARE LISTED AMONG SUPERIOR INSTRUMENT PURCHASERS: Standard Oil Company of New Jersey; U. S. Dept. of Agriculture; U. S. Dept. of Commerce; U. S. War Department; C.C.C. Camps; National Youth Administration; Goodyear Tire and Rubber Co.; E. I. duPont de Nemours & Co.; University of Nebraska; Leland Stanford Junior University; Westminster College; Oberlin College; University of Michigan; Boston College; Pomona College; Board of Education, Remus, Michigan; Board of Education, City of New York; Board of Vocational Education, State of Illinois; City of Bartow, Florida; Florida State Dept. of Education; Educational Dept., Custer, North Dakota.



The New Model 1220 POCKET LABORATORY

- ★ WEIGHS ONLY 28 OUNCES!!
- ★ USES A 2% ACCURATE 0-200 MICROAMMETER—ENABLING MEASUREMENTS AT

5000 OHMS PER VOLT SPECIFICATIONS

- ★ 6 D.C. Voltage Ranges: 0-3-10-50-250-500-5,000 volts.
- ★ 3 A.C. Voltage Ranges: 0-15-150-1500 volts.
- ★ 4 Resistance Ranges: 0-3000 ohms, with 15 ohm center, direct reading to 0.2 ohm; foregoing base range multiplied by 10, by 100 and by 1,000, to read up to 3 Meg. with self-contained 3 V. flashlight battery.
- ★ D.C. Current Ranges: 0-200 microamperes; 0-2-20-200 Milliampères, using wire-wound shunts.
- ★ 3 Output Meter Ranges: Same as A.C. Voltage Ranges.
- ★ 3 Decibel Ranges: From -2 to +58 D.B., based on .006 watt in 500 ohms.

Model 1220 comes complete with cover, self-contained battery, test leads and instructions. ONLY **\$10⁴⁵**

THE NEW CHANNEL-ANALYZER

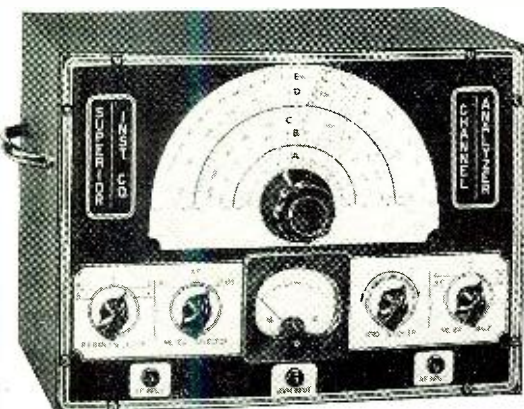

FOLLOWS THE SIGNAL

FROM ANTENNA TO SPEAKER OF ANY SET

The well-established and authentic SIGNAL TRACING METHOD of locating the very circuit in which there is trouble, and the very component that causes the trouble, is now for the first time available at a price any radio serviceman can afford.

THE CHANNEL-ANALYZER WILL

- ★ Follow the signal from antenna to speaker through all stages of any receiver ever made.
- ★ Instantly track down exact cause of intermittent operation.
- ★ Measure both Automatic-Volume-Control and Automatic-Frequency-Control, voltages and circuits without appreciably loading the circuit, using built-in highly sensitive Vacuum-Tube Voltmeter.
- ★ Check exact gain of every individual stage in receiver.
- ★ Track down and locate cause of distortion in R.F., I.F., and A.F. amplifier.
- ★ Check exact operating voltage of each tube.
- ★ Locate leaky condensers and all high-resistance shorts, also show opens.
- ★ Measure exact frequencies, amount of drift and comparative output of oscillators in superhets.
- ★ Track down exact cause of noise.

The Superior Channel-Analyzer comes housed in shielded cabinet and features an attractive etched aluminum panel. Supplied complete with tubes, three specially engineered shielded input cables, each identified as to its purpose. Also full operating instructions. Size 13" x 10" x 6". Shipping weight 19 pounds. Only **\$19⁷⁵**

Canadian Distributors; Radio Parts Supply Company, 962 Bleury St., Montreal, Canada

The New Model 1240 TUBE TESTER

Instantaneous snap switches reduce actual testing time to absolute minimum. Tests all tubes 1.4 to 117 volts.

Sockets for all tubes—No adapters.

SPECIFICATIONS:

- ★ Tests all tubes, 1.4 to 117 volts, including 4, 5, 6, 7, 7L, octals, octotals, Bantam, Jr., Peanut, single ended, floating filament, Mercury Vapor Rectifiers, the new S series, in fact every tube designed to date.
 - ★ Spare socket included on front panel for any future tubes.
 - ★ Tests by the well-established emission method for tube quality, directly read on the GOOD ? BAD scale of the meter.
 - ★ Jewel protected neon.
 - ★ Tests shorts and leakages up to 2 megohms in all tubes.
 - ★ Tests leakages and shorts in all elements AGAINST all elements in all tubes.
 - ★ Tests BOTH plates in rectifiers.
 - ★ Tests individual sections such as diodes, triodes, pentodes, etc., in multi-purpose tubes.
 - ★ Latest type voltage regulator.
 - ★ Features an attractive etched aluminum panel.
 - ★ Works on 90 to 125 volts 60 cycles A.C.
- Model 1240 comes complete with instructions and tabular data for every known type of receiving tube. Shipping weight 12 pounds. Size 6" x 7 1/2" x 10 1/4". Our Net Price **\$11⁸⁵**
- PORTABLE COVER \$1.00 ADDITIONAL



MODEL 1230 SIGNAL GENERATOR

WITH FIVE STEPS OF SINE-WAVE AUDIO

SPECIFICATIONS:

1. Combination R.F. and A.F. Signal Generator; R.F.—100 K.C. to 90 Megacycles, A.F.—200 to 7500 cycles; Sine-Wave—WITH OUTPUT OF OVER 1 VOLT. All direct reading, all by front panel switch manipulation.
2. R.F. and A.F. output independently obtainable, also on or with A.F. (any frequency) modulating R.F.



3. Latest design full-range attenuator used for controlling either the pure or modulated R.F.
4. Accuracy is within 1% on I.F. and broadcast bands; 2% on higher frequencies.
5. Giant dial etched directly on front panel, using a new mechanically perfected drive for perfect vernier control.
6. Operates on 90 to 130 V. A.C. or D.C. (any frequency).

The Model 1230 comes complete with tubes, shielded cables, molded carrying handle and instructions. Size 14" x 8" x 11". Shipping weight 15 pounds. Only **\$12⁸⁵**

SUPERIOR INSTRUMENTS CO.

136 Liberty St., Dept. RN6
New York, N. Y.

Real Power

**COSTS LESS
THESE DAYS ...**

In a little over a year the RCA-812 has become one of the most widely used, most highly praised triodes in the entire amateur field. And no wonder!

Here is a tube that delivers real power in true big-league style at the rate of over 60 watts input per dollar. The only low-priced tube with the Zirconium-Coated anode, the RCA-812 gives you 170 watts output with only 6.5 watts of grid drive; or, if you want still higher power, two 812's in class C telegraph service will take a plate input up to 450 watts with the exceptionally low driving power of only 13 watts!

Equally important, the RCA-812 is built to stand the gaff. Its Zirconium-Coated anode, an RCA development, has exceptional heat-dissipating qualities and, in addition, functions as a highly effective getter. The tube will take heavy temporary overloads and come back for more. In brief, the 812 gives you just about all any amateur could ask for—at a price within easy reach of all.

RCA-812 Medium-Mu Triode (ICAS RATINGS)

Plate Voltage . . . 1500 V. max.
Plate Input 225 W. max.
Plate Dissipation . . 55 W. max.
Amplification factor 29
Amateur Net, \$3.50 each.

HIGH-MU RCA-811

Similar to the 812, the RCA-811 has the extremely high mu of 160. Like the 812, it is unexcelled as an r-f power amplifier, frequency doubler, class B modulator, or oscillator.

NEW RCA TT-100 Transmitting and Special-Purpose Tube Chart

Contains comprehensive characteristics, descriptions, etc. See your RCA Tube and Equipment Distributor or send 10c to the Commercial Engineering Section, RCA Manufacturing Co., Inc., Harrison, N. J.

W3HFD's 812 R-F Unit

Frank Fenimore of Carol Park, Pa., gets outstanding results with a pair of 812's working either as buffer or as final in his 10-, 20-, and 80-meter transmitters. RCA Transmitting Tubes are used exclusively at W3HFD, and include 807's, 806's, 810's, 852's, 866's and 872's.



Transmitting Tubes

RCA MANUFACTURING CO., INC., CAMDEN, N. J. • A Service of The Radio Corporation of America.
In Canada: RCA Victor Company Limited, Montreal

