

RADIO'S FOREMOST MAGAZINE



# RADIO NEWS

AND

# SHORT WAVE RADIO

MARCH, 25¢

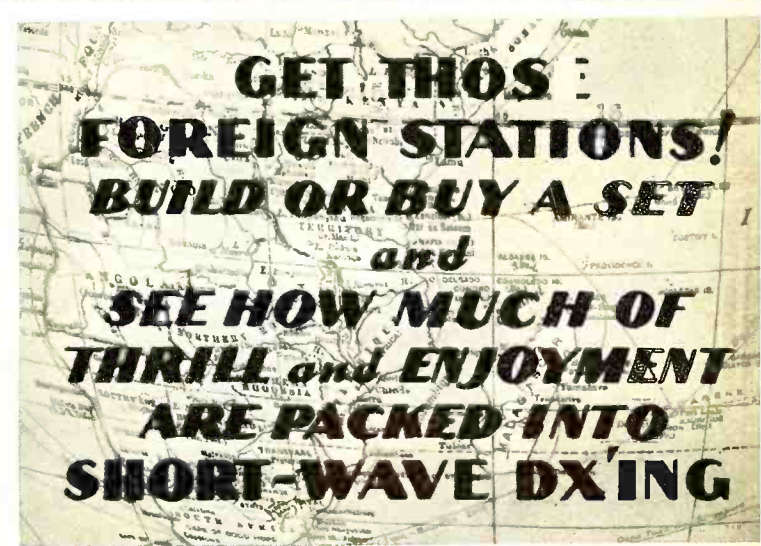

## NEW SIGNAL GENERATOR

A Publication Devoted to Progress in Radio

- |              |                  |              |
|--------------|------------------|--------------|
| Service Work | Set Building     | Television   |
| Engineering  | Short Waves      | Electronics  |
| Experiments  | DX Reception     | Broadcasting |
| Measurements | Amateur Activity | Applications |



Six YAXLEY  
Volume Controls  
Service More Than  
2500 Receivers

Yaxley  
Manufacturing Co.  
Division of  
P. R. Mallory & Co., Inc.  
Indianapolis, U. S. A.

APPROVED  
RADIO  
PRODUCTS  
are designed to meet the  
most exacting radio re-  
quirements and are made  
to give reliable and last-  
ing service.

All parts  
fully guaranteed

Yaxley  
Manufacturing Co.  
Division of  
P. R. Mallory & Co., Inc.  
Indianapolis, U. S. A.

APPROVED  
RADIO  
PRODUCTS

are designed to meet the  
most exacting radio re-  
quirements and are made  
to give reliable and last-  
ing service.

All parts  
fully guaranteed

Yaxley  
Manufacturing Co.  
Division of  
P. R. Mallory & Co., Inc.  
Indianapolis, U. S. A.



No service  
man can  
afford to be  
without this  
FREE re-  
placement  
wrench.



Here is the Most  
Complete Manual  
For Service Men  
Ever Published

## 3,000 Service Men Are Finding This Kit *Indispensable*

A few months ago Yaxley announced to the industry a new kit of six Yaxley Volume Controls that will service more than 2,500 set models, at a substantial saving over the regular list price.

To date, 3,000 service men in all parts of the country have availed themselves of this offer and are finding the kit indispensable in their daily work. They have discovered that it is a real saver of time and money.

They have also found that the beautifully finished wrench that is given free with each kit, or in exchange for the tops of 6 Yaxley Control cartons, is a mighty handy tool for a service man.

And then there is the free copy of the Yaxley Replacement Volume Control Manual—the most complete and authoritative service manual ever published, which tells all about the 30 new Yaxley Replacement Volume Controls that will service 98 per cent of the 3,200 set models now in existence. Mail the coupon today!

### YAXLEY MANUFACTURING COMPANY, INC.

Division of P. R. Mallory & Company, Incorporated  
INDIANAPOLIS, INDIANA Cable Address: *Pelmallo*

YAXLEY MANUFACTURING CO., INC.  
Indianapolis, Indiana

Gentlemen:

I enclose \$3.60 (which is 40% less than the regular list price of individual controls) for kit of 6 Volume Controls which entitles me to FREE Wrench.

I enclose 6 carton tops for FREE Wrench.

Please send free copy of Replacement Manual.

Name.....

Address.....

My Jobber's Name is.....



# WE'LL TRAIN YOU AT HOME IN SPARE TIME FOR A GOOD RADIO JOB



J. E. SMITH, Pres.  
National Radio Institute

## HERE'S PROOF

### Good Position Station WSMK



"I have a good job, make a nice salary, and all my success is due to N.R.I. I am operator of Station WSMK. I highly recommend the N.R.I. Course. It enabled me to pass the Government examination for an operator's license."

JOHN HAIDUK, JR., 21 Gerard Avenue, Southern Hills, Darton, Ohio.

### \$18 a Week in Spare Time

"Although I am doing only spare time Radio work, I have averaged \$18 a week. I recommend N.R.I. training. It is certainly a complete Course. In a short time, it will take a man, give him a sound fundamental training in Radio theory, practice and design." STEPHEN J. DRACHATY, 407 Wunderlich Ave., Barberton, Ohio.



### Nets about \$50 a Week besides Sales

"I have been getting along fine. I average ten calls a week, which nets me about \$50, not counting profits on sales. I have serviced almost every make of set and have earned more than I ever expected. I owe my success to the N.R.I. and its wonderful Course." BERNARD COSTA, 150 Franklin St., Brooklyn, New York.



# FREE:

### Radio Servicing Tips

Let me PROVE that my Course is clear, easy to understand and fascinating to study. Send the coupon for a free lesson, "Trouble Shooting in D.C., A.C., and Battery Sets." This interesting lesson gives 132 ways to correct common Radio troubles. I am willing to send this book to prove that you too can master Radio—just as thousands of other fellows have done. Many of them, without even a grammar school education, and no Radio or technical experience, have become Radio experts and now earn two or three times their former pay. Mail the coupon now.

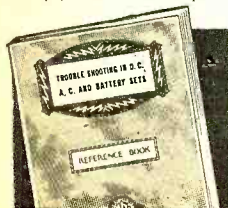

## FREE BOOK TELLS HOW MAIL COUPON

Act today for better pay. Act to break away from a low pay, no-future job. Act to get away from having to skimp, scrape to pay your bills. Mail coupon for my free 64-page book. It tells you how I will train you at home in your spare time to be a Radio Expert; about my training that has doubled and tripled the pay of many.

### Many Radio Experts Make \$40, \$60, \$75 a Week

Consider these facts—think of the good jobs they stand for. Over 17,000,000 Radio sets in use, over 600 broadcasting stations, over 40 large manufacturers of Radio sets, over 3,000 manufacturers of parts, over 100 Police Departments Radio equipped, airplanes and airports Radio equipped. Thousands of ships touching every seaport of the world are Radio equipped. Over 35,000 stores selling sets and parts, about 2,000,000 autos Radio equipped and about 20,000,000 unequipped. Loud speaker systems wherever people gather, indoors and outdoors. Commercial Radio stations dotting our coast lines. Radio a big industry—is growing bigger fast. A few hundred \$40, \$60, \$75 a week jobs have grown to thousands.

### Get Ready Now for Jobs Like These

A spare time or full time service shop; installing, maintaining, operating—broadcast, aviation, commercial, ship, television and police stations. A Radio retail business of your own. Installing, maintaining, servicing, loud speaker systems. A service or sales job with a store or jobber. I'll train you for good jobs in every branch of Radio.

### Many Make \$5, \$10, \$15 a Week Extra in Spare Time While Learning

Every neighborhood can use a good part time serviceman. I'll start giving you special instruction material, plans, ideas, the day you enroll, for making money in spare time. Get my book—read how many of my students make \$200 to \$1,000 in their spare time while learning.

Stanley Tuik, 2705 Hector Street, Montreal, Canada, writes—"I have been doing so much service work I haven't had time to study. In two months, I made about \$200 in spare time." Lloyd V. Sternberg, 217 Fourth Avenue, Willmar, Minn., tells me—"I earned enough in spare time to pay for my course. In one month I earned \$125 in spare time." Yes, my training pays!

### Your Money Back if Not Satisfied

I'll make this agreement with you. If you are not entirely satisfied with my Lesson and Instruction Service when you finish, I'll refund your tuition.

### Find Out What Radio Offers

Mail the coupon. My book of information on Radio's spare time and full time opportunities is free to any ambitious fellow over 15. Read what Radio offers you. Read about the training I offer you. Read letters from graduates—what they are doing and making. There's no obligation. Mail coupon in an envelope or paste it on a postal card—NOW.

J. E. SMITH, President  
National Radio Institute, Dept. 5CR  
Washington, D. C.

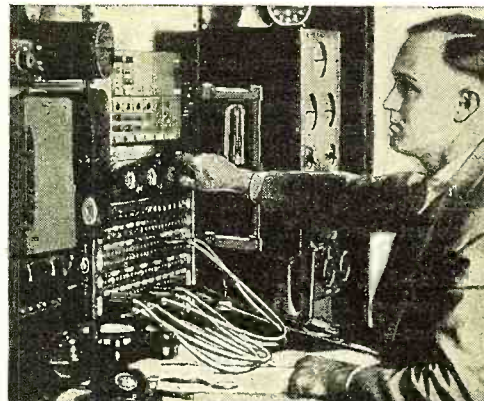

## SAVE MONEY—LEARN AT HOME

### Special Equipment Gives You Practical Experience

Hold your job. No need to leave home and spend a lot of money to be a Radio Expert. I'll train you quickly and inexpensively right at home in your spare time. You don't need a high school or college education. Many of my successful graduates didn't finish grade school. My practical 50-50 method of training—half with lessons, half with Radio equipment—gives you broad practical experience—makes learning at home easy, fascinating, practical and rapid. There is opportunity for you in Radio. Old jobs are becoming more complicated—many need better trained men. New developments are making new jobs. Short waves, loud speaker systems, police Radio, auto Radio, aviation Radio, television—Radio's newest uses are covered by my training. Here's a field that's growing. It is where you find growth that you find opportunity.

## I have doubled and tripled the salaries of many



## MAIL THIS NOW!

J. E. SMITH, President  
National Radio Institute, Department 5CR  
Washington, D. C.

Dear Mr. Smith: I want to take advantage of your Special Offer. Send me your two books, "Trouble Shooting in D.C., A.C., and Battery Sets" and "Rich Rewards in Radio." I understand this does not obligate me. (Please print plainly.)

NAME.....AGE.....  
ADDRESS.....  
CITY.....  
STATE..... "M"

## The Tested Way to BETTER PAY



March, 1935

Edited by LAURENCE M. COCKADAY

S. GORDON TAYLOR  
*Managing Editor*

WILLIAM C. DORF  
*Associate Tech. Editor*

JOHN M. BORST  
*Technical Editor*

SAMUEL KAUFMAN  
*Broadcast Editor*

EVERETT M. WALKER  
*Associate Editor*

JOSEPH F. ODENBACH  
*Art Editor*

## Reading Guide to this Issue—

As a matter of convenience for those having specialized interests in the radio field, the following lists the articles and features in this issue, classified under 14 heads. The numbers correspond with the article numbers in the Table of Contents on this page:

- Amateurs—6, 8, 11, 12, 13, 15, 16, 23, 26.
- Broadcast Fans—4, 5, 7, 10, 12, 21, 22, 23, 24, 26.
- Dealers—3, 5, 7, 15, 16, 17, 23, 25, 26.
- Designers—6, 8, 16, 18, 19, 23, 26.
- DX Fans—5, 7, 8, 9, 10, 12, 13, 14, 15, 21, 22, 23, 26.
- Engineers—6, 16, 18, 19, 23, 26.
- Experimenters—4, 5, 6, 7, 8, 11, 12, 13, 15, 16, 18, 21, 22, 23, 25, 26, 27.
- Manufacturers—16, 23, 26.
- Operators—11, 23, 26, 28.
- Servicemen—4, 5, 7, 12, 14, 15, 16, 17, 19, 20, 23, 25, 26, 27.
- Set Builders—3, 4, 5, 7, 8, 12, 13, 16, 19, 23, 25, 26.
- Short-Wave Fans—5, 7, 9, 10, 12, 13, 14, 15, 23, 26.
- Students—6, 8, 13, 18, 19, 20, 23, 25, 26, 27.
- Technicians—4, 5, 7, 13, 17, 20, 23, 25, 26.

## Next Month—

The April issue will provide a wealth of helpful information for the short-wave fan on receiver design and construction, short-wave antennas, new commercial receivers, a new world-distance map, a complete wavelength-frequency conversion chart, etc., in addition to the regular Short-Wave DX Corner and World-Wide Short-Wave Time Table.

For the Experimenter: Short-wave coil design, information on inventions and patents, and applications of the new 12A7 tube.

For the Amateur: A new "Ham" crystal superheterodyne receiver, the "Ham" shack.

For the Serviceman: Profits in group hearing aids, controlled high-fidelity, interference eliminating antennas, new receivers, etc.

1	Dots and Dashes.....	532
2	Radio Facts and Oddities..... <i>By H. T. Elmo</i>	534
3	Radio Set Building..... <i>Editorial</i>	535
4	Home-Built "High-Fidelity" Receiver..... <i>By John M. Borst</i>	536
5	How to Build the Browning '35..... <i>By Glenn H. Browning</i>	538
6	Designing Saturable Reactors..... <i>By Myron J. Brown</i>	540
7	The "All-Star" Junior All-Wave Receiver..... <i>By Laurence M. Cockaday</i>	542
8	Experiments with Multiple Regeneration..... <i>By J. Plebanski</i>	544
9	Capt. Hall's Short-Wave Page..... <i>By Capt. Horace L. Hall</i>	546
10	13-550 Meter Superheterodyne Receiver..... <i>By S. Gordon Taylor</i>	547
11	The "Ham" Shack..... <i>By Everett M. Walker</i>	548
12	Short-Wave Converter Design..... <i>By S. Gordon Taylor</i>	549
13	Improving Your Regenerative Receiver..... <i>By Robert Hertzberg</i>	549
14	The DX Corner for Short Waves..... <i>By Laurence M. Cockaday</i>	550
15	World Short-Wave Time-Table..... <i>Compiled by The Editors</i>	553
16	New Type of Carbon Resistor.....	556
17	A New Rack-and-Panel Amplifier (Part 2)..... <i>By B. J. Montyn</i>	557
18	First Aid to Inventors (Part 5)..... <i>By E. E. Free, Phd.</i>	558
19	An All-Wave Signal Generator (Part 2)..... <i>By John H. Potts</i>	560
20	Radio in Aircraft (Part 4)..... <i>By Henry W. Roberts</i>	562
21	Sunset to Sunrise with Foreign DX (Part 2)..... <i>By R. H. Tomlinson</i>	563
22	The DX Corner for the Broadcast Band..... <i>By S. Gordon Taylor</i>	564
23	The Technical Review.....	568
24	Backstage in Broadcasting.....	570
25	The Service Bench.....	572
26	What's New in Radio.....	574
27	Students' Radio Physics Course.....	576
28	QRD?.....	578

Published Monthly by Teck Publications, Inc., Washington and South Avenues, Dunellen, N. J.

Lee Ellmaker  
*President and Treas.*

B. Holcepl  
*Secretary*

H. D. Crippen W. P. Jeffery  
*Advertising Management*  
Virgil Malcher  
205 W. Wacker Dr., Chicago  
*Western Representative*

EDITORIAL AND EXECUTIVE OFFICES

461 EIGHTH AVENUE, NEW YORK CITY, N. Y.

Entered as second class matter at the Post Office at Dunellen, N. J., under the act of March 3, 1879. Copyright, 1935, by Teck Publications, Inc., in U. S. and Canada. All rights reserved. Registration of title of this publication as a trade mark applied for in United States Patent Office. Printed in the United States of America. The contents of this magazine must not be reproduced without permission. We cannot be responsible for lost manuscripts, although every care is taken for their safety.

25c a Copy, \$2.50 a year,  
\$3.00 in Canada, \$3.50 in  
Foreign Countries. Sub-  
scribers are notified that  
change of address must reach  
us five weeks in advance of  
the next date of issue.

# 'LL LET MASTERPIECE OWNERS TELL YOU THE STORY!



McMurdo Silver

## CERTAINLY NO ONE KNOWS BETTER WHETHER THIS IS ACTUALLY THE FINEST RADIO OF ALL TIME

None can contradict that "the proof of the pudding is in the eating." So, the value of a particular radio may well be gauged by what a number of owners get from it. The owners who report below know radio.

They've all owned a great many receivers. They selected the MASTERPIECE after long experience, thorough investigation, test and comparison. They expected much. You judge whether they got it!

### Quiet Operation

"The first thing that strikes a prospect is the quiet operation, for with a carrier above noise level, the ear can detect no indication of action when no signal is being received . . . the next is the clear and brilliant tone."—F. J. Reese, 78 Main St., Hacketts-town, *New Jersey*.

### Perfect Reproduction

"Since 1919, I have spent endless energy, time and money in my search for perfect mechanical reproduction of sound.—For several years, I have been rather hopeless about it. Now, at last you have provided PERFECT RECEPTION with PERFECT REPRODUCTION.—Music is my profession and pleasure . . . I am sure you cannot know what it means to me to have here at my command the symphony concerts of the world; flooding the house, in full volume, sans distortion, sans apology, tolerances, compromises; with straight line amplification curve, from the 32 foot pedal octave to the highest violin harmonics, and beyond; consequently with absolute realism, full dynamic values and all the thrilling dramatic qualities which are so sadly flattened out in ordinary reception."—Horace Middleton, The Firs, South Millbrook, *New York*.

### World-Wide Reception

"For workmanship, material, tone and reproduction of programs, it is the best by far" . . . (He now includes a short wave reception log showing all North Americans, Bolivia, Paris, Berlin, London, Canada, Japan, Argentina, Madrid, Portugal, Switzerland, Australia, Brazil, Cuba, Colombia, Ecuador, Venezuela, Africa, Russia, Vatican and many others not definitely identified, and observes that "this is good for Oregon")—F. H. Bohn, Box 542, Klamath Falls, *Oregon*.

### South Pole in Colorado

"Upon my return from a meeting last night, Mrs. Finch reported receiving KFZ (Little America) direct . . . Reception clear and free from background noise . . . England, Germany and Spain are daily occurrences with us to amazement of our friends.—One former radio dealer remarked 'the first one I ever heard here that could deliver short wave reception which didn't sound like a bucket of coal falling downstairs!'—I am mildly insane over the set."—Donald F. Finch, 764 Gilpin St., Denver, *Colorado*.

### Foreigners Clear as Locals

"I am greatly pleased with my new receiver for its fine tone and selectivity.—Foreign stations are free from distortion, no fading and as clear as local broadcast."—Henry D. Hannah, Mansfield, *Conn.*

### Alabama Casts Its Vote

"I have now had my MASTERPIECE III about two months and although I am using a makeshift 30-foot, one wire antenna, I am getting any and everything."—J. M. Reed, Bay Minette, *Alabama*.

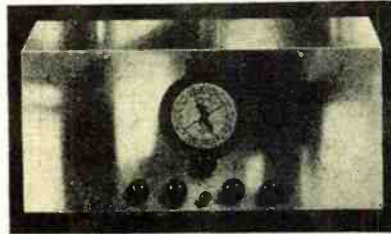

## MASTERPIECE III

With new Watch Dial—new Bandsread—class A Prime Audio—Single Channel Selectivity—Fractional Microvolt Sensitivity, controllable for all locations and conditions.

### Stands the "Third Degree" of Expert Scientists, Too

That this is no ordinary radio is eloquently proven by its widespread choice and unstinted praise by acknowledged experts. Major Glen, British scientist, after testing 47 of the world's "best" allwave receivers chose the MASTERPIECE alone as capable for his exacting research in transmission phenomena . . . Dr. Wm. C. Bostwick of Ithaca, N. Y., after exhaustive tests brands the MASTERPIECE as incomparable . . . Paramount sound technicians sought a receiver proficient enough to produce performance results so startling as to be NEWS. Thus they chose MASTERPIECE III for Bing Crosby and Richard Arlen who have now smashed all DX reception records. . . . Columbia Broadcasting System uses MASTERPIECE III in their New York Studios to bring Europe into the heart of New York's business district . . . Chosen as a result of comparative tests made by Navy officers, MASTERPIECE III now serves aboard Uncle Sam's flagship U. S. S. Pennsylvania, most completely radio equipped ship in the U. S. Navy . . . In all radio history, no receivers were ever given such gruelling tests as that made by Admiral Byrd's radio adviser in selecting the MASTERPIECE for use on the greatest of all Antarctic expeditions . . . Mr. Cyril Mockridge, famous musical authority, creator of many immortal musical backgrounds for Fox Films, selected MASTERPIECE for its musical superiority . . . Can you go wrong in following the lead of these known authorities, when you select your allwave receiver? Why deny yourself this kind of radio performance?

### Reaches Out—Easy to Tune

"The tone is best I have heard (including the so called hi-fidelity sets) . . . The ability of the MASTERPIECE to reach out and pull in foreign stations with such volume and tone and hold them is beyond me . . . also very quiet on short waves. The bandsread dial is great and makes short wave stations easier to tune than long waves on some sets.—Tuned in almost everything including Japan."—Gene Morris, 5022 Bienville, New Orleans, *Louisiana*.

### 10 K. C. Selectivity Plus!

"Impossible to speak of mine as a radio, because it is not at all like the instruments we have come to know as radios.—Music reproduced is smooth, soothing, fully rounded, has great depth and you hear all the treble and bass notes.—None can match the low noise level and wonderful sensitivity. Selectivity? Only one I've found to cut out local WBZ, 990 KC, whose antenna is ¼ mile away! and bring in WOC, Des Moines, 1000 KC without slightest bit of cross talk."—Wm. L. Riley, Jr., Belmont Hotel, Springfield, *Mass.*

### 10,000 Miles—No Noise!

"Getting most consistent reception of foreign stations—England and Germany every day, Admiral Byrd direct, Australia clear as a bell with absolutely no noise. Impossible to talk merits of the MASTERPIECE—it just has to be demonstrated."—Jas. F. Overton, 924 Pizer Ave., Houston, *Texas*

### An Ohioan Speaks

"I put up my RCA antenna and tried for distant stations. Picked up from West Coast: KIHQ, KGW, KFI, KPO, XEBC, KGO, KGA, KNX, KEE (7797 KC) . . . very good this time of year. On short waves my quick log covers: DJD, GSD, CJRX, EAQ, IRM, GSB, PRF5, COH, TIEP, PRADO, HJAJAB, CJRO, YV3BC, VE9GW, GSA, DJC, COC, XEBT."—H. G. Eichorst, 2535 Burnet Ave., Cincinnati, *Ohio*.

### In Peruvian Desert

"It is a splendid radio and the entertainment received over it, as well as world news, is a source of keen enjoyment to me and my wife, here on a Peruvian desert."—John D. Hall, Negritos, *Peru, S. A.*

### No Fading—Real AVC

"No trick to tune GSB, GSA, DJC, DJB, FYA, 2RO and EAQ with tremendous volume almost every day, no fading. Heard Byrd direct several occasions. Broadcast dial is a peach—KFI, KPO, KSL and others too numerous to mention come in like locals in the evening."—Louis Hausotter, 1500A Destrahan St., St. Louis, *Mo.*

## 10 DAY FREE TRIAL

Send now for the "Blue Book of Radio" and abundant proof that this is really the finest radio of all time. Learn how I let the receiver itself do its own selling job with you, through a 10 days' test right in your own home. Also a Questionnaire covering your location for advice as to proper installation. All is FREE, no obligation. Mail the coupon today!

## MAIL COUPON

McMURDO SILVER, INC.  
3352C N. Paulina Street, Chicago, U. S. A.  
Send me full particulars and specifications of MASTERPIECE III.

Name.....  
Street.....  
Town.....State.....

**McMURDO SILVER, INC.**  
3352C No. Paulina Street. Chicago, U. S. A.



**Sales of Radio Sets Attain All-Time High During 1934**

NEW YORK—After fifteen years of radio broadcasting we find this era of ether transmission so deeply entrenched in all the ramifications of modern life that few pause to realize that it was only in 1919 that the first broadcasting station started to operate. From even the last few years of economic difficulties the industry has emerged with interest in its products at a new high pitch and manufacturers have proved their versatility and resourcefulness by rising above the adverse circumstances encountered. During the past year there was an almost uninterrupted month-to-month gain in sales, with the demand for all-wave receivers impervious to the usual period of summer dullness. Automobile, motorboat and portable sets tended to help create this situation and the introduction of all-wave sets at prices within the reach of the multitude has been one of the outstanding contributions. Radio sales for the whole country averaged 40 percent larger than for 1933 bringing total sales to 5,350,000 for 1934 as compared to the previous peak of 4,438,000 for 1929.

**Ultra Short Waves Help Studies**

NEW YORK—Recent experiments with 5-meter transceivers made at the School of Commerce, New York University, demonstrated the feasibility of using ultra-short-wave sets for inter-classroom communication for lectures and two-way communications. During recent demonstrations Assistant Dean Edward Kilduff lectured to assembled classes direct from his



**DOTS . . . . .**  
**and**  
**— — — DASHES**

**Short but Interesting Items from the Month's Radio News the World Over**

office. In another demonstration Dr. C. C. Clark, in charge of the Science Department, spoke to the class from his home on a similar set. The short-wave instruments employed were National transceivers.

**Marconi and Alexanderson Honored**

SCHENECTADY, NEW YORK — Dr. E. F. W. Alexanderson, Consulting Engineer of General Electric Company, noted for his contributions to radio, and the famous inventor, Senatore Marconi, have been elected to membership in the Royal Academy of Science of Sweden.

**Doctors Hear Nervous System Broadcast**

NEW YORK—Three hundred astonished physicians attending the annual meeting of the Association for Research in Nervous and Mental Diseases held here recently heard sounds amplified from the nervous impulses sent out from the lungs to the

**ULTRA SHORT WAVES IN EDUCATION**

*In recent experiments at New York University, Dr. C. C. Clark addressed classes holding a two-way conversation and lecture between his home and the classroom in the School of Commerce. Photo at left shows the scene in the classroom. Photo at right shows Dr. Clark reading lecture. (Another photo appears in the DX Corner for Short Waves.)*



**PACIFIC TELEPHONE LINK**

*The three pictures above illustrate the new Tokio-Dixon Trans-Pacific radiotelephone recently inaugurated. At left is the speech "garbler" panel for insuring secrecy. Center: The receiving station at Komuro, and at right Chiduko Kashiwagi, the Japanese telephone operator who will handle all calls*

brain of a cat. They made a noise resembling machine-gun fire. The experiment was made by Dr. Detlev W. Bronk, Director of the Eldridge Reeves Johnson Foundation for Medical Physics at the U. of P. Standard vacuum-tube amplifiers were used.

**Two Great American Companies Combined**

CAMDEN, NEW JERSEY—Consolidation of the RCA Radiotron Company with RCA Victor Company into a single organization to be known as the RCA Manufacturing Company, Inc., was announced recently by Mr. E. T. Cunningham, President of the new company.

**President's Cabinet Makes New Record**

WASHINGTON, D. C.—The Roosevelt administration made new records in broadcasting in 1934 according to the NBC. The President made 23 broadcasts during that year. The Vice-President made one radio speech and each member of the Cabinet spoke at least once, or a total of 78 appearances on the air. Postmaster General Farley spoke 22 times during this period.

**Long Distance Records Broken**

CHATHAM, MASSACHUSETTS—Spoken greetings flashed across 8905 miles of space last week when a British mail pilot flying over Persia exchanged greetings.  
*(Continued on page 568)*

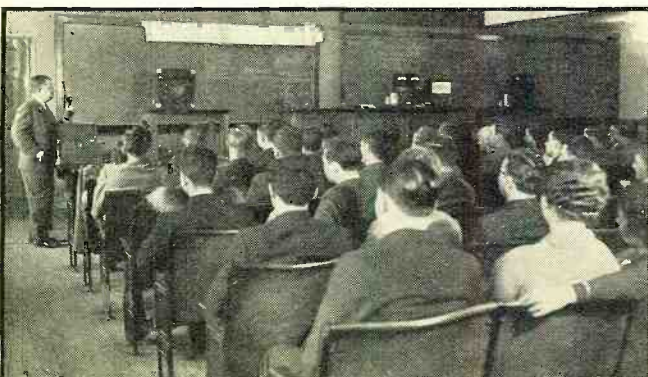

# Be a RADIO EXPERT

## THE ONE MAN IN 1000 WHO CAN SERVICE MODERN RADIO RECEIVERS

**RADIO SERVICE WORK NOW OFFERS GREATEST OPPORTUNITIES SINCE RADIO BEGAN . . . . .**

Radical changes have taken place in radio receiver design during the past year. Circuits and construction are very different from the receivers with which the radio service industry has had its greatest experience. Even more sensational developments with further complications are coming next season. Who will service these receivers? Certainly not the "old timer" who knows nothing about modern receivers! He can't do it. That is why, right now, there is an urgent demand for reliable service men with up-to-the-minute knowledge of modern radio receivers. Such men can step right out and earn up to \$3 an hour doing nothing but pleasant service work in the better homes around town.



**THIS CIRCUIT ANALYZER AND POINT-TO-POINT RESISTANCE TESTER INCLUDED FREE OF EXTRA CHARGE.**

*Also*  
**FOUR LARGE KITS OF HOME PRACTICE EQUIPMENT . . . .**

**No Past Experience Needed**

Past experience actually counts for little at this time, because the swift changes in receiver construction have made knowledge of old equipment practically useless. Even though you may not know one tube from another today . . . still, you can take R.T.A. training and make more money servicing modern radios than most of the "old timers" are making. R.T.A. graduates are doing it every day. Many of them are making more money as R.T.A. Certified Radio Technicians than they ever made in their lives before!

**Be An R. T. A. Man and You'll Be the One Man in 1000**

R.T.A. training will equip you to give fast, complete service to any radio receiver built. The jobs that puzzle and sometimes baffle the usual service man will be simple as "A.B.C." to you . . . when you become an R.T.A. Certified Radio Technician. It is very possible that you will be the only service man in your locality able to quickly diagnose and quickly repair the new types of radio receivers. Be the one man in 1000! You *can*.

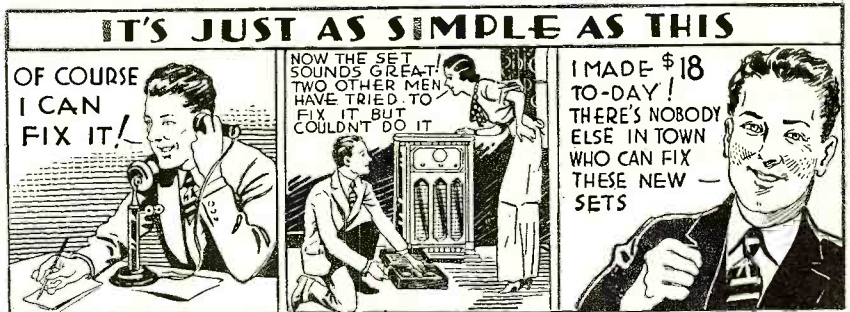

**R.T.A. Membership Keeps You Ahead of Competition**

With your course of training, and without extra cost, you get a valuable lifetime membership in R.T.A. This gives you a big advantage over ordinary service men . . . because we constantly furnish *advanced* information to our members . . . information that puts money in your pocket while the other fellow is stumbling around in the dark.

**To Start You Making Money Right Away**

Quickly following your enrollment for training with R.T.A. you get, *without extra cost*, the R.T.A. Set Analyzer and Resistance Tester . . . the handiest piece of portable service equipment ever devised. Instantly helps you locate the trouble in any type of receiver, old or new, and shows you precisely what to do about it.

**SEND COUPON**

A. G. Mohaupt, Engineer  
Radio Training Ass'n. of America  
Dept. RN-53, 4513 Ravenswood Ave., Chicago, Ill.

Dear Mr. Mohaupt: Please send me your free book of facts about radio opportunities and how I can make big money quickly. Also tell me how I can obtain your Set Analyzer and four big experimental outfits—FREE OF EXTRA CHARGE.

Name.....  
Address.....  
City..... State.....

**RADIO TRAINING ASSOCIATION of AMERICA**  
4513 Ravenswood Avenue CHICAGO, ILLINOIS

# RADIO FACTS and ODDITIES ....

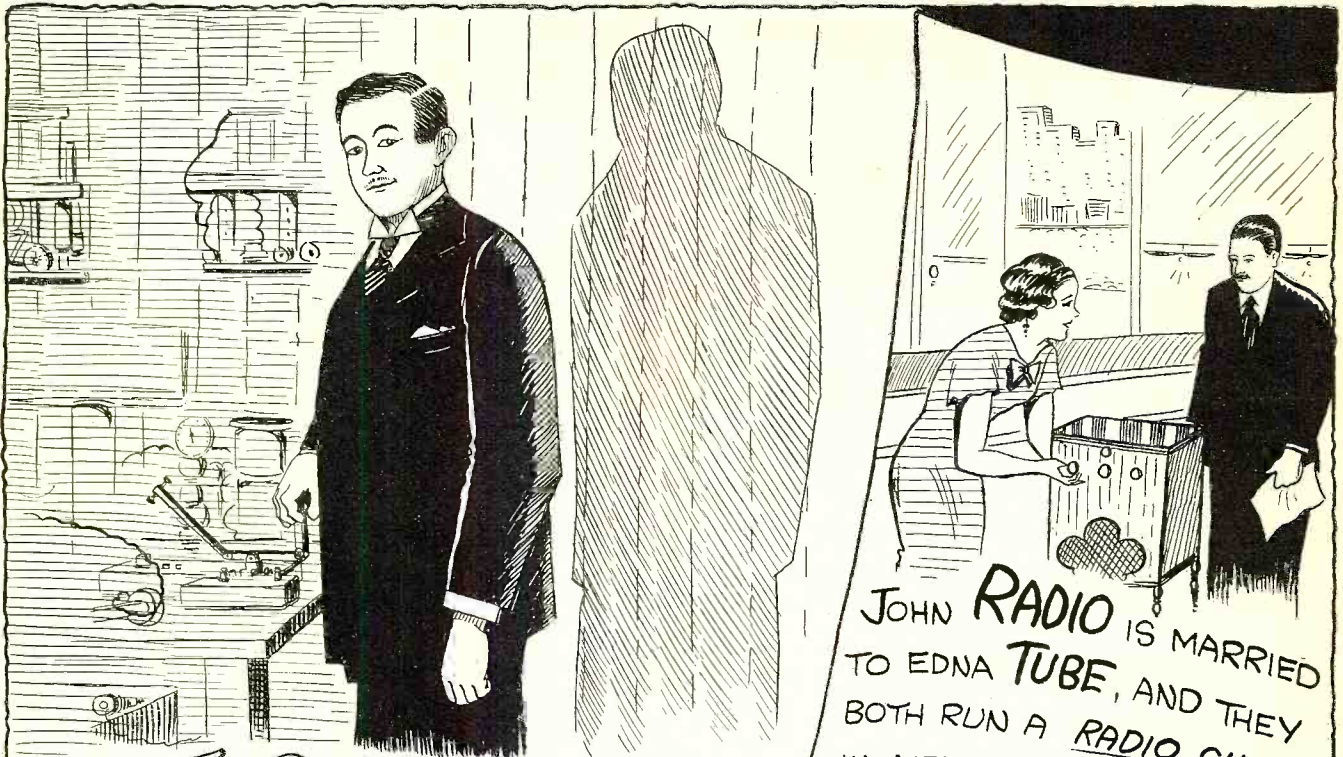

JOHN RADIO IS MARRIED TO EDNA TUBE, AND THEY BOTH RUN A RADIO SHOP IN MELBOURNE, AUSTRALIA!!!

**THE FIRST** RADIO SIGNAL ACROSS THE ATLANTIC OCEAN WAS RECEIVED BY MARCONI AT ST. JOHN, NEWFOUNDLAND, FROM POLDHU, ENGLAND, A DISTANCE OF 1800 MILES, IN FEB. 1901 ..... IT CONSISTED OF THE LETTER **S** ...



**THE FIRST** INTERNATIONAL RADIO CONFERENCE WAS HELD IN BERLIN, BACK IN 1904!!

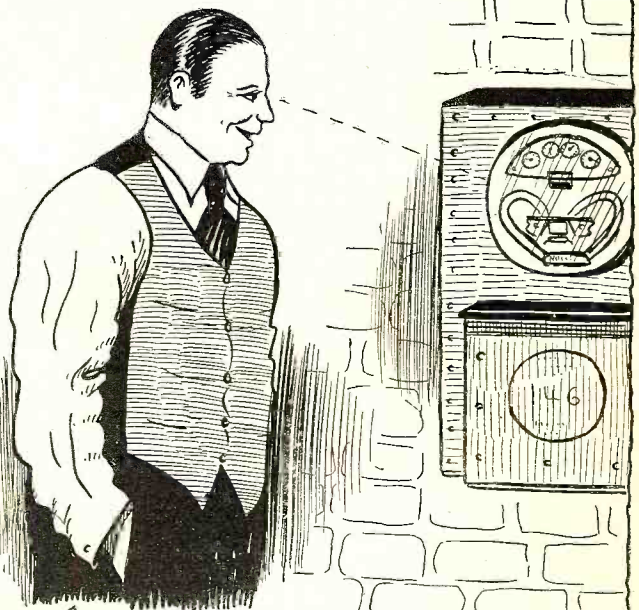

THE ELECTRICITY CONSUMED BY THE AVERAGE RADIO SET COSTS LESS THAN 1/2 CENT AN HOUR!!!



# Radio News

March, 1935

## RADIO SET-BUILDING

*(The Editor—To You)*

Most Americans really enjoy doing things with their own hands and co-ordinating their workmanship with their own individual brain power. That is why Americans have always been interested in radio construction. Recently set-building has been growing in popularity, in leaps and bounds; at least, that is how it is with RADIO NEWS readers

SET building as a hobby seems to have engaged the interest of more radio fans recently than at any time since the popular home-construction days of 1924. People, young and old, are turning to set building at home to enable them to listen in to short-wave transmissions from all over the world. It is true that the increase of activity on the short waves has had a lot to do with this revival of interest, but it is also true that people want to build not only short-wave sets, but sets that will bring in the regular broadcast-band transmissions.

Today's increasing group of set builders are better informed than they were ten years ago. They do not build any old circuit that comes along, but seem to have learned how to tell when a *really good set* is brought to

their attention. They want the latest development in circuits and in construction, incorporating the new multi-purpose tubes, automatic volume control, beat-frequency oscillators, band-pass filters, distortionless demodulators and amplifiers. They want a simple but good-quality output circuit. They require the use of good loudspeakers to give good reproduction. They want the latest and most efficient methods of noise reduction, along with good sensitivity, in their antenna equipment.

Realizing these needs of a large number of radio experimenters who have been "steady customers" in the more experienced set building field as well as the thousands of new recruits who have been turning to set building during the past year, RADIO NEWS has specialized in the better designs *(Continued on page 567)*

### THE THRILL THAT COMES FROM TUNING IN DISTANT STATIONS

*Some experimenters go in for 1, 2 or 3-tube sets exclusively. Others have felt the urge to build and operate larger sets up to 4, 5, 6 and even 7 or 8 tubes. But whether it be 2 tubes or 10, the accomplishment lies in getting results and in tuning in hard-to-get stations on the other side of the world with an instrument you have built with your own hands*

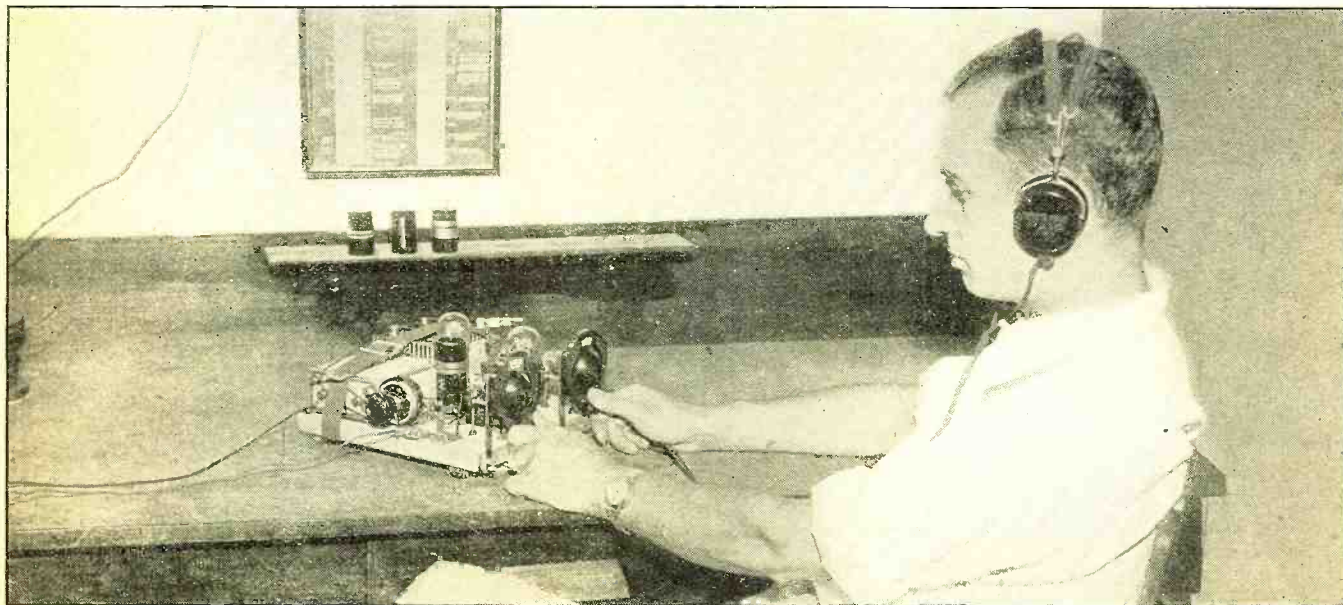

# A HOME BUILT RECEIVER "HIGH-FIDELITY"

The receiver illustrated and described  
RADIO NEWS, whose primary interest  
of receiving apparatus for the lifelike

John M.



LOUDSPEAKER MOUNTING

The speaker is mounted on a small wooden base which is bolted to a rubber pad. This pad in turn is clamped to the top of the large wooden block.

INDIVIDUALS differ in their idea of the "perfect" receiver. Some want the best of quality and never listen to anything farther away than 50 miles while others want to receive stations from the Antipodes regardless of quality. The owner, builder and designer of the set illustrated here is Mr. W. W. Kuhlman of Woodcliff, N. J. It was Mr. Kuhlman's idea to build a receiver which would have the best tone quality possible within a price range of approximately \$100. Incidental requirements were attractive appearance and ease of operation.

Most people do not like to get up out of a comfortable chair to change the tuning of the receiver or adjust the volume control. Although it is possible to have a remote control conveniently placed, this system has its complications. It was therefore decided to separate the loudspeaker from the set, to place the receiver where it would be convenient to tune, and locate the loud speaker where it sounded best. This arrangement also eliminates one source of microphonism.

DETAIL OF BAFFLE

Figure 2. The baffle is made of four pieces of Celotex cemented together. The edge of the center hole is beveled, improving the appearance. (See photograph)

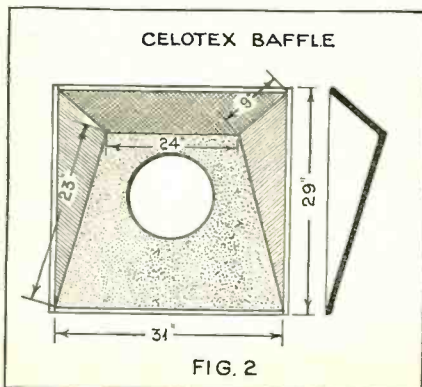

Above then, are the requirements the receiver had to meet. Let us see now how the problem was solved. For high fidelity it is undesirable to have too much selectivity, and therefore no attempt was made to reach any greater degree of selectivity than was necessary for adequate separation of "local" stations. Thus, a superheterodyne was out of the question, since even the broadest of its kind cut sidebands. Also, the frequency conversion causes some noise.

So it was decided to employ a t.r.f. circuit, a diode detector and as few audio stages as possible with an output stage of Class A triodes in push-pull (See Figure 1) The r.f. section consists of three tuned stages employing the 58 type tubes. Sensitivity is controlled both in the antenna and in the cathode circuit of the first two stages. It is essential that a good potentiometer be used here in order to avoid noise. All plate, screen and cathode circuits are filtered.

Since the diode detector places quite a load on the circuit, the selectivity of this stage is usually so poor that an untuned circuit can logically be employed. The three previous stages give satisfactory selectivity to receive the best local station and more was not required.

There have been receivers which used untuned stages and some of the transformers can still be picked up. The transformer employed in this receiver was a DeForest D2 iron core r.f. trans-

former. After several others were tried this one was found to give the most even response at frequencies between 550 and 1500 kc.

The triode section of the 55 tube serves as the first audio amplifier. It works at a fixed bias and is coupled to the output stage by an Amertran D21 input transformer. The transformer primary does not carry the plate current; a shunt feed arrangement being employed. Note that the cathode circuit is bypassed by a 10 mfd condenser and that resistance-capacity filters are employed in grid and plate circuit.

When the phonograph is used, it is necessary to cut in an extra audio stage. This is accomplished by SW2 (Figure 1). The switch is a four-pole-double-throw Yaxley switch. It changes the input and output of the 56 stage and also turns on the 56 filament. There is then a second switch to change over from radio to phonograph (SW1). Since the volume of radio programs is regulated by a control in the r.f. amplifier, a second volume control is incorporated in this second a.f. stage. With this system of switches it is possible to add one a.f. stage when receiving radio programs—by moving SW2 only—but this is not needed.

The output stage is quite conventional except that the bias resistor is adjustable so one can set it for minimum harmonic distortion. The output transformer is a Jensen, the one that

REAR VIEW OF RECEIVER

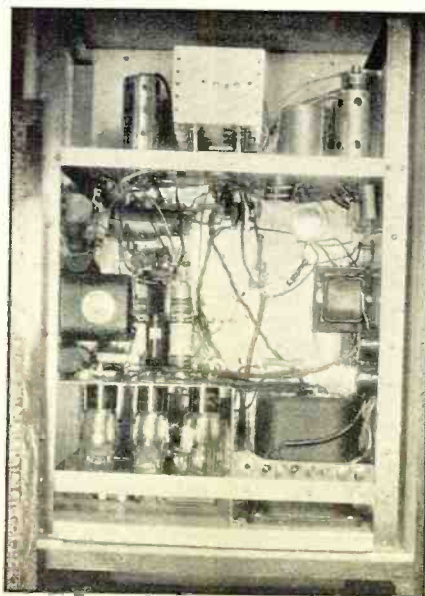

MOUNTING DETAILS

Figure 3. Speaker is mounted on a rubber pad, which in turn is bolted to a wooden block, thereby insulating the speaker from the cabinet. Spaces between speaker, pad and wood block are shown exaggerated for the sake of clarity

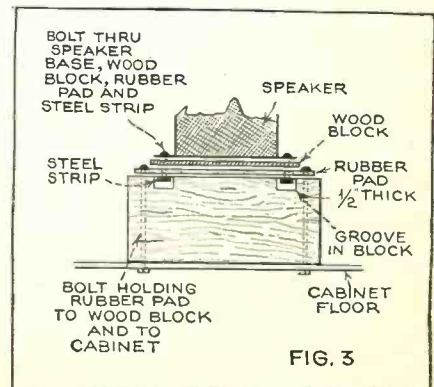

# DESIGNED FOR RECEPTION

here is one constructed by a reader of in radio experimentation is the design reproduction of local radio programs

## Borst

comes with the speaker. It is mounted inside the set, and 20 foot leads run to the voice coil.

The power pack is also quite conventional. The power transformer is an Amertran WA321, the chokes are Thoradson and the condensers are made by Aerovox. However, other makes of good quality can be substituted.

The radio cabinet was made to order by a cabinet maker but the panel was made by Mr. Kuhlmann himself and is stained a dark mahogany.

The construction of the set itself as shown in the photographs includes some noteworthy ideas. The chassis carries a pair of steel brackets on top. These serve as a stand when the set is turned upside down so that one can work on it without hunting for supports to fit the irregular height of various parts above the chassis.

It will be noticed in the rear view that the power tubes and rectifier hang upside down. This was done to keep the heat of the tubes away from the electrolytic condensers and yet have the connections short.

The speaker is a Jensen type M-10 auditorium speaker with an a.c. field. This speaker had to be supplied with a baffle large enough and yet reasonably good looking. It is well known that in

order to effectively hear low notes the size of the baffle would have to be large, 1/2 wavelength across, and this would mean 11 feet at 50 cycles. The best solution seemed to use some kind of a cabinet, which makes it possible to have more baffle area in less space, but precautions must be taken to avoid cabinet resonance. The construction of this baffle and speaker cabinet are unique and contribute a great deal to the excellent quality.

Cabinet resonance, so Mr. Kuhlmann reasoned, is caused by sound reflecting from parallel surfaces or from double reflections at right-angled surfaces. The idea then is to avoid right angles and parallel surfaces in the cabinet. Furthermore, the speaker and the baffle had to be mounted in such a way as to prevent the transmission of vibration from speaker to cabinet.

Figures 2, 3 and the photographs show how this was accomplished. The speaker has been mounted in an inclined position and the baffle consists of four pieces of celotex, cemented together. The odd angles are clearly shown in Figure 2 and in the illustrations. This celotex baffle was placed into a wooden cabinet, but insulated from it by strips of sponge rubber. The cabinet is not

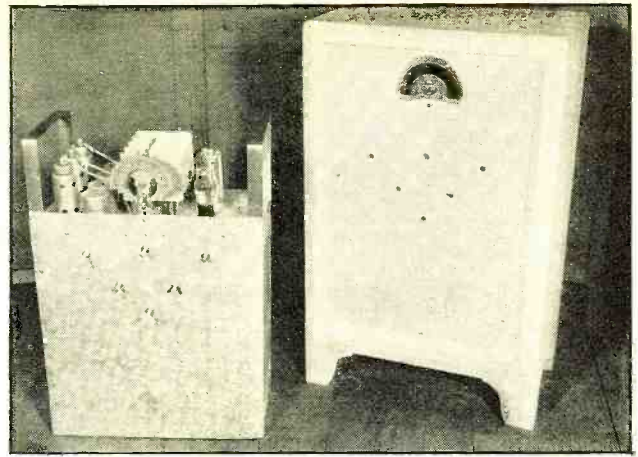

RECEIVER-AMPLIFIER CHASSIS

a square box but the opening at the back is much wider than at the front.

The speaker itself was bolted to a piece of wood having the proper slant to fit against the inclined baffle. This wood rests on a sponge rubber mat which in turn is fastened to the wooden blocks below. The speaker itself is thereby mechanically insulated from the cabinet. This is shown in Figure 3.

The cabinet was made to order by a cabinet maker; it is constructed of approximately 3/4-inch oak. It is 48 inches wide at the rear, 34 inches wide in front, 32 1/2 inches high and 18 inches deep. The special baffle was cut to order and cemented by the dealer in celotex. The cabinet was finished in black and the celotex was given a coat of gold paint.

The writer went to Mr. Kuhlmann's home to listen to this set. Several programs on the larger local stations were tuned in and also programs on the smaller stations. It was found that the speaker will reproduce at full volume without a trace of cabinet resonance. It has apparently a wide frequency range, for the lower bass-viol notes and organ notes—those (Continued on page 567)

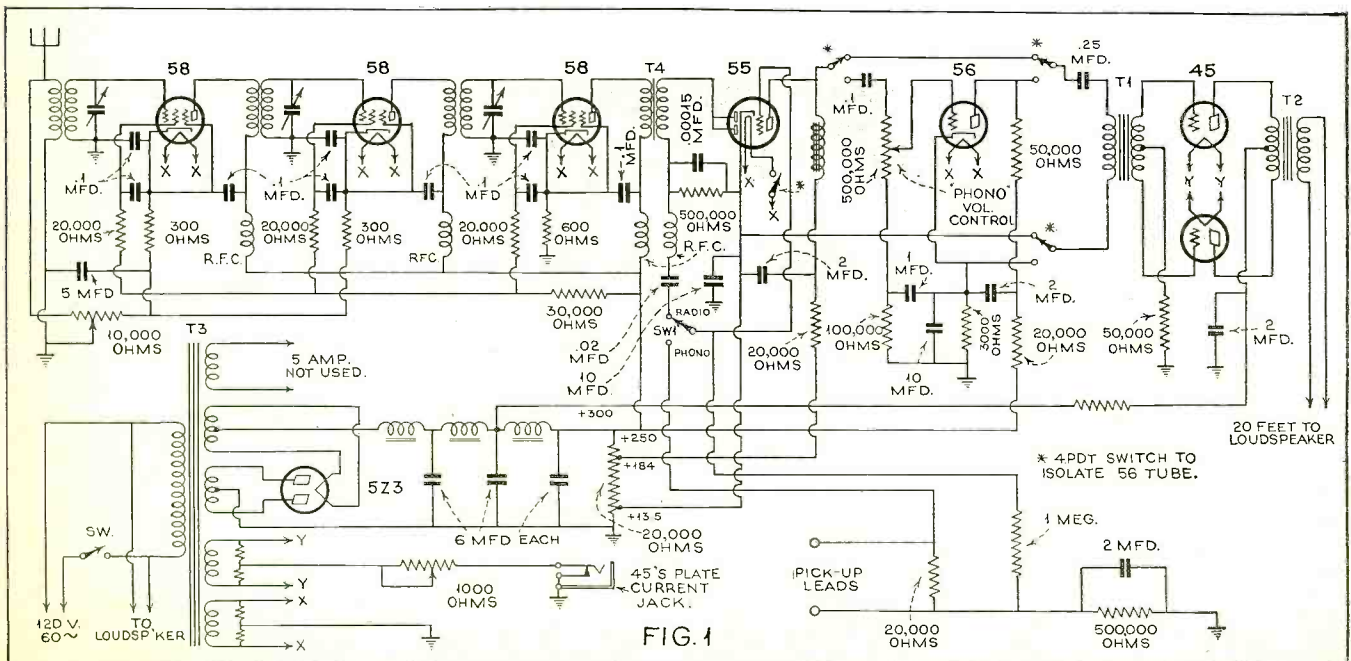
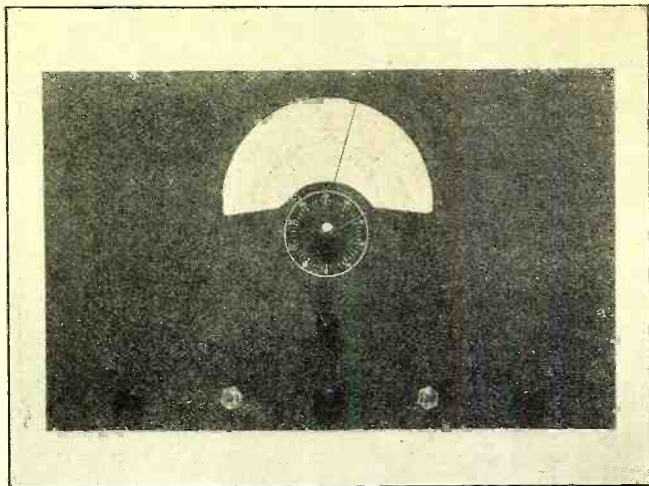

FIG. 1

# The "HOW TO BROWNING

(By Glenn H. Browning)



FRONT PANEL LAYOUT

*This view of the Browning 35 shows the neat and efficient layout of the front panel, with a new type tuning dial that should prove to be a DX'er's paradise*

A FEW years ago all-wave receivers which were designed for maximum efficiency all used plug-in coils. Today, however, equal efficiency may be obtained by carefully designed switching arrangements, and in the years to come the writer ventures to predict that coil switching is the only method that will be used where more than one band is frequently used in the same receiver. The reason for this is obvious. In a plug-in arrangement there are two wiping contacts for each coil, while in coil switching one contact per coil is all that has to be changed. True, the other coils that are not being used at that time should be short-circuited, but advance switch design has solved that problem for the engineer. Other considerations that must be observed for high efficiency are low losses and low capacitances in the switch itself. These points have been given serious consideration and today switches are available with silver contacts, insulated with low-loss materials and mechanically designed to have low capacities between their various conducting elements.

THE writer has, for the last year, felt that there was a demand for an all-wave kit so designed that the average set builder would have no difficulty in putting it together easily and in obtaining good results. It is also believed that most experimenters and amateurs will welcome an efficient coil-switching tuning unit. With that object in view work was started on the set to be described in this series of articles. It is not within the scope of this article to give the details of the design difficulties which were encountered. It suffices to say that all were finally overcome and that the final model is one that I can give my honest O. K.

The superheterodyne circuit I have evolved incorporates several features I think worth mentioning. As will be

### NEAT AND SELECTIVE

*A rear view of the receiver, showing the center unit, which is furnished complete. Figure 2, at right, is a comparison of the band-pass intermediate-frequency amplifier selectivity and an ordinary i.f. amplifier using high-Q tuning circuits*

Here is the latest creation of the Drake receiver. A brand new set principles. The Editors feel that in forming a distinct service to all Radio tending Post Observers to whom high

Part

noted from the wiring diagram in Figure 1 a stage of tuned-radio-frequency amplification precedes the detector on all wave-bands, thus giving added selectivity which eliminates image frequencies and harmonics, as well as materially adding to the sensitivity of the receiver. This will be especially appreciated by those who have used short-wave receivers consisting of only a tuned detector and oscillator.

In order to obtain greater selectivity and at the same time finer quality, a band-pass "filter" intermediate stage is used between the 2A7 and the 58. This band-pass filter consists essentially of three separate tuned circuits. Each of the three inductances are tuned, and in turn made up of three individual "pies". The effect of the "pie" construction gives a much sharper tuning coil than may be obtained by a lumped inductance of the same value. The gain in selectivity obtained by this construction alone is about 16%. The use of "pies", together with the three tuned circuits, results in a resonance curve for the intermediate stage which has a band width of only 25 KC at 100 times input voltage, and a band width of 5.5 KC at 2 times input voltage.

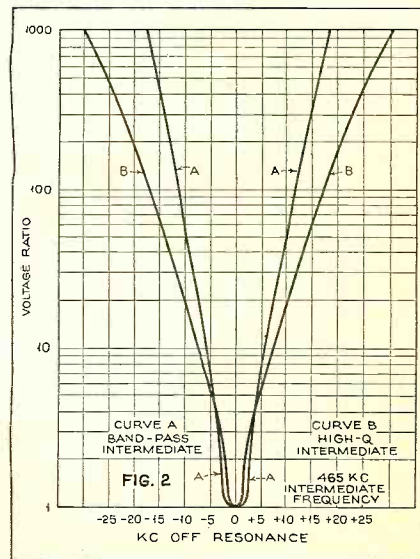
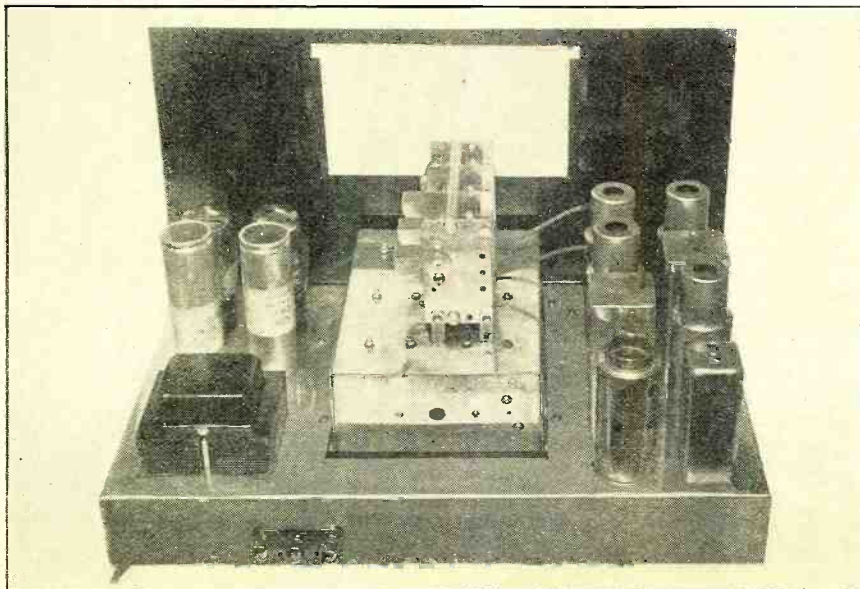

BUILD''

# 35!

designer of the famous Browning-incorporating a startling array of new publishing this series they are per- Experimenters and Short-Wave Lis- signal-to-noise ratio is important

One

The ordinary high-Q intermediate stage has a band width of 36 KC at 100 times input voltage and 3.3 KC wide at 2 times input voltage. It will be noted from the figures just given that not only does the band-pass intermediate stage have greater selectivity but also will give better quality as the "nose" of the curve is broader, thus passing the higher modulating frequencies readily. Figure 2 gives a graphical representation of these facts.

Automatic volume control is obtained by the use of a 2A6 tube for the detector amplifier. A switch is arranged so that the AVC may be turned off at will. An auxiliary volume control (on the cathode of the 58 tube), when retarded, precludes any possibility of this tube over-loading and causing cross modulation even under the severest conditions.

The receiver has a sensitivity of well under one microvolt (over its entire range which is from 23 megacycles to 550 kilocycles) so that in practice this additional volume control on the 58 RF tube can be well-retarded except under

the best conditions when atmospheric static is exceptionally light.

A 2A7 is used as a mixer and oscillator. As is well known this tube electronically couples the incoming signal with the oscillator's signal without interaction between the tuned-detector input and the tuned-oscillator circuit. As used in this set, the second grid (anode grid) is parallel fed through a resistance of 20,000 ohms. This allows the switch arm on the oscillator tickler coil to be at low d.c. potential and at the same time "evens out" the voltage delivered by the oscillator over the bands covered.

A beat-frequency oscillator is included as an integral part of the set so that CW signals may be received.

THE FUNDAMENTAL CIRCUIT

Figure 1. The fundamental circuit application for the new receiver. The builder, however, has to wire only a part of this, as the tuner section comes completely mounted and wired, requiring only seven connections to the rest of the set

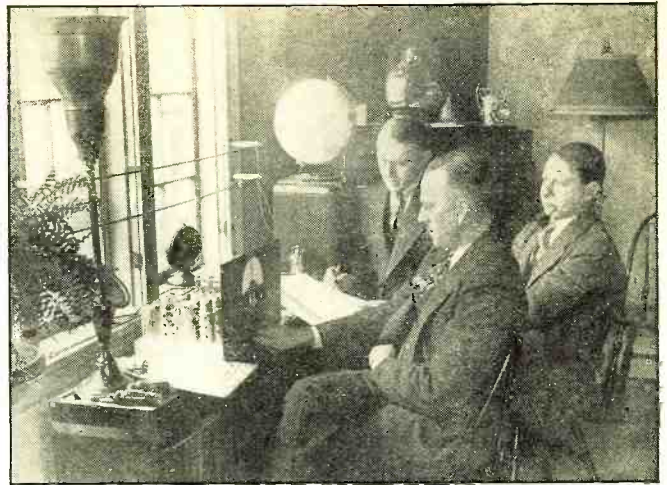

DURING AN ALL-NIGHT TEST Seated at the control is the designer, with an operator and "ear-witness" at the Westchester Listening Post. This test started at 6 p.m. and lasted until 2 p.m. the next day

Coupling from the oscillator to the intermediate-frequency stage is obtained through the suppressor grid of the 58 tube. A switch in the plate of the 56 tube oscillator turns off heterodyning frequency. A semi-variable condenser is used to tune this oscillatory circuit. For maximum signal strength this circuit should be tuned about 1000 cycles, above or below the intermediate frequency. The intermediate frequency is 456 KC, which was chosen after a great deal of experimenting with the band-pass filter design.

The heart of the set is really the Tobe Tuner which is essentially a "catacomb" in which the twelve tuning and oscillator coils are mounted. For each of the four bands there are three sets of coils, one for the tuned-antenna circuit, one for the tuned-radio frequency amplifier, and one for the oscillator circuit. These coil sets are all shielded from each other so that the tuning of one will in no way react on the others. In each of the three compartments there are four coils, that is, the oscillator (Continued on page 546)

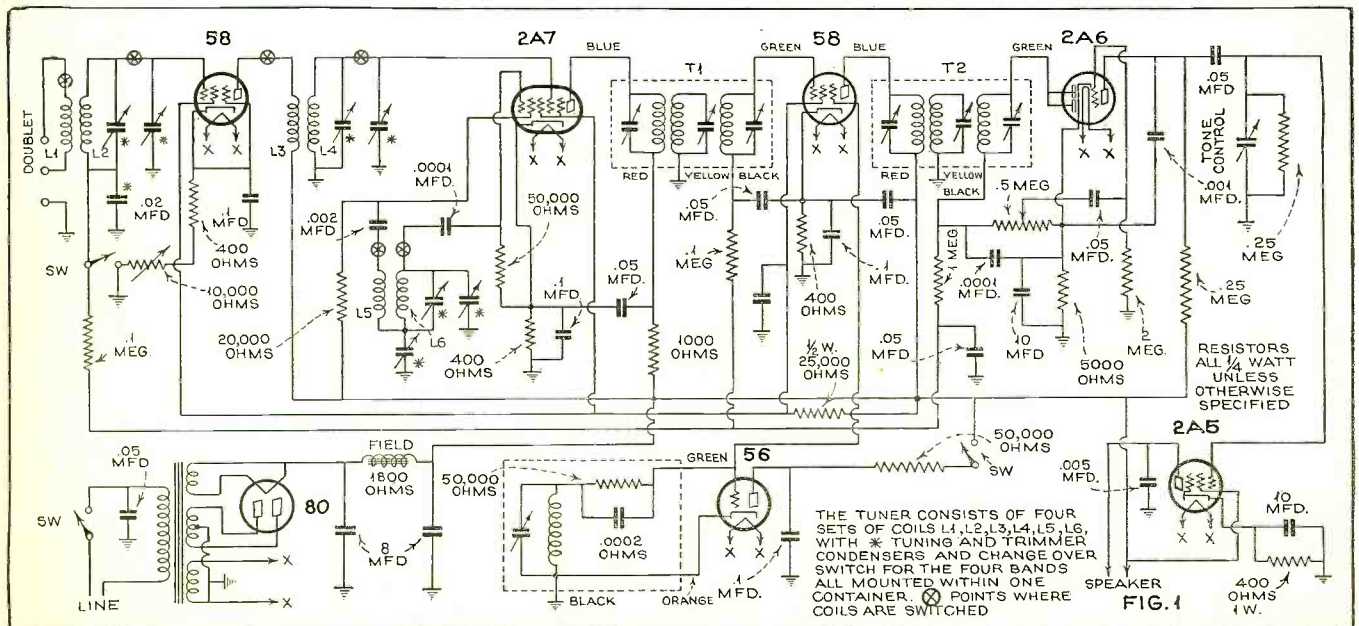

# The Design of SATURABLE REACTORS

Minute vacuum-tube regulation of heavy a.c. loads is made possible by this device

Myron J. Brown

THE unlimited number of applications that can use the delicate and sensitive control offered by vacuum tubes has always been a fascinating study for experimenters and designers.

A radio impulse, a beam of light, a sound wave, or a change in temperature when transformed into electrical energy, is capable of energizing the grid of a vacuum tube. Many applications of these vacuum tube circuits controlled by these physical quantities can be made when the output of the tube circuit controlled is great enough to be used to regulate lights, motors, electric ovens, generators, or the action of other electrical devices. The designer is often thwarted in developing new uses for vacuum tubes when he finds that the amount of power available from easily procured tubes is inadequate for the direct operation of the device that he wishes to control.

If a simple off and on operation is sufficient, magnetic contactors (relays) operated by the plate current of the tube are suitable. But in cases where a gradual gradation of the current applied to an electrical device is desired, some other means of current amplification is necessary. In this case, provided the circuits to be controlled are a.c. circuits, saturable reactors have been found very satisfactory. A saturable reactor is a closed core reactor that can be magnetically saturated by the d.c. output of a vacuum tube. About 100 times the power output of the tube can be controlled. Thus a 2 watt radio tube can control a 200 watt load.

Commercial applications use the saturable reactor as a control for the large

lighting loads in theatres. Vacuum tubes and grid glow tubes furnish the direct current. Another application employs the reactor as a control for a neon lamp tuning indicator on automatic volume control sets.

It is possible to control the temperature of quartz crystal ovens by vacuum tubes if the saturable reactor is used to adjust the current through the heating coils. Thermocouples would be used in the grid circuit, biasing the tube so as to raise or lower the oven current as needed. Numerous other applications come to mind, such as radio controlled lights, varying in brilliancy with the strength of signal received; line voltage regulators; generator voltage regulators; and photo electrically controlled devices.

### The Principles of Operation

A schematic diagram of a saturable reactor is shown in Figure 2. Two a.c. coils, having an equal number of turns, are mounted on the outer legs of the reactor core. They are connected in series. The inner leg is wound with a d.c. coil.

With no current flowing in the d.c. coil, the a.c. windings form a closed core reactor whose impedance is roughly determined by the number of a.c. turns and the amount of iron in the magnetic circuit. The a.c. magnetic circuit of the reactor is indicated by the solid line in Figure 3. Under the condition where there is no d.c. flux the impedance of the a.c. circuit is high and the amount of current passed will be low.

When a current is passed through the d.c. coil a flux is set up in the paths indicated by the dotted lines of figure

3. The d.c. flux magnetizes the iron and makes it less receptive for additional magnetic flux from the a.c. coils, hence the a.c. impedance is lowered and more current will flow through the a.c. circuit. A.C. impedance can be reduced to 10 or 20 percent of its maximum value by saturating the reactor with d.c. flux. Reactors can be built to handle any amount of power from a few watts to many kilowatts.

Vacuum tubes with high plate current will be found to have the best characteristics for operation with saturable reactors. Radio tubes such as the 45, 50, 71A, can be used. Industrial tubes are used with the larger reactors. Grid glow tubes, thyratrons, externally controlled vapor rectifiers, and power amplifiers such as the RJ563, and DRJ 564 are suitable.

A wiring diagram of a simple reactor circuit is shown in Figure 4 where a small direct current from a battery is used to control the brilliancy of lamps in a large a.c. lighting load. Since the reactor is a series impedance there is very little power lost in it. Hence this circuit is far more efficient than one in which the brilliancy of the lamps is controlled by a series resistance. For a one kilowatt lamp load only ten watts is required of the battery. A vacuum tube applied to the same circuit is shown in Figure 5.

The first step in the design of a reactor is to find the requirements of the a.c. load being controlled. For an example let us consider a one hundred watt lamp load such as indicated in Figures 4 and 5. About 10 volts through a tungsten filament lamp will cause the

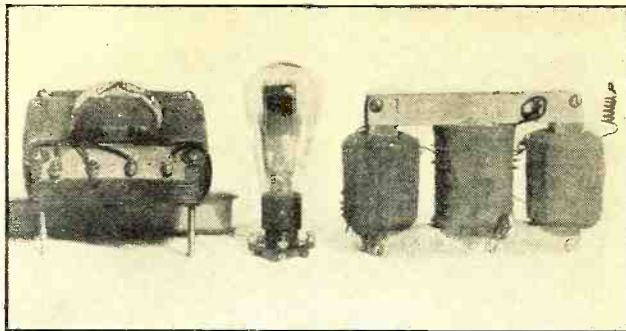

THE MODELS

Here are shown two reactors each of which when actuated by a type 45 tube is capable of controlling a 60-watt load

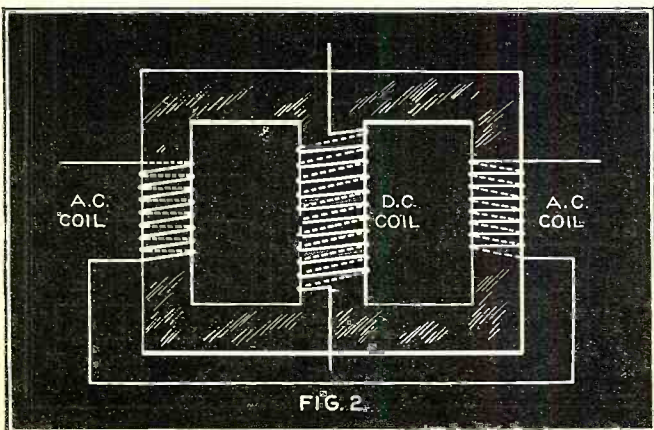

FIG. 2.

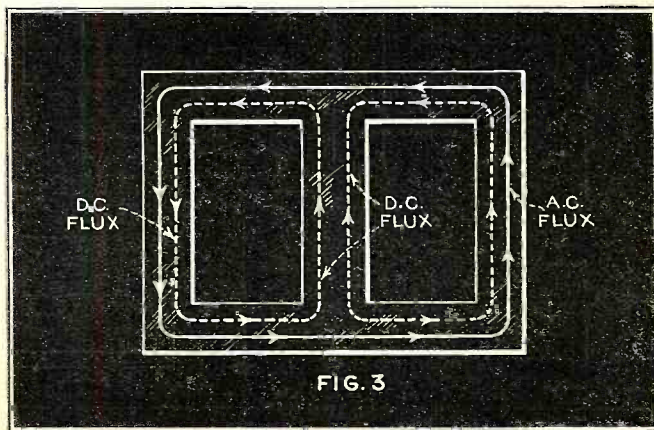

FIG. 3

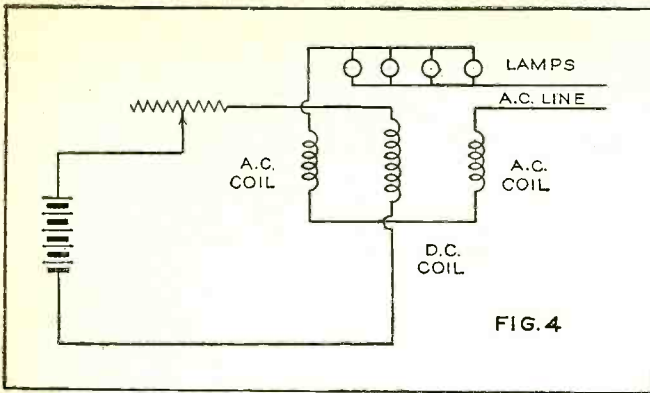

FIG. 4

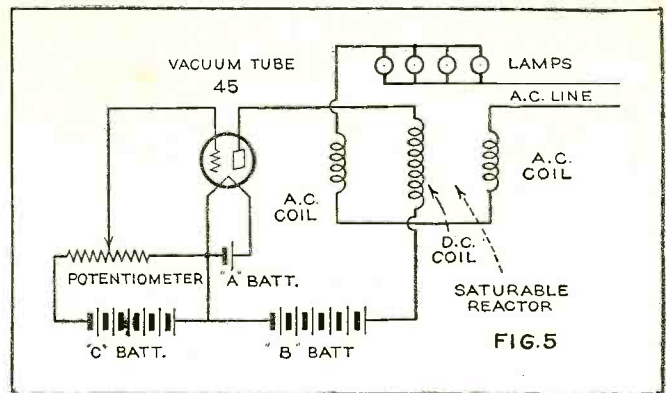

FIG. 5

filament to be just visibly red. Hence this value could be considered as an ample minimum voltage for the lamp load. Its maximum voltage will be the lamp rating, 115 volts. It is preferable to deal with current so we find the lamp current corresponding to these two voltages. At 10 volts the current is about 18% of its 115 volt value. The decrease in resistance of the filament with a decrease in temperature explains why the current is not proportional to voltage.

The full load and minimum load currents will be found as follows:

$$\begin{aligned} \text{Full load current} \\ \text{Lamp wattage} \\ = \frac{\text{Lamp voltage}}{100 \text{ watts}} \\ = \frac{115 \text{ volts}}{100} = .870 \text{ ampere} \end{aligned}$$

$$\begin{aligned} \text{Minimum load current} \\ = .18 \times \text{Full load current} \\ = .18 \times .87 = .157 \text{ ampere} \end{aligned}$$

The line voltage will be the sum of the lamp voltage and the reactor voltage drop at full load. Assume that the line voltage will be 15% higher than the lamp voltage. Therefore it will be 132 volts for 115 volt lamps.

For design purposes it is well to neglect the voltage across the lamps at minimum load and assume that the total line voltage is across the reactors.

Summarizing the requirements for dimming a 100 watt 115 volt lamp, we find that we need a reactor capable of changing a lamp load current from .157 amperes to .870 amperes. The maximum voltage across the a.c. windings will be 132 volts.

### The a.c. Coils and Core

The volts per turn will vary with the size of the reactor being designed.

A good value for this can be found from the law:

$$\begin{aligned} \text{Volts per turn} \\ = .0034 \times \sqrt{\text{Maximum load wattage}} \end{aligned}$$

Apply this law to the 100 watt reactor design:

$$\text{Volts per turn} = .034 \times \sqrt{100} = .340$$

The number of a.c. coil turns will be found from the equation:

$$\begin{aligned} \text{A.C. Turns} = \frac{\text{Maximum Voltage on a.c. coils}}{\text{Volts per turn}} \end{aligned}$$

$$\text{This gives } 132 / .340 = 388 \text{ turns.}$$

The cross sectional area of the core in each outer leg is found from the equation:

$$\begin{aligned} \text{Area (sq. in.)} = \frac{375 \times \text{volts per turn}}{\text{a.c. frequency}} \\ \text{Area} = \frac{375 \times .340 \text{ v. p. t.}}{60 \text{ cycles}} = 2.12 \text{ sq. in.} \end{aligned}$$

A core is sketched in Figure 6. The number of core sizes which will give a certain core area is unlimited, however there is only a certain range of sizes which gives desirable designs. No definite law can be set down for selecting a stamping so the usual method is a trial and error selection from the types available. Generally a core stack ("c" dimension in Figure 6) of 2 to 6 times the width of the outer leg ("a" in Figure 3) is suitable.

In selecting core dimensions a check must be made on the a.c. saturation

value. When the a.c. ampere-turns per inch of length of the a.c. magnetic path through the iron exceeds a certain value the iron becomes saturated without the action of the d.c. coil. Hence the d.c. coil has less effect than it would have on an unsaturated core. The ampere turns per inch are found by the following formulae (the letters "d", "e", and "a" refer to the stamping dimensions of Figure 6):

$$\begin{aligned} \text{Ampere turns per inch} = \frac{[(\text{Total a.c. turns} \times \text{max. alternating current}) - (60 \times \text{number of joints in a.c. flux patch})]}{(2d + 2c - 4a)} \end{aligned}$$

While it is general practice to alternate the stampings in a shell core assembly so that the joints come first on one side of the coils and then on the other, there is still a joint or air gap between the "e" piece and the straight stamping that must be considered.

Applying this formula to our 100 watt reactor, using a stamping of the following dimensions,

$$\begin{aligned} a = 1\frac{1}{8} \text{ inch; } b = 1\frac{3}{8} \text{ inch; } d = 7 \text{ inches; } \\ e = 5\frac{1}{4} \text{ inches; } \frac{1}{4} \text{ inch thick;} \end{aligned}$$

$$\begin{aligned} \text{Ampere-turns per inch} = \\ \frac{[(388 \text{ turns} \times .87 \text{ amperes}) - (60 \times 2)]}{1} \end{aligned}$$

$$\begin{aligned} & \times \frac{1}{14 + 10\frac{1}{2} - 3\frac{3}{4}} \\ = \frac{388 - 120}{20\frac{3}{4}} = \frac{268}{20.75} = 9.5 \text{ turns per in.} \end{aligned}$$

Values up to 10 ampere-turns per inch will be satisfactory. Above this point it is well to increase the volts per turn and recalculate the design for the corresponding number of turns and core area.

Having (Continued on page 583)

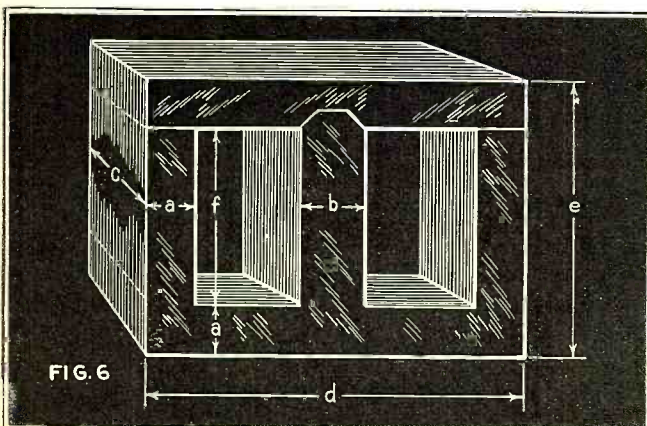

FIG. 6

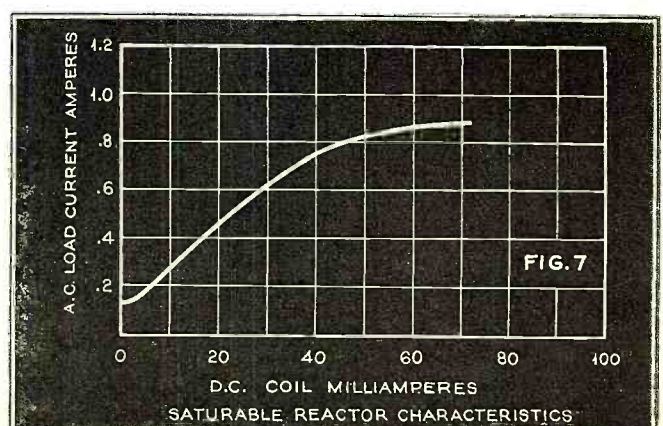
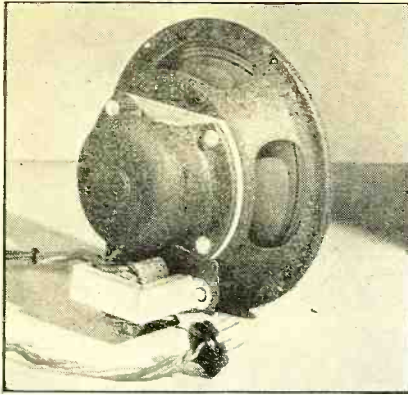

FIG. 7



**LOUDSPEAKER RECOMMENDED**

*This is the small but efficient speaker recommended for use with the new All-Star Junior.*

# Build the "ALL-STAR"

Here is a simplified design for a home-constructed receiver for all-wave reception, from 10 to 550 meters. The design was produced to work efficiently with standard parts, available through radio dealers

**Laurence M. Cockaday**

**L**IKE its predecessor, the All-Star Junior receiver is completely band-spread for all frequency bands between 30 megacycles and 545 kilocycles. Each band may be selected with the two knobs which operate the tank condensers; thereafter the tuning is accomplished with the master airplane type dial. Its pointer travels over a 270° arc, thus spreading out the tuning of each range and spacing the closely-grouped trans-oceanic stations far enough apart to permit accurate logging.

A new circuit, much easier to wire than that employed in the previous model, uses new high-gain coils and i.f. transformers. The amplification secured by the 6A7 tube and the 6F7 tube with the 77 pentode detector is practically the same as that obtained with the first four tubes of the original All-Star set. A desirable feature is the manner in which the tank condensers eliminate the need for an oscillator padding condenser. This, with the pre-tuned i.f. coils, makes special adjustments unnecessary. The Junior receiver is ready to operate when the last wire is soldered in place. The power-pack contains a "brute-force" type filter system which effectually eliminates a.c. hum from the reception. A standard type 80 rectifier tube is employed.

The intermediate-frequency amplification is extremely high, due to the use of

new i.f. coils, with the shielding spaced far enough from the electro-magnetic fields of the coils to have negligible damping effect. This added spacing eliminates most of the eddy-current

losses which would otherwise be present at 370 k.c. Each i.f. transformer employs a tuned primary and tuned secondary, the impedance of which is matched to the characteristics of the 6F7 and the 77 tube. The choice of the i.f. band for the receiver was the result of extensive experiments, greater gain and reduced harmonics and image frequencies being secured at this range.

Six pairs of coils are recommended, for complete coverage of the 10 to 550 meter range. Each pair of coils consists of one antenna and one oscillator coil. The frequency coverage of each pair slightly overlaps the range of the following pair of coils to assure complete coverage without skips. The pin-plugs on the base of the antenna coil fit a standard 4-hole tube socket, while the oscillator coil has five pins which fit a standard 5-hole tube socket. These coils may be inserted with no more difficulty than putting sugar in your coffee. No shielding is employed on these coils, due to the high losses which shielding introduces in the field of high-frequency coils. The All-Star Junior is a receiver designed for the short-wave fan who builds his own and who wants world-wide reception and broadcast on the same set.

Construction plans for the Junior have been simplified by the use of three pictorial wiring layouts, each showing a successive portion of the wiring.

**You Will Need  
Complete Instructions  
for Building This Set**

**A** DESCRIPTIVE folder on the new All-Star Junior superheterodyne receiver is waiting for you, to help you build this set more accurately and more easily. Simply address your requests for this informative literature to RADIO NEWS, Blueprint Department, 461 Eighth Avenue, New York City. The folder will contain a schematic diagram, three pictorial wiring diagrams, a parts list, as well as complete assembly wiring and tuning instructions. These will be sent to our readers free of charge. Send your requests in *early*, as there is sure to be a long waiting list!

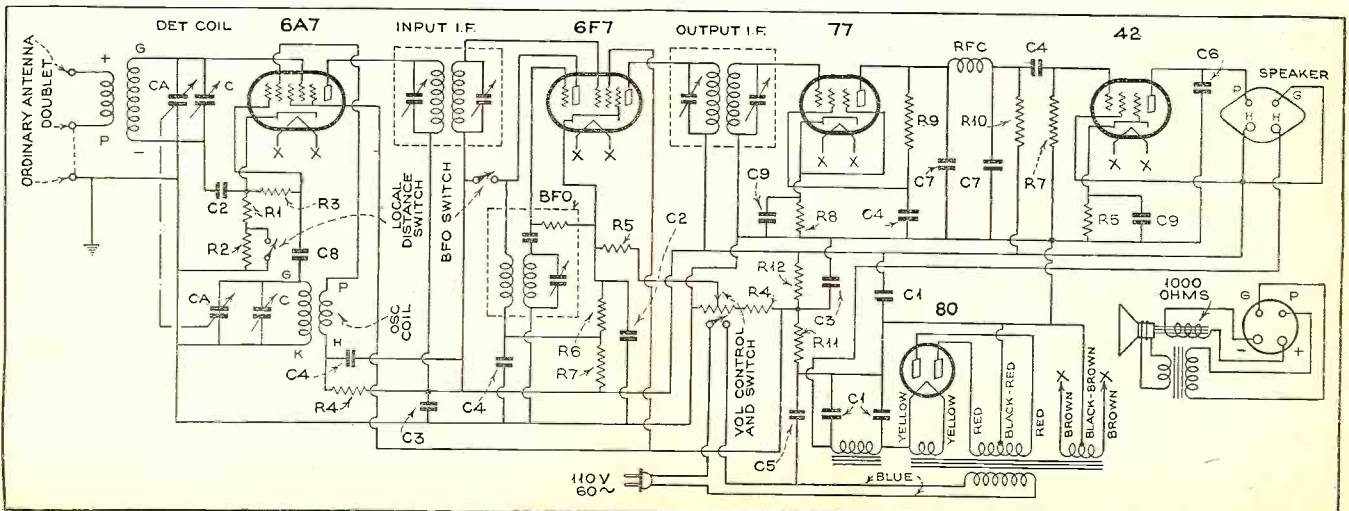



# JUNIOR

When the constructor has completed these three projects in the wiring program, the set is ready for its tubes and coils. No technical knowledge is necessary to assemble this receiver. A screwdriver, soldering iron and pliers are all the tools required. A radio serviceman could wire the receiver in four or five hours; a novice in radio might require a couple of evenings on the kitchen table. If the instructions and plans are carefully followed, the results in either case will be the same—amazing performance with the first turn of the switch.

The loudspeaker recommended for use with the set employs a 1000-ohm field with an inductive hum bucking device built in the field coil. The speaker comes equipped with a 24-inch connecting cord and a 4-prong plug. The output transformer is mounted on the speaker and is designed to match the Type 42 power tube to the speaker's voice coil. The voice coil is so supported that warping of the cone will not throw the coil out of alignment. A 6-inch cone size is recommended for all ordinary requirements. An 8 or 12-inch speaker of the same type will reproduce the lower tones with greater fidelity.

The controls on the receiver, from left to right in the front view of the panel are: A local-distance switch changing the C bias on the i.f. tube when the set is used with broadcast coils. This arrangement makes the tuning exceptionally sharp for broadcast reception and prevents overloading of the detector tube on strong nearby signals. The second control from the left is the oscillator tank condenser which will be found very sensitive to variations. Its position should be logged accurately for every important frequency band. Under the main airplane tuning

dial will be found the beat frequency oscillator switch. The antenna tank condenser is next, and it is not particularly critical in adjustment. The extreme right-hand control is the volume regulator and a.c. power switch.

The operation of the Junior receiver is very similar to the routine prescribed in the October issue of RADIO NEWS in 1934. With the power turned on, a good antenna and ground or doublet connected, and a pair of coils (designated for the same band) in place, adjust the volume control full on. Set the oscillator tank condenser at zero, with the condenser plates entirely out of mesh. Adjust the antenna tank condenser until a hissing sound can be heard at its loudest point. Then tune with the main airplane dial. When a station is heard, back off the volume control until the signal is clear.

For extreme distance reception, the beat-frequency oscillator will be found most helpful. Flip the BFO switch "open" and tune in a near-by station. A canary-like whistle will be heard as the main dial is tuned. The pitch of the whistle will first be very high and will gradually deepen until it can't be heard; then raise in pitch as the dial is turned further. The exact point of resonance with the station is the spot where the whistle has the lowest pitch. After tuning to this position, turn the switch "off" or to the closed position and listen

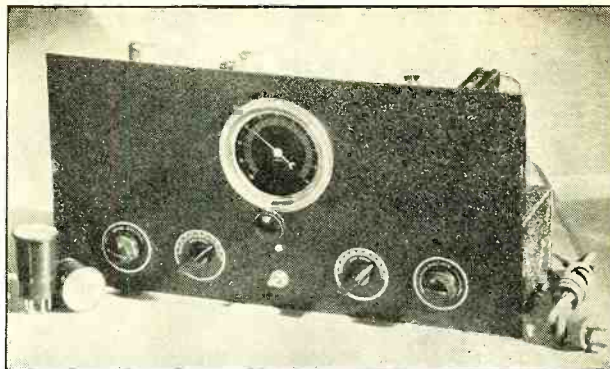

FRONT PANEL VIEW

*Here is the new layout for the receiver. The main center dial is the band-spread control. The lower controls are explained in the text. In the laboratory model the beat-frequency oscillator switch and the local-distance switch were placed in reversed positions. In the regular models these will be as shown in the folder.*

for the station. This is particularly valuable for DX reception, as often the announcements are several minutes apart and only the carrier wave of the station can be detected with the aid of the beat-frequency oscillator.

From our experience with the previous All-Star set and with the Junior, we can highly recommend the doublet type of aerial. It will eliminate the major portion of the noises picked up in the high frequency wave bands. The plain antenna and ground will prove quite efficient on distant reception, but is often subject to interference from passing cars and electrical disturbances. The new receiver, although much simpler to construct than the earlier model, will prove to be an equally good performer, bringing in stations from all over the world. The much lower cost of parts should now enable many more thousands of fans to build it. The whole secret of its success lies in a careful design using multi-purpose tubes so that few do the work of many!

When completed this little receiver has the advantage of commercial ap-  
(Continued on page 581)

## SUB-BASE VIEWS

*Here are two views taken underneath the sub-base, to show the left end of the set and the right end, respectively, in greater detail.*

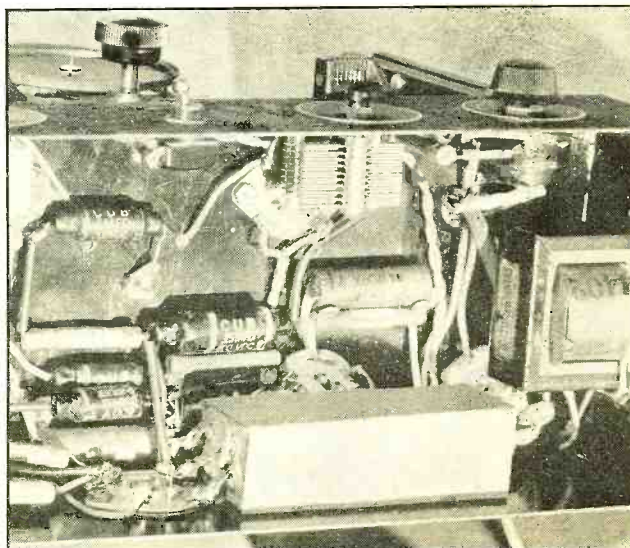
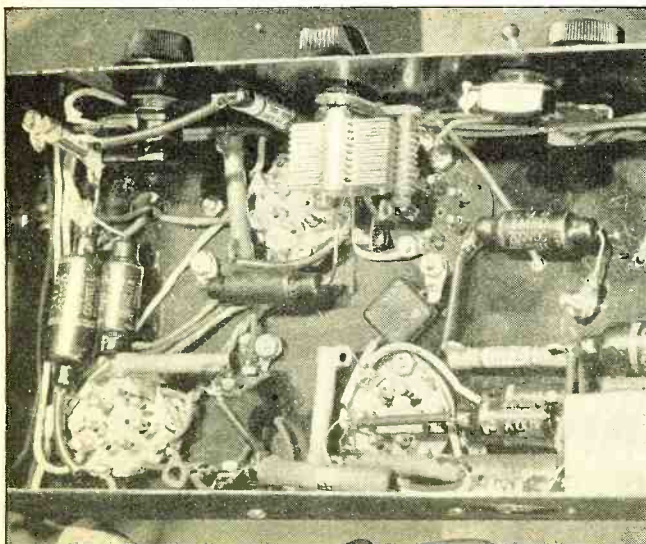

# Experiments With MULTIPLE REGENERATION

Nothing intrigues the experimenter as does an untried regenerative circuit. The author, a Polish experimenter, who has carried on extensive investigations of multiple regeneration, describes the methods employed and the results

J. Plebanski

**T**O date the application of the regenerative principle has been limited largely to the detector circuit. It is quite clear that if controlled regeneration could be employed in more than one circuit, the amplification would be far greater and the selectivity considerably improved.

Take, for instance, a set with two screen-grid tubes and three tuned circuits. If the input circuit is made regenerative, for instance, by means of a special tube, the grid of which is in parallel with the control grid of the first radio-frequency tube, considerable improvement should be observed in amplification, selectivity, with intermodulation and amplitude distortion less severe. This scheme is, however, more

complicated and more expensive. Theoretically the special regenerative tube could be omitted and reaction taken from the detecting tube. I tried such schemes; the results, however, were not good, particularly as the set becomes very unstable.

I searched for a more simple solution and finally found out that taking the feed-back, not from the anode side of the tube, but from the cathode, particularly with indirectly heated tubes, wonderful results could be obtained. See Figures 1, 2 and 3. Such reaction can be used with any tube, radio-frequency, detector, low-frequency screen-grid tube, ordinary triode, pentode, etc., giving absolutely stable conditions with practically any circuit.

First of all, I tried the circuit shown in Figure 1. The r.f. choke, CH, must have an inductance such that it responds to a wavelength greater than the longest wavelength to be received. Many of the radio-frequency chokes used at present are suitable for such purposes. The grid-bias resistance, R, must be about 600-1000 ohms. The reactive windings, L<sub>r</sub>, must be something from 5 to 15 turns, closely coupled to the grid winding. The regeneration control condenser, C<sub>r</sub>, should be about .0005 mfd.

The choke, Ch, and condenser, C<sub>r</sub>, can be omitted if the reaction turns, L<sub>r</sub>, are wound on a variable coupling member enabling adjustment of the coupling between tuning coil and reaction coil.

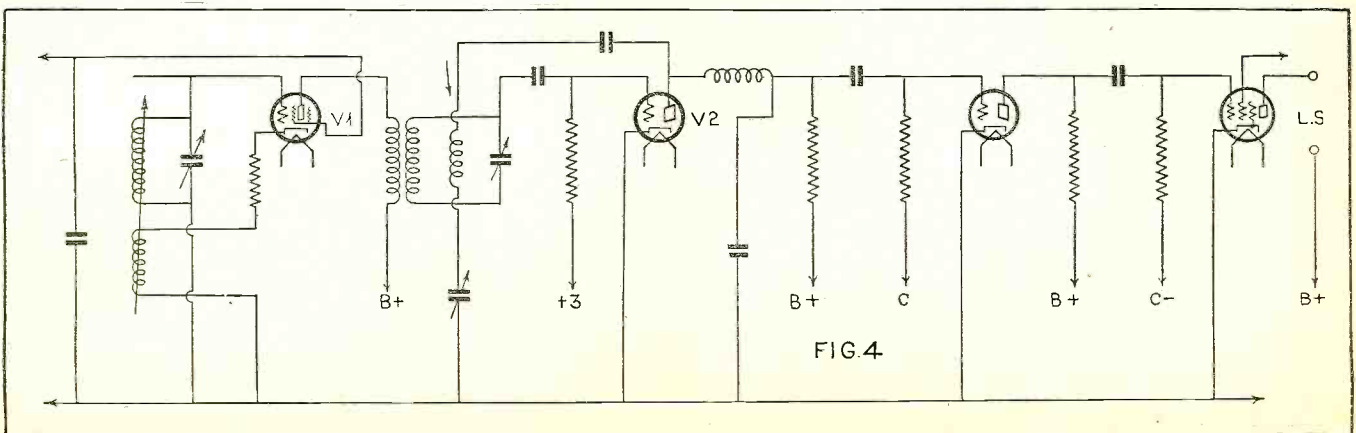
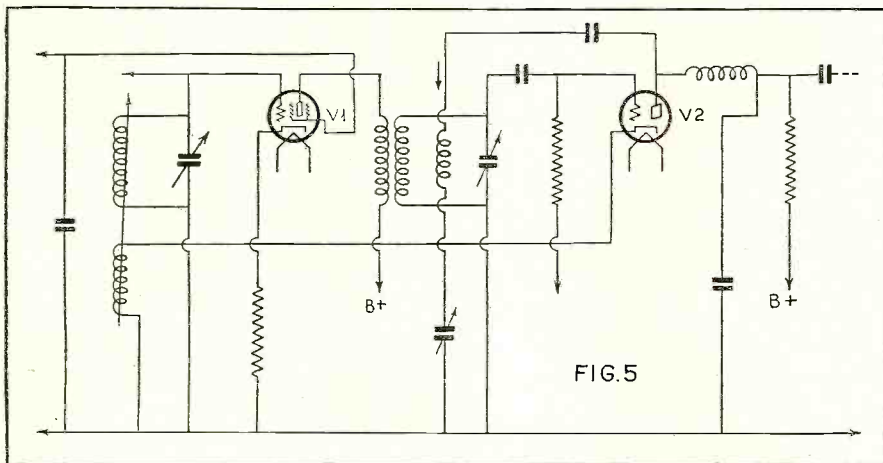
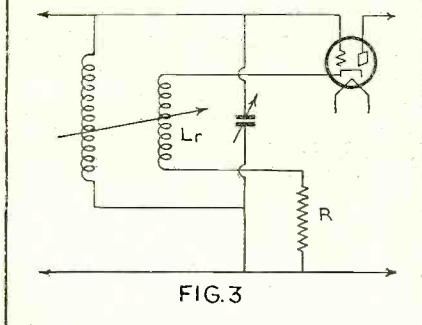
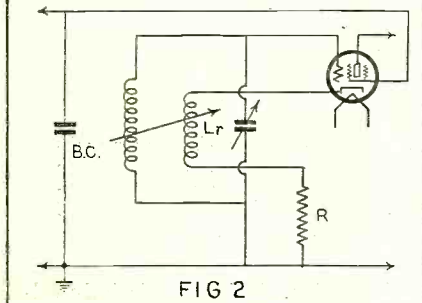
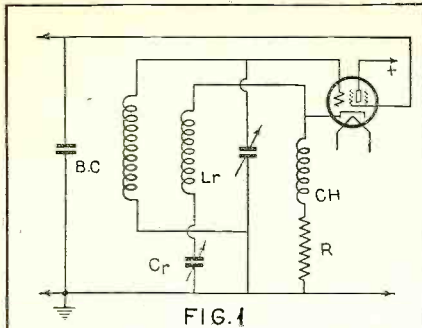

Such arrangements are shown in Figures 2 and 3.

Such reaction is really not critical, if the plate is connected direct to B+. In practice, however, there are always subsequent tuned stages, and where such is the case regeneration cannot be pushed to maximum, for if it is the set starts to oscillate. It is interesting to note that in such a case the set oscillates only at one frequency, the first stage driving the next ones, whether they too are regenerative or not. There is, however, no need to push the reaction too far. Even slight regeneration will give much greater gain.

In a set using one r.f. stage and a regenerative detector, the amplification has been improved from 10 to 100 times and the selectivity greatly increased by introducing regeneration in the r.f. tube circuit, as shown in Figure 4. Cathode regeneration in the detector may be adjusted by means of a variable condenser Cr or by variable coupling between the tickler and grid coils. The cathode regeneration in the r.f. circuit is also adjustable and feeds back into the input circuit. It has been observed that an aerial connected direct to the tuning circuit gives the best results, and only a 5- or 10-foot aerial can be used. The earth connection of the set makes practically no difference and can be omitted. Of course a larger antenna may be used if coupled inductively to the input circuit. However, this does not improve the selectivity. Using an indoor aerial of 10 feet or less, practically all stations can be heard with full volume, and selectivity is excellent.

I tried also the diagram shown in Figure 5. The two reactions are taken from the same tube, V2. In this case it was found that the two reactions are not independent, as in Figure 4. As a result, if reaction is pushed too far in the detector circuit, then lowering reaction in the r.f. circuit will stop oscillation and vice versa. The two reactions can, however, be so adjusted as to regenerate both circuits adequately. It means both circuits can be made sharp in tuning, or, if desired, one can be made to regenerate more than the other. However, the scheme in Figure 5 seems to be inferior to that of Figure 4, which gives better selectivity, more amplification and is easier to adjust.

One may say that with such a system of multiple regeneration the side-band

cutting must be severe. That is of course true, but only to a certain extent. For the short-wave range 10 to 100 meters and even for the range 200 to 600 meters the reaction can be pushed very far before appreciable side-band cutting occurs.

For the range of 1000 to 2000 meters the side-band cutting is more noticeable, but even in this range satisfactory conditions can be found. While experimenting with the set in Figure 4 I found, for instance, that upon strongly regenerating both circuits I could receive with adequate quality speech and music from Koenigswusterhausen (1600 meters) while the local (Warsaw, Poland) station, only 12 miles distant, worked with full power of 120 kilowatts, highly modulated on a wavelength of 1414 meters. From the point of view of selectivity, this is an excellent performance. Using any other set with

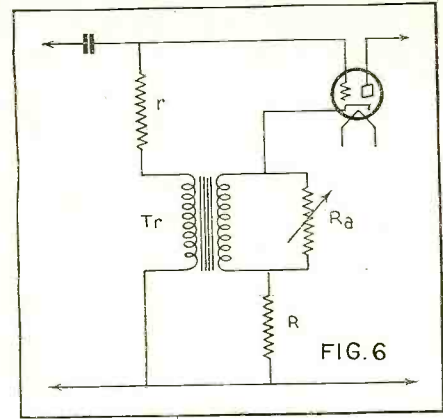

only two tuned circuits, such results are entirely impossible.

For superheterodynes the above reaction system (Continued on page 577)

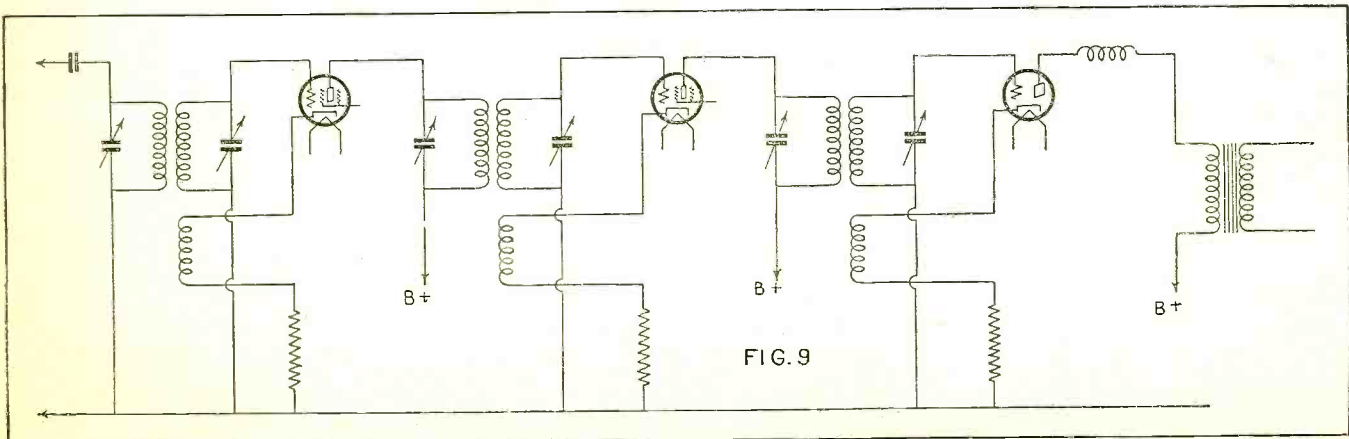
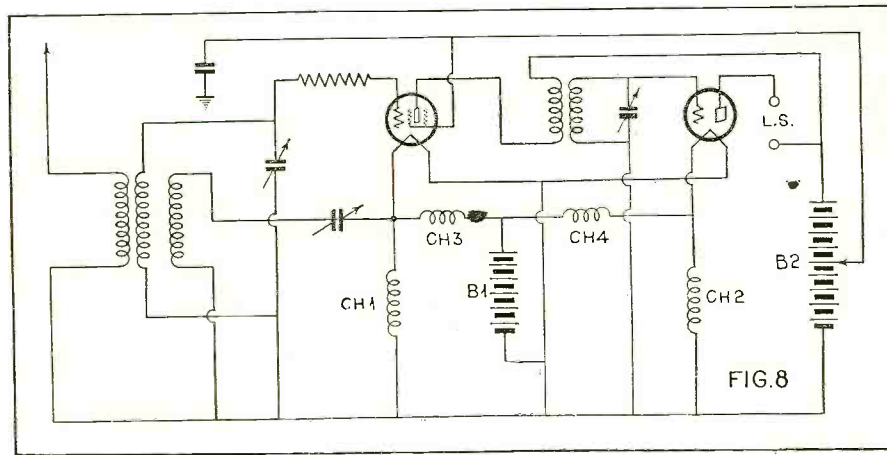
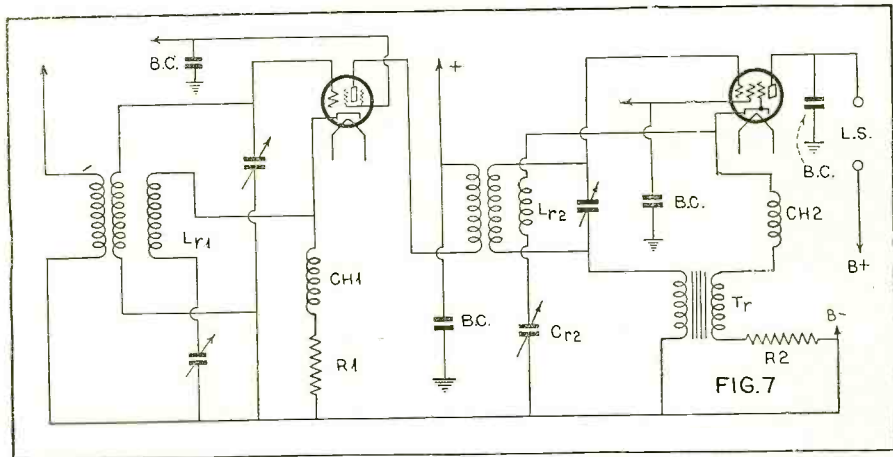



## SHORT-WAVE PAGE

**R**ECEPTION conditions this winter have been the worst and most erratic of any the writer has ever experienced in all his years of "dial twirling." We have had wonderful DX days and then an entire week of "almost nothing." We have accounted for this condition by the fact that the weather, here in the eastern part of the United States, was just as dependable as the signals from abroad. One day we were going out with a spring overcoat and the next imploring the superintendent of our apartment to "send up more steam"! Two days later we would have the windows wide open and the next the papers would be headlining disasters at sea caused by gales of wind and waves, mountain high.

**W**E, in all our lack of knowledge of just how radio waves are ruled, know that if the strongest thing on earth, sea water, can be whipped to fury by the changing winds we can easily surmise the disastrous effect these same winds might have on the atmosphere that carries all radio signals from over seas. I know what that old North Atlantic can do (when she gets angry). Many a time I have left the bridge of my ship, everything fine. Wind mild, sea quiet. Within a few hours all hands would be on deck getting ready to fight a raging sea, putting on extra tarpaulins and battening down hatches and watching the barometer for sudden highs or lows or keeping a lookout for shifting of wind. These terrific disturbances are often experienced over the North Atlantic and it is over this same sea that signals from Europe have to come in order to reach us.

Speaking of barometers, reminds me that many of my short-wave fan friends have just bought barometers. I have had numerous requests about the use of one as it has been my life's companion. The barometer is useless to anyone who does not thoroughly understand it as well as the directions of winds, movements of clouds which should be noted at least every four hours. Just looking at a barometer and taking a reading means nothing. The lettering on the glass, i.e., Dry, Fair, Change, etc., does not mean a thing, it is only there for decoration.

I will give you one example of the action of a barometer. Let us say that it is raining in the morning. The first thing to do is note the direction of the wind. The wind will be either south, south-east or

east. The glass may be falling. This indicates the wind will shift to the north-west and be clear. If you note, with the rainy condition, the glass has not fallen, but raised a little, the stormy weather will continue. Barometer readings range from about 28.30 to 31 in this hemisphere. If your glass fell below 27, you would be *blown off the earth*, and there is no telling what would happen if a reading went above 31. Nothing short of complete evaporation would be the result! Again I repeat, the use of the barometer is a serious study and when I see barometers in pictures of radio shacks I often wonder if the fan knows what it is all about. My barometer has made many a trip around the world with me and I know it thoroughly but if I neglect to keep a record of the readings and weather conditions for at least two days, I am lost when it comes to foretelling what weather we will have.

South American stations are everywhere but although their programs are sometimes very pleasing from an entertainment standpoint, they lose many listener's interest because they talk so rapidly and rarely if ever identify themselves in any other language but their own. I doubt very much if even the thousands of Spanish-speaking, short-wave fans, here in the States can "make them out." I doff my hat to the fan who can distinguish the various call letters, especially the ones of six variations. Is it a good old Spanish custom to send hours of musical selections and then go off the air without giving call letters? Time and again I have written page after page of a South American program, into my log book, only to have the announcer sign off with "Good night everybody".

More International Reply Coupons are sent to South American stations, without results being obtained than any other country throughout the world. I do not think I am alone when I say, "I am thoroughly disgusted with the stations bordering on the equator." Some exceptions are made, and to these stations we certainly should be thankful. HC2RL, PRADO, HCJB, both the Caracas stations and HJ4ABB all verify correct reception reports but as for the rest it is almost a waste of energy to write to them. My mail is overflowing with complaints about the South American stations that "wander" on the ether waves and defy identification and even if identified, ignore all letters addressed to them.

Into the lives of every short-wave fan there always comes one experience that makes him literally scratch his head and wonder. Well, the writer is not above such an experience and as it is really laughable we will recount it here. There was a special broadcast sent from CT2AJ, Azores, for the International DXers Alliance. We tuned for it and, although reception was far below par, we did manage to pull in this station and log over 23 minutes of the musical selections. The station signed off in code and we eventually sent them our reception report telling them the truth, i.e., how poorly we had received it. In the course of time we received this letter from the station's director. Quote: "We wish to thank you for your report dated November 9th; it is rather difficult for us to positively verify your report because such a report might easily refer to the transmissions of another station but it looks like you did pick us up. We quite agree with you about the interference on the frequency which we use and we shortly expect to be working either slightly above or below the 3500-4000 kc. amateur band." Hi! Hi! To which we might also add, if they had kept an accurate log they surely would have known at least the time they signed off which according to our log was 9:08 P.M., E.S.T. The part which says "looks like you did pick us up" has left us wondering. I know many a fan has received just such a letter as this from a station, and I sympathize with them. For my own part I would have preferred CT2AJ to have said, "No, you did not hear us," or "Yes, you did hear our transmissions." This station is on the air every Wednesday and Saturday from 5 to 7 P.M., E.S.T., and gives their call-letters as "Aquo, Say, Tay, Doix, Ah, Jhota. Now operating on 3500 kc. with .05 kw. power." They call themselves "The Voice of the Atlantic". The second paragraph in CT2AJ's letter is very interesting. They say "Here are two hot tips for you, Captain Hall: Station CTIGO, the short-wave transmitter of the Radio Club of Portugal, in Parede, Lisbon, are now testing practically every night on 6196 kc. with about 2 kw., also, the Emmissora Nacional, of Portugal, on 6207 kc., is testing with 500 watts. Both these stations have been heard in these islands during the last week at exceptional strength and there is no reason why you should not get them well in New York. Again thanking you for your letter, we shall notify the management of your Club when we change frequency."

*Capt. Horace E. Hall*

### The Browning 35

(Continued from page 539)

coils for each of the four bands are mounted in one compartment, the antenna coils in the second compartment and the r.f. stage coils in the third compartment. Each compartment also contains the associated switches. These switches have silver-plated contacts, low losses and low capacities, and are so designed that all coils that are not used are short-circuited. This eliminates any resonance effects in the larger coils when the set is operating on the higher-frequency bands. A great deal of thought was put into the mechanical as well as electrical design of the tuner, and as a result, all leads are exceptionally short. To reduce losses to a minimum, bare wire is used in making all connections. The high-frequency-band coils are "space-

(Continued on page 579)

*Informal Tests on a*  
**13-550**  
**METER**  
**"SUPERHET"**

*(Scott All-Wave 15)*

**S. Gordon Taylor**

**R**UNNING back over receiver designs of the past ten years emphasizes the tremendous advantages offered by present-day receivers. Naturally, improvements were to be expected, but it is extremely doubtful that anyone, ten years ago, could have been optimistic enough to vision many of the refinements which are now an accomplished fact. This was brought to mind quite forcibly during the tests of the Scott "All-Wave Fifteen" receiver which was recently put through its paces by the RADIO NEWS staff.

As its name implies, this receiver employs 15 tubes which provide one r.f. stage, tuned in all wave ranges by one section of the single-control gang condenser; separate tubes for first detector and oscillator; three i. f. stages; type-55 second detector; three audio stages, utilizing a 56 tube in the first stage, 56's in the second stage and push-pull 2A3's in the power output stage; a beat-frequency oscillator which is cut in and out by a push-button immediately below the wave-band switch on the front panel; and a 56 tube used as a tuning meter amplifier, its purpose being to exaggerate the swing of the tuning indicator needle so that it will properly indicate resonance even on weak signals. A 5Z3 rectifier is employed.

The loudspeaker and the power pack-power amplifier are separate units which are interconnected by means of a plug and cable. Another cable connects the tuner chassis to the power unit. This power unit includes the power supply for the entire receiver, the field supply for the speaker, and the push-pull power output stage. This power stage provides a rated output of 11 watts of undistorted power. The speaker employed is a new type which has an excellent response characteristic to better than 8000 cycles.

The receiver continuously covers a range from 13-550 meters, in four bands. The desired band is selected by means of a range-selector switch and the tuning dial is calibrated in kilocycles (or megacycles) for each range. Each calibration shows up on a strip of different color and the wave-change switch has four colored dots so that in



**A HOME INSTALLATION**

*A wide variety of consoles is available for housing this receiver. Or, because of the beautiful appearance of the chromium-plated chassis, it can be exposed to view, as in the installation shown here*

each of its four positions the dot color indicates the scale in use.

All tuning is accomplished by means of a single knob with no auxiliary tuning controls of any kind. The tuning indicator line takes the form of a shadow thrown across the scales themselves and is therefore not subject to parallax. The shadow of the tuning meter needle is also thrown on the calibrated scales so that the receiver may be tuned to resonance (as indicated by the tuning meter) without taking one's eyes off the scale calibration. This tuning meter, incidentally, is a vast improvement over most of those in use today, inasmuch as an unusually wide deflection is obtained. In actual operation in New York City, the shadow of this needle deflects more than an inch on local stations and up to a half-inch or more on stations 2000-3000 miles distant. In effect, it was found that any station strong enough to be heard above the local noise level results in a sizable movement of this needle. The result is that even the most distant DX stations can be tuned in with the volume control set at zero, then the volume turned up as desired. Thus it is possible to accomplish DX tuning in complete silence—a decided asset to those who do their DXing late at night.

The only other controls on the front panel are the audio volume control, which provides for any desired variation of output from zero to the full 11 watt capacity; and a 3-position switch for noise control. In the right-hand position of this switch, high-fidelity reproduction is provided for use in tuning local stations. In the center position a high degree of sensitivity is provided but a considerable amount of noise reduction is obtained. In other words, in this position the signal-to-noise ratio is excellent and this position is used for DX tuning where high-fidelity is not imperative. The left-hand position provides still further

noise reduction but also less sensitivity than the middle position.

In addition to these controls, there is a continuously-variable bass-control knob at the rear of the chassis. This permits a variation in tone to meet individual taste and is also further helpful in reducing the effect of local electrical interference.

Automatic volume control is, of course, a feature of the receiver, and that the system employed is highly effective is evident from the fact that stations near and far are tuned in with approximately equal loudspeaker volume without readjustment of the manual volume control knob.

As is the Scott custom, the chassis and power unit are both finished in chromium throughout. The equipment may, therefore, be left exposed to view and, unlike some present-day receiver chassis, presents a pleasing appearance. There are, however, a wide variety of console cabinets available for use with this equipment for those who prefer this type of installation.

So much for the general description of the receiver. It was put through comprehensive tests by the RADIO NEWS staff and was found to be exceptional in many respects. On the broadcast band the sensitivity is really amazing—and by sensitivity is meant the *usable* sensitivity. The actual high sensitivity of the receiver is only one factor, the other being the unusually favorable signal-to-noise ratio. The over-all result is that during the heart of the early evening stations 2000 miles distant can be tuned in with real program value, night after night, even in a mediocre location.

Perhaps the best illustration of this feature is found in the fact that it was possible to tune in three European stations (on the broadcast band) in one of the New York City Listening Posts where it had never before been possible to tune in (Continued on page 585)



# THE "HAM" SHACK

CQ                      CQ                      CQ

THE amateur has conquered another problem. The problem is that of operating on ultra-short wavelengths and maintaining reliable communication over distances beyond those anticipated by the pioneer experimenters who first delved into the possibilities of these frequencies as long ago as 1928, and in some instances before that. Early experiments indicated that frequencies of the order of twenty-eight megacycles and higher had characteristics similar to light and, for that reason, could not be transmitted much farther than the range of vision.

WITH the pioneering work done and the evolving of a more or less adequate means of communication on the ultra-short-wave channels (although there is still a vast amount of room for improvement) others, with a little less of the pioneering spirit but nevertheless with an adequate supply of experimental intuition, have followed. Within the last three or four years there has been a tremendous increase in activity on 5 meters (sixty megacycles). Increased activity has made possible further experimentation and has greatly facilitated the work of the pioneering group who are still seeking to probe further into the possibilities of the ultra-high frequencies. Much interest now is centering in the possibility of transmitting 5-meter signals beyond the line of vision, with the result stations have been erected at the highest possible locations, including mountain tops and tall buildings; experimentation has progressed with types of antennas that concentrate a signal in a given direction with greater field strength and carrying power.

One of the most interesting experiments along this line has been conducted by the Garden City Radio Club, of Garden City, Long Island. This organization is exceedingly active on 5 meters, 2½ meters as well as on 1¼-meter tests that have attracted wide attention. Their latest interest has been to participate in an attempt to organize a "network" of stations linking Boston with Washington, D. C., with relay points at Hartford, New York, Philadelphia and Baltimore. The Garden City group engineered the erection of a 5-meter station atop of the Hotel New Yorker, a 42-story building not far from the Hudson River that commands a line of sight of close to 60 miles, with practically no obstructions in north, south or westerly directions. The towering Empire State building is to the east.

The station has been set up in a corner of the elevator control room on the 41st floor of the building, through the kindness of the hotel's management and the efforts of Eli M. Lurie, chief radio engineer for all of the hotels under the management of Ralph Hitz. The club negotiated the arrangements with the New Yorker through Arthur H. Lynch, W2DKJ, who needs no introduction to short-wave experimenters. The transmitter was designed by Stanley P. McMinn, W2WD; was constructed by Edward Ruth, W2GYL, and belongs to Lynch. The call letters are W2DLG. More than 100 contacts, some over a distance of 60 miles, have been made. Thus far the complete plan of the Atlantic Coast network has not been realized, but it is believed further experiments and tests with directive antennas will bring the group nearer to its goal.

The station itself is not much unlike the average 5-meter "ham" installation. The transmitter consists of a pair of Sylvania 801 tubes in a push-pull oscillator circuit with a so-called "long lines" tuning arrangement. This arrangement is a radical departure from the conventional coil system of tuning and is gaining wide favor among 5-meter experimenters. Two sets

## W2DLG, WORLD'S HIGHEST "HAM" STATION

Inside the Garden City Radio Club's "Shack" on the 41st floor of the Hotel New Yorker. Starting at the left, the equipment includes a home-made power supply, the Lynch Airod, a National 5-meter Superhet-converter, a Federated Microphone Control Box, a telegraph key, and a National audio oscillator. Directly above this hangs the speaker. To the right of Arthur H. Lynch, who is shown on the job, is a National SRR 5-meter receiver; next, a Federated No. 196 speech amplifier, and, above, a 2-stage pre-amplifier (used with a crystal microphone at the operator's right hand). At the extreme right is the complete 28-watt, 5-meter transmitter

of parallel rods, each 42 inches long, provide the sole means of tuning the transmitter. Two are used to tune the plate circuit; two to tune the grid. The rods themselves are ½-inch hard-drawn copper tubing and are mounted vertically. The plate circuit rods are arranged so their centers are 1 inch apart and parallel. The grid circuit rods are arranged in a similar manner, but are placed about 6 inches from the plate rods so when mounted, the four rods form a rigid four-legged table with a 6-inch by 1-inch top and 42-inch legs. This facilitates mounting the tubes and component parts in a symmetrical arrangement between the tuning circuits, thus providing the shortest possible leads. The high volt-

(Continued from page 573)

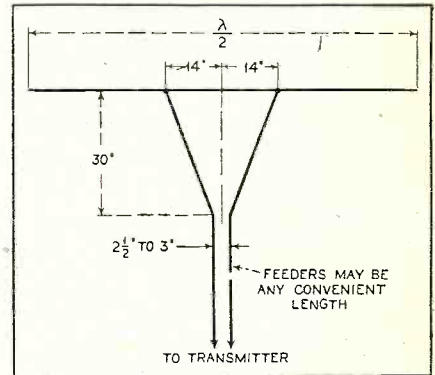

W2DLG'S ANTENNA

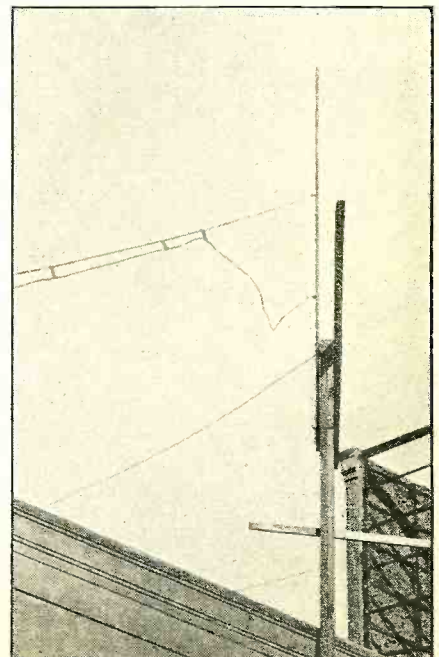
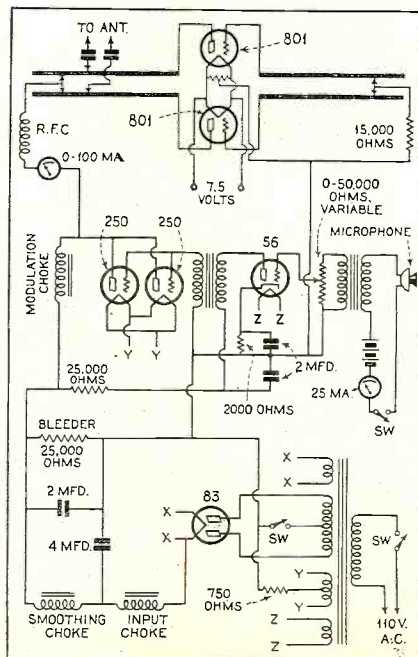

# Radio News Laboratory SHORT-WAVE CONVERTER

S. Gordon Taylor

LAST month a brief discussion of short wave converters was presented in which it was pointed out that possessors of good broadcast band receivers could obtain excellent short wave results through the use of a properly designed converter. It was further stated that such a converter was in process of development in the Radio News Laboratories, and would, it was hoped, be completed in time to be described in the present issue.

The development model was completed and proved to be eminently satisfactory until attempts were made to duplicate by hand the original homemade coils employed in this model. It was

then found highly impractical to specify homemade coils for the converter because it was found utterly impossible to exactly duplicate the originals. The resulting variations would either make alignment of the three circuits impossible throughout the entire band, or the band width would be reduced, chopping off some of the 49 meter stations or some of the 19 meter stations. The only way of overcoming the difficulty was through a

rather complicated series of "cut-and-try" adjustments in which the use of a signal generator and output meter were practically essential.

After extensive investigation along these lines it was concluded that the most practical (Continued on page 586)

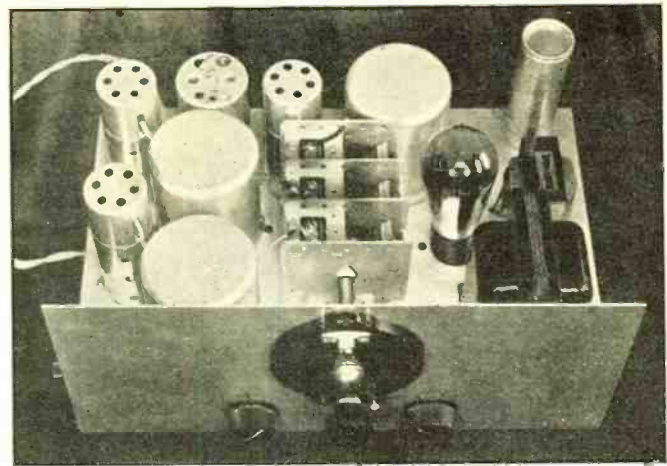

THE ORIGINAL CONVERTER MODEL

It is expected that the final model will be more compact than this unit, but capable of equally good results.

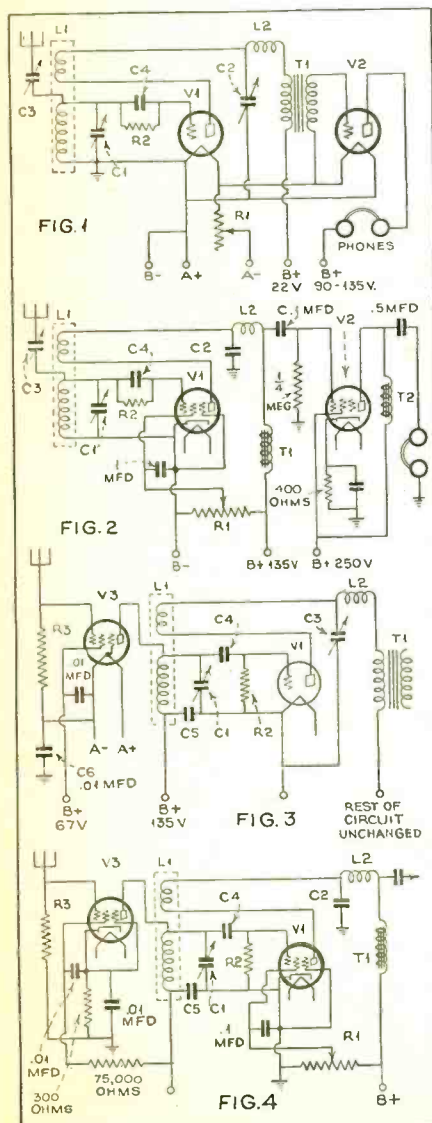

## How to Improve Your REGENERATIVE RECEIVER

Robert Hertzberg

ELEMENTARY short-wave receivers of the straight regenerative type continue to be highly popular in spite of the advanced state of superheterodyne development, because they are cheap and easy to build and because they are capable of pulling in most everything on the short-wave bands.

However, there are two little features of straight regenerator operation that arouse a steady stream of inquiries from otherwise satisfied users. These are irregular feed-back and lack of selectivity. The first trouble can be cured by a little revamping of the circuit, but the second is a real problem.

The circuit of Figure 1 represents in a general way thousands of little sets that have been exploited under dozens of different names, and will serve our purpose for analysis. Most of these sets are dry-battery operated, V1 being a 30 or 32 and V2 another 30 or possibly a 33 pentode. Invariably L1 is a two-winding plug-in coil, C1 a 100 or 140 mmfd. tuning condenser, C2 a similar condenser for regeneration control, C3 a "postage stamp" trimmer for antenna coupling, C4 a .0001 mf. mica condenser, R1 a filament rheostat, R2 a 2 to 5 megohm leak, L2 a small r.f. choke and T1 a small audio transformer (or choke

if a screen-grid detector is used). In 1928 RADIO NEWS featured a set using this identical circuit under the name "The Junk Box Receiver", and more than 75,000 blueprints of it were distributed. If the present mail is any indication, this set is still in very wide service.

An a.c. version, also very popular, is shown in Figure 2. The essential radio-frequency portion is the same as before, but V1 is usually a type 58 pentode and V2 either a 56 or a 2A5, and regeneration is controlled by a screen potentiometer R1. T2 is merely a plate choke. A separate power pack furnishes 2.5 volts a.c. for the heaters of the tubes and 135 to 250 volts d.c. for the plates and screens.

Irregular feed-back and complete dead spots are due in most cases to antenna absorption. Adjustment of the antenna coupling condenser C3 may help to relieve this on one coil but not on another. The dead spots may disappear, but sometimes the signals go with them. In Figure 2, different value at C2 may help also.

By far the best thing to do is to add another tube as an untuned r.f. amplifier, as shown in Figures 3 and 4. This thoroughly isolates the sensitive regenerative circuit (Continued on page 567)

## S.W. PIONEERS Official RADIO NEWS Listen- ing Post Observers

LISTED below by States are the Official RADIO NEWS Short-Wave Listening Post Observers who are serving conscientiously in logging stations for the DX Corner:

### United States of America:

Alabama, J. E. Brooks; Arkansas, Don Pryor, Jas. G. Moore; Arizona, Geo. Pasquale; California, E. G. DeHaven, C. H. Canning, O. I. Noda, E. S. Allen, A. E. Berger, Ralph Leavitt, Geo. C. Sholin, Wesley W. Loudon; Colorado, Wm. J. Vette, F. Erich Bruhn; Connecticut, Phillip Swanson, Geo. A. Smith, H. Kemp; District of Columbia, Douglas S. Catchim; Florida, Geo. H. Fletcher, E. M. Law, James F. Dechert; Georgia, James L. Davis, C. H. Armstrong, Guy R. Bigbee, John McCauley; Idaho, Bernard D. Starr, Lawrence Swenson; Illinois, Phillip Simmons, E. Bergeman, Robert L. Weber, Floyd Waters, Chas. A. Morrison; Indiana, Freeman C. Balph, J. R. Flannigan, Henry Spearing; Iowa, J. Harold Lindblom; Kansas, C. W. Bourne, Wm. Schumacher; Kentucky, Charles Miller, Wm. A. McAlister, Geo. Krebs; Louisiana, Roy W. Peyton; Maine, R. I. Keeler; Maryland, Howard Adams, Jr., James W. Smith, J. F. Fritsch; Massachusetts, Armand A. Boussy, J. Walter Bunnell, Harold K. Miller, Donald Smith, Elmer F. Orne, Arthur Hamilton, Roy Sanders; Michigan, Stewart R. Ruple; Minnesota, Dr. G. W. Twomey, M. Mickelson; Mississippi, Dr. J. P. Watson, Mrs. L. R. Ledbetter; Missouri, C. H. Long; Montana, Henry Dobrovainy; Nebraska, P. H. Clute, G. W. Renish, Jr., Harold Hansen; New Hampshire, P. C. Atwood, A. J. Mannix; New Jersey, William Dixon, R. H. Schiller, Wm. F. Buhl; New Mexico, G. K. Harrison; New York, Joseph M. Malast, Capt. Horace L. Hall, S. G. Taylor, John M. Borst, Wm. C. Dorf, R. Wright, I. H. Kattell, Donald E. Bame, Albert J. Leonhardt, Wm. Kochlein, Edmore Melanson, H. S. Bradley; Nevada, Don H. Townsend, Jr.; North Carolina, H. O. Murdoch, Jr., W. C. Couch, E. Payson Mallard; Ohio, Oker Radio & Electric Shop, R. W. Evans, C. H. Skatzes, Donald W. Shields, Albert E. Emerson, Samuel J. Emerson, Clarence D. Hall; Oklahoma, H. L. Pribble, Robert Woods; Oregon, Virgil C. Tramp, James Haley, Geo. R. Johnson; Ned Smith; Pennsylvania, Edward C. Lips, K. A. Staats, C. T. Sheaks, George Lilley, John A. Leininger, F. L. Stitzinger, Hen. F. Polm, Chas. Nick; Rhode Island, Joseph V. Trzuskowski; South Carolina, Ben F. Goodlett, Edw. F. Bahan; South Dakota, Paul J. Mraz; Tennessee, Charles D. Moss, Adrian Smith; Texas, Heinie Johnson, Bryan Scott, John Stewart; Utah, Harold D. Nordeen; Vermont, Joseph M. Kelley, Eddie H. Davenport; Virginia, Gordon L. Rich, G. Hampton Allison, D. W. Parsons; Washington, A. D. Golden, Glenn E. Dubbe, Chas. G. Payne; West Virginia, Kenneth Boord, R. E. Sumner; Wisconsin, Willard M. Hardell, Walter A. Jasiorkowski; Wyoming, Dr. F. C. Naegeli.

Applications for Official Observers in the remaining States should be sent in immediately to the DX Corner.

### S.W. LISTENING POSTS

Summer listening post "shack" of Senor Eduardo Illero. He is the official announcer of Station HJIABG, of Barranquilla



## S. W. TIME SCHEDULE

LAURENCE M. COCKADAY

THE 24th installment of the DX Corner for Short Waves features a new method of presentation for the World Short-Wave Time-Table for 24-hour use all over the world. The list starts at 01 G.M.T. and runs 24 hours through 00 G.M.T., right around the clock! This new Time-Table contains a List of Short-Wave Stations, logged during the last month in the RADIO NEWS Westchester Listening Post (in our Editor's home), as well as at our official RADIO NEWS Short-Wave Listening Posts throughout the world. It provides an hour-to-hour guide to short-wave fans, whether experienced or inexperienced. The new type of Time-Table shows the Call Letters, Station Locations, Wavelength and Frequency in the middle column. The column at the left gives the times of Transmission, in G.M.T. a.m., and the column at the right gives the Times of Transmission, in G.M.T. p.m. The corresponding time in E.S.T. is also given and space has been left for filling in your own Local Time. The time, E.S.T., in the U. S. would be 8 p.m., E.S.T., for 01 G.M.T., as there is a five-hour difference. The time E.S.T. for 13 G.M.T. would, therefore, be 8 a.m., E.S.T. These two features can be seen at the beginning of each outside column in the new Time-Table. The times, C.S.T., for these two corresponding hours would be 7 p.m., C.S.T. and 7 a.m., C.S.T. The times, M.S.T., for the corresponding hours would be 6 p.m., M.S.T., and 6 a.m., M.S.T. The times, P.S.T., for corresponding hours would be 5 p.m. and 5 a.m., P.S.T. In this way American listeners can easily fill in their own Local Times at the top of the columns. Foreign listeners would probably prefer to use G.M.T., anyway, or, if not, can compute the time difference from G.M.T. and fill in their Local Time in each column head. We earnestly request our readers to give us their opinions of the new Time-Table, as we think it is simpler and saves turning over four pages to find out the schedule of a particular station at a particular time of day. At the end of the Time-Table is a List of Symbols, covering the various irregularities of transmission, schedules, etc. We believe our readers will find this new system a superior one when they have become familiar with it.

### Affiliated DX Clubs

We are hereby placing a standing invitation to reliable DX Clubs to become affiliated with the DX Corner as Associate Members, acting as advisers on short-wave activities, in promoting short-wave popularity and reception efficiency. A list of associate organizations follows: Interna-

tional DX'ers Alliance, President, Charles A. Morrison; Newark News Radio Club, Irving R. Potts, President, A. W. Oppel, Executive Secretary; Society of Wireless Pioneers, M. Mickelson, Vice-President; U. S. Radio DX Club, Geo. E. Deering, Jr., President; the Radio Club Venezolano of Caracas, Venezuela, President, Alberto Lopez. Any DX fan wishing to join any one of these Clubs or Associations may write for information to the Short-Wave DX Editor, and his letter will be sent to the organization in question. Other Clubs who wish to become affiliated should make their application to the Short-Wave DX Editor. Clubs associated with the DX Corner have the privilege of sending in Club Notes for publication in RADIO NEWS.

### Your DX Logs Welcome

Please keep on sending in information on any stations and Best Bets that you hear during the coming month, getting them in to the short-wave DX Editor, by the 20th of the month. In this way you share your "Best Catches" with other readers and they, in turn, share with you making for improved general knowledge on short-wave reception. Our Editors are doing the same thing, working with you day and night, to bring you the best and most reliable short-wave information. Your logs are welcome and are sincerely invited.

### Listening Post Observers and Other Fans Please Notice!

Listed below is this month's partial information regarding short-wave stations, heard and reported by our World-Wide Listening Posts. Each item in the listing is credited with the Observer's surname. This will allow our readers to note who obtained the information given. If any of our readers can supply actual Time Schedules, actual Wavelengths, correct Frequencies, or any other Important Information regarding these items, the DX Corner Editor and its readers will be glad to get the information. There are some hard stations to pull in in these listings, but we urge our Listening Posts and other readers to try their skill in logging the stations and getting correct information about them. When you are satisfied that you have this information correct, send it in to the editor; or if you have received a "veri" from any of the hard-to-get stations, send in a copy of the "veri" so that the whole short-wave fraternity may benefit. The list follows:

12RO, Rome, Italy, was reported (also as IRA) 49.2 meters with a program in English from 5:15-7:30 p.m., E.S.T. Some other listeners reported him as on 49.05 meters, on 6115 kc., and on 6120 kc. From





Courtesy C. H. Armstrong

**THE INTERIOR OF STATION PRADO, AT RIO BAMBA**

*This is a view of the Ecuadorian, South American, station, showing the transmitter panels and the control desk with two well-known receivers for monitoring*

our own measurements at the Westchester Listening Post, we believe it is about 6085 kc. Exact frequency is requested. (Reported by C. D. Hall, Frame, Lawton, Potts, Fritsch, Vassallo, Edge, Maugeri, Kalmbach, Spaulding, W. T. Thompson, Spearing, Oker and Robinson)

VP6TB, Barbados, B. W. I., 7000 kc., reported as an Amateur doing broadcasting. (Rosa)

YNA, Managua, Nicaragua, 20.7 meters, 14485 kc. (Pasquale)

CT2AJ, 83.5 meters, 3600 kc., reported as being San Miguel, Azores. (Pasquale)

OAX4C, Radio Dusa, Lima, Peru, reported heard 7-10 p.m., E.S.T., on 6230 kc., also reported on 51 meters as well as 13,000 kc. Also reported on the air 9-11:30 p.m., E.S.T. Other listeners report this station as OAX4D, as OAX4B; still others say it is OA4AD and OA4D. (Saldana, Tobler, Baker, Skatzes, D. Smith, Wright, McCarley, G. R. Johnson, H. Johnson, Armstrong, Miller)

CT1GO, Parede, Portugal, heard on 48.4 meters and on 24.2 meters testing. (S. J. Emerson, Vassallo, Lawton, Styles, D. T. Donaldson)

HP5B, Panama City, 6040 kc., 49.75 meters, heard on the air 6-10 p.m., E.S.T. (S. J. Emerson, Arms, Malast, Saldana, Twomey, Miller, D. Smith, Skatzes). Also heard testing on 25 meters. (Baker)

TGTH, Almatica, San Jose, Costa Rica, heard on 5760 kc., 52 meters, 7:20 p.m., E.S.T. (Saldana)

Rome was reported testing on 49.5 meters at 15 G.M.T. (Smith)

Radio L.L., Paris, may be heard testing 3 days a week on 80 meters, 3.7 megacycles, with 200 watts. (Meillon)

IRM, Rome, Italy, 9820 kc., heard 3-4:30 p.m., E.S.T. (Eisler, N. C. Smith, Daboll, Oker)

I2RO, Rome, Italy, heard testing on its regular wavelength of 25.4 meters. (Gunn, Haley, Westchester Listening Post). Some other tests by I2RO were reported as 42.38 meters from 5-5:15 p.m., E.S.T. 36.7 meters 2:40-5:30 p.m., E.S.T. 31.25 meters, 3-5 p.m., E.S.T. (These special tests were reported by C. H. Armstrong. FB OM, Ed.)

IRS, Rome, Italy, reported on about 37 meters, also on 42 meters. (D. Smith, Oker, S. J. Emerson)

HIH, La Voz del Hieucamo, San Pedro de Macoris, D. T., 44 meters, 6814 kc., 75 watts. 12:30-2 p.m., 7-8 p.m., daily E.S.T. An extra program on Sunday, 4:30-5:30 p.m., E.S.T. (Armstrong)

COH are the correct call letters of the new Cuban station on 31 meters (Johnson, Clarkson, Swanson, Catchim, Kemp, Skatzes, Baadsgaard, Peters, Eisler, Smith, Dank, Adams, Curtis, Bower, Trzuskowski, Naegel, Noda, Frame, Oker, Baker, Win-

free, Potts, Herren, Hall, Fritsch)

Prado, Riobamba, reported heard on 6200 kc.

An experimental short-wave station was heard testing in Cienfuegas, Cuba, on 6180 kc., 8-9 p.m., E.S.T., calling New York and COH, and playing music, etc. (Spaulding)

CM6XS, Tuinucucu, Cuba, 36.28 meters, 8.25 megacycles, reported sending music, etc., afternoons and evenings irregularly. (McCarley)

HI4D, La Voz de Quisqueya, San Domingo, D. R., 46.25 meters, 6482 kc., heard 11:55 a.m. to 1:40 p.m., E.S.T., and from 4:40-7:40 p.m., E.S.T., except Sundays. (Hall, Armstrong, Malast, McCarley)

VUB, Bombay, India, 31.36 meters heard with special Armistice morning program 5-7:30 a.m., in Ponoka, Canada. (Baadsgaard, FB OM, Ed.)

TFK, Reykjavik, Iceland, heard on 9050 kc. (Sholin, Armstrong)

VK15, 6425 kc., heard 2-3 p.m., E.S.T. (Twomey)

HI7G, San Domingo, D.R., reported heard. (Spaulding)

HBJ, Switzerland, 20.6 meters, 14.60 kc., reported heard 1-3 p.m., irregularly (McCarley)

CT1CT, Lisbon, Portugal, 24.83 meters now reported on the air with an extra program 14-16 G.M.T. Sundays and 20-21 G.M.T. Thursday. (Styles)

LCL, Jeloy, Norway, reported heard again on 48.9 meters. (Lawton)

HB9B, Switzerland (Basle Radio Club) 42.14 meters, reported heard 21-21:30 G.M.T. (Lawton)

EA4AQ, Madrid, Spain, 43 meters, reported heard 20-22:10 G.M.T. (N. C. Smith)

VE9CS, Vancouver, B. C., is reported to be transmitting with only 2 watts of power. Anyone hearing him is doing some real DX work. (Fletcher)

XEBT now seems to be transmitting on less than 6010 kc. (may be about 6000 kc.) and is interfering less with COC. (Fletcher)

HJ2ABA, Tunja, Colombia is reported to be now on about 48.6 meters instead of 50.4 meters. Who knows its exact frequency? (Armstrong)

PSK now reported on the 49-meter band. Who else has heard them? (T. Clarke)

KBJ, Manila, P. I., reported heard on 22 meters, 09-11 G.M.T., sending musical and special programs to Japan. (Matthews)

CJRX, 11,720 kc.; CJRO, 6150 kc.; VEGGW, 6095 kc.; VE9DN, 6005 kc., are all reported as transmitting news, messages, etc., to trappers, nurses, mounted police, etc., until the middle of the month of May, every Saturday night at 11:30 p.m., E.S.T. (Fletcher)

COH, Havana, Cuba, reported testing on

**S.W. PIONEERS**  
Official RADIO NEWS Listening Post Observers

LISTED below by countries are the Official RADIO NEWS Short-Wave Listening Post Observers who are serving conscientiously in logging stations for the DX Corner:

Argentina, J. F. Edbrooke.  
Australia, C. N. R. Richardson. C. Arthur Matthews, A. H. Garth, A. E. Faull.

Bermuda, Thursten Clarke.  
Brazil, W. W. Enete, Louis Rogers Gray.

British Guiana, E. S. Christiani, Jr.  
British West Indies, E. G. Derrick, N. Hood-Daniel, Edela Rosa.

Canada, J. F. Atkinson, Jack Bews, Robert Edkins, W. H. Fraser, Charles E. Roy, A. G. Taggart, Douglas Wood, A. B. Baadsgaard.

Canal Zone, Bertram Baker.  
Canary Island, Manuel Davin.  
Central America, R. Wilder Tatum.

Chile, Jorge Izquierdo.  
China, Baron P. D. N. von Hoyningen-Huene.

Colombia, J. D. Lowe, Italo Amore.  
Cuba, Frank H. Kydd, Dr. Evelio Villar.

Denmark, Hans W. Priwin.  
Dutch East Indies, A. den Breems.  
Dutch West Indies, R. J. van Ommereit.

England, Alan Barber, Donald Burns, Leslie H. Colburn, C. L. Davies, Frederick W. Gunn, R. S. Houghton, W. P. Kempster, R. Lawton, John J. Maling, Norman Nattall, L. H. Plunkett-Cheekman, Harold J. Self, N. C. Smith and John Parkinson, R. Stevens, L. C. Styles, C. L. Wright, John Gordon Hampshire.

France, J. C. Meillon, Jr.  
Germany, Herbert Lennartz.

Hawaii, O. F. Sternemann.  
India, D. R. D. Wadio.  
Italy, Dr. Guglielmo Tixy.

Japan, Masall Satow.  
Malta, Edgar J. Vassallo.

Mexico, Felipe L. Saldana.  
New Zealand, Dr. G. Campbell Macdiarmid, Kenneth H. Moffatt.

Norway, Per Torp.  
Philippine Islands, Victorino Leonen.

Portugal, Jose Fernandes Patrac, Jr.  
Scotland, Duncan T. Donaldson.

South Africa, Mike Kruger, C. McCormick.  
Spain, Jose Ma. Maranges.

Switzerland, Dr. Max Hausdorff, Ed. J. de Lopez.

Turkey, Hermann Freiss.  
Venezuela, Francisco Fossa Anderson.

Applications for Official Observers in the remaining countries should be sent in immediately to the DX Corner.

**OFFICIAL OBSERVER FOR SCOTLAND**

*Duncan T. Donaldson, of Kelty, Fife, Scotland, seated in his DX corner showing some of the verification cards. It isn't necessary to say what magazine he reads*





#### NEW CERTIFICATES FOR OFFICIAL OBSERVERS

Here are the new 1935 certificates now being mailed out to Official RADIO NEWS Short-Wave Listening Post Observers who are serving this year in helping keep up the high standard of DX news and the Time-Table for this department

6220 kc., from 6-6:30 p.m., irregularly. (Malast)

TGW will soon be on the air on 5940 kc., and on 11880 kc., with 200 watts. (Skatzes)

DJM, Zeelson, Germany, 49.35 meters reported heard the same times as DJC. (Vassallo)

HCK, Quito, Ecuador, 5830 kc., 51.4 meters, reported heard 8-11:30 p.m., E.S.T. (Armstrong)

CGA4, Canada, 9330 kc., heard testing 3 p.m., E.S.T. (Spaulding)

XGW, Shanghai, China, reported heard on 28.70 meters, 10420 kc. (Pasquale)

CE?, a station on about 6610 kc., thought to be Santiago, Chile. (Saldana)

VK3LR is reported *not* to be leaving the air but *rather* increasing power. They have been testing under the call VK3XX and in the future will drop the prefix VK on the air, using only the call 3LR. They have been heard on the air as early as 12 midnight E.S.T. (Sholin)

HJ1ADC, Baranquilla, Colombia, heard contacting "Hams" 11 p.m., E.S.T. (Saldana)

XGBD, Shanghai, China, reported heard on 31.2 meters, 9580 kc. (Pasquale)

JZI, Japan, heard testing on about 17.3 meters and talking with California. (Baier)

CT1AA, Lisbon, Portugal, heard on 31.25 meters, 9600 kc., on Tuesdays and Fridays, and lately also on Saturdays, 21:30-00 G.M.T. (Shields, Self, S. J. Emerson). This station also reported testing on 19.6 meters with songs and music. (Smith)

KZRM, Manila, P. I., heard testing on 31.55 meters, 9510 kc. (Pasquale)

OCJ, Peru, reported on 15.82 megacycles. (Kemp)

#### I2RO Transmissions

An official communication from the Ente Italiano Audizioni Radiofoniche states that the new short wave station of Prato Smeraldo transmits the American hour from Rome on Monday, Wednesday, and Friday from 6 to 7:30 p.m., E.S.T., on a wavelength of 49.2 meters.

#### German Transmissions

An official communication from the Reichsrundfunkgesellschaft states that the German short-wave stations will be on the air according to the schedule shown in this month's table. A new station has been added to the group, Station DJQ, which works on 19.63 meters transmitting a program directed to East Asia.

#### WIXAL Transmissions

An official communication from the World-Wide Broadcasting Corporation, in Boston, states that short-wave station WIXAL transmits three educational broadcasts per week. Each broadcast is of approximately two hours' duration beginning Sundays at 5 p.m. and Tuesdays and Thursdays at 7:30 p.m. The programs consist of music through the cooperation of the New England Conservatory of Mu-

#### LECTURES TO CLASSES BY ULTRA SHORT WAVES

In a series of experiments at the School of Commerce, New York University, Dean Edward Kilduff delivers a lecture to a general science class from his office via 5-meter radio equipment



sic, the Malkin Conservatory of Music, and the Boston Conservatory of Music. Faculty members from Harvard University, Columbia University, Massachusetts Institute of Technology, Wellesley College, Amherst College, and the Boston Museum of Fine Arts are providing cultural material.

#### VK3LR Transmissions

An official communication from the Postmaster General's department at Melbourne, Australia, states that Broadcasting Station 3LR is on the air on week days from 04:15 to 08:30 G.M.T. The station transmits on a frequency of 9850 kc. with a power of 600 watts. The station is now regularly utilized for relaying programs of the National Broadcasting Service.

#### CT2AJ Transmissions

An official communication from the station director of CT2AJ, at San Miguel, Azores, states that they will be on the air every Wednesday and Saturday night from 5 to 7 p.m., E.S.T. At present they are transmitting on 3612 kc. which may be changed to 3500 kc. soon. The power is 50 watts. Announcements are made in Portuguese and the station announcement sounds like "Aqui Say Dois Ah Jhota em Ponta Delgada, Açores."

#### KDKA Transmissions

An official communication from the Westinghouse Radio Stations states that the schedule of station W8XK is still the same as it has been for the last two years, but that a special program was transmitted on Thanksgiving Day in order to broadcast the Royal Wedding from England. A change in schedule is to be made in the near future.

#### W2XAD Transmissions

An official communication from the General Electric Company states that Station W2XAD can sometimes be heard on the air at other times than the regular program. Special tests are conducted with stations in Australia and South America.

#### PCJ Transmissions

An official communication from Philips Radio, at Eindhoven, Holland, states that the old time short-wave station, PCJ, has resumed its activities. It can be heard on the air on 15220 kc., 19.71 meters. During the month of December, for instance, the station was on the air on December 18 from 0 to 8 G.M.T., on December 19 from (Continued on page 582)



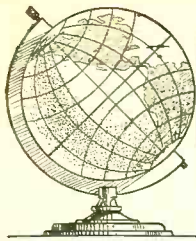

# WORLD SHORT WAVE TIME-TABLE

(Continued from the Previous Page)

Hours of transmission for the World's Short Wave Broadcast Stations



HOURS OF TRANSMISSION												FILL IN LOCAL TIME												HOURS OF TRANSMISSION											
8	9	10	11	M	1	2	3	4	5	6	7	EASTERN STANDARD TIME												8	9	10	11	N	1	2	3	4	5	6	7
01	02	03	04	05	06	07	08	09	10	11	12	GREENWICH MEAN TIME												13	14	15	16	17	18	19	20	21	22	23	00
<b>HOURS OF TRANSMISSION</b>												<b>WAVE-LENGTH METERS</b>												<b>HOURS OF TRANSMISSION</b>											
<b>Call Letters</b>												<b>Frequency Kc</b>												<b>City Country</b>											
Th Th Th												45.3 PRADO 6616 Riobamba, Ecuador																							
D D												45.3+ RW72 6611 Moscow, U. S. S. R																							
D D I												46.1 HJ5ABD 6504 Cali, Colombia																							
D D I												46.2+ H14D 6482 San Domingo, D. R.																							
D D I												46.5+ HJ1ABB 6447 Barranquilla, Col.																							
Sa Sa Sa												46.6 W3XL 6425 Bound Brook, N. J.																							
XS XS D												47.0+ YV4RC 6375 Caracas, Venez.																							
H D I												47.5 HIZ 6315 San Domingo, D. R.																							
D D I												47.8 HJ3ABF 6275 Bogota, Colombia																							
D D I												48.4 CT1GO 6198 Paredo, Portugal																							
D D I												48.4 H11A 6188 Santiago de Los Caballeros, D. R.																							
FS ES												48.7+ HJ2ABA 6150 Tunja, Colombia																							
D D D												48.7+ CJRO 6150 Winnipeg, Manitoba																							
D D D												48.7 YV3RC 6150 Caracas, Venezuela																							
D D D												48.7 VE9CL 6150 Winnipeg, Man.																							
D D D												48.8+ W8XX 6140 Pittsburgh, Pa.																							
D D D												48.9+ ZGE 6130 Kuala Lumpur, F. M. S.																							
XS XS												48.9+ ZTJ 6122 Johannesburg, Africa																							
D D												49.0+ W2XE 6120 New York, N. Y.																							
I I I												49.0 YDA 6120 Bandoeng, Java																							
D D D												49.0+ PK1WK 6116 Java																							
D D D												49.0+ YV2RC 6112 Caracas, Ven.																							
D D D												49.0+ VE9HX 6110 Halifax, N. S.																							
D D D												49.0+ VUC 6109 Calcutta, India																							
Y Y Y												49.1+ W3XAL 6100 Bound Brook, N. J.																							
AE AE AE												49.1+ W9XF 6100 Chicago, Ill.																							
D XS XS												49.1+ VE9GW 6096 Bowmanville, Can.																							
D D I												49.2+ I2RO 6085 Rome, Italy																							
D D D												49.3+ CP5 6080 La Paz, Bolivia																							
S S S												49.3+ W9XAA 6080 Chicago, Ill.																							
S S S												49.3+ QCN 6073 Macao, Asia																							
S S S												49.3+ OER2 6072 Vienna, Austria																							
S S S												49.3+ VE9CS 6070 Vancouver, B. C.																							
S S S												49.4+ VQ7LO 6060 Nairobi, Kenya, Afr.																							
S S S												49.4+ W8XAL 6060 Cincinnati, Ohio																							
S S S												49.4+ W3XAU 6060 Philadelphia, Pa.																							
S S S												49.4+ OXY 6060 Skamlebaek, Den.																							
S S S												49.5 GSA 6050 Daventry, England																							
S S S												49.6+ HJ1ABG 6042 Barranquilla, Col.																							
S S S												49.6+ W1XAL 6040 Boston, Mass.																							
S S S												49.7+ HP5B 6030 Panama City, Pan.																							
S S S												49.8 DJC 6020 Zeesem, Germany																							
S S S												49.8+ ZHI 6012 Singapore, Malaya																							
S S S												49.8+ COC 6010 Havana, Cuba																							
S S S												49.8+ XEBT 6010 Mexico City, Mex.																							
S S S												49.9+ VE9DN 6005 Montreal, Quebec																							
S S S												49.9+ HIX 6000 San Domingo, D. R.																							
S S S												49.9+ RW59 6000 Moscow, U. S. S. R.																							
S S S												49.9+ FIQA 6000 Tananarive, Madag.																							
S S S												50.1 TGX 5984 Guatemala City																							
S S S												50.2+ HVJ 5969 Vatican City																							
S S S												50.6+ HJ4ABE 5860 Medellin, Colombia																							
S S S												51.2+ YV5RMO 5850 Maracaibo, Venez.																							
S S S												51.4+ HJ2ABC 5824 Cucuta, Colombia																							
S S S												51.9 OAX4D 5820 Lima, Peru																							
S S S												51.9+ TIX 5795 San Jose, Costa Rica																							
S S S												52.0 TGTH Almatice, San Jose, Costa Rica																							
S S S												52.9+ XOAJ 5660 Shanghai, China																							
S S S												54.5+ HC2EP 4650 Guayaquil, Ecuador																							
S S S												60.4 G6RX 4320 Rugby, England																							
S S S												69.5 YNLF 4316 Managua, Nicaragua																							
S S S												70.2 RW15 4273 Khabarovsk, Siberia																							
S S S												73.0 HC1B 4107 Quito, Ecuador																							
S S S												80.0 CT1CT 3750 Lisbon, Portugal																							
S S S												80.0+ Radio LL 3700 Paris, France																							
S S S												83.0 CT2AJ 3612 San Miguel, Azores																							
S S S												84.6+ CR7AA 3543 Lourenco Marques, Mozambique																							

## KEY TO TIME TABLE SYMBOLS

- A—Sunday, Winter only
- B—Sunday, Monday, Wednesday, Friday
- C—Monday, Wednesday, Friday
- D—Daily at hours indicated
- E—Tuesday, Thursday
- F—Friday
- G—Tuesday, Thursday, Saturday
- H—Wednesday, Friday, Sunday
- I—Irregularly
- J—Thursday, Saturday
- K—Monday, Friday
- L—Wednesday, Saturday
- M—Monday
- N—Monday, Wednesday, Thursday
- O—Tuesday, Friday, Sunday

- P—Except Tuesday, Wednesday, Summer only
- Q—Except Tuesday, Wednesday
- R—Thursday, Friday, Saturday
- S—Sunday
- T—Tuesday
- TH—Thursday
- U—Sunday, Summer only
- V—Wednesday, Sunday
- W—Wednesday
- Y—Monday, Wednesday, Saturday
- Z—Tuesday, Friday
- AA—Saturday, Sunday
- AB—Except Monday, Tuesday, Wednesday
- AC—Monday, Tuesday, Saturday
- AD—Time at 20 G.M.T.

- AE—Except Monday, Wednesday, Friday
- AF—Saturday irregularly
- AG—Tuesday, Sunday
- AH—Time at 7:30 G.M.T.
- AI—Tuesday, Friday, Saturday
- SA—Saturday
- XA—Except Saturday, Sunday
- XF—Except Friday
- XG—Except Tuesday, Thursday, Saturday
- XM—Except Monday
- XS—Except Sunday
- XSa—Except Saturday
- XT—Except Tuesday
- XTh—Except Thursday
- XW—Except Wednesday

# THE WORLD'S FINEST ALL-WAVE RECEIVER

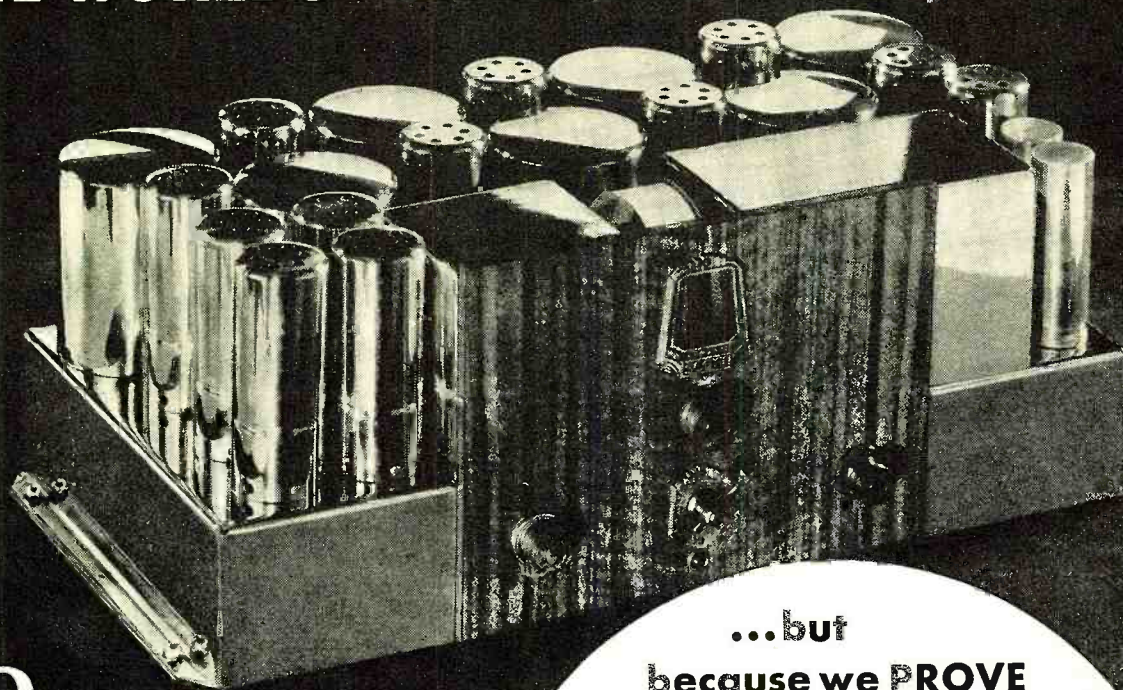

*Not because  
we say so....*

The reputation of this receiver has been won in the toughest kind of service to the most discriminating type of buyers. Scott capability... in distance-getting—in dependability—in gloriously rich, true tone... comes from finer methods of building—custom-construction in which every operation is held to the closest limitations known in radio manufacture.

## E. H. SCOTT RADIO LABORATORIES, INC.

4440 Ravenswood Avenue, Dept. 5C5, Chicago, Illinois

*Inquiries may be addressed direct to the laboratories, or the foreign office nearest you.*

AZORES, Rua da Misericordia, 2, 4, 6, Ponta Delgada; BRITISH WEST INDIES, 10—12 Port Royal St., Kingston, Jamaica; COLOMBIA, Apartado 621, Bogota; ENGLAND, Ethelburga House, 91—93 Bishopsgate, London; GREECE, 8 Rue Canaris, Athens; MEXICO, Independencia 100, Mexico City, D. F.; Calle Diaz Miron 40, Ore, Tampico, Tamps., Mexico; NEW ZEALAND, 9—11 Pacific Bldg., Auckland; PERU, Casilla 1915, Lima; PUERTO RICO, 7 Jefferson St., San Turce; SPAIN, Alameda Recalde 46, Bilbao; Paz 14, Valencia; SOUTH AFRICA, Beckett's Bldg., President St., Johannesburg; STRAITS SETTLEMENT, 96 N. Bridge Rd., Singapore; VENEZUELA, Caracas.

...but

because we **PROVE**  
it in this sensational way!

You must be satisfied that the SCOTT All-Wave XV is truly "The World's Finest All-Wave Receiver." To convince you, we make this offer: Get a SCOTT All-Wave XV from the laboratory where it is custom built. Install it in your home anywhere in U. S. A. and test it competitively against any other radio in the world during a 30-day trial period. If it does not bring in *more* stations, from *greater* distances, with *more* volume and *better* tone, on both the *short waves* and the *broadcast band*, it may be returned without question. Every part used in the construction of the SCOTT All-Wave XV (except tubes) is guaranteed for five years. The Console illustrated is the Waverley — one of a complete line of beautiful Scott Cabinets.

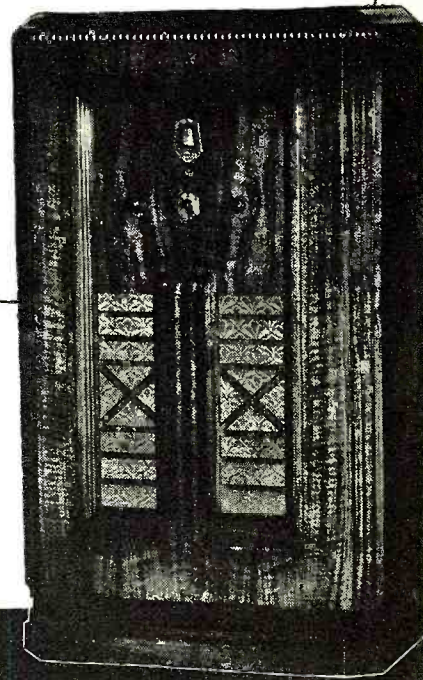

## SEND COUPON FOR DETAILS



E. H. Scott Radio Laboratories, Inc. 4440 Ravenswood Ave., Dept. 5C5, Chicago, Ill.  
Please send full particulars about the Scott All-Wave XV, including technical data, performance proofs, etc., and details of your 30-day trial offer anywhere in the U. S. A.

Name \_\_\_\_\_  
Address \_\_\_\_\_  
City \_\_\_\_\_ State \_\_\_\_\_

# A New Type of CARBON RESISTOR

After extensive research the chemists have developed a new type of carbon resistor which offers some attractive advantages for radio applications

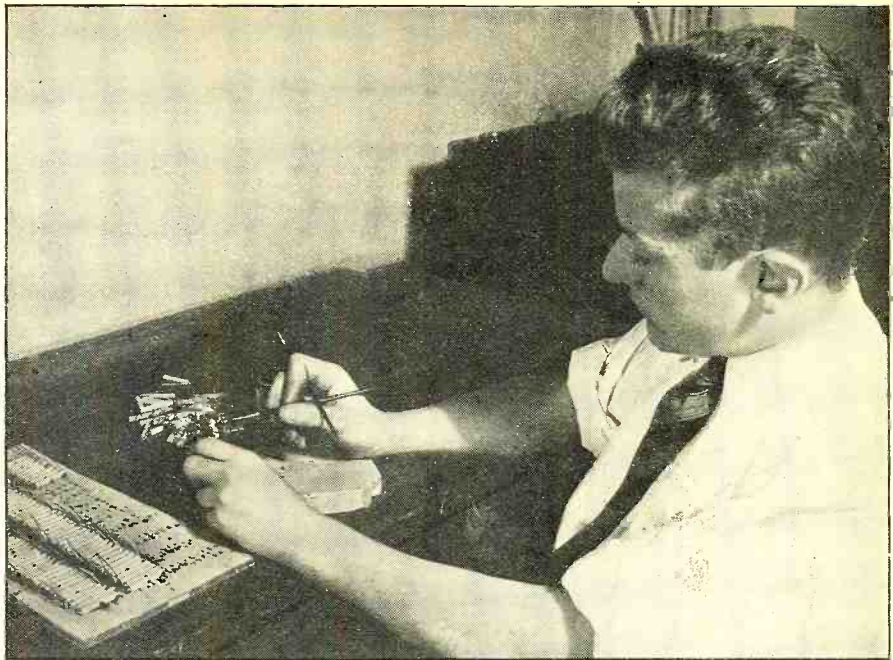

**T**HE innocent looking carbon resistor has been subjected to intensive study and painstaking research in order to improve its quality. In general, there are two kinds of carbon resistors. The first is the carbon coated type and the second is the well known carbon composition moulded type.

The carbon coated type consists of a glass tube or rod with a thin film of conducting material on its external surface. In order to make the various resistance values, the thickness of this film is varied but at most it is extremely thin. This delicate exposed film is of course liable to be damaged easily and also, because the cross-sectional area is so small, the current density is small, causing overheating.

The second type is the most gener-

## AN ORDINARY RESISTOR

*Figure 1. A cross section photographed through an 80-power microscope. Note the coarse, porous appearance in contrast to that of Figure 2*



**CARE IN COLOR CODING**  
*Great care is used in clearly coding each of these new resistors to avoid confusion in determining values*

ally used today and consists of a mixture of some conducting material, carbon and an insulating material. This mixture is moulded under relatively low pressure. Mixing several ingredients may make the composition uniform to the naked eye, but in many cases when a sufficiently powerful microscope is used, the mixture will still consist of three distinct substances each of which is present in the form of "pebbles." These pebbles touch each other at one point generally, and besides, the mass is porous, having comparatively large "open spaces." This can be seen in the microphotograph of Figure 1. The picture was taken through a microscope of 80 power and shows the cross-section of an ordinary carbon resistor.

The foregoing should make plain that the usual carbon resistor is not uniform in composition. At certain places there may be more conducting material than at others and the distribution of current will also be irregular. So it might happen that nearly all the current has to pass through a comparatively small part of the cross-sectional area and in any case it must pass through the point-contacts between individual particles with resulting high current density at these points.

This theory has been checked experimentally by placing such a resistor under a higher load than its rating and it was observed by the use of microscopes that some points became hot enough to emit light. Under these conditions it is likely that the resistance value of the resistor will vary. The presence of relatively large voids also causes variations of resistance because the unit will absorb moisture. Furthermore, mechanical strains will have the same effect.

A new type of carbon resistor was

developed by Lynch Mfg. Co. which consists of a more uniform mass and hence has an even distribution of current density. The new resistor consists of a basic resistance material—instead of insulating material—and another resistance material of higher conductivity. The two are mixed in various proportions to make the different resistance values. The mixture is formed into rods under very high pressure.

The uniformity of the material insures that the entire cross-section carries current and the high pressure eliminates the point contacts. Such a resistor has a uniform current distribution and the tests do not show any "light points" as they did in the old type. A microphotograph (80 power) of this new type (*Continued on page 581*)

## THE NEW RESISTOR

*Figure 2. Photographed under the same enlargement as Figure 1, the close-grained texture of the new resistors is evident*



# A New RACK and PANEL AMPLIFIER

(Pre-Amplifier Unit)

The pre-amplifier described here offers relatively high gain with substantially complete freedom from hum. It is operated from the power supply of the main amplifier and is adaptable to either rack or table mounting

**B. J. Montyn**

Part Two

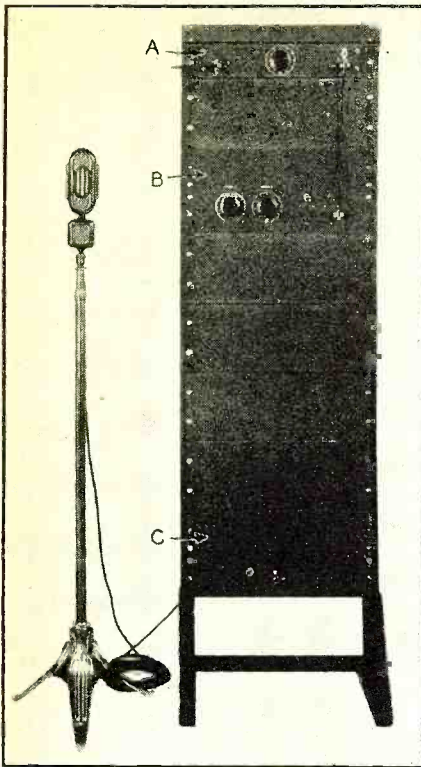

THE COMPLETE AMPLIFIER

The top panel is the pre-amplifier and the third panel down is the main amplifier. The power supply panel is at the bottom of the rack. Below are shown close-ups of the pre-amplifier unit which is discussed in this article

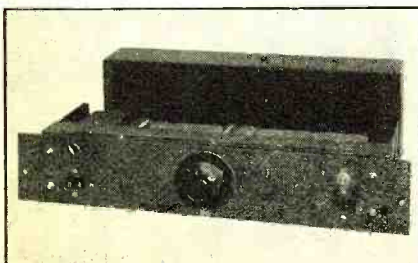
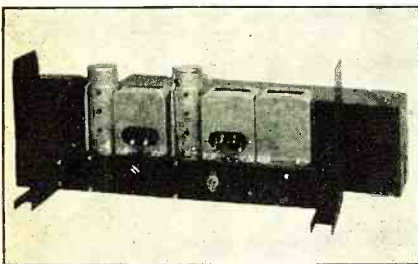
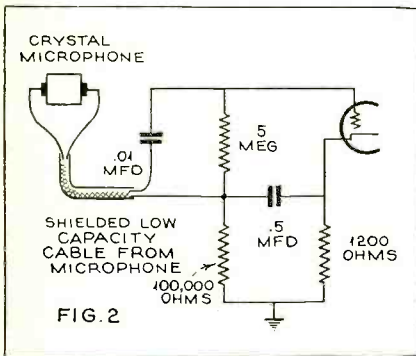

LAST month the main amplifier and power pack of this public address system were discussed. This month the description is completed by the addition of a pre-amplifier.

From all reports received, many readers are having difficulty with pre-amplifiers. The writer has listened to this pre-amplifier connected ahead of the main amplifier, using phones and having everything turned up full. The hum is noticeable, of course, but remarkably low. The total gain of the two amplifiers is 130 db. A limit of gain must be reached, due to thermal agitation.

The pre-amplifier consists of two transformer coupled stages using 77 or 6C6 tubes as shown in the circuit of Figure 1. It has been found that connecting the screen and suppressor of a 77 or 6C6 to the plate converts it into an efficient triode. This connection provides a mu of 20 and a relatively low plate resistance. The characteristics for this connection were measured in the laboratory of the Connecticut State College and are given herewith: Plate voltage, 250 volts; plate current, 7 volts; grid voltage, -8

volts; Amplification factor, 20; mutual conductance, 2000 micromhos; plate resistance, 10,500 ohms; load resistance, 15,000 ohms; power output, 300 milliwatts.

Great care has been taken to minimize noises and hum in this unit. Two extra filter sections have been placed in the power supply and the tube sockets are mounted in sockets using non-microphonic springs. The pre-amplifier is, of course, completely shielded and so are all the cables leading to it.

The input transformer has a tapped primary with an impedance of 500 ohms with provisions to accommodate 333, 200, 125 and 50 ohms. Nearly all velocity microphones now have a transformer in the base which will match the input of the pre-amplifier. Those who wish to use a crystal microphone should employ the resistance-coupled input as shown in Figure 2.

The output transformer accommodates 500, 200, and 50 ohm lines.

The construction of the preamplifier is similar to that of the main amplifier. It can be had for rack-mounting or for table-mounting, and the same chassis serves for both. (Continued on page 586)

THE PRE-AMPLIFIER CIRCUIT

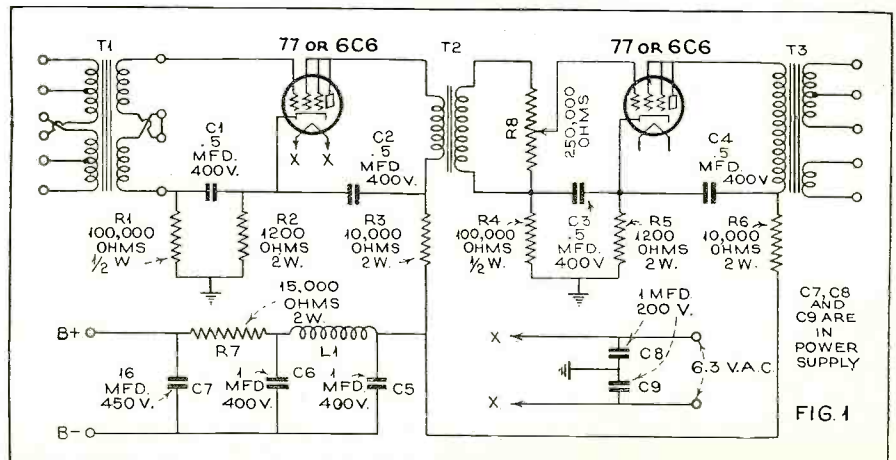

# FIRST AID TO INVENTORS

## SELLING

*your*

## INVENTION

This is the fifth of the series of articles written exclusively for RADIO NEWS readers explaining little-known facts about patents. The subject this month is "How to Obtain Financial Recognition on Your Invention"

E. E. Free, Ph.D.

Part Five

**P**ROBLEMS discussed in previous articles of this series, protecting your inventor's rights, embodying these rights in a patent and the rest of them, mean nothing in themselves. They merely are preliminaries to the last and most important step, which is to *turn the patent into money!*

**W**ITH rare exceptions there are only four ways of realizing a profit out of an invention. One is by *outright sale* of the invention for a sum of money. The second is by *royalty*, which means that the purchaser agrees to pay the inventor specified sums for each article manufactured under the invention, or some other payment proportional to the ex-

tent to which the invention is used. The third source of cash from an invention is to *use it yourself* in some profitable way, and the fourth is to *raise money, organize a company* and then use the invention for the profit of that company's stockholders. This article discusses the first two of these possibilities. The inventor's chances of

### WHAT IS THIS PATENT WORTH?

*The newest invention of the German scientist, Carl von Dreger, that he calls a physiological instrument for testing musicians, may be worth a fortune, but unless it is sold and comes into wide usage it will not bring a very large financial return to the inventor*

using an invention himself or of financing a company to do so will be discussed next month.

O outright sale of an invention is the simplest and in many ways the best method of making money from an invention, if it is possible at a price upon which seller and buyer can agree. A sale involves no possibility of later arguments about mutual rights, for there are none. All rights pass at once to the buyer. There are no complicated contracts to be drawn and interpreted. The transaction is over and done with at once, like a purchase over the counter of a store.

The difficulty is that outright sale seldom is possible. In the nature of the case, the commercial value of a new invention usually is unproved and problematical. The inventor naturally considers it immensely valuable. Prospective buyers, on the other hand, are more likely to remember the many slips which happen between financial cups and lips and to be unwilling to pay a cash sum which the seller considers adequate. Even if the inventor sets his price for an invention on the basis of what it cost him to develop it, the same difficulty is likely to arise. If the invention is really valuable it will be worth many times its cost of development. If it meets no commercial success its value may not equal even a fraction of these costs.

Sometimes the probable commercial value can be assessed with some accuracy, especially if the invention is one for which a clearly determined market already exists and if its practical working and its engineering features have been established by sufficient tests. In my experience this very

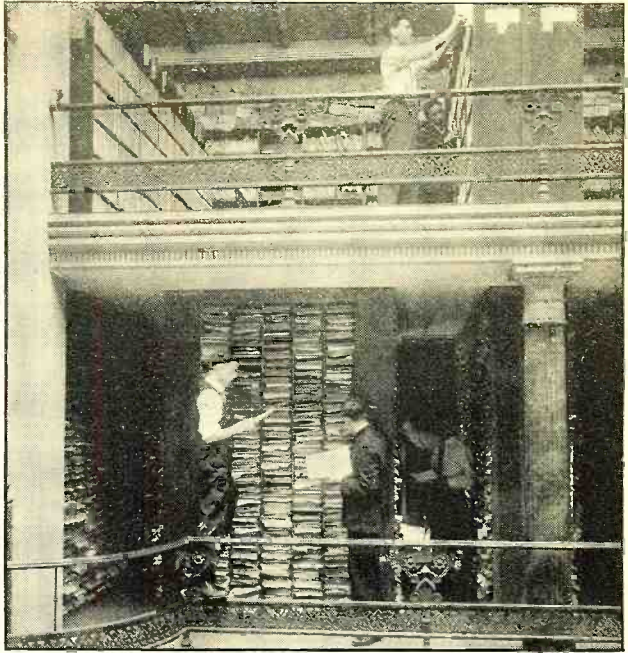

YOUR PATENT IS FILED HERE

*Some of the cabinets for filing patents are shown in these balconies of the Patent Office. But that does not get you any return for your work. A patent must be sold and used to bring a return to the inventor*

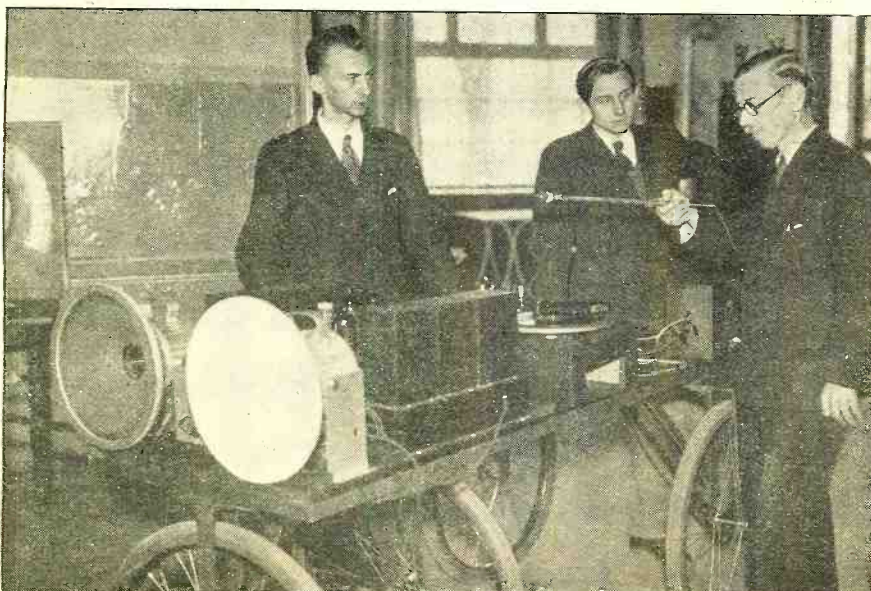



seldom is the case. Long and expensive commercial trials usually are necessary before anybody can say with certainty whether an invention is worth a million dollars, a thousand dollars, or nothing. Think of de Forest's invention of the three-element vacuum tube. When that device was invented radio broadcasting was undreamt of. Need for a telephone repeater was appreciated but there was no assurance that the vacuum tube would be useful for this purpose; indeed, the first vacuum tubes developed by Dr. de Forest were not good repeaters. Even aside from legal questions of breadth and validity, who could have said what the vacuum tube patent really was worth? It then was valued, I understand, at \$40,000. It turned out to be worth many times that sum. It might have turned out to be worth almost nothing.

Just as inventors as a class are too likely to suspect everyone of trying to steal their inventions, so it has been my experience that they tend to regard all business men as crooks trying to buy their inventions for a fraction of the real value and to make enormous fortunes by doing so. This is nonsensical. Naturally, everyone buying an invention wants to get it for as little money as possible. The inventor himself, if he is even moderately sensible, does exactly the same thing with everything he buys, from the food that he eats to the parts he needs to work out new inventions. In actuality, I am convinced that the price at which inventions are sold averages too high rather than too low. For every patent, like the vacuum tube one, which is sold at what later proves to be below its real value, there certainly are hundreds, probably thousands, which are sold for much more than they later turn out to be worth.

This is not saying to the individual inventor that he must sell his invention "cheap." What it does say is that outright sale usually is an unfair and unsatisfactory way to dispose of an untried invention, both for the seller and for the buyer. Both necessarily must take gamblers' chances. One or the other often loses money or potential profits, and feels disgruntled. That is why the royalty contract, with all its disadvantages, usually is a fairer way to transfer an inventor's rights.

The simplest royalty contract provides merely that the buyer shall have the right to use the invention (exclusively or otherwise as may be specified) and shall pay to the inventor a certain sum of money for every one of the invented articles that is made. Other royalty contracts may specify payment of a percentage of the sale price, a percentage of profits, or sums fixed in still other ways. The essence of the plan is merely that the payment to the inventor is made to depend upon the value which the invention proves to have for the buyer, not upon the value which anyone imagines that the invention will have. Naturally, the total price which a buyer will give for an invention on a royalty basis is much larger than on a basis of outright sale. On the other hand, the inventor gets little or no immediate cash, but must

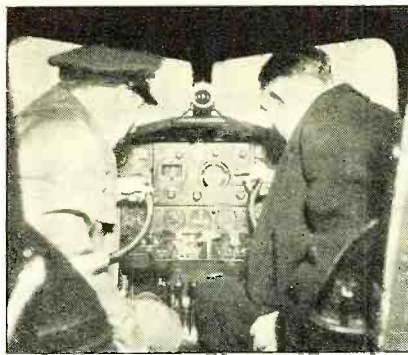

AN IMPORTANT INVENTION

*The instruments in back of this panel are proving their worth as important and remunerative inventions. All the pilot has to do in this plane is to press buttons for the plane's operation. It will take off to the elevation you pick out on the board, will keep to a set course, will straighten out of a wind pocket, and in fact will completely fly the plane*

wait for his returns until the invention has proved its utility and its money value.

A royalty contract may be on either of two different bases; what might be called a sale basis and what is called a license basis. The first is legally similar to an outright sale. Ownership of the invention passes to the purchaser, who merely pays for it slowly and in proportion to its use and value instead of paying immediately. The alternative license arrangement leaves the ownership of the patent with the inventor. The purchaser merely obtains a license to use the invention, under specified terms and conditions and for specified payments, usually depending upon the

WHOSE INVENTION IS THIS?

*Here is a new radio-receiving set for use on Washington's Police motorcycles. The device certainly shows originality and possibly a number of inventions were employed in its make-up*



extent to which the invention is used. Such licenses may be either exclusive to one purchaser or may be non-exclusive, permitting the inventor to make similar licenses with other purchasers if he can and if he so desires.

Details of these three general plans, outright sale, royalty and license, may be almost as varied as the inventions they cover. An invention protected by a patent is legally a piece of property, like a diamond ring or a house and lot. It may be sold, mortgaged, rented, given away or lent, much as can be done with any other kind of property. In all such transactions the inventor will be well advised to have the aid and advice of a competent lawyer; not necessarily an expert patent lawyer but a general lawyer familiar with business dealings. It is impossible to say categorically that either outright sale, royalty or license is the best way to turn any individual patent into cash. Everything depends on the circumstances. It is my belief, however, that some royalty or other basis of making the total payment depend on the invention's commercial value as later developed is likely to be fairer and more satisfactory all around than a basis of outright sale.

There exists, however, one serious objection to many royalty contracts, the possibility that the invention may be purchased not with any idea of using it but with the idea of preventing anyone from using it. This sometimes is called "pocketing" an invention. Suppose that an independent inventor has perfected something which might replace a device sold or used by a large and powerful business organization. It may be good business for that organization to buy the patent with the idea of keeping it off the market, so that the existing business situation will not be upset. Suppose, for example, that some one invented an entirely new and cheaper way of producing radio waves. It might be well worth-while for existing radio interests to buy this patent, put it (Continued on page 588)

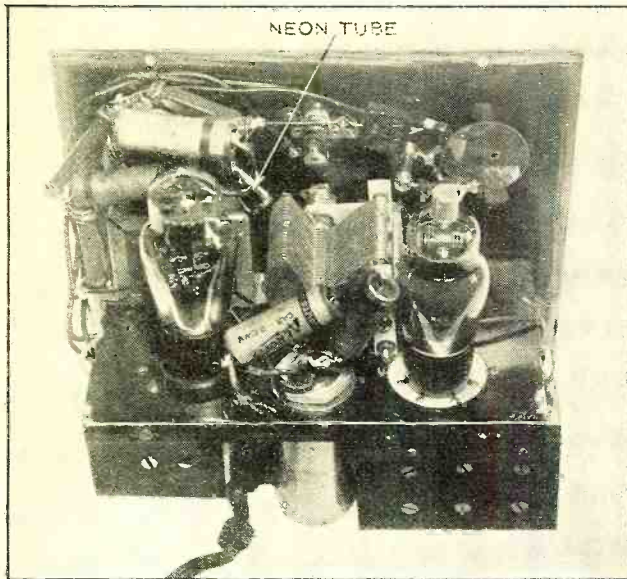

# A 100—22,000 kc. SIGNAL GENERATOR

This article provides the constructional details of a new service unit developed in the RADIO NEWS Laboratory. The schematic diagram appeared last month

John H. Potts

Part Two

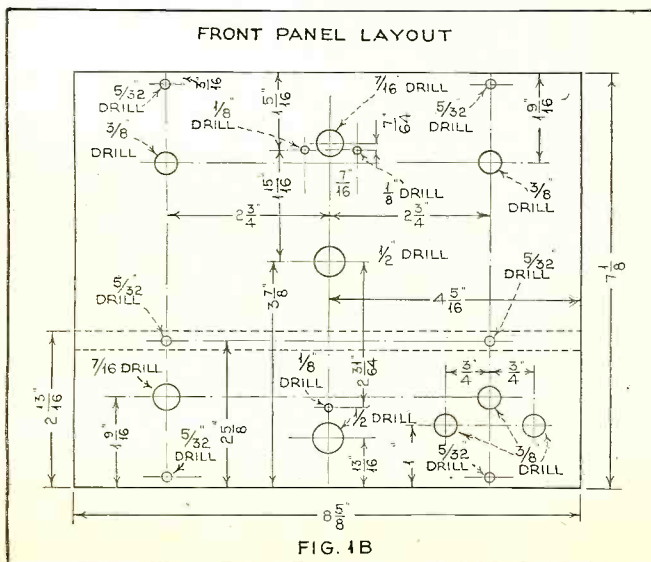
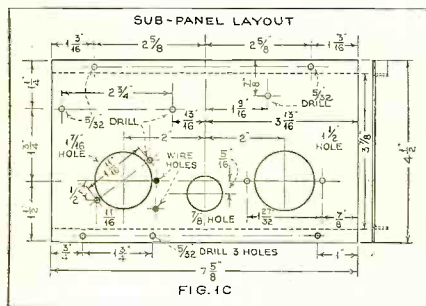
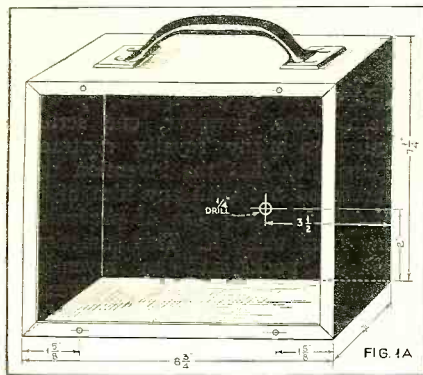

**I**N spite of its compactness, the construction of the signal generator described in last month's issue of RADIO NEWS will not be found difficult if the assembly procedure to be outlined is carefully followed. It is recommended that the cabinet and oscillator coils be purchased unless the constructor is equipped to do this type of work.

For those who wish to make the cabinet, specifications are given in Figure 1. The flange of the back of the front panel making contact with the flange should be gone over with emery cloth to remove all traces of enamel and assure good electrical contact when the instrument is assembled.

The oscillator coils are wound in impregnated wooden dowels according to the specifications given in Figure 2. Coil number 1 must be carefully constructed if oscillation over the entire tuning range is to be achieved. The tickler winding must start as closely as possible to the secondary winding. After construction, the leads should be anchored in place with thin strips of fabric

dipped in coil dope and the entire coil thoroughly impregnated with this same moisture-resistant dope. The coils should then be assembled on the mounting panel which is constructed according to the specifications of figure 3. The individual coil assemblies have their terminals brought out to thin bakelite terminal panels for convenience in wiring. Flat head brass wood screws are used to fasten the dowel forms to the assembly panel. The complete assembly is shown in figure 4.

The line filter coils may be conveniently constructed by following the specifications shown in Figure 5. The mounting for these coils consists of thin sheet copper with partitions soldered to the mounting to shield the coils from each other. The can in which the filter coil assembly is installed may consist of a discarded shield from an i.f. transformer.

The oscillator coil assembly and the line filter apparatus should not be mounted on the sub-panel until the other parts have been assembled and wired in to the circuit. This method of

FIG. 2

NOTE-ADJUSTABLE COUPLING

COIL NO.	1	2	3	4	5	6
PLATE	SIZE	36 ENAM	36 ENAM	36 ENAM	34 ENAM	34 ENAM. NOTE A
	TURNS	12	48	45	75	150 NOTE A
GRID	SIZE	28 D.C.C.	28 D.C.C.	30 ENAM	30 SSE	30 SSE NOTE A
	TURNS	5	20	65	440	300 NOTE A
RANGE		22 TO 9 MC.	9.7 TO 2.9 MC.	3.5 TO 1.49 MC.	1580 KC TO 570 KC.	600 KC TO 220 KC. 250 KC TO 100 KC.
	FORM OF WINDING	A	A	A	B	B
SPACE BETWEEN WINDINGS	LESS THAN 1/64	1/32	1/32	1/8 TO 1/16	3/16	3/16
NOTE A - DATA ON MANUFACTURED COIL NOT AVAILABLE AT TIME OF WRITING; CAN BE MADE FROM 415 KC. I.F. TRANS COIL						

assembly will leave plenty of room to work around in. After the panel and sub-panel wiring have been completed as far as possible, the oscillator coil assembly may be temporarily mounted in position and a few bus-bar leads, insulated with spaghetti tubing, soldered to the range switch. These leads will serve to support the gang switch which may now be removed from the panel and the wiring from the coil assembly to the switch terminals completed without difficulty. When this is done, the switch and coil assembly may be installed as a unit in the signal generator circuit.

The line filter assembly is handled in like manner. When the line filter is permanently installed care should be taken that its shield does not touch the signal generator shield. The line filter condensers should be installed last of all.

The output tip jacks are both carefully insulated from the panel. The lead from C11 to the moving arm of the attenuator is shielded and the shielding is insulated from the signal generator, which may be done by taping it or with a large diameter piece of insulating tubing. This shielding is connected to J2.

The variable condenser is mounted with the isolantite stator support perpendicular to the sub-panel to afford room for the pilot light assembly. The stator lead to Sw 3 should be as short as possible and passes to the switch through a hole in the sub-panel. The usual single-hole mounting is reinforced by drilling and tapping the rotor support so that a 6/32 screw may be passed through the front panel and a spacing bushing to the condenser frame and thereby relieve strain on the single-hole mounting, which otherwise might loosen causing the condenser to shift position and ruin the calibration.

The modulation frequency control is mounted at the right above the filter choke and the percentage modulation control in a corresponding position at the left. The associated condensers and resistors are wired in as closely as possible to these controls. The condenser leads from the variable condenser rotor should be kept as short as possible. C18 should be installed beneath the sub-panel, close to the oscillator coil assembly, likewise the voltage divider resistors, R8 and R9.

The neon tube employed as the modulator is a special miniature type made by the General Electric Vapor Lamp Company, Hoboken, N. J. It is supplied without a base and is wired directly into the circuit by its pigtail leads. The positive lead is indicated by a red dot. The lamp is located beside the modulation frequency control potentiometer, R1.

This lamp should not be confused with the miniature neon lamps (known as the 1/4 watt type) generally available. These standard lamps will not work satisfactorily as audio-frequency oscillators because they are not sufficiently stable in their frequency characteristics. Also the presence of a base on a lamp of this type introduces leakage, and it is for that reason that the special type specified here is supplied without a base.

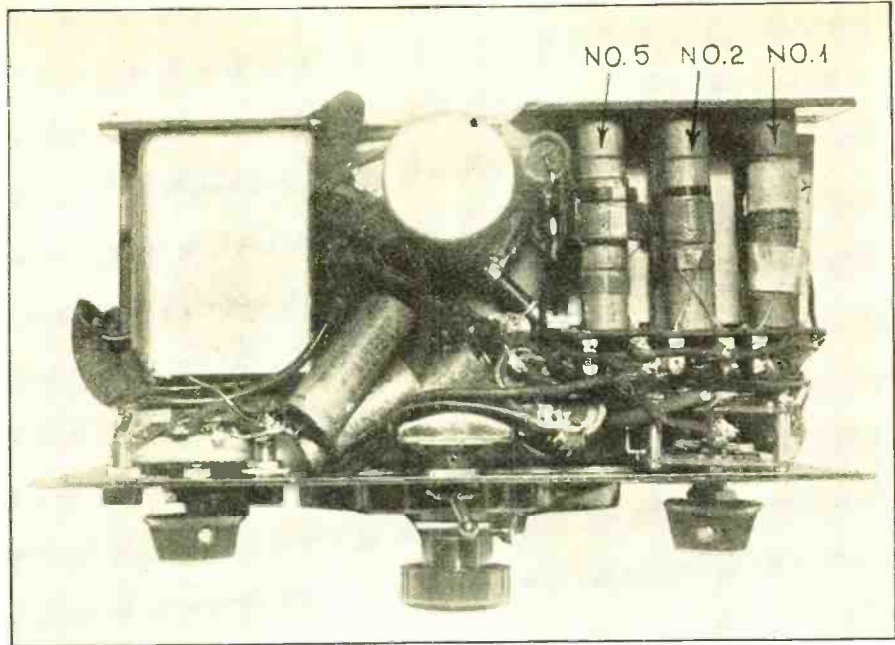

Incidentally, these are the only miniature neon lamps available, to the writer's knowledge that are sufficiently stable for use in experimental electrical organs and other audio oscillator applications. These lamps, known as the type T-4 1/2 may be obtained by individuals or dealers direct from the above named concern.

When the assembly and wiring have been completed, the oscillator coils may be conveniently checked for operation by connecting a 1 ma. meter in series with the grid-leak, R 13. The reading secured will be proportional to the strength of oscillation. A less sensitive method is to connect a 5 ma. meter in series with the output plate circuit and note the change in plate current when the variable condenser stator is touched with a moistened finger. Since the change produced at the low frequency end of coil No. 1 is very small, this latter method, though more convenient is not quite as reliable. If oscillation is not secured on all coil bands, the connections to either grid or plate should be reversed. Do not reverse both windings. All coils must be wound in the same direction. Otherwise oscillation may be secured over a portion of the band only, or none at all. Coils must be assembled in the rotation shown in Figure 4 or absorption effects will be indicated by abrupt peaks in the curves. They should (Continued on page 584)

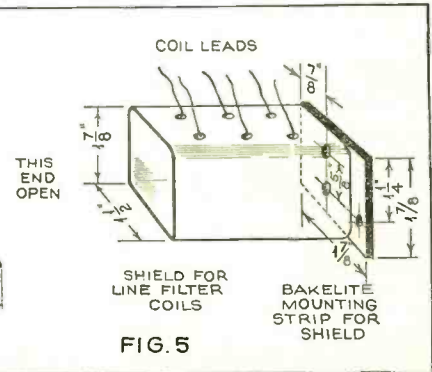
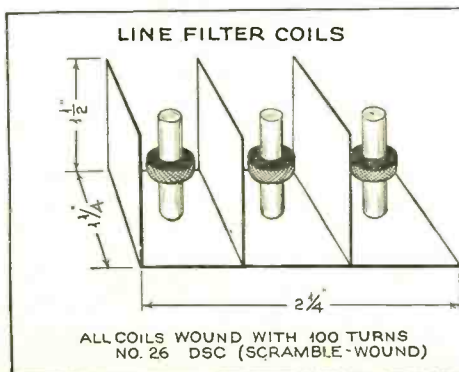
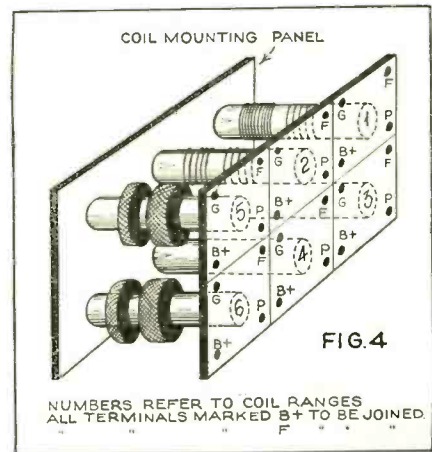
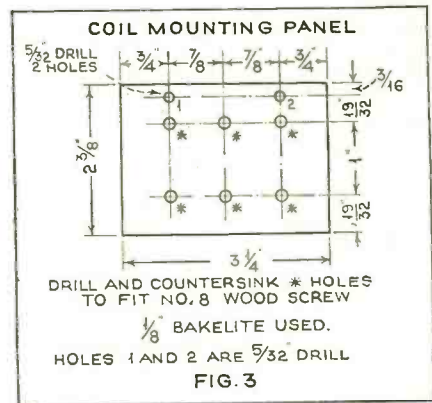



**I**N the last installment of this series the author dealt with the servicing of aircraft radio receivers and transmitters. Now he discusses checking over generators and other accessory jobs.

**W**ITH the set proper out of the way from a service standpoint the next job is to inspect the auxiliary equipment, starting with the generator. Generators, while strictly speaking a part of the engine, are usually left to be serviced by the radio mechanics; and since generator servicing is seldom encountered in ordinary radio work, we will describe briefly the more essential features of the operation.

As the brushes wear down, fine carbon dust accumulates inside the generator, mixes with lubricant, and forms a sticky paste which interferes with operation, particularly with the movement of the brushes. These deposits must be cleaned out, and the brushes

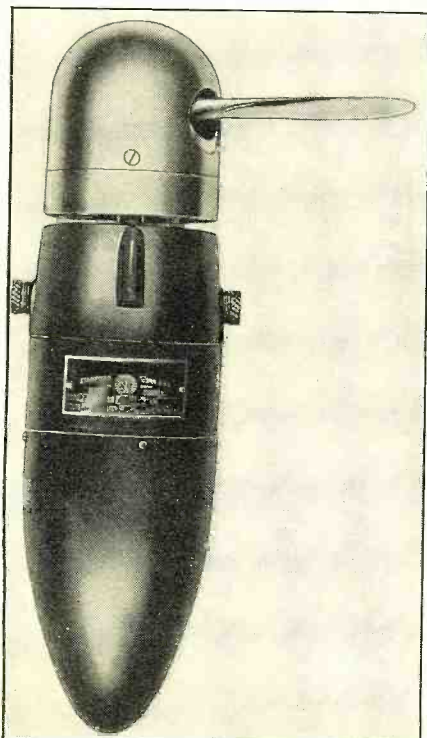

**POWER GENERATORS**  
*At the left is shown the wind-driven electric generator for use on aircraft. Below is the newer and tiny but powerful type of generator preferred for modern aviation radio installations. As brushes wear down, as bearings need oiling, the serviceman must make the necessary checks and repairs*

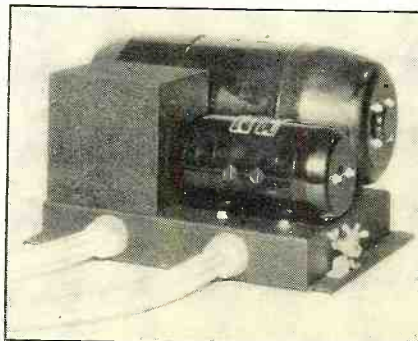

#### GOOD SERVICE IS ESSENTIAL

*In aviation radio no slipshod service methods can be tolerated, for the safety of the passengers and pilot, today, rest mainly with perfectly working apparatus*

disassembled, washed in gasoline, and dried before reassembly. In reassembling, care should be taken that the brushes are "seated" properly on the commutators, making full contact along their entire length. If it is necessary to reseat the brushes, insert a strip of sandpaper between the commutator and the brush, and draw the sandpaper against the direction of rotation of the armature, repeating the operation until the brush is seated properly. The sanded side is held against the brush; never sandpaper generator commutators (unless extremely rough), nor remove the dark surface film normally found on the commutator surfaces. Be sure to clean out or blow out all sand particles. Chipped or worn brushes should be replaced.

Repack all bearings with high melting-point grease, oil where necessary, and replace worn oil-seal washers. Give the generator an hour's run-in on a

# RADIO

*in*

## AIRCRAFT

*(Servicing Accessories)*

Henry W. Roberts

Part Four

bench, starting at slow speed (not over 500 r.p.m.), and gradually speeding up during the last fifteen minutes until the rated speed is reached; then reinstall on the engine, taking care to see that the generator drive shaft is properly aligned, the flexible coupling secured, and all bolts "safetied" with wire.

Air-driven generators, although more expensive and less reliable, are still occasionally found. The servicing procedure remains the same, except for the very troublesome item of the single-bladed air propeller. Check the generator shaft carefully against side play in all positions of the blade, as this may unbalance the propeller to such an extent that it will break (or break the shaft). See that the retaining lock-nut on the propeller shaft is tight, or the propeller may back up the shaft and fly off. The speed of the propeller may be increased by turning the adjustment screw in the propeller boss, opposite the blade root, in the clockwise direction; or reduced, by turning the screw anti-clockwise. The armature should rotate without humming at the cruising speed of the airplane; reduce the generator r.p.m. if humming develops. Damaged blades can sometimes be straightened out in the shop, but unless the damage is very slight, it is better to install a new blade; it is *still better* to install an engine-driven generator.

The generator control box will seldom cause any trouble, but its interior must be maintained scrupulously clean, to prevent oxidation of contacts. When rough, the contacts should be smoothed off, using a piece of canvas or very fine crocus cloth. Do not change the factory setting of the cut-out, or increase the charging rate.

The battery requires more frequent inspection than every 20 hours, and is normally cared for by the ship's mechanic; nevertheless, satisfy yourself that it is being properly maintained, that the spill-proof caps are tight, and that none of the acid found its way into the shielding box containing the battery.

The dynamotor will not require any servicing except lubrication, and occasional repacking of bearings. However, if the (Continued on page 579)

# SUNSET TO SUNRISE *with* FOREIGN DX

R. H. Tomlinson

*Part Two*

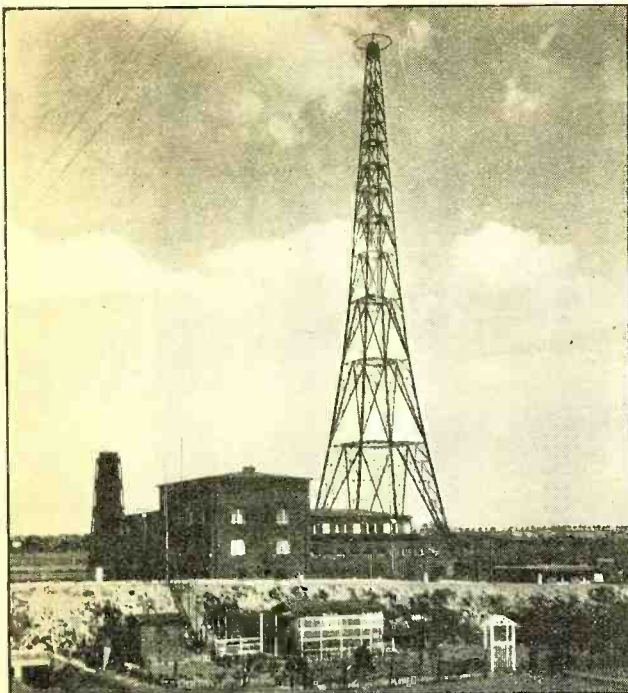

HAMBURG, 904 KC., 100 KW.

*This is one of the stations logged by the author. The 450-foot tower is unique in that it is built entirely of wood*

**I**N the previous article the reception of European broadcast-band stations was discussed. Now, what about Australia? Here we find a different story. Both short and long wave DX'ers must rise at 5:00 a. m. to log these stations, so I am up again after two hours sleep. I then proceed to tune in more Australians on the regular broadcast band than the short wave listener can hope to log. Space doesn't permit a description of all these nor was any attempt made to copy any of the transmissions. My aim at this time was to log and identify as many as possible.

At 5:02 a. m. my first station was 2BL, Sydney on 855 kc., giving time announcements as 5 minutes after 8 p. m., Sydney time. Then in rapid order, between 5:05 and 6:00 a. m. the following were logged and identified: Rockhampton, 4RK, on 910 kc., Brisbane 4QG 760 kc., Sydney 2FC 665 kc., Wellington N. Z. 2YA on 570 kc, Perth 6WF on 690 kc., Crystalbrook 5CK on 635, Corowa 2CO on 560, Sydney 2GB on 949, and Adelaide 5CL on 730. Christchurch 3YA on 720 is the second from New Zealand. Another in Adelaide 5DN on 960, one more in Sydney, 2UE on 1025. Then to top off the morning's reception I proceeded to tune in 4BC on 1145 kc., in Brisbane, using a power of 300 watts. My total is one dozen Australians and two in New Zealand. Is there any short wave DX'er that can find fault with that log?

Is it necessary for the listener to have special receivers and aerials for this long wave reception? Absolutely not. Two standard receivers were used in tuning all the stations I mention, one a late model super and the other a five year old t.r.f. 8 tuber. A super is of course needed to receive Europeans

before 1:00 a. m., due to interference from locals.

Slightly better signals can be obtained by using directive antennas, but with the modern supers I can find little important advantage gained through their use.

Successful broadcast band DX'ing to the extent mentioned, depends on several factors. You must know where to look for the stations, what time

they start transmission and how they are identified. If a few words of the language of each country is not known, then you must at least know what their announcements sound like. For the benefit of those wishing to try their luck on long wave DX'ing, I will list a few of the better heard Europeans, giving the time they start and how they announce.

At midnight tune to 904 kc. and wait for Hamburg to begin. A man will announce first, "Ach-toong, ach-toong, here Hamboerg." This station can be heard until as late as 2:30 a.m. Cologne, Germany on 658 kc. is another

well heard. Their announcements sound like this: "Ach-toong, here vest-doytcher Roondfoonk." Transmissions begin at 12:30 a. m., but due to interference from WEAF, it is well to wait until after 1. Berlin on 841 starting at 12:30 a. m. with gym class is perhaps the easiest of the German to identify. Their announcements are "Ach-toong, here Bear-leen". Between announcements you may hear a few notes from a music box. Budapest is another well heard here. Transmissions begin at 12:45 a. m. and can be identified by the lady announcing, "Allo, here Budapest". Budapest leaves the air at 1:15 a. m. Turin Italy, 11TO, on 1140, is the best of the Italians, with announcements starting off something like this, "e-yahh rah-de-o nord e-tal-eya Tor-ino".

The easiest of all Europeans to identify and the best heard, is Poste Parisien in Paris, on 959 kc. Their transmission begins at 2:10 a. m. each week day. At 2:10 sharp, you will first hear a bugle blowing reveille. This is repeated twice, with drums coming in on the third time. Our announcement follows, always by a man: "Allo, allo, Poste Pare-ree-sun." One more of the Europeans and we will have finished with them. This is Prague on 638 kc., who comes on at midnight. Their announcements are simply: "Here Praha".

For those wishing South American reception a (Continued on page 586)

AN INDOOR STUDIO AT MUNICH, 740 KC., 100 KW.

*Broadcasting House, Munich, has five studios, the largest of which is shown here*

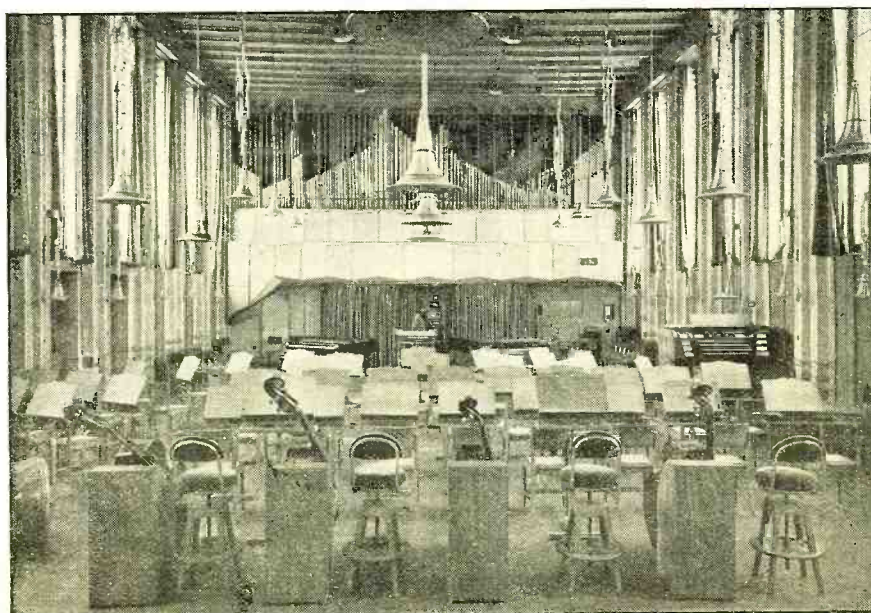

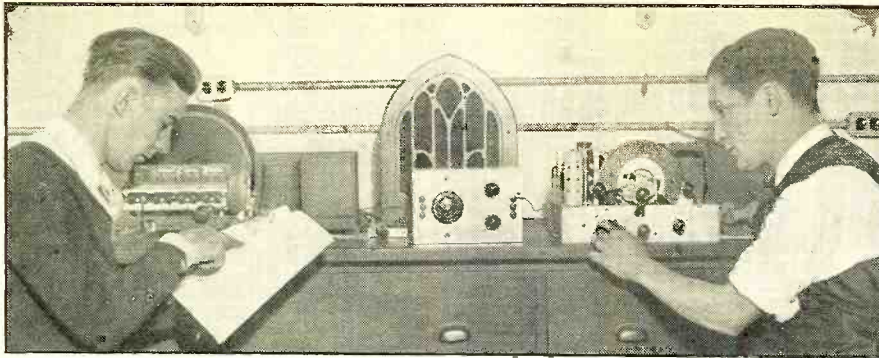

# THE DX CORNER

(For Broadcast Waves)

S. GORDON TAYLOR

THE list of Official RADIO NEWS Broadcast Band Listening Post Observers is constantly growing, but additional applications for appointment are invited from all regular DX'ers who care to function in this capacity, and who, if appointed, are willing to submit monthly reports to this department covering their DX achievements. Each Official Observer will receive a formal certificate like that pictured on the opposite page.

In the effort to make this DX Corner best serve the interests of DX listeners, the editor will be more than glad to have the comments and suggestions of readers.

## RADIO NEWS DX Broadcast

Station WSVS, the Seneca Vocational High School of Buffalo, New York, will dedicate their F. C. C. monitor period of March 6 to RADIO NEWS. This broadcast will continue twenty minutes, beginning at 3:30 a.m., E.S.T., on that date. We hope all readers hearing this broadcast will drop a line of acknowledgment to this station.

Observer Kalmbach arranged for this broadcast.

## Stations in Mexico

Through the good offices of Felipe L. Saldana, the following list of Mexican stations is presented:

Kc.	Call	Location	Watts
560	XEAO	Mexicali, B. C.	250
590	XEPN	Piedras Negras, Coah.	50000
610	XFX	Mexico, D. F.	1000
630	XEZ	Merida, Yucatan	500
660	XEOX	Saltillo, Coah.	1000
690	NET	Monterrey, N. L.	500
710	NEN	Mexico, D. F.	1000
720	XEFI	Chihuahua, Chih.	250
750	NEMC	Merida, Yuc.	250
760	XEB	Aguascaliente, B. C.	5000
780	XEYZ	Mexico, D. F.	10000
810	XFC	Aguascalientes, Ags.	350
820	NETW	Mexico, D. F.	500
		(Off for some time)	500
850	XETZ	Mexico, D. F.	500
860	XEMO	Tijuana, B. C.	2500
890	XEW	Mexico, D. F.	50000
920	XEOK	Tijuana, B. C.	2500
940	XEFO	Mexico, D. F.	5000
960	XEAW	Reynosa, Tamps.	10000
970	NEP	Mixcoac, D. F.	500
970	XES	Tampico, Tams.	250
980	XEU	Veracruz, Ver.	100
980	XEAE	Tijuana, B. C.	250
1020	XEJ	Cidad. Juarez, Chih.	250
1030	XEB	Mexico, D. F.	10000
1040	XEPG	Mexico, D. F.	250
1060	XEA	Guadalajara, Jal.	125
1080	XEAF	Nogales, Son.	250
1100	XEK	Mexico, D. F.	100
1120	XENT	Nuevo Laredo, Tams.	150000
1150	XEWZ	Mexico, D. F.	100
1150	XEH	Monterrey, N. L.	250
1150	XEY	Merida, Yucatan	10
1160	XED	Guadalajara, Jal.	500
1210	XEFV	Ciudad Juarez, Chih.	100
1210	XEFI	Monterrey, N. L.	100
1210	XEMZ	Tijuana, B. C.	30
1210	XETH	Puebla, Pue.	100
1210	XEE	Durango, Dgo.	50
1210	XEAB	Nuevo Laredo, Tamps.	7
1240	XEAZ	Leon, Gto.	7

1240	XEFB	Monterrey, N. L.	100
1240	XEAI	Mexico, D. F.	250
1270	XFB	Jalapa, Ver.	250
1310	XFA	Aguascalientes, Ags.	5
1310	XEZ	Monterrey, N. L.	50
1310	XECW	Mexico, D. F.	10
1310	XEFC	Merida, Yucatan	100
1310	XEFW	Tampico, Tams.	250
1310	XETB	Torreón, Coah.	125
1370	XEFE	Nuevo Laredo, Tamps.	100
1370	XEFZ	Mexico, D. F.	50
1370	XEZZ	San Luis Potosi, S. L. P.	100
1370	XEL	Saltillo, Coah.	100
1370	XEI	Morelia, Mich.	125

## Cuban DX Programs

Following is a list of DX transmissions to be put on by Cuban stations over a period of three months. Arrangements for these broadcasts were made by the National Radio Club of York, Pennsylvania, the officers of which deserve great credit for working out such an excellent array of programs. Readers of RADIO NEWS are urged to show their appreciation by sending reports to such of these stations as they succeed in logging. All hours are a.m., Eastern Standard Time.

Date	Time	Call	Kc.	Location
Feb. 5	2-3	CMJP	1360	Moron
6	12-4	CMHW	910	Cienfuegos
9	1-2	CMW	910	Havana
10	2-3	CMBS	775	Havana
13	1-5	CMOX	1325	Havana
16	2-3	CMOK	1250	Havana
20	12-4	CMHW	910	Cienfuegos
22	1-2	CMCA	1230	Havana
25	2-3	CMJP	1360	Moron
27	12-4	CMHW	910	Cienfuegos
27	2-3	CMBS	775	Havana
Mar. 5	2-3	CMJP	1360	Moron
6	12-4	CMHW	910	Cienfuegos
9	1-2	CMW	910	Havana
10	2-3	CMBS	775	Havana
13	1-5	CMOX	1325	Havana
13	12-4	CMHW	910	Cienfuegos
20	12-4	CMHW	910	Cienfuegos
24	2-3	CMBS	775	Havana
25	2-3	CMJP	1360	Moron
27	12-4	CMHW	910	Cienfuegos
29	2-3	CMCA	1230	Havana
Apr. 4	12-4	CMHW	910	Cienfuegos
5	2-3	CMJP	1360	Moron
6	1-2	CMW	910	Havana
7	2-3	CMBS	775	Havana
11	12-4	CMHW	910	Cienfuegos
13	1-5	CMOX	1325	Havana
18	12-4	CMHW	910	Cienfuegos
21	2-3	CMBS	775	Havana
25	2-3	CMJP	1360	Moron
28	12-4	CMHW	910	Cienfuegos

## Foreign Station Locations

This list provides the call, location, frequency and power of each foreign station reported heard in the U. S. during December by Official L.P.O.'s. See the "Consolidated 'Best Bets'" list elsewhere on these pages for a record of foreign stations heard in your part of the U. S. (or Canada).

Kc.	Kw.	Call	Location
546	120	Budapest	Hungary
556	100	Beromünster	Switzerland
560	7.5	2CB	Corowa, N.S.W., Australia
560	7.5	2CO	Corowa, N.S.W., Australia
564	60	Athlone	Irish Free State

## Official RADIO NEWS Broadcast Band Listening Post Observers

### United States

- California: Randolph Hunt, Warren E. Winkley
- Connecticut: Fred Burleigh, James A. Dunigan, R. L. Pelkey
- Illinois: Herbert H. Diedrich, Ray E. Everly, D. Floyd Smith
- Indiana: E. R. Roberts
- Iowa: Lee F. Blodgett, Ernest Byers
- Maine: Steadman O. Fountain
- Maryland: William Rank, Henry Wilkinson, Jr.
- Massachusetts: William W. Beal, Jr., Russell Foss, Eyan B. Roberts
- Michigan: John DeMyer, Howard W. Eck
- Minnesota: F. L. Biss
- Missouri: T. E. Gootee, C. H. Long
- Montana: R. W. Schofield
- New Jersey: Jack B. Schneider, Alan B. Walker
- New York: Jacob Altner, Edward F. Goss, Robert Hough, John C. Kalmbach, Jr., Harry E. Kentzel, Maynard J. Lonis, R. H. Tomlinson
- North Carolina: Marvin D. Dixon
- Ohio: Donald W. Shields, Richard J. Southward
- Pennsylvania: Joseph Stokes
- Texas: E. L. Kimmons
- Wyoming: J. H. Woodhead

### Foreign

- Australia: Albert E. Faulk, Victoria; George F. Ingle, New South Wales
- Canada: William H. Ansell, Saskatchewan; C. R. Caraven, Vancouver; C. Holmes, British Columbia; Philip H. Robinson, Nova Scotia
- England: R. T. Coales, Hants; F. R. Crowder, Yorkshire; George Ellis, N. Stockport.
- Newfoundland: A. L. Hynes, Clarendville
- New Zealand: L. W. Mathie, Hawke's Bay; R. H. Shepherd, Christchurch; Eric W. Watson, Christchurch.
- South Africa: A. C. Lyell, Johannesburg
- Sweden: John S. Bohm, Malung
- Switzerland: Dr. Max Hausdorff, Vi-ganello

565	10	TGW	Guatemala City, Guatemala
570	5	2YA	Wellington, New Zealand
574	100	Stuttgart	Germany
580	1	ZLZ	Hobart, Tasm., Australia
590	10	JOAK-2	Tokyo, Japan
592	120	Vienna	Austria
601	6.5	Rabat	Morocco
609	20	Florence	Italy
610	10	JODK-1	Keijo, Korea, Japan
610	4.5	3AR	Melbourne, Vict., Australia
618.5	50	KZRM	Manila, Philippine Islands
620	.5	4ZP	Invercargill, New Zealand
625	.5	JOTK	Matsuy, Japan
629	15	Lisbon	Portugal
630	4.5	LS3	Buenos Aires, Argentina
630	.1	CKOV	Kelowna, B. C., Canada
635	.5	JODG	Hamamatsu, Japan
635	7.5	5CK	Crystal Brook, Australia
638	120	Prague	Czechoslovakia
645	.5	JQAK	Dairen, Japan
645	3	JOUK	Akita, Japan
648	15	Lyons	France
650	.5	1YA	Auckland, New Zealand
655	3	JOCC	Asahogawa, Japan
658	100	Cologne	Germany
658	100	Langenburg	Germany
660	75	XGOA	Nanking, China
665	3.5	2FC	Sydney, N. S. W., Australia
668	50	No. Regional	Great Britain
670	10	JFAK	Taihoku, Formosa, Japan
675	...	YV6RV	Valencia, Venezuela
677	25	Sottens	Switzerland
680	.5	JOVK	Hakodate, Japan
681	1	HJN	Bogota, Columbia
690	3.5	6WF	Perth, W. Austr., Australia
695	7	PTT	Paris, France
700	.5	JOKK	Okayama, Japan
704	55	Stockholm	Sweden
710	3	JOJK	Kanazawa, Japan
713	50	IRO	Rome, Italy
720	1	JFBK	Tainan, Formosa, Japan
720	.5	JORK	Kochi, Japan
720	2.5	8YA	Christchurch, New Zealand
730	2	5CL	Adelaide, Australia
735	1	JOSK	Kokura, Japan
740	100	Munich	Germany
750	10	JOBK-1	Osaka, Japan
750	2.5	KGU	Honolulu, Hawaii
760	2.5	4QG	Brisbane, Qnsld., Australia
767	25	Mid. Regional	Great Britain
770	10	JOHK	Sendai, Japan
780	.5	JOPK	Shizuoka, Japan
780	.25	KFQD	Anchorage, Alaska
785	120	Leipzig	Germany
790	10	JOJK	Kumamoto, Japan
790	8	LR10	Buenos Aires, Argentina
790	.5	4YA	Dunedin, New Zealand

795	5	Barcelona	Spain
800	5	3LO	Melbourne, Viet., Australia
804	50	Scottish Reg.	Great Britain
810	10	JOCK-1	Nagoya, Japan
814	50	Milan	Italy
815	.25	PRA6	Rio de Janeiro, Brazil
820	.065	2ZH	Napier, New Zealand
830	16	LR5	Buenos Aires, Argentina
830	10	JOJK	Sapporo, Japan
832	100	RW39	Moscow IV, U.S.S.R.
840	2	2YC	Wellington, New Zealand
840	.34	CMQ	Havana, Cuba
840	4	VOGY	St. Johns, Newfoundland
841	100	Berlin	Germany
845	2	ZBW	Hong Kong, China
850	1.5	Valencia	Spain
850	10	JOFK	Hiroshima, Japan
855	3	2BL	Sydney, N.S.W., Australia
859	15	Strasbourg	France
870	2.1	LR6	Buenos Aires, Argentina
870	10	JOAK-1	Tokyo, Japan
877	50	London Reg.	Great Britain
880	.15	1YX	Auckland, New Zealand
900	10	JODK-2	Kobe, Korea, Japan
900	.5	KGBU	Ketchikan, Alaska
901	100	Hamburg	Germany
910	6	LR2	Buenos Aires, Argentina
910	2	4RK	Rockhampton, Australia
913	60	Toulouse	France
920	.5	JOJK	Niigata, Japan
920	1	HHK	Port-au-Prince, Haiti
922	32	OKB	Brno, Czechoslovakia
930	.4	3UZ	Melbourne, Australia
930	.5	JOAG	Nagasaki, Japan
940	.5	JONK	Nagano, Japan
941	10	Goteborg	Sweden
950	17	Breslau	Germany
950	12	LR3	Buenos Aires, Argentina
950	1	2GB	Sydney, N.S.W., Australia
959	100	Poste Parisien	France
960	10	XEAW	Reynosa, Mexico
960	.3	5DN	Aelaide, Australia
960	.3	JOJK	Kyoto, Japan
960	.5	YVIRC	Caracas, Venezuela
968	15	Grenoble	France
970	.5	JOHG	Machashi, Japan
977	50	W. Regional	Great Britain
978	1	XGOD	Hanagchow, China
980	1	5JOK	Tokushima, Japan
985	1	CE98	Santiago, Chile
986	10	Genoa	Italy
990	.3	JOFG	Fukuji, Japan
990	12	LR4	Buenos Aires, Argentina
995	20	Hilversum	Holland
1000	.05	4GR	Toowoomba, Quid., Australia
1004	13.5	OKR	Bratislava, Czechoslovakia
1010	.3	3HA	Hamilton, Viet., Australia
1013	50	N. National	Great Britain
1025	1	2UE	Sydney, N.S.W., Australia
1030	.5	LR9	Buenos Aires, Argentina
1040	2*	5PI	Crystal Brook, Australia
1040	10	CP4	La Paz, Bolivia
1031	60	Konigsberg	Germany
1050	50	Scottish Nat'l	Great Britain
1059	20	Bari	Italy
1077	12	Bordeaux	France
1085	10	JOBK-2	Osaka, Japan
1104	1.5	Naples	Italy
1120	1	CHSJ	St. Johns, New Brunswick
1125	1	2UW	Sydney, N.S.W., Australia
1131	10	Horby	Sweden
1140	7	Turin	Italy
1145	.75	4BC	Brisbane, Quid., Australia
1149	50	W. National	Great Britain
1150	5	LR8	Buenos Aires, Argentina
1158	2.6	OKM	Kosice, Czechoslovakia
1175	10	JOCK-2	Nagoya, Japan
1176	10	Copenhagen	Denmark
1180	.4	3DB	Melbourne, Australia
1190	.01	VE9EK	Montmagny, Quebec, Canada
1190	5	LS2	Buenos Aires, Argentina
1195	17	Frankfurt	Germany
1210	1	2CH	Sydney, N.S.W., Australia
1222	10	Trieste	Italy
1230	2	LS8	Buenos Aires, Argentina
1230	.....	CPX	La Paz, Bolivia
1240	1	WKAQ	San Juan, Puerto Rico
1245	2	2NC	New Castle, N.S.W., Aust'l
1258	3	San Sebastian	Spain
1267	2	Nürnberg	Germany
1270	1	2SM	Sydney, N.S.W., Australia
1270	1	HIX	Santo Domingo, Dominican Republic
1290	.5	WNEL	San Juan, Puerto Rico
1320	.25	KGMB	Honolulu, Hawaii
1456	10	Radio-Normandie	Fécamp, France
1474	1	Bournemouth	Great Britain

OFFICIAL  
L. P. O.  
CERTIFICATE

A reproduction of the certificate which is issued annually to each Official Radio News Broadcast Band Listening Post Observer. Framed and hung over the DX receiver this should lend an interesting touch to the listening post



ner, Brooklyn; R. H. Tomlinson, Port Chester; Harry E. Kentzel, Rensselaer County. Column 2 (Connecticut)—Fred Burleigh, Meriden; James A. Dunigan, New Britain Column 3 (Montana-Wyoming)—R. W. Schofield, Missoula, Montana; J. H. Woodhead, Monarch, Wyoming. Column 4 (Missouri)—Dudley Atkins, 111, Kansas City; T. E. Gootee, Springfield. Column 5 (Michigan-Ohio)—Ralph B. Baldwin, Ann Arbor, Michigan; Howard W. Eck, E. Lansing, Michigan; Richard J. Southard, Toledo, Ohio. Column 6 (Nova Scotia, Canada)—Phil Robinson, Shelburne. Column 7 (Saskatchewan, Canada)—William H. Ansell, Regina. Column 8 (North Carolina)—Marvin D. Dixon, Shelby.

Listeners living in the general vicinity of any of these observers, by following down the corresponding column, can determine the foreign stations actually being heard in his locality. If none of the observers is near you, the column or columns representing the section of the country closest to you will aid you in searching for foreign stations.

The locations and power of all stations will be found in the "Foreign Station Locations" list in these pages.

Kc.	Call	1	2	3	4	5	6	7	8
560	2CO	-	-	-	-	-	-	-	-
565	TGW	*	-	*	2	*	-	*	*
570	2YA	-	-	-	-	-	-	-	-
574	Stuttgart	1	-	-	2	-	-	-	-
609	Florence	*	-	-	-	1	-	-	-
610	3AR	-	-	-	-	-	-	-	-
618.5	KZRM	-	-	*	-	-	-	-	-
625	JOTK	-	-	-	-	-	-	-	-
635	JODG	-	-	-	-	-	-	-	-
635	5CK	-	-	3	3	-	-	-	-
638	Prague	5	*	-	-	-	-	-	-
645	JOAK	-	-	-	-	-	-	-	-
645	JOJK	-	-	-	-	-	-	-	-
648	Lyons	2	-	-	-	-	-	-	-
650	IYA	-	-	-	-	-	6	-	-
655	JOCC	*	-	-	-	2	-	-	-
658	Cologne	-	-	-	-	-	-	-	-
658	Langenburg	1	-	-	-	-	-	-	-
660	XGOA	-	-	5	-	-	-	-	-
668	North Regional	-	-	*	-	-	-	-	-
670	JPAK	-	-	-	-	-	-	-	-
675	YVGRV	-	-	*	-	-	-	-	-
680	JOVK	-	-	-	-	-	-	-	-
681	HJN	*	-	-	-	-	-	-	-
700	JOJK	-	-	-	-	-	-	-	-
710	JOJK	-	-	-	-	-	-	-	-
720	JORK	-	-	-	-	-	-	-	-
720	3YA	-	-	-	-	-	-	-	-
735	JOSK	-	-	-	-	-	-	-	-
740	Munich	1	*	-	2	-	-	-	-
750	JOBK-1	-	-	-	5	-	-	-	-
750	KGU	-	-	1	4	-	-	-	-
760	4QG	*	*	3	-	-	-	-	-
767	Midland Regional	-	-	*	-	-	-	-	-
770	JOHK	-	-	2	-	-	-	-	-
780	JOPK	-	-	-	-	-	-	-	-
780	KFQD	-	-	*	-	-	-	-	-
785	Leipzig	1	*	-	-	-	-	-	-
790	JOJK	-	-	-	-	-	-	-	-
790	LR10	-	-	-	-	-	-	-	-
790	4YA	-	-	-	-	-	-	-	-
800	3LO	-	-	-	-	-	-	-	-
804	Scottish Regional	6	-	-	-	-	-	-	-
810	JOCK-1	-	-	-	5	-	-	-	-
814	Milan	2	-	-	-	2	*	-	-
815	PRA6	-	*	-	-	-	-	-	-

830	LR5	*	*	1	9	-	-	-	-
830	JOJK	-	-	2	-	-	-	-	-
832	RW39	-	-	-	-	-	-	-	-
840	VOGY	-	-	-	-	-	-	-	-
841	Berlin	1	-	-	2	-	-	-	-
850	JOFK	-	-	-	-	-	-	-	-
855	2BL	-	*	3	-	-	-	-	6
870	LR6	-	-	-	-	*	11	-	-
870	JOAK-1	-	-	-	5	-	-	-	-
877	London Regional	*	-	-	-	-	-	-	-
900	JODK-2	-	-	-	6	-	-	-	-
900	KGBU	-	-	-	-	-	-	-	-
904	Hamburg	1	*	-	2	-	-	-	2
910	LR2	-	-	-	8	-	-	-	-
910	4RK	-	-	-	-	-	-	-	-
913	Toulouse	4	5	-	-	-	5	-	-
920	JOJK	-	-	-	-	-	-	2	-
920	HHK	*	-	-	-	-	-	-	-
922	OKB, Brno	1	-	-	-	-	-	-	-
930	JOAG	-	-	-	-	-	-	-	-
930	JONK	-	-	-	-	-	-	-	-
950	Breslau	1	-	-	-	-	-	-	-
950	LR3	*	-	-	-	-	-	-	-
950	2GB	-	-	-	-	-	-	-	-
959	Poste Parisien	*	2	-	-	2	5	-	2
960	JOJK	-	-	-	-	-	-	-	-
960	YVIRC	*	*	-	-	-	-	6	-
968	Grenoble	-	-	-	-	-	-	-	*
970	JOBG	-	-	-	-	-	-	-	-
977	West Regional	6	-	-	-	-	-	-	-
980	JONK	-	-	-	-	-	-	-	-
986	Genoa	-	-	-	-	-	-	-	-
990	JOFG	-	-	-	-	-	-	-	-
990	LR4	*	*	-	-	-	-	-	-
995	Hilversum	*	-	-	2	-	-	-	-
1004	OKR Bratislava	1	-	-	-	-	-	-	-
1010	3HA	-	-	-	-	-	-	-	-
1013	North Regional	6	-	-	-	-	-	-	-
1025	2UE	-	-	-	-	-	-	-	-
1030	LR9	-	-	-	-	-	-	-	-
1040	CP4	*	-	-	10	-	-	-	-
1031	Konigsberg	1	-	-	2	-	-	-	-
1077	Bordeaux	3	-	2	*	-	-	-	-
1085	JOBK-2	-	-	-	-	-	-	-	-
1104	Naples	2	-	-	-	-	-	-	-
1125	2UW	-	-	-	-	-	-	-	-
1131	Horby	*	-	-	-	-	-	-	-
1140	Turin	2	*	-	-	2	1	-	-
1145	4BC	-	-	-	-	-	-	-	-
1149	West Regional	6	-	-	-	-	-	-	-
1150	LR8	-	-	-	-	-	-	-	-
1158	OKM Kosice	1	-	-	-	-	-	-	-
1175	JOCK-2	-	-	-	-	-	-	-	-
1176	Copenhagen	1	-	-	-	-	2	1	-
1190	VE9EK	-	-	-	-	-	9	-	-
1190	LS2	-	-	-	-	-	-	-	-
1195	Frankfurt	1	2	-	-	2	1	-	-
1222	Trieste	2	-	-	-	2	1	-	-
1230	LS8	-	-	-	-	-	-	-	-
1230	CPX	-	-	-	-	-	-	-	-
1240	WKAQ	-	-	-	-	-	-	-	-
1267	Nurnburg	-	-	-	-	-	2	-	-
1270	HIX	-	-	-	-	-	7	-	-
1290	WNEL	*	-	-	-	2	-	-	*
1320	KGMB	-	-	-	-	-	-	-	-
1456	Radio-Normandie	*	*	-	-	2	-	-	-

Consolidated Foreign "Best Bets"

Following is a list of the foreign stations reported heard by Official Observers in different sections of the U. S. and Canada. Wherever either an asterisk (\*) or a number appears in a column it indicates that the station has been heard in the section represented by that column. Where a number appears it represents the approximate local time when the station is heard. Heavy numbers represent p.m. and light numbers a.m.

This list is made up from observers' reports as follows: Column 1 (New York)—Robert Hough, New Rochelle; Jacob Alt-

Canadian Monitor Schedules

Through the teamwork of Gordon S. Wallace, Brighton, Massachusetts; William T. Turvey, Fredericton, N. B., Canada; and C. Stillwell, Fredericton, N. B., Canada, the following schedule for Eastern Canadian stations is presented. These transmissions take place on the 19th and 20th of each month during the early morning hours indicated.

E. S. T.	Freq.	Call	Location	Watts
1:11-1:19	930	CHNS	Halifax	1000
1:21-1:29	630	CFCY	Charlottetown	1000
1:31-1:39	1310	CJLS	Yarmouth	100
1:41-1:49	950	CRCS	Chicoutimi	100
1:51-1:59	1120	CHSJ	Saint John	100

2:01-2:09	550	CFNB	Fredericton	500
2:11-2:19	580	CHRC	Quebec	100
2:21-2:29	930	CFCH	North Bay	100
2:31-2:39	730	CFPL	London	100
2:41-2:49	1310	CJKL	Kirkland Lake	100
2:51-2:59	580	KCLL	Toronto	100
3:01-3:09	1200	KCTB	Port Dalhousie	100
3:11-3:19	1210	CHNC	New Carlisle	100
3:21-3:29	1420	CKNC	Toronto	100
3:31-3:39	600	CFCO	Chattham	100

Report from Great Britain

R. T. Coales, Official L.P.O., reports the following stations heard:

Kc.	Call	Location	Kw.
590	WEEL	Boston, Mass.	1
620		Cairo, Egypt	20
650	WSM	Nashville, Tenn.	50
660	WEAF	New York, N. Y.	50
680	KPO	San Francisco, Calif	50
700	WLW	Cincinnati, Ohio	500
710	WOR	Newark, N. J.	5
730	CKAC	Montreal, Quebec	5
740	WSB	Atlanta, Georgia	5
760	WJZ	New York, N. Y.	50
790	WGY	Schenectady, N. Y.	50
820	WHAS	Louisville, Ky.	50
830	KOA	Denver, Colo.	50
860	WABC	New York, N. Y.	50
870	LR6	Buenos Aires, Arg., S. A.	2.1
890	XEW	Mexico City, Mexico	50
900	WJAX	Jacksonville, Fla.	1
910	LR2	Buenos Aires, Arg., S. A.	6
950	LR3	Buenos Aires, Arg., S. A.	12
980	KDKA	Pittsburgh, Pa.	50
990	LR4	Buenos Aires, Arg., S. A.	12
990	WBZ	Springfield, Mass.	50
1000	WHO	Des Moines, Iowa	50
1020	KYW	Philadelphia, Pa.	10
1040	WTIC	Hartford, Conn.	50
1060	WBAL	Baltimore, Md.	10
1070	WTAM	Cleveland, Ohio	50
1080	WBT	Charlotte, N. C.	50
1090	KMOX	St. Louis, Mo.	50
1100	WLWL	New York, N. Y.	5
1100	WPG	Atlantic City, N. J.	5
1110	WRVA	Richmond, Va.	5
1130	KSL	Salt Lake City, Utah	50
1140	KVOO	Tulsa, Okla.	25
1150	WHAM	Rochester, N. Y.	50
1170	WCAU	Philadelphia, Pa.	50
1190	WOAI	San Antonio, Texas	50
1190	LS2	Buenos Aires, Arg., S. A.	5
1230	WNAC	Boston, Mass.	1
1230	LS8	Buenos Aires, Arg., S. A.	2
1260	WTOC	Savannah, Ga.	1
1300	WBBR	Brooklyn, N. Y.	1
1330	WDRG	Hartford, Conn.	1
1410	WAAB	Boston, Mass.	.5
1470	WLAC	Nashville, Tenn.	.5
1480	WKBW	Buffalo, N. Y.	.5
1490	WCKY	Covington, Ky.	.5

Report from Switzerland

Official L.P.O. Hausdorff reports the following DX stations well heard at his listening post in the Swiss mountains:

Kc.	Call	Location	Kw.
175		Moscow, U.S.S.R.	500
830	LR5	Buenos Aires, Arg., S. A.	16
860	WABC	New York, N. Y.	50
870	LR6	Buenos Aires, Arg., S. A.	2.1
1060	WBAL	Baltimore, Md.	10
1170	WCAU	Philadelphia, Pa.	50
220	WCAD	Canton, N. Y.	.5

F. C. C. Monitor Schedule

The following is the monitor schedule of the Federal Communications Commission, corrected to December 19, 1934. These stations are on the air twenty minutes each, beginning with the time shown. During these transmissions these stations operate on cleared channels and each station announces its call letters at three-minute intervals. This list enables DX'ers to log these low-power stations, most of which cannot normally be heard at a distance because of numerous other stations operating on the same frequencies.

First Monday of Each Month

E.S.T. Freq.	Call	Location	Watts
2:00 a.m.	1500	WCNW	Brooklyn 100
	1310	WJAC	Johnstown, Pa. 100
2:10	1210	WFAS	White Plains 100
	1370	WRAK	Williamsport, Pa. 100
2:20	1500	WNBF	Binghamton, N. Y. 100
	580	WCHS	Charleston, W. Va. 500
2:30	1420	WAGM	Presque Isle, Maine 100
	1370	WBTM	Danville, Va. 100
2:40	1200	WLVA	Lynchburg, Va. 100
2:50	1420	WHDL	Tupper Lake, N. Y. 100
	1310	WHAT	Philadelphia, Pa. 100
3:00	1200	WCAX	Burlington, Vt. 100
3:10	1500	WSYB	Rutland, Vt. 100
	1310	WTEL	Philadelphia, Pa. 100
3:20	1200	WIBX	Utica, N. Y. 100
	1280	WCAM	Camden, N. J. 500

3:30	1370	WQDM	St. Albans, Vt.	100
	1210	WKOK	Sunbury, Pa.	100
3:40	1310	WMBO	Auburn, N. Y.	100
3:50	1370	WABY	Albany, N. Y.	100
	1210	WBAX	Wilkes-Barre, Pa.	100
4:00	1220	WCAD	Canton, N. Y.	500
	1200	KOOS	Marshfield, Ore.	100
4:10	1370	WRDO	Angusta, Maine	100
	1210	WBBL	Richmond, Va.	100
	900	KGBU	Ketchikan, Alaska	500
4:20	1290	WNBZ	Saranac Lake, N. Y.	50
	1310	WBRE	Wilkes-Barre, Pa.	100
	1200	KGVO	Missoula, Mont.	100
4:30	1200	WNBO	Silverhavea, Pa.	100
	1500	KPQ	Wentchee, Wash.	100
4:40	1310	WRAW	Reading, Pa.	100
	1210	KGY	Olympia, Wash.	100
4:50	940	WAAT	Jersey City, N. J.	500
	1370	KRKO	Everett, Wash.	50
5:00	570	WSYR-WSYU	Syracuse, N. Y.	250
	1200	KFXD	Nampa, Idaho	100
5:10	1370	KVL	Seattle, Wash.	100
5:20	1310	KGEZ	Kalispell, Mont.	100
5:30	1370	KUJ	Walla Walla, Wash.	100
5:40	1310	KGCX	Wolf Point, Mont.	100
5:50	780	KQGD	Anchorage, Alaska	250
6:00	890	KSEI	Pocatello, Idaho	100
6:10	1200	KVOS	Bellingham, Wash.	100
6:20	1310	KIT	Yakima, Wash.	100
6:30	1120	KRSC	Seattle, Wash.	100

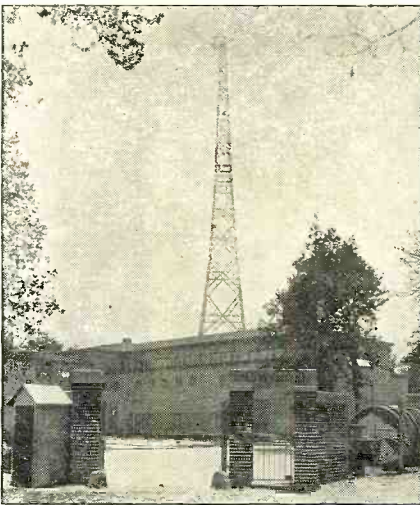

Courtesy—Observer Tomlinson

THE BERLIN TRANSMITTER (8+1 KC., 100 KW.)

Here are shown the transmitter house and antenna of the new German station, located at Tegel, a suburb of Berlin

6:40	1310	KXRO	Aberdeen, Wash.	100
6:50	1120	KFIO	Spokane, Wash.	100
7:00	1210	KFJJ	Klamath Falls, Ore.	100
7:10	1310	KMED	Medford, Ore.	100
7:20	1420	KORE	Eugene, Ore.	100

First Tuesday of Each Month

2:00	1210	WGDX	Thomasville, Ga.	100
2:10	1200	WBHS	Huntsville, Ala.	100
2:20	1370	WHBQ	Memphis, Tenn.	100
2:30	1420	WEED	Rocky Mount, N. Car.	100
2:40	1500	WOPI	Bristol, Tenn.	100
2:50	1320	WSMB	New Orleans, La.	500
3:00	1370	WMRR	Tampa, Fla.	100
3:10	1420	WNRA	Muscle Shoals, Ala.	100
3:20	1310	WSJS	Winston-Salem, N. Car.	100
3:30	1500	WHFF	Kosciusko, Miss.	100
3:40	1200	KMLB	Monroe, La.	100
3:50	1370	WAGF	Dothan, Ala.	100
4:00	1290	WNEL	San Juan, P. R.	500
	1200	KWVG	Stockton, Calif.	100
4:10	1310	WTJS	Jackson, Tenn.	100
	1500	KPJM	Prescott, Ariz.	100
4:20	1370	WFFB	Hattiesburg, Miss.	100
	1370	KERN	Bakersfield, Calif.	100
4:30	1420	WGPC	Albany, Ga.	100
	1500	KXO	El Centro, Calif.	100
4:40	1200	WBNO	New Orleans, La.	100
	1210	KIEM	Eureka, Calif.	100
4:50	1310	KROL	Knoxville, Tenn.	100
	1440	KLS	Oakland, Calif.	250
5:00	1500	WDNC	Durham, N. Car.	100
	1420	KGIX	Las Vegas, Nev.	100
5:10	1200	WJWB	New Orleans, La.	100
	1320	KGMB	Honolulu, Hawaii	250
5:20	1310	WAML	Laurel, Miss.	100
	1370	KRE	Berkeley, Calif.	100
5:30	1210	WSIX	Springfield, Tenn.	100
	750	KGU	Honolulu, Hawaii	2500
5:40	1370	KGAR	Tucson, Ariz.	100
5:50	1310	KCRJ	Jerome, Ariz.	100
6:00	1100	KGDM	Stockton, Calif.	250
6:10	1200	KSNL	Lowell, Ariz.	100
6:20	740	KTRB	Modesto, Calif.	250

First Wednesday of Each Month

2:00	1310	WEBR	Buffalo, N. Y.	100
2:10	920	WFEN	Philadelphia, Pa.	250
2:20	1310	WSAJ	Grove City, Pa.	100
2:30	1410	WBHS	Bluefield, W. Va.	250
2:40	1310	WFBG	Altoona, Pa.	100
2:50	1200	WPDR	Petersburg, Va.	100
3:00	1370	WDAS	Philadelphia	100
	1500	WKBB	East Dubuque, Ill.	100
3:10	1410	WBXX	Roanoke, Va.	250
	1200	WHBC	Canton, Ohio	100
	1420	KGIV	Trinidad, Colo.	100
3:20	1210	WMBG	Richmond, Va.	100
	1310	WTRC	Elkhart, Ind.	50
	1370	KICA	Clovis, N. Mex.	100
3:30	1370	WSVS	Buffalo, N. Y.	50
	1410	WBCM	Bay City, Mich.	500
	1200	KGHI	Little Rock, Ark.	100
3:40	1310	WGH	Newport News, Va.	100
	630	WGBF	Evansville, Ind.	500
	1420	KIDW	Lamar, Colo.	100
3:50	1210	WOCL	Jamestown, N. Y.	50
	1410	WROK	Rockford, Ill.	500
	1200	KBTM	Paraguide, Ark.	100
4:00	880	WQAN	Seranton, Pa.	250
	1310	WBOW	Terre Haute, Ind.	100
	1280	KRBB	Great Falls, Mont.	1000
4:10	1430	WHBC	Rochester, N. Y.	500
	570	WOSU	Columbus, Ohio	750
	1370	KGFL	Roswell, N. Mex.	100
4:20	1190	WSAZ	Huntington, W. Va.	1000
	1310	WBEO	Marquette, Mich.	100
	1200	KADA	Ada, Okla.	100
4:30	1500	WGAL	Lancaster, Pa.	100
	570	WKBN	Youngstown, Ohio	500
	1250	WCAL	Northfield, Minn.	1000
4:40	1070	WCAZ	Carthage, Ill.	100
	1200	KFJB	Marshalltown, Iowa	100
4:50	1400	WKBF	Indianapolis, Ind.	500
	1420	WACO	Waco, Texas	100
5:00	1070	WDZ	Tuscola, Ill.	100
	1200	KGDE	Fergus Falls, Minn.	500
5:10	900	WLBL	Stevens Point, Wisc.	2500
	1250	WLB	Minneapolis, Minn.	1000
5:20	1400	WBAA	West Lafayette, Ind.	100
	1200	WIL	St. Louis, Mo.	100
5:30	1440	WTAD	Quincy, Ill.	500
	1320	KGHF	Pueblo, Colo.	500
5:40	1240	WXYZ	Detroit, Mich.	1000

First Thursday of Each Month

2:00	1210	WSOC	Charlotte, N. Car.	100
2:10	1420	WSPA	Spartansburg, S. Car.	100
2:30	1310	WSGN	Birmingham, Ala.	100
2:40	1420	WJBO (COnly)	Baton Rouge, La.	100
2:50	1210	WGCM	Miss. City, Miss.	100
3:00	1500	WRDW	Augusta, Ga.	100
	1200	WHBY	Green Bay, Wisc.	100
	1310	WDAH	El Paso, Texas	100
3:10	1240	WKAQ	San Juan, P. R.	1000
	1420	WJMS	Ironwood, Mich.	100
	1370	KLUF	Galveston, Texas	100
3:20	1360	WCSO	Charleston, S. Car.	500
	1210	WJDC	Chicago, Ill.	100
	1310	KFSM	El Paso, Texas	100
3:30	1440	WBIG	Greensboro, N. Car.	500
	1370	KGKL	San Angelo, Texas	100
3:40	1340	WCOA	Pensacola, Fla.	500
	1210	WSBC	Chicago, Ill.	100
	1310	KPPM	Greenville, Texas	15
3:50	1360	WQBQ	Vicksburg, Miss.	500
	1420	KPIZ	Pond du Lac, Wisc.	100
4:00	580	WDPO	San Antonio, Texas	100
	1210	WEBQ	Orlando, Fla.	250
	1310	KFYO	Harrisburg, Ill.	100
4:10	1430	WNBK	Lubbock, Texas	100
	1200	WMPC	Memphis, Tenn.	500
	1370	KONO	Lapeer, Mich.	100
4:20	560	WQAM	San Antonio, Texas	100
	1210	WHBF	Miami, Fla.	1000
4:30	1220	WDAE	Rock Island, Ill.	100
	1500	WBZ	Tampa, Fla.	1000
	1370	KFJM	Ludington, Mich.	100
4:40	1210	WCBS	Grand Forks, N. Dak.	100
	1210	WCOC	Springfield, Ill.	100
4:50	880	WCOG	Meridian, Miss.	500
	1500	WKBP	Richmond, Ind.	100
5:00	1300	WIOD	Miami, Fla.	1000
	1210	WTAX	Springfield, Ill.	100
	1310	KGBX	Springfield, Mo.	100
5:10	1260	WTOC	Savannah, Ga.	1000
	1370	WHBD	Mt. Orab, Ohio	100
	1420	KCMC	Texarkana, Ark.	100
5:20	1210	WHBU	Anderson, Ind.	100
5:30	1370	WIBM	Jackson, Mich.	100
	1420	KGFF	Shawnee, Okla.	100
5:40	1210	WOMT	Manitowoc, Wisc.	100
	1500	KNOW	Austin, Texas	100

First Friday of Each Month

3:00	1210	WJW	Akron, Ohio	100
	1310	KRMD	Shreveport, La.	100
3:10	1420	WRPD	Paducah, Ky.	100
	1500	KOTN	Pine Bluff, Ark.</	





## High-Fidelity Reception

(Continued from page 537)

operated with the feet—came over well. The extent of the high-frequency response



### THE UNIQUE BAFFLE

*This construction provides ample baffle area for reproduction of the "lows", yet is reasonably compact. It will be noted that parallel surfaces and right angles are studiously avoided, thus obtaining freedom from cabinet resonance*

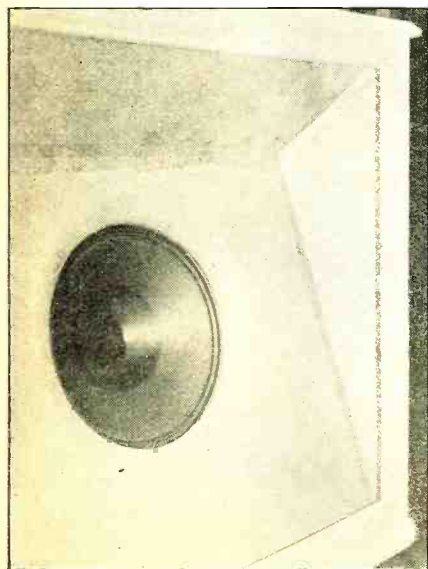

was hard to judge by ear alone. Due to the absence of heterodyne squeals of 10 kc., we must conclude that the audio amplifier or speaker does not reproduce this frequency. On the other hand, the crispness of speech and the natural reproduction of certain instruments gave evidence of frequencies higher than 5000.

One of the noteworthy results was that some small stations which never sound acceptable on ordinary receivers sounded much better on this outfit, although the difference in quality from different stations is marked.

Since this set was made and designed without the help of engineering measurements or the benefits of response curves, these results seem to be all one could hope for.

## Improving Your Receiver

(Continued from page 549)

from the pesky antenna and eliminates dead spots on all coil ranges. No additional controls of any kind are required, and the extra tube can be accommodated without trouble on most chassis.

The circuit of Figure 1 is changed as indicated in Figure 3 if dry-cell operation is to be retained. The new tube, V3, is a type 34 pentode, with its filament merely bridged across to the existing filament circuit for control by the same rheostat.

Now the ideal method of coupling the plate of V3 to the input of V1 is by means of a primary coil next to but not connected conductively to the grid winding of L1. Since it is altogether impracticable to arrange such a primary on a four-prong coil, and since there is no sense in buying a new set of three-winding, six-prong coils, we can use direct coupling with the aid of a simple blocking condenser, C5. This should be a good mica condenser of about .01 mfd. Also, the grid leak R2 is shifted across the grid filament, where it works just as well as across the grid condenser.

The d.c. plate supply for V3 now flows through the grid coil of L1, without affecting the latter's radio-frequency operation in the slightest. It cannot bias the detector grid because the grid condenser C4 is in the way, and it cannot short itself back to filament because C5 is in the way. The reactance of C5 to signal currents is so low that it practically doesn't exist, while its capacity is so large in relation to the tuning condenser C1 that it has no appreciable detuning effect even though it is in series with L1 and C1.

R3 in Figures 3 and 4 is indicated as a fixed resistor. This is not critical in value; anything between 10,000 and 25,000 ohms being acceptable. A 2.5-, 5- or 8-millihenry r.f. choke may also be used in this position. It is well to try both resistors and chokes here.

With an a.c. receiver, the changes are shown as in Figure 4. The new tube, V3, is now a 58 (or 6D6) and is provided with a 300-ohm cathode resistor for grid bias and a 75,000-ohm screen resistor so that screen voltage can be taken off the 250-volt plate lead.

An untuned r.f. stage of the kind described furnishes appreciable amplification, but its slight cost would be worth while anyhow for its stabilizing effect on the regenerative detector. Furthermore, it prevents the latter, when oscillating, from shocking the antenna into oscillation and radiating energy on its own accord. Definite logging of stations becomes easier with the antenna thus removed from the tuned circuit. Feed-back is more certain than before; in fact, it may be so much better

that the user may have to remove a turn or two from the tickler windings, particularly if the detector is a tetrode or a pentode.

When we approach the subject of selectivity we have to do a little rationalizing. Regenerative receivers have an artificial sort of selectivity when they are on the brink of oscillation, but we might say that their "rejectivity" is poor. With the circuit tuned to one frequency, a strong station on a nearby frequency may readily ride through. If the feed-back action is stepped down even a little, the artificial selectivity disappears and the set is extremely broad, as any set with only a single tuned stage will be.

The only way to increase the real selectivity is to add more tuned stages. This sounds easy, but with an existing small straight regenerative receiver the necessity for thorough shielding makes the undertaking impracticable from the start. In the long run it is easier and cheaper to build or buy a whole new receiver than to attempt the addition of a tuned r.f. stage to a straight regenerator.

While many small regenerative receivers compare favorably with superheterodynes in the matter of usable sensitivity, their comparatively poor selectivity is the price you pay for their simplicity, economy and reliability. Recently the writer made a side-by-side test between a five-tube r.f.-regenerative receiver and an eight-tube superheterodyne, both of well-known make. While the former brought in everything the latter did, frequently with less noise, the super cleanly separated bunched stations that sounded like so much hash in the other set. If you own a regenerative receiver, you simply must recognize these facts.

## Set Building

(Continued from page 535)

incorporating these latest principles. Our technical staff maintains steady contact with America's foremost designers in the "How to Build" field.

This month we are giving to our readers a number of designs in different fields, some simple and some more complicated. The Editors feel that these designs are the finest that have been put before the set-building public for some time and that they offer the set-builder the chance he has been waiting for to build a receiver really worth while and one that will produce results in both distance reception and in high quality of reproduction.

Other articles in this issue also give important information to the set-builder in helping him to design his own circuits. Many of the set-builders who are our readers prefer to lay out their own sets, relying on RADIO NEWS articles for a description of new principles that they can incorporate into their experimental designs. So our advice to the set-building fraternity is, to read every article in this and the coming two numbers, as there will be found a wealth of experimental material, any one item of which might contain just the necessary information they have been looking for to complete their new sets. Of course, the sets that we are describing are complete in all details and the reader should follow each article in the series.

RADIO NEWS' policy of putting out blueprints of its main designs will also be found to be a help to set constructors, and as the list of available blueprints grows, the Editors promise that efficient receivers for any kind of use and fitting any pocketbook will be adequately covered. Follow RADIO NEWS designs in your experimental set-building, and you cannot go far wrong!

# HOW TO BUILD, TEST AND REPAIR RADIO SETS



## Radio Construction Library

Including Television, Short-Wave Receivers and Auto Radios, 3 Volumes, 5 1/2 x 8—1177 pages, 561 Illustrations.

This practical Library includes: **PRACTICAL RADIO**—The fundamental principles of radio, presented in an understandable manner. Illustrated with working diagrams. **PRACTICAL RADIO CONSTRUCTION AND REPAIR**—Methods of locating trouble and reception faults and making workmanlike repairs. Discusses modern Short-Wave Receivers and installation of automobile radios fully. **RADIO RECEIVING TUBES**—Principles underlying the operation of all vacuum tubes and their use in reception, remote control and precision measurements.

Helps you to understand modern type receiving sets—full of construction data and practical kinks for the experimenter.

**10 Days Free Examination Easy Terms**

### FREE EXAMINATION COUPON

McGraw-Hill Book Company, Inc.  
330 West 42nd Street, New York

Send me the new **RADIO CONSTRUCTION LIBRARY**, three volumes for 10 days' free examination. If satisfactory I will send \$1.50 in ten days, and \$2.00 a month until \$7.50 has been paid. If not wanted I will return the books postpaid.

Name.....  
Home Address.....  
City and State.....  
Position.....  
Name of Company..... RN-3-35

# SERVICEMEN! help yourself to GREATER PROFITS

There's no doubt about it. I can help ANY serviceman who is willing to invest a little time and study with the aim of winning better jobs and greater profits. And I can do it at a low price which will amaze you.

Sprayberry's Practical Mechanics of Radio Service will help you in a hundred ways—just as it has helped countless others, many of whom found ordinary courses too costly, too elementary or impractical for their needs. Certainly you owe it to yourself to investigate—immediately!

**NEWS FLASH!** Several new lessons on the use of the **CATHODE-RAY TUBE** or **OSCILLOGRAPH** have just been added to the Sprayberry course—at no increase in cost. Don't miss them!

**F. L. SPRAYBERRY** 2548 University Pl., N.W. Washington, D. C.

Without obligation on my part, please send details of your system. Also tell me how I can get the new Sprayberry **DATA SHEETS** (worth \$3) at no additional cost.

Name.....  
Full Address..... RN-3-35

**SPRAYBERRY'S PRACTICAL MECHANICS OF RADIO SERVICE**

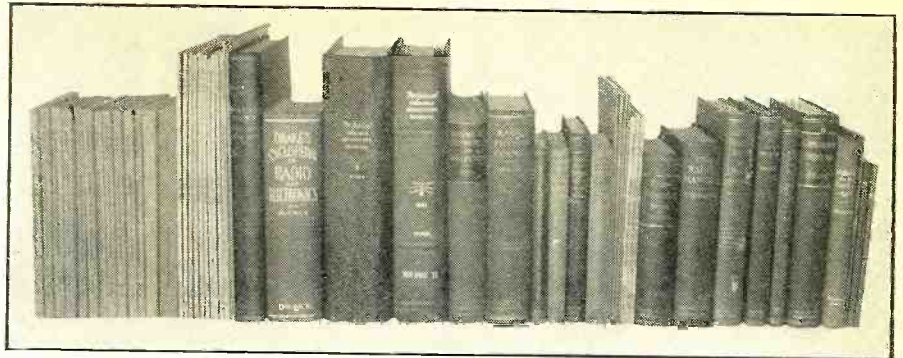

## THE TECHNICAL REVIEW

JOSEPH CALCATERRA

*Perpetual Trouble Shooter's Manual*, Volume V, by John F. Rider, published by John F. Rider. This new manual is a continuation of the earlier manuals, Volumes I, II, III, and IV, and begins where Volume IV left off. It contains diagrams and service information on numerous receivers, most of which were released during the past year. There is no duplication of diagrams in Volume V and any of the previous volumes.

For those who might not yet be familiar with Mr. Rider's Manuals let us explain that they now contain some 5150 pages of diagrams and information on commercially made receiving sets. The diagrams now practically all contain resistor and condenser values and the other information may consist of socket-layout chart, picture-wiring diagram, voltage readings (at sockets) and instructions for aligning. Any or all of these may be shown depending on whether the material was available to the author. The trend seems to be towards more information per receiver. There are models described in Volume V which occupy several pages of aligning and adjusting instructions. For instance, the new Atwater-Kent "Tune-O-Matic" receiver, which can tune itself and changes its tuning after each program by means of a clock-and-switch arrangement, can be found in this volume. The reader can find the principle of operation as well as the necessary adjustments and how to make them. There are several more new and famous receivers included in Volume V. For instance: the Magic-Brain; a Howard nineteen tube set; the Midwest 16; the Hammerlund Pro with a.v.c., etc.

A new index has been prepared which comes with the volume. It contains all the receivers shown in all five volumes arranged by the name of the manufacturer and shows the volume and page number where information on a given model can be found.

*Report of the Radio Research Board for the period of January 1st, 1932 to September 30th, 1933*. Published by His Majesty's Stationery Office, 1934. This book can be purchased from the British Library of Information, 270 Madison Avenue, New York. The cathode-ray tube figures prominently in the work of the Radio Research Board. This report records the findings of the Board during the period mentioned and discusses the methods used and the instruments employed. The book contains 137 pages and is devoted to researches on the propagation of waves, directional wireless, atmospheric, electron oscillation giving rise to centimeter waves, radio-frequency standards, electrical measurements at radio frequencies, interference and receiver selectivity, a new wireless transmitting station, time bases for use with the cathode-ray oscillograph.

Readers who are interested in any one of the above subjects will find some valuable information in the book. The section on propagation of waves discusses observations of the height of the ionosphere, the angle of incidence of the arriving waves, their apparent direction, polarisation, the study of echoes, etc. The section on directional wireless shows several improved direction finders which use the cathode-ray tube as the indicator.

*"Who's Who" in Amateur Radio*, Edition B, Radio Amateurs Publishers, 1935. The sub-title of the book approximately describes its purpose: "The Radio Amateur's Directory of Operators, Stations, and Schedules." This is mostly a collection of short descriptions of amateur stations and their owners. Sometimes it includes pictures of the owners and a part of their biography. Of course it does not contain information on all amateurs as yet, but there seem to be more than in the previous editions. Besides the "Who's Who" pages, there is some information, useful to amateurs: the Q-signals, a list of abbreviations, schedules of weather and press stations and a few short articles by well-known amateurs.

*The Wireless World Diary and experimenter's Handbook 1935*, published by Iliffe and Sons, Ltd. A pocket diary which at the same time contains useful data for the radio experimenter. The table of contents this year is quite imposing. There are: Receiving License Regulations, a list of European Broadcast stations and principal s.w. stations, electrical interference, symbols in common use; then comes the diary. This is followed by more technical data, useful formulae, 12 pages of alignment chart for quickly solving these equations, wire tables, diagrams, some practical hints and a list of tubes with their characteristics. (These are European tubes.) The diary itself even contains notes and hints on radio.

*A Thermionic-Tube Measuring Instrument*, by Tom B. Wagner; Electrical Engineering, December 1934. This paper describes a new type of tube meter employing a Wunderlich tube. It can be used

## Dots and Dashes

(Continued from page 532)

ings with an operator at the Radio Marine Corporation station on Cape Cod. Both operators stated that the reception was excellent. The previous record was a conversation from the same Cape Cod station to a plane carrying the Lindberghs while flying over the southern Pacific at a distance of 5,000 miles.

as an ammeter, a voltmeter, a wattmeter or a power-factor meter and is claimed to be accurate to 2 per cent for frequencies from 100 to 3000 cycles. For higher frequencies, proper shielding and other refinements are necessary.

**Review of Articles in the December, 1934 Issue of the Proceedings of the Institute of Radio Engineers**

*Generation and Utilization of Ultra-Short Waves in Radio Communication*, by Frederick A. Kolster. Deals with the generation and utilization of ultra-short waves, below ten meters. Describes a novel circuit used to obtain a high degree of frequency stabilization, without resorting to frequency doubling or crystal control.

*A Lapel Microphone of the Velocity Type*, by Harry F. Olson and Richard W. Carlisle. Discusses the requirements which must be met by lapel microphones and describes a new type of unit designed to accomplish the required results.

*Control of Radiating Properties of Antennas*, by C. A. Nickle, R. B. Dome, and W. W. Brown. Describes a system of tuning by which the current distribution and therefore the radiating properties of an antenna, may be varied over an extremely wide range.

*An Electron Oscillator with Plane Electrodes*, by B. J. Thompson and P. D. Zottu. Describes a new type of thermionic tube, capable of producing ultra-high frequencies by means of electron oscillations, using plane electrodes.

*Theory of the Electron Gun*, by I. G. Maloff and D. W. Epstein. Describes the theory governing the use of the electron gun or cathode-ray tube to generate, concentrate, control and focus an electron beam to a spot of a desired size. Design data on the construction of such guns is given.

**Review of Contemporary Literature**

*The Voice-Operated Compandor*, by N. C. Norman, Bell Laboratories Record, December, 1934. Description of the principles of operation of a new control system designed to automatically compress the intensity range of speech before transmitting it and to expand it to its original intensity range after it has traversed the transmission medium.

*Spot Welding*, by Lawrence Ferguson. Bell Laboratories Record, December, 1934. A chart showing approximately 250 different combinations of metals which can be spot welded with varying degrees of success is given, together with information on how to obtain best results in spot welding different metals.

*An Improved Volume Indicator*, by R. E. Kuebler. Bell Laboratories Record, December, 1934. The circuit and design of the new 700A volume indicator developed by the research department of the Bell Laboratories are given.

*The Operation of Several Transmitters on the Same Wavelength*. The Wireless Engineer and Experimental Wireless, December, 1934. An explanation of the various factors which must be taken into consideration when several transmitters are to be operated simultaneously on the same wavelength.

*"Radio Service"—Its Causes, Cures and Suggestions for Reduction in Service Costs*, by R. C. Lawes. The Proceedings of the Institute of Wireless Technology, January-March, 1935. An analysis of approximately 100 service cases with a chart showing

(Continued on page 580)



**Build this New Low-Priced ALL-WAVE SUPERHETERODYNE For World-Wide Reception 10-550 Meters, or 540 K.C. to 30 M.C. Easy to Build—Splendid Performance**

**Sponsored by**

- BELDEN MFG. COMPANY  
4647 W. Van Buren St., Chicago, Ill.
- CORNELL-DUBILIER CORP.  
4377 Bronx Blvd., New York, N. Y.
- CROWE NAME PLATE MFG. COMPANY  
1749 Grace St., Chicago, Ill.
- ELECTRAD, INC.  
175 Varick St., New York, N. Y.
- ERIE CAN COMPANY  
816 W. Erie St., Chicago, Ill.
- THORDARSON ELECTRIC MFG. CO.  
500 W. Huron St., Chicago, Ill.
- HAMMARLUND MFG. COMPANY  
424 W. 33rd St., New York, N. Y.
- OAK MFG. COMPANY  
711 W. Lake St., Chicago, Ill.
- OHMITE MFG. COMPANY  
636 N. Albany Ave., Chicago, Ill.
- OXFORD RADIO CORP.  
350 W. Huron St., Chicago, Ill.
- MEISSNER MFG. COMPANY  
2815 West 19th St., Chicago, Ill.

**AMAZING PERFORMANCE!**

Distant stations in foreign lands come in on the ALL-STAR JUNIOR with splendid volume and clarity. The regular American broadcasts are available when you desire conventional entertainment. Thrill your family and friends with this receiver.

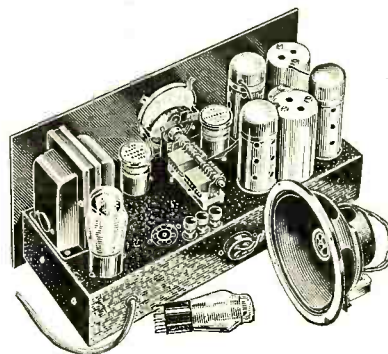

**SENSATIONAL DESIGN!**

Equal to the finest professional type communication receivers, yet you can build it yourself without special tools or test equipment. A soldering iron, screw-driver, and pliers are all you need to build the ALL-STAR JUNIOR.

**CONTINUOUS BAND SPREAD**—over the entire tuning range makes possible the separation of hundreds of stations that are jammed together at a single spot on the ordinary receiver dial.

**BEAT-NOTE OSCILLATOR**—using the new 6F7 tube, brings in DX carrier waves inaudible on any other short wave receiver.

**SUPERHETERODYNE CIRCUIT**—Five tubes in the latest design; does the work of 7 tubes!

**PRE-ADJUSTED I. F. COILS**—Tuned at the factory to 370 k.c. No adjustment required.

**ALL ELECTRIC**—For 110-120 volts, 60 cycle, standard A.C. house current.

**STANDARD PARTS**—Ask your radio dealer or jobber for the ALL-STAR JUNIOR Foundation Unit that includes drilled sub and front panels, enlarged drawings of wiring and pictorial diagrams, three-step assembly, and all instructions. Start with the Foundation Unit. Buy the remaining parts as you need them. For further information, fill out coupon below.

**ALL-STAR JR**  
★ ALL-WAVE Superheterodyne ★

**ALL-STAR HEADQUARTERS**  
360 N. Michigan Ave., Chicago, Ill.

Free circuit diagram, parts list, and all information on the ALL-STAR JUNIOR.

NAME.....  
ADDRESS.....  
CITY..... STATE.....



MORTON DOWNEY



GERALDINE FARRAR



PEG LA CENTRA



LEFT:  
DOROTHY PAGE

# BACKSTAGE *in* BROADCASTING

Chatty Bits on Radio Personalities

**M**ORTON DOWNEY, the noted radio tenor who had been absent from the air for a period while filling personal appearance engagements, has returned to NBC Sunday afternoons and Tuesday nights in a new series sponsored by Carlsbad Sprudel Salts. NBC executives tell us that Downey draws \$6,000 per week on this program and thus ranks with the highest paid stars in broadcasting. Downey is accompanied on his semi-weekly programs by Ray Sinatra's orchestra.

**T**HE cry for original musical comedy on the networks is still being heeded by the program moguls. The Gibson Family (NBC), "Hollywood Hotel" (CBS), and numerous other chain features with a dramatic-musical theme have been gaining sufficient listener attention to warrant more features of the type. "Gigantic Pictures, Inc.," is a new NBC musical comedy feature presented by Tastyest Sunday afternoons. The program features Sam Hearn, comedian, and music by Johnny Blue's orchestra. Alice Frost, character actress, has also been cast in this series. While on the subject of musical comedy, we might mention that Owen Davis, veteran playwright, is now librettist for "The Gibson Family" feature.

**G**ERALDINE FARRAR, Metropolitan Opera Company star of more than a decade ago, has returned to the scene of her great triumphs as raconteuse (NBC

ALICE FROST



## Samuel Kaufman

officials chose this word) of the Saturday afternoon full-length opera programs direct from the Metropolitan Opera House stage. Listerine is being ballyhooed this year on the elaborate operatic presentations. Milton J. Cross continues to present the action description. Miss Farrar presents human interest stories and anecdotes concerning the personalities connected with the day's performance. She also interprets important passages, illustrating them with piano and voice.

**I**RENE BEASLEY, known to many radio fans as "the long, tall gal from Dixie," and Dorothy Page, one of the prettiest girls in radio, have been designated as alternate vocal soloists on Jesse Crawford's NBC pipe organ programs. Miss Beasley is presented on Crawford's Monday and Friday programs while Miss Page is heard with the organist's Sunday and Thursday renditions.

**D**R. E. E. FREE, prominent sound expert, recently presented a novel scientific series over CBS which attracted wide attention. The network's microphones were brought right into the E. E. Free Laboratories, in New York, where a "sound microscope" was utilized to bring some very strange types of din to air listeners. A weevil running around inside a grain of wheat was heard on the air with a bang and clatter. The humming inside

DR. C. C. CLARK AND DR. E. E. FREE

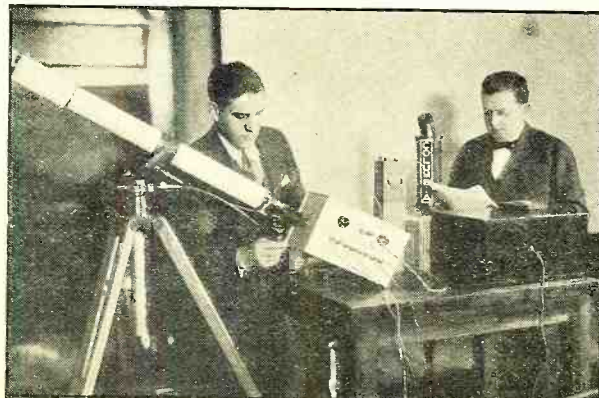

a bee-hive, through the "sound microscope," was made to sound like the roar of Niagara Falls. A fishworm and a goldfish were matched against each other to determine which makes the most noise. Subsequent broadcast tests revealed that many "ghostly" noises are merely due to changes of temperature or moisture in the materials of buildings. The sounds of cities and voices were following subjects of radio programs based on the findings of the "sound microscope."

**K**ATE SMITH, who had been going along sponsorless for some time, now once again heads the cast of a commercial series. Sponsored by the Hudson Motor Car Company, Kate Smith's New-Star Revue is heard Mondays over CBS. As the name of the program indicates, the broadcasts will embody a search for new talent—an idea that many programs seem to be using these days. Kate plans to travel to a different municipality each Friday as presiding judge in the final selection of the two "most talented" auditionists and the chosen ones will make their network debuts on her following Monday broadcast. Jack Miller's Orchestra and the Three Ambassadors, male trio, will be heard on the entire series.

**A** NEW CBS Friday series, "The O'Flynn," is based on the novel and the Broadway musical drama of the same name. The program, sponsored by Esso, differs from the majority of current dra-

KATE SMITH





MILTON WATSON

matico-musical series in that its action is of the seventeenth century instead of the present. Viola Philo, a soprano with considerable radio experience, and Milton Watson, baritone, sing the leading rôles. Nathaniel Shilkret conducts a thirty-piece orchestra while David Ross is the announcer. The large dramatic cast is headed by Ray Collins, Lucille Wall, Jack Smart and Leigh Lovell. The series had a pretentious start and seemed headed toward the hit classification.

**HARRY RESER**, veteran radio dance orchestra conductor, has returned to the air on a new series sponsored by Wrigley's Spearmint Toothpaste. The program heard on NBC Sunday afternoons also features Peg La Centra, contralto, and Ray Heatherton, baritone. Reser gained radio fame as conductor and banjoist of the old Clicquot Club Eskimos feature. Miss La Centra once announced over a Boston station and has appeared in both singing and dramatic rôles on NBC. Heatherton, who was once a boy soloist with the noted Paulist Choristers, has had considerable NBC experience.

**THE RCA Radiotron Company**, sponsors of the Radio City Party programs presented Saturday nights over NBC, have put an interesting twist into the broadcasts. Instead of dedicating the programs to outstanding established radio stars, as at the start of the series, the periods are being  
(Continued on page 576)

HARRY RESER



# STILL AHEAD in Performance!

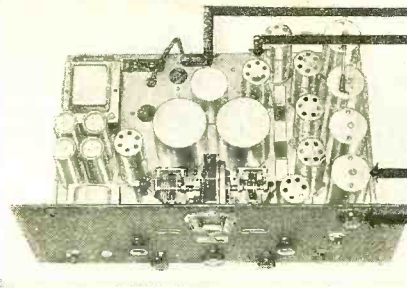

**AUTOMATIC VOLUME CONTROL**

*and*

**CRYSTAL FILTER**

## COMET "PRO" The Most Modern RECEIVER

*4 models*  
STANDARD  
STANDARD + A.V.C.  
CRYSTAL  
CRYSTAL + A.V.C.  
Operating on  
Battery, D.C.,  
or A.C. in all  
Voltages and Cycles

**TWO YEARS** ago, the Hammarlund COMET "PRO" Superheterodyne assumed instant leadership because it met the exacting demands of professional operators and advanced amateurs, interested in both phone and code reception between 15 and 250 meters. It still holds its eminence by virtue of conspicuous performance.

The Hammarlund files bulge with praise for "PRO" users—amateurs, professionals, air and steamship lines, broadcasting networks, police and armies and navies—in every corner of the world, who chose this amazing receiver after exhaustive competitive tests.

All models include the distinctive features of single-control band-spread tuning at all frequencies, without extra coils—plus all other refinements one would expect in so advanced a receiver.

The crystal model, for CW and amateur 'phone work, employs an improved crystal circuit (*patent applied for*).



HAMMARLUND MANUFACTURING CO.,  
424-438 W. 33rd Street, New York, N. Y.

Check here for FREE information on the Comet "Pro" Receiver.  Check here for FREE new 1935 General Catalog.  Check here and attach 10c for 16-page Hammarlund 1935 Short-Wave Manual, illustrating and describing most popular S-W circuits of past year, with schematic and picture diagrams and parts list.

Name.....  
Address.....

RN-3

PORTABLE SOUND SYSTEMS

ELECTRO DYNAMIC UNITS

CARBON MICROPHONES

AMPLIFIERS

4, 5 & 6 FT. ALL ALUMINUM TRUMPETS

FIELD EXCITERS

AIR COLUMN HORNS

LOW AND HIGH FREQUENCY UNITS FOR WIDE RANGE THEATRE USE

ACCEPT OUR

5 Day  
FREE  
TRIAL



You can try any

Toledo P.A. Equipment you need 5 days under any and all conditions absolutely without cost or obligation. Accept this challenge to duplicate Toledo's amazing performance and absolute dependability at any price. Write for folder giving complete details of free trial offer, prices and descriptions of Toledo's sensational, advanced 1935 equipment.

**TOLEDO SOUND EQUIPMENT LABORATORIES**  
Formerly Bud Speaker Co.  
1134 JACKSON STREET • TOLEDO, OHIO, U.S.A.

## AMERTRAN TRANSFORMERS For Quality Amplification

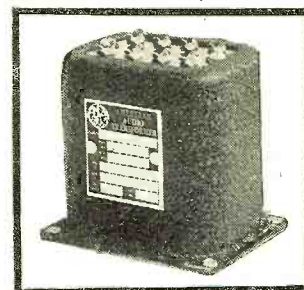

SEND FOR NEW 32 PAGE CATALOGUE

This bulletin contains the most complete listing available of transformers and reactors for audio amplification and transmission. It fully describes and illustrates five complete lines, the Standard DeLuxe, Miniature DeLuxe, Precision DeLuxe, SilCor and transmitting lines. Standard types are offered for every requirement and in three different price classes.

Ask for Bulletin 1002

**AMERICAN TRANSFORMER COMPANY**

177 EMMET ST. NEWARK, N. J.

**ALLIED RADIO** Presents  
the New

**RCA ACR  
136  
COMMUNICATIONS  
RECEIVER**

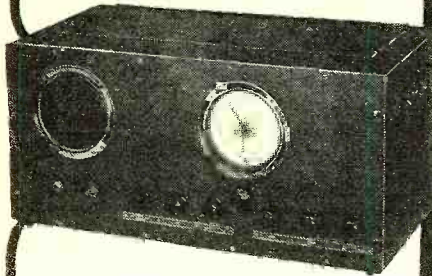

The ideal receiver for the Amateur and the DX Short Wave (and Broadcast Band) listener! The ACR-136 is a seven tube All-Wave Superhet covering 15-550 meters (540-18,000 K.C.). It is packed with attractive features but low in price. Features Pre-selection, true A.V.C., front panel band-switching, mechanical band-spread system, and separate r.f. and a.f. gain controls. Has low image-frequency response, and high signal-to-noise ratio. Exceptional for tonal fidelity and for unusual selectivity. Has separate beat oscillator switch for copying code signals. Speaker is built-in and jack is provided on front panel for phones, automatically muting speaker. Circuit is built around the famous RCA "Magic Brain." Easy to tune. Comes complete with built-in power supply and tubes at an outstanding low price. Write for FREE descriptive bulletin and quotation.

**FREE** Radio's Leading  
CATALOG

Send for your copy of the complete 1935 ALLIED Radio Catalog—the most valuable book in Radio. Packed with Set-Building Kits; Short Wave Transmitting and Receiving gear; All-Wave, Dual Wave and Short Wave sets; Sound Equipment; Test Apparatus; thousands of parts, etc. Write now!

**BUILD YOUR OWN  
ALL-STAR JR.  
ALL-WAVE Superheterodyne**

Build the new lower-priced ALL-STAR ALL-WAVE JR. Tunes 10-550 meters. A great 5 tube Superhet that can be assembled at an amazing low price. Features Band-spread tuning, world-wide reception, preadjusted coils, beat-note oscillator, excellent tone quality, etc. Easy to build. ALLIED is first with the Foundation Kit at \$2.25. Send for our FREE ALL-STAR JR. Wiring Diagram and Parts List.

**ALLIED RADIO  
CORPORATION**

833 W. JACKSON BLVD., CHICAGO, ILL.  
Dept. M

Please send me:

- FREE RCA-ACR 136 Bulletin.  
 FREE ALL-STAR JR. Diagram and Parts List.  
 FREE 1935 ALLIED CATALOG.

Name.....

Address.....

City..... State.....

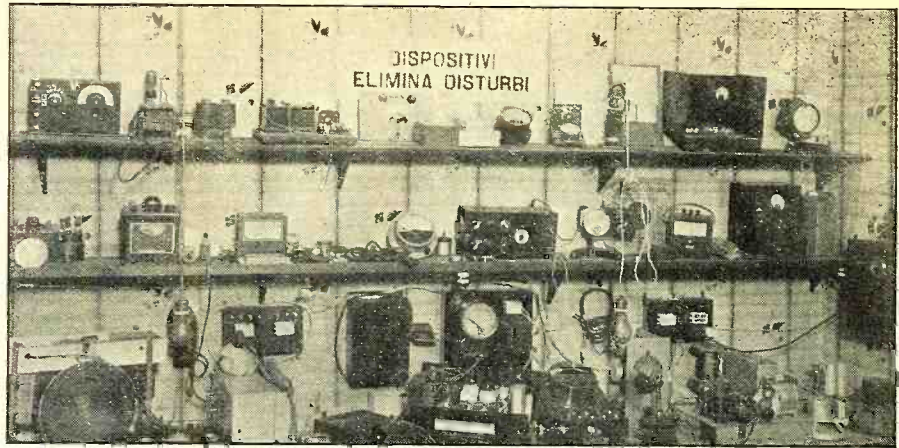

## THE SERVICE BENCH

ZEH BOUCK

### THE DAY'S WORK

Starting off this month with the meat of the service business—notes from the field—we have the following data on the Majestic 500:

#### Service Notes on the Majestic 500

Morris Chernow, New York City, sends us the following data on the above receiver: "There are three common ailments peculiar to this model set. Two of them are quite baffling when first encountered, as all voltages read normal on test. If the set suddenly stops when a light is turned on or off in the apartment, and is brought back into operation by shutting off the power switch for a moment, the remedy is to short out the a-v-c resistor in the grid return circuit of the 6A7 tube. Short-circuiting this resistor has no effect on the operation of the set, and it appears to be the only remedy for overcoming the paralysis. In later models this resistor is eliminated. It seems that the sudden turning on and off of adjacent electrical apparatus causes a current surge which biases the control grid of the 6A7 tube so as to paralyze it completely—until the switch is opened and the charge allowed to leak off. When the set does nothing but motorboat, although all voltages are okay, it is due to a primary to a secondary short-circuit in the 3rd i.f. transformer. A 20,000-ohm resistor between the two windings prevents this showing up as a voltage discrepancy. The only remedy is to replace the transformer. The third common source of failure is the opening of the audio coupling condenser going to the grid of the 42 output tube from the triode plate of the 6F7. This is of the tubular type, .05 mfd. capacity, located at the rear of the chassis under the voltage divider resistor." Mr. Chernow continues with dope on the—

is also caused by a defective 6Y5 tube. If the set draws excessive current, and plate voltage is low, one of these difficulties is invariably the cause. The set should show a reading of 7 amperes at 230 volts when properly adjusted. When testing for 'B' voltages, the bottom cover of the set need not be removed. Simply put the positive side of the meter to the i.f. trimmer condenser terminal on top of set.

"If the receiver sounds okay with the cover off, but becomes distorted upon replacing, especially on low volume, tap the metal spider of the speaker lightly downwards, recentering cone. The pressure of the top cover causes the speaker to strain out of center. New sets come that way from the factory because the sets are tested with the cover off and then packed immediately.

"Another speaker trouble is due to wetting of the set. Water seeps to the voice coil connections on the cone, and eventually causes corrosion by electrolytic action (similar to the action on the 'B' choke) and a test with an ohmmeter shows either a complete open or high resistance reading of a few thousand ohms. Resolder the affected lead, and coat with Duco cement for waterproofing.

"Another chronic trouble, when the set seems alive from the grid of the 6C7 tube only, but dead from all the preceding tubes, is the opening of the 2nd i.f. transformer secondary.

"Trouble from squeals and oscillations on lower wavelengths—generally from 1100 k.c. up. Change to a tested 6A7 tube. Some of these tubes when they age seem to give this trouble. The defective tube will not show up in a tube tester."

Continuing with some more—

### Auto Service Notes

Harry Greenberg of Troy, N. Y., ran into trouble with the Ford-Zenith when he attempted to service the receiver in accordance with the manufacturer's diagram. Several hours were wasted before he discovered that the diagram shows the grid leads to the 6F7 detector-oscillator and the 6D7 i.f. tube reversed!

"Reception with the Majestic 66 (early) and the Arvin models 255 and 160 can be improved by installing a switch short-circuiting the extra bias resistor for DX reception. The late 66's have this switch. Arvin also will supply more detailed information on its installation to any serviceman requesting it."—Charles Borden, Oneonta, N. Y.

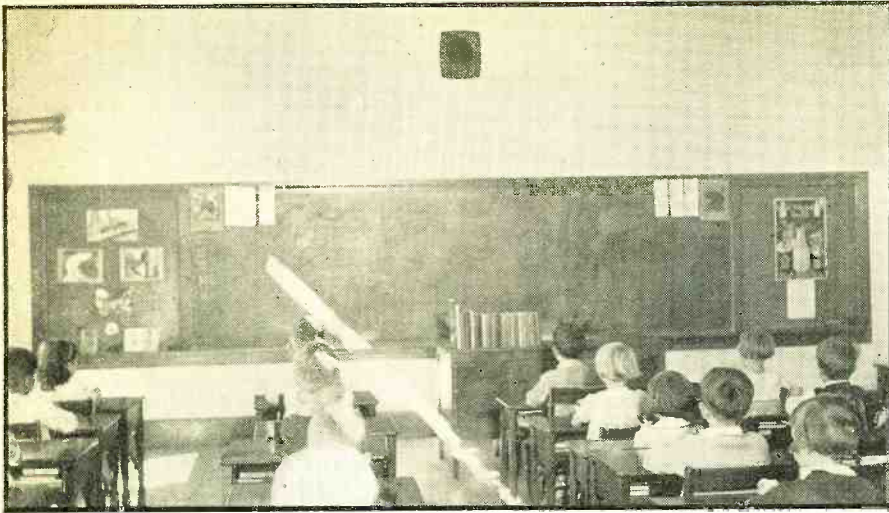

FIGURE 3

**THIS MONTH'S SERVICE SHOP**

The photograph in this month's heading is particularly interesting—not only because it shows an efficient collection of servicing equipment, but also because it is the shop of a brother serviceman from across the briny—Enrico Costa, of Naples, Italy. We have no data on the instruments shown, but by the quantity, we'd venture a guess that the usual oscillators, testers and analyzers are present if in a somewhat unfamiliar form.

**THIS MONTH'S SALES TIP**

"Kodak as you go" is a nationally known slogan that might well be applied to the radio service business. A photographic rec-

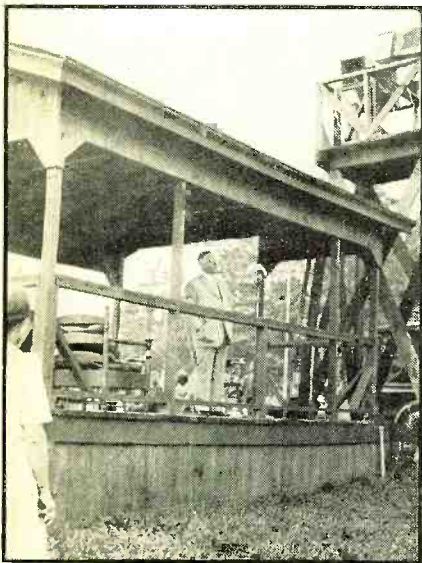

FIGURE 2

ord of your big jobs—P.A. installations, etc.—make the finest sort of a sales argument in soliciting similar work. (And you might send them in to the *Service Bench*. We'll pay for 'em!) The photos of Figures 1, 2 and 3, as well as the photo in our heading this month, help Scribner Brothers, of Schoharie, N. Y., in building up a larger and more profitable business. And at the same time cameras sell easily in summer. We know a number making a good profit in cameras as a sideline!

**Cardon Tube Replacements**

From C. W. Dynes, of Toronto, Canada, sends additional data on replacing Cardon tubes in Sparton receivers with the more conventional types—"I make it a practice

to substitute 45s for the 182s, 182-Bs and 183s—all 5-volt tubes. All that is necessary is to wire the two output-tube fila-

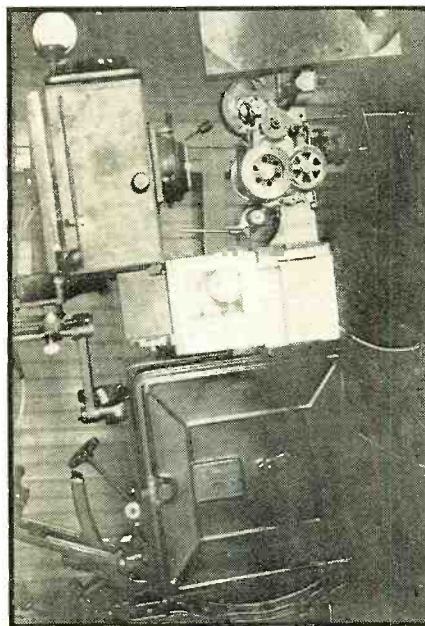

FIGURE 1

ments in series, leaving the hum-control resistor out of the circuit. The bias resistor should be changed to 1000 ohms. This helps a lot up here in Canada where Cardon tubes are both expensive and difficult to obtain."

**The "Ham" Shack**

(Continued from page 548)

age for the tube plates is fed through a radio-frequency choke coil, attached to a strap bridging the two plate rods. The grid return, with grid leak, is attached to the grid rods by means of a similar strap.

Tuning such a transmitter is extremely simple. The plate bridging strap is moved up or down on the rods until the desired frequency is attained. The strap on the grid circuit is moved up or down on the rods until minimum plate current without antenna load is obtained. This indicates resonance of the grid circuit in respect to the plate circuit. Under such conditions the transmitter will operate at maximum efficiency.

Coupling the antenna to the plate-tuning (Continued on page 586)

*Shhh! Shhh!*  
**QUIET**  
*Please!*

Individually TESTED  
for NOISE

*It Banishes Noise  
For Life!*

**ELECTRAD**  
**New QUIET**  
**VOLUME CONTROL**

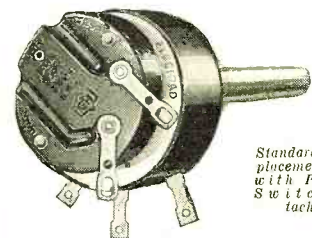

Standard Replacement Unit with Power-Switch attached.

NEVER before was such uncanny quietness made possible in a volume control. It required a radically new engineering principle and individual testing at the factory to assure its amazingly smooth, noiseless operation, which actually improves with use.

Current is evenly distributed over the flat outer rim of a rigid Bakelite ring, upon which gently glides a special alloy floating contact shoe.



Molded Bakelite case, when mounted, extends only 1/2 inch back-panel. New-type power switch (approved by underwriters) may be instantly attached or removed by a single screw. Long, easy-to-cut aluminum shaft. All standard replacement values.

Resistance element baked on flat outer rim of Bakelite ring.

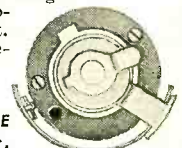

Floating contact shoe glides over resistance element in straight path.

Mail Coupon for FREE Descriptive Folder, and 1935 General Catalog of Resistors for Every Purpose.

from  
**RESISTOR**  
Headquarters

**ELECTRAD**  
Inc.  
175 Varick St.,  
New York, N. Y.

Please send new 1935 Resistor Catalog. Check here for folder on new QUIET Volume Control.

Name.....  
Address.....  
.....RN-3

MAIL COUPON FOR

**KENYON PRODUCTS**

# Low Priced Quality

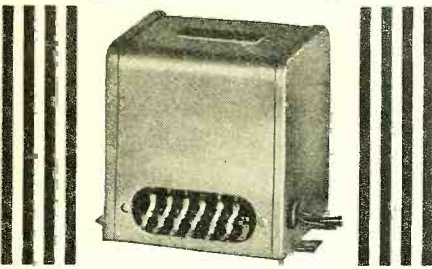

Ingenious design . . . wise choice of materials . . . large demand . . . mass production . . . low price consistent with high quality—that's the story of KENYON All Purpose Amplifier Components. Unapproachable for overall quality in materials of this price range. Uniform appearance. Silver-finished cases. Ideal for radio receivers and public address systems when price and quality count.

Complete line—input and output, class A and B; mixing-matching transformers; power and filament transformers; stepdown transformers; filter reactors.

## FREE CATALOG

Ask your Dealer for Catalog describing complete lines. If he cannot supply write us on your business letterhead giving his name.

**Kenyon Transformer Co., Inc.**



840 Barry Street  
New York City

WE DO OUR PART



**"E. H. Rietzke SPEAKING!"**



Mr. E. H. Rietzke, President of CREI, and originator of the first thorough course in Practical Radio Engineering.

## Did You Get Your "Cut" Back—or Get a Real Raise?

Of course, it's nice to get back your full salary . . . but isn't it a *real occasion* to receive a RAISE? Radio business is GOOD . . . and if you're not getting anywhere it's your own fault! There's quite a difference between "just getting along" and working toward a goal.

## CREI Will Help You Get Ahead—

The foremost engineers in the profession will tell you that TECHNICAL TRAINING is a necessity for those men who want to get the big jobs and the salaries that go with them. The man who isn't capable of better performance than his job requires, will never get a chance at more important duties. CREI is no "diploma mill". Each student receives individual, conscientious instruction.

Our courses in Practical Radio Engineering are available in home-study, residence or both. Your inquiries are invited.



44-Page Illustrated Booklet will be sent on request

**CAPITOL RADIO ENGINEERING INST.**

Dept. R. N. 3

14th and Park Road—Washington, D. C.

# WHAT'S NEW IN RADIO

WILLIAM C. DORF

## Signal Generator

Radio dealers, servicemen and radio fans will be glad to know of the new Triumph model 100 universal signal generator. It features a continuously variable r.f. and i.f. output with a four-step ladder attenuator in conjunction with a multiplier switch



and variable control to permit the use of any one of the four continuously variable ranges of output from practically zero to either 50, 500, 5000 or 50,000 microvolts. The instrument employs fundamental frequencies from 100 kc. to 10,000 kc.; low harmonics of fundamental frequencies in the fifth frequency band permit operation to 50,000 kc. It is a.c.-operated and when packed for shipment weighs 12 pounds and measures 11½ inches by 10 inches by 9½ inches.

## Amateur Receiver

The outstanding features of the new National Company model HRO amateur receiver are: ganged plug-in coils with each coil individually shielded, precision ganged

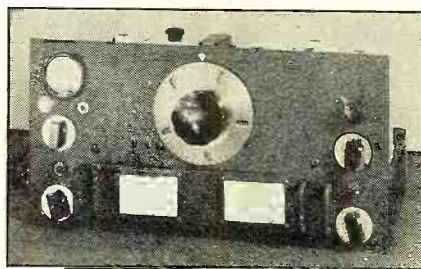

condensers with a new micrometer dial, single-signal (crystal filter) as standard equipment, two pre-selector stages, vacuum-tube voltmeter with the instrument calibrated in R scale of carrier intensity, electron-coupled, air-padded oscillators, beat-frequency oscillator and two i.f. stages with Litz wound coils and air-condenser tuned. Nine tubes are employed and the set is available with either 2- or 6-volt a.c. type tubes and also in a battery model.

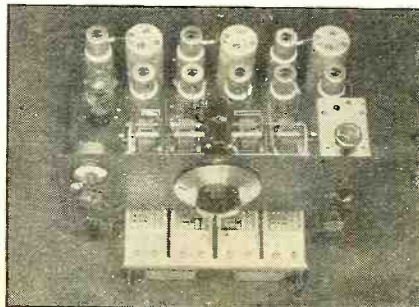

## Universal Receiver

The outstanding feature of the new International Kadette Jewel four-tube a.c.-d.c. receiver is its striking appearance. The jewel-like case which encloses the receiver and speaker is made of bakelite and plaskon

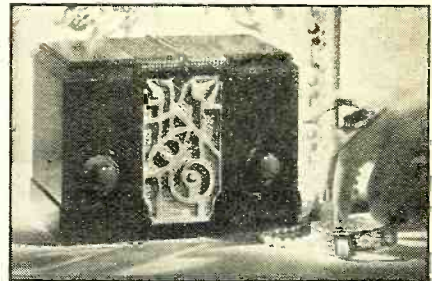

material and is available in a wide variety of colors. Its appearance is further enhanced by the contrasted grille insets, reproducing semi-precious stones such as agate, moonstone, etc. The set utilizes the 12A7 type combination rectifier and audio pentode power tube. It is equipped with a built-in antenna and a 5-inch balanced armature magnetic type speaker. The cabinet measures 5½ inches high by 7½ inches long and weighs 3¾ pounds.

## High-Gain Amplifier

Sound Systems, Inc., introduces a new line of public address systems which are

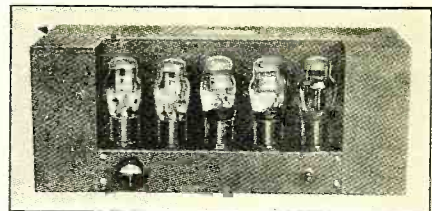

known as the series "S". These power amplifiers are available in a number of different sizes providing from 4½ to 90 watts of undistorted power output, to meet practically every public address requirement. The model PA-100 shown in the accompanying illustration employs three push-pull stages using two 53 type tubes, two 45's and one 80 type rectifier. It is designed to have an overall gain of 78 db and a power output of 4½ watts plus 28 db. Its frequency range is 30 to 8000 cycles with plus or minus 2 db. The dimensions of the chassis are 17 inches by 7½ inches by 6½ inches and it weighs 47 pounds.

## Midget Equalizing Condenser

The new Hammarlund midget equalizing condenser, measuring only ⅜ by ¾ inch is so small and light in weight that it can be conveniently mounted and supported directly on the connecting wires. With its



Isolantite base, special mica dielectric and phosphor bronze spring plates it makes a desirable r.f. trimmer condenser and is applicable to numerous other similar purposes.



**Crystal High-Frequency Speaker**

The Brush Development Company introduces the type T51 piezo-electric "tweeter." The reproduction of the speaker begins at

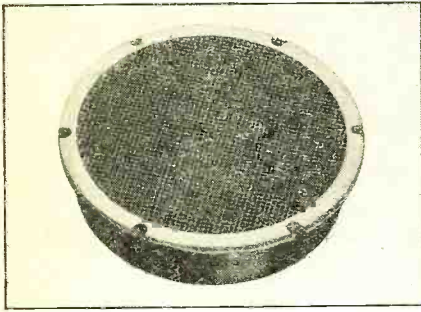

a point in the frequency range where the response of the standard dynamic type reproducer starts to fall off, and continues upward to approximately 8000 cycles. The model T51 is intended for use with radio receivers, where it may be connected across the primary side of the present output transformer. The "tweeter" measures only 4 1/8 inches in diameter by 1 3/8 inches deep, and it is suggested that where large-size dynamic speakers are used it may be conveniently suspended within the dynamic cone.

**Constant Impedance Controls**

Broadcast and public-address engineers will be interested in the new line of Centralab "Series II" sound projection controls which includes constant-impedance



T-pad attenuators, T-pad faders, L-pad attenuators, gain controls and straight faders. The outstanding characteristics of these new controls are: straight-line attenuation over a wide frequency range, constant impedance for the entire rotation, permanent freedom from noise without frequent cleansing and long life.

**A New D.C.-A.C. Inverter**

The E. D. Nunn Company offers a new d.c.-a.c. inverter operating from 115 volts d.c. lighting lines and furnishing 115 volts a.c. output. This power supply is designed to have a maximum load capacity of 150 watts at continuous duty and 250 watts in intermittent service. It is easily installed and requires no adjustments. The vibrator ordinarily provides 2500 hours of service and is easily replaced. The inverter is especially adapted to the operation of a.c. radio sets in 110-volt direct-current districts.

**A New Dynamic Type Reproducer**

The Rola model F6B 8-inch dynamic type loudspeaker has been redesigned to be economical in price and at the same time meet exacting speaker requirements. The overall diameter of the speaker is 8 3/8 inches and overall depth 4 inches and net weight 3 1/2 pounds. The field coil resistance and transformer size are optional.



*"Here's what I think about NATIONAL UNION RADIO TUBES"*

*says Fred D. Kerridge of Minneapolis, Minn.*

"So far this year (1934), I have used about 800 of them, and to date, have replaced only two tubes, which is about 400 percent better than any other tube I have ever used. "I am personally SOLD on National Union tubes and I am selling only National Union. "I have taken advantage of five of your shop equipment offers, and they have certainly been a great help in my work . . . thanks to National Union."

Thousands of alert aggressive Service Dealers have joined the National Union plan for better service business. Why not you?

**SEND COUPON TODAY**



National Union Radio Corp. of N. Y. RN-335  
400 Madison Avenue, New York City

Tell me about the National Union plan for merchandising radio service, and free shop equipment.

Name.....  
Street.....  
City..... State.....

**FREE Parts List - Data - Schematic**  
**1935 RADIO SENSATION!**

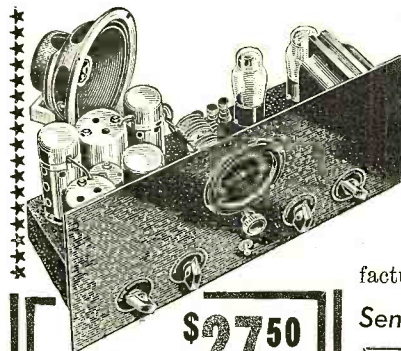

**BUILD YOUR OWN**  
**ALL-STAR JR**  
**ALL-WAVE Superheterodyne**

A 5-tube superheterodyne, all-wave receiver capable of world-wide radio reception. Its range is from 10 to 550 meters. Sponsored by 11 world-famous manufacturers of radio equipment.

**\$27.50**

- Kit of Parts.....
- Oxford 6" Speaker.....\$2.50
- Sylvania Tubes.....\$3.95

Send for 1935 184 Page Radio Catalog

**TRY-MO RADIO CO., INC.**

85R Cortlandt St. New York City

**HOW TO LEARN CODE**

Thousands of operators agree no system of printed sheets can teach you the Code. TELEPLEX has taught Code to more operators in past 10 years than all other methods combined. YOU can learn Code—or step up your w.p.m. amazingly—this surer way. No experience needed. Beginners, amateurs, experienced ops get ahead faster with Teleplex. It doesn't merely "show" you code—it IS Code! You actually HEAR dots-dashes any speed you want. Sends you practice messages and SENDS BACK your own key work, which no other system can do. For quicker license find out about this better way used by U. S. Army, Navy, R. C. A., A. T. & T. and many others. We give you complete course, lend all equipment, give personal service on MONEY-BACK GUARANTEE. Low cost, easy terms. Without obligation write for booklet R. N. 27.

**TELEPLEX COMPANY**

76 Cortlandt Street New York, N. Y.

**New "RCP" ANALYZERS LEAD IN VALUE!**

- MODEL 5414
- Complete \$28.95
- KIT \$24.50

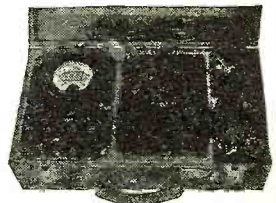

ACCURACY, completeness, fine appearance—plus convenience and provision for future needs—all at the lowest cost! What more could any analyzer provide to make your radio testing and servicing more satisfactory to your customers and more profitable to you? Write Dept. RN-3 for 1935 Catalog of complete testing equipment.

**RADIO CITY PRODUCTS CO.**  
Dept. RN-3, 28-30 W. Broadway, N. Y.

# A. C. power for Efficient Radio Operation in D. C. districts

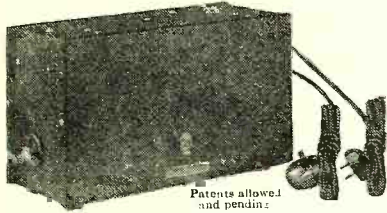

## The NUNN INVERTER

CHANGES D. C. voltage to A. C., necessary for best radio operation, particularly with short wave reception.

Type XR-115 (shown above) Line voltage, 115 volts D.C. Output voltage, 115 volts A.C. Maximum load, 150 watts, continuous. As high as 250 watts may be used intermittently. Efficiency 80%. Special models available for other voltages.

### Quiet—Efficient—Warranted

Simple, convenient, quiet-operating. May be installed easily without extra wiring, expense or difficulty. Never requires oiling, adjustment, or service attention common to former systems. Fully warranted for one year. Vibration switch, specially developed for this service, is the only wearing part... and it is long-lived and trouble-free, warranted for 90 days—and delivering 2500 hours of service in ordinary use—easily replaceable by anyone, at cost of only \$3.00.

There is a big field for dealers and service engineers with this new, truly efficient, trouble-free unit.

### LIST PRICE—MODEL XR-115

**\$30**

If your dealer does not yet stock it, order direct, sending dealer's name and address. Dealers—write for discounts. Terms to non-rated concerns or individuals, C.O.D.

## E. D. NUNN CO.

Makers of high voltage inverters for Neon Sign Service and Laboratory use.

512 W. Huron St., Dept. 11  
CHICAGO, ILL.

**One of the SUPREME FIDELITY AMPLIFIERS**

High Gain 30 Watts Class, "AAA" Push-Pull 250 tubes

SEND FOR A COPY OF OUR NEW PUBL. ADDRESS SALES MANUAL AND GENERAL CATALOG

Uses 2-56, 2-57, 2-50 and 2-81 tubes

- Tapped Inputs and Outputs
- Tone Control and Gain Control
- Mike—phono input switch
- Mike Current Supply
- Built-in mike and phono input
- No external transformers

WHOLESALE MERCHANDISERS, Inc.,  
626 Broadway, Dept. N, New York City

**free!**

**100% SHORT-WAVES**  
52 Pages—50 Hookups

ALL ABOUT: Xmitting and Receiving Antennas, Bandspreading, Receiving Foreign Stations, Xmitting tubes. HOW TO BUILD "19" Twinplex, 5 and 10 Meter Xmitter, "203-A" Xmitter Bandsread Doerle Set. How To Get Started in Short Waves, etc., etc.

Send 6c (U. S. coin or stamps) for postage. Treatise sent by return mail.

**RADIO TRADING CO.** 95 Hudson St. New York City

# RADIO PHYSICS COURSE

ALFRED A. GHIRARDI

## Lesson 38. Capacity of Condensers

IT has been found experimentally by actually inserting similar size sheets of different materials between the plates of a given condenser, that the capacitance of a condenser also depends on the kind of material used for the dielectric. Thus if the plates of a simple two-plate condenser are separated by air and the capacitance is say 1 microfarad, the capacitance will be increased to about 2 or 3 mfd. by simply filling the space in between the plates with a dielectric of paraffined or waxed paper. If the paper is taken out and sheet mica substituted, the capacitance will increase to from 3 to 7 mfd. The ratio of the capacitance of a condenser of given size having some particular material for the dielectric, to the capacitance which the same condenser would have with dry air as the dielectric, is called the *dielectric constant*, *specific inductive capacity*, or *relative permittivity* of that material. These names are all used to represent this constant, but the first is probably the most popular. Since air has the lowest dielectric constant of the various common insulating materials, it is taken as the standard and has the arbitrary value of 1. The dielectric constants of several insulating materials which may

be used in condensers are given in the table on the following page.

The variations between the low and high limits given in this table are due to possible differences between the grades and qualities of representative samples. The dielectric constant also changes with the frequency if the measurement is made with alternating current.

The reason for the fact that various materials affect the capacitance of a condenser differently when used as the dielectric, lies in the structure of their atoms. The dielectric constant depends on the number of electrons which can be displaced out of their normal positions when under the influence of an external electric force. It thus depends on the material, for all materials have different atom and electron arrangements.

We have learned that the capacitance of a condenser or capacitor is directly proportional to the total area of the plates which is exposed to the dielectric, is inversely proportional to the distance between the plates (thickness of the dielectric) and directly proportional to the dielectric constant "k," which depends upon the dielectric material (see table).

Dielectric Material	Constant	Dielectric Material	Constant
Air (taken as standard)	1.0	Oil, petroleum	2.0 to 2.2
Alcohol	15.0 to 26.0	sperm	3.0 to 3.2
Bakelite, C.	4.0 to 8.5	transformer	2.2 to 2.7
dielectro.	5.0 to 7.5	turpentine	2.1 to 2.3
micarta	4.5 to 6.0	Paper, insulating, untreated	1.6 to 2.5
Beeswax	3.0 to 3.2	oiled or waxed	2.0 to 3.2
Celluloid	4.0 to 6.0	cardboard, pressboard	3.0
Ceresin Wax	2.5	blotting, porous	5.0
Collodion	3.7 to 4.0	Paraffine wax (solid)	2.0 to 2.5
Cloth, oil or varnished	3.0 to 5.0	Phenol composition, moulded	5.0 to 7.5
Ebonite (see Rubber, hard)		Porcelain	4.0 to 6.0
Fibre, uncolored	5.5	Quartz	4.5 to 5.0
black	7.5	Resin	2.5
red	5.0 to 8.0	Rubber, gum	2.3
Film, photographic	6.8	soft, vulcanized	2.0 to 3.0
Gelatine	4.0 to 6.0	hard	2.0 to 3.5
Glass, window	7.5 to 8.0	Shellac	3.0 to 3.6
plate	7.0 to 7.0	Silk	4.6
heat resisting (Pyrex)	5.0 to 6.0	Slate, electrical	6.0 to 7.0
Gutta, percha	3.0 to 5.0	Sulphur	2.5 to 4.0
Isolantite	3.6	Varnish	4.5 to 5.5
Marble	9.5 to 11.5	varnished cambric	4.0
Mica, sheet	3.0 to 7.0	Vaseline	2.0
built up	5.0 to 7.0	Water, distilled	81.0
Oil, castor	4.5 to 4.8	Wood: bass, cypress, fir	2.0 to 3.0
cottonseed	3.0 to 3.3	maple	2.5 to 4.5
Oil, neatsfoot	3.0 to 3.2	oak	3.0 to 6.0
olive	3.0 to 3.3		

The capacitance of a condenser having any number of plates can be calculated from the equation:

$$C = \frac{2235 \times A \times k \times (N-1)}{10^{10} \times t} \quad (13)$$

where C = capacitance in microfarads (mfd.)

k = dielectric constant (or specific inductive capacity) of dielectric (see table above).

A = the area of one side of one plate. This is the area actually exposed to the dielectric (square inches).

t = separation of the plates in inches (thickness of the dielectric between any two adjacent plates).

N = total number of plates.

Example: What is the capacitance of a condenser having 51 plates each 5 by 5 inches? They have a separation of .1 inch with air between.

$$\text{Solution: } C = \frac{2235 \times A \times k \times (N-1)}{10^{10} \times t} = \frac{2235 \times 25 \times 1 \times (51-1)}{10^{10} \times .1} = .00279 \text{ mfd. Ans.}$$

## Backstage

(Continued from page 571)

used to search for microphone stars of the future. Eighteen young performers will be heard over a period of thirteen weeks and two winners will be chosen. The judges committee is headed by Lawrence Tibbett

and includes such additional distinguished names as Paul Whiteman, Jessica Dragonette, Gladys Swarthout and Frank Black. A specially designed trophy known as the Radio City Award, an RCA-Victor recording contract and other prizes will go to the lucky winning pair. Frank Black's orchestra and John B. Kennedy, the master of ceremonies, continue on.

## Multiple Regeneration

(Continued from page 545)

can be used and in this way image-frequency interference can be greatly diminished and perhaps one circuit and one tube saved in the intermediate or low-frequency amplifiers.

The above reaction systems can, of course, be used also to regenerate low-frequency circuits, for instance, as shown in Figure 6. In this experiment I used an ordinary a.f. transformer, connecting the primary between cathode and ground connections. The resistance,  $R_a$ , in parallel to the primary served to control the reaction. This arrangement has the following disadvantage: the transformers have generally a d.c. primary resistance of 1000 or 2000 ohms. With an anode current of 1 ma. it gives a negative bias of 1 or 2 volts. But varying the resistance  $R_a$  varies this bias. This, however, can be avoided by using a higher series resistance  $R$  and giving to the grid a plus bias. Thus the higher negative bias through resistance  $R$  and transformer with its shunt  $R_a$ , in combination with a suitable plus bias on the grid, will give the required operating point of the tube characteristic and will not be affected materially by adjustment of the resistance  $R_a$ .

I mentioned above that with the suggested regenerative systems the reaction is not entirely smooth. In order to provide for smoother reaction I tried putting resistance between the grid and the tuned circuits, or between the tuned circuit and the common minus, as in Figure 6. The difference, however, has not been worth while.

According to the above, simultaneous reaction at both a high and a low frequency in the same tube may be possible. In this way an efficient two-tube circuit might be used, as suggested in Figure 7.

Judging from the results of the experiments and research set forth above, it must be also possible to use the cathode reaction with directly heated tubes by inserting suitable chokes in the filament circuits, as in Figure 8, either in one lead or in both. Such a system might be very useful for portable sets where the weight must be kept down.

Another possibility might be to use the suggested reaction systems in connection with the so-called band-pass circuits. In this case, obviously, there are always more circuits than tubes, but according to the above, more than one circuit can be regenerated from the same tube.

Mr. L. E. T. Branch, in *Wireless World*, January 28, 1931, gives the band width formula:

$$bw = \frac{\sqrt{Y^2 - r^2}}{2\pi L}$$

where  $Y$  is the coupling impedance (for inductive coupling  $Y = \omega M$ , for capacity coupling  $Y = \frac{1}{C_m \omega}$ ),  $r$  the resistance of

each coil, assuming both coils having the same resistance.

From this formula it is apparent that in regenerating one or both circuits the double hump will not be lost. Moreover, the middle of the curve may perhaps drop considerably. Of course this question must still be investigated, but, anyhow, reacting only one of the two tuned circuits may be useful, as suggested in Figure 9.

I think the above investigations and results are very promising and open a relatively virgin and wide field for experimenters and constructors.

**New!**  
**Essential!**  
**A Million Facts!**



**The Last Word!**  
**Remarkable!**  
**New Done!**

### The Serviceman's Book of Knowledge



Here's what you get:

Complete descriptions and illustrations of latest 1935 testing instruments and servicing methods (including cathode-ray).

Trouble-shooting table of Symptoms and Remedies for over 500 different common receivers, listed by manufacturer and model number.

How to install and service auto radios (1935 models) — complete with ignition wiring diagrams.

Data on quick location and elimination of electrical noises and interference in broadcast and all-wave receivers and in auto radios (for every make and model of car).

Complete table of intermediate frequencies for all makes and models of superhets, new and old. (Essential in alignment work).

Thorough explanation of all forms of AVC and QAVC circuits and their servicing problems.

MODERN RADIO SERVICING tells you all about constructing and operating all types of radio test equipment according to latest methods; how to handle special servicing problems (auto, all-wave, marine, etc.); how to sell your service; etc.

## MODERN Radio SERVICING

by ALFRED A. GHIRARDI and BERTRAM M. FREED

(2nd Revised and Greatly Enlarged Edition of "Radio Servicing Course")

### Supplemented by FIELD SERVICE DATA AND ANSWER BOOK

It's really amazing—the way Ghirardi and Freed have managed to pack so much into one convenient book and a supplement. For it is true—they do give you all the essential facts you need to know about modern servicing practice. They've done something nobody else has ever been able to do. They went out in the field—direct to successful servicemen. They found out what methods were good and what were bad—what were quick, what were slow—what were profitable, what were unprofitable.

And after months of investigation, tapping every source of information available, they digested the entire mass of material to give to you just the dope you want to have, the sort that will help you make more money out of your business—and make it quicker.

How to cash in on the new technique MODERN RADIO SERVICING will show you how to be a more successful serviceman than you are today, no matter if you're just beginning or if you're an old hand at the game.

This is a book you will really have to own. It will add hundreds of new tricks to your trade and put hundreds of new dollars in your pocket. We can't begin to give you the whole story here—but we have a circular that will. It shows you just exactly what is in this remarkable new book. And it's free! So tear out the coupon—or drop us a postcard—today—right now before you forget! This may be the biggest step forward you have ever taken.



What it is—

The only complete book of its kind ever published.

Covers every phase of servicing as it is practised today. Written in simple clear, easy-to-understand language.

No radio men are better qualified to write such a book than A. A. Ghirardi, author of the famous *Radio Physics Course*, and B. M. Freed. Contains the combined experience of some of the biggest and most successful service organizations.

Profusely illustrated with diagrams and photographs.

Gives invaluable charts and tables for reference.

No knowledge of mathematics necessary — numerical problems are worked out for you.

Everything in it is practical—you can put it to work right away!

Send for free circular

Name.....

Address.....

TO:  
Radio & Technical Publishing Co.,  
45 Astor Place,  
New York, N. Y.  
Dept. RN-3

Please send me your free descriptive circular on MODERN RADIO SERVICING.

TEAR OFF AND MAIL TODAY



**BUILD YOUR OWN**  
**ALL-STAR JR**  
**ALL-WAVE Superheterodyne**

A GREATER SENSATION THAN THE FIRST "ALL-STAR"

★ ALLIED ★  
 LEADS AGAIN—FIRST WITH FOUNDATION KITS!

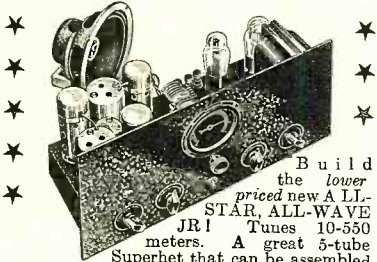

Build the lower priced new ALL-STAR, ALL-WAVE JR! Tunes 10-550 meters. A great 5-tube Superhet that can be assembled at an amazingly low price. Features Band-spread tuning, world-wide reception, pre-adjusted coils, beat-note oscillator, excellent tone quality, etc. Easy to build. ALLIED is first with the FOUNDATION KIT. Only \$2.25 will start you building this great set. Foundation Kit includes drilled front and sub-panels, instructions, etc. ORDER THE NEW ALL-STAR JR. FOUNDATION KIT TODAY.

SEND FOR FREE DIAGRAM AND COMPLETE PARTS LIST

**Allied Radio CORPORATION**  
 833 W. JACKSON BLVD. CHICAGO

Dept. M.

- Send me FREE Diagram and Parts List for building the ALL-STAR JR.
- Enclosed you will find \$2.25 for which you are to slip me the ALL-STAR JR. FOUNDATION KIT described above.

Name.....

Address.....



Insures Perfect Reception



"NOISE MASTER"

Cat. No. 14 **Antenna**

LIST PRICE  
**\$6.75**

Licensed under Amy, Aceves & King patents. Eliminates "man made" noises over both short wave and broadcast bands. Permits operation of more than one set from the same aerial. Here is the acme of engineering perfection, insuring highest possible antenna efficiency.

An Ideal Store Demonstration Kit . . .

also "EXPLORER" Cat. No. 11 List Price..... **\$3.70**  
 and "CONQUEROR" Cat. No. 12 List Price..... **\$3.40**

CORWICO stands for the best in antenna and radio wire products. Service organizations are urged to consult us freely for counsel regarding their antenna problems.

Write for Latest Bulletins

**CORNISH WIRE CO.**

30 Church Street, New York City



QRD? QRD? QRD?

CONDUCTED BY GY

It certainly looks like the boys are rallying round the old flag by the cooperation given to the ARTA officials. Strikes have been called and won because of the strength shown by the members. Broadcast, airways and marine ops are now being enrolled from all corners of the U. S. A. because of the fact that the organization has shown them what it actually can do when put to the test. President Haddock recently made a personal tour of the West Coast at the request of the majority of the members, so that they could see the type of man who is at the head of this organization. We continue to stress that "In unity there is strength."

A RECENT suggestion of a merger between the RCA and Mackay Radio Companies has thrown a scare into hundreds of their employees because if this merger should go through, it might result in the elimination of overlapping stations. There is no doubt but that it would be a saving of money to these companies, but whether it would increase the efficiency of communications ought to be taken into consideration. Congress has appointed a Communications Commission which is now holding hearings on this matter, taking into consideration the viewpoints of all involved before they arrive at a conclusion. We hope that the Communications Commission will also take into consideration the viewpoint of the radio operators and the effect of such a merger upon the labor situation.

One of the ops down at the ARTA Static Room has hit upon a novel plan to make money while waiting for an assignment. As he speaks a few languages and has travelled over Europe, he has a pretty good idea of the likes and dislikes of the people who come to the States from the various countries. So, whenever a boat pulls in, he boards her and introduces himself as a guide through New York City. So far he has been very successful. This just goes to prove that "where there's a will . . . there's relatives."

It's a funny thing how newspapers will invent stories. A certain news item describing the vain efforts of a station to "raise" a sinking steamship appeared in one of the local blabs. Upon investigation, the facts of the case were found to be that the doomed vessel never had a radio aboard her and, therefore, could not be raised. The SS Loomis, a Great Lakes package boat, was well out into Lake Superior when, during a heavy fog, she struck a Canadian boat. The latter had radio aboard and immediately sent an SOS call

out, but due to the speed with which she was sinking, the operator had to leave before he could give the ship's position. The Loomis reached port, much to the surprise of everyone as it was thought the ship was lost. This is only another instance where the seamen are taking their lives very cheaply by shipping on boats "minus" radio apparatus and radio ops, but there'll come a day when these seamen will become "protection conscious" and will refuse to ship aboard anything but a properly equipped-and-manned vessel.

The SS Henri Jasper and the Jean Jadat came into port recently, from Belgium, each carrying only one operator, which according to the Belgian government is perfectly all right, although not in accordance with U. S. regulations. Word was sent by the Belgian radio operators' organization to the ARTA requesting that the latter do something about it. President Haddock immediately communicated with the Department of Commerce, who ruled that the ships could not leave port unless they had at least two radio operators on board. Therefore Art Finch and Joe Gatley were assigned to the Jasper and the Jadat and they will get a free ride back to this country on their return trip.

There are still a few broadcast stations in the U. S. A. which are not observing the code for radio technicians. Although some station owners might plead ignorance of the various stipulations, it is reported a certain gentleman, who is the owner of a broadcast station in the midwest, cannot plead likewise, due to the fact that he was one of those who actually helped make the law. He has been able to hire radio technicians for as low as \$10.00 per week and even at this low wage, owes back wages to some of the men. One of these operators who started at \$10.00 and was raised to \$15.00 per week after having been at the station for almost six months, requested some of his back wages and was met with the reply "I will settle with you for \$5.00 and consider yourself fired." The ARTA has been advised of the situation at this broadcast station and has already communicated with NRA officials, who promised to go deeply into the matter.

Twenty-two operators on the Great Lakes had the courage to strike for higher wages, knowing full well that the law of this country permitted their ships to sail unmanned by radiomen as long as there were less than 50 men in the crew. The ships did sail without them, but found it not only hazardous but expensive to continue unmanned because of the continual

change in orders which now are delivered to them by a tug boat just before they enter a port. These orders were formerly given via radio which, of course, was quicker and cheaper. The Cleveland Cliffs will find that in the long run they will have to accede to the nominal requests of the operators because it will be to their best advantage to do so. Also, ships after leaving Duluth, are not heard from again until they reach their next port of call and are quite often overdue because when Lake Superior gets rough they have to hide behind Whitefish Point. We hope that the owners will not "bite off their noses to spite their faces."

The illustration in our heading this month shows the 50-watt Gamewell-Westinghouse police transmitter *WPHI* operating on 2490 kc. under Sgt. T. A. Bird.

The mail man brings 73 from C. R. Thompson, who hails from Toppenish, Wash., and although he has a heavy load on his chest, we sincerely believe that brighter days are ahead for the radio op. The term, "radio operator" does not necessarily mean that the average operator will die with a key in his hand. Some operators have made successes as radio servicemen, broadcast men and in the airways. We find some like Charles Vought, who owns a radio store and whose past experience as an operator is aiding him greatly in the amateur field and in service work. So, therefore, Thompson, we would suggest that you try these other fields until shipping conditions improve. . . . F. Welch (W6LDY) sends best 73 to the gang. He is now situated at Fort Bragg, California. . . . If Alfred Latimer will let me have his address, I will be glad to supply him with the information he desires. . . . We also hear from Earl Phillips of Trinidad, Colo. Any time we can be of help to you, don't be bashful, Phillips, just drop us a line. . . . Well, until next time, and with 73 . . . go . . . GY.

### The Browning 35

(Continued from page 546)

wound" with silver-plated wire which has about 5% lower resistance than copper. The various trimmers and padding or "lag" condensers are also mounted in their respective compartments. On top of the "catacomb" is mounted the 3-gang tuning condenser.

The "catacomb," including the tuning condenser, is completely wired, lined up, and tracked so that the set builder has only to make seven connections to the Tuner. The unit, as a whole, is insulated from the chassis proper by four gum-rubber washers through which the mounting bolts fit. The Tuner is then grounded to the main chassis at one point only when installed. This precludes the possibility of coupling to any of the tuned circuits (with chassis currents) and at the same time gives a cushioning effect which eliminates acoustical-mechanical microphonics. (The set builder should take particular care not to have the front metal panel make metallic contact with the Tuner.) The intermediate transformers are also tuned and adjusted at the factory so that the set builder will have only to line up the circuits for the tubes being used.

The receiver is absolutely single control, all the tuning being done by means of the 3-gang bank of condensers. Band-spread is accomplished by a micro-vernier arrangement, the shaft of which rotates a pointer on a 360-degree dial. This pointer makes 20 complete revolutions while the pointer (attached to the main shaft of the condensers) goes 180 degrees. Thus, sta-

tions may readily be logged by reference to the settings of the two pointers.

The band-spread given by this arrangement is as follows: On the 1.4 to 3.75 megacycle band, 360-degree rotation (100 divisions) is the equivalent to approximately .25 megacycle. On the 3.4 to 9.2 mc. band, 360-degree rotation is equivalent to approximately .5 mc., while on the 8.5 to 23 mc. band, 360-degree rotation is equivalent to approximately 1 mc.

In the next issue constructional details and performance curves will be given.

### Radio in Aircraft

(Continued from page 562)

airplane is to operate in extremely cold temperatures, the lubricant should be changed to the lightest grade available, to avoid congealing, which may render the unit inoperable. For constant operation in sub-zero temperatures, a vibration type "B" eliminator may be preferred, in spite of its inherent deficiencies.

Next, open up all junction and switch boxes, and check connections; once again, critical soldered joints are touched with a hot iron as a precaution against crystallization.

During the 20-hour check it will be necessary for the airplane mechanics to have the shielding harness removed from the engine in order to get at the spark plugs. The radioman should, if possible, remove the shielding harness himself; some mechanics' helpers seem to regard it as a personal enemy—it gets in their way. After the mechanics are through with the engine, replace the shielding harness, making sure that it has not been damaged, and that all bonding clips are in place. The same will apply the magneto shields, and such other electrical engine equipment as may have been inspected or serviced.

Go over the entire shielding, and see that it is not frayed or damaged. The cables will normally last about 300 flying hours, when the harness should be completely re-strung, if manifold type, or replaced, if individual-lead type. Only damaged parts need be replaced in the meanwhile.

The bonding check should be made by either of the two methods recommended in the preceding installment (ammeter or buzzer). In addition, touch a hot iron to all soldered joints, especially at the control surface bonding connections.

Last, examine the antenna and the counterpoise system. See that the supports and fittings are mechanically sound, that the insulators are unbroken, and the wire is not frayed and flexes evenly; replace rubber grommets where necessary. If an aluminum mast antenna is used, check it at both supports and at the insulation at the fuselage. It is good practice to check it for cracks every 50 hours or so; this can be done by "etching" the metal at the critical points where fatigue is most likely to develop. Etching is done by first cleaning the surface of the metal thoroughly, and then brushing it with dilute hydrochloric acid. Incipient cracks, ordinarily invisible, will show as faint black lines, and can be seen with naked eyes or through a low-power magnifying glass.

After the check has been completed and all incidental work performed, make the crucial test—switch on the receiver and see how it works.

The ideal to strive for in servicing aircraft radio is to leave the set after each check-up in as perfect condition as possible. There is no "top" or "major" overhaul in radio installations, repair work being done only as needed—but done promptly, and done thoroughly.

HARD-TO-FIND

TROUBLE SPOTS

Now Quickly Located!

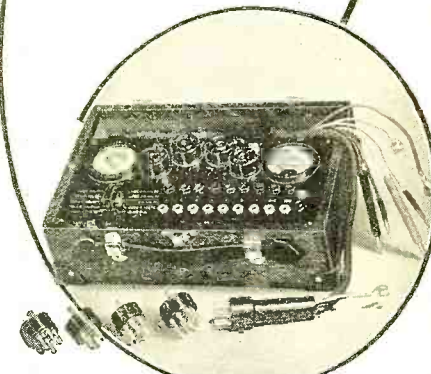

**U**P and coming service men know inefficient equipment means lost time, inaccurate work and unsatisfactory results. More and more, they are turning to the Readrite No. 730 Tester because it takes the guess work out of servicing and enables them to quickly and accurately locate trouble spots.

The No. 730 Point-To-Point Tester is designed especially for speedy and efficient servicing. It is extremely flexible. Voltage can easily be checked in any tube circuit. Also measures resistance, capacity and continuity. Tester socket terminals are arranged according to RMA standards. It is unnecessary to remove chassis from cabinet when localizing defects.

This tester includes two meters—one for reading AC, the other for DC. These meters are rugged, compact and accurate. Separate meter ranges are made possible by connecting to a single pair of jacks and using the selector switch. DC ranges are 15, 150, 300 and 600 volts. (1,000 ohms per volt). Milliamperes are 15 and 150. The AC voltmeter ranges are 10, 25, 150 and 750.

#### Your Jobber Can Supply You

At the dealer's net price of **\$18.60**

**READRITE METER WORKS**  
141 College Avenue, Bluffton, Ohio



#### MAIL COUPON FOR CATALOG!

Readrite Meter Works  
141 College Avenue, Bluffton, Ohio  
Send me catalog on Readrite No. 730 Tester and folder proving Readrite leadership.

Name.....  
Address.....  
City.....State.....

# The Technical Review

(Continued from page 569)

causes which required servicing with data on the type of receiver serviced and its age.

**All-Wave Receiver Problems**, by Murray G. Clay. Proceedings of the Radio Club of America, October, 1934. Covers the problems of circuit design, interstage coupling systems, antenna coupling systems, coil switching systems, acoustic feedback, audio and high-frequency microphonics, "on resonance" and "off resonance" howls and intermediate-frequency and oscillator microphonics involved in the design of all-wave receivers.

**Response of the Photronic Cell to Modulated Light Flux at Audio Frequencies**, by John H. Roe. The Review of Scientific Instruments, December, 1934. A discussion of an apparatus which can be used to study and determine the audio-frequency response of almost any photocell.

**A Brief Survey of the Characteristics of Broadcast Antennas**, by H. E. Gihring and Dr. G. H. Brown. Broadcast News, December, 1934. Discusses the importance of careful determination of antenna characteristics and analyzes the various factors which must be taken into consideration in its design.

**Band Switching for the Transmitter**, by D. A. Griffin. QST, December, 1934. Circuit diagram and constructional details of a band-switching transmitter to simplify transmission over several bands.

**Extending Volume Range**. Radio Engineering, November, 1934. A discussion of the importance of suitable volume range for high-fidelity transmission and reception and an explanation of the compressor-expander system for obtaining a wide volume range to provide faithful reproduction.

**Plan to Eliminate Radio Interference**, by Dr. Alfred N. Goldsmith. Electronics, December, 1934. An outline of the plan of the R.M.A. to eliminate radio interference and an analysis of the results which have been obtained in other countries where definite steps to eliminate interference have been taken.

**How to Read Selectivity and Fidelity Curves on a Cathode-Ray Oscillograph**, by Kendall Clough. Radio Retailing, December, 1934. Explains how the cathode-ray oscillograph is rapidly superseding many other test methods for checking set characteristics and describes many of its more important uses in servicing.

**The Genemotor—Modern Power System**, by G. W. Blessing. Radio Industries, October-November, 1934. Gives circuit and description of the operating principles and characteristics of the Carter genemotor power supply system for automobile radios.

## How to Get Copies of Articles Abstracted in This Department

The abstracts of articles featured in this department are intended to serve as a guide to the most interesting and instructive material appearing in contemporary magazines and reports. These publications may be consulted at most of the larger public libraries or copies may be ordered direct from the publishers of the magazines mentioned.

RADIO NEWS cannot undertake to supply copies of these articles. They are NOT included in the RADIO NEWS Free Technical Booklet Service.

## Technical Booklets Available

6. **Line Voltage Control**. Characteristics and uses of a voltage regulator and chart showing the correct Amperite recom-

mended by set manufacturers for their receivers.

26. **Auto Radio Antennas, Filters and Noise Suppressors**. The line of Lynch antennas, filters and ignition noise suppressors especially designed for motor radio installations. Data on how to eliminate motor radio noise is included.

27. **The Autostat Charging Rate Booster**. This folder describes the new Lynch Autostat designed to automatically increase the charging rate of the automobile car generator by five amperes every time the car radio is turned on, so as to eliminate danger of running down the car battery while the radio set is in operation.

34. **Serviceman's 1935 Replacement Volume-Control Guide**. Revised list, in alphabetical order, of all old and new receivers showing model number, value of control in ohms and a recommended Electrad control for replacement purposes.

57. **How to Build a High-Quality Condenser or Ribbon Microphone**. The Amperite Microphone Kit, with which it is possible to build, easily and quickly, a high-quality condenser or ribbon microphone.

65. **New 1935 Line of Testing Instruments**. Information on the new 1935 line of Supreme testing instruments including the new 5" fan-shape meter, the new Model 333 deluxe analyzer, the low-priced Model 333 standard analyzer and an improved Model 85 tube tester.

66. **An A.C.-D.C. Tester Which Can Be Built at Home at Low Cost**. Information about the Supreme 5" fan-shape meter, rectifier and resistor kit for the home kit for the home construction of an inexpensive a.c.-d.c. tester.

2. **1935 R.F. Parts Catalog**. Specifications, illustrations and prices on the new line of Hammarlund variable, midget, band-spread and adjustable condensers; trimming and padding condensers, r.f. and



## "Pretty Soft"

Not that I'm a softie . . . but with my new shaft of aluminum you can almost "bite" me off with a good pair of pliers . . . in fact a few swipes with a file and I'm down to the required size.

The new RADIO-OHM off-ers smoother attenuation.

Just another refinement that makes it so much easier to use me in a replacement job. And do I work smooth? . . . ask thousands of servicemen the world over who always use CENTRALAB RADIOHMS for ALL their jobs. Don't say "Gimme a Volume Control." Specify RADIOHMS the next time you stock up.

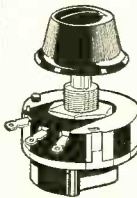

Every Radio Service Man should be a member of the Institute of Radio Service Men.



Division of

**GLOBE UNION MFG. CO.**  
RADIOHMS-RESISTORS-SUPPRESSORS

**TURN TO** page 585 and see the Special Radio News Subscription Offer

## BUILD YOUR OWN ALL-STAR JR. ALL-WAVE Superheterodyne

**MID-WEST Leads Again!**  
FIRST with FOUNDATIONS for Short-Wave Radio's Newest Sensation



**All-Star Jr.**  
**5 TUBE SUPER KIT**

Only \$2.25 will start you building this great set. For this small sum you can order the ALL-STAR FOUNDATION from MID-WEST. Includes 1- drilled Eraydo front panel, 2- drilled base, 3- enlarged schematic diagram, 4- enlarged wiring diagram, 5- pictorial diagram, 6- detailed instructions for assembly, etc. Start with the FOUNDATION and buy the remaining parts as you need them. ORDER THE ALL-STAR JR. FOUNDATION TODAY, or send for FREE wiring diagram and parts list.

## MID-WEST RADIO MART

520 S. State St., Dept. R, Chicago, Ill.

- Enclosed you will find \$2.25 for which you may ship me at once the ALL-STAR JR. FOUNDATION described above.
- Send me FREE diagrams and Parts List of the ALL-STAR JR. Superhet.
- Send me FREE 68 Page Mid-West Short Wave catalog.

Name.....  
Address.....

March, 1935  
RADIO NEWS Free Technical Booklet Service  
461 Eighth Avenue  
New York, N. Y.

Gentlemen: Please send me, without charge, the booklets or folders I have filled in below:

Numbers.....  
.....

My occupation or connection in radio is checked off below.

- Serviceman Operating Own Business
- Serviceman Employed By:
  - Manufacturer
  - Jobber
  - Dealer
  - Servicing Organization
- Dealer
- Jobber
- Radio Engineer
- Experimenter
- Laboratory Technician
- Professional or Amateur Set Builder
- Licensed Amateur
- Station Operator
- Public Address Work

I am a  subscriber  newsstand reader.

I buy approximately \$..... of radio material a month. (Please answer this question without exaggeration or not at all.)

Name.....

Address.....

City..... State.....  
PLEASE USE PENCIL AND PRINT, IN FILLING IN COUPON

intermediate-frequency transformers, coils and coil forms; sockets, shields, chokes and miscellaneous parts for receiving and transmitting.

3. *1935 Short-Wave Manual.* A circular containing list of contents, excerpts and illustrations from the new 16-page Hammarlund Short-Wave Manual with instructions on how to obtain a copy containing constructional details, wiring diagrams and list of parts of 12 of the most popular short-wave receivers of the year.

4. *A New Short-Wave Superheterodyne.* Describes the outstanding features of the standard and crystal type Hammarlund "Comet Pro" short-wave superheterodynes designed to meet the exacting demands of professional operators and advanced amateurs for a 15- to 250-meter code and phone receiver, but which can be used by anyone for laboratory, newspaper, police, airport and steamship use.

5. *A 1935 Volume Control and Resistor Catalog.* Data on Electrad standard and replacement volume controls, Truvolt adjustable resistors, vitreous wire-wound fixed and adjustable resistors and voltage dividers, precision wire-wound non-inductive resistors, center-tapped filament resistors, high-quality attenuators, power (50 and 150-watt) rheostats and other resistor specialties.

25. *Noise-Reducing Antenna Systems.* Data on the Lynch transposition type system for both long- and short-wave reception and the shielded transmission line type system for broadcast use. Explains how the polycoupler system can be used to make apartment-house and hotel installations at a profit.

60. *Audio and Power Transformers and Choke Coils.* Descriptions, circuit diagrams and prices of the new AmerTran De Luxe, standard and low-priced Silcor lines of transformers and chokes for public-address systems, amplifiers and radio receivers.

67. *Practical Mechanics of Radio Service.* Information including cost, features and outline of lessons of the Frank L. Sprayberry course in radio servicing and list of Sprayberry data sheets for modernizing obsolete test equipment and receivers.

68. *How to Modernize the Supreme 400-B.* Data Sheet No. 4 of the Frank L. Sprayberry series of data sheets on how to modernize obsolete test equipment and receivers.

69. *Case Records of Broadcast Receiver Repairs.* Gives plan, contents and price of the Capitol Radio Research Laboratories' loose-leaf case records of 1500 service jobs showing how actual troubles were corrected. Serves as a guide in correcting troubles in all types of receivers and power supply units.

70. *Data Sheet on Building an Analyzer Adapter.* Compiled by the Capitol Radio Research Laboratories to show servicemen how any analyzer may be brought up to date or how to build a complete, modern analyzer out of spare parts with a multi-meter.

71. *Radio Parts and Sets for 1935.* A new Try-Mo Radio Co., Inc., catalogue listing a wide variety of sets, chassis, standard, special and replacement parts, tubes, tools, books, public-address systems, amplifiers and other electrical equipment required by radio dealers, servicemen, experimenters, set builders, radio operators and engineers.

72. *The Skyrider Short-Wave Receivers.* Describes the Skyrider tuned-radio-frequency and Super-Skyrider superheterodyne short-wave receivers designed and built by Hallicrafters, Inc. Feature range

of 13 to 200 meters (with broadcast or 10-meter band optional), automatic wave-change switch, continuous band-spread, built-in monitor, speaker and power supply (or batteries), high-fidelity audio and other refinements.

## The All-Star Jr.

(Continued from page 543)

pearance, and it does not in any way look like a "home-made" job.

Tests are now being carried on with this receiver in one of the RADIO NEWS Listening Posts and as a result an article will appear next month giving an informal report of the reception results obtained as well as some detailed information on the operation of the receiver.

## Carbon Resistors

(Continued from page 556)

resistor is shown in Figure 2. Note the greater density and uniformity in this resistor.

Attaching the pig-tails is another difficult problem. The new Lynch resistors have a fine metal coating on the ends which provides the contact with the carbon resistor; over this the cap is placed, while the pig-tails are a part of the cap.

The resistor does not get so hot, as explained above, and so it can stand higher voltage than old carbon resistors of the same size. The margin of safety is greater because the size of resistors has not been reduced to take advantage of this property.

Tests on this type of resistors have been conducted for more than a year. The tests consist of applying loads at double wattage and higher, placing the resistor in water, subjecting them to heat, etc. Here are some of the results.

Loading the resistor at double wattage did not cause any change in resistance value. In one test several resistors were subjected to overloads up to four times the normal load and voltages of 880 volts. As a result, the maximum variation of resistance was 2 percent and majority of variations were fractions of 1 percent.

Several resistors were placed in water, boiling water or live steam, which did not impair the units.

One independent laboratory subjected resistors to load and heat simultaneously. Resistors were heated to 135 degrees Fahrenheit and subjected to normal load for 350 hours. The actual temperature of the unit then rose to 193 degrees, due to development of heat caused by the load. No change in resistance value was observed, while the old type shows 4 to 10 percent variation. Several other temperatures and loads were used. The old type resistors, when subjected to 200 degrees F. and 10 percent overload, showed a resistance variation of 4 percent in 15 hours. In this test the temperature of the resistor rose to 315 degrees F. According to the available data, it was shown that these resistors would burn out if they were subjected to a temperature of 266 degrees under load. However, the new resistors were given 100 percent overload at a temperature of 200 degrees Fahrenheit for 450 hours. The maximum variation in this case was 3.6 percent. With normal load, at the same temperature the maximum variation was 2.9 percent during the same time.

In order to determine the presence or absence of noise, cathode-ray tests were made. These tests show that the new unit is practically noiseless.

# GET THIS BOOK AND INCREASE YOUR PROFITS

YOURS  
FOR  
10c



Radio Service Men! This book will increase your profits, because in it you will find all of the latest technical information that is necessary for your job . . . how to recognize tube and set troubles . . . and, *most important*, how to solve these problems to get fine, sure performance!

The book contains 104 pages . . . and is crammed with useful information. Complete data on all tubes, including types 15, 18, 255, 25Ys, 2z2, 46B1, and 182B, and complete descriptions of over 90 types of tubes.

This is Sylvania's latest service help . . . and it's yours for 10c! Take the guess out of tube application! You can if you send for this handy pocket manual.

## YOURS! for 10c in STAMPS

### HYGRADE SYLVANIA CORPORATION

Makers of  
Sylvania Tubes  
Hygrade Lamps  
Electronic  
Products



Factories  
Emporium, Pa.  
St. Mary's, Pa.  
Salem, Mass.  
Clifton, N. J.

**Sylvania**  
THE SET-TESTED RADIO TUBE  
© H. S. CORP. 1934

#### Hygrade Sylvania Corporation Emporium, Pennsylvania (A-20)

Please send me the new Sylvania Technical Manual. I enclose 10c in stamps.

Name.....

Address.....

City..... State.....

# Super SKYRIDER

"has everything"



### FEATURES

- Built-in Power Pack and Speaker
- 4 Short-wave Bands
- Exceptionally wide Band Spread—Spreading actually 7" on 40 Meter Band
- Pre-selection
- No Plug-in Coils
- Less than 3 Microvolts Sensitivity
- 3 Watts Power Output in the Speaker
- Tone Control

### Acclaimed by Short-Wave Authorities Everywhere!

It will do your heart good to read the unsolicited testimonials from these outstanding short-wave personalities: G. A. Joyce (W9RA); Robert Hertzberg, New York Sun; R. S. Kruse, technical editor of R/9; T. P. Jordan, Scranton, Pa.; Rex Munger, Minneapolis and Lt. Com. R. H. G. Mathews, famous "Matty" of W9ZN.

Let us send them to you, together with complete details of this custom-built, "professionally-perfect" short-wave super-heterodyne.

W. J. Halligan, Pres.

### the hallicrafters, inc.

3001-A Southport Ave., Chicago, U. S. A.

a hallicrafters product

JUST OFF THE PRESS!

**NEW 1935**

**BIG BARGAIN RADIO-AMPLIFIER CATALOG**

**SEND For Your FREE COPY TO-DAY**

We have MOVED to considerably LARGER QUARTERS to give you FASTER SERVICE!

We now occupy over FOUR times MORE SPACE.

Entirely New from Cover to Cover!

Filled with Latest Design Portable, Mobile and Rack and Panel, Public Address Amplifiers, Short-Wave and All-Wave Receivers and Converters, Inter-Office Call Systems, Test Equipment, Replacement Parts, Kits, Tubes, and Accessories—all at Unbeatable Rock Bottom Prices!

**WE ARE HEADQUARTERS FOR PUBLIC ADDRESS SYSTEMS**

"COAST-TO-COAST" Presents a New Line of **1935 P.A. AMPLIFIERS**



These improved modern Amplifiers employ an all-steel black crystalline finished housing with binged top and ventilating louvers. Available with optional self-contained "Input Mixer-Fader Control Panel, Combination Output Meter and "Mike" Current Meter, Self-Contained

Models available for operation from either a 6 Volt Storage Battery, or 110 Volt A. C. Universal Models may be operated from both 6 Volts D. C. and 110 Volts A. C. Portable Models, too. Entire line, ranging in audio output from 5 Watts to 100 Watts, completely described in our FREE catalog shown above.

Buy Direct from the Manufacturer and Pay Only One Profit!

**COAST TO COAST RADIO CORP.**  
559-565 N SIXTH AVE. NEW YORK, N. Y.



### WHERE GERMANY'S SHORT-WAVE PROGRAMS ORIGINATE

The large building in the shape of a hemisphere is the modern broadcasting house for long-wave transmissions. The tiny peaked-roof house at the right contains the studios and short-wave headquarters for the round-the-world transmissions

## The DX Corner (Short Waves)

(Continued from page 552)

8 to 16 G.M.T. and on December 20, from 16 to 24 G.M.T. This was the first of a series of round-the-clock tests. The management of the station is interested in receiving as many reports as possible from listeners-in. Address your reports to Philips Radio, Holland.

### RW59 Transmissions

An official communication from Radio Centre, Moscow, states that station RW59 will transmit on a wavelength of 50 meters (6000 kc.) on Sunday, Monday, Wednesday and Friday at 21 G.M.T. On Sundays three additional broadcasts take place on a wavelength of 25 meters (12000 kc.) at 03 G.M.T., at 11 G.M.T., and at 15 G.M.T. The call letters for the 25 meter station also are RW59.

### British Empire Transmissions

An official communication from the British Broadcasting Corporation states that the Empire short-wave stations will transmit on a schedule shown in this month's Time-Table with the provision that GSC may be substituted for GSB, and GSE may be substituted for GSD or vice versa.

### HC2RL Transmissions

An official communication from Dr. Roberto Levi, Manager of Short-Wave Station HC2RL, "Quinta Piedad," states that during 1935 the station will transmit on the same frequency (6668 kc.) and always at the same hours, Sundays from 5:45 to 7:45 E.S.T., and Tuesdays from 9:15 to 11:15 E.S.T. In order to stimulate interest in the station the management will present to the writer of each ten thousandth verification letter a straw hat, made in Guayaquil, popularly known as a "Panama Hat." Listeners who write for verifications should include an International Reply Coupon for postage to cover the answer.

### Readers Who Helped Log Stations for This Month's Report

F. W. Gunn, Gosfield, England; Harry Lee

Nunn, Jr., Paul B. Frame, E. Boston, Mass.; Norman C. Smith, Sidgeup, England; Radio Club Venezolano, Caracas, Venezuela; C. H. Armstrong, Atlanta, Georgia; Bob Morrison, Vancouver, Canada; W. H. Reeks, Chicago, Illinois; J. Malone, Melbourne, Australia; John C. Kalmbach, Jr., Buffalo, N. Y.; E. J. Vassallo, Hamrun, Malta; R. Lawton, Whitefield, England; J. D. Lowe, Colombia, South America; C. H. Skatzev, Delaware, Ohio; L. C. Styles, Ingatstone, England; M. LeFranc, Managua, Nicaragua; Joseph M. Malast, Buffalo, N. Y.; Thomas Van Auker, Livingston, Texas; CT2AJ, S. Miguel, Azores; H. L. Zeelenberg, Eindhoven, Holland; Y. C. Wen, Shanghai, China; Blake H. Page, Chicago, Illinois; M. Mickelson, Minneapolis, Minn.; D. R. D. Wadia, Bombay, India; Hans Priwin, Copenhagen, Denmark; H. S. Bradley, Hamilton, N. Y.; Stanley C. Isaacs, London, England; Ellsworth Dumas, Milledgeville, Illinois; Charles W. Anderson, III, Morristown, N. J.; W. W. Eneke, Brazil, South America; R. Wright, Brooklyn, N. Y.; Russell Leader, San Francisco, Calif.; Edela Rosa, Trinidad, B.W.I.; Oriente I. Noda, Saratoga, Calif.; Sam J. Emerson, Cleveland, Ohio; James T. Spalding, Louisville, Ky.; Virgil C. Tramp, Marshfield, Oregon; Peter D. Musnicki, Luck, Poland; Walter F. Daboli, Providence, R. I.; Frank E. Baier, El Paso, Texas; J. T. Atkinson, Manitoba, Canada; George Pasquale, Phoenix, Ariz.; Wheeler T. Thompson, Fredericksburg, Va.; Harold W. Bower, Sunbury, Pa.; Donald W. Shields, Roseville, Ohio; Geo. R. Johnson, Medford, Oregon; Baron V. Huene, Tientsin, China; Heine Johnson, Big Spring, Texas; Taylor W. Gannett, Guayaquil, Ecuador; Douglas S. Catchim, Washington, D. C.; G. W. Twomey, Fort Snelling, Minn.; Roland L. Robinson, Richmond, Ind.; George C. Sholin, San Francisco, Calif.; J. C. Meillon, Jr., Paris, France; I. V. Toller, Fairbury, Nebraska; Felipe L. Saldana, Tlax, Mexico; James L. Davis, Savannah, Georgia; Henry Spearing, Indianapolis, Ind.; H. Kemp, Waterbury, Conn.; Earl Wickham, Bloomington, N. J.; Paul J. Mraz, Dupre, S. D.; J. F. Edbrooke, Argentina, South America; Donald Smith, Woburn, Mass.; H. Arthur Mathews, Victoria, Australia; Harold J. Self, Beccles, England; A. B. Baadsgaard, Ponoka, Alberta, Canada; John McCarley, Decatur, Georgia; Larry Eisler, Chicago, Ill.; Carl P. Peters, Troy, Ohio; Edward Hughes, Louisville, Ky.; Italo Amore, Bogota, South America; Robert Irving, Chicago, Ill.; George H. Fletcher, Gainesville, Florida; Thursten Clarke, Pembroke, Bermuda; Hugo Maugeri, Brooklyn, N. Y.; Howard Adams, Jr., Baltimore, Md.; Duncan T. Donaldson, Kelty, Scotland; F. R. Curtis, Washington, D. C.; Wm. Schumacher, Ellis, Kansas; Herman Freiss, Istanbul, Turkey; Ned Smith, Nehalem, Oregon; Phillip Swanson, New London, Conn.; Sherman Moulton, Bergenfield, N. J.; Wm. R. Hamilton, Vallejo, Calif.; James Haley, Seaside, Oregon; Dr. F. C. Naegeli, Jackson, Wyo.; Joseph V. Trzuskowski, Central Falls, R. I.; Raymond B. Edge, Buffalo, N. Y.; Harry Myers, Baranca-Bermeja, South America; Charles S. Potts, Kernsville, Pa.; R. W. Winfree, Atlanta, Georgia; Bertram Baker, Corozal, Canal Zone; Wm. Koehnlein, New York City; Charles Miller, Covington, Ky.; Wm. A. Oker, Cincinnati, Ohio; S. P. Herren, Jr., Haskell, Texas; Wm. T. Arms, Rowe, Mass.; John Gordon Hampshire, Wimbledon, London; J. F. Fritsch, Baltimore, Md.; C. D. Hall, Chillicothe, Ohio.



## Saturable Reactors

(Continued from page 541)

selected the stamping it is now required to find the number of them to be used. The depth of iron to give the required core area is found by dividing the area by the width of one leg. Thus:

$$\text{Depth of iron} = \frac{\text{Area of iron}}{\text{Width of outer leg}}$$

This is not the actual depth as there is a stacking loss. The actual depth or stack of iron is found as follows:

$$\text{Stack} = 1.1 \times \text{depth of iron.}$$

The number of stampings is found by dividing the depth of iron by the thickness of the stamping.

The width of the outer leg of the stamping selected for the 100 watt reactor is  $\frac{1}{8}$  inch. A depth of 1.99 inches is required. As these stampings are  $\frac{1}{16}$  inch thick, 128 of them will give a 2 inch depth. The actual stack will be 2.2 inches deep. Coil spools should be designed to have  $\frac{1}{4}$  to  $\frac{1}{2}$  inch more depth than the stack.

Each a.c. coil will have exactly one half of the total number of a.c. turns. In the case of the 100 watt reactor being designed, each coil will have 194 turns.

If unequal coils are used there is a possibility of some of the a.c. flux passing through the d.c. leg inducing a high voltage in the d.c. winding.

The wire area and size is found as follows:

$$\text{Area of wire (sq. in.)} = \frac{\text{Maximum current in amperes} \times 1000}{\text{Area of wire (sq. in.)}}$$

By referring to a wire table a size will be found having an area close to the desired area.

For a current of .370 amperes, a wire area of .00087 square inches is needed. Number 20 wire has an area of .00080 and number 19 wire has an area of .00101 square inches. The latter would be preferable as it will give less heating. Cotton covered enamel wire is very satisfactory for this use.

The turns per layer and number of layers is calculated from the stamping size, diameter of insulated wire and the number of turns. The actual diameter of the wire with insulation should be multiplied by 1.1 to take care of winding space loss. Hence:

$$\text{Turns per layer} = \frac{\text{"F" dimension of stamping} - \frac{1}{4}}{\text{diameter of wire} \times 1.1}$$

$$\text{Layers} = \frac{\text{Turns per coil}}{\text{Turns per layer}}$$

Thus the 194 turn coil of No. 19 wire wound on a stamping with a dimension  $F = 3\frac{3}{8}$  inch will be calculated as follows:

$$\text{Turns per layer} = \frac{3\frac{3}{8} - \frac{1}{4}}{\frac{3}{16} \times 1.1} = \frac{3\frac{3}{8}}{.0467} = 67 \text{ turns}$$

$$\text{Layers} = \frac{194}{67} = 2.9 \text{ or } 3 \text{ layers.}$$

The winding depth of the a.c. coil should be known as it determines the available space for the d.c. coil.

a.c. coil depth = .063 in. space between coil spool and core + .125 in. coil spool thickness + (1.1 × insulated wire diameter × number of layers) + (thickness of paper between layers × number of layers of paper).

Calculated from this formula, the depth of the 194 turn coil will be:

$$\begin{aligned} \text{a.c. coil depth} &= .063 + .125 + (1.1 \times .0466 \times 3) + (.005 \times 4) \\ &= .063 + .125 + .154 + .02 = .362 \text{ in.} \end{aligned}$$

Since the window in the stamping selected is 1.875 inch wide, there is (1.875 - .362) or 1.513 inch left for the d.c. coil depth.

### The d.c. Coil

The d.c. coil must furnish flux to saturate the reactor core. The number of d.c. ampere-turns depends upon the length of the magnetic path, the number of air gaps, the quality of the transformer iron, and the amount of load being carried by the a.c. coils.

The curve of Figure 7 shows how the alternating current increases with direct current. Beyond a certain value of direct current the rise in alternating current is slow and therefore that part of the curve is not very useful. The d.c. coil should be designed to operate up to the flat portion of this curve.

Enough ampere turns should be used in the d.c. coil to produce about 90,000 lines of flux per square inch. This will require about 34 ampere-turns per inch of length of the d.c. magnetic path through the iron. To this value must be added 90 times the number of joints in the d.c. magnetic circuit. Thus the formula for the d.c. ampere-turns is:

$$\text{d.c. ampere-turns} = (34 \times \text{length of d.c. magnetic path}) + (90 \times \text{number of joints in the d.c. magnetic path})$$

The length of the d.c. magnetic path is  $(d + 2e - 3a)$ .

The d.c. flux takes two paths, but the number of joints in only one path need be considered. In Figure 6 there are two joints. One at the top of the center leg and one at the top of the outer leg.

Substituting the design figures of the 100 watt reactor in the above formula, the d.c. ampere-turns are found.

$$\begin{aligned} \text{d.c. ampere-turns} &= [34 \times (7 + 10\frac{1}{2} - 4\frac{1}{2})] + (90 \times 2) \\ &= [150 + 180] = 680 \text{ ampere-turns.} \end{aligned}$$

Any number of combinations of current and turns can be chosen that will give the desired number of ampere-turns. The formula below shows that for any given current there will be a corresponding number of turns.

$$\text{d.c. coil turns} = \frac{\text{d.c. ampere-turns}}{\text{maximum direct current}}$$

Thus if 1 ampere is to be used to reach saturation, 680 turns will be used. If .1 ampere is used, 6800 turns are needed.

For practical purposes let us assume that the output of a -45 is to be used to saturate the reactor. A plate current of 60 milliamperes can be drawn from this tube. Therefore the d.c. coil turns will be

$$\frac{680}{.060} = 11,333 \text{ turns}$$

The d.c. wire size is found the same way as for the a.c. coils. The area will be .060 amperes divided by 1000 or .00006 square inches. Number 30 wire has an area of .0000636 square inches and is the size that should be used. Enameled wire is suitable for this coil.

Following the same procedure as for the a.c. coils, the turns per layer, number of layers, and depth of winding can be found. These are respectively 293 turns per layer, 30 layers, and .853 inches deep. There will be ample clearance between the a.c. coils and the d.c. coil.

Stray a.c. flux that passes through the d.c. coil will induce a current in it. Hence

# NATIONAL XR-20 COIL FORMS

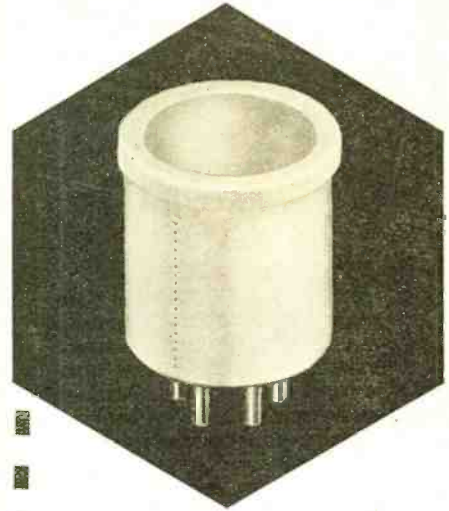

For short-wave receiver construction and experimental work when a small coil form at a low cost will fill the requirements. The XR-20 Coil Forms are made of Steatite, well known Low Loss National Dielectric. They are drilled for leads and left unglazed to provide a tooth for coil dope. Diameter  $1\frac{1}{2}$ ". Made with 4, 5 or 6 prongs and fit Standard Tube-Sockets. List Price, XR-20, \$35.

NATIONAL R-39 COIL FORMS Machinable and drillable because made of R-39, outstanding exclusive National Dielectric. Length  $2\frac{1}{4}$ ". Diameter  $1\frac{1}{2}$ ". In 4, 5 or 6 prong types. List Price, XR-4, XR-5 or XR-6, \$.75 each.

List prices subject to 40% discount when purchased through an authorized NATIONAL Distributor.

USE COUPON BELOW

**COUPON**

National Company, Inc.  
Malden, Massachusetts

Gentlemen:  
Please send me your new catalogue No. 240. I enclose 6c to cover mailing costs.

Name .....

Address .....

RN-3-35

**W3CAB SAYS!**

OSCILLATOR ON G-E  
RECEIVER OK

THE AMERICAN RADIO RELAY LEAGUE  
HEADQUARTERS, WEST HARTFORD, CONN., U.S.A.  
**RADIOGRAM**

THANKS FOR THE SEVERAL COPIES OF INFORMATION ON  
ADAPTING BROADCAST RECEIVERS FOR CODE RECEPTION STOP  
OSCILLATOR ON MY M 125 SET WORKING EXCELLENTLY  
C. A. BRIDGES  
W3CAB

G-E ALL-WAVE RADIOS are top-notch broadcast and short-wave receivers. Everyone knows that. But what will interest the amateur or experimenter even more is that they are also easily adaptable for C. W. reception. For free information on how to construct and hook up a beat oscillator, write to

R-163, MERCHANDISE DEPT.  
**GENERAL ELECTRIC**  
Bridgeport, Conn.



—and still  
more

**Exact Duplicate  
REPLACEMENTS**

To the large list of exact duplicate replacement condensers contained in the new 1935 Aerovox Catalog, many new types have been added. These are listed in separate bulletins available on request.

Aerovox Exact Duplicate Replacements are precisely matched in container design and general characteristics, to the units which they replace. Also, they provide genuine Aerovox quality and performance for lasting repairs. And any type not listed may be supplied if you send your sample and set description.

**Write for Bulletin**  
Complete listings of exact duplicate replacements, to date. Also 1935 Catalog and a sample copy of monthly Research Worker.

**AEROVOX**

CORPORATION

78 Washington St. Brooklyn, N. Y.

a 1 mfd. condenser across the d.c. coil will bypass the a.c. Or a single short circuited turn of No. 14 wire around the d.c. coil will prevent any induced current in it. Very novel effects can be obtained if the short circuited turn is of very heavy wire or if a number of bare wire turns are used. This "lag loop" as such a short circuited coil is called, will make the action of the d.c. coil very slow.

By simple arithmetic the average length of turn for either the d.c. coil or the a.c. coil can be calculated. Multiply this by the number of turns and the total number of feet of wire needed will be found. Refer to a wire table to convert this to pounds.

Summarizing the 100 watt reactor design, the specifications are as follows:

### Core

Stamping size—7" x

5 1/4" x

3/16" thick

Outer legs of stamping 1 1/8" wide

Inner leg of stamping 1 3/8" wide

Number of stampings—128

Stack—2.2"

### Coils

A.C. Coils 194 turns each

D.C. Coil 11,333 turns

### Characteristics

100 watt, 115 volt load

.157 to .87 amperes a.c. range, controlled by 0 to 60 milliamperes d.c. range.

### Signal Generator

(Continued from page 561)

have an exceptionally uniform strength of oscillation except for the very high frequency ranges.

The instrument may be calibrated over the broadcast ranges by setting the modulation percentage control to zero and bringing the oscillator to zero beat with broadcast stations of known frequency. For the short-wave bands, harmonics of calibrations obtained on standard broadcast bands may be tuned in on an all-wave receiver and, with the receiver left at the point secured, the oscillator is adjusted to a higher range and the calibration point secured. The first harmonic is of course the fundamental, the second harmonic will be double the frequency of the fundamental, the third harmonic, three times the fundamental frequency, and so on. This job must be carefully done if the calibration is to be reliable. It is wise to spot in on the curves thus secured at the higher frequency ranges short-wave stations of known reliable frequency. The i.f. ranges can be calibrated only by harmonics in the broadcast band, but if several harmonics are noted for each low-frequency oscillation point the difference in frequency between the harmonics will be the fundamental frequency and may be obtained with a reasonable degree of accuracy.

For use in aligning receivers, a shielded lead, with the shield connected to J2, should be used. A dummy antenna which, for standard broadcast bands should consist of an inductance, capacity and resistance in series, should be connected to the antenna post of the set. For short-wave aligning, a 400-ohm resistor is used instead of the standard dummy antenna. While a portion of the attenuator resistance becomes a part of the dummy antenna circuit, effect is not of consequence in service work. When the receiver to be aligned is very insensitive, preliminary aligning may be done with an unshielded lead from J1 alone to the antenna post, which will cause a decided increase in the signal generator voltage at the receiver. If the receiver under test has a tuned trap circuit, adjusted

to the i.f. frequency, in the antenna circuit, a .00025 condenser should be placed in series with J1 and the antenna post, since the line voltage by-pass condensers have to discharge to ground through the attenuator when the shielded lead is not used. This discharge current may be sufficient to damage the trap circuit unless the small blocking condenser is used. Aligning of the more modern sets should preferably be done using an unmodulated signal, in accordance with the manufacturer's recommendations as given in service manuals. If modulation is used, the modulation percentage control should be kept about one-third "on." The modulation frequency control may be adjusted to give the most agreeable note, which will vary with the line voltage. If a double peak is noted on the modulation note, which may occur with home-made, universal-wound, coils, it is indicative that critical coupling between the secondary and tickler coils has not been achieved. The tickler coils should be adjusted, by varying the coupling to the secondary coils, until only a single peak occurs. A double peak on the high-frequency coils, occurring with or without modulation, is due to poor image-frequency ratio and is normal with practically all present-day superheterodyne receivers on the ultra-high frequency bands. The proper point for aligning and calibration is the higher or highest frequency to which the receiver can be resonated. With some types of receivers, several points may be noted at the extreme high-frequency limit, due to the characteristics of the beat oscillator used. A very weak input signal should be used in such cases and the receiver adjusted at the point of maximum response, tracking being checked over many portions of the band.

The "low-output" switch on the signal generator will probably not be required except for the extreme high-frequency bands. If sufficient attenuation is still not secured with minimum output on such bands, an additional condenser may be added from J2 to the 25Z5 plate and the cathode resistor of the 6A7 may be increased to several thousand ohms. Neither of these changes will be necessary if the instrument is operating normally, but signal generators vary considerably in performance with apparently minor differences in construction.

### Parts List

- C1, C2—Aerovox mica condenser, type 1467, .002 mfd.
- C3, C4, C7, C8, C9, C10, C14, C15, C16, C17, C18—Aerovox cartridge condensers, .1 mfd., 200 volts
- C12, C13 (in one can)—Aerovox dual electrolytic condenser, 8-8 mfd., type GG2, 200 volts
- C6—Aerovox mica condenser, type 1467, .0001 mfd.
- C11—Aerovox mica condenser, type 1467, .001 mfd.
- C5—National type SEH335 variable condenser, 270 degrees, 335 mmfd.
- J1, J2—Na-Ald pin jacks, with insulating bushings
- R1—Lynch fixed resistor, 100,000 ohms, 1/4 watt
- R2—Electrad type 203, taper F, volume control, with switch, 500,000 ohms
- R3—Electrad type 203, taper F, volume control, 500,000 ohms
- R4—Lynch fixed resistor, 500,000 ohms, 1/4 watt
- R5, R6—Lynch fixed resistor, 100,000 ohms, 1/4 watt
- R7—Lynch fixed resistor, 150 ohms, 1/4 watt
- R8—Lynch fixed resistor, 10,000 ohms, 1 watt
- R9—Lynch fixed resistor, 6000 ohms, 1 watt

**Official "ALL-STAR" Cabinet**  
Fits ALL-STAR JUNIOR or SENIOR!



Available Through Your Jobber  
**Crowe Name Plate and Mfg. Co.**  
1746 Grace St. Chicago, Ill.

**LEARN IN LOS ANGELES**  
**Radio-Television**

ELECTRICITY—TALKING PICTURES  
BROADCASTING—Special Limited offer!  
GOOD JOBS WON BY TRAINED MEN  
R. R. coach fare allowed to L.A. Earn living while learning. 30,000 graduates. Latest facilities. No dummy equipment. Free employment service. Est. 30 yrs. Send for FREE illustrated Catalog. Tells how to earn good pay.  
**NATIONAL RADIO & ELECTRICAL SCHOOL**  
Dept. 3-RN, 4006 S. Figueroa Los Angeles, Calif.

**FREE!**

**"23 Lessons In Radio"**  
With  
**5 Issues of**  
**RADIO NEWS at \$1**

We still have a very limited supply of the famous book "23 Lessons In Radio" on hand. No further reprints will be made. If you want a copy, we advise you to send for it immediately!

"23 Lessons In Radio" covers the fundamentals including elementary radio theory, radio tubes, principles and construction of receivers, converters and transmitters, standard radio symbols, the amateur field, and many other important items.

Get your copy *now*—it's FREE with 5 issues of RADIO NEWS at \$1.

**RADIO NEWS**

Radio News, Dept. 353  
461 Eighth Ave., New York, N. Y.

Enclosed find \$1 for which kindly send me the next 5 issues of RADIO NEWS and my free copy of "23 Lessons in Radio." (Canada \$1.25—Foreign \$1.50).

Name .....

Address .....

City.....State.....

- R10—Lynch fixed resistor, 500 ohms, ¼ watt
- R11—Electrad type 272W, taper F, volume control, 100 ohms
- R12—Ohmite power cord resistor, 268 ohms
- R13—Lynch fixed resistor, 25,000 ohms, ¼ watt
- SW1—(See R2)
- SW2—Toggle switch, s.p.d.t.
- SW3—Yaxley gang switch, 2, deck- 6-point
- T1—General Electric special type T-4½ neon bulb
- T2—6A7 tube
- T3—25Z5 rectifier tube
- T4—Pilot light, 3.2 volts, .3 amp.
- 1 National velvet vernier dial, type B, for 270-degree condenser, with pilot lamp bracket
- 1 National "Radio News Signal Generator" cabinet
- National "Radio News Signal Generator" coils (set of 6)
- 1 line plug
- 1 rubber grommet, ½-inch
- Miscellaneous screws, wire and spaghetti tubing
- 1 National small 7-prong isolantite tube socket
- 1 Eby 6-prong tube socket, base-mounting type
- 1 Kenyon miniature 30-henry choke
- 1 piece bakelite, ¾ inches by 2¾ inches, ⅝ inch thick (for coil mounting)
- 1 piece bakelite, 1⅞ inches by 2⅞ inches, ⅝ inch thick (for line filter mounting)
- 1 shielded output lead

**13-550 Meter Superhet**

(Continued from page 547)

European stations. Poste Parisien on 959 kc., for instance, was held at good loud-speaker volume from 2:10-3:05 a.m. one morning with a degree of clarity which would have enabled one who was familiar with French to understand every word spoken. Considering the location where the receiver was used at the time, this represents a remarkable bit of reception. It was duplicated, but with somewhat less volume, in the case of two other French stations.

For the purpose of further tests, the receiver was loaned to two of the RADIO NEWS Official Listening Post (Broadcast Band) Observers and was set up in a suburb of New York City for an all-night DX session. This resulted in a log of over thirty foreign stations which included South America, Europe, New Zealand and Australia—all on the *broadcast band*. Seven of these (European) were tuned in between 4-7 p.m., and several South Americans between 7-10 p.m. The others were tuned in between midnight and daylight.

On the short-wave ranges, suffice it to say that stations all over the world, including Europe, Australia, Japan and Java, were tuned in on the loudspeaker in our tests.

For the full advantage of high sensitivity a receiver must naturally be highly selective. In New York City it was found possible to tune in distant stations 10 kc. either side of each location with no interference. Unfortunately space does not permit a more detailed report on the RADIO NEWS tests, but the fact remains that had anyone, 10 years ago, forecast such a receiver, he would have been dubbed "highly visionary," to say the least.

**APRIL ISSUE**  
Annual S.W. Number

**POWERFUL NEW AMPLIFIERS**

by

**WEBSTER**  
CHICAGO

**THE SERIES 358**  
**15 WATT CLASS "A" AMPLIFIER**



A new, flexible all-purpose Webster amplifier around which a variety of sound systems may be assembled. For auditoriums, churches, schools, clubs, factory and office call systems, and for all indoor installations requiring quality reproduction at an attractive price, the Webster 358 Class "A" amplifier is the ideal unit. Features a three stage Class "A" circuit distinguished for fidelity and for skillful minimizing of hum level. Incorporates the original Webster "stabilized bias" feature assuring maximum undistorted 15 watts output without the use of a separate bias tube. Provides dual control system for "mixing" both phonograph and microphone, with built-in microphone current supply. Equipped with tone control. Has universal output. Completely contained in a well-ventilated steel case, with tubes and terminal strip easily accessible. Effectively fused for protection. The Webster Class "A" 358 Amplifier is the logical choice for quality installations where fidelity and hum-free operation are of prime importance. Write for detailed descriptive bulletin.

**CLASS "B" 26 WATTS**

Where higher volume levels and wide range coverage are required, Webster offers the 26 watt Class "B" version of the 358 series. Essentially the same in appearance, input and output characteristics as the Class "A" unit. Particularly suited for out-door use with multiple speaker arrangements. There is a wide market for this moderately priced powerful unit. Write for complete details.

**WRITE FOR CATALOG!**

Sound specialists, Engineers, Radio Servicemen, Dealers and others who are interested in Sound installations—write for free bulletin describing the Series 358 units, as well as for the valuable complete Webster listing of Sound Equipment, covering all types of installation requirements. Submit your Sound problems to Webster engineers for complete recommendations and advice at no cost to you. Write now!

**WEBSTER**  
CHICAGO

- 3825 W. LAKE ST. CHICAGO, ILL. Dept. A
- Please send me Free bulletin covering the Series 358 Webster Amplifiers.
- Please send me the complete Webster Sound Catalog. I am interested in installations as described in the letter attached.

Name.....

Address.....

City.....State.....

# WHEN CHOOSING A RADIO SCHOOL

RCA Institutes, with its reputation firmly established by 25 years service, is an institution recognized as an important factor in the radio industry.

Whether elementary radio principles or advanced subjects, sound applications, mathematics or practical radio engineering, RCA Institutes is prepared to give you the instruction you need.

### Resident Schools at New York and Chicago

Modern Apparatus and Laboratory Equipment—Conveniently Located—Day and Evening Classes—Tuition Rates \$5 to \$10 Weekly.

### Extension courses for home study

on convenient "no obligation" plan. Examination and technical advisory services. Free post-graduate practical training at resident school with modern equipment under instructing engineers.

Write for Catalog.

## RCA INSTITUTES, Inc.

Dept. RN-35



75 Varick Street  
NEW YORK

1154 Merchandise Mart  
CHICAGO

Recognized Standard in Radio Instruction Since 1909

\*\*\*\*\* **HERE** \*\*\*\*\*  
Is the Place to Buy

**BUILD YOUR OWN**  
**ALL-STAR JR**  
ALL-WAVE Superheterodyne

Here's the Little Brother to the famous ALL STAR! It costs much less to build but it's a Giant in performance. Even a novice can build it! The most amazing ALL-WAVE superhet ever developed for home construction.

### NOTE THESE FEATURES:

- ★ Latest 5 tube circuit with multi-purpose tubes.
- ★ Continuous Band Spread
- ★ All-Wave Reception from 10-550 meters
- ★ Pre-Adjusted Coils
- ★ Beat Note Oscillator

★ Complete Kit of Parts, less tubes and speaker **\$27.<sup>03</sup>**

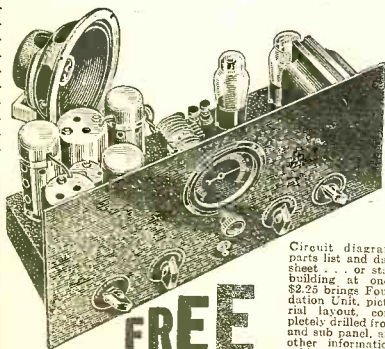

Circuit diagram, parts list and data sheet - or start building at once. \$2.25 brings Foundation Unit, pictorial layout, completely drilled front and sub-panel, and other information. Address Dept. N-35.

**FREE**

**WHOLESALE RADIO SERVICE CO., INC.**

NEW YORK NEWARK ATLANTA  
100 South Ave. 219 Central Ave. 430 W. Peachtree St. N.W.

## S.W. Converter

(Continued from page 549)

way of saving prospective constructors time and trouble was to arrange with a manufacturer to put out a foundation kit consisting of a three-gang condenser and a set of coils to match. This plan is now under way and it is believed by next month it will be possible to publish the complete constructional article with a foundation kit available which will consist of the r.f., detector and oscillator coils, a 3-gang condenser to match, the tunable output transformer and a drilled chassis—all at a very reasonable price.

It is believed that this converter will be capable of providing unusual results, judging from the reception obtained in a long series of tests with the original model of the converter, using all sorts of broadcast receivers, ranging from the best down to some of the ordinary garden variety of midgets—and including both superheterodyne and t.r.f. receivers.

Upon completion of the final model, a complete set of full-size blueprints will be made available to constructors who prefer to work from them rather than the smaller drawings in RADIO NEWS.

## P.A. Amplifier

(Continued from page 557)

When mounted on the rack, the panel can be removed without touching the mounting of the chassis itself.

The illustration on page 557 shows all three units mounted on one rack. At A is the pre-amplifier, at B the main amplifier and at C the power supply. It is desirable to place the power supply well away from the amplifiers. The lower photographs show the front and rear views of the pre-amplifier unit.

It is believed that this amplifier system is suitable for practically any public-address job. An audience of 5000 to 7000 people can be covered with a 20-watt amplifier, provided that the right speakers are used and that they are suitably placed. The power will be ample for nearly all occasions.

The fidelity, too, will satisfy most requirements.

The total power consumption is only 150 watts, which makes it possible to use the unit on a sound truck. Moreover, the separate units could be mounted in carrying cases, making the whole outfit portable. However, it is believed the rack-and-panel mounting will be more suitable for permanent installations.

## Foreign DX

(Continued from page 563)

few tips will be given of the stations that are being received right now. LS2 on 1190 kc. is heard between 7 and 8:30 p.m. YVIRC on 960 kc. is heard best at 7 p.m. TGW on 665 kc. has a special DX transmission each Sunday morning after 2 a.m. HHK, Port au Prince, Haiti, on 920 kc., can be heard each Friday evening between 7:30 and 8:30 p.m. And last, LR4 on 990 kc. when WBZ fades and LR3 on 950 when WRC fades.

The Australians can be received quite easily during the spring and autumn months. To hear these the best time is from 5 a.m. until after daylight. 2BL, Sydney, on 855 kc., is perhaps the best heard on this coast. 3LO, Melbourne, on

800, 5CK, Crystalbrook, on 635, and 2UE, Sydney, on 1025, are others that are heard well. At the present time no Japanese stations are being received by the writer, so will not touch on them.

Comparing this to short-wave reception, I say there are more thrills on the broadcast band, for the simple reason there are so many new places that one can hear. Every country in Europe that has a short-wave station can be logged on the broadcast band and in addition such countries as Hungary, Ireland, Scotland, Austria, Czechoslovakia, Denmark, and others.

## The DX Corner

(Continued from page 566)

4:40	1370	KGFG	Oklahoma City, Okla.	100
	1310	WCLS	Joliet, Ill.	100
	1420	KABC	San Antonio, Texas	100
4:50	1200	WJBL	Decatur, Ill.	100
	1370	KEJZ	Ft. Worth, Texas	100
5:00	1500	WJBK	Detroit, Mich.	100
	1430	KWCR	Cedar Rapids, Iowa	250
5:10	1210	WIBU	Poynette, Wisc.	100
	1500	KGFI	Corpus Christi, Texas	100
5:20	1370	WHDF	Calumet, Mich.	100
	1420	WLBF	Kansas City, Kans.	100
5:30	1210	WCRW	Chicago, Ill.	100
	1500	KGKB	Tyler, Texas	100
5:40	1330	WTAQ	Eau Claire, Wisc.	1000
	1420	WMBH	Joplin, Missouri	100
5:50	1210	WJIM	Lansing, Mich.	100

### First Saturday of Each Month

2:10	1210	WBRB	Red Bank, N. J.	100
2:20	1500	WWRL	Woodside, N. Y.	100
2:30	1210	WGNV	Chester, N. Y.	100
2:40	1500	WMBQ	Brooklyn, N. Y.	100
2:50	1210	WGBB	Freeport, N. Y.	100
3:00	1430	WOKO	Albany, N. Y.	500
	1200	WJBC	LaSalle, Ill.	100
	1330	KTRH	Houston, Texas	100
3:10	1370	WGL	Ft. Wayne, Ind.	100
	1210	KFPW	Ft. Smith, Ark.	100
3:20	1200	WWAE	Hammond, Ind.	100
	1120	WTAW	College Station, Texas	500
3:30	1310	WLBC	Muncie, Ind.	50
	1210	KASA	Elk City, Okla.	100
3:40	1200	WFAM	South Bend, Ind.	100
	1270	KWLC	Decorah, Iowa	100
3:50	1280	WCAP	Asbury Park, N. J.	500
	1310	WEXL	Royal Oak, Mich.	50
4:00	610	WJAY	Cleveland, Ohio	500
	1270	KGCA	Decorah, Iowa	100
4:10	1280	WTNJ	Trenton, N. J.	500
	1430	WBNS	Columbus, Ohio	500
	1210	KFVS	Cape Girardeau, Mo.	100
4:20	920	WWJ	Detroit, Mich.	1000
	780	KGHL	Billings, Mont.	1000
4:30	1380	KQV	Pittsburgh, Pa.	500
	1210	KDLR	Devils Lake, N. Dak.	100
4:40	1420	WLAP	Lexington, Ky.	100
	1370	WOC	Davenport, Iowa	100
4:50	1380	WSMK	Dayton, Ohio	200
	1200	KFKJ	Grand Junction, Colo.	100
5:00	940	WAVE	Louisville, Ky.	1000
	560	KFDM	Beaumont, Texas	500
5:10	1320	WADC	Tallmadge, Ohio	1000
	1210	KWTN	Watertown, S. Dak.	100
5:20	1340	WSPD	Toledo, Ohio	1000
	760	WEW	St. Louis, Mo.	1000
5:30	1390	WHK	Cleveland, Ohio	1000
	1210	KWEA	Shreveport, La.	100
5:40	880	WSUI	Iowa City, Iowa	500
5:50	1280	KGGM	Albuquerque, N. Mex.	250

### First Sunday of Each Month

3:00	1290	KLON	Blytheville, Ark.	100
3:30	1440	KXYZ	Houston, Texas	500
3:50	1400	KTUL	Tulsa, Okla.	250
4:00	1260	KPAC	Port Arthur, Texas	500
4:10	1340	KGDY	Huron, S. Dak.	250
4:20	1260	KRGV	Weslaco, Texas	500
4:50	890	KARK	Little Rock, Ark.	250
5:00	570	KGKO	Wichita Falls, Texas	250
5:20	1010	WNAD	Norman, Okla.	500
5:40	1260	KUOA	Fayetteville, Ark.	1000

## The "Ham" Shack

(Continued from page 573)

arrangement is simple if a form of matched-impedance feeders is used. Inductive coupling is possible but not practical. If a two-wire matched impedance antenna system is used, the two antenna feeders are attached to each of the plate rods at equal distances from the tube plates. The feeders are brought closer to the plates of

# 7-POINT MIKE FELL 20 FEET

...STILL GOOD AS EVER

... AND STILL NO FEEDBACK!

Johnston P. A. Service, Oneonta, N. Y., writes us: "We are certainly well pleased with your velocity mike (the 7-point Mike). We believe that no other mike can take the punishment it has and still work. One time it fell 20 feet to the ground. And dozens of times it has seen rain. We use it in our mobile outfit, and it's just as good as ever. Also a wonderful help in eliminating inconsistent feedback." Guaranteed. Order from your wholesaler, or write for illustrated Bulletin RN-2.

THIS

NOT THIS

AMPERITE Corporation  
561 BROADWAY NEW YORK

## AMPERITE VELOCITY MICROPHONE

**WORLD-FAMOUS INTERNATIONAL DX**  
AC-DC ALL WAVE SET  
complete kit with built-in speaker; 4 coils 15-200M and diagram.  
Wired, extra \$1.75  
3 Matched Tubes 2.25  
Broadcast coil .75  
Cabinet ..... 1.95

**6.75**

NO EXPERIENCE NECESSARY TO BUILD THEM

**ONE-TUBE ALL WAVE BABY-RADIO**  
For AC-DC complete kit including cabinet, 3 coils 40-500M, and diagram.  
Wired, extra \$1.25  
Electric or Tube \$1.00  
Battery Head Phone \$1.50  
Ask for Circular No. 110  
Experimental Radio Labs.  
168 Washington St.  
New York, N.Y.

**\$4.95**

New Yorkers can hear them at 177 Greenwich St., Blain, The Radio Man Inc.

**AUTOMOBILE COMPASS**

Have you ever taken the wrong road and traveled many miles before discovering your mistake? This new AIR-PLANE TYPE COMPASS constantly tells your direction of travel. Sticks to windshield. Base 1 7/8" diameter. ONLY \$1.95 POSTPAID, including Compressor. SATISFACTION GUARANTEED or your money refunded if returned within ten days.

**DEALERS WANTED!**

HULL MFG. CO., Box 246-K3, WARREN, O.

**Ken-Rad  
Radio Tubes**  
DEPENDABLE LONG LIFE

THE KEN-RAD CORP., Inc., Owensboro, Ky.

**ENGINEERING DEGREE IN TWO YEARS**

B.S. Degree in Radio, Electrical, Civil, Chemical, Mechanical or Aeronautical Engineering in two years. Located in an industrial center with that Engineering atmosphere. Earn board. Low tuition. Preparatory Department. Enter March, June, September, December. Catalog.

**INDIANA TECHNICAL COLLEGE**  
241 E. Washington St., Fort Wayne, Ind.

**STEP AHEAD**  
IN THE SERVICE PROFESSION WITH CASE RECORDS OF BROADCAST RECEIVER REPAIRS

ADD 10,000 HOURS to your experience! ELIMINATE GUESS-WORK in your Servicing. DON'T PUZZLE YOUR PROFITS AWAY!

Your work is already done and recorded for you in CASE RECORDS. This 9x12" leatherette binder CONTAINS 1,500 alphabetically and numerically arranged case records of SUCCESSFULLY COMPLETED SERVICE JOBS. Each Record tells—symptom—parts responsible—diagnosis—values—location—and best replacement or repair. Fastest Servicing technique known. 108 Receiver Makes 3,000 Models. SUPPLEMENTED QUARTERLY FREE for 1 year. Free Consultation Service.

**CAPITOL RADIO RESEARCH LABORATORIES INC.**  
1503-21st St. N. W., Wash., D. C.

**\$4.75 Postpaid.**

Kindly forward full details on "CASE RECORDS".

NAME.....  
ADDRESS.....

the tubes to increase input, and moved nearer the bridging strap to reduce the antenna load.

Dimensions for a typical 5-meter matched impedance antenna are shown in the accompanying diagram. The advantage of this system is that the feeder wires do not have to be cut to any specific length, and may be several hundred feet without a great loss of efficiency. The feeders used in the New Yorker installation are 125 feet long, and connect to a vertical antenna atop the highest point of the building. The antenna itself is a piece of 1-inch galvanized iron pipe 8 feet 2 inches long, or 1/2 wavelength. The feeders are run haphazardly to the pipe antenna as may be seen in the picture.

The receiving antenna consists of a similar pipe about 40 feet away from the transmitting antenna. The lead-in connection is made at the top of the pipe and brought down to the "shack" on the 41st floor. The receiver is a regular National SRR super-regenerative-type set, which is the most popular circuit for high-frequency work. Because most 5-meter transmitters are self-excited oscillators, when modulated they "wobble" or shift carrier-frequency badly. The transmitter at the New Yorker with the long-lines tuning, practically eliminates this fault. A 5-meter superheterodyne receiver also is available at W2DLG, but is not generally used because of the greater sensitivity characteristic of this type set which is made evident by the heavy background noise from the elevator equipment and large neon signs—all within a few feet of the antenna itself.

Input to the New Yorker transmitter usually is about 40 watts. This is modulated by a pair of 250-type tubes (in Class A) which gives a heavy carrier that adequately kills the super-regeneration "rush" in the receiver and gives ample modulation. W2DLG's signals have been reported quite stable when received on a superheterodyne type receiver.

At W2DLG, stations at Princeton, N. J., a distance of more than 50 miles are worked consistently. Numerous contacts have been had with stations in New Jersey, New York, on Long Island and Connecticut. Regular contact was made with the home stations of members of the Club. The location has been found to be an excellent one for 5-meter transmission and reception. Occasionally the "gang" at W2DLG take a transceiver on the roof and use a portable antenna that is set on the parapet. Contacts have been made for a distance of 20 to 30 miles. The output from the transceiver is only a fraction of a watt.

The greatest need in ultra-short-wave amateur communication is the widespread adoption of *more stable transmitters!* With the general use of arrangements such as the type described here, it is possible to practically eliminate frequency modulation. When this is done, generally, it will be possible to accommodate a great many more stations on the ultra-high-frequency band.

### Calls Heard

By F. W. Gunn, Ox Yard, Gosfield, Halstead, Essex, England, on 20-meter phone: W2OQ, W3AFW, W2EDW, W2AND, W8EOU, W3ZX, CM2MA, ZJ6A, W2ZC, VP5BY, W9BGO, W4ZF, W8FSK, W2EF, W2KR, W3MD, W9USA, SU1SG, W9DXJ, and W5BCU. On 40-meter phone: HB9B, HB9AC, F8ZP, LA1BC, LA3G and CJ1AH. On 80-meter phone: PAODK, PAOIDW and CT2AJ.

By Norman C. Smith, Forge House, High Street, Foots Cray, Sidcup, Kent, England, on 80-meter phone: VE1EI, PAOSLB,

**A SIMPLE, INEXPENSIVE WAY TO BRING MOST ANALYZERS up to date**



The **WESTON** Model 666 Type 1A SOCKET SELECTOR SET

There's no need for you to be handicapped with an analyzer incapable of analyzing all of today's radio receivers. A small expenditure will bring it out of the obsolete class.

Weston makes it possible through the improved Weston Socket Selector Set which is readily adapted to any and all analyzers. Simply attach the Socket Selector Unit to the analyzer ... and by use of the colored adapter combinations you are set for all present day 4-5-6- and 7-prong tube receivers.

It's a simple, inexpensive way for you to broaden the scope of your present analyzer. Although, nothing you can do with an old analyzer can ever give you the dependability and profit-producing service that the new Weston models illustrated can give. A bulletin describes all. Send for copy ... Weston Electrical Instrument Corp., 615 Frelinghuysen Ave., Newark, N. J.

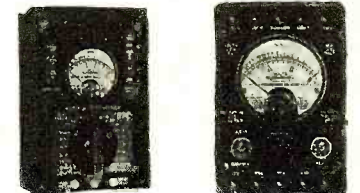

Model 665 SELECTIVE ANALYZER — available with rotary switch for selection of ranges — or, with pin jacks, in a lower cost model.

Model 698 SELECTIVE SET SERVICER — a modern Weston set servicer at extremely low cost. The outstanding value in test equipment.

## WESTON Radio Instruments

WESTON ELECTRICAL INSTRUMENT CORPORATION  
615 Frelinghuysen Avenue, Newark, N. J.  
Send bulletin on Weston Radio Instruments.

Name.....  
Address.....  
City and State.....

# "Keep Out"

Says the RCA  
Noise Reducing  
World-Wide Antenna  
To Man-Made Interference

No more need your short-wave reception be prey to every passing street car—every electrical gadget in your building! The new RCA double-doublet antenna says "No!" to man-made noises—and brings in far more foreign stations.

Ask your dealer or service engineer for a *Certified Installation*. Write for booklet, "Antenna Facts".



**\$600**

plus installation  
RCA Parts Division  
Dept. N  
Camden, N. J.



Conclusively proved before—

RIDER  
Volume



proves it  
AGAIN....

946 Models  
1200 Pages  
112 Mfrs.

You can't go wrong  
with a RIDER  
Manual!

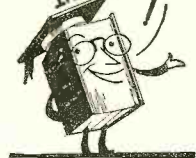

Far and away the most complete and exhaustive work of its kind—no service man can afford not to have it!

All the complications of 1935 sets explained lucidly, with more schematics, more illuminating diagrams, more data on every phase of a service man's job than was ever before compressed between two covers! JUDGED BY ANY STANDARD, this Manual exceeds anything else of its kind in the world today.

Vol. I.....	1000 pages.....	\$7.50
Vol. II.....	800 pages.....	6.50
Vol. III.....	1070 pages.....	7.50
Vol. IV.....	1060 pages.....	7.50
Vol. V.....	1200 pages.....	7.50
Servicing Superheterodynes.....		1.00

**FREE**—"Successful Servicing," our 8-page monthly house organ, with valuable data pertaining to RIDER'S Manuals, is free to service men. Are you on our mailing list?

**Money-Back Guarantee**

**JOHN F. RIDER, Publisher**  
125 West 40th St., New York City

HAF4A, G6NF, HB9B and LA3G. On 80-meter C.W.: W1GOJ, PAODC, W1BH, OZ5K and RF3U. On 40-meter C.W.: U1BL, UK3EX, YU7XA, YU7AU, G12SP, VK3MR, LY1AA, W1HM, HB9AK, AC8AG, LY1J, U1CN, LZ9ZB, PK1BO and SU6HL. On 40-meter phone: LU4AB. On 20-meter C.W.: W4EG, W1BEQ, W1DGC, W8KTE, W1EER, W1ET, W8MJR, YP5TM, VE1BV, LA4J and LA3I.

By Harry Lee Nunn, Jr., 227 South Church Street, Winston-Salem, N. C., on 20-meter phone: W5AHJ, W6CIN, W9ATP, W9DEF, W5A00, W9000, W7JW, W5AHJ, HI7G, CM2WW, CM2RA, CM2WZ and W9KVI.

By Paul B. Frame, 118 Princeton Street, East Boston, Mass., on 20-meter phone: LA1G.

Keep on sending 'em in, you fellows! Let's know how far we're all "getting out."

## Aid to Inventors

(Continued from page 559)

away, never use it, and prevent anyone else from using it, so that the existing situation in the radio industry might not be disturbed.

In a perfect world, anything like this might be condemned on grounds of public policy. In the real and imperfect world in which we all must live, there can be no objection to it so long as no one is defrauded thereby. There is a chance, however, that incautious inventors may be defrauded, or may suffer what amounts to the same thing, through use of this policy in connection with royalty contracts. An inventor of my acquaintance once patented an improvement in a certain kind of automotive machinery, about which it would be indiscreet for me to be more specific. If successful, this device would have displaced a line of machinery enjoying a sale of some millions of dollars a year. It was probable, although not certain, that the new device would be successful. Accordingly, the owners of the existing line of machinery which the new device might displace bought the patent and suppressed it. Nothing has been heard of it since. Had the purchasers paid a fair price for the patent, I do not think that the inventor or anyone else could have offered any valid objection. The inventor would have been paid. The buyer's interests would have been protected. The point is that they did not pay a fair price. They paid, in fact, no price at all. They merely made a royalty contract, promising to pay a certain number of dollars to the inventor for every machine which they sold using his invention. In fact, they never built or sold any such machines, so they owed the inventor nothing. No one else could build the machines, since the purchasers of the patent had the exclusive right to build them. The inventor was deprived of profit.

Reformers may say that something should be done about incidents of this kind. I do not think so. I am old-fashioned enough to believe that business shrewdness should not be penalized, even when it works a disadvantage to persons who are careless or ill-informed. The real remedy is that everybody who tries to do business should be well informed and careful. There is not the slightest real reason, reformers to the contrary notwithstanding, why the state, or anybody, should protect foolish people from the consequences of their foolishness. Protection against misfortunes of this kind is in the hands of inventors themselves. No inventor should sign any kind of royalty contract which does not provide either for actual use of the inven-



**WET AND DRY ELECTROLYTIC PAPER AND MICA CONDENSERS**

RECOGNIZED FOR SUPERIOR QUALITY IN ALL CLIMATES THE WORLD OVER

SOLD BY LEADING JOBBERS EVERYWHERE

**SOLAR MFG. CORP.**  
599 BROADWAY  
NEW YORK

**BEST BY TEST!**

ASK FOR CATALOG OF EXTREMELY COMPACT TYPES HANDY FOR SERVICE

### Read Classified Advertising—It Pays

Advertisements in this section twenty cents a word for each insertion. Name and address must be included at the above rate. Cash should accompany all classified advertisements unless placed by an accredited advertising agency. No advertisements for less than 10 words accepted. Objectionable or misleading advertisements not accepted. Advertisements for these columns should reach us not later than 3rd of 2nd month preceding issue.

TECK PUBLICATIONS, INC.  
461 Eighth Ave. New York, N. Y.

### A.C. Generator

TEN practical and low-cost changes covering Dodge 12-V. Ford T. A., Chevrolet Delco 6-V, generators into 100-500-watt capacity A. C. Generators, or into 32-110-V D. C. motor or generator. Dodge is 500-W. self-excited. All in one book illustrated with complete simplified instructions and drawings for only \$1. Autopower, 410-P S. Home Ave., Chicago.

### Agents Wanted

AGENTS: Stick-on-Window Sign Letters. 500% profit. Write today. Metallic Letter Co., 422 N. Clark, Chicago

### Correspondence Courses

USED Correspondence Courses and Educational Books sold or rented. Inexpensive. Money-back guarantee. Write for Free Catalog listing 4000 bargains. (Courses Bought.) Lee Mountain, Pisgah, Alabama.

### Electrical Supplies

INSULATION, wire varnishes, supplies, etc. Send 3c stamp for bulletin. Autopower, 408-C S. Hoyne Ave., Chicago.

### Instruction

GET A U. S. Government Job, commence \$105-\$200 month. Men, women, age 18-53. Are you eligible for examination? Get our Free Questionnaire—find out. No obligations whatever. Instruction Bureau, Dept. 251, St. Louis, Mo.

### Patent Attorneys

PATENTS—Advice and booklet free. Highest references. Best results. Promptness assured. Watson E. Coleman, Patent Lawyer, 724 9th Street, Washington, D. C.

PATENTS. Instruction "How to Establish Your Rights" and form, "Evidence of Conception"—sent Free! Lancaster, Alwine & Rommel, 414 Bowen Building, Washington, D. C.

### Patents and Inventions

INVENTIONS COMMERCIALIZED. Patented or unpatented. Write Adam Fisher Company, 278 Enright, St. Louis, Missouri.

### Radio

RADIO ENGINEERING, broadcasting, aviation and police radio, servicing, marine and Morse telegraphy taught thoroughly. All expenses low. Catalog free. Dodge's Institute, Elm St., Valparaiso, Ind.

### Salesmen Wanted

WANTED: County Salesman with car, to demonstrate and service for large Ohio manufacturer. First-Class job. 244 Fyr-Fyter Co., Dayton, Ohio.

RADIOS—23 models. World's cheapest. Catalog free. N-20th Century Co., K.C., Mo.

### Song Poems Wanted

WANTED: Original poems, songs. MMM Publishers, Studio Building, Portland, Ore.

### Wind Driven Lights

ELECTRIC LIGHTS—WIND DRIVEN—You build them. Write, Wind Motor Electric, Ridgway, Montana.

**YOUR INVENTION**  
**How to Protect and Merchandise it**

You may save a great many dollars in legal fees and perhaps hundreds more in mistakes avoided by getting this valuable new book by Elmore B. Lyford that gives you the "lowdown" on patents, trademarks and copyrights and "debunks" those practices designed to exploit the inexperienced inventor. From the very first step in protecting your idea down to the final stage of converting your invention into an income for yourself, Lyford gives you the true facts "straight from the shoulder." in plain, non-legal language. *Get your copy today—only \$1 postpaid—or send for free descriptive circular.*

**RADIO & TECHNICAL PUBLISHING CO.**  
 45 Astor Place, New York. Dept. RN-3

**RADIO COURSES**



**Radio Operating**  
 Prepare for Gov't. license exam.  
**Radio Amateur Code**  
**Radio Servicing**  
 Including short wave receivers.  
**Resident Courses**  
 Write for Booklet

**New York YMCA Schools**  
 7 West 63rd Street New York City

**CHOICE OF AN EXPERT**

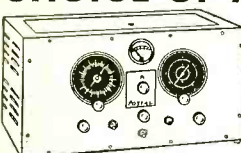

The NEW POSTAL CUSTOM BUILT '35 ALL-WAVE RECEIVER was chosen by a famous Short Wave Authority as the official receiver for his DX Listening Post. The Postal '35 is custom built for the better Short Wave Fan, Amateur and Commercial operator. Employs over 50 new features.

Send with a 10 day trial money back guarantee. **WRITE IMMEDIATELY FOR FREE CIRCULAR NO. 150 WHICH COMPLETELY DESCRIBES THE POSTAL SET CHOSEN BY THE FAMOUS S. W. EXPERT.**

**POSTAL RADIO**  
 135 - J LIBERTY ST. NEW YORK, N.Y.

**A.C. CURRENT-ANYWHERE!**  
 WITH **Kato LIGHT PLANTS**



A little gas and a Kato AC plant enables you to operate AC radios, amplifiers, refrigerators and other standard household appliances. Sizes 300 watts and up. Write for interesting descriptive literature on AC and DC models. Prices \$99.00 and up.

**KATO ENGINEERING CO.** Mankato, Minn., U. S. A.  
 AC Generators \$10.00. Converters for operating AC radios from 6, 12, 32 and 110 volts DC \$18.00.

**RADIO ENGINEERING,**  
 broadcasting, aviation and police radio, servicing, marine radio telegraphy and telephony, Morse telegraphy and railway accounting taught thoroughly. Engineering course of nine months' duration equivalent to three years of college radio work. School established 1874. All expenses low. Catalog free.  
**Dodge's Institute, Oak St., Valparaiso, Indiana**

**BROWNING**  
 UNIVERSAL  
**All-Wave Antenna Kit**  
 Radio's Greatest Value  
 Write for Complete Information  
**RIVARD MFG. CO.**  
 1014 Madison Ave. Toledo, Ohio

tion to a minimum amount each year or else for definite financial payments in case the invention is not used. That is the simple and adequate provision against any kind of "pocketing."

In another common question with regard to sale of inventions it usually is the inventor who is at fault, not the purchaser. This is the matter of control. Many inventors insist that they will make no deal covering their inventions which does not leave with them control of the business to be created. This is very nice if the inventor has his own money to exploit his invention and is willing to risk it. If this is not the case, insistence on control usually means that the invention will not be used or even tried, and that the inventor will get nothing. In my own business we have been required for many years to pass on hundreds of inventions. We have two invariable rules. The first is that we will not even listen to an account of an invention which has not either been patented or protected by some kind of dated memoranda which will form the basis of a patent application should one be decided on. The second rule is that we will consider no invention whatsoever unless the inventor is prepared, under proper terms and conditions, to give up complete control to someone else.

The basis of this seemingly harsh rule is simple common sense. Nine inventors out of ten, perhaps ten out of ten of them, are poor business men. Any good business man who contemplates putting time or money into the testing or exploitation of an invention wants to be able to control it unhampered by the ideas of the inventor. If he cannot, the shrewd business man will not put in his money. I think I safely can say to any inventor who expects to control his own invention that the only way to do this is to have enough money of his own to exploit it by himself.

In addition to control, any good business man who buys an invention demands one other item. The value of the invention must be proved; perhaps not absolutely, but at least so far as is possible without actual commercial test. If the inventor has followed the advice outlined in previous articles of this series, the nearest possible approach to this proof already has been obtained before the patent even was applied for, as a part of the precautions advised to conserve the time and money of the inventor himself.

Next comes the vexed matter of price. This usually is a matter on which the inventor and the purchaser have difficulty in agreeing, not because either of them is unreasonable, but because both usually are taking gambles and neither wants to pay too much for his chance of winning. In these circumstances, I have found a useful expedient in a method learned many years ago in Nevada in the mining business, the expedient of what used to be called a "working bond." A prospector, let us say, has a prospect which he hopes will prove to be a valuable mine. To follow down the ore in the vein and see how deep it goes and how much of it there is takes money to hire miners, install machinery, buy explosives and other supplies. The prospector has no money. He is not willing to sell his unproved prospect cheaply to some other party who does have the money, for this may mean that he will lose a valuable mine. On the other hand, no person with money will pay a large sum for a prospect which may be valueless.

So they agree on a working bond or option. The prospector agrees to give the man with money six months or a year to explore the property. The man with money agrees to take certain more or less definite steps of exploration. He has an option to buy the property at any time within the

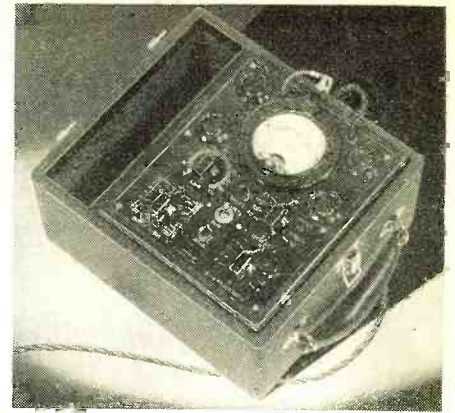

*The Final Answer*  
 to  
**TUBE TEST VALUES ...**



Portable Tube Tester, complete with case, as shown

Dealer's net price..... **\$24.00**

**H**ERE is the Triplet Tube Tester for which users of Triplet instruments have been waiting. It is a MASTER TESTER in every sense of the word. Nothing is left to be desired in either appearance or performance. Only four sockets used for every type of tube. One rotation of the switch instantly indicates interelement shorts and leakages up to 500,000 ohms.

Tests all types of tubes. Large meter. Direct reading scale in two colors—RED indicating "Bad" . . . and GREEN indicating "Good". Line voltage regulation. Makes all short tests, cathode leakage test and individual tests on diodes and full wave rectifiers. Easily adapted to any future requirements. No confusion or complications . . . no calculations. And no impairment of tube values. With only four sockets for every type of tube, you secure a true test of good and bad condition, including the slightest leakages under actual tube operation. 60 cycle, 100-130 volts.

The Master Unit No. 1210 can be furnished in a portable case, as shown above, for outside servicing or in a counter case as illustrated at right. There are three other Triplet Master Units, all of equal dimensions, for every servicing purpose.

**Counter-type Oak Case. Dealer's Net Price, Case Only . . . . \$4.00**  
**SEE YOUR JOBBER**

**THE**  
**TRIPLET ELECTRICAL INSTRUMENT CO.**  
 116 Main St., Bluffton, Ohio, U. S. A.

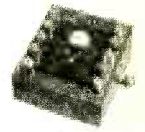

**Write for FREE Folder**

**Triplet Electrical Instrument Co.**  
 116 Main St., Bluffton, Ohio

Please send me data on the new Triplet 1210 Tester, and other units of the Master Line

Name.....  
 Address.....  
 City.....  
 State.....

# Sensational NEW 1935

**HETRO DE LUXE ALL-WAVE RADIO**

**\$34.50** With **SPEAKER and TUBES**

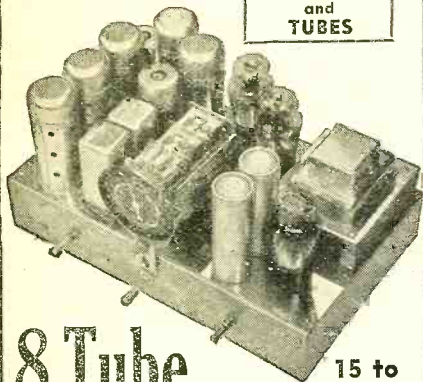

**8 Tube**

**15 to 2200 METERS**

**Amazing New Low Price!**

Why be satisfied with anything less than the New Hetro 8 tube All-Wave Super now offered for the first time at this truly remarkable price. Uses unique antenna, R.F. Pre-Selector, Oscillator Coil Assembly, big pot type speaker, and many other features found only in the highest priced receivers.

**7 DAY FREE TRIAL!**

Convince yourself that regular world-wide, high fidelity reception, need not be expensive. Try this set in your own home for seven days free trial. Foreign Reception Guaranteed or your Money back.

Write NOW for Details!

**HETRO ELECTRICAL INDUSTRIES, Inc.**  
4220 Lincoln Ave. Chicago, Ill., U. S. A.  
Cable Address "HETRO" All Codes

## Build Your Own WHEATSTONE BRIDGE For \$41.50

A simple, rugged, wide-range Wheatstone Bridge for resistance measurements. Operation identical with best laboratory instruments. Sensitive, accurate. Low cost. Kit easily assembled.



SHALLCROSS No. 630 Kit \$41.50 Assembled \$49.70

Built around a highly sensitive galvanometer and Shallcross Resistors. Range .01 ohms to 11.1 megohms. Send 6c in stamps for Bulletin 630-D.

**SHALLCROSS MFG. COMPANY**  
Electrical Measuring Instruments and Accurate Resistors  
700 MAC ODE BOULEVARD COLLINGDALE, PA.

term of the contract for an agreed price. He can then go ahead and explore the supposed mine, at his own expense for the exploration work but without paying anything to the prospector. If the mine proves to be good, he buys it at the agreed price, usually considerable. If it proves worthless, he abandons his option and no one is the loser, except that the prospector now knows that he never had the mine he hoped for.

This same device sometimes is of utility for uncertain patents. The inventor gives the prospective purchaser a year or more to test the patent's value. If it has no value, the option is abandoned. If it has value, the inventor is paid much more than he would have obtained in the beginning by an outright sale.

One final word about patent sales agents. Hundreds of these exist in the United States. Some of them, perhaps all, must make at least a little money. The idea is to take an agent's contract to sell the invention of a new inventor, who presumably is not equipped to sell it for himself.

This plan is not without its appeal to common-sense. The average inventor is not a good salesman. Someone who is a good salesman and who is in touch with probable markets might do better for him than he could do for himself. Yet I am convinced that the activities of the average patent sales agent, admitting not a few exceptions, are seldom useful.

The sound principle is, I think, never to make an exclusive sales contract with any agent and never to close a contract recommended by an agent without independent advice from your own general attorney, whom you know to be both honest and competent. I see no possible disadvantage in allowing a patent sales agent to seek and present to you possible offers for your invention, provided this costs you nothing and provided you have no obligation to accept the offers presented. If the sales agent does the inventor any good, he is well entitled to his commission, justly about ten percent. He is not justly entitled to collect any part of this prospective commission in advance or to bar the inventor for any favorable sale which may come along without the agent's assistance.

FEDERATED is the logical source of supply for the new, advanced

### BUILD YOUR OWN ALL-STAR JR ALL-WAVE Superheterodyne

Free information, diagrams and personal advice to help you build this remarkable new short wave receiver. Ask for your FREE copy of the NEW 1935 CATALOG—just released! The newest in Radios, Parts, Tubes and Sound Equipment at the LOWEST WHOLESALE PRICES!

**Federated Purchaser, Inc.**  
NEW YORK CHICAGO ATLANTA  
25 Park Pl. 1331 So. Michigan Ave. 546 Spring St., N. W.  
Newark • Bronx • Jamaica • Philadelphia • Pittsburg

## SEND FOR YOUR COPY



Every serviceman and short wave fan should have a copy of this NEW catalog showing the complete line of Na-Ald quality products.



See the new and complete line of short wave products, molded of Na-Ald Victron "AA", the material with the sensationally low power factor of 0.0002 at radio frequencies.

Includes band spread, long wave, broadcast and short wave coils of all kinds. The most complete line of popular priced plugs and connectors, adapters, modern testing accessories, molded cases, switches, dials, knobs, analyzer plugs, cables, etc.

Na-Ald items are widely stocked—try your regular supplier—if he hasn't them and does not care to get the genuine Na-Ald products order direct from us.



**ALDEN PRODUCTS CO.**  
Dept. RN-3 715 Centre St.  
BROCKTON, MASS.

## TRI-STATE COLLEGE Radio Engineering Degree in 2 Years

Complete Radio Engineering course in 96 weeks. Bachelor of Science Degree. Radio (television, talking pictures and the vast electronic field) offers unusual opportunities for trained radio engineers. Courses also in Civil, Electrical, Mechanical, Chemical, Aeronautical, Architectural Engineering; Business Administration and Accounting. Low tuition, low living costs. World famous for technical two-year courses. Those who lack high school may make up work. Students from all parts of the world. Located in picturesque hill and lake region of northern Indiana. Enter September, January, March, June. Write for catalog. 1635 COLLEGE AVE. ANGOLA, IND.

## INDEX OF ADVERTISERS

Aerovox Corp.	584	McGraw Hill Book Co., Inc.	568
Alden Products Co.	590	Mid-West Radio Mart	580
Allied Radio Corp.	572, 578	Midwest Radio Corp.	Fourth Cover
All-Star Headquarters	569	National Company, Inc.	583
American Transformer Co.	571	National Radio & Electrical School	585
Amperite Corp.	587	National Radio Institute	529
Amplivox Laboratories	591	National Union Radio Corp.	575
Birmbach Radio Co., Inc.	592	New York Y.M.C.A. Schools	589
Blan The Radio Man, Inc.	592	Nunn Co., E. D.	576
Candler System Co., The	592	Postal Radio Corp.	589
Capitol Radio Engineering Inst.	574	RCA Institutes, Inc.	586
Capitol Radio Research Laboratories, Inc.	587	RCA Manufacturing Co.	588
Central Radio Laboratories	580	Radio Circular Co., Inc.	592
Chicago Radio Apparatus Co.	591	Radio City Products Co.	575
Classified Advertisements	583	Radio & Technical Publishing Co.	577, 589
Coast-to-Coast Radio Corp.	582	Radio Trading Co.	576
Cornish Wire Co., Inc.	578	Radio Training Association of America	533
Corona Hotel	591	Readrite Meter Works	579
Coyne Electrical School	591	Rider, John F.	583
Crowe Name Plate & Mfg. Co.	585	Rivard Mfg Co.	589
Dodges Institute	589	Scott Radio Labs., Inc. E. H.	555
Electrad, Inc.	573	Shallcross Mfg. Co.	590
Experimental Radio Labs.	587	Silver, Inc., McMurdo	531
Federated Purchaser, Inc.	590	Solar Mfg. Corp.	588
General Electric Co.	584	Sound Systems, Inc.	591
Goldentone Radio Mfg. Co.	592	Sprayberry, F. L.	568
Hallcrafters, Inc.	582	Supreme Instruments Corp.	Third Cover
Hammarlund Mfg. Co.	571	Teleplex Co.	575
Hetro Electrical Industries	590	Toledo Sound Equipment Laboratories	571
Hull Mfg. Co.	587	Trimm Radio Mfg. Co.	592
Hygrade-Sylvania Corp.	581	Triplett Electrical Instrument Co.	589
Indiana Technical College	587	Tri-State College	590
Instructograph Co.	591	Try-Mo Radio Co., Inc.	575
International Correspondence Schools	592	Uron Industries, Inc.	591
Kato Engineering Co.	589	Webster Co., The	585
Ken-Rad Corporation, Inc., The	587	Weston Electrical Instruments Corp.	587
Kenyon Transformer Co., Inc.	574	Wholesale Merchandisers, Inc.	576
Lynch, Inc., Arthur H.	592	Wholesale Radio Service Co.	586
		Yaxley Mfg. Co., Inc.	Second Cover



**PORTABLE P.A. SPECIAL  
for DANCE BANDS  
CRYSTAL "MIKE"**

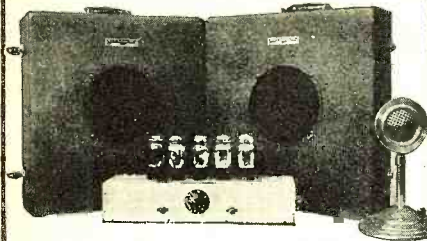

PAC 7 as shown including cables \$125.00

Powerful 7 watt amplifier with tone control and tapped impedance switch to match 1 to 6 speakers. Permanent Magnet Dynamic speakers in large cabinets. New Crystal microphone utilizing push-pull principles.

**Sound Systems, Inc.**  
1311 TERMINAL TOWER, CLEVELAND, O.

**NOW READY!!**

*New 1935 Edition  
URON Catalog No. 11*

Only such book published. Invaluable as a Profit Guide to all Service Shops. Lists replacement parts for 18 Vacuum Cleaners and 42 Washing Machines. Thousands of items from largest existing stock. Armature supplies and motor servicing at lowest cost. Belts, bearings, cois, casters, couplings, cylinders, gears, rolls, pulleys, special tools and endless material. All is best quality merchandise at immense saving. Pocket Wire Stripper or Refrigeration Guide included for 25c.

**Free to the Trade**

Learn the U-R-O-N way, the System that has established so many in a safe, sound and profitable business. "Imitated But Never Equated"

Manufacturers, Exporters and World's Largest Source of its Sort

**URON INDUSTRIES, INC.**

1235 W. Sixth St. Cleveland, O., U. S. A.

**RADIO CODE**

Learn at Home with **Instructograph**  
CODE TEACHER



CODE STUDENTS everywhere are turning to Instructograph, because there is no better way to learn radio code. No experience necessary. Just "listen" and imitate. Instructograph sends perfect code. It is available any time regardless of schedule or interference. Book of Instruction explains each step just as an Instructor would do. *Instructograph*. *Types and Book of Instruction for sale or rent.* Terms as low as \$3 per month. One additional month FREE if rented for two months. Rented supplied on purchase price. Rent for a month. If *Instructograph* please you—BUY IT! If not, return it. Write for full details NOW! No obligation.

ACQUIRING  
The  
CODE

**INSTRUCTOGRAPH COMPANY, Dept. NR-15**  
912 Lakeside Place Chicago, Ill.

**ANTENNAE  
FOR ALL WAVES**

BUILT READY-TO-HANG-UP. LYNCH materials used exclusively. For suggestions and estimate; send sketch of location.

Illustrated: LYNCH HI-FI Duplex Cage, Giant Killer lead-in ALL WAVE Antenna System, complete \$13.75.

**AMPLIVOX LABORATORIES** 227 Fulton St. New York City

**CORONA HOTEL**

Ste. Catherine and Guy Sts.  
**MONTREAL, CANADA**  
(Next door to His Majesty's Theatre)

**RATES:**

Single, from \$1.50 Double, from \$2.00  
Suites from \$4.00

GEO. V. GREEN, Managing Director

Next month, in the last of this series, we shall consider what to do if an inventor decides to try to exploit his invention for himself, either with personal funds or by raising capital.

**Attention Radio Amateurs**

The National Company just brought out this extremely interesting 12-page transmitter booklet describing a new semi-portable, six-band, crystal-controlled phone and c.w. transmitter with pentode output. The wavelength ranges covered include the 5- and 10-meter ultra-short-wave bands and

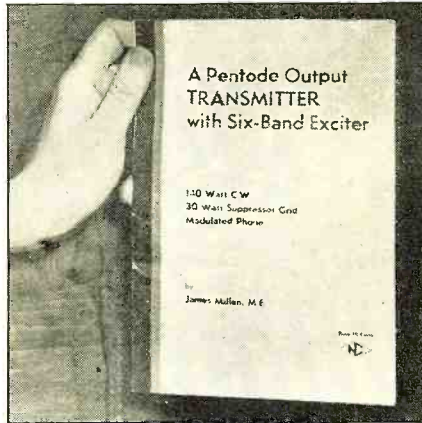

the regular 20, 40, 80 and 160-meter bands. The bulletin is complete with schematic circuit diagrams, parts data and coil specifications and ordinarily sells for ten cents. In addition to this data there is a circuit diagram with parts information on the construction of a pre-amplifier for use with a crystal, condenser or ribbon type microphone. The transmitter is rack-and-panel mounted. A pair of RK-20 type pentode tubes with suppressor-grid modulation are employed in the final amplifier stage.

Through a special arrangement, these booklets are made available, free, to RADIO NEWS readers. Address requests to RADIO NEWS, Department N, 461 Eighth Ave., New York City.

**Increasing Range of  
Voltmeters**

Probably the most widely used single test instrument of the past ten years is the old Weston Model 489, thousand-ohm-per-volt d.c. voltmeter, reading 0-50 and 0-250 volts. Thousands of them must have been sold, for the writer has seen them in service shops, experimenters' dens, amateur radio stations and commercial laboratories from one end of the country to the other. When it was brought out in the days of the first "electric" receivers, this meter was perfectly satisfactory because the limit of most power packs was about 220 volts. However, with considerably higher voltages being used for receivers, P.A. amplifiers and transmitters, its application becomes somewhat limited.

Few owners of these meters seem to realize how easy it is to increase the voltage range to 1000 volts. The idea simply is to mount the meter on a small bakelite or other insulating panel, as shown in the accompanying illustrations, and to add additional multiplier resistors to the 250-volt post.

To double the 0-250-volt scale, use a 250,000-ohm, 1-watt, wire-wound resistor; to quadruple this scale, use a 750,000-ohm, 1-watt resistor. Precision resistors with an accuracy of 1% are required. These are

**LEARN  
RADIO  
IN 10 WEEKS  
at COYNE**



*I will finance  
your training*

You can take more than a year to pay me back in small monthly payments, starting 60 DAYS after your 10 weeks' training.

*H. C. Lewis*  
PRESIDENT

**All Actual Shop Practice**



Here at Coyne you prepare for a big-pay Radio job by actual shop work—under expert instructors—on a wonderful outlay of receivers, transmitters, testers and other Radio equipment. No books, recitations or useless theory.

**Many Earn While Learning**



I aid my students in finding a spare time job by which they can help pay their living expenses while here. Should you need part time work, I'll do my best to get it for you.

**Lifetime Employment Aid**

After you graduate you get lifetime employment help and in addition to this I give you a lifetime advisory and review service.

**Electric Refrigeration—Air Conditioning**

Training for this big new companion field to Radio is given you in a complete course—included absolutely without additional cost.

**Sensational New Plan**

There are no strings to my offer. You can start at Coyne at any time—then pay for training in small monthly payments spread over a whole year, starting 60 days after your ten-week training period—Send coupon for all details.

**H. C. LEWIS, President**  
**COYNE ELECTRICAL SCHOOL**  
AND RADIO  
500 S. Paulina St., Dept. 35-3K, Chicago, Ill.

MR. H. C. LEWIS, President  
**COYNE ELECTRICAL & RADIO SCHOOL**  
500 S. Paulina St., Dept. 35-3K, Chicago, Ill.

Dear Mr. Lewis: Please send me your Big FREE Book, and details of your Pay-After-Graduation Plan.

Name \_\_\_\_\_  
Address \_\_\_\_\_  
City \_\_\_\_\_ State \_\_\_\_\_

**BUILD YOUR OWN  
ALL-STAR JR  
ALL-WAVE Superheterodyne**

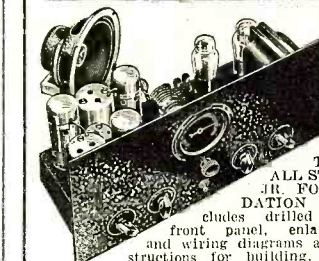

**WRITE  
CHI-RAD  
FIRST!**

Complete  
Foundation  
Kits  
Only  
\$2.25

The ALL-STAR JR. FOUNDATION includes drilled base, Eraydo front panel, enlarged schematic and wiring diagrams and detailed instructions for building, complete, only \$2.25. Send your order to CHI-RAD for quick action. FREE wiring diagram and parts list. **WRITE TODAY.** We also have foundations and schematics for the ALL STAR SR.

**NEW NATIONAL HRO De Luxe SUPER Amateur AND ALL SHORT WAVE RECEIVERS**

Send for FREE BULLETIN  
**CHICAGO RADIO APPARATUS CO.**  
415 S. Dearborn St. Dept. RN-7 Chicago, Ill.

## BIRNBACH All-Wave ANTENNA

**ACH SYSTEM 375 COMPLETE**

IMPROVES reception, strengthens signals, reduces interference and noise on all wavelengths. Complete kit includes all parts—new-type coupler, (requiring no wave-change switch), wire, new-type insulators, accessories and instructions—only \$2.75 list.

Write Dept. RN-5 for FREE data on Antenna Kits, Aerial and Hook-up Wire, Standoff Insulators, etc.

**BIRNBACH RADIO CO., Inc.**  
145 HUDSON STREET NEW YORK CITY

## DIESEL POWER A COMING AMERICAN INDUSTRY

The internal-combustion engine represents man's supreme triumph of machine power. Diesel engineers are in great demand. Many are acquiring necessary knowledge through spare-time study of this modern I. C. S. Course on Diesel engines. Free booklet!

## ELECTRICAL ENGINEERING —A Great Industry with a Great Future

The new I. C. S. Course in Electrical Engineering covers this fascinating field thoroughly. If you are just starting or are on the way to a real paying position in this industry, this course brings the knowledge necessary for advancement.

## MECHANICAL ENGINEERING —A Field with a Future

This I. C. S. Course has meant advancement to hundreds of ambitious mechanics, draftsmen, blacksmiths, foundrymen, patternmakers, apprentices, and mechanical engineers. You, too, will find that enrolling for an I. C. S. Course is an investment in a Bigger Future. Use the coupon!

## AUTOMOBILE EXPERTS are always in demand

The rapid progress in manufacture and service of the modern automobile brings new opportunities to thousands of ambitious and forward-looking men. There's always a demand for trained men. The new I. C. S. Automobile Course will make you a trained man! The time to act is now. Use the coupon.

**INTERNATIONAL CORRESPONDENCE SCHOOLS**  
BOX 8283-P. SCRANTON, PENNA.

Without obligation, send me full information on the subject checked below:

Diesel Power       Automobile Course  
 Electrical Engineering  
 Mechanical Engineering

Architecture       Drafting     Accounting  
 Concrete Construction     Good English  
 Reading Shop Blueprints     Salesmanship  
 Civil Engineering       Advertising  
 Gas Engine Operating     Show Card Lettering  
 Radio                       Civil Service  
 Refrigeration               High School Subjects  
 Chemistry                   Air Conditioning  
 Highway Engineering     Inventing and Patenting  
 Poultry Farming           Aviation Engines

Name \_\_\_\_\_ Age \_\_\_\_\_  
Address \_\_\_\_\_

quite inexpensive and are an excellent investment.

A piece of 1/8-inch bakelite measuring 4 1/2 by 6 inches is just about right. The five tip jacks along the bottom are convenient for quick connections to flexible test cords. The meter is kept at a convenient angle by means of long 6/32 machine screws acting as inclined feet. Of

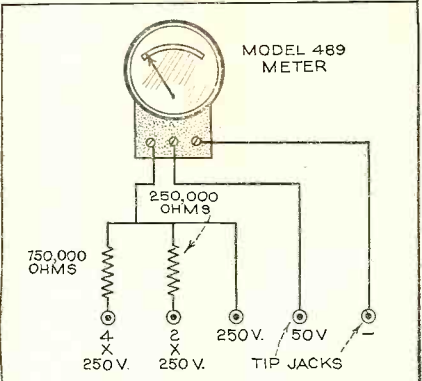

course, it is a good idea to enclose the whole instrument in a box of some kind, but this skeleton construction has survived a great deal of rough handling.

The fact that the top scale readings are



multiplied by such easy numbers as 2 and 4 makes the mental arithmetic quick and

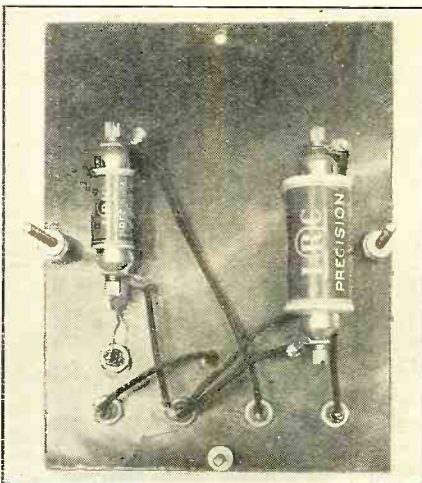

simple. Every owner of a Model 489 will find the extra resistors very much worth while.

**A New Station in Finland.**  
HELSINKI, FINLAND—A new 200-watt station located in Sortavala has been added to the network of Finnish stations. It transmits on the Finnish "common" wave of 400.5 meters. The total number of stations in Finland is now nine.

**"Satisfactory Short Wave Reception Under Worst Possible Conditions"**

## LYNCH HI-FI ANTENNA SYSTEMS

TRADE MARK REGISTERED (High-Fidelity)

"We are located on the ground floor of an eleven story office building. In this building are a number of doctors with X-ray equipment, etc., and within one hundred feet of us is another office building in which are over three hundred doctors with their associated electrical equipment. Reception conditions were so bad that in the daytime with a normal antenna, it was practically impossible to hear anything except local broadcast stations.

"We have installed two 20 1/2 foot cages and are using one of your new HI-FI Coupling Kits with 240 feet of Giant Killer Cable. EQ, Madrid, now comes through beautifully, with very little background noise. We have checked during the day and find that even if the X-rays are running, we are able to get sufficient, decent reception to give a very convincing demonstration to a customer that a short wave radio will work satisfactorily with a LYNCH Antenna System."

(Name on Request)

**"No Radio Can Be Better Than Its Aerial—No Aerial is As Good As a LYNCH Aerial."**

Full information on Request

Arthur H. Lynch, Inc., 227 Fulton St., N. Y.  
PIONEER OF NOISE-REDUCING AERIALS

SEND FOR THIS **FREE** CATALOG

Check full of BARGAINS in RADIO SETS, Long and Short Wave Apparatus, Servicemen's Repair and Replacement parts, Electrical Appliances and hundreds of miscellaneous Specials at TREMENDOUS SAVINGS. Get this big new Bargain Book. It's absolutely FREE without obligation—just send us your Name and Address on a post card.

**RADIO CIRCULAR CO., INC.**  
225 Varick St., Dept. R.N., New York, N.Y.

**You Can Become a Fast, Capable RADIO OPERATOR at Home.**

The CANDLER SYSTEM Makes it Easy for you! If you want to learn code QUICK ask about Junior Course for beginners. If you lack speed ask about Advanced Course—HIGH SPEED TELEGRAPHING. Whether Beginner, Amateur or Com'l op., tell us what ticket you're going up for and we'll show you how EASY it is to get CANDLER SYSTEM gives you Speed, Accuracy and ability to Copy Behind—shows you how to use "mill" in copying fast stuff. All questions answered. Save time and money by sending for FREE BOOK today!

**Famous Candler Students**  
McElroy, champion 13 years. Watson, WIBGL, with Byrd Expedition. Jean Hudson, W3BAK, 9 yrs. old, Champion of world in Class "E."

**CANDLER SYSTEM CO., Dept. N-3**  
6343 So. Kedzie Ave., Chicago, Ill.

## TRIMM FEATHERWEIGHT EARPHONES

High in Quality, Small in Size, Light in Weight, Neat in Appearance, Superior in Performance. Our Engineers will help you. No obligation.

**TRIMM RADIO MFG. CO.**  
528 Armitage Ave., Chicago, Ill.

**1935 RADIO CATALOG**

30 DAY FREE TRIAL SAVE UP TO 50% DIRECT TO YOU

**Free Book**  
All models: Ac-Dc midgets; dual and world-wide all-wave, farm battery and car—at factory prices! Write for 24-page Bargain Catalog and 30-DAY TRIAL plan. Prices from \$9.95 UP.

**GOLDENTONE RADIO CO.**  
127 Oakman Bldg., Detroit, Mich.

**BUY YOUR PARTS FOR THE SKYSCRAPER**

from BLAI This 3-tube T.R.F. Receiver was described as Radio News Laboratory Receiver in the November and December issues of Radio News. We carry a complete line of parts including chassis at low prices. Send for quotations on anything in Radio. We have no catalogue.

**BLAN THE RADIO MAN, INC.**  
177 Greenwich St., N. Y., N. Y.

# Magic? No! Tests ---- Thousands of them!

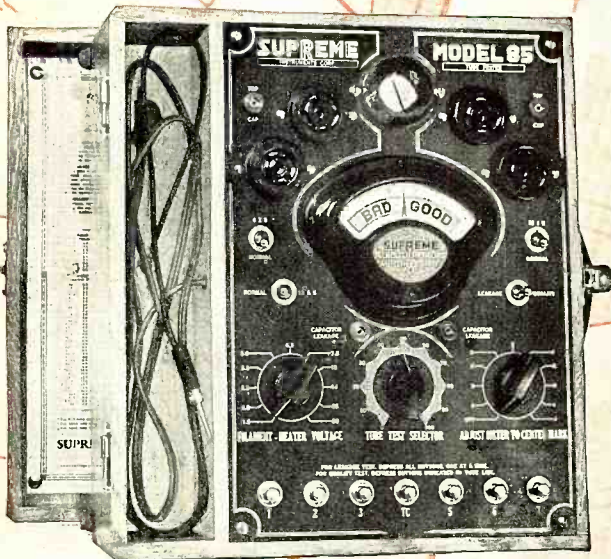

Supreme Neonized Tube Tester available from your jobber at dealers net cash wholesale price **\$39.95**  
Also in modernistic walnut upright counter model.

● The Why and Wherefore of the unflinching, outstanding accuracy of Supreme 85 Neonized Tube Tester is now available in complete bulletin form. It takes you behind the scenes in the laboratory with Supreme engineers. You see test after test . . . thousands of them . . . back of every reading and analysis of the 85. Now radio technicians can give not only the most complete, positive testing of every type of tube . . . if equipped with a Supreme 85 . . . but also know the reason why for every reading. Write for this free bulletin "TESTS —THOUSANDS OF THEM!"

● **Supreme Instruments Corporation, Greenwood, Miss., U. S. A.** ●  
Export Dept., Associated Exporters Co., 1457 Broadway, New York City

SAVE UP TO 50% BY BUYING YOUR RADIO *Direct from* MIDWEST LABORATORIES

Thrill to Guaranteed World-Wide HIGH FIDELITY Performance with This  
**Amazing New MIDWEST SUPER Deluxe 16-TUBE ALL-WAVE Radio!**  
 (ALL FIVE WAVE BANDS)

Only Midwest Gives You These Exclusive Features

HERE are a few reasons why Midwest is generally accepted as the world's most "Universal" set. They explain why it is so popular in Africa, Spain, and other countries where reception conditions vary widely—illustrate why so many police, army, navy and consular officials as well as listening posts prefer it—prove why many "hams," who own a number of sets, use the Midwest in preference to any other.

**FIDEL-A-STAT**

Three Taps  
 No Gap  
 No Stop

Absolutely new and exclusive with Midwest, this feature represents the only new departure in controlling potentials since about 1863. With the Midwest Fidel-A-Stat, the full beauty and rhythmic nature of modern music, together with the beautiful "lace work" of flutes, violins, piccolo and other reed instruments, may be brought out and accentuated to any degree desired. You'll be amazed and pleasantly surprised the first time you use this startlingly different control.

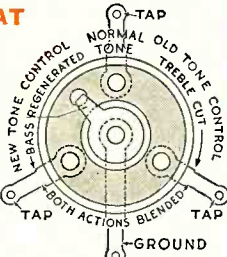

TERMS AS LOW AS \$5.00 DOWN

**30 DAYS FREE TRIAL**

**BEFORE** you buy any radio, write for the new **FREE** Midwest "Fifteenth Anniversary" catalog and see how you can save from 1/3 to 1/2 by buying direct from Midwest Laboratories. Learn why Midwest outperforms sets costing up to \$200 and more. Midwest gives you triple protection with: **One-Year Guarantee, Foreign Reception Guarantee, Money-Back Guarantee.**

Only Midwest Gives you Multi-Function Dial

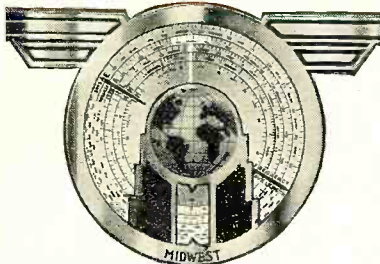

This dial is not an ordinary airplane dial. It is a many purpose unit that performs many functions. Send for **FREE** Miniature Dial showing these outstanding advantages: Dial calibrated in Kilocycles, Megacycles and Meters . . . Call letters of American Broadcast Stations printed on dial and illuminated . . . Slow-Fast, Smooth-Action Tuning . . . Station Group Locator . . . Simplified Tuning Guide Lights . . . Automatic Select-O-Band Indicator . . . Illuminated Pointer Indicator . . . Silent Shadow Tuning . . . Centralized Tuning.

**NEW STYLE CONSOLES**

The Midwest 36-page catalog pictures a complete line of beautiful, artistic deluxe consoles and chassis in four colors. Write for new **FREE** catalog . . . **TODAY!**

Midwest long-range radios are priced as low as **\$27.50**

**50 ADVANCED FEATURES**

Exclusive "Invisible Hands" features include: High Level Automatic Volume Control Action, Discriminating Automatic Tone Control, Multi-Function Dial, Micro-Tenuator, Fidel-A-Stat, etc. Only Midwest covers a tuning range of 9 to 2400 meters (33 Megacycles to 125 KC)—enabling you to easily and successfully tune in even low-powered foreign stations up to 12,000 miles away—with crystal-clear, loud speaker, High Fidelity reception.

All 5 Wave bands enable you to enjoy today's finest High Fidelity American programs. In addition, you get Canadian, police, amateur, airplane broadcasts...commercial and ship signals...and delight in exciting world-wide broadcasts from England, France, Germany, Spain, Italy, Russia, Australia, etc. Send today for money-saving facts!

**Micro-Tenuator—Midwest Expanding and Contracting I. F. Transformer**

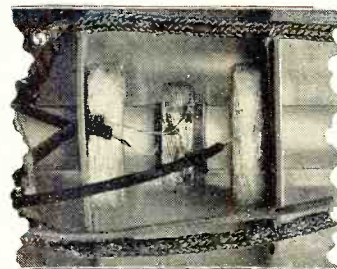

(U. S. Patent Pending, Serial No. 721,240)

This feature makes you master of your set's sensitivity. The "Electromagnetic Shield" is under your complete control at all times by means of the Micro-Tenuator lever on the front panel. By turning this lever entirely to the left, the "Electromagnetic Shield" cuts the coupling between the primary and secondary so low that the sensitivity of the set is barely sufficient to bring in local stations and powerful nearby stations. It is impossible to obtain any of the whistling heterodyne noises, static and other noises originating outside of the radio.

**ONLY RADIO COVERING 9 TO 2,400 METERS. 12,000 MILE TUNING RANGE**  
**WORLD'S GREATEST RADIO VALUE**  
**\$57.50 with New Deluxe Auditorium-Type SPEAKER**  
(16 1/2 TUBES)

**EXPERIENCED RADIO MAN PRAISES MIDWEST**  
 Trenton, N. J.—I am firmly convinced that I have received the most for my money in my 15 years' experience. My Midwest-16 brought in 12RO, Rome; EAQ, Madrid; FYA, France; GSA, GSB, Daventry; VK2ME, Sydney, etc. It has remarkable selectivity! With WCAU at 1170 KC and WOAT at 1190 KC, both 50,000-watt stations, transmitting at their peak, about 9 P.M., I have cut between these stations and received KOB, New Mexico, at 1180 K with loud speaker volume—and no interference. R. M. Scheid, Jr., 28 Boudinot Street.



**DEAL DIRECT WITH LABORATORIES**  
 Increasing costs are sure to result in high radio prices soon. Buy before the big advance . . . **NOW** . . . while you can take advantage of Midwest's sensational values. No middlemen's profits to pay! You save 30% to 50% when you buy this popular way . . . You get 30 days **FREE** trial . . . as little as **\$5.00** down puts a Midwest radio in your home. Foreign Reception, One-Year and Money-Back **GUARANTEES** protect you! Write for **FREE** catalog now . . . **TODAY!**

**SAVE UP TO 50%**

**MAIL COUPON TODAY! FOR FREE MINIATURE DIAL . . . FREE 30-DAY TRIAL OFFER . . . FREE CATALOG**

**MIDWEST RADIO CORP., Dept. 35A, Cincinnati, Ohio.**  
 Without obligation on my part, send me your new **FREE** catalog, **FREE** Miniature Dial, and complete details of your liberal 30-day **FREE** trial offer. This is **NOT** an order.

User-Agents Make Easy Extra Money  
 Check Here for Details

Name \_\_\_\_\_  
 Address \_\_\_\_\_  
 Town \_\_\_\_\_ State \_\_\_\_\_  
 Check here if interested in a Midwest World-Wide Battery Radio.

**MIDWEST RADIO CORP.**  
**DEPT. 35A - CINCINNATI, OHIO, U. S. A.**  
 Established 1920 Cable Address Miraco . . . All Codes