

48783

IN SEARCH OF
TESLA'S ELUSIVE
FIREBALL LIGHTNING

SPECIAL SEC
TEST EQUIPME

\$1.95 MAR. 1985
IN CANADA \$2.25

Radio- Electronics

TECHNOLOGY - VIDEO - STEREO - COMPUTERS - SERVICE

What's new in DMM's
and Oscilloscopes -
How much must you
spend to get the
features you really need? ▶

How to select the capacitor
that's best for your project

Build R-E's Uninterruptable
Power Supply and protect
your equipment against
power outages.

Build R-E's Cassette
Streamer to back up your
computer software

All about thermistors and
their applications

Special 16-page
tear-out section.

COMPUTER DIGEST

GERNSBACK
PUBLICATION



PLUS:

- ★ Hobby Corner
- ★ New Ideas
- ★ Service Clinic
- ★ Equipment Reports
- ★ State-Of-Sold-State

100 MHz scope, counter, timer, multimeter: All one integrated system.

100 MHz dual time base scope. 3.5 ns risetime; sweeps from 0.5 s to 5 ns/div; alternate sweep; $\pm 2\%$ vertical/horizontal accuracy; vertical sensitivity to 2 mV/div @ 90 MHz.

9-digit fluorescent display. Digitally accurate readouts accompany the CRT waveform. Error messages and prompts also appear on the display.

Dc volts and ac coupled true RMS volts. Measured through the Ch 1 scope input.

Gated measurements. Use the scope's intensified marker to measure frequency, period, width and to count events within specified portions of the signal.

Auto-ranged, auto-averaged counter/timer. Frequency, period, width, delay time, Δ -time, plus totalize to more than 8 million events—with 7 digits plus exponent displayed.

Auto-ranged DMM. Use floating DMM side inputs with up to 5000-count resolution. Get precise readouts of average dc and true RMS voltage. Measure resistance from milliohms to gigohms.

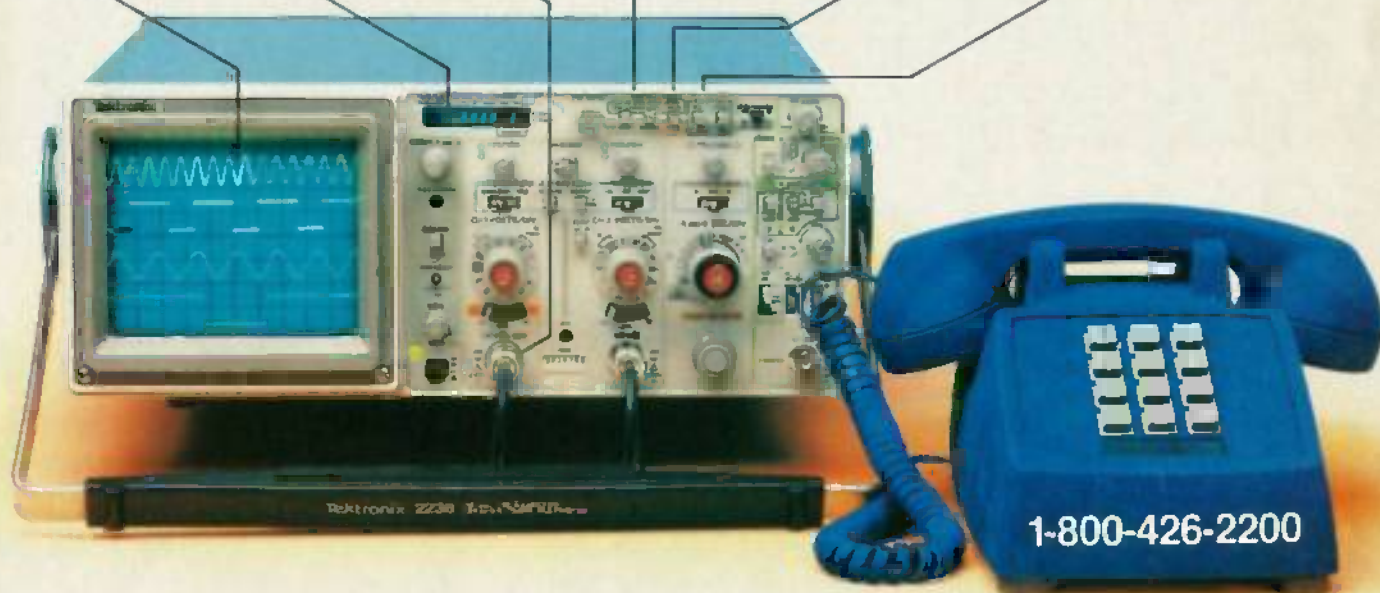

Now make measurements faster, easier, with greater accuracy and user confidence. The Tek 2236 makes gated counter measurements, temperature, time, frequency, resistance and voltage measurements push-button easy. You see results concurrently on the 9-digit numeric readout and CRT display.

Its complete trigger system includes pushbutton trigger view, plus peak-to-peak auto, TV line, TV field, single sweep and normal modes.

At just \$2650*, the 2236 includes the industry's first 3-year warranty on all parts and labor, including the CRT.

Integrated measurement system. 3-year warranty. 15-day return policy. And expert advice. One free call gets it all! You can order, or obtain literature, through the Tek National Marketing Center. Technical personnel, expert in scope applications, can answer your questions and expedite delivery. Direct orders include probes, operating

manual, 15-day return policy, full warranty and worldwide service back-up.

**Order toll-free:
1-800-426-2200
Extension 57**

In Oregon call collect:
(503) 627-9000 Ext. 57
Or write Tektronix, Inc.
P.O. Box 1700
Beaverton, OR 97075

Tektronix®
COMMITTED TO EXCELLENCE

NEW!

uniden®

Bearcat®

Rebates!

Communications Electronics,™ the world's largest distributor of radio scanners, celebrates 1985 with big savings on Bearcat scanners. Uniden Corporation of America, the manufacturer of Bearcat scanners is offering huge consumer rebates on their great line of scanners, when purchased from CE between February 1 and March 31, 1985.

Bearcat® 300-G

List price \$549.95/CE Price \$344.00/\$10.00 rebate
Your final cost is a low \$334.00
7-Band, 50 Channel • Service Search • No-crystal scanner • AM Aircraft and Public Service bands • Priority Channel • AC/DC Bands: 32-50, 118-136 AM, 144-174, 421-512 MHz.
The Bearcat 300 is the most advanced automatic scanning radio that has ever been offered to the Public. The Bearcat 300 uses a bright green fluorescent digital display, so it's ideal for mobile applications. The Bearcat 300 now has these added features: Service Search, Display Intensity Control, Hold Search and Resume Search keys. Separate Band keys to permit lock-in/lock-out of any band for more efficient service search.

Bearcat® 20/20-G

List price \$449.95/CE Price \$274.00/\$5.00 rebate
Your final cost is a low \$269.00
7-Band, 40 Channel • Crystalsless • Searches AM Aircraft and Public Service bands • AC/DC Priority Channel • Direct Channel Access • Delay Frequency range 32-50, 118-136 AM, 144-174, 420-512 MHz.
Find an easy chair. Turn on your Bearcat 20/20 and you're in an airplane cockpit. Listening to all the air-to-ground conversations. Maybe you'll pick up an exciting search and rescue mission on the Coast Guard channel. In a flash, you're back on the ground listening as news crews report a fast breaking story. Or hearing police and fire calls in your own neighborhood, in plenty of time so you can take precautions. You can even hear ham radio transmission, business phone calls and government intelligence agencies. Without leaving your easy chair. Because you've got a Bearcat 20/20 right beside it.
The Bearcat 20/20 monitors 40 frequencies from 7 bands, including aircraft. A two-position switch, located on the front panel, allows monitoring of 20 channels at a time.

Bearcat® 210XL-G

List price \$349.95/CE price \$209.00/\$35.00 rebate
Your final cost is a low \$174.00
6-Band, 18 Channel • Crystalsless • AC/DC Frequency range 32-50, 144-174, 421-512 MHz.
The Bearcat 210XL scanning radio is the second generation scanner that replaces the popular Bearcat 210 and 211. It has almost twice the scanning capacity of the Bearcat 210 with 18 channels plus dual scanning speeds and a bright green fluorescent display. Automatic search finds new frequencies. Features scan delay, single antenna, patented track tuning and more.

Bearcat® 260-G

List price \$399.95/CE price \$274.00/\$5.00 rebate
Your final cost is a low \$269.00
8-Band, 16 Channel • Priority • AC/DC Frequency range 30-50, 138-174, 406-512 MHz.
Keep up with police and fire calls, ham radio operators and other transmission while you're on the road with a Bearcat 260 scanner. Designed with police and fire department cooperation. Its unique, practical shape and special two-position mounting bracket makes hump mounted or under dash installation possible in any vehicle. The Bearcat 260 is so ruggedly built for mobile use that it meets military standard 810C. Curve y for vibration rating. Incorporated in its rugged, all metal case is a specially positioned speaker delivering 3 watts of crisp, clear audio.

FREE Bearcat® Rebate Offer

Get a coupon good for a \$35.00 rebate when you purchase a Bearcat 210XL; \$30 rebate on model 201; \$20 rebate on models 180 and 100; \$10 rebate on models DX1000 or 300; \$5 rebate on models 20/20 or 260. To get your rebate, mail rebate coupon with your original dated sales receipt from Communications Electronics and the Bearcat model number from the carton to Uniden. You'll receive your rebate in six to eight weeks. Offer valid only on purchases made between February 1, 1985 and March 31, 1985. All requests must be postmarked by April 15, 1985. Limit of one rebate per household. Special rebate coupon must accompany all rebate requests and may not be reproduced. Offer good only in the U.S.A. Void where taxed or prohibited by law. Resellers, companies and employees of Uniden, their advertising agencies, distributors and retailers are not eligible for this rebate. Please be sure to send in the correct amount for your scanner. Pay the listed CE price in this ad. Do not deduct the rebate amount since your rebate will be sent directly to you from Uniden. Orders received with insufficient payments will not be processed and will be returned. Offer subject to change without notice.

NEW! Bearcat® 201-G

List price \$279.95/CE price \$189.00/\$30.00 rebate
Your final cost is a low \$159.00
9-Band, 16 Channel • Crystalsless • AC only Priority • Scan Delay • One Key Weather Frequency range 30-50, 118-136 AM, 144-174, 420-512 MHz.
The Bearcat 201 performs any scanning function you could possibly want. With push button ease, you can program up to 16 channels for automatic monitoring. Push another button and search for new frequencies. There are no crystals to limit what you want to hear.

NEW! Bearcat® 180-G

List price \$249.95/CE price \$164.00/\$20.00 rebate
Your final cost is a low \$144.00
8-Band, 16 Channel • Priority • AC only Frequency range: 30-50, 138-174, 406-512 MHz.
Police and fire calls, Ham radio transmissions, Business and government undercover operations. You can hear it all on a Bearcat 180 scanner radio. Imagine the thrill of hearing a major news event unfold even before the news organizations can report it. There's nothing like scanning to keep you in-the-know, and no better way to get scanner radio performance at a value price than with the Bearcat 180.

Bearcat® 100-G

The first no-crystal programmable handheld scanner.
List price \$449.95/CE Price \$229.00/\$20.00 rebate
Your final cost is a low \$209.00
8-Band, 16 Channel • Liquid Crystal Display Search • Limit • Hold • Lockout • AC/DC Frequency range: 30-50, 138-174, 406-512 MHz.
The world's first no-crystal handheld scanner has compressed into a 3" x 7" x 1 1/4" case more scanning power than is found in many base or mobile scanners. The Bearcat 100 has a full 16 channels with frequency coverage that includes all public service bands (Low, High, UHF and "T" bands), the 2-Meter and 70 cm Amateur bands, plus Military and Federal Government frequencies. Wow, what a scanner!
The Bearcat 100 produces audio power output of 300 milliwatts, is track-tuned and has selectivity of better than 50 dB down and sensitivity of 0.6 microvolts on VHF and 1.0 microvolts on UHF. Power consumption is kept extremely low by using a liquid crystal display and exclusive low power integrated circuits.
Included in our low CE Price is a sturdy carrying case, earphone, battery charger/AC adapter, six AA Ni-cad batteries and flexible antenna. Order your scanner now.

Bearcat® DX1000-G

List price \$649.95/CE price \$499.00/\$10.00 rebate
Your final cost is a low \$489.00
Frequency range 10 kHz to 30 MHz.
The Bearcat DX1000 shortwave radio makes tuning in London as easy as dialing a phone. It features PLL synthesized accuracy, two time zone 24-hour digital quartz clock and a built-in timer to wake you to your favorite shortwave station. It can be programmed to activate peripheral equipment like a tape recorder to record up to five different broadcasts, any frequency, any mode, while you are asleep or at work. It will receive AM, LSB, USB, CW and FM broadcasts.
There's never been an easier way to hear what the world has to say. With the Bearcat DX1000 shortwave receiver, you now have direct access to the world.

Uniden® PC22-G

List Price \$159.95/CE price \$99.00
The Uniden PC22 is a 40 Channel AM remote mobile CB radio. It's the answer for today's smaller cars which don't always provide adequate space for mounting. Since all the controls are on the microphone, you can stash the "guts" in the trunk. The microphone has up/down channel selector, digital display, TX/RX indicator and external speaker jack. Dimensions: 5 1/2" W x 7 1/2" D x 1 1/2" H. 13.8 VDC, positive or negative ground.

QUANTITY DISCOUNTS AVAILABLE
Order two scanners at the same time and deduct 1% for three scanners deduct 2%, four scanners deduct 3%, five scanners deduct 4% and six or more scanners purchased at the same time earns you a 5% discount off our super low single unit price.

Uniden® PC55-G

List price \$89.95/CE price \$59.00
The Uniden PC55 40 Channel CB radio is a full featured transceiver that boasts a super-compact case and a front-panel mike. It has ANL, PA-CB, Channel 9 and 9 Gain switches, LED S/R/F meter, TX/RT, PA & external speaker jacks. Dimensions: 6" W x 6" D x 1 1/2" H. ±13.8 VDC. The Uniden PC55...now at a special low price.



Choose from many different models.

OTHER RADIOS AND ACCESSORIES

RD55-G Uniden vior mount Radar Detector \$119.00
RD65-G Uniden remote mount Radar Detector \$139.00
FB-E-G Frequency Directory for Eastern U.S.A. \$12.00
FB-W-G Frequency Directory for Western U.S.A. \$12.00
8C-WA-G Bearcat Weather Alert \$39.00
A60-G Magnet mount mobile antenna \$39.00
A70-G Base station antenna \$35.00
Add \$3.00 shipping for all accessories ordered at the same time.
Add \$3.00 shipping per scanner antenna.

BUY WITH CONFIDENCE

To get the fastest delivery from CE of any product in this ad, send or phone your order directly to our Scanner Distribution Center. Michigan residents please add 4% sales tax or supply your tax ID number. Written purchase orders are accepted from approved government agencies and most well rated firms at a 10% surcharge for net 10 billing. All sales are subject to availability, acceptance and verification. All sales on accessories are final. Prices, terms and specifications are subject to change without notice. All prices are in U.S. dollars. Out of stock items will be placed on backorder automatically unless CE is instructed differently. A \$5.00 additional handling fee will be charged for all orders with a merchandise total under \$50.00. Shipments are F.O.B. Ann Arbor, Michigan. No COD's. Most products that we sell have a manufacturer's warranty. Free copies of warranties on these products are available prior to purchase by writing to CE. International orders are invited with a \$20.00 surcharge for special handling in addition to shipping charges. Non-certified checks require bank clearance.

Mail orders to: Communications Electronics,™ Box 1045, Ann Arbor, Michigan 48108 U.S.A. Add \$7.00 per scanner, radar detector or CB or \$12.00 per shortwave receiver for U.P.S. ground shipping and handling in the continental U.S.A. For Canada, Puerto Rico, Hawaii, Alaska, or APO/FPO delivery, shipping charges are three times continental U.S. rates. If you have a Visa or Master Card, you may call and place a credit card order. Order toll-free in the U.S. Dial 800-USA-SCAN. In Canada, order toll-free by calling 800-221-3475. WUI Telex CE anytime, dial 671-0155. If you are outside the U.S. or in Michigan dial 313-973-8888. Order today.

Scanner Distribution Center™ and CE logo are trademarks of Communications Electronics.™ Ad #010285-G
† Bearcat is a registered trademark of Uniden Corporation.
Copyright © 1985 Communications Electronics

For more information call
1-800-SCANNER

For credit card orders call
1-800-USA-SCAN

COMMUNICATIONS ELECTRONICS™

Consumer Products Division
P.O. Box 1045 G Ann Arbor, Michigan 48106-1045 U.S.A.
Call 800-USA-SCAN or outside U.S.A. 313-973-8888

CIRCLE 276 ON FREE INFORMATION CARD

NEW!

Regency[®] Scanners

Communications Electronics,[™] the world's largest distributor of radio scanners, introduces new models with special savings on all radio scanners. Chances are the police, fire and weather emergencies you'll read about in tomorrow's paper are coming through on a scanner today.

NEW! Regency[®] MX7000-G

List price \$899.95/CE price \$449.00
10-Band, 20 Channel • Crystalless • AC/DC
Frequency range: 25-550 MHz, continuous coverage and 800 MHz to 1.2 GHz, continuous coverage
In addition to normal scanner listening, the MX7000 offers CB, VHF, and UHF TV audio, FM Broadcast, all aircraft bands (civil and military), 800 MHz communications, cellular telephone, and when connected to a printer or CRT, satellite weather pictures.

NEW! Regency[®] MX5000-G

List Price \$599.95/CE price \$354.00
Multi-Band, 20 Channel • No-crystal scanner
Search • Lockout • Priority • AC/DC
Selectable AM-FM modes • LCD display
World's first continuous coverage scanner
Frequency range: 25-550 MHz, continuous coverage
Never before have so many features come in such a small package. The Regency MX5000 mobile or home scanner has continuous coverage from 25 to 550 MHz. That means you can hear CB, Television audio, FM broadcast stations, all aircraft bands including military and the normal scanner bands, all on your choice of 20 programmable channels.

NEW! Regency[®] MX4000-G

List price \$829.95/CE price \$394.00
Multi-Band, 20 Channel • No-crystal scanner
Search • Lockout • Priority • AC/DC
Selectable AM-FM modes • LCD display
Bands: 30-50, 118-136, 144-174, 440-512, 800-950 MHz
The Regency MX4000 gives coverage in the standard VHF and UHF ranges with the important addition of the 800 MHz and aircraft bands. It features keyboard entry, multifunction liquid crystal display and variable search increments.

Regency[®] MX3000-G

List price \$319.95/CE price \$182.00
6-Band, 30 Channel • No-crystal scanner
Search • Lockout • Priority • AC/DC
Bands: 30-50, 144-174, 440-512 MHz
The Regency Touch MX3000 provides the ease of computer controlled, touch-entry programming in a compact-sized scanner for use at home or on the road. Enter your favorite public service frequencies by simply touching the numbered pressure pads. You'll even hear a "beep" tone that lets you know you've made contact.

Regency[®] Z30-G

List price \$279.95/CE price \$166.00
6-Band, 30 Channel • No-crystal scanner
Bands: 30-50, 144-174, 440-512 MHz
Cover your choice of over 15,000 frequencies on 30 channels at the touch of your finger.

Regency[®] C403-G

List price \$99.95/CE price \$62.00
5-Band, 4 Channel • Crystal scanner
Channel indicator LED • AC only • Low cost
Bands: 30-50, 148-174, 450-470 MHz
Regency's basic scanner, the C403 gives you the excitement of police, fire and emergency calls at a budget price. It can tune in to any of five public service bands and brings the signal in loud and clear...on any of four possible channels. It comes with detachable telescope antenna and AC power cord. Order one crystal certificate for each channel you want to receive.

Regency[®] HX1000-G

List price \$329.95/CE price \$209.00
6-Band, 30 Channel • No Crystal scanner
Search • Lockout • Priority • Scan delay
Sidelit liquid crystal display • Digital Clock
Frequency range: 30-50, 144-174, 440-512 MHz
The new handheld Regency HX1000 scanner is fully keyboard programmable for the ultimate in versatility. You can scan up to 30 channels at the same time. When you activate the priority control, you automatically override all other calls to listen to your favorite frequency. The LCD display is even sidelit for night use. A die-cast aluminum chassis makes this the most rugged and durable hand-held scanner available. There is even a backup lithium battery to maintain memory for two years. Includes wall charger, carrying case, belt clip, flexible antenna and nicad battery. Order your Regency HX1000 now.

Regency[®] R106-G

List price \$159.95/CE price \$92.00
5-Band, 10 Channel • Crystal scanner • AC/DC
Frequency range: 30-50, 148-174, 450-512 MHz
A versatile scanner, The Regency R-106 is built to provide maximum reception at home or on the road. Rugged cabinet protects the advanced design circuitry allowing you years of dependable listening.

NEW! Regency[®] R1050-G

List price \$179.95/CE price \$109.00
6-Band, 10 Channel • Crystalless • AC only
Frequency range: 30-50, 144-174, 440-512 MHz
Now you can enjoy computerized scanner versatility at a price that's less than some crystal units. The Regency R1050 lets you in on all the action of police, fire, weather, and emergency calls. You'll even hear mobile telephones.
Programming the R1050 is easy. Merely touch the keyboard and enter any of over 15,000 frequencies on your choice of 10 channels.

Regency[®] HX650-G

List price \$129.95/CE price \$79.00
5-Band, 6 Channel • Handheld crystal scanner
Bands: 30-50, 148-174, 450-512 MHz
Now you can tune in any emergency around town, from wherever you are, the second it happens. Advanced circuitry gives you the world's smallest scanner. Our low CE price includes battery charger/A.C. adapter.

NEW! Regency[®] HX-650P-G

List Price \$189.95/CE price \$104.00
Now, Communications Electronics offers a special packaged price on the Regency HX-650 scanner and the following items for only \$104.00. You get the Regency HX-650 scanner, a set of 4 AAA ni-cad batteries, the MA-506 carrying case, six crystal certificates, AC adapter/charger and flexible rubber antenna for only \$104.00 per package plus \$10.00 shipping/handling. To order this special package, use CE special order number HX-650P-E.

QUANTITY DISCOUNTS AVAILABLE

Order two scanners at the same time and deduct 1%, for three scanners deduct 2%, four scanners deduct 3%, five scanners deduct 4% and six or more scanners purchased at the same time earns you a 5% discount off our super low single unit price.

NEW! Regency[®] HX2000-G

The World's First 800 MHz, Handheld Scanner
List price \$569.95/CE price \$359.00
7-Band, 20 Channel • No-crystal scanner
Priority control • Search/Scan • AC/DC
Sidelit liquid crystal display • Memory backup
Bands: 118-136, 144-174, 440-512, 800-950 MHz
The new Regency HX2000, handheld scanner covers thousands of frequencies including the new 800 MHz band. Although this scanner does not have low band, you can scan up to 20 channels at the same time. Selectable AM/FM reception modes on all frequencies. With the included AC/DC transformer, the HX2000 can be operated on either 120VAC or 6VDC. Scans 15 channels per second. Size 3" x 7" x 1 1/2". Includes wall charger, carrying case, belt clip, flexible antenna and nicad batteries.

NEW! Regency[®] RH250B-G

List price \$699.95/CE price \$379.00
10 Channel VHF synthesized transceiver
Built-in scanner with programmable priority
Fully programmable CTCSS on every channel
If you're a fireman, policeman or a person on the go and it's essential that you stay in touch with headquarters, you need the Regency RH250 transceiver. You can program simplex or semi-duplex frequencies including CTCSS tones.

OTHER RADIOS & ACCESSORIES

Z10-G Scanner.....	\$136.00
Za5-G Scanner.....	\$199.00
RPH410-G 10 ch. handheld no-crystal transceiver.....	\$399.00
B-4-G 1.2 V AAA Ni-Cad batteries (set of four).....	\$9.00
A-135-G Crystal certificate.....	\$3.00
A50-G Magnet mount mobile antenna.....	\$35.00
A70-G Base station antenna.....	\$35.00
Add \$3.00 shipping for all accessories ordered at the same time.	
Add \$3.00 shipping per scanner antenna.	

BUY WITH CONFIDENCE

To get the fastest delivery from CE of any scanner, send or phone your order directly to our Scanner Distribution Center. Be sure to calculate your price using the CE prices in this ad. Michigan residents please add 4% sales tax or supply your tax I.D. number. Written purchase orders are accepted from approved government agencies and most well rated firms at a 10% surcharge for net 10 billing. All sales are subject to availability, acceptance and verification. All sales on accessories are final. Prices, terms and specifications are subject to change without notice. All prices are in U.S. dollars. Out of stock items will be placed on backorder automatically unless CE is instructed differently. A \$5.00 additional handling fee will be charged for all orders with a merchandise total under \$50.00. Shipments are F.O.B. Ann Arbor, Michigan. No COD's. Most products that we sell have a manufacturer's warranty. Free copies of warranties on these products are available prior to purchase by writing to CE. International orders are invited with a \$20.00 surcharge for special handling in addition to shipping charges. Non-certified checks require bank clearance.

Mall orders to: Communications Electronics, Box 1045, Ann Arbor, Michigan 48106 U.S.A. Add \$7.00 per scanner for U.P.S. ground shipping and handling in the continental U.S.A. For Canada, Puerto Rico, Hawaii, Alaska, or APO/FPO delivery, shipping charges are three times continental U.S. rates. If you have a Visa or Master Card, you may call and place a credit card order. Order toll-free in the U.S. Dial 800-USA-SCAN. In Canada, order toll-free by calling 800-221-3475. WUI Telex CE anytime, dial 671-0155. If you are outside the U.S. or in Michigan dial 313-973-8888. Order today.

Scanner Distribution Center and CE logos are trademarks of Communications Electronics Inc.
Regency is a federally registered trademark of Regency Electronics Inc. AD #020185-G
Copyright © 1985 Communications Electronics

For credit card orders call 1-800-USA-SCAN

COMMUNICATIONS ELECTRONICS[™]

Consumer Products Division
P.O. Box 1045 □ Ann Arbor, Michigan 48106-1045 U.S.A.
Call 800-USA-SCAN or outside U.S.A. 313-973-8888

RADIO-ELECTRONICS

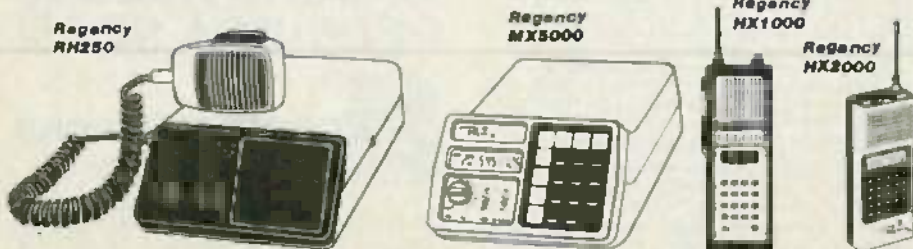

CIRCLE 79 ON FREE INFORMATION CARD

MARCH 85

**Radio-
Electronics**

Electronics publishers since 1908

Vol. 56 No. 3

SPECIAL SECTION: TEST EQUIPMENT

- 49 WHAT'S NEW IN DMM'S**
A look at the specifications and features that you should know about before you shop for a multimeter. **Herb Friedman**
- 58 WHAT'S NEW IN OSCILLOSCOPES**
The performance and features you should expect from a modern oscilloscope. **Herb Friedman**

BUILD THIS

- 43 UNINTERRUPTABLE POWER SUPPLY**
This inverter power supply can provide backup power to many AC devices from burglar alarms to emergency exit lights. **Dave Sweeny**
- 75 TAPE STREAMER FOR YOUR COMPUTER**
Part 2. Complete construction details for building a universal, high-speed cassette interface. **Mike Huddleston**

TECHNOLOGY

- 46 IN SEARCH OF FIREBALL LIGHTNING**
Ball lightning remains one of physics' biggest mysteries. But some recent experiments may answer some of our questions. **Robert K. Golka**
- 92 STEREO AUDIO FOR TV**
Part 2. The dbx noise-reduction system. **Brian C. Fenton**

CIRCUITS AND COMPONENTS

- 63 SELECTING THE BEST RESISTOR/CAPACITOR**
Part 2. This month we turn our attention to the myriad capacitor types available and how you can choose the one that's right for your application. **Victor Meeldijk**
- 67 ALL ABOUT THERMISTORS**
Part 3. Practical thermistor applications including a digital thermometer. **Harry L. Trietly**
- 80 HOBBY CORNER**
Backing up AC devices. **Earl "Doc" Savage, K4SDS**
- 88 DRAWING BOARD**
Designing with memory IC's. **Robert Grossblatt**
- 98 DESIGNER'S NOTEBOOK**
Putting an end to power supply ripple. **Robert Grossblatt**
- 102 STATE OF SOLID STATE**
Microwave PSIFET's. **Robert F. Scott**
- 105 NEW IDEAS**
An electronic watchdog.

RADIO

- 82 COMMUNICATIONS CORNER**
Half-duplex communications. **Herb Friedman**
- 100 ANTIQUE RADIOS**
Where to find antique radios. **Richard D. Fitch.**

VIDEO

- 10 VIDEO NEWS**
The present and future in the fast-changing video scene. **David Lachenbruch**
- 12 SATELLITE TV**
A look at TVRO features. **Bob Cooper, Jr.**
- 106 SERVICE CLINIC**
Op-amps in TV's. **Jack Darr**
- 107 SERVICE QUESTIONS**
Radio-Electronics' service editor answers your questions.

COMPUTERS

- Following page 88
- COMPUTER DIGEST**
How to turn your IBM PC into an Apple—and more!
- 96 COMPUTER CORNER**
Integrated software. **Lou Frenzel**

EQUIPMENT REPORTS

- 24 Valiant Telecomp 1000 Video Mixer**
- 32 Sony ICF-2002 Receiver**

DEPARTMENTS

- 128 Advertising and Sales Offices**
- 128 Advertising Index**
- 129 Free Information Card**
- 20 Letters**
- 110 Market Center**
- 108 New Products**
- 6 What's News**

Radio-Electronics, (ISSN 0033-7862) Published monthly by Gernsback Publications, Inc., 200 Park Avenue South, New York, NY 10003. Second-Class Postage paid at New York, NY and additional mailing offices. Second-Class mail authorized at Ottawa, Canada. One-year subscription rate U.S.A. and possessions \$15.97, Canada \$20.97, all other countries \$23.47, subscription orders payable in US funds only, international postal money order or check drawn on a U.S.A. bank. Single copies \$1.95. © 1985 by Gernsback Publications, Inc. All rights reserved. Printed in U.S.A. POSTMASTER: Please send address changes to RADIO-ELECTRONICS, Subscription Dept., Box 2520, Boulder, CO 80322. A stamped self-addressed envelope must accompany all submitted manuscripts and/or artwork or photographs if their return is desired should they be rejected. We disclaim any responsibility for the loss or damage of manuscripts and/or artwork or photographs while in our possession or otherwise.

COVER 1

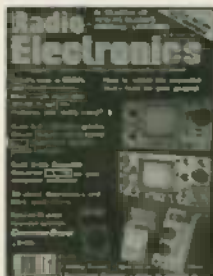

Whether you're an electronic professional, hobbyist, or student, one thing is for sure: You won't get very far without test equipment. The subjects of our special test-equipment section are also the most popular—the modern oscilloscope and the digital multimeter. In our special section, we take a look at the features that you should be familiar with and how much you can expect to pay for those features. If you're in the market for either a DMM or scope, then you'll find the section especially helpful. It starts on page 49.

NEXT MONTH

ON SALE MARCH 12

REAL TIME AUDIO ANALYZER

Adjust your equalizer for maximum performance in your listening area.

SERVICING VIDEODISC PLAYERS

The concluding installment on how to service laser and CED systems.

CELLULAR TELEPHONES

A look at the technology behind cellular phone systems.

OSCILLOSCOPE UPGRADE

Add a video-sync separator to your scope for stable displays of video signals.

AND LOTS MORE!

As a service to readers, Radio-Electronics publishes available plans or information relating to newsworthy products, techniques and scientific and technological developments. Because of possible variances in the quality and condition of materials and workmanship used by readers, Radio-Electronics disclaims any responsibility for the safe and proper functioning of reader-built projects based upon or from plans or information published in this magazine.

Since some of the equipment and circuitry described in RADIO-ELECTRONICS may relate to or be covered by U.S. patents, RADIO-ELECTRONICS disclaims any liability for the infringement of such patents by the making, using, or selling of any such equipment or circuitry, and suggests that anyone interested in such projects consult a patent attorney.

Radio-Electronics

Hugo Gernsback (1884-1967) founder
M. Harvey Gernsback, editor-in-chief
Larry Steckler, CET, publisher

EDITORIAL DEPARTMENT

Art Kleiman, editor
Brian C. Fenton, technical editor
Carl Laron, WBZSLR, associate editor
Robert A. Young, assistant editor
Julian S. Martin, editorial associate
Byron G. Wels, editorial associate
Jack Darr, CET, service editor
Robert F. Scott, semiconductor editor
Herb Friedman, communications editor
Earl "Doc" Savage, K4SDS, hobby editor
Bob Cooper, Jr., satellite-TV editor
Robert Grossblatt, circuits editor
David Lachenbruch, contributing editor
Lou Frenzel, contributing editor
Bess Isaacson, editorial assistant

PRODUCTION DEPARTMENT

Ruby M. Yee, production manager
Robert A. W. Lowndes, editorial production
Dianne Osias, advertising production
Karen Tucker, production traffic

CIRCULATION DEPARTMENT

Jacqueline P. Weaver, circulation director
Rita Sabalis, assistant circulation director
Jacqueline Allen, circulation assistant

Cover photo by Robert Lewis

Radio-Electronics is indexed in *Applied Science & Technology Index* and *Readers Guide to Periodical Literature*.

Microfilm & microfiche editions are available. Contact circulation department for details.

Advertising Sales Offices listed on page 128.

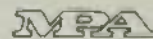

For Hz, people choose this DMM with amazing frequency.



Our 8060A has four unique buttons you won't find on any other 4½-digit handhelds.

Push the Hz button, and you're ready to measure frequencies from 12 Hz to 200 kHz.

And that's just the beginning.

Select dB for automatic conversion from voltage measurements. Continuity for quick checks for opens and shorts.

And Relative Reference for relative or offset measurements — in any function or range you're working in.

Put them together and it's obvious this is no ordinary DMM.

The 8060A also offers true RMS ac measurements, 0.04% basic dc accuracy and 10 μV resolution. Plus Fluke's traditional quality, precision, ruggedness and value. In all, the most powerful handheld DMM you can buy.

But don't take our word for it.

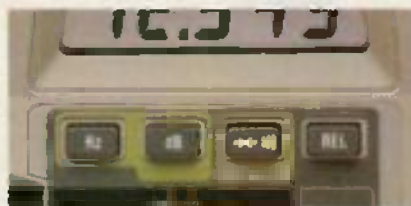

The next time you're comparing DMMs, take a closer look. Because compared to the competition, something will become very clear.

There isn't any.

That's why for Hz and many other reasons, people choose the Fluke 8060A — with amazing frequency.

To learn more about the top-of-the-line 8060A, the lower-cost 8062A and the bench/portable 8050A, contact your local Fluke Distributor, or call toll-free 1-800-426-0361.

FROM THE WORLD LEADER IN DIGITAL MULTIMETERS.

8060A DMM	8062A DMM	8050A DMM
\$349*	\$279*	\$389*
0.04% basic dc accuracy	0.05% basic dc accuracy	0.03% basic dc accuracy
Frequency measurements	Conductance	dBm readout with 16 selectable reference impedances
dBm, Relative dB	Relative reference	True rms ac
Conductance	True rms ac	Continuity and Diode test
Relative reference	Continuity and Diode test	Relative reference
True rms ac	Autorangeing megohms	True rms ac
Continuity and Diode test	One-year calibration cycle and warranty	Diode test
Autorangeing megohms	UL 1244 listed	One-year calibration cycle and warranty
One-year calibration cycle and warranty		Factory Mutual approved/CSA Certified
UL 1244 listed		

* Suggested U.S. list price

IN THE U.S. AND NON-EUROPEAN COUNTRIES:

John Fluke Mfg. Co., Inc.
P.O. Box C9090, M/S 250C
Everett, WA 98206
(206) 356-5400, Tlx: 152662

IN EUROPE:

Fluke (Holland) B.V.
P.O. Box 5053, 5004 EB
Tilburg, The Netherlands
(013) 673973, Tlx: 52237

FLUKE

Copyright © 1984, John Fluke Mfg. Co., Inc. All rights reserved. Ad No. 4701-8060

For technical data circle number 256

MARCH 1985

WHAT'S NEWS

Capacitance-coupled device may replace camera tubes

RCA has announced a new silicon imaging device that for the first time can produce color-television pictures with the image quality previously attainable only with film. This exceptional quality is largely due to the device's ability to handle bright light while at the same time producing clean images from shadows. It can practically see in the dark, producing clear images with as little as three foot-candles of light.

Under well-lit conditions, with no motion, the resolution of the RCA SID504 is about the same as that of $\frac{3}{8}$ -inch vacuum tubes. But its ability to see detail in rapidly moving objects in low light is re-

markably better than that of tubes. The signal-to-noise ratio is greater than 62 dB, about 4 to 6 dB better than the best comparable tubes. The new device also eliminates blooming, a glare caused by objects reflecting too much light into the TV camera.

These features are particularly useful in industrial surveillance and inspection, where lighting conditions are often difficult to control. Other advantages include immunity to magnetic fields and acoustic interference. And, because it is a solid-state device, the SID504 is virtually maintenance-free as compared to conventional tubes.

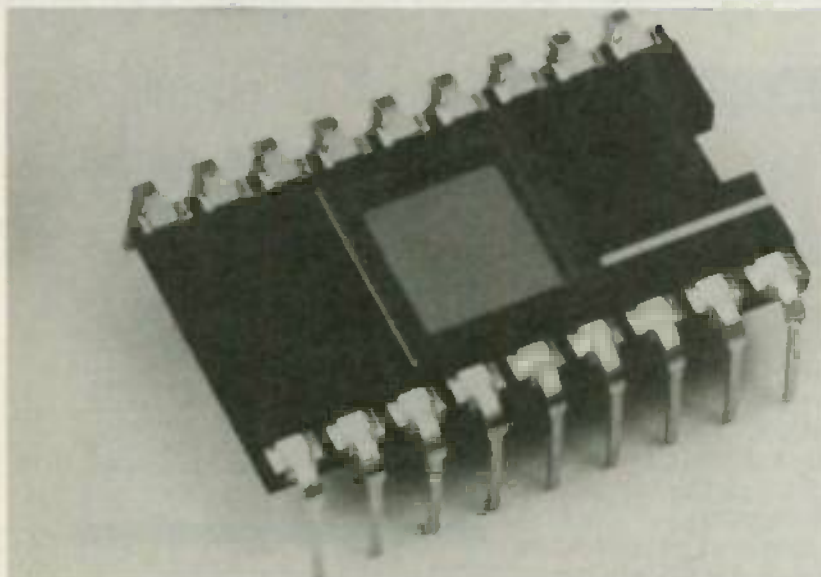

RCA'S NEW CCD IMAGING DEVICE, the SID504, produces standard 525-line video with precision. Its small size, low-light capability and freedom from lag make it especially useful in robotics, pattern recognition, industrial surveillance, and medical and scientific applications.

Columbia University opens window on Russian TV

Students and professors on the

campus of Columbia University are receiving up to 15 hours of live domestic television broadcasts a

day from Moscow. In Columbia's W. Averill Harriman Institute for Advanced Study of the Soviet Union, they are watching the programs of four "Molniya" satellites. Those satellites orbit 90 degrees apart in a highly inclined ellipse around the poles, rising as high as 40,000 kilometers (25,000 miles) at their highest point. (The popular geostationary orbit over the equator would not be practical for the Soviet Union, since so much of it lies in the far North.)

This technical breakthrough was accomplished for Columbia by a young electronics expert, Ken Schaffer. He spent three years developing the data and specialized equipment necessary to access the Molniya network that carries Moscow's Programma 1 throughout the Soviet Union.

Seemingly insurmountable problems of microwave interference in Manhattan had to be solved, as did technical difficulties of adaption: The Russian TV bandwidth is almost twice as great as the American, the signal uses circular polarization, and the color system is the French SECAM, or line sequential. The Russian system also has 625 lines, and sound is transmitted as part of the picture instead of being transmitted on a subcarrier.

Benefits of the new study, says Jonathan Sanders, director of the Institute, are many: "We will know immediately how the Soviets have or have not reacted to an event. We will learn more about how Russian is spoken. We will see how the Soviets define news, and how they use television for educational purposes. It will be a very broad exposure, from a speech by Chernenko to the Million Rouble Movie." R-E

VIDEO ACCESSORIES

■ Highest quality ■ Highest performance ■ Lowest prices

bp VIDEO-CINE CONVERTER

The BP Video-Cine Converter is an optical device that allows the easy transfer of slides, 8mm or 16mm movie film to VCR tape. The Video-Cine Converter's precision optics put the image from your movie or slide projector on a high-contrast, rear projection screen. Your video camera shoots that image, can color-correct faded pictures, add narration to other sound. Can be used with any video camera or slide projector. If your video camera lacks close-up capability, you will need a macro lens attachment.

MODEL V-1701 **\$34⁹⁵**



FOR ULTIMATE VIEWING

TEKNIKA

WIRELESS REMOTE CONTROL TV TUNER & CABLE CONVERTER WITH VOLUME CONTROL

Model 6510
\$169⁹⁵



Wireless remote control with volume for cable TV, VHF-UHF antenna systems upgrades any TV to 140 channel capability.

- Works with any TV set
- Quick, easy installation
- Off-air and cable compatible
- Quartz frequency synthesizer tuning
- Direct access/memory scan selector
- Ultra-compact, hand-held wireless remote control



61 CHANNEL WIRELESS REMOTE CONTROL

Model V7661 **\$79⁹⁵**



Wireless remote control on/off, channel selection and fine tuning.

- Works with any TV
- 61 channel capability
- Microcomputer controlled PLL operation
- Converter panel controllable for channel up, down, on/off, fine tuning
- LED display
- Compatible with CATV systems.



STABILIZER/IMAGE ENHANCER/RF CONVERTER/VIDEO FADER/2-WAY DISTRIBUTION AMPLIFIER

Model V1880 **\$99⁹⁵**



Hook-up cable kit
\$11.75

The most versatile, all-in-one video processor. Can be used as a video guard remover for video tapes, enhancer, video to RF converter, professional video fade in and out and a dual output distribution amplifier.



VIDEO SWITCH

Model V4804 **\$49⁹⁵**



Record a pay channel while viewing a standard channel. You can also connect an antenna/cable, VCR, video disc player, home computer and video game.



VIDEO TAPE REWINDER

Model V7777 VHS **\$49⁹⁵**

Model V7778 BETA **\$49⁹⁵**



Reduce wear and tear of your VCR heads with the AC powered circuit protected rewinders. LED power-on indicators.

Charge it with VISA/MASTERCARD. Phone orders accepted.

Fordham

260 Motor Parkway, Hauppauge, NY 11788

Toll Free
800-645-9518
In NY State 800-832-1446

FOR ORDERS	ADD
\$25-250	\$4.50
\$251-500	\$6.50
\$501-750	\$8.50
\$751-1,000	\$12.50
\$1,001 and up	\$15.00

Buying our reputation



Introducing a broad, new line of multi-feature, cost-competitive instruments from Beckman Industrial Corporation.™

They're in stock now and as close as your local Beckman Industrial Corporation distributor. Just walk in and choose the instruments that provide the features and functions you need. Then buy them and take them home, or to work. No more ordering and waiting.

Whichever instruments you choose, you'll be buying our reputation for high quality and reliability, plus straightforward, easy operation.

And you'll be getting it all for a very afford-

able price. In fact, you'll have a hard time finding comparable instruments that offer as much functionality and qual-

All of which makes this line of instruments an exceptional value.

Choose between our 100MHz or 60MHz advanced design oscilloscopes. Both provide professional grade performance. Both also feature dual time base and three channels.

The UC10 Universal Counter measures unit count, period, time interval and frequency to 100MHz. And the FG2 Function Generator produces sine, triangle and rectangular waves up to 2MHz and at continuously variable duty cycl-

on just got easier.



Our new circuit-powered LP10 Logic Probe is the ideal, low cost way to check TTL, DTL, HTL and CMOS signals.

The CM20 Capacitance Meter is a low cost, hand-size meter that lets you measure capacitance up to 2000 μ F, easily and quickly.

The CT233 AC/DC Current Clamp enables you to use your digital multimeter to measure AC or DC current without breaking the wire.

Plus every instrument is designed, manufactured, and tested to ensure years of trouble-free, reliable operation.

And whichever products you buy, service

and parts will be available close to home from your local Beckman Industrial Corporation distributor.

Now it's easier than ever to buy the name with a reputation for the best quality – and value – in electronic and electrical instruments: Instrumentation Products Division, Beckman Industrial Corporation, A Subsidiary of Emerson Electric Co., 630 Puente Street, Brea, CA 92621, (714) 773-8111.

Beckman Industrial™

©1984 Beckman Industrial Corporation

CIRCLE 98 ON FREE INFORMATION CARD

VIDEO NEWS



DAVID LACHENBRUCH
CONTRIBUTING EDITOR

• **8mm Video growing.** That off-again on-again 8mm video fever seems to be on again. In the past, the tiny-cassette format has received only half-hearted support from major Japanese VCR manufacturers. But now, Sony appears to be backing it with great enthusiasm, and reportedly is changing over one production line from Betamax to 8mm video—and is capable of turning out nearly 2,500,000 of the new-type VCR's in a year. Sony's first 8mm product is expected to be an extremely lightweight (less than 4 pounds) camera-recorder combination. Sony will also make camcorders for sale under the Fuji and Yashika brands, and supply Pioneer with basic components to make a tiny home-VCR deck. Eastman Kodak is already marketing an 8mm camcorder in the U.S. made by Mitsushita, and General Electric plans to sell a similar one. Polaroid is due to begin sales of a Toshiba-made version here early this year, and Sanyo plans to offer a 4½ pound portable 8mm deck soon.

• **More camcorders coming.** Although sales of portable VCR's and cameras last year failed to keep up with booming increases in AC-only video recorders, combinations of the two items—

Movie, being sold under JVC and Zenith brand names, and 8mm Video camcorders launched late in the year by Kodak and General Electric.

This year should see virtually every brand offering its own camcorder. RCA has now confirmed the report in this column that it will introduce a one-piece unit combining a camera with a VCR that can accommodate a full-sized VHS cassette. The RCA unit, and some other VHS camcorders to be marketed this year, are expected to play back as well as record. Betamovie is a record-only system, requiring a Beta deck for playback. VHS-C Video Movie records and plays back, but accommodates only 20-minute cassettes compatible with home VHS decks when placed in an adaptor. The 8mm Video record-and-playback camcorders accept the new small cassettes, which at press time were available with maximum recording time of 90 minutes, but a two-hour cassette is scheduled to become available this year.

• **More digital TV's.** As new digital-TV sets are announced, it is becoming clear that a wide variety of different features will be available under different brand names. In Japan, Sony introduced two component video systems, with 13- and 20-inch monitors, accompanied by a companion scan converter that changes the incoming 525-line signal to a non-interlaced picture with 1,050 lines—double the scan rate.

Next fall, Mitsubishi plans to introduce a digital set that will place up to nine TV-pictures on the screen—scanning all nine channels with a single tuner and refreshing the slow-scan pictures every four seconds. A single video source, such as a VCR, may be used to provide sort of a comic-strip effect, with nine sequential still-pictures frozen at pre-set intervals that can be as short as 1/30 second.

The Panasonic and Toshiba digital TV's are both designed to display a smaller picture from a video device in any corner of the screen, and freeze the picture on command. **R-E**

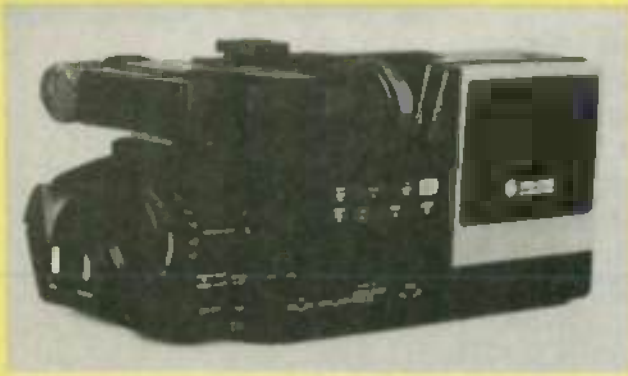

camcorders—met initial consumer acceptance. The trail was blazed by Betamovie (sold by Sony, Sanyo, NEC, Toshiba, and others), and was followed by the highly successful VHS-C Video

LITTLE THINGS MEAN A LOT

Being the first company to make solderless breadboards isn't necessarily what makes us the best. It's all the little things you don't see, like our spring clip terminals, that make AP PRODUCTS ACEBOARDS so big on reliability.

From our largest ACEBOARD with over 5000 tie points, to a single tie point block, our spring clip terminals give you nothing but good, solid contact on every connection. They accommodate a wide variety of leads and have the best electrical properties, because our spring clips are solid alloy, not plated nickel. We've even developed enough normal force to break through any oxides which could occur on solder plated leads. You've come to trust our test clips for the same reason.

Since one bad connection can ruin a whole circuit, we pay close attention to how well our spring clip terminals sit within the insulator cell areas. Spring clip edges are never exposed at the insertion window.

For the name of the distributor nearest you, call TOLL FREE (800) 321-9668. (In Ohio, call collect (216) 354-2101).



A P PRODUCTS INCORPORATED

9325 Progress Parkway, Box 540
Mentor, Ohio 44060, (216) 354-2101
TWX: 810-425-2250
In Canada, call Lanbrook Electronics • (416) 477-7722

CIRCLE 76 ON FREE INFORMATION CARD

Leads won't buckle, clips won't oxidize, it all adds up to longer life.



Even from the outside there's more to an ACEBOARD than meets the eye. Our durable Acetal Copolymer plastic body is a good insulator with excellent dielectric properties.

And special manufacturing techniques in the insertion of the contacts into the plastic body insure that your Breadboard will always remain flat. No skimpling or planned obsolescence here. Again, just good solid contact on every connection.

Turn our breadboard body over...and you'll discover another key to it's reliability. The double-sided adhesive foam you'll

see there is more than a pressure sensitive mount. It also insulates to prevent shorts and seals the bottom of the individual spring clip cells.

If solder shavings from resistors or component leads drop into the cell, they can't spread into other cells to short them out.

Take a close look at our ACEBOARDS. AP PRODUCTS has the biggest and most complete line of

ACEBOARD sizes. It's also our commitment to you that if your ACEBOARD doesn't



This coupon is worth 10% off the purchase price of any size ACEBOARD or Breadboard product. Offer expires 4/30/85.

Your Name _____

Address _____

City _____ State _____ Zip _____

Dealer Name _____

ACEBOARD # _____

Limit 6 ACEBOARDS or Breadboards per coupon. Offer valid only at participating AP PRODUCTS distributors. RE 385

MARCH 1985

SATELLITE TV



BOB COOPER, JR.*
SATELLITE TV EDITOR

TVRO receivers and remote controls

IN THE FIRST INSTALLMENT OF "SATELLITE TV," we took a "then-and-now" look at the typical home TVRO-system, concentrating on in-home TVRO-system mounts and feeds. We continued that comparison with an emphasis on LNA's and motor drives. We'll complete our analysis by concentrating on the TVRO receiver (ie. demodulator), as well as some of the new features that have turned the system into a real consumer item. Let's deal with home receiver pricing right up front because there is a strong message there!

TVRO receivers

The first home TVRO-systems were sold by Scientific-Atlanta in the summer of 1979. No other firm was offering a home TVRO-package at that time. (You may recall that the Neiman-Marcus Christmas catalog for 1979 featured the Scientific-Atlanta system priced at \$6500.)

Those early terminals were being sold with 15-foot dish antennas, a pair of LNA's—one for each of two polarizations (horizontal and vertical)—hardline coaxial cable, and typically four single-channel (tuned and forgotten) receivers.

Each receiver was equipped with a single channel MATV-style modulator. What you ended up with, by today's standards, was an "SMATV" (Satellite Master Antenna TeleVision) system. Standard RG-59/U cable running throughout the house distributed the four VHF channels to multiple

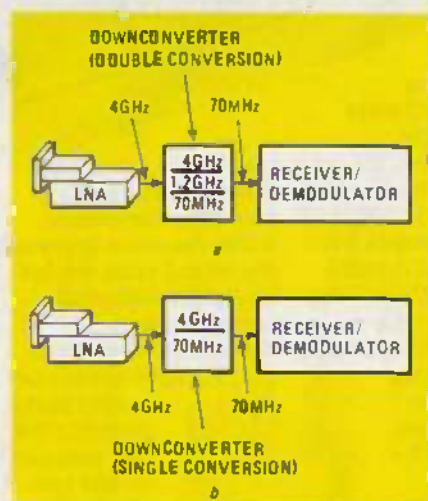

FIG. 1

outlets in the building.

As the "real" home TVRO-industry began late in 1979, system designers saw the Scientific-Atlanta home-TVRO's \$6500 price tag as the number to beat. In the fall of that year, one of the first home-style TVRO receivers was being produced by AVCOM (a small firm in Virginia). The price for the AVCOM package was extremely close to \$3,000. A real bargain, considering that a similar-featured, "commercial-grade" receiver from Scientific-Atlanta cost about twice as much.

Early receivers from AVCOM (International Crystal Manufacturing/ICM) were similar in design to existing Scientific-Atlanta and Microdyne professional receivers. The 4-GHz microwave signal, after being amplified by an LNA located at the dish antenna (see December's column), was transported inside the home through large (1/2- or 3/8-inch diameter) hardline coaxial cable.

That signal was then fed to an indoor receiver, with the downconverter mounted inside the same cabinet.

By early 1980, an engineer with the Harris Corporation, named Clyde Washburn, had completed his own receiver design. Washburn took the downconverter out of the receiver cabinet and made provisions to mount it outside, at or near the antenna. That started a modest revolution in receiver design.

Taking the downconverter out of the receiver cabinet and placing it closer to the antenna meant that long runs of expensive and hard-to-handle coaxial cable could be eliminated. Those early units used a double-conversion system that downconverted the 4-GHz microwave signal to the 70-MHz IF in two steps, as shown in Fig. 1-a. In short order, virtually all home-style receivers would be designed in the same way.

However, the big breakthrough came in mid-1980 when an Arizona microwave engineer—David Barker—revealed a new circuit for what he called single conversion. (Up to then, all downconverters were the double-conversion type.) Barker had worked out an acceptable way to reduce the 4-GHz microwave signals to the intermediate frequency (70 MHz) all in one step (see Fig. 1-b). That single-conversion unit suddenly made it possible for receivers to be built using about half the parts found in traditional dual-conversion models offered by AVCOM and others.

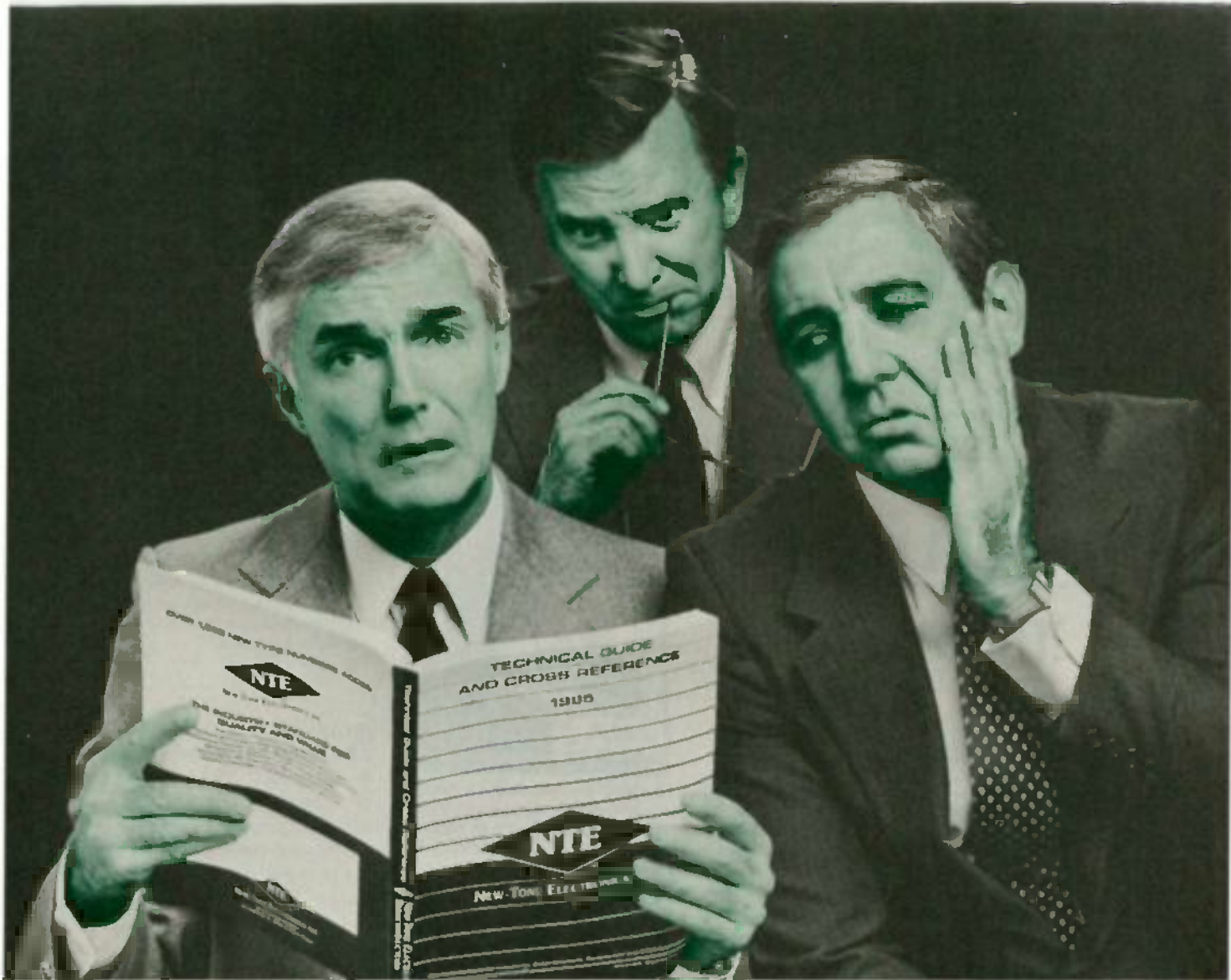

WE'RE TURNING THE COMPETITION GREEN WITH ENVY.

NTE is the red hot success story of the electronics industry and the big boys are green with envy. They don't like the fact that we've built our reputation on giving you more of what you're looking for in a replacement part. More quality. More reliability. And, more parts to choose from. That's why more and more technicians across the country are picking the package with the green NTE diamond on the front.

NTE parts are extensively tested on state-of-the-art equipment during every phase of production to ensure top performance — performance that's backed by the industry's only two year warranty.

What's more, NTE uses a special computer controlled inventory system, so when you replace or design with NTE, you can be sure that the part you need is on your distributor's shelf. Our new 1985 Technical Guide and Cross Reference manual, which has over 3,100 NTE types cross-referenced to over 220,000 industry part numbers, is now available.

Why settle for our competitor's parts when you get more quality and service with NTE? Look for NTE's replacement parts in the bright green polybags and cartons at your distributor today. Don't forget to ask about our new Flameproof Resistors and Wire Ties, too!



NEW-TONE ELECTRONICS, INC.
 44 FARRAND STREET, BLOOMFIELD, NEW JERSEY 07003
 CIRCLE 265 ON FREE INFORMATION CARD

Now the home TVRO-industry was really off and running! From double-conversion to single-conversion, there has been a steady progression of receiver innovations and reductions in parts count. The receiver of 1984 has about one-third the parts found in the 1980 (dual-conversion) models. A receiver with more features, considerably more consumer appeal and greatly simplified operation now costs TVRO dealers under \$300. Yet, they offer features

that were totally out of reach in 1980, for example:

- Scan tuning: The receiver repeatedly scans through the full 12/24 transponder channels looking for signals—a helpful feature when moving the dish in search of new satellite programming.
- Automatic polarization: The receiver knows, from a pre-programmed memory, the correct polarization (vertical or horizontal) and directs the feed system (Polarotor or similar device) to the

TVRO dealer "Starter Kit" available

Bob Cooper's *CSD Magazine* has arranged with a number of TVRO equipment suppliers to provide a single-package of material that will help introduce you to the world of TVRO dealership. A short booklet written by Bob Cooper describes the start-up pitfalls to be avoided by any would-be TVRO dealer. In addition, product data and pricing sheets from prominent suppliers in the field are included. That package of material is free of charge and is supplied to firms or individuals in the electronics service business as an introduction to the 1984-85 world of selling TVRO systems retail.

You may obtain your *TVRO Dealer Starter Kit* free of charge by writing on company letterhead, or by enclosing a business card with your request. Address your inquiries to: *TVRO STARTER KIT*, P.O. Box 100858, Fort Lauderdale, FL 33310. That kit not available to individuals not involved in some form of electronics sales and service.

SATELLITE TV/

The First Five Years!



THE MOST COMPLETE report on the mushrooming home TVRO industry ever compiled, written as only the 'father of TVRO' could have prepared. More than 1000 pages (!) tracing the complete story of home TVRO, lavishly illustrated with equipment photos, schematic diagrams, equipment analysis reports. Bob Cooper, the first private individual to own and operate a TVRO (1976) has collected and polished hundreds of individual reports into a unique 'collector's edition' which clearly explains the TVRO phenomenon in North America. From Coop's first 20 foot 'monster' dish to the present day 5 foot 'C-band' TVROs, the fascinating growth of TVRO equipment and its legal status unfolds for you.



THIS TWO VOLUME SET totaling more than 1,000 pages is available for the first time to readers of *Radio-Electronics* at special discount pricing. Originally sold at \$100 per two-volume set, a limited supply is now available ONLY through this advertisement. PLUS, you will also receive a special extraordinary bonus: the 200 page (+) October 1984 edition of *CSD Coop's Satellite Digest*. This very special edition of *CSD* is a best-seller in the TVRO industry, with the most comprehensive collection of TVRO facts and figures ever compiled. Combined with the 1,000 page 'CSD ANTHOLOGY' report, you have instant reference to everything you will ever need to know about the state of the home TVRO industry. It is MUST reading for every person in, or thinking about 'getting into,' any segment of the home TVRO world.

proper polarization at the antenna each time the channel is changed.

- Automatic fine tuning: Quartz or synthesized tuning is now available in many receivers. That means when the user changes channels, he is moving in precise "channel steps." The receiver is also equipped with an automatic frequency-control (AFC) so that fine-tuning is eliminated.

- Full audio tuning: Since audio subcarriers can be transmitted on any subcarrier frequency between 5.5 and 8.5 MHz, it no longer is adequate to have a simple preset audio subcarrier-tuner that is dedicated to a single subcarrier (such as 6.8 MHz). Receivers now tune the full range, and many have memories, so that when you switch the master channel selector to a specific transponder (on a specific satellite), the audio comes up automatically.

Those four features combine to make a "user-friendly" unit. The viewer need only change the channel and the receiver (with its memory or seeking circuits) does the rest. Much of that has happened because of the creation of IC devices that are either designed for (or adapted to) digital control-circuits. But there have been refinements within the basic receiver as well! We'll look at those next month.

R-E



___ SEND CSD ANTHOLOGY/2 Vols. + CSD Bonus.
___ SEND CSD October '84 Special Issue ONLY.

NAME _____ COMPANY _____

ADDRESS _____

CITY _____ STATE _____ ZIP _____

Payment: \$60 US funds (Anthology + Bonus), \$15 US funds CSD Oct. ONLY; payable "CSD ANTHOLOGY."

Shipping charges pre-paid. Enter order to: CSD Anthology, Radio-Electronics Magazine, 200 Park Av. S., New York, NY 10003; or call 305-771-0505 for credit card orders ONLY.

ZORBA

PORTABLE COMPUTER

THE EXPERTS' CHOICE

FEATURES:

9" GREEN OR AMBER CRT
 19 INDEPENDENT 55 PROGRAM-
 MABLE FUNCTION KEYS
 TWO 400K D5DD DRIVES
 64K BYTES 200 NS RAM
 C BASIC COMPILER
 IEEE 488 BUS MASTER PORT
 24.6 LBS
 CPM 2.2 OPERATING SYSTEM
 M80 (L80, LIB80, CREF80)
 SOURCE CODE OF THE BIOS
 PLUS UTILITIES
 DATA COMMUNICATIONS
 SETUP PACKAGE
 SERIAL & PARALLEL
 PRINTER PORT
 DATA COMMUNICATION PORT

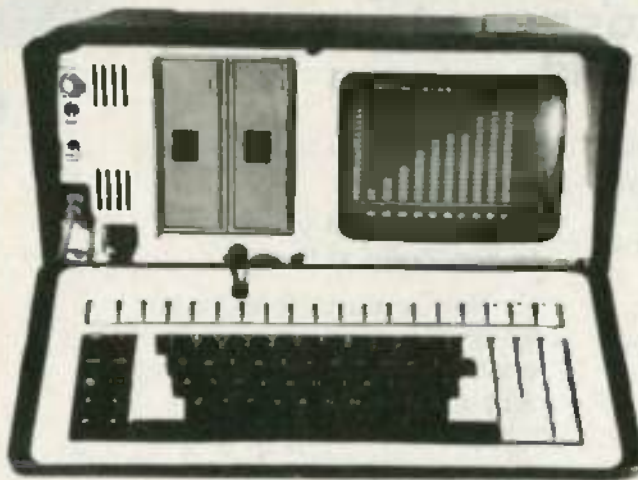

OPTIONS:

- 16 BIT 256K RAM UPGRADE (8088 CPU) \$600.00
- 800K D5DD 96TPI DRIVES \$300.00
- COMPOSITE VIDEO OUTPUT \$100.00
- SOFT VINYL CASE \$25.00
- TUTOR KIT; \$15.00 (CPM, WORDSTAR, CALCSTAR)
- SCHEMATIC SET \$5.00
- 10MB HARD DISK DRIVE

VISA/MC

BUNDLED WITH
 WORDSTAR, MAIL MERG, SPELLSTAR,
 DATA STAR, REPORTSTAR, CALCSTAR

\$799.00

W/O Bundle

DEALER INQUIRIES INVITED

\$999.00

With Bundle

General Specifications

ZORBA is the lowest cost full featured portable computer. This light weight computer is ruggedly packaged in a convenient carrying case. The case surrounds strong inner chassis which further protects the Z80A based computer with its 64K double sided double density disk drives, large easy to read 9" display screen and well designed detachable keyboard.

ZORBA uses CP/M, the industry standard operating system, which means that a wide range of existing software is readily available to the user.

The ZORBA users manual covers operation of the unit, all supplied software and interface and internal information. A system diskette is supplied with all system files and utilities. A second diskette contains the sources for all ZORBA software including BIOS, SETUP, FORMAT, and PATCH.

Keyboard

Keyboard communicates serially with CPU
 Detachable with 2 foot coiled cord
 95 keys in standard QWERTY format
 13 Key Numeric Pad
 Independent Caps Lock and Shift Lock
 55 Software programmable function keys
 All keys auto-repeat after 1 second delay
 All Standard cursor and terminal control keys

Disk System

Controller: WD1793
 Drives: 5.25 Double Sided,
 Double Density, 400K
 48 TPI

Built-in disk interchange formats: Xerox 820 (SD, DD), Kaycomp (DD), DEC VT-180 (SD), Osborne (SD) and IBM-PC (eg. CPM/86) and Televideo 802 (Read/Write and Format compatibility) (Expandable to 61 Formats)

Specifications

General Mechanical and Electrical

Width - 17.5 inches (44.45 cm)
 Height - 9.0 inches (22.86 cm)
 Depth - 18.0 inches (45.72 cm)
 Weight - 24.6 pounds (11.1 Kg)
 Power - 80-130 VAC or 190-245 VAC
 50/60 Hz
 170 watts max

Display

Display Tube:
 9" diagonal, Green or Amber
 High resolution display circuitry
 60 Hz refresh rate

Display Format:

25 lines x 80 columns
 5x7 Character Font with full descenders
 128 ASCII Characters
 8x32 Characters Graphic Font
 2K Memory Mapped Display Buffer

CPU Board

Z80A CPU running at 4 Mhz with no wait states
 64K bytes of 200 ns RAM (58K after CP/M loaded)
 16K bytes of EPROM (2732) can be switched in and out by software
 12K available for user EPROMS
 8275 CRT controller, DMA driven
 1793 Floppy disk controller, SMC data separator
 Bipolar proms configure 10 addresses
 Fully structured interrupts prioritized by bipolar proms

Interfaces

- Full asynchronous RS232 port with modem control, Baud rates and data translation and protocol programmable
- Full asynchronous full duplex RS232 port with hardware handshake (for printers), Baud rates and protocol programmable, (Serial Printer Port)
- One 8 Bit parallel port with independent strobe and ready lines. Supports Centronics interface with an available adaptor cable.
- IEEE 488 Bus Master Port (ie: General Purpose Instrumentation Bus) not Software Supported.
- 21 Standard Software Programmable Baud Rates: 45.5 to 19,200 BPS



GEMINI ELECTRONICS, INC.

130 Baywood Avenue, Longwood, Florida 32750
 305-830-8886 800-327-7182

CIRCLE 272 ON FREE INFORMATION CARD

Learn robotics and you build this

New NRI home training prepares you for a rewarding career in America's newest high-technology field.

The wave of the future is here. Already, advanced robotic systems are producing everything from precision electronic circuits to automobiles and giant locomotives. By 1990, over 100,000 "smart" robots will be in use.

Over 25,000 New Jobs

Keeping this robot army running calls for well-trained technicians . . . people who understand advanced systems and controls. By the end of the decade, conservative estimates call for more than 25,000 new technical jobs. These are the kind of careers that pay \$25,000 to \$35,000 a year right now. And as demand continues

to grow, salaries have no place to go but up!

Build Your Own Robot As You Train at Home

Now, you can train for an exciting, rewarding career in robotics and industrial control right at home in your spare time. NRI, with 70 years of experience in technology training, offers a new world of opportunity in one of the most fascinating growth fields since the computer.

You need no experience, no special education. NRI starts you at the beginning, takes you in easy-to-follow, bite-size lessons from basic electronics right on through



key subjects like instrumentation, digital and computer controls, servomotors and feedback systems, fluidics, lasers, and optoelectronics. And it's all reinforced with practical, hands-on experience to give you a priceless confidence as you build a programmable, mobile robot.

Program Arm and Body Movement, Even Speech

Designed especially for training, your robot duplicates all the key elements of industrial robotics. You learn to operate, program, service, and troubleshoot using the same techniques you'll use in the field. It's on-the-job training at home!



You get and keep Hero 1 robot with gripper arm and speech synthesizer, NRI Discovery Lab for electronic experimentation, professional multimeter with 3½-digit LCD readout, 51 fast-track training lessons.

Industrial control as

Building this exciting robot will take you beyond the state of the art into the next generation of industrial robotics.

You'll learn how your completely self-powered robot interacts with its environment to sense light, sound, and motion. You program it to travel over a set course, avoid obstacles using its sonar ranging capability. Program in complex arm and body movements using its special teaching pendant. Build a wireless remote control device demonstrating independent robot control in hazardous environments. You'll even learn to synthesize speech using the top-mounted hexadecimal keyboard.

Training to Build a Career On

NRI training uniquely incorporates hands-on building experience to

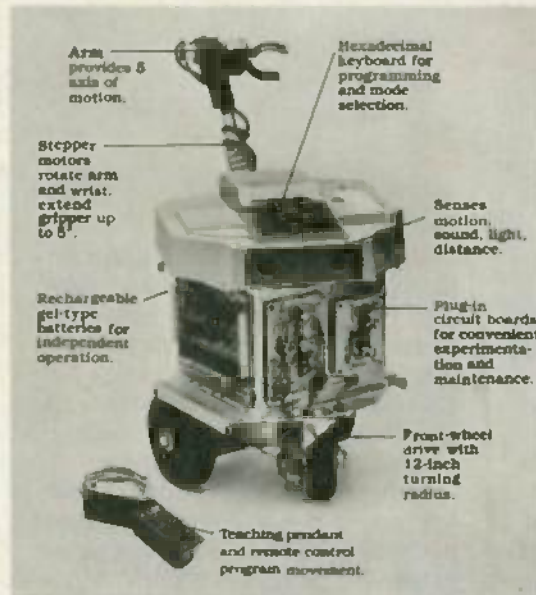

Your mobile robot duplicates functions of state-of-the-art industrial units.

reinforce your learning on a real-world basis. You get professional instruments, including a digital multimeter you'll use in experiments and demonstrations, use later in your work. And you get the exclusive NRI Discovery Lab[®], where you examine and prove out theory from basic electrical concepts to the most advanced solid-state digital electronics and microprocessor technology. Devised by an experienced team of engineers and educators, your

experiments, demonstrations, and equipment are carefully integrated with 51 clear and concise lessons to give you complete confidence as you progress. Step-by-step, NRI takes you from the beginning, through today, and into an amazing tomorrow.

Send for Free Catalog Now

Send for NRI's big free catalog describing Robotics and Industrial

Control plus over a dozen other high-technology courses. You'll see all the equipment you get in detail, get complete descriptions of every lesson, find out more about career opportunities for trained technicians. There's no cost or obligation, so send today. Your action today could mean your future tomorrow. If the card has been removed, please write us today.

NRI NRI SCHOOLS
 McGraw-Hill Continuing Education Center
 3939 Wisconsin Ave.
 Washington, DC 20016

WE'LL GIVE YOU TOMORROW.



LETTERS

WRITE TO:

LETTERS
Radio-Electronics
200 Park Ave South
New York, NY 10003

HIGH POWER FET AUDIO AMPLIFIER

A couple of errors have been called to our attention regarding the high-power audio amplifier schematic that appeared in our December and January issues. First, the outputs of the power supply were shown as -75 volts. Only two of them should be—the upper two are $+75$ -volt outputs. Also, the neon lamps shown should really be pilot lamps (which include current-limiting resistors). Q5–Q8 are 2N5087 transistors. The schematic showed them incorrectly.

The parts-placement diagram that appeared in the January issue also had an error: The base and collector leads of Q10 should be exchanged. Note that the leads for Q9 and Q10 are not in the standard plastic-package configuration. Be careful when you install them.

In the "Checkout Procedures" section (in the January issue), one of the procedures (in the last paragraph on page 60) should have read: "Connect the collector of Q4 to the collector of Q3." On page 62, we told you to install a 1-mA fuse for F2. We should have told you not to install anything—

just use the F2 position to measure for 500 mA.

STATIC ELECTRICITY MYTH

I must dispute the myth, repeated in Mr. Kanter's article "Curing Static Electricity," (Radio-Electronics, August 1984), that relative humidity is the dominant factor in controlling the buildup of static electricity.

My statements are based on 50 years of experience in the manufacture of photographic films. Those films are very susceptible to damage by static discharges, and could never be handled at 72°F and

Be Sure... with RCA's Antistatic Kit.

Protect static sensitive devices from costly damage.

Electrostatic charges build up all around the work environment, posing a constant threat to static sensitive devices.

RCA's Antistatic Kit (Stock No. 162351) protects these devices from the damaging effects of static buildup. The kit consists of a static dissipative mat, a lightweight wrist strap and coil cord, and a six-foot grounding cable that safely drains electrostatic charges to ground.

No matter what kind of static sensitive



devices you test, repair, or work with, you need RCA's Antistatic Kit working for you. See your RCA Parts Distributor; or for more information write RCA Distributor and Special Products Division, 2000 Clements Bridge Road, Deptford, NJ 08096-2088. Attention: Sales Promotion Services.

RCA Distributor and
Special Products Division

50% relative humidity as suggested by National Fire Protection Association and mentioned in the article.

The safe relative humidity varies with temperature and barometric pressure.

At sea level the following conditions are normally safe: 70% relative humidity at 70°F, 60% relative humidity at 75°F, 10% relative humidity at 135°F.

The last condition was for drying treatments (containing acetone and methanol) on cellulose acetate film base. An attempt to operate at 8.5% relative humidity resulted in fires and/or explosions about once a month.

At the elevation of Mexico City (7800 ft.), the safe operating conditions are 54% relative humidity at 70°F.

CHESTER E. ROSE, P.E.
Montrose, PA

TELEPHONE VOLUME CONTROL

Now that the door has been opened for telephone add-ons with your article "Tele-Toll Timer," (Radio-Electronics, November 1984), I would like to ask you or any of the readers if they could help solve a problem. With the cost of extension phones now so reasonable, it is convenient to have more than one phone on line. But, in my area, if more than one phone is picked up at the same time, the volume of the receiver drops drastically. My question is: Do you or any of your readers know of a device or circuit that will eliminate that problem?

RAY BLACKBURN
Lakewood, CA

SCHEMATIC NEEDED

I'm repairing a portable National Panasonic T-430 and am in need of a schematic and service manual for it. The radio was purchased in the United States. Can anyone help me with that? I can pay a fair sum for a repair manual if necessary. Thank you.

JUAN MACHADO
Calle Infantil No.63 Santa Rosa-
Maracay Aragua 2104-Venezuela

"SELLING OUT?"

I'm not old enough to have been a subscriber to your magazine

when "Hi-Fi" came along. I don't even go back far enough to remember reading your "Letters" columns when television first appeared, but I bet that if you look through those past issues you'll find letters accusing you of "selling out" to special interests by carrying articles about Hi-Fi or television.

Computers are a very large part of current electronics. But they are not all of electronics, and I'm glad to see Radio-Electronics cover vari-

ous other fields as well.

Please continue to provide computer articles which are hardware and construction-project oriented. Most of the "computer" magazines only talk about new equipment, new software, and programming techniques. Articles about interfacing and building hardware add-ons are non-existent—Except in Radio-Electronics!

Keep up the good work!
NOEL NYMAN
Seattle, WA

R-E

... Over 3,000,000 Sold and Still The
Best General Purpose Multimeter! ...



The Reason
Is Clear . . .

Simpson
260® VOM
Has Features
No Digital
Can Match!



Latest
260®
Series 7
\$119

"Instant" null, peak, trend and continuity indications
High immunity to transients, RF interference
dB measurement capability at no extra cost
Resistance indication from zero to infinity
Self-powered voltage, current and dB ranges—no batteries to fail
Reliable, accurate performance even under extreme environments
Easy, low-cost maintenance—no expensive "chips" to fail
UL Listed per UL-1244 Standard for Safety—Electrical and
Electronic Measuring and Testing Instruments
Complete line of UL recognized accessories
Options include mirrored scale, extra overload protections, roll top
carrying case

See the World Famous 260 Series 7, the 260-6XL, the 270 and the Pocket-Size 160®
at Leading Electronics/Electrical Distributors



SIMPSON ELECTRIC COMPANY

A Katy Industries Subsidiary

853 Dundee Avenue, Elgin, IL 60120
(312) 697-2260 • Telex 72-2416 • Cable SIMELCO

Canada: Bach-Simpson Ltd., London, Ontario
England: Bach-Simpson (U.K.) Ltd., Wadebridge, Cornwall

CIRCLE 273 ON FREE INFORMATION CARD

MARCH 1985

21



- 77
- 0.3% Accuracy
 - Manual or Autorange
 - 10A + mA Range
 - Beeper
 - "Touch-Hold" Function

Sale
\$119.95

WE CARRY A FULL LINE OF FLUKE MULTI-METERS. IN STOCK NOW

Sale ends April 85

FLUKE 70 SERIES MULTIMETERS

- Analog Display • Rotary Knob • Volts AC & DC • Resistance to 32 MΩ • 10 Amps • Diode Test • 3200 Counts • Fast Autoranging • Function Annunciators in Display • Power-Up Self Test • 2000+ Hour Battery Life w/ Power Down "Sleep Mode" • New Test Leads • VDE & UL Approval



\$99.00

75

- 0.5% Accuracy
- Manual or Autorange
- 10A + 300 mA Range
- Beeper



\$79.95

and free C70 holster 73

- 0.7% Accuracy
- Autorange Only
- 10 Amp Only

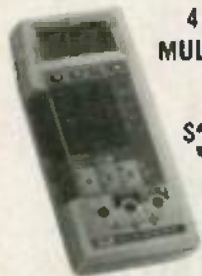

4 1/2 DIGIT MULTIMETERS

\$349.00

MODEL 8060A



- Frequency measurements to 200KHz
- dB measurements
- Basic dc accuracy 0.4%; 10μV, 10 nA and 10 mΩ sensitivity
- Relative measurements
- True RMS
- High-speed Beeper

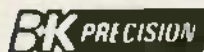

POWER SUPPLIES



\$299.95 MODEL 1601

- Isolated 0-50VDC, continuously variable; 0-2A in four ranges
- Fully automatic shutdown, adjustable current limit
- Perfect for solid state servicing



\$329.95 MODEL 1650

- Functions as three separate supplies
- Exclusive tracking circuit
- Fixed output 5VDC, 5A
- Two 0 to 25VDC outputs at 0.5A
- Fully automatic, current-limited overload protection

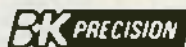

INDUSTRIAL TRANSISTOR TESTER



\$199.95

MODEL 520B

- Now with HI/LO Drive
- Works in-circuit when others won't
- Identifies all three transistor leads
- Random lead connection
- Audibly and visually indicates GOOD transistor



70 MHz Dual Time Base SCOPE

MODEL 1570

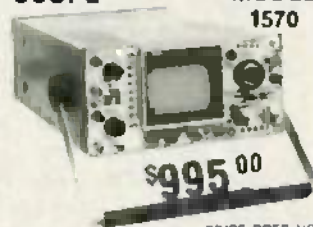

\$995.00

PRICE DOES NOT INCLUDE PROBE!

- 1mV/division sensitivity to 70 MHz
- 500 μV/division cascade sensitivity
- Four-input operation provides trigger view on 4 separate inputs
- Alternate time base operation
- Switching power supply delivers best efficiency and regulation at lowest weight



FUNCTION GENERATORS

\$189.95

MODEL 3010

- Sine, square and triangle output
- Variable and fixed TTL outputs
- 0.1 Hz to 1MHz in six ranges
- Push button range and function selection
- Typical sine wave distortion under 0.5% from 1 Hz to 100kHz

MODEL 3020 **\$319.95**

SWEEP FUNCTION

- Four instruments in one package — sweep generator, function generator, pulse generator, tone-burst generator
- Covers 0.02Hz-2MHz
- 1000:1 tuning range
- Low-distortion high-accuracy outputs



CAPACITANCE METERS **\$199.95**

MODEL 830

- Automatically measures capacitance from 0.1pF to 200mF
- 0.1pF resolution
- 0.2% basic accuracy
- 3 1/2 digit LCD display



MODEL 820

- Resolves to 0.1pF
- 4 digit easy-to-read LED display
- Fuse protected against charged capacitors
- Overrange indication

BECKMAN'S CIRCUITMATE® ALL UNDER \$100

AVAILABLE NOW...



\$64⁹⁵

Circuitmate DM 20—
3½-digit, pocket-size
multimeter; 0.8% Vdc
accuracy, diode test,
hFE test, conductance,
10 amps AC and DC
ranges, auto-polarity,
auto-zero, auto-
decimal



\$79⁹⁵

Circuitmate DM 25—
3½ digit, pocket-size
multimeter; 0.5% Vac
accuracy, diode test,
capacitance, continuity
beeper, conductance,
10 amps AC and DC
ranges, auto-polarity,
auto-zero, auto-
decimal

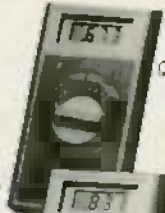

\$69⁹⁵

Circuitmate DM 40 —
3½-digit multimeter;
0.8% Vdc accuracy,
diode test, auto-
polarity, auto-zero,
auto-decimal

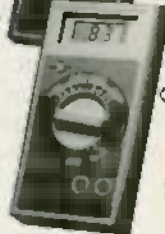

\$89⁹⁵

Circuitmate DM 45 —
3½-digit multimeter;
0.5% Vdc accuracy,
diode test, continuity
beeper, 10 amps AC
and DC ranges, auto-
zero, auto-polarity,
auto-decimal



The DM73 is the smallest digital
multimeter on the market. Its
probe-style design makes it ideal
for taking measurements in hard-
to-reach test areas.

**SALE
\$59.95**

- Small Size
- Complete Autoranging
- "Touch Hold"
- Audible continuity checking

\$76⁹⁵



The DM 77 gives you
the convenience of
autoranging plus 10
amps ac/dc
measurement
capability. You simply
select the function
you want, and the
DM 77 automatically
sets the required
range.

... Quality and Performance
Beckman and **4½ Digits** ...

True RMS

\$239⁰⁰

AVAILABLE NOW!

BECKMAN does it
again...a true RMS
4½ DMM w/1 year
calibrated cycle at
a 3½ digit price.



MODEL 4410

NEW
Beckman
Circuit-mate
DM10

\$39⁹⁵

in stock now



TOLL FREE HOT LINE
800-223-0474

212-730-7030

26 WEST 46th STREET, NEW YORK, N.Y. 10036

THE TEST EQUIPMENT SPECIALISTS

**ADVANCE
ELECTRONICS**

EQUIPMENT REPORTS

Valiant Telecomp 1000 Video Mixer

Combine the outputs from your computer and a video camera for some truly unique videotapes.

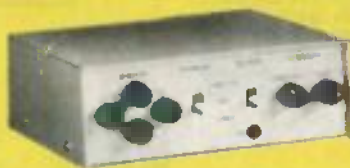

CIRCLE 5 ON FREE INFORMATION CARD

IF YOU OWN A COMPUTER, YOU doubtless know about the wide variety of programs on the market that let you generate all sorts of graphics and fancy type faces. But have you ever thought of storing your creations on videotape? Better yet, how about combining graphics or text with the output of a video camera for some truly unique home videos?

We recently had the opportunity to examine a unit that lets you do exactly that. It is the Valiant International Multimedia Corporation (195 Bonhomme St., Hackensack, *continued on page 28*)

So You've wiggled Into an Impossible position and found the problem!
BUT YOUR TOOLS ARE BACK ON THE BENCH!

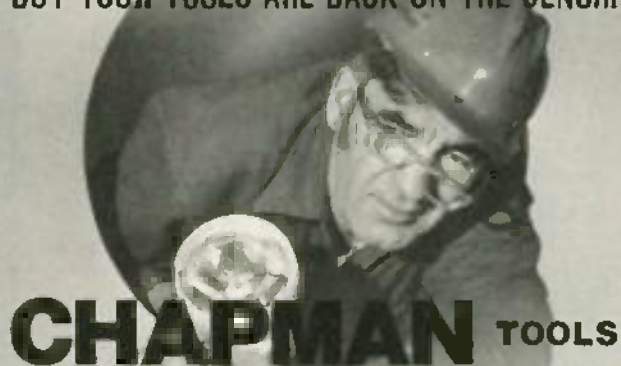

CHAPMAN TOOLS ARE MADE FOR THE TIGHT SPOTS

Complete pocket sized kits contain 17 different bits (Slotted, Hex or Phillips) plus Screw Driver Handle with Extension and the "World's Mightiest" Midget Ratchet (torque strength 200 in lbs.) Fix it on the spot with Chapman.

No. 6320 KIT

Only **\$20.85**

(Include \$2.00 for Handling)

Send Check or M.O.

MasterCard & Visa accepted

Write for industrial brochure



THE CHAPMAN MANUFACTURING CO.

P.O. Box 250, Rt. 17, Dept. RE-3

Durham, Connecticut 06422 (203) 349-9228

CIRCLE 263 ON FREE INFORMATION CARD

**DESOLDER-IT,
CLEAN-IT, COAT-IT,
FREEZ-IT...SEND FOR IT!**

Our new electronic problem solving catalog!



Chemtronics

681 Old Willets Path
Mouppouge, N.Y. 11788

800-645-5244
In NY 846-582-3322

968567

CIRCLE 54 ON FREE INFORMATION CARD



ELECTRONICS BOOK CLUB

The Best Source for Hobbyists and Professionals
for Over 19 Years!

Time- and Money-Saving Advice . . .
Practical Troubleshooting & Repair Tips . . .
State-of-the-art Technology . . . Hundreds
of Projects . . . Plus, Exceptional Savings

Take Any 4 Books for Only \$2⁹⁵



Join Now, Get A Utility Apron FREE!



1539
List \$21.95

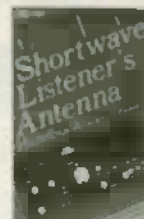

1467
List 15.95



1298
List \$18.95



1183
List \$16.95



1277
List \$21.95



1686
List \$18.95



1682
List \$14.95



800
List \$19.50 (paper)



1542
List \$21.95



1680
List \$19.95

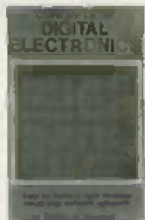

1631
List \$17.95



1465
List \$16.95



1650
List \$19.95



1709
List \$18.95

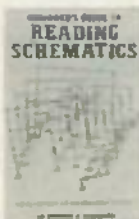

1536
List \$14.95



1108
List \$19.95



1625
List \$13.95 (paper)



1565
List \$16.95



1561
List \$19.50 (paper)



1911
List \$21.95



1604
List \$16.50 (paper)



1673
List \$12.95



1303
List \$14.50 (paper)



1440
List \$19.95



1765
List \$21.95



1605
List \$19.95



1616
List \$19.95



1679
List \$17.95



FREE Utility Apron

7 very good reasons to join the Electronics Book Club

- **Big Savings.** Save 20% to 75% on books sure to increase your electronics know-how
- **No-Risk Guarantee.** All books returnable within 10 days without obligation
- **Club News Bulletins.** All about current selections—mains, alternates, extras—plus bonus offers. Comes 13 times a year with hundreds of up-to-the-minute titles to pick from
- **Automatic Order.** Do nothing and the Main selection will be shipped automatically! But . . . if you want an Alternate selection—or no books at all—we'll follow the instructions you give on the reply form provided with every News Bulletin
- **Bonus Books.** Immediately get a Dividend Certificate with every book purchased and qualify for big discounts of 60% to 80%
- **Extra Bonuses.** Take advantage of added-value promotions, plus special discounts
- **Exceptional Quality.** All books are first-rate publisher's editions selected by our Editorial Board and filled with useful up-to-the-minute information



ELECTRONICS BOOK CLUB

P.O. Box 10
Blue Ridge Summit, PA 17214

Please accept my membership in the Electronics Book Club and send the 4 volumes circled below, plus, my FREE utility apron billing me \$2.95 plus shipping and handling charges. If not satisfied, I may return the books within ten days without obligation and have my membership canceled. I agree to purchase 4 or more books at reduced Club prices (plus shipping/handling) during the next 12 months, and may resign any time thereafter.

800 1108 1183 1218 1277 1393 1449 1465 1487
 1531 1536 1539 1542 1561 1565 1604 1605 1616 1625
 1650 1673 1679 1682 1685 1690 1709 1765 1811

Name _____ Phone _____
 Address _____
 City _____
 State _____ Zip _____

Valid for new members only. Foreign applicants will receive ordering instructions. Canada must remit in U.S. currency. This order subject to acceptance by the Electronics Book Club

RE-385

CIRCLE 261 ON FREE INFORMATION CARD

RAG ELECTRONICS, INC.



PORTABLE OSCILLOSCOPES

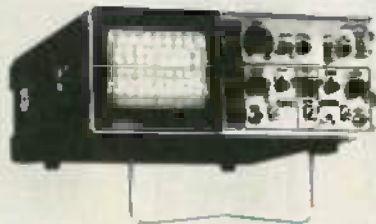

MODEL V-212 **\$461.00**
 DC to 20MHz, 1mV/div, Dual Trace
 Feature 6" Rectangular CRT
 Full 2 year parts and labor warranty.



MODEL V-650F **\$956.00**
 DC to 60MHz, Dual Trace
 Delayed Sweep



MODEL V-1050F **\$1276.00**
 DC to 100MHz, Quad Trace,
 Delayed Sweep.
 - All prices include full set of factory probes - up to \$120.00 value.

≡ Polaroid CR-10 Camera

Now you can get an instant picture in black & white or color from any oscilloscope screen. Includes CRT hood.
 *Large hoods also available to fit computer terminals and CAD/CAM screens.



\$369.00

GLOBAL SPECIALTIES

DP-1

DIGITAL PULSER **\$83.00**
 • Senses state of node, presets pulse polarity
 • Short circuit protected, circuit powered
 • Handheld digital signal injector



PROTO-BOARD
 • Length = 7.4"
 • Width = 4.5"
 • 14 pin IC capacity = 12
 • Terminals = 248
 • Tie points = 1240

MODEL PB-102 **\$34.95**

LP-1

DIGITAL LOGIC PROBE **\$19.95**
 • Use to 50 ns, 10 MHz
 • Circuit powered, portable
 • Compatible with most logic families

DIGITAL CAPACITANCE METER



• Battery operated
 • 3 1/2 digit LCD display
 • Range 1 pF to 2,000 uF
 • 0.2% basic accuracy

MODEL 3000
\$139.00

GLOBAL SPECIALTIES TRIPLE OUTPUT POWER SUPPLY



MODEL 1301 **\$219.00**
 • Fully regulated triple output
 • Fixed 5VDC, 1A
 • V1 + 5 VDC to 18 VDC .5A
 • V2 - 5 VDC to 18 VDC .5A
 • Fully automatic current limiting



TRIPLE OUTPUT POWER SUPPLY



MODEL 1650 **\$319.00**
 • Functions as three separate supplies
 • Exclusive tracking circuit
 • Fixed output 5 VDC, 5A
 • Two 0 to 25 VDC outputs at 0.5A
 • Fully automatic, current-limited overload protection
 • + and - terminals of each output are fully isolated. In all modes
 • All three outputs may be connected in series or parallel for higher voltage or current



ELECTRO INDUSTRIES, INC.
 Precision Test Instruments

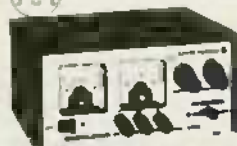

DC POWER SUPPLY
\$125.00

MODEL 3002A/0-30 VDC/0-2A

CALL US TOLL FREE

1-800-732-3457
 IN CALIFORNIA TOLL FREE
1-800-272-4225

- Master Charge
- VISA ■ COD
- Money Order
- Check



ADD FOR SHIPPING AND INSURANCE

\$0 to \$250.00	\$4.50
\$251.00 to \$500.00	\$6.50
\$501.00 to \$750.00	\$8.50
\$751.00 to \$1000.00	\$12.50
over \$1000.00	\$15.00

COD's extra (required 25% deposit)

RAG ELECTRONICS, INC. / 21418 Parthenia Street / Canoga Park, CA 91304 / 1-818-998-6500

GIANT 14th ANNIVERSARY SALE!

FLUKE 70 SERIES MULTIMETERS

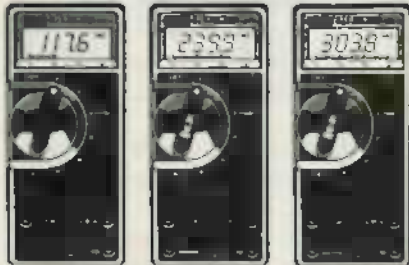

- Analog Display • Rotary Knob • Volts AC & DC • Resistance to • 32 MΩ • 10 Amps • Diode Test • 3200 Counts • Fast Autoranging • Function Annunciators in Display • Power-Up Self Test • 2000+ Hour Battery Life w/Power Down "Sleep Mode" • New Test Leads • VDE & UL Approval

73 \$85.00
 • 0.7% Accuracy
 • Autorange Only
 • 10 Amp Only

75 \$99.00
 • 0.5% Accuracy
 • Manual or Autorange
 • 10 A + 300 mA Range
 • Beeper

77 \$129.00
 • 0.3% Accuracy
 • Manual or Autorange
 • 10A + mA Range
 • Beeper
 • "Touch-Hold" Function

WE CARRY A FULL LINE OF FLUKE MULTI-METERS, COUNTERS, AND DIGITAL TEMPERATURE METERS

4 1/2 DIGIT MULTIMETER

- Frequency measurements to 200KHz
- dB measurements
- Basic dc accuracy 0.4%;
- 10μV, 10 nA and 10 mΩ sensitivity
- True RMS
- High-speed Beeper

MODEL 8060A



\$349.00

PORTABLE OSCILLOSCOPES

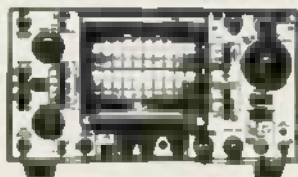

MODEL SS-5705 \$899.00

- DC to 40MHz
 Vertical and horizontal deflection accurate within ±2%. CRT acceleration voltage 12KV. 3 channels, 6 traces. High precision calibrator (±1%). Fastest sweep rate: 10 ns.
- High sensitivity 1 mv/div
 - CH1 signal output
 - Beam finder
 - Delayed sweep
 - Alternate time base



MODEL SS-5702 \$535.00

- DC - 20MHz, 5 mV/div
 Dual trace
 6 inch rectangular internal graticule CRT.
 Includes 2 each x1/x10 probes and full factory warranty; 2 years on parts, labor and CRT.

CIRCLE 252 ON FREE INFORMATION CARD

LEADER

Audio Sine/Square Wave Generator
 • Distortion from <0.03%
 • 10 Hz to 1 MHz

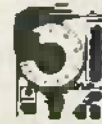

LAG-120A
\$259.95



BK PRECISION
 FUNCTION GENERATOR

MODEL 3010 \$189.00
 • Sine, square and triangle output
 • Variable and fixed TTL outputs
 • 0.1 Hz to 1 MHz in six ranges
 • Typical distortion under 0.5% from 1 Hz to 100 kHz
 • Variable DC offset
 • VCO input for sweep tests

VIZ

MULTI-FUNCTION COUNTER



MODEL WD-755
\$259.00

- 5 Hz to 125 MHz
- 8 Digit LED Display
- Period Measurement 8 Hz to 2 MHz
- Totalizes to 99,999,999 Plus Overflow
- Frequency Ratio Mode
- Time Interval Mode
- Switchable Attenuator & Low Pass Filter

RELAY VOM . . . 5-way protection



\$49.00

MODEL WV-532A

- Fast relay opens input circuit on overload
- Lamp indicates when relay is open
- Easy-access battery compartment and test-lead storage
- High-accuracy: ±2% DCV, ±3% ACV
- 3-to-1 ranges (like VTVM)
- Large, 5 1/2" mirror meter
- Front panel and meter scales coded in 3 colors for quick function identification
- Battery condition indicator for overload protection circuit

STACO

VARIABLE TRANSFORMER



\$145.00 MODEL 3PN1010V

RAG CARRIES THE COMPLETE STACO VARIABLE TRANSFORMER LINE
 CALL US WITH YOUR REQUIREMENTS.

EQUIPMENT REPORTS

continued from page 24

NJ 07602) *Telecomp 1000* computer/video mixer.

The *Telecomp 1000*

The *Telecomp 1000* is housed in an attractive beige steel cabinet, and is supplied with the three cables required to hook the unit up to a computer, video source, and

video monitor. The mixer's controls are logically arranged and easy to use. All inputs and outputs are routed via 5 rear-panel connectors (four for signal, one for power; a wall-plug transformer power supply for the mixer was supplied with the unit).

Setting up the unit is quite simple, and should only take a few minutes. The first step is to unplug the video line from the computer to the monitor, at the monitor end,

	Valiant										Telcomp 1000															
OVERALL PRICE	[Rating]										[Rating]															
EASE OF USE	[Rating]										[Rating]															
INSTRUCTION MANUAL	[Rating]										[Rating]															
PRICE/VALUE	[Rating]										[Rating]															
	1	2	3	4	5	6	7	8	9	10	1	2	3	4	5	6	7	8	9	10						
	Poor			Fair			Good			Excellent				Poor			Fair			Good			Excellent			

and feed it to a rear panel jack on the mixer that is labeled FROM COMPUTER. A cable with phono plugs at both ends (supplied) is then run from the mixer (from the connector labeled TO MONITOR) to the monitor.

The connection from a video camera is handled via the remaining two supplied cables. The video-signal connection is handled via a cable that's terminated with phono plugs at either end. But not all cameras use phono jacks for the video output; many use BNC connectors. For that reason, a BNC adaptor is supplied for use with the cable. At the mixer end, the cable is plugged into the connector labeled VIDEO.

The sync signal back to the camera is transferred via the third and final cable. That cable is terminated at one end with a phono plug, and at the other end with a DIN connector. The phono plug is connected to the jack labeled SYNC at the mixer end, while the DIN connector is plugged into the camera. The DIN jack at the camera may be labeled PULSE IN, or something similar.

Using the unit is very simple. A three-position switch on the front panel lets you select between input sources. Those sources are, of course, the computer, the video camera, or both. When both the video camera and the computer are selected, the monitor will show a combination of the two outputs.

The framing of the video camera signal is handled by four WINDOW controls. Those controls don't position the picture, however. Instead, they are used to define the edges or borders of the picture. The controls are arranged in a diamond pattern, with the upper and

continued on page 32

The Professionals' Choice

PTS

*Coast to coast
more professionals
choose PTS.*



Professional service dealers have made PTS the world's largest independent electronics rebuilder.

Servicemen depend on more PTS rebuilt tuners, modules, remotes, converters, and line amps than all other rebuilt brands combined.



PTS CORPORATION

P.O. Box 272
Bloomington, IN 47402
(812) 824-9331

Send for your free PTS Products Guide today!

With 15 PTS Servicenters, over 1,500 distributors, and 50,000 satisfied service dealers and technicians nationwide it's no wonder PTS is #1.

Choose PTS for service, quality and availability. PTS is The Professionals' Choice.

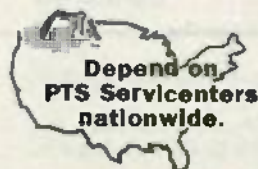

Depend on
**PTS Servicenters
nationwide.**

Learn to design your own ideas.

How many times have you looked at a clever piece of circuitry and thought "I could have designed that." Or... "I thought of that years ago, if only I had..."

Well now you can. Learn. Design. Create...your own electronic circuits. The new Heathkit/Zenith Engineering Design Series Experimenter/Trainer and Courses make it easy.



If you enjoy the challenge of creating your own circuits or have the desire to learn...then, the new ET-1000 Analog/Digital Circuit Design Experimenter/Trainer is for you. Designed to be a multi-purpose lab for experimental circuit design, the ET-1000 makes it easy to design, develop and experiment with circuits of your own design.

Unit features large solderless plug-in breadboard, built-in heavy duty power supplies, 1 Hz to 100 kHz signal generator, "no bounce" logic switches, logic probe and much, much more.

And if you need to learn circuit design before starting to create on your own, there are three self-study courses in passive, transistor and analog circuits that will teach this exciting area to you right on the ET-1000.

Find out more about the new ET-1000 trainer and courses today. Complete specifications and details are in the new free Heathkit Catalog. The catalog also features more than 450 kit and educational products for your home, hobby and business. Circle reader service number below.

New Engineering Design Series

Heathkit
Heathkit/Zenith
Educational Systems

Diskette Users...

When you've heard from all the animals in the diskette zoo, but you need fast delivery and high quality diskettes...



Call Communications Electronics

Diskette order desk
800-USA-DISK

In Canada 800-CA1-DISK

Choose your brand
Choose your price



Super Disk
diskettes $\frac{5}{8}$ "
\$0.94 each



Wabash
diskettes $\frac{5}{8}$ "
\$0.99 each



BASF
diskettes $\frac{5}{8}$ "
\$1.44 each



3M
diskettes $\frac{5}{8}$ "
\$1.44 each

Product Description

Product Description	Super Disk Part #	CE quot. 100 price per disk (\$)	Wabash Part #	CE quot. 100 price per disk (\$)	BASF Part #	CE quot. 100 Price per disk (\$)	3M Part #	CE quot. 100 price per disk (\$)
8" SSSD IBM Compatible 128 B/S, 26 Sector	_____	_____	F111-P	1.59	_____	_____	81330-P	1.94
8" SSSD Shugart Compatible, 32 Hard Sector	_____	_____	F31A-P	1.79	_____	_____	_____	_____
8" SSDD IBM Compatible (128 B/S, 26 Sectors)	_____	_____	F131-P	1.89	_____	_____	83600-P	2.39
8" DSDD Soft Sector (Unformatted)	_____	_____	F14A-P	2.09	_____	_____	88800-P	2.89
8" DSDD Soft Sector (256 B/S, 26 Sectors)	_____	_____	F144-P	2.09	_____	_____	_____	_____
8" DSDD Soft Sector (512 B/S, 15 Sectors)	_____	_____	F14B-P	2.09	_____	_____	_____	_____
8" DSDD Soft Sector (1024 B/S, 8 Sectors)	_____	_____	F147-P	2.09	_____	_____	80800-1024-P	2.89
5 1/4" SSSD Soft Sector w/Hub Ring	8481-P	1.14	M11A-P	1.19	_____	_____	_____	_____
5 1/4" SSSD Same as above but bulk product	8487-P	0.94	M11AB-P	0.99	_____	_____	_____	_____
5 1/4" SSSD 10 Hard Sector w/Hub Ring	_____	_____	M41A-P	1.19	_____	_____	_____	_____
5 1/4" SSDD Soft Sector w/Hub Ring	8481-P	1.29	M13A-P	1.34	84874-P	1.44	83100-10-P	1.64
5 1/4" SSDD Same as above, but bulk product	8487-P	1.09	M13AB-P	1.14	_____	_____	88800-01-P	1.44
5 1/4" SSDD Soft Sector Floppy (use both sides)	_____	_____	M18A-P	1.99	_____	_____	_____	_____
5 1/4" SSDD 10 Hard Sector w/Hub Ring	_____	_____	M43A-P	1.34	_____	_____	_____	_____
5 1/4" DSDD Soft Sector w/Hub Ring	8481-P	1.54	M14A-P	1.59	84885-P	1.79	80800-RN-P	2.19
5 1/4" DSDD Same as above, but bulk product	8487-P	1.34	M14AB-P	1.39	_____	_____	_____	_____
5 1/4" DSDD 10 Hard Sector w/Hub Ring	_____	_____	M44A-P	1.59	_____	_____	_____	_____
5 1/4" DSDD 16 Hard Sector w/Hub Ring	_____	_____	M54A-P	1.59	_____	_____	_____	_____
5 1/4" DSDD Soft Sector w/Hub Ring (96 TPI)	8501-P	2.44	M16A-P	2.49	84892-P	2.99	80800-9800-P	3.09
3 1/2" SSDD Soft Sector micro-floppy	_____	_____	_____	_____	84112-P	2.74	88300-P	3.74

For more information
about this brand call:

Lifetime warranty
For more info on Super Disk call
800-USA-DISK
in Michigan 313-973-1111

9 year warranty
For more info on Wabash call
800-323-9868
in Idaho 312-692-8383

Lifetime warranty
For more info on BASF call
800-343-4600
in Massachusetts 811-271-4600

Lifetime warranty
For more info on 3M call
800-328-9438
in Minnesota 812-736-6524

CIRCLE 275 ON FREE INFORMATION CARD

CE...your best source for diskettes

For you the diskette buyer, it's a jungle out there. There are so many different brands to choose from, you need to go on a safari to find a good brand at a reasonable cost. Fortunately, CE has already hunted for the best diskettes and offers you an excellent choice at a CE price. To save you even more, CE also offers bulk product where 100 diskettes are packed in the same box without envelopes or labels. Since we save packaging costs, these savings are passed on to you. Diskette envelopes are also available from CE. These super strong and tear resistant Tyvek® envelopes are only \$15.00 per 100 pack. Use order # TE-5 for a 100 pack of 5 1/4" diskette envelopes.

Quantity Discounts Available

Our diskettes are packed 10 disks to a carton and 5 or 10 cartons to a case. The economy bulk pack is packaged 100 disks to a case without envelopes or labels. Please order only in increments of 100 units for quantity 100 pricing. With the exception of bulk pack, we are also willing to accommodate your smaller orders. Quantities less than 100 units are available in increments of 10 units at a 20% surcharge above our 100 unit price. **Quantity discounts** are also available. Order 300 or more disks at the same time and deduct 1%; 500 or more saves you 2%; 1,000 or more saves 3%; 2,000 or more saves 4%; 5,000 or more saves 5%; 10,000 or more saves 6%; 50,000 or more saves 7%; 100,000 or more saves 8%; 500,000 or more saves 9% and 1,000,000 or more disks earns you a 10% discount off our super low quantity 100 price. Almost all our diskettes are immediately available from CE. Our efficient warehouse facilities are equipped to help us get you the quality product you need, when you need it. If you need further assistance to find the flexible diskette that's right for you, call the appropriate manufacturers compatibility hotline telephone number listed at the bottom of this ad. Dealer inquiries invited.

Buy your diskettes from CE with confidence

To get the fastest delivery of your diskettes, phone your order directly to our order desk and Charge It to your credit card. Written purchase orders are accepted from approved government agencies and most well rated firms at a 10% surcharge for net 10 billing. For maximum savings, your order should be prepaid. All sales are subject to availability, acceptance and verification. All sales are final. All prices are in U.S. dollars. Prices, terms and specifications are subject to change without notice. Out of stock items will be placed on backorder or substituted for equivalent product at no extra cost to you unless CE is instructed differently. A \$5.00 additional handling fee will be charged for all orders with a merchandise total under \$50.00. All shipments are F.O.B. CE warehouse in Ann Arbor, Michigan. COD terms are available. In U.S. UPS areas for \$5.00 extra, and are payable with cash or certified check.

For shipping charges add \$8.00 per 100 diskettes and/or any fraction of 100 8-inch diskettes, or \$6.00 per 100 diskettes and/or any fraction of 100 5 1/4-inch or 3 1/2-inch diskettes for U.P.S. ground shipping and handling in the continental U.S. UPS 2nd day air rates are three times continental U.S. rates. For Canada, Puerto Rico, Hawaii, Alaska, or APO/FPO delivery, shipping is three times the continental U.S. rate.

Mail orders to: Communications Electronics, Box 1045, Ann Arbor, Michigan 48106 U.S.A. If you have a Visa or Master Card, you may call and place a credit card order. Order toll-free in the U.S. Dial 800-USA-DISK. In Canada, order toll-free by calling 800-CA1-DISK. If you are outside the U.S. or in Michigan dial 313-973-8888. WUI telex anytime 671-0155. Order today.

Copyright © 1984 Communications Electronics Inc.

Ad #080284

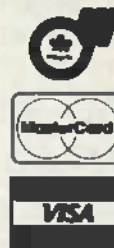

Computer Products Division

Box 1045 □ Ann Arbor, Michigan 48106-1045 U.S.A.
Call toll-free 800-USA-DISK or outside U.S.A. 313-973-8888



Verbatim diskettes **\$1.59 each**



Memorex diskettes **\$1.59 each**



Ultra diskettes **\$1.59 each**



TDK diskettes **\$1.59 each**



Fuji diskettes **\$1.59 each**



Dysan diskettes **\$1.94 each**

Verbatim Part #	CE quant. 100 price per disk (\$)	Memorex Part #	CE quant. 100 price per disk (\$)	Ultra Part #	CE quant. 100 price per disk (\$)	TDK Part #	CE quant. 100 price per disk (\$)	Fuji Part #	CE quant. 100 price per disk (\$)	Dysan Part #	CE quant. 100 price per disk (\$)
		3062-P	1.94	01720-P	1.94	F1-0-P	2.34	FD10-1260-P	1.94	000501-P	2.49
		3015-P	1.94							000005-P	2.69
		3006-P	2.39			F2-0-0-P	2.89	F020-P	2.89	000003-P	3.14
		0102-P	2.89	02701-P	2.89						
				02700-P	2.89	F2-0-1024-P	2.89	F020-1024-P	2.89	100030-P	3.14
		3104-P	2.89								
20020-P	1.59	3461-P	1.59	01401-P	1.59	M10-0-P	1.59	M010-P	1.59	001107-P	1.94
				02402-P	1.99						
				02401-P	2.19	M20-0-P	2.19	M020-P	2.19	002000-P	2.04
20021-P	2.54	3401-P	2.19								
20023-P	3.39	3501-P	2.99	02001-P	2.99	M200-0-P	2.99	M020-00701-P	2.99	002067-P	3.99
		0100-P	3.74			M10-P	2.99				

Lifetime warranty
For more info on Verbatim call
800-538-8589
In California 408-248-4400

5 year warranty
For more info on Memorex call
800-448-1422
Monday-Friday 9am-4pm ET

Lifetime warranty
For more info on Ultra call
408-728-7777
Monday-Friday 9 am-4 pm PT

Lifetime warranty
For more info on TDK call
800-645-6571
In New York 010-020-0100

Lifetime warranty
For more info on Fuji call
800-223-6535
In New York 212-710-3335

Lifetime warranty
For more info on Dysan call
800-552-2211
In California 408-670-0090

CIRCLE 27S ON FREE INFORMATION CARD

EQUIPMENT REPORTS

continued from page 28

lower controls used to position the upper and lower borders, and the left and right controls used to position the left and right borders, respectively.

The OVERLAY switch is used to provide three separate displays. When set to the COMPUTER position, the output from the video camera will only be seen where there is no computer output. In the VIDEO position, computer output will only appear outside the video "window." In the MIX position, the two outputs share the entire screen. The relative intensity (brightness) of the two outputs can be set independently using two INTENSITY controls labeled VIDEO and COMPUTER.

Once the output of the mixer meets your approval, it can be fed to a VCR and Recorded.

The unit was supplied with a simple character-generator program. That program lets you enter

a limited amount of text, and determine whether that text would be displayed continuously or scrolled up the screen. Such variables as display time, starting position of text on the screen, and how many lines may be displayed at a time can all be pre-determined by the user.

The manual that was supplied with the unit was a bit on the skimpy side. All that it contained were some simple instructions for set-up and use. There was no information on the unit's theory of operation, nor were there any schematics or servicing or alignment information. In fact, the manufacturer strongly recommends against even opening the unit, stating that doing so would void the 90-day warranty. There was also no information on the accompanying software; that was not so large a liability, as the program was pretty much self-explanatory.

On the plus side, a toll-free phone number for those who have difficulty interfacing the unit with

their computer or video equipment was provided.

In testing out the unit, we found that it was easy to use and performed exactly as claimed. The Valiant *Telecomp 1000* sells for \$499.95. R-E

Sony ICF-2002 Receiver

A feature-packed, portable shortwave receiver.



CIRCLE 6 ON FREE INFORMATION CARD

IF ANY SINGLE TREND CAN BE DISCERNED from the dozens of new short-continued on page 38

QUALITY COMPONENTS - NOT MAIL ORDER "SECONDS" ★

Send \$1.00 postage and handling for FREE COMPLETE CATALOG which includes coupon for \$1.00 OFF purchase

ARIES ZERO INSERTION FORCE SOCKETS -

can actuated, true zero insertion - tin plated solder tail pins - capable of being plugged into dip sockets, including wire wrap.

Stock No.	Pin	1-8	10-16	20
11055	24	4.98	14.35	23.80
11056	28	5.15	14.50	23.95
11057	40	6.31	18.95	31.35
11058	64	13.02	18.90	4.45

IC-COOLERS™ from UNIFRACK™

over 7 mils of heat transfer IC's eliminating longer life and better safety. And push IC's faster on - heat is conducted from top and bottom of IC and dissipated by phase transfer.

Stock No.	Pin	Price
22225	18	8.29
22226	18	8.29

SCREW MACHINED SOCKET

PHEN. base, packaged in 10-21 of 100. Stock No. 11210 is solder tail with gold color for wire. Stock No. 11211 is wire wrap with gold color gold shell.

Stock No.	Pin	1-8	16	28	40
11210	8	1.48	1.48	1.48	1.48
11211	8	1.15	1.15	1.15	1.15

TI WIRE WRAP SOCKETS

Tin plated phosphor bronze contact - 3 wrap

Stock No.	Pin	1-99	100	500
11301	8	8.40	8.38	8.30
11302	16	.58	.54	.45
11303	18	.64	.60	.48
11304	18	.73	.68	.58
11305	20	.99	.90	.75
11306	22	1.12	1.02	.85
11307	24	1.25	1.14	.95
11308	28	1.52	1.38	1.15
11309	40	2.05	1.86	1.55

TI LOW PROFILE SOCKETS

Tin plated copper alloy 688 contact pins with gas tight seal

Stock No.	Pin	1-24	25-99	100
11201	8	8.10	8.09	8.08
11202	14	.14	.13	.12
11203	18	.18	.15	.14
11204	18	.18	.17	.15
11205	20	.20	.18	.16
11206	22	.22	.20	.18
11207	24	.24	.22	.20
11208	28	.28	.26	.25
11209	40	.40	.37	.33

WILD ROVER

Touch switch capable. Operating motion is 005" without the use of a levered arm. Extremely fast and all pins are spaced normally apart - rated 11.5 VDC, 1.6 amp-30 milliamperes resistance. 615 radius by .180 thick.

Stock No.	Pin	1-8	10-8	UP
12088	8	41.42	51.28	

3 X 4 Elastomeric Keyboards

Each key board has a D.C. board, elastomeric D.C. with contacts, ABS bodies and double shot molded keys. ABS rating 12 VDC @ 20mA. Contact resistance less than 500 ohms. Contact life 100,000 cycles. Key size 1.27 x 1.27 x 1.27 mm. 2.91 x 3.81 mm.

Stock No.	Pin	Price
11301	8	1.24
10240	25	88
10240	50	11.70
10240	100	21.90
10240	200	41.30

SUB CUB I and SUB CUB II High Quality Complete LSI Counter Modules with LCD Readouts

plug in to board. Complete functional evaluation kit (Stock No. 81071) contains P.C. board, 9V battery and variable frequency oscillator to supply train of count pulses. Stock No. 81070 has LATCH, RESET and TEST functions. P.C. board plugs into bread board work.

Stock No.	Description	Price
81071	Complete functional evaluation kit (includes P.C. board, 9V battery, oscillator, test leads)	7.50
81072	SUB CUB I display counter module only	18.00
81073	SUB CUB II display counter module only	24.00
81074	Evaluation kit for SUB CUB I (does not include SUB CUB I)	12.00
81075	Evaluation kit for SUB CUB II (does not include SUB CUB II)	25

SINGLE ROW SOCKETS

Both styles brass. Strip of 25 contact sockets/pins - mount odd center components easily. Gold plated contacts.

Stock No.	Pin	1-99	100	500	1000
10850	8	1.09	0.90	0.82	0.72

OK MACHINE AND TOOL

IC INSERTION/EXTRACTION KIT. Includes DIP IC extractor and reporter to accommodate all ICs from 14 pin 40 pins. Tests that package conductive surfaces are CMOS safe and includes ground and logic. Stock No. 13309 \$41.34

PIN FORMING TOOL

puts IC's on their true low tip to low spacing. One side is for 300 centers, flip tool over for devices 600 centers. Put device in tool and squeeze. ONE TOOL DOES 8 thru 40 PINS! Hand Tool 11059 \$12.95. NEW! ANTI-STATIC MODEL 10200 \$14.95

SINTEC 28 8th St., Box 410 CO. Frenchtown, NJ 08825 **TOLL 800-526-5960 FREE In NJ (201) 996-4093**

CIRCLE 73 ON FREE INFORMATION CARD

Here's The Savvy-est True Dual Trace 10 MHz
Digital Storage Scope You Ever Saw
... At The Saving-est Price. Only \$595.

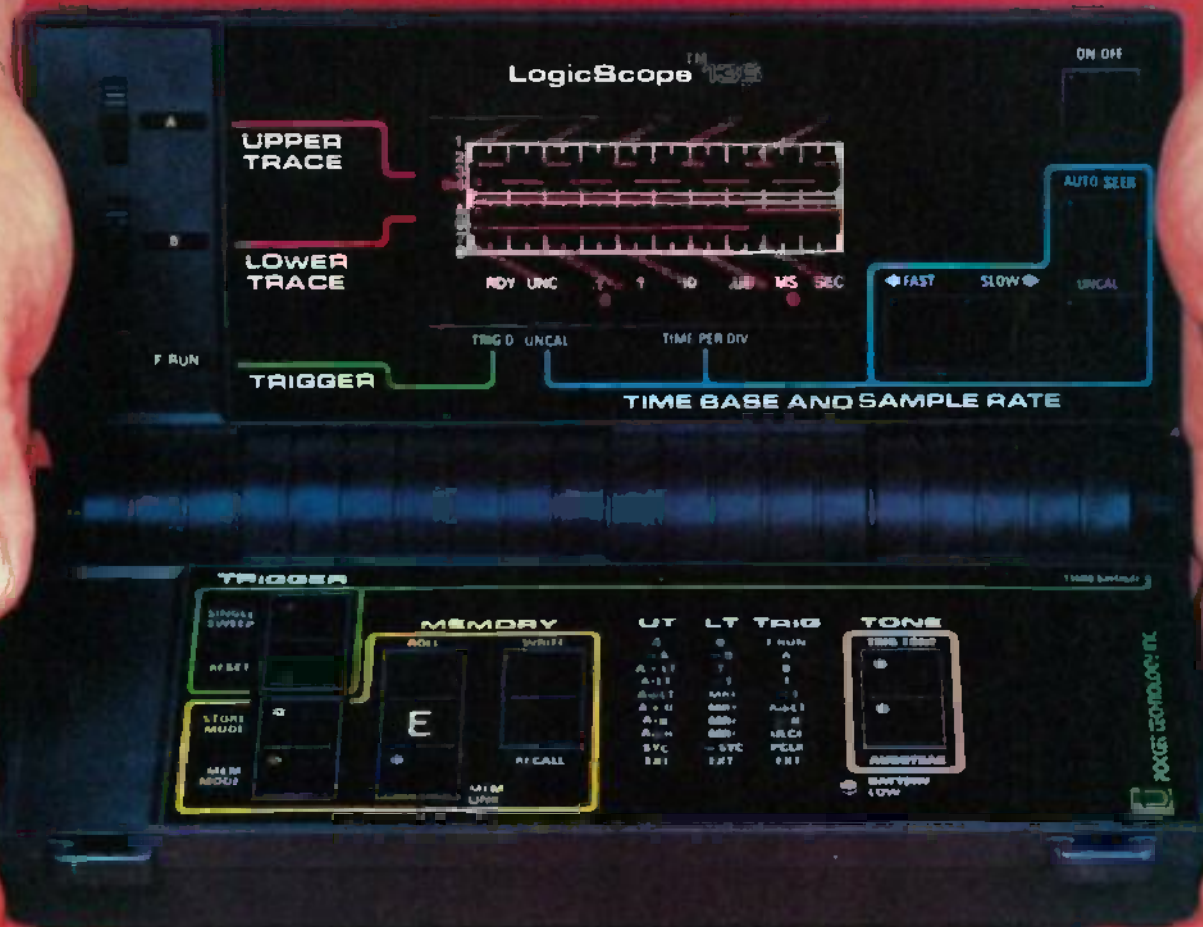

The Handy New LogicScope™ 136

True Dual Trace • 10 MHz Real Time Bandwidth • 3 Input Channels • I/O Port
Digital Waveform Storage • Boolean Waveform Operations • Audio Functions
8.0 (L) x 4.5 (D) x 1.75 (H) Inches • 1.25 Pounds • 9 Volt Battery/AC Operation

Consider the LogicScope 136

- The LogicScope 136 is the next logical step in test instrumentation for you. It combines many of the features and capabilities of sophisticated logic analyzers and oscilloscopes... and it fits in your hand. Never before has so much technology been available in so small an instrument, at such a low price.
- The pocket-sized LogicScope 136 is made possible by a patented breakthrough in display technology. The conventional CRT has been replaced by a unique array of 400 LED's that permits simultaneous display of two digital waveforms.
- The 136 can be used for viewing single shot events, or repetitive waveforms. It can be operated in real time mode, or in memory mode which permits acquisition and storage of up to 50-100 bit waveforms. These can be recalled, logically compared (AND, OR, EXCLUSIVE OR) to other input waveforms, or output to an external device via an I/O port. This I/O port will also accept future add-on 136 Modules.
- Its very low cost, convenience and ease-of-use make the LogicScope the ideal instrument, for designing, troubleshooting or repairing digital systems. Made in U.S.A.

Consider its Engineering & Field Service Applications:

- On microprocessor-based systems, check the timing relationship of various parameters relative to the system clock and other key events. Its storage capability allows visual and logical comparison of non-repetitive waveforms to known reference signals. Output in the start-up of the digital device can be compared to reference signals to determine the operating state of the device. Questionable waveforms can be stored for analysis.
- Its light weight and small size make the LogicScope convenient to take on every service call. The 136 provides much more information for trouble shooting a digital system or peripheral than a logic probe or digital counter without having to lug an oscilloscope or logic analyzer along.

Contact us for the name of your local distributor



POCKET TECHNOLOGY, INC.

7320 Parkway Drive, Hanover, MD 21076 U.S.A.

301-796-3300 TELEX 908207

Division of Renaissance Technology Corp.

CIRCLE 258 ON FREE INFORMATION CARD

At CIE, you get electronics career training from specialists.



If you're interested in learning how to fix air conditioning, service cars or install heating systems— talk to some other school. But if you're serious about electronics... even earning an Associate Degree... come to CIE —The Electronics Specialists.

Why trust your education and career future to anything less than a specialist?

You shouldn't. And you certainly don't have to.

If you talked to some of our graduates, chances are you'd find a lot of them shopped around for their training. They pretty much knew what was available. And they picked CIE as number one.

Be sure to shop around. Because, frankly, CIE isn't for everyone.

There are other options for the hobbyist. If you're the ambitious type—with serious career goals in electronics—take a close look at what we've planned for you at CIE. **What you should look for first.**

Part of what makes electronics so interesting is it's based on scientific discoveries—on ideas! So the first thing to look for is a program that starts with ideas and builds on them!

That's what happens with CIE's Auto-Programmed® Lessons. Each lesson takes one or two principles and helps you master them—before you start using them!

How practical is the training?

This is the next big important question. After all, your career will be built on what you can do—and on how well you do it.

Here are ways some of CIE's career courses help you get your "hands-on" training...

With CIE's Personal Training Laboratory...

you learn and review the basics—perform dozens of experiments. Plus, you use a 3-in-1 precision Multimeter to learn testing, checking, analyzing!

When you get your own 5MHz, solid-state oscilloscope, you take some real professional steps. You use it as a doctor uses an X-ray machine—to "read" waveform patterns...lock them in...study, understand and interpret them!

When you get your Digital Learning Laboratory, you'll

be into digital theory—essential training today for anyone who wants to keep pace with the state of the art of electronics. With CIE's Digital Lab, you'll be applying in dozens of fascinating ways the theory you've learned. For example, you'll compare analog and digital devices. You'll learn to make binary to decimal conversions and to work with semiconductor devices and circuits. You'll see how digital equipment is vital to today's exciting, growing fields such as security... where digital theory provides the brains for space-age alarm and protective devices. **You'll build your Microprocessor Training Laboratory,** a working microcomputer—from "scratch." You'll also learn how to program and interface it with displays, memories, switches, and more.

Earn An Associate Degree from CIE.

One of the best credentials you can have in electronics—or any other career field—is a college degree. That's why CIE gives you the opportunity to earn an Associate in Applied Science

in Electronics Engineering Technology. Any CIE career course can offer you credit toward the degree...more than half of the number needed in some cases.

You can also prepare for the government-administered FCC (Federal Communications Commission) Radiotelephone License, General Class. It can be a real mark in your favor... government-certified proof of your specific knowledge and skills.

Shop around...but send for CIE's free school catalog first!

Mail the card. If it's gone, cut out and mail the coupon. If you prefer to write, mention the name and date of this magazine. We'll send you a copy of CIE's FREE school catalog—plus a complete package of independent home study information! For your convenience, we'll try to have a representative contact you to answer your questions.

Mail the card or coupon—
or write: CIE, 1776
East 17th St.,
Cleveland,
OH 44114.

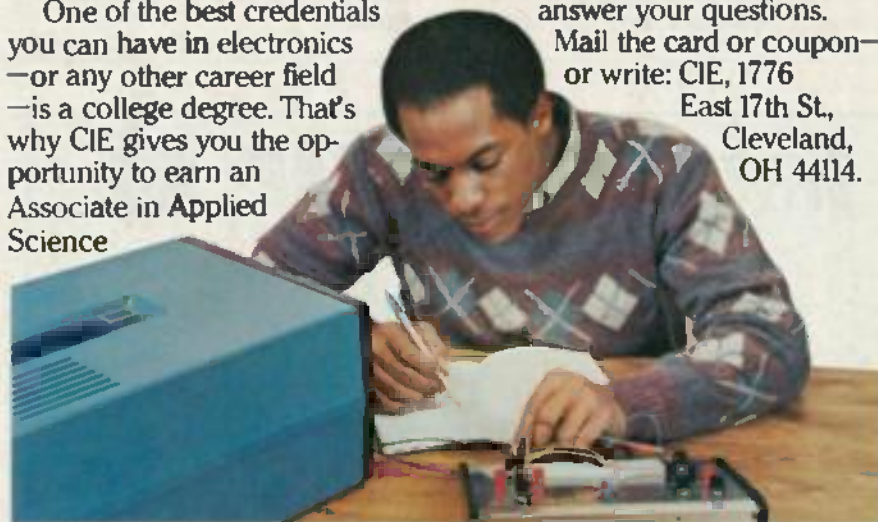

CIE Cleveland Institute of Electronics, Inc.

1776 East 17th Street, Cleveland, Ohio 44114
Accredited Member National Home Study Council

YES... I'm shopping around for the right kind of career training in electronics—and CIE sounds well worth looking into. Please send me my FREE CIE school catalog—including details about the Associate Degree program—plus my FREE package of home study information!

Print Name _____
Address _____ Apt. _____
City _____ State _____ Zip _____
Age _____ Area Code/Phone No. _____ / _____
Check box for G.I. Bill information: Veteran Active Duty

MAIL TODAY!

RE-05

MARCH 1985

EQUIPMENT REPORTS

continued from page 32

wave receivers introduced over the last few years, it would have to be ease of operation for both the neophyte and experienced listener. That goes especially for tuning—it is easier, more precise, and more accurate than ever.

The *ICF-2001*, introduced by Sony (9 West 57th St., New York, NY) in 1980 was the first portable general-coverage receiver to use frequency memories, direct-access tuning, scanning, and performance that was good enough to make it the central receiver in many ShortWave Listening (SWL) stations. But now Sony seems to have outdone itself with the introduction of its *ICF-2002* receiver (model *ICF-7600D* outside the U.S.).

The *ICF-2002*, housed in a slim package only slightly larger than a paperback book, is a PLL-synthesized receiver with continuous tuning capabilities from 153 kHz to

Sony		ICF-2002									
OVERALL PRICE											
EASE OF USE											
INSTRUCTION MANUAL											
PRICE/VALUE											
		1	2	3	4	5	6	7	8	9	10
		Poor		Fair		Good		Excellent			

29.995 MHz in AM and SSB modes. The radio also covers the FM broadcast band. Power for the unit is provided by six AA-type batteries: two for its 10-memory tuner and built-in clock/timer, and four for the receiver portion of the unit.

The receiver may be tuned in any of several ways. If you know the frequency of the station you want to hear, you can directly access that station by first pressing the AM button (unless, of course, you want to listen to FM) and then entering the station's frequency on the ten-button keypad, followed by a press on the EXECUTE button.

If you don't know what frequency you're after, you can use a rocker-type tuning switch to manually tune up or down the spectrum. Pressing the manual tuning buttons (+ or -) and the BAND SELECT button simultaneously allows you to jump to the bottom of each broadcast band, with annunciators appearing in the LCD readout to show the shortwave band (75, 60, 49, 41, 31, 25, 21, 19, 16, and 13 meters).

Scan tuning is also possible; it is intended for use in the predefined bands noted above, but it will work on all bands, including FM. A single button on the front of the unit starts and stops scanning. Pressing the button while tuned to 11,750 kHz, for example, starts the tuner on its way up to the top of the 25-meter band (12,100 kHz), and then it starts over at the bottom (11,600 kHz).

When a strong signal is encountered, the scanner stops for about two seconds, giving you time to halt scanning if desired. Otherwise, it continues to climb up the

Vector

SLIT-N-WRAP®
CONNECTIONS are RELIABLE



P210 Milliohm Probe
Probe made
resistorless as low
as 1.0 milliohm. Finds
faults fast in wire
wrapping or any
connection in switches,
relays, sockets, I.D.,
joints, printed
circuits . . .

Write for free
brochure:

Vector Electronic Co.
12460 Gladstone Avenue
Sylmar, CA 91342-0336
Telephone (818) 365-9661



VERIFY
NOW WITH NEW
P210 MILLIOHM
PROBE.

Wrap 28 or 30
gauge insulated wire
four times faster
without stripping,
measuring or
threading! Daisy-
chain continuous
gas-tight joints.
Each connection
is in/out, lowering
profile so 7 turns
is equal to 14
standard wraps.
Patented.

106-84-1

CAN/AM SATELLITE TV DESCRAMBLER

Works on Everything

Fully Assembled & Tested

No Internal Connections
to Receiver

Works on both American
& Canadian Birds

For Use with TVRO's
Only

Modulator Installed,
Baseband Output
Optional

\$395.00

Tampa Electronic
Supply
9207 N. 14th St.
Tampa, FL 33612

CIRCLE 253 ON FREE INFORMATION CARD

CIRCLE 271 ON FREE INFORMATION CARD

band. The PLL tuner is rock solid. We had one memory (which we'll discuss shortly) set to tune SSB signals of inflight aeronautical transmissions on 11,282 kHz. From a cold start, the tuner was right on the signal.

The LCD frequency readout responds in predefined increments depending on the band segment you're in. For longwave (153-520 kHz), tuning is in increments of 3 kHz; for 520-1600 kHz, increments of 9 or 10 kHz (selectable from a switch inside the battery compartment)—10 kHz for North American stations, 9 kHz for the rest of the world. Above 1610 kHz, tuning is in 5-kHz increments.

For most broadcast stations, the preset increments are perfect. But if you want to tune to some station between increments, like a utility or amateur-radio station, a slide switch on the right side of the cabinet selects a vernier tuner (also on the side) for use in either the straight AM or SSB/CW mode. Although the LCD readout doesn't change with the vernier tuner, you can still tune the bands continuously.

You can store up to ten frequencies in the memory of the ICF-2002. To do that, you simply tune to the desired frequency and press the small ENTER button and a memory-number key simultaneously. Then, when you want to return to that frequency from memory, simply press the appropriate memory-button number on the keypad.

A welcome addition to the ICF-2002, not featured in the ICF-2001, is the digital clock/timer. You can set the receiver to turn itself on at a given time. The clock can be set for 12- or 24-hour operation using a small recessed switch on the back panel. Setting the clock or timer is extremely simple unless you have very large fingers, in which case the small buttons may be a problem.

When the timer turns on the receiver, the unit's 65-minute, sleep-switch timer is activated. Thus, if you have the main timer set and you're not around to turn off the radio (say, for unattended audio recording), it will power itself down after 65 minutes of playing.

Other convenience features in-

clude a tuning LED, which may not be an accurate enough indication of signal strength for a dedicated SWL, but it should be more than adequate for the casual listener. A separate master-power switch on top of the cabinet disconnects the pushbutton ON/OFF switch to prevent the radio from accidentally switching on when stowed away in a suitcase or pocket.

The built-in telescoping whip antenna is rather short—only a little over 15 inches in length. An external antenna can be connected to the receiver by using a special plug-in adapter supplied with the unit.

The adapter has two screw terminals for connection to an antenna lead-in and ground. The antenna adapter can be left on your desk or other main listening area, and quickly unplugged when portable operation is desired.

Performance with the whip antenna is adequate for picking up major broadcasts. With an external wire antenna, however, the ICF-2002 rivals a desk-top receiver, like the Kenwood R-2000, with a similar antenna. Strong signals coming through an external antenna overloaded the receiver and had a tendency to pull the PLL off frequency by one or so kilohertz (extremely noticeable when tuned to an SSB or CW station). However, switching on the built-in attenuator usually solves that problem.

Although the ICF-2002 does not have switchable selectivity, the filtering chosen is surprisingly good for a portable of such small dimensions.

Adjacent channel interference seems less severe than on the original ICF-2001, and the variable tuning lets you tune a kilohertz or so away from the intruding signal. After using the receiver for a short time, it was hard to believe that all its features and relatively good performance could be crammed into an easy-to-operate unit that can be lost on the top of your desk. Overall, the ICF-2002—with its manufacturer's suggested retail price of \$299.95—is perhaps the most sensibly designed receiver (desktop or portable) now available. R-E

AT LAST



AN AFFORDABLE VOCODER

Our VOCODER with 8 bands of resolution makes electronic instruments speak with remarkable intelligibility. Features by-pass select, mic signal mix, noise reduction, sibilance enhancement, hito gain option, fuzz option, mono/stereo select and more. Requires a +/- 15v. DC supply @ +/- 75ma. Our easy to assemble kit, is only \$99.95 plus \$3 shipping. Other special effects kits include: Reverb, limiters, EO, Hyperflange & Chorus, Quadra fuzz, synchronizers and more.

Ask for our FREE Catalog.

PDA Electronics, Inc.

Dept R 1020 W. Wilshire, Okla City, OK 73116
Inquiries (405) 843-9626
orders (800) 654-8657

CIRCLE 90 ON FREE INFORMATION CARD

SEE YOUR DEALER TODAY



FROM

Firestik
ANTENNAS
ACCESSORIES

HERE'S A TIP
THAT'S PERFECT!

AM/FM AUTO RADIO
AND CB

Firestik II

GOLDEN SERIES

BARE-HANDS TUNABLE
"NO TOOLS NEEDED"
HIGH PERFORMANCE ANTENNAS

ALSO ANTENNAS FOR
CORDLESS TELEPHONES
MONITOR SCANNERS

Dealer & Distributor Inquiries Invited
SEND FOR FREE CATALOG

Firestik Antenna Company
2614 East Adams Phoenix, AZ 85034

Name _____
Street _____
City _____
State _____ Zip _____

Serving the CB and
Communications Market Since 1962.

5-YEAR REPLACEMENT WARRANTY

CIRCLE 100 ON FREE INFORMATION CARD

MARCH 1985

39

MICRO CHARTS



Instant Data on the Most Popular
Computer and Microprocessor Parts

- Fully decoded data
- Compact 8 1/2" x 11" size
- Durable credit card plastic
- Clear and concise two-sided tables for:
Full instruction set, disassembly, ASCII,
base conversion, pinout & much more...

Part No.	Description
MLZ80	Z80 CPU
ML6502	6502 (85XX)
ML7400	5400/7400 TTL Pinouts
ML8080A	8080A/8085A
ML8086	8086/8088

FIBEROPTICS

The EDU-LINK Learning Kit

The EDU-LINK fiber optic system is a low-cost, TTL compatible data transmission system designed specifically as an educational tool for students and engineers working in many different industries.



- Includes:
- Transmitter PCB
 - Receiver PCB
 - One meter of plastic optic fiber
 - All necessary electrical hardware
 - Complete step-by-step instructions
 - Theory of operation
 - Tutorial information

Part No. ELK-1

Additions to INTEGRATED CIRCUITS



74LS00 Series

Part No.	Description
74LS273	8-Bit D Type Register
74LS640	Octal Bus Transceiver (Inv.)
74LS641	Octal Bus Transceiver (True)
74LS645	Octal Bus Transceiver (True)

Linear

Part No.	Description
LM387N	Low Noise Dual Pre-Amp
NE555N	Quad Timer
LM3905N	Precision Timer

Microprocessor

Part No.	Description
2732A	32K EPROM (21V)
4164N-200	64K Dynamic RAM (200ns)
6116LP-4	16K Static CMOS RAM (200ns) Low Power
6264P-15	64K Static CMOS RAM (150ns)
6502B	MPU with Clock (3MHz)
6845	CRT Controller (CRTC)
8085A	CPU 8-Bit N Channel
8086	CPU 16-Bit (8MHz)
8088	CPU 16-Bit (8-Bit Data Bus)
8251A	Programmable Comm. I/O (USART)
8253-5	Programmable Interval Timer
27128	128K EPROM 250ns (21V)
MM58167	Microproc. Real Time Clock

OPTO-ISOLATOR

Part No.	Description
4N33	Single Channel Photo-Darlington

DATA BOOKS



Part No.	Description
30001	Nat. CMOS (CD4000/74C)
30003	National Linear
30005	National TTL Logic
30009	Intersil Data
30013	Zilog Microprocessor
30014	National Intuitive IC CMOS Evolution
30015	National Intuitive Op Amps
30016	National Voltage Regulator
30017	National MOS Memory
30018	National CMOS (74HC, RAMs, PROMs)
30019	National Interface, Bipolar (LSI & Memory), Prog. Logic
210830	Intel Memory Components
230843	Intel Microsystem Components

OWI Educational Electronic Robot Kits



Part No.	Description	PEPPY
MV915	Piper-Mouse (Sound Sensor)	
MV916	Peppy (Sound/Touch Sensor)	
MV918	Memocon Crawler (Programmable Memory)	
MV931	Mr. Bootsman (Wired Control)	
MV935	Circular (Remote Control)	
MV939	Medusa (Sound Sensor)	

FANS AND ACCESSORIES



Part No.	Description
MU2A1	Muffin Style Fan (4.68 inch square)
PWS2107	Sprite Style Fan (3.125 inch square)
MFG481	Muffin-style steel wire finger guard
SFG648	Sprite-style steel wire finger guard

CONNECTORS

SOLDER-TYPE CONTACTS

Part No.	Description
57-30360	36 Contact Plug (Centronics)
57-60360	36 Contact Socket (Centronics)
57-30500	50 Contact Plug
57-60500	50 Contact Socket

GENDER CHANGERS

Part No.	Description
JRSMM	Gender Changer (Connects 2 DB25P) RS232
JRSFF	Gender Changer (Connects 2 DB25S) RS232
JCENMM	Gender Changer (Connects 2 Male Centronics cables)
JCENFF	Gender Changer (Connects 2 Female Centronics cables)

The Famous Silicon Chip

Includes the popular verse:
"I'm a computer memory chip
Just a little brain
I do so many things for you
Too many to proclaim
Look through my window
See what makes me tick
A thousand tiny circuits
And my silicon chip."



Part No. MKC-1
Memory Key Chain (Gold)

INDUSTRIES DATASHIELD SURGE PROTECTOR

Eliminates voltage spikes and EMI-RFI noise before it can damage your equipment or cause data loss.

- 6 sockets • 6 ft. power cord
- Brown-out/black-out reset switch • Brown-out notification (audible alarm) • 6 mo. warranty

Part No.
Model 100

Jim-pak
DIODES
CRYSTALS
TRANSISTORS
SOCKETS
KITS
SWITCHES
RESISTORS
LEDS
HEAT SINKS
KEYBOARDS
WIRE
SPEAKERS
TOOLS
CORDS
SOLDER
IC'S
BOOKS
CAPACITORS
and more...

Where's Your **ELECTRONICS** Career Headed?

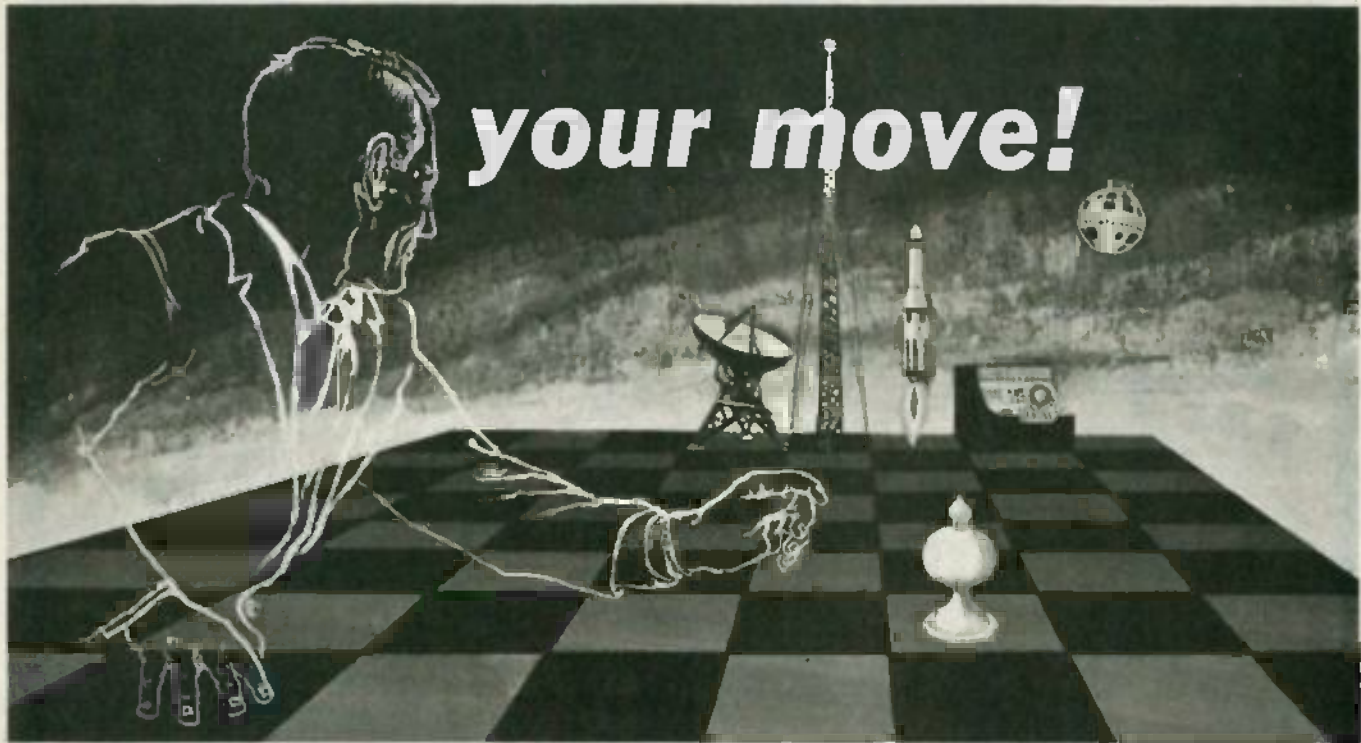

your move!

The Move You Make Today Can Shape Your Future

Yes it's your move. Whether on a chess board or in your career, you should plan each move carefully. In electronics, you can *move ahead* faster and further with a

B. S. DEGREE

Put professional knowledge and a COLLEGE DEGREE in your electronics career. Earn your degree through independent study at home, with Grantham College of Engineering. No commuting to class. Study at your own pace, while continuing your present job.

The accredited Grantham non-traditional degree program is intended for mature, fully employed workers who want to upgrade their careers . . . and who can successfully study electronics and supporting subjects through

INDEPENDENT STUDY, AT HOME

Free Details Available from:

Grantham College of Engineering
10570 Humbolt Street
Los Alamitos, California 90720

Independent Home Study Can Prepare You

Study materials, carefully written by the Grantham staff for independent study at home, are supplied by the College, and your technical questions related to those materials and the lesson tests are promptly answered by the Grantham teaching staff.

Recognition and Quality Assurance

Grantham College of Engineering is accredited by the Accrediting Commission of the National Home Study Council.

All lessons and other study materials, as well as communications between the college and students, are in the English language. However, we have students in many foreign countries; about 80% of our students live in the United States of America.

Grantham College of Engineering R3-85
10570 Humbolt Street, Los Alamitos, CA 90720

Please mail me your free catalog which explains your B.S. Degree independent-study program.

Name _____ Age _____

Address _____

City _____ State _____ Zip _____

BUILD THIS

Uninterruptable



Power Supply

Did you ever wish you could have a backup AC power supply in case of a power failure? Or did you ever wish you could take one or more of your home appliances with you on family outings? Well, this easy-to-build power inverter can help you do both!

DAVE SWEENEY

A POWER INVERTER IS USEFUL GADGET that can lend some degree of portability to otherwise home-bound electronics devices. Its function is to convert a low DC-voltage to a usable AC level. The power inverter we'll describe here will let you generate alternating current that will allow you to power a small television, personal computer, strobe light, or other AC-operated device without being tied down to an AC outlet.

While the project was originally designed so that AC devices could be operated in a car (from the 12-volt system), it has another important use: it can serve as part of an uninterruptable (backup) AC supply. If you suffer from some short-term power outages, it could be particularly valuable. Your burglar alarm could still operate during a blackout, and your clock would still keep time.

We won't go into detail on particular applications of the uninterruptable power supply. But we will mention that you have several options for making the unit "kick in" automatically when the power company cannot deliver. The easiest way, as

shown in Fig. 1, is to use a 117-volt relay to switch between the standard AC line or the 117 volts from the inverter. One possible disadvantage there is that the relay might not be fast enough in some applications. For example, only a very slight disruption in power can overwrite your computer's memory with garbage. Only experimentation will let you know for sure. A solid-state relay, which typically has a faster switching time than a mechanical relay, might be your best bet. In either case, you'll want to make sure that you have a fully charged battery to supply power to your inverter. A trickle charger would be a valuable addition to the circuit.

Provided the inverter's power capacity is not exceeded, you can power most any AC-operated device indoors or outdoors, and during power failures. Be cautioned however, that the output of this inverter is closer to a squarewave than a sinewave. Even though the high-frequency components of the squarewave output are filtered, some devices will not operate properly with such an input and others

may even be damaged!

In a motor vehicle (which is where this unit was designed to be used), the inverter produces 117-volt AC from your auto's 12-volt DC battery. So you can use the unit to add to the fun of an outdoor party, or even to power an electric razor while you wait in line at the drive-in bank!

Voltage isn't everything

Besides generating the correct AC voltage, an inverter must provide the correct frequency. Many devices, especially those with transformers or motors, require 60 Hz. If the frequency varies as the load changes, or when the DC input fluctuates, the performance of the device may be reduced, or the equipment might be damaged.

Low-power, inexpensive inverters typically rely on a special winding of the transformer for oscillation. Since most inverters are little more than an oscillator with specially wound transformers, the unit's output frequency is determined by transformer's inductance. Therefore, loading the transformer changes its effective

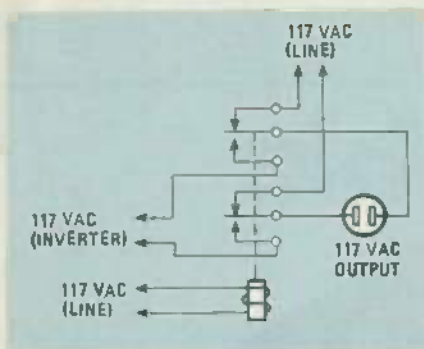

FIG. 1—A SIMPLE RELAY SETUP will let you use the inverter as a backup power supply.

tive inductance, and results in an output-frequency that varies with load requirements.

The inverter power supply that we'll describe here overcomes that deficiency by using a 555 oscillator to control the output frequency. Isolated from the power output, the oscillator maintains a 60-Hz output frequency regardless of the load. And if that isn't enough, it has a low parts-count and the parts used are easy to find.

For example, the transformer is an inexpensive, general-purpose 25.2-volt center-tapped, 2-amp unit with a single high-voltage winding.

Circuit description

Figure 2 shows a schematic of the power supply inverter. MOSFET transistors, Q3 and Q4, form a flip-flop whose output is used to turn power transistors Q1 and Q2 on and off alternately. When Q1 is on, current flows in half the low-voltage winding; when Q1 is off, Q2 is on and current flows in the other half of the low-voltage winding.

Transformer T1, which has a 117-volt primary and 25.2-volt secondary is used as a step-up, rather than a step-down, transformer. (A transformer transfers power in either direction—the terms *primary* and *secondary* are assigned rather arbitrarily.) Current in each half of the center-tapped winding flows in opposite directions (i.e., positive and negative). That alternating current (AC) in the center-tapped "secondary" winding induces AC in the high-voltage "primary" wind-

ing. That voltage step-up results from the operation of Q1 and Q2, which are turned on and off alternately.

As long as the power transistors (Q1 and Q2) alternate at 60 Hz, the output voltage will also be at 60 Hz. To maintain that operating frequency, the flip-flop (Q3 and Q4) switches the base currents of Q1 and Q2. The flip-flop is triggered by the output of the 555 oscillator, IC1. Since Q3 and Q4 conduct alternately, they are always inversely related to each other. And because they operate from the same trigger, they'll always generate a symmetrical AC squarewave.

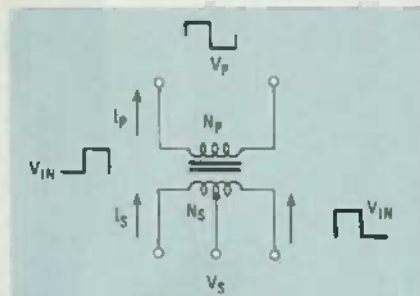

FIG. 3—WHEN A 60-Hz AC VOLTAGE is applied to a standard transformer, the relationships of the voltage (V), current (I), and windings (N) may be expressed as $V_p/V_s = I_p/I_s = N_p/N_s$.

Now let's turn to Fig. 3 for a discussion of the turns ratio and transfer characteristics of the transformer. When a 60-Hz AC voltage is applied to a standard transformer, the relationships of the input/output voltage (V), current (I), and the number of turns in the transformer windings (N) can be expressed as $V_p/V_s = I_s/I_p = N_p/N_s$. For the transformer specified, the turns ratio is 117/25.2; therefore, feeding 25.2-volts AC to the secondary of T1 (without allowing for inefficiencies) produces a 117-volt output.

Since transformer T1 is rated at 2-amperes maximum in the secondary winding, the transferable power is 25.2 (V) × 2 (A) or 50.4 watts. Because the turns ratio determines the output voltage, applying 12-volts AC to half the secondary also yields an output of 117 volts. However, the output power capacity will be cut in half.

To increase the capacity of the unit, connect two identical transformers in parallel, a similar effect to placing two batteries in parallel. Just be sure to connect like terminals together, so as not to cause a phase difference that could damage the transformers! The unit's power-handling capacity will then be the sum of all parallel transformers.

The net result is while transformer T1 determines the step-up voltage level, the 555 oscillator determines the output frequency. Therefore, even if T1 is severely loaded, the oscillator and MOSFET's maintain a symmetrical 60-Hz AC signal for T1.

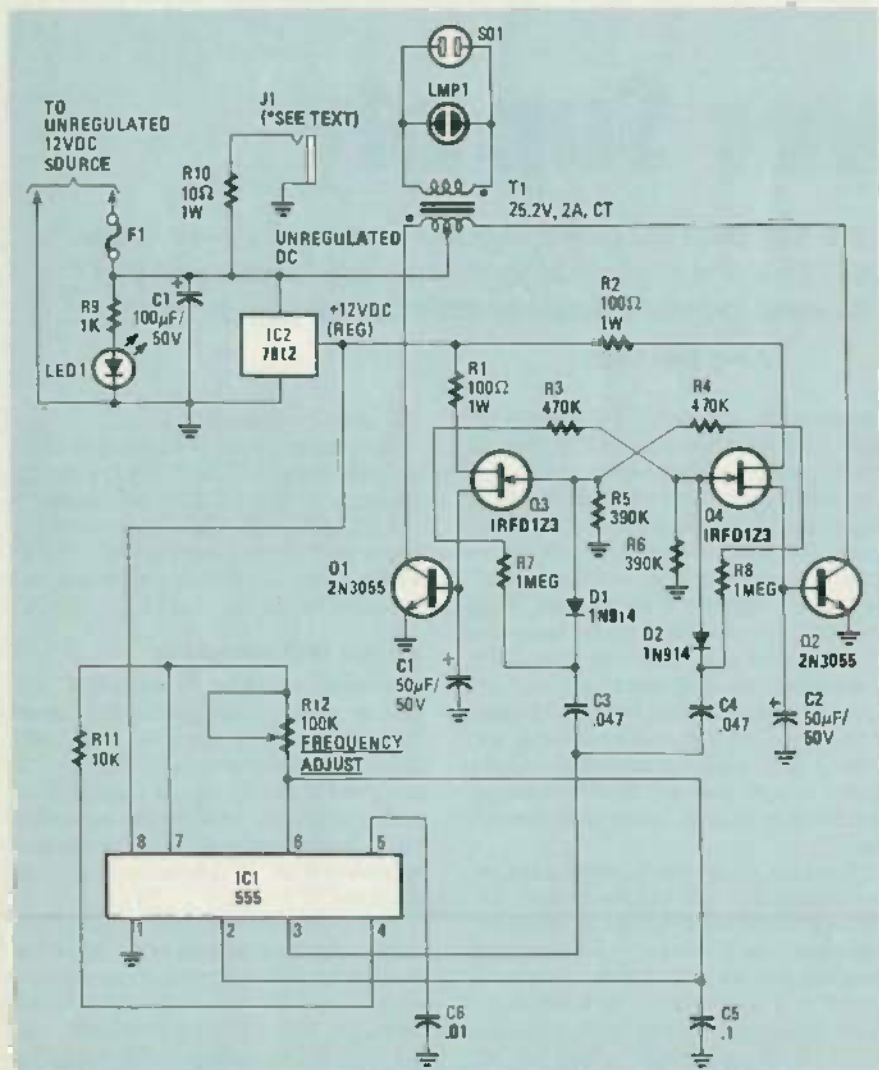

FIG. 2—THE INVERTER SCHEMATIC. Note that the transformer's center tapped secondary is connected as the input. So T1 is used as a step-up transformer.

PARTS LIST

All resistors $\frac{1}{4}$, 5% unless otherwise noted.

R1, R2—100 ohms, 1 watt
 R3, R4—470,000 ohms
 R5, R6—390,000 ohms
 R7, R8—1 megohm
 R9—1000 ohms
 R10—10 ohms, 1 watt
 R11—10,000 ohms
 R12—100,000 ohm potentiometer

Capacitors

C1, C2—50 μ F, 50 volts electrolytic
 C3, C4—.047 μ F, ceramic disc
 C5—.1 μ F, ceramic disc
 C6—.01 μ F, ceramic disc
 C7—100 μ F, 50 volts electrolytic

Semiconductors

IC1—555 oscillator
 IC2—7812 12-volt regulator
 Q1, Q2—2N3055 NPN power transistor
 Q3, Q4—IRFD123 N-channel FET
 D1, D2—1N914
 LED1—Standard red LED
 LMP1—neon panel lamp
 T1—25.2 volts, 2A center-tapped

Miscellaneous: Cabinet, perforated construction board, AC panel socket, miniature phono jack, 4A slow-blow fuse, cigarette lighter plug, etc.

Circuit operation

Capacitor C5 and potentiometer R12 determine the frequency of the output signal at pin 3 of IC1, the 555 oscillator. The output signal is differentiated by C3 and C4 before it's input to the base of the two power transistors (Q1 and Q2) via diodes D1 and D2, respectively. The signal from IC1 is adjusted to 120 Hz. That's because the flip-flop formed by transistors Q3 and Q4 divides the frequency by 2.

When Q3 is on, the base of Q1 is connected via R1 to the regulated 12-volt supply. Then, when the flip-flop changes states, Q4 is turned on and the base of Q2 connected to the 12 volt supply through R2. The 100 mA base current allows Q1 and Q2 to alternately conduct through their respective halves the transformer's secondary winding.



FIG. 4—THE ABOVE TRACE SHOWS the 60-Hz output from the inverter. Note that although the output is closer to a squarewave than a sine-wave, most of the high-frequency components have been removed.

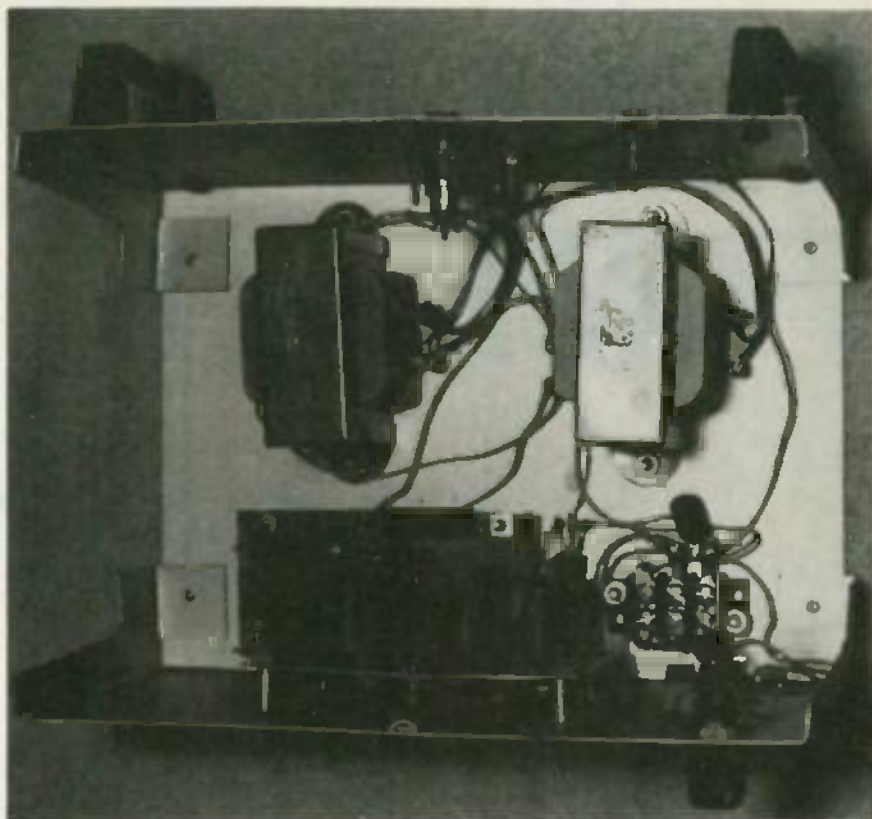

FIG. 5—THE AUTHOR'S PROTOTYPE is shown here installed in metal cabinet. Note that two transformers are used to increase power handling capabilities.

To eliminate switching transients caused by the rapid switching of Q3 and Q4, capacitors C1 and C2 filter the inputs to the base of Q1 and Q2 respectively. Figure 4 shows the waveform that appears at the output (primary) of the transformer. Though the output is not a sine wave, it is close enough to operate all but the most critical equipment. But don't risk damage to your expensive equipment if you're not sure. As a rule of thumb, if your equipment can be damaged by transients, it's not a good candidate for this backup power supply.

Power for the unit comes from your automobile's 12-volt system, or—if you want to use the inverter for backup applications—from a storage battery. It is regulated by IC2 (a 7812 regulator). LED 1, connected across the 12-volt input, may be used to indicate whether power is being fed to the circuit. The neon pilot lamp, LMP 1, shows a presence or absence of output power. Jack J1 is included to provide a convenient 9-volt DC supply for a videogame, like the Atari 2600.

Circuit construction

The method of construction is not critical, but if you're going to build the inverter as a portable unit, it's important to build it to withstand punishment. The author's prototype was built on perforated construction-board using point-to-point wiring, as shown in Fig. 5. Note that there are two transformers shown; as mentioned

previously, two or more transformers may be paralleled to increase the unit's power handling capacity.

The power-inverter circuit should be housed in a metal cabinet, and power transistors Q1 and Q2 should be heat sunked. To avoid damage from vibration, the components should be secured to the driver board with an epoxy adhesive.

The FREQUENCY-ADJUST potentiometer, R12, should be set prior to connecting the collectors of Q1 and Q2 to the transformer. Set the frequency at pin 3 of the IC1 to 120 Hz; then using a scope, monitor the base of both Q1 and Q2 to verify that a 60-Hz signal is present. Once the signal is established, the Q1 and Q2 collectors may be connected to the transformer.

Potentiometer R12 may be mounted on the panel to allow frequency adjustments from outside the inverter. To test the unit out, plug it into the cigarette-lighter socket in the vehicle. Both pilot lights should come on. If not, go back and check your work. If all is well, the unit is ready for use.

Safety procedures

Caution: Keep in mind that the inverter, whether being tested or used, has the same output-voltage level as that of an ordinary household power-outlet and is just as dangerous. Exercise the same caution that you would in dealing with household line voltage.

R-E

In Search of *FIREBALL* *LIGHTNING*

ROBERT K. GOLKA

The author's latest experiments have provided new insight into one of physics' biggest mysteries. Here's a report on those rather unique experiments, and the results that they produced.

NIKOLA TESLA'S ACHIEVEMENTS AND DISCOVERIES have done much to shape modern electronics. After all, among his patents are those for the AC motor and the tuned circuit. But none of his achievements were more spectacular than his legendary 12.5-million volt Tesla Coil. The coil was built in Colorado Springs, CO, in 1899, as part of Tesla's experiments in worldwide communications (although some say he was also interested in the transmission of power). But it is not the experiment that is of interest here; instead, it is one of the by-products that it produced.

Ball lightning

In his diary, Tesla made note of little fireballs that were produced during his experiment. Those fireballs measured about an inch and a half in diameter, and persisted even after his apparatus was turned off. Though their production was accidental, it was also repeatable.

The nature of ball lightning, or fireballs, have long been a mystery. That phenomenon consists of glowing balls, apparently of electrical plasma, that are a foot or less in diameter. They appear in the wake of thunderstorms, move slowly, and bounce when they hit the earth or some other solid object.

There was little interest in Tesla's observations and experiments until the coming of the "nuclear age." Since then, nuclear scientists have been struggling to contain and control the plasma of ionized and superheated gases that are necessary for a sustained fission reaction. Since in ball lightning, it appears that electrical plasma is controlled, that phenomenon has drawn attention from a few scientists.

In addition to myself (reports on my work appeared in the June 1976 and February 1981 issues of *Radio-Electronics*), the two men most interested in this phenomenon were Russia's Dr. Peter L. Kapitsa, winner of the 1978 Nobel Prize in physics, and James L. Tuck of Manhattan Project fame and the founder of the Los Alamos Plasma Physics Laboratories. Both men are now deceased, but Dr. Tuck left something behind of great importance.

About two years ago, while going through Dr. Tuck's personal papers at Los Alamos National Laboratories, I came across a series of four sequential photos of a submarine battery-bank circuit breaker being opened: the current through the breaker was on the order of 10,000 amps. Dr. Tuck had shown those pictures to me in 1971, and mentioned that after about

30,000 shots over a 2½ year period, he had gotten only those 4 pictures of what he thought were ball lightning. Three of those photographs are reproduced on the facing page.

Upon seeing those photographs once again, I decided to reproduce Dr. Tuck's experiments using a real World War II submarine. Unfortunately, there are few of those left in our "nuclear Navy." The only one I managed to locate was not being used, but that may have been due to the fact that it had no propellers and only one working engine. I thus decided to try the experiment with a diesel railroad locomotive instead.

The next problem was finding a railroad that was willing to loan me a locomotive, box cars, and track for such an experiment. Thankfully, the president of the Boston and Maine railroad had the wisdom, foresight, and love of progress necessary to fulfill my needs; the railroad provided me with two locomotives, a train, and a mile and a half of track. It was because of that, that I was able to conduct 3½ months of experiments that completely altered my thinking on the nature of ball lightning.

First of all, I now feel that it is more of a particle rotation flow than a high voltage

electrostatic effect; that is, more like a giant plasma vortex donut with a tiny hole than an electrostatic sphere. Now, there are a whole host of phenomena in aeronautical engineering, particularly in the area of fluid dynamics, that are not yet fully understood. One of those is the physical properties of vortices. One can blow smoke rings inside of smoke rings, and have the inner ring move back and forth. You can also blow smoke rings that stand perfectly still. In liquids, rings can form spheres and other shapes.

Well, back to the railroad! To perform my experiments, I grafted a submarine circuit breaker into the high-voltage circuit between the million watt, 1600-horsepower diesel generator and the 2000-horsepower motor trucks beneath the locomotive. By opening the circuit breaker (using a long broomstick handle), I was able to generate ball lightning.

The effects of opening the circuit breaker were quite astonishing. Temperatures in the cab of the locomotive would go instantly from 60°F to 110°F. As you might imagine, there was an overwhelming desire to leave the train cab for some fresh air. I, of course, could not do that since the train was still moving (at a speed of about 20 miles an hour), and the likely result would have been running the train off the end of the track and destroying the experimental setup.

In any event, after redoing the experiment countless times, I was able to convince myself that the fireball effect was due to the elimination of turbulence. In fact, I found that when I closed the door and windows of the cab, the effect was most likely to occur.

My earlier experiments involved placing the breaker on the top of the locomotive, over the updraft of the engine radiators; that proved to be the most ineffective way to go. It was only after I realized that shielding the set up from turbulence aided the effect that I began to see results. If nothing else, that shows that one must have almost a Sherlock-Holmes-like approach to this kind of research if it is to succeed. Also, that was probably the first plasma physics experiment ever performed on a moving train!

I now feel that there is much to be done in this area. The next step is to perform the experiment using a more conventional setup: in a low velocity wind tunnel, using controlled arc discharges to form ball lightning. I believe that setup would be very productive.

While the mechanism that allows the confinement of the plasma is still unknown, now the probable nature of that mechanism is known, at least in part. The next task is to demonstrate the phenomenon over and over again. By doing that, the remaining questions will be answered and the true nature of ball lightning will be revealed.

R-E



Electronics Paperback Books

Quality Paperbacks at Affordable Prices



20 SOLDERLESS BREADBOARD PROJECTS BOON-L. \$5.75. Whenever you need to save time and avoid the hassle of soldering, use a breadboard. It's a simple, fast, and easy way to build your projects.

HOW TO GET YOUR ELECTRONIC PROJECTS MADE. \$5.95. These 100 projects are designed to help you build your projects.

8080 MATRIX BOARD PROJECTS. \$8.95. A variety of projects that can be built upon a mini-matrix board that has 10 strips and 24 holes long.

MODERN OP-AMP PROJECTS. \$5.00. Wide range of operational amplifier circuits including inverting, non-inverting, and more.

MULTI-CIRCUIT BOARD PROJECTS. \$5.00. 21 very simple projects that can be built on a single breadboard board.

IC PROJECTS FOR THE GENERAL PUBLIC. \$5.95. Includes projects for 741, 742, 743, 744, 745, 746, 747, 748, 749, 750, 751, 752, 753, 754, 755, 756, 757, 758, 759, 760, 761, 762, 763, 764, 765, 766, 767, 768, 769, 770, 771, 772, 773, 774, 775, 776, 777, 778, 779, 780, 781, 782, 783, 784, 785, 786, 787, 788, 789, 790, 791, 792, 793, 794, 795, 796, 797, 798, 799, 800.



ART OF PROGRAMMING THE 1K Z801. \$8.95. Topics include full screen, scrolling, PEEK & POKE, and actual working programs.

THE 4809 COMPANION. \$5.95. Written for the average assembly language programmer. A discussion of 4809 features & reference work for the 4809 programmer.

PRACTICAL COMPUTER EXPERIMENTS. \$8.95. A background in microprocessor by constructing typical computer projects using one or more logic components.

ART OF PROGRAMMING THE 1K Z801. \$8.95. How to use the features of the Z801 in programs that fit the 1K machine and are still fun to use.

INTRODUCTION TO BASIC PROGRAMMING TECHNIQUES. \$5.00. Based on author's own experience in learning BASIC and helping others to learn to program.

A MICROPROCESSOR PRIMER. \$4.95. Provides approach to computing for the beginner. Step-by-step explains computer operations and assembly.

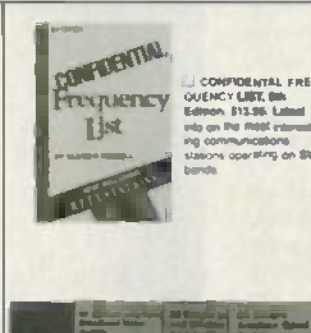

CONFIDENTIAL FREQUENCY LIST. 8th Edition. \$13.95. Listed only on the most interesting communications stations operating on SW bands.

25 SIMPLE SHORT-WAVE BROADCAST BAND ANTENNAS. \$5.00. Simple & easy to build. Covers 160, 170, 190, 220, 30, 40, 60, 80, 100, 120, 160, and 170 meter bands.

25 SIMPLE TROPICAL AND M.W. BAND ANTENNAS. \$4.95. For 80, 75, 90 & 135-meter bands. Also SW, 1600 and broadcast band.

25 SIMPLE INDOOR AND WINDOW ANTENNAS. \$4.95. Shortwave listening is possible even where outdoor antennas are prohibited. Here's how.

25 SIMPLE AMATEUR BAND ANTENNAS. \$5.00. Dipole, beam, Yagi, and even a new magnetic.

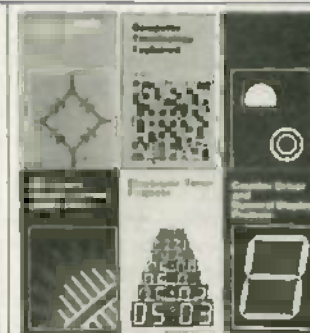

POWER SUPPLY PROJECTS. \$4.95. Contains designs and construction details for almost 100 power supply projects.

COMPUTER TECHNOLOGY EXPLAINED. \$5.00. See out there explanations for most of the common terms encountered by the home computer enthusiast.

ELECTRONIC TEST EQUIPMENT CONSTRUCTION. \$4.95. Construction details of a wide range of test equipment the experimenter can build at home.

ELECTRONIC PROJECTS USING SOLAR CELLS. \$8.95. Simple circuits that have numerous applications around the home.

ELECTRONIC TIMING CIRCUITS. \$8.95. Timing circuits for almost any application the experimenter might need. A most valuable reference.

COUNTER DRIVER & NUMERICAL DISPLAY PROJECTS. \$4.95. Features applications & projects using various types of numerical display devices.



PRACTICAL ELECTRONICS CALCULATIONS AND FORMULAE. \$7.95. A basic reference work that brings the 500 formulas and equations together in one place.

INTERNATIONAL GUIDE EQUIVALENTS. \$5.95. Helps you find substitutes for the many different types of semiconductor devices in use today.

HOW TO DESIGN ELECTRONIC PROJECTS. \$5.75. How to take several different projects and combine them into one new project that fits your needs.

HOW TO MAKE WALKIE TALKIES. \$5.00. Describes equipment for 100 power handheld operation. 112 pages of step-by-step instructions for the dedicated experimenter.

ELECTRONIC CALCULATOR USING MICROPROCESSOR. \$8.95. Features formulas, conversion factors & more than the steps of the calculator.

DIGITAL IC PROJECTS. \$8.95. All projects are based on 741, 742, 743, 744, 745, 746, 747, 748, 749, 750, 751, 752, 753, 754, 755, 756, 757, 758, 759, 760, 761, 762, 763, 764, 765, 766, 767, 768, 769, 770, 771, 772, 773, 774, 775, 776, 777, 778, 779, 780, 781, 782, 783, 784, 785, 786, 787, 788, 789, 790, 791, 792, 793, 794, 795, 796, 797, 798, 799, 800.



INTRO TO PROGRAMMING THE ATARI. \$5.00. Text is designed to complement info provided by the manufacturer. Essential reading for Atari owners.

INTRO TO PROGRAMMING THE COMMODORE 64. \$5.95. Text is designed to complement info provided by the manufacturer. Essential reading for Commodore 64 owners.

BASIC & PASCAL IN PARALLEL. \$8.95. Takes BASIC & Pascal and device programs in both languages simultaneously.

BASIC & FORTH IN PARALLEL. \$8.95. Takes BASIC & Forth and device programs in both languages simultaneously.

BASIC & FORTH IN PARALLEL. \$8.95. Takes BASIC & Forth and device programs in both languages simultaneously.

ELECTRONIC SYNTHESIZER PROJECTS. \$4.95. Everything you need to know—including analog only program, microprocessor, 100, power supply and more.

INTRO TO PROGRAMMING THE ATARI. \$5.00. Text is designed to complement info provided by the manufacturer. Essential reading for Atari owners.

INTRO TO PROGRAMMING THE COMMODORE 64. \$5.95. Text is designed to complement info provided by the manufacturer. Essential reading for Commodore 64 owners.

BASIC & PASCAL IN PARALLEL. \$8.95. Takes BASIC & Pascal and device programs in both languages simultaneously.

BASIC & FORTH IN PARALLEL. \$8.95. Takes BASIC & Forth and device programs in both languages simultaneously.

BASIC & FORTH IN PARALLEL. \$8.95. Takes BASIC & Forth and device programs in both languages simultaneously.

ELECTRONIC SYNTHESIZER PROJECTS. \$4.95. Everything you need to know—including analog only program, microprocessor, 100, power supply and more.



ANTENNA PROJECTS. \$5.95. Covers practical antenna designs including active, loop & ferrite types that are easy & inexpensive to build.

WHITE'S RADIO LOG. \$4.95. Up-to-date directory of North American AM, FM and TV stations including worldwide shortwave stations.

LONG DISTANCE TV RECEPTION (TV-D) FOR THE ENTHUSIAST. \$5.00. Practical & authoritative introduction to the crucial aspect of electronics.

CB PROJECTS. \$8.95. A number of useful and interesting designs for CB accessories: Speech processor, microphone, intercom, etc.

CRYSTAL SET CONSTRUCTION. \$4.95. Packed full of easy to duplicate designs for crystal radio receivers.

AN INTRODUCTION TO RADIO DX. \$8.95. Learn in your home to broadcast originating, frequency of interest, etc. Tells how you can do it.



THE SIMPLE ELECTRONIC CIRCUIT & COMPONENTS. \$5.75. All the fundamental theory needed to lead to a full understanding of the simple electronic circuit and its components.

ALTERNATING CURRENT THEORY. \$5.75. A complete guide to all the elements of AC theory without which there can be no comprehension of speech, music, radio, or television.

MICROPROCESSOR SYSTEMS & CIRCUITS. \$7.95. A truly comprehensive guide to all the elements of a microprocessing system.

25 TESTED TRANSDUCER PROJECTS. \$8.95.

SEMICONDUCTOR TECHNOLOGY. \$8.95. Everything you always needed to know about solid-state devices in one volume.

COMMUNICATIONS. \$5.95. Covers most modern communication systems. Lists micro-wave, plasma, satellite, digital, radio, radio & telemetry.

FIRST BOOK OF HI-FI SPEAKER ENCLOSURES. \$8.95.

SOLID STATE NOVELTY CIRCUITS. \$3.95.

ELECTRONIC TECHNOLOGY TODAY INC.
P.O. Box 240, Massapequa Park, NY 11762

RE 3/85

RADIO-ELECTRONICS

Number of books ordered

Total Price of Books \$

Sales Tax (NY State Residents)

Shipping (75¢ 1st two books, 30¢ ea additional)

TOTAL ENCLOSED \$

Name
Address
City State ZIP

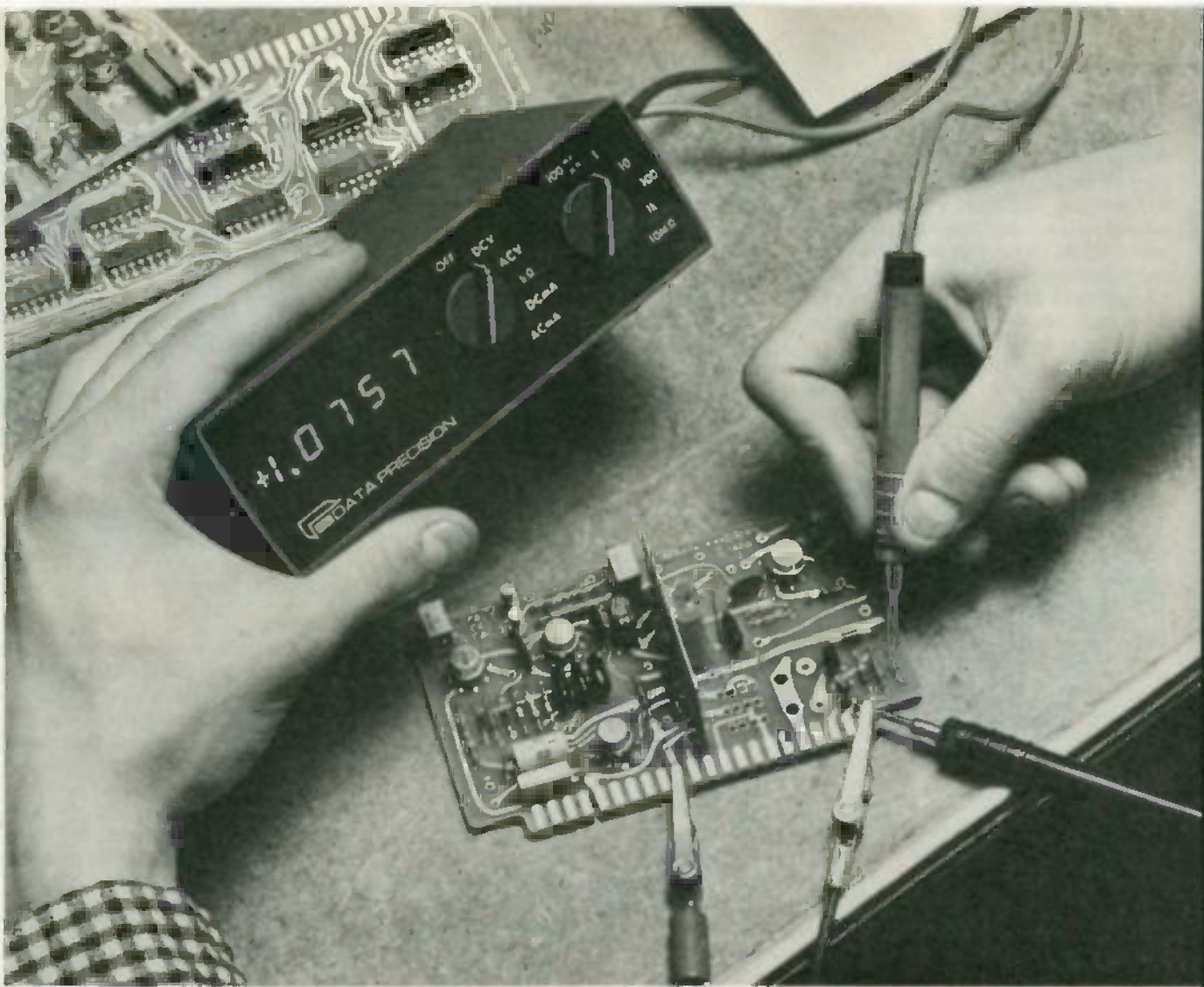

What's New In DMM's

HERB FRIEDMAN

*Here's a overview of the features and specifications
you should look for in the most popular
electronics test instrument: the modern digital multimeter.*

BEFORE DIGITAL MULTIMETERS BECAME A commercial reality, the multimeter in primary use was called a VOM (Volt-Ohm-Milliammeter). In those days, whether the multimeter was to be used in a commercial or school laboratory, in a basement workshop, or by the local radio/TV service center, selecting a VOM was a simple task. You had your choice of the "legendary" VOM's from Simpson and Triplett in either the "pocket" or "bench" sizes, or similar but less expensive models from other sources.

An amplified version of the VOM—called the VTVM (Vacuum Tube Volt Meter)—which had an input impedance of 1 to 10 megohms (depending on the specific model) was required when the lower input-impedance of VOM's might

load the circuit being measured and affect the reading.

Except for the astronomically-priced laboratory instruments, within each category, VOM's and VTVM's were similar in features and performance, being generally limited to measuring AC and DC voltages and currents, and resistance. Price differences generally reflected long-term reliability and accuracy rather than operating features. Occasionally, a VOM or VTVM would be introduced that was touted as a multi-function *supermeter*, but more often than not the *superfunctions* turned out to be some way to measure small capacitance values, and possibly a low-current variable-voltage supply used to test the leakage of, or to reform, electrolytic capacitors.

Though a VOM and modern solid-state equivalents of the VTVM are still available (primarily in the lowest and highest price ranges), for general all-around use the DMM (Digital MultiMeter) is the standard test, service, experimenter, and laboratory meter.

Unlike the early DMM that simply substituted a digital readout for an analog meter, and whose accuracy and reliability were often substantially less than that of a VOM of equivalent price, the modern DMM provides functions, accuracy and reliability rarely, if ever, attained by conventional analog meters. (Note: The first DMM introduced in this country was produced by Non-Linear Systems, now better known for their compact oscilloscopes and *Kaypro* computers.—Editor).

DMM's are not the same

In a general way, few DMM's are alike. Whether it's the power supply, the display, the functions, or the kind of batteries used to power the instrument, every manufacturer has its own idea as to what should go into a DMM: what functions, tolerance and reliability should be provided for a given price. More often than not, the user must trade off a feature or function for cost-effectiveness, or just plain convenience of operation. So instead of looking at specific models, we'll take a look at the various functions and features. You select the ones that answer your needs.

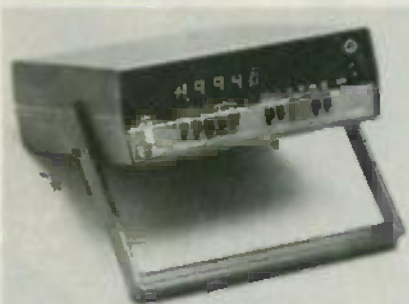

DATA PRECISION MODEL 2480.

The display

First things first, let's look at the display devices because they determine how long a battery can power a portable DMM. (Even though a portable DMM might have a connection for a line-powered AC adapter, away from a powerline it runs off its internal batteries.)

Both LCD (Liquid Crystal Display) and LED (Light Emitting Diode) displays are used for DMM's. The LCD is the most commonly used display for battery powered instruments because it requires a minimal amount of operating current. In fact, the current required by an LCD display is often less than a battery's internal leakage current. The typical LCD DMM uses a 9-volt rectangular type battery that will last from 300 to 2000 hours depending on the design of a particular meter.

The problem with LCD's is that they are difficult or impossible to see under low ambient light, and some of them respond relatively slowly when the reading is updated.

On the other hand, the LED (Light-Emitting Diode) display can be seen in total darkness and responds almost instantaneously to updating. Unfortunately, compared to the LCD, the LED display requires a considerable amount of power, and a small 9-volt battery—even of the alkaline type—cannot provide substantial operating life. So LED DMM's generally use either two or four AA-type batteries, which provide considerably more current than 9-volt rectangular-type batteries. However, the total life per AA battery set is approximately 50 to 75 hours when powering LED's, though some are

as low as 30 hours.

Because each element of an individual LED digit requires considerable current—usually in the range of 3 to 10 mA, the instantaneous load on the DMM's power supply depends on how many display segments are lit. An LED display whose reading is continuously changing will produce a varying load on the meter's power supply. An LED DMM will usually (not always) use an internal voltage regulator of some kind to prevent the power-supply voltage fluctuations from affecting other circuits. As you might expect, this increases the relative cost of the LED DMM.

Resolution

Assuming similar internal circuitry, a DMM's resolution as well as its price is determined by the number of display digits. Resolution means the smallest measurable increment. The most common service-grade DMM's have 3½ digits, meaning three active digits that can indicate from 0 to 9, and a MSD (Most Significant Digit) "half-digit" that is either blanked, or can indicate a value of 1. For example, a typical service instrument would indicate .999 volt. An increase of .1 volt would result in a display of 1.000. The "1" is the "half" digit; it cannot step to a "2." At 1.999 volts, an increase of .001 volt would produce a reading of 2.00 volts (three digits). Notice the "half" digit is blanked. More important, the resolution decreases. With 3½ digits used for the display, a voltage variation of only .001 could be observed. With only three digits in use, the minimum resolution is .01 volt.

Going a step farther, 120 volts would be displayed as 120. Now the resolution is 1 volt. Unless some form of unusual range selection is provided, the half-digit would not turn on until the display reached 999; i.e., 1200 volts would be displayed as 1.200. But note that although the half digit is turned on the decimal is still in the same location, so resolution remains at 1 volt.

Because of internal circuitry, the common service-grade DMM's have a resolution of approximately 100 millivolts; higher performance meters have a more sensitive resolution. Resolution is also determined by the sample rate, meaning the time interval between updates of the display. The shorter the sample rate, the greater the inherent resolution capability. The sample rate depends on the function, price and quality. Low cost service-grade DMM's have a sample rate in the range of 2.5 to 5 seconds; the better-quality service-grade DMM's have a nominal sample/update rate of 2.5 seconds. A somewhat higher price buys a sample rate of nominally 1.5 seconds. Laboratory-grade DMM's have sample rates into the millisecond range. The only time sample/update gets sticky or frustrating is when



FLUKE MODEL 8022B.

making resistance measurements above 10 megohms because the sample/update can be almost 10 seconds.

Where the internal circuits permit greater resolution, it can only be observed if the DMM has sufficient digits to indicate the increased resolution. To this extent, high-performance service-grade DMM's are available with 4½ digits, while laboratory-grade DMM's have from 6½ to 8½ digits.

Digits don't mean accuracy

The fact that a meter uses digital technology doesn't necessarily mean it is any more accurate than an analog VOM because it is the internal circuits rather than the display that determines the overall accuracy. Accuracy ranges from about 3%–5% of full-scale for the low cost pocket DMM's, to .002% for the laboratory grade meters. The high-performance service-grade instruments fall in the range of .01% to .5% for DC voltage and resistance, and possibly as high as 1% for high values of current.

What should be remembered is that the accuracy is in addition to a factor of ± 1 count, even if not specified. This means that the LSD (Least Significant Digit) can be 1 count higher or lower than the worst-case tolerance. For example, if a DMM should indicate 120 volts, it will also be within specifications if the display is 119 volts, or 121 volts. Naturally, the greater the number of digits used for the display the smaller the effect of the ± 1 count on the total reading. While a 3½ digit display could indicate 119, 120, or 121 volts and still be on spec, a 4½ digit display with the same effective meter tolerance might indicate 119.99, 120.00, or 120.01 volts.

A critical area, however, is AC measurements. The AC accuracy is heavily dependent on the operating frequency. Most of the conventional and even laboratory grade DMM's have their maximum

accuracy in the range of 40 Hz to 20 kHz. That is, of course, more than an adequate frequency range for most AC measurements. However, if you are interested in high-fidelity audio service or experimentation, your measurements should be accurate down to at least 20 Hz, and possibly as low as 15 Hz, or 10 Hz. Finding relatively inexpensive DMM's that go down to the basement so to speak isn't the easiest of tasks because many of the service grade instruments don't show a frequency range in their tolerance specifications.

Analog DMM's

We have previously mentioned the sample/upgrade rate, which is nominally 1.5 to 2.5 seconds for most service-grade DMM's. This means that any sudden peaks or dips in voltage, current or resistance will not be displayed if the reading returns to the average value before the next sample is taken. In many instances the short-term variation is really what the technician is looking for, and this is the reason so many analog meters are still sold. Two techniques are used to inform the technician of variations that might occur between samples. Neither is commonly found on DMM's, although they are available on a few of them.

The first is simply a small analog meter built into the DMM. While the DMM provides the convenience and accuracy of a digital display, the analog meter allows the user to observe short-term variations. If the user suspects there are short-term variations, he can keep one eye on the analog meter.

The second way in which short-term variations are indicated is with a built-in tone generator whose output frequency is proportional to the measured voltage, current, or resistance. While a change in pitch doesn't indicate the magnitude of the variation to the measured voltage, current or resistance, it is an effective way to call attention to a change that might otherwise be concealed by the DMM's sample/update rate.

True RMS

Unlike analog VOM's and early DMM's, the modern DMM can indicate "true" rather than interpreted values. Pre-TV, and certainly pre-digital, the typical voltage or current being measured was either DC or sinusoidal. The conventional meter movement responded to the DC value. For AC measurements, the AC voltage or current was first passed through a rectifier with the resultant DC passed on to the meter. (The rectifier's DC output depends on inherent non-linearity characteristics of the rectifier and whether it's a half- or a full-wave rectifier.) Since the AC world was sinusoidal, the range divider was simply calibrated so the AC and DC meter scales were similar, with the AC



DATA PRECISION MODEL 945.

scales indicating RMS volts or current. And again, since the AC world was sinusoidal, a peak-voltage scale was obtained by simply multiplying the RMS value by 1.4. The peak-to-peak value was attained by multiplying the RMS value by 2.8. It was all quick and dirty, and it was accurate for most applications in those days.

While interpolation works out quite well if the applied input signal is always the same waveform, the TV and digital world uses non-symmetrical waveforms whose average, RMS, and peak values have no relationship to each other. Since DMM's are digitally-based to start with, it is often cost-effective to include measurements of non-sinusoidal true RMS and peak values, and as we move away from the relatively low-cost service-grade DMM's, we can find models that feature true RMS indications and peak hold.

True RMS is exactly what the term implies: The DMM determines rather than interpolates the true RMS value of a waveform—whether it be sinusoidal or non-symmetrical makes no difference when the value is determined. That is of particular importance when power is involved because a pulse of extremely narrow width has relatively low power even if the peak value is substantial, and a true RMS DMM would indicate the actual power, or an accurate RMS voltage value from which power could be accurately calculated.

Peak hold is when the DMM stores and displays the measured value until deliberately cleared by the user. The feature is effective because it can often display the peak value of a waveform so narrow that a scope was previously required for measurement. It also displays the value of a peak variation that might occur during the lag in the DMM's sample/update rate.

With no presently known exception, commonly-used DMM's have the peak hold as a switch-selected feature in addition to conventional metering. Similarly, true RMS is also generally switch-selected, though some high priced laboratory-grade instruments measure all non-sinusoidal waveforms in terms of true RMS.

Autoranging

Much ado about nothing goes into how a DMM's functions and ranges are selected. Some models have the selector buttons on the side, others on the bottom, still others have the buttons on the front panel, and some use rotary switches. The way the ranges are selected has absolutely no effect on performance unless it is done by *autoranging*.

Autoranging is an internal electronic switch that automatically attempts to select the most efficient display range when the user connects the DMM's probes into the circuit being tested. Since autoranging also automatically repositions the display's decimal point, the user need only glance at the display to know the measured value—there is no fussing with range switches. There is also no need to worry about meter overload, or even about possible damage caused by overload, because the autoranging circuits initially set the meter to its highest range.

Autoranging is generally provided in addition to standard range selection because the range that is automatically provided might not be optimum for a particular kind of circuit or test. The user might want to lock the meter to a fixed range to obtain a specific degree of resolution.



HICKOK MODEL MX-333.

Diode tests

Another somewhat unusual feature usually found in the higher priced DMM's is a "diode test." In the conventional VOM, the voltage across the test probes when the meter is set for resistance measurements ranges upwards from 1.5 volts, which is more than enough to test conventional signal and rectifier diodes for forward and reverse conduction. Unfortunately, one of the disadvantages of this kind of check is that the current flow through the test probes can reach to almost 500-mA or higher, a value that has been known to fry what was previously a good diode or transistor junction.

DMM's, on the other hand, have no such problems because the test voltage across the probes is generally less than 1 volt, and the maximum test probe short-circuit current is most often in the range of 100- μ A to 1-mA, which isn't enough to fry anything. Unfortunately, neither the voltage nor the current is sufficient to perform the most rudimentary check of a

IF YOU WANT TO GET YOU HAVE TO GET INTO

Learn PC Servicing By Building Your Own NTS/HEATH HS-15 Desk-Top Computer, Circuit-By-Circuit

NTS Intrinsic Home Training Takes You Below The Surface

NTS gets you right down into the heart of computer circuitry. You learn how microprocessors function, how they are designed, how they operate and are used to solve problems. Your program includes a wide variety of tests and projects, as you assemble your PC. You experience the excitement of seeing your own skills grow, the security of knowing you really understand what makes a computer tick.

A Career in PC Servicing

The world of computers is constantly expanding. Applications have spread from business to manufacturing, from industry to medical and scientific fields. Computer-aided design, engineering, and production have revolutionized drafting, graphics, and prototyping. Computer sales figures point to a continuing need for service technicians as well as installation and maintenance specialists. The type of training you receive will largely determine your ability to take advantage of these opportunities and nothing beats the practical, down-to-earth training you get from NTS.

The NTS/HEATH 16-Bit HS-151

This desk-top PC is the most powerful and versatile ever offered in any home training program. Check the advanced features listed below:

1. 128 KB RAM user memory on board, expandable to 640 KB
2. 16-bit 8088 Microprocessor accepts advanced software, speeds word processing; also allows selection from the huge library of IBM software.
3. 5.25-inch floppy disk drive, double density, IBM formatted, stores up to 360 KB. (Expandable to dual disk drive, and optional 10.5 MB hard-disk drive.)
4. MS-DOS operating system, IBM compatibility, make a wide choice of software programs available.
5. Four open IBM-compatible slots provide for future expansion, printer, modem, etc. Will accept most peripheral boards designed for IBM-PC.
6. Two video outputs for color or monochrome display monitor. Your NTS course includes a high resolution monitor displaying 80 characters by 25 lines, or graphics.
7. Editing capabilities help you insert or delete characters and lines, erase, jump or smooth scroll, etc.

Your NTS training course will teach you to program on this outstanding PC, using lessons, texts, and diagrams to make full use of its capabilities. Catalog contains complete details.



Learning circuitry through the construction of this equipment offers practical training for which there is no substitute. Test equipment is included.

Field servicing is interesting and rewarding. Technicians may work for a service company, manufacturer, or major users.

The NTS/HEATH HS-151 PC completed, includes monitor and full-function keyboard with calculator style keypad, and typewriter format.



INTO PC SERVICING A MICROCOMPUTER

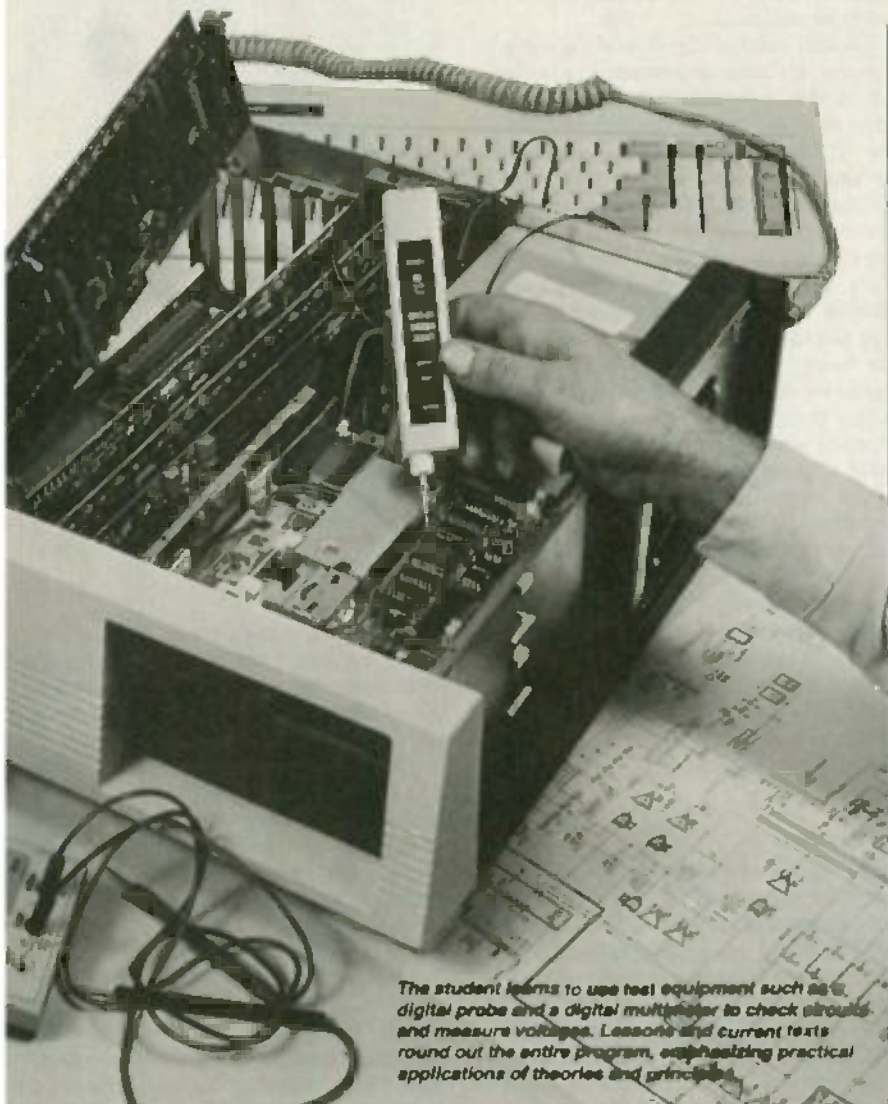

The student learns to use test equipment such as a digital probe and a digital multimeter to check circuits and measure voltages. Lessons and current texts round out the entire program, emphasizing practical applications of theories and principles.

Installing the disk-drive in the PC is one of the final stages in the assembly of the microcomputer. Learning the use of test equipment to check circuits is an integral part of the training which, with field experience, develops invaluable career skills.



NTS COURSES COVER MANY AREAS OF SPECIALIZATION IN ELECTRONICS:

Robotics: Build the NTS/HEATH Hero 1 Robot as you learn robotic programming. Robot is complete with arm and gripper, voice synthesizer. Robotics is becoming increasingly important in industry as almost daily news features attest.

Video Technology: Build one of the most advanced Color TV sets in America as you learn circuit diagnostics, and the use of digital test instruments. Course covers color TV, video tape recorders, computer fundamentals, solid-state devices.

Industrial and Microprocessor Technology covers circuit analysis, microprocessors and automation applications, lasers, and basic industrial robotics.

TV & Radio Servicing is a specialized course offering an excellent foundation in the use and application of both analog and digital test equipment as applied to the TV servicing field. Learn circuits, adjustments, trouble-shooting, and servicing of Color and monochrome monitors.

Digital Electronics offers the student the opportunity to get involved with computer concepts, computer technology fundamentals, and digital equipment by training on the NTS Compu-Trainer.

Basic Electronics is a course designed for those wishing to have an over-view of electronics in many of its aspects including radio receivers, solid state devices, and electronic components.

NTS Intrinsic training programs include a variety of superb equipment, most of which is classified as field-type, making the training practical and career oriented. Texts and lessons have been tested in our Resident School in Los Angeles to assure home study students their courses of training are easy to understand. NTS, now in its 80th year, continues to be at the leading edge in Electronics home training.

* IBM is a trademark of International Business Machines Corp.
* MS is a trademark of Microsoft Corp.

If card is missing, simply write to the address shown below stating the course you are interested in. A FREE color catalog with all details will be sent to you by return mail.

**NTS NATIONAL
TECHNICAL
SCHOOLS**

TECHNICAL TRADE TRAINING SINCE 1905
Resident and Home-Study Schools

4000 So. Figueroa St., Los Angeles, CA 90037

MARCH 1985

55

diode, so some DMM's make special provisions for a diode test by providing either a special set of terminals or switch-selection of a special diode test voltage and current.

A variation of the diode test actually measures the voltage at which the diode starts to conduct. The DMM first applies a voltage higher than needed to cause a diode to conduct, and then the DMM indicates the voltage at which the diode starts to conduct. While not all that important a feature—generally, a plain go/no-go test is adequate—it is helpful for those circuits whose performance is somehow dependent on the precise turn-on voltage.



WESTON MODEL 6500.

Oddball features

While the conventional DMM measures voltage, current, and resistance, and might possibly have some form of special circuit for diode tests, some make provision for unusual tests or accessories. At least one DMM also features a rudimentary transistor tester, others can measure capacitance. Several DMM's have connections for an optional transducer to measure temperature. Some multi-function meters also include power measurements, while others go a step further and provide logarithmic dB (decibel) scales for audio amplifier tests.

Other functions, usually found in the more sophisticated test-bench DMM's, are a *peak* and *null* indicator, or a *relative-reading baseline*. *Peak* and *null* is essentially a substitute for an analog device in that it can indicate or track variations in the circuit being tested. Usually, two or three LED's or LCD dots or + and - indicators are used to indicate when a varying voltage or current has passed through a peak or a null. A variation of the LCD dots is an LCD "analog" bar-graph—a line of dots or dashes—that tracks the input signal between updates of the display. This bar-graph display is coupled with the standard digital display so that the meter contains both display-types. Since the bar-graph consists of segments, it is not really analog. It is a digital read-out. However, the update rate is much faster than the standard digital display. For example, the Fluke 70-series contains a bar-graph display, but its update rate is 10 times faster than the standard digital display.

The *relative-reading baseline* does essentially the same thing but the variations

can be measured. A reference test probe is used in this technique. The meter accepts the signal on the reference test probe as "0." The value of the variations in the voltage or current sensed by the test probes are indicated in values referenced to the "0" level. For example, if the baseline is 10 volts, 11 volts at the test probes would be indicated as +1 volt.

Another unusual variation is the digital versions of clamp-on ammeters, a device specifically designed to measure moderate to large AC current through an induction device that clamps around a current-carrying conductor.

Most clamp-on meters also provide for measuring voltage (in the line voltage range) and resistance, so they are, in effect, a DMM, though they are most effective and convenient for measuring large amounts of current because the circuit being tested doesn't have to be opened for the insertion of test probes or a sensing device.

Unlike what we consider conventional DMM's, clamp-on DMM's are intended for use on powerline equipment, hence, the frequency range of the voltmeter circuit is generally optimized for the powerline frequency range of approximately 40 to 500 Hz: The AC meter isn't intended for measuring AC voltages in the 20 Hz to 20 kHz audio range.

Since most service-grade clamp on meters are intended for field service, they are almost without exception housed in a hand-sized enclosure that is impact resistant.

The package

Finally, we come to the way the meter is assembled and packaged. Many different kinds of enclosures are used to house DMM's. Some are simply conventional plastic cabinets, others are made of high-impact plastic that will bounce rather than shatter if dropped on a hard surface. Some are water or moisture resistant, still others are completely sealed for use in areas where explosive gases might be present; and some DMM's are enclosed in a conventional metal cabinet.

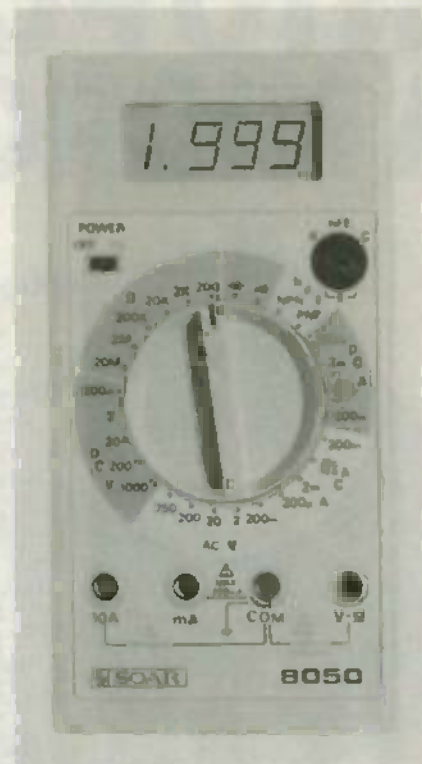

SOAR MODEL 8050.

Almost without exception (we say "almost" because there is always an exception somewhere), the DMM's with a plastic cabinet have no exposed metal surfaces that might present a shock hazard.

The DMM's housed in a metal cabinet generally have both probe terminals insulated from the cabinet, with the cabinet grounded through a 3-wire linecord. Many of the better-quality metal-enclosed DMM's also provide a ground connection on the front panel that allows the use of test probes encased in an isolated shield so that RF interference does not get into the probes and interfere with low-level test signals. Also, the ground connection allows the frame or cabinet of the equipment being tested to be connected to a common ground, in this way preventing ground loop "hash" from interfering with the test signals, while also protecting

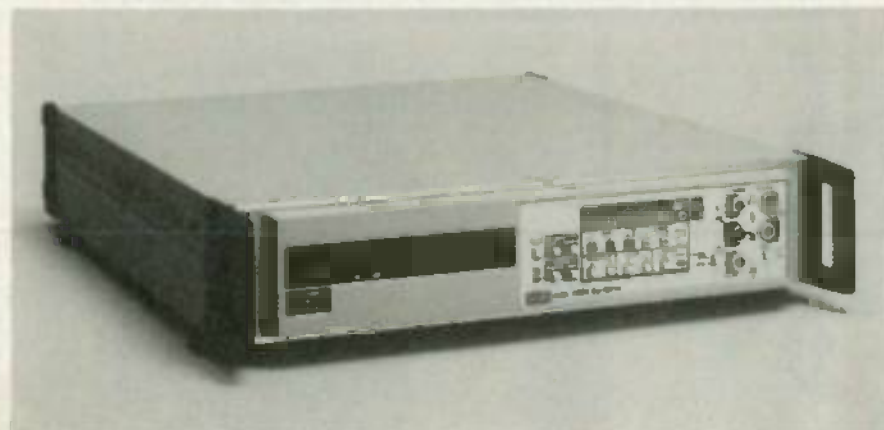

FLUKE MODEL 8520A.

DMM MANUFACTURERS

Amprobe Instruments
630 Mernck Rd.
Lynbrook, NY 11563

B&K Precision
6460 W. Cortland
Chicago, IL 60635

Ballantine Labs
90 Fanny Rd.
Boonton, NJ 07005

BBC-Metrawatt
6901 West 117th Ave.
Broomfield, CO 80020

Beckman Industrial
2500 Harbor Blvd.
Fullerton, CA 92634

Data Precision
Electronics Ave.
Danvers, MA 01923

Datron Instruments
3401 Southwest 42nd St.
Stuart, FL 33494

Fluke
Box C9090
Everett, WA 98206

Hameg
88-90 Harbor Rd.
Port Washington, NY 11050

Heath Co.
Benton Harbor, MI 49022

Hewlett-Packard
1820 Embarcadero Rd.
Palo Alto, CA 94303

Hickok
10514 DuPont Ave.
Cleveland, OH 44108

Hitachi
175 Crossways Park West
Woodbury, NY 11797

IET Labs
534 Main St.
Westbury, NY 11590

Keithley Instruments
28775 Aurora Rd.
Cleveland, OH 44139

Kontron Electronics
630 Price Ave.
Redwood City, CA 94063

Krista
PO Box 3423
Torrance, CA 90510

Leader Instruments
380 Oser Ave.
Hauppauge, NY 11788

Mura
177 Cantiague Rock Rd.
Westbury, NY 11590

Non-Linear Systems
533 Stevens Ave.
Solana Beach, CA 92075

Racal-Dana
4 Goodyear St.
Irvine, CA 92718

Simpson Electric
853 Dundee Ave.
Elgin, IL 60120

Soar
200 13th Ave.
Ronkonkoma, NY 11779

Soltec
11684 Pendleton St.
Sun Valley, CA 91352

A.W. Sperry
245 Marcus Blvd.
Hauppauge, NY 11788

Techni-Tool
5 Apollo Rd.
Plymouth Meeting, PA 19482

Triplett
One Triplett Dr.
Bluffton, OH 45817

VIZ Manufacturing
335 East Price St.
Philadelphia, PA 19144

Weston Instruments
614 Frelinghuysen Ave.
Newark, NJ 07114

Yokogawa Corp of America
2 Dart Rd.
Shenandoah, GA 30265



KRISTA MODEL 308-140.

against a cabinet or chassis being unknowingly at a high potential with respect to ground.

It's really gold

Some service-grade, and most laboratory grade DMM's feature gold-plated contacts on the selector switches. The value of gold plating on a self-wiping contact has never really been established. Self-wiping contacts usually grind down the rotary sliders, so in a year or two there's not likely to be any gold on at least one contact surface. In fact, there are many VOM's built 40 years ago with ordinary switches (for their day) that are still giving reliable service. The real value of gold plated selector switch contacts is that it's usually done only in the better-built instruments (within the same general price range), so you can make the logical assumption—which actually might not have any validity—that an instrument with gold contacts is built with higher quality components, or was subject to a more vigorous inspection during its assembly.

Anything goes

Just about anything is possible using digital technology; the only limitation is price. (Some far out measurement systems are unusually expensive.) But if you can think of some obscure, seemingly unknown feature that might be of unusual value to you, either someone builds it into a meter today, or will do so tomorrow. Almost nothing is impossible. R-E



What's New In OSCILLOSCOPES

HERB FRIEDMAN

High technology has changed the high-priced oscilloscope, and it has also added a lot of convenient features to lower priced scopes.

THE OSCILLOSCOPE PRESENTLY STANDS with one foot in the past and the other in the future. New digital technologies are creating new concepts of use and, more important, new magnitudes of accuracy for scopes commonly used for servicing and general laboratory work. Unfortunately, the cost of the new digitized and computerized circuitry is not yet low enough to completely replace conventional circuits, so what we presently find in moderately priced scopes is often a mix of the old and the new. How much (if anything) is truly new in a given oscilloscope depends on its price.

The modern service-grade and general-purpose laboratory scope is simply a log-

ical development of the reliable oscilloscopes introduced in the late 1940's. Those scopes weren't all that much better than the scopes of the 1930's: They simply had available reliable components that were originally developed for war-time conditions. While solid-state devices have replaced vacuum tubes, and *high-tech* triggering circuits allow us to more accurately freeze, observe, and measure transient waveforms, the overall accuracy of the moderately priced (meaning under \$600) scopes really isn't that much better than it was 30 years ago. The really big difference is that modern scopes often have features that make them more convenient, reliable and accurate.

Three classes of scopes

There are presently three categories of conventional scopes: general-purpose/TV, TV service, and general laboratory. (For the moment I am excluding the digital scopes and the astronomically-priced laboratory scopes.)

The general-purpose/TV scope is the direct upgrade of the old general purpose scope that had a calibrated vertical input attenuator. What makes a scope a member of the general-purpose/TV category isn't the tolerance of the vertical input(s), the kind of triggering, or the relatively low cost. Rather it is a frequency response that extends to between 5 MHz and 8 MHz (measured at 3-dB down) and an *external*

CRT graticule that makes these scopes members of the general-purpose/TV category.

A bandwidth that stretches to 5 or 8 MHz makes these scopes just about suitable for DC, low-frequency AC, TV-receiver signals, and general experimentation. The external graticule is a plastic or glass device having etched lines that is placed over the CRT from the outside. Often, it can be replaced by a graticule calibrated for a specific purpose. Because the graticule is external, there is approximately $\frac{1}{4}$ to $\frac{1}{2}$ -inch between the graticule and the coating on the back of the CRT face on which the trace is displayed. The *parallax error* produced by the separation between the graticule and the trace can easily add 10% error to the measurement, which generally started out with a combined attenuator and amplifier tolerance of 2% to 5%.

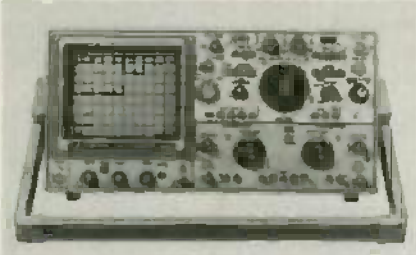

IWATSU model 88-5710

Worse still, if a camera is used to make hard copies of the CRT display, its angle of view is not "straight in;" instead, the camera sees the screen from what is effectively a single point out in front of the graticule. The camera's view cuts in behind the graticule lines and sees the traces located near the extreme edges of the CRT displaced from 25% to 50% per graticule division.

Higher-cost scopes improve the overall accuracy by using a CRT that has the graticule etched directly on its face. In that way, there is no parallax error; measurement error is entirely that of the vertical attenuator and the amplifier's non-linearity. Even photographs of the CRT trace show no parallax error.

The higher-cost general-purpose laboratory scopes and the better quality TV-service scopes—ranging in price from about \$600 to \$1000—also feature a greater vertical-channel frequency response. Their (3-dB down) frequency response is in the area of 15 MHz to 25 MHz, which makes them ideally suited for servicing high-performance TV equipment, high-resolution computer monitors, and laboratory instrumentation. However, while 3 dB is the accepted reference point for measurements, some scopes "stretch" the frequency response by employing specifications that use 6-dB down as the reference for high-frequency response. The 6-dB down spec can make

what is otherwise a 3-dB down 10-MHz upper frequency limit into a "15-MHz frequency response." In fact, some scopes specify the "overall frequency response" as any frequencies that can cause some form of movement—no matter how slight—to the CRT's trace.

While one might logically assume that a higher price means a scope has greater vertical measurement accuracy than the lower-cost models, it's not necessary true. Amplifier design has been refined to the point where the distortions are equal regardless of overall instrument cost; price has little bearing on a vertical amplifier's linearity. Most of the loss of accuracy comes from the vertical attenuator, which ranges from 2% to 5% in the lower and moderate cost scopes.

It is in the error generated by the CRT that price usually reflects improved measurement accuracy. Virtually all better quality scopes have a recessed screwdriver adjust control (TRACE ROTATION) that rotates the CRT's trace so it is precisely parallel to the graticule. Another recessed control (ASTIGMATISM) forms the beam into a precise circle rather than an oval. But the very high-priced laboratory grade scopes are so precisely made and factory-adjusted that many have no external user adjustments for the CRT trace.

Triggering

In addition to the features and performance common to other scopes in its price range, models specifically intended for use by TV technicians—or others who will do a modest degree of TV service work—usually feature what is called TV/H and TV/V triggering, or timebase. This is nothing more than a switch-selected horizontal timebase that is automatically corrected for TV, providing 2½ to 3 horizontal lines or 2½ to 4 vertical fields; the precise number depending on the particular scope. The feature doesn't make the scope more accurate; only more convenient to use (it's a BIG convenience).

For real convenience you must consider the vertical or video delay, which is not to be confused with a timebase or trigger delay. Consider, if you will, using a scope to observe the leading edge of a transient one-shot waveform. If you're using an internal timebase trigger—one derived from the vertical input signal—the waveform's leading edge will be long gone before the horizontal sweep is triggered. If you're using an external trigger signal—which probably is generated by the same device that generates the scope's vertical input signal—at least part of the waveform's leading edge will have past before the trigger starts the timebase oscillator.

The way to see the entire waveform is to use a TV scope—of which there aren't too many models to choose from—that has a

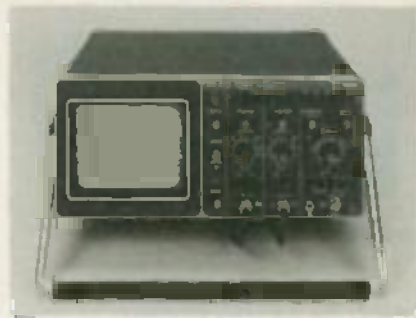

PHILIPS model PM-3215

delay line in the vertical amplifier. The sample for the timebase trigger is taken off at the input to the delay line. By the time the signal itself gets out of the delay line, the trigger sample has triggered the timebase and the entire leading edge can be observed. Since the slope of the timebase trigger—the trigger point—is somewhat variable, the user can generally set the trigger so the CRT trace starts slightly before the waveform's leading edge. In this way the complete leading edge of the waveform can be observed.

Dual scopes

A major area of upgrading for the higher cost general purpose and general purpose/TV scope is the dual vertical-input (dual trace) and dual-timebase, features that until recently were found primarily on the higher-cost laboratory scopes.

The dual-trace scope has two identical vertical inputs. On the higher cost laboratory scopes there are separate compartments for two plug-in modules, which may be individual vertical amplifiers. Depending on the purpose for which the scope is intended and its selling price, there will be one or two timebase oscillators; but whether there are one or two oscillators, almost without exception, the scope will have a dual-trace function, also known as a *chopper* or *input switcher*.

The dual-trace function allows "simultaneous" display of both vertical input signals using just one timebase oscillator. At the lower frequencies, the dual-trace function "chops" portions out of each signal to form two separate CRT traces, one for each vertical input signal. For high-frequency input signals—because the chop rate would be greater than the period of the signal and would distort the traces—the dual-trace function also provides an *alternate mode*. In the alternate mode, one complete vertical input trace is displayed and then the other. Two distinct methods—*chop* and *alternate*—are used because each is not usable at all input frequencies. Separate centering controls for each vertical channel permit the position of each trace to be adjusted independent of the other.

Generally, the user must decide whether to use *chop* or *alternate*. In some new scopes, however, an internal circuit



NON-LINEAR SYSTEMS model MS-1S

automatically selects the mode that provides the optimum display.

One of the major difficulties with the single timebase, dual-trace scope is that the triggering pulse is the same for both input channels: the adjustment or setting that locks one trace locks the other in-phase. In the era when most waveforms were sinewaves or related asynchronous pulses, a common synchronizing scheme wasn't a problem because both vertical inputs were often phase-related. Today, however, even related waveforms might be in two different ballparks, and the trigger adjustment for one vertical input might have absolutely no effect on the other.

To get around the problem of the common trigger point, some of the very latest analog scopes employ a digital timebase that permits timebase trigger points to be set independently for each vertical input. The digital circuits switch the two timebase trigger points back and forth between the two traces.

The two separate and distinct horizontal oscillators of a dual-timebase scope provide many advantages over a single timebase. Each timebase can be independently switched to one or the other of the dual vertical inputs, making it easy to observe two totally unrelated signals. Also, in the somewhat higher priced scopes overall measurement accuracy is improved because the first timebase can be used to delay the triggering of the second timebase, or the second timebase can be used to enhance a small part of the trace for magnification and closer observation.

Three inputs are better?

If two inputs are good then it follows that three must be better. Right? Usually wrong! Almost all commonly used scopes allow the horizontal (timebase) amplifier to be used as a third input—the x input. Signals applied to the x-input results in a horizontal, rather than a vertical, deflection of the CRT beam. Since the horizontal amplifier was originally used for the timebase oscillator, except for some very high-priced scopes that can use one of the vertical amplifiers for the x-input, it generally has nowhere near the performance of the vertical inputs because the timebase signals are lower in frequency than that of their associated vertical input. Of late, some manufacturers provide a means whereby the horizontal amplifier or a trigger amplifier can be used as a third vertical input, with a switching circuit

providing three CRT traces.

While the idea is perfectly suitable and reliable when you know the third input is generally not the equivalent of the conventional vertical input in terms of frequency response, sensitivity, or even attenuator ranges, the surface specifications create the appearance of three *similar* vertical inputs. If your work requires multi-screen traces, double-check those specs and make sure that you're really getting what you think your getting.

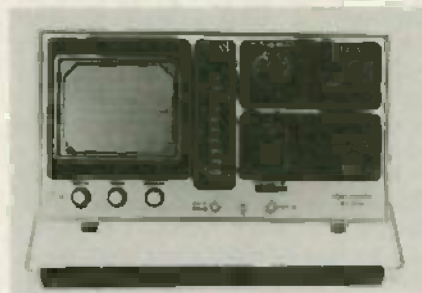

VIZ model WO-S27A

Plotting

If you have need of X-Y plotting, you generally will have need for identical horizontal and vertical inputs. That is usually available on the better-quality (meaning higher-priced) laboratory-type scope rather than the conventional general purpose or TV scope. Plotting is accomplished through plug-in modules: The main frame of the scope itself has neither vertical nor horizontal amplifiers. To obtain an X-Y plot, the user installs a matching vertical amplifier module in what is generally the timebase or horizontal amplifier compartment. That provides matched H and V inputs, and therefore accurate and meaningful X-Y plotting.



PHILIPS model PM-3207

Because the X-Y plot is becoming more frequently required in laboratory work, some of the latest scope models provide an output for driving a plotter. This feature is generally provided in the digital and computerized scopes that we'll get to shortly.

While it is possible to more easily take a picture of the CRT with one of the low-cost CRT cameras presently available, the printed X-Y plot is more convenient to use and usually more accurate than the photo.

On-screen help

Several years ago, Tektronix literally astonished the industry by providing an alphanumeric CRT display that indicated the settings of the vertical amplifier(s) and timebase switches. Since the screen characters were digitally generated, a logical extension was a means whereby the user—through an accessory character selector—could actually write small messages on the screen. A photograph of the CRT could now show not only the trace(s), but the settings of all involved selector switches and a short message as to what was represented by the display. Years later, someone could select a CRT photograph from a file and know exactly



IWATSU model 88-5711D

what it all meant; in fact, the display might even show the name or initials of the person making the measurement.

Once the digital circuitry was on board, it was just a matter of time before it was used to enhance the actual measurement in addition to providing messages. Among the first of the exotic digital features added to a conventional scope—now used in some of the higher priced models—was digital on-screen display of the actual measured value(s) in addition to the range switch settings. Whereas the scope displays *peak-to-peak* waveforms, the on-screen digital display might also indicate the true RMS value. There might also be electronic *cursors or cross-hairs* for period measurement of sections of the displayed waveform. For example, if the screen indicates a series of pulses, centering the cursor cross-hairs on one part of the waveform and then another will produce a digital display of the actual time between the selected points. The measurement could be made between periods, between multiple periods, or between points on the same period. The accuracy of cursor-determined measurements is generally superior to "eyeball" measurements by the user.

An extension of the on-screen digital display is the auxiliary DMM and/or counter—often called a *time/voltage module*—which is available either built in or as an optional accessory for what is otherwise a conventional laboratory-type scope. Usually, the time/voltage module functions in conjunction with a CRT cursor, the digital display providing an instant readout of time, frequency or DC voltage for any point on the CRT display on which the cursor is positioned.

A variation of the time/voltage module is a digital meter (without cursor) that is actually a DVM that provides a digital voltage or frequency readout of the signal at the test probe(s). The readout can be in DC volts, *peak-to-peak* volts, time, or frequency. The precise functions of the DVM-type module varies from scope to scope, but regardless of its functions and ranges, their purpose is to provide a more convenient or reliable reading than a straight "eyeball" measurement. Whereas the scope's trace might have an overall accuracy of 2% to 5%, the digital meter's accuracy is more likely to be in the range of .002% to 1%—the precise value depending on the specific instrument and its selected function and range. While the scope shows the physical attributes of the applied input waveform, the digital meter provides the exact time and voltage values.

Digital scopes

With few exceptions, the conventional scope is limited to real-time analysis regardless how many enhancements we hang on it; when the input signal ceases,

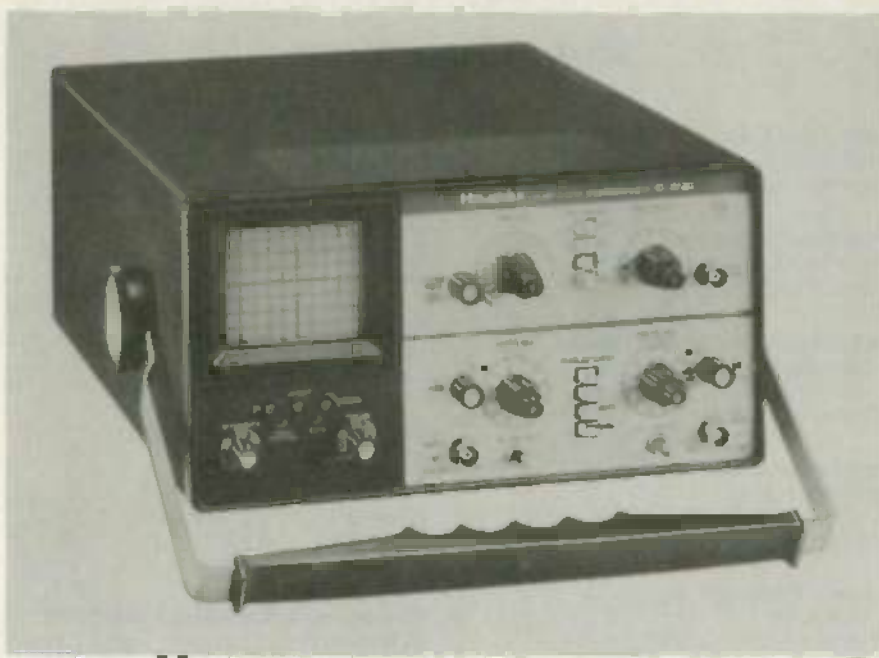

HEATH model IO-3220

the CRT goes blank. The usual way we store a display for future analysis is to use a CRT having a special phosphor that "remembers" the trace until deliberately erased, or until the power switch is turned off.

While effective, the conventional storage scope has many limitations, among them that the CRT trace(s) are volatile and data cannot be stored for future use, cannot be passed from location to location by hand, and cannot be integrated or compared with previously stored data. Those functions are the province of the digital/computerized scope. With conveniences, functions, and accuracy many times that of the analog scope, the digital/computer scope is the modern standard of reference.

The digital scope should not be confused with a conventional scope that employs a digital timebase for exotic sweep triggering. The digital scope is completely digital and employs conventional computer circuitry such as you would find in your personal computer. In fact, the newer digital scopes can be directly interfaced with a personal computer through an IEEE bus.

The digital scope first converts the input signal into digital form through an analog-to-digital converter. From this point on the electrical bits that represent the input signal can be processed like any other computer signal: They can be stored in volatile or non-volatile RAM, combined with previous information stored in RAM; they can be stored on floppy disks and passed on from one scope to another; translated; processed...you name it and it can be done. The stored bits eventually end up as a bit representation of the CRT trace, often bit mapped. Depending on the particular scope being used, the CRT

trace might be displayed as a densely packed group of dots, or the scope might generate connecting lines for greater visual resolution.

The actual signal values such as peak or RMS voltage, time and period, frequency, etc., represented by the bit pattern is usually displayed on the CRT along with the graphic trace. Cursor cross-hairs select any point of the bit trace for analysis by an internal or external computer.

Unlike conventional scopes, which might have a $\times 5$ or $\times 10$ horizontal magnifier, digital scopes often feature a *zoom* function that generates almost any reasonable degree of trace expansion. Top-of-the-line digital scopes have a high resolution capability, such that you can detect a change of .25 millivolts in a 1-volt signal; along with an overall measurement accuracy of 0.2%. Admittedly, the average service technician has little use for such a high degree of accuracy, but the performance of new equipment is rapidly outpacing the tolerances of conventional test equipment: One cannot reasonably adjust and service the emerging high-tech hardware if the accuracy of the test equipment is less than that of the hardware.

Perhaps the primary feature of the latest digital scopes is disk or bubble memory storage. The disk and bubble memory overcome the problems of volatile display storage. Since the digitized display actually is a bit representation of the data in RAM, a mirror image can be stored on disk or bubble. Months, even years later, a mirror image of the disk or bubble data can be entered into a scope's RAM and then directly compared on the screen with the waveforms from other storage devices, or even a real-time trace. The overall accuracy of the waveform representation is

SCOPE MANUFACTURERS

Ballantine Labs
90 Fanny Rd.
Boonton, NJ 07005

Beckman Industrial
630 Puente Street,
Brea, CA 92621

B&K Precision Products Group,
Dynascan
6460 W. Cortland
Chicago, IL 60635

British Aerospace
P.O. Box 17414
Dulles Int'l Airport
Washington, D.C. 20041

Calvert Electronics, Inc.
1 Branca Rd.
East Rutherford, NJ 07073

Continental Resources
175 Middlesex Tpke.
Bedford, MA 01730

Data Check Corp.
10070 Willow Creek Rd.
San Diego, CA 92131

Dumont Oscilloscope Labs
40 Fairfield Pl.
W. Caldwell, NJ 07006

Gould Inc., Instruments Division
3631 Perkins
Cleveland, OH 44114

Hameg, Inc.
88-90 Harbor Rd.
Port Washington, NY 11050

Heath Co.
Benton Harbor, MI 49022

Hewlett-Packard
3000 Hanover St.
Palo Alto, CA 94304

Hickok
10514 DuPont Ave.
Cleveland, OH 44108

Hitachi Denshi America Ltd.
Test & Meas. Div.
175 Corssways Pkwy
W. Woodbury, NY 11797

Infodex, Inc.
395 W. Main St.
Waterbury, CT 06702

Kikusui International Corp.
17819 S. Figueroa St.
Gardena, CA 90248

Leader Instruments Corp.
380 Oser Ave.
Hauppauge, NY 11788

Lectrotech, Inc.
5810 N. Western Ave.
Chicago, IL 60659

Marconi Instruments.
100 Stonehurst Ct.
Northvale, NJ 07647

Nicolet Instruments
5225 Verona Rd.
Madison, WI 53711

Non-Linear Systems, Inc.
533 Stevens Ave.
Solana Beach, CA 92075

Norland
Norland Dr.
Ft. Atkinson, WI 53538

Phillips Test & Measuring Instruments
85 McKee Dr.
Mahwah, NJ 07430

REI Sales
19525 Business Centre Dr.
Northridge, CA 91324

Simpson Electronics
853 Dundee Ave.
Elgin, IL 60120

Soar Electronics
100 13th Ave.
Ronkonkoma, NY 11779

Soltec
11684 Pendelton St.
Sun Valley, CA 91352

Sunshine Science Instruments.
1810 Grant Ave.
Philadelphia, PA 19115

Tektronix, Inc.
Box 1700 - DS 53/067
Beaverton, OR 97075

Telonic/Berkeley
2824 Laguna Canyon Rd.
Laguna Beach, CA 92652

Tucker Elctrns
Box 401060
Garland, TX 75040

VIZ Manufacturing
335 E. Price St.
Philadelphia, PA 19144

Voltex
3460 Great Neck Rd.
Amityville, NY 11701

Vu-Data
7170 Convoy Ct.
San Diego, CA 92111

Wavetek Indiana, Inc.
5808 Churchman
Beech Grove, IN 46107



VU-DATA model 4100

constant—there is no storage loss. In the event the scope itself is damaged, even destroyed, all its data can be reproduced on another scope because it exists on a disk or in a bubble. Though disk and bubble storage are expensive options, keep in mind that just a couple of years ago, a pair of disk drives for a home computer cost more than \$1000.

Whether compared to the conventional scope or considered by itself, the potential application of the digital scope's accuracy and storage devices is awesome; unfortunately, its price is presently also awesome—in the range of about \$4000 to \$14,000.

Summing up

In the final analysis one could say that the "best" scope is the one that's most reliable. But what is reliability? Is it physical reliability? Modern scopes are not more or less reliable than any other test gear—they should easily go 10 to 20 or more years without breakdown. Is it accuracy? Two percent, even 5% total accuracy is adequate for most consumer electronic products: If you need tighter accuracy, it's available at additional cost—but greater accuracy and greater costs doesn't mean the scope is physically more reliable. Most likely, reliability simply means the scope will do exactly the job that needs to be done *with the least amount of fuss and bother*. The scope that helps you get the job done easily with the least amount of effort and possibility of error is probably the most reliable. **R-E**



"When I was his age, they wouldn't let me use even a slide rule."

VICTOR MEEDIJK

Part 2 AS WE SAW LAST TIME, there are a lot of factors you should consider in selecting resistors for your projects and designs. As you might expect, the same holds true for capacitors. In capacitor selection, you should consider such things as operating temperature, humidity, AC ripple, and operating frequency. In addition, capacitance, as well as other capacitor specifications such as current rating, leakage current, voltage rating, and life expectancy, should be considered so that the device chosen will be appropriate for the application at hand.

Materials used in manufacturing a capacitor, as well as how those materials have been assembled, will effect capacitor specifications. As an example, capacitance is based upon electrode area and the type and thickness of the dielectric used. Varying any or all of those things will, of course, change the capacitance of the device. But that is not the only parameter that will change.

For instance, if the electrode surface area of an aluminum electrolytic capacitor is increased (to increase the unit's capacitance) through the use of finely etched electrode foils, the device will have a larger ESR (Equivalent Series Resistance) than similar smooth-metal foil units. That is because the ESR depends upon the volume of the foil used.

You can also increase capacitance by using dielectrics with high dielectric (high-K) constants. But capacitors that use high-K dielectrics are not as stable (they are more sensitive to temperature and voltage variations) and generally have a higher dissipation factor than capacitors that use dielectrics with lower dielectric constants.

Capacitor package styles also should be considered. High lead inductances, common to tubular units, restrict high-frequency performance. Tubular ceramic capacitors however, are the most stable form of capacitor and, since there is no opposing electrode to provide stray capacitance pickup, almost the total capacitance is provided by the ceramic.

Dipped or molded radial-lead packages reduce interconnection impedances by allowing the capacitor to be mounted close to a PC board surface.

Chip capacitors have contacts, rather than leads, to even further reduce interconnection impedances. In addition,

SELECTING THE BEST RESISTOR/CAPACITOR

There are a lot of factors to consider when selecting the proper capacitor for your design or project. In this article we'll look at those factors, and which of the many, many types of capacitors is right for your application.

those devices are thin enough to mount beneath unsocketed IC's, thus reducing the length of a trace for a bypass capacitor. That is important in high-frequency circuitry since a PC trace can have an inductance of 10 nanohenries/inch.

Capacitors come in a variety of styles including ceramic, mica, paper, plastic, aluminum, and tantalum types.

Each type was designed for best performance in a specific application or environment. Each type of capacitor is discussed below, and the important specifications and considerations that pertain to the type of capacitor are summarized in Table 2. Table 3 is a glossary of capacitor terms and specifications.

One note about Table 2—the specifications shown there are only provided as guidelines. It is certainly possible to find units with slightly, or even greatly different specifications.

Ceramic capacitors

Ceramic capacitors are used in many applications. For instance, they are used as bypass capacitors. They are also used to

compensate for temperature-caused changes in resonant frequency in tuned circuits. When used in that second application, the ceramic capacitors should be mounted close to the tuned circuit, but be shielded from any heat generating components.

The EIA has broken ceramic capacitors into categories. Class 1 capacitors are

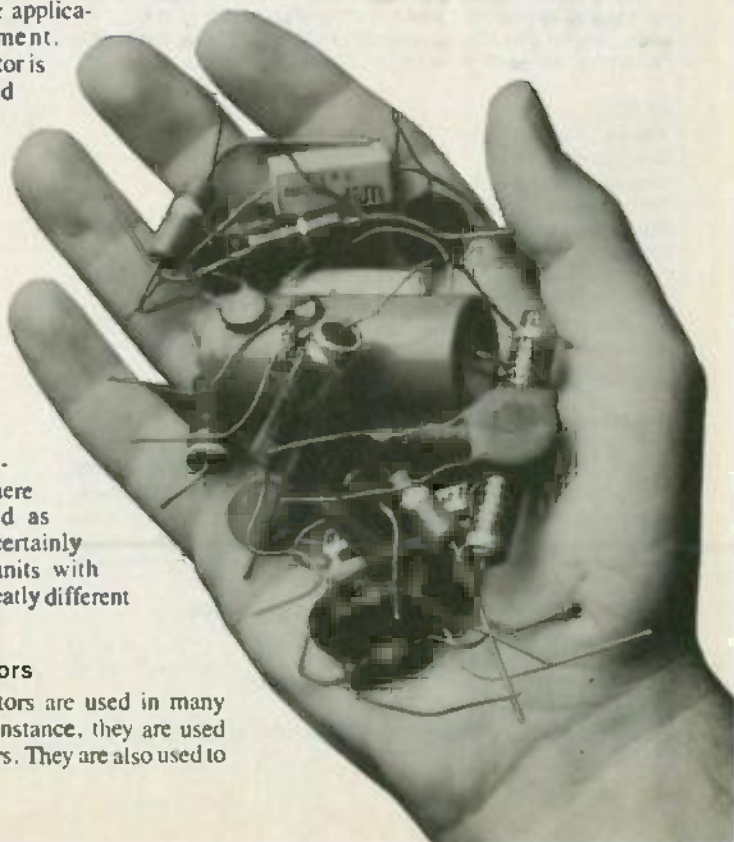

TABLE 2—CAPACITOR SELECTION GUIDELINES

CERAMIC

Values: 1 pF to 2.2 μF
 Tolerance: 10% or 20%
 Voltage rating: 3.3 volts to 6 kilovolts DC
 Dissipation factor: to 5%
 Temperature coefficient: to 200,000 PPM/°C

For NPOs—

Tolerance: 25% to 10%
 Temperature coefficient: 0 ± 30 and 0 ± 60 PPM/°C

Notes: General purpose high insulation-resistance devices used for transient decoupling of IC's and compensation of reactive changes caused by temperature variations. Applications include filtering, bypass, and non-critical coupling in high frequency circuits. Frequency sensitive (capacitance will vary with frequency) so characteristics should be measured at intended operating frequency. Should be mounted next to components being compensated, and shielded from sources of heat. Due to low voltage failure problems, should not be operated significantly under rated voltage under humid conditions. In circuit design, considerations should be given to changes in the dielectric constant caused by temperature, electric field intensity, and shelf aging.

CERAMIC CHIPS

Values: 10 pF to .18 μF
 Tolerance: 5 to 20%
 Temperature range: -55 to +125°C
 Insulation resistance: greater than 100,000 megohms

MICA

Values: 1 pF to .1 μF
 Voltage ratings: 100 to 2500 volts DC
 Temperature range: -55 to +150°C
 Temperature coefficient: -20 to +100 and 0 to +70 PPM/°C
 Derating factor: 60% voltage (dipped case) and 40% voltage (molded case)

Mica chips—

Values: 1 to 10,000 pF
 Voltage rating: to 500 volts
Notes: Used in timing, oscillator, tuned circuits, and where precise high frequency filtering is required. Capacitance and impedance limits are very stable and capacitors perform very well at frequencies of 10 kHz to 500 MHz. Devices using silver in their construction are very susceptible to silver ion migration resulting in short circuits. Failures can occur in a few hours if capacitors are exposed to DC voltage stresses, humidity, and high temperature.

GLASS

Values: .5 to 10,000 pF
 Tolerance: to 5%
 Voltage rating: 100 to 500 volts DC
 Temperature range: -55°C to +125°C
 Temperature coefficient: 0 to 140 PPM/°C
Notes: High insulation resistance, low dielectric absorption and fixed temperature coefficient. Has much higher Q than mica devices. Performs very well at high frequencies up to 500 MHz and can operate in range of 100 kHz to 1 GHz. Capable of withstanding severe environmental conditions but are susceptible to mild mechanical shocks and should be mounted accordingly.

PAPER PLASTIC DIELECTRICS

Many dielectric and case configurations are available. Each type has its own characteristics. For example, metalized paper units have low insulation resistance and are prone to dielectric breakdown failures. Plastic types have superior moisture characteristics than paper units. Polycarbonate and Mylar types are used in applications that require minimum capacitance change with temperature, such as tuned or timing circuits.

Metalized polycarbonate and polycarbonate film—

Values: up to 50 μF
 Voltage rating: to 1000 WVDC
 Dissipation factor: .5% (at 25°C and 120 Hz)
 Temperature range: -55 to +125°C
 Derating factors: 50% voltage; 80% of rated temperature

Notes: DC blocking, filter, bypass, coupling, and transient suppression applications. Close tolerance, high frequency capability (40–400 kHz) and high insulation resistance. Not suitable for sample/hold circuits, fast settling amplifiers, or filters due to dielectric absorption characteristics. Small size, medium stability, and long life expectancy under load.

Metalized polyester polyester foil—

Values: .001 to 100 μF
 Voltage rating: up to 1500 WVDC
 Dissipation factor: 1% (at 25°C and 120 Hz)
 Temperature range: -55 to +125°C (with 50% derating above 85°C)

Notes: See polycarbonate for typical applications. Moisture resistant and high insulation resistance. Small size, medium stability and very good load life. Capacitance will however vary widely with temperature. Foil units are generally lower cost than metalized types. Polyester film is commonly known as Mylar, which is a DuPont trademark.

Polystyrene foil—

Values: to 10 μF
 Voltage rating: up to 1000 WVDC
 Dissipation factor: .03% (at 25°C and 120 Hz)
 Temperature range: -40 to +85°C without derating

Notes: Used in timing, integrating, and tuned circuits. High insulation resistance, and small capacitance change with temperature. Has excellent dielectric absorption characteristics. Large size with excellent stability and very good load life.

Papermetalized paper paper foil—

Values: to 100 μF
 Voltage rating: to 5000 WVDC
 Temperature range: -30°C to +100°C (derated by 30% over 75°C)

Temperature coefficient: greater than 4,500 PPM/°C
Notes: General purpose. Medium stability and very good load life. Large size; low cost. Metalized paper has paper coated with thin layer of zinc or aluminum and are smaller than metal foil units. They are, however, prone to dielectric breakdown of insulation resistance and have poor surge handling capability. Paper foil units used in high voltage high current applications. Their dissipation factor varies with temperature. Maximum temperature is +125°C.

Polypropylene foil metalized polypropylene—

Values: to 10 μF
 Voltage rating: to 400 volts DC and 270 volts AC (foil units: 200 to 1600 volts DC and 300 to 440 volts AC)
 Temperature range: -55°C to +105°C

Notes: Foil units are used in tuned circuits, integrating circuits, timing circuits, and CRT deflection circuits. Metalized units are used in DC blocking circuits. Good high frequency capability, high insulation resistance, close tolerance, high stability, and excellent dielectric absorption characteristics.

Less common types—

Polysulfone: Similar to polycarbonate and polypropylene capacitors. Small size, high temperature range (to 150°C), suitable for high-frequency applications, and high insulation resistance. Excellent in high current and military applications. Not for sample hold, fast settling amplifiers, or filters due to dielectric absorption characteristics. Poor history of availability.

Polyvinylidene fluoride: Considered experimental; Has high dielectric constant (about four to twelve times that of polyester devices), which results in a very small sized capacitor. Those units suffer from significant capacitance change with temperature, particularly at low temperatures.

Polyethylene terephthalate: For applications that require high reliability; high insulation resistance at high temperatures.

Metalized paper polyester/paper polyester foil: The foil unit has a slightly better dissipation factor than the metalized type. Operating temperature of -55°C to +125°C with voltage ratings of 240 to 600 (DC) available.

Paper polypropylene: Available in voltage ratings of 400 to 800

(AC). Operating temperature from -40°C to $+80^{\circ}\text{C}$.

Teflon/Kapton: Has a temperature range of -55°C to $+250^{\circ}\text{C}$ with a temperature coefficient of $.009\%/^{\circ}\text{C}$. Teflon's extremely low dielectric absorption makes it good for critical sample and hold circuitry. Those capacitors used in specialized applications such as oil well drilling equipment. Those capacitors are large in size since the dielectric is not available in thin gauges.

Parylene: Manufactured by Union Carbide, those capacitors are equivalent to polystyrene types in performance but are rated to $+125^{\circ}\text{C}$, versus $+85^{\circ}\text{C}$ for polystyrene.

TANTALUM ELECTROLYTIC

Solid type—

Values: .001 to 1000 μF

Temperature range: -55°C TO $+85^{\circ}\text{C}$ (if derated, to $+125^{\circ}\text{C}$)

Voltage rating: 6 to 120 volts DC

Tolerance: 5% TO 20%

Leakage current: varies with temperature

Derating factor: 50% voltage

Notes: Used in low-voltage DC applications such as bypass, coupling, and blocking. Not for use in RC timing circuits, triggering systems, or phase shift networks due to dielectric absorption characteristics. Also not recommended for applications subject to voltage spikes or surges. High capacitance in a small volume with excellent shelf life. Solid types not temperature sensitive and have lowest capacitance-temperature characteristic of any electrolytic unit. Dielectric absorption and high leakage currents make them unsuitable for timing circuits. Except for non-polarized units, these devices should never be exposed to DC or peak AC voltages in excess of 2% of their rated DC voltage. To prevent failures due to leakage or shorting when series connecting for higher voltages, parallel each unit with a shunt resistor.

Chip types—

Values: .068 to 100 μF

Tolerance: 5% to 20%

Voltage rating: 3 to 50 volts DC

Temperature range: -55°C to $+125^{\circ}\text{C}$

Leakage current: varies with temperature.

Non-solid types—

Values: .5 to 1200 μF

Tolerance: -15 to $+30$, and 20%

Voltage rating: to 350 WVDC

Temperature range: -55°C to $+85^{\circ}\text{C}$ (if derated, to $+125^{\circ}\text{C}$)

Leakage current: varies with temperature

Notes: Polarized foil units are used for bypassing or filtering out low-frequency pulsating DC. Allowance must be made for leakage current. Not suitable for timing or precision circuits due to wide

tolerances. Large values available. Etched foil has 10 times the capacitance per unit volume as plain foil types. Peak AC and applied DC voltages should not exceed rated maximums. Usable to 200 kHz. Non-polarized foil are used in tuned low-frequency circuits, phasing low-voltage AC motors, and in servo systems. Sintered slug units are used in low-voltage power supply filtering and in DC applications. Can not withstand any reverse voltage. Leakage current lowest of all tantalum types; no appreciable leakage below 85°C . Usable to frequencies of 1 MHz.

ALUMINUM ELECTROLYTIC

Values: .68 to 220,000 μF

Tolerance: -10 to $+75\%$

Voltage rating: up to 350 volts

Temperature range: -55°C to $+85^{\circ}\text{C}$ (if derated, to $+125^{\circ}\text{C}$)

Dissipation factor: varies with temperature

Temperature coefficient: varies with temperature

Notes: Used in filter, coupling, and bypass applications where large capacitance values are required and capacitances above nominal can be tolerated. Sum of the applied AC peak and DC voltages should never exceed the rated DC voltage. Aluminum electrolytics are larger than tantalum electrolytics but less expensive. Loss of capacitance, to as little as 10% of rated value, will occur as the aluminum oxide electrode electrochemically combines with the electrolyte. Oxide film deterioration also requires capacitors to be "re-formed" after storage to prevent dielectric failure. That involves application of rated voltage for a period of 30 minutes, or more, to restore initial leakage current value. Over time, dissipation factor can rise by as much as 50%. Four terminal devices are available (two leads for each connection) that offer low ESR and inductance at high frequencies. Those units were designed for use in switching power supplies.

TRIMMER CAPACITORS

Values: range from .25 to 1 pF and 1 to 120 pF.

Glass Quartz: Low loss, high Q, and high stability for high tuning sensitivity applications. Frequency range up to 300 MHz.

Sapphire: High level of performance between 1 and 5 GHz.

Plastic: High grade units can be operated up to 2 GHz

Ceramic: Smallest sized single turn units with maximum capacitance under 100 pF. Capacitance changes with temperature.

Air: High level of performance through UHF Band, from 300 MHz to 1 GHz.

Mica: Has wide capacitance range and relatively high current handling capability.

Vacuum Gas: Used for high voltage applications. Values from 5 to 3000 pF, with voltage ratings from 2 to 30 kilovolts (DC).

those that have very predictable temperature vs. capacitance characteristics. One type of Class 1 ceramic capacitor is the NPO (Negative-Positive-Zero) capacitor. That designation means that the negative and positive temperature coefficients of the device are zero and that they suffer almost (nothing is ever absolute) no change in capacitance vs. temperature. Other Class 1 capacitors have very predictable changes in capacitance vs. temperature. For instance, a ceramic capacitor that is specified as N750 has a negative temperature coefficient of 750 parts-per-million, per-degree-centigrade. That is, for each degree centigrade the temperature rises, the capacitance of the unit will drop 750 parts-per-million.

Class 2 capacitors are those that are non-linear. Their temperature coefficients are specified by a three letter code that specifies the low and high temperature ranges and the maximum change in capacitance from that at 25°C . Table 4 shows the EIA Class 2 code, and what the

various designations mean. As an example, an X7R capacitor will vary in capacitance by no more than a factor of $\pm 15\%$ over the temperature range of -55°C to $+125^{\circ}\text{C}$.

Mica capacitors

There are two types of mica capacitors. One type is a stacked foil unit consisting of alternate layers of metal foil (or deposited metal film) and sheet mica insulators. The metal foil layers are connected together with tin-lead foil strips with terminals attached by using solder coated pressure clips.

The second type of mica capacitor is the silver-mica capacitor. Those have a silver electrode material screened on the mica stampings, which are then assembled as described above. The silver-mica capacitors are very susceptible to silver-ion migration, which can occur within a few hours, when exposed to high DC-voltage stress, high humidity, and high temperature. The ion migration results in the

capacitor short circuiting.

To keep internal inductance small for high-frequency use, button-style silver-mica capacitors have the anode connected through the center of the stack of mica sheets. The other terminal is formed by the case, which is connected to all points around the outer edge of the electrode. That design permits the current to fan out in a 360° pattern from the center terminal thus providing the shortest RF current path from the center terminal to the chassis.

One of the more common micas used for capacitors is Muscovite mica, which comes from India. That substance has a dielectric constant between 6.5 and 8.5, can be split into thin sheets, is non-porous, and does not readily absorb moisture.

Mica capacitors are temperature and frequency stable, have a low dissipation factor, and perform well at frequencies up to 500 MHz. Those high precision units are used in a variety of applications, in-

cluding tuning circuits, oscillators, filters, and RF power circuits.

Glass capacitors

Glass capacitors are used in applications that require high stability in a hostile environment. Those devices can withstand vibration, acceleration, extreme moisture, vacuum, and high operating temperatures; they are, however, susceptible to damage from mild mechanical shocks. They have a life expectancy of 30,000 hours or greater.

Glass capacitors perform very well at high frequencies up to 500 MHz, and have a frequency range of 100 kHz to 1 GHz. Because of their characteristics, those devices are commonly used in missile and spacecraft electronics.

Paper/plastic capacitors

Paper and plastic capacitors are used in applications that require high and stable insulation resistance at high temperatures, and good capacitance over a wide temperature range. (However, an exception to that are the metalized—we'll talk about metalization in a moment—

TABLE 3—GLOSSARY

- DC leakage**—Small current that flows through or across the surface of the dielectric or insulation of the capacitor.
- Dielectric**—Insulating material between the plates of a capacitor.
- Dielectric absorption**—A property of a capacitor's dielectric such that even when the capacitor is discharged to zero, a residual charge remains stored in the dielectric.
- Dissipation Factor**—Important in AC applications, it is the ratio of effective series resistance (ESR) to capacitive reactance X_C , and is usually expressed as a percentage. The dissipation factor varies with temperature, humidity, and frequency.
- Electrolyte**—Current conducting solution (liquid or solid) between two electrodes or plates of a capacitor.
- Equivalent series resistance (ESR)**—Energy losses in the capacitor due to lead resistance, termination losses, and dissipation in the dielectric.
- Insulation resistance (IR)**—Measure of a capacitor's insulation quality expressed either in megohms or as a time constant, RC, in seconds. That value determines a capacitor's leakage current for a continuously applied DC voltage when a capacitor is fully charged.
- Temperature coefficient**—A capacitor's change in capacitance per °C. May be positive, negative, or zero and is usually expressed in parts per million per °C (PPM/°C).
- Working voltage (WVDC)**—The recommended maximum voltage at which a capacitor should be operated.
- Quality factor (Q)**—A figure of merit used mostly in tuned circuit applications. It is defined as a $1/DF$ or X_C/ESR .

TABLE 4

Letter Symbol	Low Temp.	Number Symbol	High Temp.	Letter Symbol	Maximum Capacitance Change
Z	+10°C	2	+45°C	A	± 1.0%
			+65°C	B	± 1.5%
		4	+85°C	C	± 2.2%
Y	-30°C	5	+105°C	D	± 3.3%
			+125°C	E	± 4.7%
X	-55°C	7		P	± 10.0%
				R	± 15.0%
				S	± 22.0%
				T	± 22%—33%
				U	± 22%—56%
				V	± 22%—82%

paper units, which have low insulation resistance and are prone to dielectric breakdown.) Plastic types are less affected by humid conditions than paper units since they are non-absorbent. Plastic capacitors, such as polycarbonate and polyester (Mylar) types, are generally intended for applications where minimum capacitance change with temperature is required. They are especially suited for tuned and precision-timing circuits.

In metalized capacitors, a thin film of metal is deposited directly on the paper or plastic dielectric. Doing that gives the capacitor a "self-healing" characteristic called "clearing." If there is a hole or contaminant in the dielectric of the capacitor, a short may occur, resulting from the heavy current flow in the fault area. In a metalized capacitor, that heavy current flow will melt away a very small part of the thin metal film, thus disconnecting the fault from the capacitor. These capacitors are best for analog circuits because the momentary current flow during the clearing action may result in a spurious signal and cause false triggering in digital logic circuits.

Metalized plastic devices work well in switching power-supply output filters because they have a comparatively low ESR, as well as stable temperature characteristics. When using those capacitors in such an application, however, be sure that the unit selected is rated to handle the voltage surges produced by the circuit.

Tantalum electrolytics

Tantalum capacitors offer high capacitance in a small package size and have an excellent shelf life. Various types of tantalum electrolytic capacitors are available including solid, sintered slug, plain foil, etched foil, wet slug, and chip. Applications include low-frequency filtering, bypassing, coupling, and blocking. The solid types are not temperature sensitive and have a lower capacitance-temperature characteristic than any other electrolytic capacitor.

Applications that tantalums are not

suitable for are in RC timing circuits, triggering systems, or phase-shift networks. That's because they have high "dielectric absorption" characteristics. That is, when a capacitor is discharged, the dielectric retains a residual charge. Thus, even if a capacitor that has a high dielectric absorption characteristic has been discharged to "zero," it may still be holding a considerable charge. That, as you might imagine, can cause considerable problems in timing circuits and the like.

Tantalum capacitors also are not recommended for circuits that produce spikes, surges, or pulses. If their voltage rating is exceeded by even a few volts, the device is likely to fail.

Tantalums may be polarized or non-polarized. Polarized capacitors should never be exposed to a reverse DC or peak AC voltage greater than 2% of its rated DC voltage. Non-polarized units, as their name would apply, do not suffer from that limitation. Non-polarized units are made up of two polarized units in series with their cathodes connected together.

Aluminum electrolytics

Aluminum electrolytic capacitors are generally larger than tantalums, and are less expensive. One problem with aluminums is that they will change capacitance (drift) over time. That is caused by the aluminum oxide electrodes chemically combining with the electrolyte. Because of that, capacitance can drop substantially, to 10% of rated values. Those units also have a limited shelf life due to oxide film deterioration and must be "re-formed" after long periods of storage. Re-forming consists of applying the capacitor's rated voltage to the unit for a period of 30 minutes. Re-forming also prevents dielectric breakdown or shorting. In addition, the dissipation factor of these devices can rise as much as 50%.

To prevent electrolyte evaporation and component cleaning problems, aluminum electrolytics sometimes have an epoxy end seal. However, without a vent, such

continued on page 109

ALL ABOUT THERMISTORS

HARRY L. TRIETLEY

We conclude our look at thermistors with two simple but practical projects—a digital thermometer and a temperature-to-frequency converter—that you can build.

Part 3 BEFORE WE MOVE ON to our thermistor-based projects, let's finish up our discussion of matched thermistor sets.

At least two manufacturers, Yellow Springs Instrument Co. (Box 279, Yellow Springs, OH 45387) and Fenwal (63 Fountain St., Framingham, MA 01701), sell preselected and precalculated sets of components. The thermistor pair is constructed as a single component and looks just like an ordinary small, epoxy-coated disc, except that it has three leads instead of two. Internally, the two thermistors are connected in common on one side. The resistors are low temperature-coefficient, 0.1% metal film resistors.

Table 3 lists the values of four different component sets from the Yellow Springs Instrument Co. that are intended to be used with either the 44018 thermistor-pair or the 700-series thermistor probe. The selected values of R1 and R2 optimize the linearity over several temperature ranges. Table 3 also lists a *resistance mode* equation—we will get to this a bit later. The thermistor-pair itself has an accuracy of $\pm 0.15^\circ\text{C}$ ($\pm 0.27^\circ\text{F}$), which should be added to the linearity deviation to find worst-case error. Other prepackaged thermistor sets are available, including a three-thermistor set for even better linearity.

Table 4 lists the bridge component val-

ues (R3, R4, and V_S) needed for an output of 10 mV-per- $^\circ\text{C}$ or 5 mV-per- $^\circ\text{F}$. You can get 10 mV-per- $^\circ\text{F}$ by doubling the supply voltage, but that's not recommended—the power dissipation in the thermistors may become high enough to affect accuracy.

Resistor-thermistor networks

It is often useful to create a network whose resistance changes linearly with temperature. Such networks are used to temperature-compensate other circuit values or to measure temperature using an ohmmeter-like circuit. An NTC thermistor may be linearized by simply connecting a resistor in parallel as shown in Fig. 14.

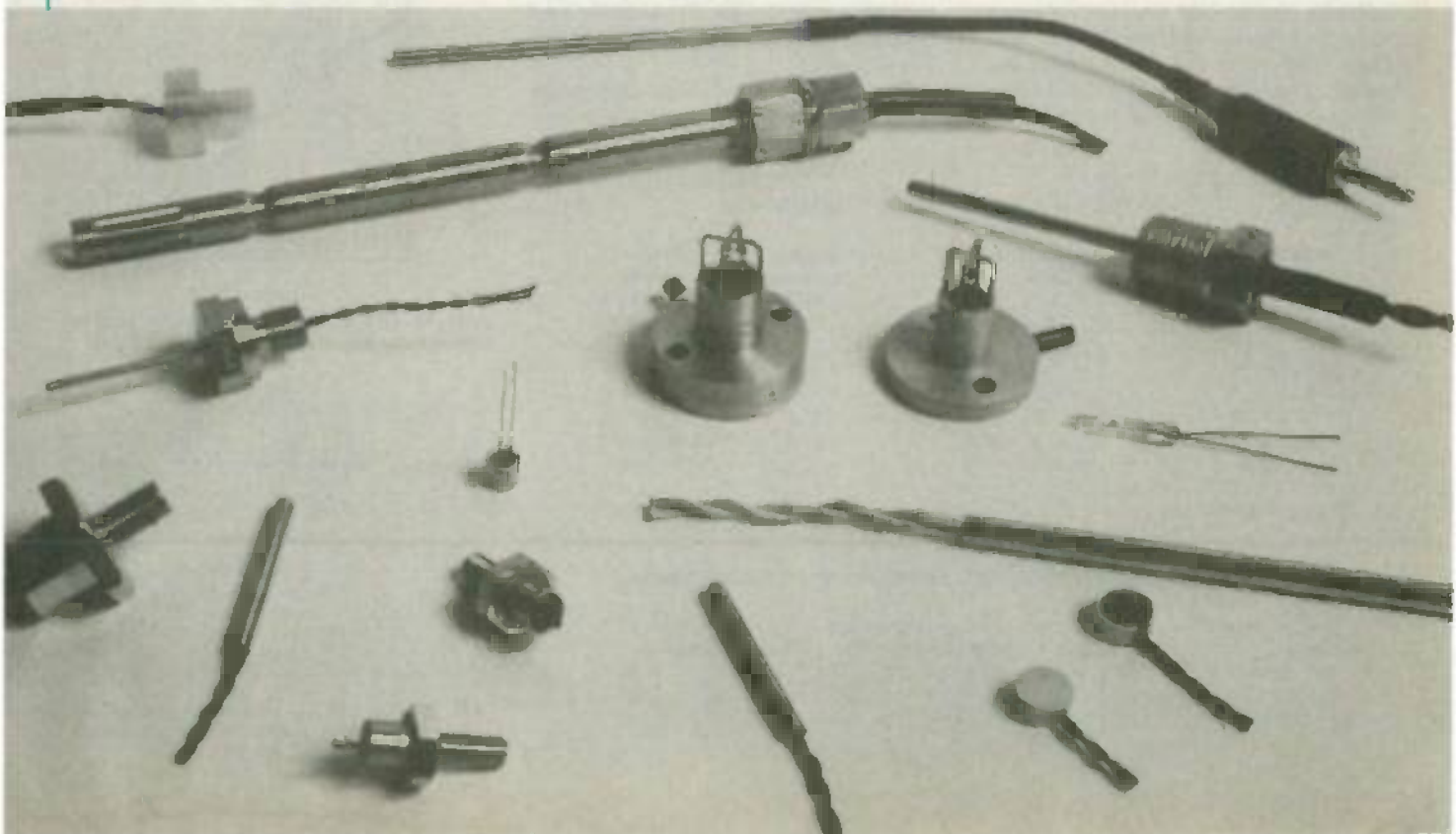

TABLE 3—MULTIPLE THERMISTOR LINEAR NETWORKS

Linear temperature range	R1	R2	Bridge equation* (V _{out} , volts, when V _s equals 1 volt.)	Resistance mode* equation (ohms)	Linearity deviation	Manufacturer's component set no.
0 to 100°C or 32 to 212°F	3.20K	6.25K	0.0053483 T + 0.13493 or 0.00297127 T + 0.03985	2768.23 - 17.115 T or 3072.48 - 9.508 T	±0.216°C or ±0.388°F	YSI 44201
-5 to 45°C or 23 to 113°F	5.70K	12.0K	0.0056846 T + 0.194142 or 0.0031581 T + 0.093083	4593.39 - 32.402 T or 5169.42 - 18.001 T	±0.065°C or ±0.12°F	YSI 44202
-30 to 50°C or -22 to 122°F	18.7K	35.25K	0.0067966 T + 0.34893 or 0.00377588 T + 0.228102	12175 - 127.096 T or 14435 - 70.608 T	±0.16°C or ±0.29°F	YSI 44203
-2 to 38°C or 30 to 100°F	5.70K	12.4K	0.00563179 T + 0.192437 or 0.0031289 T + 0.09232	4603.11 - 32.1012 T or 5173.8 - 17.834 T	±0.03°C or ±0.055°F	YSI 44204

The values shown work with YSI 44018 thermistor-pair. Resistors must be 0.1% or better.

Bridge equation refers to Fig. 13. Resistance mode equation refers to Fig. 16.

Figure 15 shows the resistance-versus-temperature curve for such a network. You can see that it is the same S-shaped curve as was seen earlier for a thermistor bridge, only inverted. As it turns out, the same rules apply for linearization: you can get good linearization over narrow ranges by simply choosing the resistor to be equal to the thermistor's value at mid-scale. For best possible linearization, you can use the same equation as was used earlier to linearize the bridge.

Table 5 lists the resistance equations and linearity deviation for three temperature ranges. Just as with the bridge, linearity becomes worse as the temperature range increases. Of course, sensitivity and zero-offset are not adjustable, although you can add a resistor in series with the network without affecting linearity. Only negative-going slopes are possible, since the thermistors' resistance decreases with increasing temperature.

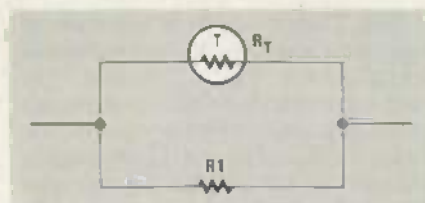

FIG. 14—A THERMISTOR'S RESISTANCE can be linearized over small temperature ranges simply by placing a fixed resistor in parallel with it.

Networks like those are useful if you need to generate a gain or an offset voltage that changes with temperature. They also may be used in series with a coil such as a meter-movement or a TV deflection coil. Since the resistance of copper increases with temperature, the series thermistor network can be designed to keep the total resistance constant despite temperature fluctuations.

For best linearity over wide temperature ranges, two thermistors (or a single ther-

mistor-pair) can be used as shown in Fig. 16. The resistor values for the circuit shown in Fig. 16 turn out to be the same as were used earlier in the bridge circuit. Therefore, you can use the same pre-selected component sets that are available from the manufacturers. Table 3 can again be used to select the optimum value of R1 and R2. The total resistance of that circuit is calculated using the resistance-mode equation listed in Table 3.

Analogue-to-digital conversion

You can connect the output of a thermistor bridge directly to the input of an

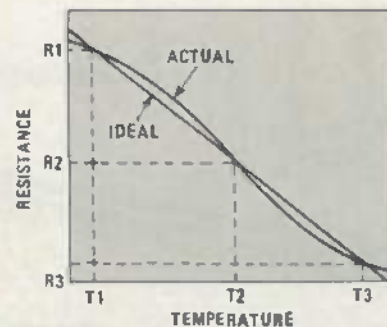

FIG. 15—RESISTANCE VS. TEMPERATURE of the resistor-thermistor combination of Fig. 4

TABLE 4—LINEAR BRIDGE COMPONENTS

Temperature range	Resistors R3, R4	Supply voltage V _s	Bridge output
0 to 100°C	20.52K, 3.20K	1.6698 V	10 mV/°C
32 to 212°F	77.10K, 3.20K	1.6828 V	5 mV/°F
-5 to 45°C	23.66K, 5.70K	1.7591 V	10 mV/°C
23 to 113°F	55.54K, 5.70K	1.5832 V	5 mV/°F
-30 to 50°C	34.89K, 18.7K	1.4713 V	10 mV/°C
-22 to 122°F	63.28K, 18.7K	1.3242 V	5 mV/°F
-2 to 38°C	23.92K, 5.70K	1.7756 V	10 mV/°C
30 to 100°F	56.04K, 5.70K	1.5980 V	5 mV/°F

Note: Resistors should be 0.1% or better. For values of R1 and R2 see Table 2a.

TABLE 5—LINEARIZED THERMISTOR-RESISTOR NETWORK VALUES

Temperature range	R1	Linear resistance equation (ohms)	Linearity deviation
10 to 30°C	2,168 ohms	1697.84 - 23.664 T	+0.07, -0.06°C
0 to 50°C	1,763 ohms	1422.12 - 17.330 T	+0.86, -0.95°C
0 to 70°C	1,164 ohms	1004.96 - 10.147 T	+2.0, -2.3°C

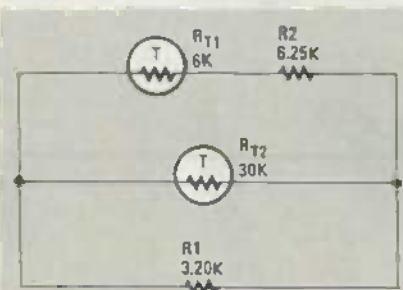

FIG. 16—FOR BETTER LINEARITY, you can use two thermistors in parallel. This circuit provides a linearity of ±0.216°C from 0-100°C.

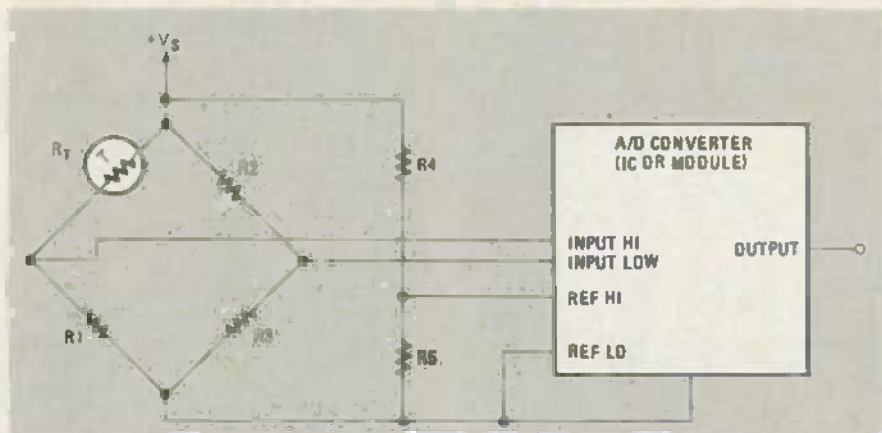

FIG. 17—CONNECTING THE BRIDGE OUTPUT to an A/D converter provides digital temperature information.

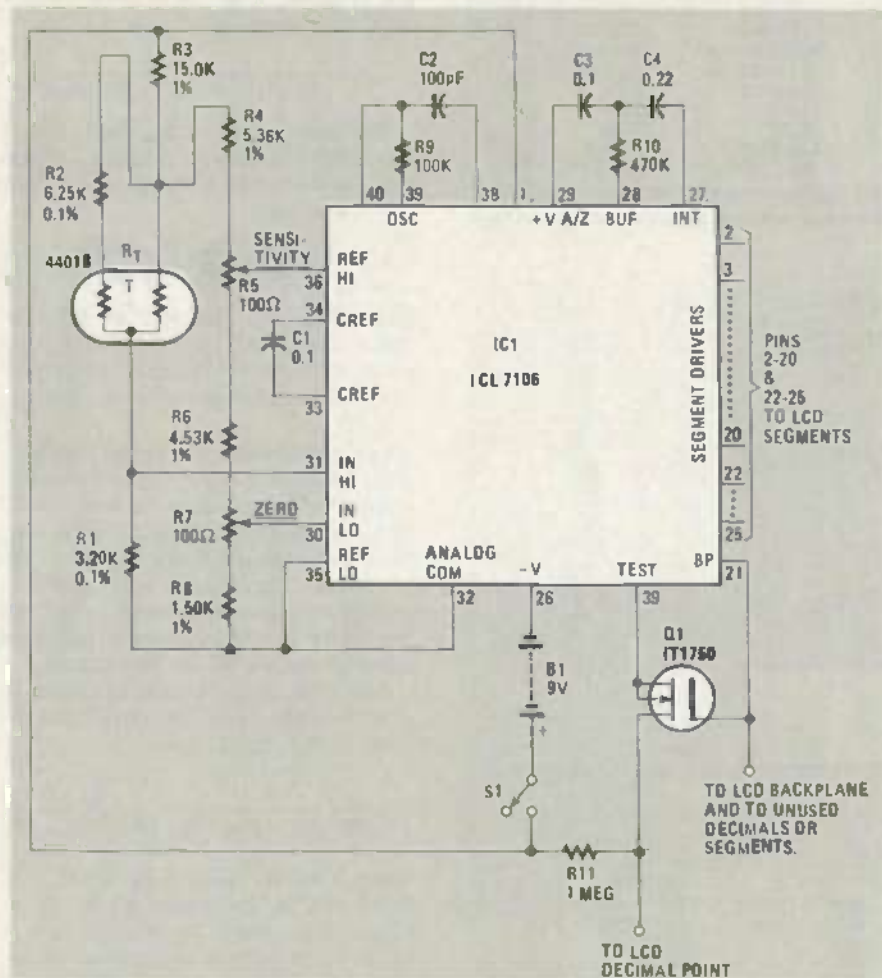

FIG. 18—A BATTERY-POWERED DIGITAL THERMOMETER using a single IC and a thermistor pair.

analog-to-digital converter IC or module as shown in Fig. 17. The bridge values are selected as before to provide best linearity, needed voltage sensitivity, zero offset, etc. Either a single thermistor or a thermistor-pair may be used, and the component values of Tables 2 and 3 will work just as well here. The reference voltage input should be set for the desired sensitivity or for the desired full-scale output.

One interesting observation results from the fact that an analog-to-digital

converter is really a ratio device; that is,

$$\text{Output} = K \times \frac{\text{Input}}{\text{Reference}}$$

If the supply voltage, V_S , varies, the input and reference voltages will vary by equal percentages, leaving the output unchanged. That means that the regulation, and even the exact value of V_S , are not critical—an inexpensive zener diode or regulator may be used. In fact, if the cir-

cuit's power supply is only moderately regulated, you may be able to use a simple voltage divider to create V_S . We will see this in the next example. A very simple circuit can give accurate and stable results.

Digital thermometer

If we replace the A/D converter with an digital voltmeter IC, we can produce a simple, accurate, battery-powered thermometer. Figure 18 shows the complete circuit we need. It uses an Intersil ICL7106 A/D converter IC and a two-thermistor linear network.

The thermistor-pair R_T forms the left-hand side of a Wheatstone bridge. The right-hand side of the bridge is formed by the voltage-divider string R_4 through R_8 . That same string provides the reference voltage for the A/D converter.

The ICL7106 maintains its ANALOG COMMON (pin 32) 2.8 volts below the supply voltage. Resistor R_3 reduces the voltage for the bridge, to minimize thermistor self-heating. You will notice that the bridge voltage varies as the thermistors change with temperature, from about one volt at 0°C to 0.5 volt at 100°C. In a normal analog situation, that would be disastrous. In this case, however, the A/D converter's output equals the input divided by the reference and, since the input and reference vary by equal percentages, the output is unaffected.

The IC itself is a dual-slope A/D converter with an auto-zero cycle. Its output will directly drive a 3-1/2-digit, seven-segment LCD readout. The output (as seen on the display) is given by:

$$\text{Output} = \frac{\text{Input}}{\text{Reference}} \times 1000$$

The IC's clock timing is set by R_9 and C_2 to 48 kHz, which results in three readings per second. Transistor Q_1 inverts the backplane waveform to drive the decimal point. The thermistor-pair shown is a 4401B or 700-series probe from Yellow Springs Instrument Co.

To calibrate the thermometer, you first have to know the R versus T values of the thermistor-pair. That information is shown in Table 6. Once you know their characteristics, you can replace two thermistors of the pair with accurate, known resistances (from precision decade resistors, for example). Set both to the zero-degree resistances, then adjust R_7 (zero control) for a reading of 0.2 (the setting for minimum nonlinearity error). Next, set the decades to 100°C and adjust R_5 (sensitivity) until the reading is 100.0. Repeat as necessary.

Temperature to frequency converters

You can make a temperature-to-frequency converter by replacing the A/D converter of Fig. 17 with a voltage-to-

TABLE 6—R VERSUS T VALUES

Temperature	T1 (6K @ 25°C)	T2 (30K @ 25°C)
-30°C (-22°F)	106.2K	481.0K
-20°C (-4°F)	58.26K	271.2K
-10°C (14°F)	33.20K	158.0K
0°C (32°F)	19.59K	94.98K
10°C (50°F)	11.94K	58.75K
20°C (68°F)	7496 ohms	37.30K
30°C (86°F)	4834 ohms	24.27K
40°C (104°F)	3196 ohms	16.15K
50°C (122°F)	2162 ohms	10.97K
60°C (140°F)	1493 ohms	7599 ohms
70°C (158°F)	1051 ohms	5359 ohms
80°C (176°F)	753.8 ohms	3843 ohms
90°C (194°F)	549.8 ohms	2799 ohms
100°C (212°F)	407.6 ohms	2069 ohms

put frequency (pin 13) is given by $f = 1/(2.2RC)$. Therefore:

$$f = \frac{1}{2.2(R_A + R_T)C} + \frac{1}{2.2R_B C}$$

The combination of R_A and C affects the circuit's sensitivity, while R_B affects only the frequency offset. Resistor R_1 is selected using:

$$R_A = \frac{R_{T1} R_{T2} + R_{T2} R_{T3} - 2R_{T1} R_{T3}}{R_{T1} + R_{T3} - 2R_{T2}}$$

where R_{T1} , R_{T2} , and R_{T3} are the thermistor's resistances at the low-end, mid-scale, and high-end temperatures, respectively. Linearity is the same as shown in Fig. 12.

A high-resistance thermistor should be used for this temperature-to-frequency converter. Depending on the supply voltage, the 4047 will generate several volts between terminals 2 and 3, and a low resistance thermistor will self-heat enough to cause large errors. Once the thermistor and the temperature range are chosen, compute R_A for best linearity.

Next, the capacitor must be chosen to give the right sensitivity (Hertz per degree). In the circuit shown:

$$C = \frac{1}{2.2S} \left[\frac{1}{R_A + R_{T3}} - \frac{1}{R_A + R_{T1}} \right] \left[\frac{1}{T3 - T1} \right]$$

where S has the units of $\text{Hz}/^\circ\text{C}$, C is in farads and all resistances are in ohms. Finally, R_2 is found by substituting R_A , R_{T1} and C in the original frequency equation and solving for the value of R_B that gives the desired frequency at T_1 . Figure 19 includes a table of component values for three temperature ranges. Notice that the calculations generally produce odd component values. The needed value of C must be created by using a parallel combination of capacitors; R_A and R_B include trimmer potentiometers.

Just as with the bridge, linearity and range of the temperature-to-frequency converter may be improved by using a two-thermistor network. The design process is complex, but Fig. 20 shows such a circuit. R-E

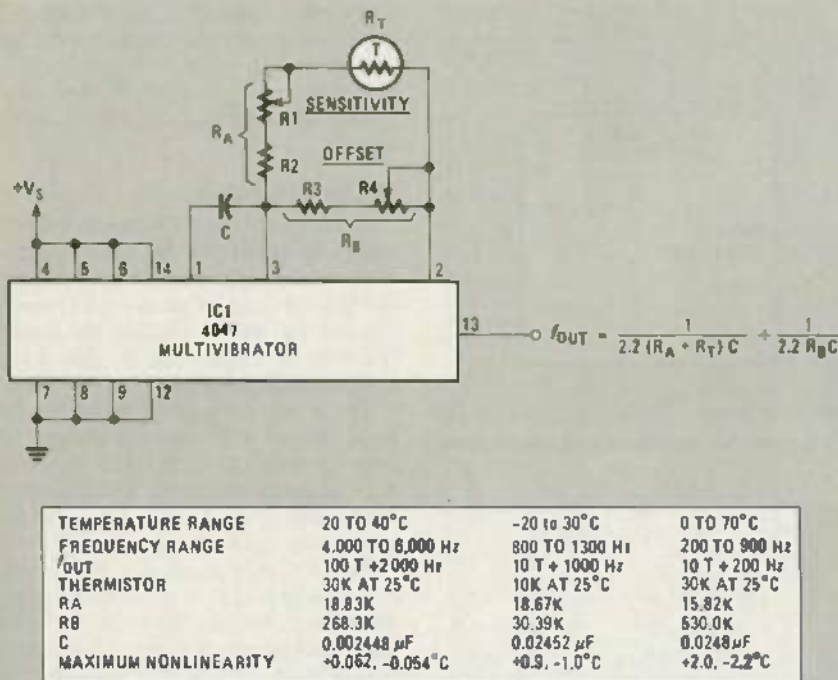

FIG. 19—A MULTIVIBRATOR can be used to give a frequency output that varies linearly with temperature.

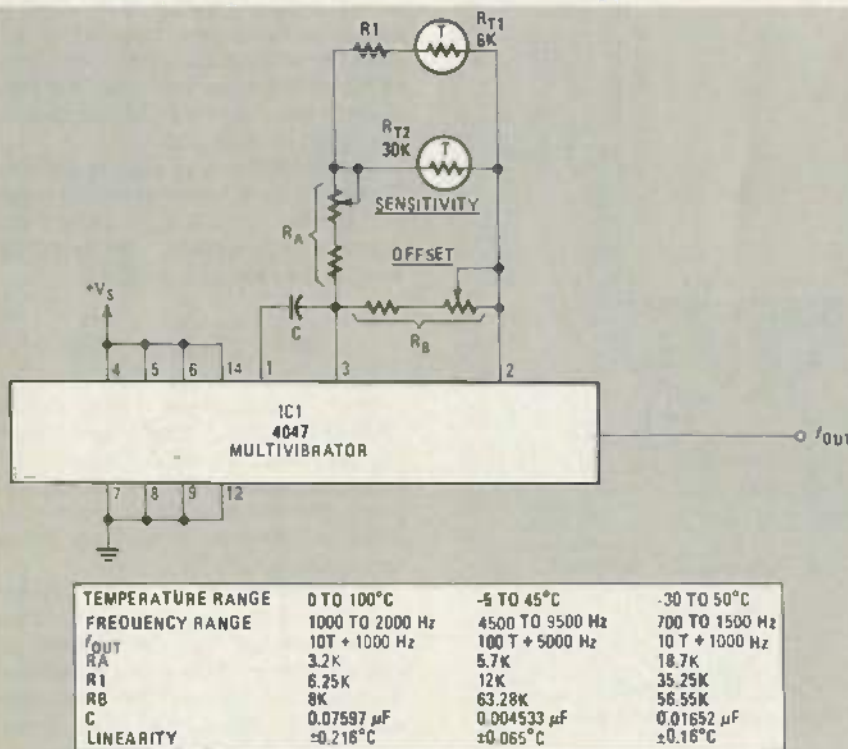

FIG. 20—USING TWO THERMISTORS improves the linearity of the temperature-to-frequency converter of Fig. 19

frequency converter. Even simpler and less expensive, though, is a circuit that uses a thermistor as part of the resistance in an R-C multivibrator circuit.

Temperature-to-frequency converters are useful in telemetry applications because the frequency signal is not affected by line resistance or by normal amounts of noise pickup. They are especially

useful if temperature data must be transmitted by RF, through telephone lines or optical cable, (where D.C. transmission is impossible). The frequency range can be tailored to suit the transmission medium.

Figure 19 shows a temperature-to-frequency converter built around a 4047 CMOS multivibrator IC. The 4047's out-

FREE high tech catalog



Metal Detector



Triple-Trace Oscilloscope/Time-Voltage Display

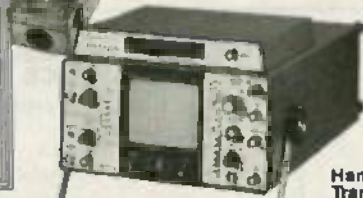

Ham Radio Transceiver



Computerized Weather Station



Real Time Spectrum Analyzer



Discover the pride.

With Heathkit, you'll discover the pride of accomplishment that comes with creating handbuilt quality that is uniquely yours.

And you'll develop skills and abilities in many technologies as you follow the step-by-step directions through the building process.

You work confidently, always backed by our simple promise, "We won't let you fail."

If you don't have the latest Heathkit Catalog, you're missing something great, so mail the coupon now, while you're thinking about it.

Microprocessor Trainer & Course



Most Accurate Clock



HERO[®] 1 Robot

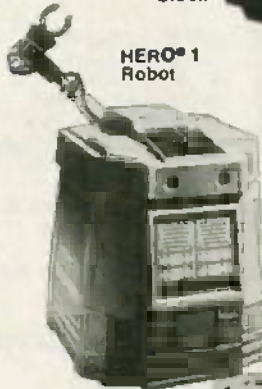

IBM-PC Compatible Computers



40-Channel Scanner



More than just a catalog, a trustworthy guide to what's new in computers and electronics.

Ever since radio grew into electronics, the illustrated Heathkit catalog has been a guide to new and exciting kit products for people like you to build. To enjoy and learn from, while saving money in the process.

What sets the Heathkit catalog apart is its range of high quality products and accurate information on every product offered. And that's a lot of products — over 450 separate items, including:

- Computer hardware and software
- Robots
- Precision test instruments
- Computerized weather instruments
- Solar hot water systems
- Automotive and home energy products
- Security devices
- Color TVs and video accessories
- Quality stereo components
- Amateur radio gear
- Educational courses that lead from the basics of electronics all the way to high tech.

Send NOW for your FREE Heathkit Catalog
It's the beginning of something great for the whole family.

Heath Company
Dept. 020-274
Benton Harbor, Michigan 49022
Please send me the latest Heathkit Catalog Free.

Name _____

Address _____

City _____ State _____

Zip _____

CL774C

Heathkit[®]
Heath
Company

A subsidiary of Zenith Electronics Corporation

CIRCLE 274 ON FREE INFORMATION CARD

MARCH 1985

73

HITACHI OSCILLOSCOPES

LOWEST PRICES
OFF-THE-SHELF
DIRECTLY TO YOU

CALL TOLL FREE
FOR FAST DELIVERY

800-645-9518

In New York State 800-832-1446

HITACHI 100 MHz W/CRT READOUT & BUILT-IN MICROCOMPUTER

Model V-1100
\$2500⁰⁰
Probes included.

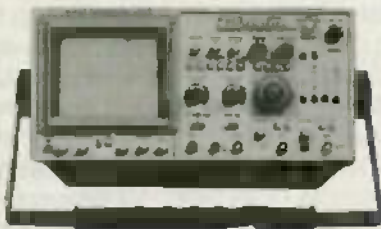

- Quad channel (Ch. 1,2,3,4) with independent position controls • 8 trace with alternate sweep
- 18kV-6" rectangular CRT • Minimum deflection factor 1 mV/div, maximum sweep time 2ns/div
- TV-sync • X-Y

operation up to 1 MHz (3° or less), variable hold-off • Gate output for A and B sweep • CH 1 signal output to 100 MHz (-3db)... plus much more.

HITACHI 100 MHz QUAD TRACE DELAYED SWEEP SCOPE

Model V-1050F
\$1299⁹⁵

(Reg. \$1980) Probes included.

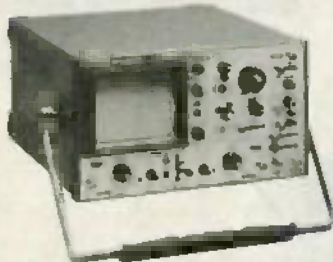

- Use of low halation dome mesh and large 6" rectangular CRT with internal graticule
- 500 uV/div high sensitivity design
- Alternate and single sweep functions
- TV sync separator circuitry with one touch synchronization

• Automatic focus circuits • Variable hold-off circuitry • X-Y operation • Delayed sweep function with one touch control 10X magnification

HITACHI 60 MHz DUAL TRACE DELAYED SWEEP SCOPE

Model V-650F
\$995⁰⁰

(Reg. \$1195) Probes included.



- 6" rectangular CRT with internal graticule.
- 1 mV/div high sensitivity design
- Triple trace for checking synchronous signals and relationship and timing between observed waveforms
- TV sync separator circuitry • Automatic focus circuitry • Variable hold off circuitry • X-Y operation
- Delayed sweep function with one touch control 10X magnification • Signal output CH1 output terminal to frequency counter, etc.

HITACHI PORTABLE OSCILLOSCOPES 1 mV/div DUAL TRACE

Model V-222 (20 MHz)
\$549⁹⁵

(Reg. \$715) Probes included

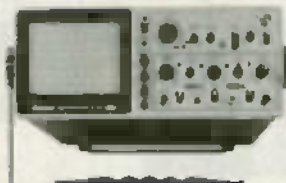

Model V-422 (40 MHz)
\$699⁹⁵

(Reg. \$895) Probes included

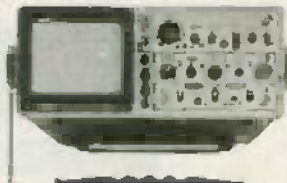

- Thin, light and compact design • Large 6-inch rectangular, internal graticule CRT • Autofocus circuit and scale illumination
- DC offset function • Voltage and frequency reading outputs
- Alternate magnify function • 8 divisions of displayed dynamic range • TV sync separation circuit • X-Y operation mode

HITACHI PORTABLE OSCILLOSCOPE DC TO 20 MHz, 1 mV/div DUAL TRACE

Model V-212
\$499⁹⁵

(Reg. \$615)
Probes included.

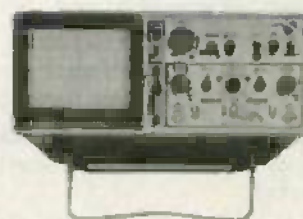

- Thin, light and compact design
- Large 6-inch rectangular, internal graticule CRT • High accuracy - +3% • High sensitivity - 1 mV/div
- Stable, low-drift design • 8 divisions of displayed dynamic range • TV sync separation circuit • X-Y operation mode

MASTERCARD/VISA ACCEPTED

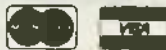

PHONE ORDERS
ACCEPTED

Service and Shipping Charge Schedule

FOR ORDERS	ADD
\$501-750	\$8.50
\$751-1,000	\$12.50
\$1,001 and up	\$15.00

Fordham

260 Motor Parkway, Hauppauge, New York 11788

BUILD THIS

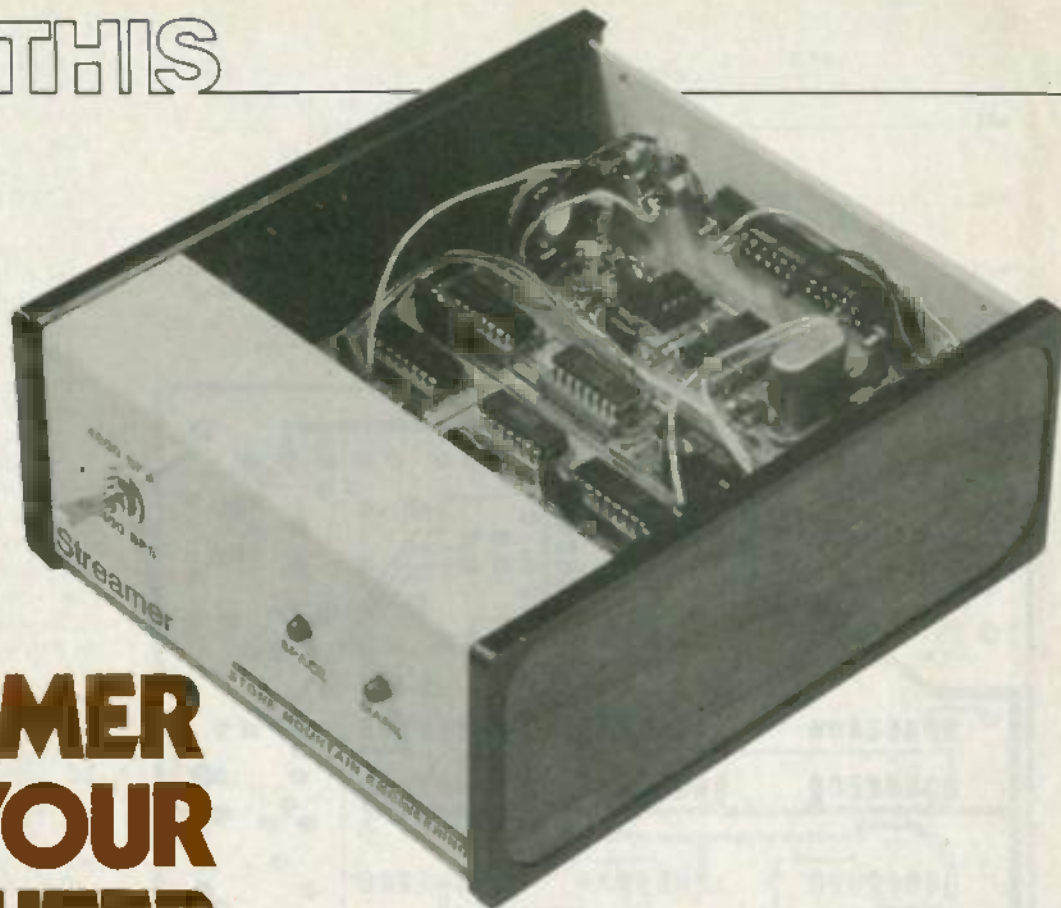

TAPE STREAMER FOR YOUR COMPUTER

MIKE HUDDLESTON

We've looked at the circuit of this universal cassette interface. Now we'll look at its data encoding scheme and then get set to build the device.

Part 2 LAST MONTH, WE DESCRIBED the circuit of an interface that lets you take data from your RS-232 port and store them on cassette tape. During our description, we made many references to Manchester and NRZ data-encoding techniques. We're going to start off this month with an explanation of those techniques so you can better understand the circuit's operation.

Manchester encoding

Manchester coding is a method of phase-encoding serial data. It was introduced during the early days of data recording as a means of efficiently including clocking information with transmitted data. The technique was invented at Manchester University in England to be used in Ferranti computers and it is in widespread use today in both the computer and the communications industries.

Non-return-to-zero, or NRZ, code is by far the most common means of serial data interchange between computers and their peripherals. Whether represented by TTL levels, RS-232 levels, or current loops, the conventions are the same: An idle line stays at a mark level; a data word

is represented by a specific number of bits, mark or space, and each data word is preceded by a start bit (which is a space) and followed by one or more stop bits (which are marks). The word size is not specified, but is usually five to eight bits, and may or may not contain a parity bit for error detection.

There are several good reasons for the proliferation of NRZ code. First, it's easy to understand. (If you take a look at Fig. 4, you'll probably be able to immediately see what's going on with the NRZ code before we even discuss it.) Second, NRZ is supported by numerous LSI communications controllers (UART's, USART's, etc.). Third, almost every peripheral available uses it.

One characteristic of NRZ code is that it must be capable of preserving very long periods of idleness or marking. That implies that the link must have a low-end frequency response reaching down to DC. In the typical data-equipment environment, that requirement is met by hard-wired connections. But when connections without DC continuity are used for data, NRZ code cannot be used. Telephone lines and audio tape, for example, where

frequency response drops off below about 30 Hz, are two applications for which raw NRZ code is unsuitable. Due to the very nature of NRZ coding, there is only one place in an entire transmitted word where bit timing may be recovered during reception. That is the initial mark-to-space transition at the beginning of the start bit. Since all other bits in the word are undefined (and indeed, may be all spaces or all marks), it is easy to see that there are simply no other places in the word that can be predicted. That technique is known as *word synchronization*, as all the bits of the word are recovered by timing from that one known point.

Word synchronization implies that timing errors are cumulative: The longer the data word, the more likely the chances for recovery errors. Recognizing that, devices using NRZ coding generally are designed with crystal-controlled clocks at each end of the link, and word length is kept under ten or so bits in order to avoid timing errors.

From the above, we can see that NRZ coding is unacceptable for audio magnetic media: Audio tape devices are not responsive to DC levels, and the lack of stability

MARCH 1985

75

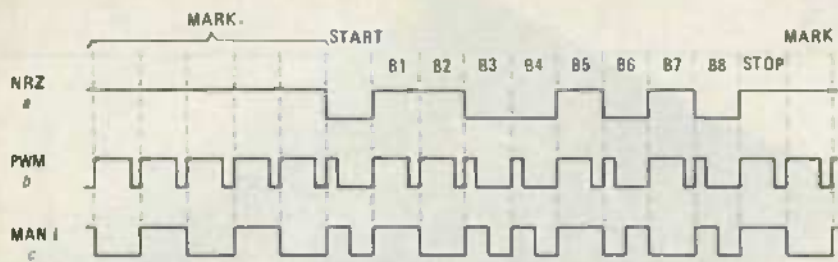

FIG. 4—THREE WAYS TO REPRESENT the serial data stream 11001010. Shown in *a* is NRZ or non-return-to-zero encoding. In *b* is pulse-width modulated encoding, and in *c* is Manchester IA.

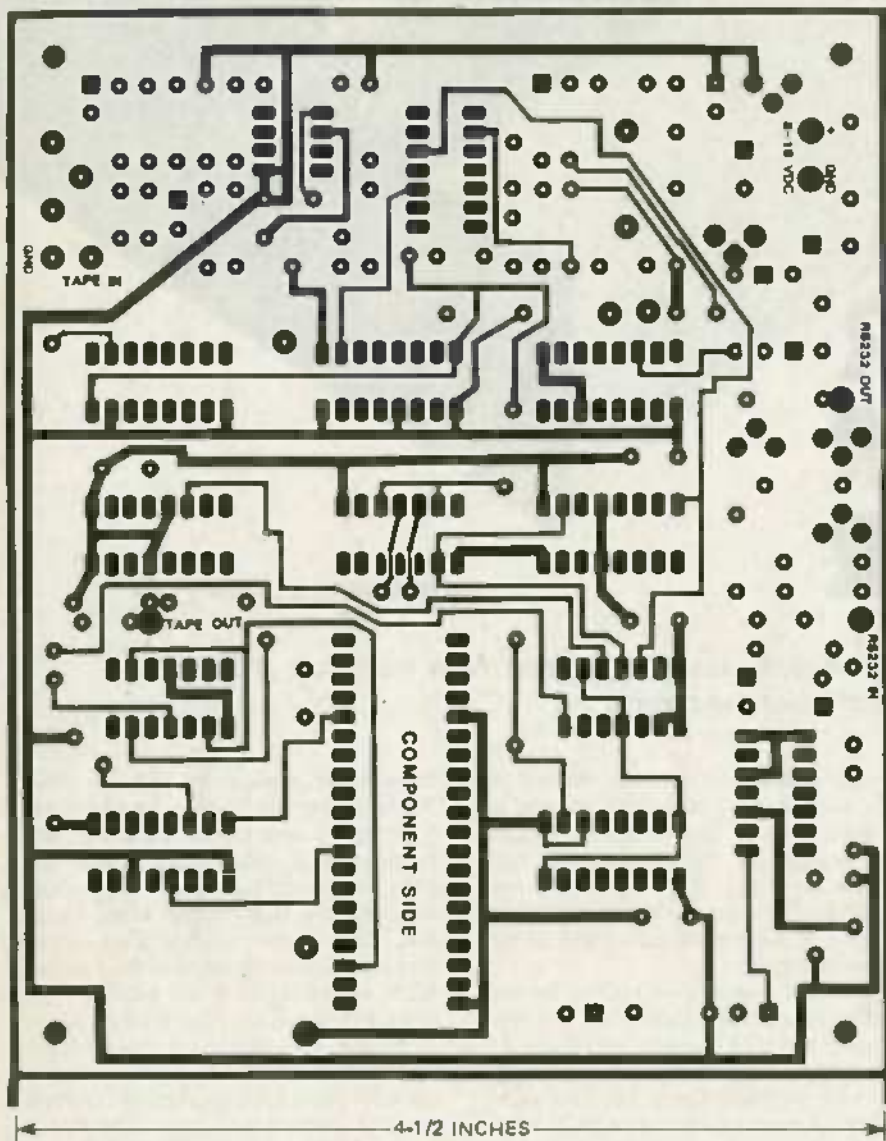

FIG. 5—THE COMPONENT SIDE of the double-sided streamer circuit board. Note that the square pads represent the positive end of electrolytic capacitors or the banded (cathode) end of diodes.

of their motor-driven capstans precludes precision clocking. An audio data interface, then, must convert NRZ marks and spaces to signals that can be successfully recorded and recovered. In addition, the interface must compensate for the tape device's inherent timing instability.

Historically, the most common method of audio data recording has been to represent NRZ data with two audio tones, one for mark, and another for space. (That

modulation technique is known as FSK or Frequency Shift Keying.) Those two frequencies are then detected during playback with either high-Q audio filters or phase-locked loops. With either technique, some individual tuning is required, and the higher the data rate, the more critical the tuning becomes.

However, if you're not interested in maximum performance, then it's possible to design quite simple interfaces. The

combination of modulating fairly high audio tones with low data rates allows greatly simplified (and thus lower-cost) decoder hardware to be used. The old Kansas City Standard—300 baud 1200- and 2400-Hz audio tones—is a prime example.

The maximum frequency of the audio tones is limited by the available bandwidth of the recording medium. In order to maximize data rate, the available bandwidth should be made use of and the recording format should be bandwidth-efficient. (In other words, the ratio of the higher audio-tone frequency to the data rate should be low.) The 300-baud format discussed above uses a 2400 Hz maximum frequency, indicating a frequency to data ratio of 8 to 1. The Manchester code used by the Streamer sports a ratio of 1 to 1—an eight-fold increase in efficiency. By doubling the modulation frequency, a 16x speed advantage is attained!

Building the Streamer

Now that we understand the theory of Manchester encoding and of the Streamer's circuit, we can get on to building it. Because of the large number of discrete components, it is highly recommended that the Streamer be built on a printed circuit board. Full scale artwork for the component and foil sides of a suitable circuit board is shown in Fig. 5 and 6. If you can't make your own board, you can buy a pre-etched, drilled, silk-screened, and solder-masked board from the source listed in the parts list.

The parts-placement diagram for the Streamer is shown in Fig. 7. When you install the parts, use a clean, low-power soldering iron. The finer the tip, the better. If you purchase a PC board, you'll note that it has a solder mask, so the chances of the solder inadvertently bridging is greatly reduced. Even so, it pays to be careful. If you make your own board, take particular care to avoid solder bridges. They may be hard to find and will definitely keep the unit from operating.

There is nothing critical about the components. Everything is available through vendors that regularly advertise in **Radio-Electronics**. Normal precautions should be taken in the handling of the CMOS IC's as they can be destroyed by static charges.

None of the capacitors are used for timing, so they may have tolerances as low as 20% without ill effects. The power-supply filter capacitors, C14 and C15, can be as large as you want (as long as they fit on the board!). If the DC supply isn't filtered, however, C14 must be at least 220 μ F to smooth out the ripples.

The Streamer is overdesigned with power-supply bypass capacitors. While it never hurts to include them, feel free to eliminate three or four if you want—it won't impair the circuit's operation. Note that the bypass capacitors—although

listed in the Parts List—were not shown in the schematic of Fig. 1. They are, however, shown in the parts-placement diagram.

The resistor values also are not critical. All resistors may have 10% tolerance, and you may even go to either the next higher or next lower standard value, if it's more convenient. The PC-mounted potentiometer may be replaced, if desired, with a 1000-ohm resistor, as long as a jumper is added between the audio input terminal and the negative side of C1. That potentiometer is used only when extremely poor quality tape information requires an additional "tweak." In normal use, it will never be touched.

The use of IC sockets always seems to be a controversy. On the one hand, including them adds a potential long-term reliability problem; on the other, trouble shooting soldered-in IC's is a nightmare. Ultimately, it is the decision of the builder; but we recommend their use, as

long as high quality sockets are used. (Cheap ones may cause more problems than they solve.)

Be careful to observe polarity on the diodes and electrolytic capacitors. The proper polarity is shown in Fig. 7. If you study the foil patterns, you'll notice that as an extra precaution, the PC board uses square pads to denote the positive end for the capacitors, and the cathode (banded) end of the diodes. The parts-placement pattern shows the transistor orientation for TO-92 packages. If you use substitute transistors, be careful that the right wires go into the right holes. The LED's must have long enough leads to reach the front panel. If they don't, simply solder enough additional wire so they do. It won't matter if they are a little longer than necessary.

The Streamer PC board may be mounted in its own enclosure (the one you see in the photos is available from the source mentioned in the Parts List). Alternatively, it can be mounted inside your

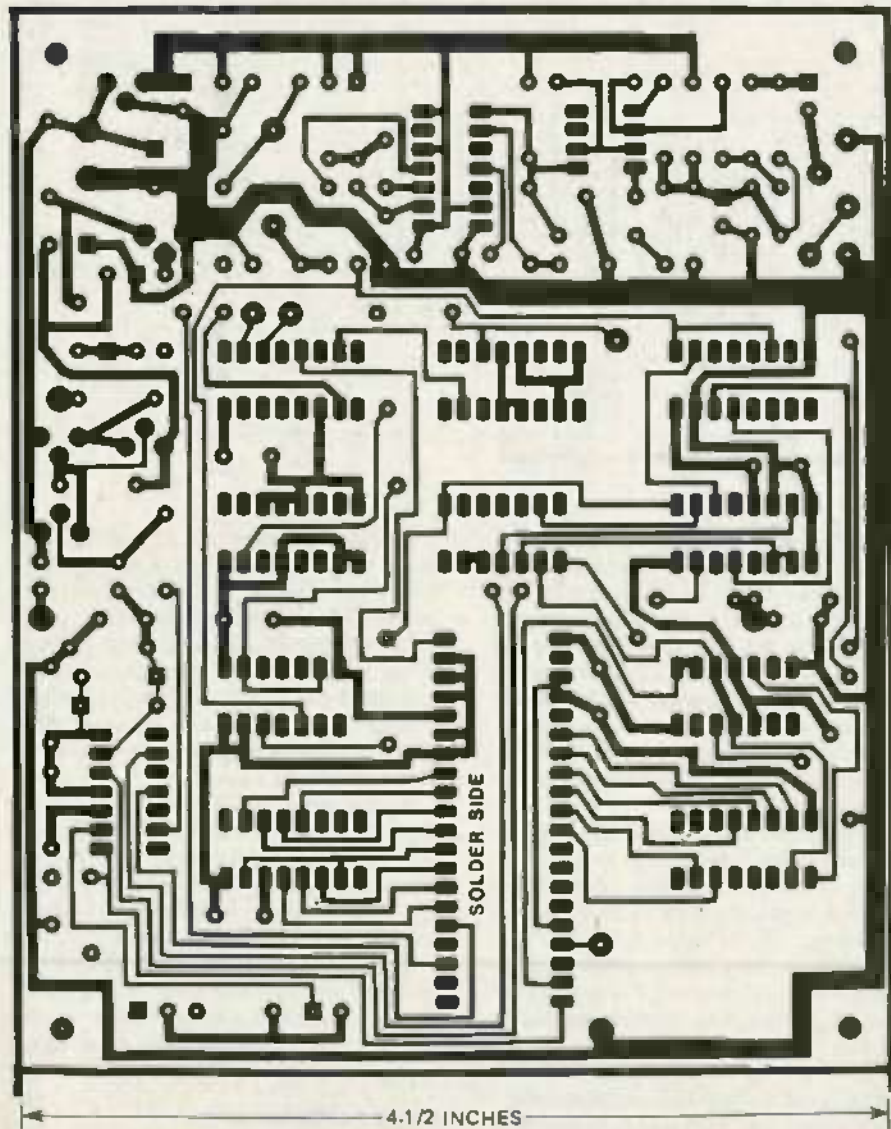

FIG. 6—THE SOLDER SIDE of the streamer circuit board. Note that square pads are used here for the same reason as on the component side.

PARTS LIST

All resistors 1/4 watt, 10% unless otherwise noted

R1—1000 ohms, PC-mount, trimmer potentiometer
 R2, R5, R6, R11, R16, R17, R20, R26, R29—1000 ohms
 R3, R4, R7, R8, R13, R14, R18, R19, R22, R23, R25, R26, R30—10,000 ohms
 R9—1 Megohm
 R10—100,000 ohms
 R12, R21, R27—47,000 ohms
 R15—10 Megohms
 R24—2200 ohms
 R31—330 ohms

Capacitors

C1, C4, C13—10 μ F, 25 volts, electrolytic
 C2, C21—0.001 μ F, ceramic disc
 C3, C12, C16—0.1 μ F ceramic disc
 C5, C7, C17, C18, C20, C22, C23, C24—0.01 or .1 μ F bypass capacitors (not shown in schematic)
 C6, C10—20 pF, ceramic disc
 C8, C9—250 pF ceramic disc
 C11—5 pF, ceramic disc
 C14—100–330 μ F, 25 volts, electrolytic
 C15—47–220 μ F, 25 volts, electrolytic
 C19—0.01 μ F, ceramic disc

Semiconductors

IC1—LM392 or LM2924 op-amp/comparator
 IC2—4070 or 74C86 quad XOR gate
 IC3—4040 12-stage binary ripple counter
 IC4, IC6—4029 presettable up/down counter
 IC5—4520 dual 4-bit synchronous counter
 IC7—4011 quad 2-input NAND gate
 IC8—4027 dual J-K flip-flop
 IC9, IC12—74C74 dual D-type flip-flop
 IC10—4015 dual 4-bit static shift register
 IC11—6402 CMOS UART (Intersil)
 IC13—4021 8-stage static shift register
 IC14—LM339 quad comparator
 IC15—78L05 low power 5-volt regulator
 D1–D5—1N914 or similar
 D6, D7—standard red LED
 Q1, Q3—2N3904
 Q2, Q4—2N3906
 XTAL1—2.4576 MHz crystal

MISCELLANEOUS: PC board, enclosure, DPDT switch, DB25 connector, phono jacks for tape deck connectors, hardware, solder, etc.

The following are available from Stone Mountain Engineering Co., PO Box 1573, Stone Mountain, GA, 30086: Printed circuit board, double-sided with plated-through holes, solder masked and silkscreened, for \$28; Enclosure, with all holes punched and legends silkscreened, \$16; Both PC board and enclosure for \$40. All orders must include \$1.50 shipping and handling, and Georgia residents please enclose 3% sales tax.

computer, or even inside the tape deck. Mounting it inside the tape deck is a good idea if the tape deck supplies the Streamer power (as long as the deck won't be used for other recording!). Baud-rate switch S1 can be eliminated, since only one data rate will be used, and the DB-25 connector can be located on the rear of the

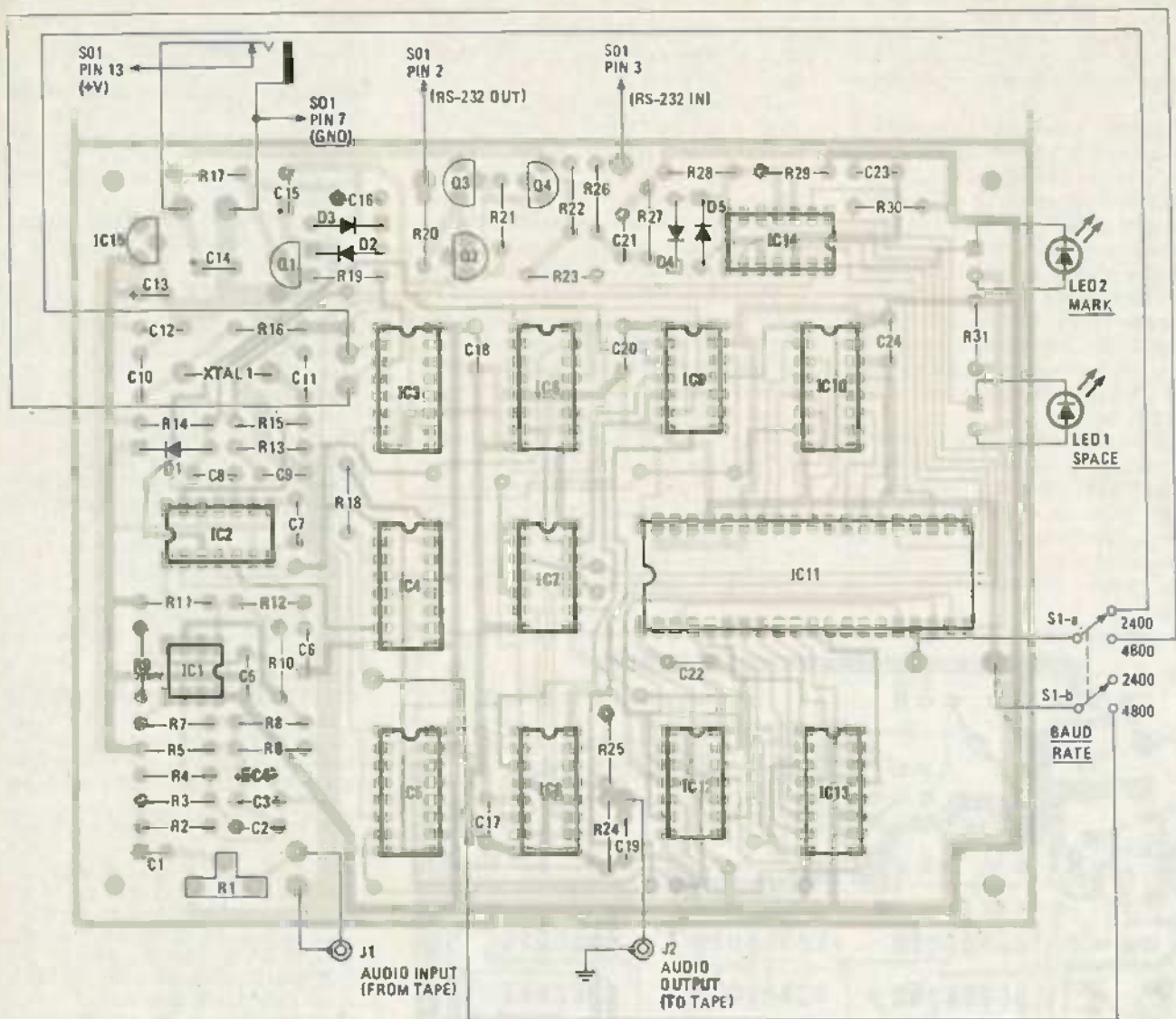

FIG. 7—PARTS PLACEMENT DIAGRAM for the Streamer shows both the on-board and off-board components.

deck. Locating the LED's may be a problem, though, depending on the configuration of your tape deck.

Installing the Streamer inside a computer is the least attractive option, as this precludes its use with other computers. One of the most important uses for the Streamer is to transfer files from one computer to another, and that cannot be accomplished if it is dedicated to one unit.

If the Streamer is to be mounted in its own enclosure, the procedure should be to: 1. Assemble the PC card. 2. Wire the DPDT switch (S1) to the card. 3. Wire the connectors on the rear panel. 4. Install the card and attach the rear panel wires. Follow the schematic for the proper connections to the DB-25 and the closed-circuit jack carefully. The power connection to DB-25 pin 25 is optional, and may be omitted if an external plug-in supply is to be used.

Troubleshooting

Initial trouble-shooting can be accom-

plished with an ordinary 20,000 ohms/volt (or better) volt-ohm-milliammeter. Connect the VOM, on its highest current scale, between the Streamer and its power supply. The streamer should draw in the range of 10–30 mA, and no LED's should be on. A very high current would indicate a short or a component in backwards, while a low current would indicate an open in either the power supply lines or the ground return.

If the above test is successful, remove the meter and connect the Streamer directly to the power supply. Measure the +5 volt supply at any convenient place. If it is above 5.25, or below 4.75, IC15 may be defective. Now measure the voltage at the end of R21 closest to Q2. There should be a negative voltage with a magnitude slightly less than that of the positive supply. If there is, that indicates the clock, the negative supply, and IC3 are functioning. Measure the voltage on IC8, pin 15. If it reads about 2.5 volts, then the Manchester encoder is working.

Connect the encoder's AUDIO OUTPUT to the AUDIO INPUT. Adjust R1 to the normal full-on position. (If you are using the PC board, this is the full-clockwise position, viewed from the board's edge.) If the MARK LED comes on, both the encoder and decoder are working. That is about all the testing that can be done with a VOM. If everything looks good, it should work properly the first time.

If an oscilloscope is available for testing, much more extensive trouble shooting may be accomplished by referring to the schematic and the theory of operation. A word of caution, however; the bit sequence that appears at the output of IC12-b will be in a different order than that received. That "bit shuffling" was done to simplify the board layout. The received bits, then, will also be in a scrambled order until IC10 corrects them.

Using the Streamer

The Streamer is one of the simplest add-ons to any computer system. As long

as your computer has an RS-232 port capable of a transmission rate of 4800 baud and a reception rate of 9600 baud, and as long as you have some sort of software to support storing and loading, you should have no problems. The tape machine can be just about anything—even a cheap portable (although, as we'll mention shortly, you'll sacrifice some performance). If you have a tape deck as part of your stereo system, it's probably ideal.

The supporting software may be the SAVE and LOAD commands with a BASIC interpreter, as long as they can be routed to an RS-232 port. BASIC programs can also be conveniently saved by LISTing them out to the Streamer, and read back in through an RS-232 port assigned as the console. The latter method has the advantage of allowing BASIC programs from different machines to be loaded, as the ASCII listing is, in effect, the same information that would be entered through the keyboard. The same can be done with source files, or, for that matter, any ASCII file.

Machine-language program storage and retrieval can be handled by any of a great many approaches, at least one of which is probably resident in the computer you now use. The routine the author uses on his system, like many others, transmits in sequence a delimiter stream, a load address, 255 bytes of data, and then a checksum. That is followed immediately by the next load address, data, checksum, and so forth, until all the data is done. When the tape is played back to the computer, each checksum is compared with a calculated checksum, and any error causes the routine to halt.

If you ever run across data errors when loading programs back into your computer, the cause is probably dirty tape heads. Simply cleaning the heads should eliminate the problem.

When configuring your RS-232 port, remember that the Streamer works with 8-bit data words. Those eight bits can be all data, seven data and one parity bit, or seven bits, no parity, and at least two stop bits. The only real requirement is that start bits must be at least nine bit-times apart, such as with eight data bits and one stop bit. In storing 7-bit ASCII files, it is normal to follow with a parity bit. The Streamer will treat the eighth bit as part of the data, faithfully recording it and playing it back. The Streamer itself does no parity checking; it simply records the data and returns what is presented to it.

The audio output of the Streamer is designed to present a signal compatible with the audio input of a hi-fi type tape deck. Since modern decks have input-level controls, the control should be adjusted for best performance. Unlike conventional cassette interfaces, that adjustment is not critical at all. To determine your optimum adjustment, use the tape

counter to record segments at various settings, then play them back, noting any recovery errors. The errors should occur at the extremes of the level control settings. Simply set the control approximately half way between where errors occurred, and you're under way.

The Streamer can be used with low-cost portable tape recorders, with some loss of performance: Because of their lower bandwidth capability, the Streamer must be operated at 2400 baud instead of 4800 (which is possible with hi-fi type decks). The audio signal out of the streamer is

about 0.9 Volt peak to peak, which suits most decks just fine. But you'll probably have to reduce that level if you want to apply it to a portable recorder. You can do that with either a resistive voltage divider at the recorder's input, or by simply reducing the value of R24: Try values in the 100- to 1000-ohm range.

Whether you use the Streamer for primary data and program storage, disk backup, or to exchange programs with other computers, it will undoubtedly be a welcome addition to your computer system. R-E

“People of all ages die of heart disease and stroke.”

With your help, we're out to change that.



American Heart Association

WE'RE FIGHTING FOR YOUR LIFE

PROBES FOR SALE

FROM THE BEST SOURCE FOR OSCILLOSCOPE PROBES AND DMM/VOM TEST LEAD SETS.

- Low Cost
- High Quality
- Excellent Performance
- Slender, Flexible Cable
- Wide Range of Choice
- Switchable X1 and X10 Attenuation Factor
- 100 MHz Bandwidth

MODEL SP100

\$41⁰⁰

TEST PROBES, INC.

TPI

Your Probe Specialists

SOLE U.S. SALES & STOCKING SOURCE

P.O. BOX 2113, LA JOLLA, CALIFORNIA 92036 (619) 450-4197

CIRCLE 123 ON FREE INFORMATION CARD

MARCH 1985

79

HOBBY CORNER



EARL "DOC" SAVAGE, K4SDS,
HOBBY EDITOR

Backing up AC power supplies

MANY OF YOU HAVE WRITTEN TO EXPRESS an interest in providing backup power for various projects. Most often, the need is for a clock backup, but other devices, such as radio monitors and exit lights, have been mentioned. No matter what type device is involved, the goal remains the same—to have a battery take over automatically when the AC power fails.

Since most electronic circuits are powered by DC (rectified AC), using a battery as a back-up supply is a simple matter. If the device is operated strictly by AC, then you'll need an *inverter power supply*, which converts DC into AC. Such a device is too complicated to discuss in this column, but one was covered in a feature article in the March 1984 *Radio-Electronics*.

Figure 1 shows a simple circuit that can be used for backing up circuits powered by a DC power supply. When the supply is functioning normally, operating current is passed by diode D1 and goes to the device, all or a portion of which is connected to point A. (We will get to point B in a moment.)

The device continues to operate on DC (rectified AC) as long as there is no power interruption. But where does the backup battery come in? As long as the battery voltage is chosen to be lower than that of the DC supply, diode D2 is reverse biased and prevents the battery from affecting the device.

Now, suppose the AC power fails. The battery voltage is then

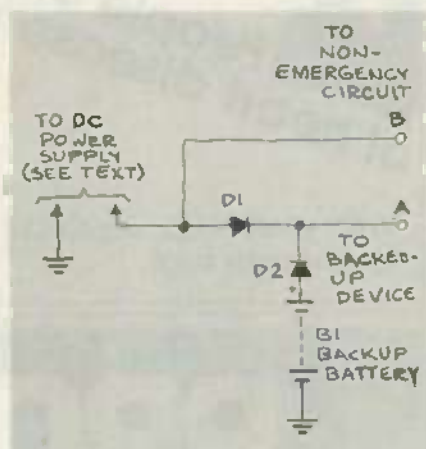

FIG. 1

higher than that of the DC supply, which is effectively zero. Diode D2 is now forward biased and passes battery current to operate the device. Of course, diode D1 is now reverse biased, and as such no battery current gets to the DC supply or point B.

When AC power is restored, everything goes back to normal: The DC power supply powers the device, and diode D2 is once again reverse biased. Thus, D2 automatically disconnects the battery, and the battery is saved for the next AC power-line failure.

Note that the circuit in Fig. 1 works *only* if the battery voltage is lower than that of the normal DC supply. That condition will cause no problem with most devices because the operating voltage can vary at least a volt or two without any apparent effect. Of course, if the device operates on a regulated voltage, be sure to place the back-

up circuit between the DC supply and the regulator.

The ratings on the diodes are not critical, provided they can handle the current and reverse voltage (PIV). The 1N4000 series works well for applications requiring currents up to 1A. Also keep in mind the maximum Peak Inverse Voltage (PIV) rating of the unit (it varies). The PIV rating of the 1N4000 is 50 volts, 1N4002 is rated 100 volts PIV, and so on. Make sure that you choose a PIV of at least twice the applied voltage for an extra margin of safety. (There is very little cost difference.)

Now, let's look at point B. Notice that it branches off the supply line before current reaches D1. Because D1 is reversed biased during power failures, anything connected to point B receives no battery-derived current. If the device contains some circuitry that need not be operated under emergency conditions, you may wish to disconnect that portion of the device from point A and connect it to B. That conserves battery power.

Say, for example, the device being powered is a clock that uses an oscillator to maintain time. (This circuit will not work for clocks that rely on the 60-Hz line to keep time!) You want to keep the clock's timing circuits "going" during a power failure, but you don't need the LED readout.

By connecting the display circuitry to point B and the timing circuits to point A, the timing circuits will operate much longer on the backup battery supply. And if

needed, you can put a normally open momentary switch between A and B to permit you to check the time during a power outage.

Certainly, a backup supply can be put in other types of devices. Just choose the diodes and the battery voltage appropriately. If the device is one that you want to be able to turn off without having the battery take over, simply put a switch in series with the device.

Those of you who wish to get fancy may want to use rechargeable batteries and build a trickle charger into the circuit to keep the batteries charged while the AC is operating. Doing so isn't worth the effort when dealing with clocks because a little 9-volt battery lasts a long time in that application. However, in other cases (such as with computers to save memory), a trickle-charged backup battery is certainly worth the extra effort.

Expanding your horizons

I recently told you that I've moved into a new community. Since then I have re-discovered an old truth and "discovered" something that some friends have been telling me for years.

First, a bit of background: I'm an old dyed-in-the-wool ham who began with CW (code), got into AM phone, and had a fling with Single SideBand (SSB) phones in the early days of that technology. (Anyone remember the 2EWL special?) After a few years, voice communication became tiresome to me and I "retired" to CW exclusively, apparently forever!

As I went from key to keyer, and then to keyboard, the use of 144 MHz (2 meters) changed and grew also, but with no participation or interest on my part. Over the years several friends urged me to get a microphone and try two meters, a suggestion that was quickly dismissed. After all, nothing above 30 MHz could be of much consequence (or so I thought).

In my new community, I met several new ham friends. In a short time, Jack K14DL and Bob WA8MWI had put a two 2-meter, hand-held transceiver in my paws saying, "Try it and see how you like it." Thereby, I re-learned that old truth: hams are the friendliest

people in the world, and can present a most convincing argument.

Well a guy just can't be impolite so I tried it and made my big discovery. Two meters is populated by a large contingent of hams and yet remains uncrowded. The countryside is literally peppered with repeaters (some linked to others far away) to increase coverage, and with auto-patches to make telephone calls conveniently from the car or elsewhere. Hey, this is FUN!

And that is saying nothing about joy of easily taking an entire functioning ham station with you anywhere—car, office, lake, trail, mountain-top—anywhere.

If you're not a ham, become one—it is a great way to add a new dimension to your interest in electronics. It is not difficult to get a ham license. Look up a local ham operator for help, or write the American Radio Relay League in Newington, CT 06111. R-E

PRINT™

Products International Inc.
8931 Brookville Rd.
Silver Spring, MD 20910
(301) 587-7824

Equipment, Tool, & Supplies
for Maintenance & Service

PACE DESOLDERING EQUIPMENT

MBT-100



Now \$349.00

- Self Contained
- Spike-Safe
- Instant Rise Rotary Carbon Vane Pump
- Pencil Grip Low Voltage Handpiece
- Meets UL Standards
- MBT 200 Desoldering & Soldering

TRACKER AND SWITCHER #2000



Reg. \$2,620.00
Special, Both \$2,489.00

HUNTRON INSTRUMENTS

The Art of Trouble Shooting

- In-Circuit Testing
- Power-Off Testing
- CMOS SAFE
- 20-Pin-40 Pin Dip Cables (Standard in 2000 System)
- Comparative Testing
- Incoming Inspection

TRACKER AND SWITCHER #1000



Reg. \$1,490.00
Special, Both \$1,415.00

3M STATIC CONTROL

Work Station



Now \$191.00

- 24x Table Mat (Available Separately)
- 47x Floor Mat (Available Separately)
- 2066 Wrist Strap (Available Separately)
- Static Control Electrically Conductive

Gold, Blue, Brown, Beige

Field Service



Now \$41.00

- 24x24x10 Mil Velostat Work Surface
- Portable
- Convenient Storage Pocket
- Static Shielding Bags Available

CIR-KIT



Basic \$57.00
Advanced \$87.00
Master \$159.00

- Edge Connector Repair
- Plated Thru Hole Repair
- Track and Pad Repair
- Conductor Repair
- Lifted Circuit Trace Repair

SPECIAL OFFER!

With every desoldering system or repair system ordered, receive free a 70-page how to repair circuit boards textbook. A \$19.95 VALUE.

USA G.O.D.

TOLL FREE 800-638-2020

CIRCLE 265 ON FREE INFORMATION CARD

www.americanradiohistory.com

COMMUNICATIONS CORNER



HERB FRIEDMAN,
COMMUNICATIONS EDITOR

What is half duplex?

TWO SURE-FIRE INDICATORS OF THE state of advancing technology are newspaper articles and reader mail. For instance, about a year ago, newspaper articles of any kind that contain the term "modem" always provided a concise explanation of what a modem was (or what it did). Similarly, reader mail almost without exception referred to radio or telephone voice-transmissions.

Today, newspaper and magazine articles use the term modem with no attempt to explain what it is because it is now assumed that everyone knows about the device. And as for reader mail, it now reflects a substantial interest in data communications via a modem.

However, there is a feature of computerized communications through a modem—called *half duplex*—that seems to confuse newcomers to the computer field. One reason for the confusion is because some modem manufacturers (as well as some software authors) use the term out of context. That means that the user suddenly finds himself with three different explanations of what half duplex is—one in computer's documentation, one in the modem's instruction manual, and the other in the software manual.

Full-duplex communications

To understand the term "half duplex" we must first go back to "full duplex." In communications, full duplex means simultaneous transmission and reception. An example of full-duplex communications is the telephone system,



FIG. 1

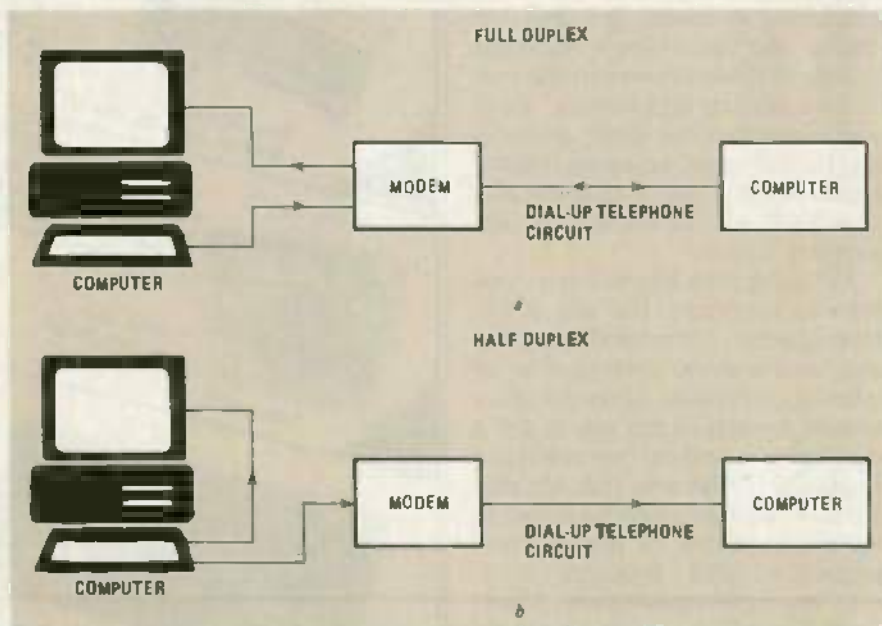

FIG. 2

where two parties can talk and listen at the same time.

In radio communications, the same thing can be done by using two frequencies, as shown in Fig.

1. Let's assume that two radio amateurs are using full-duplex systems on 20 and 10 meters (even though it is supposedly illegal).

Transmitter A broadcasts to re-

ceiver B on a frequency of 14 MHz. The transmitter at B broadcasts on 28 MHz to receiver A. With that arrangement, the operators can talk and listen at the same time, as if they were using the telephone. Now enter the computer.

Computerized communications

The terminal-to-computer circuit used for the dial-up telephone system is shown in Fig. 2. Notice that one wire (Fig. 2-a) carries the signal in both directions. Bear in mind that a terminal's display and keyboard aren't connected; they are two distinct and separate units.

The terminal is connected to the telephone line through a modem. The modem routes the outgoing signal from the keyboard to the telephone line, and the incoming signal from the line to the display. That arrangement is called "full duplex" because it allows you to transmit as well as receive data.

Imagine for a moment that you're in Boston inputting data to a terminal for transmission via the dial-up telephone system to a computer 3,000 miles away in, say, San Diego. Now, let's suppose that you type in a single letter "Z," for instance. But how do you confirm that your transmission was actually received by the computer at the other end of the telephone circuit?

The computer at the other end confirms that it has received your transmission by echoing back the letter "Z" (which appears on your display)—telling the originating operator that the computer (at the other end) has received the correct character. (That takes place so fast that it appears as if the letter "Z" pops up on the display as you press the key.)

However, there is one problem that may occur: The computer (at the other end) receives the correct transmission, but the echo gets garbled by line noise. The echo would then appear at originating computer as something other than what was originally transmitted. What happens then depends on your software.

At high transmission rates (4800 to 19,200 baud), several characters would be transmitted before the first echo returned, causing confusion as to what was going out. To

DON'T FORGET



USE
YOUR
READER
SERVICE
CARD

NO OTHER DMM GIVES YOU ALL THIS...

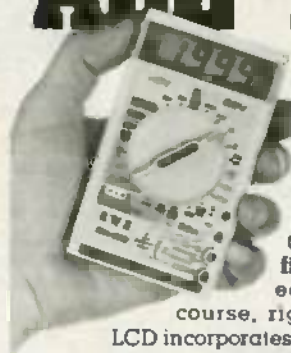

SMALLEST SIZE

Our new AWS Model DM-2000 is the smallest Rotary Switch DMM available today. (4.8" x 2.8" x 0.9". Wt. 7 oz.) Size was a prime consideration in the design of the DM-2000. Its compact size fits comfortably in one hand, easily in a toolkit, and of course, right in your pocket. Still, the LCD incorporates large 0.5" easy to read digits.

MORE FUNCTIONS The truly unique 3½ digit AWS DM-2000 is capable of reading 8 functions: • DC Volts • AC Volts • DC Current • Resistance • Conductance • Diode Test • HFE Test • Battery Test.

MORE RANGES The new AWS DM-2000 offers you an amazing 22 ranges! DC Volts: 200mV/2V/20V/200V/1000V. AC Volts: 200V/750V. DC Current: 200µA/2mA/20mA/200mA/10A. Resistance: 200Ω/2KΩ/20KΩ/200KΩ/2MΩ/20MΩ. Conductance: 2µS. Diode: 2KΩ. HFE Test: 0-1000. Battery Test: 2Vdc.

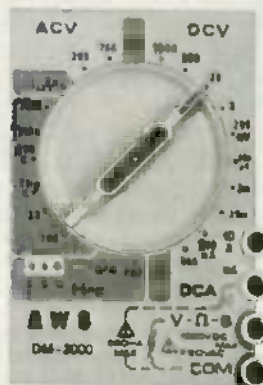

PLUS A.W. SPERRY INSTRUMENT QUALITY The AWS DM-2000 boasts 0.5% basic DC Volt accuracy and an "OFF" position, making it ideal for the professional engineer, technician or hobbyist. All ranges are overload protected. Special solid state protection on all resistance ranges protects the instrument and end-user up to 250Vac/dc without blowing the fuse.

FOR JUST \$54.95!

So put the new AWS DM-2000 to work for you now. Call your local distributor or contact A.W. Sperry Instruments Inc., P.O. Box 9300, Smithtown, NY 11787, 800-645-5398 Toll Free (N.Y., Hawaii, Alaska call collect 516-231-7050).

A.W. SPERRY INSTRUMENTS INC.
The Measurable Advantage.

CIRCLE 50 ON FREE INFORMATION CARD

MARCH 1985

83

100 JOB OFFERS?

A COMPLETE LIST of HI TECH companies compiled by executive with inside knowledge of companies on the move. Updated monthly listing contains employers located in California's famous Silicon Valley. Only \$5.00 - "CAREER 1", P.O. BOX 221, SUNNYVALE, CA. 94086.

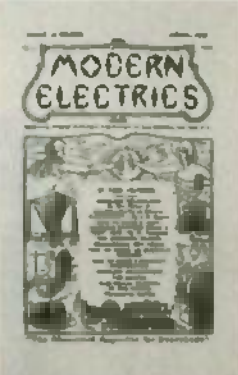

MODERN ELECTRICS. Miniature souvenir of the first publication ever produced by Gemback Publications. This issue appeared in April 1908—just 75 years ago. You can own your own reprint of this unique first edition for just \$2.50 plus 75c P&H. It's available from R-E BOOKSTORE, Radio-Electronics, 200 Park Avenue South, New York, NY 10003

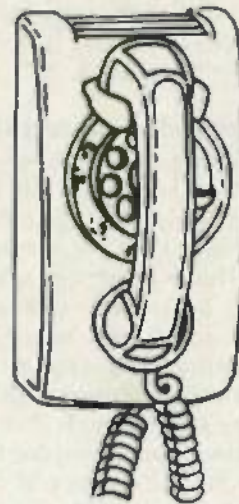

CALL NOW AND RESERVE YOUR SPACE

- 6 x rate \$650 per each insertion.
- Reaches 225,016 readers.
- Fast reader service cycle.
- Short lead time for the placement of ads.
- We typeset and layout the ad at no additional charge.

Call 212-777-6400 to reserve space. Ask for Arline Fishman. Limited number of pages available. Mail materials to: mini-ADS, RADIO-ELECTRONICS, 200 Park Ave. South, New York, NY 10003.



FREE CATALOG OF HARD-TO-FIND TOOLS is packed with more than 2000 quality items. Your single source for precision tools used by electronic technicians, engineers, instrument mechanics, schools, laboratories and government agencies. Also contains Jensen's line of more than 40 tool kits. Send for your free copy today! **JENSEN TOOLS INC.**, 7815 46th St., Phoenix, AZ 85040. (602) 968-6231.

CIRCLE 115 ON FREE INFORMATION CARD

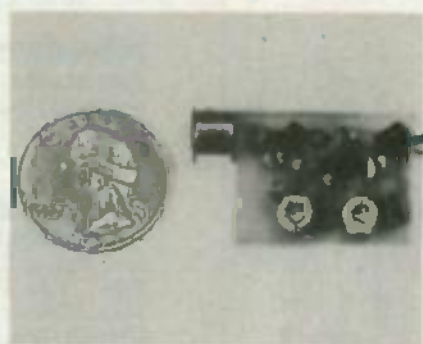

THE MOST EXCITING KIT YOU WILL EVER BUILD The model WAT-50 miniature FM transmitter uses a 4-stage circuit NOT to be confused with a simple wireless microphone. Up to 1 mile range. So sensitive, it will pick-up a whisper 50 feet away! Use with any FM radio. Complete kit only \$29.95 tax incl. **FREE SHIPPING. DECO INDUSTRIES, BOX 607, BEDFORD HILLS, NY 10507.**

CIRCLE 282 ON FREE INFORMATION CARD



TIMEX SINCLAIR 1000, 1500, 2068, ZX81. SPECTRUM Hardware & Software for all computers: **PRTR I/F**—A Centronics parallel printer interface. Order **PRTIF** \$50 **EPROMER**—Programs 2716, 2732, 2764's Order **EPRMR**: \$75. **ASM DSM**—A full featured assembler/disassembler. Order **ASMSM**: \$40. **TEXTEDIT**—A very complete editor, including 64-column mode. Order **EDIT** \$40. When ordering, specify type of computer. Cash, check, or C.O.D. only. Send to: **RESEARCH SERVICE LABORATORIES, P.O. Box 19124, OKC, OK 73144.**

CIRCLE 278 ON FREE INFORMATION CARD



SATELLITE CONTROL CABLE—NEMAL ELECTRONICS has designed a new series of combination cables for TVRO installations. These cables provide all necessary wires for signal, motor and receiver power and sense circuits together in one direct burial jacket. **TYPE-1 RG-59 + 9 conductor (2-18gu) \$495/1000'**. **TYPE-2 RG-59 + 11 conductor (2-12gu) \$689/1000'**. **TYPE-3 dual RG-59 + 11 conductor (2-12gu) \$879/1000'**, all made with milspec RG59, 96% copper shield, lined drain wires. Over 500 types of cable, connectors. **SMATV** products in stock. Authorized distributor **Kings-Amphenol-Columbia, NEMAL ELECTRONICS Inc.**, 12240 N.E. 14th Ave., N. Miami, FL 33161 (305) 893-3924.

CIRCLE 268 ON FREE INFORMATION CARD



ELECTRO IMPORTING CO. CATALOG. This reprint of the historic 176-page catalog No. 20 gives you an accurate look at the state of electronics in 1918. Contains everything from a Zinc Spark Gap to a 1000-Mile Receiving Outfit. You can get your own copy of this modern antique, profusely illustrated, for only \$4.95 plus \$1.00 P&H. Order yours from **R-E BOOKSTORE, Radio-Electronics, 200 Park Avenue South, New York, NY 10003.**

Radio-Electronics mini-ADS



CALIFORNIA-DC REGULATED SWITCHING POWER SUPPLY +5v dc @ 5 amp + 12v dc @ 2.8 amp + 12v dc @ 2 amp - 12v dc @ .5 amp 115-230v ac input, fused, EMI filtered. Removable DC Power Harness and Schematics included, 7.4" x 8.2" x 1.7" ht. Visa/MC/M.O./check; when clears. \$37.50 ea. (Free shipping in U.S.) 1-800-327-7182/305-830-8886. **POWER PLUS**, 130 Baywood Ave., Longwood, FL 32750. (Call for quantity price).

CIRCLE 125 ON FREE INFORMATION CARD

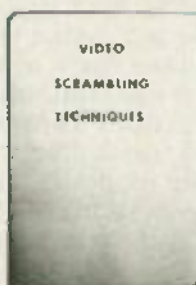

SUBSCRIPTION TV MANUAL. This information packed book details the methods used by subscription TV companies to scramble and descramble video signals. Covers the Sinewave, Gated Pulse, SSAVI system, and the methods used by most cable companies. Includes circuit schematics, theory, and trouble shooting hints. Only \$12.95 plus \$2.00 first class P&H. **ELEPHANT ELECTRONICS INC.** (formerly Random Access) Box 41770-R, Phoenix, AZ 85080.

CIRCLE 120 ON FREE INFORMATION CARD



FREE 1984 ELECTRONIC TOOL & INSTRUMENT CATALOG is packed with over 5,000 quality technical products for assembling, testing and repairing electronic equipment. All products fully illustrated with photographs, detailed descriptions and pricing to allow for easy ordering by phone or mail. Most orders are shipped within 24 hours. 100% satisfaction guarantee. **CONTACT EAST**, 7 Cypress Drive, Burlington, MA 01803. (617)272-5051.

CIRCLE 55 ON FREE INFORMATION CARD

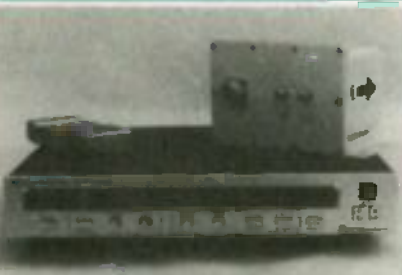

SATELLITE TELEVISION RECEIVER SEMIKIT with dual conversion downconverter. Features infrared remote control tuning, AFC, SAW filter, RF or video output, stereo output, Polarator controls. LED channel & tuning indicators. Install six factory assembled circuit boards to complete. **Semikit \$400.00.** Completed downconverter add \$100. Completed receiver and downconverter add \$150. **JAMES WALTER SATELLITE RECEIVER**, 2697 Nickel, San Pablo, CA 94806. Tel 415-724-0587.

CIRCLE 124 ON FREE INFORMATION CARD

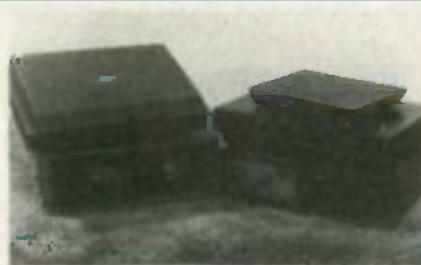

ZENITH SSAVI DESCRABLERS only \$169; **GATED PULSE & SINEWAVE** decoders \$199 each. Original equipment for UHF chs. 23,27,31,51,54,57,68, etc. Quantity discounts. Surplus Cable TV equipment: Jerrold SB-3, Oak N-12, Zenith Z-Tac, Hamlin 1400, etc. Complete Satellite Systems at \$845 and up; Installation and program guide, \$3. Dealers welcomed. Catalog \$1. Visa/MasterCard. Satisfaction guaranteed. **AIS SATELLITE**, P.O. Box 1226-E, Dublin, PA 18917. 1-800-643-2001 or 215-249-9411.

CIRCLE 267 ON FREE INFORMATION CARD



RS232C VOLTMETER FOR PC's. 8 channel, 4 1/2 digit AC/DC voltmeter, **SENSATROL** talks your computer's language. Sensors hook up easily to differential inputs providing ± 20000 steps of 100µV. Includes seven binary control outputs. Uses simple PRINT and INPUT with BASIC. Manual gets amateurs started. \$385. **DATA WORLD PRODUCTS**, BOX 33, FRANCETOWN, NH 03043 (603) 588-3746.

CIRCLE 257 ON FREE INFORMATION CARD

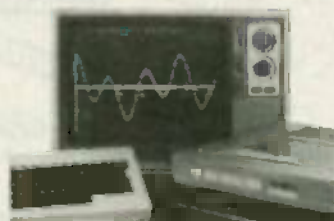

CONVERT YOUR T.V. to a High Quality Monitor/Receiver...The TRVM kit permits Dual Mode operation on transformer isolated B&W or Color Sets • Features High Resolution Direct Video • Up to 80 characters per line • Wide Bandwidth • Easy installation • Low cost...\$34.95...DVM-1 kit with Audio available for "Hot Chassis" sets...\$64.95. Both kits usable with computers, VCR's and Video Cameras **VAMP INC.** Box 411 Los Angeles, California 90028 (213) 466-5533

CIRCLE 255 ON FREE INFORMATION CARD



MONITORING DEVICE. The Listener—Plugs into any modular phone jack. You activate an ultra-sensitive microphone from anywhere in the world. Only \$115.95. Never get out of your chair again. The LCC-58 turns any television with cable into a wireless remote control paradise. Only \$109.95. Unbelievable VHF/UHF/FM television reception from our 24dB amplifier. A must for stabilizing descrambler units. Only \$24.95. **HOWARD RESEARCH AND DESIGN**, P.O. Box 204, Eillicott City, MD 21043. 301-465-8116.

CIRCLE 281 ON FREE INFORMATION CARD



APPLIANCE REPAIR HANDBOOKS—13 volumes by service experts; easy-to-understand diagrams, illustrations. For major appliances (air conditioners, refrigerators, washers, dryers, microwaves, etc.), elec. housewares, personal-care appliances. Basics of solid state, setting up shop, test instruments. \$2.65 to \$5.90 each. Free brochure. **APPLIANCE SERVICE**, PO Box 789, Lombard, IL 60148. 1-(312) 932-9550.

CIRCLE 84 ON FREE INFORMATION CARD

avoid that problem, baud rates for single-wire circuits are generally limited to 1200 baud. For a faster transmission rate, we would use separate send and receive circuits—but that is beyond the scope of this article, so let's stick to the dial-up telephone system and 1200-baud maximum.

If there is a transmission delay when using a terminal, there's nothing you can do as the terminal operator. You must put up with the "gibberish" displayed on your ter-

iminal, unless you can send a code to the other computer to shut off its return echo. But if you're using a computer as a "smart terminal" (which is more likely in this day and age), it's possible that your communications software can overcome a transit delay.

To handle moderate delays at normal transmission rates (300 and 1200 baud), some communications software will not transmit a character until it receives an echo for the previous character. That's

all it takes to accommodate a transit delay—just wait until the echo is received.

There is, however, another problem—dual echo—a phenomenon that's caused when the computers at each end of the circuit are generating a return echo. Neither would be able to distinguish between the echo and the transmitted signal.

To further explain, let's again assume that the originating computer transmits a letter "Z," which is picked up at the other end by the receiving computer. The receiving unit would then send a conformation (echoing the letter "Z") back to the sending unit. When the sending computer receives the echo, it assumes that that signal is (not an echo but) a transmitted character and echos its conformation, causing a feedback loop.

The single character "Z" would bounce back and force between the two units filling their screens with "Z's." (In other words, the first operator could press just one

Are you buying too much instrument? Or too little!

Here at Global, we believe that users of benchtop instruments have often been faced with the decision of either buying an expensive array of test equipment that far exceeds their needs or purchasing instruments which may not meet the specifications. Our solution? Families of precision benchtop and portable instruments that include advanced features and performance, human-engineered operation, and consistently superior quality at affordable prices.

Global packages these capabilities without those expensive cosmetics or redundant features which contribute to price but not to performance or flexibility. Our instrument line includes Function Generators, Frequency Counters, Pulse Generators, Frequency Standard, Digital Capacitance Meters, Scope Multiplier, Power Supplies, and more.



Want to dig deeper into Global Instruments? Contact your local distributor today or call our Customer Service Department: 1-800-572-1028.

The Global line includes (clockwise from top) the LM-4 Logic Monitor, Model 3000 Digital Cap Meter, 4001 Pulse Generator, and 6002 Frequency Counter.



GLOBAL SPECIALTIES

An Interplex Electronics Company

70 Fulton Terrace, New Haven, CT 06512-1819
(203) 624-3103 TWX: 710-465-1227
Europe: Phone Selkon-Walden, England 0799-21682; TLU: 817477.

CIRCLE 62 ON FREE INFORMATION CARD

SUPER LONG PLAY TAPE RECORDERS

10 Hour Model — \$95.00*
14 Hour Model — \$159.00*

Modified Panasonic Slimline, high quality, AC-DC Recorders provide 5 or 7 continuous hours of quality recording & playback on each side of cassette for a total of 10 or 14 hours depending on model. Built-in features include • Voice level control. • Digital counter. etc. TDK DC 180 Cassette Furnished



PHONE RECORDING ADAPTER

Records calls automatically. All Solid state connects to your telephone jack and tape recorder. Starts recording when phone is lifted. Stops when you hang up. \$24.50*



VOX VOICE ACTIVATED CONTROL SWITCH

Solid state. Self contained. Adjustable sensitivity. Voices or other sounds automatically activate and control recorder. Uses either recorder or remote mike. \$24.95*



*Add for ship & hold. Phone Adapter & Vox \$1.50 ea. Recorders \$4.00 ea. Cal. Res. add tax. Mail order, VISA, M/C, COD's OK. Money Back Guarantee. Qty. disc. avail. Dealer inquiries invited. Free data. AMC SALES INC. Dept. A 9335 Lubec St., Box 928, Downey, CA 90421 (213) 868-8519

CIRCLE 108 ON FREE INFORMATION CARD

key and watch the screen fill with "Z's.")

Half duplex

To avoid the problem of return-echo delay, or dual-echo bounce back, we can use what is called "half duplex." Figure 2-b shows that the terminal's keyboard is connected to the display, so the display reproduces whatever is input for transmission. There are no connections between the modem and the display: The modem transmits only to the computer on the opposite end of the dial-up circuit. Whether the computer echoes or not makes no difference since the originating computer does not display the return echo.

Normally, it's difficult to muck up half-duplex when only a terminal is involved. It's when we use a computer as a "smart terminal" that things can get sticky (as when the software isn't well thought out). Using "half duplex" should automatically disable reception of the echo; however, that isn't the case with all communications software.

If the computer can operate in half-duplex—showing all characters entered on the keyboard—and still display the echo, everything will be displayed twice on the screen. For instance, the word "ZAP" would be displayed as "ZZAAPP."

When that happens the software author usually avoids lock-up and continuous looping by somehow disabling the return echo, even though the screen is displaying the characters twice. Quite frankly, he either has no understanding of half-duplex, or has simply screwed up (which is more likely).

The general rule for half-duplex is that if you're having problems, such as your screen displaying every character twice, turn off the half duplex because you're receiving an echo. If the screen is in a continuous loop and only one character is repeating, either you or the other end (not both) must turn off the computer echo. Though both computers can operate individually in half-duplex, that's not usually recommended because then there is no check (of any kind) on the status of the computer-to-computer link. R-E

Now we can detect a breast cancer smaller than this dot.

At such an early stage, your chances of living a long, healthy life are excellent. But we need your help. The only proven way to detect a cancer this small is with a mammogram. A mammogram is a low-radiation x-ray of the breast capable of detecting a cancer long before a lump can be felt. If you're over 50, a mammogram is recommended every year. If you're between 40 and 50, or have a family history of breast cancer, consult your doctor. In addition, of course, continue your regular self-examinations.

American Cancer Society

HAMEG® Oscilloscopes

For Field Service and Laboratory

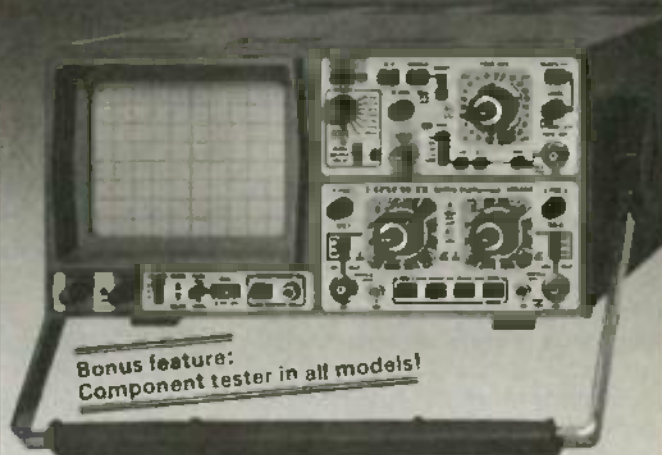

HM605 60MHz Dual Trace · US\$ 965,-

Sensitivity 5mV-20V/div at 60MHz, 1mV at 5MHz • Automatic peak-value or normal triggering to 80MHz • Delay line • Variable sweep delay from 100ns-1s • Timebase range from 2.5s/div to max. 5ns/div • Unique fast-rise-time 1kHz/1MHz calibrator • Bright high-resolution 14kV CRT.

HM204 20MHz Dual Trace · US\$ 758,-

Sensitivity 5mV-20V/div • 1mV at 5MHz • Timebase range 1.25s/div-10ns/div • Automatic peak-value triggering to 50MHz • Delay line • Variable sweep delay • Single sweep mode • Y-Output • Z-modulation • Overscan indicator • Unique 1kHz/1MHz calibrator.

HM203 20MHz Dual Trace · US\$ 605,-

Western Europe's best selling 20MHz Scope! • Sensitivity 2mV-20V/div • Triggerbandwidth 40MHz • Timebase range 0.2s - max. 20ns/div

HM103 10MHz Single Trace · US\$ 410,-

Small, compact service scope • Sensitivity 2mV-20V/div • Timebase range 0.2µs-0.2s/div • TV-V and TV-H triggering.

Modular System HM 8000

An expanding
range of
signal generators,
multimeters,
counter-timers,
etc.

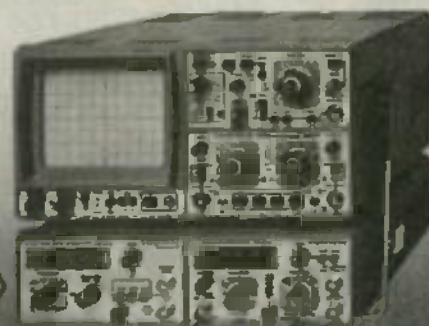

For more details
write or call collect:

HAMEG, INC.

88-90 Harbor Road · Port Washington N.Y. 11050
Phone (516) 883.3837 · TWX (510) 223.0889

DRAWING BOARD



ROBERT GROSSBLATT

Designing with memory IC's

EVERYONE KNOWS THAT THERE'S A world of difference between theory and practice in electronics. As we've seen time and time again, what works perfectly well on paper tends to blow up perfectly well on the breadboard. I can't tell you how many times I've helplessly sat back and watched acres of silicon "real estate" go up in smoke at the speed of light!

One way to avoid blowing up expensive or even inexpensive components is to be really familiar with the eccentricities of the device. That applies to everything in your design and not only IC's. Switches, relays, batteries, and even lowly resistors have operat-

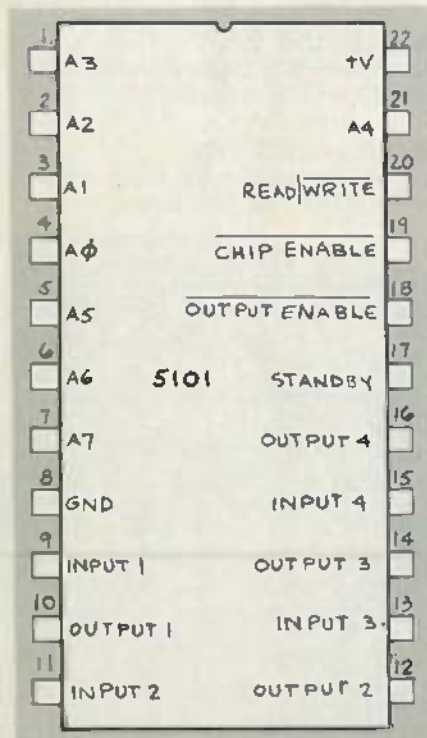

FIG. 1

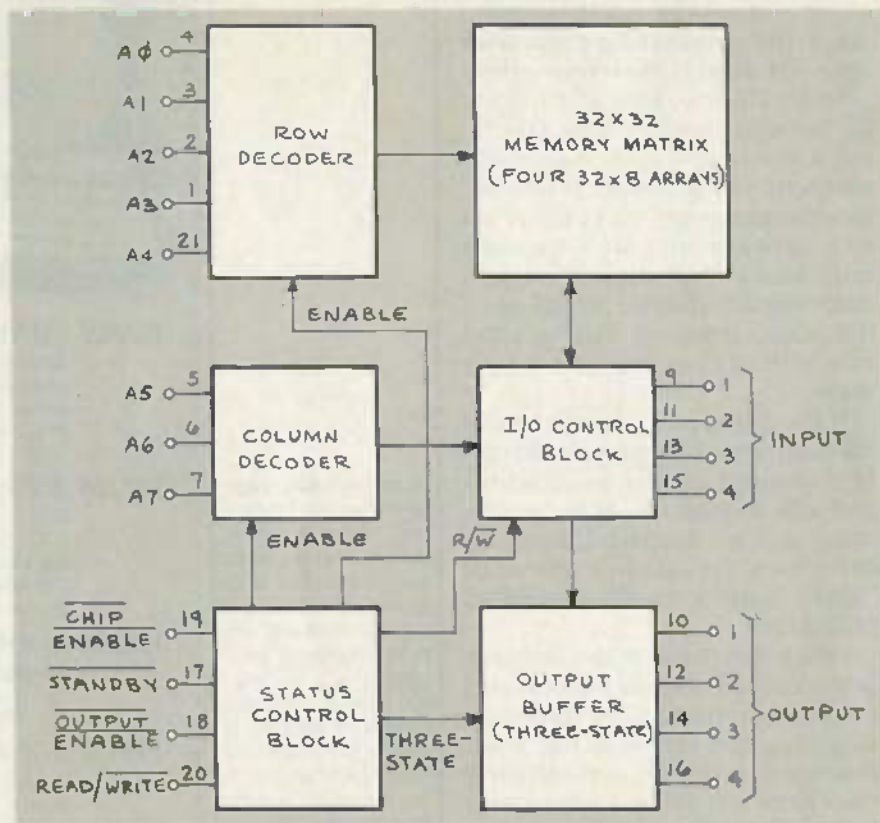

FIG. 2

ing peculiarities that can screw things up under what would seem to be the most ordinary of circumstances. Therefore, it is best to know a little something about a component before you begin using it.

The best way to learn about any electronic component is to pick up a few and do a little experimenting, or build a demonstration circuit. Nowhere is that more true than when designing memory-based circuits. Using a demonstration circuit lets you learn to safely use a particular memory, and see what requirements have to be kept

in mind for its use in general.

Now, there's no single circuit you can design that will teach you everything about all types of memory. And even if we limit our discussion to RAM, we'll find that looking at one type won't teach us everything we need to know. (We've already seen that there's a big difference between the *static* and *dynamic* types.) So that you may become familiar with the fundamentals, let's start off with *static* RAM. When we're done, we'll see that only a few additions and changes have to be made to accommodate *dynamic* RAM.

COMPUTER DIGEST

VOL. 2 No. 3 March 1985

NEW KIND OF MAGAZINE FOR ELECTRONICS PROFESSIONALS

PUT AN END TO YOUR RS-232 INTERFACING PROBLEMS

Smart Cable lets you connect your peripherals without thinking twice

TURN YOUR IBM-PC INTO AN APPLE COMPUTER

Run Apple programs on your IBM-PC with Quadlink plug-in board.



A
GERNSBACK
PUBLICATION

MACHINE CODE DEVELOPMENT SYSTEM

Build this add-on and put your Timex/Sinclair ZX81 computer to work as a development system and an EPROM programmer and emulator.

What's New at AMERICAN DESIGN COMPONENTS?

"The Source" of electro-mechanical components for the hobbyist.

Warehouse 60,000 items at American Design Components—expensive, often hard-to-find components for sale at a fraction of their original cost! You'll find every part you need—either brand new, or removed from equipment (RFE) in excellent condition. But quantities are limited. Order from this ad, or visit our retail showroom and find exactly what you need from the thousands of items on display. Open Mon.-Sat., 9-5.

A. APPLE 2c DISC DRIVE



Original equipment drive, compatible with Apple 2e, 2+, and 2c.
\$139.50 RFE

B. 115 CFM MUFFIN FAN



Metal frame with 5 high impact plastic blades. For cooling HiFi, electronic equipment, computers, etc. Mounts for intake or exhaust. 115 VAC, 60Hz. Dim: 4 1/4" x 1 1/2" D.
\$7.95 RFE

C. 150 CFM SUPER MUFFIN FAN



Upgrade your computer with this larger, super quiet, 5 aluminum ball bearing blade fan. Slightly larger, but mounts in same holes as regular Muffin. 115 VAC, 50/60 Hz. Torin TA500PSC.
\$19.95 NEW

INTEGRATED CIRCUITS

To order, please list on separate sheet of paper and attach to coupon

Description	Price
Microprocessor	
COP402N	\$ 4.80
64C10N	5.00
6800	2.60
68A09P	3.50
MCM6810P	.80
68A21P	1.25
68A45	3.75
SY6821A/SY68021	1.75
IPC16A-5200	9.00
D780C	2.50
P6066	12.00
P8216N	1.25
INS8250AN	6.00
8253-5	4.50
8255A	4.50
P-8255A-5	4.50
8256A	3.25
8279-5	4.50
C8751H	125.00
MB6877AP-8	20.00
Memory	
2102L2PC	\$ 1.00
SY2128-4	3.50
2148	3.50
2167	14.00
2764	5.50
2716	2.60
TMS4116	.90
4164-15	4.00
IM65X51UF	3.75
HM3-6518B-9	2.00
N82S417N	5.00

5 1/4" TANDON DISC DRIVES

IBM Compatible

1/2 Ht.

D. TM55-2 DS/DD \$179.00

Full Ht.

E. TM100-1 SS/DD 99.50
F. TM100-2 DS/DD 159.00

Other 5 1/4" R.C. Drives

1/2 Ht.

G. TM55-4 DS/Quad \$179.00
H. TM100-4 DS/Quad 179.00
J. TM101-4 DS/Quad 199.00

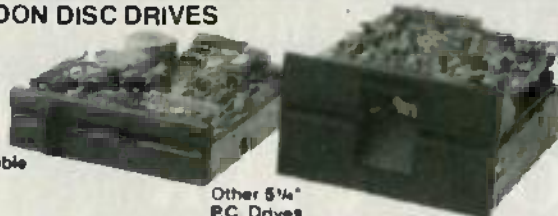

K. 48 KEY KEYBOARD



Replace the membrane keyboard on your Times/Sinclair Z-81/1000 with this brand new "big computer" keyboard from Texas Instruments. Simple to install—complete instructions and schematic included.
\$5.95 NEW

COMPUTER DISC DRIVE SWITCHING POWER SUPPLIES



L. Input: 115 VAC
± 12V @ 1A
± 5V @ 8A
- 5V @ 1A
Dim: 9 1/2" x 7"
\$29.95 NEW

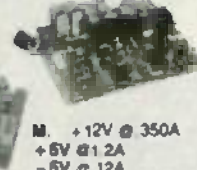

M. +12V @ 350A
+5V @ 1.2A
-5V @ .12A
Dim: 4 1/2" x 4 1/4"
Input: 115VAC when used with AC wall transformer (supplied)
\$6.95 NEW

N. CONSTANT VOLTAGE TRANSFORMER



Protect Your Computer. Harmonic neutralized 500 VA, provides 120V/60Hz continuously, with input variations as great as ± 15%. Input Voltage: 95-130 or 190-280 VAC, 60 Hz. (accepts either voltage).
Mfr. Sole. **\$99.00 NEW**

O. 19" COLOR X-Y DISPLAY



Originally designed for use in Atari coin-operated games. Contains a 19VLUP22 3-gun color tube, focus and brightness controls. Has electromagnetic deflection and solid state circuitry with three "Z" amp inputs (red, green, blue). Ideal for arcade replacement or, with the addition of external circuitry, for color graphics display. Manual included.
\$129.00 NEW

BLOWERS—POTENTIOMETERS—COUNTERS TIMERS—RELAYS—VOLTAGE REGULATORS—POWER SUPPLIES

P. EXPAND YOUR PC STORAGE CAPACITY



5 1/4" floppy disc drive. Self-contained power supply Plus matching disc drive controller. Originally used with TI home computer. Each unit tested and in working condition, but sold "as is"—no warranty.

While they last, **\$99.00** for both units

Q. 12V NICAD BATTERY BACK-UPS (RECHARGEABLE)

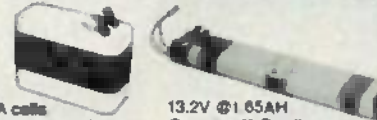

12V @ 450mA. Contains 10 AA cells. Recharge rate 45MA, 16-18 hours. Charge with lab output connections. Dim: 2 1/4" H x 1 1/4" x 2 1/4" L. Mfr. GE #123233 or equiv.
\$5.95 RFE

13.2V @ 1.65AH. Contains 11 C cells. Portable computer battery back up. Mfr. GE # 41B03JBB00101
\$15.95 RFE

R. AUDIO & VIDEO MODULATOR

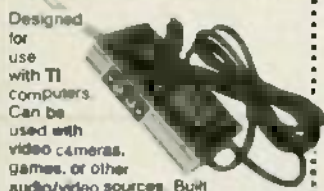

Designed for use with TI computers. Can be used with video cameras, games, or other audio/video sources. Built in A/B switch enables user to switch from TV antenna without disconnection. Channel 3 or 4 selection. Operates on 12VDC. Schematic included. IBM and Apple compatible. Mfr. TI #UM1381-1
\$7.95 NEW

AMERICAN DESIGN COMPONENTS, 62 JOSEPH STREET, MOONACHIE, N.J. 07074

YES! Please send me the following items:

A.B.C. etc.	How Many?	Description	Price	Total
Total				

FREE CATALOG of electro-mechanical devices sent with every order.

Shipping and handling, we ship UPS unless otherwise specified. Add \$3 plus 10% total. Canadian: \$3 plus R/P cost. Charge only. Sales Tax. (N.J. residents only, please add 6% of total)

ORDER TOTAL

My check or money order is enclosed.
 Charge my credit card
 Visa MasterCard

MINIMUM ORDER \$15.

RE-35

Card No. _____
Exp. Date _____
Signature _____
Telephone Area Code _____ Number _____
Name _____
Address _____
City _____
State _____ Zip _____

All inquiries and free catalog requests call 201-939-2710.

For all phone orders, call TOLL-FREE 800-524-0809. In New Jersey, 201-939-2710.

CONTENTS

Vol. 2 No. 3

March 1985

- 7 Turn your IBM-PC into an Apple Computer**
Run Apple programs on your IBM-PC with this new plug-in board from QUADRAM.
- 10 Smart Cable**
Here's how to end those interfacing problems forever. And you won't need a custom cable for each application.
- 13 Machine Code Development System, Part II**
Here are the finishing notes for this project, begun in January
- 15 Practice morse code with your computer**
You select the speed, and your computer transmits five-letter word groups.
- 4 Editorial**
- 5 Letters**
- 5 New Products**



See page 10.



See page 13.

ON THE COVER

If you've been looking jealously at some of the Apple software and wishing that your IBM-PC could handle some of it, look no longer! The *Quadlink* plug-in board lets your PC run Apple programs! See page 7.

COMPUTER DIGEST
THE NEW KIND OF MAGAZINE FOR ELECTRONICS PROFESSIONALS

PUT AN END TO YOUR RS-232 INTERFACING PROBLEMS
Smart Cable lets you connect your peripherals without thinking twice

TURN YOUR IBM-PC INTO AN APPLE COMPUTER
Run Apple programs on your IBM-PC with Quadlink plug-in board.



MACHINE CODE DEVELOPMENT SYSTEM
Build this add-on and put your Times Sinclair ZX81 computer to work as a development system and an EPROM programmer and emulator.

EDITORIAL

When all else fails, read the instructions.

■Your editor got his writing career started many, many years ago, working in the publications department of a major electronics equipment manufacturer. The hardest part of the job was getting people to read the instruction manuals.

Take the guy who sent his brand new transmitter back because it "smoked" when he turned it on. Obviously, this dude never read the section titled "Unpacking." The final amplifier tubes were still surrounded by cotton wadding, put there to protect them during shipment. It was still there, but now burned to a crisp. We told him to "tune for minimum smoke!"

In one case, we even had a jumper wire taped to the last page of the instructions, which, when properly installed alongside the AC input, would complete the primary circuit so the power could be turned on!

Take a careful look at the instruction manuals that come with your new computer equipment, and you'll see that the manufacturers go to great and costly lengths to make those instructions as palatable as they can. (At least some of them do!) They spot little fetching cartoons throughout the pages, copiously use photographs, add color where they can, and the writing is light and breezy, written to express, not to impress. They do whatever they can to make you read the instructions, and hopefully, read them in detail before you throw the big switch for the first time.

The fact of the matter is that by spending some time reading the instructions, you're going to save yourself a lot of time when you power up and go online. That little bit of familiarization can be of tremendous help and add to your previous knowledge.

It's a good idea to begin by unpacking the unit just enough to gain access to the instruction booklet and then stop. Take the book out, and go through it a few times until you know that piece of equipment like the back of your hand. Then and only then should you proceed with the unpacking and really make friends with the equipment you've spent your bucks for.

You'll probably save a small fortune in telephone calls to the manufacturer's service department too.

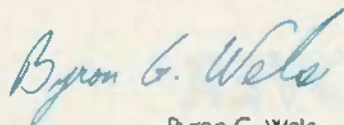

Byron G. Wels
Editor

ComputerDigest is published monthly as an insert in Radio-Electronics magazine by Gernsback Publications, Inc., 200 Park Avenue South, New York, NY 10003. Second-Class Postage Paid at New York, N.Y. and additional mailing offices. All rights reserved. Printed in U.S.A.

A stamped self-addressed envelope must accompany all submitted manuscripts and/or artwork or photographs if their return is desired should they be rejected. We disclaim any responsibility for the loss or damage of manuscripts and/or artwork or photographs while in our possession or otherwise.

COMPUTER DIGEST

Hugo Gernsback (1884-1967)

founder

M. Harvey Gernsback, editor-in-chief

Larry Steckler, CET, publisher

Art Kleiman, editorial director

Byron G. Wels, editor

Brian C. Fenton, technical editor

Carl Laron, associate editor

Robert A. Young, assistant editor

Ruby M. Yee, production manager

Robert A. W. Lowndes, production associate

Dianne Oslas, production assistant

Karen Tucker, production assistant

Jacqueline P. Weaver, circulation director

Arline R. Fishman,

advertising coordinator

Gernsback Publications, Inc.

200 Park Ave. South
New York, NY 10003

Chairman of the Board:

M. Harvey Gernsback
President: Larry Steckler

ADVERTISING SALES 212-777-6400

Larry Steckler

Publisher

EAST/SOUTHEAST

Stanley Levitan

Radio-Electronics

200 Park Ave. South

New York, NY 10003

212-777-6400

MIDWEST/Texas/Arkansas/Okla.

Ralph Bergen

Radio-Electronics

540 Frontage Road—Suite 325

Northfield, Illinois 60093

312-446-1444

PACIFIC COAST

Mountain States

Marvin Green

Radio-Electronics

15335 Morrison St., Suite 227,

Sherman Oaks, CA 91403

818-986-2001

LETTERS

ZX81's OK!

I am a long-time admirer of the enthusiastic and talented work of those who contribute to putting **Radio-Electronics** in my mailbox each month. More recently, I have added the people who put together **ComputerDigest** to that category of "good company."

With that truthfully said, and with the hope that the truth will not only set one free, but get the recipient to the next paragraph, I would like to offer a comment or two to Mark Latham's comments contained in his worthwhile article, "Machine code Development System" in the January issue.

Mr. Latham commented in the second paragraph of his article that the lack of speed (in loading and running programs) really prevents the ZX81 and/or the Timex Sinclair 1000 from serving any useful purpose.

First, may I say that he and I are, apparently, of one mind in our desire to find useful purposes for the ZX81. It seems to possess great speed and capability. We diverge though at the point of the program-running ability in terms of

speed.

The text characters being manipulated to produce them in acceptable written form and send them on to you are being done in BASIC and at a speed which is comparable with that which I can get on paper with the IBM in the closet; and with less effort.

Once "finalized", it goes to a Gemini printer at 4600 baud via a Byte-Back RS-232 Serial device; at a speed that is very fast.

I have a quarterly federal and state estimated tax program jammed within the perimeters of VU-CALC which allows me to perform that chore four times yearly in at least a twentieth of the time it would take me without it; and, from what I'm able to read, the expensive machines could not really do it substantially quicker.

I therefore find that the ZX81, despite the negative comments by both friends and non-friends, as to running speed, do not correspond to my own experience. Further, when one weighs the cost vs. utility factor, there simply is no contest for home use.

As to loading: The approximately 200-baud loading

speed is a tad slow for most programs. However, for a modest sum, fast loading programs and devices are available and in constant use by many of us who spend much time at the ZX81.

Recently, I was amazed to read, I think the article was by Mr. Friedman, in another publication, that it took him 72 seconds to disk-load CP/M to, I presume, one of those more costly machines. Honestly, and excuse my naivete, from the many, many articles I had read to that time, I believed that a "slow" disc loading took 10 seconds while the fast one probably took 5 seconds.

My "amazement" changed rather quickly to smugness as I realized that I have been loading three-16 programs back-to-back, accessible to each other and run-able (48K's worth) in 76 seconds flat (and that's with a \$23.00 cassette recorder and an under-\$1.00 data cassette tape).

In conclusion, I wish to say that the ZX81 is not as slow running as many say and for one-one-hundredth the cost of a disc drive, is not slow loading either.
J.E. JUERGENS, *Pacifica, CA* ◀◀▶▶

COMPUTER PRODUCTS

For more details use the free information card inside the back cover

FIVE-SLOT EXPANSION INTERFACE, the **CARDBOARD/5**, is designed for the Commodore 64. It allows the user greater flexibility to switch-select any cartridge slot or combination of cartridge slots. Twenty-two LED's are used to give status indication. Each slot has four LED's and two toggle switches for indication and control.

The different-colored LED's indicate the status (on/off) that the cartridge in that slot is requesting on the XROM and GAMERON LINES. The user has the choice of honoring that request by turning on one of the toggle switches; when the green LED is lit, that shows

that the request is being honored. Two master amber LED's are at the rear of the board, and will show the cumulative status of all the slots selected. The second toggle switch at

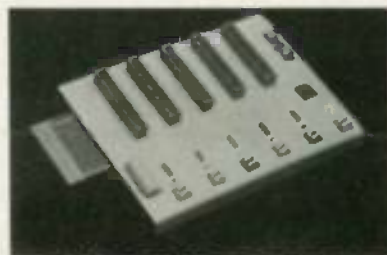

CIRCLE 21 ON FREE INFORMATION CARD

each slot enables the power to reach the cartridge, and the fourth LED (red) indicates power-on condition. The user can supply power to a cartridge without allowing it to auto-start or to affect other operations. In addition, there are two master toggle switches that allow the user to manually override any situation and set the lines as desired.

The **CARDBOARD/5** is priced at \$79.95.—**Cardco, Inc.**, 313 Mathewson, Wichita, KA 67214.

THE GRAMMAR EXAMINER is an educational journalism game designed to

help kids ages 10-14 improve their basic grammar skills. The player starts by landing a job as a cub reporter with *The Grammar Examiner* newspaper. Editing copy and answering questions pay off as the junior reporter earns promotions and moves his way to the top spot on the masthead.



CIRCLE 22 ON FREE INFORMATION CARD

To edit copy, the reporter moves the cursor through the given paragraph, stopping to revise faulty punctuation and incorrect words. The computer either approves the entire amended text or flashes the proper answer where mistakes were made.

The Grammar Examiner has a suggested retail price of \$44.95.—**DesignWare**, 185 Berry Street, San Francisco, CA 94107.

UTILITY PROGRAM, *EasyDisk*, simplifies the disk-operating system of the *Commodore 1541*. It enhances and extends that system by providing features that allow users to back up disks, print both program and sequential files, and display them on the screen. The program, which is accessed by a

EASYDISK

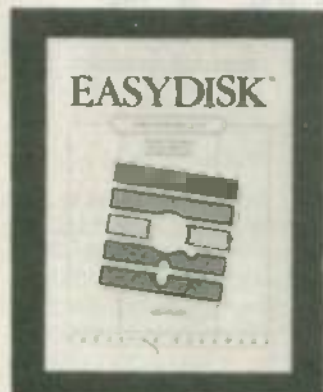

CIRCLE 23 ON FREE INFORMATION CARD

keystroke, does not interfere with the normal operation of the computer.

EasyDisk is currently available for the *Commodore 64* at a retail price of \$29.95.—**Creative Software**, 230 East Caribbean Drive, Sunnyvale, CA 94089.

ENU SYSTEM, the *Magic Menu*, enables users of IBM XT, IBM PC, and PC-compatible computers to move



CIRCLE 24 ON FREE INFORMATION CARD

from a word-processing program to a spreadsheet program to a payroll program without dealing with DOS or consulting manual. *Magic Menu* interfaces between the user and the DOS (version 2.0 or later) and allows any application with just a few keystrokes.

Sequence screens allow automatic execution of a series of menu entries, while password security can be provided for any and all applications. *Magic Menu* also provides automatic screen blanking, dynamic variables for customizing general entries, speed entries for advanced users, and a host of other features. It is priced at under \$100.00.—**DeereSoft, Inc.**, PO Box 1360, Melbourne, FL 32901.

ADAPTABLE CABLE, the Data Spec *Easy Match*, is a cable assembly kit for microcomputer use. The shielded-cable assembly kit includes a 6' or 12'



CIRCLE 25 ON FREE INFORMATION CARD

color-coded, 9-conductor shielded cable with pins attached to the conductors. Those pins can be inserted into any location in the connector block, with the aid of a special tool. The tool is included with the kit, and can also be used to remove the pins for reconfiguration.

The kit contains two 3-pin jumper leads for handshaking and other purposes, plus Data Spec hood assemblies, which feature clamp-style strain relief.

The kit comes in either 6' or 12' lengths, in male/male (model ARU-

MM-6) or male/female (model ARU-MF-6). List price of the 6' kit in model ARU-MM-6 is \$22.95 and for model ARU-MF-6 is \$23.95.—**Data Spec**, Alliance Research Corporation, 18215 Parthenia St., Northridge, CA 91325.

MUPPET LEARNING KEYS, is a computer keyboard that helps children aged three and up learn letters, numbers, and colors with the Muppets.

The keyboard simulates the contents of a child's school desk—ruler, watercolor set, penmanship slate, compass, and arithmetic exercise book. There is even a comic book on the desk to provide key commands for the programs. Kermit the Frog, Miss Piggy, Gonzo, and Fozzie Bear provide friendly and humorous instruction.



CIRCLE 27 ON FREE INFORMATION CARD

Muppet Learning Keys has a price of \$79.95.—**Koala Technologies Corp.**, 3100 Patrick Henry Drive, Santa Clara, CA 95052-8100.

COLOR-DISPLAY MONITOR, the Sakata model SC-100, is compatible with Apple II, Apple III, Commodore-



CIRCLE 26 ON FREE INFORMATION CARD

64, or VIC-20, NEC-PC, Atari-800, and other personal computers. The model SC-100, has a 13" CRT with a 0.65mm dot pitch, and accepts composite video signals. It is designed for the home, at school, or in any business.

The model SC-100 is priced at \$329.00.—**Sakata USA Corporation**, 651 Bonnie Lane, Elk Grove Village, IL 60007A ◀▶

TURN YOUR IBM-PC INTO AN APPLE COMPUTER

Now you get two from one
—A bargain in any man's language!

HERB FRIEDMAN

■The term *obsolete* has really taken on a new meaning when applied to personal computers. For anything else it can mean a product that hasn't all the modern bells and whistles but is still usable. For personal computing, the popular press has made *obsolete* synonymous with *unusable*.

The concept is incorrect. The software might be obsolete in the sense that it won't run properly on some of the newer computer models, but it will certainly work on the computer it was designed for. The spreadsheet will still function as a spreadsheet, the word processor will still function as it did before, and a database will still manage data, because software obsolescence is generally not a function of its features or performance, but of the non-compatibility of the hardware—the computer.

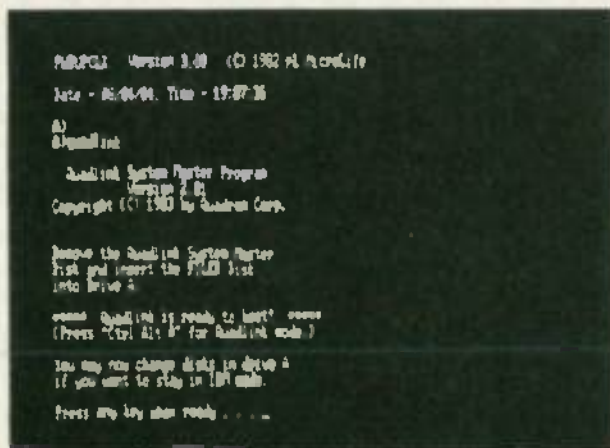

FIG. 2—A MASTER PROGRAM installs the Quadlink and gives fingertip toggle between the Apple and IBM PC modes.



FIG. 1—THE QUADLINK IS A COMPLETE COMPUTER SYSTEM with its own CPU, disk controller, and RAM. It takes up only one PC expansion slot.

Perhaps the greatest area of non-compatibility is that of the Apple and IBM computers. For many years Apple computers were the primary school and business computer. By some "expert's" count, there is more educational and business software available for Apple computers than for all others.

But the picture is changing rapidly. The IBM PC has become the de facto standard computer for business, and it is rapidly becoming the standard school computer since the PCjr was upgraded to run virtually all PC software.

Regardless of what is accepted as the new standard computer, the older machines do exist, along with a mountain of effective applications software that's not going to be scrapped. And let's not forget the weeks and months that went into learning how to maximize the performance of the older software; few users of personal computers have the money or time to do it all over again.

If you're caught in a software bind created by having added IBM PC's to an installed base of Apple computers, the answer to your software problems might very well be Quadram's (4355 International Blvd., Norcross, GA 30093) *Quadlink*, an Apple emulator for the IBM PC. That device allows a PC to function as an Apple computer (see Fig. 1).

The *Quadlink*, which takes up a single expansion slot in a PC or PC/XT, is essentially a complete computer that emulates an Apple. The board contains a 6502 CPU, 64K of RAM, and a disk controller. The *Quadlink* is essentially the complete guts of an Apple II+ computer. Switching loop-through circuits use the PC's disk drives, speaker, and color/graphics adapter for both PC and Apple operation. Simply touching a few keys toggles the PC between the IBM and Apple operating modes (see Fig. 2).

Yes, "toggle" is the correct word. Since the emulator has its own CPU and its own RAM, the user can actually run two programs in RAM at the same time—one in the IBM mode, the other in the Apple mode—and toggle back and forth while they are running.

The *Quadlink* provides full emulation of an Apple computer right down to the disk drives. Since one of the verities of personal computing is that non-identical disk formats aren't compatible, perhaps we should first look at how the *Quadlink* accommodates both the PC and the Apple disk formats on the same disk drive.

Disk conversion isn't much of a problem when two computers use the same kind of microprocessor. For example, much "conversion" software is available that allows a CP/M computer to run "foreign" software if it is transferred to a compatible disk format. If you can transfer the software from computer X to the disk format of computer Y, it will run on computer Y.

There is even a hardware device that will run non-compatible microprocessor software—in this instance CP/M on a PC computer—if the software is transferred to an IBM PC formatted disk. But only the *Quadlink* runs software for non-compatible microprocessors directly from the original disk because the user uses PC-formatted disks when the computer is in the PC mode, and Apple-formatted disks when the computer runs as an Apple. That is accomplished by a separate disk controller for the Apple emulation. When the PC is toggled for the Apple mode, the emulator switches the disk drives to the emulator's controller. As far as the emulator is concerned, the PC's disk drives are correct for the Apple format.

The design of a PC's disk drive however, puts limits on how far the Apple disk emulation can be carried. The *Quadlink* can only be used with software from the Apple II and Apple II+ computers, but not usually from the Apple IIe. The Apple IIe uses what is called half-stepped disk drives, meaning data or information—usually for copy protection—can be recorded between the usual track locations. Since the PC's disk drives were not designed to half-step they will not read half-stepped Apple IIe software. However, there is non-protected Apple IIe software that is not half-tracked, and such software can often run on the PC.

The *Quadlink* is furnished on a single printed-circuit board along with a disk containing the initializing software, a disk of Apple utility programs that also contains floating point (Applesoft) and integer BASIC, and three jumper cables; those are for sound, video, and the disk controller.

Installation of the *Quadlink* could not be easier, involving only the PC board itself and the three plug-in adapter cables. The board installs in a PC expansion slot, while the three cables simply plug into existing connectors. There is no alignment.

Because of the way the *Quadlink* must be connected to the IBM disk adapter (card), the first step is the relocation of the cable that connects the PC's disk adapter to the drives. The cable is disconnected from the IBM disk adapter and plugged into the *Quadlink*. The *Quadlink* adapter board is then installed in the PC's expansion slot that is immediately adjacent to the slot having the PC's disk adapter card. Then, a short cable from the *Quadlink* is plugged into the IBM disk adapter, completing the disk system loop-through. You use the specified PC slot not for electrical reasons, but because it's the only slot the adapter's cable will reach.

The sound is looped through the *Quadlink* by moving the speaker wire's connector from its mate—which is located on the PC's motherboard near the speaker—to a connector on the *Quadlink*. A short supplied jumper connects the *Quadlink* to the PC's original motherboard connection.

Finally, the video from the PC's color/graphics monitor adapter is looped through the *Quadlink* via a supplied jumper cable that connects the RGB connector on the back of the PC's color/graphics adapter to a matching

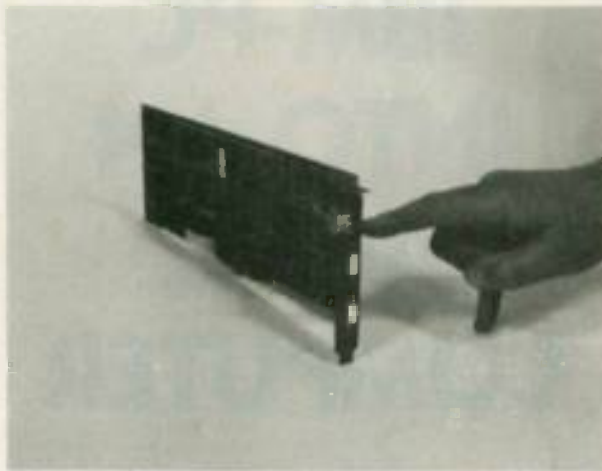

FIG. 3—FINGER POINTS to the *Quadlink*'s composite video output, which can be used for monochrome or composite color monitors. Note the two DB connectors below, which provide the PC loop-through and RGB color output.

connector on the *Quadlink*. The backplate of the *Quadlink* provides both an RGB monitor output, and a composite video output that can be used for either a monochrome or a composite color display (see Fig. 3).

Essentially, the *Quadlink* now serves as a switching center for the PC peripherals: Software determines whether the peripherals will be used by the PC or the Apple emulator.

The primary functional difference between a real Apple computer and the *Quadlink* emulator is the first 16K of memory. All 64K of *Quadlink*'s memory—including the first 16K—is RAM. In the Apple II and Apple II+ computers, only the memory from 16K to 64K is RAM; the first 16K is ROM, which contains integer or Applesoft BASIC (depending on the specific computer), the high-resolution graphic routines, and the monitor. (Apple DOS for the disk system loads into high memory.)

The *Quadlink* emulator does not use Apple's ROM. Instead, the *Quadlink* uses software to create an image of the Apple ROM in the first 16K of RAM, while DOS 3.3—which is supplied with the *Quadlink*—loads into high memory, again emulating the Apple.

Disk control is somewhat easier in the emulator than in a real Apple. Apple computers use a plug-in controller card that must be initialized. The *Quadlink* has the controller built in and functioning as "PR#6"—the "#6" slot in Apple computers.

The *Quadlink* emulates everything about a disk-equipped Apple except for the video display and sound.

Figure 4 shows how the disks, the sound, and the video are handled by the *Quadlink*. Both the sound and video are looped through the Apple emulator along with the PC's disk drives. The emulator switches their operation between the PC and the Apple emulator when the system is toggled. Note that RAM is

not toggled; the PC's RAM always functions as the PC's RAM, while the Quadlink emulator has its own RAM. Pressing the CTRL-ALT-A keys toggle the Apple mode and

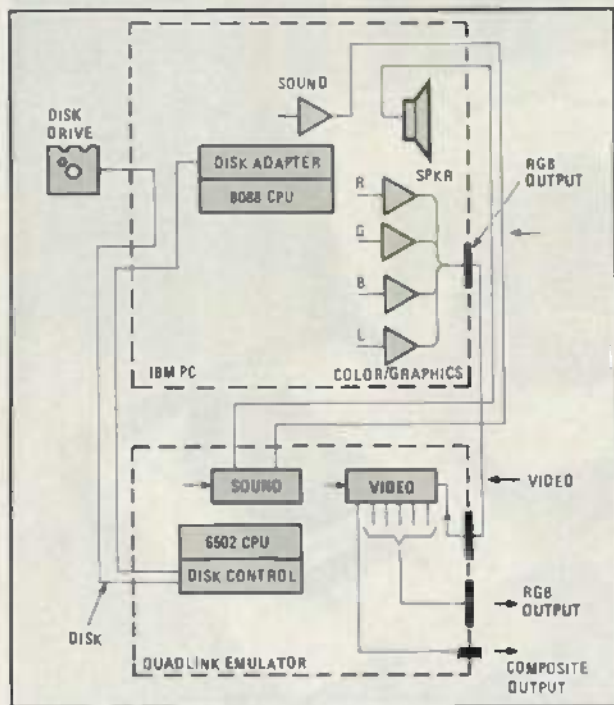

FIG. 4—THREE CABLES PROVIDED BY QUADRAM break into the PC's circuits to loop the disk, sound, and video display connections through the Quadlink. All connections are direct plug-in: There is no soldering or trace cutting. Remove the Quadlink, and the PC's connections can be automatically restored.

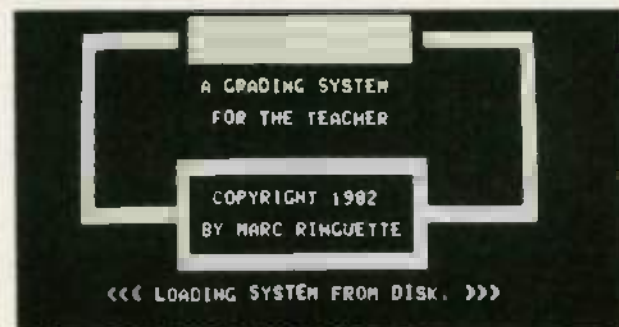

FIG. 5—NOTE THAT QUADLINK is in the process of auto-loading a school program.

the screen display actually resembles that of the Apple, right down to the screen prompt character (see Fig. 5). Pressing the CTRL-ALT-A keys toggle the PC mode, and the screen reverts to the standard PC display. Programs running in RAM keep running even when the function is toggled because—except for the sound, the video display, and the disk system—the computers are actually independent.

When the Quadlink is toggled for Apple emulation, the PC's disk drives function as Apple drives running under DOS 3.3. When the PC mode is toggled the drives revert to the IBM DOS. Switching between the two DOS systems is done by the emulator.

If the Apple software was originally self-booting it

will self-boot on the PC when the Apple mode is toggled because the PC-derived Apple works just like "the real thing." The Quadlink is supplied with an

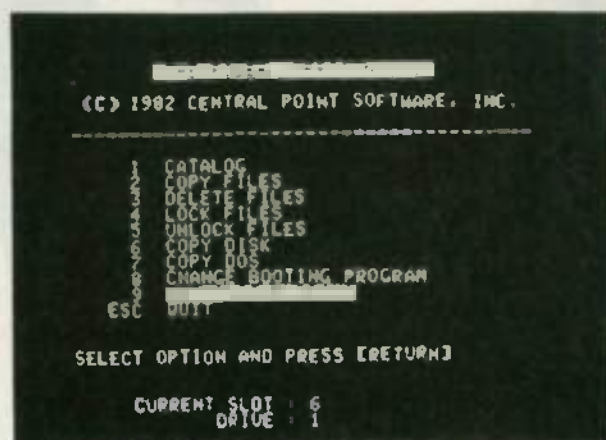

FIG. 6—THE SUPPLIED Filer program selects various Apple functions and utilities by cursor or number. Notice that the characters are more legible than those of the PC: The Quadlink has its own character generator.

Apple-licensed software package called *The Filer* (See Fig. 6), which contains DOS 3.3, Applesoft and integer BASIC, a disk system check, a disk speed check, a super-fast copy program, file utilities (Copy, Lock, Unlock), and a program called "Quadcopy" that copies ASCII text and binary files from Apple formatted disks to PC formatted disks and vice versa. While you, of course, cannot run an Apple binary file on the PC because the CPU's are incompatible, the ASCII text files are fully compatible; if you use the same word processor for both computers, the files can be exchanged between the two.

Since the Quadlink specifically emulates the Apple II+ computer, it is downward compatible and will run software from the Apple and Apple II computers. Software that is half-tracked or which uses the enhancements of the Apple IIe will not run; for example, the Apple II+ version of *VisiCalc* runs on the Quadlink; *VisiCalc* for the Apple IIe won't run. However, software written on an Apple IIe that does not use the IIe's enhancements will often run on the Quadlink (because without the enhancements, the IIe software is effectively II+). Copy-protected software that uses half-tracking won't run at all.

Quadram will provide a list of the Quadlink compatible software. If you're interested in specific commercial software, make sure you check with Quadram first. If the software is a program you developed yourself for school, business, or home use, it will most likely run on the Quadlink if the original computer was an Apple, Apple II, or Apple II+.

As far as we could determine from experimentation, the Quadlink runs as intended if the PC is equipped with IBM and/or Quadram expansion adapters. We had some unusual and inconsistent problems with some adapters from other sources: everything from disk emulators and serial I/O's simply failing to operate, or one adapter affecting another. We have no explanation except to say that no problems were encountered as long as all adapters were Quadram or IBM. ◀▶

S M A R T C A B L E



Here's how one manufacturer solves the RS-232 confusion!

MARC STERN

■How many times have you seen the words "RS-232-compatible" in personal-computer advertising or documentation? The RS-232 communications "standard" was formulated by the EIA (Electronic Industries Association) so that various peripheral devices could be interfaced compatibly.

In some ways, today's RS-232 standard bears little resemblance to the original standard drawn in the late 1960's. Yes, the signal lines and names are still the same. A DB-25 D-type connector is still used, but each computer manufacturer seems to use some of the lines and the connector for its own purposes.

For instance, according to the RS-232 standard, Line 4 is called Request To Send and Line 20 is Data Terminal Ready. (See Fig. 1 for a complete listing of the RS-232 signals.) Both of those lines are supposed to tell one device that another is ready to accept data. At the same time, Line 5 is Clear To Send and Line 6 is Data

Set Ready. Again, this second set of lines is used to indicate a device is ready to handle data.

It all seems pretty clear with little room for misinterpretation. If all things were equal, it would be a simple matter to tie the devices together using the RS-232 lines. After all, those lines are part of the "standard" interface, so, tying the pieces of equipment together should only be a matter of buying a standard cable and hooking things up.

It's not that simple.

All things in the world of computers aren't so simple and clear cut. Over the years, different computer manufacturers have come up with their own ways of handling the RS-232 lines. Some use Lines 5 and 20 to enable devices to indicate when they are ready to accept data. Others use Lines 5, 6, and 20; and still others use Lines 4, 5, and 6, as well as other lines, such

as Line 8 and Line 11. About the only thing now common about the RS-232 "standard" is grounding (Lines 1 and 7)!

Let's be more specific and look at the IBM *Personal Computer*. To correctly interface a PC with another serial device, you must use Lines 5 and 20 and—sometimes—Lines 5, 6, and 20. That seems reasonably straightforward. It would seem all you have to do is connect Line 20 on one side of the connector to Line 20 on the other and Lines 5 and/or 6. But, that isn't the way it works because Line 20 on the peripheral side of the connector must be connected (jumped) to Line 5 on the IBM *Personal Computer*. And that is only to implement handshaking—Data Terminal Ready. So, although the connectors may look the same, the pinouts are entirely different.

PIN NO.	EIA NAME	CCITT NAME	DESCRIPTION	TYPE	DIRECTION
1	AA	GND	Protective Ground (bonded to chassis)	Ground	N/A
2	BA	TD	Transmitted Data	Data	To DCE
3	BB	RD	Received Data	Data	From DCE
4	CA	RTS	Request To Send	Control	To DCE
5	CB	CTS	Clear To Send	Control	From DCE
6	CC	DSR	Data Set Ready	Control	From DCE
7	AB	GND	Signal Ground (common return)	Ground	N/A
8	CF	DCD	Received Line Signal Detector	Control	From DCE
9	—	—	(reserved for data testing)	—	—
10	—	—	(reserved for data testing)	—	—
11	—	—	(unassigned)	—	—
12	SCF	(S)RCD	Secondary Received Line Signal Detector	Control	From DCE
13	SCB	(S)CTS	Secondary Clear To Send	Control	From DCE
14	SBA	(S)TD	Secondary Transmitted Data	Data	To DCE
15	DB	TC	Transmission Signal Element Timing	Timing	From DCE
16	SBB	(S)RD	Secondary Received Data	Data	From DCE
17	DD	RC	Receiver Signal Element Timing	Timing	From DCE
18	—	—	(unassigned)	—	—
19	SCA	(S)RTS	Secondary Request To Send	Control	To DCE
20	CD	DTR	Data Terminal Ready	Control	To DCE
21	CG	SQ	Signal Quality Detector	Control	From DCE
22	CE	RI	Ring Indicator	Control	From DCE
23	CH/CI	—	Data Signal Rate Selector	Control	(CH) To DCE (CI) From DCE
24	DA	TC	Transmitter Signal Timing	Timing	To DCE
25	—	—	(unassigned)	—	—

FIG. 1—PIN ASSIGNMENTS FOR THE RS-232 STANDARD. Timing circuits are used for synchronous communications.

It gets more complicated. Suppose you would like to interface a printer with your computer. To do this you would enable Lines 2 and 3, Transmit and Receive. Again, it seems pretty straightforward, but wait. The printer is also using Lines 2 and 3 for the same things, so you have to reverse the lines in your computer connector 3 to 2 and 2 to 3. However, if you're interfacing a modem, then you leave things alone.

The RS-232 standard not only covers transmission and receiving lines, but two different types of equipment, DCE or Data Communications Equipment (such as modems) and DTE, or Data Terminal

Equipment (such as terminals or computers). When you're interfacing one type of device to the other, the cable goes "straightthrough." That means that Line 2 of one device goes to Line 2 of the other, and Line 3 of one device goes to Line 3 of the other. It's pretty easy to set up one of these devices with your Computer.

But what happens if your computer is set up as a DCE device and the device you're trying to interface is DCE? The answer is that you have to reverse lines to get it to work correctly. You can do that by using a null-

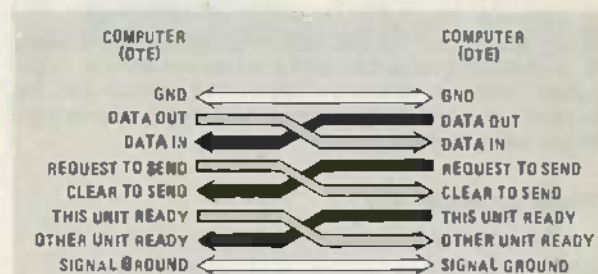

FIG. 2—TO CONNECT TWO DCE OR TWO DTE devices together, you'll need what is known as a null-modem cable.

modem cable, as shown in Fig. 2. You might wonder why you would want to connect two DCE or two DTE devices together. After all, didn't the people who thought up the standard think about such things? There are lots of reasons you'd want to hook up two similar devices together. That becomes very clear when you realize that both computers and printers (and other non-modem devices) are DTE devices. Why didn't the developers of the standard think about that? Well, it's because things were different back then. Printers were usually connected to auto-answer modems, and personal computers didn't even exist!

Confused?

At this point, we won't blame you if you're confused. But the problem is that the computer world has changed quite a bit from the days when the standard was developed. And the problem is only made worse by manufacturers who use their RS-232 signals for non-standard applications.

One thing that you should remember is that when you are transmitting, the data line (Line 2) always goes to the DCE device and received data (Line 3) always runs from it. Most microcomputer printer ports are DTE and they are usually indicated by male DB-25 connectors. DCE devices are usually indicated by female connectors.

One last thing about this "standard" that we should mention is that it's expensive. Because of the many variations, nearly every device requires its own special cable. Unless you're willing to spend time with a soldering iron and more time checking to see whether you've made the correct connections, you'll spend between \$35 and \$65 for special cabling. It can get very expensive if you must have special cables made up for a printer (or printers), modem and plotter, or other device.

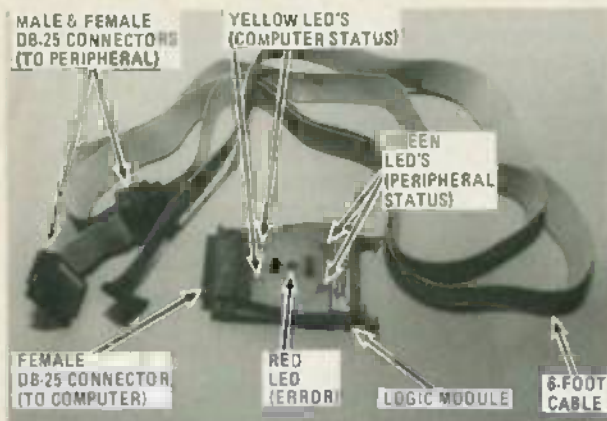

FIG. 3—SMART CABLE CONSISTS of two elements; a "logic module" and the extension cable. The module can be equipped with male or female connectors, depending on your own computer's needs.

Is there an easier way?

There is an easier way to hook two serial devices together without spending hours poring over your equipment documentation. A device called *Smart Cable* takes all the worry out of configuring RS-232 cables. It costs \$89.95 and is available from IQ Technologies (11811 N.E. First St., Bellevue, WA 98005).

Smart Cable consists of two elements, the "logic" module and the extension cable (See Fig. 3). The logic module can be equipped with either male or female DB-25 connectors, depending on your computer, while the extension cable is fitted with a header connector to attach to the logic module and is terminated in both male and female connectors.

Inside the logic module is what can best be described as a breakout box—an automatic breakout box. It checks each end of the link for different voltage states and handshake signals and then finds a suitable connection at the other. The voltages are fed first to a test circuit, which passes them to a pattern comparator, which compares those voltages to known values. Once those values are determined, the interconnection circuit takes care of the interface.

Using the Smart Cable

The best thing about *Smart Cable* is that it's easy to use. In fact, you might even be able to get by without reading the instruction manual because the abbreviated instructions printed on the logic module's case take care of most setups. As you can see in Fig. 3, the logic module sports five LED's (two green, two yellow, and one red) and two switches. The LED's are used to indicate the state of the RS-232 connection. In effect, they tell you how to set up the switches.

The first step is to power up both pieces of equipment and make sure that the word length, parity, etc. are properly matched. (*Smart Cable* is transparent to such settings.) You then connect the ribbon cable to the logic module and plug the logic module into your computer. (The logic module is available in either a male or female configuration. If you use it with a different computer, you *may* need a gender reverser.) Next, the other end of the ribbon cable is connected

to your peripheral. (Both male and female DB-25 connectors are supplied.)

Once the cable is connected between the two devices, you'll use the LED's on the logic module to set the switches correctly. Unfortunately, if your port is located at some inconvenient place at the back of the computer, doing that will be a bit inconvenient.

The bottom switch (between the two green LED's) should be set in its center position. If both of the top (yellow) LED's are lit, the top switch is in the correct position. If only one light is on, the switch between them should be set to the position most-distant from that light. Both yellow lights should then come on, indicating that the top switch is now in the correct position. If *neither* yellow LED comes on, check the port on the computer. You are probably plugged into a parallel instead of a serial port. If only one yellow light comes on in either switch position (as will be the case with a receive-only printer), you'll have to try sending data in each switch position. The one that permits data flow is (obviously) correct.

If *only* one of the bottom (green) LED's is on, slide the bottom switch towards that light. If neither green light is on, leave the switch in the center position.

If the center red light comes on, it indicates that something *might* be disabling data transfer. The red light will flicker during normal operation. And some systems operate with the red light on constantly. If your red light remains on but data transfers properly (as we found in many cases), don't worry about it.

When both switches are set and the red light is off, the installation is complete. Leave *Smart Cable* in place as long as you like.

Now that sounds really simple—and it is. But things can go wrong. For example, when we were transferring data to a plotter, it seemed that everything was working fine. But then the printer came to a standstill and flashed its ERROR light. The reason? The BUFFER FULL signal was of the wrong polarity, and had to be changed at the plotter. (*Smart Cable* couldn't do anything about it.) Luckily, the instruction manual covered just that occurrence. The instruction manual, incidentally, is not bad. Along with a diagnostic guide is a glossary, setup examples, and other useful information.

Do you really need it?

With a price tag of about \$90, *Smart Cable* is not inexpensive. It doesn't cost too much more than a custom made cable, but it's a lot more expensive than a home-made cable. If you need a cable to link your computer and printer, then a dedicated cable is the way to go—whether you make it yourself or buy it custom made. However, if you often switch peripherals and try out new devices, *Smart Cable* will save you lots of set-up time. (Breakout boxes can take some time to set up, and making a custom cable just to test something out is not the way to go about things.) Computer clubs, computer stores (especially!), and any computer hardware hacker will really love the device because it makes connecting two devices together (even two devices you've never seen before) nothing short of simple. ◀▶

MACHINE CODE DEVELOPMENT SYSTEM

FOR YOUR TIMEX SINCLAIR 1000

PART II



BACK VIEW OF UNIT shows clean, uncluttered look. Refer to text for clarification of connectors.

MARK W. LATHAM:

Back in January, we started an interesting and important article on how to build a machine code development system for the Timex Sinclair 1000. We promised to complete the article with the second part, in the February Issue.

But something slipped, and the February Issue went to press without the rest of that important information.

For those of you who may have been wondering what happened to the rest of the article, or who had started it and were hoping to complete it, the

remainder of the information is all here, in this issue. We apologise for any inconvenience that this may have caused.

The fact of the matter is, that while at one time, Timex was shipping 100,000 units a month. The price was right, and lots of people bought real keyboards and extra RAM to make these units work like real business or entertainment machines. Others were content to simply fool around with whatever they could hook up to the back of the unit.

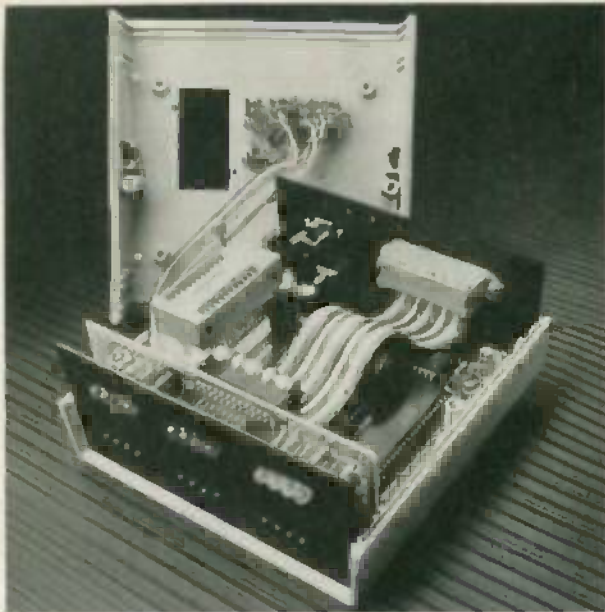

INSIDE THE EPROM I/O, the picture is total neatness that reflects care in assembly. Follow the layout guides and refer to the text for parts positioning.

The three tricolor LED's (LED3-LED5) are used to monitor the RAM \overline{CS} , EPROM \overline{CS} , and \overline{OE} lines. Transistors Q5-Q7 reverse the current flow through those LED's when the associated outputs of IC6 are high. Those LED's will be green if the corresponding line is high (inactive) and red if the line is low (active). If the line is rapidly changing, the LED will appear to be yellow.

All the software for controlling the I/O port, block data moves, and EPROM programming can be permanently stored in IC8, the resident EPROM. IC1-b, IC2-a and IC2-b decode the Z80A \overline{MREQ} and address A11-A15 signals to place the resident EPROM in the 8-10K area. IC1-a and D6 hold the computer's \overline{ROMCS} line high during the resident EPROM read to prevent bus contention. (The computer is wired to see the 8K ROM anywhere in the 0-16K area.) If the program is written at the machine-language level (the EPROM I/O operating system provided by the supplier listed) you will have an I/O-port/EPROM-programmer that is fast, easy to use, and ready to go the second you plug it in.

Construction

The circuit shown in Fig 1 can be built using perforated construction boards. A better method, however, would be to use double-sided printed-circuit boards such as the ones shown in Figs. 2 and 3.



FIG. 5—PARTS POSITIONING ON THE SMALL BOARD is shown here. Placement of the LED's is fairly critical as they must show through front panel holes.

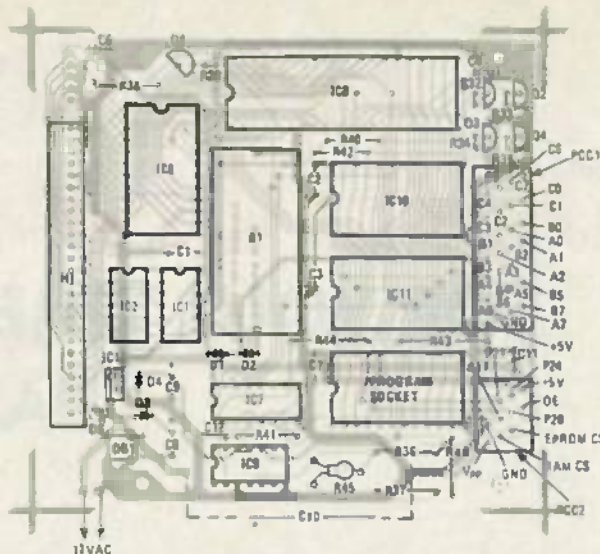

FIG. 4—PARTS PLACEMENT ON THE MAIN BOARD is shown in this diagram. Take care to observe the proper polarities for all components.

Using the PC boards is the easiest way to go. A parts-placement diagram for those boards is shown in Figs. 4 and 5. Note that the board identifies the functions of the LED's (in other words, which lines they monitor). Note that all the resistors on the display board (Fig. 4) and R39-R43 and the diodes on the main board (Fig. 5) are all end-mounted. A holder for the lithium battery should be used and $\frac{1}{8}$ -inch alignment holes is drilled as shown. Depending on the case you use, filter capacitor C10 can be positioned either to the side or above IC9 and R45. A $\frac{1}{8}$ -inch hole through the PC board and the bottom of the case will allow you to adjust R45 without opening the enclosure.

Mount all of the passive components first, then the diodes, transistors and IC's. A heat sink for IC12 can be made of angle aluminum and placed above H1. Sockets for the IC's are recommended. If you are going to mount the CMOS IC's directly to the board, save them for last and be sure to ground the soldering iron to the board's ground (alligator clips work fine.) With a 26-conductor ribbon cable you can daisy chain the main board (via PCC1) to the display board (H2) to the DB-25 connector at the back of the unit (in this application the DB-25 is not used as an RS-232 connector). The outside wire, 5-volts, should be torn away from the others before insertion into the DB-25 connector.

If you are going to place the PC boards in a project case you will need to raise the program socket through the top by replacing it with its wire wrap counterpart or by soldering extended posts to its base. The switches and LED1 (in a panel clip) can be mounted directly to the top of the case and wired to the board with a 10-conductor ribbon cable PC board connector assembly. The ribbon cable connects to the board at PCC1, which wires connect to which pads is shown in the parts-placement diagram. The switches, which are mounted on the case, should be wired according to the schematic diagram. Note that R1, R47, C13, and D5 are mounted directly on the switches at the top of the case. ◀▶

Morse Code Practice On Your Commodore 64.

Here's one way to lure a computer-oriented son back to amateur radio!

BOB WOODS, W5QPD

■ In an effort to reinterest my 13-year old son in amateur radio after he succumbed to the siren song of a microcomputer, I wrote the following program for our Commodore 64. The computer has a built-in audio capability, and while I *did* have a lot of fun writing the program, and spend a lot of time using it myself, the idea didn't work. Our computer freak in residence tried it out and went back to the monitor.

You select the speed, the program sends five-letter word groups, and displays them on your screen. After 50 such groups, it pauses, so you can correct your copy. Then when you are ready, it sends a new set. If you're using a monitor without sound capability, use the built-in interface that comes with the Commodore, and any TV set. Your Commodore provides a port that permits you to connect through an interface to any television receiver, permitting that receiver to be used in place of a monitor. As the TV receiver does have audio capability, the problem is thereby solved.

The heart of the program is in statements 230 to 330 where the number of elements (dits or dahs) in the letter, number or punctuation mark are counted and loaded in sequence into successive values of array EL(I). A dit is a value of one, a dah is three. These are used in statements 350 to 430, where the values of the elements of EL—renamed XX—are multiplied by S, the speed, and used to control the duration of the sound produced by the monitor or TV.

Tone characteristics are set by the statements ending in 120. The 64 has three "voices," but as we do not want to interfere with the pure tone, we silence voices two and three with statements 30 through 60. Statements 80 and 90 set voice one to one kilohertz. Statement 110 provides a steady tone instead of one with amplitude modulation, and 120 provides a sharp make and break. You can putter with these statements and try to reproduce the sound of an underpowered "peanut whistle" transmitter if you like. Statement 100 sets the volume.

There are 41 letters, numbers and punctuations in the data table. Statement 210 selects these at random by picking values of NO (the number of the table entry) and then jumping to the table.

Statement 320 might be confusing. The digits of X are stripped off and entered in sequence as values of EL(I). This is done by first finding the two numbers that are gotten by moving the decimal point in X one and then two places to the right and discarding the decimal fraction. The smaller number is then multiplied by ten and subtracted from the larger. This leaves only the single digit that was to the left of the decimal, which will be one or three, to encode a dit or a dah.

Let's also explain statements 160 through 200. S is used to control transmission speed. This is related to words-per-minute, entered as SS in statement 150,

TABLE 1
PROGRAM

```

30 POKE 54279,0
40 POKE 54286,0
50 POKE 54280,0
60 POKE 54287,0
70 REM 2 & 3 SILENCED
80 POKE 54272,20
90 POKE 54273,64
100 POKE 54296,15
110 POKE 54278,240
120 POKE 54277,0
130 WO = 1 : LE = 1
140 PRINT "W.P.M. (APPROX). 5 TO 20"
150 INPUT SS
160 IF SS<9.5 THEN GOTO 200
170 S = 226.4 - 27.67*SS + 1.5*SS^2
180 S = S-.0377*SS^3 + .000353*SS^4
190 GOTO 210
200 S = 231.7-17.02*SS
210 NO=INT (RND (9) *41)
220 GOTO 1000
230 N=6
240 M=N-1
250 R = INT(X/10^M)
260 IF R<>0 THEN GOTO 290
270 N=N-1
280 GOTO 240
290 EL (I) = R : FOR I = 2 TO N
300 P=N-1
310 Q = P + 1
320 EL (I) = INT (X/10^P)-INT (X/10^Q)+10
330 NEXT I
340 PRINT AS;
350 FOR K=1 TO N
360 XX = EL(K)
370 POKE 54276,17 :REM TURN ON
380 FOR L=0 TO S*XX : NEXT L
390 POKE 54276,16 :REM TURN OFF
400 FOR L=0 TO S : NEXT L
410 NEXT K
415 FOR L=0 TO S : NEXT L
420 LE = LE + 1
430 IF LE<6 THEN GOTO 210
440 FOR L=0 TO 500:NEXT L
450 LE = 1
460 PRINT " ";
470 WO = WO + 1
480 IF WO<50 THEN GOT TO 210
490 END

1000 IF NO=0 THEN AS="A":X=13: GOTO230
1001 IF NO=1 THEN AS="B":X=3111: GOTO230
1002 IF NO=2 THEN AS="C":X=3131: GOTO230
1003 IF NO=3 THEN AS="D":X=311: GOTO230
1004 IF NO=4 THEN AS="E":X=1: GOTO230
1005 IF NO=5 THEN AS="F":X=1131: GOTO230
1006 IF NO=6 THEN AS="G":X=331: GOTO230
1007 IF NO=7 THEN AS="H":X=1111: GOTO230
1008 IF NO=8 THEN AS="I":X=11: GOTO230
1009 IF NO=9 THEN AS="J":X=1333: GOTO230
1010 IF NO=10 THEN AS="K":X=313: GOTO230
1011 IF NO=11 THEN AS="L":X=1311: GOTO230
1012 IF NO=12 THEN AS="M":X=33: GOTO230
1013 IF NO=13 THEN AS="N":X=31: GOTO230
1014 IF NO=14 THEN AS="O":X=333: GOTO230
1015 IF NO=15 THEN AS="P":X=1331: GOTO230
1016 IF NO=16 THEN AS="Q":X=3313: GOTO230
1017 IF NO=17 THEN AS="R":X=131: GOTO230
1018 IF NO=18 THEN AS="S":X=111: GOTO230
1019 IF NO=19 THEN AS="T":X=3: GOTO230
1020 IF NO=20 THEN AS="U":X=113: GOTO230
1021 IF NO=21 THEN AS="V":X=1113: GOTO230
1022 IF NO=22 THEN AS="W":X=133: GOTO230
1023 IF NO=23 THEN AS="X":X=3113: GOTO230
1024 IF NO=24 THEN AS="Y":X=3133: GOTO230
1025 IF NO=25 THEN AS="Z":X=3311: GOTO230
1026 IF NO=26 THEN AS="1":X=13333: GOTO230
1027 IF NO=27 THEN AS="2":X=11333: GOTO230
1028 IF NO=28 THEN AS="3":X=11133: GOTO230
1029 IF NO=29 THEN AS="4":X=11113: GOTO230
1030 IF NO=30 THEN AS="5":X=11111: GOTO230
1031 IF NO=31 THEN AS="6":X=31111: GOTO230
1032 IF NO=32 THEN AS="7":X=33111: GOTO230
1033 IF NO=33 THEN AS="8":X=33311: GOTO230
1034 IF NO=34 THEN AS="9":X=33331: GOTO230
1035 IF NO=35 THEN AS="0":X=33333: GOTO230
1036 IF NO=36 THEN AS=" ":X=131313:GOTO230
1037 IF NO=37 THEN AS=",":X=331133:GOTO230
1038 IF NO=38 THEN AS="?":X=113311:GOTO230
1039 IF NO=39 THEN AS="~":X=31113: GOTO230
1040 IF NO=40 THEN AS="^":X=31131: GOTO230

```

through the expression starting in 170 and continuing in 180. For those of you interested in mathematics, this is a Chebychev polynomial fitted to data that were taken to explore the relationship between S and transmission speed. To obtain the data, we wrote a program that transmitted 100 dahs and clocked the time this took for various values of S. The information was combined with the knowledge that the number of dahs in a five-second period roughly equals code speed in Words Per Minute (WPM). The relationship seemed linear for under 9.5 WPM, hence the branch at statement 160.

Actual character transmission occurs at statements 350 through 410. Memory location, at 54276 is the "switch." Statement 370 turns on the tone and, after killing the proper length of time in statement 380, 390 turns it off.

Of course, entering the data can be tedious. If you are new at this, you might not have noticed that the easiest way is to key in the first line, and after you "ENTER" it, go back, make the few changes needed, and enter it as the next line. Continue this until you have entered the whole table. Anybody experienced with morse code will automatically punch in the proper patterns of 3's and 1's corresponding to dahs and dits.

There is no need to restrict the data table to the 41 lines shown. If certain characters give you trouble in copying (such as double dashes) enter them several times. This will cause those characters to be transmitted more frequently. The only other change required, is to increase the constant (now 41) in line 210 until it is one more than your new maximum value of NO in the data table. ◀▶

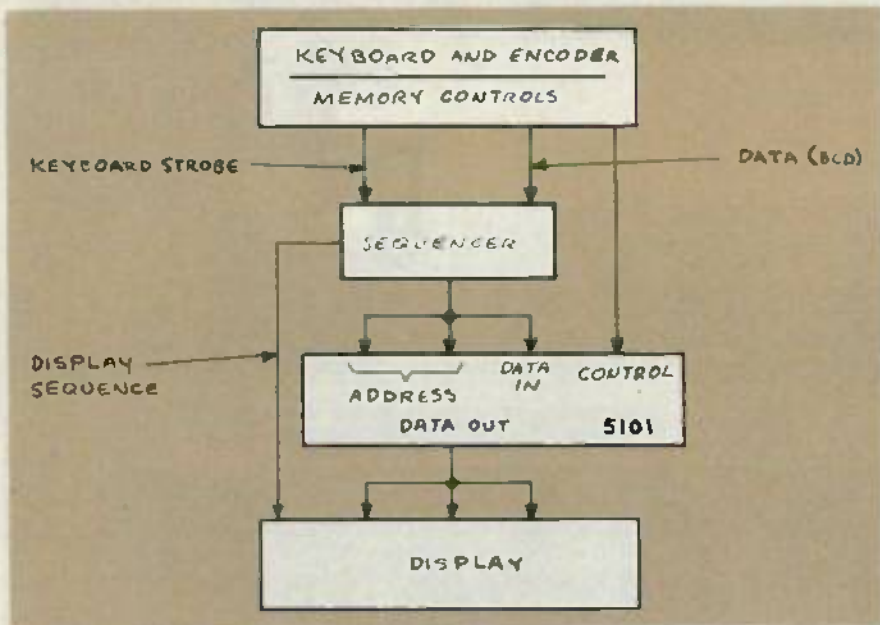

FIG. 3

Static RAM

For our discussion we'll be using the 5101 256x4 RAM. There are several advantages to using that IC: It's cheap, (under \$3 mail-order), widely available, CMOS, and features a low-power data-retention mode so a battery can be used to back up stored data.

Several manufacturers make the 5101 and although there are minor differences between them, any one you can get your hands on will be fine for our purposes. Table 1 is a listing of several pin-for-pin equivalents of the 5101. The variations in the IC usually have to do with things like maximum operating-voltage, access time, and the like. If we keep the supply at 5 volts and are willing to live with a 450-nanosecond access time, we can forget about the differences altogether.

Figure 1 shows the pinout of the 5101. A block diagram of the IC's

innards is shown in Figure 2, but it's no substitute for a data sheet. The timing diagrams and such that are found on data sheets are *absolutely invaluable* when you're using memory IC's. You can build a demonstration circuit without them, but you'll learn a lot more if you have them in front of you while you work. (Think of it as a poor man's substitute for an oscilloscope.)

The first step in designing the demonstration circuit or any other circuit, for that matter, is to have a perfectly clear idea in your mind of exactly what you want the circuit to do. That means we first must list all design criteria, and then draw a block diagram of the circuit. Once that's done, we can actually begin the breadboarding. The design criteria for our circuit are:

- Keyboard entry of data and address
- Switch control of read and write
- Random read and write operations
- Display of address, data in, and data out
- Automatic keyboard sequencing of address and data
- Keyboard control of all memory functions and modes

A block diagram of a circuit that meets those requirements is shown in Fig. 3.

The first thing we need is a way to generate a binary code from a keyboard. That's exactly what we'll take care of next time.

R-E

TABLE 1

AMI—S5101 (any suffix)
HARRIS—6561
HITACHI—43S101
INTEL—5101
NATIONAL—74C920 or NMC6551
MOTOROLA—14S101
NEC—5101
RCA—MWS5101 or CDP1822 (any suffix)
SSS—5101
SYNERTEX—5101
TOSHIBA—5101

Be an FCC LICENSED ELECTRONIC TECHNICIAN!

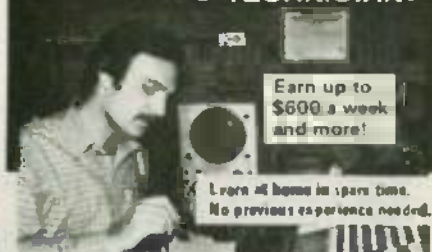

No costly School. No commuting to class. The Original Home-Study course that prepares you for the FCC Radiotelephone license exam in your spare time! An FCC Government license is your "ticket" to thousands of exciting jobs in Communications, Radio & TV, Mobile two-way, Microwave, Computers, Radar, Aerospace and more. You don't need a college degree to qualify, but you do need an FCC License. No need to quit your job or go to school! You learn how to pass the FCC License exam at home at your own pace with this easy-to-understand, proven course. It's easy, fast and low cost! **GUARANTEED PASS!** You get your FCC License or money refunded. Write for free details. Soon you could be on your way to being one of the highest workers in the electronics field. Send for **FREE** facts now. **MAIL CDUPON TODAY!**

COMMAND PRODUCTIONS

FCC LICENSE TRAINING, Dept. 90
P.O. Box 2223, San Francisco, CA 94126
Rush **FREE** facts on how I can get my FCC License in spare time. No obligation. No salesman will call.
NAME _____
ADDRESS _____
CITY _____ STATE _____ ZIP _____

Learn micro-processing with the new MICRO-PROFESSOR 1P



Students, engineers or technicians—upgrade your micro-processing skills with the new Micro-Professor 1P.

The MPF-1P features!

- extensive software support
- more built-in memory
- improved keyboard
- larger display

Three tutorial guides help cover all capabilities. The ideal training tool! MPF-1P will deliver you into the growing world of micro-processing. Invest now!

Plus—FREE GIFT Only \$179.95

Check this box for **FREE** Z-80 Microprocessor Programming and Interfacing textbook when you order within 7 days. \$12.95 value. (Include \$5.00 postage & handling)

ETRONIX
Dept. RE0385
14803 N.E. 40th
Redmond, WA 98052

For immediate action call **TOLL FREE:**

1-800-426-1044

Full money back guarantee.

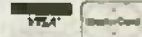

CIRCLE 111 ON FREE INFORMATION CARD

MARCH 1985

89

\$129 PRICE EXPLOSION

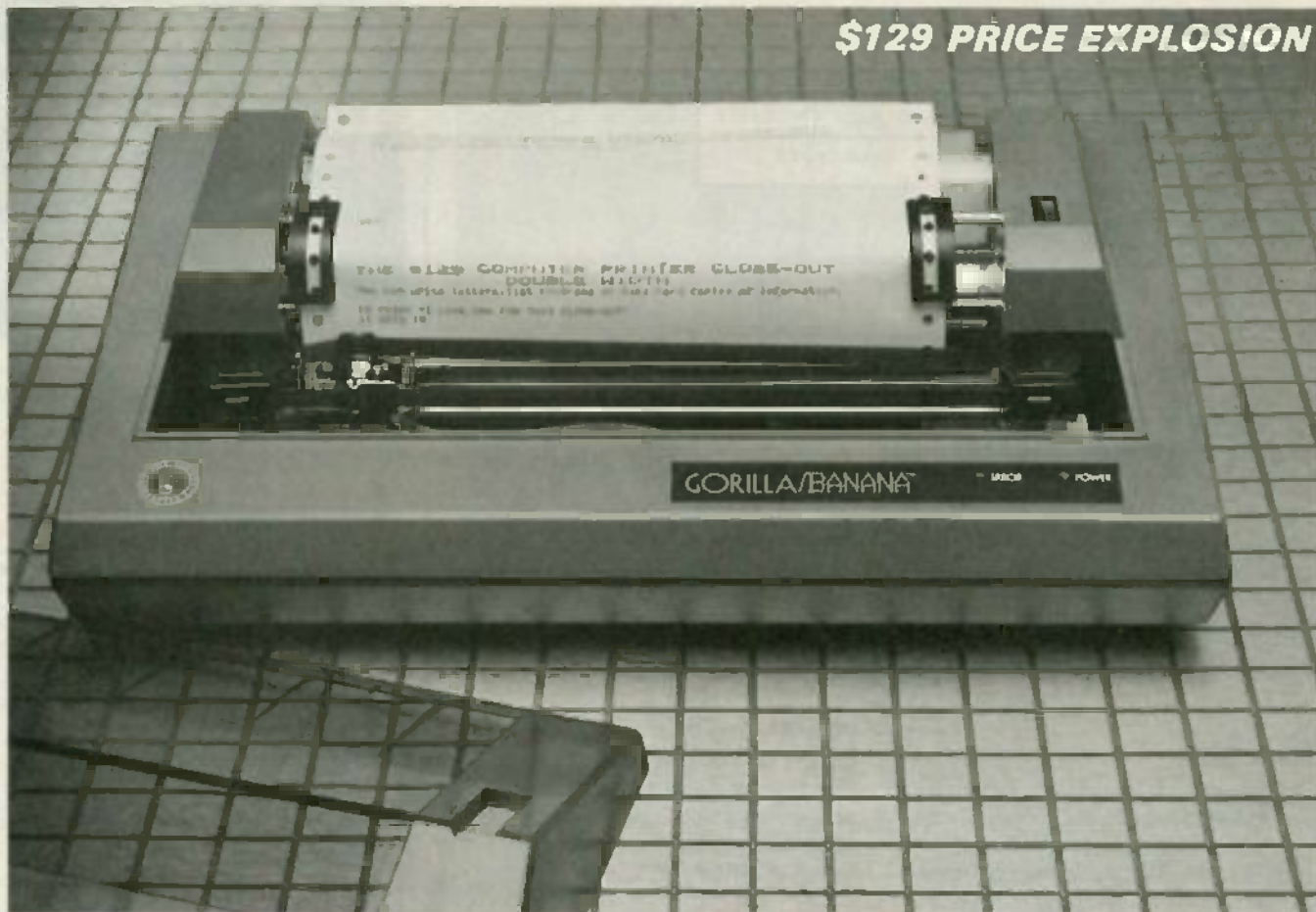

The Complete Computer

Here's a 50 character per second, plain paper, dot matrix printer that you can use with virtually any home or office personal computer. It's built really tough to withstand heavy use. It's really easy to use. And, it even prints graphics. Price Slashed to \$129.

By Drew Kaplan

Complete your computer. Now you can harness the full power of your computer. From writing letters to listing programs, your computer will be incredibly more useful.

It uses plain paper and it's super reliable. It prints both upper and lower case characters. And, if you aren't using a printer with your computer, read on.

LISTING/INDEXES/LETTERS AND MORE

Experience the thrill of actually writing your letters and reports on your computer. Now you'll be able to use all of your computer's word processing and correcting capabilities to really explore your creative talents.

It's easy. Some of the new word processing programs are so 'user friendly' that you can learn to use them in just about 10 minutes. Change a line, change a word, move a line. Just push a button.

Are data bases a four letter word? Not on your life. Now you can use your computer to organize all your telephone numbers, your stocks, stamps, and recipes.

If you're using your computer for business, you can have a complete, instantly accessible file for each customer by name, what they bought, when, etc.

A data base will let you find or organize and print out any information you want, however you want, whenever you want.

There's no more complicated programming required. And, inexpensive data base programs are available at any computer store.

PERMANENT RECORD

If you have a modem, you're in for a treat. You can access encyclopedias, stock market reports, and much more. When you sign on a service like CompuServe or The Source, the world is quite literally at your finger tips.

With a printer, you can get a 'hard copy' of all the incoming information. You can get everything from SAT test simulations and IQ tests to loan amortization schedules.

AFRAID OF PROGRAMMING?

You don't need to know the first thing about programming to use this or any printer. But, if you've never typed in and run a program, here's the easiest one I know. Turn on your computer.

Commodore Owners, and Atari Owners, your computer, and most others will say 'Ready'. Just push Control and Reset on an Apple. Then type the following:
**10 PRINT "DAK IS WONDERFUL"
20 GOTO 10
RUN**

You should type a carriage return at the end of each line. Why not try this program now? Next time, I'll tell you how to get out of the program, and maybe even discuss peeks and pokes.

If the program isn't running, type LPRINT instead of PRINT in line 10.

To you sophisticated programmers, think how easy your life will be when you can print out program lists that you can study at length.

And, you won't have to load a bunch of disks to find a program when you print out a menu for each of your disks.

LOOK AT ALL IT DOES

An ad in several August computer magazines listed a \$149 thermal printer (that needs expensive thermal paper) as the lowest priced printer in the U.S.

Imagine a 50 character per second, plain paper, full 80 column dot, matrix printer with a built-in standard Centronics Parallel Interface, slashed to just \$129.

This printer handles plain old cheap standard fanfold pin feed computer paper from 4.5" to 9.5" wide, with it's built-in adjustable tractor pin feed drive.

It's so powerful you can even use two-part forms for a carbon copy. Plus, there's an impact control for print darkness.

It understands and prints 116 upper and lower case characters, numerals and symbols. And that's not all.

You can even print Double Width characters. And, look at this. This printer has full graphic capabilities with 480 dot horizontal resolution and 63 dot per inch vertical resolution. So, you can print out your pictures, pie charts or graphs.

It prints 10 characters to the inch, six lines to the inch. In short, it's going to make typewriters into dinosaurs. When hooked to your computer, you'll never have to retype anything again. If you find an error, just make the correction and let the computer retype your work for you.

The printer is made by C. ITOH/Leading Edge in Japan. It's built to really take heavy use. But in the unlikely event that it should need service, there are approximately 400 service centers nation wide.

It takes standard long life inked ribbon cassettes that are readily available nation-wide. This is a printer that will give you many years of continuous reliable service and enjoyment.

AND NOW THE BAD NEWS

If you're the president of a large company sending important business letters, you may want a \$1000 daisy wheel printer. But for most uses, dot matrix printers are incredibly faster, and there isn't any way to print out a graph or picture on a daisy wheel printer.

But, there are two things you need to know about this printer. First, it has about the dumbest name I've ever seen. It's built tough and rugged. So, they named it The Gorilla Banana Printer.

Second, like many dot matrix printers, the letters g, j, p, q, and y are level with the other letters. Each letter is completely and perfectly formed, but each sits level with the rest of the alphabet.

Upper case letters and symbols are unaffected. So, if you don't want letters that look like they were printed by a computer, this printer isn't for you.

But for most letters, term papers or reports, programming and all the data bases and information you'll get through a modem, this printer is perfect.

COMPATIBLE COMPUTERS

Any Computer with a standard Centronics parallel port, such as: Apple, Franklin, IBM PC, TRS80, Osborn, Atari, Commodore VIC20, Commodore 64, Kaypro, and virtually any other personal computer. Plus, most briefcase portables.

FEAR OF INTERFACES?

Your computer is smart. But, it doesn't know how to 'talk' to other devices. That's why you need an interface.

An interface isn't just a cable. It's actually an intelligent translator that lets your computer talk to other equipment.

Usually the computer manufacturers don't include the various interfaces when you buy your computer, because they don't know if you'll ever add peripherals such as disk drives, printers or modems.

So, rather than sell you something you don't need, you don't buy an interface until you add onto your computer.

There are two types of printer interfaces. The first allows you to do text word processing. For 99% of computer use, this is all that is needed. It translates all the possible letters and punctuation known as ASCII. This printer understands 116 characters and symbols.

A second type of interface also allows you to dump pictures or graphics from your screen or memory. This is more complicated because every dot must be told where to go. This interface, or 'driver program' as it is called, is available in two forms: built into an interface card, or as a program on a disk which you use in

conjunction with any standard interface.

Either way, you'll have the printer operating in just a few minutes. And if you already have a printer, the same Centronics parallel interface and cable (about 85% of all printers are compatible) should work with this printer.



With this printer you can alter your graphics as you desire. You can print normal or reversed (both shown above, reduced to fit in this catalog) and you can even print double size.

WHY SO CHEAP

A new model will emerge soon with a different name. Leading Edge had just 28,000 of these remarkable printers which have been selling at discount for as little as \$199, left in stock.

DAK bought them all for cold hard cash. And now we're offering them to you for less than the original price we were quoted as wholesale.

The printer is approximately 16½" wide, 9" deep and 7" tall. It's backed by Leading Edge's standard limited warranty.

ADD PRINTING POWER TO YOUR COMPUTER RISK FREE

Now you can really make use of your computer. 50 characters per second printing on plain paper for just \$129. Wow!

Now you can print out your programs, your notes or your letters. If you're not 100% satisfied, simply return the printer and any accessories in their original boxes to DAK within 30 days for a refund.

To order your 50 Character Per Second Dot Matrix, Plain Paper Printer with a built-in Centronics Parallel Interface, risk free with your credit card, call toll free, or send your check for the breakthrough close-out price of just \$129 plus \$8 for postage and handling to DAK, Order No. 4101. CA res add 6% sales tax.

Special Note: If you need a serial printer for a computer, such as the TRS80 Color Computer, order the identical printer with a built-in Serial Interface for the same price. Use Order No. 4102.

The Printer comes packaged with a long life ribbon. Extra ribbons are available at computer stores. DAK has them for \$4 each (\$1 P&H) Order No. 4103.

Standard Centronics Interfaces for your computer are available at any computer store. This Printer has its receiving inter-

face built in. You simply need one, complete with its cable, to plug into your computer to send information. Below are our favorites for 5 of the most popular computers.

For your Apple. We have Practical Peripherals' text interface for just \$49 (\$2 P&H) Order No. 9877. We have their graphics capable interface for just \$79 (\$2 P&H) Order No. 4104. If you already have a Centronics Parallel Interface, we have a graphics driver program on disk for just \$7 (\$1 P&H) Order No. 4105.

For your IBM PC, you don't need an interface. It's usually already built-in. But, you do need a cable. We have a cable, ready to connect this printer to your computer, for just \$19 (\$2 P&H) Order No. 9879. We have a graphics driver program on disk for just \$7 (\$1 P&H) Order No. 4106.

For your Atari 800, 800XL, 400, or 600XL, we have a text interface for just \$69 (\$2 P&H) Order No. 9881. We have a graphics driver program on disk for just \$7 (\$1 P&H) Order No. 4107.

For your Commodore VIC 20 or 64, we have a text interface for just \$39 (\$2 P&H) Order No. 9883. We have a Graphics Interface for just \$54 (\$2 P&H) Order No. 4108.

Special Bonus for Commodore 64 owners. We have a powerful word processing program with editing, including changing a line, a word, or moving a line. Once you've tried computer word processing, you'll never want to look at a typewriter again.

Plus, we have a super data base program that lets you use 8 fields of information on up to 200 subjects at a time. Then you can search for any part, sort alphabetically or numerically and print out an address book, a list of your stocks or anything you can imagine. They're both yours for just \$5 (\$1 P&H) with purchase of the printer. Use Order No. 4122 for Disk, or Order No. 4123 for Cassette.

For most TRS80 Computers, you don't need an interface, just a cable. For the Black and White Computers, we have a Parallel Cable for just \$18 (\$2 P&H) Order No. 9885. For the Color Computers we have a Serial Cable (you need the Serial Printer as well) for just \$18 (\$2 P&H) Order No. 4109.

For briefcase-type portables, the Centronics Interface is usually built-in. Just stop by any computer store. All Centronics Printers use the same cable at the printer end, but you'll need a cable that fits your particular computer's plug.

Get hard copy print-outs of your programs or your graphics. Turn your computer into a powerful word processor. Forget retyping ever again. For just \$129 you can make your computer complete.

Apple, Atari, IBM PC, Franklin, Commodore VIC 20 & 64, TRS80, Osborn, and Kaypro, are registered trademarks of Apple Computer, Atari Inc., International Business Machines Corp., Franklin Computer, Commodore Electronics Ltd., Radio Shack/Tandy, Osborn Corp. and Kaypro respectively.

DAK
INDUSTRIES INCORPORATED

TOLL-FREE ORDER LINE
For credit card orders call 24 hours a day 7 days a week
CALL TOLL-FREE... 1-800-325-0800
8200 Remmet Ave., Canoga Park, CA 91304

Dept. RE01

MARCH 1985

91

ALL ABOUT

STEREO Audio For TV



BRIAN C. FENTON, TECHNICAL EDITOR

We finish up our look at multichannel television sound with a description of the dbx noise-reduction system.

Part 2 THIS MONTH, WE'LL turn our attention to the noise reduction system for multichannel TV sound and why it's so important.

dbx noise reduction

As we mentioned earlier, the BTSC system is similar to the broadcast-FM stereo system. And, just like broadcast FM, the high-frequency components of the BTSC signal contain more noise than the low-frequency components. The L-R subcarrier is, of course, at a higher frequency than the main channel, and therefore suffers from more noise.

The Zenith transmission system increases the modulation level or deviation of the L-R signal to help matters somewhat, but the difference is limited to 6 dB because too much modulation will cause interference to the main channel. Even with the increased modulation of the L-R channel, the noise level of stereo reception is about 15 dB greater than mono reception *even under ideal reception conditions*.

In less-than-ideal conditions, the noise-level difference would be worse. For example, in a *grade B* reception area (where the received picture is somewhat snowy but considered acceptable by most people), the mono signal-to-noise ratio is about 65 dB—most listeners won't hear any noise. Without noise reduction, however, the stereo signal-to-noise ratio would be about 50 dB. That's 5-10 dB worse than a standard compact cassette without noise reduction! It's obvious that

for stereo TV to sell, its performance would have to be better than that. To get that better performance, a noise-reduction system is needed that will:

- Provide noise reduction even in poor-reception areas.
- Preserve the dynamic range of the input signal without losing *headroom* (the safety margin between the maximum level and the actual level of severe overload).
- Prevent the subcarrier from interfering with transmitted power levels. (The modulation level of the composite-signal depends on the sum of the L+R and L-R signals, the modulation level of the *sum* must be limited—not just the level of the separate signals.)
- Be reliable regardless of manmade noise.
- Be reasonably inexpensive and simple to implement.

The Broadcast Systems Test Committee of the EIA felt that the dbx-TV system best met those criteria better than other systems.

We mentioned that the most important characteristic of any MTS signal is its compatibility with existing signals. Therefore, we can't do anything to the main channel. That works out fine—the noise in a multichannel system comes from the higher-frequency subcarriers. The stereo (L-R) signal, however, is encoded, as is the SAP channel. Both the stereo difference signal and the SAP signal use the same encoding scheme so that, as shown in Fig. 6, a receiver needs only a single decoder that can be switched be-

tween the two. (Keeping costs down is one way to ensure that the system will be accepted by the public!)

Companding

The dbx-TV system is a *companding* system: The signal is encoded or *COMPRESSED* before it is transmitted and then decoded or *EXPANDED* by the receiver. Two types of compansion (or compandoring) are used by dbx: *spectral* and *wide-band*. We'll get to the details shortly.

Companding (like other noise-reduction methods) works to reduce noise using the principle of *masking*: That is, if the desired signal is loud enough and has a broad enough frequency spectrum, then you will hear that signal, and not the noise of the transmission medium. You can see that principle in action yourself by recording on cassette tape—and at the same level—both a low-frequency tone and some music with a much broader spectrum (some rock-'n-roll music, for example). You will note that the recording of the rock music will have much less perceivable noise. If you record the low frequency tone at a higher level; it will appear to have less noise than the original recording of the same tone.

From the above description, we can see that for the dbx-TV system to work, it must meet two criteria. First, the level of the audio signal must be high when compared to the background noise. Second, the spectrum must be wide enough to mask the background noise. Another important consideration is that the compand-

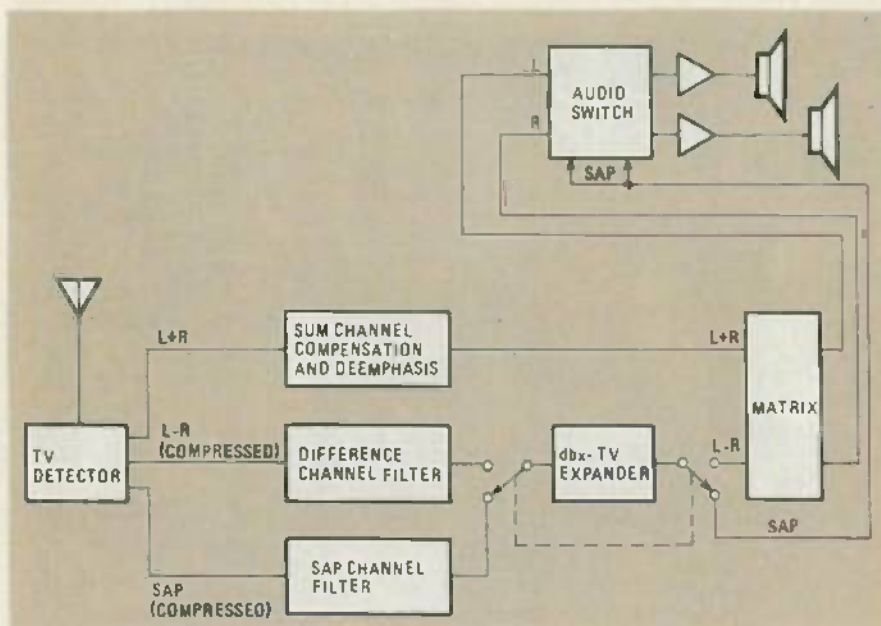

FIG. 6—THE STEREO DECODER can use the same expander for stereo and SAP decoding, and the same speakers can be used for either stereo or SAP programming. It may be desirable, however, to use a separate SAP expander and separate SAP speaker. That's because the SAP channel isn't limited to carrying second-language programming. It could carry an extra audio signal to enhance what's on the main speakers, or it could carry non-program-related material.

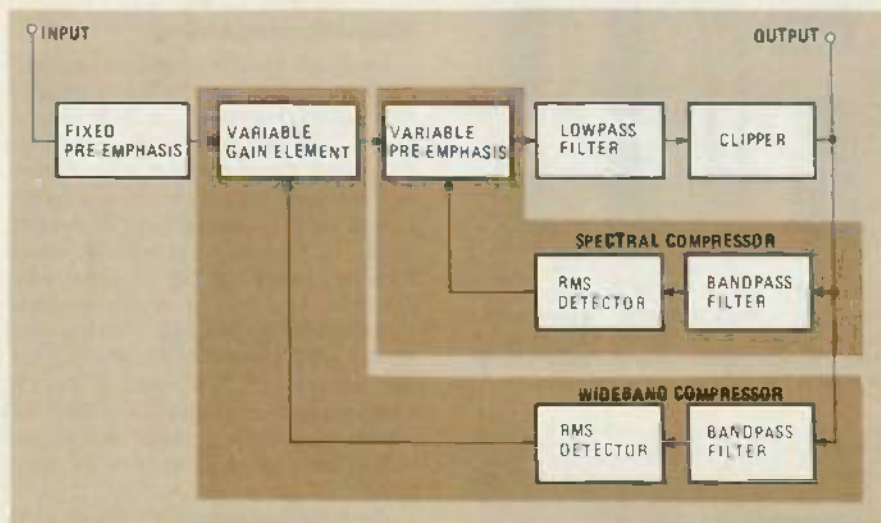

FIG. 7—BLOCK DIAGRAM of the dbx-TV compressor. Note that the compressor contains three main sections: a fixed preemphases network, a spectral compressor network, and a wideband compressor network.

ing process must not add any distortion to the desired signal. Figure 7 shows a block diagram of the dbx-TV compressor that meets those criteria. We'll cover its main sections separately.

Fixed preemphasis

Because the level of the background noise increases with frequency—by 3-dB per octave in the stereo channel of the Zenith system and 9 dB per octave in the SAP channel—masking will occur only if the spectrum of the transmitted signal contains quite a bit of high-frequency information.

Unfortunately, the energy of most program material is concentrated at relatively low frequencies, so keeping the program-

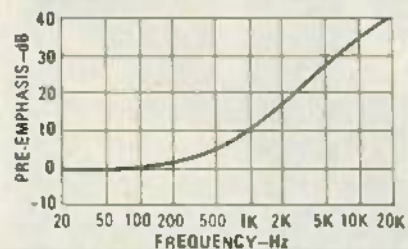

FIG. 8—FIXED PREEMPHASIS FREQUENCY RESPONSE curve shows that the combined effect of the of the 75- μ s and 390- μ s networks helps to overcome the large amounts of noise present in poorer-reception areas.

signal amplitude levels high will not mask the noise sufficiently.

We can, however, change the spectrum

of the audio signal so that it is more evenly balanced between highs and lows by using *preemphasis*. FM broadcasting and mono TV-audio uses a 75-microsecond preemphasis. In the dbx-TV system, two preemphasis networks are used to reduce noise and hiss in even less-than-ideal reception areas. The frequency response of the complete fixed preemphasis is shown in Fig. 8. A deemphasis network must, of course, be included in the receiver.

As you might guess, fixed preemphasis is not enough: Signals that already contain mostly high frequencies will be overmodulated, and low-level signals that contain only low frequencies will still be noisy, even with the strong preemphasis.

Spectral companding

To get around the problem of reducing noise in program signals that contain mostly high or mostly low frequencies,

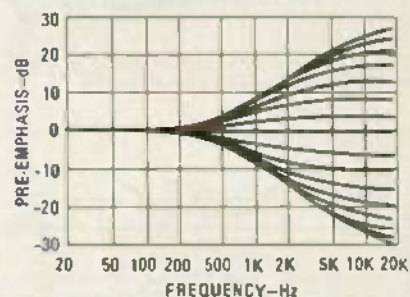

FIG. 9—SPECTRAL COMPRESSION. Here we see the range of variation in frequency-response that the spectral compressor can produce. The spectral compressor examines the input signal to determine the appropriate preemphasis or deemphasis.

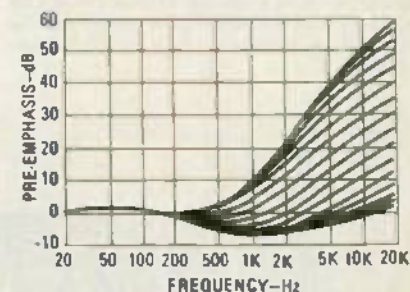

FIG. 10—THE COMBINATION OF fixed preemphasis and spectral compression leads to responses that can range from nearly flat to a high-frequency boost of 55 dB at 15 kHz!

spectral companding is used. The spectral compressor examines the frequency content of the signal and varies the high-frequency preemphasis accordingly. In other words, the high-frequency preemphasis is boosted in signals that contain low frequencies. But if a signal contains mostly high frequencies, some deemphasis is provided.

The range of the frequency response of the spectral compandor is shown in Fig 9. As you can see in the figure, that range is broad, which ensures that masking will be provided. That's because the encoded sig-

nal is dynamically adjusted so that it contains a high proportion of—but not too much—high frequencies

A spectral expander is used in the receiver to restore the program signal to its proper amplitude. It is essentially a mirror image of the compressor. Spectral companding gives us high masking regardless of the frequency content of the input signal and also helps to maintain the necessary headroom by using preemphasis only when necessary. The range of the frequency response available from the combina-

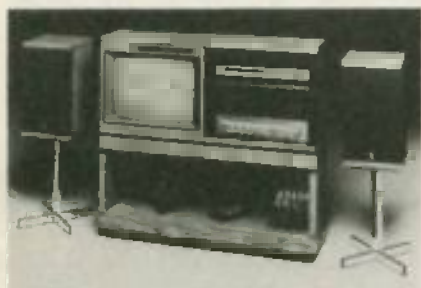

THIS COMPONENT-STEREO VIDEO SYSTEM from G-E can be adapted for stereo TV.

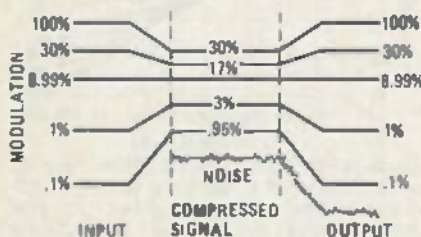
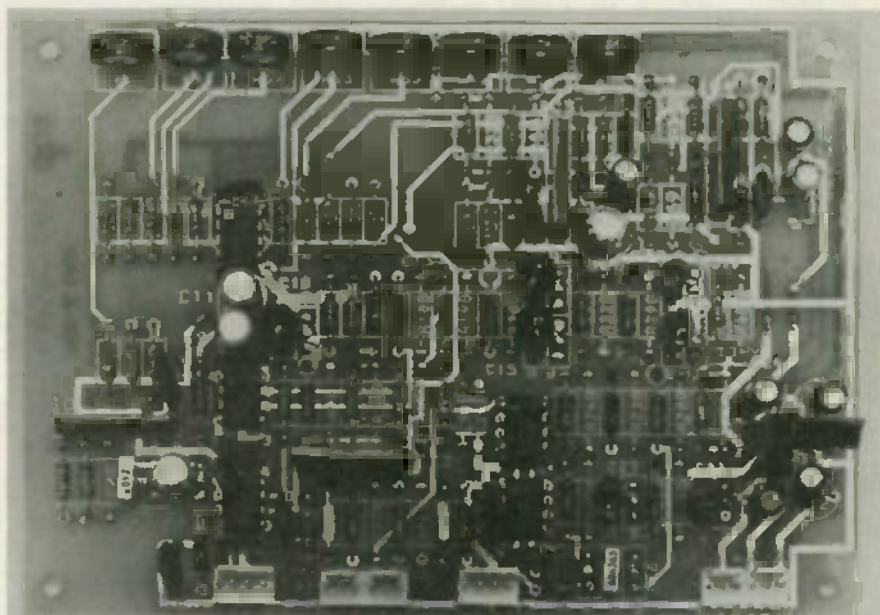
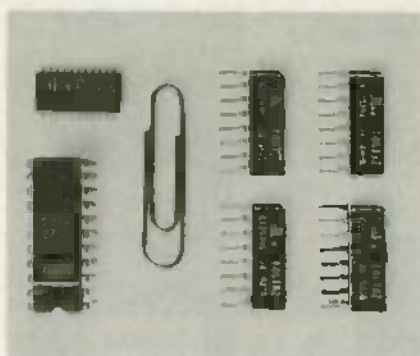

FIG. 11—WIDEBAND COMPANSION. The compressor reduces the dynamic range of input signals by increasing the level of low-level signals and reducing the level of high-level signals. The expander restores the signal to its original amplitude.



CIRCUIT CARDS FOR THE dbx companding system were designed to make implementation of multichannel TV sound easy for broadcasters.



NOISE REDUCTION CIRCUITRY for the dbx system is available in three different IC configurations. The paper clip is shown to provide a sense of scale.

tion of the spectral compander and fixed preemphasis is shown in Fig. 10.

Wideband companding

Even with fixed preemphasis and spectral companding, we still have a problem with low-level signals (especially low-frequency, low-level signals). That's why the dbx system also uses wideband companding, which adjusts the level of all frequencies to keep the signal level high at all times. That companding method, whose response is shown in Fig. 11, reduces the dynamic range of the compressor-input signal by a factor of 2:1 dB—the low-level signals are boosted while high-level signals are reduced. The result is that the signal is always above the noise floor and always below 100% modulation (so as not to interfere with other parts of the spectrum).

The wideband expander in the receiver is essentially a mirror image of the compressor. It restores the signal to its proper amplitudes by reducing the level of low-level signals and increasing the level of high-level signals.

Stereo TV equipment

We mentioned earlier that many stations are stereo capable—or will be shortly. TV set manufacturers are getting set, too. You'll see sets with built-in stereo capability, you'll see set-top decoders, and you'll also see Hi-Fi VCR systems tailored specifically for multichannel television sound. In cities with large bilingual populations, it's likely that we'll see SAP-only decoders.

Some of those devices are already on the market. And as stereo capability becomes a selling point, you're sure to see more. And you can be sure that Radio-Electronics will keep you up to date. R-E



BUILT IN STEREO AND SAP DECODING are what make this 25-inch Zenith Smart Set different from most other TV's currently on the market. A stereo amplifier is built in, but audio-output jacks are also provided for greater flexibility.

\$89 CLOSE-OUT

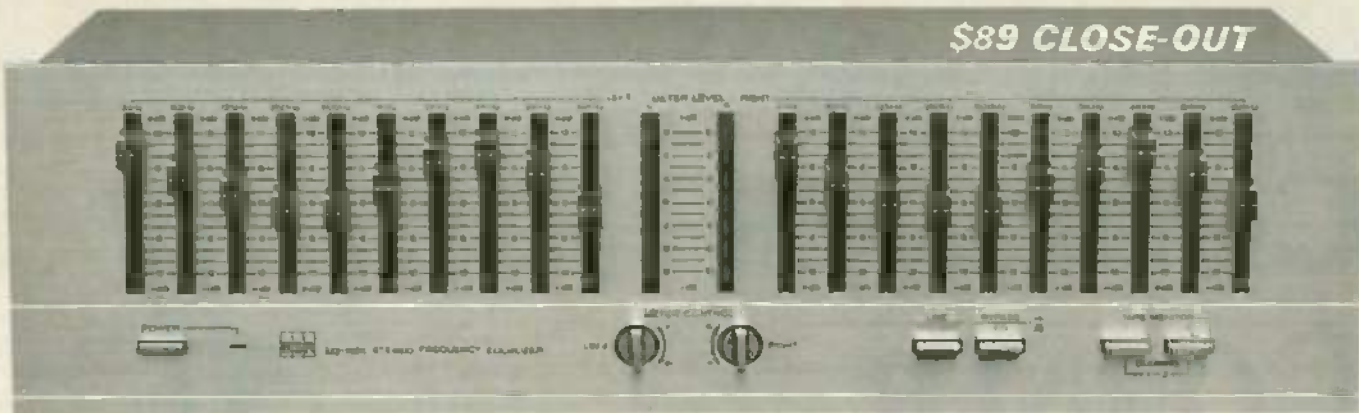

Sound Detonator Plus

Make your stereo system's sound explode with life. Improve the sound quality by 30 to 50%. Plus, you'll add tape dubbing too with this limited BSR \$89 close-out.

It's like night and day. Crashing cymbals, the depth of a string bass, more trumpets or more voice will come bursting forth from your stereo at your command.

You'll make your music so vibrant that it will virtually knock your socks off when you use this professional quality 10 band stereo Sound Detonator Plus Equalizer.

It has a frequency response from 5hz to 100,000hz \pm 1 db. BSR, the ADC equalizer people, make this super equalizer and back it with a 2 year limited warranty. Our \$89 close-out price is just a fraction of its true \$249 retail value.

CAN YOUR STEREO SOUND BETTER?

Incredibly better. Equalizers are different from regular bass and treble controls. And, 10 band EQs are the best.

Bass controls turn up the entire low end as well as the low mid-range, making the sound muddy and heavy. With an equalizer, you simply pick the exact frequencies you want to enhance.

You can boost the low-bass at 31hz, 62hz and/or 125hz, and the mid-bass at 250hz and 500hz to animate specific areas of the musical spectrum.

And, when you boost the part of the bass you like, you don't disturb the mid-range frequencies and make your favorite singer sound like he has a sore throat.

The high frequencies really determine the clarity and brilliance of your music.

You can boost the mid-range and highs at 1,000hz, 2,000hz, 4,000hz, 8,000hz and 16,000hz. So, you can bring crashing cymbals to life at 16,000hz while at the same time you cut tape hiss or annoying record scratches at 8000hz.

You can also boost or cut specific mid-range frequency areas to add or subtract vocal, trumpets, guitars or whatever instrument ranges you prefer.

GREAT FOR 2 TAPE DECKS

You can push a button and transfer all the equalization power to the inputs of two tape decks. So, if you have a cassette deck in your car or a personal stereo that you wear, now you can pre-equalize your cassettes as you record them.

Now you can get all the dramatically enhanced sound wherever you are. This

is an especially great feature for bass starved portables and high-end starved car stereos to make them come alive.



And, look at this. There are two tape inputs and outputs, so you can dub from tape deck A to B, or make two tapes at once with or without equalization.

EASY HOOK UP

Use your tape monitor circuit, but don't lose it. Now your one tape monitor circuit lets you connect two tape decks.

Just plug the equalizer into the tape 'in' and 'out' jacks on your receiver. We even supply the cables.

As you listen to your records, FM or 'aux', any time you push the tape monitor switch on your receiver you'll hear your music jump to life.

The output from your receiver is always fed directly to your tape decks for recording, and with the touch of a button, you can choose to send equalized or non-equalized signal to your recorders.

When you want to listen to a tape deck, just press a tape monitor button on the equalizer and your tape deck will work exactly as it did before. Except, that now you can choose to listen with or without equalization and you can dub.

You won't be listening to any distortion or hum. The Sound Detonator Plus has a 95db signal to noise ratio and total harmonic distortion of just 0.018%.

Once you've set your equalizer controls, switch it in and out of the system. You'll hear such an explosive improvement in sound, you'll think you've added thousands of dollars of new equipment.

WHY A CLOSE-OUT?

Last year DAK closed out over 18,000 of BSR's 7 band equalizers because BSR had decided to only sell equalizers under their ADC name and they still had some left with the BSR name on them.

Well, as Detroit comes out with new cars each year, ADC comes out with new equalizers. We got them to supply us

with just 15,000 of last year's model before they shut down for the new one.

They had already paid for all the tooling, all the research and design, so we were able to buy these for less than half the normal price, for cold hard cash.

So, you can go to any HiFi store and buy this year's design in an ADC equalizer made by the parent company BSR, or you can get this \$249 value BSR equalizer, while our limited supply lasts, for \$89.

THE FINAL FACTS

There are 20 slide controls, each with a bright LED to clearly show its position. Each control will add or subtract up to 12db. (That's a 24db range!)

There are separate sound detonation slide controls for each channel at 31hz, 62hz, 125hz, 250hz, 500hz, 1,000hz, 2,000hz, 4,000hz, 8,000hz, and 16,000hz.

LED VU meters with \pm 0.5db accuracy show levels for each channel. It is 17" wide, 6 1/2" deep and 4 1/2" tall.

PUT LIFE INTO YOUR MUSIC RISK FREE

Prepare for a shock the first time you switch in this equalizer. Instruments you never heard in your music will emerge and bring a lifelike sound that will envelop you and revolutionize your stereo system.

If your system doesn't spring to life, simply return the equalizer within 30 days in its original box for a refund.

To order your Sound Detonator Plus Tape Dubbing BSR 110X 10 Band Stereo Frequency Equalizer risk free with your credit card, call toll free or send your check not for AOC's \$249 value, but for only \$89 plus \$7 for postage and handling. Order No. 9724. CA res add 6% tax.

Wake up the sound in your stereo. Your sound will explode with life as you detonate each frequency band with new musical life. And now you'll be in control of two tape decks as an added plus.

Dept. RE02



DAK

INDUSTRIES INCORPORATED

TOLL-FREE ORDER LINE

For credit card orders call 24 hours a day 7 days a week
CALL TOLL-FREE... 1-800-325-0800
8200 Remmel Ave., Canoga Park, CA 91304

MARCH 1985

COMPUTER CORNER



LOU FRENZEL

A different kind of software

THE MAIN THING THAT HAS MADE PERSONAL computers so popular in business is good software that solves problems and increases productivity. The most popular programs are word processors, spreadsheets, and *DataBase Management Systems (DBMS)*.

Word-processing software turns a personal computer into a highly efficient electronic typewriter with editing and storage capabilities.

Spreadsheets help to organize financial data, like budgets and sales forecasts, and allow you to analyze different scenarios by asking "What if?" questions.

DBMS's let you store huge volumes of data and retrieve it conveniently. They also allow you to manipulate the stored data (sort, etc.).

Until recently, most applications programs were simply *not* compatible with each other. But now a new breed of software—called *integrated software*—has emerged to improve on those already useful programs. That latest form of software combines several different compatible programs into one that readily shares a common set of data files. Integrated software represents a significant advance in the power and convenience of computer software, because it allows the user to rapidly switch from one program to another.

Integrated software

The typical integrated-software package contains a spreadsheet, a graphics program, a DBMS, and often a word-processor and/or communications program. The combined software is supposedly

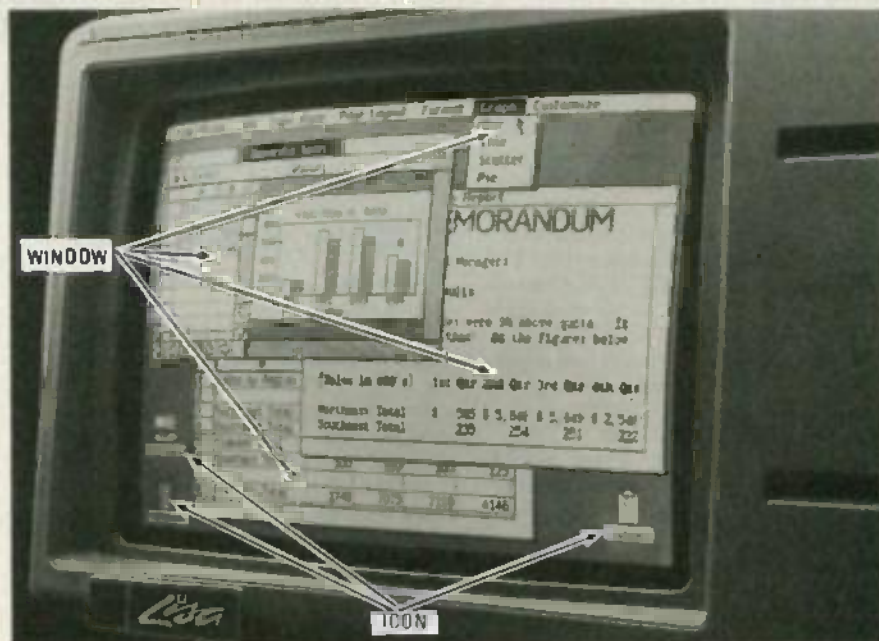

FIG. 1

more powerful and easier to use. But is the whole really greater than the sum of the individual parts?

Some users of spreadsheets, DBMS's, and the like often find it necessary to use several different programs together. Further, their needs may involve the sharing of information between various programs. Therefore, it was inevitable that some means be found to make those programs compatible, thereby allowing them to "talk" to each other.

The first formal step toward that goal was VisiCorp's (2895 Zanker Rd., San Jose, CA 95134) development of the data-interchange format (DIF). That standardized format permits files to be constructed in a way that allows spreadsheets, word processors, etc. to share the same informa-

tion. But, despite the progress in making related programs compatible, using integrated software is somewhat less than simple. An example of that is the use of the popular *VisiCalc* spreadsheet from VisiCorp and its companion program, *VisiPlot*.

Using *VisiPlot* involves first creating a spreadsheet under *VisiCalc* and storing it to disk. Then *VisiPlot* is booted up separately and the data disk created under *VisiCalc* is accessed. *VisiPlot* is used to graph tabular information developed and manipulated under *VisiCalc* and then generate a graphics output. The result is a bar graph or pie chart from the spreadsheet data. The process is effective, but somewhat cumbersome and time consuming.

Similar problems arise when

using other compatible—but separate—programs. For instance, it is often necessary to incorporate tabular spreadsheet data into a report or letter being developed on a word processor. Further, it might be desirable to analyze and then transmit the information contained in a database. Therefore, some means had to be provided for the transfer of information between the various programs.

Operating environments and windows

There are two different types of integrated software. The first bypasses the normal disk-operating system and creates its own special environment and file system. The programs in those packages are tightly integrated into a closed system, meaning that no additional software may be added.

The other form of integrated software works with an existing disk-operating system and is open to additions. That means that it works as an enhancement to—or extension of—the normal operating system. Those packages create an environment in which applications programs designed to run under the same operating system can work together and share information. Both types may contain a windowing feature.

The windowing feature implements the so-called “desk-top metaphor.” In other words, it’s an attempt to simulate a person’s desk top by allowing the user to view several applications at the same time. For example, typical desk-top documents, such as memos, letters, budgets, sales forecasts, customer lists, and stock-market reports can be displayed simultaneously. Some windowing programs even overlap the windows to visually emulate the effect of overlapping papers, as seen in Fig. 1. The window feature may be (but is not necessarily) controlled by a hardware device called a *mouse*.

A mouse is an external hand-controller that is used to move the cursor. (The mouse contains a track-ball that, when rotated—by moving the mouse across the desk top—moves the cursor on the screen.) The mouse also contains

one or more pushbuttons that permit you to begin various operations, such as changing window size or scrolling within a window.

The mouse is normally connected to a computer through a serial communications-port, and it may be used to point to an *icon*. An icon is a graphic symbol drawn on the screen and used to refer to a specific function or operation (see Fig. 1). Instead of typing in a command via the keyboard, the cursor is moved to the icon with the mouse and a button is pressed to start the operation.

The fact that windows let you see several applications at once does not mean that all the programs are running simultaneously—in reality, only one runs at a time. However, you may use the spreadsheet, while portions of a letter on the word processor and a data file in the DBMS are displayed, giving the impression that you’re really doing several things at once.

What’s available

Integrated-software packages are usually large and complex, and can require large amounts of RAM and two floppy-disk drives. In fact, there are some that won’t work without a hard disk. In integrated software, all applications programs must be immediately accessible, and you *must* have plenty of storage space for your data. Not only that, but the windowing software can also “eat-up” large amounts of RAM.

Some popular integrated-software packages include *MBA*, *1-2-3*, *VisiON*, and *Windows*.

MBA by Context Management Systems (23864 Hawthorne Blvd., Suite 101, Torrance, CA 90505) was the first integrated-software package introduced. It’s also one of the most complete and powerful integrated-software packages around. *MBA* combines an advanced spreadsheet, a database management system, a word processor, a graphics program, and telecommunications capabilities. Plus, you can create and use up to four windows. That gives you all the most popular productivity-software “tools” combined into one versatile software package.

The most popular (best selling) integrated-software package is a program called *1-2-3* from Lotus Development Corp. (55 Wheeler St., Cambridge, MA 02138). It combines a powerful spreadsheet, a simple database management system, and a graphics system. At present, *1-2-3* does not include word-processor or telecommunications capabilities; however, a future version is expected to include those features.

Although *1-2-3* does not have windowing capabilities, it does allow you to split its screen in two sections so you can look at two files at once.

The newest and perhaps the most powerful integrated-software package is *VisiON* from VisiCorp. Like the others, *VisiON* includes a spreadsheet, a DBMS, a graphics program, and telecommunications program. One exceptional feature of *VisiON*—when compared to other programs—is that it is structured in an open-ended way so that other programs may be readily added.

VisiON also includes a windowing feature, while the use of a mouse is optional for those who prefer keyboard entry. However, the program does require 512K of RAM and a hard disk.

Another software package recently introduced is *Windows* by Microsoft (10700 Northup Way, Bellevue, WA 98004). Like *VisiON*, it is an operating environment that works with and is an extension of the disk-operating system. Most applications programs designed to run under MS-DOS will also run under *Windows*. But to take advantage of *Windows*’ capabilities, they must be modified.

While Microsoft will undoubtedly develop applications programs of their own, they’re now relying heavily on other software companies to support *Windows* by modifying existing programs and creating new applications software. As its name implies, *Windows* does include a windowing feature, but approaches it in an unusual way: Instead of overlapping the windows, it keeps them separate but adjacent. (Microsoft calls that “tiling.”) *Windows* also uses a mouse. R-E

DESIGNER'S NOTEBOOK



ROBERT GROSSBLATT

A simple solution to power-supply ripple

ONE COMMON PROBLEM THAT PLAGUES everybody who plays around with electronics hardware is power-supply noise. How critical that problem is depends entirely on the sort of circuit you want to power. Some circuits will "laugh off" ripple as high as ten percent of the supply voltage, while others will go "belly up" if any ripple at all is present.

Of course, there are several different kinds of power-supply noise—AC ripple and RF are two. How you go about dealing with the problem depends on the kind of noise you have. With all due respect to Einstein and his *Unified Field* theory, curing RF is a lot different than dealing with poor regulation.

Probably the most common cause of noise is poor regulation in the supply. The 60-Hz that surrounds us has a nasty habit of finding its way into the output stages of even the most carefully regulated supply. That means when you put that plug into the wall socket, you usually get problems along with power!

Reducing ripple is a matter of careful power-supply design—proper shielding, and a whole host of other things we've all dealt with a million times. And if we had to point a finger at the single most important component in the elimination of ripple, it would have to be the filter capacitor that sits right on the output of the power supply.

More noise problems have been cured by increasing the size of that capacitor than by any other single means that I can think of. Unfortunately, finding huge capacitors is

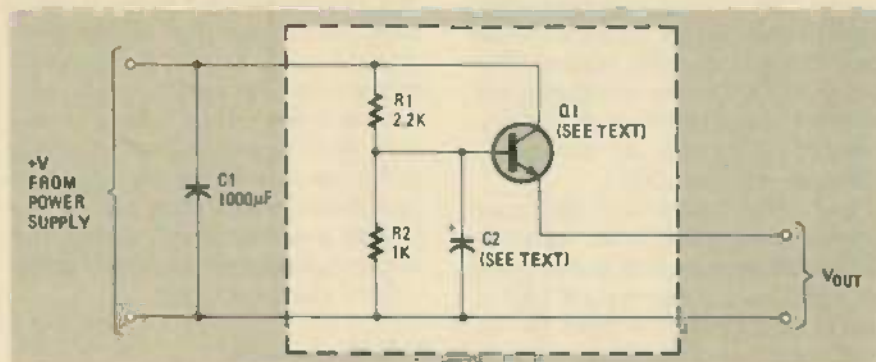

FIG. 1

a practical problem and fitting them on the board is often a physical problem. However, there is a better way!

This month's "brainsaver" can go a long way toward solving the problem of unacceptable amounts of ripple. It's a very simple capacitance multiplier that works along with and helps the filter capacitor you put on the back end of your supply. If you use it intelligently, you'll be amazed at how quiet (ripple free) the DC can be.

The operation of the circuit is virtually foolproof and it will easily stand up to a lot of experimenting. The basic design is flexible enough to operate with a wide range of component values. Figure 1 shows a schematic of the capacitance multiplier. The part values shown are a good starting point, and you should have no trouble getting the circuit to operate successfully.

How it works

The transistor is set up as a high-gain amplifier that effectively amplifies C2, the capacitor connected to its base. Capacitor C1 is

the regular filter capacitor you should have in the circuit to start off with. Since the circuit is in parallel with the filter capacitor, the net capacitance will be the sum of C1 and the "phony" capacitance of the multiplier.

The actual effective capacitance you can produce with that circuit depends on the value of C2 and the gain of transistor Q1. If you pick your values carefully for those two components, you can get a simulated capacitance of over 1 farad at the output and that's enough to quiet even the noisiest supply. (Yes, I said 1 farad, the equivalent of 1 million microfarads!)

As with any circuit, there are trade-offs—the thing that data books usually refer to euphemistically as *design considerations*. One glance at the circuit will show you that all the load current has to pass through the collector-emitter junction of the transistor. Therefore, you'd better make sure to pick a transistor for Q1 that can handle the current you're going to draw from the supply.

There's also going to be a voltage

drop for the same reason, so make sure you feed the capacitance multiplier with a voltage that's about a volt or so higher than the value you want at the output. The effective capacitance of the circuit will be roughly the product of C2 and the gain of the transistor.

Since a good rule of thumb is that a transistor's gain decreases as its power handling capacity increases, you'll have to decide for yourself where the break-even point is for your application. If you really have a noise problem, and you want to handle large amounts of current, you might consider using a Darlington. Either the store-bought variety, or a home-made one put together from two transistors and some resistors will do the job. The key here is experimentation.

As with all the circuits that appear here, the schematic (Fig. 1) is only the starting point. What saves the day in one application will undoubtedly blow up in another. I'm sorry I can't give you exact values and part numbers for all the components, but the circuit's parts values are dictated by its use. The best advice I can give you is to breadboard the thing and start off with relatively small values. Use a 500- μ F capacitor for C2, a 2N2222 for the transistor and see how the circuit operates.

Since you're dealing with a circuit that can emulate big capacitors, it pays to *exercise more than a bit of caution!* You'll be storing plenty of energy in a small place, and any circuit that can melt the tip of a screwdriver deserves to be treated with respect.

The voltage ratings of the capacitors should match up with the output of your supply—the higher the voltage rating of the capacitors the better. If you decide on the right components, the circuit can go a long way toward reducing hum in audio, and all the other nasties that ripple can produce. Just be careful; remember, you'll be dealing with increased amounts of energy.

A correction

November's "Designer's Notebook" had an error in Fig. 1: Power to IC1 is supplied to pin 1 (not to pin 16 as shown). R-E

Enter A Whole New World of TV Entertainment

Regency invites you to enter the exciting world of home satellite television. Imagine being able to choose from over 100 channels, including movies, sports, news, and educational programs, all at the touch of a button. Regency offers a complete selection of satellite system components including the new SR5000 remote controlled satellite receiver pictured here. For more information on

the whole line of Regency satellite products, see your Regency dealer or write us at the address below.



Regency Electronics Inc. • 7707 Records Street • Indianapolis, IN 46226

CIRCLE 279 ON FREE INFORMATION CARD

FREE

McIntosh STEREO CATALOG and FM DIRECTORY

Get all the newest and latest information on the new McIntosh stereo equipment in the McIntosh catalog. In addition you will receive an FM station directory that covers all of North America.



SEND TODAY!

McIntosh Laboratory Inc. RE
 East Side Station P.O. Box 96
 Binghamton, N.Y. 13904-0096

NAME _____
 ADDRESS _____
 CITY _____ STATE _____ ZIP _____

If you are in a hurry for your catalog please send the coupon to McIntosh. For non rush service send the Reader Service Card to the magazine.

CIRCLE 67 ON FREE INFORMATION CARD

MARCH 1985

ANTIQU RADIO

In search of antique radios

IT ISN'T REALLY NECESSARY TO OWN AN antique radio to be part of the *antique radio club*. You can be a member whether you actually own an old set or not. All that's needed is an interest in yesterday's technology. So join us as we purchase and analyze different sets of a bygone era. And then follow along as we restore those old radios—from chassis to cabinet—to better-than-new condition!

Newcomers to the world of antique radios often find that just reading about them isn't enough. They are soon overcome by intrigue, and their attention quickly turns to owning one—at least to begin with. But, where to look for antique radios can be a real problem!

Shops that deal in "fine antiques" may seem like the logical place to start, but you're not likely to find antique radios in such places. You may find an expensive beautifully-restored, wind-up Victorian or Grandfather clock; but few, if any, radios!

Most antique dealers (or antiquarians as they are called) do not consider an old radio to be antique, mostly because of strict guidelines that dictate the age of an item before it is considered an antique. Some collectables, like timepieces or photographs, date back over a hundred years. But radio didn't really get started until the early 1900's with the invention of diode and triode tubes (which we'll discuss from time to time).

Where to look for antiques

The classified section of the newspaper is a likely place to locate an old radio. It usually takes about two hours to go over the for-

sale column in the newspaper looking for old radios. Each ad must be read thoroughly, since there's no old radio category. Often the radio is buried in some obscure ad that reads: "For sale—sofa, bike, etc, and old radio."

Many fine old radios of all types and ages, and in various conditions can be found in the for-sale columns. However, most of them seem to have a price problem, because selling an old radio is only worthwhile if the advertiser can make a profit after paying for the ad. Often the antique radio is part of an estate sale. There are few bargains to be found at those sales because the commissions and heirs who'll be dividing the money keep the price inflated.

One radio in my collection that



FIG. 1



RICHARD D. FITCH

was purchased through a newspaper ad is the the *Majestic* shown in Fig. 1. I found that old set buried in an ad that listed other household items for sale. I called to inquire about the set, but the description I was given left me hanging—"It's old, and has four long legs," is what I was told. But, since I couldn't think of any new radio with four long legs, I decided to check it out.

When I finally got to see the set, it looked exactly the way it looks in Fig. 1, an old *T.R.F. Majestic* in need of some work. But since I didn't have anything like it my collection, I had to have it. The front veneer was peeling and the grill cloth was torn, but those two conditions are common with old radios. Grill cloth and veneer repairs are not too difficult to do, and will be discussed in the future.

Looking in the back of that old *Majestic*, all the parts seemed to be there. However, there was a heavy wire-harness hanging from the chassis, which was laying on a shelf (inside the cabinet) above the speaker. Since it had been severed, rather than unplugged, there was no question that restoring the chassis would be a much greater challenge than doing the same for the cabinet.

Having a phone number to call about a possible *find* is often as bad as having none at all because the information that people give can be misleading. So be prepared to face disappointment at least nine times out of ten. At least half of what's called a *really old radio* in ads turn out to be table models from the 1950's, like the set shown in Fig. 2. However, take the time to check it out anyway. Who knows,

you just may find something worth the effort.

While things may sound bad for antique-radio collectors, all is not lost. There's always the flea markets and used furniture stores. A used furniture store may sell antiques, but reproductions are more likely. Of the two, flea markets seem to be the best place.

Flea-market operators rarely restore or repair their wares. That helps to keep the price down and more in line with what we're looking for—an antique radio that can be restored and refinished, at a reasonable price, of course.



FIG. 2

What to look for

By now, we all know what is meant by antique radio. But do you know what to look for when purchasing one? Your own individual needs and abilities play an important part in the selection process. For instance, if you're an expert in cabinet work, you can make allowances for appearances. If you're not, or you have no place to work, try to find a set with a passable finish. Many old sets only need some cleaning and a little polish to brighten up the cabinet.

However, even more important than the cabinet is the chassis (a metal base where most working components are mounted). Unlike mostly-wooden cabinet parts, chassis components can not be manufactured to replace those that are missing. Therefore, trying the set out before you buy is a big plus in your favor. But that's not always possible, especially at flea markets.

If you're at a flea market where

you can't see the set light up or listen for a little hum, do the next best thing; check the chassis for missing parts. And if you're not familiar with old radios, take someone along who is. Remember once you buy something at a flea market, it cannot be returned.

Missing loudspeakers is probably the most common problem associated with buying old radios. Everyone knows enough to check the chassis for tubes and other

components, but don't overlook the speakers, especially in the larger console models. Most of the early radios had the speaker mounted high in the cabinet above the chassis. Make sure the complete speaker assembly is there or you may never restore the unit to its original condition.

Other things to look for include dry rot in line cords, grill cloths, the inside wiring, and missing knobs. Remember these tips and happy hunting. R-E

VIEW 8 TRACES ON YOUR SINGLE OR DUAL TRACE SCOPE WITH THIS LOW COST DEVICE!!

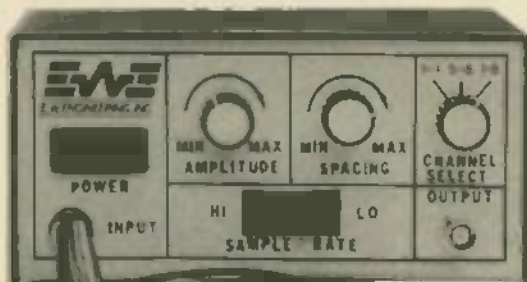

Now you no longer have to spend thousands on an expensive multi-trace oscilloscope - our single trace Hiachi scope combined with this module will allow you to view up to 8 simultaneously occurring analog or digital (for both) signals in their real time and amplitude relationship. The MPX 101 may be used on any oscilloscope, whether single, dual or multiple traces. Its low cost makes it a particular favorite for designers, testers, hobbyists and repairmen who want to compare and analyze displayed signals in a timing diagram format. The controls on the front panel of the metal case allow you to vary amplitude and spacing of the displayed signals.

MODEL MPX101
FULLY ASSEMBLED & TESTED



NOT
A
KIT

\$99.88

FULL 1
YEAR
REPLACEMENT
WARRANTY

- Made In The United States -

SPECIFICATIONS

Inputs: 8 signals plus ground via 9 input leads terminated with alligator clips
Bandwidth: ± 1 dB to 5 MHz
Impedance: 10.9 K
Input Voltage: ± 5 V peak (diode clamped to ± 5 Volt supplies)
Output: Staircase waveform summed with input signals, 0-800 mV full scale
Step Amplitude: Variable 0 to 150 mV/step
Signal Voltage: Variable 0 to

150 mV/step @ 5V Input
Multiplex Rate: Switch selectable, 40 KHz or 4 KHz
Impedance: 50 Ohms
Power: 105-135 VAC @ 1 V a
Dimensions: 6.25" x 3.25" x 4.75" (WxHxD)
Operating Temperature: 0-40°C
Weight: 1 lb. 10.5 oz.
Warranty: one year full replacement warranty from date of purchase
Lighted on/off power switch
Wood grain finished metal case

DISTRIBUTOR AND REPRESENTATIVE INQUIRIES INVITED

EWE
E.W. ENGINEERING, INC.

VISA, MASTERCARD, AMEX TELEPHONE ORDERS ACCEPTED
6 Herman Drive, E. Granby, CT 06026 □ 203/651-0285

CIRCLE 61 ON FREE INFORMATION CARD

MARCH 1985

STATE OF SOLID STATE



ROBERT F. SCOTT,
SEMICONDUCTOR EDITOR

High-power microwave FET's

MOST POWER MOSFET'S DEVELOPED SO far have been low-frequency devices that are mainly used in switching and audio applications. Thus, silicon bipolar transistors have handled the work load in the design of VHF, UHF, and microwave equipment.

However, it now appears that recent improvements in MOSFET technology will make possible transistors that can handle appreciable amounts of power in the GHz-range, yet provide several advantages over the silicon bipolar transistor. Among the advantages are: DC bias unaffected by temperature fluctuations, higher input-impedance, and lower output-impedance.

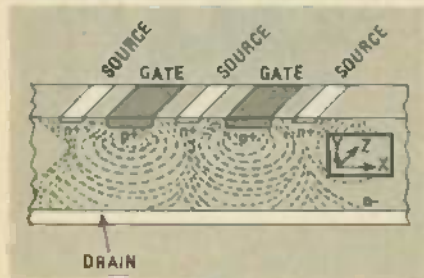

FIG. 1

The FET is a voltage-driven device so it is ideal for use in Class-A and -AB amplifiers, and other amplifiers that require linear transfer characteristics.

The new high-frequency power MOSFET is called the Power Silicon FET (PSIFET) by the developer—Microwave Semiconductor Corp., 100 School House Rd., Somerset, NJ 08873. It is the result of work advanced by Microwave Semiconductor after J. Nishizawa of Mitsubishi proposed that a JFET with a very short vertical channel

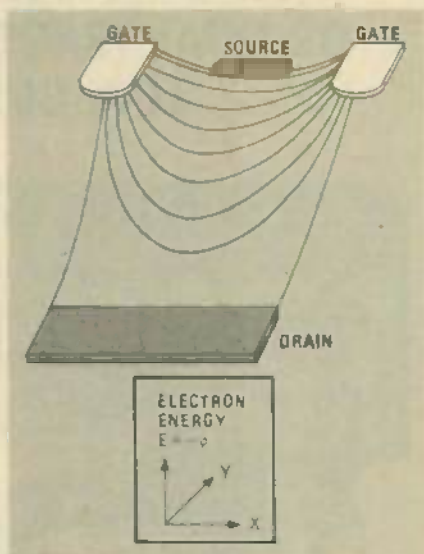

FIG. 2

would provide superior microwave performance.

The PSIFET uses a short-channel vertical JFET configuration similar to that of the TMOS FET described in the February column. Like other vertical-channel FET's, both gate and source are formed on the top surface of the silicon die and the drain is on the bottom as shown in Fig. 1.

In the conventional JFET, the

gate voltage controls the cross-section of the lateral source-to-drain channel; thus it also controls the channel's resistance and the current flowing through it. Note that in the PSIFET, the channel is always fully depleted (completely devoid of holes and free electrons), although the electric potential in the depletion area varies with gate voltage.

The electric potential in the channel's depletion region forms a barrier that tends to block electron flow between the source and drain. However, if a sufficiently high voltage is applied to the drain, it generates an electrostatic field that counteracts the poten-

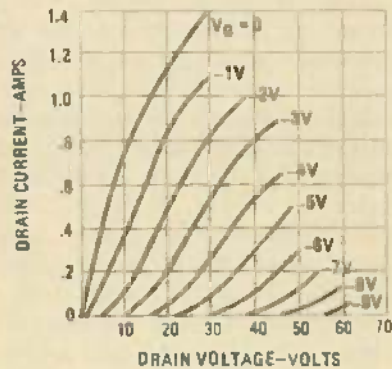

FIG. 3

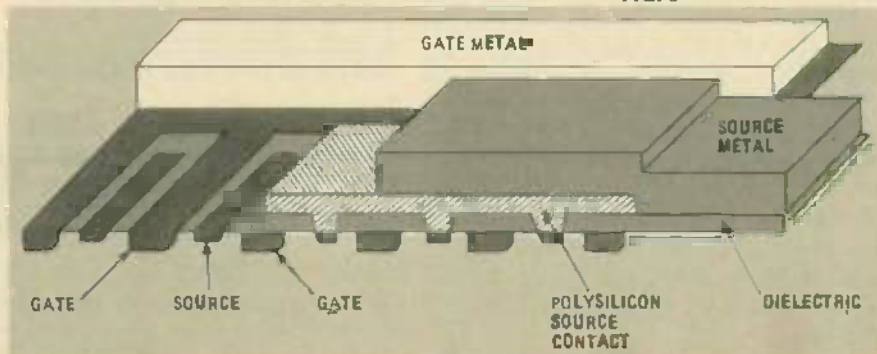

FIG. 4

tial-barrier in the depletion area. That allows electrons to be injected from the source into the drain.

Figure 2 shows the distribution of the electric potential in the PSIFET. We can see that the source-to-drain current must flow through a potential "neck." That neck impedes electron flow to a degree determined by the gate and drain voltages. (That's similar to the action of the grid of a triode vacuum tube in controlling plate current. Plate current is determined by the grid and cathode voltages.)

A more negative voltage on the gate increases the potential in the neck and reduces drain current. A more positive drain voltage increases drain current by pulling down the potential in the neck. You "old timers" will immediately recognize the triode-like performance of the voltage-current characteristics curves in Fig. 3.

Despite its non-saturating traits, the PSIFET is similar in operation to a silicon bipolar-transistor. The most important difference is that the neutral p-type base has been replaced by a depleted n-type region. Injected carriers in the PSIFET are majority carriers—not minority carriers—and they travel by drift, not diffusion.

PSIFET design

The design configuration of the PSIFET is unique and differs from other vertical FET's. In the PSIFET's design, individual source sites (see Fig. 4) run at right angles to the length of the source metallization fingers and extends across their width. That layout allows the use of wide gate and source metal-fingers as compared to the 1 to 2 fingers in other microwave silicon FET designs. The wide fingers keep current density low.

A highly n-doped polysilicon material provides the intimate contact with the source. That removes a metal contact from the sensitive source area and increases reliability during long periods of high-temperature, high-current operation.

Advantages of the PSIFET

Since its carriers travel by drift rather than diffusion, a PSIFET's

carrier velocity is higher than that of a bipolar device and can exhibit a higher f_t (gain-bandwidth product) along with a high breakdown voltage. The PSIFET is relatively insensitive to both long-term and transient exposure to high-energy radiation.

It has a negative temperature coefficient so it is immune to thermal runaway and hot spots at high current levels. The drain area of the PSIFET is spread out on the back side of the die, where it can be

closely coupled to a heatsink. The configuration of the new device does not include the thin SiO_2 insulating film around the gate area, so it is immune to catastrophic failure due to accumulated static charges.

Extensive tests have been run on PSIFET's at 450 MHz and 1 GHz. Input and output microstrip circuits were used to match the devices to 50-ohm impedances. For the 450-MHz test, a PSIFET with a 5.6 cm gate-width and eight sepa-

A QUALITY TRIPLE-REGULATED POWER SUPPLY AT A LOW, LOW PRICE!!

NOT A KIT!



MODEL PS101
FULLY ASSEMBLED & TESTED!

\$ **119** ⁸⁸

FULL 1 YEAR REPLACEMENT WARRANTY

- Made In The United States -

SPECIFICATIONS

3 outputs:
Fixed 5 VDC \pm 0.2V
2 variable \leq 1% V to \geq 18 VDC
Polarity - floating; can be used as pos. or neg.
Ripple less than 10mV at full load.
Regulation \leq 1% no load to full load.
Line Regulation $<$ 0.2% 108 VAC to 135 VAC.
Current:
Fixed supply 1.0 amp max.
Variable supplies 0.5 amp max.

Protection built in, current limiting, with thermal shutdown.
Power: 108-135 VAC.
Dimensions: 5 1/2" x 3 1/2" x 7 1/2" (WxHxD)
Wood grain finished metal case.
Weight: 4 lbs., 9 oz.
Lighted on/off power switch, easy-to-read Voltmeter, and large binding posts.
Warranty: one year full replacement warranty from date of purchase.

DISTRIBUTOR AND REPRESENTATIVE INQUIRIES INVITED

E.W.E.
E.W. ENGINEERING, INC.

VISA, MASTERCARD, AMEX TELEPHONE ORDERS ACCEPTED!
6 Herman Drive, E. Granby, CT 06026 □ 203/651-0285

CIRCLE 280 ON FREE INFORMATION CARD

MARCH 1985

rate transistor cells, was formed on a 33 x 75 mil die. The transfer characteristics of the device are in Fig. 3. That single die delivers 48.5 watts of saturated CW power with 60% drain efficiency. A similar device with 3.5-cm gate fingers was tested at 1 GHz, and it delivered 21.5 watts saturated CW power at 40% drain efficiency.

Applications

Unless it is quickly superseded by vastly improved technology, we

can expect PSIFET's to easily find their way into linear amplifiers for communications applications. It is possible to make 70- to 100-volt V_{DD} CW microwave-power FET's. These would be ideal for lower-cost, low-current high-power linears. Another possible application is as a high-power modulator for a modulated pulsed-power amplifier chain. We're going to go on the alert and watch for further developments of the PSIFET. Hope you will also.

Transistor data book

The *Small-Signal Transistor Data Book* is an all-new 1350-page databook providing the complete specifications and typical performance curves on the more than 1750 Motorola bipolar and FET devices.

The devices covered are packaged in metal-can, plastic, and miniature housings and are grouped together by families.

The first section is the "Selector Guide," which indexes the transistors into groups according to the headings of the six following chapters. Each chapter has at least three tables listing each device according to a sub-grouping. For example, tables listed in the second chapter ("Plastic-Encapsulated Transistors") are general-purpose, high-speed switching, RF/UHF/VHF amplifiers, high-voltage, dual diodes, and choppers. The five following chapters are: "Micro-miniature Products" (SOT-23 and SOT-89) which covers those devices contained in surface-mount packaging.

"Metal-Packaged Transistors" covers those devices in TO-18, TO-39, TO-46, TO-52, and TO-72 package options. Included are general-purpose, switching, high-voltage, choppers, Darlingtons, low-noise amplifiers, and RF amplifiers.

"Multiple Transistors" covers both quad and dual transistors that have been implemented on a common substrate.

"Field-Effect Transistors" includes devices operating from DC to UHF for switching and amplifying applications. They are available in plastic and metal-can packages. "RF Transistors" characterizes small-signal high-frequency transistors as low-noise amplifiers, oscillators, high-speed switches, Class A linear amplifiers, and Class C amplifiers. Package types include plastic/ceramic stripline and various metal cans.

The wrap-up is an 8-page section of package outline drawings and dimensions and application information. *Small-Signal Transistor Data Book* (DL226) is available for \$6.95 per copy (1 to 9 pieces) from Motorola Semiconductor Products, PO Box 20912, Phoenix, AZ 85036. R-E



In the rapidly changing field of electronics, it isn't surprising to be able to telephone a company many miles away, place an order (the computer tells you it is in stock) and have it delivered within a matter of hours. The surprise comes when you receive the bill.

At CEI, our surprise is that when you call, you will know the full price of your order and the method and cost of delivery. You see, we give you a choice of overnight delivery or a less costly transportation depending on your needs.

Just like our competitors, we can ship your needed part immediately but if you are supplementing your store stock with specials from the CEI catalog why not let us save you the extra cost of immediate delivery.

That's extra savings to you making our already value priced catalog items even a better deal. Give us a call to find out just how much you can save on our complete selection of electronic parts. But don't tell your competitors. Leave the surprise for them.

**It's no surprise,
CEI saves you money.**

1-800-543-3568

NATIONAL WATS
TELEX NO. 288-229

1-800-762-3412

OHIO WATS
IN DAYTON: 513/252-5462

CALL TOLL FREE!

CEI Consolidated Electronics, Incorporated

705 WATERVLIET AVE.
DAYTON OH. 45420-2599

CIRCLE 81 ON FREE INFORMATION CARD

NEW IDEAS

Entryway monitor

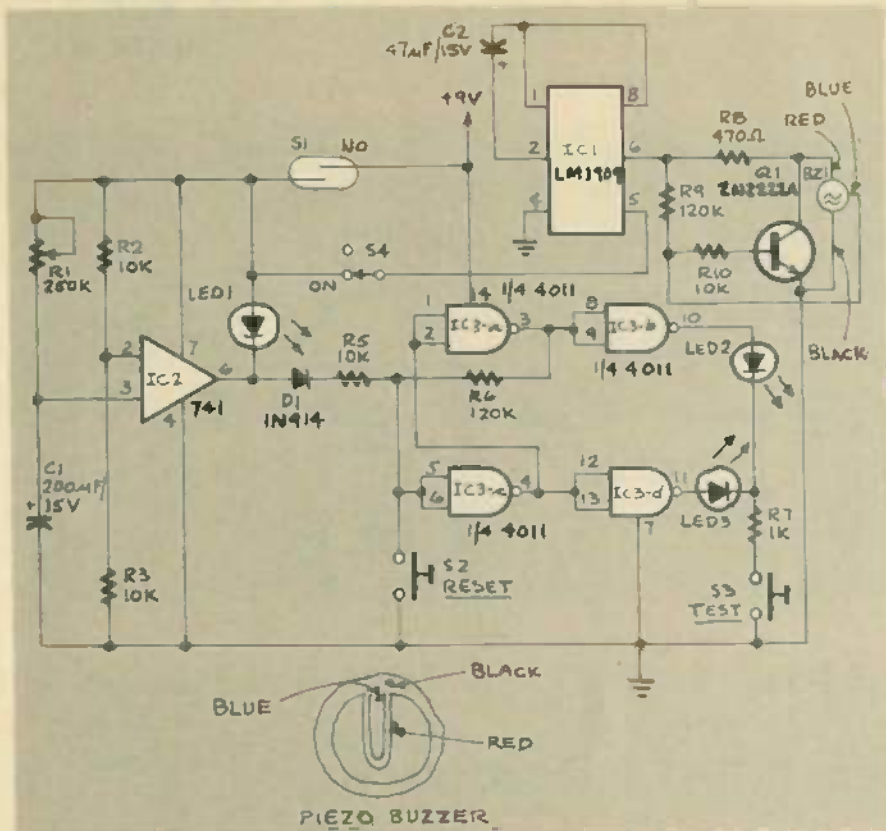

FIG. 1

EVER WONDER IF A GAS OR ELECTRIC company representative came to read the meter while you were out, or if your landlord has visited your apartment without your knowledge? Well, wonder no longer! The circuit described here is designed to be your personal *watchdog*. Figure 1 is a schematic of the watchdog circuit.

How it works

At first glance, the circuit in Fig. 1 may appear a bit complex. However, a closer look shows that it's really a simple circuit made up of only three IC's and a few discrete components, all of which fit nicely into a small project box. The circuit has three main sections: a

time delay provided by IC2 (a 741 op-amp); a set/reset flip-flop made up of IC3 (a 4011 quad NAND gate), and a piezo-element driver section consisting of a IC1 (LM3909 LED flasher) and transistor Q1.

With a simple flick of a switch (S4), you can choose either a silent or audible mode. Either way, once tripped, the circuit can only be reset by you. In the silent mode, one of two LED's light to show the status of the circuit. In the audible mode, a piezo buzzer sounds off to show that the circuit has been tripped. In that mode, the buzzer can also double as a door annunciator.

You may choose between two audio outputs: warbling tone or

constant tone. The warbling-tone effect is produced by IC1, and that is its only function in the circuit. Depending on the value chosen for C2, anything from a warbling tone to a slow pulsed output can be produced. However, if no audio output is desired, the driver section and the piezo element can be eliminated.

Checking the status of the circuit is as simple as pressing a switch, before the delay has timed out. If, when switch S3 is pressed, LED2 lights, all is well. But if LED3

continued on page 101

NEW IDEAS

This column is devoted to new ideas, circuits, device applications, construction techniques, helpful hints, etc.

All published entries, upon publication, will earn \$25 in addition, for U.S. residents only. Panavise will donate their model 333—The Rapid Assembly Circuit Board Holder, having a retail price of \$39.95. It features an eight-position rotating adjustment, indexing at 45-degree increments, and six positive lock positions in the vertical plane, giving you a full ten-inch height adjustment for comfortable working.

I agree to the above terms, and grant Radio-Electronics Magazine the right to publish my idea and to subsequently republish my idea in collections or compilations of reprints of similar articles. I declare that the attached idea is my own original material and that its publication does not violate any other copyright. I also declare that this material has not been previously published.

Title of Idea

Signature

Print Name

Date

Street

City

State

Zip

Mail your idea along with this coupon to: New Ideas Radio-Electronics, 200 Park Ave. South, New York, NY 10003

MARCH 1985

SERVICE CLINIC

The ubiquitous op-amp

UBIQUITOUS IS A WORD THAT I PICKED up quite a while ago, and I've been trying to use it ever since—Well, now I have the chance! *Ubique* is Latin for "everywhere you look." It's the perfect word to describe op-amps (or operational amplifiers). Op-amp IC's are showing up in the newer TV sets and are used in a number of applications: vertical oscillators, signal amplifying stages, and so on. In many sets, they are used as the vertical-output amplifier.

Each op-amp has two inputs: The inverting input (denoted by -) and the non-inverting (+) input. By grounding one input, we can get a "straight" amplifier, which will invert the signal or not, depending on the input that's grounded. By fiddling with the feedback or bias resistors, op-amps can be made to have a very high gain, and also an almost infinite input-impedance!

Servicing video circuits

Figure 1 is a partial schematic of a TV set (E53 chassis) that uses an op-amp as an vertical-output amplifier. Sets of that type are easy to check; at least this one is. All you need to do is check the waveforms at the input and output. That will tell you all you want to know: Is the darn thing working?

First notice that the input is a sawtooth wave of only 1.2-volts P-P. But at the output, there's quite a different waveform. That's because the circuit is driving an inductive load, the vertical yoke. Not only that, the 1.2-volt input has been amplified to 19-volts P-P (a pretty hefty gain), which is needed to provide full deflection.

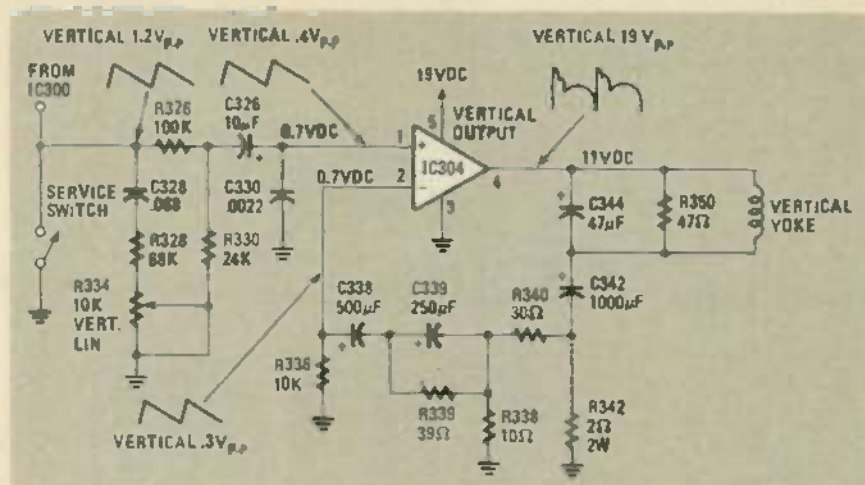

FIG. 1

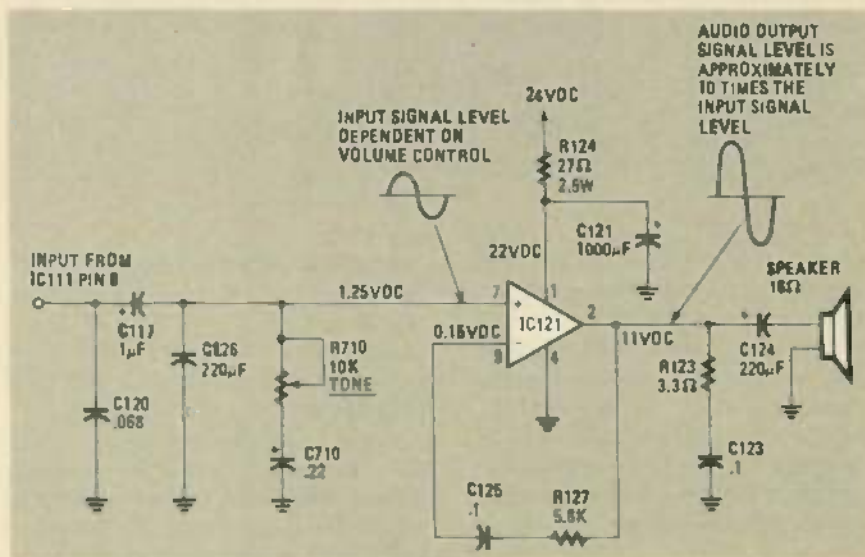

FIG. 2

Now look at the op-amp, IC304, which is configured as a non-inverting amplifier with negative feedback applied to pin 2, the inverting input. That feedback is extremely important in maintaining the linear operation of the op-amp. Without it, the op-amp would go to

positive saturation whenever pin 1 is more positive than pin 2.

The first step in servicing (after a visual check, of course) is to measure the peak-to-peak voltage of the input and output waveforms with a scope. If you find that the input is OK, but the output isn't,



JACK DARR

measure the operating voltages. If they're in the ballpark, measure some of the resistors and make sure the IC has the full 19 volts DC on pin 5. Then check pin 4 for the normal 11-volt DC output. That is a key voltage; if it's off, the chances are the IC is defective.

Audio circuits

Video stages aren't the only circuits where op-amps are used; it is now becoming common to find them used in audio circuits, as shown in Fig. 2. (I told you they were ubiquitous, didn't I?) Note that the output level is specified at ten times the input.

The circuit is checked in the same way as the previous one—read the DC voltages (input, supply, etc), and then check the DC voltages that are output from the IC. Check both sides of the coupling capacitor, C124—a simple task using a scope. Signal levels on both sides of a coupling capacitor should be identical.

If the input waveform is present at the input side of the capacitor but not at the output, the job is over. (The capacitor is open.) If the coupling capacitor is a low-voltage electrolytic, look there first—it's the most likely trouble spot. Many have been found to be open.

Also, watch for intermittent components; I have found several capacitors that were obviously open, but when unsoldered and taken out, they checked out good! What happens is the capacitor leads open up inside the unit, and when unsoldered, they "heal up!" Always replace capacitors that show that condition; the problem can—and probably will—return if you don't!

So, you can see that the op-amp is a very useful gadget, and one deserving of your attention. You can expect to see more and more of them as time goes by. R-E

SERVICE QUESTIONS

STRANGE SYMPTOMS

I have an RCA CTC120 chassis that's about to drive me crazy. I've

replaced the flyback and the deflection IC (U401), and now the vertical is stretched out so far that the scanning lines are 3/8-inch apart. I have never run into a problem like this.—
T.B., Brooks, KY

You're not alone; I have no simple answer. However, I do have a rule of thumb that I follow in cases such as yours. First, let us presume that the reasons for changing the flyback and deflection IC had nothing to do with the present situation. Further, we'll also presume

that the vertical problem did not exist before changing those parts.

It would follow, then, that something we did may have introduced the new problem. Hence, I would re-examine every solder connection and component that I'd touched—including the IC itself. More than that, this job requires a scope. Check the input and output waveforms around the vertical circuits. An overscan that large should stand out like a duck in a teacup. R-E

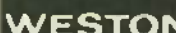
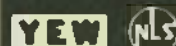
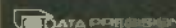
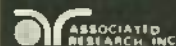
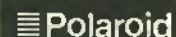
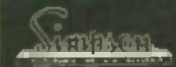
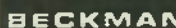
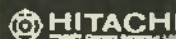
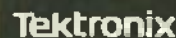

AN INNOVATIVE 20 MHz OSCILLOSCOPE THAT EMPHASIZES OPERABILITY \$535*

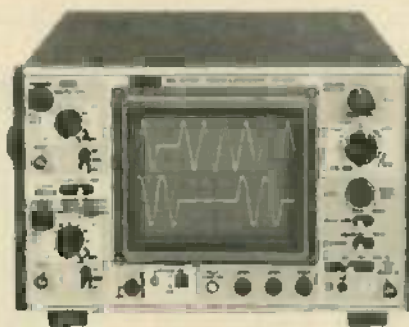

IWATSU

SS-5702

DC-20 MHz OSCILLOSCOPE

- 6-inch rectangular, parallax-free CRT
- TV-V trigger
- Variable sweep length
- Double Lissajous figure
- 1 mV/div to 10 V/div sensitivity
- 100 ns/div to 0.2 s/div sweep
- Differential input with ADD mode

*User price, including probes.



The Professional Test Equipment Source

The Instrument Mart

295 Community Drive, Great Neck, New York 11021
(516) 487-7430 Outside N.Y. (800) 645-6535

Sales, Service, Rental/Leasing Programs
... and Pre-Owned Test Equipment also Available



NEW PRODUCTS

CLEANER/PRESERVATIVE, *CRAMOLIN Red Liquid*, is a fast-acting, anti-oxidizing lubricant that cleans and preserves metal contact/connector surfaces. Corrosive atmospheric compounds coat metal connections with non-conducting oxide films that increase contact resistance; eventually the film becomes so thick that intermittent signals or complete failure results. *CRAMOLIN Red Liquid* dissolves oxide films and leaves a long-lasting protective layer.

It is particularly for use on switches, potentiometers, relays,



CIRCLE 11 ON FREE INFORMATION CARD

PCB connectors, and interconnecting cables, but the applications are unlimited.

CRAMOLIN Red Liquid is available in 2-ounce bottles (*R100C*) at

\$9.95 each and 6-ounce 5% spray cans (*R5*) at \$6.95 each.—Caig Laboratories, Inc., 1175-0 Industrial Ave. (PO Box J), Escondido, CA 92025-0051.

LEAD BENDER, model *LB-300*, is a hand tool for bending component leads to preset dimensions prior to insertion in PC boards. Pointers on the tool set lead distance to match hole-to-hole locations on printed-circuit boards. Setting and bending adjustments are made by turning a thumb wheel to the desired spacing.

Lead wires are held securely during forming to prevent lateral stress on component body; the model *LB-300* is designed so that components are always positioned centrally for equal leg

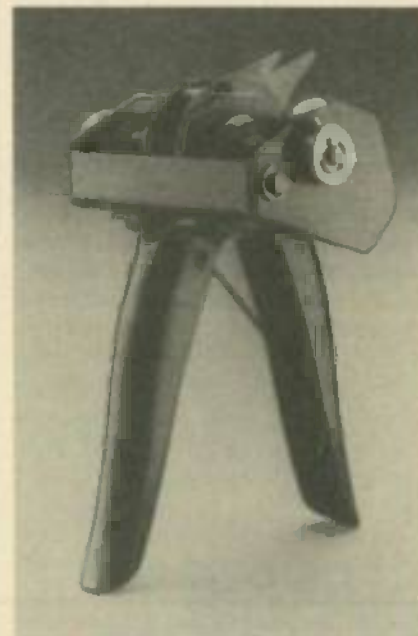

CIRCLE 12 ON FREE INFORMATION CARD

length. The suggested price for the model *LB-300* is \$31.10.—OK Industries, Inc., 3455 Conner Street, Bronx, NY 10475. R-E

ELECTRONIC COMPONENTS



MANUFACTURERS OF QUALITY ELECTRONIC COMPONENTS

• BATTERY CLIPS & HOLDERS

- CABLE SETS • CONNECTORS • CAPACITORS
- DISPLAYS • SEDs • FUSES • JACKS & PLUGS
- BNOSS • LAMPS • POTENTIOMETERS
- RF COILS • RELAYS • RESISTORS
- SWITCHES • SEMICONDUCTORS • SPEAKERS
- TEST EQUIPMENT • TRANSFORMERS • TOOLS
- WIRE & CABLE

OVER 15,000 DIFFERENT ITEMS IN STOCK!

- Sales and Order Dept. Open from 8:00 - 5:00 (PST)
- 118MS C.O. Van Meter-Chart
- Phone and Mail Orders Welcome
- Carriers Mailed Overseas USA
- 10 Open Account Available
- 1-800-345-2222

MOUSER ELECTRONICS

11433 WOODSIDE AVE. SANTEE CA 92071
PHONE (619) 449-2222 TWX 910 331-1175

CIRCLE 117 ON FREE INFORMATION CARD

Copies of articles from this publication are now available from the UMI Article Clearinghouse.

Yes! I would like to know more about UMI Article Clearinghouse. I am interested in electronic ordering through the following system(s):

- DIALOG/Dialorder
- OnType
- ITT Dialcom
- OCLC ILL Subsystem
- Other (please specify) _____
- I am interested in sending my order by mail
- Please send me your current catalog and user instructions for the system(s) I checked above.

Name _____
 Title _____
 Institution/Company _____
 Department _____
 Address _____
 City _____ State _____ Zip _____
 Phone (____) _____

UMI Article Clearinghouse

Mail to: University Microfilms International
300 North Zeeb Road, Box 91 Ann Arbor, MI 48106

NEW IDEAS

continued from page 97

lights, someone has tripped the circuit. The remaining LED provides a visual indication of the delay time.

When the circuit is untripped, a low is applied to the input of IC3-b. Therefore, a high is output at pin 10. Pressing switch S3, TEST, provides a path to ground through LED2 and causes it to light, indicating that the circuit has not been tripped.

However, pressing the RESET switch (S2) causes the flip-flop to change states, which means that pin 10 goes low and pin 11 of IC3-d goes high. Now a press on S3 causes LED3 to light and LED2 remains dark. Also, a delay is provided so that you can enter or leave your apartment without triggering the circuit.

If switch S1 is closed when the delay times out, or the circuit is tripped by someone entering the apartment, IC2 outputs a high. That high is delivered to the input of the flip-flop via diode D1 and resistor R5. That, in turn, causes the flip-flop to change states. Now a high is at the anode of LED3, which means it will light when S3 is pressed, showing that someone has been in your apartment.

The delay time is dependent on the setting of potentiometer R1 and the value of capacitor C1. Make sure that the delay provides ample time for you to enter and check the status of the watchdog circuit, or to leave the apartment. The delay time may be varied to suite your needs using R1.

When switch S1 is tripped, capacitor C1 begins charging through R1 and the voltage at pin 3 of IC2 begins to rise. When that voltage reaches the level of that at pin 2 (set by the R2/R3 series combination), IC2 outputs a high at pin 6, which triggers the flip-flop. That turns LED2 off and LED3 on.

The method of construction is not critical; wirewrap, point-to-point wiring, or a PC board of your own design works fine. Housing for the circuit is again a matter of choice. S1 is a normally-open magnetic, security-type switch, and is

mounted at the door so that it makes contact when the door is opened and visa versa when the door is closed. S2 and S3 are normally-open momentary switches, and S4 is a SPST.

With switch S4 engaged, the circuit draws 10-11 milliamps of current, and when open, it draws only 5-6 milliamps. If you include the audio portion of the circuit, it can be used to test the operation of the circuit. LED's 2 and 3 should be red and green, respectively, to make it easier to check the status of the circuit. LED1, the delay time indicator, can be either color. (It's your choice.)

To test the project simply trip the circuit several times and check its status, as shown by watching the LED's, and listening for the buzzer (if it's included). The unit may also be used at windows along with a loud bell or siren to scare off unwanted visitors. There are other possibilities as well, like triggering a hidden video monitor and recorder, etc.—Ronald I. Goers

RESISTOR/CAPACITOR

continued from page 66

capacitors may explode if exposed to reverse or overvoltage conditions.

Aluminum electrolytics are used in filtering, coupling, and bypass applications where large capacitances, and capacitance that are higher than the nominal value, can be tolerated.

Trimmer capacitors

Trimmer capacitors fall into three categories: multi-turn, single turn, and compression types. Multi-turn capacitors have either glass, quartz, sapphire, plastic, or air dielectrics, while single-turn devices use ceramic, plastic, or air dielectrics. Compression types use a mica dielectric.

Glass, quartz, or air dielectric devices are selected for applications requiring low loss, high Q, stability, and tuning sensitivity. Glass and quartz devices are used at frequencies up to 300 MHz. Air dielectrics are usable to about 1 GHz. For frequencies of 1 GHz, sapphire dielectrics offer the best performance.

Ceramic and plastic styles are less expensive, with high grade plastic dielectric devices being usable at frequencies up to 2 GHz. R-E

Radio-Electronics REPRINT BOOKSTORE

- | | |
|--|--|
| <input type="checkbox"/> Build Your Own Satellite TV Receiver \$7.00 | <input type="checkbox"/> Special Projects (Spring 1981) \$4.50 |
| <input type="checkbox"/> 8-Ball Satellite TV Antenna \$5.00 | <input type="checkbox"/> Special Projects #4 (Summer 1982) \$4.50 |
| <input type="checkbox"/> Build Your Own Robot \$12.00 | <input type="checkbox"/> Special Projects #5 (Winter 1983) \$4.00 |
| <input type="checkbox"/> TV Descrambler (January, February 1981) \$3.00 | <input type="checkbox"/> Special Projects #6 (Spring 1983) \$4.00 |
| <input type="checkbox"/> Radio-Electronics back issues (1984) \$3.00 | <input type="checkbox"/> Special Projects #7 (Summer 83) NOT AVAILABLE |
| <input type="checkbox"/> Radio-Electronics back issues (1983) \$3.50 | <input type="checkbox"/> Special Projects #8 (Fall 83) \$4.00 |
| (January, February 1983 not available) | <input type="checkbox"/> Special Projects #10 (Spring 84) \$4.00 |
| Write in issues desired. | <input type="checkbox"/> Radio-Electronics Annual 1983 \$3.50 |
| <input type="checkbox"/> Radio-Electronics back issues (1982) \$3.50 | <input type="checkbox"/> Radio-Electronics Annual 1984 \$2.50 |
| Write in issues desired. | <input type="checkbox"/> How to Make PC Boards \$2.00 |
| <input type="checkbox"/> Radio-Electronics back issues (1981) \$4.00 | <input type="checkbox"/> All About Kits \$2.00 |
| (Jan., Feb., March, Dec. 1981 not available) | <input type="checkbox"/> Modern Electronics (Vol. 1, #1 \$2.25 |
| Write in issues desired. | April 1988) |
| <input type="checkbox"/> Etch your own PC boards \$3.00 | <input type="checkbox"/> Electro Importing Co. Catalog \$4.95 |
| <input type="checkbox"/> Hands On Electronics #1 \$3.00 | (1918) (176 pp) |
| <input type="checkbox"/> RE Annual '85 \$2.50 | <input type="checkbox"/> Low Frequency Receiving Techniques \$6.00 |
| To order any of the items indicated above, check off the ones you want. Complete the order form below, include your payment, check or money order (DO NOT SEND CASH), and mail to Radio-Electronics, Reprint Department, 200 Park Ave. South, New York, NY 10003. Please allow 4-6 weeks for delivery. | <input type="checkbox"/> Building and using VLF Antennas |
| | <input type="checkbox"/> New Ideas - 42 circuits for experimenters .. \$4.00 |

If you need a copy of an article that is in an issue we indicate is unavailable you can order it directly from us. We charge 50¢ per page. Indicate the issue (month & year), pages and article desired. Include payment in full, plus shipping and handling charge.

ARTICLE _____
 PAGES _____ MONTH _____ YEAR _____
 @ 50¢ each
 TOTAL PAGES _____ TOTAL PRICE _____

MAIL TO: **Radio-Electronics**
 Reprint Department, 200 Park Ave. South, New York, NY 10003

Total price of order \$ _____
 Sales Tax (New York State Residents only) \$ _____
 Shipping & Handling (U.S. & Canada only) (Includes FIRST CLASS POSTAGE) \$1.00 per item \$ _____
 All other countries (\$2.00 per item, sea mail) \$ _____
 (\$4.00 per item, air mail) \$ _____

Total Enclosed \$ _____

Name _____
 Address _____
 City _____ State _____ Zip _____

All payments must be in U.S. funds

MARKET CENTER

FOR SALE

CABLE-TV Secrets—the outlaw publication the cable companies tried to ban. HBO, Movie Channel, Showtime, descramblers, converters, etc. Suppliers list included. \$8.95. **CABLE FACTS**, Box 711-R, Pataskala, OH 43062.

RESISTORS 1/4W&1/2W5% 3 cents, 1% metal films, precision custom wirewounds, \$1.00 refundable to: **JR INDUSTRIES**, 5834-B Swancreek, Toledo, OH 43614.

FREE catalog featuring scanner accessories, carriers, subcarrier detectors, voice scramblers, unusual kits. **CAPRI ELECTRONICS**, Route 1R, Canon, GA 30520.

THE Intelligence Library—Restricted technical information & books on electronic surveillance, surveillance-device schematics, lock-picking, investigation, weapons, identification documents, covert sciences, etc. The best selection available. Free brochures. **MENTOR**, (Dept. Z), 135-53 No. Blvd., Flushing, NY 11354.

CABLE-TV equipment, tunable notch filters for "beeping" channels. Information \$1.00, **DK VIDEO**, PO Box 83/6025, Margate, FL 33063.

DIGITALKER Speech Synthesizer has 136 word vocabulary. Interfaces with parallel port of your computer. PCB and plans \$12.00. **JIM RHODES, INC.**, 1025 Ransome Lane, Kingsport, TN 37660.

WHOLESALE F-59 cable connector \$80.00/1000. Free MATV catalog, S.A.S.E. (212) 897-0509. **O&W.R.** 68-12 110 Street, Flushing, NY 11375.

T1-99/4A software/hardware bargains. Hard-to-find items. Huge selection. Fast service. Free catalog **DYNA**, Box 690, Hicksville, NY 11801.

TUBES, new, unused. Send self-addressed, stamped envelope for list. **FALA ELECTRONICS**, Box 1376-2, Milwaukee, WI 53201.

FREE Pay-TV reception, "How-To" book HBO, Showtime, Cinemax. \$5.00. **DIPTRONICS**, Box 80 (E4), Lake Hiawatha, NJ 07034.

AUTOMOTIVE Security Catalog, 1984, 24-page color catalog, \$2.00. **ASE**, Dept 1, PO Box 382, Plainview, NY 11803.

THE BEST PLACE to BUY, SELL or TRADE NEW and USED EQUIPMENT

NUTS & VOLTS MAGAZINE
BOX 1111-E • PLACENTIA, CA 92670
(714) 433-7721

John Thousands of Readers Nationwide Every Month

ONE YEAR U.S. SUBSCRIPTIONS
\$18.00 - 3rd Class • \$15.00 - 1st Class

\$35.00 - Lifetime - 3rd Class

NUTS & VOLTS

HOW TO BUY
COMPUTERS
SOFTWARE
REARVIEW & OPTICAL
VIEW EQUIPMENT
REARVIEW
SATELLITE
AUDIO VISUAL
AND PERIPHERALS
COMPONENTS • SETS
ANTHROUS ELECT
PUBLICATIONS
PLANS • SERVICES

CORDLESS-phone owners. Increase distance, reduce static on 1.7/49MHz phones. Details \$1.00 refundable. **HP PHONES**, Box 273, Mesa, AZ 85201.

COCO owners—Free color computer software and hardware catalogue. **SPECTRUM**, Box 9866, San Jose, CA 95157-0866.

INDIVIDUAL photofact folders. No. 1 to no. 1400, \$3.00 postpaid. **LBT**, 414 Chestnut Lane, East Meadow, NY 11554.

DESCRAMBLERS for downconverters. High gain. Send \$2.00. **RB ELECTRONICS**, PO Box 643, Kalamazoo, MI 49005.

TOKO Coil set (four) \$8.00. BFG85 substitute transistor \$2.00. **JIM RHODES, INC.**, 1025 Ransome Lane, Kingsport, TN 37660.

CABLE-TV products. Jerrold, Hamlin, and Oak converters. Send \$3.00 for information. **ADDITIONAL OUTLET CORP.**, 1041 W. Commercial Blvd., Ft. Lauderdale, FL 33309.

TOKO coils and printed circuits. Quantity discounts. **JIM RHODES, INC.**, 1025 Ransome Lane, Kingsport, TN 37660.

ELECTRONICS catalog. Over 4,500 items. Parts & components. Everything needed by the hobbyist or technician. \$2.00 postage & handling (United States only), refundable with first \$15.00 order. **T & M ELECTRONICS**, 472 East Main Street, Patchogue, NY 11772. (516) 289-2520.

CABLE-television facts and secrets. Now you can get the informative publication that CATV companies have been unsuccessfully trying to get banned for 15 years. **Movie Channel**, HBO, and **Showtime** converters, etc. Send \$8.95 to: **CABFAX**, PO Box 091196, Bexley, OH 43209.

CLASSIFIED AD ORDER FORM

To run your own classified ad, put one word on each of the lines below and send this form along with your check to:

Radio-Electronics Classified Ads, 200 Park Avenue South, N.Y., N.Y. 10003

PLEASE INDICATE in which category of classified advertising you wish your ad to appear. For special headings, there is a surcharge of \$20.00.

() Plans/Kits () Business Opportunities () For Sale
() Education/Instruction () Wanted () Satellite Television

Special Category: \$20.00

PLEASE PRINT EACH WORD SEPARATELY, IN BLOCK LETTERS.

(No refunds or credits for typesetting errors can be made unless you clearly print or type your copy.) Rates indicated are for standard style classified ads only. See below for additional charges for special ads. **Minimum: 15 words.**

1	2	3	4	5
6	7	8	9	10
11	12	13	14	15 (\$37.50)
16 (\$40.00)	17 (\$42.50)	18 (\$45.00)	19 (\$47.50)	20 (\$50.00)
21 (\$52.50)	22 (\$55.00)	23 (\$57.50)	24 (\$60.00)	25 (\$62.50)
26 (\$65.00)	27 (\$67.50)	28 (\$70.00)	29 (\$72.50)	30 (\$75.00)
31 (\$77.50)	32 (\$88.00)	33 (\$82.50)	34 (\$85.00)	35 (\$87.50)

We accept MasterCard and Visa for payment of orders. If you wish to use your credit card to pay for your ad fill in the following additional information (Sorry, no telephone orders can be accepted.):

Card Number

Expiration Date

Signature

IF YOU USE A BOX NUMBER YOU MUST INCLUDE YOUR PERMANENT ADDRESS AND PHONE NUMBER FOR OUR FILES. ADS SUBMITTED WITHOUT THIS INFORMATION WILL NOT BE ACCEPTED.

CLASSIFIED COMMERCIAL RATE: (for firms or individuals offering commercial products or services) \$2.50 per word prepaid (no charge for zip code). **MINIMUM 15 WORDS.** 5% discount for same ad in 6 issues; 10% discount for same ad in 12 issues within one year; if prepaid. **NON-COMMERCIAL RATE:** (for individuals who want to buy or sell a personal item) \$2.00 per word, prepaid, no minimum. **ONLY FIRST WORD AND NAME** set in bold caps at no extra charge. Additional bold face (not available as all caps) 50¢ per word additional (20% premium). Entire ad in boldface, add 20% premium to total price. **TINT SCREEN BEHIND ENTIRE AD:** add 25% premium to total price. **TINT SCREEN BEHIND ENTIRE AD PLUS ALL BOLD FACE AD:** add 45% premium to total price. **EXPANDED TYPE AD:** \$3.75 per word prepaid. All other items same as for **STANDARD COMMERCIAL RATE.** **TINT SCREEN BEHIND ENTIRE EXPANDED TYPE AD:** add 25% premium to total price. **TINT SCREEN BEHIND ENTIRE EXPANDED TYPE AD PLUS ALL BOLD FACE AD:** add 45% premium to total price. **DISPLAY ADS:** 1" x 2 1/4"—\$270.00; 2" x 2 1/4"—\$540.00; 3" x 2 1/4"—\$810.00. **General Information:** Frequency rates and prepayment discounts are available. **ALL COPY SUBJECT TO PUBLISHERS APPROVAL. ADVERTISEMENTS USING P.O. BOX ADDRESS WILL NOT BE ACCEPTED UNTIL ADVERTISER SUPPLIES PUBLISHER WITH PERMANENT ADDRESS AND PHONE NUMBER.** Copy to be in our hands on the 15th of the third month preceding the date of the issue. (i.e., August issue copy must be received by May 15th). When normal closing date falls on Saturday, Sunday or Holiday, issue closes on preceding working day.

CIRCUIT boards: Your artwork, quick delivery, reasonable. **ATLAS CIRCUITS**, Dept. A, PO Box 892, Lincoln, NC 28092. (704) 735-3943.

TRANS-AM ELECTRONICS—this month's specials include two digit display with drivers—\$2.95, 16 volt, 3 amp transformer, 2.95, 16 LED Chaser kit, 11.95, 383 Canal Street, New York, NY 10013, (212) 226-3893, \$10.00 minimum order.

CONVERT videotapes, PAL - SECAM - NTSC (overseas), 110-220 Audio, Videorecorders, televisions. **APPLE AUDIO**, 74-18, 37th Avenue, Queens, NY 11372, (718) 507-5800.

ALMOST new television test equipment and inventory liquidation due to severe eye problem. Ask for list and details. Will take best offer. **OSCHIN PESCHTIMALDJIAN**, 111 North Kenmore Ave., Los Angeles, CA 90004.

SURPLUS PRC-6 radio \$18.00 ea., \$30.00 for two, antenna \$2.50 ea., add \$5.00 shipping and handling. Operation check \$5.00 ea. Write for quantity price, **MINITRON**, POB 285, Beltsville, MD 20705.

 **WRITE FOR MCGEE'S SPEAKER & ELECTRONICS CATALOG**
1001 BARGAINS IN SPEAKERS
Tel: 1 (816) 842 5092
1901 MCGEE STREET KANSAS CITY, MO. 64108

OPTICAL character reader input any computer. Construction cost \$75.00. Plans \$29.95. 50 page catalog \$3.00. DBE, Box G, Waikiki, HI 96815. MC/VISA orders (808) 395-7458.

NEW! Precision scientific calculator w/over 50 functions plus LCD clock in handy ruler! Solve electronics equations easily! Matchless value: \$19.95. Guaranteed. Free information. **ALLEGRO ELECTRONIC**, Cornwall Bridge, CT 06754.

CABLE television secrets fully revealed! HBO, Cinemax, and more. \$5.00 to **MR. JA**, 5968 E. 29th, Tucson, AZ 85711.

CABLE-TV converters, police radar detectors and scanners. Send \$1.00 for catalog. **GREAT LAKES COMM..INC.**, 0-2026 Chicago Dr., Jenison, MI 49428

IMPORTS—discounts, stereos, boosters, speakers, tools, more! List \$1.00 (refundable). **J.R.C.**, 329-76th, N. Bergen, NJ 07047.

CABLE-TV, converters, & VCR's. Unlock the mystery of recording one channel while watching another. \$4.95 diagrams, instructions. **ADDITIONAL OUTLET CORP.**, 1041 W. Commercial Blvd, Ft. Lauderdale, FL 33309.

FREE catalog featuring lowest price on electronic test equipment and parts. **EF ELECTRONICS**, 10 Alton, Aurora, IL 60538.

COMPLETE line of electronics for the home telecommunication hobbyist. Integrated circuits, resistors, caps, coils, and much more. We now have over a 1/4 of million dollars in parts stocked. COO welcome. UPS daily. Information, COO's call (301) 574-7882 or 7883. Call or write for free catalog to **S.E. CORPORATION**, PO 9534, Baltimore, MD 21237.

Hi voltage supply DC outputs 16 KV, 400 V, 90V. DC input 25 V., new, over 40 components, schematic. \$7.88 + \$2.50 handling and postage. **TRU-OC-TANE**, PO Box 623, Lakeside, CA 92040.

UNIQUE Booklet, "How Neurocele (body) converts signals/pulses-circuit & computer simulation." Check/money order \$7.95. **TRONLERT INC.**, Box 355, Montreal North, Canada H1H 5L4.

1.3 GHz Pre-Scaler kit. Upgrade counter read 10-1300 MHz. Divide by 4 \$24.95 postage paid M/C-Visa-COD, guaranteed. **DIGITAL INSTRUMENTS**, 636R Sheridan Dr., Tonawanda, NY 14150.

1.3 GHz frequency counter-reads 1296 MHz. Freq. 10Hz to 1.3GHz. Sensitivity 10mV, 1 GHz RF shielding metal case 8.4" digits. \$249.95 M/C-Visa-COD guaranteed. **DIGITAL INSTRUMENTS**, 636R Sheridan Dr., Tonawanda, NY 14150.



A SINGER'S DREAM!
REMOVES VOCALS FROM RECORDS!
Now You can sing with the world's best bands! The Thompson Vocal Eliminator can remove most or virtually all of a lead vocal from a standard stereo record and leave the background! Write or call for a free brochure and demo record.
LT Sound, Dept. R-1, P.O. Box 338, Stone Mountain, GA 30086. (404) 493-1258

AUTOMOTIVE AM/FM stereos \$49.95 up. 40 piece socket set, lifetime warranty \$39.95. Free catalog. **NEPTUNES CAVE**, Box 8837, Fort Worth, TX 76124-0837.

WANTED

OLD tubes, unused and boxed, send your stocklist. **TSUTOM YOSHIHARA**, G1-105, Deguchicho-34, Suita, Osaka 564, Japan.

INVENTIONS, ideas, new products wanted! Industry presentation/national exposition. Call free (1-800) 528-6050. Arizona, (1-800) 352-0458. X831.

CABLE CONVERTERS & DESCRAMBLERS
HAMLIN OAK JERROLD SCIENTIFIC SYLVANIA ZENITH
ALL TYPES OF CABLE TV EQUIPMENT
MICROWAVE ANTENNAS & ACCESSORIES
— FREE ILLUSTRATED BROCHURE —
— CALL OR WRITE —
M.M.R. SALES
221 E. CAMELBACK #1
PHOENIX, AZ 85012
(602) 993-0398



NEW ORLEANS AND WM. B. ALLEN

UP TO 25% OFF
ON

LARGEST FULL LINE INVENTORY OF HAND HELD METERS
FOR EXAMPLE

- FLUKE 73 \$ 75
- FLUKE 75 \$ 88
- FLUKE 77 \$115
- FLUKE 8020B \$170
- FLUKE 8021B \$139
- FLUKE 8022B \$128
- FLUKE 8024B \$174
- SOAR SX220 \$ 22
- SOAR ME540 \$ 44

AS CLOSE AS YOUR TELEPHONE

CALL TOLL FREE FOR SAME DAY SHIPMENT ON

DISCOUNT PRICED TEST EQUIPMENT

18 LEADING MANUFACTURERS IN INSTRUMENTATION INCLUDING HUNTRON

UP TO 28.5% OFF
ON
HITACHI SCOPES

- SAVE UP TO \$480
- V212 .. 20MHz (SAVE \$184) .. \$ 451
 - V222 .. 20MHz (SAVE \$191) .. \$ 524
 - V422 .. 40MHz (SAVE \$246) .. \$ 679
 - V650F .. 60MHz (SAVE \$257) .. \$ 938
 - V208 .. 20MHz (SAVE \$250) .. \$ 692
 - V1050F 100MHz (SAVE \$343) .. \$1252
 - V089 Vectorscope (SAVE \$480) .. \$1204
 - V099 .. Waveform (SAVE \$468) .. \$ 882
- All Prices Include FREE \$50 Probe

WM. B. ALLEN SUPPLY CO.

ALLEN SQUARE
300 BLOCK NORTH RAMPART, NEW ORLEANS, LA 70112

CALL TOLL FREE
800 535-9593
LOUISIANA 800 462-9520

CIRCLE 103 ON FREE INFORMATION CARD

SINCE 1976

1985 CATALOG Send \$1.00

Corporate Buyers ... Call For Volume Quotes!

IF YOU DON'T SEE IT HERE CALL TOLL FREE

APPLE COMPATIBLE PERIPHERALS

Table listing various Apple compatible peripherals such as cables, keyboards, and mice with their respective prices.

HI-TECH SPECIALS

C2256 (MkII) \$219.95, M632104 (2) \$99.00

LCD DISPLAYS

1 Line 39.95, 14 Line 79.95

IBM PC HARDWARE

Table listing IBM PC hardware components including monitors, keyboards, and mice.

5-100 SALE ITEMS

Table listing 5-100 sale items such as RAM cards, hard drives, and other components.

PRINTERS

Table listing various printer models and their prices.

MONITORS

Table listing various monitor models and their prices.

MODEMS

Table listing various modem models and their prices.

HARD DISKS

Table listing various hard disk drive models and their prices.

EDGE CONNECTORS

Table listing various edge connector models and their prices.

LEO LAMPS

Table listing various LEO lamp models and their prices.

O-SUBMINIATURE

Table listing various O-subminiature components and their prices.

IC SOCKETS

Table listing various IC socket models and their prices.

DRIVE CABINETS

Table listing various drive cabinet models and their prices.

APPLE DISK DRIVES

Table listing various Apple disk drive models and their prices.

MAIL ORDER PRICING ONLY

Table listing various electronic components under the 'MAIL ORDER PRICING ONLY' section.

2-RO

Table listing various electronic components under the '2-RO' section.

DISK CONTROLLERS

Table listing various disk controller models and their prices.

CRT CONTROLLERS

Table listing various CRT controller models and their prices.

UARTS/UARTS

Table listing various UART/UARTS models and their prices.

EPROMS

Table listing various EPROM models and their prices.

STATIC RAMS

Table listing various static RAM models and their prices.

DMYNAMIC RAMS

Table listing various dynamic RAM models and their prices.

COEX 80/FT PRINTER

Table listing Coex 80/ft printer models and their prices.

SUPER SAVER IBM PC

Table listing Super Saver IBM PC models and their prices.

HI-TECH SPECIALS

Table listing Hi-Tech Specials models and their prices.

DATA ACQUISITION

Table listing various data acquisition models and their prices.

FULL PRICE

Table listing various full price models and their prices.

800-854-8230

LINEAR

Table listing various linear components and their prices.

VOLTAGE REGULATORS

Table listing various voltage regulator models and their prices.

SPECIAL PURPOSE CHIPS

Table listing various special purpose chip models and their prices.

DISKETTES

Table listing various diskette models and their prices.

5 1/4" DISKETTES

Table listing various 5 1/4" diskette models and their prices.

EXPANSION MEMORY

Table listing various expansion memory models and their prices.

CABLES/ACCESSORIES

Table listing various cables and accessories models and their prices.

SPECIALS OF THE MONTH

Table listing various special offers of the month models and their prices.

74500-PROGMS

Table listing various 74500-program models and their prices.

74C00

Table listing various 74C00 models and their prices.

800-854-8230

STOP DREAMING START BUILDING

HANDY MAKES IT EASY!

Build anything from computers to LED flashers... any project you want the fast, easy, fun way. Use HANDY solderless breadboards to build, test, modify and expand your ideas.

**SATISFACTION GUARANTEED
OR YOUR MONEY BACK!**

JUST LOOK AT THESE SOCKET FEATURES...

- Full contact labeling — simplifies component layouts
- New durable clip design assures reliable, low resistance, corrosion-free interconnections
- High temp plastic — no warping or melting...ever!
- Self-adhesive backing — mounts anywhere
- Big 9 14-pin IC capacity per socket
- Expands horizontally and vertically

HB-0100. 1 Buss Strip.
100 tie points. Compares
at \$3.00!

\$2²⁵

HB-1000. 1 Socket Strip.
640 tie points. 9 14-pin
IC capacity. Compares at
\$12.50!

\$9⁹⁵

HB-4714. 4 Socket Strips.
7 Buss Strips. 4 Binding
Posts. 3260 tie points.
36 14-pin IC capacity.
Compares at \$89.00!

\$63⁹⁵

HB-2312. 2 Socket Strips.
3 Buss Strips. 3 Binding
Posts. 1580 tie points.
18 14-pin IC capacity.
Compares at \$51.50!

\$31⁰⁰

HB-2112. 2 Socket Strips.
1 Buss Strip. 2 Binding
Posts. 1380 tie points.
18 14-pin IC capacity.

\$24⁹⁵

HB-1110. 1 Socket Strip.
1 Buss Strip. Ground plate.
740 tie points 9 14-pin
IC capacity. Compares at
\$15.50!

\$11⁹⁵

HB-1210. 1 Socket Strip.
2 Buss Strips. Ground plate.
840 tie points. 9 14-pin
IC capacity. Compares at
\$18.50!

\$13⁹⁵

HB-3514. 3 Socket Strips.
5 Buss Strips. 4 Binding
Posts. 2420 tie points.
27 14-pin IC capacity.
Compares at \$66.00!

\$47⁹⁵

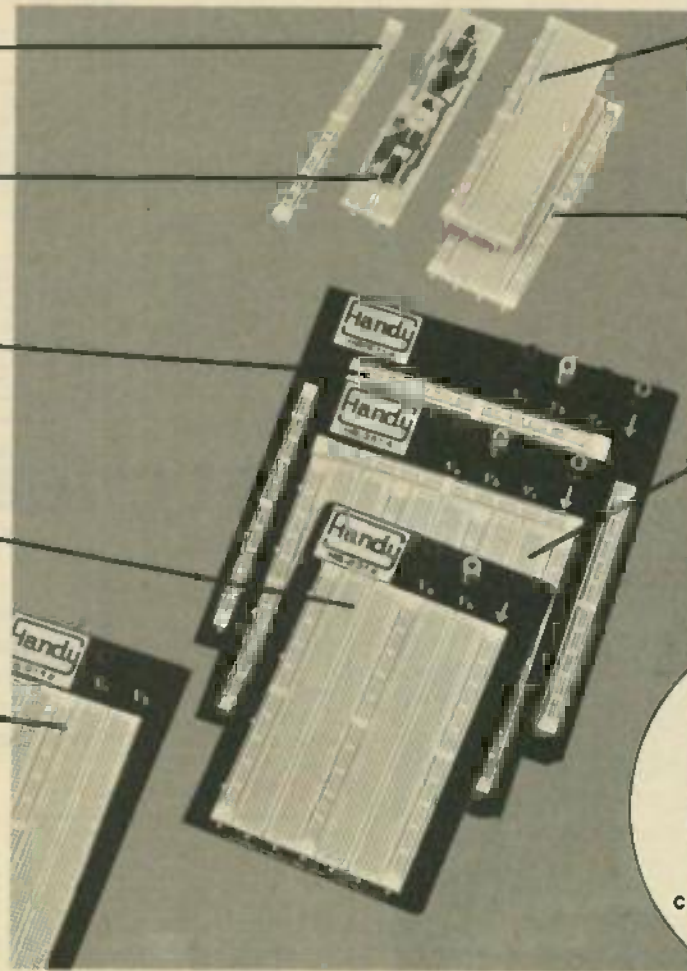

Clear, easy-to-read end identify
contact markings simplify
layout, wiring and
documentation.

FOR LESS!

**SEND FOR
FREE
Colorful
Brochure!**

Available at Selected Distributors throughout the USA and Canada
HANDY PRICES ARE UP TO 25% LESS THAN COMPETITORS!

Handy

a division of RSP Electronics Corp.
7 Business Park Drive • P.O. Box 699 • Branford, CT 06405
Telephone: (203) 488-6603 CompuServe: 71346, 1070
TWX: (910) 997-0648 Easy Link Mail Box: 62537580



ORDER TOLL FREE
1-800-34-HANDY
charge with VISA or
MasterCard. All items
off the shelf for
immediate shipment!

Mail Orders: Please add \$3 (Canada & Int'l add \$5) for shipping/handling.
Charge Cards: (Min. \$15). Please include Acct. No., Exp. Date and your signature.
Checks: drawn in U.S. Dollars on U.S. banks only. C.O.D.'s accepted
Connecticut Residents: Add 7.5% Sales Tax.

CIRCLE 71 ON FREE INFORMATION CARD

MARCH 1985

115

SCANNERS

JOIN 30,000 other scanner owners in the nation's largest not-for-profit association of scanner owners. Bi-monthly publication with tech tips, fascinating true stories, news of new listening adventures. Plus member benefit package including car rental discounts, no-extra-cost insurance coverage, free classified ad service, and more. Send just \$9.75 for 10-month trial membership to: **SCANNER ASSOCIATION OF NORTH AMERICA**, 240-A Fencil Lane, Hillside, IL 60162.

PRINTED CIRCUIT BOARDS

PRINTED circuit boards, double sided with plated through holes or single sided. No set up charge. **CAUDILL INC.**, 205 East Westwood Ave., Highpoint, NC 27622. (919) 884-0229.

CABLE TV "CYLINDERS"

NOTCH filters. Equivalent of cable company "cylinders". For elimination of unwanted or interfering signals. Channels available: 2 through 8; 14(A) through 22(I). Only \$19.00 each. **Money back guarantee**. Quantity discounts. **CATV**, PO Box 17621, Plantation, FL 33318.

SINE WAVE QUESTIONS?

TROUBLE shooting, alignment, antenna hookup, improvements manual, \$6.00. **STV authorization control**, \$3.00. Both, \$8.00. **SIGNAL**, Box 2512-R, Culver City, CA 90231.

REEL-TO-REEL TAPES

AMPEX professional series open reel tape, 1800- or 2400-foot on 7-inch reels, used once. Case of 40, \$45.00. 10 1/2 x 3600 feet and cassettes available. MasterCard Visa. **VALTECH ELECTRONICS**, Box 6-RE, Richboro, PA 18954 (215) 322-4866.

BUSINESS OPPORTUNITIES

US \$8.00 including disk thousand name brand programs for Apple IBM-PC details **RELIANT**, PO Box 33610, Sheungwan, Hong Kong.

MECHANICALLY inclined individuals desiring ownership of small electronics manufacturing business—without investment. Write: **BUSINESSES**, 92-R, Brighton 11th, Brooklyn, NY 11235.

ELECTRONIC-BARGAINS

100's OF ITEMS WALKMAN HEADPHONES
WAY BELOW RETAIL **WOW!** \$199 EA.
SEND \$1 FOR CATALOG REFUNDABLE

Q-ELECTRONICS

STE. 632
24-16 STEINWAY ST.
ASTORIA, N.Y. 11103

PROJECTION TV. Make \$\$\$'s assembling projectors... Easy... Results comparable to \$2,500.00 projectors... Your total cost less than \$200.00... Plans, 8" lens & Dealer's information \$17.50... Illustrated information free... **MACROCOMA GGX**, Washington Crossing, PA 18977. Creditcard orders 24 hours (215) 736-2880.

MINI-BUSINESS — Ideal one-man business. New manual illustrates step-by-step how to Design, Build & Sell Miniature Electronic Devices for maximum profit. Unique S&D method revealed. 30-Day Money-Back Guarantee if not satisfied. It's up to you. A month from today, you can be nothing more than 30 days older — or you can be on your way to making good money. You decide. Send \$15 plus \$2 shipping for

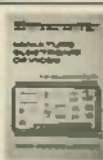

MINI-TECH • Dept. R, Box 1511, Troy, Michigan 48099

BIG PROFITS ELECTRONIC ASSEMBLY BUSINESS

Start home spare time investment knowledge or experience unnecessary. **BIG DEMAND** assembling electronic devices. Sales handled by professionals. Unusual business opportunity.

FREE: Complete illustrated literature
BARTA, RE-O Box 248
Walnut Creek, Calif. 94597

YOUR own radio station! AM, FM, cable. Home operation possible. **BROADCASTING**, Box 130-F3, Paradise, CA 95969.

GRAPHIC EQUALIZERS, ETC.

NOISE eliminators, expanders, power meters, others. Twelve-24 bands channel equalizers from \$89.00. Kit see R-E 5-6/78, 2/80, 3-4/81. Catalog: **SSS**, 856R Lynnrose, Santa Rosa, CA 95404, (707) 546-3895.

INVENTORS!

CAN you profit from your idea? Call us today regarding the marketing of your invention, or write for your free information package. Over a decade of service. **AMERICAN INVENTORS CORPORATION**, 82 Broad Street, Dept. RE, Westfield, MA 01086. (413) 568-3753. (Not an answering service.) A fee based marketing company, offices nationwide.

NEWSLETTERS

ELECTRONIC SYSTEMS NEWSLETTER is a monthly publication written especially for the electronics hobbyist experimenter. Fascinating projects, new ideas, sources. Free details. **AF PUBLISHING**, Dept. R2, PO Box 524, So. Hadley, MA 01075.

MICROWAVE TV ANTENNA SYSTEMS

Freq. 2.1 to 2.7 GHz · 34 db Gain +

COMPLETE SYSTEMS:
(as Pictured)

Commercial 40"
Rod Style \$99.95
Parabolic 20"
Dish Style \$79.95

COMPONENTS
Down Converter's
(either style) \$34.95
Power Supplies \$24.95
(12V to 16V, DC+)
Data Info (Plans) \$ 9.95

CALL OR WRITE FOR
KITS, PARTS, OR MORE
INFORMATION

Shipping & Handling Add \$5.00
We Repair Most Types Down
Converters & Power Supplies

**Phillips-Tech
Electronics**
P.O. Box 34772
Phoenix, AZ 85067
(602) 967-8972

Special Quantity Pricing
Dealers Wanted



LIFETIME LIMITED WARRANTY
PARTS & LABOR



CIRCLE 116 ON FREE INFORMATION CARD

REPLACEMENT FOR ECG®/GE®/SK®

POPULAR
TRIPLERS MIN. 3 PC./TYPE

300/GE527/SK3304..... 9.50
523/GE528/SK3306..... 9.95
526A/GE521..... 9.95
528/SK3906..... 11.75
529/GE529/SK3307..... 10.75
556/SK3905..... 14.95
557/SK3904..... 14.95

**HORIZONTAL OUTPUT
TRANSISTORS**
MIN. 5 PC. PER TYPE

165..... 2.25
238..... 2.25
283..... 2.75
25C1308K..... 2.45
25D1341P..... 2.25



POPULAR
DIODES MIN. 100 PC. PER TYPE

125 1000V/2.5A..... 7¢ ea.
156 1000V/3.0A..... 18¢ ea.
177 FAST SW./DET..... 9¢ ea.
506 DAMPER-HI VOL.
FAST RECOVERY..... 28¢ ea.

**AUDIO POWER
TRANSISTORS**

152... 30¢
153... 50¢
196... 49¢
197... 59¢
201... 49¢
202... 49¢



5E5020 35¢ ea. 712/LA1365 75¢ ea.
RF/IF OSCILLATOR, MIN. 10 PC. TV Sound/IF/FM/Det. Min. 10 PC.

SPECIAL OF THE MONTH

152... 25¢ MIN. 10 PC.

SPECTACULAR SAVINGS!!

ON REPLACEMENT FOR ECG TYPES MIN. 10 PC. PER TYPE

85..... 21	130..... 58	171..... 80	181..... 65
102A..... 55	154..... 75	184..... 58	198..... 65
108..... 16	157..... 48	185..... 58	199..... 18
121..... 1.20	158..... 18	186..... 48	234..... 18
123A..... 18	180..... 88	187..... 48	287..... 29
123AP..... 13	181..... 85	188..... 30	288..... 29
128..... 34	182..... 2.25	189..... 50	375..... 40
129..... 38	183A..... 2.35	190..... 58	376..... 55
			398..... 59

FOR A COMPLETE LIST CALL OR WRITE — C.O.D. Orders Welcome (Min. Order \$25)

DIGITRON ELECTRONICS

110 HILLSIDE AVENUE, SPRINGFIELD, NEW JERSEY 07081
Toll Free 800-526-4928 In NJ 201-379-9016 Telex 138441
PRICES SUBJECT TO CHANGE WITHOUT NOTICE. OFFER GOOD WHILE SUPPLY LASTS.
ECG is a Trade Mark of PHILIPS ECG.
Digitron Electronics is not associated in any way with Philips ECG.

CIRCLE 57 ON FREE INFORMATION CARD

WE HAVE QUALITY PARTS. DISCOUNT PRICES AND FAST SHIPPING!

TRANSFORMERS

120 volt primaries

6.6 VOLTS @ 780 MA	\$3.00
6 VOLTS @ 150 MA	\$1.25
12 VCT @ 200 MA	\$2.00
16 V. @ 480 MA	\$3.50
16 VOLTS @ 1 AMP	\$4.50
24 VOLTS @ 250 MA	\$2.50
24 VCT @ 1 AMP	\$4.50

RS-232 EXTENSION

9 LINE CONNECTED LINE 5 1 THROUGH 8 & 20 DB25 MALE TO FEMALE 10 FEET SHIELDED \$11.00 EACH

MIKE CONNECTOR

5 CONDUCTOR IN-LINE PLUG AND CHASSIS MOUNT JACK TWIST LOCK STYLE, SAME AS SWITCHCRAFT 17C15M \$2.50 PER SET

7 CONDUCTOR RIBBON CABLE

SPECTRA STRIP RED MARKER STRIP 28 GA STRANDED WIRE \$5.00 PER ROLL (100 FT.)

REVERBERATION UNIT

ACCUTRONICS COIL SPRING TYPE UNITS USED IN ELECTRONIC ORGANS TO PROVIDE ACOUSTIC DELAY SOUND EFFECTS. INPUT IMPEDANCE 8 OHMS OUTPUT IMPEDANCE 2250 OHMS 4 1/2" x 1 1/2" x 1 1/2"

\$7.50 EACH

TRANSFORMER WALL

ALL ARE 115 VAC PLUG IN

4 VDC @ 70 MA	\$2.00
6 VDC @ 800 MA	\$6.00
9 VAC @ 1 AMP	\$3.00
12.6 VAC @ 265 MA	\$3.50
16.8 VAC @ 10 VA	\$3.00
17 VAC @ 900 MA	\$4.00

MULTI-SWITCHES

3 STATION NON-INTERLOCKING 3-2PDT SWITCHES EACH OPERATES INDEPENDENTLY 1/8" BETWEEN MOUNTING CENTERS \$1.75 EACH

5 STATION INTERLOCKING MADE BY ALPS 3-2PDT AND 2-8PDT SWITCHES ON FULLY INTERLOCKING ASSEMBLY 3/8" BETWEEN MOUNTING CENTERS \$2.50 EACH

METER

0-15 V.D.C. THIS 2-1/8" SQUARE METER MEASURES 0-15 VDC \$4.50 EACH

2K 10 TURN

M.A.T.I. TURN POT SPECTROL #M00-534-7181 \$5.00 EACH

SOUND AND VIDEO MODULATOR FOR T.I. COMPUTER

T.I. UM1381-1 DESIGNED FOR USE WITH T.I. COMPUTERS. CAN BE USED WITH VIDEO SOURCES BUILT IN AND SWITCH CHANNEL 3 OR 4 SELECTION SWITCH OPERATES ON 12 VDC HOOK UP DIAGRAM INCLUDED. \$10.00 EACH

SPRING LEVER TERMINALS

TWO COLOR CODED TERMINALS ON A STURDY 2 3/4" x 3 3/4" BAKE LITE PLATE GREAT FOR SPEAKER ENCLOSURES OR POWER SUPPLIES \$1.00 EACH 10 FOR \$9.00

5 STATION NON-INTERLOCKING

SAME AS ABOVE, EXCEPT EACH SWITCH OPERATES INDEPENDENTLY \$2.50 EACH

SUB-MINIATURE D TYPE CONNECTOR

SOLDER TYPE SUB-MINIATURE CONNECTORS USED FOR COMPUTER HOOK UPS

DB 15 PLUG	\$2.75
DB-15 SOCKET	\$4.00
DB-15 HOOD	\$1.50
DB 25 PLUG	\$2.75
DB-25 SOCKET	\$3.50
DB 25 HOOD	\$1.25

ROTARY SWITCH

1 POLE 6 POSITION 1 1/2" DIA x 1 1/2" HIGH 75¢ EACH 10 FOR \$6.00

48 KEY ASSEMBLY FOR T.I. COMPUTER

NEW TEXAS INSTRUMENTS KEYBOARD UNHODDED 48 S.P.S.T. MECHANICAL SWITCHES. TERMINATES TO 15 PIN CONNECTOR. SOLID METAL FRAME 4" X 9" \$6.50 EACH 2 FOR \$11.00

TI SWITCHING POWER SUPPLY

T1 4 1053214-2 COMPACT, WELL-REGULATED SWITCHING POWER SUPPLY DESIGNED TO POWER TEXAS INSTRUMENTS COMPUTER EQUIPMENT. INPUT: 115VAC ± 25.1VAC AT 1A OUTPUT: +12VDC AT 350MA ± 5VDC AT 1.2A - 5VDC AT 200MA SIZE: 4 3/4" X 4 1/4" X 1 1/4" \$5.00 EACH

"PARALLEL" PRINTER CONNECTOR

SOLDER STYLE 36 PIN MALE USED ON "PARALLEL" DATA CABLES \$5.50 EACH

PUSHBUTTON POWER SWITCH

DOUBLE POLE POWER SWITCH PUSH ON, PUSH OFF \$1.00 EACH

EDGE CONNECTORS

ALL ARE 156" SPACING

10 PIN EDGE CONNECTOR 10 FOR \$2.00

22/44 TIN P.C. STYLE NO MOUNTING EARS \$1.50 EACH 10 FOR \$14.00

22/44 GOLD P.C. STYLE \$2.00 EACH 10 FOR \$18.00

28/56 GOLD 28/56 GOLD PLATED CONTACTS 156 CONTACT SPACING \$2.50 EACH 10 FOR \$22.00

120V INDICATOR

NEON INDICATOR, RATED 120 V 1/2 W MOUNTS IN 5/16" HOLE. RED LENS 75¢ EACH 10 FOR \$7.00 100 FOR \$65.00

I.D.C. MALE

SAME AS ABOVE. WILL PRESS FIT ON STANDARD RIBBON CABLE \$8.00 EACH

SWITCHES MINI-PUSH BUTTON

S.P.S.T. MOMENTARY NORMALLY OPEN 1/4" BUSHING 35¢ EACH 10 FOR \$3.25 100 FOR \$30.00 SPECIFY COLOR RED, BLACK, WHITE, YELLOW

GEL CELL BATTERY

12 VDC @ 1.2 AMP HOUR 4" X 1 1/2" X 2 1/8" \$15.00 EACH

FREE! FREE! FREE! SEND FOR NEW LARGER 48 PAGE CATALOG FREE! FREE! FREE!

LINE CORDS

TWO WIRE 6' 18ga TWO WIRE 3 FOR \$1.00

THREE WIRE 18 INCH 18ga THREE WIRE 2 FOR \$1.00

8 FOOT 18ga THREE WIRE \$2.00 EACH

KEY ASSEMBLY

5 KEY \$1.00 EACH CONTAINS 5 SINGLE-POLE NORMALLY OPEN SWITCHES. MEASURES 3 3/4" LONG 5 KEY \$1.25 EACH CONTAINS 5 SINGLE-POLE NORMALLY OPEN SWITCHES. MEASURES 4 1/4" LONG

RELAYS SOLID STATE RELAY

HEINEMANN ELECTRIC #101-5A 140-5 AMP CONTROL 3 3/2VDC LOAD 140VAC 5 AMPS SIZE 2" X 1" X 8" HIGH \$5.00 10 FOR \$45.00

COMPUTER GRADE CAPACITORS

2,000 mfd. 200 VDC 1 3/4" DIA. - 5" HIGH \$2.00

3,600 mfd. 40 VDC 1 3/8" DIA. - 3 3/4" HIGH \$1.00

6,400 mfd. 60 VDC 1 3/8" DIA. - 4 1/4" HIGH \$2.50

31,000 mfd. 15 VDC 1 3/4" DIA. - 4" HIGH \$2.50

72,000 mfd. 15 VDC 2" DIA. - 4 3/8" HIGH \$3.50

185,000 mfd. 6 VDC 2 1/2" DIA. - 4 1/2" HIGH \$1.50

CLAMPS TO PPT CAPACITORS 500 ea.

SLIDE POTS

100K linear taper 2" LONG 75¢ EACH

500K linear taper 2 7/8" LONG 75¢ EACH

DUAL 100K audio taper 3 1/2" LONG \$1.50 EACH

2 1/2" TRAVEL \$1.50 EACH

L.E.D.'S STANDARD JUMBO DIFFUSED

RED 10 FOR \$1.50

GREEN 10 FOR \$2.00

YELLOW 10 FOR \$2.00

FLASHER LED 5 VOLT OPERATION RED JUMBO SIZE \$1.00 EACH

BI POLAR LED 2 FOR \$1.70

LED HOLDERS TWO PIECE HOLDER FOR JUMBO LED 10 FOR \$54 200 FOR \$10.00

SOLDERING IRON STAND

SPRING STEEL IRON HOLDER ON WEIGHTED BASE \$8.00 EACH

DC-DC CONVERTER

DESIGNED TO PROVIDE A STEADY 5 VDC @ 240 MA FROM A BATTERY SUPPLY OF 3.5 TO 6.25 V 2 1/16" x 1 1/16" x 1 1/16" HIGH \$1.50 EACH

MINIATURE 6 VDC RELAY

SUPER SMALL SPDT RELAY. GOLD COBALT CONTACTS RATED 1 AMP AT 30 VDC. HIGHLY SENSITIVE. TTL DIRECT DRIVE POSSIBLE. OPERATES FROM 4.3 TO 6 V. COIL RES 220 OHM 1 3/16" x 1 3/32" x 7/16" AROMAT # R5D-8V \$1.50 EACH 10 FOR \$13.50

MINIATURE TOGGLE SWITCHES

ALL ARE RATED 5 AMPS @ 125 VAC

S.P.D.T. (on-on) P.C. STYLE NON-THREADED BUSHING 75¢ EACH 10 FOR \$7.00

S.P.D.T. (on-on) SOLDER LUG TERMINALS \$1.00 EACH 10 FOR \$9.00 100 FOR \$80.00

S.P.D.T. (on-off-on) P.C. LUGS THREADED BUSHING \$1.00 EACH 10 FOR \$9.00 100 FOR \$80.00

D.P.D.T. (on-on) SOLDER LUG TERMINALS \$2.00 EACH 10 FOR \$18.00 100 FOR \$180.00

CRYSTALS

CASE STYLE HC33/U 2 MHZ \$3.50 EACH

COLORBUST 3579-545 KC \$1.50 EACH

METAL OXIDE VARISTOR

G.E. # V822A12 50 VOLTS NOMINAL D.C. VOLTAGE 5/8" DIAMETER 2 FOR \$1.50

TRANSISTORS

2N708	4 FOR \$1.00
2N2222A	3 FOR \$1.00
PH2222	4 FOR \$1.00
2N2904	3 FOR \$1.00
2N2905	3 FOR \$1.00
2N2907	3 FOR \$1.00

13 VDC RELAY

CONTACT S.P.N.G. 10 AMP @ 120 VAC ENERGIZE COIL TO OPEN CONTACT COIL 13 VDC 650 OHMS SPECIAL PRICE \$1.00 EACH

4 PDT RELAY

14 pin style 3 amp contacts 24 volt d.c. or 120 volt a.c. 600 ohm Used but fully tested \$1.70 EACH specify coil voltage LARGE QUANTITIES AVAILABLE SOCKETS FOR RELAY 500 EACH

3 1/2" SPEAKER

8 OHM IMPEDANCE FULL RANGE SPEAKER 8 OZ MAGNET 4" DIAGONAL MOUNTING CENTERS \$2.50 EACH 10 FOR \$20.00

SOLID STATE BUZZER

STAR #SMB 06L 6 VDC TTL COMPATIBLE \$1.00 EACH 10 FOR \$9.00

POWER SUPPLY W/ PRE-AMP

THIS SUPPLY WAS USED TO POWER AN 8 TRACK CASSETTE UNIT IT WILL SUPPLY APPROX. 18 VDC AND INCLUDES A SMALL PRE-AMP TO BOOST SIGNAL LEVEL. RCA PLUGS FOR LINE IN/OUT \$4.50 EACH

ALL ELECTRONICS CORP.

QUANTITIES LIMITED

MINIMUM ORDER \$10.00 USA \$3.00 SHIPPING FOREIGN ORDERS INCLUDE SUFFICIENT SHIPPING C-11F RES. ADD 6 1/2% NO C.O.D.

905 S. VERMONT AVE. P.O. BOX 20406 LOS ANGELES, CA 90006

6228 SEPULVEDA BLVD. VAN NUYS, CA 91411

ALASKA HAWAII, OR INFORMATION (213) 380-8000

MARCH 1985

QUALITY - Name brand products from nationally recognized manufacturers. **SERVICE** - Computerized order processing and inventory control. **SAVINGS** - Volume Discounts • OEM Quantity Pricing • Toll Free 800 Number

INTEGRATED CIRCUITS

7400	Hex Inverter	1.00
7401	Hex Inverter	1.00
7402	Hex Inverter	1.00
7403	Hex Inverter	1.00
7404	Hex Inverter	1.00
7405	Hex Inverter	1.00
7406	Hex Inverter	1.00
7407	Hex Inverter	1.00
7408	Hex Inverter	1.00
7409	Hex Inverter	1.00
7410	Hex Inverter	1.00
7411	Hex Inverter	1.00
7412	Hex Inverter	1.00
7413	Hex Inverter	1.00
7414	Hex Inverter	1.00
7415	Hex Inverter	1.00
7416	Hex Inverter	1.00
7417	Hex Inverter	1.00
7418	Hex Inverter	1.00
7419	Hex Inverter	1.00
7420	Hex Inverter	1.00
7421	Hex Inverter	1.00
7422	Hex Inverter	1.00
7423	Hex Inverter	1.00
7424	Hex Inverter	1.00
7425	Hex Inverter	1.00
7426	Hex Inverter	1.00
7427	Hex Inverter	1.00
7428	Hex Inverter	1.00
7429	Hex Inverter	1.00
7430	Hex Inverter	1.00
7431	Hex Inverter	1.00
7432	Hex Inverter	1.00
7433	Hex Inverter	1.00
7434	Hex Inverter	1.00
7435	Hex Inverter	1.00
7436	Hex Inverter	1.00
7437	Hex Inverter	1.00
7438	Hex Inverter	1.00
7439	Hex Inverter	1.00
7440	Hex Inverter	1.00
7441	Hex Inverter	1.00
7442	Hex Inverter	1.00
7443	Hex Inverter	1.00
7444	Hex Inverter	1.00
7445	Hex Inverter	1.00
7446	Hex Inverter	1.00
7447	Hex Inverter	1.00
7448	Hex Inverter	1.00
7449	Hex Inverter	1.00
7450	Hex Inverter	1.00
7451	Hex Inverter	1.00
7452	Hex Inverter	1.00
7453	Hex Inverter	1.00
7454	Hex Inverter	1.00
7455	Hex Inverter	1.00
7456	Hex Inverter	1.00
7457	Hex Inverter	1.00
7458	Hex Inverter	1.00
7459	Hex Inverter	1.00
7460	Hex Inverter	1.00
7461	Hex Inverter	1.00
7462	Hex Inverter	1.00
7463	Hex Inverter	1.00
7464	Hex Inverter	1.00
7465	Hex Inverter	1.00
7466	Hex Inverter	1.00
7467	Hex Inverter	1.00
7468	Hex Inverter	1.00
7469	Hex Inverter	1.00
7470	Hex Inverter	1.00
7471	Hex Inverter	1.00
7472	Hex Inverter	1.00
7473	Hex Inverter	1.00
7474	Hex Inverter	1.00
7475	Hex Inverter	1.00
7476	Hex Inverter	1.00
7477	Hex Inverter	1.00
7478	Hex Inverter	1.00
7479	Hex Inverter	1.00
7480	Hex Inverter	1.00
7481	Hex Inverter	1.00
7482	Hex Inverter	1.00
7483	Hex Inverter	1.00
7484	Hex Inverter	1.00
7485	Hex Inverter	1.00
7486	Hex Inverter	1.00
7487	Hex Inverter	1.00
7488	Hex Inverter	1.00
7489	Hex Inverter	1.00
7490	Hex Inverter	1.00
7491	Hex Inverter	1.00
7492	Hex Inverter	1.00
7493	Hex Inverter	1.00
7494	Hex Inverter	1.00
7495	Hex Inverter	1.00
7496	Hex Inverter	1.00
7497	Hex Inverter	1.00
7498	Hex Inverter	1.00
7499	Hex Inverter	1.00
7500	Hex Inverter	1.00

TEST INSTRUMENTS

I.C. SOCKETS

Standard 16 Pin DIP Socket \$3.99

WIRE WRAP DIP SOCKETS

Standard 16 Pin Wire Wrap DIP Socket \$3.99

TEST INSTRUMENTS

EDGEBOARD CONNECTORS

EDGEBOARD CONNECTORS

EDGEBOARD CONNECTORS

TEST INSTRUMENTS

I.C. SOCKETS

Standard 16 Pin DIP Socket \$3.99

WIRE WRAP DIP SOCKETS

Standard 16 Pin Wire Wrap DIP Socket \$3.99

TEST INSTRUMENTS

EDGEBOARD CONNECTORS

EDGEBOARD CONNECTORS

EDGEBOARD CONNECTORS

TEST INSTRUMENTS

I.C. SOCKETS

Standard 16 Pin DIP Socket \$3.99

WIRE WRAP DIP SOCKETS

Standard 16 Pin Wire Wrap DIP Socket \$3.99

TEST INSTRUMENTS

EDGEBOARD CONNECTORS

EDGEBOARD CONNECTORS

EDGEBOARD CONNECTORS

TEST INSTRUMENTS

I.C. SOCKETS

Standard 16 Pin DIP Socket \$3.99

WIRE WRAP DIP SOCKETS

Standard 16 Pin Wire Wrap DIP Socket \$3.99

TEST INSTRUMENTS

EDGEBOARD CONNECTORS

EDGEBOARD CONNECTORS

EDGEBOARD CONNECTORS

TEST INSTRUMENTS

I.C. SOCKETS

Standard 16 Pin DIP Socket \$3.99

WIRE WRAP DIP SOCKETS

Standard 16 Pin Wire Wrap DIP Socket \$3.99

TEST INSTRUMENTS

EDGEBOARD CONNECTORS

EDGEBOARD CONNECTORS

EDGEBOARD CONNECTORS

SERVICE CHARGES VOLUME DISCOUNT

1-800-344-4539

MARCH 1985

CIRCLE 82 ON FREE INFORMATION CARD

10th ANNIVERSARY 'SALE-A-BRATION' "1974 PRICES" ARE BACK

MECHANICAL TUNER UPF DETENT TUNING 12 VDC 45 MHZ OUT \$.99 ea.	POWER TRANSFORMER 25VAC - 350A 115VAC PRIMARY DIM. 2 1/2" x 1 1/2" x 2 1/4" \$.99 ea. 10/27.00	INTEGRATED CIRCUITS ALL ARE NEW - PRIME 1330 - \$1.00 504 - \$1.00 505 - \$1.00 1000 - \$1.00 1300 - \$1.00 1406 - \$1.00 1456 - \$1.00 MV2100 - 3/21.00 1500 - \$1.75 7010 - \$1.46 7024 - \$1.46
PC DRILL \$.30 ea. SOLID CARBIDE 10/23.00 #55 1/2" SHANK	RF MODULATOR ASTEC UM1205-B \$3.00 VIDEO IN AUDIO IN 	F-90 CONNECTOR 10/21.00 F-91 F DOUBLE FEMALE 4/21.00 F-91A F CHASSIS CONN 7/21.00
LINE CORD \$.30 ea. 5 FT. LONG 2 WIRE BLACK 3/21.00	PANEL MOUNT FUSE HOLDER for 3 AG fuses 3/21.00	24 PIN IC SOCKETS LOW PROFILE 10/21.00
REED SWITCH SPST DIM. APPROX. = 2 20/21.00	I.R. DIODES 1N4071 50 PWT 1 AMP NEW - PRIME 20/21.00	SOLDERING IRON HOLDER \$1.00
DB-25S FEMALE \$.99 ea.	CAPACITORS METAL FILM 50VDC SILVER MICA 100 PF 1% 1/4" 210 PF 200 PF 1% 1/4" 250 PF 500 PF 1% 1/4" 330 PF 1000 PF 1% 1/4" 330 PF 1000 PF 1% 1/4" 330 PF	MINI TOGGLE SWITCHES 5 AMP - 125VAC SPDT 5.75" - 10/21.00 SPDT C-Off - PRICE SAME AS ABOVE DPDT C-Off \$1.00 ea. 10/21.00
MOV \$.30 ea. 130 VOLT 22 JOULE 3/21.00	ELECTROLYTIC 50VDC 1000UF 10% 1/4" 1000UF 1000UF 10% 1/4" 1000UF 1000UF 10% 1/4" 1000UF 1000UF 10% 1/4" 1000UF	SOLID STATE RELAY 3-32VDC INPUT TO AMP-120VAC \$6.00
CHOKES 4/21.00 15UH 330H 100UH 100/230.00	HEAT SINK CLIP ON FOR TO 200/220 DEVICE 3 6/21.00	TRANSISTORS NPN - GENERAL PURPOSE 2N4124 or 2N3850A 10/21.00 - 100/20.00
MATCHING TRANSFORMER 75-300 OHM - INDOOR TYPE \$.30 ea.	RELAY MINIATURE DPDT 24V DC COIL 3A CONTACTS (FITS INTO 16 PIN IC SOCKET) \$.99 ea.	BOAR PEN DVM MOD 3100 \$30.00
LED'S T1 RED 12/21.00 T1-1 RED T1-1 GREEN	DIODES 1N4001 1000UF 10% 1/4" 1000UF 1N4002 1000UF 10% 1/4" 1000UF 1N4003 1000UF 10% 1/4" 1000UF 1N4004 1000UF 10% 1/4" 1000UF	

Network Sales, Inc. 90 TURNER AVE. ELK GROVE VILL., IL 60007 312-952-1118

CIRCLE 88 ON FREE INFORMATION CARD

ALL SALES SUBJECT TO THE TERMS OF OUR 90 DAY LIMITED WARRANTY. FREE COPY UPON REQUEST.

DISK DRIVE SPECIAL: Shugart #SA 200 5 1/4 In. 2/3 Height. New In Box. 40 Track, SS-DD. Compare At Up To \$159 Ea. Our Price \$69.95 or Two For \$125. Limited Qty.

THE NEW ZRT-80 CRT TERMINAL BOARD!

A LOW COST Z-80 BASED SINGLE BOARD THAT ONLY NEEDS AN ASCII KEYBOARD, POWER SUPPLY, AND VIDEO MONITOR TO MAKE A COMPLETE CRT TERMINAL. USE AS A COMPUTER CONSOLE, OR WITH A MODEM FOR USE WITH ANY OF THE PHONE-LINE COMPUTER SERVICES.



- FEATURES:**
- Uses 8 Z80A and 6845 CRT Controller for powerful video capabilities.
 - RS232 at 15 BAUD Rates from 75 to 19,200.
 - 24 x 80 standard format (80 Hz).
 - Optional formats from 24 x 80 (50 Hz) to 64 lines x 96 characters (80 Hz).
 - Higher density formats require up to 3 additional 2K x 8 6116 RAMS.
 - Uses N.S. INS 8250 BAUD Rate Gen and USART combo IC.
 - 3 Terminal Emulsion Modes which are Dip Switch selectable. These include the LS-ADM3A, the Heath H-18, and the Beehive.
 - Composite or Split Video.
 - Any polarity of video or sync.
 - Inverse Video Capability.
 - Small Size: 8.5 x 9 inches.
 - Upper & lower case with descenders.
 - 7 x 9 Character Matrix.
 - Requires Par ASCII keyboard.

BLANK PCB WITH 2716 CHAR. ROM, 2732 MON. ROM
\$49.95
SOURCE DISKETTE - ADD \$10
SET OF 2 CRYSTALS - ADD \$7.50

WITH 8 IN. SOURCE DISK! (CP/M COMPATIBLE) **\$99.95** (COMPLETE KIT, ZRT-80 2K VIDEO RAM)

Digital Research Computers

P.O. BOX 461565R • GARLAND, TEXAS 75046 • (214) 225-2309

Call or write for a free catalog on Z-80 or 6809 Single Board Computers, SS-50 Boards, and other S-100 products.

TERMS: Add \$3.00 postage. We pay balance. Orders under \$45 add 75¢ handling. No C.O.D. We accept Visa and MasterCard. Texas Res. add 5-1/2% Tax. Foreign orders (except Canada) add 20% P & M. Orders over \$50 add 85¢ for insurance.

FREE CATALOG

This new Spectrum Electronics 116 page catalog contains Electronic Parts, Tools, and Test Equipment to serve all of your technical and service needs.

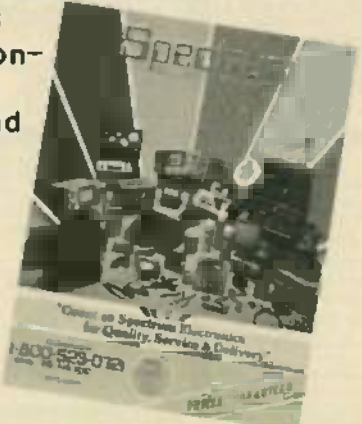

The 116 pages are fully illustrated, with prices you can count on. All products are guaranteed.

CALL TOLL FREE
Spectrum 1-800-523-0721
ELECTRONICS In PA 215-748-3010
Mail To: 5930 Market St. Phila., PA 19139

Name _____
Company _____
Address _____
City _____ State _____ Zip _____
RE 3/85

CIRCLE 262 ON FREE INFORMATION CARD

ALUMINUM EQUIPMENT CABINET
9" X 12" X 3-1/2" DRIG COST \$40. NEW HEAVY GAUGE ALUMINUM (1/8" SIDEWALLS) WITH ATTRACTIVE BLACK FINISH, GREAT FOR ALL SORTS OF TEST AND COMPUTER EQUIP. FRONT PANEL IS PUNCHED FOR COUNTER/DVM USE (EASILY COVERED). REAR PANEL HAS OPENINGS FOR LINE PLUG, SWITCH, ETC.
X-8000 WT 5 LB \$9.95 10/589 100/575

END STACKABLE LED VU METER
M-4275 WT 0.1 LB
NATIONAL NSM 3916-9 INCLUDES A 10 ELEMENT LED LINEAR ARRAY WITH AN LM3916 DECODER/DRIVER. THRESHOLDS ARE SET AT COMMON VU POINTS. THE FIRST 7 LEDS ARE GREEN, THE LAST 3 ARE RED. 7" X 0.85" OVERALL, OPERATES FROM 3 TO 24 VDC, 10 ACCURACY. DATA - .500
\$3.75 10/34 100/300

SOUND EFFECTS PC BOARD
WEEPA!
WEEPA!
BAM!
COMPLETE, OPERATING ASSY. HAS FLASHING LIGHTS, HEAVY DUTY 2-1/4" SPEAKER, RUNS ON 9-12 VDCI MAKES SIREN & EXPLOSION SOUNDS. BUT YOU CAN RE-PROGRAM THE SN76487 TO MAKE LOTS OF OTHERS!
X-1560 WT 0.2 LB
\$1.95 10/1750

7-12 VDC LED CLOCK
\$2.75
NATIONAL MA-6008 IS A COMPLETE DC POWERED CLOCK WITH KEYBOARD TIME/DATE ENTRY, TIME BASE CONSISTING OF AN MM5369 AND 3.579 MHZ CRYSTAL, ALL IN A 2-3/8 X 3-1/4 MODULE. BRAND NEW, 100% FUNCTIONAL. DATA-.254
10/25 100/200.
M-6008 WT 0.1 LB

DIAMONDBACK
ELECTRONICS COMPANY
PO BOX 12055
SARASOTA, FL. 33578
Phone Orders (813) 953-2029
Continental US add \$1.00 for the first pound and 50¢ for each additional pound. Canada add \$3.50 first lb and \$1 for each additional. Florida add 5¢ sales tax. MAIL ORDER \$7 MINIMUM. C.O.D. UPS CASE ONLY \$15 MIN. VISA & MASTERCARD \$15 MIN.

CIRCLE 269 ON FREE INFORMATION CARD

RADIO-ELECTRONICS

MCM ELECTRONICS

WE HAVE WHAT YOU NEED AT THE PRICES YOU WANT!

CALL TOLL FREE
1-800-543-4330

(IN OHIO, 1-800-762-4315)

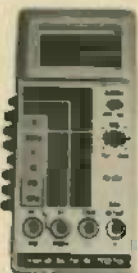

TENMAT®

3 1/2 DIGIT LDC MULTIMETER

- DC input impedance 10M ohm
- Diode and HFE transistor tests
- Overload protection ■ Auto polarity ■ Backed by our 2-year limited warranty ■ For more specifications see MCM catalog #9, page 116

#72-050 **\$3680**
\$39.80 (1-9) (10-up)

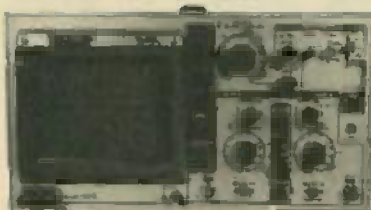

TENMAT®

20 MHZ DUAL TRACE OSCILLOSCOPE

- Two High Quality 10:1 probes included
- Backed by our 2-year limited warranty
- For specifications see MCM catalog #9, page 116

#72-320 **\$38995**



TENMAT®

DROP PROOF DIGITAL MULTIMETER

- DC input impedance 10M ohm
- Shock-mounted LCD display
- Overload protection ■ Auto polarity ■ Backed by our 2-year limited warranty ■ For more specifications see MCM catalog #9, page 124

#72-057 **\$2995**
\$33.80 each (2-up)



TENMAT®

35 MHZ DUAL TRACE OSCILLOSCOPE

- Two High Quality 10:1 probes included
- Backed by our 2-year limited warranty
- For specifications see MCM catalog #9, page 116

#72-330 **\$56900**

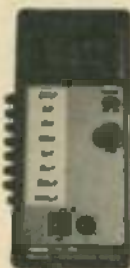

TENMAT®

DIGITAL CAPACITANCE METER

- Measures capacitors from 0.1pF to 1999mFd ■ Accuracy 0.5% typical ■ Fuse protected
- Checks capacitors in and out of circuit ■ Backed by our 2-year limited warranty ■ For more specifications see MCM catalog #9, page 118

#72-040 **\$5495**
\$59.80 each (2-up)

PYLE 1" COMPRESSION DOME TWEETERS

- Made in USA
- Display packaged (per pair) ■ 1" compression dome high frequency driver



- SPECIFICATIONS: ■ 8 ohm ■ 1" V.C. ■ 8 oz. magnet ■ Freq. response: 4,000-20,000 Hz
- SPL: 92 dB ■ RMS: 40W ■ MAX: 80W
- MFG# #P-CD35C80-X

#53-150 **\$2195**
\$2575 (1-3 prs) \$2350 (4-19 prs) (20+ prs)

3-WAY CROSSOVER



- Build your own High Quality Speaker System
- 60 Watt RMS Input Power
- Crossover Points 700 Hz and 4K Hz
- 12 dB Octave

#50-030 **\$995**
\$14.20 each (2-up)

PYLE 10" SUB WOOFER



- Made in USA
- White cone
- 4-layer V.C., 8 ohm
- 1 1/2" V.C.
- 20 oz magnet
- Free Air: 35 Hz
- Freq. resp.: 25-5500 Hz ■ RMS: 75W
- MAX: 150W ■ MFG# #WW10C200-FS
- Special offer, while quantities last

#55-390 **\$1720** each

BE SURE TO CALL FOR YOUR FREE

128 PAGE CATALOG!
OVER 4,800 ITEMS!



PYLE 6 1/2" MIDRANGE

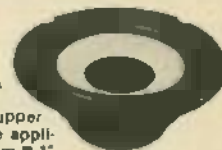

- Made in USA
- White cone
- Perfect for upper bass-midrange applications ■ 8 ohm ■ 1" V.C. ■ 10 oz. magnet
- Free Air: 80 Hz
- Freq. response: 70-10K Hz ■ SPL: 94 dB ■ RMS: 40W
- MAX: 80W ■ Special offer, white quantities last

#54-105 **\$1225** each

We Also Have... a full line of test equipment, computer accessories, telephone accessories, speakers, television parts, flybacks, yokes, switches, fuses, lamps, capacitors, resistors, cartridges, styl, wire, CATV equipment, and many more. Over 4,800 items AT THE LOWEST PRICES AROUND!

Terms:

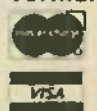

- \$10 minimum order \$1.00 charge for orders under \$10.
- \$20 minimum charge card order
- Orders shipped UPS G.O.D.
- Most orders shipped within 24 hours
- Sales office open 8:30 am to 6:00 pm Saturdays 10:00 am to 3 pm EST
- For prepaid orders add \$2.50 for shipping and handling
- Should shipping & handling charges exceed \$2.50 the balance due will be sent C.O.D.
- Prices effective 2-15-85 through 3-31-85



MCM ELECTRONICS
858 East Congress Park Drive
Centerville, Ohio 45450
513-434-0031

SOURCE NO. RE-7

We have the Largest Selection of Domestic and Imported Components in the Country!

Commodore Accessories

RS232 ADAPTER FOR VIC-20 AND COMMODORE 64



The JE232CM allows connection of standard serial RS232C printers, modems, etc. to your VIC-20 and C-64. A 4-pole switch allows the inversion of the 4 control lines. Complete installation and operation instructions included.

VOICE SYNTHESIZER FOR APPLE AND COMMODORE



Over 730 word vocabulary affords clear pronunciation of more than 500 words. Built-in amplifier, speaker, volume control, and auto shut-off. Accurate diction, natural male voice.

Applications: Security Warning, Teletypewriter, Teaching, Handicap Aid, Entertainment, Games.

Computer Memory Expansion Kits

IBM PC, PC XT and Compatibles. IBM PC expansion memory. IBM PC AT expansion memory.

Apple IIe. JE864. 64K RAM expansion kit.

TRS-80 Model III. TRS-16K3 200ns. TRS-16K4 250ns.

TRS-80 Model IV & 4P. TRS-64K-2. TRS-64K2PAL.

TRS-80 Color and Color II. TRS-64K-2.

Model 100. Model 75. Model 85. Model 100. Model 110/DAES.

Model 100. Model 75. Model 85. Model 100. Model 110/DAES.

Model 100. Model 75. Model 85. Model 100. Model 110/DAES.

Model 100. Model 75. Model 85. Model 100. Model 110/DAES.

Model 100. Model 75. Model 85. Model 100. Model 110/DAES.

Model 100. Model 75. Model 85. Model 100. Model 110/DAES.

Model 100. Model 75. Model 85. Model 100. Model 110/DAES.

Model 100. Model 75. Model 85. Model 100. Model 110/DAES.

ProModem 1200 and Options

Intelligent 300/1200 Baud Telephone Modem with Real Time Clock/Calendar

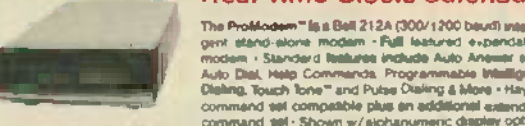

The ProModem is a Bell 212A (300/1200 baud) intelligent stand-alone modem. Full featured expandable modem.

Table with columns: Part No., Description, Price. Lists various ProModem options and configurations.

KEYBOARDS

Mitsumi 54-Key Unencoded. 13 1/2" x 4 1/2" x 1 1/2".

76-Key Serial ASCII Keyboard. 16 1/2" x 10 1/2" x 1 1/2".

Apple Keyboard and Case for Apple II & II+. 14 1/2" x 5 1/2" x 1 1/2".

POWER SUPPLIES

TRANSACTION TECHNOLOGY, INC. 5VDC @ 1 AMP Regulated Power Supply. P551194.

Power/Mate Corp. REGULATED POWER SUPPLY. EMAS/80. EMAS/9C.

KEPCO/DIRK 4-OUTPUT SWITCHING POWER SUPPLY. MRM 174KF.

Switching Power Supply for APPLE II, II+ & IIx. KHP4007.

4-CHANNEL SWITCHING POWER SUPPLY. FCS-604A.

10.00 Minimum Order — U.S. Funds Only. Shipping — Add 3% plus \$1.50 Insurance.

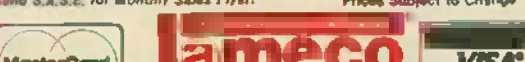

3155 SHOREWAY ROAD, BELMONT, CA 94002. 365 PHONE ORDERS WELCOME — (415) 592-8037 Telex: 176043

Apple Accessories

5 1/4" APPLE Direct Plug-In Compatible Disk Drive and Controller Card

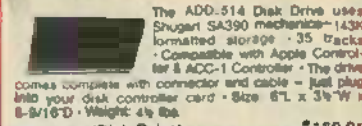

The ADD-514 Disk Drive uses Shugart SA390 mechanics—143K formatted storage—35 tracks.

More Apple Compatible Add-Ons... APP-1 Cooling Fan with surge protection. KHP4007 Switching Power Supply.

DISK DRIVES

Table listing various disk drives: MPI515, RFD480, TM100-2, FD558, SA455, FDD100-8, PKC-5, PKC-8.

UV-EPROM Eraser



Erases all EPROMs. Erases up to 8 chips within 21 minutes (1 chip in 15 minutes).

JE664 EPROM PROGRAMMER



Programs and updates EPROMs. Checks for defective erased EPROMs. Complete PROMs to EPROMs.

8K to 64K EPROMS — 24 & 28 Pin Packages. JE664-A EPROM Programmer.

JE664-A EPROM Programmer. JE664-B EPROM Programmer.

EPROM Programmer w/JE665 Option. JE664-ARS.

Table listing various EPROMs: JE664-ARS, JE664-ARS, JE664-ARS.

7400

74F00

NEW

74ALS00

DISK CONTROLLERS

Table listing various 7400 series components with columns for Part No., Price, and Description.

Table listing various 74F00 series components with columns for Part No., Price, and Description.

Table listing various 74ALS00 series components with columns for Part No., Price, and Description.

MICROPROCESSOR COMPONENTS

New Super Low Prices!

Table listing microprocessor components with columns for Part No., Price, and Description.

74LS

Table listing various 74LS series components with columns for Part No., Price, and Description.

6500 8088 8080 SERIES

Table listing 6500, 8088, and 8080 series components with columns for Part No., Price, and Description.

74S PROMS

Table listing various 74S PROMS components with columns for Part No., Price, and Description.

SPECIAL PACKAGES

Table listing special packages with columns for Part No., Price, and Description.

74S LINEAR

Table listing various 74S linear components with columns for Part No., Price, and Description.

74S CMOS

Table listing various 74S CMOS components with columns for Part No., Price, and Description.

Digitalker

DT1050 - Digitalker featuring built-in applications, stackable, and...

INTERISIL

Table listing various Interisil components with columns for Part No., Price, and Description.

74HC High Speed CMOS

Table listing various 74HC High Speed CMOS components with columns for Part No., Price, and Description.

74C CMOS

Table listing various 74C CMOS components with columns for Part No., Price, and Description.

LINEAR

Table listing various linear components with columns for Part No., Price, and Description.

Jameco Electronics logo and address: 1355 SHOREWAY DRIVE, BELMONT, CA 94002

AMAZING DEVICES

PERSONAL DEFENSE AND PROPERTY PROTECTION UTILIZE SPACE AGE TECHNOLOGY. CAUTION THESE DEVICES CAN BE HAZARDOUS AND MAY SOON BE ILLEGAL.

PHASORS

POCKET PAIN FIELD GENERATOR — IPG50
Assembled \$84.50
IPG5 Plans \$1.00 IPG5K Kit/Plans \$44.50

PHASOR PAIN FIELD CROWD CONTROLLER — PPF10
Assembled \$250.00
PPF1 Plans \$15.00 PPF1K Kit/Plans \$175.00

BLASTER — Provides a plasma discharge capable of puncturing a can
Assembled \$89.50
BLS1 Plans \$10.00 BLS1K Kit/Plans \$69.50

SHOCKER/PARALYZING DEVICE — Very intimidating and effective 5 to 10 feet
Assembled \$99.50
SHG60 Plans \$10.00 SHG6K Kit/Plans \$69.50

LASERS

RUBY LASER RAY GUN — Intense visible red beam burns and welds hardest of metals. **MAY BE HAZARDOUS.**
RUB3A/1 Parts Available for Completing Device \$15.00

CARBON DIOXIDE BURNING, CUTTING LASER — Produces a continuous beam of high energy. **MAY BE HAZARDOUS.**
LCS. All Parts Available for Completing Device. \$15.00

VISIBLE LASER LIGHT GUN — produces intense red beam for sighting, spotting, etc. Hand held complete
LOU3 Plans \$10.00 (Kit & Assembled Units Available)

IR PULSED LASER RIFLE — Produces 15-30 watt infra-red pulses at 200-2000 per sec.
LRG3 All Parts & Diodes Available \$10.00

BEGINNERS LOW POWER VISIBLE LASER — Choice of red, yellow, green — provides an excellent source of monochromatic light
LHC2 Plans \$5.00 LHC2K Kit \$34.50

SECURITY

SNOOPER PHONE — Allows user to call his premises and listen in without phone ever ringing
SNP20 Assembled \$89.50
SNP2 Plans \$9.00 SNP2K Kit/Plans \$90.50

LONG RANGE WIRELESS MIKE — Miniature device clearly transmits well over one mile. Super sensitive, powerful
MFT1 Plans \$7.00 MFT1K Kit/Plans \$49.50

WIRELESS TELEPHONE TRANSMITTER — Transmits both sides of phone conversation over one mile. shuts off automatically.
VWPM5 Plans \$8.00 VWPM5K Kit/Plans \$38.50

TALK & TELL AUTOMATIC TELEPHONE RECORDING DEVICE — Great for monitoring telephone use
TAT20 Assembled \$24.50
TAT2 Plans \$5.00 TAT2K Kit/Plans \$14.50

Our phone is open for orders anytime. Technicians are available 9-11 a.m., Mon-Thurs for those needing assistance or information. Send for free catalog of hundreds more similar devices. Send check, cash, MO, Visa, MC, COD to: **INFORMATION UNLIMITED**
DEPT RR, P.O. Box 716, Amherst, N.H. 03031 Tel: 603-673-4730

CIRCLE 72 ON FREE INFORMATION CARD

DON'T BLAME THE SOFTWARE!

Our Isolators eliminate equipment interaction, clean up interference, curb damaging power line spikes and lightning bursts.



- ISO-1 ISOLATOR**
3 isolated sockets; quality spike suppression; basic protection. . . \$81.95
- ISO-3 SUPER-ISOLATOR**
3 dual isolated sockets; suppressor; commercial protection. . . . \$122.95
- ISO-17 MAGNUM ISOLATOR**
4 quad isolated sockets; suppressor; laboratory grade protection. . \$213.95

Electronic Specialists, Inc.
171 S. Main, Natick, MA 01760 (617) 655-1532

CIRCLE 60 ON FREE INFORMATION CARD

CABLE TV

CONVERTERS AND DESCRAMBLERS

- * JERROLD
- * OAK
- * ZENITH
- * HAMLIN
- * SCIENTIFIC
- * ATLANTA
- * SATELLITE
- * DESCRAMBLERS
- * CABLE KIT

LOW PRICES
QUANTITY DISCOUNTS

SEND \$5.00 FOR CATALOG

R & M DISTRIBUTORS
PO BOX 266-R
BOSTON, MA 02190
(617) 871-5838

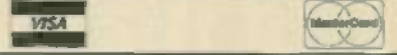

CIRCLE 270 ON FREE INFORMATION CARD

HIGH QUALITY up to 75dB GAIN

MICROWAVE TV SYSTEM

Variable from 1.9 to 2.5 GHz

The latest advance in microwave technology with a **SNOW-FREE PICTURE.**

Two Models to choose from. Both Models Include:
• 20" Parabolic Dish
• Pre-assembled Probe with Down Converter

- Power Supply and Coax Switch
- 60' of RG-59 U Coax with Connector
- Transformer for 75 to 300 Ohms
- All Mounting Hardware for Fast and Easy Installation

20" Fiberglass Dish Up to 55dB Gain Special **\$98.95**

20" Aluminum Dish Up to 55dB Gain Low Priced **\$98.95**

Add 10% for Foreign orders or U.S. Parcel Post

High Gain Yagi Antenna with Down Converter and Power Supply, Complete System, Ready to Use. **\$89.95**

Send \$2.00 for Catalog. Refundable with first purchase. Available thru Mail and Phone Orders Only. 20% deposit for COD, CA Res add 6.1% Tax. Send Cashiers Check or Money Order to: (Personal Checks, allow 2-4 weeks to clear)

PROFESSIONAL VIDEO, Inc.
4670 Hollywood Blvd., Hollywood, Calif. 90027

For C.O.D. Orders Call (213) 219-0227

CIRCLE 119 ON FREE INFORMATION CARD

MCAD BATTERY ZAPPER KIT

This is one of the most vital red money saving kits you can buy! The Battery Zapper kit will save you money that you no longer see because they won't recharge. Many acids that inhibit a charge after a period of time because they produce hydrogen sulfide gas. It is easy to use and the acid will be clean again in 10-15 minutes. The most life span is from 6V DC (4 AA cells, etc.), but produces 200V AC which is applied momentarily to the acid to "blow the bubbles" without damaging the battery. Replaces about 90% of needs in size from 2A to 100A. A fast charging, the acid is ready to be fully charged again and again. Great kit to do a lot of work in. The kit is a great product available in many formats. Ship this on a light weight plastic case. The kit comes with all parts, PC board and instructions that are easy to use.
C6278 \$14.95

STYLISH CASE
This is the case that makes that professional look in your office. It is a stylish case that is available in many colors. It is a great addition to your office. The kit is a great product available in many formats. Ship this on a light weight plastic case. The kit comes with all parts, PC board and instructions that are easy to use.
C6252 \$4.95

PHONE ORDERS: 303-973-7291

120 VAC Xenon Strobe Kit
C3071 \$10.95

BOX OF ELECTRONICS
Super kit of 75 electronic components, IC's, transistors, and more. Includes: Resistor, Inductor, Capacitor, Diode, Transistor, IC, etc. The kit is a great product available in many formats. Ship this on a light weight plastic case. The kit comes with all parts, PC board and instructions that are easy to use.
C6282 \$10.00

GOLD PAST (LARGE) AA MCAD
This is the fast charging kit for AA cells. It is a great product available in many formats. Ship this on a light weight plastic case. The kit comes with all parts, PC board and instructions that are easy to use.
C6299 \$1.49

2732 EPROM
Blank Hitachi 450WSEC Eprom
C4972 \$2.95

SEND FOR YOUR FREE COPY OF OUR 1988 CATALOG LISTING

"Over 70 electronic kits which include parts and plans!"

"A million dollars worth of good deals (plus a giveaway prize)!"

"100 million electronic bargains!"

CHANEY
ELECTRONICS INC.
P.O. Box 17838
1616 R, COLORADO 80227

• Minimum AU Order \$5.00
• Please include \$2.00 for postage (USPS)
• VISA, MC accepted
• Phone orders are subject to
• Send for our free catalog of unique items

CIRCLE 109 ON FREE INFORMATION CARD

ACTIVE RECEIVING ANTENNA

Gives excellent reception, 50 KHz to 30 MHz.

New MFJ-1024 Active Receiving Antenna mounts outdoors away from electrical noise for maximum signal. Gives excellent reception of 50 KHz to 30 MHz signals. Equivalent to wire hundreds of feet long. Use any SWL, MW, BCB, VLF or Ham receiver. High dynamic range RF amplifier. 54 in. whip. 50 foot coax. 20 dB attenuator prevents receiver overload. Switch between two receivers. Select auxiliary or active antenna. Gain control. "ON" LED. Remote unit. 3x2x4 in. Control. 6x2x5 in. 12 VDC or 110 VAC with optional adapter, MFJ-1312. \$9.95.

\$129.95

Order from MFJ and try it. If not delighted, return within 30 days for refund (less shipping). One year unconditional guarantee. Order today. Call TOLL FREE 800-647-1800. Charge VISA, MC. Or mail check, money order. Write for free catalog. Over 100 products.

CALL TOLL FREE 800-647-1800

Call 601-323-5869 In Miss., outside continental USA, tech/order/repair info. TELEX 53-4590.

MFJ ENTERPRISES, INCORPORATED
Box 494, Mississippi State, MS 39762

CIRCLE 105 ON FREE INFORMATION CARD

RAMSEY

THE FIRST NAME IN ELECTRONIC TEST GEAR

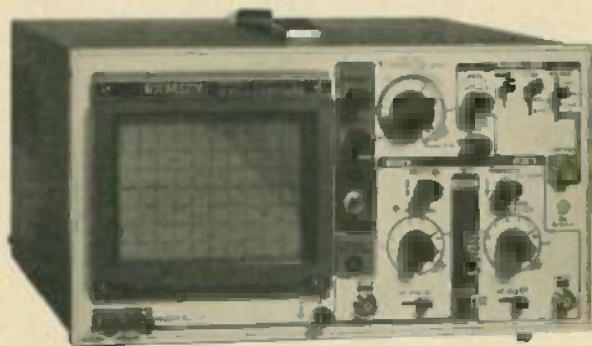

20 MHz DUAL TRACE OSCILLOSCOPE

Unsurpassed quality at an unbelievable price, the Ramsey oscilloscope compares to others costing hundreds more. Features include a component testing circuit for resistor, capacitor, digital circuit and diode testing • TV video sync filter • wide bandwidth & high sensitivity • internal graticule • front panel trace rotator • 2 axes • high sensitivity any mode • regulated power supply • built-in calibrator • rock solid triggering

*USA—Add \$10.00 per unit for postage, overseas orders add 15% of total order for insured surface mail

\$399⁹⁵*

high quality hook on probes included

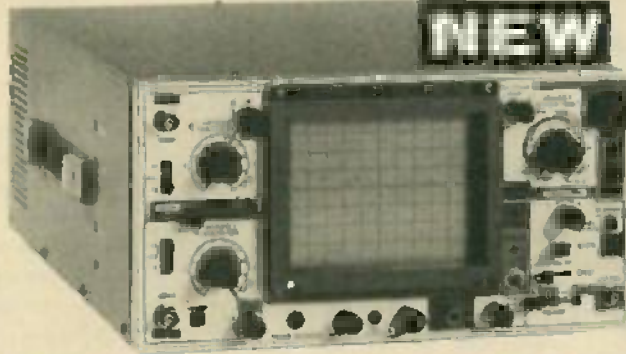

NEW

45 MHz DUAL SWEEP OSCILLOSCOPE

The Ramsey 805 is a dual trace beam, delayed sweep unit that includes a built-in signal delay line to permit clear viewing during very short rise times of high frequency waveforms. Other features include: variable trigger holdoff • 20 calibrated sweep time ranges from 0.5 n/div to 0.2 μs/div • fully adjustable sweep time • 35 sweep magnification • five trigger sources: CH1, CH2, LINE, EXTERNAL and INTERNAL (V mode) • front panel CRT operation, 2 axis input • sum driver • CH1 and CH2 waveforms displayed as single trace • sweep BSM and sweep output • auto focus • single sweep

*Same as unit to left.

\$799⁹⁵*

high quality hook on probes included



RAMSEY D-1100 VOM MULTIMETER

Compact and reliable, designed to service a wide variety of equipment. Features include • mirror back scale • double-throw precision moving coil • double overload protection • an ideal low cost unit for the beginner or as a spare back-up unit.

\$19⁹⁵ test leads and battery included



NEW RAMSEY 1200 VOM MULTIMETER

Check transistors, diodes and LEDs with this professional quality meter. Other features include, decibel scale • 20K volt metering system • 3" mirrored scale • polarity switch • 20 measuring ranges • safety probes • high impact plastic case

\$24⁹⁵ test leads and battery included



RAMSEY O-3100 DIGITAL MULTIMETER

Reliable, accurate digital measurements at an amazingly low cost • in-line color coded push buttons, speeds range selection • abs plastic bit stand • recessed input jacks • overload protection on all ranges • 3 1/2 digit LCD display with auto zero, auto polarity & low BAT. indicator

\$49⁹⁵ test leads and battery included

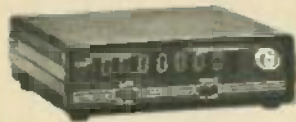

CT-70 7 DIGIT 525 MHz COUNTER

Lab quality at a breakthrough price. Features • 3 frequency ranges each with pre amp • dual selectable gate times • gate activity indicator • 50mV @ 150 MHz typical sensitivity • wide frequency range • 1 ppm accuracy

\$119⁹⁵ wired includes AC adapter

CT-70 kit \$99.95
BP-4 nicad pack 6.95

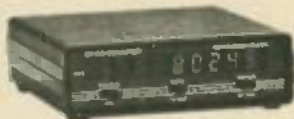

CT-90 9 DIGIT 600 MHz COUNTER

The most versatile for less than \$300. Features 3 selectable gate times • 8 digits • gate indicator • display hold • 25mV @ 150 MHz typical sensitivity • 10 MHz timebase for WWV calibration • 1 ppm accuracy

\$149⁹⁵ wired includes AC adapter

CT-90 kit \$129.95
CP-1 1x1 PPM oven timebase 59.95
BP-4 nicad pack 6.95

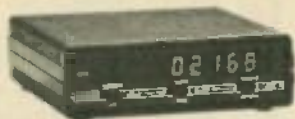

CT-125 9 DIGIT 1.2 GHz COUNTER

A 9 digit counter that will outperform units costing hundreds more. • gate indicator • 25mV @ 150 MHz typical sensitivity • 8 digit display • 1 ppm accuracy • display hold • dual inputs with preamps

\$169⁹⁵ wired includes AC adapter

BP-4 nicad pack 6.95



CT-50 8 DIGIT 600 MHz COUNTER

A versatile lab bench counter with optional receive frequency adapter, which turns the CT-50 into a digital readout for most any receiver • 25 mV @ 150 MHz typical sensitivity • 8 digit display • 1 ppm accuracy

\$169⁹⁵ wired

CT-50 kit \$129.95
RA-1 receiver adapter kit 14.95



OM-700 DIGITAL MULTIMETER

Professional quality at a hobbyist price. Features include 20 different ranges and functions • 3 1/2 digit, 1/2 inch LED display • automatic decimal placement • automatic polarity

\$119⁹⁵ wired includes AC adapter

OM-700 kit 119.95
MP-1 probe set 6.95

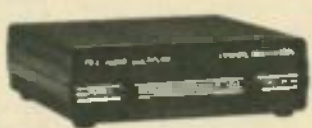

PS-2 AUDIO MULTIPLIER

The PS-2 is handy for high resolution audio resolution measurements, multiplies UP in frequency • great for PL tone measurements • multiplies by 10 or 100 • 0.01 Hz resolution • built-in signal preamp/conditioner

\$49⁹⁵ wired

PS-2 kit \$39.95



PR-2 COUNTER PREAMP

The PR-2 is ideal for measuring weak signals from 10 to 1,000 MHz • flat 25 db gain • BNC connectors • great for shifting RF • ideal receiver/TV preamp

\$44⁹⁵ wired includes AC adapter

PR-2 kit \$34.95

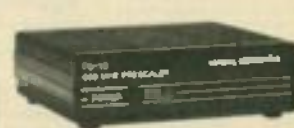

PS-1B 600 MHz PRESCALER

Extends the range of your present counter to 600 MHz • 2 stage preamp • divide by 10 circuitry • sensitivity 25mV @ 150 MHz • BNC connectors • drives any counter

\$59⁹⁵ wired includes AC adapter

PS-1B kit \$49.95

ACCESSORIES FOR RAMSEY COUNTERS

- Telescopic whip antenna—BNC plug .. \$ 8.95
- High impedance probe, light loading .. 16.95
- Low pass probe, audio use .. 16.95
- Direct probe, general purpose use .. 13.95
- Till ball, for CT-70, 90, 125 .. 3.95

VISA

MasterCard

PHONE ORDERS CALL
716-586-3950

TELEX 466735 RAMSEY CI

RAMSEY

RAMSEY ELECTRONICS, INC.
2575 Baird Rd.
Penfield, N.Y. 14626

CIRCLE 70 ON FREE INFORMATION CARD

MARCH 1985

127

SPARTAN Electronics Int'l



CALL MAIL
(516) 499-9500
6094 Jericho Tpke.
Commack, N.Y. 11725

CTC9R Philips Remote Cable Converter

Micro computer technology • Quartz controlled IC's • 100 channels • 24 hour 120 degree • Flexible channel memory • 1000 plus • Wireless hand held • Auto rec. transmitter system • Automatic line lock • Adaptable to any brand message • One year warranty service

\$139.95

RS232 TRANSMISSION LINE TESTER

Features: Male to Female connector for easy insertion into RS232 Lines • Test 7 lines (TD, RD, RTS, CTS, DSR, CD, DTR) using LEDs to indicate status of each • Directly powered by RS232 Line no AC power needed

\$29.95

SOUND ACTIVATED SWITCH MODEL R-1 \$29.95

For Home Security
Hears & Noise, Turns On Lights!

When lights turn on, intruders are frightened away. Ask any policeman the new SOUND activated SWITCH automatically turns on lights as any sound so it looks like you're home even when you're not.

SOUND activated SWITCH protects your home better than beams. It turns on lights at the sound of an attempted break-in, and automatically turns them off when it's safe.

SOUND activated SWITCH
It's the lightest switch you can't afford to be without.

• Entry Hall • Nursery • Sex Room • Family Room • Stairways and Halls • Children's Rooms • Attic • Basements • Garage • Closets

REFURBISHED MONITORS

9" and 12" Bell & Howells or GBC Commercial Grade as low as \$10.00 off with a purchase of 2 refurbished monitors

\$39.95

RS232 TRANSMISSION LINE TESTER

Features: All 25 Signal Lines accessible • Dual Color Red Green

Accessories: 1 Cable 10' male to Female Extension Jumper Set • 8 Straight 1 T-Jumper

Velvet Case
Call for quantity prices

\$169.95

Jerrold 58 Channel Wireless Remote Converter \$109.95

Jerrold 36 Channel Remote CATV Converter w/on/off Fine Tuning \$94.95

40 Channel VHF to UHF Block Converter

28.95 Ea.
24.95 4 & up

Deluxe Version - Features fine tuning knob, matching X former & 2 cables \$38.95

BEFORE YOU PAY \$5 FOR A TELEPHONE SERVICE CALL, TEST IT YOURSELF

Telephone Line Analyze Model #1042

• Tests telephone line functions that affect telephone operation.
• Verifies line and ring voltage levels.
• Checks condition of telephone line from central office to user's telephone jack.
• Verifies telephone line polarity. Will call ground faults sensitive telephones.

\$19.95

PROFESSIONAL TELEPHONE PRODUCT TESTER

Features: MODEL 1045

• Provides 8000 operation tests for standard and cordless telephones, answering machines, and automatic stations.
• Checks telephone line opens and hardware circuit for continuity, voltage and impedance.
• Verifies number display and volume for fully or touch tone telephones.
• Provides the dual normal loop ring test sequence.
• Verifies the cord and other dual tone multiple frequency tests for standard telephones.

• Can be used by the consumer without the aid of a technician or only to follow directions that are provided with the tester.
• Can be used by the technician to determine operation and features of telephones, cordless and to correct telephone circuits and to correct telephone malfunctions.

\$335.95

Volume Discounts

Min. Order \$25.00
International shipping Add'l
Prices subject to change without notice

75.00 to 250.00	\$4.50
251.00 to 500.00	\$6.00
501.00 to 750.00	\$8.50
751.00 to 1000.00	\$12.00
Over 1000.00	\$12.50

(516) 499-9500
Mon Th Tu W F Sa
CIRCLE 75 ON FREE INFORMATION CARD

ADVERTISING INDEX

RADIO-ELECTRONICS does not assume any responsibility for errors that may appear in the index below.

Free Information Number	Page		
267	A.I.S. Satellite	85	New-Tone Electronics
50	A.W. Sperry	83	PTS
108	ADC Sales	86	Paia
76	AP Products	11	Philips Tech
—	Active Electronics	114	Pocket Technology
—	Advance Electronics	22,23	Power Plus
106	Advanced Computer Products	113	Print Products International
107	All Electronics	117	Professional Video
72	Amazing Devices	126	R&M Distributors
—	American Design Components	CD2	RAG Electronics
84	Appliance Service	85	RCA Dis. & Special Prod.
77	B&K Precision	CV3	Radio Shack
98	Beckman Instruments	8,9	Ramsey
—	Career I	84	RE Bookstore
81	CEI	104	Regency
—	CIE	34-37	Research Service Lab
109	Chaney	126	Simpson
263	Chapman Tools	24	Sintec
54	Chemtronics	24	Solder Craft
—	Command Productions	89	Spartan Electronics
79,275,276	Communications Electronics	1,2,30,31	Spectrum
55	Contact East	85	Tampa Electronic Supply
—	Coop's Satellite Digest	14	Tektronix
—	Dak Industries	90,91,95	Test Probes
257	Data World Products	85	Unitech
269	Diamondback	122	VAMP
82	Digi-Key	119	Vector Electronics
—	Digital Research Computers	122	Wm B Allen
57	Digitron	116	
110	Dokay	118	
60	Electronic Specialists	126	
61,280	Electronic Warehouse	101,103	
261	Electronics Book Club	25	
120	Elephant Electronics	85	
111	Etronix	89	
—	ETT	48	
100	Firestik II	39	
256	Fluke Manufacturing	5	
—	Fordham Radio	7,74,CV4	
272	Gemini Electronics	15	
62	Global Specialties	86	
—	Granham College of Engineering	42	
259	Hamag	87	
71	Handy Prods./RSP Elec.	115	
86,274	Heath	29,71,73	
281	Howard Research & Design	85	
63	Instrument Mart	107	
113	JDR Microdevices	120,121	
114	Jameco	124,125	
124	James Walter Satellite Rec.	85	
115	Jensen Tools	84	
251	Jim-Pac	40,41	
87	MCM Audio	123	
105	MFJ	126	
67	McIntosh Labs.	99	
117	Mouser	108	
—	NRI	16-19	
—	NTS	52,55	
268	Nemal Electronics	84	
88	Network Sales	122	

Gernsback Publications, Inc.
200 Park Ave. South
New York, NY 10003
(212) 777-6400
Chairman of the Board:
M. Harvey Gernsback
President: Larry Steckler

ADVERTISING SALES 212-777-6400

Larry Steckler
publisher

Shelli Weinman
advertising associate

Arline Fishman
advertising coordinator

Ilsa Strassman
credit manager

Donna Sala
credit associate

Naomi Matten
advertising assistant

Sales Offices

EAST/SOUTHEAST

Stanley Levitan
Radio-Electronics
200 Park Ave. South
New York, NY 10003
212-426-6037, 212-777-6400

MIDWEST/Texas/Arkansas/Okla.

Ralph Bergen
Radio-Electronics
540 Frontage Road—Suite 325
Northfield, IL 60093
312-446-1444

PACIFIC COAST/ Mountain States

Maryn Green
Radio-Electronics
15335 Morrison St.—Suite 227
Sherman Oaks, CA 91403
818-986-2001

RADIO-ELECTRONICS

Quick... who makes the scopes that out-tech the competition?

NEW
10MHz
590A
1995

NEW
10MHz
570A
1395

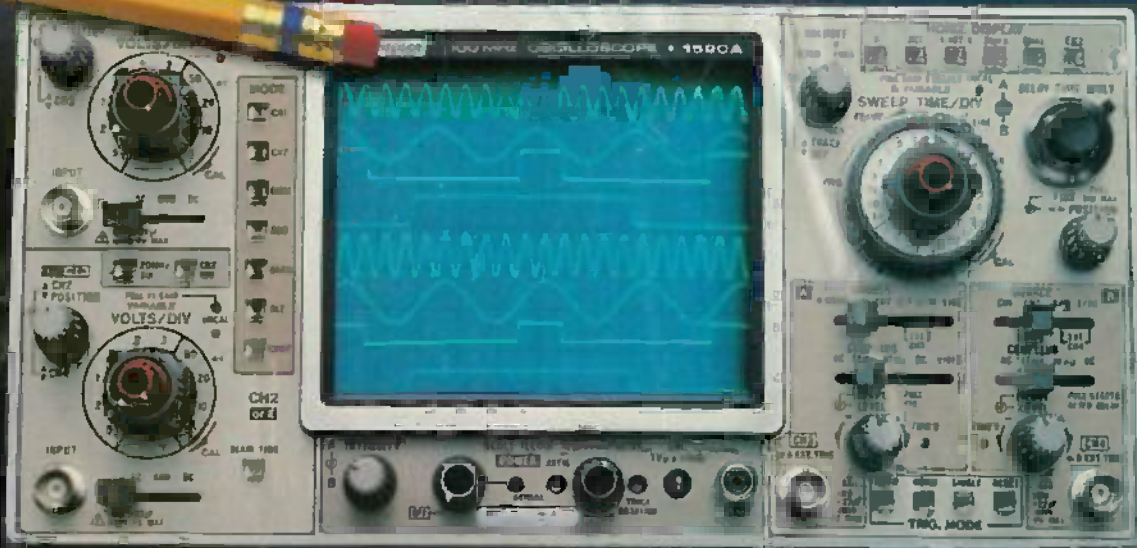

Compare these features and performance specifications.

Bright 20KV display
(12KV on 1570A)
with illuminated
graticule.

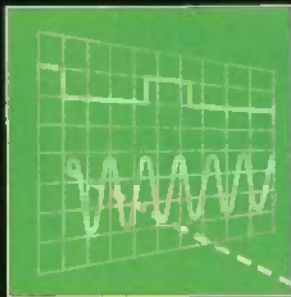

1mV

SENSITIVITY
FULL BANDWIDTH



Dual timebase
with dual-
independent
timebase on
1590A

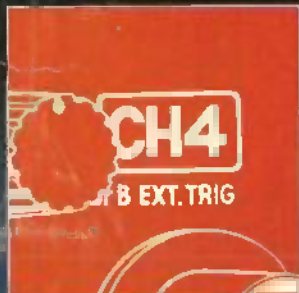

Four vertical inputs
with 8-trace display

- $\pm 2\%$ VERTICAL AND HORIZONTAL ACCURACY
- V-MODE DISPLAYS FOUR UNRELATED SIGNALS
- SOFT-TOUCH, LT CONTROLS
- 500 μ V CASCADE SENSITIVITY
- CHANNEL 1 BUFFERED OUTPUT

Five times more
sensitive than
most competitors.

Compare all of the features and performance benefits
with any scopes in their price range. See your local
stocking distributor or contact B&K-PRECISION.

CIRCLE 77 ON FREE INFORMATION

B&K PRECISION DYNASCAN CORPORATION
6460 West Cortland Street • Chicago, Illinois 60635 • 312 389-9087

International Sales, 6460 W. Cortland St., Chicago, IL 60635
Canadian Sales, Arco Electronics, Unit 10
Southwest Control, Sematron Corp., 10000 E. 1st Ave., Denver, CO 80231

PERFORMANCE

SCOPE HAND-HELD DIGITAL CAPACITANCE and MULTIMETERS

- 0.5% DC Accuracy
- Highest Quality
- Highest Performance
- Lowest Prices

THE ULTIMATE TEST



Model DCM-602
\$7995

Digital Capacitance Meter
8 ranges with full scale values to 2000 uF
FEATURES • Broad test range - 1 pF to 2000 uF • LSI circuit provides high reliability and durability • Lower power consumption • Clear readout even in bright light • Crystal time base • Easy to operate, compact, lightweight • Protected from charged capacitors • Frequency range - 800 Hz to 8 Hz



Model DVM-634
\$4875

7 functions, 32 ranges.
Transistor measurement included.

Digital Multimeters

- DC Voltage 100 uV - 1000 V
- AC Voltage 100 uV - 750 V
- AC/DC Current 200 uA - 10 Amps
- Resistance 20 Megohms
- Capacitance (DVM 636/638) 1 pF - 20 uF



Model DVM-638
\$7995

11 functions, 38 ranges.
Includes logic level detector, audible visual continuity, capacitance and conductance measurement.



Model DVM-636
\$6275

8 functions, 37 ranges.
Capacitance measurement included.

- FEATURES** • Overload Protection • Auto-decimal LCD readout • Polarity Indication • 3000 hour battery life with 9V transistor battery • Low battery indication

Charge it with VISA/MASTERCARD. Money orders, checks accepted. C.O.D.'s require 25% deposit.

Fordham

260 Motor Parkway, Hauppauge, NY 11788

Toll Free
800-645-9518
In NY State 800-832-1446

Service and Shipping Charge Schedule FOR ORDERS	ADD
\$25-250	\$4.50
\$251-500	\$6.50
\$501-750	\$8.50
\$751-1,000	\$12.50
\$1,001 and up	\$15.00