

48783 **Radio-**

**HOW TO TROUBLESHOOT
AND REPAIR YOUR
CORDLESS TELEPHONE**

**\$1.95 MAY 1985
IN CANADA \$2.25**

Electronics

TECHNOLOGY - VIDEO - STEREO - COMPUTERS - SERVICE

**Build a power meter
for your stereo
that doubles as a
speaker protector**

**Electronics in medicine —
how electronic technology
helps doctors diagnose
breathing problems**

**How to design
intelligent projects
using microprocessors**

**Build a computer-
controlled robot arm**

**All about optocouplers
and how to
put them to
work for
you**

**Understanding
logic gates - the
building blocks of
digital electronics**

**Special 16-page section:
COMPUTERDIGEST**

PLUS:

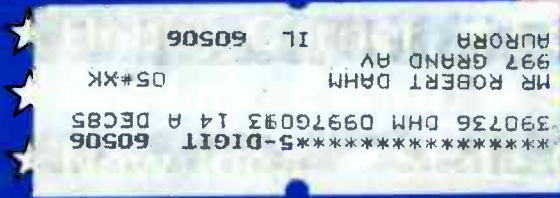

**Equipment Reports
Service Clinic
Of-Solid-State**

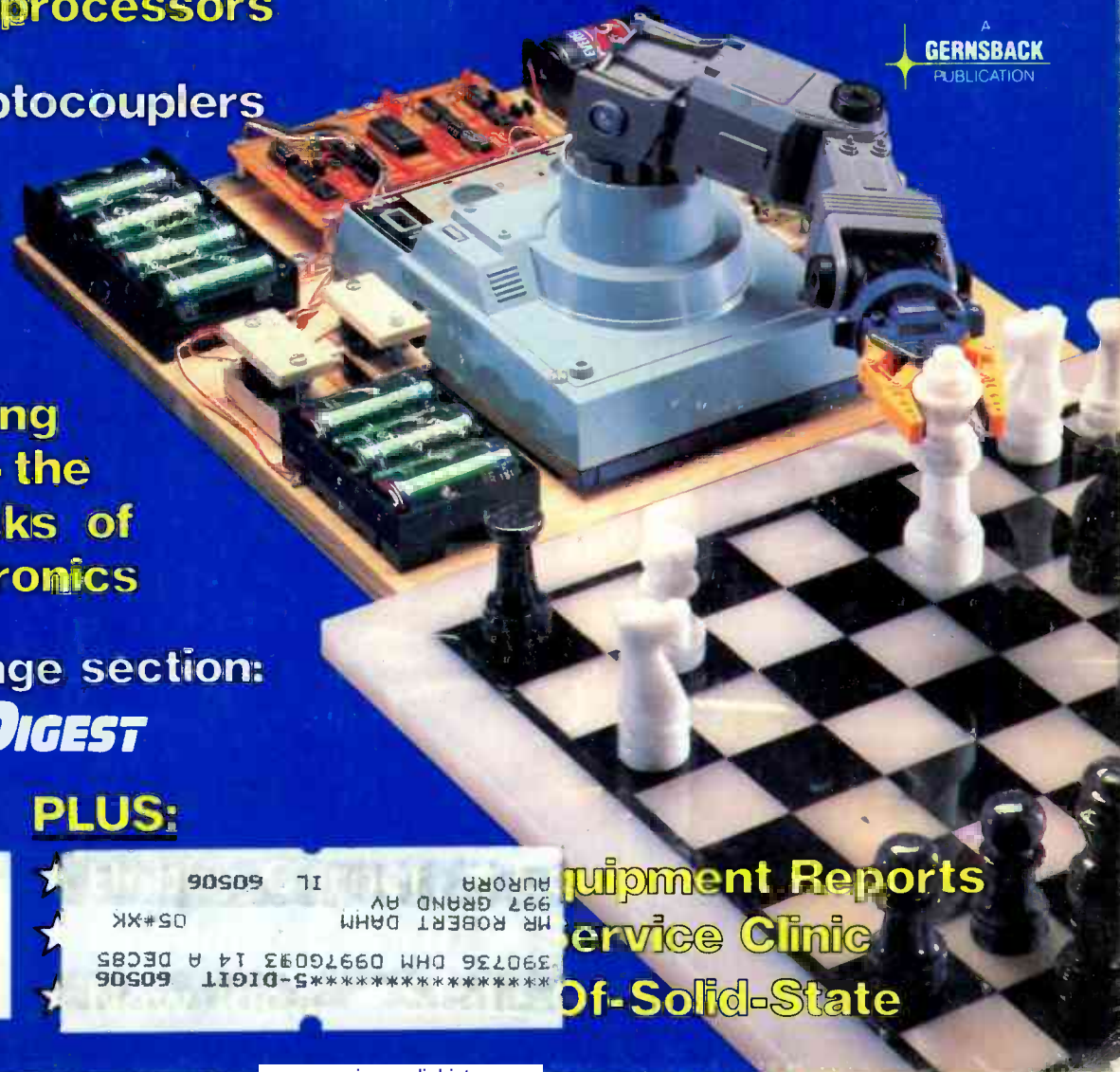

**A
GERNSBACK
PUBLICATION**



You can't judge a scope by its cover.

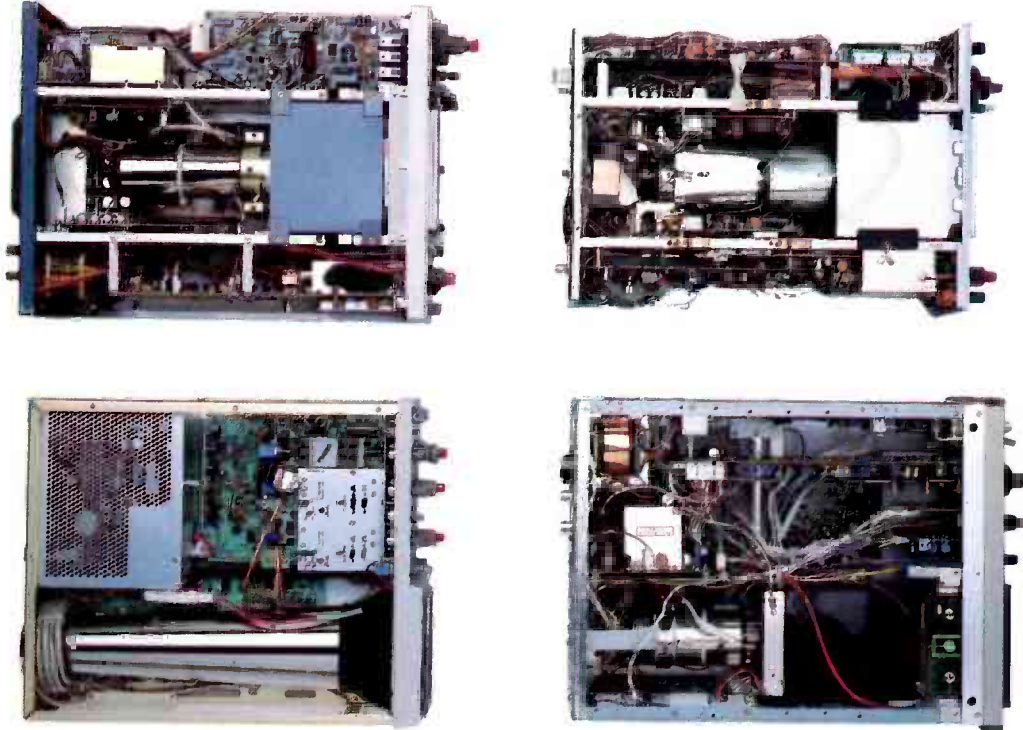

When you look at our simplified, practical internal design, you see why the Tek 2200 Series delivers unparalleled high performance and reliability in the field. You get quality that's unmistakably Tektronix in scopes so advanced, they cost you less to buy and own.

Through an innovative new concept in scope design we reduced the number of mechanical parts by 65%. Reduced cabling by 90%. Virtually eliminated board electrical connectors. And eliminated the need for a cooling fan.

The result: a scope with designed-in simplicity that increases reliability as it cuts downtime and repair costs. All of which means outstanding value in

a compact, lightweight package that your service technicians will appreciate.

Plus, you get a selection of performance to precisely match your needs. There are the 60 MHz single time base delay 2213A at \$1200* and the 60 MHz dual time base 2215A at \$1450*. And at 100 MHz, the dual time base 2235 at \$1650* and the 2236 with an integrated counter/timer/multimeter at \$2650*.

The industry's first three-year warranty† is testimony to 2200 Series dependability. Adding value to value are a variety of optional service plans that can economically extend this coverage to five years.

Consider what you're paying

now in downtime, in service, in back-up scopes. On the bottom line, a Tek 2200 Series scope will save you money, time and trouble now and in the years to come.

Contact your Tek Sales Engineer for a demo today. Or call 1-800-426-2200, Ext. 201.

In Oregon, call collect: (503) 627-9000, Ext. 201.



Tektronix
COMMITTED TO EXCELLENCE

*Prices F.O.B. Beaverton, Oregon
†3-year warranty includes CRT and applies to 2200 family oscilloscopes purchased after 1/1/83. Scopes are UL listed, CSA and VDE approved.

Copyright © 1984, Tektronix, Inc. All rights reserved. TTA-517.

INCLUDING
800 MHz COVERAGE!

Regency hand held scanners

*bring you all the action...
wherever you are!*



HX1000

HX2000

HX750

HX650

When you need to hear the action from wherever you are, Regency delivers. Our portable scanners keep you in touch with the local news. Whether it's bank hold ups, three alarm fires, weather, business, marine radio, or aircraft calls, Regency portables bring you the on the scene action. While it's happening from where it's happening . . . in your neighborhood.

PROGRAMMABILITY WITH A CHOICE

Regency offers you two new exciting keyboard programmable hand held scanners. First there's the HX2000 20 channel, no crystal scanner. It offers UHF and VHF ranges with the important addition of 800 MHz and aircraft frequencies. And with features like search and scan, priority, liquid crystal display, and selectable search

increments, the HX2000 is a sure winner.

If you don't need the extended coverage, there's the HX1000. It let's you cover your choice of over 15,000 frequencies on 30 channels at the touch of your finger. No crystals are necessary. Six band coverage, search and scan, priority control, and a liquid crystal display with special programming messages and clock are all part of the package. And with the sealed rubber keyboard and die-cast aluminum chassis, the HX1000 is the most rugged and durable hand held on the market.

CRYSTAL-CLEAR

If you don't need all the features of programmables, but you want the convenience of portability, we've got you covered. Our two crystal controlled hand held scanners, the HX650 and HX750, offer

six channels, individual channel lock outs, LED channel indicators, step control, two antennas and an adaptor/charger. Both cover VHF high and low, UHF and "T" public service bands, with the HX750 offering the additional coverage of VHF aircraft band.

DECIDE FOR YOURSELF

Your Regency Scanner dealer would be happy to give you a free demonstration of these and other new Regency Scanners. Stop in today. Or, write Regency Electronics, 7707 Records St., Indpls., IN 46226.

Regency®

ELECTRONICS, INC.

7707 Records Street
Indianapolis, IN 46226

CIRCLE 257 ON FREE INFORMATION CARD

NEW!

Regency[®] Scanners

Communications Electronics[™], the world's largest distributor of radio scanners, introduces new models with special savings on all radio scanners. Chances are the police, fire and weather emergencies you'll read about in tomorrow's paper are coming through on a scanner today.

NEW! Regency[®] MX7000-G

List price \$699.95/CE price \$449.00
10-Band, 20 Channel • Crystalless • AC/DC
Frequency range: 25-550 MHz, continuous coverage and 800 MHz, to 1.2 GHz, continuous coverage
In addition to normal scanner listening, the MX7000 offers CB, VHF, and UHF TV audio, FM Broadcast, all aircraft bands (civil and military), 800 MHz communications, cellular telephone, and when connected to a printer or CRT, satellite weather pictures.

NEW! Regency[®] MX5000-G

List price \$599.95/CE price \$354.00
Multi-Band, 20 Channel • No-crystal scanner
Search • Lockout • Priority • AC/DC
Selectable AM-FM modes • LCD display
World's first continuous coverage scanner
Frequency range: 25-550 MHz, continuous coverage.
Never before have so many features come in such a small package. The Regency MX5000 mobile or home scanner has continuous coverage from 25 to 550 MHz. That means you can hear CB, Television audio, FM broadcast stations, all aircraft bands including military and the normal scanner bands, all on your choice of 20 programmable channels.

NEW! Regency[®] MX4000-G

List price \$629.95/CE price \$394.00
Multi-Band, 20 Channel • No-crystal scanner
Search • Lockout • Priority • AC/DC
Selectable AM-FM modes • LCD display
Bands: 30-50, 118-136, 144-174, 440-512, 800-950 MHz.
The Regency MX4000 gives coverage in the standard VHF and UHF ranges with the important addition of the 800 MHz, and aircraft bands. It features keyboard entry, multifunction liquid crystal display and variable search increments.

Regency[®] MX3000-G

List price \$319.95/CE price \$182.00
6-Band, 30 Channel • No-crystal scanner
Search • Lockout • Priority • AC/DC
Bands: 30-50, 144-174, 440-512 MHz.
The Regency Touch MX3000 provides the ease of computer controlled, touch-entry programming in a compact-sized scanner for use at home or on the road. Enter your favorite public service frequencies by simply touching the numbered pressure pads. You'll even hear a "beep" tone that lets you know you've made contact.

Regency[®] Z30-G

List price \$279.95/CE price \$166.00
6-Band, 30 Channel • No-crystal scanner
Bands: 30-50, 144-174, 440-512 MHz.
Cover your choice of over 15,000 frequencies on 30 channels at the touch of your finger.

Regency[®] C403-G

List price \$99.95/CE price \$62.00
5-Band, 4 Channel • Crystal scanner
Channel indicator LED • AC only • Low cost
Bands: 30-50, 148-174, 450-470 MHz.
Regency's basic scanner, the C403 gives you the excitement of police, fire and emergency calls at a budget price. It can tune in to any of five public service bands and brings the signal in loud and clear...on any of four possible channels. It comes with detachable telescope antenna and AC power cord. Order one crystal certificate for each channel you want to receive.

Regency[®] HX1000-G

List price \$329.95/CE price \$209.00
6-Band, 30 Channel • No Crystal scanner
Search • Lockout • Priority • Scan delay
Sidelit liquid crystal display • Digital Clock
Frequency range: 30-50, 144-174, 440-512 MHz.
The new handheld Regency HX1000 scanner is fully keyboard programmable for the ultimate in versatility. You can scan up to 30 channels at the same time. When you activate the priority control, you automatically override all other calls to listen to your favorite frequency. The LCD display is even sidelit for night use. A die-cast aluminum chassis makes this the most rugged and durable hand-held scanner available. There is even a backup lithium battery to maintain memory for two years. Includes wall charger, carrying case, belt clip, flexible antenna and nicad battery. Order your Regency HX1000 now.

Regency[®] R106-G

List price \$159.95/CE price \$92.00
5-Band, 10 Channel • Crystal scanner • AC/DC
Frequency range: 30-50, 146-174, 450-512 MHz.
A versatile scanner, the Regency R-106 is built to provide maximum reception at home or on the road. Rugged cabinet protects the advanced design circuitry allowing you years of dependable listening.

NEW! Regency[®] R1050-G

List price \$179.95/CE price \$109.00
6-Band, 10 Channel • Crystalless • AC only
Frequency range: 30-50, 144-174, 440-512 MHz.
Now you can enjoy computerized scanner versatility at a price that's less than some crystal units. The Regency R1050 lets you in on all the action of police, fire, weather, and emergency calls. You'll even hear mobile telephones.
Programming the R1050 is easy. Merely touch the keyboard and enter any of over 15,000 frequencies on your choice of 10 channels.

Regency[®] HX650-G

List price \$129.95/CE price \$79.00
5-Band, 6 Channel • Handheld crystal scanner
Bands: 30-50, 146-174, 450-512 MHz.
Now you can tune in any emergency around town, from wherever you are, the second it happens. Advanced circuitry gives you the world's smallest scanner. Our low CE price includes battery charger/A.C. adapter.

NEW! Regency[®] HX-650P-G

List Price \$189.95/CE price \$104.00
Now, Communications Electronics offers a special packaged price on the Regency HX-650 scanner and the following items for only \$104.00. You get the Regency HX-650 scanner, a set of 4 AAA ni-cad batteries, the MA-506 carrying case, six crystal certificates, AC adapter/charger and flexible rubber antenna for only \$104.00 per package plus \$10.00 shipping/handling. To order this special package, use CE special order number HX-650P-E.

QUANTITY DISCOUNTS AVAILABLE

Order two scanners at the same time and deduct 1%, for three scanners deduct 2%, four scanners deduct 3%, five scanners deduct 4% and six or more scanners purchased at the same time earns you a 5% discount off our super low single unit price.

NEW! Regency[®] HX2000-G

The World's First 800 MHz, Handheld Scanner
List price \$569.95/CE price \$359.00
7-Band, 20 Channel • No-crystal scanner
Priority control • Search/Scan • AC/DC
Sidelit liquid crystal display • Memory backup
Bands: 118-136, 144-174, 440-512, 800-950 MHz.
The new Regency HX2000, handheld scanner covers thousands of frequencies including the new 800 MHz band. Although this scanner does not have low band, you can scan up to 20 channels at the same time. Selectable AM/FM reception modes on all frequencies. With the included AC/DC transformer, the HX2000 can be operated on either 120V AC or 6 VDC. Scans 15 channels per second. Size 3" x 7" x 1 1/2". Includes wall charger, carrying case, belt clip, flexible antenna and nicad batteries.

NEW! Regency[®] RH250B-G

List price \$699.95/CE price \$379.00
10 Channel VHF synthesized transceiver
Built-in scanner with programmable priority
Fully programmable CTCSS on every channel
If you're a fireman, policeman or a person on the go and it's essential that you stay in touch with headquarters, you need the Regency RH250 transceiver. You can program simplex or semi-duplex frequencies including CTCSS tones.

OTHER RADIOS & ACCESSORIES

| | |
|---|----------|
| Z10-G Scanner..... | \$136.00 |
| Z45-G Scanner..... | \$199.00 |
| RP410-G 10 ch. handheld no-crystal transceiver..... | \$399.00 |
| B-4-G 1.2 V AAA Ni-Cad batteries (set of four)..... | \$9.00 |
| A-135-C G Crystal certificate..... | \$3.00 |
| A60-G Magnet mount mobile antenna..... | \$35.00 |
| A70-G Base station antenna..... | \$35.00 |

Add \$3.00 shipping for all accessories ordered at the same time. Add \$3.00 shipping per scanner antenna.

BUY WITH CONFIDENCE

To get the fastest delivery from CE of any scanner, send or phone your order directly to our Scanner Distribution Center.[™] Be sure to calculate your price using the CE prices in this ad. Michigan residents please add 4% sales tax or supply your tax I.D. number. Written purchase orders are accepted from approved government agencies and most well rated firms at a 10% surcharge for net 10 billing. All sales are subject to availability, acceptance and verification. All sales on accessories are final. Prices, terms and specifications are subject to change without notice. All prices are in U.S. dollars. Out of stock items will be placed on backorder automatically unless CE is instructed differently. A \$5.00 additional handling fee will be charged for all orders with a merchandise total under \$50.00. Shipments are F.O.B. Ann Arbor, Michigan. No COD's. Most products that we sell have a manufacturer's warranty. Free copies of warranties on these products are available prior to purchase by writing to CE. International orders are invited with a \$20.00 surcharge for special handling in addition to shipping charges. Non-certified checks require bank clearance.

Mail orders to: Communications Electronics,[™] Box 1045, Ann Arbor, Michigan 48106 U.S.A. Add \$7.00 per scanner for U.P.S. ground shipping and handling in the continental U.S.A. For Canada, Puerto Rico, Hawaii, Alaska, or APO/FPO delivery, shipping charges are three times continental U.S. rates. If you have a Visa or Master Card, you may call and place a credit card order. Order toll-free in the U.S. Dial 800-USA-SCAN. In Canada, order toll-free by calling 800-221-3475. WUI Telex CE anytime, dial 671-0155. If you are outside the U.S. or in Michigan dial 313-973-8888. Order today.

Scanner Distribution Center[™] and CE logos are trademarks of Communications Electronics Inc.

[†]Regency is a federally registered trademark of Regency Electronics Inc. AD #020185-G

Copyright © 1985 Communications Electronics

For credit card orders call 1-800-USA-SCAN



Consumer Products Division
P.O. Box 1045 □ Ann Arbor, Michigan 48106-1045 U.S.A.
Call 800-USA-SCAN or outside U.S.A. 313-973-8888

RADIO-ELECTRONICS

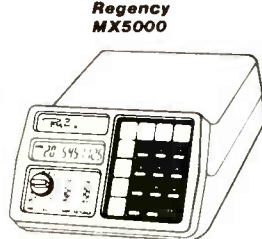
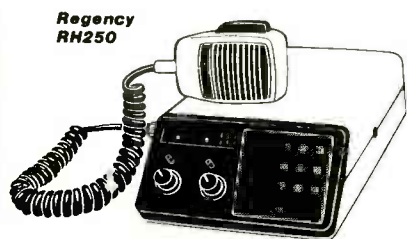

CIRCLE 79 ON FREE INFORMATION CARD

| | | | | |
|--|--|--------------------------|---|--|
| BUILD THIS | 49 COMPUTER-CONTROLLED ROBOT ARM Experiment with robotics. Control an Armatron robot arm with your computer to learn the basics of robotics—or just to have fun! Jimmy Banas | RADIO | 105 COMMUNICATIONS CORNER Stocks via satellite. Herb Friedman | |
| | 73 POWER METER FOR YOUR STEREO This meter does more than measure power. It protects your speakers from excessive power levels and provides a turn-on delay. Mark S. Cohen | | VIDEO | |
| | 97 THREE HIGH-PERFORMANCE SCANNER ANTENNAS Part 2. Construction details for double-zepp and coaxial-collinear antennas that will beef up your scanner's reception. Loren Frieburg | | 12 VIDEO NEWS The present and future in the fast-changing video scene. David Lachenbruch | |
| TECHNOLOGY | 14 SATELLITE TV The personal dish. Bob Cooper, Jr. | COMPUTERS | 114 SERVICE CLINIC Bringing a dead TV back to life. Jack Darr | |
| | 54 ELECTRONICS AND BREATHING A look at the respiratory system and the role that electronics technology plays in monitoring it. Ray Fish, Ph.D, M.D. | | 81 HOW TO DESIGN MICROPROCESSOR-BASED PROJECTS Part 2. This month, we look at Tiny BASIC and at a demo/development board. Then we put the INS8073 to work. Tom Fox | |
| | 77 SERVICING CORDLESS TELEPHONES As cordless phones grow in popularity, broken cordless phones will grow in number. But you can help put an end to that! Christopher Kite | | Following page 106 COMPUTER DIGEST A serial-to-parallel converter—and lots more. | |
| CIRCUITS AND COMPONENTS | 87 ALL ABOUT OPTOCOUPERS A look at how to use optocouplers to interface digital circuits to the real world. Daniel M. Flynn | EQUIPMENT REPORTS | 28 Multiplex Technology ChannelPlus Video Multiplexer | |
| | 91 DESIGNING WITH DIGITAL IC'S Part 3. A look at logic gates—the building blocks of digital electronics. Joseph J. Carr | | 36 Mirage B23A 2-Meter RF Amplifier | |
| | 101 HOBBY CORNER Power-surge protection. Earl "Doc" Savage | | DEPARTMENTS | |
| | 108 DRAWING BOARD Using our extra latch. Robert Grossblatt | | | 138 Advertising and Sales Offices |
| | 112 STATE OF SOLID STATE A light-dimmer circuit. Robert F. Scott | | | 138 Advertising Index |
| 110 NEW IDEAS An electronic heat-sniffer | 139 Free Information Card | | | |
| | | 22 Letters | | |
| | | 121 Market Center | | |
| | | 6 What's News | | |

COVER 1

Robots are here to stay! In the next year or so, there's going to be a personal-robot explosion just like the personal-computer explosion we've just witnessed. Well, here's where you can get started!

We'll show you how to convert a commercially available toy robot arm by adding computer control to it. It's a whole lot easier than building a robot from scratch, and you can learn just as much—and you can have at least as much fun! Whether you put your robot to work or just use it to play with, it's sure to attract a lot of attention. The story starts on page 49.



NEXT MONTH

ON SALE MAY 9

INSTALLING SATELLITE TV

One article will cover the decisions you have to make before you set up a TVRO. A second will show you how to set things up once you've made your decisions.

TURN YOUR DVM INTO A THERMOMETER

Why just measure voltage?

BARGRAPH VOLTMETER FOR YOUR CAR

Keep tabs on your electrical system with this easy-to-read meter.

ELECTRONICS IN MEDICINE

How electronics technology is used to aid the blind.

DIGITAL IC's

An indepth look at flip-flops.

AND LOTS MORE!

As a service to readers, Radio-Electronics publishes available plans or information relating to newsworthy products, techniques and scientific and technological developments. Because of possible variances in the quality and condition of materials and workmanship used by readers, Radio-Electronics disclaims any responsibility for the safe and proper functioning of reader-built projects based upon or from plans or information published in this magazine.

Radio-Electronics

Hugo Gernsback (1884-1967) founder
M. Harvey Gernsback, editor-in-chief
Larry Steckler, CET, publisher

EDITORIAL DEPARTMENT

Art Kleiman, editor
Brian C. Fenton, technical editor
Carl Laron, WB2SLR, associate editor
Robert A. Young, assistant editor
Julian S. Martin, editorial associate
Byron G. Wels, editorial associate
Jack Darr, CET, service editor
Robert F. Scott, semiconductor editor
Herb Friedman, communications editor
Earl "Doc" Savage, K4SDS, hobby editor
Bob Cooper, Jr. satellite-TV editor
Robert Grossblatt, circuits editor
David Lachenbruch, contributing editor
Lou Frenzel, contributing editor
Bess Isaacson, editorial assistant

PRODUCTION DEPARTMENT

Ruby M. Yee, production manager
Robert A. W. Lowndes, editorial production
Dianne Osias, advertising production
Karen Tucker, production traffic

CIRCULATION DEPARTMENT

Jacqueline P. Weaver, circulation director
Rita Sabalis, assistant circulation director
Jacqueline Allen, circulation assistant

Cover photo by Robert Lewis

Radio-Electronics is indexed in *Applied Science & Technology Index* and *Readers Guide to Periodical Literature*.

Microfilm & Microfiche editions are available. Contact circulation department for details.

Advertising Sales Offices listed on page 138.

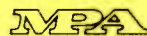

More quality accessories for more DMMs than anyone else in the world.

Fluke has over thirty ways to expand the horizons of your DMM — even if your existing DMM is made by someone else.

Take our new, low-priced 80i-400 current clamp, for example. It's one of five different accessories offered by Fluke to let you take safer, more accurate current measurements in high energy circuits.

Or consider our universal temperature accessories. They convert your DMM into a thermometer for air, surface, and non-corrosive liquid temperature measurements.

Fluke also offers a variety of probes to measure high voltage and probes for high frequency ac measurements. Plus a complete selection of test leads, battery eliminators, carrying cases, and more.

It's the largest selection of DMM accessories available in the world.

So why spend a lot of money on new equipment, when all you may really need are new accessories.

To get the whole story, ask for a copy of our complete DMM accessories booklet. It's yours for free by contacting your local Fluke Distributor, or by calling toll-free **1-800-426-0361**.

FROM THE WORLD LEADER IN DIGITAL MULTIMETERS.



FLUKE®

IN THE U.S. AND NON-EUROPEAN COUNTRIES: John Fluke Mfg. Co., Inc., P.O. Box C9090, M/S 250C, Everett, WA 98206. Sales: (206) 356-5400, Other: (206) 347-6100.
EUROPEAN HEADQUARTERS: Fluke (Holland) B.V., P.O. Box 2269, 5600 CG Eindhoven, The Netherlands, (040) 458045, TLX: 51846.
© Copyright 1985 John Fluke Mfg. Co., Inc. All rights reserved. Ad No. 4703-9020

CIRCLE 251 ON FREE INFORMATION CARD

WHAT'S NEWS

Four countries join for direct broadcast

The Nordic Council of Ministries of Culture, Communications, and Industry has decided on a new transmission system for Nordic direct broadcasting satellites. Denmark refrained from joining the decision by the Ministries of Finland, Iceland, Norway, and Sweden. The Danish Communications Administration, however, supports it.

In one satellite channel, the new system, C/MAC/PACKET, can send television pictures, TV sound, commentator channels, and two sound radio channels in stereo. It also improves sound and picture quality.

England has also chosen the C/MAC/PACKET system, and it is recommended by the European Broadcast Union as the only form for satellite broadcasting in Europe.

World's fastest circuit developed at Bell Labs

The fastest, most efficient semiconductor circuit ever made has been developed at AT&T Bell Labs. A frequency divider using the new technique operated at 10 billion cycles per second when cooled to 70 degrees Kelvin, and did it with about one tenth the power dissipation of the equivalent silicon device. That is about twice the speed of present-day circuits. (At room temperatures, the best silicon circuits approach its speed, but use 20 to 30 times as much power.)

The new circuit is based on a Selectively Doped Heterostructure Transistor (SDHT), a multi-layer sandwich of aluminum gallium arsenide and gallium arsenide (AlGaAs-GaAs) in which the



AN SDHT FREQUENCY DIVIDER IC is examined by J.V. DiLorenzo, head of the Bell Labs Electronic Materials and IC department. It was developed by Raymond Dingle, Horst Stormer, and Arthur Gossard at Bell Labs.

electrons are able to move faster than up to now was considered possible. That is accomplished by placing the silicon donor impurities in the AlGaAs layer and forcing the electrons to migrate to the GaAs layer. Thus, the electrons can move without being impeded by collisions with donor impurities in the crystal. They move at twice the "normal" speed at room temperatures—twenty times as fast at liquid-nitrogen temperatures.

The first of the many applications of the new technology are expected in the supercomputer field, where speed of operation is a critical factor.

Electronics taught by videodisc

Eastman Kodak Co. has licensed J.A.M. Inc., a maker of video and

computer training software, to produce and market an interactive videodisc course: *New Electronic Technologies*. Subjects include electronic displays, electronic imaging, magnetic and nonmagnetic recording, integrated circuits, and electronic transmission.

The package will consist of six laser discs, with the corresponding computer-interface card and computer program (stored on flexible diskettes). It is designed for use with a laser-disc player and either an IBM or IBM-compatible personal computer.

Kodak anticipates that the course will appeal to business and industrial organizations, colleges, and government agencies. J.A.M. expects to market the course for \$6,750.

New standard announced for tape recorders

The Electronic Industries Association (EIA) has announced the availability of a new Interim Tape Recorder Measurement Standard (IS-12). It is the result of an industry-wide effort to standardize the measurement of high-fidelity analog tape recording and reproducing equipment.

An important feature of the new standard is the establishment of reference levels to which such specifications as signal-to-noise ratio, maximum recorded-level, and meter calibration are referred. Ambiguities due to the choice of reference input and output levels have also been addressed, so that products can be compared.

Copies of IS-12 are available from the Electronic Industries Association, Standards Sales Office, 2001 Eye Street, N.W., Washington, D.C. 20006 at the price of \$18.00 per copy.

R-E

Time- and Money-Saving Advice . . .
Practical Troubleshooting & Repair Tips . . .
State-of-the-art Technology . . . Hundreds
of Projects . . . Plus, Exceptional Savings

Take Any 4 Books for Only \$2⁹⁵



Join Now, Get a Utility Apron FREE!

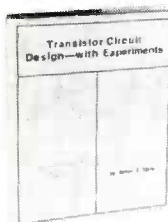

1875
List \$21.95



1583
List \$19.95

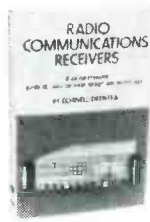

1393
List \$14.50 (paper)



1431
List \$17.95



1108
List \$15.95

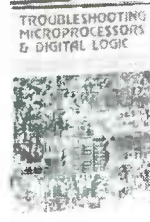

1183
List \$16.95



1765
List \$21.95



1777
List \$21.95



1492
List \$14.95



1211
List \$12.95 (paper)



1820
List \$16.95



1616
List \$19.95



1605
List \$19.95

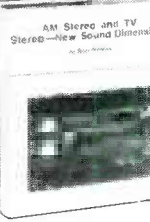

1932
List \$17.95



1690
List \$19.95



1604
List \$24.95

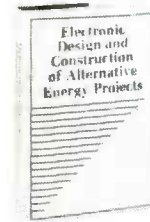

1672
List \$18.95

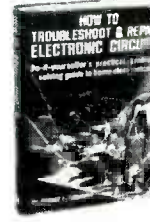

1218
List \$18.95



1665
List \$15.95 (paper)

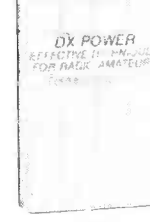

1740
List \$18.95



1650
List \$19.95



1577
List \$19.95



FREE Utility Apron

7 very good reasons to join the Electronics Book Club

- **Big Savings.** Save 20% to 75% on books sure to increase your electronics know-how
- **No-Risk Guarantee.** All books returnable within 10 days without obligation
- **Club News Bulletins.** All about current selections—mains, alternates, extras—plus bonus offers. Comes 13 times a year with hundreds of up-to-the-minute titles to pick from
- **Automatic Order.** Do nothing and the Main selection will be shipped automatically! But . . . if you want an Alternate selection—or no books at all—we'll follow the instructions you give on the reply form provided with every News Bulletin
- **Bonus Books.** Immediately get a Dividend Certificate with every book purchased and qualify for big discounts of 60% to 80%
- **Exceptional Quality.** All books are first-rate publisher's editions selected by our Editorial Board and filled with useful up-to-the-minute information



ELECTRONICS BOOK CLUB

P.O. Box 10, Blue Ridge Summit, PA 17214

Please accept my membership in the Electronics Book Club and send the 4 volumes circled below, plus, my FREE utility apron, billing me \$2.95 plus shipping and handling charges. If not satisfied, I may return the books within ten days without obligation and have my membership cancelled. I agree to purchase 4 or more books at reduced Club prices (plus shipping/handling) during the next 12 months, and may resign any time thereafter.

1108 1183 1211 1218 1393 1431 1492 1539 1542
1577 1583 1593 1599 1604 1605 1616 1650 1665 1670
1672 1690 1699 1740 1765 1777 1820 1875 1932

Name _____ Phone _____
Address _____
City _____
State _____ Zip _____

Valid for new members only. Foreign applications will receive ordering instructions. Canada must remit in U.S. currency. This order subject to acceptance by the Electronics Book Club.

RE-585

Wouldn't you like to have a new skill you could call your own? Learn TV, audio, and video servicing with at-home training from NRI.



You can learn to service and repair TVs, stereos, electronic musical instruments and amplifiers, car and portable radios, record and tape decks, videocassette recorders and disc players, almost any kind of electronic equipment on the market. And you can learn to do it at home, in your spare time, without quitting your job or wasting time and gasoline on night school. NRI will train you, as it has over a million and a quarter others, with effective methods proven over 69 successful years.

Hands-On Training

NRI training is practical training all the way. Throughout your course, you'll perform hands-on experience projects that make theory come to life and give you real understanding.

Includes Both 25" TV And VCR, Plus DMM And More

As part of your training, you'll build your own 25" Heath/Zenith color TV, a state-of-the-art unit with infrared remote tuning, programmable channel selection, and the incredible space phone for remote calling. You also get a front-loading, remote-controlled videocassette recorder to play your videotaped lessons and learn about servicing this complex instrument.



Practical training on a real state-of-the-art TV, VCR or stereo, using professional equipment

You'll learn troubleshooting techniques using a professional 3½-digit digital multimeter. You'll use it when assembling your TV to check demonstration circuits you build on the NRI Discovery Lab, and in your professional work. It's the equipment and training you need for success.

Exclusive NRI Training On Videotape

In addition to profusely illustrated lessons, you get NRI Action Videocassettes . . . videotaped lessons that show you graphic presentations of electronic systems, vivid closeups of servicing techniques and professional "shortcuts" to study and replay as often as you want.

Training For Success

NRI not only prepares you to become a top technician, we get you ready for independence. NRI Video/Audio servicing gives you a great new way to earn

extra money doing part-time servicing for appliance and department stores—building a good-paying, new career with an electronics firm . . . or even starting your own business. You can start small, even part-time in your basement or garage, make the most of your opportunities to grow into a successful businessman.

Free Catalog . . . Mail Card Today

Send the postage-paid card for our free 104-page color catalog describing our courses in full, showing all equipment, lesson outlines, and career opportunities. It also shows other exciting courses like Microcomputers, Electronics Design, Industrial Electronics, Digital Electronics, and more. Mail the postage-paid card today for your copy. And



see how you can make the most

of your talent. If card has been removed, please write to:



NRI Schools of Electronics
 McGraw-Hill Continuing Education Center
 3939 Wisconsin Avenue
 Washington, DC 20016

We'll give you tomorrow.



VIDEO NEWS



DAVID LACHENBRUCH
CONTRIBUTING EDITOR

● **VCR's hottest year.** Videocassette recorders became a true mass-market product in 1984, EIA's official sales figures prove. Dealers in the United States bought 7,615,791 VCR's last year, up 85.1% from the 4,091,321 sold in 1983. In fact, 1984's sales exceeded the total for 1981, 1982, and 1983 combined. And the momentum continued into 1985, with sales in January eclipsing those of January 1984 by more than 64%.

● **New videocassette products.** Since many people buy VCR's solely to watch pre-recorded cassettes, why not make a play-only videocassette machine? That question has come up repeatedly, and the answer always has been that hardly any savings is made possible by eliminating the record function, especially since production of record-and-play machines is so high. But apparently the demand is there, and the videocassette player, or VCP, could be a hot product this year.

VCP's are now being imported by Funai of Japan, mainly for the rental market, selling at around \$260. Another version could be designed to retail for less than \$200. Funai's initial offerings have aroused enough interest to encourage big Matsushita to enter the market, and it is exploring bringing them to the United States. As reported last month, Quasar and General Electric are considering offering these VCP's (although at a much higher price than the Funai machine). Korea's Gold Star, Samsung, and Daewoo have developed VCP prototypes, as has Sampo of Taiwan.

Another videocassette product—which isn't on the market here and might not ever be—is stirring up plenty of excitement nevertheless. That is a double-deck VCR, being offered by Sharp in the Middle East only. The reason it has raised a furor here is that it can easily be used for copying cassettes—just put a recorded cassette in one slot and a blank one in the other. The Motion Picture Association of America, which has been pressing for legislation to levy a fee on VCR and tape sales

(to be paid to copyright owners) has hailed the existence of the two-cassette machine as proof that one of the main purposes of VCR's is to make illicit copies of copyright material.

● **New video products.** Pioneer has introduced its combination laser videodisc and digital audio compact disc player. Priced at \$1,200, it can play the 4½-inch CD audio discs as well as 12-inch and 8-inch videodiscs, including the new ones with digital soundtracks.

General Electric, Magnavox, Panasonic, and Quasar around midyear will market camcorders that use full-sized VHS videocassettes and weigh just over seven pounds, with batteries; they were unpriced at press time, but are expected to list between \$1,600 and \$1,800. They can play back as well as record.

The Beta Group—including Sony, NEC, Sanyo, and Toshiba—will soon market the third version of the record-only Betamovie camcorder. This one has a solid-state CCD pickup in place of a camera tube, and has automatic focus.

Hitachi is introducing a filmless still camera, using the standard 1.85-inch micro-floppy disc to store 25 pictures; it will be priced around \$2,000 (including TV playback system and dye-transfer color printer) in Japan.

● **Korean VCR's coming.** The first VCR's from Korea are scheduled to start arriving this spring and summer. They had been kept off the export market previously under the terms of license agreements with Japanese developers of the VHS and Beta formats; but beginning this year, export is permitted. The major effect of the new source for video recorders is expected to be lower prices. The first Korean VCR's—both VHS models—have been announced by Samsung and Gold Star, their lowest suggested list prices being \$349 and \$399, respectively. However, list prices don't necessarily represent true "street prices," and there is conjecture that the units will settle down to \$299 or less.

R-E

HITACHI OSCILLOSCOPES

LOWEST PRICES
OFF-THE-SHELF
DIRECTLY TO YOU

CALL TOLL FREE
FOR FAST DELIVERY

800-645-9518

In New York State 800-832-1446

HITACHI 100 MHz W/CRT READOUT & BUILT-IN MICROCOMPUTER

Model V-1100
\$2500⁰⁰
Probes included.



- Quad channel (Ch. 1,2,3,4) with independent position controls
- 8 trace with alternate sweep
- 18kV-6" rectangular CRT
- Minimum deflection factor 1 mV/div, maximum sweep time 2ns/div
- TV-sync • X-Y

operation up to 1 MHz (3° or less), variable hold-off • Gate output for A and B sweep • CH 1 signal output to 100 MHz (-3db)... plus much more.

HITACHI 100 MHz QUAD TRACE DELAYED SWEEP SCOPE

Model V-1050F
\$1299⁹⁵
(Reg. \$1980.) Probes included.

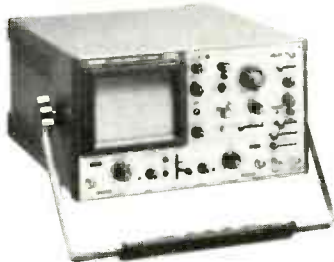

- Use of low halation dome mesh and large 6" rectangular CRT with internal graticule
- 500 uV/div high sensitivity design
- Alternate and single sweep functions
- TV sync separator circuitry with one touch synchronization

• Automatic focus circuits • Variable hold-off circuitry • X-Y operation • Delayed sweep function with one touch control 10X magnification

HITACHI 60 MHz DUAL TRACE DELAYED SWEEP SCOPE

Model V-650F
\$995⁰⁰
(Reg. \$1195.) Probes included.



- 6" rectangular CRT with internal graticule.
- 1 mV/div high sensitivity design
- Triple trace for checking synchronous signals and relationship and timing between observed waveforms
- TV sync separator circuitry • Automatic focus circuitry • Variable hold off circuitry • X-Y operation
- Delayed sweep function with one touch control 10X magnification • Signal output: CH1 output terminal to frequency counter, etc.

HITACHI PORTABLE OSCILLOSCOPES 1 mV/div DUAL TRACE

Model V-222 (20 MHz)
\$549⁹⁵

(Reg. \$715.) Probes included.



Model V-422 (40 MHz)
\$699⁹⁵

(Reg. \$895) Probes included.



- Thin, light and compact design • Large 6-inch rectangular, internal graticule CRT • Autofocus circuit and scale illumination
- DC offset function • Voltage and frequency reading outputs
- Alternate magnify function • 8 divisions of displayed dynamic range • TV sync separation circuit • X-Y operation mode

HITACHI PORTABLE OSCILLOSCOPE DC TO 20 MHz, 1 mV/div DUAL TRACE

Model V-212
\$499⁹⁵

(Reg. \$615.)
Probes included.

- Thin, light and compact design
- Large 6-inch rectangular, internal graticule CRT • High accuracy - +3% • High sensitivity -1 mV/div
- Stable, low-drift design • 8 divisions of displayed dynamic range • TV sync separation circuit • X-Y operation mode

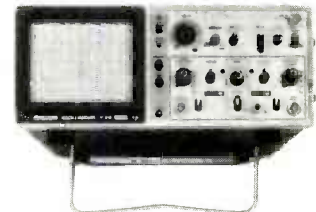

MASTERCARD/VISA ACCEPTED



PHONE ORDERS ACCEPTED

Service and Shipping Charge Schedule

| FOR ORDERS | ADD |
|----------------------|---------|
| \$501-750 | \$8.50 |
| \$751-1,000 | \$12.50 |
| \$1,001 and up | \$15.00 |

Fordham

260 Motor Parkway, Hauppauge, New York 11788

SATELLITE TV



BOB COOPER, JR.,
SATELLITE TV EDITOR

What's new in TVRO systems

WHAT'S SMALLER THAN A 10-FOOT DISH, but bigger than a bread box?—a PD™, or *Personal Dish*™. A Personal Dish is a small C-band (4 GHz) satellite terminal, like that shown in Fig. 1. (It is also a registered trademark of PD, Inc., 3 Claremont Road, Bernardsville, NJ 07924.)

About five years ago, a 10-foot dish was a form of a PD; two years ago, it was the 8 footers; one year ago, the 6 footers. But now you can't be a respectable PD supplier unless you have a 4-foot dish.

Are dishes getting better and better? Is TVRO electronics getting better and better? (So much so that a 4 foot dish today works like a 10 foot dish of yesteryear?) Without qualification, the answer is no! In fact, that would be a resounding NO! Still, dishes are getting smaller and more and more firms are offering the miniature C-band terminal systems. So what's the story here?

What's happening

There are actually two and a half stories. All are true and we'll be brief. For one, dish designs have improved, but not that much. Besides, as dishes get larger and larger, more and more of their surface area (or gain-ability) is thrown away in the manufacturing or assembly process by sloppy tolerances.

A bigger dish, with inaccurate surfaces, is no better (no more sensitive) than a smaller dish with an accurate surface. It is far easier

* Publisher, CSD magazine



FIG. 1



FIG. 2

to maintain good surface accuracy, and therefore maximize gain, with a smaller surface. That's basic.

Second, satellites have become more powerful. In particular, the present generation Galaxy (Hughes built) satellites are nearly 9 watts per channel. That's nearly 3 dB better than the older, original SATCOM and Westar birds! More signal from the satellites allows you to back-off on the ground system, and reduce the dish size for the equivalent picture detail.

Finally the half-story: Satellite receivers perform more efficiently. By reducing the receiver's (IF) bandwidth, greater receiver sensitivity has been achieved. Of course, there is some sacrifice; you lose some of the crispness of the picture when you chop out some of the satellite-transmitted information. But that's generally

considered an acceptable trade-off.

So we have smaller dishes today than we had in 1980 or even 1983 because they are of better quality (by a 10% factor), receiver circuits about 20% more sensitive, and satellites stronger by a 50% factor. That adds up to 80% better quality, not quite 100%.

Because there are trade-offs involved in the smaller dishes, you never really get you back to the 100% you started with when using a quality 10-foot dish system to begin with. You can never regain the extra signal margin—for example, to compensate for system aging—nor can you put back the picture detail sacrificed with the narrow-banded receiver (IF).

In spite of those negatives, PD's are here and selling well, in sizes from 4 feet to 6 feet. And if you are thinking about selling or servicing new TVRO systems, or simply buying one for yourself, you need to understand what this "smaller is better" mania is all about.

The smaller units have several obvious advantages: size is one, of course. Many people wouldn't have a dish on the roof or in the yard if it had to be 10 feet in diameter. Many roofs can't stand the wind loading of a 10-footer or even an 8-footer. (Figure 2 will give you some idea about the differences in dish size. Shown are a 4-foot C-band, left; 2-foot Ku-band, center, and a 10-foot C-band dish.) That's a plus in favor of four to six foot dishes.

Another advantage is the price:

TVRO dealer "Starter Kit" available

If you are into electronics, operating or working for an electronics sales or service center, and are interested in learning more about the business opportunities offered by the rapidly growing TVRO industry, Bob Cooper has a special data-packet for you. And it is free of charge! Simply send your name and address, preferably on a company letterhead or with a company business-card attached to: TVRO Starter Kit, P.O. Box 100858, Ft. Lauderdale, FL 33310 and ask for your kit.

You will be sent a complete packet of current information on the TVRO dealer world, including valuable reprinted articles from CSD magazine outlining the start-up problems associated with becoming a TVRO dealer in the 1985 TVRO industry. There is no obligation, of course.

A popular dealer-net price on a well known 6-footer is under \$250, including the mount. That's a hard number to argue with when 8 to 10 foot dishes are twice as much (or more) in the dealer-distribution line.

At least two East Coast firms have made a science of 4 to 5 footers and their experience to date is instructive. Personal Dish, Inc. has created a series of 4- and 5-foot dishes with special side-of-building and roof-top mounts intended for the often over-built northeastern corridor.

Their concept is that people who live in townhouses, condos, and apartments should not be shut off from satellite-TV service just because they don't have a suitable backyard in which to "plant" a 10-foot dish. But that's not all; they have another marketing direction as well: Personal-Dish-fed mini-cable systems.

A look at the system

By placing a single antenna on a fixed mount, anchored on just a single satellite such as Galaxy 1, customers can be provided with between 10 and 12 satellite-delivered channels. The dish feeds a Block Down Converter (BDC), which outputs a wide spectrum of signals in the UHF range.

Those UHF-range signals, all from a single satellite, are then amplified and cable-fed to individual apartments from the master dish

antenna. It's cable-TV with a satellite twist. With proper planning and proper equipment, you can serve 2 or 200 individual outlets in that way. Each home has independent access to all the signals on one satellite through one or two cables from the PD.

People can subscribe or simply pay into a cost-sharing "kitty." In that way individual homes have access to the same programming that regular cable-TV customers have, when and where regular ca-

ble is not available, typically for under \$600 per home. Not a bad trade. But is it really satellite TV? Think again.

Until recently, you couldn't be a satellite TV person unless you were equipped with the latest dish, LNA, receiver, and motor drive. That's fine; there has been a market of at least 500,000 such people to date and more undoubtedly will be found with the same instincts. But there is another market developing as well.

SATELLITE TV/

The First Five Years!

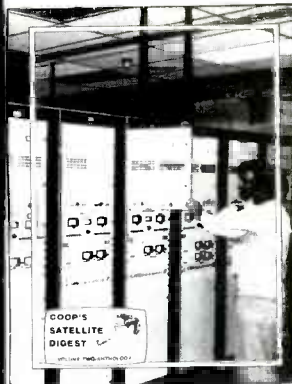

THE MOST COMPLETE report on the mushrooming home 'TVRO' industry ever compiled, written as only the 'father of TVRO' could have prepared. More than **1000 pages** (!) tracing the complete story of home TVRO, lavishly illustrated with equipment photos, schematic diagrams, equipment analysis reports. **Bob Cooper**, the first private individual to own and operate a TVRO (1976) has collected and polished hundreds of individual reports into a unique 'collector's edition' which clearly explains the TVRO phenomenon in North America. From Coop's first 20 foot 'monster' dish to the present day 5 foot 'C-band' TVROs, the fascinating growth of TVRO equipment and its legal status unfolds for you.

THIS TWO VOLUME SET totaling more than 1,000 pages is available for the first time to readers of **Radio-Electronics** at special discount pricing. **Originally** sold at \$100 per two-volume set, a limited supply is now available **ONLY** through this advertisement. **PLUS**, you will also receive a special extraordinary bonus: the 200 page (+) **October 1984** edition of **CSD/Coop's Satellite Digest**. This very special edition of CSD is a best-seller in the TVRO industry, with the most comprehensive collection of TVRO facts and figures ever compiled. Combined with the 1,000 page 'CSD ANTHOLOGY' report, you have instant reference to **everything** you will ever need to know about the state of the home TVRO industry. It is **MUST** reading for every person in, or thinking about 'getting into,' any segment of the home TVRO world.

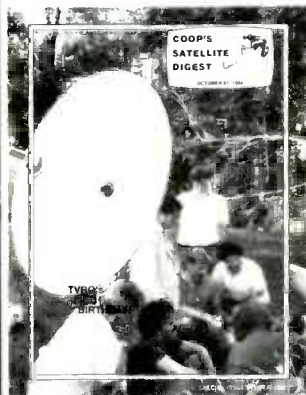

SEND CSD ANTHOLOGY/2 Vols. + CSD Bonus.
 SEND CSD October '84 Special Issue **ONLY**.

NAME _____ COMPANY _____
 ADDRESS _____
 CITY _____ STATE _____ ZIP _____

Payment: \$60 US funds (Anthology + Bonus), \$15 US funds CSD Oct. **ONLY**; payable "CSD ANTHOLOGY."
 Shipping charges prepaid. Enter order to: **CSD Anthology**, Radio-Electronics Magazine, 200 Park Av. S., New York, NY 10003; or call 305-771-0505 for credit card orders **ONLY**.

That market is made up of people who live where cable-TV has not reached, but would like the finer things that the premium programming of cable offers. In fact, that market may turn out to be far more significant and lasting than the present TVRO market. That's because you are selling entertainment, not technology, and we all know that technology is always a hard sell.

Blair A. Gilbert, of StarTrak Satellite Systems (GBS, Lamplighter Plaza, PO Box 349, Kulpville, PA 19443), thinks it's the trend of the future. Operating out of a suburb of Philadelphia, he put 50 of his 4-foot terminals on trial this past summer. It was a marketing test to determine how many people would be willing to pay \$30 per month for a dozen or so channels from a single satellite.

He found out that more than 80% of the homes—after being exposed to his GBS system—kept it. Many paid him \$1495 for the installation after the trial. The balance went on a 48-month credit

program he had arranged.

Gilbert didn't mess up his marketing by selling satellite-TV. His literature and sales presentation barely mentioned satellite-TV. What he sold was entertainment: 12 channels of it, with a small 4-foot dish for \$30 a month. Since he completed his test, he has launched a national distribution network for his dish package, his electronics, and his marketing expertise.

Gilbert got his original idea by watching the growing pains of USCI, the 12-GHz DBS firm that launched the mini system with great fanfare (followed by financial chaos) just over a year ago. He saw that people were interested in the USCI 5-channel package, but he also saw that USCI was making, in his judgment, errors in "pitching" their home systems.

For one thing, he found that USCI was pushing too hard on the satellite-delivery part of the package. He felt that if you're limiting your customers to something less than the 100 "sky-channels" of true

TVRO service, you shouldn't make a big thing of the satellite-connection.

The "plain vanilla" truth is that smaller dishes are with us, although their sales success has been spotty to date. The equipment suppliers selling those compromise antenna-systems have made the same mistake that USCI apparently made. They are trying to pretend that you can do the same thing with a 4- or 6-foot antenna that you can do with a 10-foot antenna. Gilbert has proven, and Personal Dish, Inc. is proving, that if you concentrate on the product and soft-sell the vehicle, you can be a very, very busy businessman.

Businesspeople exposed to Gilbert and PD, Inc. are wising up. They've realized that really small antennas won't perform all over the USA—in south Florida, for example, a 6 footer is still not enough even on the hotter satellites. But they will work adequately (if not flawlessly) over more than 85% of the continental 48 states. And you can sell them if you don't try to represent them for being something they are not.

There is a trend here; perhaps an entirely new marketplace that's driven not by technology, but purely by the entertainment value of a dozen channels or so. As Peter Sutro of Personal Dish notes, "We tried to sell the 5- and 6-foot antennas as *junior* TVRO's and that was a mistake. People invariably would look at the performance and channels available on a fully motorized 6-footer and compare that to our standard 10-footers.

"The 6-foot system was not a fair match for the 10-footers. We sold very few 6-foot units that way. And even as loss leaders for advertising, we created a certain amount of buyer resentment and resistance. That's when we decided to take away the motor drive and offer the 6-foot package only as a dedicated system intended for sharing between two or more residences. When we did, we discovered an entirely new market."

So, are smaller dishes just toys? Not if you recognize that they are not TVRO system pieces, but rather that they have a market identity all their own.

R-E

FREE

McIntosh

STEREO CATALOG and FM DIRECTORY

Get all the newest and latest information on the new McIntosh stereo equipment in the McIntosh catalog. In addition you will receive an FM station directory that covers all of North America.



**SEND
TODAY!**

McIntosh Laboratory Inc. RE
 East Side Station P.O. Box 96
 Binghamton, N.Y. 13904-0096

NAME _____
 ADDRESS _____
 CITY _____ STATE _____ ZIP _____

If you are in a hurry for your catalog please send the coupon to McIntosh.
 For non rush service send the Reader Service Card to the magazine.



Heathkit instruments. Some buy them for pride...some, to save money.

Whether you're pursuing a proud hobby...or earning a living, don't trust the accuracy of your measurements to anything less than Heathkit instruments. Our kits are a little bigger, more rugged than "disposable" instruments that discourage self-servicing. Performance is superior, too. Just check the specs on our new IO-4360 Scope and IOA-4200 Time-Voltage Module.

Get to know our full line of instruments. They're built by experienced hands. Your hands. So they'll save money and help you do a better job. Heathkit instruments. Don't trust your pride or money to anything less.

Professional specs for serious users

- 1 IG-4244 Scope Calibrator. <1 ns rise time. 0.015% tolerance.
- 2 IO-4205 Dual-Trace 5 MHz Scope. 10mV/cm sensitivity.
- 3 IT-2232 Component Tracer. Checks circuits without power.
- 4 IP-2718 Power Supply. Fixed 5 volt and two variable 0-20 V supplies.
- 5 IG-1271 Function Generator. Sine, square, triangle waveforms. 0.1 Hz to 1 MHz.
- 6 IG-1277 Pulse Generator. 100 ns to 1 sec width pulses.
- 7 IT-5230 CRT Tester. Tests, cleans, restores CRT's, TV tubes.
- 8 IM-2264 DMM. True RMS readings. Analog metering, too.
- 9 IM-2420 Frequency Counter. 5Hz to 512 MHz. Ovenized oscillator. Includes period, frequency, and ratio modes.
- 10 IM-2215 Hand-held DMM. 24 DC/AC volts, amps and resistance ranges. = .25% DC accuracy.
- 11 IT-2250 Capacitance Meter. 199.9 pF to 199.9 mF. Auto ranging.
- 12 IO-4360 Scope and IOA-4200 Time/Voltage Module. Triple trace, 60 MHz, <7 ns rise time. IOA-4200 controls CRT cursor and displays frequency, time, or voltage.

Heathkit instruments.
The professional instruments.

more measurement for your money

Heathkit
Heath
Company

A subsidiary of Zenith Electronics Corporation
CIRCLE 86 ON FREE INFORMATION CARD



Take another look at the instruments you should be building.

FREE
COLOR HEATHKIT CATALOG

Mail this coupon to:
Heath Company, Dept. 020-296
Benton Harbor, MI 49022

Name _____

Address _____

City _____

State _____ Zip _____

GX-393R1

POWERFUL TRAINING CAREERS IN PC

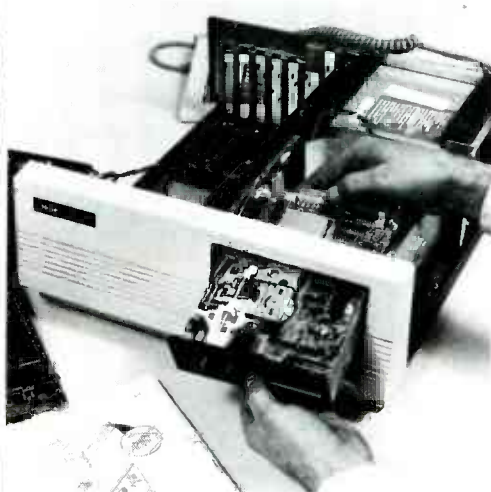

Learn PC Servicing By Assembling Your Own NTS/HEATH HS-151 16-Bit Desk-Top Computer

This is the most powerful and versatile Personal Computer ever offered in any home study course, and NTS Intronic Training gets you right down into the heart of it. You learn how microcomputers function, and how they operate to solve problems. Your program includes a wide variety of tests and projects you perform as you build this remarkable PC, circuit board by circuit board. There is no better way to learn PC servicing. Lessons, texts and equipment are completely integrated to make your training easier to understand, more practical, and applicable to many other types of computers.

A Rewarding Career in PC Servicing Lies Ahead.

The world of computers is constantly expanding. Industrial and business applications of computers show every sign of consistent growth. In fact, the market for PC's will expand to an expected 3.7 million units this year, and by the end of the decade the entire computer market worldwide will pass the trillion dollar mark.

These sales figures point to continued growth in the peripherals market, networking, modems, printers, and a host of other "add-ons" needing installation technicians and skilled service-maintenance personnel. It's a career field with dynamic potential, and NTS PC Training is aimed right at it.

Your Training Includes Test and Other Equipment

Most NTS courses include test equipment to teach you the uses and applications of such units as Digital Logic Probes, Digital Multi-meters, Trans/Diode Testers, and the like. The NTS Compu-Trainer is included in several courses to familiarize you with principles involved in circuitry used in a wide variety of computer types and brands. You perform hundreds of experiments with it, learning the how and why of computer operation. NTS courses are designed to prepare you for jobs in electronics where you can grow with the experience you receive in the field. It's the kind of training that keeps pace with developments, assuring you of a solid foundation on which to build a career.

The Exciting NTS/HEATH 16-Bit HS-151 is Loaded with Features:

- A. 128KB RAM user memory on board, expandable to 640KB.
- B. 16-Bit 8088 microprocessor accepts advanced software and speeds word processing; also allows selection from the huge library of IBM* software.
- C. IBM-compatibility with *MS-DOS operating system.
- D. 5.25-inch floppy disk drive, double density, IBM formatted, stores up to 360KB. (Expandable to dual-disk drive, and optional 10.5MB hard-disk drive.)
- E. Four open IBM-compatible slots provide for future expansion, printer, modem, etc. Will accept most peripheral boards designed for the IBM PC.
- F. Two video outputs for color or monochrome display monitor. Your NTS course includes a high-resolution monitor displaying 80 characters by 25 lines, or graphics.

FOR POWERFUL SERVICING

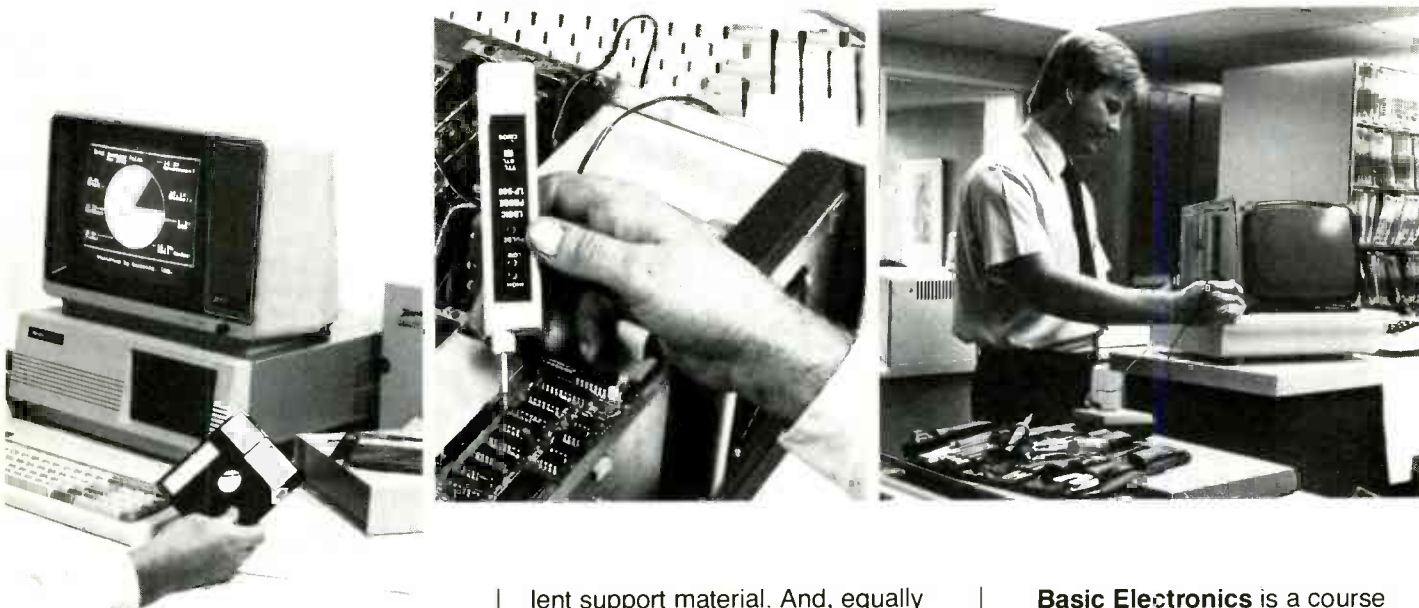

G. Editing capabilities help you insert or delete characters and lines, erase, jump or smooth scroll, plus several other convenience features.

H. The NTS/HEATH HS-151 is complete with full-function keyboard, calculator-style keypad, and typewriter format.

NTS Training Takes You Beyond Equipment Assembly.

Field service personnel are required to analyze and solve problems, many times on the spot. Whether the problem is in the disk drive or the monitor, the memory or the power input, you learn how to spot the difficulty and take steps to resolve it. Your NTS course includes test equipment, and teaches you how to use it.

Three courses, one starting with basics, and two different advanced courses for those with previous experience, give you a choice of programs suited to your particular needs. You learn how to program this advanced computer with excel-

lent support material. And, equally important, the NTS/HEATH HS-151 enjoys a reputation backed by a major American manufacturer. There is no substitute for first-class equipment, and you keep it to use for years in your home or business.

NTS TRAINING PROGRAMS COVER MANY AREAS OF ELECTRONICS:

Robotics: Build the NTS/HEATH Hero 1 Robot as you learn Robotic programming technology. This field is at the leading edge of electronics.

Video Technology: Learn circuit diagnostics and digital principles as you build one of the most advanced color TV sets available. Your course also covers VTR's, computer fundamentals, solid-state devices.

Industrial and Microprocessor Technology: Train in microprocessor and automation applications, lasers, and basic industrial robotics.

TV & Radio Servicing: Acquire a foundation in the use and application of both analog and digital test equipment in the TV servicing field. Learn to service Color and monochrome monitors, troubleshoot receivers, and maintain entire systems.

Basic Electronics is a course designed to give you an over-view of electronics. It is particularly helpful to electronic sales personnel, and those wishing to get into technical writing.

NTS Intrinsic training programs are practical, and job-oriented. You train on field-type equipment, and lessons and texts are tested and proved in our Resident School in Los Angeles. This assures you of understandable lessons and texts, as well as projects which get right to the heart of your subject. NTS, now in its 80th year, continues to offer economical training at the leading edge of Electronics.

*IBM is a trademark of International Business Machines Corp. *MS is a trademark of Microsoft Corp.

If card is missing, write directly to the School at the address below stating the course in which you are interested. A FREE color catalog and all details will be sent to you by return mail.

NTS NATIONAL TECHNICAL SCHOOLS

TECHNICAL TRADE TRAINING SINCE 1905
Resident and Home-Study Schools

4000 South Figueroa Street
Los Angeles, CA 90037-9988

LETTERS

WRITE TO:

LETTERS
Radio-Electronics
200 Park Ave South
New York, NY 10003

BANDWIDTH ACCURACY

I take exception to the text in the October 1984 article, "Satellite Stereo Demodulator," by Roger Cota and Lloyd Addington. The authors unfortunately have confused baseband modulating frequencies with broadband uplink/downlink bandwidths.

Their contention that the "effective bandwidth of a satellite transponder is about 10 MHz" is in error. To be accurate, the effective bandwidth of the modulated carrier is 36 MHz, which is centered in the satellite's transponder bandwidth of 40 MHz.

The 36-MHz bandwidth is comprised of at least three composite elements:

1. The peak video deviation of a 4.2-MHz baseband video signal that modulates the carrier ranging from 8.46 MHz to 13.8 MHz, (depending on the up-linking operator and the number of audio subcarriers and their modulation index.)

2. The peak deviation of the energy dispersal waveform, which is usually 1 MHz.

3. The peak deviation of the carrier by any audio subcarrier.

A mathematical manipulation of

all those peak deviations must fit Carson's rule where the bandwidth, in this case 36 MHz, will be two times the sum of the composite deviation of the carrier and the instantaneous modulating frequency.

The deviation of the carrier has nothing to do with a baseband adaptation of the NTSC 6 MHz TV-channel bandwidth (which is derived from the FCC's in-channel bandwidth for VHF television stations) and the placement of the audio subcarriers in the spectrum of 6-10 MHz.

continued on page 26

REPLACING FIVE BELTS AT ONCE IS SMARTER THAN ONE AT A TIME.



It makes sense for your customers. And dollars for you. Sooner or later, every VCR belt needs replacing. And when one goes, the others aren't far behind. So make the most of it with RCA's VCR Belt Kits (stock numbers 199094 and 199095) for RCA, Magnavox, Panasonic, Quasar,

Sylvania, and other VCRs. You'll save customers the expense of extra repair trips and make extra profit for yourself replacing all the belts at once.

The smart money's on RCA, for a whole line of VCR replacement parts and accessories. See your RCA VCR Parts Distributor or for more information, write: RCA Distributor and Special Products Division, Deptford, N.J. 08096-2088. Attn: Sales Promotion Services.

RCA VCR
Parts

LITTLE THINGS MEAN A LOT

Being the first company to make solderless breadboards isn't necessarily what makes us the best. It's all the little things you don't see, like our spring clip terminals, that make AP® PRODUCTS ACEBOARDS so big on reliability.

From our largest ACEBOARD with over 5000 tie points, to a single tie point block, our spring clip terminals give you nothing but good, solid contact on every connection. They accommodate a wide variety of leads and have the best electrical properties, because our spring clips are solid alloy, not plated nickel. We've even developed enough normal force to break through any oxides which could occur on solder plated leads. You've come to trust our test clips for the same reason.

Since one bad connection can ruin a whole circuit, we pay close attention to how well our spring clip terminals sit within the insulator cell areas. Spring clip edges are never exposed at the insertion window.

Leads won't buckle, clips won't oxidize, it all adds up to longer life.

Even from the outside there's more to an ACEBOARD than meets the eye. Our durable Acetal Copolymer plastic body is a good insulator with excellent dielectric properties. And special manufacturing techniques in the insertion of the contacts into the plastic body insure that your Breadboard will always remain flat. No skimping or planned obsolescence here. Again, just good solid contact on every connection.

Turn our breadboard body over...and you'll discover another key to its reliability. The double-sided adhesive foam you'll

see there is more than a pressure sensitive mount. It also insulates to prevent shorts and seals the bottom of the individual spring clip cells.

If solder shavings from resistors or component leads drop into the cell, they can't spread into other cells to short them out.

Take a close look at our ACEBOARDS. AP PRODUCTS has the biggest and most complete line of ACEBOARD sizes. It's also our commitment to you that if your ACEBOARD doesn't

work perfectly, bring it back to your AP PRODUCTS distributor. He'll replace it, no hassles.

To help you see for yourself what a big difference the little things make, we're offering you a 10% discount on the entire AP PRODUCTS ACEBOARD/Breadboard line.

Just fill out the coupon and present it to your AP PRODUCTS distributor.

For the name of the distributor nearest you, call TOLL FREE (800) 321-9668. (In Ohio, call collect: (216) 354-2101.)



A P PRODUCTS INCORPORATED

9325 Progress Parkway, Box 540
Mentor, Ohio 44060, (216) 354-2101
TWX: 810-425-2250
In Canada, call Lenbrook Electronics • (416) 477-7722

CIRCLE 76 ON FREE INFORMATION CARD

10% OFF

The purchase price of any size ACEBOARD or Breadboard product.

Your Name _____

Address _____

City _____ State _____ Zip _____

Dealer Name _____

ACEBOARD # _____

Limit 5 ACEBOARDS or Breadboards per coupon. Offer valid only at participating AP PRODUCTS distributors. RE 585

Buying our reputation



Introducing a broad, new line of multi-feature, cost-competitive instruments from Beckman Industrial Corporation.™

They're in stock now and as close as your local Beckman Industrial Corporation distributor. Just walk in and choose the instruments that provide the features and functions you need. Then buy them and take them home, or to work. No more ordering and waiting.

Whichever instruments you choose, you'll be buying our reputation for high quality and reliability, plus straightforward, easy operation.

And you'll be getting it all for a very afford-

able price. In fact, you'll have a hard time finding comparable instruments that offer as much functionality and quality.

All of which makes this line of instruments an exceptional value.

Choose between our 100MHz or 60MHz advanced design oscilloscopes. Both provide professional grade performance. Both also feature dual time base and three channels.

The UC10 Universal Counter measures unit count, period, time interval and frequency to 100MHz. And the FG2 Function Generator produces sine, triangle and rectangular waves up to 2MHz and at continuously variable duty cycles.

ion just got easier



Our new circuit-powered LP10 Logic Probe is the ideal, low cost way to check TTL, DTL, HTL and CMOS signals.

The CM20 Capacitance Meter is a low cost, hand-size meter that lets you measure capacitance up to 2000 μ F, easily and quickly.

The CT233 AC/DC Current Clamp enables you to use your digital multimeter to measure AC or DC current without breaking the wire.

Plus every instrument is designed, manufactured, and tested to ensure years of trouble-free, reliable operation.

And whichever products you buy, service

and parts will be available close to home from your local Beckman Industrial Corporation distributor.

Now it's easier than ever to buy the name with a reputation for the best quality – and value – in electronic and electrical instruments: Instrumentation Products Division, Beckman Industrial Corporation, A Subsidiary of Emerson Electric Co., 630 Puente Street, Brea, CA 92621, (714) 773-8111.

Beckman Industrial[™]

©1984 Beckman Industrial Corporation

CIRCLE 98 ON FREE INFORMATION CARD

LETTERS

continued from page 22

In addition, the R7-C14 (R23-C27) combination used for de-emphasis has a time constant of 100 μ s—that is not widely used. To accommodate the more widely used 75 μ s pre-emphasis curve, R7 (and R23) should be changed to 7500 ohms.

Also, the R10-R9 (R26-R25) resistors for IC5-c (IC5-d) will give that non-inverting amplifier a gain of 7.7, not 6.6.

Finally, demodulating in the matrix mode will produce audio levels twice as high as in the discrete mode according to the circuit diagram.

TOM BENTSEN
Upper Montclair, NJ

We did not mean to mislead readers on the technology of modulating satellite transponders. Apparently the letter writer has some confusion about the word "effective".

For the letter writer to assert "to be accurate the effective bandwidth of the modulated carrier is 36 MHz," demonstrates a fundamental misunderstanding of how FM modulation is molded mathematically and the intent of Carson's rule.

To be even more accurate, performing the derivation of the spectrum bandwidth for FM is typically a very difficult task. Strictly speaking, the bandwidth of a frequency modulated signal is infinite. Since frequency modulation of a carrier results in the generation of an infinite number of sidebands. However, at the extreme edges of the bandwidth, the amplitude and consequently the power of those sidebands become negligible so that bandwidth can be defined by considering only those sideband signals that contain significant power. The acceptable power ratio is dictated by the particular application of the system. Accepting some distortion in satellite transmission and throwing away 2% of the bandwidth power then:

$$BW \approx 2(\text{DEVIATION RATIO} + 1) \times (\text{MAXIMUM MODULATING FREQUENCY.})$$

That expression for bandwidth is generally referred to as Carson's rule. But that is not fully descriptive of what is happening. A more accurate derivation involves the tabulated Bessel functions and the Fourier series:

$$e^{jB\sin\omega mt}$$

The purpose of the article was not to get hung up on semantics, but to present a fun and useful kit. I am glad that all this bandwidth stuff works out, however, for it has allowed me to enjoy stereo movies for over a year. As for other matters, we apologize for the misprints.

DR. ROGER COTA,
Video Control Vancouver, WA

APOLOGY

I feel that I owe Mr. Grossblatt an apology; I tender it herewith.

In his June, 1984, article on the CD4018 sinewave generator he stated that "We are not using the Q₅ output of the 4018 because it's a

WAVETEK®

Our 2 MHz Function Generator has an unlimited range.

Model 20 not only covers the .002 Hz to 2.1 MHz frequency range, it covers the world. With internal NiCad batteries,* you can take Model 20 anywhere and get triggered, gated or continuous waveforms—sines, squares, and triangles up to 20 volts peak to peak. It recharges from wall transformer (included) or external source from 12 to 25 VDC or 10 to 18 VAC. Model 20 also has many of the features you would expect from the industry leader in function generators, including VCG input connector for external sweep or FM, step attenuator to -80dB, and a TTL pulse output. The price is just \$395. For a data sheet or to order, call or write Wavetek San Diego, P.O. Box 85265, 9045 Balboa Ave., San Diego, CA 92138. Phone (619) 279-2200; TWX (910) 335-2007. *Batteries not included.

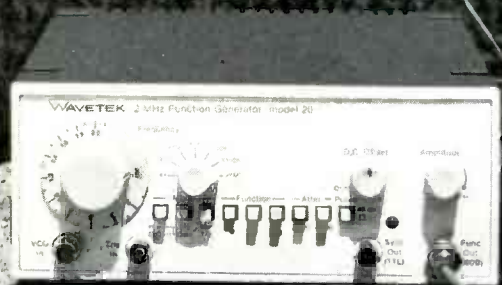

CIRCLE 271 ON FREE INFORMATION CARD

quick and dirty way to make the waveform conform more closely to a sinewave." On the basis of symmetry considerations I jumped to the conclusion that the circuit would not work with that output. (See "Letters," Nov. 84.) I was wrong. It will function better with than without it.

Fourier waveform analysis reveals that even harmonics are absent from both waveforms; odd harmonics (particularly the third) are higher for the flat-topped waveform, which will make it unsuitable for many applications.

This application of his "common sense" approach reminds me of a proverb: Nothing is obvious unless you have seen it before. I wonder if he has seen this before? I have, so I have no excuse; I just allowed myself to be carried away in the heat of the moment.

L.D. SMITHEY
Pacific Palisades, CA

MORE ON ANTENNAS

The "Communications Corner" column on phased VHF vertical

antenna arrays (*Radio-Electronics*, October, 1984) was a good article, except for a couple of items that should be added.

The antennas are going to have definite driving point impedances, which will include mutual impedance, that can be calculated from knowledge of the antenna's length and spacing. Those driving point impedances will then be *transformed* to different values at the other end of the phasing lines (lines other than one wavelength long), that can easily be determined from a Smith chart. The transmitter will then see the parallel combination of those two transformed impedances, and that number will most likely be a mismatch to the standard 50-ohm resistive termination.

Varying the length of the phasing lines and/or the antennas slightly can help in neutralizing the reactive components, and thus bring the VSWR down; also keep in mind that if the feed-point impedances of the lines are different, the antenna currents will be dif-

ferent, and the radiation pattern will be affected. An excellent introductory book on such things is the *ARRL Antenna Book*.

MARTIN E. GASPAR
Salt Lake City, UT

APPLAUSE

I'm not much for writing—but after saying amen to many reader's letters asking you not to become a computer magazine, now I'm applauding your construction articles on the *Timex/Sinclair 1000*.

I own a number of computers, but would not attempt to modify most of those. An exception to that is the *1000*. Thanks to your articles on using that computer as a controller (*Radio-Electronics*, July, August, and September 1984), I am making the *1000* into a dedicated controller for my solar heating system, and learning a lot about how computers work in the process. So, keep providing your readers with good construction articles of all types.

O.R. HERMAN
Williamsport, PA

R-E

Your customer just paid good money for a service call. Don't let him blow it!

All your hard work and your customer's hard-earned money are wasted when a voltage surge hits. All it takes is a nearby lightning strike or the switching of a load within a building. RCA's Voltage Surge Suppressor can prevent this damage to sensitive electronic equipment, and assure you of extra profit on every service job you do.

Available in a 3-way version, SK403, and a single-socket version, SK401, the suppressor plugs into any 15-amp, 125-volt grounding receptacle or cord connector. If constantly overloaded, the suppressor will cut off power to equipment connected to it, guarding against unprotected operation and signalling the



RCA
SK Replacement
Solid State

need for a replacement suppressor.

Once they realize how much damage it can prevent, your customers will want to buy RCA's Voltage Surge Suppressor to protect their TVs, computers, sound systems, microwave ovens and other electronic equipment. Every SK403 and SK401 has been tested before leaving the factory. So why blow a perfect opportunity to protect a satisfied customer? Stock up on RCA's profitable Voltage Surge Suppressors today.

Call your RCA SK Distributor or write: RCA Distributor and Special Products Division, 2000 Clements Bridge Road, Deptford, NJ 08096, Attn: Sales Promotion Services.

EQUIPMENT REPORTS

Multiplex Technology ChannelPlus Video Multiplexer

Here's a video "switcher"
that's not a switcher!

AS YOU ADD MORE VIDEO-ENTERTAINMENT equipment to your TV, the need for some type of switcher grows. That usually means more knobs to turn, more required set-



CIRCLE 5 ON FREE INFORMATION CARD

up time, and more intimidation for the "electronic-shy" in your family. But that doesn't have to be true, thanks to *ChannelPlus* from Multiplex technology (251 Imperial

Highway, Fullerton, CA 92635).

ChannelPlus works to give your home-video sources their own UHF TV channels. It accepts your video and audio inputs and it outputs an RF signal. Three sets of inputs and outputs are available. And although it come preset to certain channels, you can select other UHF channels for your output. (Those between Channels 20 and 40 give the best results.)

Using *ChannelPlus*

Let's look at how you would use *ChannelPlus* to connect your VCR, *continued on page 32*

**DESOLDER-IT,
CLEAN-IT, COAT-IT,
FREEZ-IT...SEND FOR IT!**
Our new electronic problem solving catalog!



Chemtronics
581 Old Mills Rd
Hauppauge, NY 11788
800-345-5244
In NY 516-582-3322
Telex 968567

CIRCLE 54 ON FREE INFORMATION CARD

PRICE SLASHERS

CONVERTERS

ONLY \$59.95
FACTORY
REFURBISHED

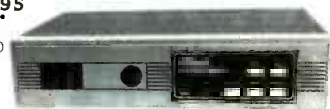

- 60 Channel Capacity
- P.L.L. Tuning
- 6 Channel Memory
- TV On-Off Feature
- Infra-Red Wireless Remote Control

OTHER MODELS ALSO AVAILABLE

Jerrold JRX-3 \$49.95* Jerrold DRX-3 \$69.96*
Jerrold RSC-3 \$39.95*

*Reconditioned Units With 30 Day Warranty

VIDEO SWITCHERS



DW42K
\$49.95



DW63K
\$74.95

- MasterCard & Visa Add 5%
- Checks - Allow 14 Working Days
- Freight Charges: Sent Collect
- Order 20 or More - Freight Prepaid
- Special Price on New Factory Fresh Units - \$69.95
- Warranty Not Valid After 15 Days From Receipt

Phoenix Electronics

1 Midwood • Allendale, NJ 07401
(201) 848-8229

MASTER THE NEW ELECTRONICS WITH MCGRAW-HILL'S

Contemporary Electronics Series

The fast, easy and low cost way to meet the challenges of today's electronic innovations. A unique learning series that's as innovative as the circuitry it explains, as fascinating as the experiments you build and explore.

From digital logic to the latest 32-bit microprocessor, the McGraw-Hill Contemporary Electronics Series puts you into the electronic picture one easy step at a time. Fifteen unique Concept Modules, sent to you one every 4-6 weeks, give you a handle on subjects like optoelectronics, robotics, integrated circuits, lasers, fiber optics and more.

Each Concept Module goes right to the heart of the matter. You waste no time on extraneous material or outdated history. It's a fast, efficient, and lively learning experience... a non-traditional approach to the most modern of subject matter.

Unique Interactive Instruction

With each module, you receive a McGraw-Hill Action Audio Cassette. Each tape is a dynamic discussion that drives home the key facts about the subject. Your learning

With your first module, you get this solderless breadboarding system. You'll use it throughout the series to build electronic circuits and bring concepts to life.

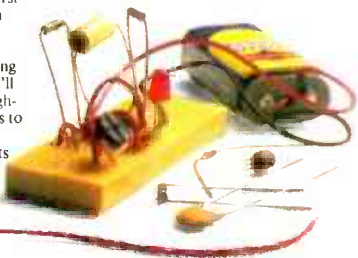

experience is reinforced through interaction with vividly illustrated text, audio cassettes, and actual electronic experiments. Indexed binders preserve backup material, notes, and tapes for convenient referral.

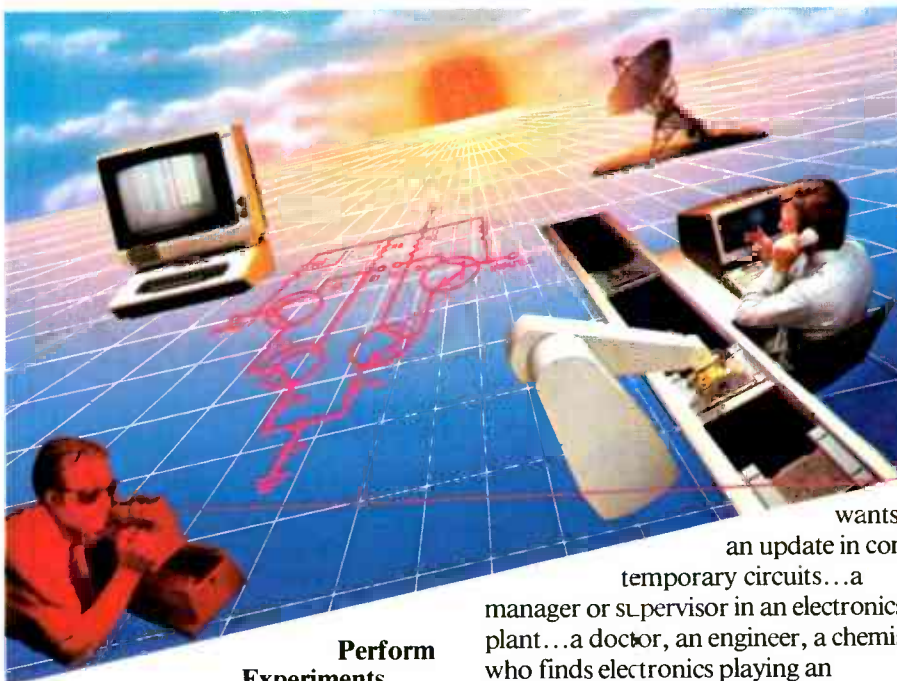

Perform Experiments in Contemporary Electronics

Throughout your series, laboratory experiments reinforce every significant point. This essential experience... dynamic, hands-on demonstrations of theory in practice... will help you master principles that apply all the way up to tomorrow's latest VLSI (Very Large Scale Integrated) circuitry.

In your very first module, you'll use integrated circuits to build a digital oscillator, verifying its operation with a light emitting diode (LED). You'll learn to identify passive and active components, understand concepts common to all electronic circuits.

For Anyone Interested in Electronics

The Contemporary Electronics Series is designed for anyone from hobbyist to professional. It's for you if you're looking for new fields of interest... if you're a teacher who

wants an update in contemporary circuits... a manager or supervisor in an electronics plant... a doctor, an engineer, a chemist who finds electronics playing an increasingly important role in your work. It's even for electronics engineers or technicians who feel their training needs freshening up. It's the quickest, most convenient, probably least expensive way to do it. And the only one that gives you hands-on experience.

15-Day No-Risk Trial

To order your first module without risk, send the postage-paid card today. Examine it for 15 days under the terms of the order form and see how the Contemporary Electronics Series gets you into today's electronics. If card has been used, write us for ordering information.



McGraw-Hill
Continuing Education Center
3939 Wisconsin Ave.
Washington, D.C. 20016

EQUIPMENT REPORTS

continued from page 28

videodisc player, and your home computer to your TV. The first thing to do is to hook your present TV antenna to *ChannelPlus*. Its antenna output can then be fed to your TV—or to a splitter if you have more than one TV. (We'll see where that can come in very handy.) You can even daisy-chain the antenna output to the antenna

input of another *ChannelPlus* if you want to expand your system at a later time.

Once you have your antenna connections made, you can hook up your video sources. The video and audio outputs of your VCR, videodisc player, and computer would go to the video and audio inputs on *ChannelPlus*. When everything's turned on, the antenna output that is fed to your TV will contain three signals that it previously didn't—the UHF TV signals

that are modulated with your video and audio inputs.

Advantages of *ChannelPlus*

The main advantage of *ChannelPlus* is that once you set it up, you never really have to worry about it. That can be seen by the front panel—it has no controls (except those under a decorative cover). There are 4 LED's however. One indicates that power is supplied. (There is no power switch—the unit is always left plugged in.) The other 3 indicate that an acceptable video signal is being input to the device.

ChannelPlus is attractive but, since you never have to touch it, you can position it somewhere out of sight. As long as you remember, for example, that your VCR is on channel 25 and your personal computer is on Channel 35, all you have to do is turn to one of those channels to watch the appropriate source. And you can even use your remote control to tune it in.

If you have several TV's presently wired to the same antenna, you'll be able to use *ChannelPlus* to watch different video sources throughout the house. For example, even if all your video equipment is in one central location, the VCR could be watched on one TV, while a videodisc is watched on another. Using that feature another way, you could watch a single source on all the TV's in the system at the same time.

That would come in very handy for a home-security system that uses several video cameras. You could assign, for example, the cameras in the nursery, and at the swimming pool to different channels. And you could watch those cameras simply by turning to the appropriate channel *on any TV in the house*.

You might wonder why you would want to use *ChannelPlus* with your VCR—after all, the VCR has an output on Channel 3. Unfortunately, there is a very good reason: As a cost-cutting measure, the RF modulators used in many VCR's—even some of the most expensive—are not of the best quality. So bypassing the VCR's own modulator and using one in

continued on page 36

The Professionals' Choice

PTS

“PTS rebuilt modules are better than brand new . . .”

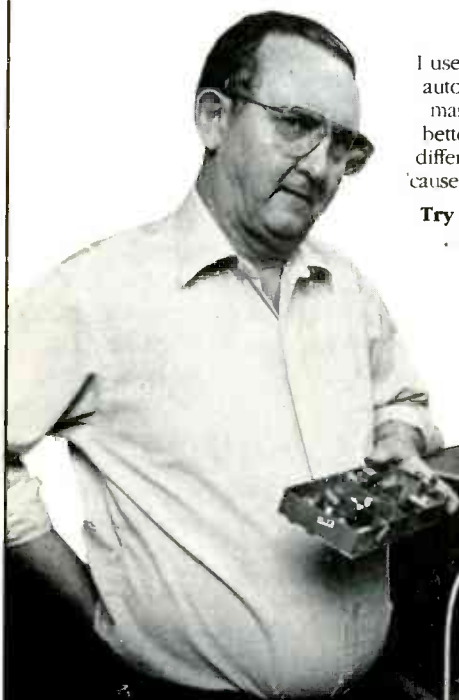

I use PTS modules and tuners because of their automatic updates. Compared to original manufacturers' new and rebuilt parts, PTS is better. Quality and turnaround makes the difference. PTS does a better job of rebuilding cause that's all they do."

Try PTS rebuilt modules and tuners for:

- Fast 8 hour rebuilding service
- Full year limited warranty
- One stop shopping for all makes/all models
- Availability at over 1500 authorized stocking distributors
- Quality rebuilds that meet or exceed original manufacturers specs.



For your free copy of the PTS Price and Technical Information Guide write:

PTS CORPORATION
P.O. Box 272
Bloomington, IN 47402
(812) 824-9331

Depend on
PTS Servicenters
and Authorized Distributors
nationwide.

CIRCLE 89 ON FREE INFORMATION CARD

ADVANCE ELECTRONICS

IS PROUD TO ANNOUNCE

BK PRECISION

DYNASCAN CORPORATION

BREAKS THE PRICE BARRIER

**WITH THESE HIGH PERFORMANCE
OSCILLOSCOPES**

100 MHz Dual Trace/ Dual Time Base

- 1 mV/div sensitivity
- 23 calibrated sweeps
- Rectangular CRT with internal graticule and scale illumination
- Signal Delay Line

\$995

Does not include probes

(\$60.00 a pair when purchased with scope)



Model 1580

QUANTITIES ARE LIMITED



New Model 1540

40 MHz Dual Trace

- 1 mV/div sensitivity
- 21 calibrated sweeps
- Rectangular CRT with internal graticule and scale illumination
- Video sync separators
- Signal delay line
- 12 kV accelerating voltage
- X-Y operation
- Z axis input
- X10 sweep magnification
- Delayec sweep/dual time base
- Single sweep
- Auto focus

20 MHz Dual Trace

- 1 mV/div sensitivity
- 20 calibrated sweeps
- Rectangular CRT with internal graticule and scale illumination
- Video sync separators
- X-Y operation
- Z axis input
- 6 kV accelerating voltage
- X10 sweep magnification
- Auto sweep
- V mode—displays two signals unrelated in frequency
- Sum & difference capability



New Model 1522

Please add \$15. shipping in Continental U.S.

CALL FOR PRICES

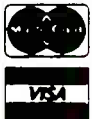

TOLL FREE HOT LINE
800-223-0474

212-730-7030

26 WEST 46th STREET, NEW YORK, N.Y. 10036

THE TEST EQUIPMENT SPECIALISTS

ADVANCE ELECTRONICS



- 77
- 0.3% Accuracy
 - Manual or Autorange
 - 10A + mA Range
 - Beeper
 - "Touch-Hold" Function

Sale (with holster)
\$11995

WE CARRY A FULL LINE OF FLUKE MULTI-METERS. IN STOCK NOW

Sale ends May 85



4 1/2 DIGIT MULTIMETERS

\$349 00

MODEL 8060A



- Frequency measurements to 200KHz
- dB measurements
- Basic dc accuracy 0.4%; 10 μV, 10 nA and 10 mΩ sensitivity
- Relative measurements
- True RMS
- High-speed Beeper

THE NEW FLUKE 27 SERIES WORLDS TOUGHEST METER



NOW IN STOCK!

FLUKE 70 SERIES MULTIMETERS

- Analog Display • Rotary Knob • Volts AC & DC • Resistance to • 32 MΩ • 10 Amps • Diode Test • 3200 Counts • Fast Autoranging • Function Annunciators in Display • Power-Up Self Test • 2000+ Hour Battery Life w/ Power Down "Sleep Mode" • New Test Leads • VDE & UL Approval



\$99 00

75

- 0.5% Accuracy
- Manual or Autorange
- 10A + 300 mA Range
- Beeper

\$7995

and free C70 holster

73

- 0.7% Accuracy
- Autorange Only
- 10 Amp Only



70 MHz Dual Time Base SCOPE

MODEL 1570



\$995 00

PRICE DOES NOT INCLUDE PROBES

- 1mV/division sensitivity to 70 MHz
- 500 μV/division cascade sensitivity
- Four-input operation provides trigger view on 4 separate inputs
- Alternate time base operation
- Switching power supply delivers best efficiency and regulation at lowest weight



INDUSTRIAL TRANSISTOR TESTER

\$199 95

MODEL 520B



- Now with HI/LO Drive
- Works in-circuit when others won't
- Identifies all three transistor leads
- Random lead connection
- Audibly and visually indicates GOOD transistor



\$199 95

MODEL 830

- Automatically measures capacitance from 0.1pF to 200mF
- 0.1pF resolution
- 0.2% basic accuracy
- 3 1/2 digit LCD display

\$159 95

MODEL 820

- Resolves to 0.1pF
- 4 digit easy-to-read LED display
- Fuse protected against charged capacitors
- Overrange indication



BECKMAN'S CIRCUITMATE[®] ALL UNDER \$100

AVAILABLE NOW....



\$64.95

Circuitmate DM 20—
3½-digit, pocket-size
multimeter; 0.8% Vdc
accuracy, diode test,
hFE test, conductance,
10 amps AC and DC
ranges, auto-polarity,
auto-zero, auto-
decimal



\$69.95

Circuitmate DM-40 —
3½-digit multimeter;
0.8% Vdc accuracy,
diode test, auto-
polarity, auto-zero,
auto-decimal



\$89.95

Circuitmate DM 45 —
3½-digit multimeter;
0.5% Vdc accuracy,
diode test, continuity
beeper, 10 amps AC
and DC ranges, auto-
zero, auto-polarity,
auto-decimal



\$79.95

Circuitmate DM-25—
3½ digit, pocket-size
multimeter; 0.5% Vac
accuracy, diode test,
capacitance, continuity
beeper, conductance,
10 amps AC and DC
ranges, auto-polarity,
auto-zero, auto-
decimal



The DM73 is the smallest digital
multimeter on the market. Its
probe-style design makes it ideal
for taking measurements in hard-
to-reach test areas.

SALE
\$59.95

- Small Size
- Complete Autoranging
- "Touch Hold"
- Audible continuity checking

\$76.95



The DM 77 gives you
the convenience of
autoranging plus 10
amps ac/dc
measurement
capability. You simply
select the function
you want, and the
DM 77 automatically
sets the required
range.

...Quality and Performance
Beckman and 4½ Digits...



True RMS

\$239.00

AVAILABLE NOW!

BECKMAN does it
again...a true RMS
4½ DMM w/1 year
calibrated cycle at
a 3½ digit price.

MODEL 4410



NEW
Beckman
Circuit-mate
DM10 **\$39.95**
in stock now

BK PRECISION

POWER SUPPLIES



\$299.95

MODEL
1601

- Isolated 0-50VDC, continuously variable; 0-2A in four ranges
- Fully automatic shutdown, adjustable current limit
- Perfect for solid state servicing



\$329.95

MODEL 1650

- Functions as three separate supplies
- Exclusive tracking circuit
- Fixed output 5VDC, 5A
- Two 0 to 25VDC outputs at 0.5A
- Fully automatic, current-limited overload protection



\$189.95

FUNCTION GENERATORS

MODEL
3020

\$319.95

SWEEP FUNCTION

- Sine, square and triangle output
- Variable and fixed TTL outputs
- 0.1 Hz to 1MHz in six ranges
- Push button range and function selection
- Typical sine wave distortion under 0.5% from 1 Hz to 100kHz

- Four instruments in one package — sweep generator, function generator, pulse generator, tone-burst generator
- Covers 0.02Hz-2MHz
- 1000:1 tuning range
- Low-distortion high-accuracy outputs



TOLL FREE HOT LINE
800-223-0474

212-730-7030

26 WEST 46th STREET, NEW YORK, N.Y. 10036

THE TEST EQUIPMENT SPECIALISTS

**ADVANCE
ELECTRONICS**

EQUIPMENT REPORTS

continued from page 32

ChannelPlus can result in a sharp-er picture.

ChannelPlus is well constructed, well shielded, and does everything it claims. The isolation between video inputs is greater than 70dB, and its maximum power consumption is only 7 watts. Our only objections are minor. For example, no cables are

supplied with the unit.

The manual serves its intended interest well—it tells you how to set up the unit. But it did have some shortcomings. For example, there is no power switch on the ChannelPlus. But there is no mention of leaving the unit on all the time.

If you are a cable-TV subscriber, you can still use ChannelPlus, but you'll have to order the "CR" or cable-ready model. You can still output signals on UHF, but you can

| Multiplex Technology | | ChannelPlus | | | | | | | | | | | | |
|----------------------|--|-------------|---|------|---|---|------|---|---|-----------|----|--|--|--|
| OVERALL PRICE | | | | | | | | | | | | | | |
| EASE OF USE | | | | | | | | | | | | | | |
| INSTRUCTION MANUAL | | | | | | | | | | | | | | |
| PRICE/VALUE | | | | | | | | | | | | | | |
| | | 1 | 2 | 3 | 4 | 5 | 6 | 7 | 8 | 9 | 10 | | | |
| | | Poor | | Fair | | | Good | | | Excellent | | | | |

also output signals on cable channels 57–64.

There are several models of ChannelPlus available. The two main types are the "V" series and the "R" series, which accept composite-video (and audio) signals and RF (Channel 3 or 4) signals respectively. In each type, models with one, two, or three sets of inputs and outputs are available. We examined the model H3V, which accepted 3 video and audio inputs. That model is priced at \$269.95. The one- and two-input models are priced at 129.95 and 199.95 respectively. The one- two- and three-channel RF-input models are priced from about \$160 to \$360. For cable-ready models, you must add \$10 per output.

If you have only one TV and just need a way to switch between video sources, then ChannelPlus may be more than you need. But if you have several TV's tied into the same system, ChannelPlus becomes a worthwhile addition. R-E

Texas Instruments Understanding Series.™

Books about today's science and technology...for everyone.

Only \$14.95 each.



Novice, professional, technician or hobbyist, there's an Understanding Series title just for you. Each book is a self-contained volume that takes you through the material step-by-step. For the newcomer, it's a quick and easy way to learn. Practitioners will find it an ideal way to catch up, keep pace and review. You'll like the look, too. These editions will make attractive additions to any reference library. Information-intensive, with color illustrations, they're easy to read. And marginal notes speed and simplify summary or review. The Understanding Series. Exciting, timely subjects in an inviting new format. Check your choices on the coupon and mail it, today.



TEXAS INSTRUMENTS

Creating useful products and services for you.

Please send me the following titles @ \$14.95 each:

of copies

- _____ Understanding Automation Systems LCB8472
- _____ Understanding Automotive Electronics LCB8475
- _____ Understanding Communications Systems LCB8474
- _____ Understanding Computer Science LCB8452
- _____ Understanding Data Communications LCB8483
- _____ Understanding Digital Electronics LCB8471
- _____ Understanding Digital Troubleshooting LCB8473
- _____ Understanding Microprocessors LCB8451
- _____ Understanding Solid State Electronics LCB8453
- _____ Understanding Telephone Electronics LCB8482

Add \$1.25 per book, postage and handling. Prices subject to change without notice.

Enclose check or money order with sales tax (except AK, DE, NH, OR). Foreign orders must be in U.S. dollars and include shipping charges. Sorry, no phone orders.

© 1985 Texas Instruments Incorporated

Mail to:

Texas Instruments Incorporated
Information Publishing Center
P.O. Box 225474, M/S 8218
Dallas, Texas 75265

Name _____

Address _____

City _____

State _____ Zip _____

Mirage B23A 2-Meter RF Amplifier

Turn your 2-meter handi-talki into a 30-watt mobile transceiver.



CIRCLE 6 ON FREE INFORMATION CARD

IF YOU'RE AN ACTIVE RADIO AMATEUR, one of the necessities of life—*continued on page 42*

2122
RE485

VIDEO ACCESSORIES

■ Highest quality ■ Highest performance ■ Lowest prices

bp VIDEO-CINE CONVERTER

The BP Video-Cine Converter is an optical device that allows the easy transfer of slides, 8mm or 16mm movie film to VCR tape. The Video-Cine Converter's precision optics put the image from your movie or slide projector on a high-contrast, rear projection screen. Your video camera shoots that image, can color-correct faded pictures, add narration to other sound. Can be used with any video camera or slide projector. If your video camera lacks close-up capability, you will need a macro lens attachment.

MODEL V-1701 **\$34⁹⁵**



FOR ULTIMATE VIEWING

TEKNIKA

WIRELESS REMOTE CONTROL TV TUNER & CABLE CONVERTER WITH VOLUME CONTROL

Model 6510
\$169⁹⁵



Wireless remote control with volume for cable TV, VHF-UHF antenna systems upgrades any TV to 140 channel capability.

- Works with any TV set • Quick, easy installation • Off-air and cable compatible
- Quartz frequency synthesizer tuning • Direct access/memory scan selector • Ultra-compact, hand-held wireless remote control



61 CHANNEL WIRELESS REMOTE CONTROL

Model V7661 **\$79⁹⁵**



Wireless remote control on/off, channel selection and fine tuning.

- Works with any TV • 61 channel capability
- Microcomputer controlled PLL operation
- Converter panel controllable for channel up, down, on/off, fine tuning • LED display
- Compatible with CATV systems.



STABILIZER/IMAGE ENHANCER/RF CONVERTER/VIDEO FADER/2-WAY DISTRIBUTION AMPLIFIER

Model V1880 **\$99⁹⁵**



Hook-up cable kit
\$11.75

The most versatile, all-in-one video processor. Can be used as a video guard remover for video tapes, enhancer, video to RF converter, professional video fade in and out and a dual output distribution amplifier.

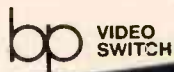

VIDEO SWITCH

Model V4804 **\$49⁹⁵**



Record a pay channel while viewing a standard channel. You can also connect an antenna/cable, VCR, video disc player, home computer and video game.



VIDEO TAPE REWINDER

Model V7777 VHS **\$49⁹⁵**

Model V7778 BETA **\$49⁹⁵**



Reduce wear and tear of your VCR heads with the AC powered circuit protected rewinders, LED power-on indicators.

Charge it with VISA/MASTERCARD. Phone orders accepted.

Fordham

260 Motor Parkway, Hauppauge, NY 11788

Toll Free
800-645-9518
In NY State 800-832-1446

Service and Shipping Charge Schedule

| FOR ORDERS | ADD |
|----------------------|---------|
| \$25-250 | \$4.50 |
| \$251-500 | \$6.50 |
| \$501-750 | \$8.50 |
| \$751-1,000 | \$12.50 |
| \$1,001 and up | \$15.00 |

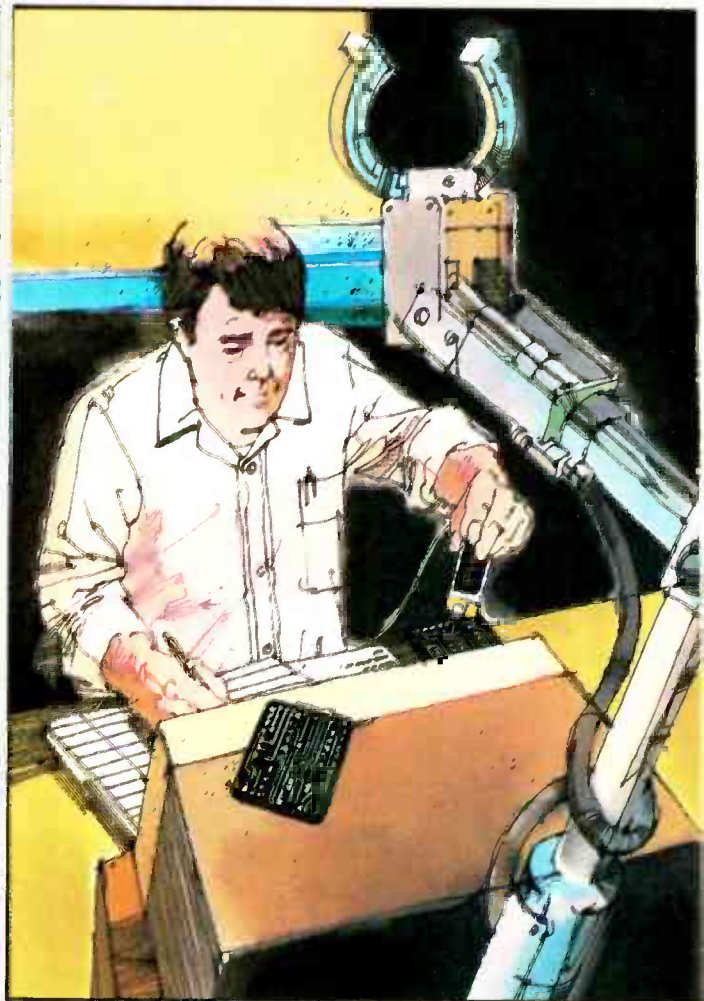
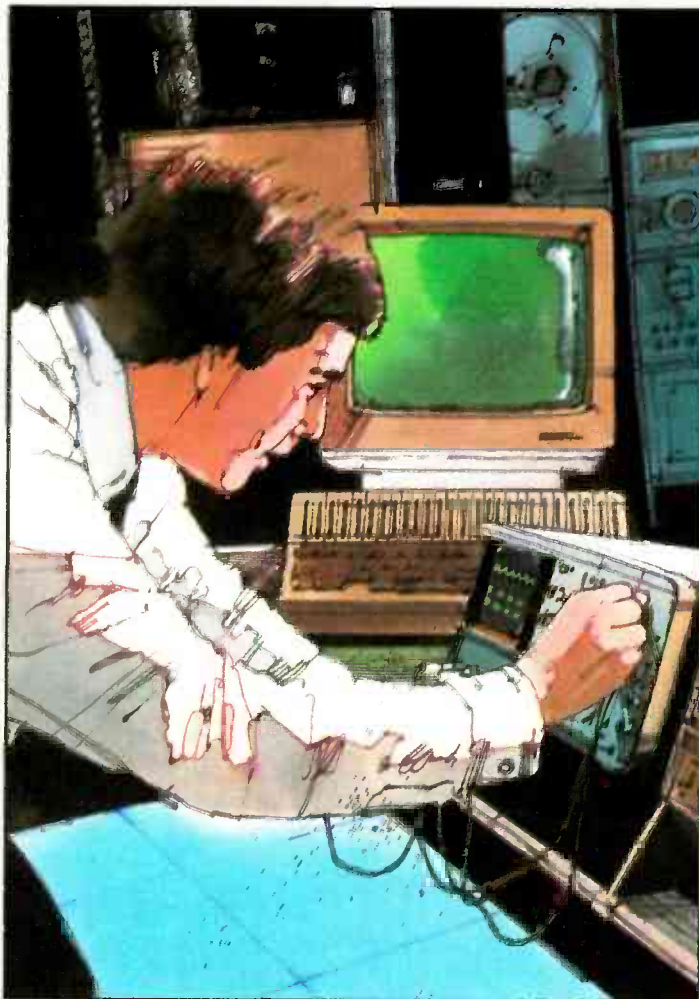

What can you do Just about

CIE can show you how.

Computer technology. Satellite communications. Cable television. Cellular radio. Digital electronics. Robotics. Just a few of the hottest career areas in electronics. The ones everybody is talking about. The ones that are changing the way we live, the way we do business, the way we entertain ourselves. The best way to start a career in any of them? By learning the basic electronics theory and principles of how they work from CIE.

Join a leader.

Leading the world in specialized electronics training, CIE is the largest school of its kind with over 25,000 students at home and abroad. And with over 50 years of experience teaching electronics to thousands of men and women through proven

methods of independent study **without** classroom sessions.

Learn as much as you want,
when you want.

Whether you're interested in learning new skills or upgrading old ones, earning a diploma or an A.A.S. degree, CIE can match your needs with courses and programs that let you start where you want, go as far as you want from a basic beginner course all the way to CIE's Associate in Applied Science Degree in Electronics – a comprehensive program that prepares you for advanced electronics careers.

Custom training
equipment helps you learn.
CIE believes in the importance of learning by

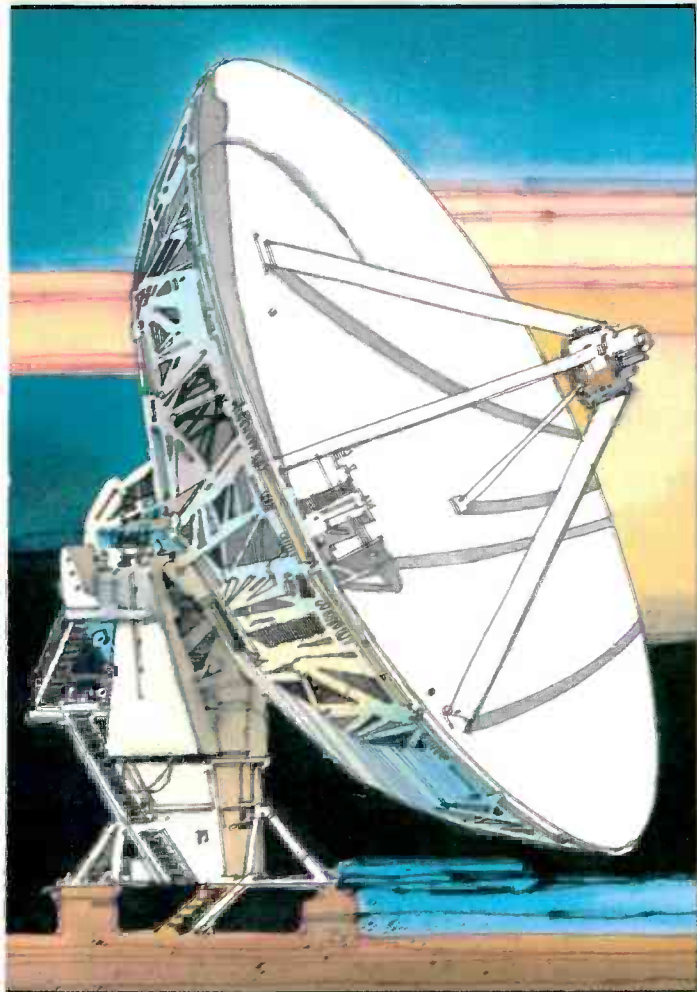

with electronics? anything.

doing. So most of our courses include specialized training laboratories keyed to specific lessons for practical experience through teaching experiments. Our CIE Microprocessor, for example, comes fully assembled and ready to use to teach you how a computer CPU works through a series of experiments you perform on your own.

Are you ready?

If you're ready to do something now about your future, there's no waiting to enroll with CIE. Get all the information you need to enroll simply by calling us toll-free at 1-800-321-2155 (in Ohio, 1-800-362-2105). Or mail in the handy reply coupon or card to Cleveland Institute of Electronics, 1776 East 17th Street, Cleveland, Ohio 44114.

CIE World Headquarters

Cleveland Institute of Electronics, Inc.
1776 East 17th Street • Cleveland, Ohio 44114

- Please send me your CIE Off-Campus Studies Catalog, including details about the Associate Degree program. I understand there is no cost for the catalog and a CIE representative may call, but there is no obligation.

Print Name _____

Address _____ Apt. No. _____

City _____ State _____ Zip _____

Age _____ Area Code/Phone No. _____ / _____

Check box for G.I. Bill bulletin on Educational Benefits

- Veteran Active Duty

MAIL TODAY!

RE-09

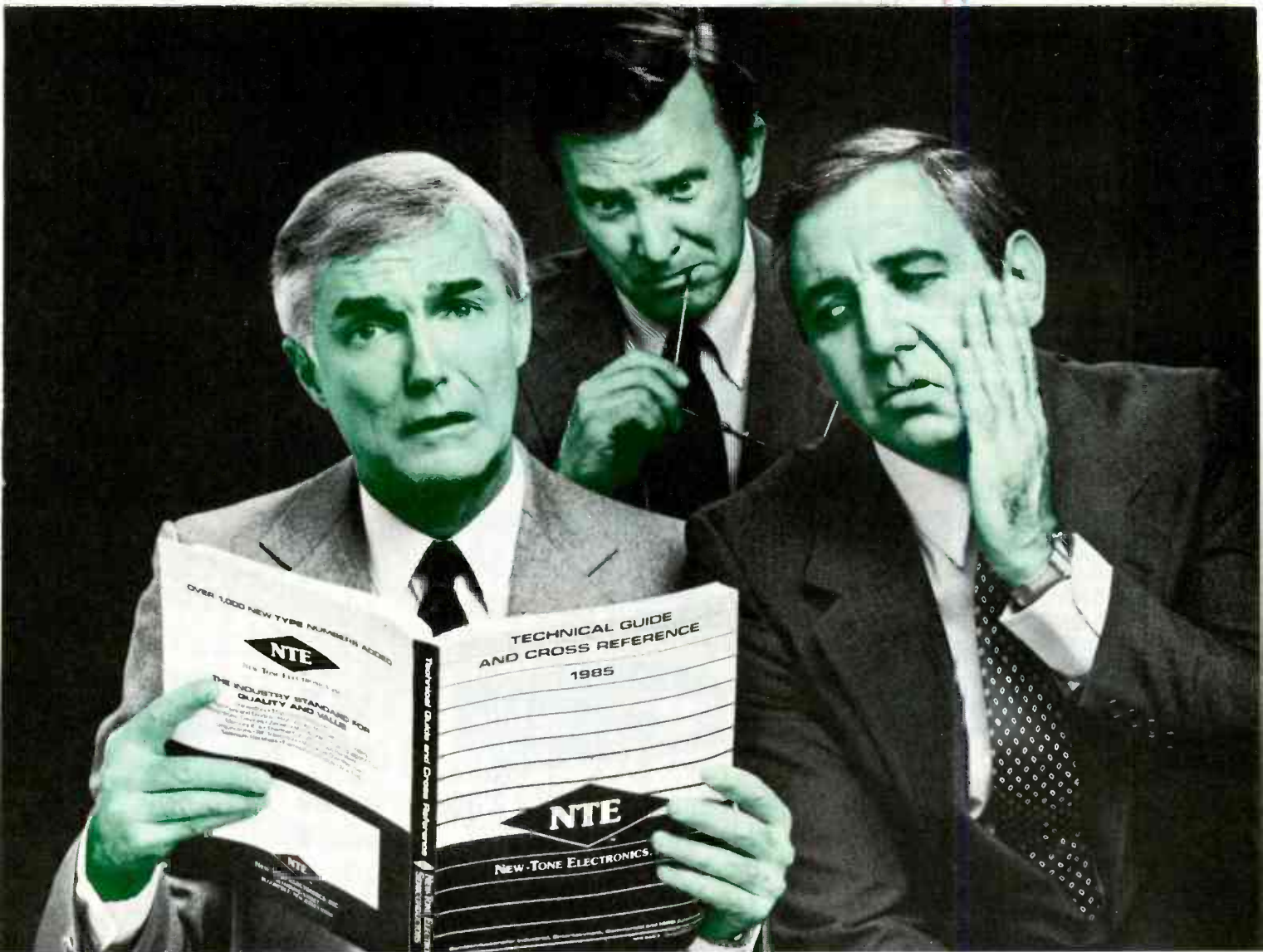

WE'RE TURNING THE COMPETITION GREEN WITH ENVY.

NTE is the red hot success story of the electronics industry and the big boys are green with envy. They don't like the fact that we've built our reputation on giving you more of what you're looking for in a replacement part. More quality. More reliability. And, more parts to choose from. That's why more and more technicians across the country are picking the package with the green NTE diamond on the front.

NTE parts are extensively tested on state-of-the-art equipment during every phase of production to ensure top performance — performance that's backed by the industry's only two year warranty.

What's more, NTE uses a special computer controlled inventory system, so when you replace or design with NTE, you can be sure that the part you need is on your distributor's shelf. Our new 1985 Technical Guide and Cross Reference manual, which has over 3,100 NTE types cross-referenced to over 220,000 industry part numbers, is now available.

Why settle for our competitor's parts when you get more quality and service with NTE? Look for NTE's replacement parts in the bright green polybags and cartons at your distributor today.

Don't forget to ask about our new Flameproof Resistors and Wire Ties, too!



NEW-TONE ELECTRONICS, INC.

44 FARRAND STREET, BLOOMFIELD, NEW JERSEY 07003

CIRCLE 260 ON FREE INFORMATION CARD

RAG

ELECTRONICS, INC.

New and Used Electronic Test Equipment
Sales • Service • Rental • Leasing

■ Polaroid DS-34

Now you can get an instant picture in black & white or color from any oscilloscope screen. Includes CRT hood.
*Large hoods also available to fit computer terminals and CAD/CAM screens.

\$369.00



POWER SUPPLIES

GLOBAL SPECIALTIES TRIPLE OUTPUT POWER SUPPLY



MODEL 1301 \$198.00

- Fully regulated triple output
- Fixed 5VDC, 1A
- V1 + 5 VDC to 18 VDC .5A
- V2 - 5 VDC to 18 VDC .5A
- Fully automatic current limiting

ELECTRO INDUSTRIES, INC.
Precision Test Instruments

DC POWER SUPPLY



MODEL 3002A/0-30 VDC/0-2A

\$125.00

BK PRECISION TRIPLE OUTPUT POWER SUPPLY



MODEL 1650 \$319.00

- Functions as three separate supplies
- Exclusive tracking circuit
- Fixed output 5 VDC, 5A
- Two 0 to 25 VDC outputs at 0.5A
- Fully automatic, current-limited overload protection
- + and - terminals of each output are fully isolated, in all modes
- All three outputs may be connected in series or parallel for higher voltage or current

PROBE MASTER Oscilloscope Probes

| MODEL | ATTENUATION | BAND WIDTH (MHZ) | PRICE |
|-------|-------------|------------------|---------|
| 2904 | 10X | 100 | \$35.00 |
| 2901 | 10X/1X | 100/5 | \$39.00 |
| 2205 | 10X | 250 | \$59.00 |
| 2960 | 10X | 60 | \$30.00 |

CALL US TOLL FREE

1-800-732-3457

IN CALIFORNIA TOLL FREE

1-800-272-4225

- Master Charge
- VISA ■ COD
- Money Order
- Check



ADD FOR SHIPPING AND INSURANCE

| | |
|----------------------|---------|
| \$0 to \$250.00 | \$4.50 |
| \$251.00 to \$600.00 | \$6.50 |
| \$501.00 to \$750.00 | \$8.50 |
| \$751.00 to \$1000 | \$12.50 |
| over \$1000.00 | \$15.00 |

COD's extra (required 25% deposit)

RAG ELECTRONICS, INC. / 21418 Parthenia Street / Canoga Park, CA 91304 / 1-818-998-6500

LEADER Instruments Corporation

Audio Sine/Square Wave Generator

- Distortion from <0.03%
- 10 Hz to 1 MHz

\$259.00

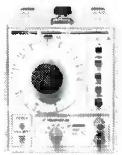

LAG-120B



BK PRECISION

FUNCTION GENERATOR

\$189.00

MODEL 3010

- Sine, square and triangle output
- Variable and fixed TTL outputs
- 0.1 Hz to 1 MHz in six ranges
- Typical distortion under 0.5% from 1 Hz to 100 kHz
- Variable DC offset
- VCO input for sweep tests

VIZ

MULTI-FUNCTION COUNTER



MODEL WD-755

- 5 Hz to 125 MHz
- 8 Digit LED Display
- Period Measurement 5 Hz to 2 MHz
- Totalizes to 99,999,999 Plus Overflow
- Frequency Ratio Mode
- Time Interval Mode
- Switchable Attenuator & Low Pass Filter

\$259.00

STACO ENERGY PRODUCTS CO.

VARIABLE TRANSFORMER

\$145.00



MODEL 3PN1010V

RAG CARRIES THE COMPLETE STACO VARIABLE TRANSFORMER LINE
CALL US WITH YOUR REQUIREMENTS.

DIGITAL CAPACITANCE METER

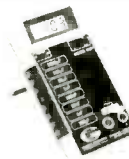

- Battery operated
- 3 1/2 digit LCD display
- Range 1 PF to 2,000 UF
- 0.2% basic accuracy

GLOBAL MODEL 3000 \$139.00

SCOPE SPECTACULAR

HITACHI PORTABLE OSCILLOSCOPES



Model V-212 shown

MODEL V-212 **\$461.00**
DC to 20 MHz, 1 mV/div, Dual Trace
Features 6" Rectangular CRT
Full 2 year parts and labor warranty (w/two X10 probes).

MODEL V-222 **\$536.00**
DC to 20 MHz, 1 mV/div, Dual Trace, D.C. offset for DMM Output, Verticle Mode Trigger
6" CRT (w/two X1/X10 probes).

MODEL V-422 **\$694.00**
DC to 40 MHz,
other features same as V-222 (w/two X1/X10 probes)



Model V-1050F shown

MODEL V-1050F **\$1276.00**
DC to 100 MHz, .5 mV/div, Quad Trace, Delayed Sweep, Full T.V. Triggering, alternate time base (w/two X10 probes)

MODEL V-650 **\$956.00**
DC to 60 MHz, 1 mV/div, tripple trace, delayed sweep, Full T.V. Triggering, variable trigger hold-off (w/two X10 probes)

IWATEBU PORTABLE OSCILLOSCOPES

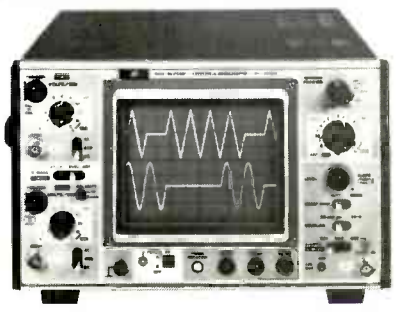

MODEL SS-5702 **\$535.00**
DC - 20MHz, 5 mV/div
Dual trace
6 inch rectangular internal graticule CRT.
Includes 2 each X1/X10 probes and full factory warranty; 2 years on parts, labor and CRT.

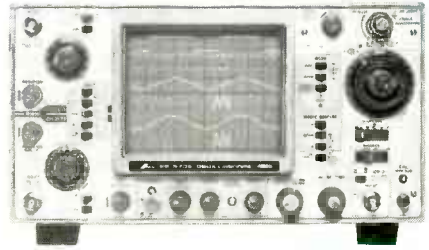

MODEL SS-5705 **\$899.00**
DC to 40MHz
Vertical and horizontal deflection accurate within $\pm 2\%$. CRT acceleration voltage 12KV. 3 channels, 6 traces. High precision calibrator ($\pm 1\%$). Fastest sweep rate: 10 ns.

- High sensitivity 1 mv/div
- CH1 signal output
- Beam finder
- Delayed sweep
- Alternate time base
- 2 ea. X1/X10 Probes

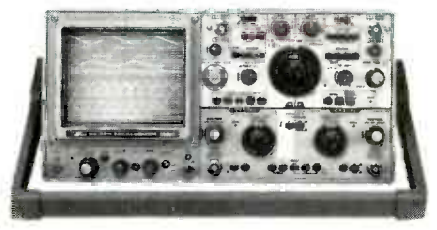

MODEL 5711 **\$1695.00**
DC to 100MHz (typically over 120 MHz), 5 mV/div, True 4 channel input, eight trace, Delayed sweep, alternate time base, CRT acceleration voltage 20 KV, (w/saddle bag, front cover, 2 ea. X10 probes).

MODEL 5711 D **\$2495.00**
(5711 with counter and DMM).

CIRCLE 254 ON FREE INFORMATION CARD

**At Home Professional Quality
Fine Line PCB's.**

Introducing an easy, inexpensive, step by step method for the home production of professional quality printed circuit boards without a major equipment investment—KeproClad, by Kepro, makers of quality industrial equipment and supplies. KeproClad was designed for the home user who needs professional results with:

A Simple Circuit Board;

Use KeproClad unsensitized copper-clads. These boards come in 2 popular sizes with 1 sided foil, a marking pen, all for a suggested retail price as low as \$3.50.

A Fine Line Detailed Board;

Use KeproClad photosensitized copper-clads. Available in 2 sizes with 1 or 2 sided foil. These copperclads use the latest technology of negative acting dry-film photoresist. This material is rugged, yet holds extremely fine detail. It comes with a premeasured amount of developer and sells for as little as \$3.90 (suggested retail).

Other KeproClad products such as a photo reversal kit for making negative film, etch, tin plating solution and photoflood lamps are all available at your local distributor. (For the distributor nearest you, call or write:

KEPRO CIRCUIT SYSTEMS, INC.
630 Axminister Drive., Fenton, MO 63026-2992
In MO 314-343-1630 Toll Free 800-325-3878

CIRCLE 258 ON FREE INFORMATION CARD

**SAVE BY BUILDING
OUR RACK MOUNT
STUDIO
EQUIPMENT**

QUADRAFUZZ — for separate frequency bands of distortion are mixed for the smoothest fuzz you've ever heard. no. 6720 **\$39.88**

HYPERFLANGE/CHORUS — the cleanest, widest range, most versatile flanger anywhere at any price. no. 6750 **\$149.95**

VOCODER — unmatched performance in a versatile, low cost rack package. no. 6710 **\$99.95**

HOT SPRINGS — user's agree, short of studio plate systems, you won't find a better reverb at any price. no. 6740 **\$59.95**

**ADD \$3 SHIPPING
FOR EACH KIT ORDERED**

Innovative, cost effective designs by Craig Anderton in easy to assemble kits from:

RAA Electronics, Inc.
Direct mail orders and inquiries to: Dept. 11R
1020 W. Wilshire, Oklahoma City, OK 73116 · (405)843-9626
Ask for your free catalog.

CHARGE TO VISA OR MC TOLL-FREE
1-800-654-8657 9AM to 5PM CST MON-FRI

CIRCLE 90 ON FREE INFORMATION CARD

**NEW
PRODUCTS**

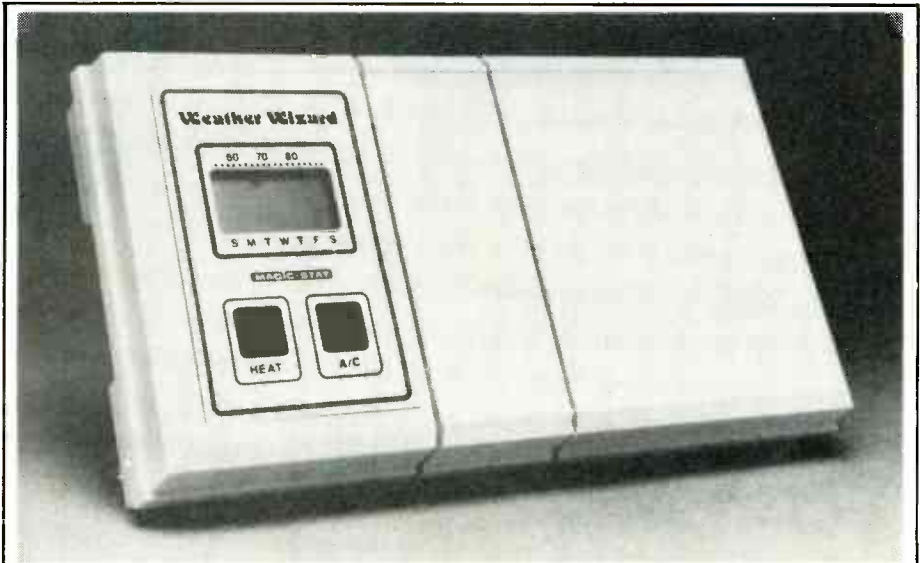

CIRCLE 11 ON FREE INFORMATION CARD

THERMOSTAT, the *Weather Wizard*, can be programmed for the entire year in five to ten minutes (and can be reprogrammed at any time, in one sitting). The user can program in his or her lap, or at a table, before installing the thermostat on the wall.

Both heating and cooling temperatures can be programmed simultaneously. The unit retains both heating and air-conditioning settings in its electronic memory, so that the desired room temperature can be maintained with-

out needing to reprogram the thermostat when the weather changes.

Users may have different programs for each day of the week, and up to six heating/cooling settings per day. There is also a vacation-setting feature that holds an economical temperature while the user is away, and allows him or her to specify the temperature desired upon return.

The *Weather Wizard* is priced at \$99.95.—**Quad Six, Inc.** 3753 Plaza Drive, Ann Arbor, MI 48104.

VIDEO CASSETTE RECORDER, model AVS-6200, offers hi-fi stereo and three playback speeds: SP, LP, and EP. It incorporates such video features as a signal-to-noise ratio of >45dB and horizontal resolution at 240 lines, with audio features that include audio-frequency modulation—permitting distortion-free wide dynamic range—and Dolby B noise reduction.



CIRCLE 12 ON FREE INFORMATION CARD

The model AVS-6200 has remote control, and provides easy-to-use record-playback functions on the

VHS format. It comes with double-gap integrated 4-head configuration; noise-free field-still frame advance and slow-motion playback, and dynamic aperture control for picture clarity. It also provides stereo-simulcast recording capability, and two separate stereo outputs.

The model AVS-6200 is priced at \$1,399.00.—**International Jensen**, 4136 N. United Parkway, Schiller Park, IL 60176.

INTERFACE DEVELOPMENT SYSTEM, the eZ System, is a hardware-development system that provides an easy solution to the designer, test engineer, student, or experimenter who needs quick access to a personal computer's bus-expansion slot for rapid circuit development. The system features three major components:

(1) The eZ Board is a solderless prototyping board that connects to the expansion slot of the micro-computer through an integral 18-inch flat cable, allowing the user to work freely without interfering with the system unit. The entire bus is available at clearly labelled and conveniently accessible solderless tie-point blocks. The large breadboarding module is used for rapid development of experimental circuits. The eZ Board is avail-

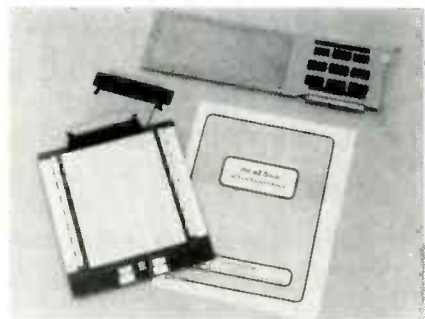

CIRCLE 13 ON FREE INFORMATION CARD

able for the IBM PC, Apple IIe/II+, and Commodore 64.

(2) The eZ Card is a prototyping board for the IBM PC/xT that features a fully buffered address, data, and control bus. All buffered signals are conveniently accessible for use in the large prototyping area, which consists of over 2,300 holes on a 0.1" x 0.1" grid and can accommodate over 60 sixteen-pin DIP sockets for wire-wrapping. Circuits developed and debugged

on the eZ Board can be permanently transferred to the eZ Card.

(3) The eZ Book features technical information on the computer system and contains several practical and useful project circuits, such as A/D conversion, parallel port, joystick interface, etc.

The eZ System is available direct from the manufacturer at \$225.00 plus \$10 S&H. Delivery is from stock.—**Sabadia Export Corporation**, 3920 Coronado Street, Suite 206, Anaheim, CA 92807.

AC/DC CURRENT CLAMP, model CT233, is designed for applications requiring DC- or AC-current measurement without breaking wires or electrical connections to divert the current through the meter. A Hall-effect device measures magnetic flux, which is converted to a current measurement by the circuitry in the clamp.

The model CT233 may be used with most DMM's, or an oscilloscope may be substituted, allowing the user to see the signal. Maximum current capacity is 600

amps AC, DC, or AC on DC. Also, the AC frequency response extends to 400 Hz; that is useful for aircraft-maintenance operations.

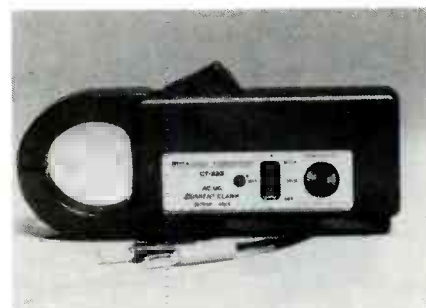

CIRCLE 14 ON FREE INFORMATION CARD

A flashing battery indicator and a three-position power and range switch are also featured. When the power is on, the battery indicator blinks; no blinking means that a change of batteries is needed. The power and range switch turns on the unit, selecting 0-200 amp or 0-600 amp operation.

The model CT233 is priced at \$150.00.—**Beckman Industrial Corporation**, 630 Puente Street, Brea, CA 92621. R-E



"In Just A Few Days, I'll Show You How To Do

REAL MATH

On Your Calculator!"

$$\int_a^b f \quad \sum_{n=1}^{\infty} a_n \quad \frac{df}{dx} \quad \lim_{n \rightarrow \infty}$$

•Quick. •Guaranteed.
•Easy. •Fun, Too!

INTRIGUED BY CALCULATORS? Then you can step up your math skills fast! Use my new method in guidebook form. It's called **CALCULATOR CALCULUS**. This space-travel spinoff is sure-fire, so it has a **simple guarantee** — just return it for an immediate refund if you are not astounded at the problems you're solving with it!

But the point is — you won't want to send it back. For this is the **easiest, fastest shortcut ever!** The day you receive your copy in the mail you'll want to put it to work. It's that exciting and helpful.

My name is Dr. George McCarty. I teach math at the University of California. I wrote this guidebook to cut through the confusion. I guide you with examples you follow step-by-step on your calculator — you do simple exercises — then you solve practical problems with real precision!

POWER METHODS. Need to evaluate functions, areas, volumes — solve equations — use curves, trig, polar coordinates — find limits for sequences and series? It's all here!

If you're in the biological, social or physical sciences, you'll be doing Bessel functions, carbon dating, Gompertz growth curves, half-life, future value, marginal costs, motion, cooling, probability, pressure — and plenty more (even differential equations).

Important numerical techniques? Those algorithms are here, too: rational and Padé approximation, bracketing, continued fractions, Euler's method, Heun's method, iteration functions, Newton's method, predictor-corrector, successive substitutions, Simpson's method and synthetic division.

LOOK AT WHAT USERS SAY: Samuel C. McCluney, Jr., of Philadelphia writes:

"CALCULATOR CALCULUS IS GREAT! For ten years I have been trying to get the theory of calculus through my head, using home-study courses. It was not until I had your book that it became clear what the calculus was all about. Now I can go through the other books and see what they are trying to do. With your book and a calculator the whole idea becomes clear in a moment, and is a MOST REFRESHING EXPERIENCE. I program some of the iterative prob-

lems you suggest and it always GIVES ME A THRILL to see it start out with a wild guess and then approach the limit and stop."

Professor John A. Ball of Harvard College (author of the book *Algorithms for RPN Calculators*) writes: "I wish I had had as good a calculus course."

Professor H. I. Freedman of the U. of Alberta, writing in *Soc. Ind. Appl. Math Review*, states: "There can be no question as to the usefulness of this book...lots of exercises...very clearly written and makes for easy reading."

Tektronix Engineer Bill Templeton says "CALCULATOR CALCULUS is the best, most clearly written book I have seen for improving your math skills."

I WANT YOU TO DO THIS. Get my complete kit, with a TI-35 calculator, plus its 200 p. Student Math Book, AND the guidebook, ALL for \$44.95 (for shipping to USA add \$2, or \$5 by AIR; Foreign \$5, or \$10 AIR; in Calif. add \$2.70 tax).

If you already have a scientific calculator, you can invest in the guidebook, *CALCULATOR CALCULUS*; for only U.S. \$19.95 (to USA or foreign: add \$1 for shipping, or \$4 by AIR; in Calif. add \$1.20 tax).

As pennywise Ben Franklin said, "An investment in knowledge pays the best dividends." GET STARTED NOW — Tax deductible for professionals.

MONEY-BACK GUARANTEE! Send for it today. Be sure to give me your complete mailing address with your check or money order. If you want to charge it (Visa or MC), tell me your card no. and exp. date. Prompt

shipment guaranteed.

Thank you!
EduCALC Publications, Dept. D-4
27953 Cabot Road, Laguna Niguel, CA 92677
For fast service, phone MC or VISA orders
TOLL FREE to (800) 633-2252, Ext. 340.

MAKE MORE MONEY



TRAIN FOR ELECTRONICS

You say you're *already* trained in electronics but that you're *not* making enough money??? Well then, maybe you don't have an accredited bachelor's degree to prove that your education is *up to snuff!* Check out the Grantham Independent-Study B. S. Degree Program. It could make a *dollars and sense* difference in your electronics career.

Grantham offers this program, complete but without laboratory, to electronics technicians whose objectives are to upgrade their level of technical employment. Since the field of electronics is so enormous, opportunity for advancement is always present. Promotions and natural turnover make desirable positions available to the man who is ready to *move up*.

Grantham College of Engineering
10570 Humbolt Street
Los Alamitos, California, 90720

Do You REALLY Want to Make More Money?

Yes it does take *work* and a few sacrifices to climb up the electronics ladder to where the bigger money is. But, if that's where you want to be, then that's what you must do — *work* harder at learning and getting the right credentials, even if it takes a few sacrifices. A *B. S. degree* and the knowledge that rightly goes along with it can give you powerful ladder-climbing equipment in your search for *success in electronics*.

The accredited Grantham non-traditional B.S. Degree Program is intended for mature, fully-employed workers who want to upgrade their electronics careers.

Put Professional Knowledge and a COLLEGE DEGREE in your Electronics Career through Independent Home Study

Study materials, carefully written by the Grantham College staff for independent study at home, are supplied by the College. Your technical questions related to these materials and the lesson tests are promptly answered by the Grantham home-study teaching staff.

Recognition and Quality Assurance

Grantham College of Engineering is accredited by the Accrediting Commission of the National Home Study Council, as a degree-granting institution.

All lessons and other study materials, as well as communications between the college and students, are in the English language. However, we have students in many foreign countries; about 80% of our students live in the United States of America.

This booklet FREE!

This free booklet explains the Grantham B.S. Degree Program, offered by independent study to those who work in electronics.

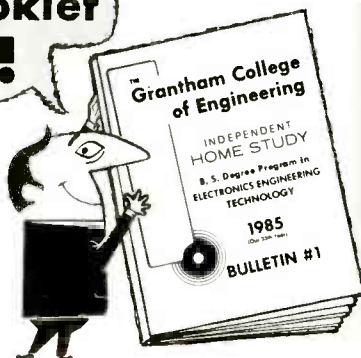

for **FREE Booklet CLIP COUPON** and mail in envelope or paste on postal card.

Grantham College of Engineering R-5-85
 10570 Humbolt Street, Los Alamitos, CA 90720

Please mail me your free catalog which explains your B.S. Degree independent-study program.

Name _____ Age _____

Address _____

City _____ State _____ Zip _____

BUILD THIS

Computer-Controlled ROBOT ARM

You can experiment with computer-controlled robotics without a lot of cash and without most of the mechanical headaches that usually accompany robot construction.

JIMMY BANAS

ROBOTS NO LONGER EXIST ONLY IN SCIENCE FICTION—they're quickly becoming a part of everyday life. Robots are being used to manufacture cars, assemble electronic circuits, and even to build other robots! They are also helping to eliminate the need for humans to do tasks in dangerous chemical or radioactive environments.

Robots like the ones we mentioned above usually cost thousands of dollars. But you don't have to

spend that much if you want to get started experimenting with robots. And you can avoid a lot of the headaches with mechanical construction that robots usually bring to mind.

We'll show you how to add computer control to a commercial toy robot-arm—the *Armatron*. There's a big advantage to not building the robot from scratch: You can avoid the problems of getting parts, and many of the mechanical

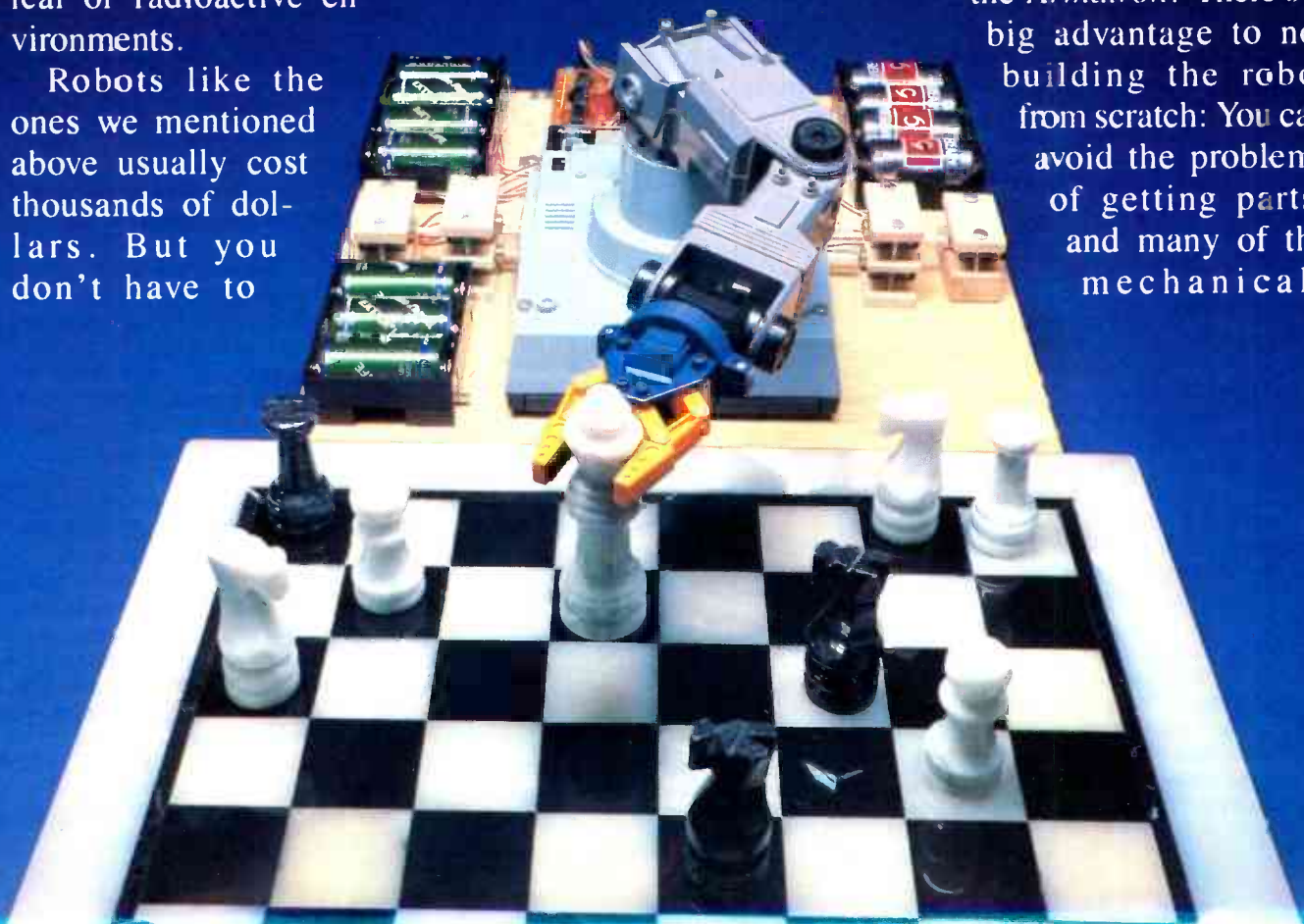

problems that usually accompany robot construction and experimenting. That's not to say there's no mechanical work involved—you will have to modify the *Armatron*. But the work is nothing like what you'd have to do to build a robot from scratch.

What is a robot?

Even though humans have dreamed about robots for centuries, the word "robot" is a relatively new one. It was first used in Karel Capek's 1923 play *R. U. R.* (Rossum's Universal Robots) and means "slave worker."

Early attempts at making robots were mechanical endeavors only. The results were basically dolls that looked human but ones that could perform special functions (like writing or playing music) based on a mechanical design of levers and gears.

The advent of the computer and electronic components brought robots the capability to perform much more sophisticated tasks. Some robots can "see" and others can make decisions about their actions. Even so, today's robots—although complicated machines—can perform only relatively simple tasks like pick-and-place operations. It's expected that someday—but not in the very near future—robots will perform much like those made famous in *Star Wars*. Rest assured that we won't be giving our robot that much power. But if you are interested in such endeavors, and make your robot more "intelligent," then we'd like to hear about it.

Robots used in industry are usually defined as programmed manipulators that automatically perform useful work. They can move in different ways: the *anthropomorphic-type* closely simulates the movement of a human through six degrees of freedom—with motions similar to those of the waist, shoulder, elbow, wrist, and fingers. A computer is generally used to command the robot to move to the desired positions.

The Armatron

For an investment of about \$32, you can be the owner of a robot that is capable of the same maneuvers as industrial robots costing many thousands of dollars. Tomy Toy Company copied the design of industrial robots and built their *Armatron* robot arm. Radio Shack (Tandy) bought the exclusive rights to it. Of course, the *Armatron* robot arm doesn't have the accuracy and repeatability of industrial robots. But we don't think that it's a toy, either.

As purchased, the *Armatron* is controlled by two mechanical joysticks. By pushing the joysticks forward or back and left or right you can rotate the entire arm about its base, raise and lower the arm, bend the elbow, and raise and lower the wrist. By rotating the joysticks you can

rotate the wrist and open and close the gripper.

A single motor powers all six joints of the *Armatron* through a cleverly designed planetary gearing system. The joysticks actuate levers that engage gears, giving forward, neutral, and reverse operations for each joint. Despite the clever design, we will remove and discard the joysticks, planetary gearing system, and the motor. We will replace them with six computer-controlled motors that will power the six joints.

The computer/robot system

Figure 1 shows a block diagram of the computer-controlled robot arm. Any computer that has at least a 4-bit output port can be used for control—the author used a Commodore *VIC-20*. Although the programming examples we'll discuss were written for that computer, they can be easily altered to run on other computers.

A 4-to-16 line decoder is used to decode the 4 bits from the computer port into 16 output lines. We need only 12 of the lines—there are six motors, and each needs a forward and a reverse control line. That means that you have 4 lines left over for your own experimentation. How about using those extra lines to control a movable platform?

The twelve outputs of the decoder interface with six motor-controller switches. Figure 2 shows one of those circuits, which are basically transistor switches that turn the motors off or on in either direction.

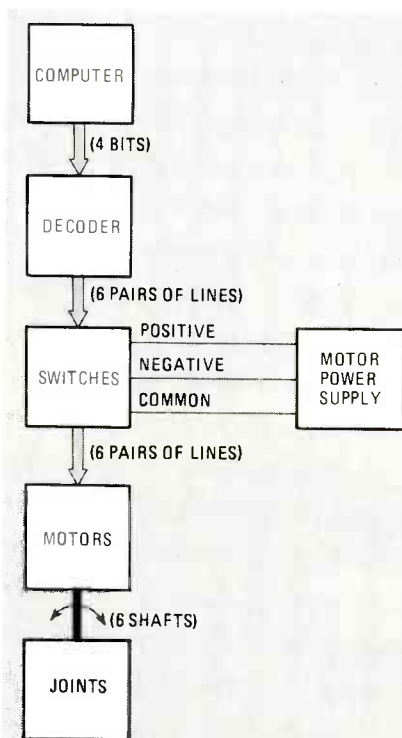

FIG. 1—THE COMPUTER/ROBOT SYSTEM. This block diagram shows us the basic components that make up our computer-controlled robot.

Small DC motors were selected to control the *Armatron* joints because they proved most practical. The motors are inexpensive, small, and don't require large amounts of power. They are also easy to work with. By POKE-ing a number from 1 to 12 to the output port we can drive any of the six joints either forward or reverse. We'll get to the details on that shortly. But now that we have a basic idea of how the system works, let's look at the mechanical interface in detail.

The mechanical interface

The hardest part of converting the *Armatron* into a computer-controlled robot is making the mechanical modifications. But as long as you're careful, you really shouldn't have any problems. The first thing we'll do is remove the existing joystick mechanism, the planetary gearing system, and the motor drive so that our motors can control the arm.

To start, remove the seven screws from the bottom of the *Armatron* and carefully separate the arm and top cover from the bottom tray. Figure 3 shows what you should see. Discard all components on the gear cover except the ring gears, which interface to the arm.

When you remove the gear cover (it's held on by five screws), you will expose the motor, the joystick parts, and the gears that interface with the ring gears. Remove the three screws that hold on the joystick cover. At this point, you can discard the joystick cover and all the joystick components. But do not throw any of the gears away. Next clip the wires at the ends of the battery holder. After you've done that, you should be left with the base and the planetary gears as shown in Figs. 4 and 5.

The bearing blocks

After all unnecessary parts have been removed, you have to make preparations to interface control motors to the *Armatron* gears. The motors will be mounted outside of the *Armatron* case, so shafts have to be brought out from the gears to the motors. Those shafts are supported by two bearing blocks.

Each bearing block has three holes drilled through it to support three shafts. Each bearing block also has three vertical slots that hold gears that engage with *Armatron* gears.

A bearing block, along with its associated shafts and gears, is shown in Fig. 6 prior to installation in the *Armatron*. Figure 7 shows the dimensions of the bearing blocks. The author arrived at the design by trial and error; the dimensions are fairly critical and should be followed closely.

The bearing blocks can be made from a variety of materials. The author's were made from maple wood. But you can use any material that's easy to drill and cut and yet hard enough for accurate dimensioning. Wood is probably the least ex-

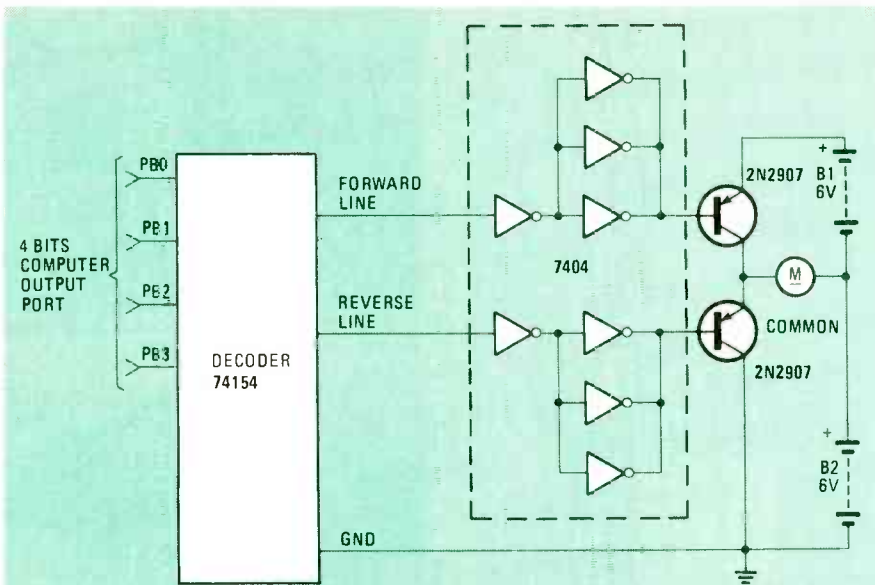

FIG. 2—MOTOR-CONTROLLER CIRCUIT. To control all of the *Armatron's* joints, you will need six motors. Even so, you will still have 4 unused outputs from the 74154 decoder.

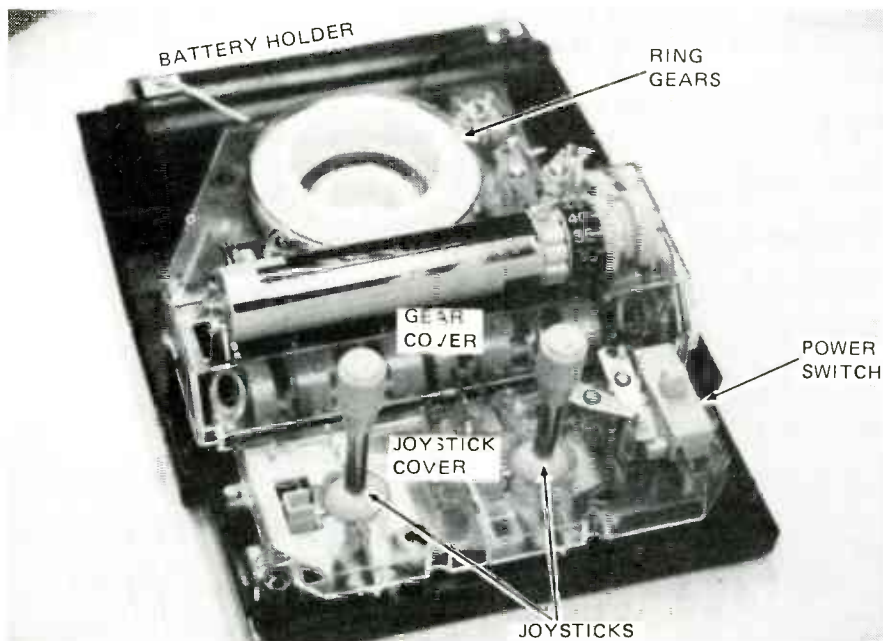

FIG. 3—WHEN YOU REMOVE THE COVER and the arm, you should be left with what is shown here.

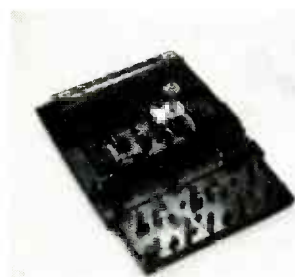

FIG. 4—THE BASE AND GEAR COVER are what are left when the mechanical joystick components are removed.



FIG. 5—THE PLANETARY GEARING SYSTEM. Don't throw this out! You'll need six $\frac{3}{8}$ -inch gears from the system.

pensive way to go. For example, the author purchased a $2 \times 2 \times 24$ -inch piece of raw stock maple for about \$3 at his local lumber store. A table saw was used to cut the slots; a #29 drill bit was used to

drill the holes for the shafts.

Shafts and Gears

Six shafts are needed to transfer power from the motors to the gears. Those shafts

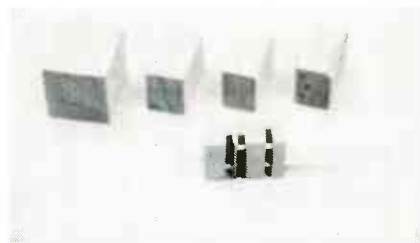

FIG. 6—A COMPLETED BEARING BLOCK with shafts and gears is shown in the foreground. The background shows the progression of fabrication steps.

must connect with the short motor shaft and must fit tightly through the gear that will interface to an arm gear. After much experimentation it was found that plastic rods, found at a local hobby store, made the best shafts. One of the key advantages of plastic rods is that they can bend slightly without breaking. That means that, even if everything is not in precise alignment, they will still work and they won't bind. The rods, with nominal outside diameter of $\frac{1}{8}$ inch, have a hole down the middle that allows them to be easily press-fit onto the motor shafts. The lengths of the shafts, as shown in Fig. 8, are determined by the arrangement of the motors next to the *Armatron*. You may want to make yours longer or shorter. For clean cuts on the plastic shafts, use a small tubing cutter.

The gears that fit on the shafts and interface with the *Armatron* gears were obtained from the planetary gearing system that you removed earlier (Fig. 5). The ability to use these gears is an advantage because they are already sized to mesh with the other gears. The $\frac{3}{8}$ -inch diameter gears must be removed from the planetary gearing system. You will have to modify the gears slightly by redrilling the center hole to a size just under the diameter of the shaft so that the gear can be press-fit tightly onto the shaft. For best results, use a series of drills of increasing diameter up to $\frac{1}{8}$ inch so that you won't offset the hole from the center of the gear as you drill.

The next step is to assemble the shafts and gears in the bearing blocks. The longest shaft belongs in the middle hole and is press fit into a gear in the deepest bearing block slit; the top shaft is press fit into a gear in the middle, shallow slit and the bottom shaft is press fit into a gear in the remaining shallow slit.

Motors and mounting blocks

Each of the six joints is powered by an individual small DC motor. Small motors are necessary because the shafts exiting the *Armatron* must be spaced close together—otherwise they will not be able to fit the bearing-block gears.

To hold the motors, we need five mounting blocks on each side of the *Armatron*. Figure 9 shows the dimensions for the mounting blocks. Use those di-

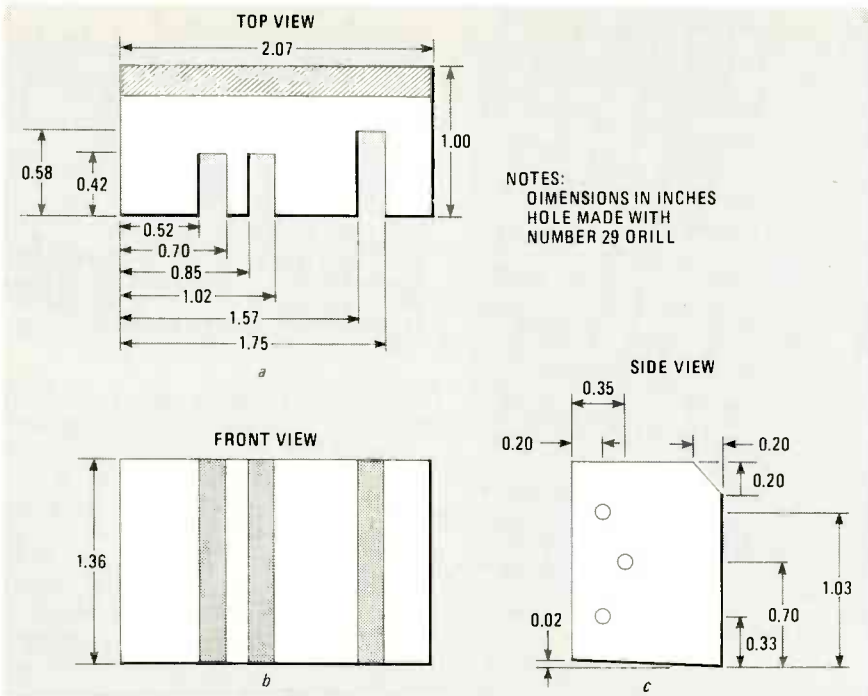

FIG. 7—BEARING BLOCK DIMENSIONS must be followed closely. The dimensions shown are in inches. All holes are made with a #29 drill.

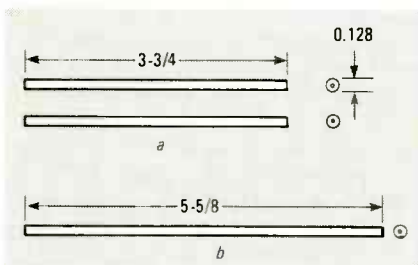

FIG. 8—SHAFT DIMENSIONS. Two sets of three shafts are required.

(The same material used in the bearing blocks can be used in the mounting blocks.) The spacer block is sanded until the width is just slightly thicker than the diameter of the shaft.

Final mechanical modifications

The *Armatron* must be modified to accommodate the bearing blocks and shafts. Figure 11 shows the right side of the *Armatron* with modifications to the base and ring gear cover/holder. A slot must also be

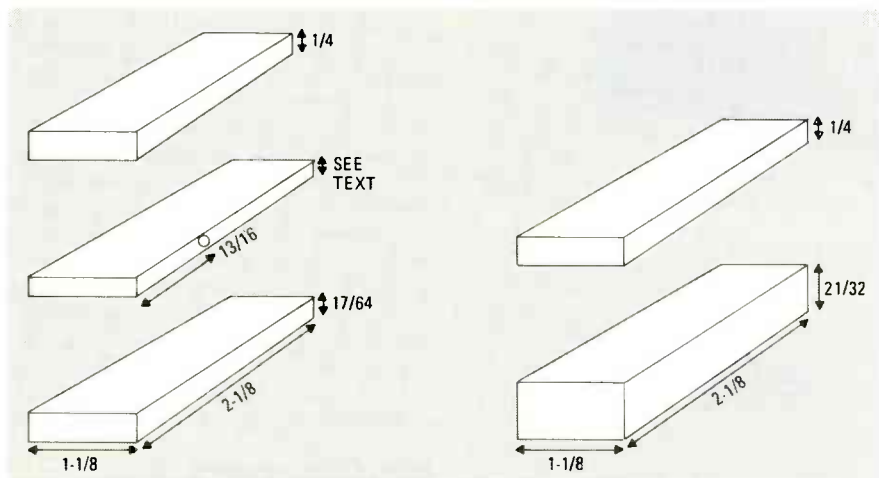

FIG. 9—MOTOR-MOUNTING BLOCK DIMENSIONS. The dimensions shown are for the author's system. You may have to change the dimensions to fit your motors.

dimensions only as a guide—you may have to change your dimensions to fit the motors that you use. The critical block is the spacer between the two motors closest to the *Armatron* (see Fig. 10). That spacer block is made by first drilling a hole using a #29 drill bit through a piece of wood.

cut in each side of the outer cover so that the shafts can protrude. A thin hacksaw blade and file can be used to cut away the plastic to make the modifications.

Final assembly of the mechanical components starts with mounting the bearing blocks in the base. Place each bearing



FIG. 10—THE MOTOR-MOUNTING BLOCKS on the right side of the *Armatron*.



FIG. 11—YOU WILL HAVE TO MODIFY the base and gear cover to accommodate the shafts.

block in the base and match drill two holes; use 1/2-inch self-tapping screws to secure the bearing blocks to the base. Replace the gear cover with the original screws. Assemble the outer cover and the arm to the base with the original screws. Attach the *Armatron* to a 1/2 × 12 1/2 × 12 1/2-inch plywood base with four 3/4-inch screws located in the four corners of the *Armatron*. Mount the two motors on each side closest to the *Armatron*. The motors are press fit into the plastic shafts. Finally, mount the third motor on each side of the *Armatron*. To hold down the mounting blocks, use 2/4-inch screws. Do not overtighten the mounting blocks: when operated, final adjustments to the motor positions can be done to achieve proper alignment. You may want to use paper spacers under the bottom mounting blocks so that the motors turn freely.

The electronic interface

Now that the mechanical modifications are complete, we can turn to the easy part: the electronic interface.

Figure 12 shows the complete schematic of the circuit that's required to interface the motors to a computer. As we mentioned earlier, we need 12 control lines to drive the six motors. In other words, two lines—one for forward control and one for reverse—are required for each of the six motors.

Your computer must have at least a 4-bit output port to operate the interface. Those four lines are fed to IC5, a 74154 4-to-16 line decoder. That decoder takes an input and selects one of sixteen lines as an output. (That output depends on the value of the 4-bit word. (If you are familiar with binary numbers, you'll realize that there are 16 possible combinations of 4 bits. The selected output line is driven low,

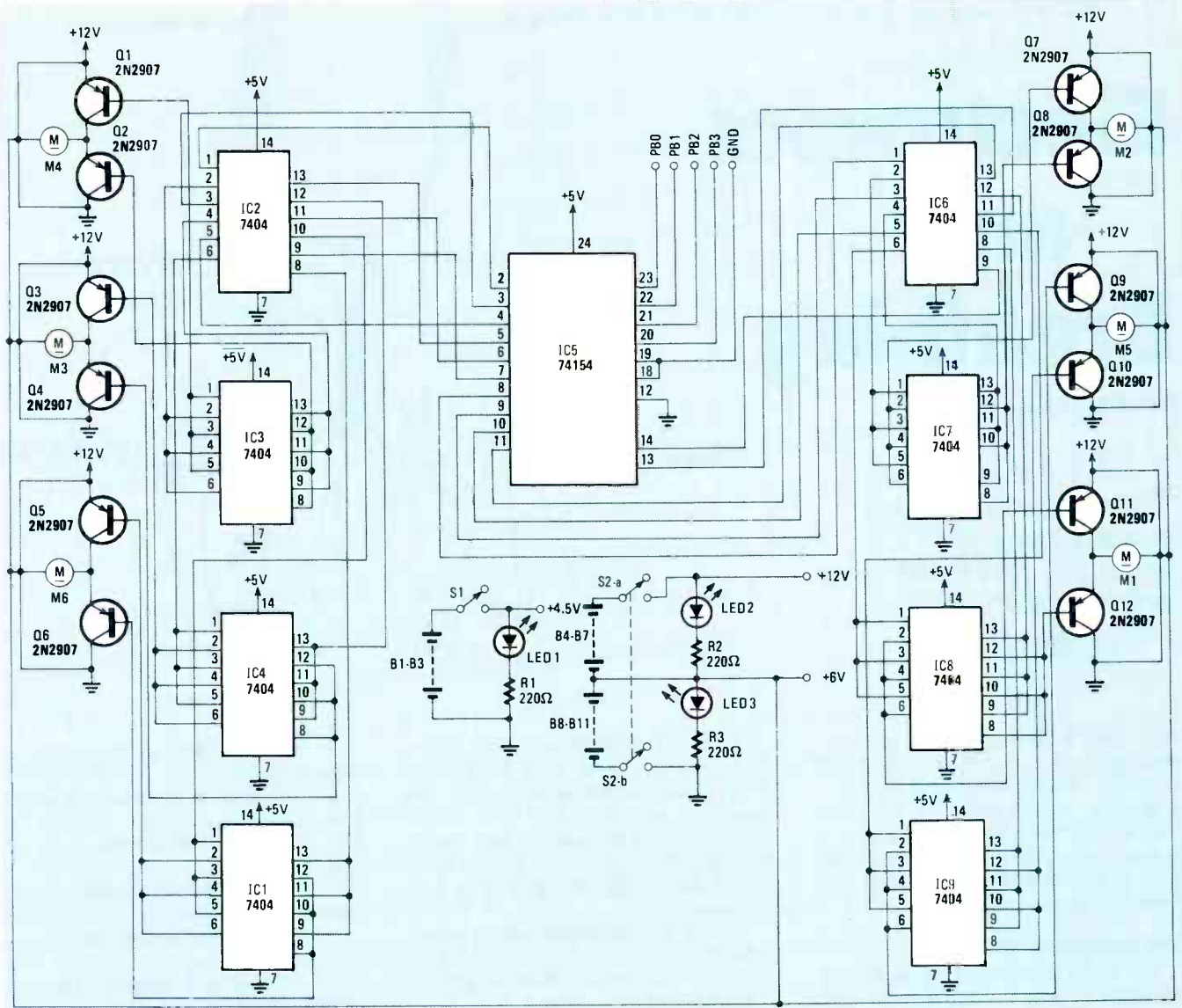

FIG. 12—THE COMPLETE SCHEMATIC of the electronic interface. Note that two lines are required to control each motor. One will cause the motor to go forward, the other will cause it to go in reverse. Motors M1–M3 correspond to the bottom, top, & center of the right side; M4–M6 correspond to the top, bottom, & center of the left side.

while the other 15 lines remain at a high logic level.

Each output line is first connected to a single 7404 inverter and then to three 7404 inverters arranged in parallel. That not only boosts the output current to sufficient levels, it also returns the control signal back to its original logic level. The inverter outputs are fed to the bases of 2N2907 transistors, which act as simple switches and determine the direction of the flow of current through the motor.

For example, if the forward line is low and reverse line is high, then the forward transistor conducts turning the motor in the forward direction. If both inputs are high then neither transistor conducts and the motor remains off. Note that if somehow both lines go low the entire loop is connected putting 12 volts across the two transistors. That will quickly burn them out. Fortunately, using a decoder like the

74154 should prevent that from ever happening.

Two separate switches are used to turn the power supplies on and off. Three LED's are used to show that the power is on. During system operation the switch for the electronic circuit should be turned on before the switch for the motor controllers to insure that the transistors are properly biased. Similarly the switch for the electronic circuit supply should be turned off last.

Circuit layout and final assembly

Circuit layout is not critical and you should feel free to use the construction technique you're most comfortable with. The author's circuit, shown in Fig. 13, was built using a pre-drilled "universal PC board."

A 1³/₂₄ pin card-edge connector was used to interface the electronic circuit

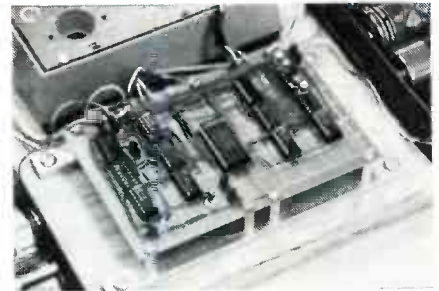

FIG. 13—THE COMPLETED INTERFACE. Universal PC boards were used. Note how the transistors are mounted in IC sockets.

with the VIC-20 computer. Of course, the connector you use will depend on the computer you use.

Three separate battery packs, using D-cells, are used for power supplies. Two 6-volt supplies are used for powering the motors; a 4.5-volt supply is used for the integrated circuits.

continued on page 117

Electronics and Breathing

RAY FISH, Ph.D., M.D.

A look at breathing, and the role electronics plays in making sure that someone's next breath isn't their last!

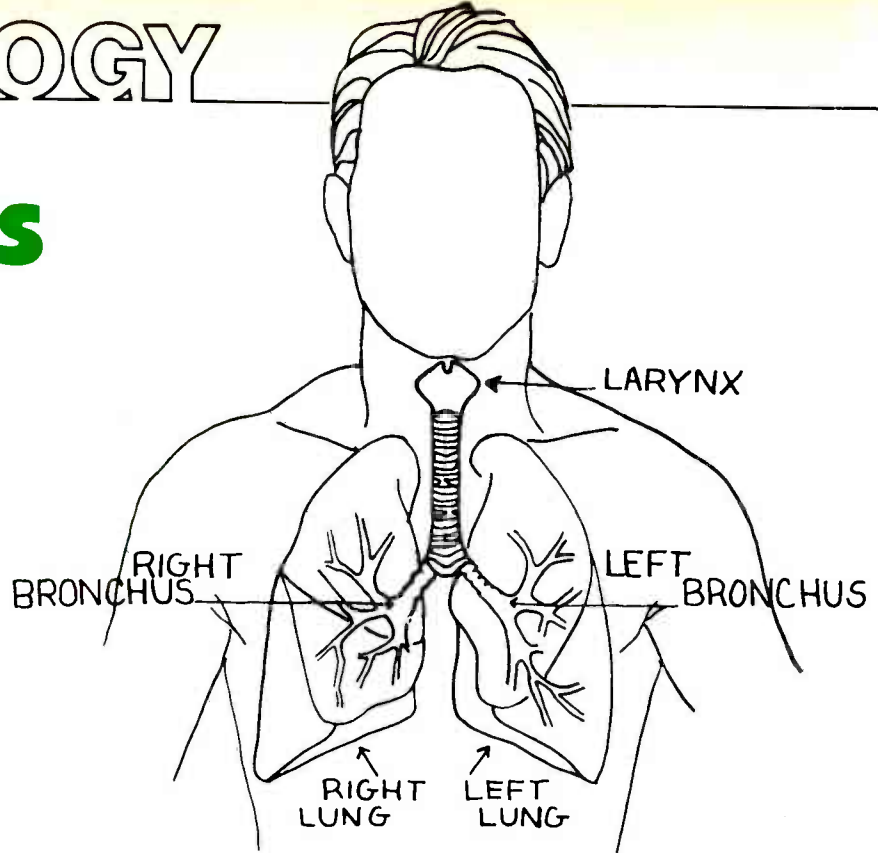

THIS MONTH, OUR LOOK AT MEDICAL electronics will focus on the act of breathing, which is otherwise known as respiration. In particular, we'll look at how the *respiratory* system works, what it is made up of, and the role electronics plays in making sure that everything continues to function properly.

The respiratory system

The end result of breathing is delivery of oxygen to body tissues. The same process is also used to remove carbon dioxide from the body. A "block diagram" of the respiratory system is shown in Fig. 1.

One of the main functions of blood is to carry oxygen to, and remove waste products (such as carbon dioxide) from all of the cells in the body. Blood that has circulated through the body has given up much

of its oxygen and has an excess of carbon dioxide. That blood goes through the lungs where carbon dioxide leaves the blood and oxygen is added to the blood. The circulation then carries the blood to the body where the oxygen is given to the tissues and carbon dioxide is taken from the tissues.

Carbon dioxide and oxygen enter and leave the circulatory system through thin-walled blood vessels called capillaries. Capillaries are one cell thick. In the body, the arteries branch repeatedly until the capillaries are reached. At that level, oxygen and carbon dioxide (as well as nutrients and other chemicals) can diffuse across the walls of the blood vessels quickly enough to be of use to the tissues. The capillaries join to form veins, which return blood to the heart.

In the lungs, there are two systems of branching: the airway and the blood vessels. Air comes in the nose and mouth, goes through the trachea, and then into the lungs. The large airways going into each lung are called bronchi (see Fig. 2). Those divide into two smaller branches repeatedly, giving smaller and smaller airways. The smallest airways, the result of about 20 branchings, are roundish structures called alveoli. There are about 150 million alveoli in each lung, each being 75 to 300 microns in diameter (one million microns equal one meter). The total surface area of the lungs is about 70 square meters.

Some of the medium sized airways are surrounded by muscular walls that can contract to make the airway smaller. Mucous glands in the walls of the airways provide mucus secretions that can catch foreign particles and debris. Cells with moving hair-like projections, called cilia, wave the mucus toward the mouth to carry the foreign particles out.

Ever wonder why cigarette smokers seem to cough a lot? It is because cigarette smoke paralyzes the cilia. It is then up to the cough mechanism to bring up the mucus, and any debris that it has caught. Cigarette smoke also increases mucous production and ties up 5% to 10% of the oxygen carrying capacity of the blood with carbon monoxide.

Blood to be oxygenated comes from the heart through the pulmonary arteries. In each lung, those arteries divide repeatedly down to the capillary level. Those capill-

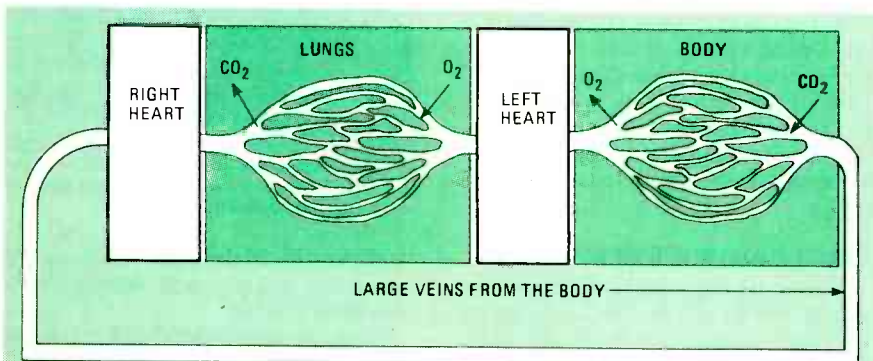

FIG. 1—"BLOCK DIAGRAM" of the respiratory system. Oxygenated blood from the lungs is pumped through the body. In the body, oxygen is removed from the blood and carbon dioxide is picked up. Blood is then pumped back to the lungs, where the carbon dioxide is removed and oxygen is picked up. The process is then repeated.

aries line the walls of the alveoli. Thus the blood stream is carried within one cell thickness of the air in the lungs (about 0.1 micron). Air in the lungs can then diffuse into the blood stream, while carbon dioxide can diffuse out of the blood stream into the lungs.

Although you can consciously control the rate and depth of breathing, it is usually an automatic function. The brain controls breathing in such a way as to maintain the carbon dioxide content of the blood at normal levels. Actually, centers in the brain sense the acidity (pH) of the cerebrospinal fluid. That acidity depends on the carbon dioxide content of the blood. (Rapid or deep breathing will decrease the carbon dioxide content of the blood; shallow breathing will increase it.)

Some diseases and conditions cause the blood to be acidic. Those include kidney failure, diabetic ketoacidosis, and aspirin overdose. Individuals suffering from those conditions are said to be suffering from a metabolic acidosis and will be breathing rapidly or deeply. That's because the brain senses the abnormal acid level and causes the respiratory system to compensate with the rapid or deep breathing.

While it is sensitive to changes in carbon-dioxide levels, the normal respiratory control system is relatively insensitive to oxygen levels. But in persons who have chronic lung disease, the normal carbon-dioxide level cannot be maintained, and the body learns to ignore the higher car-

bon-dioxide levels that result. Instead, those persons do have their breathing controlled by the content (partial pressure) of oxygen in their blood. If given a high concentration of oxygen, their breathing will slow, the carbon dioxide level will rise so high as to change the blood pH and affect brain and heart function, and they may die. Those persons are called carbon-dioxide retainers and are recognized by the elevated partial pressure of carbon dioxide in their arterial blood gases.

Arterial blood gases

When blood is exposed to air in the alveoli, various gases diffuse into and out of the blood. The partial pressures of carbon dioxide and oxygen, which are measured in millimeters of mercury (mmHg), in the blood will depend on the concentrations of oxygen and carbon dioxide in the lungs. Those concentrations depend on the composition of the inhaled air and also upon gases released into or taken up from the lung by the alveoli. Gas exchange in the lung will decrease the oxygen content and increase the carbon dioxide content of air in the lung. Breathing very rapidly or deeply will lead to more oxygen and less carbon dioxide in the lungs and therefore in the blood.

Electrodes can be placed in samples of blood to determine the blood gases. An electrode may simply consist of a wire. More commonly, an electrode consists of a wire placed in a solution-filled thin-walled container or membrane. The mem-

brane allows the passage of certain molecules or ions.

When a wire is placed in a solution, a voltage will develop between the wire and solution. The voltage depends on the types of metal in the wire and the types and concentrations of ions in the solution surrounding the wire.

Indicating electrodes develop voltages in response to the presence of a certain compound or ion. Electrodes have been developed that indicate the concentration of hydrogen ions; such hydrogen ion-sensitive electrodes can be used to measure pH.

As we said previously, changes in the carbon-dioxide content of blood will change the pH of blood. Therefore, if a pH-indicating electrode is surrounded by a membrane that allows only carbon dioxide to pass, the pH-indicating electrode will become a carbon-dioxide indicating electrode.

There are several types of oxygen-indicating electrodes. Small assemblies containing all the electrodes needed to measure pH, carbon dioxide, and oxygen have also been built.

Monitoring respiration

Carbon dioxide strongly absorbs infrared light with a wavelength of 4.26 micrometers. Use has been made of that fact to build respiration monitors that measure the efficiency of the breathing process. Such monitors place a sample of the exhaled breath between an infrared light source and detector (see Fig. 3). Light filters are used as shown so that only the absorption of light by carbon dioxide is monitored.

The model shown in Fig. 3 is a simplified one. Depending on components used and system design, the temperature of the sensor, detector, and gas analyzed may need to be controlled or taken into account if any readings taken are to be useful. In addition, the barometric pressure and the presence of other gases can affect readings and need to be accounted for.

When a person depending on a machine gets insufficient oxygen, the results are sometimes disastrous. Therefore, the oxygen concentration in inhaled gases is often monitored when a person breathes gases from a respirator or other machine. An alarm will sound if there is inadequate oxygen in the inhaled gases. Such problems arise when the wrong tanks are connected to a respirator or anesthesia machine, the tank runs out, a line is cut, or a valve malfunctions. Many precautions are taken to prevent such problems, and the number of accidents is relatively small. Nevertheless, monitoring the inhaled oxygen concentration can indicate when something is wrong.

Sometimes measuring the concentration of oxygen being pumped to the

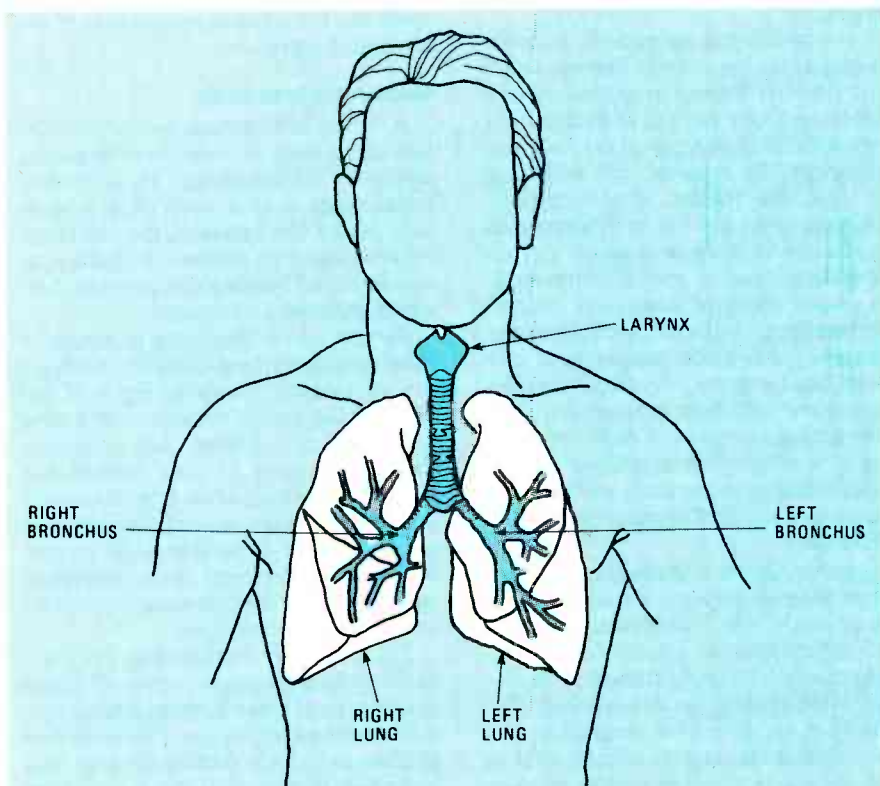

FIG. 2—FROM THE NOSE AND MOUTH, air passes into the trachea. The trachea branches off into large airways, called the left and right bronchus, which in turn enter the lungs.

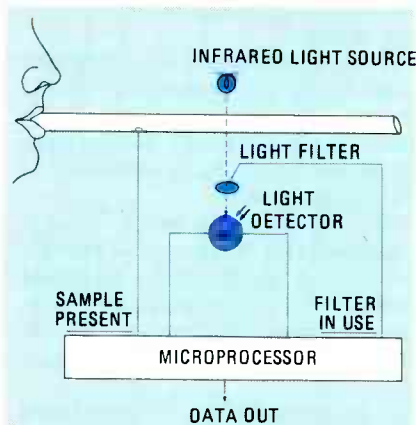

FIG. 3—CARBON DIOXIDE strongly absorbs infrared light. That fact has been used to make exhaled carbon-dioxide monitors similar to the one shown here.

patient may not be adequate. That may occur, for instance, if tubing to the patient is kinked so that the oxygen does not get to the patient. Another possibility is that the tubing may accidentally be placed into the esophagus (the pathway which carries food from the mouth to the stomach) instead of the trachea. Pumping air into the esophagus may or may not distend the stomach. If it does, the chest will move a little with air movement into the stomach, which may appear similar to the movement caused by normal breathing. In addition, the sounds heard when listening to the "lungs" with a stethoscope will instead be caused by air moving through the esophagus; the sound produced will be very similar to that produced by normal breathing.

Thus, it is not always obvious when oxygen is not getting to a person. If the person is unconscious, anesthetized, or

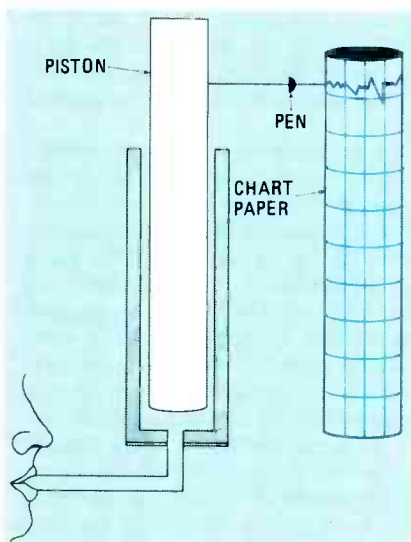

FIG. 4—BREATHING EFFICIENCY can be measured by a device called a spirometer. The model upon which almost all spirometers are based is shown here.

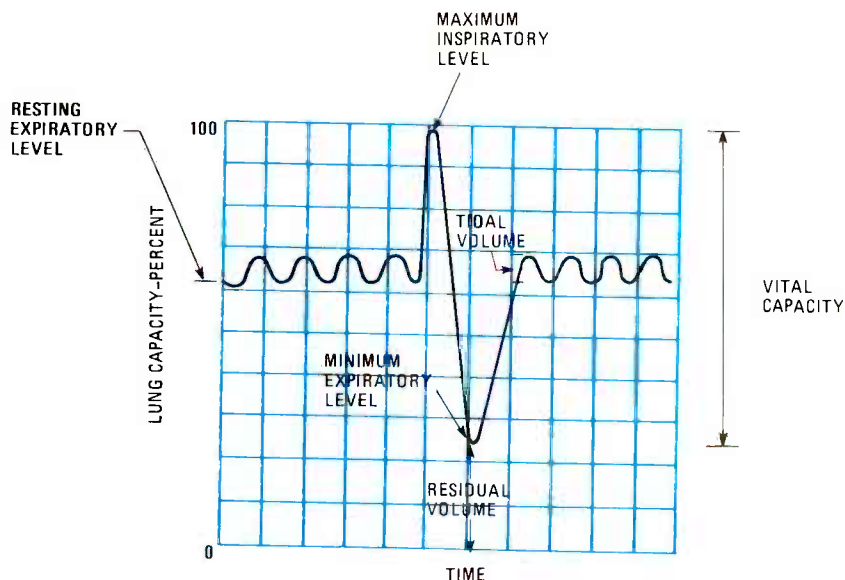

FIG. 5—THE OUTPUT produced by a simple spirometer. Note the parameters shown; today's computerized instruments can provide even more detailed measurements.

an infant, the problem may not surface until brain damage occurs.

Because of those problems, it would be desirable to continuously measure blood oxygen content in persons receiving oxygen via a machine. The normal procedure of testing blood gases is not fast enough for that. Drawing a blood sample often takes 5 minutes, and it is another 5 or 10 minutes before the sample can be analyzed. Brain damage occurs in 5 minutes or less when a person does not receive oxygen.

It is possible to continuously measure the blood oxygen content through intact skin (that is called *transcutaneous monitoring*). One method of doing that is to shine light through part of the body, say the earlobe, for instance, and analyzing the light that results. That technique makes use of the fact that well oxygenated blood varies in color from poorly oxygenated blood (blue vs. red). Unfortunately, the results obtained using that method may be affected by factors such as earlobe thickness, skin color, temperature, and other gases present. Practical earlobe "oximeters" take light transmission measurements at as many as 8 different wavelengths in order to calculate blood oxygen content. Those instruments are thus expensive and not used as commonly as one would like.

Another approach to continuous transcutaneous monitoring is via an electrode placed on the skin. In addition to oxygen and carbon dioxide sensors, skin electrodes contain a heating element. The element is used to heat the skin to about 43°C (109°F) to improve local circulation and gas exchange between the circulatory system and the skin surface. From the skin surface, gases from the blood further diffuse across an artificial membrane into the

electrode and are then analyzed.

The measurements obtained at the skin surface are not as accurate as those obtained by taking blood samples. The electrodes must be kept clean and firmly attached to the skin. Calibration every few hours is commonly needed. However, repeatedly taking blood samples is undesirable, especially in very young children. Commercially available instruments can provide analog and digital readouts of oxygen and carbon dioxide levels that are accurate enough to be of use in clinical applications.

Measuring breathing

A variety of electronic and/or mechanical instruments are used to evaluate the efficiency of breathing. Those instruments range in complexity from a handheld device that measures the maximum air flow velocity a person can produce, to computerized systems that measure dozens of different parameters.

But the device that is the prototype of most respiratory measurement systems is the spirometer, shown in Fig. 4. Conceptually, a person breathes via a tube connected to a piston. Air movement causes the piston to move upward and downward, causing a line to be drawn on a strip chart recorder or similar device. Figure 5 shows an output that might be produced by a spirometer. Some important parameters that are commonly measured are indicated in that figure.

The spirometer shown in Fig. 5 is, once again, only a prototype. More advanced systems, most notably computerized systems, are used in practice. Computerized systems commonly provide the user with a printout of the graph and a list of the measured parameters. One commercially

continued from page 118



**DICK SMITH ELECTRONICS
IS PROUD TO BE IN AMERICA**



G'DAY FROM DOWN UNDER

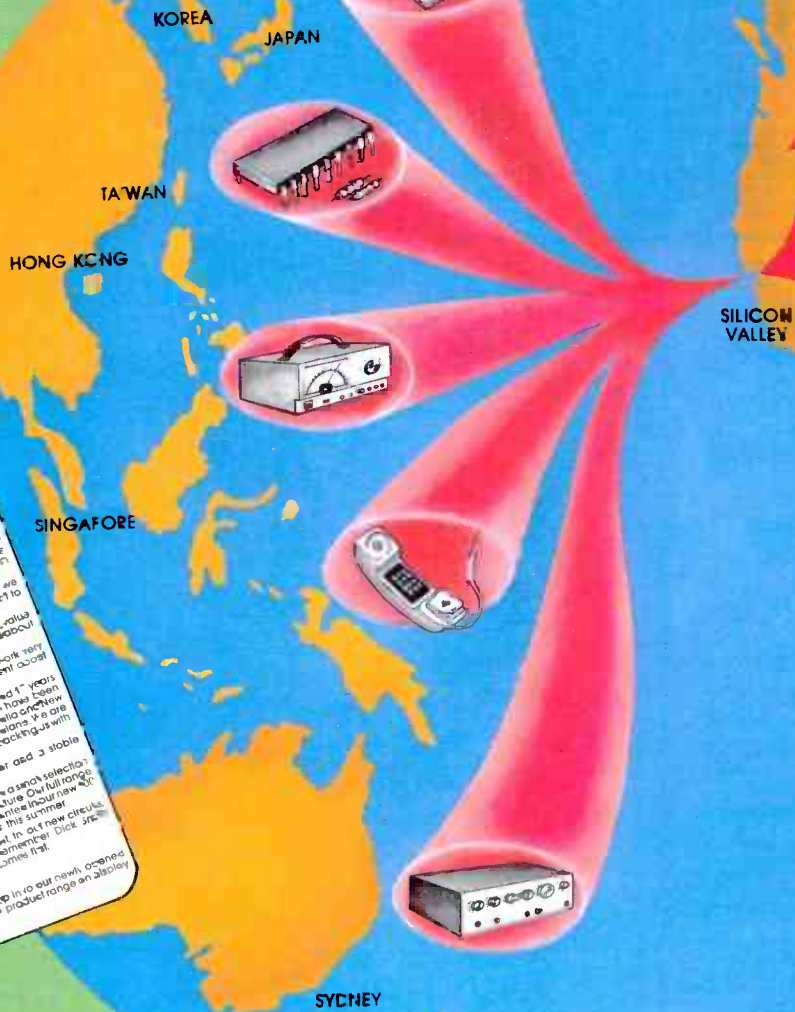

Dear Electronic Enthusiast

We're really excited about occupying our business in Silicon Valley, USA. We hope you'll be too. We, Americans, have always felt close to Americans, but we wondered how you would respond to us when we arrived. Well, frankly your views on the item are your own. We do care out what we're doing here, but we're not here to sell our goods. We're here to offer American electronics to you. We don't have a good job of selling our goods, but we're doing our best. We don't have a good job of selling our goods, but we're doing our best. We don't have a good job of selling our goods, but we're doing our best.

Now you may be wondering what our advantage is being close to all those open spaces in the world. We don't have a good job of selling our goods, but we're doing our best. We don't have a good job of selling our goods, but we're doing our best. We don't have a good job of selling our goods, but we're doing our best.

Although we can't claim to know a great deal about your market, we believe we can provide you with a great deal of information about our products. We don't have a good job of selling our goods, but we're doing our best. We don't have a good job of selling our goods, but we're doing our best. We don't have a good job of selling our goods, but we're doing our best.

The Electronics Enthusiast

If you can shop in person, why not drop in to our new, opened showroom in Redwood City and see the full product range on display. We'd like to meet you.



BRINGS YOU THE BEST OF BOTH WORLDS IN ELECTRONICS

Multimeter with audible continuity tester



Cat Q-1022

\$1995

A compact, reliable multimeter with an added bonus: a built-in buzzer for continuity testing! Also has a battery checker PLUS 10A DC range - not normally found on low-priced multimeters! On top of this, you get a high sensitivity (20,000 ohms per volt) meter mirrored scale and large banana plugs for sure contact.

- Diode and fuse protection
 - 19 ranges plus dB
 - Built-in battery checker plus continuity checker
- David L. Walker, W9 6270
- Ranges:
DCV: 2.5, 10, 50, 250, 1000
ACV: 10, 50, 250, 1000
DC (mA): 5, 50, 500 & 10A
RES: x1, x10, x1k
Batt: 1.5V, 9V
Continuity

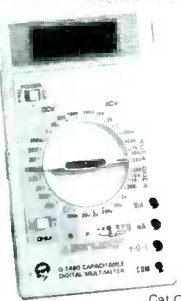

Cat Q-1460

A quality LCD Multimeter that measures capacitance as well!

VERY HIGH ACCURACY! **\$9995**

RANGES:
DCV: .2, 2, 20, 200, 1kV @ 0.25% 1 digit
ACV: .2, 2, 20, 200, 750V @ 0.75% 2 digit
DC: 200mA, 2mA, 20mA, 200mA, 10A
RES: 200, 2k, 20k, 200k, 2M, 20M ohms
COND: 2us, 200us
CAP: 2nF, 20nF, 200nF, 2uF, 20uF,
LCD TEST: 1mA, - 2.8V

Complete with Test Leads, carry case and full instruction manual.

Yes! It not only features the normal ranges found on a digital multimeter, it also has five ranges of capacitance checking, two ranges of conductance AND a diode check position! All this in a very accurate (less than 0.25% on DCV) and high impedance (10Mohm) instrument that is good enough for the designer's test bench, but has a low enough price for the hobbyist. All this plus overload protection, automatic polarity, 2.5cm LCD digits - and measurement to 10A AC & DC.

Power/SWR Meter

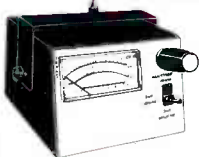

TRULY GREAT!

Now a meter which not only has the usual power and SWR measurements - it also has a built-in field strength measurement function enabling you to make accurate and precise antenna radiation pattern and other RF energy measurements. Fitted with standard SO-239 sockets for easy connection to your CB or low power amateur rig, it can be left permanently in the antenna line to warn you of any problems before they start cooking output transistors.

Q-1350

- Field strength graduation: 1-10
- Measuring power: 10W full scale
- Frequency response: 27MHz (CB band)
- SWR indication: 1.0 - 3.0 and above
- Impedance: 50 ohms

A great buy at **\$1995**

Multimeter Accessories! PROBES & LEADS

16 Piece Universal Meter Lead Sets

This set has everything you'll need for your multimeter. You get a pair of red and black test leads with screw-in connectors on each end. Into these you screw any of the 14 adaptor probes and plugs: 4 x 4mm plugs, 2 x 1.5mm plugs, 2 long probes, 2 spade lugs & 4 insulated alligator clips. As you can see, it is suitable for any meter, and it is truly versatile. High quality - than other sets on the market. Cat W-4526

\$995

Logic Probe

A superb time-saving tool for the hobbyist, technician, engineer etc. This outstanding logic probe hooks onto the circuit under test for its power (5V or 12V), and you can tell at a glance what the logic level is by which of the three LEDs is glowing. It is easily held in one hand - so your other hand is left free! Cat Q-1272

- \$1895**
- Features:
- Adjustable threshold for DT/LTL or CMOS circuits
 - Two modes of operation: pulse (with time stretching so you don't miss quick pulses) and mem (holds display until cancelled).
 - Low circuit loading (approx 30uA input)
 - Tested to 12.6MHz

Signal Injector \$995

One of the handiest devices to have in your tool box. Check out both audio and RF circuits (harmonics extend to many MHz) simply and easily. Often the quickest method of fault finding (and one of the cheapest!) Cat Q-1270



Self contained, with probe and earth clip

REMEMBER - YOU'LL BE SERVED BY AN ELECTRONIC ENTHUSIAST AT DICK SMITH ELECTRONICS



AMATEURS



Cat Q-1340

super value! \$8995

Incredibly popular with the keen amateur. Uses Directional Coupler and Through Line principles for minimum loss, covers 3 to 200MHz (guaranteed) and suits both 50 & 75 ohm lines. Each instrument is individually calibrated and comes with calibration chart. PL259 Connections.

Oskerblock SWR200 SWR/Power Meter

Specifications:

| BAND | SWR METER (MAX. PWR) | POWER METER (MAX. SCALE) |
|-------|----------------------|--------------------------|
| 80 | 100W | 200/2kW |
| 40 | 50W | 200/2kW |
| 20 | 15W | 20/200/2kW |
| 15/10 | 5W | 20/200/2kW |
| 6/2 | 1W | 2/20/200W |

Size: 220 x 76 x 110 (mm) © H. McNulty ID 83707

Mini Multimeter

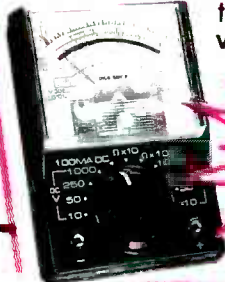

top value!

RANGES:
AC & DC Volts: 10, 50, 250 & 1000
DC Current: 0.5, 1.00mA
Resistance: x1k (4.28k centre scale)

A great little multimeter for anyone starting out in electronics... or for anyone who is likely to knock their multimeter around a lot and cannot justify the higher price/higher spec meters. For less than \$8 you get an 11 range, 2000 ohm/volt pocket size meter that's ideal for most of the general purpose test work we all do - power points and light sockets in the home, work on the car, basic circuit testing etc. It's rugged, reliable.

WILL BE \$12.95 Opening Special \$7.95

- 2000 ohms per volt
 - 11 ranges
 - Very simple to operate
- Cat Q-1010

Case to suit will be \$2.95
Opening special \$1.95
Cat Q-1011

Standard Range Panel Meters

A high quality range of moving coil meters, with full scale accuracy better than 2%. Pre-calibrated in 5 popular varieties, easily adapted to suit virtually any requirement with shunts and multipliers. The scale area is covered in clear perspex, with the remainder of the meter body matte black. All the meters have a fine needle for optimum accuracy in reading, and all have mechanical zero adjustment. Mounting is by four bolts (mounted on meter body) with nuts and washers supplied.

Dimensions: Mounting: Hole Required - 44mm
Scale area - 58 x 31mm Bolt holes: 38mm square
Overall - 58 x 52mm

Great Values **795 ea** (10 or more \$8.95 ea)

| | | | | |
|------------------|--------------------|------------------------|----------------------|------------|
| 0-1mA (200 ohms) | 0-50uA (3500 ohms) | 0-5A (0.03 ohms shunt) | 0-20V DC (1k ohms/V) | (0 to 20A) |
| Cat Q-2010 | Cat Q-2020 | Cat Q-2030 | Cat Q-2040 | Cat Q-2035 |

Multimeter & Logic Tester

Virtually two instruments in one! With built-in Logic Tester! Built-in LEDs give instant recognition of 'HIGH', 'LOW' and 'PULSE' states of logic circuits. 18 voltage, current and resistance ranges, with 20K ohm sensitivity DC and 8K ohm VAC. Shielded movement is unaffected by external magnetic fields. The ideal serviceman's multimeter!

Richard Campbell TX 78010

super - low price **\$2495**

- Built-in Logic Tester
 - 20 Ranges
 - Diode & Fuse Protection
- Ranges:
DVC: 3, 3, 12, 60, 300, 1200
ACV: 6, 30, 120, 300, 1200
DC: .06, 3, 30, 300mA
RES: x1, x10, x1k, x10k

Cat Q-1026

FANTASTIC ENTHUSIAST PRICE

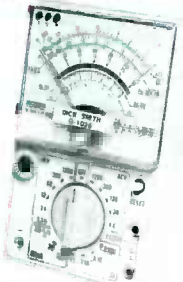

TESTCLIPS & JUMPERS

Alligator Clips - Mini

Fully insulated with plastic shroud, easy to solder to; two colours available.
RED Cat W-4550
BLACK Cat W-4552 **10c** each

Coiled Test Leads Self Retracting

You know the problem of meter leads cluttering up the bench? It won't happen with these leads. They're coiled and return to their coiled shape after being extended. A red & black pair with 1.5mm meter plugs. Cat W-4520 **\$350**

IC Test Clips

Similar to the popular E-Z hooks, but cheaper. Ideal for working with small components, easy to solder to.
RED Cat W-4580 **70c** each
BLACK Cat W-4582

Alligator Clips - Large

With red or black insulated grips, each
RED Cat W-4554 **12c**
BLACK Cat W-4556

IC Jumper Lead Set

A pair of matching red & black leads, one metre long, with matching IC test clip at each end. Cat W-4572 **GREAT VALUE! \$495**

Jumper Lead Set

Makes breadboarding easy! 10 380mm leads, with alligator clips each end. 5 different colours for easy identification. Cat W-4570 **\$200**

1.5mm Plug Test Lead Sets

As supplied with most multimeters (and which are always getting lost!) 90cm long red and black lead with 1.5mm plugs and long insulated probes. Cat W-4504 **\$200**

4mm Plug Test Lead Sets

As above but with 4mm banana plugs to suit large diameter multimeter sockets. Cat W-4508 **\$250**

16 Pin IC Test Clip

Makes connection of DIL IC easy - without the danger of shorting out pins. Use on 8, 14 or 16 pin IC's. Often used as part of a test jig for production testing or service work. Spring loaded. Cat W-4600 **\$495**

One of the most useful devices!

BUY NOW AND SAVE!

The Saga of the Electronic Wizz's and why they came to America

(see LEARN TO SPEAK STRINE Page 12)

A fair while ago, a young Aussie bloke called Dick Smith went to work for a radio repair company in Sydney. Dick had been dead keen on radio and electronics since he built his first crystal set at the age of eight years so he was a natural for the job.

Being a very dynamic bloke, Dick soon started his own car and two way radio repair business. That was in 1968 and fair dinkum, there are still cab drivers in Sydney who remember him fixing their radios.

But, by crickey, Dick soon found that electronic parts were hard to get so he had a Captain Cook around for his own suppliers. He found some bonza products and thought to himself, "stone the crows! I might be able to make a quid flogging this stuff myself." So he opened a small component store alongside the car radio business. Hobbyists flocked to it and it became an overnight success.

continues next page

LOOK FOR OUR GIANT SUMMER CATALOG IN JUNE

MEET ELAMI JR.,

DICK SMITH ELECTRONICS IS PROUD TO BE THE FIRST TO BRING YOU 'ELAMI' - THE WORLD'S FIRST EDUCATIONAL ELECTRONIC FRIEND.

AN UNBELIEVABLY LOW PRICE TO PAY FOR THE ULTIMATE IN TECHNOLOGY

ONLY \$149.00

Car Y-200 0

ELAMI will be a friend to you and your children as well as being a wonderful educational help for your children.

With speech, mechanical arms and hands, infrared sensors

The latest in "EDUTAINMENT" (Educational Entertainment)

Size: Height 12" Base 7.6"

Processor: 8 bit microcomputer, custom designed, built-in 2K ROM and 1/2K of RAM for storing and operating of programs, plus 16K of ROM and 1/2K of ROM, for speech processor, and 190 word english vocabulary.

Features: - Elami Jr. has tactile sensors around its base, when bumped, it turns 90° left and then continues his program.
- LCD face with back-lighting: blue eyes, red mouth, 4 expressions: happy, sleepy, angry, sad, and talking expressions.
- LED antenna
- Front panel, with 16 LED display, lights
- Talking Keyboard Function: Elami Jr. speaks the command to be performed, with 25 touch keys.
- Speaker, on and off switch, charger pin
- Mobility in 2 speed - forward, backward, left, right, left curve and right curve.

Speech: Standard 190 word english vocabulary, with programmable words and sentences and 'ELAMI JR.' speaks each command as he performs it.

I.D. Card Each Elami has his individual computerized security code and I.D. Card.

Motors: Two 6V Mabuchi heavy duty carbon brush motors with noise suppressor.

Batteries: Four AA size and four C size 1.5V batteries not included.

COME OUT OF THE CABBAGE PATCH

Now you can have a real friend that will walk with you and talk with you. ELAMI Jr.

We have rushed this shipment by airfreight at enormous expense so that you can have the chance to be one of the first people in the world with your very own ELAMI Jr. The first time ELAMI Jr. smiles at you, you'll leave the cabbage patch for ever and the only thing you'll have to worry about is ELAMI Jr. being jealous at your dog or cat!

When first you turn me on, I will say "Please Enter My Code" with a sleepy expression. I have my very own individual computerized I.D. card with serial number, date of creation and security code which must be entered to wake me up. Once you enter my code correctly, I wake up with a smile saying "Good Morning Master, Can I Help You?" 2 minutes after my program is finished I will ask you to "Please Turn Me Off" with an angry expression.

I can be happy, sad, angry, sleepy. I can walk perfectly straight even on thick carpet.

I do hope we can be friends for a long time.

Come into Dick Smith Electronics and see me or place your order now so that we can soon become friends for a long time

Your friend,
ELAMI

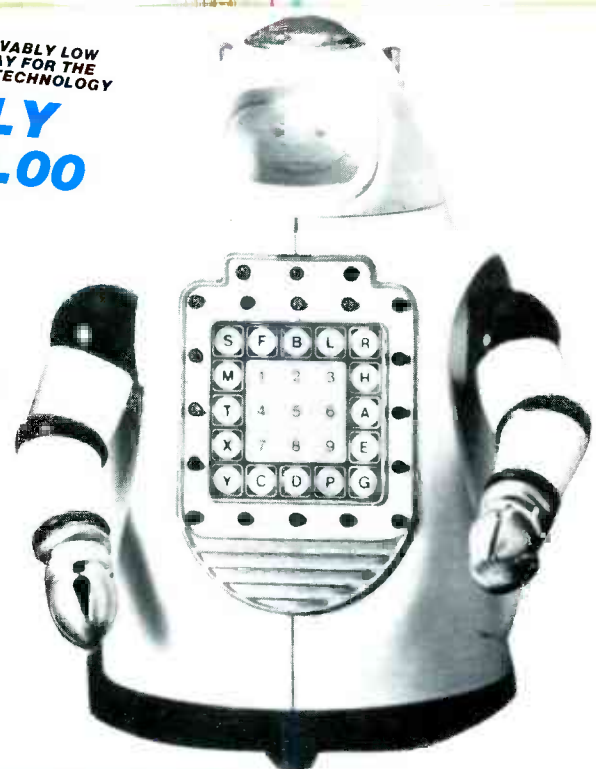

WHY ELAMI WAS CREATED

ELAMI was designed by Uwe Meffert for the RE Institute which is part of the Resources and Energy Foundation. This is a non-profit organisation of world famous scientists whose objectives include the solution of such world-wide problems as starvation and lack of education.

Profits from the sale of ELAMI by the RE Institute will go towards furthering the very worthwhile objectives of the R.E. Foundation. So you see, ELAMI is not only the most advanced educational electronic robot of its type - ELAMI has a serious job to do in helping the world to be a better place to live for more people.

JUST IMAGINE!

YOUR VERY OWN INTELLIGENT ROBOT THAT WILL TALK TO YOU, CARRY OUT YOUR COMMANDS WILLINGLY AND WITH A SMILE.

BE QUICK - WE ONLY HAVE A LIMITED STOCK AND ELAMI IS ONLY MADE IN LIMITED PRODUCTION SO HURRY TO AVOID DISAPPOINTMENT.

SCHOOLS RESELLERS

ASK ABOUT OUR WHOLESALE PRICES ON THE FANTASTIC ELAMI

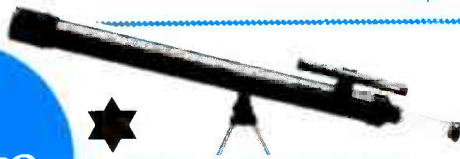

REFRACTOR TELESCOPE

40 x 40mm in TASCO Radiant Red. Features a removable 3-way 8x finderscope which converts to an 8x telescope or 30x pocket microscope. Easy push/pull focusing. Includes a 15" tabletop tripod.

Cat Y-0520

RECOMMENDED RETAIL \$31.95

OUR PRICE \$24.95

tasco®



Cat Y-0525

ZOOM REFRACTOR

90 x 60mm in Tasco Radiant Red. Resolves to 2.5 seconds. Rack and pinion focusing, alt-azimuth mount with adjustable 30" to 54" all metal tripod.

RECOMMENDED RETAIL \$199.95

OUR PRICE \$149.00

HIGH POWER STAND MAGNIFIERS

2 1/2" Double-glass lens, stamp/coin viewer. Excellent for inspecting hairline cracks on your PCB's

Cat Y-0500

\$6.50

\$2 OFF THIS MAGNIFYING GLASS FOR ANY CUSTOMER WHO HAS DIFFICULTY READING THIS MINI-CATALOG.

YES! We know the type is very small but you see there was this uncontrollable urge to cram in as many products as possible so that you could see more of our fantastic range and benefit from our low prices.

SHORT TUBE CATADIOPTRIC REFLECTOR

200x 3" MIRROR (30x, 60x, 100x, 200x)

in Tasco Radiant Red. Modified English fork equatorial mount, interchangeable lenses, 600mm focal length, moon filter, 5x right angle finderscope, photo adapter tube, tabletop tripod with rubber feet.

Cat Y-0530

RECOMMENDED RETAIL \$369.95

OUR PRICE \$249.00



Cat Y-0515

\$89.95

COMPACT BINOCULARS

This top-grade model is small, lightweight and super streamlined... but has all the power and visual capabilities of first-rate, full-sized binoculars! Fully coated and includes case and straps. 8x (21 mm)

FREE, with each pair of binoculars these sophisticated designer glasses with high fashion accents in silver.

Polarized, quality lenses and vinyl case.

Recommended retail \$19.95

YOURS FREE WITH PURCHASE!

IS IT A BIRD? IS IT A PLANE? IS IT...? NO - IT'S HALLEY'S COMET

Now is the time to buy your telescope so that you will be familiar with the stars by the time Halley's Comet begins to come into view later this year. TASCO are well known for their very high quality optical products and we are very pleased to be able to offer you this selection of their range at

WELL BELOW REGULAR RETAIL PRICES



WIZZ SAGA (Cont.) ...

Stuck for an advertising theme, Dick's advertising agent racked his brains for a while and then said, "No River Murrrays, they reckon he's a wizzard so a wizz he'll be - The Electronic Wizz!" And that's how the saga of the Electronic Wizz's got going.

Just to stir up a bit of interest, Dick got hold of a petrol powered pogo stick and pogoed across the Sydney Harbour Bridge. Bloomin' heck! The rozzers weren't too pleased but the papers cottoned on and Dick was away.

The business grew like blazes and Dick's ads got crazier each week. He even ran an ad with no words but the biggedy-piggeldy letters used for mark-up. It pulled like a beauty! Mobs of people turned up to see what he was selling and found it so good that they stayed on - many became mates of Dick's and some of them still work for Dick Smith Electronics.

The company has always attracted oied-in-the-wool electronic enthusiasts.

continues next page



MAIL ORDER CENTER AND SHOWROOM LOCATED AT 390 CONVENTION WAY REDWOOD CITY CA 94063

CIRCLE 255 ON FREE INFORMATION CARD

www.americanradiohistory.com

LUCKY NAMES

You could win \$20.00 off the value of your first order if your name is in this Mini-Catalog. We have stripped in a name from each state of the Union, selected at random, from a list of Radio-Electronics Subscribers. If your name, state and zip appears the \$20.00 will be deducted from the value of your first order.

LOOK CAREFULLY - THE NAMES ARE IN VERY SMALL TYPE

BONUS! We'll throw in a free Ozzie Survival Bag!

ENERGY SAVING LIGHT BULBS

Reduce the shock of your next electricity bill - install energy saving light bulbs throughout your home and be amazed by the huge savings you will make!

You can help save the earth's dwindling energy supplies too - by using ENERGY SAVING LIGHT BULBS.

- Huge range of sizes available - the larger the watt rating the more energy you save.
- Pre-blow to save your time
- Guaranteed never to use electrical energy.

| Sizes and Savings | |
|-------------------|---|
| Cat S-9999 | 60 watt \$49.50 Proven Saver |
| Cat S-9991 | 80 watt \$69.50 You'll notice the savings as soon as you turn it on. |
| Cat S-9992 | 100 watt \$79.50 Most popular saver |
| Cat S-9993 | 200 watt \$89.50 A real savings boost. You'll save this cost over and over. |

Cat S-9994 400 watt \$99.50 The big bucks saver
Just think! For less than \$100 you can save 400 watt hours - every hour.

You may not believe these savings so we suggest you try our pre-blow light bulb you have in the house for your next billing period to test the results.

Giant Handbook of Electrical Circuits

Raymond A Collins-880 pages
Giant isn't the word: it's a whopping 880 pages! With 60 chapters covering everything from crystal sets to computer circuitry, you're sure to find what you want here!

Cat B-1780 Opening Special \$14.95

RECTIFIER DIODES

| Type No. | Cat No. | Price Ea. | PIV 10up | IF mA | USE |
|----------|---------|-----------|----------|-------|-------------------|
| IN4004 | Z-3204 | 10 | 08 | 400 | 1 General Purpose |
| IN4007 | Z-3207 | 13 | 10 | 1000 | 1 General Purpose |

1 WATT Zener diodes Cat Z-3575/63 20c ea 10 up .15c ea.

4 1/2 digit 10mm Liquid Crystal Display Cat Z-4175. \$9.95 ea 10 up \$9.00 ea

3 1/2 digit LCD driver Cat Z-6300 \$9.95 ea 10 up \$9.00 ea

4N28 Optic Coupler - LED and photo diode in DIP package Cat Z-4804. 80c ea 10 up .70c ea

All semi's, prime spec, premium quality. You reap the benefit

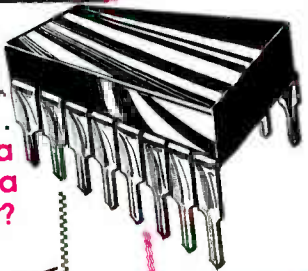

Psst... Wanna know a secret?



The Confidential Frequency List

Want to know the frequencies used by U.S. President in Air Force One? How about the Soviet Embassy in Dublin, Ireland? Or any of the 8,499 other stations spread right around the world... They're all here in this amazing book: legitimate and clandestine stations, armed forces, even spy networks... from 4000Hz right through to 27.998MHz. If you own a short wave receiver, this book is an absolute MUST!

Cat B-9602 low price \$13.95

WIZZ SAGA (Cont.)

Pretty soon Dick was on clover with several stores giving him a good living and he would have been happy to sit pat, but he didn't reckon on young Ike Bain, a ham operator who blew-in from Canada in 1972 and quickly developed a strong passion for opening more and more Dick Smith Electronics stores.

Ike was a real goer; thought up Dick's video, a 30 minute video taped, sort of camp fire yarn with Dick doing all the talking, but with facilities for feedback so that everyone in the company could get in their two-bob's worth about what products to sell and so on. That's just one of the clever things that Ike has done and he's such an enthusiast about electronics and the company, that he left the top job in Australia, not a cushy number, but comfortable; to cross the great Pacific lake and set up shop in the heart of Silicon Valley! Ike started out as a Cannuck but he's a true blue Aussie citizen now.

continues next page

At last! 'No leak' Rechargeable

12V 2.6Ah Gel Cell



GRAND OPENING SPECIAL

1.2Ah from \$6.95
2.6Ah from \$12.95

Now there's no need to mess around with motorcycle batteries, etc for your burglar alarms, emergency supplies, etc. This superb new edition to our range gives you all the advantages of conventional lead-acid batteries without the fuss. Rated at 12 volts and 2.6Ah, it is intended for 'trickle charge' circuits where it is always kept topped up for use.

Gel Cells are supplied with Data Sheets packed with technical information.

Cat S-3315 12V 1.2Ah Reg \$9.95 Special \$7.95 10 up \$6.95

Cat S-3320 12V 2.6Ah Reg \$17.95 Special \$13.95 10 up \$12.95

LED! 2 LED SPECIALS

| Type No. | Colour | Size | Cat No. | Price ea | 10 up | if (mA) | v _f @ 20ma | Intensity @ 20ma |
|----------|--------|-----------|---------|----------|-------|---------|-----------------------|------------------|
| TL4211 | Red | 3mm | Z-4077 | 20c | 15c | 40 | 2.1 | 3.5Cd |
| TL4231 | Green | 3mm | Z-4079 | 25c | 20c | 40 | 2.1 | 5.0Cd |
| TL4251 | Yellow | 3mm | Z-4081 | 30c | 25c | 40 | 2.1 | 7.0Cd |
| TL4291 | Orange | 3mm | Z-4083 | 30c | 25c | 40 | 2.1 | 4.0Cd |
| TL4213 | Red | 5mm | Z-4087 | 22c | 18c | 40 | 2.1 | 6.0Cd |
| TL4233 | Green | 5mm | Z-4089 | 30c | 25c | 40 | 2.1 | 9.0Cd |
| TL4253 | Yellow | 5mm | Z-4091 | 30c | 25c | 40 | 2.1 | 1.2mCd |
| TL4293 | Orange | 5mm | Z-4093 | 30c | 25c | 40 | 2.1 | 1.2mCd |
| TL3215S | Red | 2mm x 5mm | Z-4095 | 30c | 25c | 40 | 2.1 | |
| TL3235S | Green | 2mm x 5mm | Z-4095 | 30c | 25c | 40 | 2.1 | |

The semi's listed here are only a tiny fraction of our huge range - please enquire about types and prices.

LINEAR IC'S

| Type No. | Cat No. | Description | Price Ea | 10 up |
|----------|---------|-----------------|----------|-------|
| TL555CP | Z-6144 | CMOS timer | .70 | .60 |
| NE/DS555 | Z-6145 | Universal timer | .35 | .30 |
| NE556 | Z-6146 | Dual timer | .80 | .70 |

General purpose linear operational amp uA741

Cat Z-6382 40c ea 10 up .35c ea

DYNAMIC RAMS (memory chips)

| Type No. | Description | Cat No. | Price ea | 10 up |
|----------|---------------------|---------|----------|-------|
| 4116 | 16K x 1 dynamic RAM | Z-9310 | 1.00 | .90 |
| 4164 | 64K x 1 dynamic RAM | Z-9312 | 7.95 | 6.95 |

1,000's SOLD!

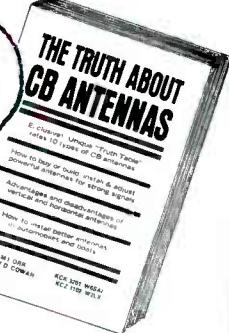

Truth About CB Antennas \$8.95

Orr and Cowan - 240 pages
Now, for the first time, a handbook exposes the false antenna claims and enables CBers to determine true power gain of the 10 most popular antennas. With this book you can buy or build, install and adjust for the strongest signals.
Cat B-2327

Magazine File



\$3.95

A magazine binder, ideal for any magazines that cover 12 issues in one year. Hard spine with metal rods for placement of the magazines. Vinyl covering with place to write on the spine. Maximum size of magazine insertions is 11" high by 8" wide.
Cat B-4045

12V DC MOTORS

Grab 'em while they last!

These little beauties are used in car cassette players so they are robust and spin freely. They have plenty of torque so you can use them for all sorts of projects.

The 3 flanges on most of the motors makes it extremely easy for mounting. EVEN IF YOU DON'T USE THEM NOW AT THIS PRICE YOU'D BE CRAZY NOT TO GET A FEW AND STOW 'EM! But be quick. Stocks not expected to last long at this rock bottom price.

WOW! IT'S AMAZING... BUT TRUE!



PRICE ON THIS SCOOP PURCHASE ONLY \$1.00... LIMITED STOCK ONLY 1,000 PIECES AVAILABLE

made for DICK SMITH by "Delwoc"

SORRY - Still being modified for the U.S.A.



WATCH FOR THE EXCLUSIVE HEATED TOILET SEAT IN OUR ADVERTISEMENTS - EXCLUSIVE TO DICK SMITH ELECTRONICS INC.

Home Satellite Television

Is home satellite TV a practical alternative to the network's offerings? Can you set up a personal Earth Station? What about equipment, cost and just about anything else? The answers to these and many other questions you may have on home satellite TV are included in this outstanding new sourcebook.
Cat B-1840 \$13.50

Would you like to work with us?

Dick Smith Electronics is expanding in America and we're on the lookout for good people who would like to help us to grow.
If you're an electronics enthusiast you already have one of the major qualifications we're looking for! If you think you'd enjoy working for Dick Smith Electronics, why not drop us a line, telling us about yourself. Vacancies will be occurring in just about all areas so we could be able to offer you employment!
People who start now may be our future managers and there will also be opportunities for overseas travel.
Write to: The Personnel Manager, Dick Smith Electronics, PO Box 2249 Redwood City CA 94063

Our Redwood City Distribution centre means you get your order faster

© Copyright 1985

All rights reserved. The entire contents of this catalog are copyright, and no copy, illustration, photograph or diagram may be reproduced in whole or in part without the written permission of Dick Smith Electronics Inc.

PLACE YOUR ORDER NOW - PHONE (415) 368 1066

CIRCLE 255 ON FREE INFORMATION CARD

www.americanradiohistory.com



USEFUL INFORMATION TO HELP YOU DEAL WITH DICK SMITH ELECTRONICS

ORDER BY PHONE
To make ordering even easier we have installed a special 'Order-by-credit card' phone line. To place an order, ring us on

(415) 368 1066
(8.30 - 5.00pm Monday to Friday) and quote your credit card no. and street address. We'll have your order on its way.

MINIMUM ORDER VALUE
The minimum order amount is \$10.00 unless otherwise implied in Special Offers through advertisements.

INSURANCE
Customer may nominate insurance for their goods. Where this is not specified, the goods will be sent at the customers' - your - risk!

DAMAGED GOODS
All claims for damaged or missing goods must be filed with the carrier concerned - do not open parcels or suggest that the goods are damaged.

DESPATCH OF ORDERS

All goods in stock are despatched promptly. Goods out of stock are Back Ordered and sent later at our expense (and it's an extremely costly job) unless we advise otherwise. All back orders are despatched immediately we receive the goods from our suppliers. When we send a copy of the order back to you, the delay times will be quoted. At any time you have the option to receive a full refund on goods not supplied.

ENQUIRIES ON ORDERS

If you wish to enquire in any way about your order, please give FULL DETAILS. Give date of posting your order to us, your name, address and zip code, a list of the products ordered, any relevant mail or cash sale invoice numbers, if the above are not given, we have no way of checking your order.

PHONE ENQUIRIES ON ORDERS

You are welcome to enquire about your mail order by phoning. Simply ask for 'Mail Orders Enquiries'. When connected give the following information: your name, zip code and the information you require. You will then be asked to phone back in 15 minutes. You will appreciate, it may take us a little time to locate your order. Phoning back saves time and expense, especially with long distance calls.

CREDIT ACCOUNTS

We do not operate general credit accounts and we suggest that customers use their credit card whenever possible.

ORDER FORMS

To speed delivery we have pre-printed Order Forms. All orders on this form receive preferential treatment. Extra forms are available free of charge if requested and one is enclosed with each order despatched.

CATALOG NUMBERS

To minimise the chance of error in your order please quote the catalog number as well as a description of the product.

PRICES

If prices vary, the new price will be shown on your delivery advice and a debit/credit issued. You may return the goods for a full credit under our satisfaction guarantee, if you are not satisfied.

PAYMENTS

Checks to be sent with order. DO NOT SEND CASH through the post. Checks made payable to Dick Smith Electronics Inc.

CREDIT CARDS

For your convenience, we accept orders for mail orders on Visa or Mastercard. The minimum order value credit card purchase is \$10.00.

COMPUTER CONNECTORS

'D' TYPE PLUG
25 pin plug for RS-232C port and Sorcerer parallel port. P-2690

\$3.95
10 up \$3.45 ea

'D' TYPE SOCKET
25 pin socket for RS-232C port and Sorcerer parallel port. P-2691

\$4.75
10 up \$4.45 ea

BACKSHELL FOR P-2690, P-2691, P-2692

\$2.50
10 up \$2.30 ea

9 pin plug - solder tail
P-2684 \$1.25 10 up \$1.10 ea
9 pin jack - solder tail
P-2685 \$1.75 10 up \$1.60 ea
9 pin backshell hood
P-2686 90¢ 10 up 75¢ ea

IDC - NO SOLDERING

'D' TYPE 25 PIN 'D' PLUG \$5.49
Cat P-2693 10 up \$4.80 ea

25 PIN 'D' SOCKET \$5.95
Cat P-2694 10 up \$5.40 ea

'D' TYPE 36 WAY CENTRONICS CONNECTORS

57.30360 Plug Solder Tail with cover. P-2680 ~~\$2.95~~ 10 up **2.50** ea

57.40360 Socket Solder Tail P-2681 \$5.95 10 up \$5.50 ea

15 pin plug - solder tail P-2687 \$1.60 10 up \$1.45 ea
15 pin jack - solder tail P-2688 \$2.20 10 up \$2.00 ea
15 pin backshell hood P-2689 \$1.00 10 up 85¢ ea

RGB MONITOR PLUG
8 pin Cat P-2682 **\$9.95**

GRAND OPENING SPECIAL 10 of any combination **1/2 price BANANA SPECIAL WE GO BANANAS ON BANANAS**

★ ★ ★ ★ ★
2" PLUGS
RED P-1710
BLACK P-1712
YELLOW P-1714
GREEN P-1716
40¢ ea

SOCKET WITH BINDING POST
RED P-1730
BLACK P-1732
YELLOW P-1734
GREEN P-1736
50¢ ea

RESISTORS

All resistors are stocked in the E12 series (e values are 10, 12, 15, 18, 22, 27, 33, 39, 47, 56, 68, 82, 100 thru to maximum resistance indicated in each case on multiples x .01, x 0.1, x 100, x 1000 etc.)
NOTE: For 100 up price resistors must be of same type and value no mixes.
1/4W 5% Carbon film to 10 M ohm 5¢ ea 100 up 2¢ ea
1/4W 1% High tolerance metal film to 1M ohm 8¢ ea 100 up 6¢ ea
1/2 W 5% Carbon film to 10M ohm 5¢ ea 10 up 2¢ ea
1 W 5% Carbon Film to 10M ohm 10¢ ea 100 up 6¢ ea

All of our resistors are listed with a catalog number in our annual catalog but there is a no room here so please order by value and type for the present.

IC SOCKETS & PLUGS

Why endanger valuable IC's by soldering them directly into circuit? Take the safe approach: use an IC socket! It makes service and repair of your project much, much easier too. There's an IC socket to suit almost all common IC's.

8 Pin Mini DIL Socket 15¢ Cat P-4080 (10 up \$1.3¢)
14 Pin DIL Socket 16¢ Cat P-4140 (10 up \$1.4¢)
16 Pin DIL Socket 18¢ Cat P-4160 (10 up \$1.6¢)
18 Pin DIL Socket 25¢ Cat P-4180 (10 up \$2.3¢)
20 Pin DIL Socket 30¢ Cat P-4200 (10 up \$2.5¢)
22 Pin DIL Socket 31¢ Cat P-4220 (10 up \$2.6¢)
24 Pin DIL Socket 33¢ Cat P-4240 (10 up \$2.8¢)
28 Pin DIL Socket 40¢ Cat P-4245 (10 up \$3.5¢)
40 Pin DIL Socket 45¢ Cat P-4250 (10 up \$4.0¢)
14 Pin w/wrap DIL Skt 75¢ Cat P-4260 (10 up \$6.5¢)
16 Pin w/wrap Skt 79¢ Cat P-4262 (10 up \$6.5¢)
20 Pin w/wrap DIL Skt \$1.22 Cat P-4264 (10 up \$1.00)
24 Pin w/wrap DIL Skt \$1.50 Cat P-4268 (10 up \$1.40)

UHF

PL 259 coax line plug to connect antenna/ancillary equipment to rig P-2310
85¢ 10 up **80¢** ea

REDUCING ADAPTOR
No soldering required, use with PL 259 to give tight fit for 50 ohm co-ax Suit P-2310 (above) P-2360
30¢ 10 up **25¢** ea

PL 259 suits RG-58 coax without the need for a reducer P-2312
95¢ 10 up **90¢** ea

CO-TANGER CAR AERIAL

Had your car aerial ripped off, bent over, stolen or otherwise vandalized? Here's the answer!
FIRST TIME IN AMERICA!

Developed and produced in Australia after an incredible amount of complex and expensive research - the CO-TANGER AERIAL. As used by thousands of Australian car owners. Early models were based fairly closely on the old World War II Radio Direction Finding Loops (RDF) which are still found on DC-3's and Beech 18's. However, through years of development and individual experimentation, models are available which can be fine tuned to give you fantastic performance in your own area. The co-tanger can even be modified to suit the styling of your automobile or your own aesthetic tastes.

- Just look at these features:
- Suits any type, make, model or year of automobile or truck.
 - Tuneable to any radio station for peak listening performance.
 - Shape may be varied to suit your tastes or your car styling.
 - Bending through vandalism may even improve performance.
 - No one would be stupid enough to steal it.
 - We do not claim that it will increase the resale value of your auto.

FAIR DINKUM VALUE AT \$395.00
(or you can make your own from a spare coat hanger for nothing)

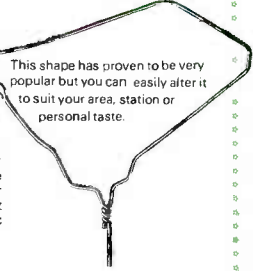

This shape has proven to be very popular but you can easily alter it to suit your area, station or personal taste.
Cut here and insert into broken aerial base.



Cat A-9999

Mini Project Board

80 x 60 x 8 mm one-piece board with 58 groups of 5 connected terminals, and 4 bus lines of 25 connected terminals.
All terminals are alpha-numerical coded so you can remember what you connect to what. Complete with self-adhesive pad so it won't slide around the table.
Cat P-4614
\$4.95
10 up **\$4.50** ea

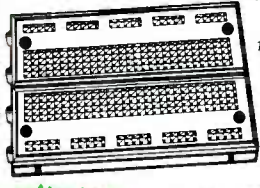

And the big gun: Giant Project Board

A massive 175 x 67 x 8mm board which can be split into three parts for convenience. Similar to above board one has 128 groups of 5 connected terminals plus 8 bus lines of 25 connected terminals. AND you get the large work sheet pad too!
Cat P-4615
\$9.95
10 up **\$8.95** ea

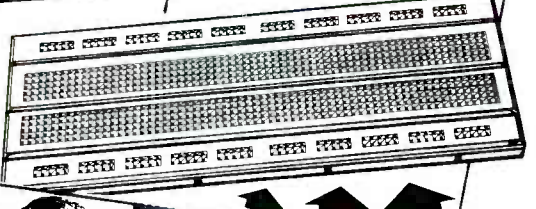

SCHOOLS ASK ABOUT OUR FANTASTIC BULK PRICES

REMEMBER!
If you only want one of each component at Dick Smith Electronics we are happy to sell it to you. You don't have to accept more than you need in expensive packaging.



FREE OZZIE SURVIVAL BAGS

The first 200 customers into our Redwood City store and the first 200 mail order customers will each receive a fair-dinkum Ozzie Survival Bag. Each bag contains assorted goods worth around \$10 at market price but absolutely priceless to any Aussie lions traveling outside the land downunda. You can buy the bags too for only \$5.00 each. You save the cost of the airfare to obtain all of the items in the bag.
Get in early! This offer closes on May 15 1985

BNC Line Plug
Suitable for RG58RU cable
P-2210 1-9 **\$1.50**
..... 10 up **\$1.40** ea

BNC Panel Socket
accepts P-2210
P-2220 1-9 **\$1.20**
..... 10 up **\$1.10** ea

RIGHT ANGLE
with SO 239 socket & PL 259 plug.
\$1.75
10 up **1.55** ea

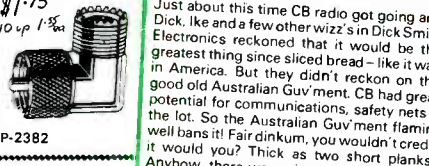

WIZZ SAGA (Cont.)
Anyhow back to this flamin' yarn. Just about this time CB radio got going and Dick, like and a few other wizz's in Dick Smith Electronics reckoned that it would be the greatest thing since sliced bread - like it was in America. But they didn't reckon on the good old Australian Gov'ment. CB had great potential for communications, safety nets - the lot. So the Australian Gov'ment flamin' well bans it! Fair dinkum, you wouldn't credit it would you? Thick as two short planks! Anyhow, there were pirates galore, so Dick and his mates wrote a set of rules to legalize CB. They offered their ideas up to the powers that be, saying, "There you go. Use these and she'll be sweet." It took a fair while for the Gov'ment to tumble but they cottoned on in the end.
continues next page

Why you should insist on a quality Dick Smith Kit

We only use brand new, prime quality spec components in our kits. Beware of other kits which may use inferior parts or manufacturer's seconds.

Our kits are complete! We supply everything you need to build the project, down to the last nut and bolt (unless it is a 'short form' kit). We even include step-by-step instructions, rewritten by our technical specialists (in conjunction with the electronics magazines) to make construction easy. If we do have to make any parts substitutions, we check these out with the magazine and the designer of the project first.

Our kits are guaranteed! Every kit we sell is covered by our exclusive 7 day satisfaction guarantee. After purchasing the kit, before you open any of the individual component packs, if you think that the kit is beyond your capabilities, you can return it (in its original condition and packaging) for a full refund of purchase price.

And you save by building it yourself! Because you supply the labour, your project could cost you less than half the amount of the equivalent commercial product. And that's a saving worth making! Also, buying our components in kit form is a substantial saving over buying parts individually AND think of the convenience!

SPECIAL 'DEGREE OF DIFFICULTY' KEY

To assist you in determining if a kit is suitable for you, we have included a 'star rating' on each kit as follows:

- ★ suitable for beginners, quite easy
- ★★ suitable for the average hobbyist
- ★★★ suitable for advanced hobbyists with good soldering & construction techniques.

SCHOOLS

We believe we have many products that can be used extensively in your school. Most importantly however, is a concept our company developed due to a tremendous demand from educators and parents to create an introduction to electronics that is educational and enjoyable to learn.

Fun Way Into Electronics was the answer. Firstly it is fun (a necessary component in having students learn quickly). Most importantly though it leads your students through the basics of electronics with practical projects that actually work. Another important aspect is that these Fun Way projects are extremely safe (working on a 9 volt battery or no battery at all!) The first 20 projects in the series actually use a unique breadboard that enables

youngsters and adults to connect the components without the use of a soldering iron.

Fun Way Into Electronics Vol. 1 is one of Australia's most popular books. We even find it hard to believe that it is now into its 6th printing!

All the books and kits are described here in this mini catalog but if you would like to know more and also obtain information regarding the SCHOOL QUANTITY BULK DISCOUNTS that are available please write to us on your school letterhead.

Upon receiving your applications we will actually send (at no charge) a copy of Fun Way Into Electronics Vol. 1 for your evaluation to keep in your school library afterwards.



50 Watt Amp Module

- Ideal for home stereo systems. An economical solution for those who want to update their old system without a huge outlay of money.
- Input sensitivity is 500mV
- Supplied with exclusive instruction booklet
- rugged fiberglass PCB
- easy assembly. Heatsink bracket is supplied but heatsink itself is extra.

Cat K-3440 ★★ **\$14.95**

100 Watt Amp Module

- 100 watts RMS, 5kHz at 100dB signal to noise ratio.
- the ultimate in simplicity; even the power transistors mount on the PCB.
- PCB heatsink bracket is supplied
- Hason-board fuse protection
- input sensitivity: 1V
- Use with K-3468 power supply. Ideal for the home constructor or technician who wants to 'roll his own' amplifier system for the home or professional use.

Cat K-3442 ★ **\$19.95**

IT'S AMAZING!

Makes computer generated effects. Sound even more effective in stereo!

Stereo Simulator

Wish those old video movies had modern stereo sound? This low cost gadget turns almost any mono signal into amazingly good synthetic stereo! Cat K-3421 ★

\$19.95
Opening Special **\$14.95**

SOUNDBENDER

Easy to build
Very useful

With this great little kit you can sound like a Darth Vader, a Cylon, or any one of a dozen robotic spin-offs! Used for special effects on electric guitars and other musical equipment. Cat K-3509 ★

\$19.95

Economy Car Alarm

This alarm senses the voltage drop in your car's electrical system when a thief breaks into it. There's a visual warning to scare thieves - saves a lot of trouble. Cat K-3250 ★

\$14.95
Opening Special **\$9.95**

Speaker Protection Kit

Our speaker protector delays connection at turn on and removes it at turn off to prevent 'thumping' overloads. Suits most amplifiers. Cat K-3425 ★

\$14.95

Super Siren

A great little screamer! This siren has got an ear-splitting sound yet it is compact and draws very little current. It uses a piezo-electret tweeter, which can be soldered directly to the PCB board. Has many uses: an alarm, car alarm etc.

Cat K-3505 ★ **\$14.95**

LED Level Meter

Use two for separate stereo readouts. 10 green LEDs for level display, 1 yellow for max. power and 1 red for overload. Requires 10V-16V AC or DC at 50 ma. Cat K-3370 ★

\$12.95

Transistor Tester

speedy fault finding

Cat K-3052 ★ **\$16.95**

Not just another Transistor Tester! This one tests the lot! Ideal for the beginner and serviceman alike, or in schools. Battery operated and supplied with one of our new 2" panel meters in a deluxe 'Speedy' box. Requires 9V battery Cat S-3006 75c extra.

R-L-C Bridge

Measures unknown components

\$34.95

Measure the values of new and used components easily and simply. Resistance, (10 ohms to 10 Megohms), Capacitance (10pF to 10uF) Inductance (down to a few hundred microhenries). The complete kit of parts includes a specially printed front panel. Battery not supplied. Cat K-3468 ★★

Shortwave Antenna Kit

Why spend hundreds of dollars on a good receiver if you are only using a piece of string for an antenna? Get the best reception with this high quality short wave antenna ● designed especially for Dick Smith Electronics by a short wave expert ● Complete and ready to assemble ● needs no soldering ● Instruction included.

Cat K-3490 ★ **\$14.95**

General Purpose Stereo Preamplifier

This amazingly versatile preamp can be built as a magnetic cartridge preamp (for upgrading your stereo), a tape preamp or an auxiliary preamp with 40, 55 or 80dB gain ● extremely simple ● any reasonable power supply from 10 to 40V will do ● frequency response 20-20kHz ● full instructions supplied. Cat K-3427 ★ **\$9.95**

Sine & Square wave Oscillator

Covers frequencies from 15Hz to 150kHz. All parts are supplied including specially printed front panel, attractive 'Speedy' case and full instructions. 9V battery not included. **\$9.95**

Cat K-3469 ★★

Negative Ion Generator

Runs on 12V DC, which means that you can put one in your car too! Kit includes exclusive Dick Smith Electronics emitter head, power pack and tough moulded case. Cat K-3335 ★★ **\$39.95**

Ignition Killer

Based on a 555 timer, it literally kills your car ignition and then re-sets itself, making the thief think something is wrong with the engine. Cat K-3255 ★★ **\$14.95**

LCD Panel Meter

Incorporate module into other projects

\$29.95

Keyboard Kit

Standard QWERTY typewriter layout keyboard with individually switched keys (no matrix necessary!) High tactile response, suitable for a huge range of computer and allied projects. ● 60 keys. Cat K-3601 **\$19.95**

3 Digit Counter

The most versatile counter circuit around ● Designed for maximum flexibility [display can be removed for external mounting] and with a very wide operating voltage (5-15V).

Cat K-3451 ★ **\$14.95**

- LED display
- Up to 2MHz counting speed
- Clock enable
- Very comprehensive manual included!

Microwave Leakage Detector

Microwave ovens are fantastic - but is yours really safe? Could it be leaking dangerous radiation? Check it out with this handy meter. No batteries required.

Cat K-3095 ★ **\$8.95**

WIZZ SAGA (Cont.)

Dick threw a beauty shindig the day CB was legalized - even though legalization knocked the sales for a six.

In 1976 Dick had the brainwave to charter a 747 and fly to Antarctica with a few of his Scouting and bush-walking mates. They just wanted to have a gander and come back the same day and that'd be that. But struth! The press got wind of it and the place went crackers, every man and his flamin' dog wanted to get in on the act. So Dick reckoned, "she'll be right mate. We'll make a few quid for charity out of this caper." And they did - over \$120,000.

continues next page

JOIN THE THOUSANDS OF PEOPLE WHO HAVE DISCOVERED:

DICK SMITH'S FUN WAY INTO ELECTRONICS

OVER 500,000 FUN WAY KITS SOLD!

Fun Way 1 Volume 1

Electronics should be fun, but far too often it is presented as a difficult, mysterious subject. The Fun Way series deals with this fascinating subject in an easy to understand, fun way. The first volume starts off with the very basics, assuming that you know absolutely nothing about electronics. It will show you what all the components look like and how to connect them into the circuit. No soldering is required and so is completely safe for even the youngest enthusiast.

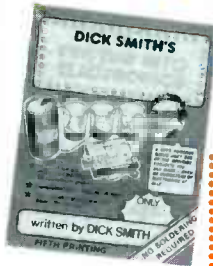

\$4.95

The ideal introduction for beginners from 6-66!



Fun Way One Project Kit 1-10
Enables you to build any of the first ten projects in Fun Way One. And because the components are not soldered, they are all re-usable so you can build any other of the first ten projects too.
\$7.25
Cat K-2600

- Continuity Indicator
- Transistor Tester
- Water Indicator
- Light/Dark Indicator
- The Flasher
- An electronic Siren
- Dog and cat communicator
- A decision maker
- Morse code communicator
- Music Maker

Fun Way One Project Kit 11-20
Contains the more specialised components required to complete the last ten projects (11-20) in Fun Way One.
\$7.90
Cat K-2610

- Sound Effects Generator
- A Crystal Set
- One Transistor Amplifier
- Beer Powered Radio
- Two Transistor Amplifier
- World's Simplest Transmitter
- Voice Transmitter
- CB Radio Receiver
- Amateur Radio Receiver
- Radio Booster Amplifier



Fun Way 1 Gift Box \$24.95

All the components AND the Fun Way 1 book in one great pack - everything needed to build any of the projects in Fun Way 1. This gift box makes an ideal birthday or Christmas present... and who knows, it could even be the start of an exciting career in electronics!



Everything you need

Fun Way 2 Volume 2

You've built all the projects in Fun Way 1 and now you're looking for something bigger, better and more exciting. Here it is - Fun Way 2. It takes over where Fun Way 1 finishes. There's 20 exciting new projects to try. These ones are different though. They teach you how to solder onto a professional printed circuit board and also how to use a multimeter! All of these projects have been specially chosen to be 'useful'. Just have a look and you'll agree.

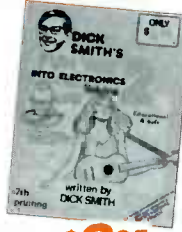

\$6.95

BOOK ONLY B-2605

K-2620 GIFT PACK



\$19.95

Now here's a gift bargain. Over \$28 worth of value for less than \$20! This pack has been specially selected for quality and value. You get: a copy of Fun Way Volume 2; a quality Dick Smith soldering iron; a pack of solder; a 9 volt battery PLUS our most popular kit - a wireless microphone.

| | | | | |
|---|--|---|---|---|
| Flasher Make it as the latest in electronic jewellery, or a burglar warning light, etc. The choice is yours and it's easy! Cat K-2621 \$2.95 | Ding Dong Doorbell Yes, it actually sounds like a great old fashioned doorbell. But it's electronic and you can build it! Cat K-2622 \$4.50 | Morse Code Trainer You can turn this audible alarm into just about anything requiring sound. Even for Morsecode - and it's fun to learn! Cat K-2623 \$4.50 | Universal Timer Eggs too hard? Time them with this great little timer. It really works - set it for a few seconds to 15 mins. Cat K-2624 \$5.50 | Electronic Dice Just as much fun using it as it is building it! And it's really random - no cheating with this dice! Cat K-2625 \$4.95 |
| Mono Organ Snazzy little circuit uses the back of the PCB as the keyboard! Play a tune - it's easy. Cat K-2626 \$7.95 | Pocket Transistor Radio Build this set and learn about the fundamentals of radio. And then you'll have fun using it too! Cat K-2627 \$7.95 | Touch Switch Ever wondered how lift buttons work? Build this kit yourself and you'll be able to work it out. Cat K-2628 \$5.50 | Mosquito Repeller Use it to make the mozzie repellers really work? Build this one and find out. You won't hear it - but the mozzies will! Cat K-2629 \$4.95 | Intercom Amplifier Use it to make the intercom (project 18) or use as a general purpose amplifier. Really handy, good sound output too. Cat K-2630 \$6.50 |
| Wireless Mic. Just like the 'bugs' used in spy movies! Transmits to any standard FM radio in another room or next door, etc. Hear it all! Cat K-2631 \$6.50 | Light Activated Switch Useful in many security applications around the home etc. You could even use it to trigger a burglar alarm. Cat K-2632 \$5.50 | Metal/Pipe Locator Extremely handy for locating pipes, wires, etc. in walls before drilling holes. Surprisingly simple for such an effective circuit. Cat K-2633 \$6.50 | Sound Activated Switch Picks up sound and triggers. Use as a telephone bell extender or in security applications. Cat K-2634 \$6.95 | Home/Car Alarm Very practical! You could use this alarm to protect your home and property! Uses any of the normal alarm triggering devices. Cat K-2635 \$6.50 |
| Electronic Siren Just what you need with the alarm! Also makes a great sound effects circuit - and Fun Way 2 tells you what to do! Cat K-2636 \$4.95 | LED Level Display Hook it up to your stereo and it can warn you of dangerous overloads. Looks pretty nifty. The LED's light up in time to the music! Cat K-2637 \$8.95 | Intercom Unit Build your own intercom & use it around the home. Practical, simple to build with the intercom amplifier (Project 10). Cat K-2638 \$8.95 | Led Counter Module An introduction to the world of IC's. This useful gadget can be used for counting applications - or just for fun! Cat K-2639 \$7.95 | Short Wave Receiver Tune in to short wave stations or emergency services and amateurs etc. Easy and fun to build. Cat K-2640 \$6.95 |

Fun Way 3 Volume 3

Here it is - the one you've been waiting for - Fun Way 3. This is for the more advanced hobbyist - those who have worked their way through volumes 1 & 2. There's ten really great projects in Fun Way 3 and each one is based on integrated circuits. Because the projects are more complex, than previously, they are dealt with in more detail. More explanation, more construction, more fun! B-2610



\$6.95

The latest and greatest

| | | | | |
|---|---|--|--|--|
| Light and Sound Another multi-talented project. Sound effects, flashing lights, continuity tester, Morse code oscillator... it's got the lot! Cat K-2665 \$8.95 | Two Up Australia's national game - now done electronically because the original King George pennies are hard to get! Cat K-2661 \$9.95 | Cricket Whaaaa! Hide it in a dark room and it starts chirping. Turn the light on and it stops. It's infuriating! Cat K-2663 \$9.95 | Mini Stereo Amp Just the shot for 'Walkie' stereo - now you can listen to it in your bedroom through speakers! Or make yourself a PA amplifier. Cat K-2667 \$14.95 | Minder A multipurpose project for the car. 'Lights on' warning, 'door open' warning plus a pseudo burglar alarm. Cat K-2660 \$7.95 |
| Mini Colour Organ Like a disco - but battery operated so it's safe! Connect to your radio, etc. for a LED lightshow. Cat K-2664 \$12.95 | Combination Time Lock Switch Make it into a game... or use it as a real alarm component. It's that good! Just try getting into this one! Cat K-2666 \$12.95 | Lil Pokey It's a barrel of fun to play. And you don't risk losing your shirt like the real thing. Cat K-2662 \$19.95 | Binary Bingo A game of skill and reaction time - and a valuable teaching aid! It might sound pretty simple to play - but try it and see! Cat K-2668 \$19.95 | Mini Synth Wow! A real musical synthesiser, with decay, frequency doubling & halving, tremolo... unique circuit uses YOU as the note generator! Cat K-2669 \$19.95 |

WIZZ SAGA (Cont.) ...
Back to the serious business of the Electronic Wizards.
Due to the slump in CB sales brought on by the saturation of the CB market the Wizz's were going bonkers looking for new hi-tech products to fill the yawning cavern. It was around this time that they introduced the heated toilet seat. Dick has one at home and reckoned the rest of Australia would appreciate some warmth on the seat of learning as well.
... continues next page

And when you've finished Fun Way 3?? You're ready to build just about any of the kits from the Dick Smith range.

High quality recording on movie & video cameras

Uni-directional electret condenser

A compact uni-directional super cardioid microphone which is exceptional for video and movie use. It switches easily from super cardioid to standard uni-directional. The super directional response pattern enables individual sound sources to be easily isolated from extraneous background sounds. Also ideal for naturalists, surveillance work, stage plays, etc. Cat C-1069

Specifications: • 2.3kohm Impedance (super-cardioid), 520 ohm Impedance (uni-directional) • Freq. response 80-12kHz • Sensitivity -58dB at 1kHz (super-cardioid), -66 dB at 1kHz (uni-directional) • Coiled cable, battery, windscreen and mic holder supplied.

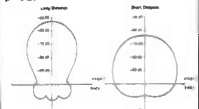

AMAZING

\$59.95

Fitted with 3.5mm plug Cat C-1069



Universal Dynamic Mic

Designed especially for AM & SSB transceivers, this economical mic is supplied with a 5-wire (4 lead plus shield) 2 metre lead that can be adapted to any transceiver — even ones with electronic switching! Has a nominal 500 ohms impedance, can be re-wired with internal transformer for 50k. Supplied with a standard 4 pin socket. Cat C-1102

\$11.95

Noise Cancelling Mic

Ideal for the amateur or CB'er. Noise cancelling is achieved by use of twin out-of-phase inserts. Fitted with a high quality PTT switch and coiled lead, impedance is 250 - 600 ohms with a frequency response of 300-5000Hz. Cat C-1105

\$19.95

Noise Cancelling Power Mic

The cleanest signal yet. Get both audio amplification AND noise reduction for under \$40! Noise enters front and rear of the mic — cancelling each other out. Comes wired to a standard 4 pin socket. Needs 9V battery (not supplied) Cat C-1108

\$24.95

This budget priced general purpose dynamic microphone is ideal for recording purposes. It is high impedance to suit most tape recorders. Cat C-1025

Specifications: • 50kohm Impedance • Freq. response 80-13kHz • Sensitivity -54dB at 1kHz • 6 metre cable, mic holder and 6mm plug supplied.



VALUE AT **\$17.50**

Omni Directional Dynamic

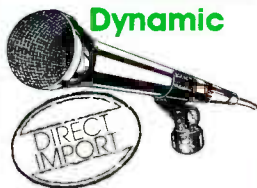

Uni-Directional Dynamic 500ohm

Freq. response 50-15kHz

IDEAL FOR STUDIO USE

ONLY \$44.95

Top of the range professional quality microphone at a fantastic price. Famous name ADI brand compares with others you'd pay up to 3 times the price for. Solidly constructed to suit stage applications. Balanced output — compatible with all professional recording equipment. Excellent for more prominent mid-range and high response. An excellent mic for vocal use. Cat C-1050

Specifications: • 500 ohm Impedance (unbalanced at plug end) • Freq. response 50-15kHz • Sensitivity -71 dB at 1kHz • 6 metre cable and mic holder supplied.

Speaker Box Lining

65¢/ft

28" wide

Innerbond is light, clean, dust-free and easy to handle. Fibre bonding ensures that this cellulose acetate insulation will remain resilient and not fracture or break down due to vibration. Weighs approximately 300 grams/sq. metre and is 25mm thick by 700mm wide — this is recommended density for most speaker usage.

How much can a koala bear?



COMMUNICATIONS ACCESSORIES

Waterproof 5 inch Horn

WILL BE \$8.95

OPENING SPECIAL \$4.95

ABSOLUTELY UNBEATABLE PRICE



Excellent versatile speaker which is perfect for use on boats, alarm systems, P.A.'s and anywhere there may be moisture. Sturdy plastic eliminates rust worries. Rated at 10W output however has been tested as high as 15W @ 8 ohms impedance. Complete with 3.5mm plug, lead wire and metal bracket. 5" diameter. Cat C-2705

Mobile Mic

SCREW-IN: A simpler type clip, can be screwed to any convenient location — the mic is held securely by a spring in the clip. Complete with mounting screws. Cat C-1262

45¢ 55¢

Mounting Clips

MAGNETIC: Cure a dangerous dangling microphone with this clip. It attaches to the rear of most hand-held microphones. A strong magnet holds the microphone securely in place to any ferrous surface. Cat C-1260

Tie clasp Electret

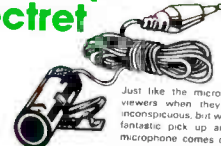

\$17.50

Just like the microphones used by interviewers when they want the mic to be inconspicuous, but with this one you also get fantastic pick up and perfect clarity. The microphone comes complete with tie-clasp and 2 metre cord, terminated with a 3.5mm phone plug. Being a low impedance device it is also ideal for use with your cassette-recorder for recording the family or lecture notes, etc. Cat C-1060

Carbon fibre record cleaning brush \$2.95

Space age carbon fibre brush gives your records the sparkling clean treatment they need for long life and pure music. Cat C-7096

Floor Stand and Boom



This professional floor stand and boom is a very advanced design. It converts easily from a regular mic stand to a boom stand. This unit is lightweight, portable, collapsible and stable. Comes complete with universal mic holder which adapts to virtually any sized mic. Cat C-1200

VALUE AT **\$39.95**

15W Audio Amplifier

Fantastic for PA, modulators, intercoms, etc etc. Multi-tapped output tranny suits 4-16 ohm speakers, huge 15W peak output (10W continuous) from a 12V supply. Ideal for car use, too. Cat. F-4115

\$24.95



5W Audio Amplifier

Don't need all that power? Smaller module has 5W peak rating (3W cont) with extended frequency response and lower supply rat. Think of the uses: intercoms, megaphones, modulators, radio amplifiers, etc etc.

\$12.95



SPECIFICATIONS: Power output: 5W max, 3W cont. Supply 9V DC, 0.9A maximum. Input: 10mV for rated output. Input Impedance: Approx 30k ohms. Output Impedance: 4-16 ohms. Freq response: 70Hz-20kHz. Size: 75 x 55 x 30mm. Cat. F-4105

Aluminium Speakers

WHAT A SOUND!

You'll be staggered when you hear the quality of these beauties. Even though they measure just 4 1/2" x 4 1/4" x 7 1/2", they give a performance right up there with their big brothers. The enclosures are aluminium, so they're extremely robust and great for outside (under cover) use. Great for the flat owner who hasn't much space, too.

Specifications: 8 ohms impedance • 35 watts handling • Freq. response 35Hz to 20,000Hz • two way system (4" woofer & 1" dome tweeter) Cat A-2375

ONLY **\$79.95 PAIR** compare our price

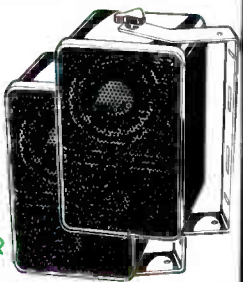

MYLAR HEADPHONES

Specifically intended for use with today's tiny radios, cassettes, etc. — they even come fitted with a 3.5mm stereo plug to suit. PLUS at no extra charge there's a 3.5 to 6.5mm adaptor plug so you can also use them on your home hi-fi. Many walkie stereos, radios, etc. have dual headphone sockets — now you can share your music with a friend: at our price they certainly won't break the bank! Cat C-4106



Switch your sound from room to room

7 way switch **\$5.95**

Stereo selector switch enables you to select any combination of three sets of remote speakers. Terrific for when you have parties in more than one room. Attractive brushed gold finish. Steel wall plate fits any standard electrical box outlet. Cat C-7208

\$6.95

Low cost, light weight

Gooseneck

Allows the microphone to be bent into its required operating position. Can be used with floor stand and boom. Cat C-1226

\$3.95

Electret Insert

Making up legating a microphone? This unit will fit most makes and has a high sensitivity with omnidirectional characteristics. Convection data supplied. Weight only 1.5 grams! Cat C-1160 10 up **\$1.25 ea**



WIZZ SAGA (Cont.)

Backing-up the heated toilet seats were the co-tanger car aerials and the energy saving light bulbs. These are offered for the first time in America as it's still going through the heated toilet seat is still going through the incredibly complex developmental and modification process needed before they can be let come into contact with American backsides. You wouldn't credit that there would be so much difference would you?

Back to work and the TV games were taking off. Do you remember that? Those chips just kept coming out of the Valley and there were new generations of developments nearly every second day. Great! Fantastic! Wonderful! For the people who were up with it, but what about those who'd never learnt electronics? They weren't drongos, they just didn't have a fair go.

The Electronics Wizards changed all that they brought out Furway into Electronics Volume 1. Crike! What a bottle! — even the little tin lids around the age of 8-10 can put the beer powered radio together because it doesn't need any soldering. It works just as well with vinegar too. Can you imagine what it sounds like? ... continues next page



PLACE YOUR ORDER NOW - PHONE (415) 368 1066

CIRCLE 255 ON FREE INFORMATION CARD

50 watt 3 way Speaker System

Stereo sound in your car is unbeatable and these car stereo speakers not only sound great but look great. The Dick Smith FX-16 is a 3-way, 3 speaker system and is capable of handling up to 50W for those high powered systems. They are incredibly easy to install - with the quick connect wires, no soldering or tools are required. They also come with detachable brackets so they can be mounted horizontally or vertically.

- Blends in with any decor
- Suit most in-car systems

SPECIFICATIONS: Speaker units - 4 inch high compliance woofer, 2 1/2 inch cone squawker, 2 inch twin mini dome tweeter. Cabinet - sealed enclosure, Impedance 4 ohms, nominal power 20 watts each, maximum power 50 watts each.

- Top quality sound
- Latest attractive gun-metal finish
- No messy wiring

Cat A-7082



The DICK SMITH

Engine Analyser

Save a fortune on tune ups!

Why pay others to do the simple jobs you can do yourself!

- Lo Volts
- Hi Volts
- Points
- Lo Tach
- Hi Tach
- Dwell

\$19.95

That's most of the electrical testing needed to keep your car in top condition. Fits the palm of your hand, has multi-coloured scale for easy reading. Complete with heavy duty leads and clips and can be used on most 4, 6, and 8 cylinder cars. Pays for itself in just one tune up!

Cat A-8514



Budget Stereo Speakers Rear shelf mount

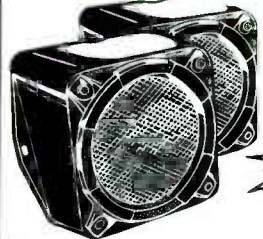

Unbeatable Value

\$4.95 ea

Mount them anywhere... on the rear parcel shelf, from the roof - you name it! Now a brand new model with even better performance: huge 15W maximum power rating; with deluxe ceramic 3oz magnets for great sound. 4 ohms impedance, suits almost all car hi fi systems.

Cat A-6980

8 TRACK CAR CARTRIDGE PLAYER FOR ONLY \$4.95!

YES CONFIRM FOUR DOLLARS AND NINETY FIVE CENTS!

Here is an unbelievable opportunity to play all those old 8 tracks you have at the bottom of your cupboard. Bring them back to life and enjoy your music while you drive. Many new cars don't have 8 track players so all you have to do is install this very low profile player under the dash and hey presto!

ONLY 250 AVAILABLE

Big Secret We're not allowed to divulge the very well known Japanese company that manufactured these cartridge players. You can be assured that they will be reliable. We can tell you though, they were to go in the top Toyota cars so you know they'll be great.

At this amazingly low price you can afford to give them away as presents to other members of your family so they can once again enjoy the 8 track sound of years ago.

WONDERFUL FOR PARTS ALONE

8" Air Suspension with Aluminium Voice Coil

Cat C-2100

\$11.95

10 up **\$10.95 ea**

What a thumper! Powerful high compliance air suspension dual cone speaker with aluminium voice coil. Dual impedance of 4 and 8 ohms for almost any requirement. This is an amazingly powerful speaker but is also pleasant in response. Can be used in bookshelf systems or in PA systems. It is rated at 30 watts with a free air resonance of around 35Hz. This speaker is so compliant that you could see the cone move up to 13mm on heavy audio passages.

AMAZING VALUE!

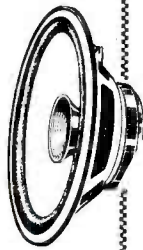

Gutter Grip Antenna \$9.95

Twin telescopic rods of about 3 feet each pull in those weak signals. Attaches to the gutter of your car very easily. Comes with about 6 feet of lead and plug. Very popular antenna in Europe.

Cat A-7320

AM/FM Mini Rubber

This is a very flexible antenna that is ideal for both AM and FM. It is only 1.5 in. high. This antenna will not rust or break. Mount it on the cow!.

\$4.95

Cat A-7345

Lock Down Antenna

The ever popular lock down, 5 section telescopic antenna. Comes with key.

Cat A-7300

\$4.95

12 foot Car Antenna Extension Lead

Fully compensated (low signal loss) 4 metre lead. Complete with plug on one end and socket on the other. Ideal for when your new antenna has a lead that is too short! For rear mounted antennas.

\$2.95

Cat A-7452

3 foot Car Antenna Extension Lead

Exactly the same as the above lead but only this one is 3 feet in length. Ideal for short runs.

Cat A-7450

\$1.95

Electric Antenna \$24.00

A dash mounted switch enables you to raise or lower this antenna from inside the car. Works on both 12V DC negative or positive earth. Requires 13" clearance below cow! Slipping clutch ensures no burn outs.

HI POWER LOW PROFILE CAR SPEAKERS

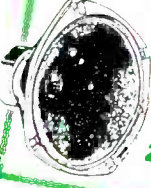

PAY ONLY \$1 each for the 2nd one

10W into 4 ohms - speaker a real "hum-dinger"
These specifications make this "A" are ideal for mounting in car doors to add extra sound to your car hi-fi system. Easy installation and connection is made possible by the quick connect tabs on the speakers.
Pay only \$1 for the second one!
That's right - \$4 each!!
2 for \$5.00
ONLY 1,000 PIECES AVAILABLE

GRAND OPENING SPECIAL \$14.95

Hi Power Plug In 6V, 7.5V, & 9V in one!



800mA Max.

GRAND OPENING SPECIAL \$4.50

Suitable for battery powered equipment that requires more than average current (eg larger cassette & radio units, etc.) Complete with 4 way plug and battery snap connector. 6, 7.5, & 9V at a massive 800mA! Switchable polarity on output. Cat M-9584

Flush Mount

ONLY \$12.95 pair



Boss Audio CH 4401

Power Supply

Panther Power! Regulated 13.8 volts supply, ideal for running CB radios as a base station... or any other 'car' equipment from a power point. Makes a great bench supply for test purposes, too. 2 amps continuous rated, with a massive 4 amps peak pulse (suits SSB CB's perfectly). Fully approved supply, with colour coded banana terminals and 2 metres mains cable. Cat M-9545



OPENING PRICE

\$19.95

- Housed in case with massive ventilation for long service.
- Rubber feet to keep stable, eliminate scratching.

Quality sound from these Co-axial speakers

Co-axial speakers have the excellent bass response of dual cone types PLUS a fantastic top end range achieved through a tweeter that is suspended across the main cone. They have a large 10 oz magnet and are rated at 4 ohms. They will suit most in-car systems. Hardware, mounting template and deluxe grille are included in the price.

Cat A-7000

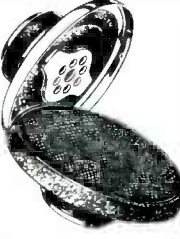

ONLY

\$29.95 PAIR

BLIMEY!

Inductive Pick-up

Complete with lead and plug

\$1.75 10 up **\$1.50 ea**



A great accessory which can be fitted to your intercom or any piece of equipment that has low output sound levels. Fitting is achieved via a suction pad. Record directly onto tape or feed into a more powerful amplifier. Comes complete with a 1/4" plug and 1 yard of lead. Just attach and you are ready to record! Cat C-7300

Super thin flush mount Car Door Speakers

\$16.95 PAIR

800 Adams NC 27514

Super thin type for mounting in door or kick panels, etc. Heavy wire mesh for maximum protection 4 ohms impedance, 4" size suits standard cut-out found in many Japanese cars. Handles up to 15 watts. Complete with mounting hardware. Cat A-7050

Economy Grille \$2.95

Here's a high impact, 8" plastic grille that has thousands of uses! If you want to place speakers into the wall or ceiling of your home then this grille makes an ideal cover. Also ideal on boats and in vehicles. Has four screw hole fitting points. Cat C-2646 10 up **\$2.50 ea**



WIZZ SAGA (Cont.)

In 1980 the founding wizard, Dick Smith, sold the company, lock, stock and barrel, to over 800's supermarkets, and retired to the But in 1982 he took off and flew his helicopter around the world! The first person ever to do it on his Pat Malone too. Dick's flight would have been virtually impossible if it wasn't for the hundreds of hams who made contact with him all over the world and yarned to him to stop him getting lonely. At the same time they provided a continuous safety network and a constant check on his progress. The customers and staff of Dick Smith Electronics were Dick's greatest barracks, bearing out the idea that electronic enthusiasts have the characteristic of admiring people who are prepared to have a go and are usually prepared to have a go themselves.

continues next page



How can the Wizz's sell top quality stainless steel tools at such amazing prices?

It's easy! They import direct

Introducing our brand new range of stainless steel tools - without the normal stainless steel price tag! Every professional, every hobbyist needs the best tools to get the best job. But they cost a fortune - until Dick Smith's stainless steel tools came on the scene. Amazing value - they'll last far longer than other tools, are ultra precision made and resist corrosion! Carefully chosen types for practical applications.



S/S Mini Needle Nose Plier

Precise, non-serrated tip and jaw. Ideal for use with semiconductors - the very fine (1mm) tip will reach into places others won't! Cat T-3570 **\$9.95**



S/S Transistor Nipper

Ideal for pcb work. Very sharp precision cut with long life cutting edge. 95mm body with spring return. 9mm cutting blades. Cat T-3205 **\$5.95**



S/S Mini Flat Nose Plier

Non-serrated working surface to avoid damaging components. Also great as heat sinks because of larger component contact area - and wide nose absorbs lots of heat. 4mm wide blade. Cat T-3325 **\$9.95**

Side Cutting Plier \$6.95

This is a hard working tool for linesmen, electricians and general purpose use. Made of sturdy gunmetal with a polished finished and insulated handles. Has flat serrated jaws with inbuilt cutting edge. They represent excellent value. Length 150mm, jaws 25mm. Cat. T-3270



Cutting Nipper/Stripper

This nipper/stripper has sturdy insulated handles and a positive cutting edge. It features two very handy wire stripping holes, one of 1.2mm and the other 1.6mm making it a very versatile tool. Length 125mm, cutting edge 22mm. Cat. T-3220 **\$6.95**

Scissor Clamps

Made of stainless steel with screw joint. These scissor clamps are 127mm long so they will reach hard-to-get-at places. They can be used as a third hand for small items as they can be locked on to the article they are holding. Cat T-3690

VALUE \$4.75

Needle File Set

Cat T-4960
This handy set of files has five different types, all 185mm in length. The types are round, square, half-moon, triangular & rectangular. **\$14.95**

Piercing (Fret) Saw

An absolute MUST for the modelmaker, hobbyist, etc. Fully adjustable universal type saw frame, complete with 3 blades. NOTE: because it's fully adjustable, you can even use broken saw blades - never be caught again! Quality Japanese made. Cat T-4965 **\$9.95**



Spare Saw Blades

Even though you can use broken blades, you're going to eventually need replacements! Your choice of three special SK alloy blades in packs of 12. Cat T-4966, T-4967, T-4968 **\$1.95/pack**

Don't discard them - check them first with a Dick Smith Battery, Lamp & Fuse Tester

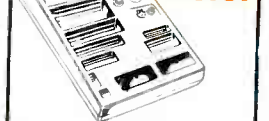

*BATTERIES Checks a huge range of 1.5V - 9V cells actually under load - the way they should be checked! Even checks NiCads, calculator, watch & photographic batteries.
*LAMPS Checks miniature lamps for continuity.
*FUSES Checks cartridge type fuses for continuity.
May be used as a general continuity tester and as a NiCad charger. Cat S-3006 9V battery required. Cat Q-1525 **\$9.95**

and it's just

Philips (Series 82)

This series covers all of the most popular Philips screw sizes.
L-75mm, D-3mm, H-54mm x 12mm Cat. T-4030 **75¢**
L-100mm, D-4mm, H-75mm x 15mm Cat. T-4040 **\$1.10**
L-125mm, D-5mm, H-85mm x 18mm Cat. T-4050 **\$1.75**

Popular (Series 71)

This has been voted the most used size. The medium size makes them ideal for general purpose work. **\$1.10**
D-4.5mm, H-73mm x 16mm Cat. T-4085 **85¢**
L-75mm **\$1.10**
L-150mm **\$1.10**

Nibbling Tool

A unit that can cut any shape opening in sheet steel to 0.6mm thick or light alloy to 1.5mm. Ideal for plastics too. Easy to use, gives good clean cut without distortion. Follows curved or straight lines with ease. Put one in your tool box today! Cat T-4940 **\$11.95**

Solder Stand with magnifier!

The helping hand when you need it most when you have a 'hot stick' in your hand! Heavy die-cast base, solder stand, clips for holding PCB, etc. - plus a unique magnifying lens for those close assembly jobs. Cat T-5710 **BEAT THIS PRICE \$6.95**

CRIKEY

Drills

MINIATURE HIGH SPEED TWIST DRILLS
Suitable for PC Board work.
Cat T-4820 No. 60 (1.0mm) **\$1.95**
Cat T-4825 No. 65 (0.8mm) **\$1.95**

Solder Sucker Cat T-2580 **\$9.95**
A rugged all metal construction solder sucker complete with Teflon tip and a nozzle sweeper as well. Light thumb release mechanism for the removal of solder from the board. Don't pay twice the price - a top quality import from Dick Smith.

Spare Teflon Tip to suit Cat T-2565 **\$1.95**
Vincenti Simmonds MA 01404

Economy 12V

KEEP ONE IN CAR OR BOAT

This little iron is superb - and very popular! It operates from 12 volts, either AC or DC - so it's just as much at home in the car or on the workbench. Use it with any 12 volt battery, supply or transformer capable of delivering 2.5A. Element is 30 watts, so this iron is ideally suited to small PCB work, etc. With a low power iron there's less chance of damaging delicate components. Complete with long lead, fitted with cigar lighter plug. Why not buy a couple - one to keep in the car and one on the bench? You never know when you might need it. Cat T-1910 **\$3.95**

ONLY VINCENTI SMOG HI 98817

DURACELL ALKALINE BATTERIES

TOP VALUE ENERGY

Top brand name, top quality! Duracell Alkaline Batteries, recommended for extra heavy duty applications where normal batteries turn up their toes! All normal sizes available. **\$1.95**

Qty/type Cat No. Price ea
Pack 2 x AAA S-3278 2.40 pk
Pack 2 x AA S-3279 2.40 pk
Pack 4 x AA S-3280 4.30 pk
Pack 2 x C S-3282 3.20 pk
Pack 2 x D S-3283 3.20 pk
1 x 9V S-3286 3.20 ea

NICADS GRAND OPENING FULL RANGE SPECIAL

(NOT JUST AA & C - The whole kit & kaboodle)
ALL AT BARGAIN PRICES

Ni Cads work out much cheaper in the long run, especially if you buy them from Dick Smith Electronics. From only \$1.49 each!

| TYPE | Cat No. | Price each |
|------|---------|------------|
| AAA | S-3305 | 1.95 |
| C | S-3304 | 2.95 |
| D | S-3303 | 2.95 |

AND - THE MOST POPULAR OF ALL S-3300 - AA at \$1.99 each or \$1.49 ea 10 up price

Soldering Aid Set

For the person working with PC boards this is an essential aid. Kit contains: guide fork tool, reamer point and knife point tool, scrubber, heatsink clip and stainless steel brite brush. Can also be used for resinsoldering dials! **High Quality \$6.95** Cat T-2610

Desoldering Bulb

Simple and efficient. Simply squeeze bulb, hold up to molten solder and release bulb. Solder is sucked straight up. Use for blow cooling tool! Cat T-2580 **\$3.95**

Multi-purpose Stand

Hold boards or components firmly in rubber faced vice. Angle of vice may be varied widely in three dimensions for greatest accessibility to board. Convenient soldering iron holder also adjustable. Adjustable spool holder for solder & desoldering wick. Ideal for the hobbyist or professional. Leaves both hands free. Cat T-5700 **\$24.95** 10 up **\$19.95 ea**

BATTERY HOLDER & SNAPS

BATTERY SNAP
Suit 216 Cat P-6216 **15¢** (10 up 10¢ ea)

4 x "D" size HOLDER-square Cat P-6101 **50¢** (10 up 45¢ ea)

4 x "C" size HOLDER-flat Cat P-6104 **60¢** (10 up 55¢ ea)

4 x "A" size HOLDER-long flat Cat P-6114 **50¢** (10 up 45¢ ea)

8 x "AA" size HOLDER-rectangular Cat P-6128 **75¢** (10 up 70¢ ea)

8 x "AA" size HOLDER-rectangular Cat P-6128 **75¢** (10 up 70¢ ea)

10 x AA size holder cat P-6130 \$1.00 ea. Not shown

WIZZ SAGA (Cont.)

Now they've got Funway Volumes 2 and 3 and Gramme and Grandpa have joined the ankle-biters in sussing out electronics. Mobs of people have gone on to make their own hi-fi gear, textexers and the dozens of other exciting and useful kits they can get from Dick Smith Electronics as well as the Funway Books and kits.

It was good for business to keep the Company name in the headlines but cop this! On April Fool's day 1977 they towed an iceberg into Sydney Harbour. That's right, it was a fake, but blimey, everyone had a good laugh when the plot was revealed and the Electronic Wizz's had scored another six.

Dick Smith Electronics is opening in Redwood City on the first of April this year and those blobs could get up to anything, so watch out

... continues next page

PLACE YOUR ORDER NOW - PHONE (415) 368 1066
CIRCLE 255 ON FREE INFORMATION CARD

www.americanradiohistory.com

DON'T GIVE THIEVES AN OPENING

Normally Closed Detection Sensors

Window Foil **\$5.95**

Cat L-5200
Very fine, adhesive backed aluminium foil which adheres to window or door glass. Forms part of detection loop; if glass is broken foil breaks, setting off the alarm. Also great for sticking on sliding doors to show they're there! 1/4" wide. 10 or more **\$5.50** ea
105 ft per roll.

Tape Blocks **40¢**

Termination points for window foil to alarm wires. Self adhesive, screw 10 or terminals connection. Cat L-5205 more **35¢** ea

Magnetic Reed Switches

Reed switches are small, glass encapsulated contacts closed by an external magnetic field. They are ideal for alarm use because of their incredibly long life.

The reed switch is mounted on the jamb and the magnet on the door/window so the switch is held closed while the door/window is closed. When opened, the magnet moves away and the reed switches opens, setting off the alarm.

Standard Reed Switch Cat L-5215 **\$1.00** ea 10 up **.90** ea
Magnet to suit either Cat L-5214 **75¢** ea 10 up **.60** ea

Reed Switch/magnet set

In plastic cases, ideal for aluminium windows; include screw holes for mounting, screw terminals for alarm wires.

Cat. L-5210

\$1.95

10 or more **\$1.75** ea

Heat/Fire Switch

If heated, contacts close to trigger alarm. Can be used on 'fire' contacts of some alarms, or 'N/O' contacts of others with instant triggering. Cat L-5254

10 or more **\$5.50** ea

Watch the platypus duck

Audio Alarm **\$2.95**

This is an incredibly loud audio alarm that works on a nominal 9V DC, but can be used with voltages varying between 5 and 29V DC. It can be used in all manner of applications including: computer alarms, fire signalling equipment, telephone signalling etc. etc. Cat L-7024 10 or more **\$2.75** ea

BOAT ALARM

Incredible value in effective boat protection. This versatile, durable alarm is specially designed to meet the demands of recreational and commercial boat owners. Be prepared to meet the marauders at marinas and moorings! Includes controller, siren, strobe light, various switches and comprehensive installation manual. Cat L-5098 **.99** ea

Microwave Alarm Detector

The very latest in intruder detection sensors. Silent, invisible microwave detect any movement in the target area and trigger the alarm device. Even works through plaster, fibro etc walls or ceilings - fantastic! Cat. L-5000

Economy Home Alarm Control Module

The lowest price alarm module around - but it features pro quality circuitry and facilities. Both n/o and n/c inputs, suits all normal detection devices and has one minute alarm period. 12V DC operated - use batteries or AC adaptor as required. Cat L-5060

\$29.95

ONLY **\$12.95**

Huge stock inventory held in our distribution centre located at our USA Headquarters in Redwood City

Movement Detectors

Passive Infra Red

The best system you can fit. As used by banks etc - detects human movement. Cat L-5010

\$59.95

Piezo Transducer

Sound transducer driven by 3-30V p-p AC signal around 4kHz (eg TTL, CMOS, transistor, etc) Sound output typically 80dB min. 10 or **.95¢** ea
5mm thick, 30mm dia. Cat L-7022 more **.80¢** ea

Normally Open Detection Sensors Pressure Mat

Hide under carpet - it's only a few millimeters thick so it's almost impossible to detect. When trodden on it closes the contacts inside the mat to trigger an alarm.

\$11.95

Cat L-5270

Panic Switch

A must for the old, infirm, etc. Set alarm off instantly - use near bed, in bathroom, etc. 10 or more

Cat L-5285 **\$1.40**

Ultraloud Bell

Good old-fashioned fire bell: kicks up a real din! Drive from relay output in alarm controller. Cat L-5280

\$19.95

GRAND OPENING SPECIAL Solid State Buzzer

* A TRUE ELECTRONIC BUZZER
* SILICON TRANSISTOR AND DIODE REVERSE POLARITY PROTECTION

Features:
* Compact - 32mm x 14.5mm
* Rich, clear tone - 450Hz
* Wide operating voltage range 4 - 15V DC
* Low operating current - 15mA @ 9V
* High output level 70dB min @ 1M

\$1.50 each

Cat L-7009

10 for **\$10** ea

How To Install Your Own Burglar Alarm

ONLY **\$1.95**

'How to install your own burglar alarm'

Considering an alarm system but were put off by the cost of a professional installation or thought you were not capable of doing the job by yourself? By reading this booklet you will see how easy an installation is. Tells you all the basic theory about Alarm Systems, their components and the tools you'll need to install them. By installing an alarm system yourself, you could save hundreds of dollars - and have the satisfaction of greater security for your loved ones and property. Cat B-5000

Flashing Strobe

Bright blue flash (just like police cars!) to tell the neighbourhood your place is being 'hit'. Data sheet available to show how to 'latch'. Cat L-6000

\$14.95

Deterrent Sticker



10 or more **.45¢** ea

This printed sticker is ideal for your car, house, factory etc. to show you have an alarm system installed. A would be intruder seeing this sticker is not likely to attempt a break-in. Whether your property has an alarm system or not, this bright, easily read sticker will really have a deterrent effect. Cat L-5430

ONLY **50¢**

Shock-detector switch

About the best form of protection for motor bikes. Also great for 'tamper proofing' other alarms. Cat L-5250 10 or more **\$2.75**

at only **\$2.05**

Barrel Key Switch

For car or home alarms needing external switching. Two keys supplied with each switch. Cat L-5290

\$3.95

Vehicle Alarm Switch

N.C. under spring tension, will go open circuit when vehicle door is closed. Ideally suited to vehicles whose courtesy lights are not actuated by the doors. Cat L-5256

at just **\$2.00** 10 or more **\$1.80** ea

CAPACITORS

We stock a huge range and variety of capacitors for many applications - far too many to list individually here but, as with the resistors and pots they are losted fully in our annual catalog due out in June, in the meantime please order by type and value.

Current Sensing Car Alarm

No external switches: it triggers when anything electrical in the car is used (interior light, starter, brake lamps, etc). Very easy to install, full instructions supplied. Our most popular alarm! Cat L-5090

\$3.95

● Mounting kit and interior switch supplied

● Easy do-it-yourself wiring

WIZZ SAGA (Cont.)

Dick's leaving the Company unleashed the amazing and here-to-fore unknown Ike-force! The incredible, overwhelming, unalterable obsession of one man to take the Wizzards to America. Ike reckoned that maybe there were Americans who were just as enthusiastic about electronics as Aussies were.

And so he went - with Gary, Dave and Steve, all dinki-dink electronic Wizzards. But they won't be importing any more Wizz's from downunder, they reckon they've got enough here now to start a movement. With the incredible Ike-force acting there's bound to be big mobs of electronic Wizzards in America pretty soon.

Well, I have to hit the frog and toad - I'll see you around the ridges.

Jolly Swagman

DICK SMITH ELECTRONICS SECRETS!

Have you ever thought "I'd like to run my own electronics business" or "I'd like to make my existing business more profitable"?

You can! And we're willing to give you the secrets that have made us Australia's number one specialist retailer - absolutely free of charge. We are now here in the U.S.A. however, the procedures we have adopted for here as they do anywhere else in the world. Apart from a large number of company owned stores we have hundreds of independent businesses that are selling our products through their stores.

The reason for this is that it is not economical for us as a company to open Dick Smith stores in all areas. But the opportunities are incredible for already established businesses in the country cities and towns of all sizes.

Many of our current re-sellers were already successful businesses before deciding to add electronic components, TV repairs, motor cycle dealers, marine shops, etc. They're even more successful now! And many others started their businesses off by selling Dick Smith products. You could do the same! There are areas all around the USA where the opportunity is there for the taking.

- And we'll help you with:
- A great range of products with realistic margins
 - Subsidies and advertising in centres
 - Merchandising and promotional material
 - Regularly up-dated pricing service
 - Help and advice - if you want it
 - And much, much more!

How do you start? If you're really serious about becoming a successful Dick Smith Electronics re-seller, our products just drop us a line! We'll send you everything you need to know - including the method Dick Smith Electronics uses to stay on top.

Don't delay. This could be your opportunity of a lifetime! For further details contact:
David & Milson
Dick Smith Electronics Inc.
P.O. Box 2249 Redwood City
CA 94063



WHAT'S ALL THIS METRIC?

Em's, em-em's, see-em's - what size is the darn thing anyway?

We've converted most of the Australian metric measurements into U.S. Imperial but we haven't been able to do them all so we're including these simple conversions to help you get the picture.

- 2.54cm = 1 inch
 - 30.48cm = 12 inches
 - 91.44cm = 36 inches
 - 1 litre = 0.22 US gal
 - 1 kilogram = 2.2lb
- Eventually we'll get fully converted and we thank you for your patience until we do.



PUSH BUTTON SWITCH SPST 'LAMP SWITCH'



Has many, many uses but is ideally suited to replacement of desk light switches.
Cat S-1205 1-9.75c
10 or more \$1.60ea

TOGGLE SWITCH ULTRA-MINIATURE DPDT



The contact rating to size ratio is very high with this miniature toggle switch. Ideal for models, miniature portable instruments, or any use where a high quality miniature switch is required.

DPDT 125V AC 3A Chrome toggle with colour insert body. Body size: 1/2" x 5/32". Clearance: 1/8". Complete with 2 nuts and two washers. Gold plated connecting lugs.
Cat S-1245 \$1.75
10 or more \$1.50 ea

JUST LOOK AT THESE FOR VALUE

BAYONET HOLDER (3AG)



Chassis or panel mounting fuse holder, accepts standard 3AG fuse. 1/2" mounting hole required.
Cat S-4206 1-9.75c ea
10 for \$4

FAIR DINKUM QUALITY MICROSWITCHES

Microswitches are used wherever a limited switching movement is required - they require only 2 or 3mm of blade movement to actuate. Very positive switching action when triggered - ideal for use in burglar alarms, machinery guards & limit switches, tamper switches, etc. Cat S-1920



Features: SPDT contacts
125V/20A rating
Quick connect terminals

10 or more \$1.70 ea

SP ALTERNATE ACTION

This switch features a beautiful red 11mm square actuating button in an all black plastic case. Makes an excellent mains switch for projects.

- Features: 125V AC 3A
Body Size: 1/2" square
Clearance: 1"
Hole size: 3/8"

Cat. S-1198 \$1.60
10 or more \$1.45 ea



SP MOMENTARY ACTION

As above switch, Cat S-1198, but with momentary action push/on.

- Features: 125V AC 3A
Body size: 1/2" square
Clearance: 1"
Hole size: 3/8"

Cat. S-1199 \$1.60
10 or more \$1.45 ea



8-WAY PCB DIL SWITCH

8 SPST rocker switches mounted in a DIL package. Designed for PCB mounting and may be placed in blocks or rows without wasting space. Use for pre-programming, changing circuit constants and many more uses.

Cat. S-1608 \$1.90
10 or more \$1.70 ea



ILLUMINATED SPST (12V)

Intended for automotive use. The soft glow from the toggle is not distracting in night driving, but means the switch can quickly be located. 12V lamp operates from supply being switched.

- Features: 12V DC, 16A contacts
9mm mounting hole
Body size: 28 x 15mm

Cat S-1214 \$1.75
10 or more \$1.50 ea



40 CHANNEL CB SWITCH

As used in most Cybernet CB radios. Binary coded output for PLL02A IC: the most commonly used PLL. Ideal replacement part.

Cat S-6300 \$7.95
10 or more \$7.75 ea



MINIATURE

Small in size but very handy contact rating! The silver plated SPDT contacts will handle up to a massive 2 amps (at 24V DC or 100V AC). Nominally 8 to 12V operating, but will work ok up to 15 volts.

- Contact current (max): 2A
Contact voltage (max): 100V
Nominal coil voltage: 8-12V
Coil resistance: 225 ohm

S-7120 Price ea: \$1.95
10 or more: \$1.75 ea

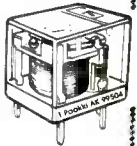

LEARN TO SPEAK STRINE

As you probably realised not all Australians speak the way the 'WIZZ SAGA' is written all of the time but if you spent a day with a couple of Aussies (pronounced Ozzies) you'd be pretty likely to hear most of the words and phrases at least once. The further away from the main cities you get the more they are used and the broader the accent becomes. Australians from the outback are sometimes criticized for not opening their mouth when they speak. The reason is of course that if they do open their mouth they would probably get a fly or some dust in it - fair dinkum!

This glossary will help you understand the 'WIZZ SAGA' and perhaps the next Australian you meet.

| WORD OR PHRASE | APPROXIMATE MEANING |
|----------------|---|
| ankle biters | young children |
| bawdy | really good, as in bawdy bottle |
| blimey | exclamation, surprise, wonder, awe, depending on the emphasis |
| bloomin' heck | surprise, disappointment, a curse |
| bloke | male Australian person |
| blow-in | a person who is new in town |
| bonkers | bananas, crazy |
| bonza | very nice, e.g. a bonza day |
| caper | a project, activity |
| Captain Cook | cockney rhyming slang for 'look' |
| in clover | well off, like cattle in a clover patch |
| cottoned on | understand |
| crackers | see bonkers |
| crikey | assertion of surprise, or to add emphasis to a statement e.g. I'm serious by crikey, m-ans I'm pretty darned serious. |
| cushy number | easy job |

MERCURY 'TILT' SWITCH

LOW COST - RELIABLE - PERFECT FOR ALARMS

This is essentially a movement detecting switch. It is operated by changing the horizontal plane. A 'ball' of mercury runs from one end of the elongated tube to the other as the position is changed. One end has a set of contacts that 'make' with the mercury. It is basically a low current device but is suitable for such uses as movement detectors for car or bike alarms.

Price ea: \$1.20
10 up \$1.10 ea



MINIATURE TYPES

MOST POPULAR RANGE - SPECIALLY IMPORTED - EXCELLENT QUALITY

All feature: 125V AC 5A
Chrome toggle
Complete with two nuts and two washers

SPDT Body 8mm x 13mm, clearance 17mm
125V AC 5A (240V AC 2A)

Cat S-1173 1-9 \$1.00
10 or more 90c ea



DPDT Body 13mm x 13mm, clearance 17.5mm
125V AC 5A

Cat S-1174 1.50
10 or more 1.35 ea



NEONS

Small pigtail type neon bulb as used in indicators, timing circuits, oscillators, etc. etc. Striking voltage 70 - 90 volts at 600uA. For 240V operation use 270k 1/4W resistor (other voltages can be worked out from Ohm's law.) Cat S-3862

Price ea: \$1.50
or 10 up \$1.20 ea



IN-LINE HOLDER (3AG)

.55c
10 or more .50c ea

Protection for car radios, stereos, transceivers, etc. All plastic casing, takes standard 3AG fuse, with spring loaded contacts for positive connection. Complete with 600mm lead at no extra charge. Cat S-4277



XENON FLASHTUBE

Xenon-filled flash tube, as used in strobes, warning and safety applications, photographic work, etc. etc. And look at the bargain price: you'd expect to pay double! Operate from 200 - 400 volts (300V nominal) with 4kV trigger. 5 watts maximum input power. Cat S-3882 10 or more \$1.40 ea



Trigger transformer to suit: 4kV trigger transformer for above flashtube. PCB mounting type. 300V primary, 4kV sec.

Price ea: \$1.25
(10 up 90c) ea

Cat M-0104

PLACE YOUR ORDER NOW - PHONE (415) 368 1066
CIRCLE 255 ON FREE INFORMATION CARD

COMPONENTS

KNOBS

Small knob with fluted sides, small skirt with dot pointer. Size: $\frac{3}{8}$ " dia. $\frac{1}{2}$ " deep. Cat H-3762

10 or more
30 25¢ ea

A superb instrument knob with wide skirt, calibrated 1-10 in black on silver. Size: $1\frac{1}{2}$ " dia. 12" deep. Cat H-3770

10 or more
60 55¢ ea

A very popular knob for all instruments, etc. Very positive grip and wide skirt with white pointer engraved on top. Size: $1\frac{1}{2}$ " dia. $\frac{1}{2}$ " deep. Cat H-3766

10 or more
40 35¢ ea

Another very popular knob. The pointer runs right through from the top to the edge of the skirt. Silver insert. Size: $1\frac{1}{2}$ " dia. $\frac{1}{2}$ " deep. Cat H-3772

10 or more
40 35¢ ea



METAL CABINETS

Beautifully made cabinets to suit a huge variety of projects:

- Strong aluminium base
- Cooling slots
- Screw together
- Attractive two-tone finish

PLEASE COMPARE OUR PRICES

| | | Ea | 10 up |
|------------|---------------------|--------|--------|
| Cat H-2741 | 4" x 2.2" x 3.3" | \$2.25 | \$2.00 |
| Cat H-2742 | 5.9" x 2.4" x 4" | \$2.95 | \$2.70 |
| Cat H-2743 | 5.9" x 3" x 5.3" | \$3.50 | \$3.00 |
| Cat H-2744 | 7.3" x 2.75" x 6.3" | \$4.50 | \$4.00 |

STONE THE CROWS TIZZY UP YOUR PROJECT WITH THESE BEAUT KNOBS

THREE EASY WAYS TO ORDER

1. BY PHONE

What could be easier! All you have to do is ring our special order line on (415) 368 1066. It's a 'hotline' especially to take your order - so you won't have to wait! Then quote your credit card number and your address - and tell us what you want. That's all! You don't pay a cent until you get your credit card statement next month!

2. BY TELEX or FAX

You can use your credit card to order using the ultra modern mediums too! Simply send your request to Telex 160488 or Fax (415) 368 0140.

3. BY POST

Over 1,000,000 delighted customers around the world just can't be wrong! Everybody loves our simple, reliable order-by-mail service. Try it! Use the mail order form on right. You choose the method of payment you want. And once again, we'll have your order on its way.

Dick Smith Electronics Inc
Express Order Center
P.O. Box 2249 Redwood City CA 94063

PRICES IN THIS MINI-CATALOG ARE
CURRENT UNTIL 30 JUNE 1985

OR UNTIL STOCKS RUN OUT
We've got all our customers' mail order needs wrapped up!

Just look at the great services we offer you!

You can order from Dick Smith Express Mail Orders with confidence. Why? Our exclusive 14 day money-back guarantee - if you're not completely satisfied, return your purchase within 14 days and we'll refund the purchase price in full! (Note: this policy does not apply to semiconductors or books - goods must be returned in original condition and packaging.)

● We're no fly-by-nighters - when it comes to the mail order business, we really know our stuff! (After all, we've had 17 years practice at giving the best service possible!)

● A large selection of electronics - over 3,000 lines in all! There's something for the hobbyist, the homemaker, the professional... and for you. Our mail order service offers just as big a range as a Dick Smith store (sometimes even larger, with our mail-order-only specials!)

● A clever system called 'Automatic back-ordering'. You see, very popular lines sometimes sell out quickly. If any item you order is out of stock, we save you the worry of reordering it. When stock arrives, you're the first in line and we send you the goods - post free! Yes, it is a costly process... but we do it as a service to our customers.

● You also have the option to get a refund on goods not supplied

● No matter where you are in the world, Dick Smith Electronics will send mail orders to you!

19" RACK MOUNTING CASE



\$19.95
10 up **\$17.95** ea

Professional quality black instrument case fits standard 19" racks, overall they're 16.75" x 9.8" x 5.5". Supplied flat, assembly takes just a couple of minutes. Heavy gauge (0.12") front panel; top and bottom pre-punched for ventilation. Cat H-2481

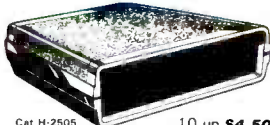

REGULAR PRICE WILL BE \$9.95

A superb case for all 'instrument' type projects, and many other besides. Case splits apart for ease of working, comes complete with 4 moulded feet and assembly screws. Amazingly versatile allowing for various PCB mounting positions, front & rear panel are moulded plastic for ease of working (they can be replaced with aluminium panel if required). Size approx. 8" x 6 1/2" x 2 1/4". Cat H-2505

Clean up all your bits and pieces!

16 DRAWER CABINET



Cat H-2588... 16 drawer unit

UNBEATABLE LOW PRICE
\$9.95

Sick of looking for those small bits and pieces? This cabinet of drawers is just what you need for components, screws, nuts, bolts and other items around the house - that need tidying up!

- ECONOMICAL ● COMPACT ● CLEARVIEW DRAWERS
- USEFUL SIZE ● 16 DRAWER UNIT - a total of 16 drawers each 2.5" (w) x 5.4" (l) x 1.4" (d) ● CABINET SIZE - 11.8" (w) x 7" (h) x 5.5" (d).

IDEAL FOR THOSE LITTLE BITS ON THE SIDE
\$19.95 10 or more
\$17.95 ea

Components/Parts Cases

Clean up your workplace

- Strong plastic ● Very versatile ● Variable component sizes ● Clear lid ● Positive fasteners ● Removable trays

Ideal for hobbyist, servicemen, house-holders and artists

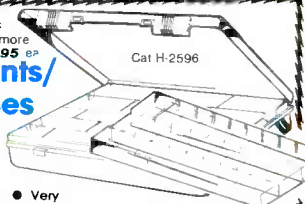

Cat H-2596

The Stackable System

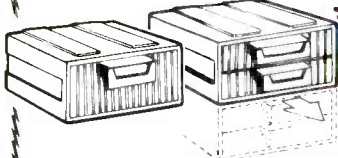

Over the years we have seen many types of component drawers come and go - BUT these drawers go on because they are so popular. ● Large handles ● Index card slot for labelling ● Precision dovetail ways so that the boxes may be securely locked together ● Wall or bench mountable ● White high impact plastic with the drawers moulded in red & blue. Overall dimensions (both types) 4.5" (w) x 2.25" (h) x 5" (d).

TWO USEFUL TYPES

Cat H-2584 one drawer per box 1-9 **\$1.95** 10 up **1.70** ea
Cat H-2585 two drawers per box 1-9 **\$1.95** 10 up **1.70** ea

Quality Components Low-Low Prices

DINKI DI GENUINE

There is only one 'Speedy' box - the one with the all-round deep ribbing. Don't be fooled by inferior copies - this is the one used because of its versatility. Insist on the one and only - genuine - Speedy Box from Dick Smith!

- Small - #5 (1.1" x 2.1" x 3.25") \$1.25 ea 10 up \$4.05 ea
- Medium - #3 (1.6" x 2.7" x 5.1") see below Cat H-2753
- Large - #4 (1.9" x 3.5" x 5.9") \$2.00 ea 10 up \$1.70 ea
- Giant - #2 (2.4" x 4.45" x 7.7") \$2.50 ea 10 up \$4.05 ea

MOST USEFUL SIZE #3 SPEEDY BOX H-2753

POWERFIN FOR TO-3



This heatsink has a unique fin design that gives a very high air to metal (thermal rating approximately 41°F/Watt). Measures only 2" square x 1" high, pre-punched to suit TO-3 case. Black anodised finish. Cat H-3400... 1-9 **95¢** 10 up **85¢** ea

VERSATILE POWER HEATSINK

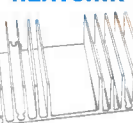

The ingenious design of this heatsink makes it possible to mount it either flat on a panel, or at right angles to it (e.g. inside a case). They may be joined sideways. Takes 2 x TO-3's. Size is 3" x 4.3" x 1.3". Pre-drilled Cat H-3461... 1-9 **\$3.50** 10 up **\$3.00** ea

ALUMINIUM HEATSINKS

ROUND TO-5

Manufactured to exacting tolerances to ensure a snug fit and best possible heat transfer on TO-5 cases. Cat H-3412... 1-9 **45¢** 10 up **40¢** ea

COMPARE OUR PRICES ON HEATSINKS AND SEE HOW MUCH YOU SAVE!!!

UNIVERSAL

Universal hole pattern takes most 'power' type semiconductors. Ribbed walls and black anodised finish for maximum efficiency. Cat H-3401... 1-9 **75¢** 10 up **65¢** ea

ECONOMY POWER HEATSINK



Flag mounting with fins both top and bottom, accepts two power transistors of most type: TO-3, TO-18, TO-220, etc. Size 3" x 4" x 1". Pre-drilled Cat H-3471... 1-9 **\$2.50** 10 up **\$2.00** ea

EXTRA HEAVY DUTY POWERFIN HEATSINK



8.85" long! Radial fin cross section, for those big projects where a lot of heat has to be removed. Cat H-3426... 1-9 **\$8.95** 10 up **\$7.95** ea

Learn to Speak Strine

She'll be right mate
shindig
silt pat
stone the crows
struth
sussing
tin lids
true blue
tumble
two bob's worth
yarn

see "No River Murrays" - same as she'll be sweet
a really slip-up party
not going anywhere, satisfied with the situation as it is
has meanings ranging from amazement to disgust
surprise or disappointment
gaining understanding
rhyming slang for kids - young children
genuine Australian article - including people
this is what happens when the penny drops
your say on the matter

a relaxed conversation about things in general - not small talk
To 'spin a yarn' is to tell a fairly long joke or a tall story.



ORDER FORM

DICK SMITH ELECTRONICS INC.

Mail Order Center located at 390 Convention Way Redwood City CA 94063

P.O. Box 2249 Redwood City CA 94063 For orders telephone: (415) 368 1066

17 YEARS OF RELIABLE MAIL ORDER SERVICE

A
Name Address
..... STATE ZIP Tel. No

B DO YOU WISH TO USE OUR BACK ORDER SERVICE IF THERE ARE SOME ITEMS NOT IN STOCK? YES NO Date

| Cat. No. | Qty. | Description | MINIMUM ORDER \$10.00 | Item Price | Total Price |
|----------|------|-------------|-----------------------|------------|-------------|
| | | | | | |
| | | | | | |
| | | | | | |
| | | | | | |
| | | | | | |
| | | | | | |
| | | | | | |
| | | | | | |
| | | | | | |
| | | | | | |
| | | | | | |
| | | | | | |
| | | | | | |
| | | | | | |

PLEASE CHECK YOUR ORDER

Ensuring that your order is correct now will save confusion and time—enabling us to speed it to you more quickly.
A Have you written your name and correct address clearly?
B Please check that you have correct Cat No., Qty, Description and prices
C Have you calculated your postage and packaging and added your TOTAL correctly?
D Ensure that you have completed your card number and expiry date correctly and signed the form if using a credit card

POSTAGE AND PACKAGING WITHIN U.S.A.

Postage & Packaging: 5% of total order (Minimum \$1.50) This includes all handling of your order.
Insurance: \$2.00 per \$100 of order
Tax: Californian residents add 6.5%

OUTSIDE U.S.A.

Postage & Packaging: 20% of total order (Minimum \$5.00)
Insurance: \$3.00 per \$100 of order
Payment: VISA, Mastercard or Bank Draft in U.S. Dollars

| | |
|-------------------------|--|
| Merchandise Total: | |
| Tax, 6½%: (Calif. only) | |
| Postage and Packing: | |
| Optional Insurance: | |
| SUB TOTAL: | |
| Less Credit* | |
| TOTAL \$ | |

VISA PAYMENT: VISA Mastercard D.S.E. Credit Note Check Expiry Date:

D Authorized Signature:

14 DAY MONEY BACK GUARANTEE



This is our huge Australasian buying complex and distribution center of over 100,000 square feet area near Sydney in Australia.



The exciting new Dick Smith Electronics showroom and large distribution center at Redwood City in Silicon Valley.

Why you should buy from Dick Smith Electronics

Buying power – lower prices

Even by world standards we're one of the largest electronic hobbyist suppliers with over 30 stores and more than 300 dealers. This gives us tremendous buying power. The better our buying power the lower our costs – the lower our costs, the lower our prices. You reap the benefit!

We're well established

With 17 years in business means we're no fly-by-night company – we'll be here when you need support.

Nearly \$1 billion in assets

Being backed by nearly one billion dollars in assets means management and financial strength.

Commitment to you, the electronics enthusiast

Dick Smith Electronics was founded and built by electronics enthusiasts. This commitment is now stronger than ever.

Satisfaction Guarantee

Our 14 day mail order satisfaction guarantee means that if you are not absolutely delighted with any purchase, you can return it (in original condition and packaging) for a full refund and you owe us nothing, not even an explanation.

Guarantee on all products

90 day warranty for parts and labour on all products. We don't forget you after the purchase.

International buying

17 years of world buying experience means we've discovered who can supply us with the best quality and value.

More exclusive products

Our buyers visit factories throughout the world every month. We'll keep you supplied with the newest products as soon as they're released.

UNBEATABLE VALUE, UNBEATABLE SERVICE

Here's how to find us in California:

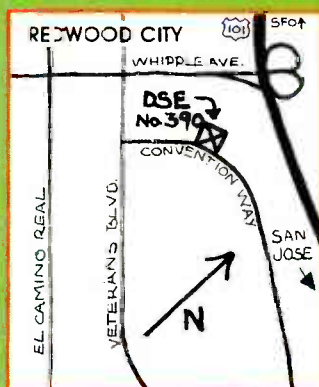

STOP PRESS

We will be opening a fabulous new Electronic Enthusiasts store in the San Francisco Bay Area soon. Watch for details of Grand Opening Day BARGAINS in our advertisements in electronics magazines and local papers.



... and look at the exciting wonderland of products for electronic enthusiasts you'll find when you get there. There are literally thousands of different products – many exclusive to Dick Smith Electronics.

Like what you see? Our new catalog (out in June) will have 10 times as many fascinating products as what you see here.

Mail this coupon today to reserve your FREE copy of our goody packed, 100 page ELECTRONIC ENTHUSIASTS CATALOG.

Name

.....

..... City State Zip

MAIL TO: Dick Smith Electronics Inc
P.O. Box 2249 Redwood City CA 94063

WIN a trip to
THE LAND DOWNUNDA
for 2 people flying **QANTAS**



Send in the coupon to reserve your FREE copy of our GIANT Summer ELECTRONIC ENTHUSIASTS CATALOG and we'll put your name in a DRAW for the airfare for two people to Sydney, Australia and return. The draw will be made on June 30, 1985.

Note: Dick Smith Electronics Inc. makes this offer freely and without requirement for you to buy, but your freedom to take part will be governed by the laws of your home state.

POWER METER

IT'S NOT UNCOMMON TO see loudspeakers with power ratings of 500 watts or more. Now, you might think it safe to connect such speakers to any amplifier of 500 watts or less, and expect that combination to comfortably run at full power. Unfortunately, that's not so!

While some speakers may be able to handle instantaneous peaks of that magnitude, they can also be destroyed by continuous operation at substantially lower power levels. For example, the author's speakers are rated at 680 watts but are only capable of handling 30 watts in continuous operation!

While most amplifiers have some sort of built-in protection circuitry, that circuitry does nothing, of course, to protect the speakers. That circuitry is designed to protect the amplifier *only*, and therefore will not kick in until long after the speakers have begun to smoke!

Here's something else to consider: Many of today's otherwise fine power amplifiers have no turn-on delay. At power up, the output may swing briefly to the positive or negative supply rail. (We've all heard that loud, dull thump at turn-on.) Even if that doesn't destroy the speakers outright, it certainly does nothing for their performance.

From what we've seen it is clear that a proper speaker-protection device must pass large power levels for musical peaks, but disconnect the speakers if the amplifier produces a sustained high-level output. The circuit described here does that, and also provides a turn-on delay.

If that doesn't peak your interest, included in this circuit is a peak-reading LED dot display that shows the output level being fed to your speakers. Not only is the circuit helpful in protecting speakers, but it also provides a fascinating demonstration of the power required to handle musical transients. The power monitor is designed so that successive LED's are turned on by a each 3-dB increase. That allows high resolution at low power levels,



for your STEREO

More than just a peak-reading power meter, this easy-to-build project disconnects your speakers before your amplifier does the job—permanently!

MARK S. COHEN

Circuit description

Figure 1 is a schematic diagram of our circuit. It consists of four parts: an input buffer and peak detector, power-metering circuit, relay-control section, and, of course, the power supply.

Let's see how the circuit works. The left- and right-channel inputs are independently rectified and their peaks sampled. That information is sent to the metering circuits for display, and to the relay-control section. That section disconnects the speakers from the amp when the continuous power level is above a user-defined level (which is determined by the rating of your speakers). The relay-control section also contains the turn-on delay.

Let's take a closer look at the individual sections. **Note:** From here on, we'll only discuss the left channel as both left and right are identical. At the input, resistors R1 and R3 form a voltage divider to attenuate the input signal. Those resistors are selected to yield an output of 10 volts when the amplifier is delivering its maximum rated output. Table 1 is provided to

help in the selection of R1 (R7 for the right channel) for various amplifier power and speaker impedance combinations.

Transistor Q1 is configured as a voltage follower. The Q1 output is rectified by diodes D1 and D2, which conduct only when the emitter voltage exceeds that at capacitor C1.

The parallel combination of R5 and C1 produces an extended time constant for the peak-reading operation of the meter. Capacitor C1 charges rapidly through resistor R4 (at the Q1 collector) and discharges slowly through R5. That allows easy viewing of peak power-levels.

The speaker protection circuit is formed by comparators IC3, IC4, relay RY1, and a few discrete components. Potentiometer R24 is used to set the circuit trip point, which is equal to your speakers' continuous power-handling rating (we'll explain just how that's done

TABLE 1
ATTENUATION RESISTOR VALUES

| Speaker Impedance | 50W | 100W | 200W | 400W | 800W |
|-------------------|------|------|------|------|------|
| 2 ohms | * | 3.9K | 10K | 18K | 30K |
| 4 ohms | 3.9K | 10K | 18K | 30K | 47K |
| 8 ohms | 10K | 18K | 30K | 47K | 68K |
| 16 ohms | 18K | 30K | 47K | 68K | 100K |

(*To read a maximum power level of 50W into 2 ohms, R1 and R7 should be replaced by a piece of wire between the appropriate printed circuit board pads.)

in a moment). That trip voltage is applied to pin 2 of IC3-a.

The voltage from the input section is fed to pin 3 of IC3-a via the series combination of R6 and C2. The values of the components in that R-C circuit are selected so that the capacitor charges almost instantaneously for high voltages, but slowly for lower voltage levels.

Should the voltage at pin 3 exceed the voltage at pin 2, the comparator outputs a high. When that happens, the voltage at pin 2 of IC4 rises above that at pin 3,

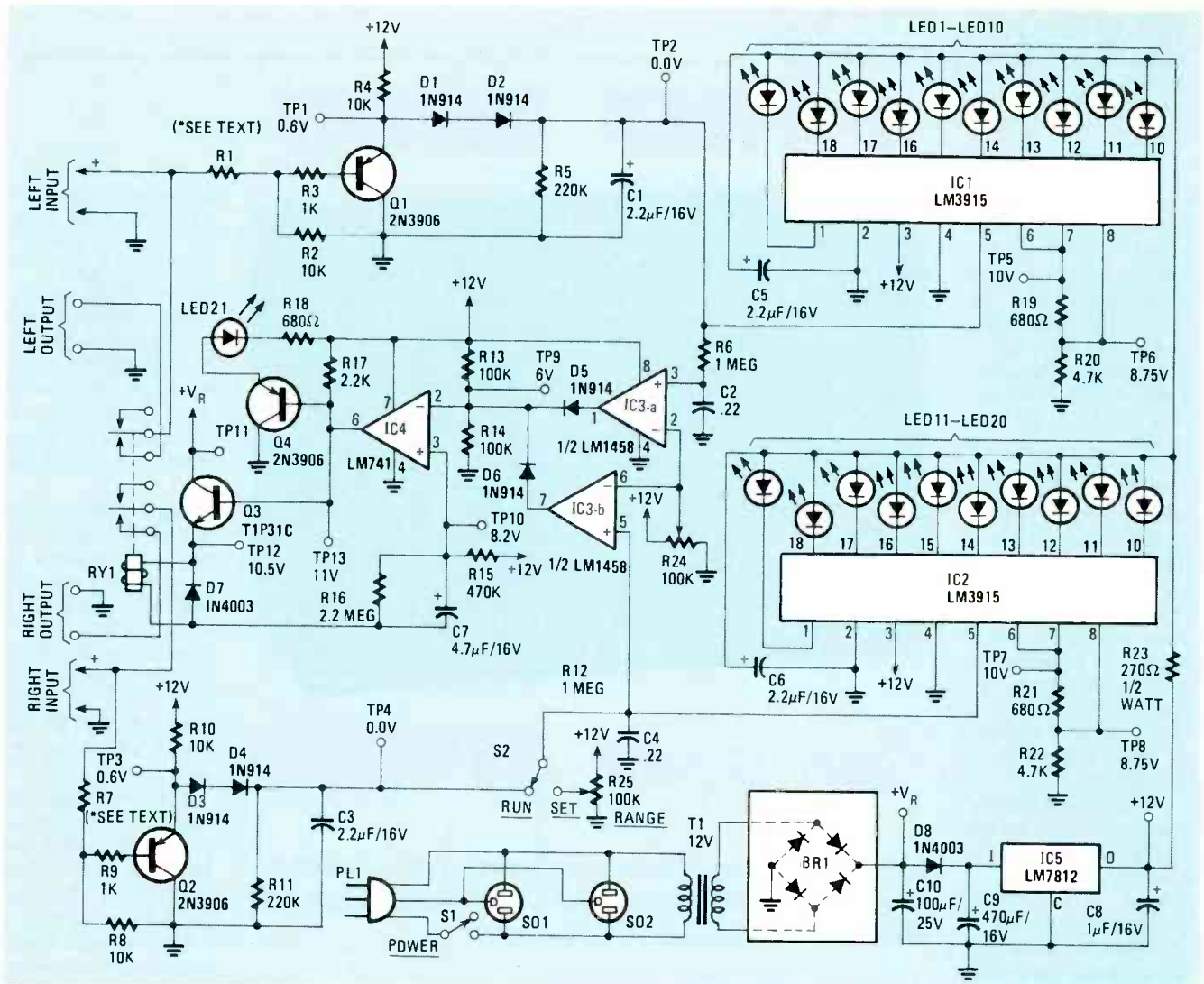

FIG. 1—THE SCHEMATIC DIAGRAM for the circuit is shown here. Note that a separate power supply is provided for transistor Q3.

causing that comparator's output to go low.

When the output of IC4 goes low, Q3 stops conducting. That, in turn, cuts off the current flow through RY1 causing the relay to open, disconnecting the speakers.

Also, when IC4 goes low, transistor Q4 begins to conduct. That causes LED21 to light, indicating that the protection circuit has been tripped.

Diode D7 protects Q3 against energy stored in the relay that might otherwise damage the transistor when the relay is turned off. Also, note that transistor Q3 is fed from a separate 16-volt power supply, +V_R. We will see later that +V_R is designed to turn off rapidly so that the relay quickly opens when power is removed from the circuit, to protect the speakers from both turn-off and turn-on transients.

A six-second turn-on delay is provided by C7 charging through R15. At power up, the voltage at pin 2 of IC4 is set to 6 volts by a voltage divider made up of resistors R13 and R14. Diode D5 is included to ensure that the reference voltage

at pin 2 of IC4 is not affected by a low at the output of IC3-a.

Pin 3 of IC4 is initially at ground; therefore, its output is low and the relay is turned off. At power up, capacitor C7 charges slowly through R15. When the charge on C7 (tied to pin 3) exceeds 6 volts, IC4 outputs a high, turning on Q3. That closes the relay contacts, connecting the speakers.

The display portion of the circuit is made of an LM3915 LED display driver (IC1). That IC can produce either dot or bargraph outputs. As shown in the schematic, it is wired as a dot-display driver. Successive LED's are turned on when the input voltage is increased by 3 dB (power doubled). Table 2 lists the peak power level at which each LED lights. As that table shows, those power levels depend on the maximum rated output of your amplifier, assuming that R1 has been selected as described earlier. For instance, if the maximum output of your amplifier is 50 watts, then LED's 1 and 11 light at 0.1 watt, and so on. Resistors R19 and R20, tied to pins

TABLE 2
PEAK POWER DISPLAYED

| LED | 50W | 100W | 200W | 400W | 800W |
|-------|-----|------|------|------|------|
| 1,11 | 0.1 | 0.2 | 0.4 | 0.8 | 1.5 |
| 2,12 | 0.2 | 0.4 | 0.8 | 1.5 | 3 |
| 3,13 | 0.4 | 0.8 | 1.5 | 3 | 6 |
| 4,14 | 0.8 | 1.5 | 3 | 6 | 13 |
| 5,15 | 1.5 | 3 | 6 | 13 | 25 |
| 6,16 | 3 | 6 | 13 | 25 | 50 |
| 7,17 | 6 | 13 | 25 | 50 | 100 |
| 8,18 | 13 | 25 | 50 | 100 | 200 |
| 9,19 | 25 | 50 | 100 | 200 | 400 |
| 10,20 | 50 | 100 | 200 | 400 | 800 |

6 and 7 of IC1, control the brightness of the display and set the voltage level needed to light LED10. Resistors R19 and R20 are chosen so that a 10-volt input lights LED10.

If preferred, a bargraph display may be selected by connecting pin 9 of IC1 to the power supply; appropriate holes for a jumper wire are provided on the PC board. If you chose the bargraph mode, R23 (270 ohms 1/2 watt) should be replaced with a 39 ohm, 5 watt unit. Note that the LM3915 has a nasty tendency to oscillate under some conditions: C5 is in-

cluded to protect against that.

The power supply is straightforward—a simple bridge rectifier and a single LM7812 regulator (IC5) gives a constant 12-volt output. The $+V_R$ supply is filtered only by C10, which is isolated from C9 by D8. That produces a fast turn-off of the relay when power is removed.

The power switch, S1, also turns convenience outlets SO1 and SO2 on and off. Those outlets are intended to be used as power connections for the rest of the stereo system. Using those outlets ensures that power is applied to all components simultaneously, and that all transients have ended before the speakers are connected. Thus, S1 acts as a master power switch.

Finally we come to S2 and R25. Switch S2 is a SPDT unit that is used to disconnect the right channel input and instead connect potentiometer R25 to the comparator and display circuitry. With S2 in the SET position, R25 is used to set the trip point (which is determined by R24 and your amplifier's maximum rated output) so that the speakers are disconnected at the desired power level.

Construction

The circuit is straightforward enough to be built on perfboard, but it is strongly recommended that a PC board be used. PC board minimizes construction errors and saves time in the long run.

A few factors had to be taken into account in the circuit layout. Capacitors C5 and C6 should be placed as close to the LED's as possible. All ground connections on the left and right input and display circuits should be returned directly to pin 2 of IC1 and IC2 respectively. That's done to prevent oscillation of the LM3915, which may occur under some circumstances. When LED's 1-20 are all turned on, R23 may have to dissipate as much as 5 watts; so it's a good idea to put some space between it and any other components.

The first step is to etch your own PC board or acquire one from the supplier given in the Parts List. The PC-board pattern is shown in Fig. 2; the corresponding parts-placement diagram is shown in Fig. 3.

First note that the IC's are not socketed (see Fig. 4), although sockets may be used if desired. Also note that some resistors and diodes are mounted vertically (like radial lead capacitors).

Turning to the resistors first, the holes on the board are spaced for 1/4-watt units with their leads bent flush to the resistor body. Install all fixed resistors, making sure they are in their proper positions. Once that's done finish up by installing potentiometers R24 and R25.

The capacitors should be the next components installed. Observe capacitor polarities and be sure that all units are

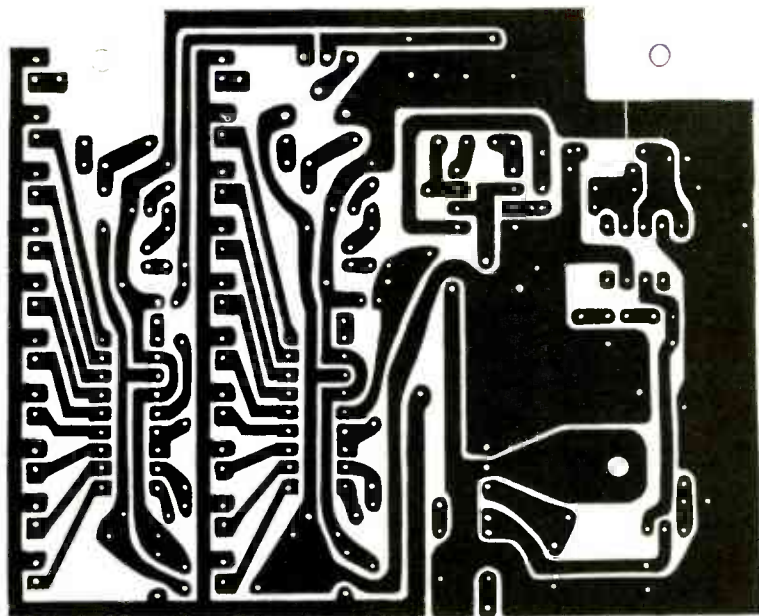

3-15/16 INCHES

FIG. 2—THE FOIL PATTERN for our speaker-protection device/power meter is shown here full size.

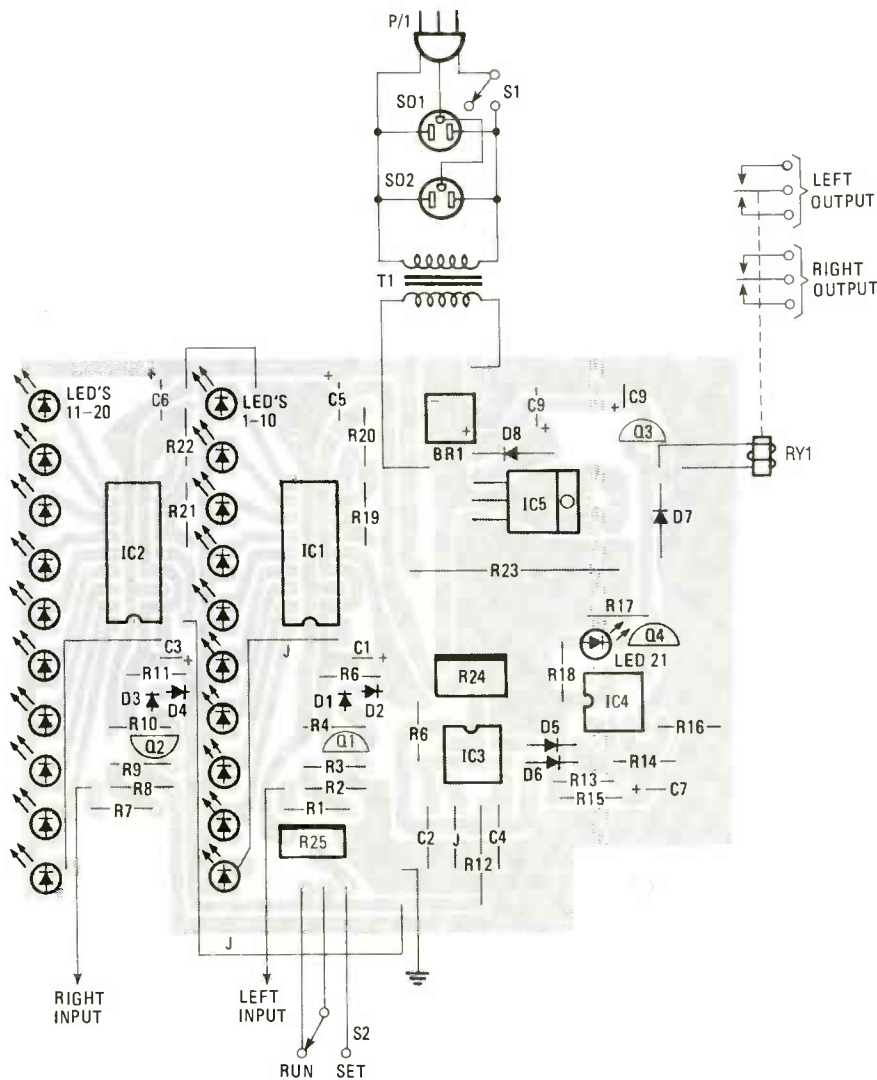

FIG. 3—PARTS-PLACEMENT DIAGRAM for the foil pattern given in Fig. 2 is shown here. Note that several of the holes are not used.

PARTS LIST

All resistors ¼ watt, 5% unless otherwise noted.

R1, R7—see Table 1
 R2, R4, R8, R10—10,000 ohms
 R3, R9—1000 ohms
 R5, R11—220,000 ohms
 R6, R12—1 Megohm
 R13, R14—100,000 ohms
 R15—470,000 ohms
 R16—2.2 Megohms
 R17—2200 ohms
 R18, R19, R21—680 ohms
 R20, R22—4700 ohms
 R23—270 ohms, ½ watt
 R24, R25—100,000 ohms, trimmer potentiometer

Capacitors

C1, C3, C5, C6—2.2µF, 16 volts, tantalum
 C2, C4—0.22µF, ceramic
 C7—4.7µF, 16 volts, tantalum
 C8—1µF, 16 volts, tantalum
 C9—470µF, 16 volts, electrolytic
 C10—100µF, 25 volts, electrolytic

Semiconductors

IC1, IC2—LM3915 LED dot bar display driver
 IC3—LM1458 dual op-amp
 IC4—LM741 op-amp
 IC5—LM7812 12-volt regulator
 Q1, Q2, Q4—2N3906 PNP transistor
 Q3—TIP31C NPN transistor
 BR1—50 PIV, 500-mA bridge rectifier
 LED1—LED21—jumbo LEDs
 T1—12-volt, 500-mA transformer
 S1—SPST, rocker switch, 15 amps
 S2—SPDT submini PC mount switch
 RY1—DPDT 12-volt DC relay
 SO1, SO2—grounded convenience outlets (see text)

Miscellaneous:—case, 3 conductor line cord, strain relief, PC board, jacks for input and output, screws, solder, wire, etc.

The following is available from Clearview Designs, Inc., 217 East 85 St., Suite 467, New York, NY 10028: complete kit including wire, solder, step-by-step instructions, and all components except case for \$59.95, plus \$3 postage and handling; circuit board only available for \$10. New York State residents add 8¼% sales tax. Other selected components available by arrangement, contact Clearview Designs, Inc. for details.

oriented properly.

Next, install the diodes. Once again, carefully note their orientation (see Fig. 3). It is a good idea when soldering semiconductors to attach an alligator clip to the lead being soldered. The clip acts as a heat sink to protect the device from damage during soldering. Diodes D1—D4 are all installed vertically as shown in Fig. 4. When done with the diodes, install the transistors.

Install the IC's next, noting the orientation of pin 1. Pin 1 may be marked with a painted band, notch, or dot. With the marked end on top, pin 1 is in the upper left corner. The LM7812 regulator, IC5, should be installed so that when bent back, its flat side is flush with the board.

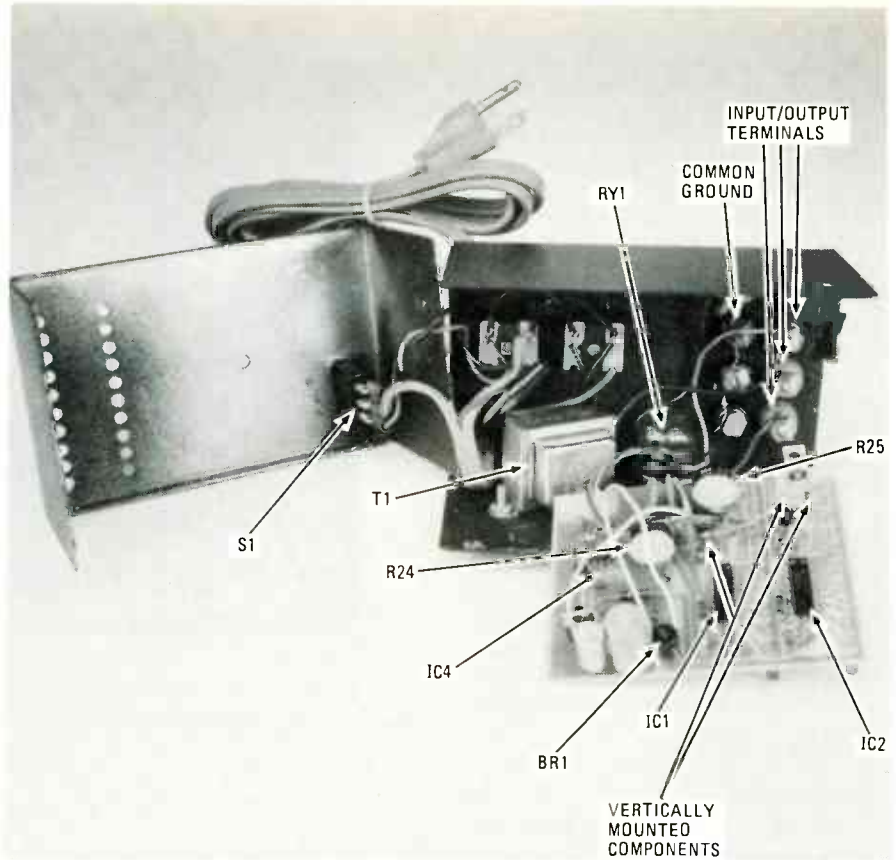

FIG. 4—INSIDE THE UNIT. Note that several components are vertically mounted on the PC board.

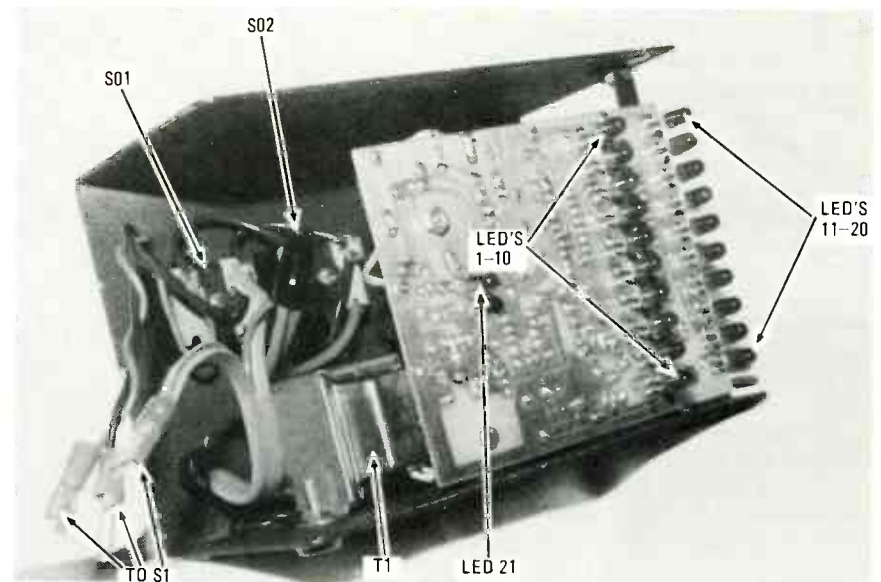

FIG. 5—LED1—LED21 ARE MOUNTED on the foil side of the PC board. Using a cardboard spacer during installation as described in the article helps ensure that all of the LED's are mounted at the same height.

Next install the bridge rectifier, BR1, again noting the proper orientation.

Next solder S2 in place on the PC board. Then install the five jumper wires; either bare or insulated wire may be used. The LED's, which mount on the foil side of the board (see Fig. 5), should all be positioned at the same height. To make the task easier, insert a cardboard spacer, about ¼-inch wide, beneath the LED's during soldering.

As the circuit does not require any special shielding, it can be placed in any appropriately sized cabinet. Prepare the cabinet by drilling carefully spaced holes into the front panel for each LED. Or you may cut out a single block and use a bezel with lens to improve the unit's appearance. The relay, transformer, power switch, AC outlets, and input/output jacks are mounted on the cabinet as shown

continued on page 119

Servicing Cordless Telephones

A cordless telephone, like any other piece of electronic equipment, is bound to break down sooner or later. This article will show you how to troubleshoot and repair the problem.

CHRISTOPHER KITE

CORDLESS TELEPHONES ARE FAIRLY COMPLEX pieces of electronic equipment that in addition to containing all of the circuits of a standard telephone, also include two FM transmitters and receivers. If you've ever done any troubleshooting of communications equipment, you should have little trouble servicing cordless telephones. The radio portion is pretty straightforward, once you understand the frequency scheme and modulation technique used. However, telephone circuit operation and testing techniques may be somewhat new

to you, and as such, special attention will be given to that area of servicing in this article.

Of course, an article like this cannot cover all the variations found among the numerous brands and models of cordless telephones available. However, the basic operation of all cordless telephones is the same. The examples cited in this article can be readily adapted to the particular make and model you are servicing to help you track down specific problems in most cordless telephones.

How they work

Before we jump into our look at troubleshooting, let's learn a bit more about how a cordless telephone works. Basically, a cordless telephone contains all the circuits and functions of a conventional telephone, plus a two-way radio communication link. The two-way radio link must handle not only voice communications, but also some method of dialing, ringing, and controlling the hook switch.

Cordless telephones are made up of two



separate units: a base unit and a portable unit. Communications between the base and portable units are full duplex: that means that both the base-to-portable link and the portable-to-base link can operate simultaneously. Both the base and portable units have a transmitter and a receiver. The base unit is connected directly to the telephone line and serves as a link between the portable unit and the telephone line. Figure 1 shows how a typical cordless telephone system works. A block diagram of a cordless phone is shown in Fig. 2.

Cordless telephone base-to-portable links use a carrier signal in either the 1.7-MHz or 46-MHz frequency band. Earlier cordless telephone base-to-portable links use the 1.7-MHz band and use the AC power line as an antenna. That is necessary because a relatively long antenna is required at that low a frequency. Newer cordless telephone base-to-portable links use the 46-MHz band and a telescoping antenna. The base unit contains a power supply (operating from the AC line) that is used to power the transmitter and receiver and also to charge the batteries of the portable unit.

Cordless telephone portable-to-base links use a carrier signal in the 49-MHz frequency band. That signal is transmitted using a telescoping antenna. In addition to the transmitter and receiver, portable units contain a speaker, microphone, dialing keypad, and rechargeable batteries.

There are 10 pairs of carrier frequencies available for cordless telephone operation. Each base-to-portable channel has a

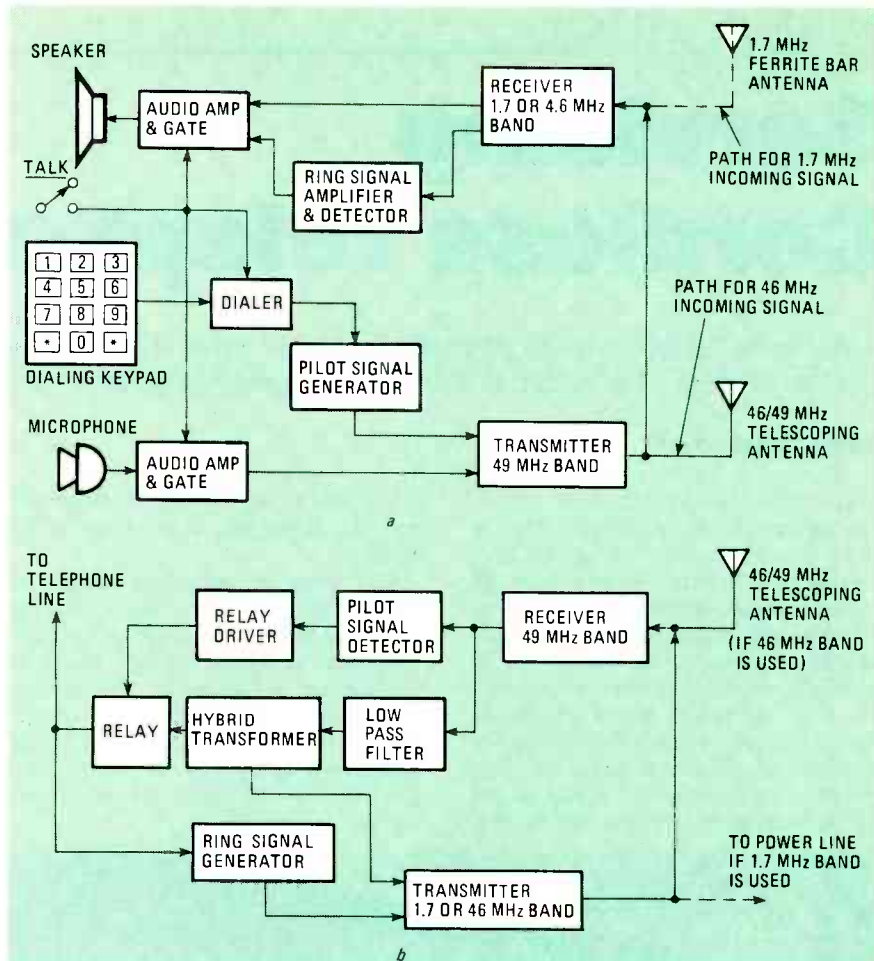

FIG. 2—HOW A CORDLESS TELEPHONE WORKS. A block diagram of a portable unit is shown in a, while the block diagram of the base unit is shown in b.

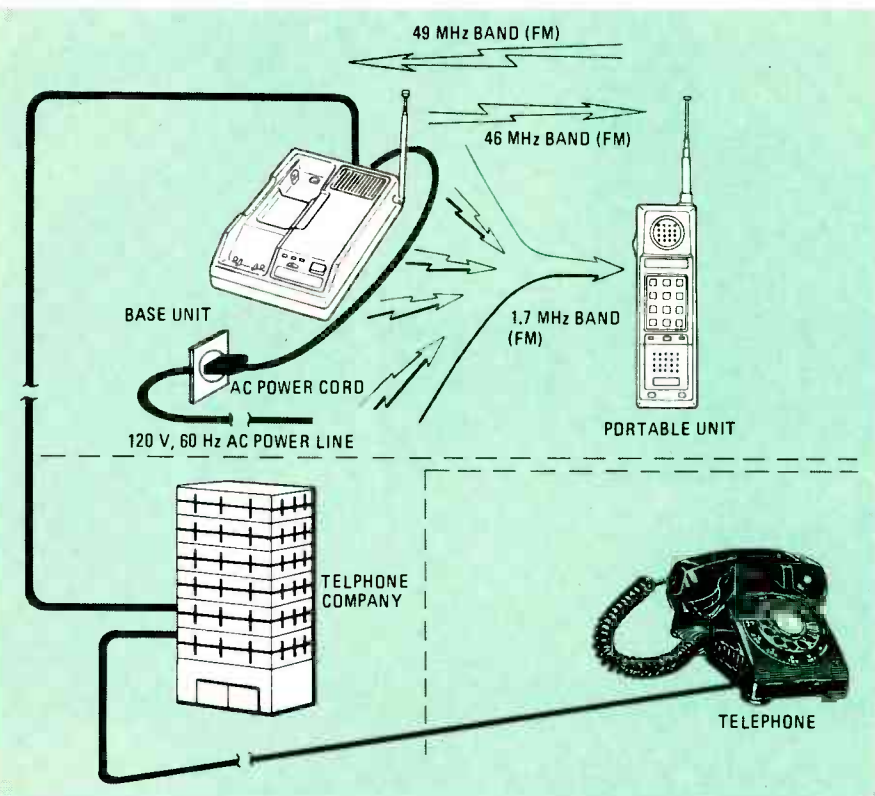

FIG. 1—THE BASE UNIT'S TRANSMITTER in a 1.7-MHz unit uses the base's AC power line as an antenna. That can pose some additional complications when servicing the cordless phone.

specific corresponding portable-to-base channel. The frequency pairs are listed in Table 1. Initially only the 1.7/49-MHz bands were allocated by the FCC. The 46/49-MHz bands were added after January 1, 1984.

Because of the limited number of cordless telephone frequencies, the same channels are used over and over again. With the relatively short range of cordless telephones and the use of the following techniques, a minimum of interference, false ringing, and security problems (i.e. unauthorized capturing of a telephone line) occur.

False ringing is reduced by using several specific ring frequencies for the base-to-portable link. In that way, two cordless telephones with overlapping range and operating on the same channel, but with different ring frequencies, will not cause ringing of the neighboring unit.

Similarly, use of several specific guardtones (pilot signals) for the portable-to-base link reduces unauthorized use of a telephone line. The base unit will not respond to a portable unit unless the proper guardtone is sent. That prevents capture of a base unit by a nearby portable unit on the same channel, but with a different guardtone.

Earlier cordless telephones used only

TABLE 1—CORDLESS TELEPHONE FREQUENCIES

| 1.7 MHz Band Frequencies | 49 MHz Band Frequencies | 46 MHz Band Frequencies |
|-----------------------------|----------------------------|----------------------------|
| 1.665 MHz | 49.670 MHz | 46.610 MHz |
| 1.690 MHz | 49.770 MHz | 46.710 MHz |
| 1.695 MHz | 49.830 MHz | 46.770 MHz |
| 1.710 MHz | 49.845 MHz | 46.630 MHz |
| 1.725 MHz | 49.860 MHz | 46.670 MHz |
| 1.730 MHz | 49.875 MHz | 46.730 MHz |
| 1.750 MHz | 49.890 MHz | 46.830 MHz |
| 1.755 MHz | 49.930 MHz | 46.870 MHz |
| 1.770 MHz | 49.970 MHz | 46.970 MHz |
| | 49.990 MHz | 46.930 MHz |

guardtones and ring frequencies to help prevent unauthorized capturing of telephone lines and false ringing. New cordless telephones use digital coding. With digital coding, ringing, dialing, and disconnecting are usually caused by a frequency shift of the carrier. That frequency shift is digitally encoded, and the encoding techniques vary from one manufacturer to another.

Incoming calls

Between calls, the cordless telephone is in a "standby" mode; that is, both the base and portable transmitters are turned off and both receivers are awaiting incoming signals.

When a 20-Hz ringing signal is received by the base unit from the telephone line, a 20-Hz ring detector turns on the base-unit transmitter and a ring-signal generator circuit that feeds a ring signal to the transmitter. Typically, that ringing signal has a frequency in the 700-Hz to 1500-Hz range. Different frequencies are used for ring signals in different cordless telephones to help prevent false ringing (i.e. the ringing of portable units that use the same channel when the ring signal does not originate from that portable unit's base unit). At the transmitter, the ring signal is used to modulate a carrier signal (either in the 1.7- or 46-MHz band). That modulated carrier is then transmitted to the portable unit.

The receiver section of the portable unit has power if the the portable unit is in either the talk or standby mode, as long as the power is turned on and the batteries are charged. The incoming signal is demodulated by the receiver and fed to the ring-signal detector. The ring-signal detector is a filter that only passes a ring signal of a certain frequency. If the ring frequency transmitted by the base unit is correct (i.e. is passed by the filter), the ring signal is passed to an audio amplifier. There the signal is amplified and fed to the speaker.

When someone answers the call, the portable unit is switched from the standby mode to the talk mode. That disconnects the ring signal from the amplifier and turns on the RF transmitter, pilot-signal generator, and both of the audio-ampli-

fiers-and-gates. The pilot signal (guardtone) and audio (from the microphone) are fed to the transmitter where they modulate a 49-MHz band carrier. That modulated signal is then transmitted over the telescoping antenna to the base unit.

The base unit receives the signal, demodulates it, and feeds it to the pilot-signal detector and a low-pass filter. When the pilot signal (guardtone) is of the correct frequency, the pilot-signal detector energizes the relay into an off-hook condition through the relay driver. The off-hook relay turns on the base-unit transmitter. The low-pass filter blocks the guardtone and feeds voice audio (300 Hz to 3 kHz) to the hybrid transformer. The hybrid transformer feeds the audio signal to the relay where it is sent out over the telephone line when the relay is in the off-hook state. The hybrid transformer also feeds a low-level audio signal to the transmitter for sidetone in the portable unit.

Incoming audio (from the telephone line) is fed through the relay to the hybrid transformer when the relay is in the off-hook state. That audio signal is fed to the transmitter where it is used to modulate a carrier signal in either the 1.7- or 46-MHz band. That modulated signal is transmitted over the antenna to the portable unit.

The portable-unit receiver demodulates the signal and feeds it to the audio-amp-and-gate. When the portable unit's switch is in the TALK position, the demodulated audio signal is amplified and fed to the speaker (earpiece).

Outgoing calls

When a telephone call is initiated from a cordless telephone, the portable unit is switched from the standby mode to the talk mode. That turns on the transmitter and pilot-signal (guardtone) generator. The guardtone or pilot signal is typically a frequency tone in the 4- to 7-kHz range. The pilot signal modulates a 49-MHz-band carrier, and is transmitted to the base via the telescoping antenna.

That signal is demodulated by the base unit's receiver and fed to the pilot-signal detector and the low-pass filter. The pilot-signal detector energizes the relay to an off-hook state (through the relay driver) if

the pilot signal is at the correct frequency. The cordless telephone is now off-hook and a telephone number can be dialed. The low-pass filter only allows signals below 3 kHz to pass, so the guardtone signal is rejected by the low-pass filter, while dialing and voice signals are allowed to pass.

When a digit on the keypad (located on the portable unit) of a pulse-dial cordless telephone is pressed, the pilot signal is interrupted a certain number of times for each digit. The relay goes from off-hook to on-hook each time the pilot signal is interrupted. That on-hook/off-hook change at the relay causes dialing pulses to go out over the telephone line. Those pulses are decoded by the telephone exchange in the same manner as the pulses from an ordinary pulse-dial telephone, and the telephone call is routed to the telephone number dialed.

Turning to a DTMF (tone dial) cordless phone, when a digit on the keypad of the portable unit is pressed, the dialing tones and guardtone are used to modulate the carrier signal. Dialing tones have frequencies in the 300–3000 Hz band, and guardtones have frequencies above 3000 Hz. The modulated signal is received by the base unit, demodulated, and then (if the guardtone frequency is correct) the tones are sent out over the telephone line, decoded, and used to route the telephone call just as with a standard telephone.

As we said earlier, when in the off-hook state, both transmitters operate in a full-duplex mode to permit talking and listening simultaneously. Incoming and outgoing audio are handled as described in the previous section. When the call is completed, the cordless telephone portable unit is set back to the the standby mode and the pilot signal is discontinued. That causes the base-unit relay to go back to an on-hook state and incoming calls can now be accepted.

Test equipment

The proper test equipment is essential for effective cordless telephone troubleshooting. General-purpose test equipment such as a multimeter, oscilloscope, and audio generator will fill part of the requirements, but some special-purpose telephone test equipment is also needed. First, we must either tie up a telephone line (for some tests two lines are needed) or use a telephone line simulator. A 48-volt DC power supply fed through a 1.5 kilohm series resistance will suffice for the basic telephone-line simulator, with input/output jacks for applying ring voltage and test tones, and measuring dialing and audio signals.

A 20-Hz ring generator is also needed; it should provide an output that is variable from 45- to 100-volts RMS. A ring generator is a special-purpose device used only for telephone testing. Ideally, the ring

generator should shut off automatically when the telephone is taken off-hook. If not, you must be very careful never to take the telephone off-hook when the high-voltage (45-100-volts RMS) signal is applied. Applying such a high voltage to an off-hook telephone may damage the telephone.

Another special-purpose device is a dial decoder. It is used to determine whether the telephone is dialing the correct digits.

For RF testing, we need a method of measuring transmitter RF-level. The simplest method is to use an RF probe and a multimeter. The RF probe can be touched to the antenna for RF level measurements. That technique is not useful for 1.7-MHz band transmitters that use the AC power line as an antenna. For those, a special tester is required.

A deviation meter is needed for measuring FM modulation and an FM-modulated, RF signal-generator is needed for receiver testing. A frequency counter is good for measuring transmitted RF carrier-frequency and setting the RF-signal generator on frequency. It is also needed for measuring guardtone and ring-signal frequencies, whether generated by the cordless telephone or by an audio signal generator for injection into a cordless telephone. Note that once again, 1.7-MHz transmitters may prove to be a problem in that sometimes the radiated signal level is insufficient to drive a frequency counter.

One piece of equipment that the author has found useful is the B&K-Precision model 1050 telephone analyzer (see Fig. 3). It includes many of the specialized test instruments required in cordless telephone repair. Among those are a telephone-line simulator, 20-Hz ring generator, pulse- and DTMF dial-decoder, FM-deviation meter, RF-signal generator (for cordless-telephone frequencies only), a dummy load for measuring 1.7-MHz RF levels, two audio generators, and other convenience features. A general-purpose oscilloscope, multimeter, frequency counter, and service manual for the tele-

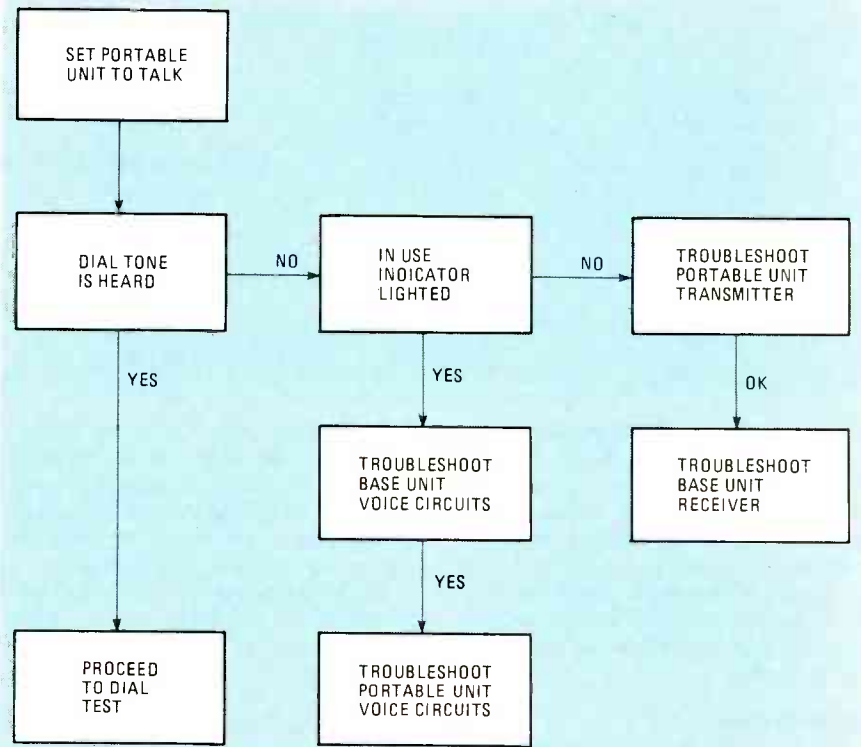

FIG. 4—THE STEPS THAT ARE FOLLOWED in performing the ring test are outlined in this flow chart.

phone being serviced complete a well-equipped test bench for cordless telephone servicing.

Operational tests

Let's start our cordless telephone tests with a ring test, dial-tone test, dial test, and voice test. Even if you have a complete description of the symptoms, and have a fairly good idea of where the problem lies, it is a good idea to verify those symptoms and performing the above operational checks will usually do it. They take very little time to perform, no more than 10 or 15 seconds for the entire sequence. If problems are encountered during any of the tests, you will have at least isolated the problem to a particular section and a few additional tests will narrow it down to a specific circuit or component.

If the cordless telephone passes those tests, we know that it will operate at short range. We can then proceed to check more subtle symptoms such as short range, interference, etc.

To perform a ring test, apply AC power to the base unit and connect it to a telephone jack. Leave the portable unit in standby (on-hook). Apply a 100-volt, 20-Hz ring signal to the telephone line and see if the portable unit rings. If the telephone does not ring, ring-test troubleshooting is needed. If the telephone rings, check further that the ringing threshold is below 45 volts. If not, troubleshoot that problem. If so, proceed to the dial-tone test.

To perform a dial tone test, first remove the 20-Hz ring signal. Then simply set the portable unit to TALK and listen for the dial tone. If the dial tone is not heard, dial-tone-test troubleshooting is needed. If everything is working, proceed to the dial test.

To perform the dial test, dial each digit, 0 through 9, and observe whether the correct digits are shown on the dial decoder. If not, dial-test troubleshooting is needed. If dialing is normal, proceed to the voice test.

To perform the voice test, speak into the mouthpiece and listen to the earpiece for correct sidetone level and overall voice quality. If satisfactory, the cordless telephone is operational. If not, voice-test troubleshooting is needed.

Let's now see what the above tests show us, and how they can be used to help

continued on page 118



FIG. 3—THE B + K 1050 telephone analyzer contains many instruments and features required to adequately service a cordless telephone.

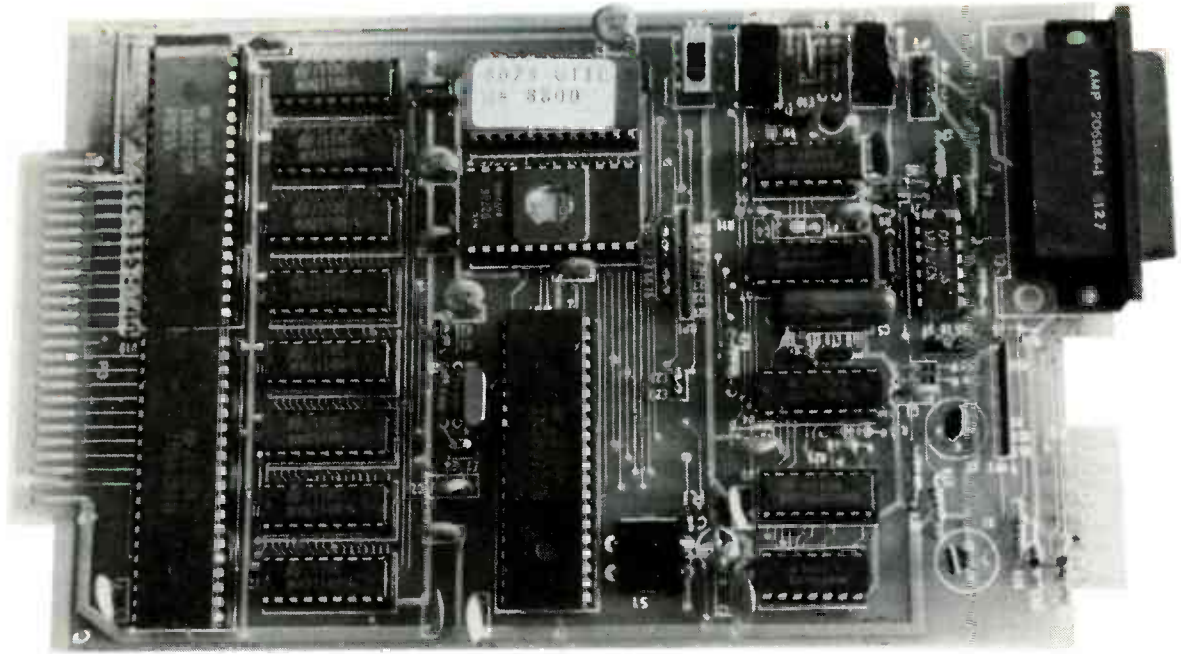

How to Design Microprocessor-based Projects

Make your next project "intelligent." Use a single-chip microcomputer to control it.

TOM FOX

Part 2 LAST MONTH, WE INTRODUCED National Semiconductor's INS8073 microinterpreter and described, in detail, its pin connections and their functions. In this second part of the series we will look at a handy demo/development board as well as introduce the language of the 8073, NSC Tiny BASIC.

Before we get started with that, we should mention that National Semiconductor has, unfortunately, discontinued production of the INS8073. However, many suppliers still have stocks of that IC, so you should be able to find it rather easily. Even if you can't, don't worry. There are many other single-IC computers available. You may even learn more if you try to use another microinterpreter.

Even if you don't want to pore over data sheets and design interfacing circuits, you can still put the power of a microinterpreter to work by using development and demonstration boards. Several manufacturers offer such boards. For exam-

ple, we'll look at a demonstration board for the INS8073 that is available from Digi-Key Corp. (Highway 32 South, PO Box 677, Thief River Falls, MN 56701). That board, shown in Fig. 5, sells for \$250. A user manual is \$10.

The demonstration board makes designing with the 8073 so simple it seems as if you're cheating! After you receive the board, all you have to do to start programming in NSC Tiny BASIC is to connect up power (+5 and -12 volts). If you use an RS-232 terminal, you have to add a jumper to the board, and use a standard male-male cable to connect the D-type connector on the board (J1) to your terminal's RS-232 connector. Of course, you can also use your computer along with communications software to emulate a smart terminal. Baud rates (110, 300, 1200 4800 baud) can be set by adding jumpers on the board.

After you turn on the power, a prompt (>) should appear on your terminal screen. You are then ready to start pro-

gramming in Tiny BASIC.

Besides being easy to hook up and get running, the development board contains 4K of RAM, a 8255 programmable peripheral interface IC, an 8154 RAM-I/O that provides 128 bytes of scratch-pad memory for use in assembly-language subroutines, and has 16 I/O lines that can be individually programmed.

Perhaps the nicest features of the board is that it has an EPROM-resident utility program as well as an EPROM programmer (which is controlled by the utility program). The utility program allows you to store and retrieve programs on cassette tapes and download programs from a "host" computer. It also has a variety of other features such as the DUMP command, which allows you to "display" part of memory in both the hexadecimal and converted ASCII format. However, for our purposes (the design of smart machines), its greatest feature is that it makes the programming of EPROM's easy and nearly foolproof. All you need is a single-

supply 2716 EPROM and a +25-volt source. The built-in program does all the rest. One caution: the S (setup) command is not mentioned in the manual, but it should be used immediately before the P (program) command.

While the demonstration board is definitely helpful if you want to design circuits using the 8073, it is not essential if you have access to an EPROM programmer. However, if you don't have an EPROM programmer available, then the board is recommended.

NSC Tiny BASIC

Like most tiny BASIC's, that supplied with the INS8073 allows only signed integers from -32767 to +32767 and 26 single-letter variables (A to Z). However, as you will soon see, this Tiny BASIC is remarkable in most other respects.

The commands RUN, CONT, CLEAR, LIST, and NEW are similar to the commands used by many standard BASIC languages. The command NEW <expr> resets the program pointer to that of the <expr>. That command should be given before you enter a program. For instance, say you want to start your program at 1100H. (The "H" indicates that the number is in hexadecimal). You should type: NEW#1100<return> and then type: NEW<return>. NOTE: In NSC Tiny BASIC "#" is used as a prefix to indicate to the interpreter that the number is in hexadecimal. Numbers that do not have that prefix will be treated by the interpreter as if they are decimal.

The following NSC Tiny BASIC statements and operators are similar to those of other BASIC's and will be listed without comment: REM, LET, PRINT, IF-THEN, FOR-NEXT, GOTO, GOSUB, RETURN, INPUT, STOP, +, -, ×, /, >, <, =, AND, OR, NOT, and MOD.

The DO-UNTIL, statement is used to program loops and has been borrowed from PASCAL. That statement is rare in the BASIC language, although the proposed ANSI standard BASIC contains it.

The LINK statement is used to transfer control to machine language subroutines, which can be used where speed is important.

The DELAY statement causes a delay in the program execution up to a maximum of just over 1 second. The number following the DELAY statement gives the time in milliseconds that the program will be delayed. DELAY 100 causes a delay of about 100 milliseconds (1/10 of a second) and DELAY 0 gives the maximum delay of about 1040 milliseconds. (Note all times are only approximate and depend on the frequency of the clock.) The DELAY command is used extensively in our example project.

The function RND (random) is also used frequently in our example project.

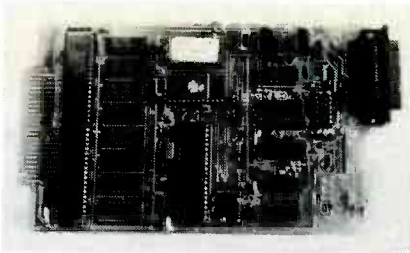

FIG. 5—THIS DEMO/DEVELOPMENT BOARD is not necessary if you want to use the 8073, but its on-board EPROM programmer and utility program makes it easy.

The statement LET A=RND(1,10) assigns a pseudo-random number between 1 and 10 (inclusive) to the variable A.

Let's take a look at a short program segment that will give us a delay in program execution between 1 and 5 seconds:

```
310 LET L=0
320 LET M=RND(1,5)
330 DELAY 0
340 LET L=L+M
350 IF L<5 GOTO 330
```

The TOP function gives the address of the top of memory. (The top of memory is the first memory location in external RAM that is not used by the NSC Tiny-BASIC program.)

The following is an example of how the TOP function is used. (Note that this example is printed here exactly as it would appear on your terminal.)

```
>NEW#1100
>NEW
>10 PRINT TOP
>RUN
4366
```

The number displayed on the terminal after the program has run (4366) is the first address of unused RAM. Note that like all numbers displayed on the terminal under the control of the INS8073 microinterpreter, 4366 is in decimal. While the interpreter "understands" numbers given to it in hexadecimal (with a "#" prefix), it only displays decimal numbers on the terminal.

The STAT function allows you to monitor and set the 8073 status register. For details on that register, refer to the *National Semiconductor Tiny BASIC User Manual* and/or the INS8070 data sheet.

The ON statement is used for processing interrupts. It has two formats; ON 1 <expr> and ON 2 <expr>. Notice there are two interrupts, 1 and 2. Number 1 interrupt occurs when there is a high-to-low transition at pin 38. Interrupt number 2 occurs when there is a high-to-low transition at pin 39. After the 8073 senses the interrupt, the interpreter will execute a GOSUB beginning at the line number given by <expr>. It is important to note

that the statement, STAT="odd number" (where the odd number is often 1), should be used before an ON statement in order to enable the interrupts.

The INC(X) and DEC(X) functions increment and decrement, respectively, the memory at the locations given by X. Those functions are useful in multi-processing. For our purposes, however, we will ignore them.

The indirect operator

One of the most important features of NSC Tiny BASIC, especially for those who look to the 8073 to provide "brains" for "brainless" machines, is the indirect operator "@." That operator is simpler to use than the PEEK and POKE commands found in most BASIC languages. For instance, to store a 4 (decimal) at location C000H, simply make the following statement; @#C000=4. The statement "LETB=@#6000" sets the value of the variable B equal to the value stored at the hexadecimal address 6000.

Be aware that the INS8073 is an 8-bit device and it can only store an 8-bit binary number (0 to 255 in the decimal system) at any memory location. Thus, if you use the @ operator to attempt to store a two-byte (16 bit) number or larger at any memory location, you might experience sleepless nights trying to debug your program. The interpreter will only "see" the least-significant byte. For instance, the statement "@#C000=260" (260=100000100) would actually store "4" (00000100) at location C000.

Putting the microinterpreter to work

Now that we've introduced you to the INS8073 microinterpreter and taken a quick look at a demo/development board and the NSC Tiny BASIC language, it's time to design a project that is based on the 8073. In particular, we will describe, in detail, how to build a "burglar outwiter."

The first step in the design of any project should be to decide exactly what you want the project to do. As the name of this project suggests, we would like to fool or outwit a burglar into thinking that someone is in the house, even when it is empty. The circuit we'll describe is fairly simple—it's meant simply to be a demonstration of what you can do with the INS8073. If you decide to build such a device, you'll learn a lot more if you customize the circuit and/or program to better meet your needs. We'll give you some hints on how to do that.

The burglar outwiter

We want our demonstration circuit to control three lights: The living-room light (called light A), the hallway light (light B) and the bathroom light (light C). When it gets dark, we want light A to go on for random length of time between 10 and 60

minutes. We want light B to go on about a second after light A goes out. Light B will stay on for 1 to 5 seconds. About a second after light B goes out, we would like light C to light for a random length of time that is no greater than 20 minutes but no less than 5 minutes. About a second after this light goes out light B should go on and stay lit for 1 to 5 seconds. After a second pause let's have light A go on again, but only if it is still dark.

That completes the first cycle. After 5 such cycles, we would like the controller to go into a "sleep" phase for the rest of the night. During that "sleep" phase, light C (the bathroom light) will go on every 1½ to 5 hours for between 1 and 10 minutes. That should continue until sunrise, when the controller will be reset and prepared for the next night.

If possible, we would like to use a 2716 EPROM to store the software. And we would like to design the system so that it is easy to expand. After all, we'll probably want to add another light—or maybe a dozen appliances.

Now that we know what we want our controller to do, we have to design an actual circuit to do the job. First, however, let's look at some input and output details. Let's pick address C000H for both our output and input port address. Note that C000H is equal to 1100 0000 0000 0000 in binary notation. To decode that address, address lines A15 and A14 (the two most significant bits) must be high while A13 and A12 are low. (We don't care about the other address lines here since there is no memory at those locations.)

The NSC Tiny BASIC statement `LET B=@#C000` assigns the value at address C000 to the variable B. (Remember the prefix "#" stands for "hexadecimal" in NSC Tiny BASIC.) We have to design a circuit that places information on dark/light at input-port location C000. When it's dark, let's make D0 "one" (high) and when it's light, let's have D0 "zero" (low).

For the output port, we will use the same address, C000. We can do that because the 8073 has READ and WRITE control lines that tell external circuits (such as address decoders) whether the 8073 is inputting information (reading) or outputting information (writing). TTL latches will be used to temporarily store output information. We'll use one latch for each light controlled.

The output circuit will be designed so that the statement `@#C000=1` will set latch 1. Also the statement `@#C000=2` will set latch 2 and `@#C000=4` will set latch 3. All latches will be reset by the statement `@#C000=0`. (Note that those statements work because a decimal 1 = 00000001 (binary), 2 = 00000010 (binary) and 4 = 00000100 (binary).)

A buffer/driver/relay circuit will be connected to the latches' output to actually control the lights. But we're getting a

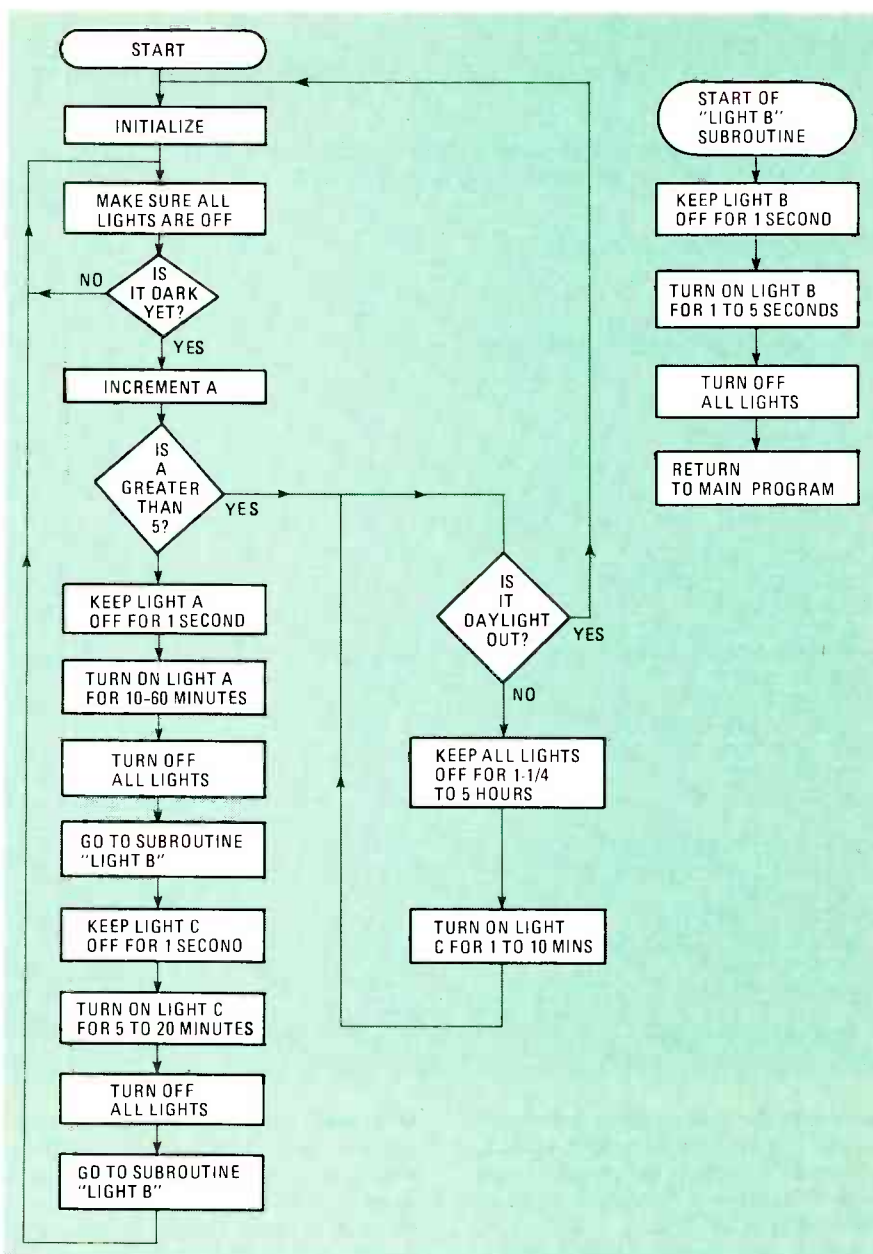

FIG. 6—THE FLOW CHART FOR the burglar outwiter. The actual program could have been written more compactly, but then it wouldn't have been as valuable a learning tool.

little ahead of ourselves. We'll go into specific detail on how to wire real-life parts. But first, let's look at a program that will accomplish our objectives.

The control program

The first step in writing any non-trivial program should be the sketching out of a flow chart. Figure 6 shows a simplified flow chart for our BASIC program. Although this project has a definite practical application, it also provides us with the opportunity to explain the basics of designing with the INS8073. You may find that the program (and circuit itself) was not designed to be especially compact. The primary objective is to have something that's easy to understand. You might like to write a shorter and more elegant

program that accomplishes the same task.

The wordy program shown in Table 1 is allowable here since there is plenty of memory space in the 2716 EPROM. Longer, more complicated programs may not fit in a single 2716.

While we could go through the program line-by-line to explain its operation, it is probably less confusing to study the flowchart. There are some lines that we should describe, however.

The program statement in line 20 turns off all lights, while the statement in line 30 places information on dark/light into variable B. In line 40, all data bits are masked except the least-significant bit of data (D0). The variable "C" has the value of 1 when it's dark and 0 when light.

When it's dark, the statement on line 60

TABLE 1
BURGLAR OUTWITTER PROGRAM

```

1 REM GHOSTLY BURGLAR OUTWITTER PROGRAM
5 REM SET ALL VARIABLES TO ZERO AND INITIALIZE
10 CLEAR
20 @ #C000 = 0
25 REM TEST FOR DARKNESS
30 LET B = @ #C000
40 LET C = 1 AND B
50 IF C = 0 GOTO 20
55 REM ITS DARK SO INCREMENT A
60 LET A = A + 1
70 IF A > 5 GOTO 500
80 GOSUB 200
90 GOSUB 300
100 GOSUB 400
110 GOSUB 300
120 GOTO 20

200 LET J = 0: DELAY 0
205 REM TURN ON LIGHT A
210 @ #C000 = 1
220 LET K = RND(1,6)
225 REM KEEP LIGHT A ON FOR 10 TO 60 MINUTES
230 DELAY 0
240 LET J = J + K
250 IF J < 3600 GOTO 230
255 REM TURN OFF LIGHT A
260 @ #C000 = 0
270 RETURN

300 LET L = 0: DELAY 0
305 REM TURN ON LIGHT B
310 @ #C000 = 2
320 LET M = RND(1,5)
325 REM KEEP LIGHT B ON FOR 1 TO 5 SECONDS
330 DELAY 0
340 LET L = L + M
350 IF L < 5 GOTO 330

355 REM TURN OFF LIGHT B
360 @ #C000 = 0
370 RETURN

400 LET N = 0: DELAY 0
405 REM TURN ON LIGHT C
410 @ #C000 = 4
420 LET P = RND(1,4)
425 REM KEEP LIGHT C ON FOR 5 TO 20 MINUTES
430 DELAY 0
440 LET N = N + P
450 IF N < 1200 GOTO 430
455 REM TURN OFF LIGHT C
460 @ #C000 = 0
470 RETURN

500 LET A = 0: LET D = 0: LET F = 0
510 LET E = RND(1,4)
515 REM TEST FOR DAYLIGHT
520 LET H = @ #C000
530 LET I = 1 AND H
535 REM IF ITS NOW LIGHT OUT BRANCH TO START
540 IF I = 0 GOTO 10
545 REM IF STILL DARK WAIT FOR 1¼ TO 5 HOURS
550 DELAY 0
560 LET D = D + E
570 IF D < 18000 GOTO 520
575 REM TURN ON LIGHT C
580 @ #C000 = 4
590 LET G = RND(1,10)
595 REM KEEP LIGHT C ON FOR 1 TO 10 MINUTES
600 DELAY 0
610 LET F = F + G
620 IF F < 600 GOTO 600
625 REM TURN OFF LIGHT C
630 @ #C000 = 0
640 GOTO 500

```

increments the "sleep-phase variable," A. After that has been incremented past 5, statement 70 instructs the program to go to the "sleep phase" program segment, which starts at line 500.

If there have been less than 5 passes, the program jumps to the subroutine at line 200, which controls light A. First, the subroutine clears the variable J and delays the program for about a second (DELAY 0). Next, the subroutine turns on light A (@ #C000 = 1). The statement on line 220 sets K equal to a pseudo-random number between 1 and 6. The statement "DELAY 0" delays further program execution for about a second and is the first part of the loop, which consists of the statements in lines 230, 240, and 250. The statement in line 240 increases the value of the variable J by the amount of K. (Remember "K" is between 1 and 6.) Line 250 causes a branch to line 230 if J is less than 3600. Note that if K = 1, this program loop will cause a delay of about 3600 seconds (60 min.). When K = 6 the delay is about $3600 \times 6 = 6000$ seconds (10 min). Notice that with this program shorter delay times are more likely than longer ones. That fact has nothing to do with an inherent defect

in the RND command. Rather, it is built into the design of the program. For instance, when K = 2, the delay time is about 30 minutes, with K = 3 the delay is about 20 minutes. There is no delay time between 60 and 30 minutes. Can you figure out the approximate delay times for K = 4 and K = 5?

The other light-control subroutines work the same way, but take the time to read through them to make sure you understand.

The statement at line 120 causes a branch back to line 20. After making sure all lights are off, the program checks to see if it's still dark out and if it is, variable "A" is incremented. When A reaches 6, the program branches to line 500. The program segment from lines 500 to 640 is the sleep phase. Lines 520, 530 and 540 check to make sure it's still dark. If it is light, the program branches back to the beginning. If it's still dark the program proceeds. Lines 550, 560 and 570 causes a delay of between 4,500 seconds (1¼ hours) and 18,000 seconds (5 hours).

When that "rest" time is over, the next statement, @ #C000 = 4, turns on light C. The delay loop formed by the state-

ments in lines 600, 610 and 620 keeps light C on for a period of time between about 1 and 10 minutes. The statement "@ #C000 = 0" turns off all lights and the program branches back to line 500.

The controller circuit

The schematic of the complete burglar outwitter is shown in Fig. 7. The first thing we'll look at is photodarlington transistor Q1, which monitors the light level. When hit by light, the photodarlington conducts current. That produces a voltage drop across R4. That voltage also appears at pin 3 of IC5-a, the op-amp's non-inverting input. When the voltage at that input exceeds that at the inverting input (pin 2), the op-amp output of jumps to almost 5 volts. That triggers IC6-a (a Schmitt trigger NAND gate), whose output jumps low.

The output of IC6-a is fed to the input of the three-state buffer, IC7-a. This buffer is enabled only when a READ operation is taking place on location C000. (When a three-state buffer is not enabled, it is basically disconnected from the circuit.) The decoding for that buffer is provided by IC6-b, IC9-a and IC10-a.

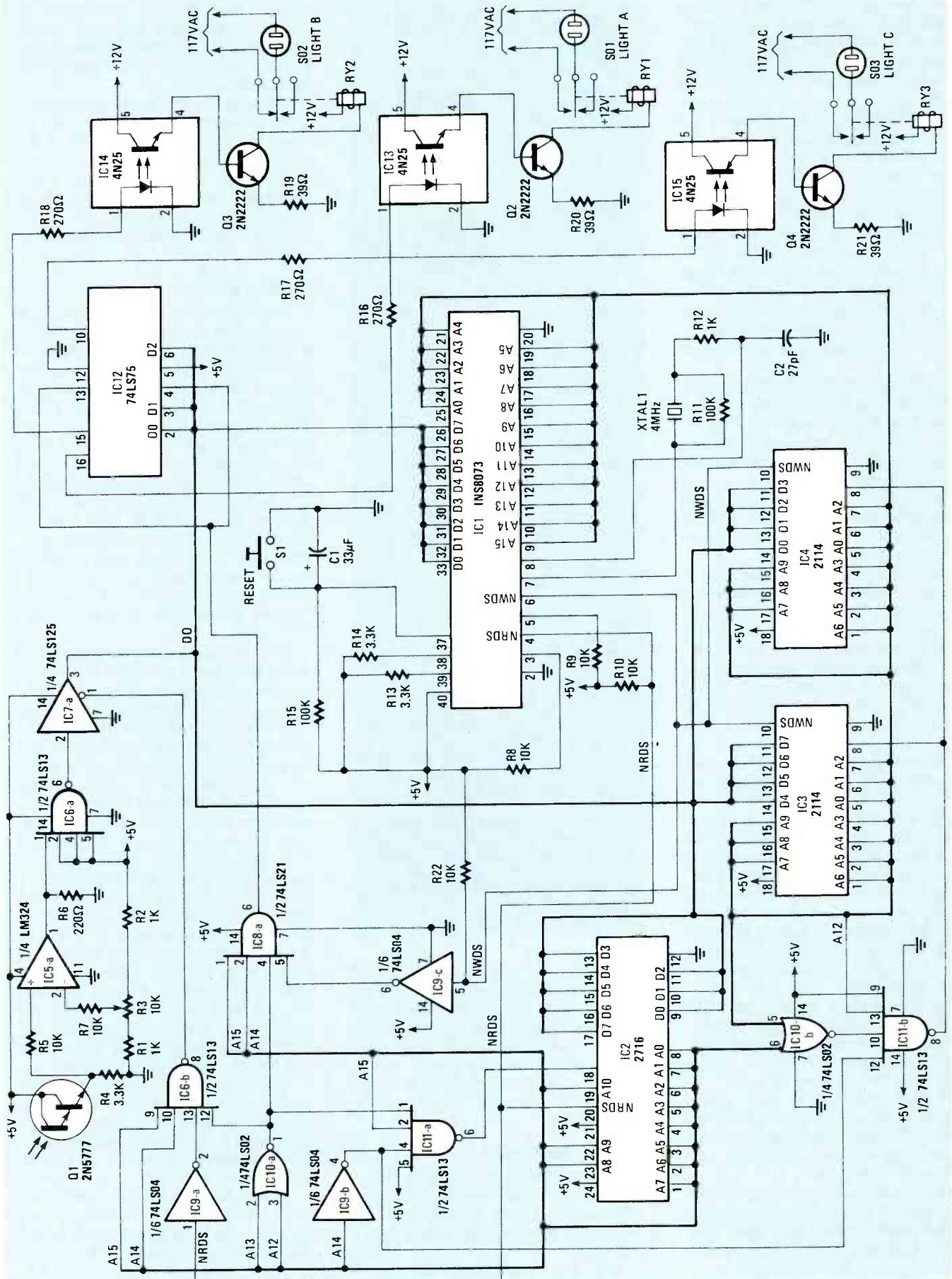

FIG. 7—THE BURGLAR ALARM. Note that, although not shown in the schematic, bypass capacitors (about .1 µF) should be installed at each IC between the power lead and ground.

The output of IC7-a is fed to data-line D0. Pulling the previous discussion together, we can see that when a READ operation is taking place on address C000, IC7-a's output will be low (D0 will be 0) when it is light out. Of course, when it's dark, the output of IC7-a will be high (D0 will be 1).

The 2716 EPROM, IC2, contains our Tiny BASIC program. As far as the microinterpreter is concerned, it is located at addresses 8000 to 87FFH. The address decoder for IC2 consists of IC9-b, IC10-a and IC11-a. Since the EPROM's OUTPUT ENABLE pin (20) is connected to IC1's NRDS (READ DATA STROBE) output, IC2 is ENABLED only during a READ operation. Note that with the 8073, the first ASCII character of the program in EPROM must be located at hex address 8000 if the circuit is to be self-starting at power up or reset.

Two 1K x 4 static RAM's, IC3 and IC4, provide the scratch-pad memory required by the Tiny BASIC interpreter. The decoding required is provided by IC9-b, IC10-b, and IC11-b. That RAM memory starts at hex address 1000.

The 4-MHZ crystal and associated lowpass filter network (R11, R12, and C2) form the frequency-control network for the on-chip oscillator.

Start-up (initialization) of the 8073 is achieved with the R-C network consisting of R15 and C1. The RESET pin of IC1 (pin 37) goes low for about a second after power-up and then gradually rises to +5 volts. That slow rise in voltage is allowable as input since the RESET pin is buffered with a TTL-compatible Schmitt trigger. (The first instruction to be fetched, after pin 37 goes high, is at location 0001. Unlike microprocessors, which only understand machine language, the designer who uses an 8073 need not know this specific information since the on-chip interpreter takes care of these details. That is just one example of the savings in time microinterpreters provide to the designer.)

The output circuit that controls lights and appliances consists of the quad-latch IC12, optocouplers IC13-IC15, and associated circuitry. The address-decoding network for IC12 is made up of IC8-a, IC9-c, and IC10-a.

The quad latch is enabled when IC1 attempts to write to location C000H. Once a latch is enabled it can store data. Thus the statement @ #C000 = 1 enables IC12. Since D0 is connected to the "D" input of latch one (pin 2), it also causes latch one to store a 1. The result is that pin 16, the "Q" output of latch one, goes high and stays that way at least until IC1 writes to location C000 again.

When pin 16 goes high, the LED inside optocoupler IC13 is energized causing the internal phototransistor to conduct. That turns on transistor Q2, which causes relay RY1 to close and thus turn light A on.

PARTS LIST

All resistors 1/4 watt, 5% unless otherwise specified

R1, R2, R12—1000 ohms
R3—10,000 ohms potentiometer
R4, R13, R14—3300 ohms
R5, R7, R9, R10, R22—10,000 ohms
R6—220 ohms
R11, R15—100,000 ohms
R16, R17, R18—270 ohms
R19, R20, R21—39 ohms

Capacitors

C1—33 μ F, 10 volts, electrolytic
C2—27 pF ceramic disc
C3-C13—0.1 μ F bypass capacitors (not shown on schematic)

Semiconductors

IC1—INS8073 microinterpreter
IC2—2716 EPROM (properly programmed, see TABLE 1 and the text)
IC3, IC4—2114 1K x 4 RAM
IC5—LM324 quad op-amp
IC6, IC11—74LS13 dual NAND Schmitt trigger
IC7—74LS125 quad buffer
IC8—74LS21 4 input AND gate
IC9—74LS04 hex inverter
IC10—74LS02 quad NOR gate
IC12—74LS75 4-bit bistable latch
IC13, IC14, IC15—4N25 or equivalent optocoupler.
Q1—2N5777
Q2, Q3, Q4—2N2222

Other components

RY1, RY2, RY3—6-volt DC relay with 50 ohm coil, (Calectro D1-973 or equivalent)
S1—SPST momentary type switch
XTAL1—4 MHz crystal
Miscellaneous: PC or prototyping board, two-conductor cable (for Q1), 14-gauge U.L. approved wire (for wiring the light circuits to the relays), hook up wire, solder, etc.

The INS8073 demo/development board (Part No. DB10-ND), is available from Digi-Key Corporation, Highway 32 South, P.O. Box 677, Thief River Falls, MN 56701-9988 (1-800-346-5144) for \$250.00.

Similarly, the statement @ #C000 = 2 causes D1 to go high, which turns on light B. The statement @ #C000 = 4 will cause D2 to go high and light C will go on. Notice that by connecting D3 to pin 7 and adding another optocoupler/transistor/relay circuit, another light/appliance can be controlled by the statement @ #C000 = 8.

Burning the EPROM

As we mentioned previously, the demo/development board from Digi-Key contains an on-board burner for 2716 EPROM's. A brief review of how to use it follows.

After you obtain the prompt (>) on

your terminal, type: NEW #1100 <return>. Then type: NEW <return>. You are now ready to enter the program in Table 1 (or your own program). To save time (and memory space for longer programs), you might want to leave out the REM statements.

After entering your program, connect a +25 volt source to pin 3 of "P1" on the board and insert an erased 2716 in the empty socket. Now type: NEW #8800 <return> and then type: S <return>. Switch S2 to P and then type: P <return>. If everything goes well, "DONE.CMD?" should show on the display.

Building the outwitter

Since this project is fairly simple (for a computer-based project, that is) it can be put together on a solderless breadboard. If you use such a system, make sure you keep all the wires that are connected to IC1 and IC2 as short as possible. While such a breadboarding technique isn't suitable for permanent installations, it is ideal for design work since the circuits can be quickly constructed and easily modified. This is also an economic method of testing your design, since the parts from the breadboard can be used in a different project or can be used in the final circuit. If you do make a permanent version on a PC board or wire-wrap board, be sure that you use IC sockets—at least for the EPROM.

The photodarlington transistor, Q1, should be mounted so that it is facing out a window. Make sure that you don't locate it near an indoor light. When it starts to get sufficiently dark out, carefully adjust R3 so that light A goes on. The relays listed in the parts list are Calectro D1-973 and can control 200 watt (120-volt) light bulbs. By connecting the contacts of those relays in series with the coil circuit of a power relay, much larger currents can be controlled.

The beauty of using microinterpreters is that the program contained in the EPROM can be quickly and easily changed—short programs can be modified in less than an hour. As a real-life example, let's look at our circuit. It is possible to modify the program so that the circuit can tell whether it is summer or winter. One way that could be done is by writing a program so that the "outwitter" measures the length of day. The circuit can then modify its behavior according to the season.

The output circuit itself can be easily modified to control more lights/appliances. The addition of light D has already been touched upon previously. By adding an additional 74LS75 quad-latch, 4 more lights/appliances can be easily controlled. With the use of a suitable decoder to the output of these 8 latches (and a modification of the program) 256 lights/appliances can be controlled. That should be nearly enough for everyone! **R-E**

All About OPTOCOUPPLERS

Interfacing digital signals to real-world devices has always been a difficult task. But optocouplers can help make it easy!

DANIEL M. FLYNN



HOW OFTEN HAVE YOU WANTED TO INTERFACE a logic circuit to real-world devices that operate from an AC source or a high DC voltage? That interfacing problem can be overcome in many ways. But perhaps the best way is to use an *optocoupler*. Optocouplers have a lot to offer: electrical isolation, logic-circuit compatibility, small size, and high reliability.

Optocouplers can be used in applications that require electrical isolation—when the low DC output of a logic circuit is used to control an AC motor. Since a logic circuit is incapable of delivering an AC voltage, and AC induced in the logic circuit can cause all kind of trouble, the motor and the logic circuit must be electrically isolated. And that's where the optocoupler really comes in handy.

An optocoupler might be used in applications where the high-level output of a metering device is fed to a microprocessor-controlled circuit to automatically start or stop operation at a predetermined point. (Consider a robotic assembly line, for example.)

In this article, we'll look at several optocoupler circuits that may be used to interface logic circuits to the "real world," or to interface any low-voltage circuit to one that operates on higher voltage. But before we do that, we should first take a closer look at what optocouplers are and discuss their parameters.

Optocoupler basics

The optocoupler (also called optoisolator or photocoupler) is a single component consisting of a light source and photodetector. The two elements are isolated from each other by a transparent insulator, and the assembly is completely enclosed in an opaque package.

The light source for most optocouplers is a gallium arsenide (GaAs) IRED (*In-fraRed Emitting Diode*). The detector, or output element, may be a phototransistor, photodarlington, light-activated bilateral

switch, or light-activated SCR. Figure 1 shows the schematic symbols for those types. Although other types are available, those shown are the most common.

Signals are transmitted between the two electrically isolated elements by means of a light path, or light source. The two elements cannot reverse their roles. And since there are no electrical connections between them, a signal passes through the unit in one direction *only*.

Optocoupler parameters

To successfully design with optocouplers, a clear understanding of their parameters is required. Because we'll be dealing only with low-frequency circuits, we'll define only the DC parameters of those devices. The DC parameters are divided into input, output, and current-transfer ratio.

The *Current Transfer-Ratio* or CTR is the ratio of the input current to output current of an optocoupler (at a specified bias). It is often represented by η . That value depends on the efficiency of the IRED and the spacing between input and output elements. The area, sensitivity, and gain of the detector also play a role.

The DC input parameters define the

electrical parameters of the IRED. They are: I_F , diode forward current; V_F , diode forward voltage, and V_R , maximum reverse voltage. (See Fig. 2.)

Because the DC output and transfer parameters differ depending on the type of detector element used by the optocoupler, we'll list and define them separately according to the detector.

Phototransistor- and photodarlington-type optocouplers work on the same principle. The collector-to-base junction is enlarged and works as a reverse-biased photodiode controlling the transistor. That is, radiation striking the junction generates electron-hole pairs, which are swept across the junction by the field developed across the depletion region. The parameters for the photodarlington and phototransistor types are:

- I_C , maximum continuous collector (output) current
- $V_{(BR)CBO}$, maximum collector to base breakdown voltage
- $V_{(BR)CEO}$, maximum collector to emitter breakdown voltage
- $V_{(BR)ECO}$, maximum emitter to collector breakdown voltage

Optocouplers that use light-activated bilateral switches in the output are de-

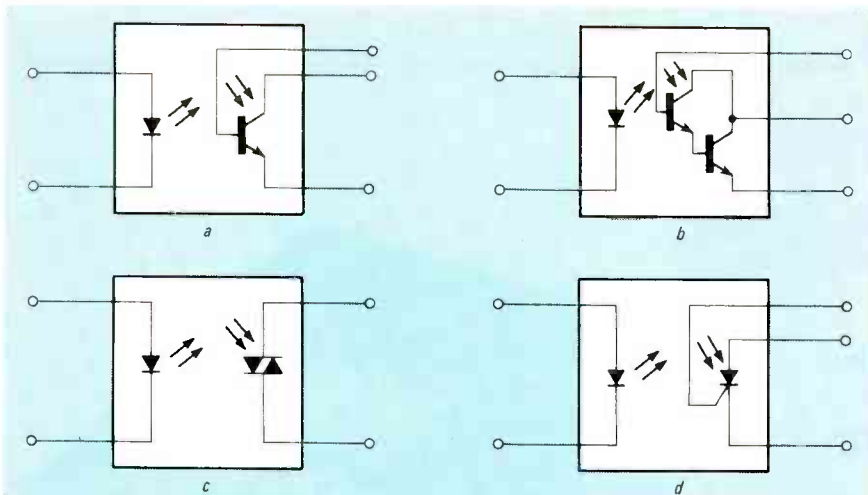

FIG. 1—MOST COMMON OPTOCOUPLERS: a has a phototransistor output; b, a photodarlington; c, a light-activated bilateral switch, and c has an SCR output.

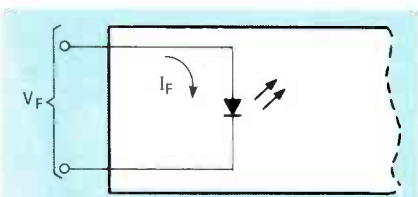

FIG. 2—THE INPUT ELEMENT of most optocouplers is a gallium arsenide (GaAs) IRED.

signed for applications that require isolated triac triggering, low-current isolated AC switching, and high electrical isolation. For that type of device the parameters are:

- $I_{T(RMS)}$, maximum on-state RMS current
- V_{DRM} , maximum repetitive off-state output terminal voltage
- V_{TM} , peak on-state voltage.

Light-activated SCR optocouplers are designed for applications that require high electrical isolation between low-voltage circuitry (like those using IC's) and the AC line. The parameters for the SCR devices are:

- $I_{T(RMS)}$, maximum on-state RMS current
- V_{DRM} , maximum repetitive off-state output terminal voltage
- V_{RM} , maximum reverse voltage

The transfer parameters of an optocoupling device (as mentioned above) is the measure of the ratio of current transmitted between the input and output elements. For phototransistor and photodarlington type units, the parameters are:

- CTR (η), ratio (in percent) of the minimum high collector output-current to diode current at a given V_{CE} and I_F .
- $V_{CE(sat)}$, the collector-to-emitter saturation voltage

For light-activated bilateral switch and SCR types:

- I_{F1} , maximum IRED trigger current required to latch (trigger) the output
- I_H , holding current required for the output to remained latched

The specifications for three optocoupling devices—4N33, 4N26, and MOC3010—are given in Table 1, Table 2, and Table 3 respectively.

Voltage level shifters

When a logic circuit is required to accept inputs from the real world, it is often necessary to shift the voltage level of an input signal to 5-volt logic levels. If the input is a DC signal, it can be interfaced to the logic circuit using an optocoupler without electrically tying the two together (i.e., the two circuits do not share a common ground.)

The advantage to that is that any noise or voltage spikes on the signal-circuit ground are not directly impressed on the logic-circuit ground. An optocoupler can also be used to convert AC signals to 5-volt logic levels, while isolating the logic circuit from the high AC voltage.

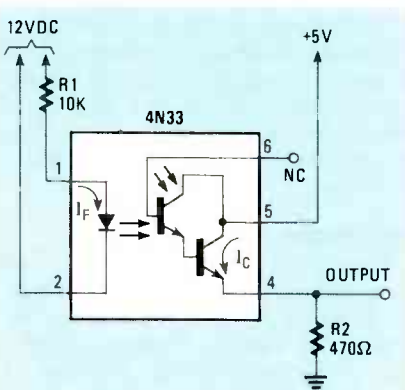

FIG. 3—THIS CIRCUIT MAY be used to trigger a TTL gate input.

Figure 3 shows one optocoupler application where a 12-volt DC (V_{IN}) input is converted to 5-volt logic levels. Here we see a circuit using a 4N33 optocoupler. (Specifications for that device are given in Table 1.) The 12-volt input causes the output of the optocoupler to go to a high logic level. In addition, any common-mode noise is rejected because of the op-

GLOSSARY OF OPTOELECTRONIC TERMS

- Bandgap (electronic)**—the potential difference between the valence and conduction bands, which determines the forward voltage drop and frequency of light out of a diode.
- Current transfer ratio (electronic)**—the ratio of input current to output current at a specified bias of the optocoupler.
- Dark current (electronic)**—the leakage current of a photodetector with no incident light, usually I_{CEO} .
- Detector (radiometric)**—a device that changes light energy (radiation) to electrical energy.
- Effective irradiance (electronic)**—IR perceived by a detector.
- Emittance (radiometric)**—power radiated per unit area from a surface.
- Emitter (radiometric)**—a source of radiation.
- Infrared (photoelectric)**—radiation of longer wavelength than normally perceived by the eye; i.e., 78 to 100 micron wavelengths.
- Irradiance (radiometric)**—radiated power per unit area incident on a surface, broadband analogy to illumination.
- Isolation voltage (electronic)**—the dielectric withstanding voltage capability of an optocoupler under defined condition and time.
- Light current (electronic)**—current through a photodetector when illuminated under specified bias conditions.
- Optocoupler (electronic)**—a single component that transmits electrical information between a light source and a light detector, which are not electrically connected; also called optoisolator or photocoupler.
- Photoconductor (electronic)**—a material whose resistivity is a function of the radiation level falling on it.
- Source (radiometric)**—a device that provides radiant energy.

tocoupler's diode input.

When a 12-volt signal is presented to the input, current flows through R1 and the IRED. That current lights the IRED, and the light striking the photodarlington's collector-to-base junction causes it to turn on. The photodarlington output is used here because its large CTR value allows enough current to pass through resistor R2 to develop the required voltage at the output for a logic 1. The output signal can now be used to drive a logic-gate input.

Removing the 12-volt DC signal turns the photodarlington off, and R2 pulls the output low. (In low-speed switching circuits, the base input of photodarlington and phototransistors typically remain unconnected. However, high-speed circuits use the base input to increase the switching speed of the device.)

When designing similar circuits for various DC-input levels, remember that

FREE high tech catalog

Heathkit

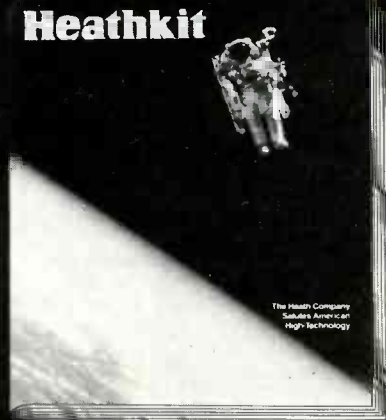

Metal Detector

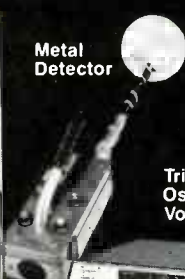

More than just a catalog, a trustworthy guide to what's new in computers and electronics.

Triple-Trace Oscilloscope/Time-Voltage Display



Ham Radio Transceiver



Computerized Weather Station

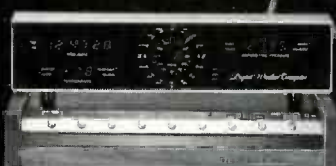

Real Time Spectrum Analyzer



Discover the pride.

With Heathkit, you'll discover the pride of accomplishment that comes with creating handbuilt quality that is uniquely yours.

And you'll develop skills and abilities in many technologies as you follow the step-by-step directions through the building process.

You work confidently, always backed by our simple promise, "We won't let you fail."

If you don't have the latest Heathkit Catalog, you're missing something great, so mail the coupon now, while you're thinking about it.

Microprocessor Trainer & Course



Most Accurate Clock



HERO® 1 Robot



IBM-PC Compatible Computers



40-Channel Scanner



Send NOW for your FREE Heathkit Catalog
It's the beginning of something great for the whole family.

Heath Company
Dept. 020-294
Benton Harbor, Michigan 49022
Please send me the latest Heathkit Catalog Free.

Name _____

Address _____

City _____ State _____

Zip _____

CL774D

Heathkit®
Heath Company

A subsidiary of Zenith Electronics Corporation
CIRCLE 262 ON FREE INFORMATION CARD

the value of R2 is determined by the input parameters of the logic gate being fed. The value of R2 given by:

$$R2 < V_{IL}/I_{IL}$$

where V_{IL} is the low-level input, gate voltage and I_{IL} is the low-level input, gate current.

The value of R1 is found by first solving for I_C (collector current):

$$I_C = V_{IH}/R2$$

where V_{IH} is the high-level input to the driven gate and R2 is resistance in ohms. Next, solve for I_F (diode forward current):

$$I_F = I_C/\eta$$

where η is the CTR of the optocoupler. To find the CTR, go to the specification sheet in Table 1 and look under the heading I_C for the coupled parameters. From that we get:

$$\eta = I_C/I_F = 50/10 = 5$$

Now the nominal value for R1 is given by:

$$R1 = (V_{IN} - V_F)/I_F$$

As an example, let's calculate the values of R1 and R2 for Fig. 3, assuming that the driven logic gate is a standard 7400 series. For that type of device, the input parameters are: $V_{IL} = .8$ volt, $V_{IH} = 2$ volts, and $I_{IL} = -1.6$ mA. Therefore, the value of R2 is given by:

$$R2 < V_{IL}/I_{IL} = .8/(1.6 \times 10^{-3}) < 500$$

Now it can be seen that R2 is chosen to be the largest common resistor value that is less than 500, which is 470 ohms. Using the value of R2, solve for the collector current:

$$I_C = V_{IH}/R2 = 2/470 = 4.3\text{mA}$$

where 2 is the high-level gate input voltage and 470 is the value of R2 in ohms. The value of I_F is found from:

$$I_F = I_C/\eta = 4.3/5.00 = 1.0\text{mA}$$

Now look up I_F under the input heading and I_C under output. Since neither of the calculated values exceed the maximum ratings of the 4N33, we can now solve for R1:

$$R1 = \frac{V_{IN} - V_F}{I_F} = \frac{12 - 1.2}{1 \times 10^{-3}} = 10.8\text{K}$$

The closest common resistor value to the one calculated for R1 is 10K.

Decreasing the value of R1 increases the loading effect on the signal source and decreases the transfer efficiency. For instance, in a similar circuit with R1 chosen to yield a I_F of 20mA, the current-transfer

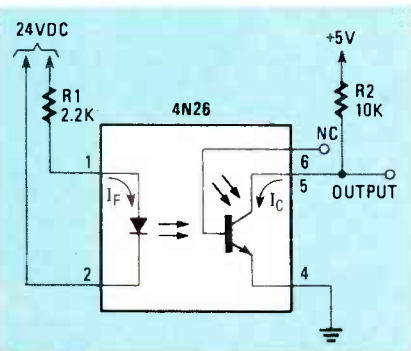

FIG. 4—THE BASE CONNECTION OF THE 4N26 IS USED TO INCREASE SWITCHING SPEED.

TABLE 1
4N33 SPECIFICATIONS

| | | Minimum | Typical | Maximum | Units |
|--------------------|---|---------|---------|---------|-------|
| Input | I_F | | | 80 | mA |
| | V_F ($I_F = 10\text{mA}$) | | 1.2 | 1.5 | V |
| | V_R | | | 3 | V |
| Output | I_C | 30 | | 100 | mA |
| | $V_{(BR)CBO}$ | 30 | | | V |
| | $V_{(BR)CEO}$ | 30 | | | V |
| | $V_{(BR)ECO}$ | 5 | | | V |
| Coupled Parameters | I_C ($I_F = 10\text{mA}$, $V_{CE} = 10\text{V}$) | 50 | | | mA |
| | $V_{CE(sat)}$ ($I_F = 8\text{mA}$, $I_C = 2\text{mA}$) | | | 1.0 | V |

TABLE 2
4N26 SPECIFICATIONS

| | | Minimum | Typical | Maximum | Units |
|--------------------|--|---------|---------|---------|-------|
| Input | I_F | | | 80 | mA |
| | V_F ($I_F = 10\text{mA}$) | | 1.1 | 1.5 | V |
| | V_R | | | 3 | V |
| Output | I_C | | | 100 | mA |
| | $V_{(BR)CBO}$ | 70 | | | V |
| | $V_{(BR)CEO}$ | 30 | | | V |
| | $V_{(BR)ECO}$ | 7 | | | V |
| Coupled Parameters | CTR ($I_F = 10\text{mA}$, $V_{CE} = 10\text{V}$) | 20 | | | % |
| | $V_{CE(sat)}$ ($I_F = 50\text{mA}$, $I_C = 2\text{mA}$) | | .1 | .5 | V |

TABLE 3
MOC3010 SPECIFICATIONS

| | | Minimum | Typical | Maximum | Units |
|--------------------|-----------------------------------|---------|---------|---------|---------------|
| Input | I_F | | | 50 | mA |
| | V_F ($I_F = 10\text{mA}$) | | 1.2 | 1.5 | V |
| | V_R | | | 3 | V |
| Output | I_T (RMS) | | | 100 | mA |
| | V_{DRM} | | | 250 | V |
| | V_{TM} ($I_T = 100\text{mA}$) | | 2.5 | 3.0 | V |
| | | | | | |
| Coupled Parameters | I_F | 8.0 | | 15 | mA |
| | I_H | 100 | | | μA |

ratio is only 46%.

The circuit in Fig. 4 converts a 24-volt input, V_{IN} , to an inverted 5-volt output. That is, a high input causes the output to go low. When a 24-volt signal is present, current flows through the IRED, and the phototransistor conducts. Because the output of the device is taken at its collector, the input to the logic gate is low.

When the input signal is removed, the phototransistor turns off and R2 pulls the output high. The 4N26 is used here instead of the 4N33 because of its lower $V_{CE(sat)}$ value. Table 2 shows the specifications for the 4N26.

The resistance of R2 is not critical. A nominal value for R2 for any input voltage (V_{IN}) level is given by:

$$R2 = (V_{IN} - V_F)/I_F$$

where $I_F = (V_{CC} - V_{CE(sat)})/R2 - I_{IL}/\eta$.

The I_F value guarantees that the phototransistor will saturate. The value of R1 when V_{IN} is 24 volts is easily found. Let's say that the driven gate is once again a 7400 series TTL. Since R2 is 10K and the gate requires an input current, I_{IL} , of -1.6mA, then:

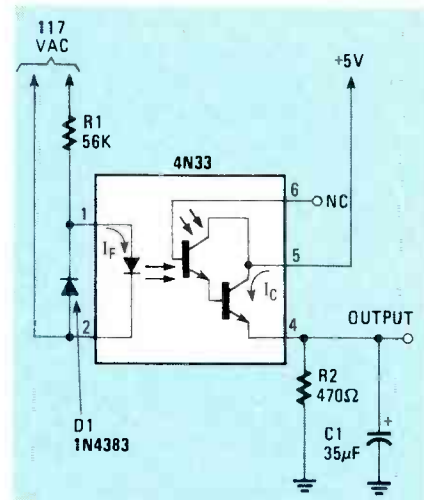

FIG. 5—NON-INVERTING circuit that converts 117 volts AC to 5-volt logic levels.

$$I_F = \frac{5 - .4}{10,000} + \frac{.0016}{.20} = 10\text{mA}$$

Using that value, you can now find the resistance of R1:

$$R1 = 24 - 1.1/10 \times 10^{-3} = 2.3\text{K}$$

The closest standard value is 2.2K.

A non-inverting circuit that converts a 117 volts AC to a 5-volt logic level is shown in Fig. 5. With a 117-volt input applied, current flows in the IRED for one-half the AC cycle and in diode D1 during the other half.

During each positive half-cycle, the photodarlington conducts. That causes a pulsating DC voltage to develop across R2, which is then filtered by capacitor C1. The voltage across C1 forces the gate input high. When the AC input is removed, the photodarlington turns off. The voltage across C1 drops as the capacitor discharges through R2. Now, R2 pulls the gate input low.

Load control

When interfacing logic circuits to the

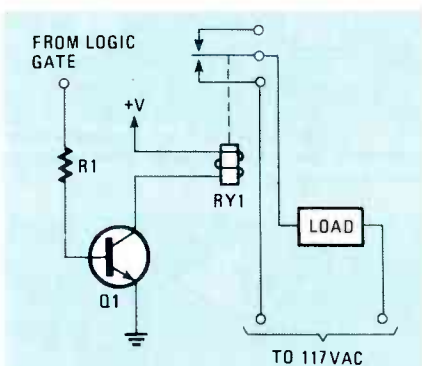

FIG. 6—A RELAY can be used to interface logic gates to real world devices, but circuit requirements may exclude its use.

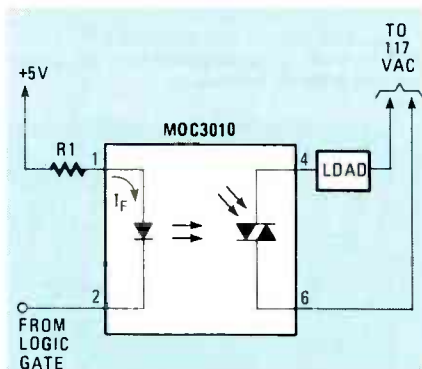

FIG. 7—THIS CIRCUIT MAY be used in applications that have small AC power requirements.

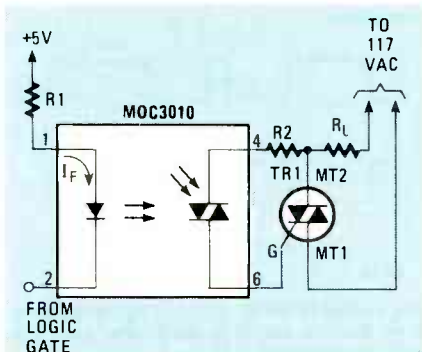

FIG. 8—HERE THE MOC3010 is used to trigger a triac to accommodate larger load requirements.

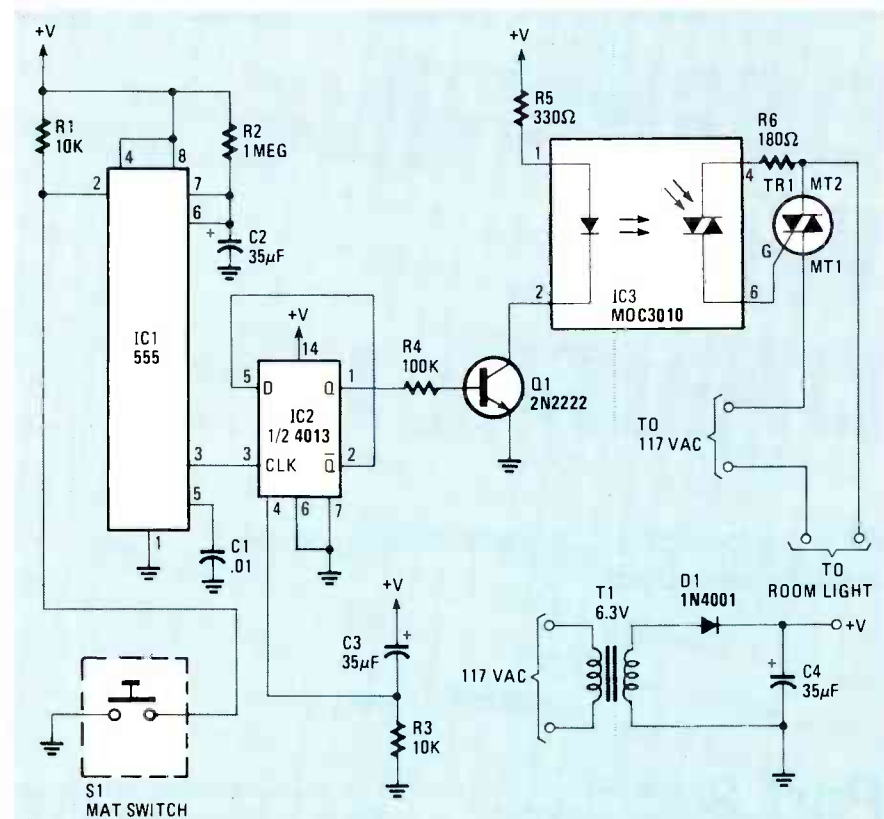

FIG. 9—THE OPTOCOUPLER is triggered by a one-shot to turn on room lights when some one steps on the mat switch, S1.

real world, a logic gate output is often required to control a 117-volt AC load. The relay circuit of Fig. 6 can be used in such applications. However, many circuit design requirements may *exclude* the use of a relay.

The optocoupler designs shown in Fig. 7 and Fig. 8 provide electrical isolation and control without the disadvantages of the relay-circuit design. The control circuit of Fig. 7 may be used to drive loads with small AC power requirements. Here a MOC3010 optocoupler is used; its parameters are shown in Table 3.

When the logic-gate output is low, current flows through the IRED of the optocoupler. If I_F is equal to I_{FT} , the bilateral switch output is triggered into conduction. Since the bilateral switch conducts in both directions, power is delivered to the load during the positive and negative halves of the AC cycle. As the output of the logic gate that's feeding the optocoupler goes high, I_F is reduced below I_H of the MOC3010 and the bilateral switch turns off.

The maximum value for R1 is given by:

$$R1 \leq \frac{V_{CC(MIN)} - V_{F(MAX)} - V_{OL}}{I_{FT}}$$

where V_F and I_{FT} are parameters of the optocoupler used and V_{OL} is the low-level output voltage of the logic gate.

Choose the largest resistor value available that's less than the calculated value. Remember, the logic gate must be capable of sinking a current of I_{FT} with some mar-

gin of safety. The largest load that the MOC3010 can handle is 12 watts.

The circuit in Fig. 8 overcomes the power switching limitation of the MOC3010. Now we see that the output of the MOC3010 is used to gate a power triac. The value for R1 is calculated in the same way as done for R1 in Fig. 5.

The minimum current required to trigger the triac determines the maximum value for R2, while the power dissipation of the triac gate determines the minimum value for R2. The maximum value of R2 is given by:

$$R2 = (2V_S - V_{TM} - R_L) / I_{GM}$$

where V_{TM} is the output parameter of the optocoupler, I_{GM} is the maximum gate trigger current of the triac, and V_S is the AC supply voltage.

Load control application

Figure 9 shows a circuit that can turn room lights on and off as the pressure-mat switch, S1, is activated. The 555 timer, IC1, is configured as a monostable (one-shot) to de-bounce S1 and allow time for the person to step off the mat.

The output of IC1 at pin 3 is fed to half of a 4013 dual, D-type flip-flop, IC2-a, so that it is triggered on each clock pulse. When the Q output of IC2-a is high, transistor Q1 conducts. That provides a path to ground for the diode current, and that, in turn, causes the IRED to conduct. The light from the IRED striking the photodetector causes it to turn on triggering TR1, delivering power to the load. R-E

DESIGNING WITH DIGITAL IC'S

All about logic gates, the basic building blocks of digital electronics.

JOSEPH J. CARR

Part 3 GATES ARE THE FUNDAMENTAL building blocks of digital circuits. From the simplest devices to the most complex computers, digital circuits are ultimately no more than collections of the basic gates described in this article. Those gates include the NOT, AND, OR and EXCLUSIVE-OR. In addition, two other gates are considered basic, although they are essentially formed by marrying two other gates. Those are the NAND (formed from a NOT and an AND) and the NOR (formed from a NOR and an OR).

Circuit symbols

Over the years there have been several different sets of schematic symbols used for digital devices. As a result, at times, the industrial and military/aerospace segments of the electronics industry have had difficulty reading each others' drawings. More recently, however, the set of symbols shown in Fig. 1 has become more or less accepted by all. Those are the symbols that we will use in the remainder of this series.

The NOT gate

The NOT gate, or inverter, is the simplest form of gate, and, indeed, some do not even consider it a gate. Figure 2-a shows the circuit symbol for that device, while its truth table is shown in Fig. 2b. The equivalent circuit for the inverter is shown in Fig. 3.

An inverter inverts. That is, its output signal is the complement of the input signal, as is shown in Fig. 4, and is always the opposite of the input.

In our equivalent circuit, the input state is indicated by the switch position, while the output state is indicated by the bulb. With the input low (switch open) the power supply is connected to the bulb through a current-limiting resistor, so the output is high (bulb on). But when the input is high (switch closed), the output is low (bulb off). Symbolically, if the input is A , the output is \bar{A} , and if the input is \bar{A} , the output is A .

There are several TTL and CMOS IC's that contain inverter stages. The most common form are hex inverters, which are integrated circuits that contain six independent inverters in one package. Examples of hex inverters include the 7404, 7405, 7406, 7407, 7416, and 7417. Of these, all but the 7404 use open-collector outputs.

At this point, it might be prudent to digress a little and mention noninverting buffers. Those also come in hex form (such as the 4050B). Those devices have fanout ratings of 10 and up, and do not invert the input signal. They are used to provide isolation between circuits and to increase the drive capacity of certain device outputs. Microprocessor outputs typically have fan-outs of 2, so they will not drive the heavily loaded lines normally found in personal computers. Devices with fan-outs to 100 are available.

An indication of the influence of personal computers is that IC manufacturers now offer octal buffers and inverters (devices with eight independent buffers or inverters). Those devices match the 8-bit data bus typically used by many popular personal computers.

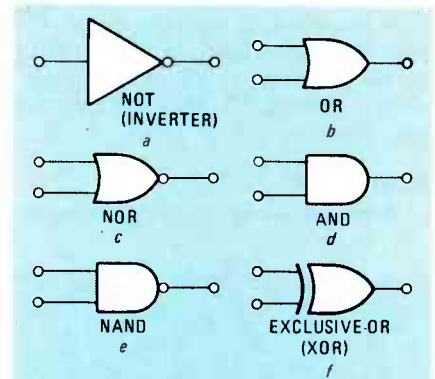

FIG. 1—THESE SYMBOLS are the ones now commonly used to denote logic gates in schematic diagrams.

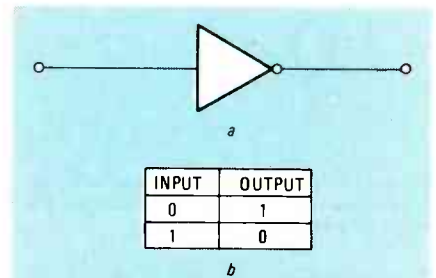

FIG. 2—THE SCHEMATIC SYMBOL FOR a simple inverter, or NOT gate, is shown here, along with the truth table for that device.

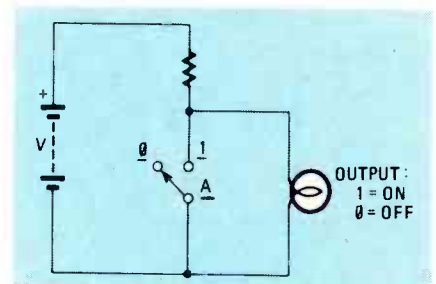

FIG. 3—THE OPERATION of an inverter can be seen by examining the operation of this equivalent circuit.

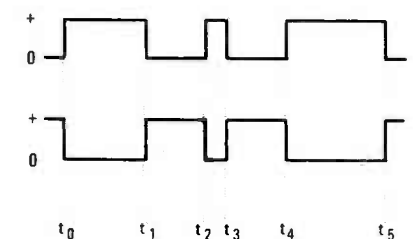

FIG. 4—THESE INPUT AND OUTPUT waveforms show that the output of the inverter goes low whenever the input is high.

The OR gate

Figure 5 shows an OR gate. Its schematic symbol is shown in Fig. 5-a, its equivalent circuit in Fig. 5-b, and its truth table in Fig. 5-c. The input/output waveforms for the device are shown in Fig. 6. For our example, we've chosen to show a two-input device, although OR gates with three, or more inputs are available.

The equivalent circuit can help us understand how an OR gate operates. Once again, the switches are used to represent the inputs, while the light bulb is used to represent the output. If either switch is closed, then the output lamp lights. In other words, if either A OR B is closed, then the lamp is on. Both A and B must be open for the lamp to be off.

That operation is also seen by examining the truth table. Note that a 1 on either input, or on both inputs, will result in a 1 output. The only situation where the output is 0 is when both A and B are also 0.

The NOR gate

A NOR gate is a combination gate made from an OR gate followed by a NOT gate. As seen in Fig. 7-a, the NOR gate symbol is an OR symbol with a small circle indicating inversion at the output terminal. The equivalent circuit for the NOR gate is shown in Fig. 7-b, while the truth table for that device is shown in Fig. 7-c.

Let's see how that gate works by examining its equivalent circuit and truth table. When either switch is closed (logic 1), the lamp is shorted out so that it will be off (logic 0). Both switch A and B must be open (logic 0) for the lamp to be on (logic 1).

We can see graphically the operation of the NOR gate by examining its input and output waveforms shown in Fig. 8. The waveforms labeled A and B, respectively, are applied to inputs A and B, respectively. As is shown, the output is low if either A or B, or both, is high. Only when both A and B are low

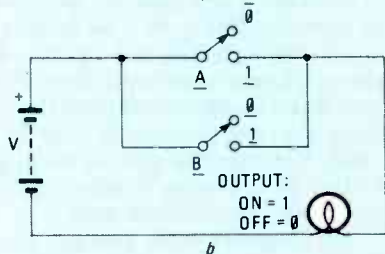
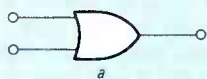

| A | B | OUTPUT |
|---|---|--------|
| 0 | 0 | 0 |
| 0 | 1 | 1 |
| 1 | 0 | 1 |
| 1 | 1 | 1 |

FIG. 5—THE OR GATE. The schematic symbol, equivalent circuit, and truth table for that device are shown here.

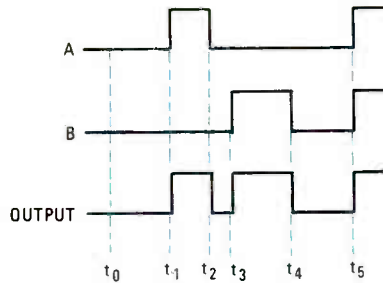
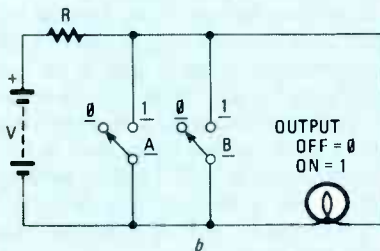
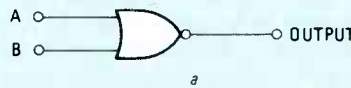

FIG. 6—THE OUTPUT of an OR gate goes high whenever either, or both, of the input are high.



| A | B | OUTPUT |
|---|---|--------|
| 0 | 0 | 1 |
| 0 | 1 | 0 |
| 1 | 0 | 0 |
| 1 | 1 | 0 |

FIG. 7—THE NOR GATE. The schematic symbol, equivalent circuit, and truth table for that device are shown here.

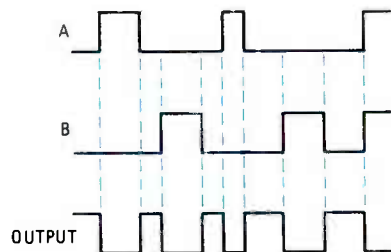

FIG. 8—THE NOR gate—output is high only when neither input is high.

is the output high.

An example of the NOR gate is 7402. That TTL device is a quad two-input NOR gate, so there are four independent two-input gates in the same IC package.

The AND gate

The AND gate is shown in Fig. 9; the circuit symbol is shown in Fig. 9-a, the equivalent circuit is in Fig. 9-b, and the truth table is in Fig. 9-c. The input and output waveforms for the device are shown in Fig. 10.

As you can see in the truth table and the waveform diagram, for the output of the AND gate to be high, all of the inputs must be high; otherwise the output is low. That operation is further illustrated by the equivalent circuit. That circuit consists of

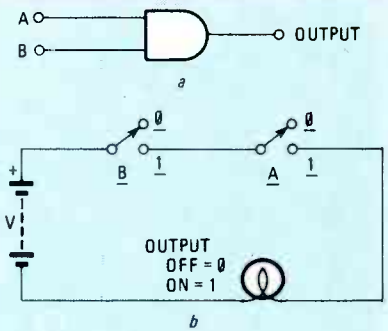

| A | B | OUTPUT |
|---|---|--------|
| 0 | 0 | 0 |
| 0 | 1 | 0 |
| 1 | 0 | 0 |
| 1 | 1 | 1 |

FIG. 9—THE AND GATE. The schematic symbol, equivalent circuit, and truth table for that device are shown here.

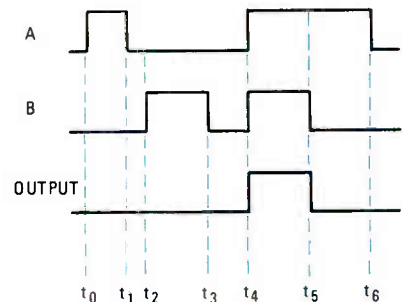

FIG. 10—ONLY WHEN BOTH INPUTS are high, is the output of the AND gate high.

two series connected switches, labelled A and B. Those switches correspond to the inputs of a two-input AND gate. Note that the lamp will not be on, indicating a high, unless both switches are closed (in the logic 1 position).

In some older manuals on digital logic, they call the AND gate by a very appropriate name: "coincidence detector." In other words, a circuit that generates an output indicating the coincidence of input pulses.

The NAND gate

The NAND gate is another example of a composite gate. In this case, the NAND gate is essentially an AND gate followed by an inverter (NOT-gate). Figure 11-a shows the schematic symbol for a NAND GATE. Fig. 11-b shows the equivalent circuit, and Fig. 11-c shows the truth table. Figure 12 shows the input/output waveforms for that device.

In operation, as is shown in the waveform diagrams and the truth table, if either input sees a low, the output is high. The only way that the output can be low is if both inputs see a high.

It is instructive to compare the operations of NAND and NOR gates, keeping in mind that a positive-logic NAND is also a negative-logic NOR, and vice-versa.

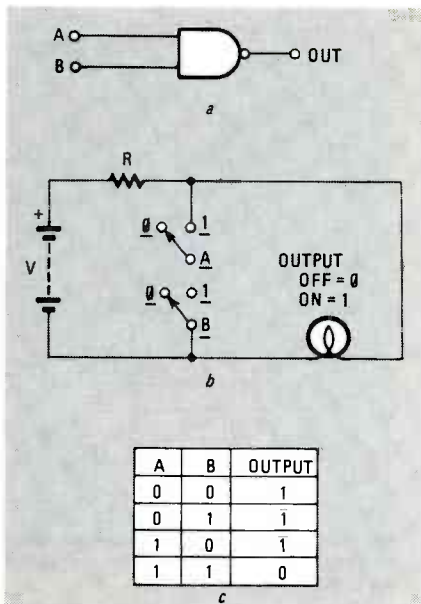

FIG. 11—THE EQUIVALENT CIRCUIT of a NAND gate is shown in *b*. Note that the output is low only when both inputs are high. That operation is confirmed by looking at the truth table for that device.

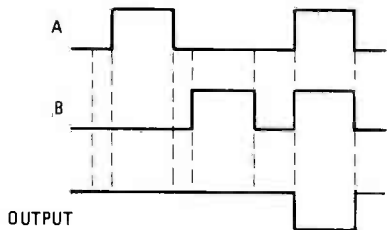

FIG. 12—THE INPUT AND OUTPUT waveforms for a NAND gate. Note, once again, that the output is low only when both inputs are high.

In the equivalent circuit for a NAND gate, the two switches that represent the inputs are connected in series with each other, and the series pair is in parallel with the lamp. Thus, both switch A and switch B must be set to 1 for the output to be 0.

The EXCLUSIVE-OR (XOR) gate

The EXCLUSIVE-OR (XOR) gate is like an OR gate in that it will produce a high output if either input A or input B are high. It differs in that it will not produce a high output if both inputs are high. Figure 13-*a* shows the circuit symbol for the XOR. Fig. 13-*b* shows the equivalent circuit, and Fig. 13-*c* shows the truth table. Figure 14 shows the input/output waveforms for that device.

In operation, a high on either input will produce a high output, but if either both inputs are high, or both are low, then the output is low.

Simple digital circuits

Digital logic gates can be more flexible than they appear at first glance, especially when two or more are used in a combination circuit. In this section, we will see a few such circuits.

For example, it is possible to combine gates to form other gates. That fact can be quite handy when you have designs that use only a few gates on a multiple-gate IC. Inverters, for instance, are often packaged six to an IC, while NAND and NOR gates come packaged four to an IC. Now, if we need a two input NOR gate, and there is a hex inverter in the circuit that has two unused sections, then we can fashion our NOR gate from those unused inverters, thereby avoiding the need to use another IC.

Figure 15 shows a four-input NOR gate fashioned by wiring together the outputs of four open-collector inverters. A pull-up resistor is needed between the wired-OR output and the power supply. If any one of the inverter outputs is low, then the output terminal of the gate will be low also. Since the inverter output is low if the corresponding input is high, we know that a high on any one input will make the output low, and all four inputs must be low for the output to be high. Looking back at our discussion of the NOR gate, we find that the circuit we've built functions exactly like that gate.

The use of wired-OR outputs to form an N-input NOR gate is normally limited to cases where extra inverters already exist in the circuit.

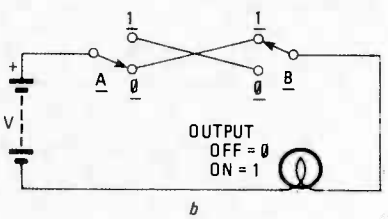
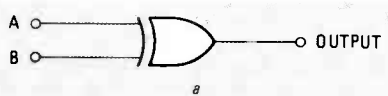

| A | B | OUTPUT |
|---|---|--------|
| 0 | 0 | 0 |
| 0 | 1 | 1 |
| 1 | 0 | 1 |
| 1 | 1 | 0 |

FIG. 13—THE EXCLUSIVE-OR GATE. The schematic symbol, equivalent circuit, and truth table for that device are shown here.

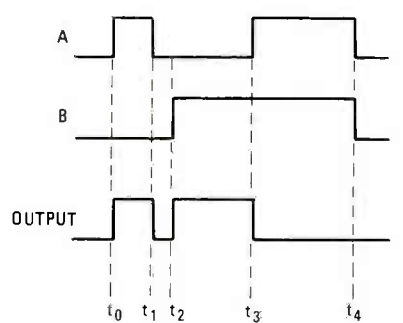

FIG. 14—IN THE EXCLUSIVE-OR, the output is high only when either input, but not both, are high.

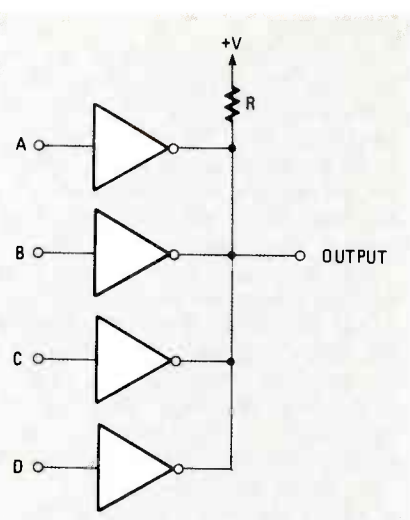

FIG. 15—MORE COMPLEX GATES can be built using simple inverters. Here four inverters are configured as a four-input NOR gate.

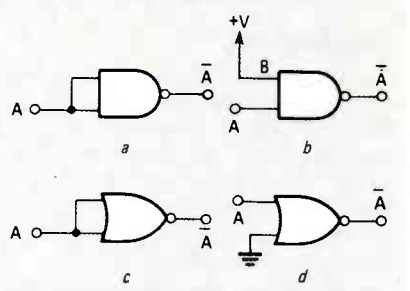

FIG. 16—BY WIRING NAND or NOR gates as shown here, they can be used as simple inverters.

Figure 16 shows the opposite case—the use of more complex gates to form a simple inverter. Again, the purpose in doing that is to make efficient use of extra gates in the circuit. If, for example, you need an inverter and find that one or more NAND sections are otherwise wasted, you can make the NAND work as an inverter and thereby avoid using another IC.

From NAND gates (Figs. 16-*a* and 16-*b*), we can make an inverter by either tying both inputs together or by tying the unused input permanently high.

Similarly, a NOR gate can also be used as an inverter. In Fig. 16-*c*, we see the case where both inputs are tied together. That case is the same as for NAND gates. Figure 16-*d* shows an alternate method. Here, we show one input grounded to form the inverter. Compare that with the NAND gate of Fig. 16-*b*, keeping in mind the rules governing NAND and NOR gates.

The properties of the XOR gate give us the ability to build a circuit that is either an inverting or noninverting buffer, depending upon the setting of a switch. Figure 17 shows such a circuit. Switch S1 is connected between ground and one input of the XOR gate. Also connected to the gate input is a pull-up resistor to the power supply. When S1 is open, the resistor will ensure that the gate input is high. When S1

continued on page 120

3 High-Performance Scanner Antennas

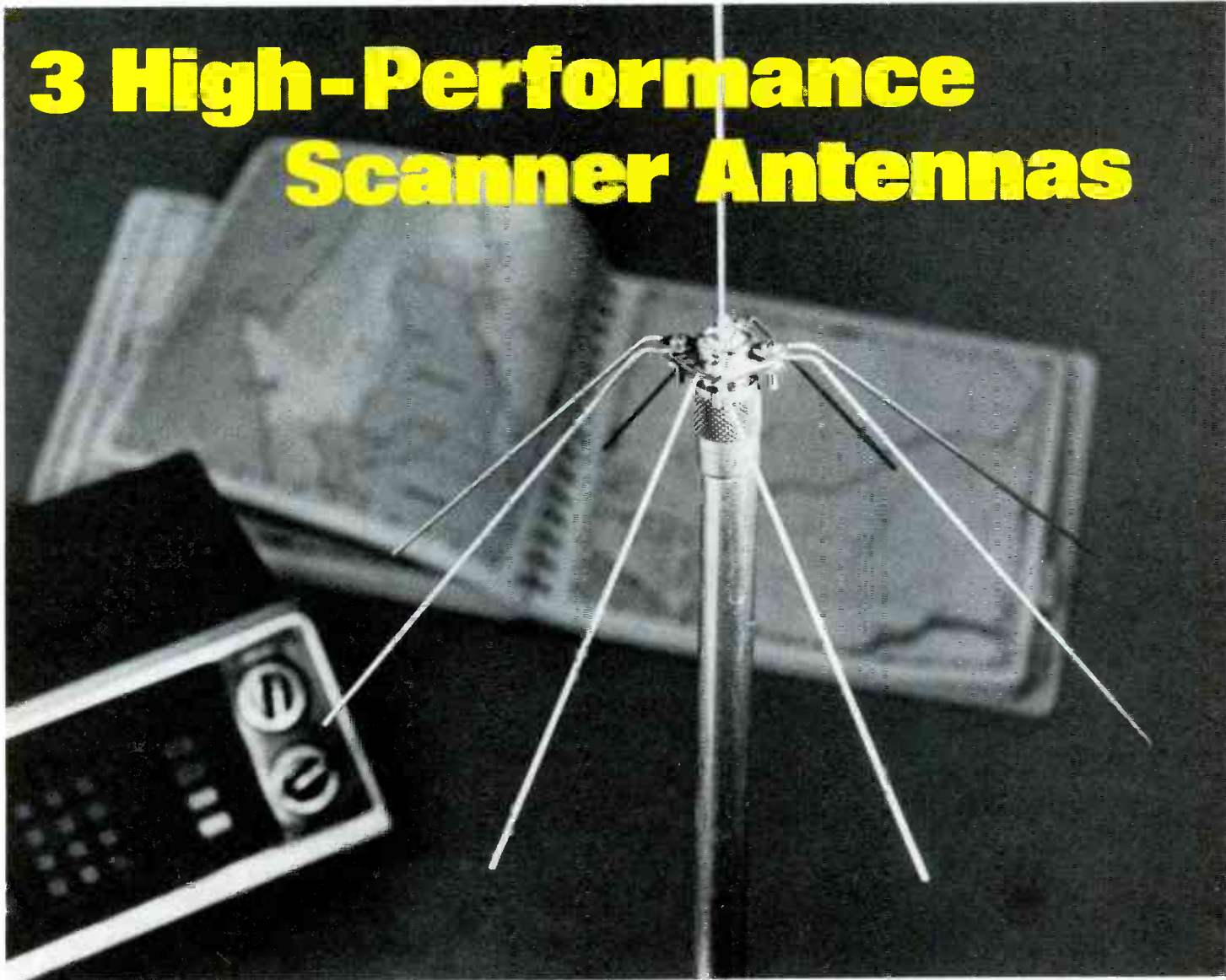

Are you still using your scanner's built-in antenna? Build one of these custom antennas and pull in those weak signals you've been missing!

LOREN FREBURG

Part 2 WHEN WE LEFT YOU last time, we were discussing the extended double-Zeppelin antenna. As mentioned then, the antenna is made of $\frac{3}{4}$ -inch tubing, as shown in Fig. 8, which allows the feedline to be run down the center where it cannot affect the antenna's performance.

The center (phasing) stub is made from brass brazing rods; $\frac{3}{16}$ -inch diameter for a VHF-low, and $\frac{1}{16}$ inch for the VHF-high or UHF bands. Calculate the length of each section using Fig. 9 as a guide. Then correct the length for the diameter of the material used in each section according to

Table 3. The calculation for the stub length must include the length of the leads on the transformer, see Fig. 10, which should be cut as short as possible.

If the antenna is intended for the VHF-low band, 30–50 MHz, each element will be from 12- to 20-feet long. That means that you'll need more than one length of tubing. Use two sizes, maybe $\frac{3}{4}$ and $\frac{7}{8}$ -inch diameters, so that one fits inside the other. Use the larger size for the portions nearest the feedline connection. Cut two one-inch long slots lengthwise on the outside end of larger tube, and insert the smaller one. Use a hose clamp to hold them together.

Drill two $\frac{3}{16}$ -inch holes in each element

to mount the antenna on the mast and hold the phasing stub: one $\frac{1}{4}$ -inch from the end and the other about 4–6 inches from the end. Bend the brazing rod to form the stub. That's easily done by temporarily inserting the bolts into the tubing and then bending the rods around them. Cut to the final length after forming the bends.

Mount the antenna and phasing stub near the top of the mast (see Fig. 8) with No. 10 machine screws and washers. Run the coaxial feedline, preferably RG-8/M, through the lower tubing before inserting the screws. The RG-58/U has higher losses, but will fit easily. (If you've chosen RG-8/U, either solid or foamed dielectric, there's will not be enough

space for the machine screws and the larger cable.) Secure the tubing to the mast with U-bolts.

Although not necessary, the phasing stub may be bent into a semicircle around the mast. That streamlines the appearance and reduces the stress slightly because the stub does not have to support as much feedline. That's particularly advantageous for the VHF low-band antenna. Solder the transformer leads to the end of the phasing stub, and connect it to the coaxial cable

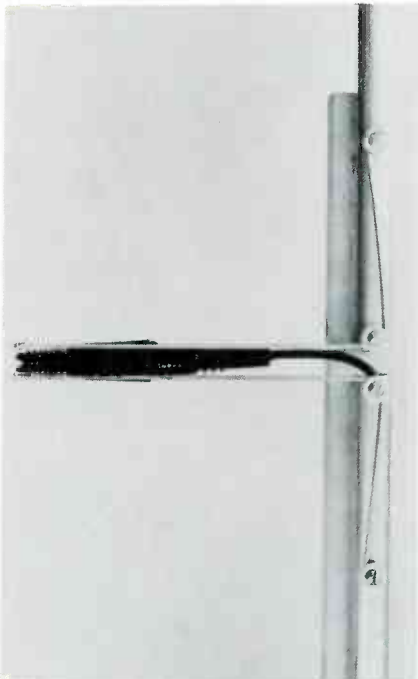

FIG. 8—CENTER OF THE extended double-Zepp antenna. Note the orientation of the balun transformer and phase reversal stub.

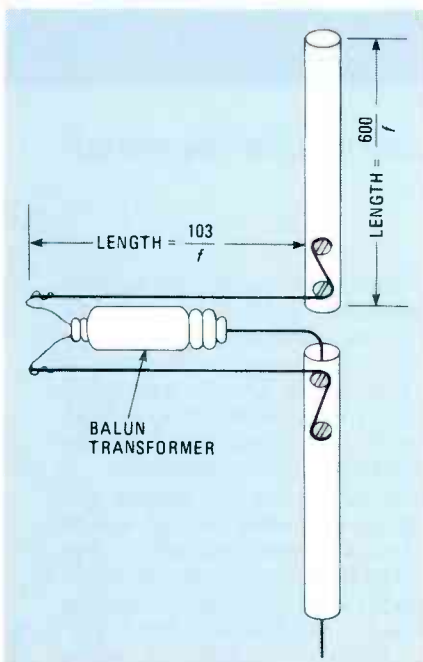

FIG. 9—EXTENDED DOUBLE-ZEPP. Calculate the length of the elements as shown.

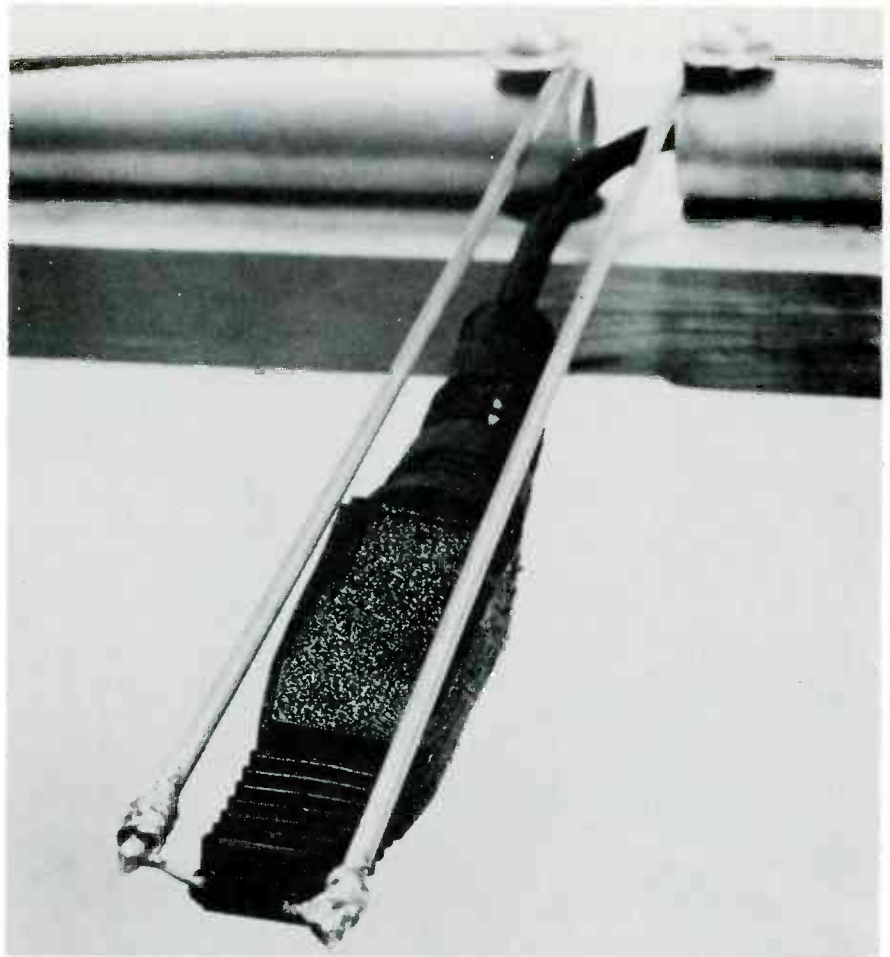

FIG. 10—EXTENDED DOUBLE-ZEPP with balun transformer connected; the transformer leads should be cut as short as possible.

with the appropriate connector.

The mast material must be a non-conductor. Wood that has been weather-proofed with two coats of varnish or polyurethane is a good choice. Shorter antennas for UHF or VHF-high band are easily supported on 2 × 2-inch lumber, but for VHF low, use a 2 × 4 or even a 4 × 4, depending on the height the mast will be. Before raising the mast, cover all the electrical connections with silicone rubber cement to prevent oxidation.

The upper element of the extended double-Zepp does not have to be made of tubing since there's no coaxial cable to shield. For UHF and VHF high band, you may prefer to use brazing rods, very small diameter tubing, or even heavy-gauge copper wire for smaller sections. The lower element is, of course, all tubing. The very top of the upper element is an 8½-foot fiberglass, CB whip antenna.

The whip antenna is bolted to a metal cap, which is then bolted to a lower 5½-foot aluminum tubing. That reduces both wind resistance and weight for this tall, effective antenna. The total length of the antenna will be about 14 feet.

Coaxial-collinear antenna

This antenna is a modification of the stacked-dipole. It is made of coaxial cable

and all the elements lie on the same line, hence the name, *coaxial-collinear*. (Refer to Fig. 11.) One side of the dipole is the center conductor of the coaxial cable and the other side is the outside braiding as shown in Fig. 11-a. The feedline is connected to the center of a half-wave dipole. Figure 11-b shows the dipole folded on itself and Fig. 11-c is the folded dipole with the center conductor extended.

Additional half-wave sections are stacked on with the center conductor of each section connected to the outside braid of the next as shown in Fig. 11-d. The braid acts as a shield, preventing a signal from reaching the center conductor.

The result is that every other half-wave section is exposed to the incoming signal and the induced current is in phase, thus providing gain. The configuration at the top of the antenna array makes each leg of the series of dipoles equal in length. The feedline is therefore connected at the very center, where the impedance is lowest and comes closest to matching the feedline.

The basic design can be modified for more or less gain. Eight half-wave sections provide about a 6-dB gain over a simple dipole, and sixteen sections give about a 9-dB gain. Because of its length, the design is most applicable for VHF high-band and UHF signals.

The coaxial cable used should have a 50-ohm impedance with a solid dielectric. (RF travels slower in solid polyethylene, thus the antenna can be made shorter.) Use either RG-8/U or RG-58/U. The RG-8/U is heavier and stiffer, but has lower losses. The RG-58/U is easier to solder with a small soldering iron.

The single most important requirement for a good coaxial-collinear antenna is patience. The work is not difficult, but it can be time consuming, especially if you're not comfortable with coaxial cable. Concentrate on only one joint at a time. Be careful when connecting the sections: an accidental short circuit can turn your carefully engineered antenna into just a random length of wire.

Calculate the lengths of the sections according to Fig. 12. Then correct for the velocity factor of the coaxial cable you're using, usually 0.66 for the solid dielectric. For example, a half-wave section designed for 155 MHz:

$$\lambda = 984/155 = 6.348 \text{ feet}$$

$$\lambda/2 = 6.348/2 = 3.174 \text{ feet}$$

$$3.174 \times 0.66 = 2.094 \text{ feet}$$

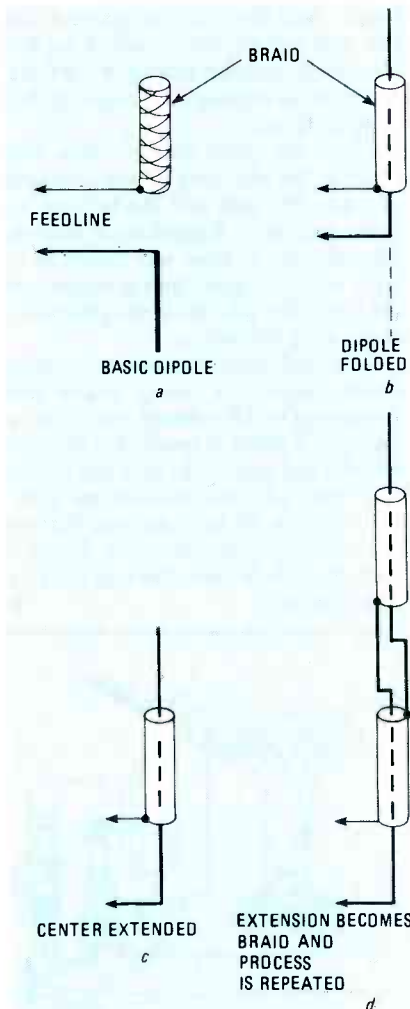

FIG. 11—COAXIAL-COLLINEAR antenna made from coaxial cable: *a* is a basic dipole; *b* shows the dipole folded on itself; in *c*, the center conductor is extended, and *d* shows two stacked coaxial sections.

After determining the dimensions, begin by preparing one end of your coaxial cable as shown in Fig. 13. Do *not* cut to length until after the end is properly prepared. That way, if you make a mistake you lose only an inch or so rather than the entire section. Do the same for each of the eight sections, preparing one end and then cutting to length. (By the time you return to complete the other end of each section you'll be an expert!)

Prepare the coaxial cable by stripping away some of the insulation according to Fig. 13; a tubing cutter or knife work well, but be careful if you use a knife. It is a good idea to tin the copper braid before joining the sections, but be careful not to overheat the polyethylene core. If the core melts, it runs over the braid making further soldering almost impossible.

If you use high-quality coaxial cable with a closed braid, you will not experience the difficulty of molten plastic oozing through the spaces, as you would with the cheaper stuff.

After preparing the individual sections, begin connecting them (see Fig. 14). Note that at the joint, the center conductor of each section is joined with the shielding of the next. Be careful that you leave no frayed ends of braid that might short the joint. The best way to handle that is to lay the center conductor of one section on the braid of the next and wrap the braid end around the joint as shown in Fig. 14.

Seal each joint with silicon rubber cement and wrap it securely with electrical tape to protect it from moisture and make it stronger. Slide the completed antenna into a length of heavy-walled (Schedule 40) PVC plastic tubing about 3/4 inch in diameter. The thicker RG-8/U coaxial will easily slide through the tubing. But the lighter RG-58/U needs some help: For support, use a small nylon cord about 1/8 inch in diameter cut a foot longer than the antenna. Tie knots in the cord every foot or so and tape to your antenna, starting at the bottom.

Put the tape on the top side of the knot to prevent it from slipping when the entire assembly is in position. Slide the cord through the PVC tubing and pull the assembly through using the cord for support. With the antenna inside the tubing, there will be about a foot of nylon cord protruding from the top. Tie a large knot an inch beyond the end of the top wire section and then cap the end of the tubing, with the knot just outside.

If the cap fits too tightly, file a notch on the outside of the tubing to accommodate the cord. Glue the cap in place and dab a little glue on the knot so it won't come loose. Your antenna is now ready to be taken to its final location.

Depending on the antenna's length, you may want to brace it with lumber. And if it is exceptionally long, you may have to use guy wires as well. Non-stretching

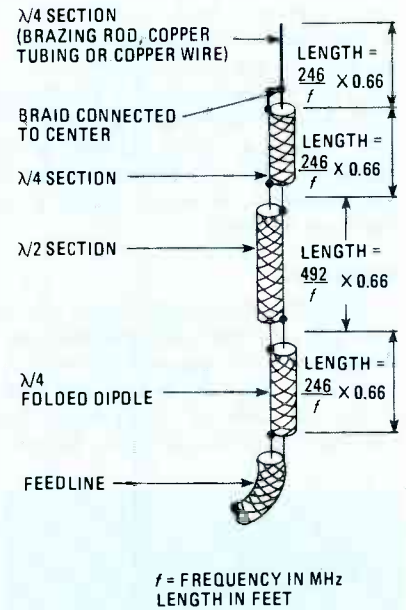

FIG. 12—COAXIAL-COLLINEAR antenna dimensions are shown here. Note that the center conductor of each λ/4 section is connected to the braid of the next.

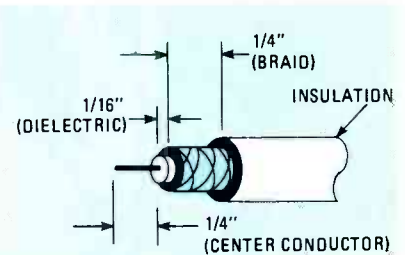

FIG. 13—PREPARE THE COAXIAL cable sections by stripping off some insulation and peeling back the braided shielding.

polypropylene clothesline is fine. The guy wires don't have to go to the very top because at least 5 feet will be self-supporting even in extremely high wind.

Which antenna is best?

The three different antennas described varying in size, complexity, performance, and appearance. Begin designing your antenna by choosing the type that best suits your needs. In making your decision, you must consider all the variables. You can be assured that any choice made is an improvement over your monitor's built-in antenna system.

First, pick the band for which the antenna will be used. If you are lucky, all frequencies used by your local services will be in one band, and close together in frequency. Use Table 1 to help make that selection.

Often you will be interested in frequencies in all three bands; therefore you must decide which is most important to you. That choice should not be too painful. Your new antenna will probably outperform the built-in one on all frequencies solely because it is mounted higher and away from interfering objects.

After choosing the band, consider how the antenna will look, where it will be located, and is there enough room for the radials: will the coaxial-collinear be too tall?: do you really need a lot of gain? Table 4 is provided to help with that decision. With that out of the way, go the section that describes the antenna and begin building it. Be sure to follow all instructions carefully.

Installation

For optimum performance, an antenna should be positioned high and in the open. Remember that reception is best when the antenna is within the line of sight of the transmitting antenna. Don't pick a location that is hazardous to get to, and *never*



FIG. 14—FINISHED JOINT: Note that the center conductor is placed on the braid and braid ends wrapped around to secure conductor in place before soldering.

place an antenna near any electrical line before, during, or after installation. And do not mount near metal objects.

Other than the obvious shock hazards presented by power and telephone lines, nearby metal objects can change the effective inductance of the antenna and, thereby, reduce its performance. Also, before installation, ask yourself: "If the antenna falls or is blown down during a storm, where will it land?" It might also be a good idea to ask: "If I fall during installation, where will I land?"

Try to pick a location where you'll need only the minimum amount of feedline. In other words, don't place the antenna 200 feet away from the receiver's location simply to gain 10 feet in height. The height advantage will be overshadowed by additional losses due to the extra feedline. Also try to keep as much of the feedline vertical as possible.

Use coaxial cable to connect the antenna to your monitor. It is rugged, flexible, and the shielding allows you to place it in any convenient location. Running the cable along metal gutters will have no effect. Coaxial cable is available in a wide variety

of sizes and efficiencies, with corresponding costs. Pick one that has a nominal 50-ohm impedance.

An important difference between cables is the structure of the dielectric material. If it's foamed it will have significantly less loss at radio frequencies than the solid core. RG-58/U, about 1/4 inch in diameter, with a foamed-dielectric is an excellent cable for our purposes. Try to avoid RG-8/U. It is larger in diameter, less flexible, and costs more.

If you can find RG-8/M (miniature RG-8/U) it is also a good choice. It's only slightly thicker than RG-58/U and exhibits a good balance of flexibility and low loss at a reasonable cost. Remember when choosing your cable that signal loss increases with frequency and feedline length. For long runs at high frequencies, it is an excellent idea to use the best cable that you can afford. You'll also need a Motorola-type plug to connect the feedline to your scanner.

The simplest place to bring the feedline into the house is usually in the vicinity of a window. Drill a small hole through a non-movable part that can be easily patched

TABLE 4
ANTENNA SELECTION GUIDE

| Band | Ground Plane | Extended Double-Zepp | Coaxial-Collinear |
|----------|---|--|--|
| VHF-low | Shortest antenna Radials may need support Good Choice | Fairly tall but no radials | Excessive length |
| VHF-high | Short Easy construction | Reasonable length Neat installation | Highest gain Neat installation Good choice |
| UHF | Tiny Easy construction | Small size is difficult to build | Highest gain Neat installation Good choice |

later if necessary. The window frame, top or bottom is best for that. Some houses allow easy access through a basement vent and then up through the floor.

When running coaxial cable, avoid sharp bends and be certain that the external connections are weather sealed. The foamed-dielectric cable in particular can absorb moisture, which increases feedline losses. And don't feel obligated to keep the antenna in the original location chosen. Sometimes raising or lowering it a few feet, or moving it sideways can make a big difference.

There are often unpredictable influences in the area, like power, telephone, or cable TV lines and maybe even your own rain gutters. Regardless of how good your antenna is, there will always be distant, weaker signals barely audible over the noise. The position of the antenna may make a big difference.

As a final thought, consider turning the disadvantage of a closely placed metal downspout or TV-antenna mast to an advantage. If either is spaced $\lambda/4$ from your antenna and parallel to it, it can function as a reflector. That provides less gain in the direction of the reflector, but more gain in the opposite direction. If you live on the far side of town, that may be exactly what you need.

R-E

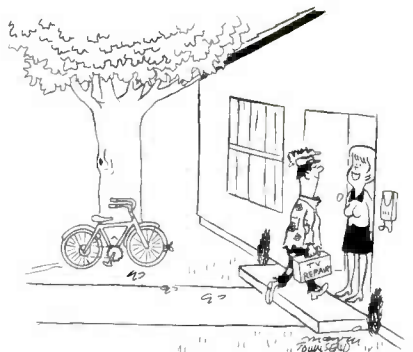

"I understand that you're the only TV service man in the area who still charges \$10.00 an hour."

HOBBY CORNER



EARL "DOC" SAVAGE, K4SDS,
HOBBY EDITOR

Power-surge protection, and more!

A SURGE ON THE AC POWER LINE CAN cause you all kinds of problems. Don Maxwell (OK) has had a couple of line-voltage monitors blown by surges induced in the line during electrical storms. R. Fortier (Ont) just wants to protect his equipment from "normal" surges caused by power company switching or by an industrial user.

Well, fellows, one of the easiest ways to protect your equipment from most varieties of power-line surges is to install an MOV (Metal Oxide Varistor) or two.

A MOV is a small component that looks like a fat disc capacitor. It is inexpensive and you can get one from many sources, including Radio Shack.

The MOV is connected across the AC line and simply shorts to ground the spikes that exceed the rated voltage. Of course, you could install an MOV in each piece of equipment, or in an outlet box or strip, to protect all the equipment.

That's it, fellows—nothing could be simpler. And, Don, good luck with those storms!

Headphone adapter

Bob Thorsen (CT) sent in a circuit for installing a headphone jack on your radio or TV. That is a handy feature to add to any radio, TV, or record player, and it can be used to connect an additional speaker as well as a headphone.

With a couple of minor changes, Bob's hook-up is shown in Fig. 1. In Fig. 1-a, one of the leads to the built-in speaker is broken. Figure 1-b shows a 2-conductor, single

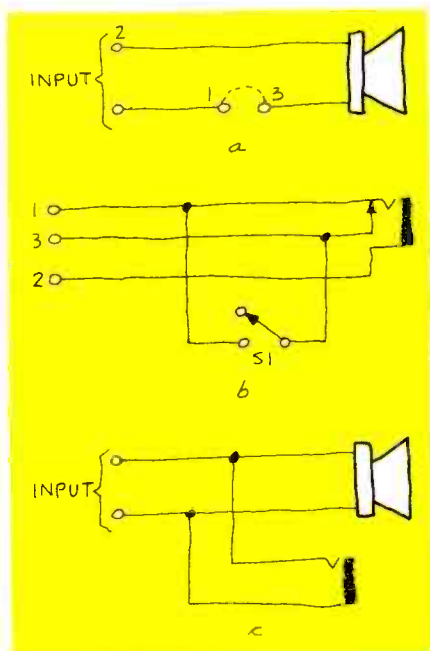

FIG. 1

closed circuit jack; the numbered points shown in the figure are connected to the like numbered points in Fig. 1-a. Note that points 1 and 3 are disconnected when the phone plug is inserted into the jack. Normally, that would mean that no sound comes from the speaker when using the headphones. By adding the SPST switch, it is possible to choose between routing the signal to the headphones only or to both the headphones and speaker at the same time. Do not wire that switch any other way or you may end up with either a short across the amplifier or no load on the amplifier. Either or both conditions can be

fatal to some amplifiers.

If you want sound from the speaker whether the phones are plugged in or not, just wire an open-circuit jack as shown in Fig. 1-c.

Questions without answers

I wish it were possible to answer every one of your questions. Unfortunately, that cannot be done because time just will not permit it (to say nothing of the fact that the answers to some of them cannot be found).

Don't let that stop you from sending your questions. We will get to as many of them as we can. There are a couple of types of questions, however, that get put aside as soon as they come in. To save you time, here are two examples of questions that will not or can not be answered.

We won't knowingly tell you how to get yourself in trouble. That's why one reader did not get a circuit to shock anyone who touched his car and another did not find out how to increase the power of a CB transmitter. For the same reason, we just set aside a letter from a gentleman in NY who wanted a device to disrupt the reception of his neighbor's too-loud TV.

Secondly, you know, of course, that special circuits can't be designed to your specifications. Most of you are very understanding about this restriction and we appreciate it. But some are not.

For instance, there is a fellow in PA who has become insistent

about a circuit design using the components he has on hand. Such service is not available here! We suggest that you study until you can design it yourself.

Crossed signals

C. W. Sturgeon (NY) has built a multiple-input device that controls several relays. When individual sections are tested, they function perfectly. A problem shows up when the several sections are connected. In that event, there is interaction between the sections, which, in turn, causes some unforeseen and undesirable consequences.

On the basis of the information sent by CW, he has a classic case of stray signal paths. I won't try to show you CW's entire complex circuit, but will instead demonstrate the problem and solution with a simple example.

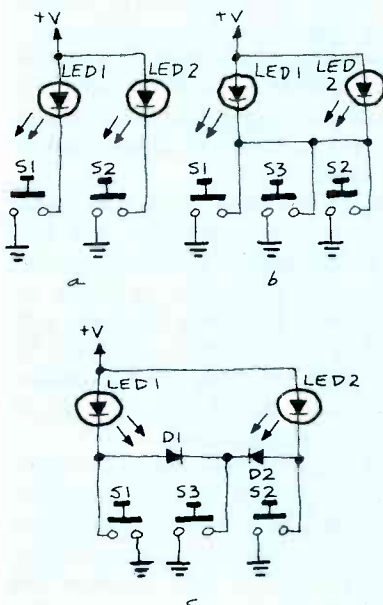

FIG. 2

Suppose you have two LED's, labeled A and B in Fig. 2-a, controlled individually by momentary switches S1 and S2. Now, you want to add a third switch to light both LED's.

You might be tempted to wire S3 as shown in Fig. 2-b. If you did so, however, all three switches would light both LED's. Trace the signal paths and you will see the interactions. That certainly makes the device worthless but you can save the day.

The signal paths can be isolated



ZENITH SSAVI DESCRAMBLERS only \$169; GATED PULSE & SINEWAVE decoders \$199 each. Original equipment for UHF chs. 23,27,31,51,54,57,68, etc. Quantity discounts. Surplus Cable TV equipment: Jerrold SB-3, Oak N-12, Zenith Z-Tac, Hamlin 1400, etc. Complete **Satellite Systems** at \$845 and up; Installation and program guide, \$3. Dealers welcomed. Catalog \$1. Visa/MasterCard. Satisfaction guaranteed. **AIS SATELLITE, P.O. Box 1226-E, Dublin, PA 18917. 1-800-643-2001 or 215-249-9411.**

CIRCLE 263 ON FREE INFORMATION CARD



THE VIDEO SIMULCASTER REBROADCASTS ANY TV SOUND TRACK ONTO FM RADIO! Use with home stereo system for dramatic, high fidelity TV sound. Perfect for rock videos, sports games, etc. High & low level input sensitivity will rebroadcast a VCR, record player, tape deck, etc. 300' range covers entire home. Easy to build kit only **\$29.95.** Tax included. **FREE SHIPPING.** **DECO INDUSTRIES, Box 607, Bedford Hills, NY 10507**

CIRCLE 272 ON FREE INFORMATION CARD

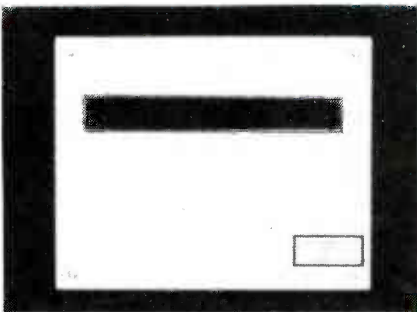

REAL WORLD CONTROL/MONITOR from your personal computer. 16 digital inputs, 16 digital outputs, 8 channel A to D converters with on-board kelvin to fahrenheit converters, enable/disable selectable per channel, allows direct use of temperature sensors. Comes complete with software. **\$249.95** for most P.C.'s **LOGICAL TECHNOLOGIES INC. 313-522-2385 30591 Schoolcraft, Livonia, MI. 48150**

CIRCLE 273 ON FREE INFORMATION CARD

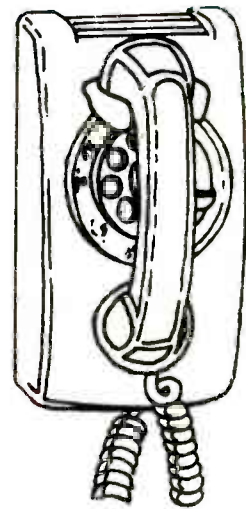

CALL NOW AND RESERVE YOUR SPACE

- 6 x rate \$650 per each insertion.
- Reaches 225,016 readers.
- Fast reader service cycle.
- Short lead time for the placement of ads.
- We typeset and layout the ad at not additional charge.

Call 212-777-6400 to reserve space. Ask for Arline Fishman. Limited number of pages available. Mail materials to: mini-ADS. RADIO-ELECTRONICS. 200 Park Ave. South. New York. NY 10003.



ELECTRO IMPORTING CO. CATALOG. This reprint of the historic 176-page catalog No. 20 gives you an accurate look at the state of electronics in 1918. Contains everything from a Zinc Spark Gap to a 1000-Mile Receiving Outfit. You can get your own copy of this modern antique, profusely illustrated, for only **\$4.95** plus \$1.00 P&H. Order yours from **R-E BOOKSTORE, Radio-Electronics, 200 Park Avenue South, New York, NY 10003.**

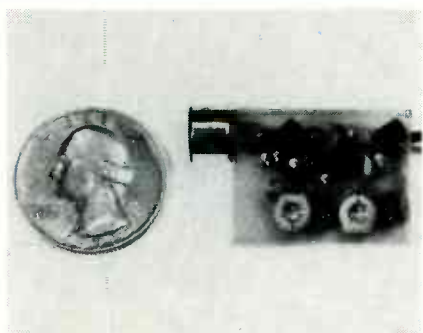

THE MOST EXCITING KIT YOU WILL EVER BUILD The model WAT-50 miniature FM transmitter uses a 4-stage circuit NOT to be confused with a simple wireless microphone. Up to 1 mile range. So sensitive, it will pick-up a whisper 50 feet away! Use with any FM radio. Complete kit only \$29.95 tax incl. FREE SHIPPING. **DECO INDUSTRIES, Box 607, Bedford Hills, NY 10507.**

CIRCLE 266 ON FREE INFORMATION CARD



SUBSCRIPTION TV MANUAL. This information packed book details the methods used by subscription TV companies to scramble and descramble video signals. Covers the Sinewave, Gated Pulse, SSAVI system, and the methods used by most cable companies. Includes circuit schematics, theory, and trouble shooting hints. **Only \$12.95 plus \$2.00 first class P&H. ELEPHANT ELECTRONICS INC., (formerly Random Access) Box 41770-R, Phoenix, AZ 85080.**

CIRCLE 120 ON FREE INFORMATION CARD

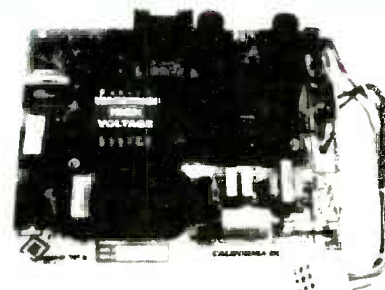

CALIFORNIA-DC REGULATED SWITCHING POWER SUPPLY +5v dc @ 5 amp + 12v dc @ 2.8 amp + 12v dc @ 2 amp - 12v dc @ .5 amp 115-230v ac input, fused. EMI filtered. Removable DC Power Harness and Schematics included. 7.4" x 6.2" x 1.7" ht. Visa/MC/M.O./check; when clears. **\$37.50 ea.** (Free shipping in U.S.) **1-800-327-7182/305-830-8886. POWER PLUS, 130 Baywood Ave., Longwood, Fl. 32750.** (Call for quantity price).

CIRCLE 125 ON FREE INFORMATION CARD



GALAXY ELECTRONICS, INC. the leader in microwave announces the new dual-polarity, multi-channel, wide-band microwave TV tuner. Tunes entire 800 MHz from 1.9 to 2.7 GHz. Receive sports, education, religious, news, movie programming, & more is being added to this frequency spectrum almost on a daily basis in most major cities. Complete systems from \$69.95. **GALAXY ELECTRONICS, INC., 5644 North 53rd Avenue, Glendale, AZ 85301. 602-247-1151.**

CIRCLE 252 ON FREE INFORMATION CARD

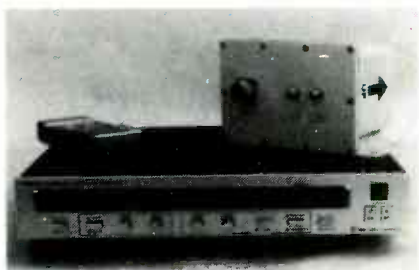

SATELLITE TELEVISION RECEIVER SEMIKIT with dual conversion downconverter. Features infrared remote control tuning, AFC, SAW filter, RF or video output, stereo output, Polorator controls, LED channel & tuning indicators. Install six factory assembled circuit boards to complete. **Semikit \$400.00.** Completed downconverter add \$100. Completed receiver and downconverter add \$150. **JAMES WALTER SATELLITE RECEIVER, 2697 Nickel, San Pablo, CA 94806. Tel 415-724-0587.**

CIRCLE 124 ON FREE INFORMATION CARD



APPLIANCE REPAIR HANDBOOKS—13 volumes by service experts, easy-to-understand diagrams, illustrations. For major appliances (air conditioners, refrigerators, washers, dryers, microwaves, etc.), elec. housewares, personal-care appliances. Basics of solid state, setting up shop, test instruments. \$2.65 to \$5.90 each. Free brochure. **APPLIANCE SERVICE, PO Box 789, Lombard, IL 60148. 1-(312) 932-9550.**

CIRCLE 84 ON FREE INFORMATION CARD

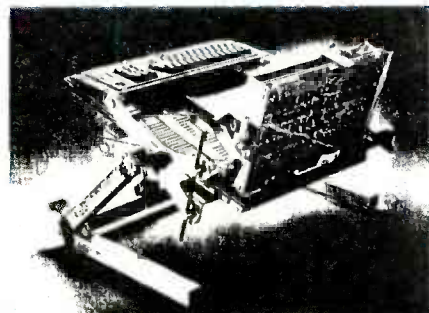

INDUSTRY'S MOST VERSATILE CHASSIS MOUNT. Lightweight, Aluminum, Portable, bench top Chassis Mount with features and advantages never before available. Two models, either self-centering heads or scissor clamps, 100 lb load capacity and width up to 18", 360 degree rotation and pivot center height of 9". Only \$199.95. See your dealer or contact: **PANAVERSE PRODUCTS INC., 2850 East 29th Street, Long Beach, CA 90806 (213) 595-7621**

CIRCLE 253 ON FREE INFORMATION CARD

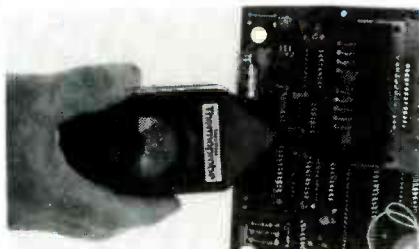

THERMOPROBE—QUICKLY IDENTIFIES DEAD PC BOARD COMPONENTS. Locates dead resistors, transistors, IC's, diodes, and transformers without direct contact, in seconds. Operating active components radiate heat. dead components don't. **Thermoprobe** is sensitive to 1/25°F change in temperature. A must for your workbench or field service. Order #209TM. **ONLY \$21.95 + \$3.00 shipping.** NY Res. add tax. **BUYUS, INC., Dept. RE124, 10 White Birch Dr., Ossining, NY 10562. VISA or MASTERCARD (914) 762-4799.**

CIRCLE 53 ON FREE INFORMATION CARD



FREE CATALOG OF HARD-TO-FIND TOOLS is packed with more than 2000 quality items. Your single source for precision tools used by electronic technicians, engineers, instrument mechanics, schools, laboratories and government agencies. Also contains Jensen's line of more than 40 tool kits. Send for your free copy today! **JENSEN TOOLS INC., 7815 46th St., Phoenix, AZ 85040. (602) 968-6231.**

CIRCLE 115 ON FREE INFORMATION CARD

with two diodes wired as shown in Fig. 2-c. Again, trace the signal paths to understand how and why it works.

Let's look at how the circuit works together. When switch S3 is pressed, diodes D1 and D2 permit current to flow through both LEDs. When switch S1 is pressed, current flows through LED1 but diode D1 prevents current from flowing through LED2. When switch S2 is pressed, current flows through LED2 but diode D2 prevents current from flowing through LED1.

Thus, the device functions properly: You can light one LED or the other or both. The switches do not interact—they have been "isolated" by the diodes.

Now, CW, put some diodes in your device and cut out those stray signal paths. I suspect that your circuit will work properly with them installed.

AC-powered clock

It is much more convenient to have some types of devices powered by batteries than by the

AC line. When purchasing or building, each of us has to make the power-source decision considering relative costs, convenience, and other factors.

Walter Quick (FL) wants to build a 1.5-volt AC-powered DC supply to put into a battery-operated clock.

Well, Walter, I really can't understand why you want to change a cordless clock into one tied to the AC line. Of course, you wouldn't have to replace a battery every year or so, but, on the other hand, your clock would stop with each power outage.

But, if you really want to do that, just build a regular half-wave power supply using the physically smallest components you can find. Lacking a transformer with a lower output, use one-half of a center-tapped 6.3-volt AC filament transformer. Probably, you will have to use a voltage divider or a dropping resistor to get down to 1.5 volts. The final result will look like the circuit in Fig. 3.

You can determine the value of

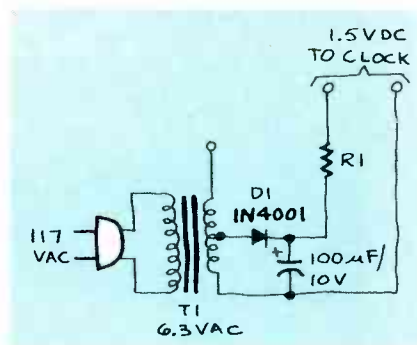

FIG. 3

R1 by trial and error or by calculation. To do the latter, measure the clock current when using a battery; subtract 1.5 from the supply voltage to determine V (the amount of voltage to be dropped across the resistor), and then, use the $R = V/I$ formula to determine the resistance necessary to get the supply voltage down to the 1.5 volts that is required.

But, I suggest that you not change the clock so that you can't go back to a battery supply when, as is bound to happen, you get tired of resetting it. R-E

REPLACEMENT FOR
ECG®/GE®/SK®

| | |
|---|--|
| POPULAR TRIPLERS MIN. 3 PC./TYPE | HORIZONTAL OUTPUT TRANSISTORS MIN. 5 PC. PER TYPE |
| 500/GE527/SK3304..... 9.50 | 165..... 2.25 |
| 523/GE528/SK3306..... 9.95 | 238..... 2.25 |
| 526A/GE521..... 9.95 | 283..... 2.75 |
| 528/SK3906..... 11.75 | 291..... 49¢ |
| 529/GE529/SK3307..... 12.75 | 292..... 49¢ |
| 556/SK3905..... 14.95 | 25C1308K..... 2.45 |
| 557/SK3904..... 14.95 | 25D1341P..... 2.25 |

| | |
|--|--------------------------------|
| POPULAR DIODES MIN. 100 PC. PER TYPE | AUDIO POWER TRANSISTORS |
| 125 1000V/2.5A 7¢ ea. | 152... 30¢ |
| 156 1000V/3.0A 18¢ ea. | 153... 30¢ |
| 177 FAST SW./DET. 9¢ ea. | 196... 49¢ |
| 506 DAMPER • HI VOL FAST RECOVERY..... 29¢ ea. | 197... 59¢ |
| | 291... 49¢ |
| | 292... 49¢ |

SE5020 35¢ ea. 712/LA1365 75¢ ea.
RF/IF OSCILLATOR. MIN. 10 PC. TV Sound/IF/FM/Det. Min.10 PC.

SPECIAL OF THE MONTH
152... 25¢ MIN. 10 PC.

SPECTACULAR SAVINGS!!

ON REPLACEMENT FOR ECG® TYPES MIN. 10 PC. PER TYPE

| | | | |
|---------------|----------------|-------------|-------------|
| 85..... 21 | 130..... 59 | 171..... 49 | 191..... 65 |
| 102A..... 35 | 154..... 75 | 184..... 38 | 198..... 65 |
| 108..... 18 | 157..... 49 | 185..... 38 | 199..... 18 |
| 121..... 1.20 | 159..... 16 | 186..... 48 | 234..... 19 |
| 123A..... 18 | 160..... 88 | 187..... 48 | 287..... 29 |
| 123AP..... 13 | 161..... 65 | 188..... 50 | 288..... 29 |
| 128..... 38 | 162..... 2.25 | 189..... 50 | 375..... 49 |
| 129..... 38 | 163A..... 2.35 | 190..... 59 | 376..... 55 |
| | | | 398..... 59 |

FOR A COMPLETE LIST CALL OR WRITE—C.O.D. Orders Welcome (Min. Order \$25)

DIGITRON ELECTRONICS
110 HILLSIDE AVENUE, SPRINGFIELD, NEW JERSEY 07081
Toll Free 800-526-4928 In NJ 201-379-9016 Telex 138441
PRICES SUBJECT TO CHANGE WITHOUT NOTICE. OFFER GOOD WHILE SUPPLY LASTS.
ECG is a Trade Mark of Philips ECG.
Digitron Electronics is not associated in any way with Philips ECG.

PREPARE

For The Future

1985 National Professional Electronics Convention

INFORMATIVE SPEAKERS
MANAGEMENT SEMINARS
TECHNICAL TRAINING
NAT'L. SERVICE CONFERENCE
NEW PRODUCT DISPLAYS
SPONSORED MEALS
TENNIS/GOLF OUTINGS

Sponsored by the National Electronics Sales & Service Dealers Association and the International Society of Certified Electronics Technicians

Hartford CT • Parkview Hillton • August 5-10

Send for more information and an application to
NPEC, 2708 W. Berry St., Ft. Worth, TX 76109; Ph (817) 921-9061

Name _____
Address _____
City _____ State _____ Zip _____

COMMUNICATIONS CORNER



HERB FRIEDMAN,
COMMUNICATIONS EDITOR

The talking heads

A SURE-FIRE WAY TO TELL WHEN SOMETHING has become trendy is when you find university professors and professional seminarians hitting the lecture circuit glorifying both the virtues and evils of the most recent technologies. The latest subject for their learned papers, discourse, and expensive seminars is "communications." In the past few weeks, I've listened to the largest collection of old ideas described as "new technology" that one can imagine!

One expert, for example, dwelt at length on the "new directions" created by a TV network's recent three-way satellite hookup so three political pundits could discuss the latest developments in yet another third-world conflict. And what was so spectacular about the program? A satellite relay transmission that permitted each analyst to see the others on a TV monitor. (For this we need a seminar?)

Many years ago, the legendary Edward R. Murrow wrote about the first live three-way transatlantic broadcast between the U.S., Europe, and Africa as World War II unfolded. It was no big deal; simply a straight telephone interconnect that allowed each commentator to hear the others. The circuit terminated at the CBS broadcast transmitter.

Here we are some 40-years later, and what took a real communications *pro* only three paragraphs to describe has now become the subject for a half-day seminar. It's really the same old thing with a different "twist;" instead of low-

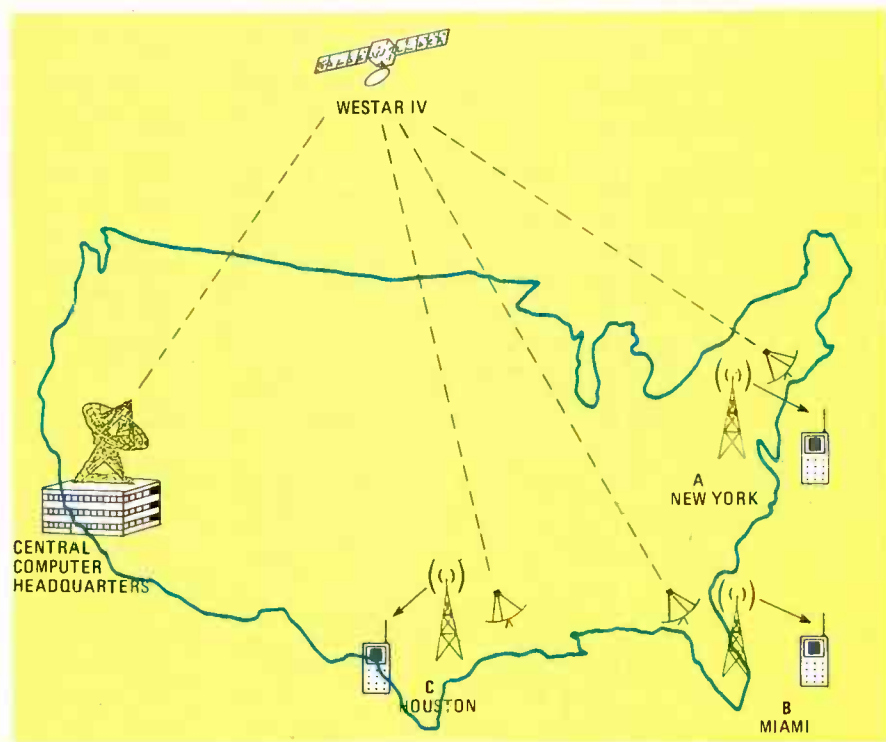

FIG. 1

cost telephone circuits we are now using multi-million dollar satellites to end up with "talking heads"—radio with pictures. (Sorry, I will not buy "talking heads" as state-of-the-art, even if it sells on the lecture circuit or packs a communications seminar at \$250 a throw.)

High-technology serves no useful purpose if the best it can do is to require mega-bucks to only marginally improve something we have been doing all along at reasonable cost and effort. To have value, high-tech must add a new concept to communications; it must give us something important that was not previously available or

attainable. Or it must so sharply reduce the overall cost of a service or product that it becomes generally affordable.

Let me use something called *QuoTrek* as an example. QuoTrek is a service that uses a pocket receiver—a handheld receiver terminal—to display trading and instant updates on selected stocks and commodities. The receiver has a 40-character LED display, and an alphanumeric keyboard for selecting the specific stock quotes desired.

While you might have no interest in the stock market (preferring to do your gambling in Las Vegas),

ATTENTION TV TECHNICIANS

Diehl Engineering, the same people who conceived, designed and now manufacture **Super Tech** diagnostic computers for analyzing start up, shut down, flyback and flyback related circuits, now has something else that will make your job faster, easier and much more profitable.

A NEW PUBLICATION

You might say that our monthly **Technician / Shopowner** newsletter is an all out training program for those who are already working in the TV service industry, as well as for those who soon plan to be doing so.

Each month we take at least one concept, circuit or function and totally dissect it. We then explain every conceivable aspect in plain and simple English. When we are finished, you not only understand the operation, you also understand how the operation, "inter-reacts" with all of the other circuits that it is related to.

Once every aspect of operation has been explained, we show you how to break the subject down into sections. Then, show you how to troubleshoot each section on an individual basis.

Because of the manner in which our publication is written, the subject knowledge that is gained in each monthly issue is so broad, that it "spills over" into your every day troubleshooting routine.

Our **Technician/Shop owner** monthly newsletter is 100% devoted to the TV technician. It contains nothing but pertinent information on TV repair. We do not sell advertising space. Those who subscribe, do so because of its technical content, which we pledge to be far superior to anything else that you can obtain.

Each monthly issue (manual) contains up to 68 pages filled with schematics, diagrams and illustrations that relate to the very circuits that you are seeing today. We do not teach this year's chassis, we realize that you are seeing sets that are five, ten or even fifteen years old.

Our newsletter is not a collection of part numbers that cause specific problems in specific chassis when they fail. Instead, we explain what each individual component in a given circuit does, what purpose it serves, and what effect it will have if and when it fails.

Our subscribers can look at any resistor, any capacitor, any diode, any transformer, etc., in any circuit, and know exactly what purpose it serves. They will know what turns the circuit on, what turns it off, why and when such action occurs, and what happens if a specific action does not occur.

Our subscribers will no longer have to be content to know that R421 causes a particular chassis to shut down if it becomes open, they will know **why** it does.

Our subscribers will no longer run around in circles hoping to stumble over a "bad" component, they will know **exactly** what they are looking for, and - - - how to find it!

When it comes to troubleshooting color TV sets, we have introduced more, innovative techniques than any other firm in the world (including manufacturers).

In case that amuses you, consider this:

Everyone else in the industry is telling you to probe here and there in this chassis, there and somewhere else in another chassis, in hopes of isolating the actual circuit that has failed. Conventionally, one specific technique that works for one chassis may do nothing but smoke components in the next.

Yet, while others have been teaching "conventional" techniques (usually a different one for each chassis), we at **Diehl Engineering**



designed a computer that will isolate the defective stage in any hi-voltage circuit that employs a horiz output transistor (including Sony). With our **Super Tech** computer, you push the same four buttons no matter which set you are working on. Any brand, any age any chassis, **Super Tech** will give you an **accurate** answer. (see ad in March issue.)

We are not implying that those who teach "conventional" techniques are technically incompetent. Far from it, some of them are brilliant! We simply have a new and much easier way of looking at things. Ours is easier to understand and far more versatile. Because of the manner in which we present it, the retention level is also higher (according to those who are now using our literature).

Any staff that can design a computer that can analyze **any** hi-voltage circuit (except for those which use a trace and retrace SCR i.e. RCA CTC 40-81) must surely have a thorough knowledge of **all** circuits. Soon we will release similar computers for vertical and audio circuits, another for tuner, IF, AGC, video, blanking, ABL, Chroma, matrix and CRT, and still another for troubleshooting VCR!

The point is, we at **Diehl** engineering understand circuitry. We also know how to **explain** circuitry in such a way that it is easily understood.

Each month's issue is printed in the form of a manual. Each manual is pre-drilled so that it can be filed in a 3 ring binder for instant reference (the 3 ring binder is not provided).

The First Issue covers resistors, capacitors, diodes, inductors, transistors, IC chips and time constant circuitry. It explains how each component works, why it works, why it fails, and how each component relates to the overall circuit, all in plain and simple, down to earth, everyday English, without the use of mathematical formulas. After reading this issue, you can look at any component in any circuit and **truly** understand **what** it does, **why** it does it and what will happen if it doesn't do it; right down to each individual resistor, capacitor, and diode.

The Second Issue covers SCR driven hi-voltage circuits such as those used in RCA CTC 40-81, Philco, Coronado, Bradford, etc. After reading this issue, this circuit will become no more complex than simple amplifier. Over 30 illustrated schematics are used to teach this circuit in absolute detail. Such things as HV regulator functions, shut down features, etc. are thoroughly explained.

The Third Issue covers RCA LV regulator circuits (CTC 85 and up). It explains how each individual component operates, what it does, when it does it and, how to effectively troubleshoot the overall circuit.

Our no paid advertising policy makes our newsletter a little more expensive, but it also gives us "cover to cover" space for nothing but pertinent technical information on TV service. At \$9.95 per issue, a twelve month subscription costs only \$119.40. Very economical, considering that its technical content is equal to a "full blown" study course on TV repair. If you wish, you may try the first three issues for only \$21.00 (just seven dollars per issue, a savings of \$8.85 off the regular price).

For immediate service on C.O.D., Visa, or Master Charge orders:

Phone (806) 359-1824 or (806) 359-0329.

If you are looking for help - - - we have it!

Diehl Engineering, 6004 Estacado Lane, Amarillo, Texas 79109.

Circle (256) on Reader Service Card.

COMPUTER DIGEST

VOL. 2 No. 5

May 1985

NEW KIND OF MAGAZINE FOR ELECTRONICS PROFESSIONALS

SERIAL-TO-PARALLEL INTERFACE

A Build-It-Yourself Problem Solver

MODEM MINDER

**No more sitting and waiting.
This device calls you!**

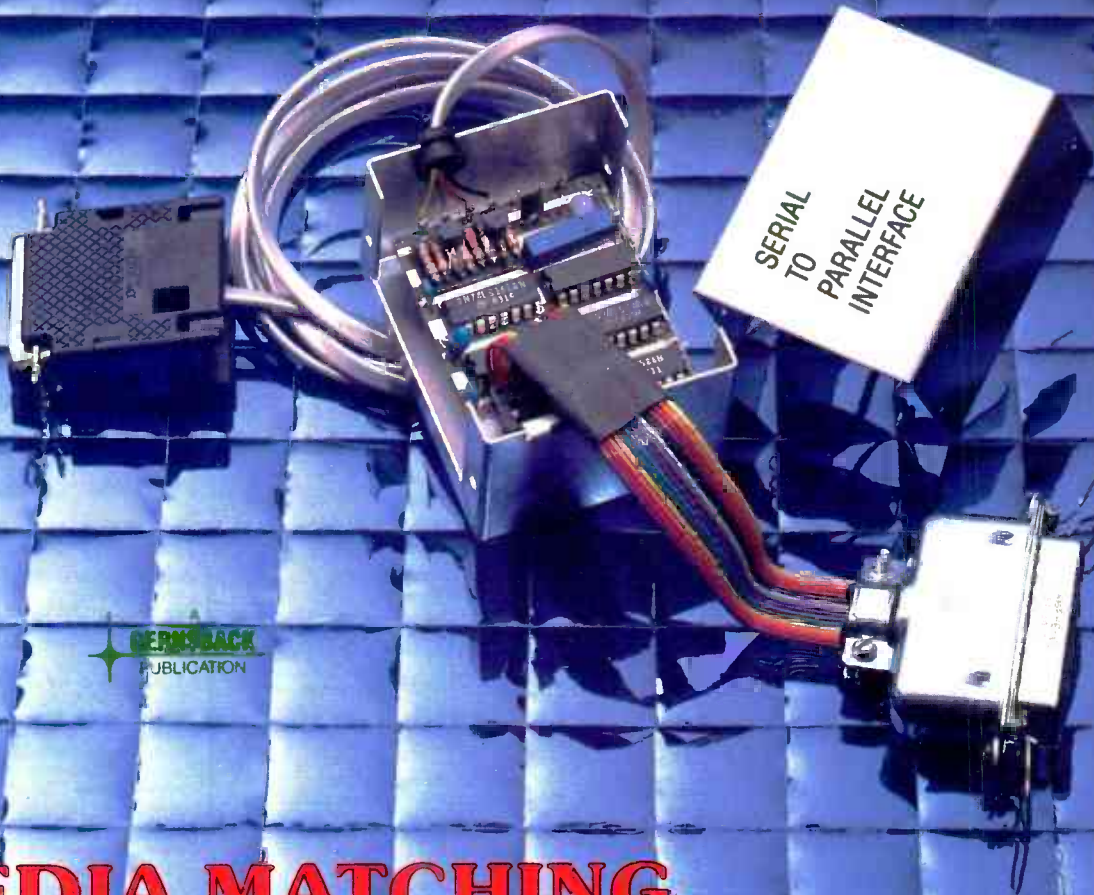

HEMLOCK
PUBLICATION

MEDIA MATCHING

**Disk translator software can
make alien computer discs compatible.**

ZORBA PORTABLE COMPUTER THE EXPERTS' CHOICE

FEATURES:

- 9" GREEN OR AMBER CRT
- 19 INDEPENDENT 55 PROGRAMMABLE FUNCTION KEYS
- TWO 400K DSDD DRIVES
- 64K BYTES 200 NS RAM
- C BASIC COMPILER
- IEEE 488 BUS MASTER PORT
- 24.6 LBS
- CPM 2.2 OPERATING SYSTEM
- M80 (L80, LIB80, CREF80)
- SOURCE CODE OF THE BIOS PLUS UTILITIES
- DATA COMMUNICATIONS SETUP PACKAGE
- SERIAL & PARALLEL PRINTER PORT
- DATA COMMUNICATION PORT

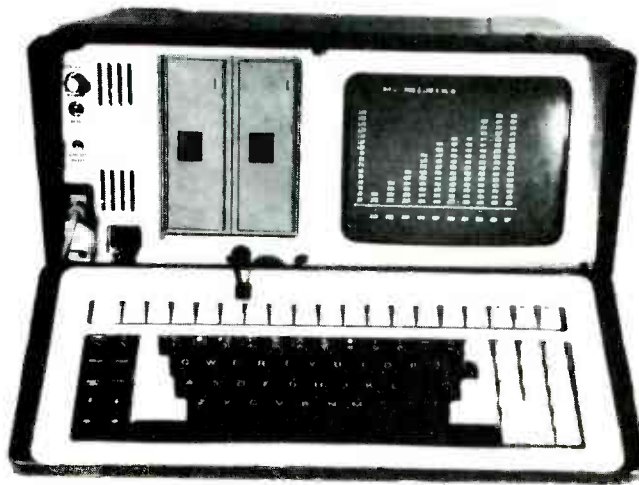

OPTIONS:

- 16 BIT 256K RAM UPGRADE (8088 CPU) \$600.00
- 800K DSQD 96TPI DRIVES \$200.00
- COMPOSITE VIDEO OUTPUT \$100.00
- SOFT VINYL CASE \$25.00
- TUTOR KIT; \$15.00 (CPM, WORDSTAR, CALCSTAR)
- SCHEMATIC SET \$10.00
- 10MB HARD DISK DRIVE

VISA/MC

BUNDLED WITH
WORDSTAR, MAIL MERG, SPELLSTAR,
DATA STAR, REPORTSTAR, CALCSTAR

\$899.00

W/O Bundle

DEALER INQUIRIES INVITED

\$1049.00

With Bundle

General Specifications

ZORBA is the lowest cost full featured portable computer. This light weight computer is ruggedly packaged in a convenient carrying case. The case surrounds a strong inner chassis which further protects the Z80A based computer with its two double sided double density disk 400K drives, large easy to read 9" display screen and well designed detachable keyboard.

ZORBA uses CP/M, the industry standard operating system, which means that a wide range of existing software is readily available to the user.

The ZORBA users manual covers operation of the unit, all supplied software and all interface and internal information. A system diskette is supplied with all system files and utilities. A second diskette contains the sources for all ZORBA software including BIOS, SETUP, FORMAT, and PATCH.

Keyboard

Keyboard communicates serially with CPU
Detachable with 2 foot coiled cord
95 keys in standard QWERTY format
13 Key Numeric pad
Independent Caps Lock and Shift Lock
55 Software programmable function keys
All keys auto-repeat after 1 second delay
All Standard cursor and terminal control keys

Disk System

Controller: WD1793
Drives: 5.25 Double Sided,
Double Density, 400K
48 TPI

Built-in disk interchange formats: Xerox 820 (SD, DD), Kaycomp (DD), DEC VT-180 (SD), Osborne (SD) and IBM-PC (eg. CPM/86) and Teletype 802 (Read/Write and Format compatibility) (Expandable to 61 Formats)

Specifications

General Mechanical and Electrical

Width -17.5 inches (44.45 cm)
Height - 9.0 inches (22.86 cm)
Depth -16.0 inches (40.64 cm)
Weight -24.6 pounds (11.1 Kg)
Power -80-130 VAC or 190-245 VAC
50/60 Hz
170 watts max

Display

Display Tube:
9" diagonal, Green or Amber
High resolution display circuitry
60 Hz refresh rate

Display Format:

25 lines x 80 columns
5x7 Character Font with full descenders
128 ASCII Characters
8x9 32 Characters Graphic Font
2K Memory Mapped Display Buffer

CPU Board

Z80A CPU running at 4 Mhz with no wait states
64K bytes of 200 ns RAM (58K after CP/M loaded)
16K bytes of EPROM (2732) can be switched in and out by software
12K available for user EPROMS
8275 CRT controller, DMA driven
1793 Floppy disk controller, SMC data separator
Bipolar proms configure 10 addresses
Fully structured interrupts prioritized by bipolar proms

Interfaces

- Full asynchronous RS232 port with modem control. Baud rates and data translation and protocol programmable
- Full asynchronous full duplex RS232 port with hardware handshake (for printers). Baud rates and protocol programmable. (Serial Printer Port)
- One 8 Bit parallel port with independent strobe and ready lines. Supports Centronics interface with an available adaptor cable.
- IEEE 488 Bus Master Port (ie: General Purpose Instrumentation Bus) not Software Supported.
- 21 Standard Software Programmable Baud Rates: 45.5 to 19,200 BPS



**GEMINI
ELECTRONICS, INC.**

130 Baywood Avenue, Longwood, Florida 32750
305-830-8886 800-327-7182

CIRCLE 265 ON FREE INFORMATION CARD

CONTENTS

Vol. 2 No. 5

May 1985

7 Software Review

8 Parallel-to-Serial Printer Interface

This quick-and-easy project will allow you to interface a Centronics parallel output to an RS232 Serial printer. **R.L.L. Hu**

11 Build the Modem Minder

You don't have to sit there waiting and watching. This device does it for you, and calls you when you've made contact! **Kirk Vistain**

14 Media Matching

You can mix 'em and match 'em—Computers and media, that is—if you know what you're doing, incompatibility can be overcome. **Herb Friedman**

4 Editorial

5 Letters

5 Computer Products

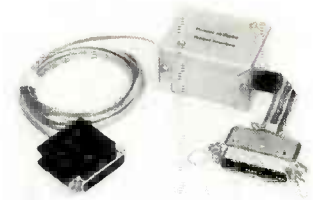

Page 8.



Page 11.

Radio
Electronics YOUR OWN
Computer

ON THE COVER

More and more, people are collecting equipment that may be very useful, but not compatible. If you have a Centronics output on the computer you want to connect to a printer with an RS232 connector, this interface device will make it all possible. See page 8.



EDITORIAL

We get letters...

■Charley Buehner of Scobey, MT, wrote to say that he liked the piece we did on the Commodore Cassette Interface, but that he has an Atari. His friend has a Commodore *Plus/4* which has a din port connector, and Charley wants to know if there's anything that they can do.

Charley, it's a problem.

There are so many varieties of computer out there, and we have only 16 (count'em) pages each month! The name of the game, of course, is "standardization" which would put us all back in the game. It all really began when the resistor manufacturers decided on a standardized color-coding system that really worked out well for everybody. The capacitor manufacturers *tried* to follow suit, but the result was utter chaos, with ramifications, ifs, and's and but's.

In the world of computers, standardization was attempted with interconnects, the RS-232 being the biggest bug-a-boo of all. Still, it's *called* a "standard," and we have to live with it. So non-standard is this standard, that hundreds of articles have been (and still are) written about it. At least one manufacturer offers a cable that lets you interconnect regardless of deviations from that so-called standard!

We attempt to aim articles at the various types of computers, but no magazine can be all things to all men. What's needed, we feel, is an organization of computer manufacturers that will sit down like rational people and try to sort things out with an eye toward simplification.

It seems that they're all willing to adopt standards, provided that the methods and systems they now use themselves, are adopted as the "standard." And chances are that even if that *were* to happen, they'd claim a proprietary interest and stop it all with a law suit!

There doesn't seem to be a simple solution, if solution there is at all. We can only hope for that Utopian day when there will be peace on Earth, no more crime, no more famine, love will once again prevail, and all computers, regardless of manufacture, can use any software or peripherals without complicated and devious rework.

But if you think the Peace Talks get bogged down, just try getting computer manufacturers to talk to each other. Kissinger could have a field day with those people! But until the time that happens, we're all going to have to suffer with non-standard standards.

Byron G. Wels
Editor

COMPUTER DIGEST

Hugo Gernsback (1884-1967)
founder

M. Harvey Gernsback, editor-in-chief

Larry Steckler, CET, publisher

Art Kleiman, editorial director

Byron G. Wels, editor

Brian C. Fenton, technical editor

Carl Laron, associate editor

Robert A. Young, assistant editor

Ruby M. Yee, production manager

Robert A. W. Lowndes, production associate

Dianne Osias, production assistant

Karen Tucker, production assistant

Jacqueline P. Weaver, circulation director

Arline R. Fishman, advertising coordinator

Gernsback Publications, Inc.
200 Park Ave. South
New York, NY 10003
Chairman of the Board:
M. Harvey Gernsback
President: Larry Steckler

ADVERTISING SALES 212-777-6400

Larry Steckler
Publisher

EAST/SOUTHEAST

Stanley Levitan
Radio-Electronics
200 Park Ave. South
New York, NY 10003
212-777-6400

MIDWEST/Texas/Arkansas/Okla.

Ralph Bergen
Radio-Electronics
540 Frontage Road—Suite 325
Northfield, Illinois 60093
312-446-1444

PACIFIC COAST

Mountain States

Marvin Green
Radio-Electronics
15335 Morrison St., Suite 227,
Sherman Oaks, CA 91403
818-986-2001

ComputerDigest is published monthly as an insert in Radio-Electronics magazine by Gernsback Publications, Inc., 200 Park Avenue South, New York, NY 10003. Second-Class Postage Paid at New York, N.Y. and additional mailing offices. All rights reserved. Printed in U.S.A.

A stamped self-addressed envelope must accompany all submitted manuscripts and/or artwork or photographs if their return is desired should they be rejected. We disclaim any responsibility for the loss or damage of manuscripts and/or artwork or photographs while in our possession or otherwise.

LETTERS

Glitch!

There seems to have been a slight glitch in the program listed in the March, 1985 issue in the story on Morse Code Practice On Your Commodore. Have you heard from others? Have you located the problem?—P. Childers, Orlando, FL.

Yes. Here are the corrections: Line 30 should have a comma, not a decimal point; Line 290 should read: EL (1) = R: For I = 2 to N. Line 300 should read P = N-1 and line 480 should read GOTO 210. Other than that, Bob Woods, our author, assures us that everything else is O.K.

Bottom line

I went to a "computer store" recently, more to window shop than to buy, but I did get to talk to a salesman. Actually, he did the talking, I listened. He was obviously trying to fast-talk me into buying a product I neither needed nor wanted, but which carried a heavy price tag, and I assume, a heavy commission for him. He steered me around the aisles to the equipment he wanted me to see, I couldn't get a word in edgewise, and he got more and more insistent as I got angrier and angrier. How do you handle a

situation like that?—B. Pettigrew, Seattle, WA.

The way I handle that kind of situation is simply to walk out and let him stand there and talk. Then go back to the same shop a month later. Chances are he won't be there any more.

Seiko Misses The Mark

After reading your article by Marc Stern in the February Issue, (Seiko's Datagraph System) I feel I must comment. The article, though an excellent promotion for Seiko, did not point out any of the system's obvious failings. Perhaps the author did not have the opportunity to use one. I did, and found sufficient reason to return the product to the place of purchase.

The first failing was a distinct lack of contrast in the display. The viewing angle was more critical than an ordinary LCD watch. As there is no provision for use at night (no back lighting or light) the watch functions (much less the data functions) are unusable at night or in dim light. The actual computing and recording utility, from a practical standpoint, is diminished by having to carry the keyboard module (which does not appear to be too sturdily built).

The alarm function could have been enhanced by having multiple alarms tagged to different messages, but as it currently stands, it is limited to one.

In a nutshell, Seiko's wrist "computer," despite its excellent technology, fails to provide sufficient utility as either a watch or a computer to merit its price tag. It is a good step in the right direction, but falls short of the mark.—C. N. Austin, TX

C. N., I can assure you that Marc did indeed test the system, and liked it. I guess differences of opinion are the reason that we hold elections!

Worried

I like the idea of computers being made smaller and more portable, but this also makes them more susceptible to theft. They're easily negotiable, and make fine targets for burglars. What's the best way to protect a computer against robbery?—C. Simpson, Ft. Lauderdale, FL.

You'll find a wide variety of devices to protect a computer from theft. But don't forget, when you buy a computer, to notify your homeowner's insurance agent so you can get it covered under your regular policy.



COMPUTER PRODUCTS

For more details use the free information card inside the back cover

SUBSYSTEM OPTION, has been designed by the Viasyn Corporation (formerly known as CompuPro) as a mass storage option for its *System 816* microcomputers that allows the user to tailor a disk system to fit his or her particular application needs.

The new *Tri-Disk Subsystem* offers combinations of either one 8-inch and one 5.25-inch floppy disk drive, or two 8-inch floppy drives, and a 5.25-



CIRCLE 21 ON FREE INFORMATION CARD

inch hard disk available in choices of 20 or 40 Mbytes.

The *Tri-Disk System* featuring either the 8- and 5.25-inch floppies, or the dual 8-inch floppies, is priced at \$4,995, with the 20 Mbyte hard disk. With the 40 Mbyte hard disk, the price is \$5,495.—**Viasyn Corporation**, 450 Newport Center Drive, Suite 200, Newport Beach, CA 92660.

COMPUTER SYSTEM, the *Integral Personal Computer*, comes in a 25-pound

transportable package with a built-in ThinkJet printer, a 3½-inch double-sided disk drive, a 9-inch electroluminescent display, and a full-size keyboard. It is based on the Motorola 68000 16/32-bit processor and a 16-bit HP graphics processor. Standard memory is 800 Kbytes, which can be expanded by the two standard input/output (I/O) slots. Also standard is the HP-IB expansion interface (IBEEE 488); and there are five interface options that can be plugged into the I/O slots.



CIRCLE 22 ON FREE INFORMATION CARD

The *Integral Personal Computer* is priced at \$4,995.00—**Hewlett Packard Company**, 1020 N.E. Circle Boulevard, Corvallis, OR 97330.

EDUCATIONAL GAME, *Mission: Algebra*, provides kids age 13 to 18 with an entertaining, educationally sound way to practice solving linear equations. The game features a random generator that creates thousands of problems for endless practice in coordinating pairs on a graph, determining the equation of a line and solving for "x" and "y" coordinate pairs.

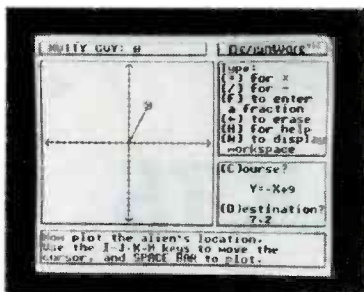

CIRCLE 23 ON FREE INFORMATION CARD

The object of the game is to recreate the course of your lost sister ship to locate its present position. In the process, you must learn to solve linear equations. Problems flash on the screen above a large workspace. The valiant reconnaissance scout must solve for "y" before plotting the x,y coordinates on a graph to locate the ship that's gone astray. Incorrect answers are identified, requiring reevaluation of tracking tactics and the selection of another approach.

"*Mission: Algebra*" is priced at \$44.95.—**Designware**, 185 Berry Street, San Francisco, CA 94107.

INK-JET PRINTER, model *PT-90*, is a dot-matrix printer with an ink-jet printing system (32 nozzles) for letter-quality printing and graphics. It is particularly designed for use in final text preparation and processing.

The model *PT-90* has an overall resolution of 240 dots per inch, both horizontally and vertically. Its letter-quality mode offers a character resolution of 96 × 32 dots (at 10 cpi), indistinguishable from fully-formed characters. Its draft mode offers a character resolution of 48 × 16 dots, comparable to the best high-density impact printers.

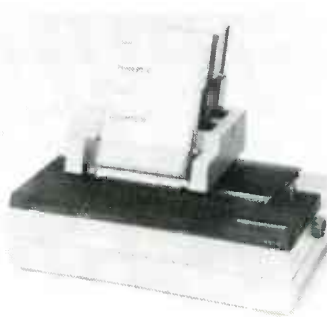

CIRCLE 24 ON FREE INFORMATION CARD

The model *PT-90* offers almost universal compatibility with popular systems and software. The suggested retail price is \$3495.00.—**Siemans**, 186 Wood Avenue South, Iselin, NJ 08830.

COMPUTER FURNITURE, the Oak 170 Series, includes a desk, hutch, printer stand, corner connector, and monitor/printer platform, all in oak with a hand-rubbed finish.

The desk, model *CT-170*, has a dual-level top with adjustable keyboard and CPU shelves. The entire left-hand surface can be lowered to a typing height of 27", 28", or 29". Detachable keyboards can be tilted at 5°, 10°, or 15° for user comfort. The desktop's fixed half can hold a cassette or disk drive, and even a printer. A pencil drawer slides below. The model *CT-170* is priced at \$329.95.

The add-on hutch, model *CTA-171*, includes a monitor shelf and two adjustable storage shelves. The monitor shelf can be raised or lowered to put the video monitor at the proper eye-level, and can also be tilted to reduce glare. The model *CTA-171* measures 28" × 49" × 13" and is priced at \$219.95.



CIRCLE 25 ON FREE INFORMATION CARD

The printer stand, model *CT-175*, has two top paper slots to accommodate either rear- or bottom-feed printers, and two interior storage shelves. The forms receiving shelf on the back can be raised or lowered depending on the user's needs or office location. The model *CT-175* measures 29" × 25" × 28" and is priced at \$229.95.

The trapezoid corner connector, model *CTA-173*, can join the desk and printer into a complete work center. It can be attached to either the right or left side of the desk, as the user prefers. It is priced at \$79.95.

The monitor/printer platform, model *CTA-172*, can be used with the desk to hold a monitor or micro printer. It also has a tilting feature to reduce monitor glare, and measures 9" × 22½" × 11¾". It is priced at \$49.95.—**Bush Industries, Inc.**, 312 Fair Oak Street, Little Valley, NY 14755.

SURGE SUPPRESSER, the SurgeFree model *SF-10*, is a single-socket electronic power center for residential use. It features fail-safe, solid-state, surge-clamping electronic circuitry. Rated at 15 amps (1875 watt) 125-volts AC, it instantly detects and suppresses high-

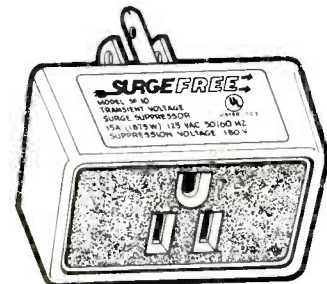

CIRCLE 26 ON FREE INFORMATION CARD

voltage spikes and surges, protecting such electronic equipment as personal computers, color-TV, and microwave ovens or any sensitive devices. It is priced at \$12.95.—**Ultima Electronics, Ltd.**, 21 Central Drive, Farmingdale, NY 11735.

SOFTWARE REVIEW

Telecommuter—Integrated word processing and communications for PC-compatibles and lap computers.

HERB FRIEDMAN

■ *Telecommuter* is an integrated word processing and communications package specifically designed for the users of IBM-compatible and Radio Shack lap computers (and the NEC 8201A lap computer). The program is based on the concept that most persons using an IBM-compatible personal computer at the office and a lap computer in the field don't want to become computer scientists in order to integrate the two. By making the office computer emulate and support the lap computer, *Telecommuter* creates a totally integrated word processing and communications environment that employs the same functions: Except for the word processor, both IBM-IBM-compatibles and the lap computers function the same way for communications and text creations: The difference in the word processor is that the IBM is a full-fledged word processor, not a text editor: It is intended for the creation of business documents or for the reworking of text, data or even BASIC programs that originated in a lap computer's text editor.

Host and cable transfer too.

In addition to the word processing and communications functions, *Telecommuter* provides HOST and CABLE TRANSFER modes. In the HOST mode the disk drives of the office Computer can be accessed directly from the field by the lap computer—or any other remote computer—and data, documents, or whatever, can be exchanged between the disks and the remote computer. For example, consider the field technician who might need to know the availability of spare parts, but the home office is closed for the day. By using a remote computer to access the office PC he could check inventory files, even start the office printer and leave a message telling the first person in the next morning to pull the parts and ship them express. Or, he might write a complete report of his efforts using the lap computer's text editor and then upload the report directly into the office PC's "electronic mailbox."

All this may sound complex. It's not. When the lap computer accesses the office PC the commands seen at the remote site appear almost exactly as they do at the PC itself; the user actually works in PC-DOS when using the PC's functions from the remote site. He can call for a DIR of either drive, ERASE, COPY, WRITE and READ files, even start and stop the office printer. It functions the same way on both ends.

Telecommuter is intended for use with a Hayes Smartmodem, a Radio Shack Modem II, or a Tandy 1000. The HOST mode can easily accommodate the small business having one phone line because *Telecommuter* allows a Smartmodem's bell (ring) pickup to be programmed by the user through a

configuration menu. Instead of having to put up with an automodem answering on the first or second ring, a Smartmodem can be programmed to pick up on the fifth ring so the computer can be left on-line at all times. Someone will usually answer before the fifth ring; if not, the computer answers the line. With this feature, the user doesn't have to wonder whether the computer and modem are turned on or off, they can be left on, or turned on by a time clock because *Telecommuter* can be set to cold boot directly into the HOST mode. For those who are into serving as a HOST for other computer systems and users, *Telecommuter* comes with a special FILTER program that converts *WordStar's* word processor.

It's safe.

Meddlers and other unauthorized users can be kept out of the HOST computer by using an optional password of up to 14 characters. If the correct password isn't entered by the fourth try *Telecommuter* automatically disconnects from the telephone circuit.

The *Telecommuter* package includes a special null modem cable that permits direct cable transfer—UPLOAD and DOWNLOAD—between the office and lap computers, or any other computer. If the user returns to the office, the material in the lap computer can be directly transferred into the office PC at speeds up to 9600 baud. However, 9600 baud assumes the computers are close to the same tolerance. We have not found that to be so, and generally run direct cable transfers at 2400 baud.

Virtually every parameter is user-programmable through installation and configuration menus: This includes color or monochrome screen display, password selection, communications default drive, communication parameters, individual selection of COM1 or COM2 for the RS232 and modem I/O's, individual baud rate, stop bit and parity for all communications modes, modem set and reset control codes, even printer selection. *Telecommuter* automatically plugs in the correct boldface, underline and optional control codes for common y-used Radio Shack, Epson, IBM, Itoh, NEC and Diablo printers.

The one thing *Telecommuter* cannot do is protocol (binary) transfers. The program is specifically intended for communications and the preparation of text and documents. In these areas its performance is superb.

Telecommuter Integrated Word Processing Communications Software, Sigma Systems, Inc., 19 Pelham Rd., Weston, MA 02193. For IBM PC and PC/XT compatibles and Tandy 2000, 1200, 1000. computers with internal or external modem. Price: \$200 postpaid, includes postage and handling. ◀CD▶

PARALLEL TO SERIAL INTERFACE

Interface a Centronics parallel output to an RS232 serial printer.

R. L. L. Hu

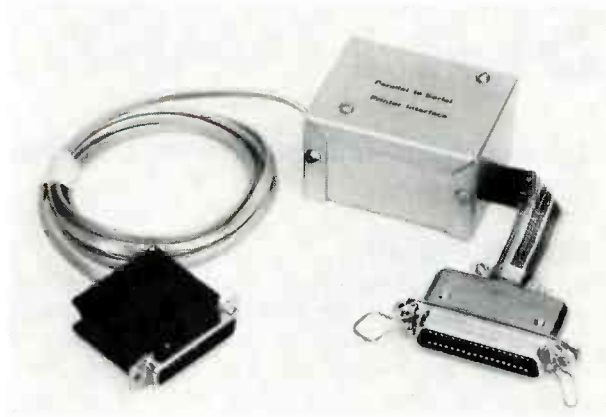

■ If you built your computer system using boards and peripherals from different manufacturers, you have probably experienced the frustrations and confusion of mixing and matching interfaces. This project meets the real need to interface a Centronics parallel output to an RS232 serial printer.

How the circuit works

Refer to the schematic diagram, Figure 1. Parallel data from the printer controller is loaded into IC1, a 74LS165 shift register by the STROBE signal if the BUSY line is low. This STROBE signal also clears IC2, a 74LS161 binary counter and presents IC3-a, a 74LS74 flip-flop. On the positive edge of the STROBE1 pulse, IC3-b is

clocked and the BUSY line to the printer controller goes high. Since most parallel interfaces found today use only the STROBE1 and BUSY lines for handshaking, the ACK signal was not implemented in this design. The BUSY line will be kept high for a minimum of 10 clock cycles for each byte transferred. During this interval, the parallel data loaded will be clocked out serially through IC3-a: first the start bit, then followed by 7 data bits and ending with 2 stop bits (total of 10 bits). The

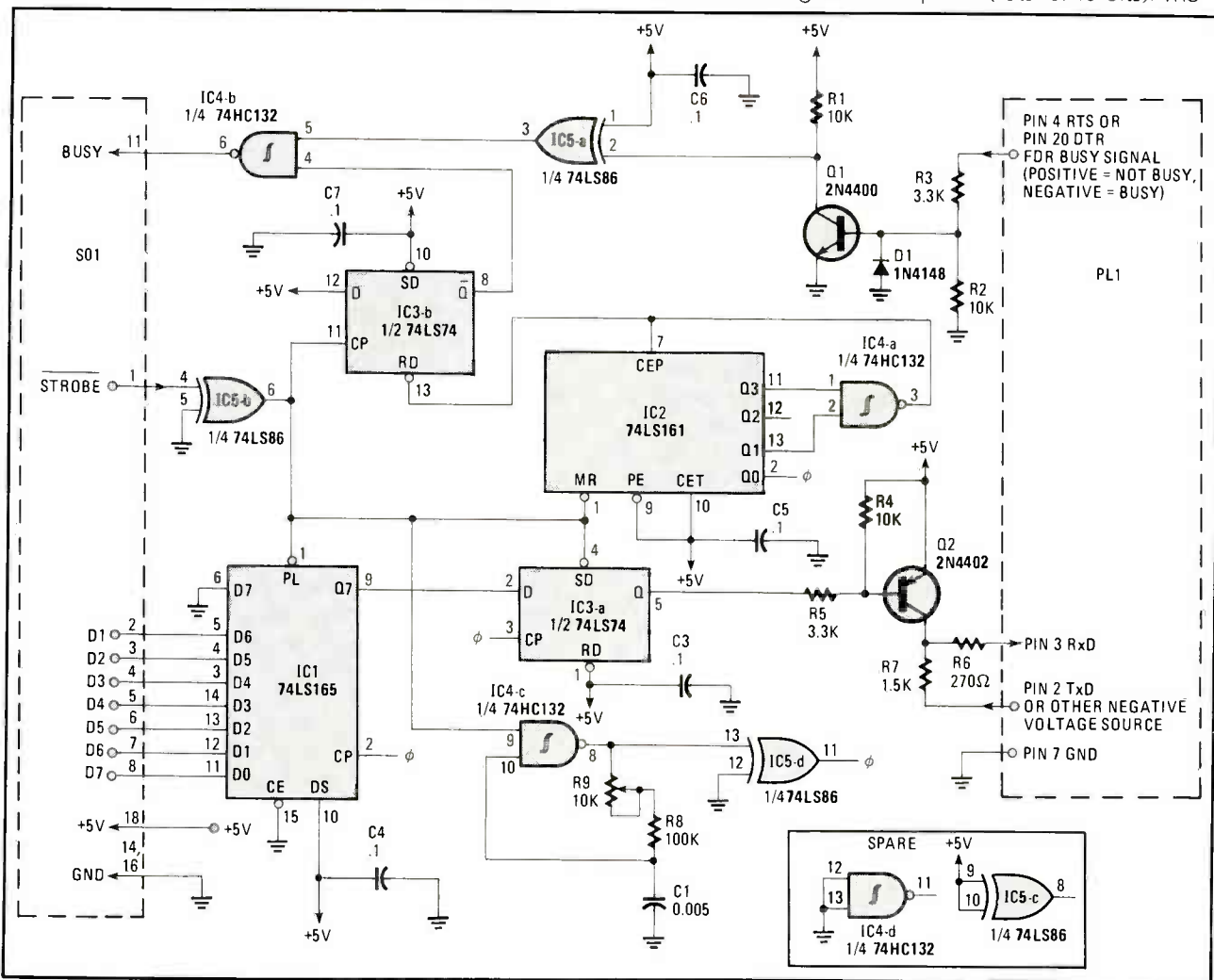

FIG.1—SCHEMATIC DIAGRAM IS STRAIGHTFORWARD with no critical wiring. Author used wire-wrap method, on ordinary perfboard. For better understanding, refer to the schematic while reading "How it works" section.

BUSY line can also be held high by the serial printer if the printer buffer becomes full, that holds off any further data transfer from the printer controller. Many serial printers use either pin 4 (RTS Request To Send) or pin 20 (DTR Data Terminal Ready) to signal this buffer-full condition.

To keep the overall parts count low, the 74HC132 (high-speed CMOS) Schmitt-trigger was used for IC4. That IC lends itself well to operating as an oscillator simply with the addition of a resistor and a capacitor. The oscillator runs at 2400 Hz or 2400 baud with the values of R and C shown.

Since the STROBE pulses occur asynchronously (when the BUSY line is low), it is possible to have the positive edge of a clock pulse arrive just at the instant the STROBE pulse goes high. Unfortunately, that would result in an unpredictable outcome. However, with the clock circuit shown, which is not the same as gating the output of the oscillator, a setup time is ensured between the last STROBE pulse and the next clock pulse. Pull-up resistors were not used in interfacing LS TTL to this CMOS, since with CMOS gates as the only load on the LS TTL outputs, the LS TTL outputs will generally rise up to one V_{be} below V_{cc} .

Transistors Q1 and Q2 serve as voltage translators, and diode D1 keeps the base of Q1 from going into negative or reverse breakdown.

Construction.

The layout of the components is not critical. The prototype was built using wirewrap technique. The RS232 receiver and driver components were all mounted on a single 16-pin component header and plugged into a wirewrap socket. The whole circuit board fits into a small chassis box (Radio Shack 270-235), with one end of the box for the parallel interface connections and the other end for the RS232 interface connections. It is best to keep the parallel interface cable short and extend the RS232 interface cable to the length desired.

Do not substitute the 74HC132 with 74LS00, unless you plan to design your own oscillator. The baud rate of this interface board can be changed to suit your printer or your inclination. However, not much can be gained by running at a baud rate greater than 2400, unless you have a very fast printer (240cps) or a print spooler, since data transfer occurs concurrently with printing anyway.

Note that some serial printers use an active-low BUSY signal, in which case, pin 1 of IC5 should be tied to ground instead of V_{cc} .

Powering-up the interface

The 5-volt supply needed to run this board can usually be obtained from the Centronics end of the interface. Check your printer controller documentation to see if it is available at one of the connector pins. If not, it would be a simple matter to install a jumper from the 5-volt source on the printer controller board to one of the connector pins. The negative supply (-9, -12, -15V, etc.) may be obtainable from the serial printer end of the interface. Check the documentation for the

printer; if pin 2 (Tx Data Transmitted) is unused and remains at a negative RS232 voltage level when operating, then it may be usable as the negative voltage source to drive the Rx Data (Received Data) line.

Apply power to the interface board. Check and adjust VRI for oscillator frequency of 2400 Hz. This frequency does not have to be accurate, since each start bit synchronizes the receiver clock of the UART/ACIA in the printer. Timing errors are non-cumulative.

Troubleshooting.

If the printer prints the correct character each time, then the baud rate is set correctly. If you get garbage, check the baud rate. Now try writing a string of characters to the printer. If the printer worked in the single character mode but now it prints garbage, check and make sure the number of data bits, parity bit and

PARTS LIST

Resistors

- R1, R2, R4—10,000 ohms
- R3, R5—3300 ohms
- R6—270 ohms
- R7—1500 ohms
- R8—100,000 ohms
- R9—10,000 ohm, 10-turn potentiometer

Capacitors

- C1—0.005uF
- C2-C6—0.1uF

Semiconductors

- IC1—74LS165 shift register
- IC2—74LS161 counter
- IC3—74LS74 flip-flop
- IC4—74HC132 Schmitt trigger
- IC5—74LS86 quad OR gate
- Q1—2N4400 transistor
- Q2—2N4402 transistor
- D1—1N4148 diode

stop bits on the printer are set as follows: 7 data bits, no parity bit and 2 stop bits, which is the same as setting for 7 data bits, mark parity bit and 1 stop bit.

The number of stop bits sent by the interface board can be increased from 2 to 4, if your printer lacks the flexibility in data format settings, by simply moving the wire from Q1 to Q2 on IC2.

If the printer prints okay initially, but starts to drop characters after a while, it is likely that the printer buffer overflowed due to improper handshaking. Check the busy line from the printer to the printer controller. If the problem is still not resolved, set up a scope loop by disconnecting the printer and issuing continuous print commands, remembering to tie up or down, depending on your particular printer, to the printer busy line. Now is a good time to pause and reflect, before you become too deeply involved in troubleshooting, on a couple of things which should have been verified before hooking up the interface: that the Centronics controller itself works, and that the RS232 printer itself works also. This interface has been tested and used with Cromenco printer controller board, Heathkit HI4 dot-matrix printer (256-character buffer) and Smith Corona TPI serial daisy wheel printer (32-character buffer). Both have been working. ◀▶

ECG® LED Lamps

Philips ECG has LED lamps in shapes and sizes for virtually any application. They're available in round, rectangular, triangular and square shapes. They come in red, yellow, green, or even in two colors. And there's a choice of clear and diffused reds. Some have jeweled lenses. And some are even available as flashing LEDs with the flasher circuit built in.

In addition, long-life, shock-resistant, vibration-resistant, LED replacements for incandescent cartridge indicator lamps are also available in red, yellow or green.

Common applications: All LED indicator applications. LED cartridges are ideal replacements for cartridge-type incandescent lamps. CIRCLE 297 ON FREE INFORMATION CARD



ECG® High-Voltage Rectifier and Voltage Divider Network

Philips ECG's ECG568 is a high-voltage rectifier used in Sanyo and Sears TV sets to supply high voltage to the picture tube. It also contains a voltage divider network which supplies focus voltage to the picture tube.

Common applications: For use in television service and repair. CIRCLE 298 ON FREE INFORMATION CARD



EMF® Transient Voltage and RF Interference Suppressors

EMF transient voltage surge suppressors by Philips ECG clamp voltage spikes on 120 VAC line to levels safe for all electronic equipment. They can handle up to 40% greater surge current than other suppressors. Single outlet suppressors are available in both two- and three-prong versions.

The multiple outlet EMF315 incorporates both a spike suppressor and a PI filter to suppress RF interference on the AC line. RF interference causes audio and video degradation and causes digital equipment to function imperfectly.

Common applications: Electronic equipment such as hi-fi and television, stereo, computers or other line-operated electronic equipment subject to voltage surges and radio frequency interference from the AC line.

CIRCLE 299 ON FREE INFORMATION CARD



ECG® A-STAT Material

Philips ECG has two sizes of anti-static foam that will prevent damage to semiconductors from static electricity. The A-STAT 12 measures 12" x 12" and is perfect for bench use. The A-STAT 2 measures 3" x 5" and can be carried in the tool box. When semiconductors are kept in A-STAT foam, static electricity is shunted through the foam instead of into the semiconductor, where it could have caused damage.

Common applications: Essential for semiconductor protection on the workbench or in the field.

CIRCLE 274 ON FREE INFORMATION CARD

The one thing we make that you have to replace every year.



The new and expanded ECG® Semiconductors Master Guide.

Your new Master Guide will be looking as dog-eared as the old one before long. Because this year the Master Guide has been expanded to include more than 400 new products and almost 25,000 new cross references. The Master Replacement Guide for 1985. 656 pages. Over 3,500 different ECG devices that provide replacement coverage for more than 227,000 industry types. And everything in the book is cross-referenced so you can find what you're looking for fast, and be sure it fits. Plus, everything we make meets or exceeds the original JEDEC or application specs. So it

works. It's the only book you'll need. But you'll need a new one every year.

To get a copy of the new Master Guide, go to your nearest Philips ECG distributor. For his name and location, just call: 1-800-225-8326 (in Mass., 617-890-6107).

If it's ECG, it fits. And it works.

Philips ECG

A North American Philips Company

Dedicated to Excellence.

CIRCLE 68 ON FREE INFORMATION CARD

BUILD THE MODEM MINDER

*You don't have to sit there
watching and waiting...*

KIRK VISTAIN

■ Like many computer users, I enjoy communicating with remote CP/M and bulletin board systems. And like many, I've spent much of my time hearing busy signals and redialing. That's why I was so happy to get a copy of MEX, the public domain Modem Executive program. With it, I could tell the computer to keep dialing a number until it connected, without my intervention. But, I ran into a slight problem. The computer is supposed to make life simpler by eliminating the need for human intervention in mundane, repetitive tasks. Yet there I was, sitting by the terminal, watching a number being dialed over and over again. Why? Because I had to know when a connection was made. Perhaps like many of you, I have a computer which does not support a terminal bell. So the only way to know when I had reached a remote was to watch the screen. I know what you're thinking. Turn the volume up and go do something productive while you're waiting. High volume? That doesn't help your concentration. That's why I designed the Modem Minder (Fig. 1).

How the Modem Minder works.

When your computer attempts to ring up a remote, it waits until it hears the answering computer's acknowledgment tone of 2225 Hz and responds with its own 1270 Hz signal. It is this tone that the Modem Minder senses acoustically.

When used with a direct-connect modem, such as the Hayes Smartmodem, it monitors the speaker output, which can be set to an unobtrusive level, and sounds a piezo buzzer when it detects the 1270 Hz tone from the originating computer. You can go about your work while the computer tries to connect, and be notified when it does, without being distracted by the dialing tones.

Design.

I designed the Modem Minder to meet several goals. First, it had to be as isolated as possible from the circuitry of both the modem and computer. This is good practice whenever you build an add-on device. Modifying commercial designs is a risky business, and will generally void any warranty you might have. The



FIG. 1—WITH UP-FRONT CONTROLS and a small footprint, the Modem Minder fits nicely just about anyplace.

idea of hard-wiring an unproven circuit to a \$250 modem just isn't appealing, unless you're a fireworks buff. So I opted for acoustic coupling. This means that the modem must have an internal speaker. All the stand-alone Hayes models and many others do, so this seemed a valid approach.

Parts availability and ease of construction constituted the second criterion (Fig. 2). This meant using off-the-shelf devices and a simple circuit. Since the Modem Minder would probably not be used for extended periods of time, the complexity of an AC supply seemed excessive, so battery power was chosen.

Because it would be sitting close to the computer, Modem Minder would have to reject noise and speech. More importantly, it would have to distinguish between the desired 1270 Hz tone and the other tones it would be likely to hear on the phone line, especially the uncomfortably proximate 1209 Hz touch-tone signal used with numbers 1, 4, and 7.

The circuit shown in the schematic, Fig. 3, satisfies these requirements. IC2-a is configured as a non-inverting amp with a gain of approximately 30. The acoustical transducer is a ceramic microphone chosen mainly for economy and its limited frequency response, which helps reduce noise problems. C4 eliminates the DC offset component of the amplified mike signal and feeds the input (pin 3) of a 567 tone decoder IC. Since the detection bandwidth of this IC is amplitude sensitive at signal levels below 200mV, the preceding preamp stage provides signal above this level.

The approximate detection frequency of the circuit is determined by the series resistance of R1 and R8, and C1, according to the formula $f = 1.1 / ((R1 + R8) \times C1)$ where f is the center frequency of the internal current controlled oscillator (CCO). R8 is used to compensate for component tolerances, and to allow precise adjustment of the detection frequency. Capacitors C2

and C3 set the detection bandwidth at about 4% (1219-1320 Hz) at input levels of greater than 200mV.

The combination of R2 and D1 provides a feedback path which causes the output of IC1 to latch until disabled by a positive pulse at pin 1 from RESET switch, S1.

Pin 8 of IC1 is an active low output. This means it goes from near the positive supply rail to ground when it detects a tone. This signal is fed to IC2-b, which is wired as a comparator. R6 and R7 set the voltage at pin 12 to approximately 1V. As long as pin 13 remains above this level, the output of the comparator is negative, which disables piezo buzzer, PB1. D2 protects the buzzer from reverse polarity.

When a detected tone causes the output of the decoder IC to drive pin 13 below the level of pin 12, the output snaps up to the positive supply rail and causes the buzzer to sound, until RESET is pushed.

Construction.

I tested the design of the Modem Minder on a Heath Digital Design Console, a handy device for the experimenter. The prototype was built on an etched board, (see Figs. 4 and 5), although, for one-time construction, wiring the device on perfboard would be quicker.

Most of the parts are readily available at electronic supply stores, or maybe even in your junk bin. A few parts need explanation. The type of ceramic microphone you use may determine the amount of gain required in the preamp. The design goal is to provide the input of the 567 tone decoder with a minimum of 200mV at 1270 Hz, with the modem's speaker output set to an unobtrusive level. If you need to adjust gain, change the value of R3. A higher value means more amplification, a lower one less. At gains above 500, offset might become a problem, but you'll probably never need to go that high.

Microphone and case.

One important consideration is how the modem's speaker is mounted. If it is on the bottom of a stand-alone design, such as the Hayes Smartmodem, you can cut a hole in the Modem Minder case, just slightly smaller than the microphone module. The module is then mounted from inside the case, facing up, that is, toward the modem's speaker. The modem sits atop the case with its speaker over the microphone opening on the Modem Minder. This allows it to block most extraneous noises, as well as keep phone line signals to an unobtrusive level.

The size of the case will be determined by the type of modem you are using and the way you mount it in your system. If you are dealing with an outboard device the box should be big enough to support it, but small enough to fit between the feet. That way, intimate contact is maintained and audio leakage from the speaker is minimized.

For those of you with Hayes Micromodems, or other types, which are mounted inside the computer, or have unusual speaker locations, it may be necessary to place the microphone, in its own enclosure, over the speaker,

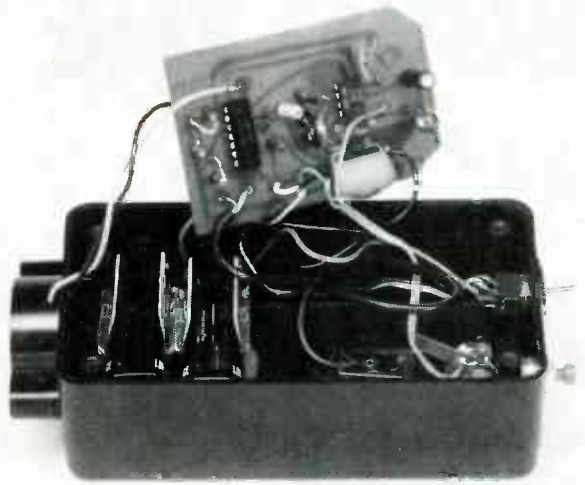

FIG. 2—INSIDE THE BOX, compact parts placement and easy wiring is revealed. Nothing super-critical makes this a comfortable project.

and connect with shielded cable to the separately mounted Modem Minder electronics.

Adjustment and use.

There are several ways to adjust the 567 to the correct frequency. The most obvious is to connect a frequency counter to pin 6 of the 567 and adjust for a 1270 Hz output. If you don't have a frequency counter, you can simply dial up a remote computer and wait for the modem to answer back with the 1270 Hz signal. This will likely require several tries, since the tone doesn't last long.

When you first power up, the Modem Minder's

PART LIST

RESISTORS

All resistors \pm 5% unless otherwise specified.

- R1—2200 ohms
- R2—18,000 ohms
- R3—15,000 ohms
- R4—470 ohms
- R5—1 megohm
- R6—8200 ohms
- R7—1000 ohms
- R8—2500 ohms linear trimpot*

CAPACITORS

- C1—.22 μ F
- C2—10 μ F
- C3—22 μ F
- C4—.01 μ F

SEMICONDUCTORS

- IC1—LM567 Tone decoder
- IC2—LM324 Quad Op Amp
- D1, D2—1N4148 Diode

MISCELLANEOUS

- MIC—Microphone element
- BZP1—Piezo buzzer
- SW1—SPST, N.O., Momentary contact
- B1, B2—9-volt battery
- Enclosure, perfboard or printed circuit materials, hardware.

*A 2500 ohm potentiometer is preferred but a 5000 ohm will work adequately.

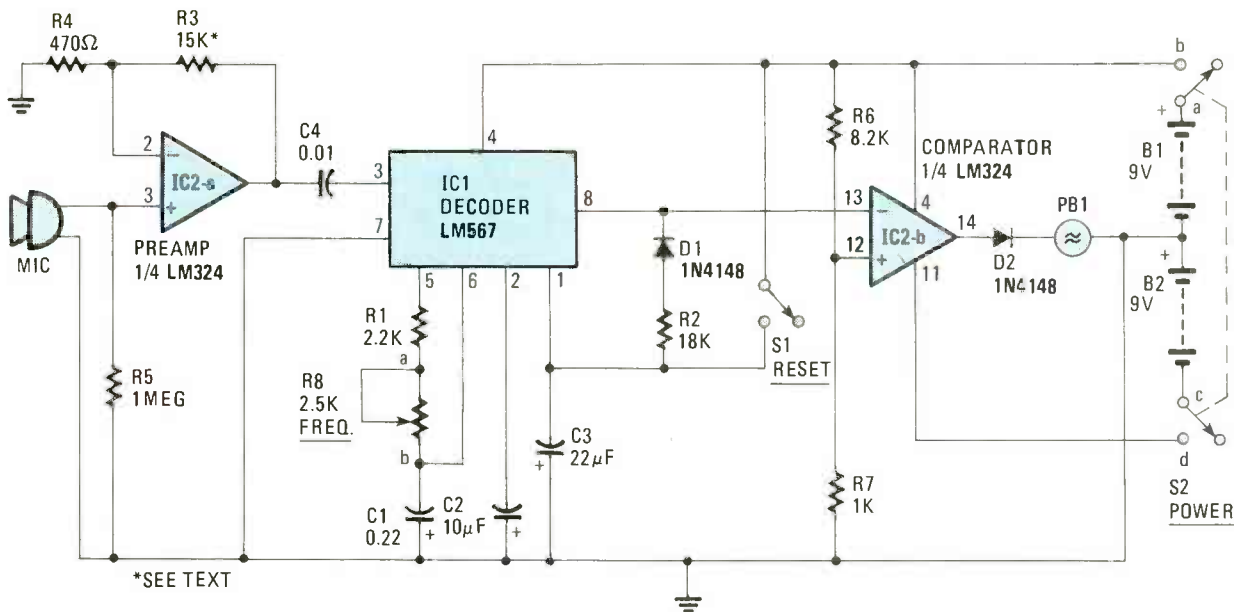

FIG. 3—SCHEMATIC DIAGRAM holds no secrets. It's easy to follow, and should be referred to while reading the text. For more information on R3, the 15K resistor, refer to the text.

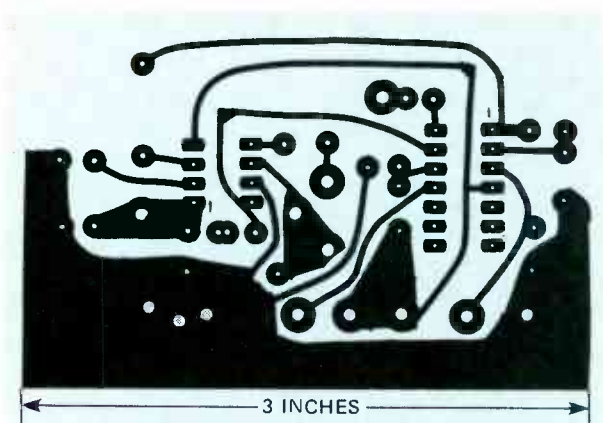

FIG. 4—FULL-SIZE CIRCUIT BOARD LAYOUT is provided here, looking at the circuit side.

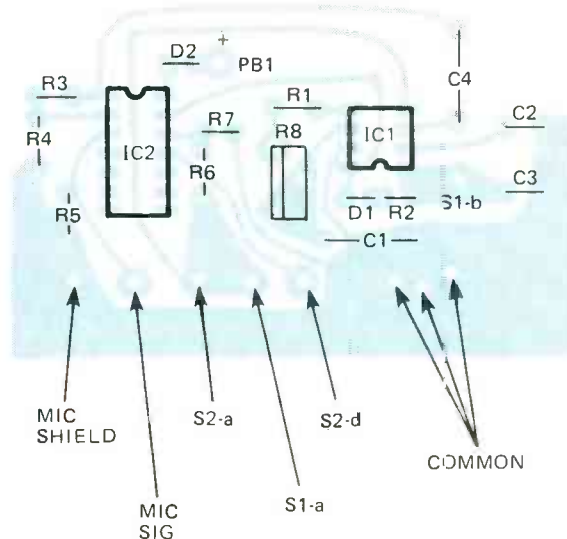

FIG. 5—PARTS PLACEMENT is shown in the above diagram.

buzzer will latch on. Pushing RESET will stop it. You could probably use the remaining two opamps in the LM324 to devise some sort of automatic-reset-at-power-up circuit, but I prefer the beep, because that tells me the batteries are good and most of the circuitry is operational.

Just a quick word about computer etiquette: It's best to be certain you're dialing the right number before you leave the terminal unattended. Imagine how you'd feel if someone's computer got your number by mistake and kept calling every two minutes, early some Sunday morning!

The Modem Minder is one of those unusual devices that you might look at and decide to build because there's nothing much on television that night, and you've got most of the parts in your junk box anyway, and besides, it's raining out. It is, after all, an interesting project, and the building doesn't take all that long to complete. What makes it unusual, is that after you've built it and installed it, you check it to see that it's operational, and then you start using it. And before

long, you wonder how you ever got along without the thing! My own unit is in constant use and if I've got any regrets at all about it, it's only that I wish I had built it a long time ago. If you're using a computer, and using a modem, the Modem Minder is one ancillary device you've got to have.

Computer databases, bulletin boards, and remote systems are fun to use, but for that very reason you're likely to run into a lot of busy signals. To make your time more productive, let the Modem Minder sit around waiting for a connection, while you go about your business. You can trust it to buzz you as soon as the connection is made. I'll be glad to answer any questions you might have about this device. Just send your mail in care of this magazine, or leave me a message on CompuServe, EMAIL box 72356, 1355. ◀▶

MEDIA- MATCHING

*You can mix and match computers
and media—if you know what you're doing.*

HERB FRIEDMAN

■ One of the major problems caused by the proliferation of computer models and types is that of media compatibility. Except for the IBM clones and the IBM-compatible computers, few computers can read the disk formats of other computers, and even though the software might be the same, neither the program nor its data can be directly exchanged between two different computers.

For example, the same version of *WordStar* is available for Osborne, KayPro and Radio Shack computers (among many others) yet neither the program itself or its text file can be directly exchanged between computers.

It is this lack of compatibility that normally prevents you from preparing a document in the office on say, an IBM-PC, and then polishing it at home on your personal Radio Shack *Model III*. It also works the other way round in that you cannot prepare a data disk for *SuperCalc* on your portable KayPro and then use the disk on the office Xerox computer.

Actually, the text, data, and even the program files are identical, or at the very worst not identical but interchangeable; it's only the way that they are written to disk that's different.

While it is entirely possible to exchange text and data between computers by using a modem, doing so requires either a telephone connection—meaning two computers, two locations, and two operators—or a direct wire connection through a null modem, which means having the two computers adjacent or physically near each other. Either way, it's a very inconvenient way to do things.

The simplest and most convenient way to exchange software between computers is to move the disks from computer to computer regardless of the manner in which the disk was electrically formatted by the originating computer. While this was almost impossible to do several years ago, today there's a seemingly endless list of low-cost programs (utilities) that allows almost any professional computer to read, and sometimes write in the format of most other computers.

In practical terms this means that you can prepare a *SuperCalc* spreadsheet on the Office IBM-PC, and then directly use the data disk on your Osborne; or at worst, you'll have to exchange the data to a disk formatted for the Osborne. Either way, all you're carrying from location to location is a disk, not a full computer.

MSDOS 1.00 File Transfer Version 1.00
(c) 1984, Purves Computer System Software

1. Read MSDOS 1.00 Disk Directory
 2. Copy MSDOS 1.00 File to TRSDOS Disk
 3. Copy TRDOS File to MSDOS 1.00 Disk
 4. Sort MSDOS 1.00 Diskette Directory
 5. Format MSDOS 1.00 Compatible Diskette
- Enter Selection:

TRANSFER not only formats a disk for MS-DOS/PC-DOS 1.0, it translates between ME-DOS/PC-DOS and any TRSDOS-like operating system such as Newdos, Dosplus, etc. It is not limited to TRSDOS, even though that's what is implied by the screen.

TRS-80 Model 4 CP/M 2.2 INTERCHANGE PROGRAM v1.42

Copyright (c) Montezuma Micro 1983. All rights reserved.

- A. Montezuma Micro (DD,SS)
 - B. Hurricane Compactor I&II (DD, SS)
 - C. IBM PC CP/M-86 (DD,SS)
 - D. Xerox 820-1 (SD, SS)
 - E. Xerox 820-2 (DD, SS)
 - F. Osborne-1 (SD, SS)
 - G. Osborne Executive (DD, SS)
 - H. Kaypro-2 (DD, SS)
 - I. Zenith H-89 (SD, SS)
 - J. Zenith Z100 (DD, SS)
 - K. Zenith Z100 (DD, DS)
 - L. Cromeco Z-2 (SD, SS)
 - M. Cromeco Z-2 (DD, SS)
 - N. Eagle 80trk. (DD, SS)
 - O. Lobo MAX-80 (DD, SS)
 - P. LNW Computers LNW80 (DD, SS)
 - Q. MM Shuffle Board (DD, SS)
 - R. Holmes VID80 (DD, SS)
 - S. Omikron Mapper I (SD, SS)
 - T. Morrow Micro Decision (DD, SS)
 - U. Access Matrix (DD, SS)
 - V. Radio Shack Mod.4CP/MPlus(DD,SS)
 - W. Televideo 802 (DD, DS)
 - X. HP-125 (DD, DS)
 - Y. DEC VT-180 (DD, SS)
 - Z. NEC PC-8001A (DD, SS)
- Select disk format by pressing [A-Z]

Press "BREAK" to exit to the CP/M operating system

INTERCHANGE for the MODEL 4 CP/M is one of the most flexible and powerful translators, because it permits an alien disk to be run on the host computer. About the only thing it can't do (at least at the time of this writing) is translate to MS-DOS/PC-DOS.

Different formats.

The reason for disk incompatibility is the way in which the information is stored on the disk. For whatever reasons—greed, or an honest belief that their system is better—manufacturers store data in different ways. Even the directory track—the list of disk files and where they are located on the disk—varies from manufacturer to manufacturer. For example, some computers have the directory on track 17, others have the directory on track 20, or track 2, or track 3. Obviously, if a computer is looking at track 17 for a list of files it won't find anything if a particular disk's

directory is on track 2.

Then there's the way in which the data itself is recorded. The directory listing for each file contains information as to which tracks and sectors used for the files, the amount of space used, etc. The file itself has assorted block markers, pointers, and checksums in addition to the data itself. Even if a computer could locate a file on an alien disk, it most likely won't understand the markers, pointers, checksums, and other bits and pieces of control information that must be interpolated before it's possible to read the data. (Alien means a disk from a different kind of computer.)

Similarly, even if the computer could write to an alien disk the file probably could not be located or used by the computer for which the alien disk was intended.

Media compatibility.

The way out of this seemingly impossible morass is to use translation software that reads and interpolates an alien disk's data to the host computer's format. Actually, the best translators can read and write most of the commonly used disk formats. Though most translation software accommodates a broad range of computers—a few specifically translate for only two or three computers—at the worst it requires two different translators to accommodate all the most popular disk formats. The major exceptions are the Apple, Atari and Commodore disk formats, for which there is presently no direct translator.

Disk translation programs are designed for computers with at least two disk drives, one of which must be a 5¼-inch floppy (the other can be a floppy or a hard disk). The program itself can be on a 5¼ diskette or on a hard disk; the alien disk, however, is always a 5¼-inch diskette: there is no such thing as an alien hard disk.

The translator causes one disk drive of the host computer to read (and sometimes write) the alien format. Once the translator is installed the alien format drive can no longer read or write in the host format.

Some of the older translation programs can only read from the alien disk. For example, if the host computer is an Osborne and the alien disk is from an IBM-PC the translator will read the IBM disk and copy the files directly to an Osborne-format disk. The more modern translators can exchange data in both directions; meaning data can be read from the IBM disk and written to the Osborne disk, or read from the Osborne disk and written to the IBM disk. Another difference between the older and more modern translators is that many of the older translators processed all files, the user could not pick and choose. The modern translators allow the user to select one or more files for translation.

The most modern translators such as Media Master, Uniform, and TRANSFER can even format an alien disk, which means you don't have to carry disks back and forth. For example, assume you have a document created on a Radio Shack *Model III* using the *TYPITALL* word processor and you want to use the document on the office IBM clone. The program TRANSFER first allows you to format a blank disk in the IBM format, and then it will copy the document from the Radio Shack

MEDIA MASTER V1.02 (4/18/84) -- Osborne I and Executive

(c) Copyright 1984 MDG and Associates

1. COPY file(s)
 2. PRINT directory
 3. DISPLAY directory
 4. LOG in a new diskette
 5. ERASE file(s)
 6. VERIFY or write toggle (VERIFY is ON)
 7. FORMAT a diskette
 8. EXIT to CP/M
- Press selection followed by <return>

Single Sided Formats Available

-
- A. Osborne (DD)
 - B. Osborne (SD)
 - C. DEC VT180
 - D. IBM PC CP/M
 - E. IBM PC-DOS 1.0
 - F. IBM PC-DOS 2.0
 - G. TI Professional CP/M
 - H. TRS-80 I w/Omikron
 - I. TRS-80 III w/Mewm Merch
 - J. TRS-80 IV CP/M
 - K. LNW-80
 - L. Xerox 820 I (SD)
 - M. Xerox 820 II (DD)
 - N. NEC PC-8001A
 - O. Actrix
 - P. Cromeco w/Int'l Term
 - Q. Cromeco CDOS (SD)
 - R. Cromeco CDOS (DD)
 - S. Lobo MAX-80
 - T. Morrow MD2
 - U. Kaypro II
 - V. Zenith Z90
 - W. Heath Z100 CP/M
 - X. Heath w/Magnolia
 - Y. Systel II CP/M
- Press selection followed by <return>

MEDIA MASTER does not support running a programming but it is most efficient at handling translation. The supported formats are the most modern and extensive for CP/M computers, and they include translation to/from IBM PC-DOS and PC CP/M.

host disk to the newly-created IBM disk.

Run time.

While the ability to read and write alien formats is by itself spectacular, some of the translation programs even allow a computer to run directly from the alien disk. For example, Montezuma Micro's translator called *Interchange*—which is supplied with their version 2.2 CP/M for the Radio Shack *Model 4* computer—will run a generic CP/M program directly from the alien disk. ("Generic" means a program that isn't hardware dependent for a specific computer—a program that will run on any conventional CP/M computer.) If you have, say, the word processor *WordStar* and the spelling checker *The Word Plus* on a Kaypro disk, *Interchange* allows you to run them directly on the Radio Shack *Model 4*. In fact, *Interchange's* transfer is so effective that you can write data to either the alien disk in the alien format, or to the Radio Shack format disk

located in the A: drive.

While it is often possible to run a program directly from the alien disk, it can only be done if both the host and alien computers use the same CPU and the same operating system. The reason we can run KayPro programs on the Radio Shack Model 4 is because both use the Z80 microprocessor and both employ the same version of CP/M. If we had CPM-86 or MS-DOS/PC-DOS programs on the alien disk they could not be run because the Z-80 op codes are different than those for the 8088 microprocessor, for which CP/M-86 and PC-DOS is written. In fact, unless the CPU's and operating system is the same there is really no point in translating binary encoded disk files because they won't run on an alien computer.

Translators are most effective when exchanging ASCII-encoded text and data because ASCII is directly transferable between computers. For example, if you have a document created with an MS-DOS version of

10 FORX = 1TO10

Microsoft's BASIC won't process the statement because most implementations require that commands be framed by spaces on either side. For Microsoft BASIC the statement must read:

10 FOR X = 1 TO 10

Some translator programs can convert BASIC statements into other BASIC dialects. Generally, they accommodate only the most commonly-used statements; the user must then manually correct the unconverted statements when they are indicated as syntax errors. Usually, it's more trouble than it's worth.

Summing up.

Translation software is what prevents your old computer(s) from becoming obsolete. Unless you have

IBM-PC SINGLE SIDED
IBM PC DOUBLE SIDED
OSBORNE DOUBLE DENSITY
KAYPRO II
ZENITH CPM-85 DS DD
OTRONA SPM-80
SANYO MBC-1000
KAYPRO-IV DS DD
HP-125
HP-9138

MORROW MICRO D
MORROW MICRO D SS
DEC VT-180 SS 9 SECTOR
NEC PC 8000 SS
ACCESS MATRIX 8 SECTOR SS
TELEVIDEO 803
NCR DECISION MATE V
EPSON QX-10

CUSTOM DISK TYPE SELECTION

USE CURSOR ARROWS TO MOVE BETWEEN FIELDS
RETURN SELECTS ENTRY
F1 ENTER THE DISK TYPE BY NAME FOR SELECTION

F10 DONE RETURN TO PRIOR MENU
ESC ABORT ABNORMAL TERMINATION

Jan-1-1980 0:24 am

SELECT FUNCTION KEY

CROSSDATA (C) COPYRIGHT 1983 AWARD SOFTWARE INC. ALL RIGHTS RESERVED IBM 2.0D

CROSSDATA translates many of the most common "commercially-used" CP/M computer disks to whatever IBM DOS you're using in either single or double-sided.

WordStar it will work directly with a CP/M version of WordStar if transferred to a CP/M machine. Similarly, ASCII Peachtext, SuperCalc, dBase II and VisiCalc files can be transferred between various computers and operating systems. If a program cannot process ASCII files directly it will have some way to convert the files to ASCII so they can be interchanged between different implementations or operating systems.

BASIC.

It is often difficult to transfer BASIC programs even if written in ASCII. The reason for what is apparent incompatibility is due to what is sometimes very subtle differences between the various versions of BASIC, even though the most commonly used BASICs are Microsoft BASIC. For example, Radio Shack's implementation of Microsoft BASIC uses a form of space compression to save RAM. While Radio Shack's BASIC can use the statement:

need for a new software that can run only on the latest computers—such as Multimate—you'll find that much of your software can run on both the old and new computers.

As example, because I work in several locations I must use several computers. This article originated on a NEC-8201 lap computer. It was dumped to a Radio Shack Model I for processing by Typital whose files are non-ASCII. The Model I disk was carried to my home and spelling checked by Hex Spell on a Model 3/4 (yes, there is a way to run Model I disks directly on a Model 3/4). A converted ASCII text file was finally translated using TRANSFER for the Model 3/4 to an IBM-PC because my high speed modem is on the PC. The file eventually wound up in R/E's computer. The article went from something new, to something very old, and back again to something new. And it was all made possible by software that translates different disk formats. ◀▶

consider the same system being used to immediately disseminate the license-plate numbers of stolen cars, descriptions of missing persons, delivery schedules, traffic conditions, etc. Figure 1 illustrates the various technologies used by QuoTrek to put fast-breaking information into your pocket almost within seconds.

How it works

The information that eventually ends up on the display of the pocket receiver originates at several stock and commodity exchanges. That information is then relayed by RCA to QuoTrek's central computer, which is located in California, via redundant satellite or landline circuits. (RCA uses the best available circuit as determined by computerized transmission-monitors.)

The central computer forms the data concerning 8000 stocks and commodities into a packet, and then dumps the packet into the top of a RAM (memory) stack. Data compaction—which is technical jargon for “gets rid of the unnecessary spaces”—maximizes the amount of data that can be squeezed into the packet.

A continuously reading microprocessor scans the RAM stack and uplinks (transmits) the data to the Westar IV satellite. Because of limitations at the final output stage of the system, the computer is programmed to loop or repeat the entire stack—all 8000 items—every two minutes.

Turning our attention once more to Fig. 1, it shows several local FM stations spread across the country receiving the downlinked data packet from Westar IV. The station, in turn, rebroadcasts the data at 4800 baud on its FM subcarrier. (It's the 4800 baud transmission rate that requires the 2 minute loop for 8000 stocks and commodities.) Individual subscribers access the data through the pocket receiver that is purchased outright, but the user still has to pay a monthly fee for the service.

The receiver has a keypad-programmable microprocessor, a 40-character display, and 40 memories to store the selected data. Any of the 40 memories can be pro-

grammed or instantly reprogrammed by the user for any of the 8000 stocks or commodities. There is also an additional manual memory (41) that allows the user to direct-access data on any stock or commodity without changing the programming of the basic 40 memories.

Of the 8000 items received every 2 minutes or so from the FM station, the receiver's computer strips off the data on the 40 user-selected items and stores it in one of the memories.

To view the latest data on a particular stock on the receiver's display, the user “punches” in the code for that stock. (If you're overwhelmed by all the high-tech that's taken us this far, there's more to come.)

Though the data on the 8000 items is downlinked from the satellite to the FM stations in a loop that repeats every 2 minutes or so, information on trading is instantaneous. The moment there is a trade at the stock exchange, the information is relayed by RCA to the West Coast where it is immediately inserted into the data stream at the output of the RAM stack. And everyone's pocket receiver updates instantly, as the central computer strips the old quote from the RAM stack and the new information is uplinked to the satellite.

It's a never-ending process of updating, instantly inserting the latest trades into the data stream and removing the old. But even with the shuttling of data back and forth across a continent, the information is barely seconds old by the time that it reaches the receiver because there is no transmission delay at the exchange.

To those who live or work in big cities, getting the latest stock and commodity information is no big deal; but consider a trader in “upper outback” Wisconsin. There is no way he's going to know what's happening unless he spends plenty of time on the long-distance telephone. But if the local FM-station provides QuoTrek, even though he's out in the boondocks, he'll be as up to date on the latest action in the market as a Wall Street Banker...and that's what communications is all about. R-E

Quietrole

The Original...



A First in the industry, with over thirty years of use by satisfied customers.

Spray Pack Mark II gets into places of close tolerance and washes out the dirt, leaving a thin film of lubricant which lasts indefinitely, with zero effect upon current capacity and resistance.

Spray Pack Mark II has been tested and proven in the Space Age and is still the finest lubri-cleaner available. It is quick, safe effective - a MUST for every tool cadcy.

Spray Pack Mark II is the best-priced lubri-cleaner.

Available at Leading Distributors



CIRCLE 267 ON FREE INFORMATION CARD

Be an FCC LICENSED ELECTRONIC TECHNICIAN!

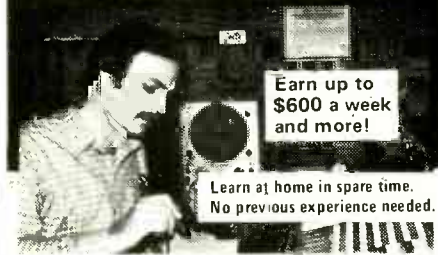

Learn at home in spare time. No previous experience needed.

No costly School. No commuting to class. The Original Home-Study course that prepares you for the FCC Radiotelephone license exam in your spare time! An FCC Government license is your “ticket” to thousands of exciting jobs in Communications, Radio & TV, Mobile two-way, Microwave, Computers, Radar, Aerospace and more. You don't need a college degree to qualify, but you do need an FCC License. **No need to quit your job or go to school!** You learn how to pass the FCC License exam at home at your own pace with this easy-to-understand, proven course. It's easy, fast and low cost! **GUARANTEED PASS** You get your FCC License or money refunded. Write for free details. Soon you could be on your way to being one of the highest workers in the electronics field. **Send for FREE facts now. MAIL COUPON TODAY!**

COMMAND PRODUCTIONS

FCC LICENSE TRAINING, Dept. 90
P.O. Box 2223, San Francisco, CA 94126

Rush FREE facts on how I can get my FCC License in spare time. No obligation. No salesman will call.

NAME _____
ADDRESS _____
CITY _____ STATE _____ ZIP _____

MAY 1985

107

DRAWING BOARD



ROBERT GROSSBLATT

Making our demonstration circuit do double duty

IF I HAD TO MAKE A LIST OF THE MOST difficult things to do in electronics, understanding someone else's design would have to top the list. Sitting down and studying a complex schematic is a time-consuming task. The drawing has to be broken down into individual sections, each of which has to be gone through by itself.

In effect, you're doing the opposite of designing. The reward you get for the work you put in is learning something new. And, if you're lucky, you may pick up a few tricks and shortcuts that can be filed away for use in your own designs.

Using the extra latch

When we left off last time, I asked if you could think of any slick tricks we could do with the extra latch we had left. Now I don't know if you've come up with anything since then, but I threw the question out to you because I already had something in mind.

One neat way to simplify a design and cut down the parts count is to make components do double, triple, or even quadruple duty. A standard place to find that sort of thing is in the design of keyboards. All computers, some calculators, and even the typewriters use that technique to keep their keyboards down to a manageable size.

Can you imagine what a typewriter would be like if there was no shift key? Or a computer without a control key? In any event, there's no reason we shouldn't use the same sort of trick ourselves. Figure 1-a lists the four control pins of the 5101, the memory we're using in

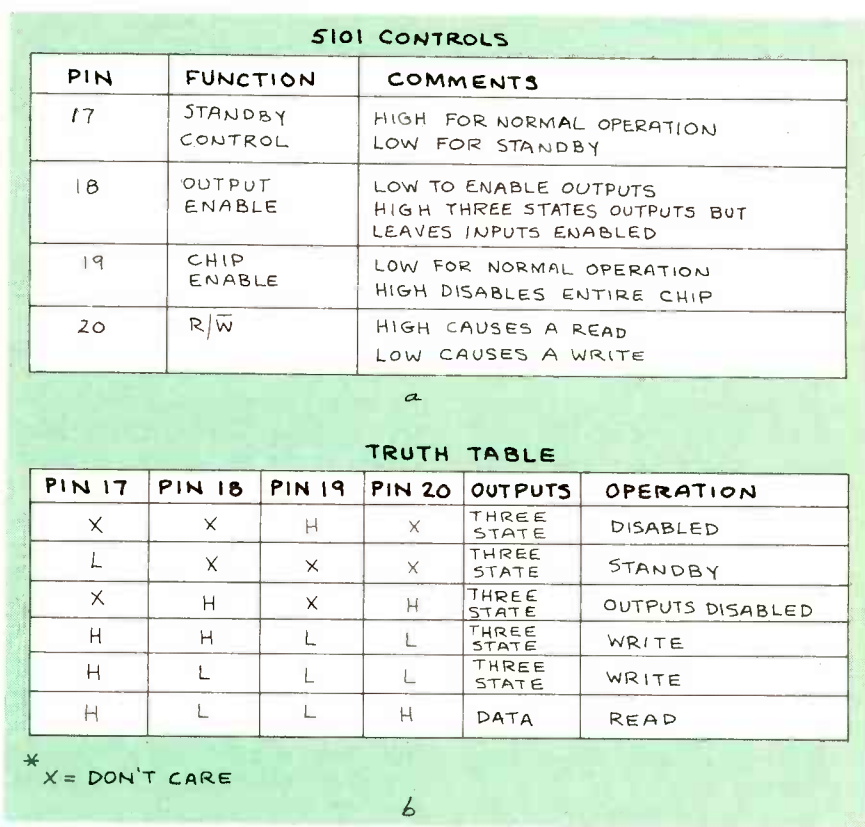

FIG. 1

our demonstration circuit. Figure 1-b is the truth table for the IC (which we'll look at later).

How it works

Since the circuit we're using has a four-bit wide bus, what we're going to do is arrange things so that our keyboard serves two purposes. The first is keying in the information to be presented to the memory, and the second is actually telling the memory what we want it to do.

Since there's a separate line on the bus for each of the memory's control pins, we have the ability to

select any one of the the sixteen possible combinations. That sounds a lot better than it really is—being able to do it doesn't mean it's worth doing.

Obviously some of our choices are junk. Doing things like triggering a write is a pretty useless if we put the memory to sleep at the same time! Let's take the control pins one at a time, see what they do, and decide what we want to do with each of them.

Looking at Fig. 1-a, we see that pin 17 switches the memory between normal operation and the low-power standby mode. If you

bring it low, you'll be putting the IC to sleep, while holding it high sets the IC up for normal operation. The 5101 and other members of the *low-power* family can remember data for a cost of only a few microamps.

Since so little power is required, the life of the battery you choose to power the IC during standby will be close to its shelf life.

There are certain timing requirements for reliably switching over to standby operation. And if it's not handled properly, the memory will glitch and you'll wind up with garbage instead of data. If you want me to spend some time on the subject, drop me a line and I'll devote a couple of columns to it.

Pin 18 is the $\overline{\text{ENABLE}}$ control for the outputs. If it's made low, the IC operates normally and data appears at its output pins. Making it high causes the outputs to go to its three-state mode. Notice that pin 18 *only* controls the outputs. You'll still be able to write to the memory regardless of how you have that pin set.

Disabling the entire IC is accomplished by bringing pin 19 high. That disconnects the inputs as well as the outputs. However, a low will enable them. Read and write operations are controlled by pin 20; read is done with a high and write is done with a low. There are very strictly defined timing needs whenever you read or write to memory.

Even though the 5101 only needs a write pulse that's 250 nanoseconds wide, the total write cycle time is 450 nanoseconds. And that's fast as far as the 5101 goes. The slower (cheaper) IC's can have minimum write-cycle times as long as 800 nanoseconds!

You'll remember from some of our earlier discussions of memories in general that a whole series of operations have to happen when you do a read or write. The address you put on the bus has to be internally decoded by the memory and the particular cells in the matrix have to be accessed. Generating a write pulse before the addresses have stabilized will result in writing to an indeterminate location and glitching whatever was there before.

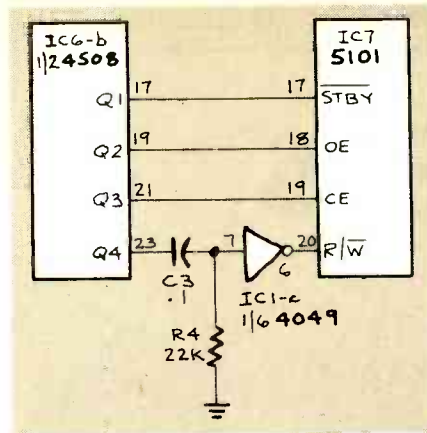

FIG. 1

The same sort of analysis applies to a read operation. The only way to be sure you're getting valid data from the IC is to design your circuit with an eye to the minimum setup times needed by the IC you're using. Since the circuit we're designing is going to be manually operated, most of those restrictions can be ignored.

If you go through all the possible configurations you can have with the control pins, you'll realize that there are very few of them that serve any useful purpose. Therefore, we can immediately cut them out. In fact, if you study the truth table in Fig. 1-b, you'll see that there's only one set of conditions that will produce data at the outputs.

Both of the enable pins (18 and 19) disconnect the outputs when they're made high. The outputs are also disconnected during a write operation. To keep the circuit as simple as possible, let's say that we want the outputs of the IC to be enabled all the time (except, of course, during a write) since we want to see the results of reads and writes as soon as they happen. Let's further say that we don't ever want to put the IC to sleep.

Our choices have been reduced considerably because all we're left with is the ability to read and write to the memory. In fact, you've probably realized by now that you can explore as many of the possibilities as you want by simply connecting the control pins to the output of the latch. If you're satisfied with losing some choices, you can hard wire the enable pins to ground and only deal with pin 20, the $\overline{\text{READ/WRITE}}$ control.

Circuit additions

In order to give you as many choices as possible, we'll draw the schematic connecting all the control pins of the memory to the latch outputs. You can select or eliminate as many options as you want. There are a couple of things to keep in mind, however, when you're making your choices. If you look over the truth table on the data sheet, you'll see that putting a high or low on one pin will set the memory in a particular mode regardless of what you do to the other pins. If, for example, you put a low on pin 17, the IC goes into the standby mode and won't respond to anything until you wake it up again.

There's one more problem we have to deal with. No matter how you decide to deal with the control pins, we can't allow the latch alone to control the $\overline{\text{READ/WRITE}}$ pin. If we leave things the way they are, the memory will lock in the write mode every time we select a write. The output of the latch has to be used to trigger some other circuit that generates the actual write pulse. The circuit has to have a normally high output that can be triggered into producing a low pulse wide enough to meet the timing needs of the memory.

There are loads of ways to accomplish that, but since we already have a couple of spare inverters in the circuit, we can use one of them to do the job. Figure 2 is a partial schematic of our demonstration circuit showing how to connect the extra latch from our last discussion to the 5101 memory IC.

The control pins are connected to the latch and the $\overline{\text{READ/WRITE}}$ pin is controlled by a half monostable. (That half monostable is made from an inverter leftover from the 4049 that formed the basis of the clocking circuit used for our keyboard.) Remember that the pulse generated by the 4049 is inverted. The circuit produces a negative pulse when it's triggered by a positive going pulse at its input.

The values of the resistor and capacitor are chosen for an output pulsewidth of about one millisecond. That's long enough for any

continued on page 111

NEW IDEAS

Electronic heat sniffer

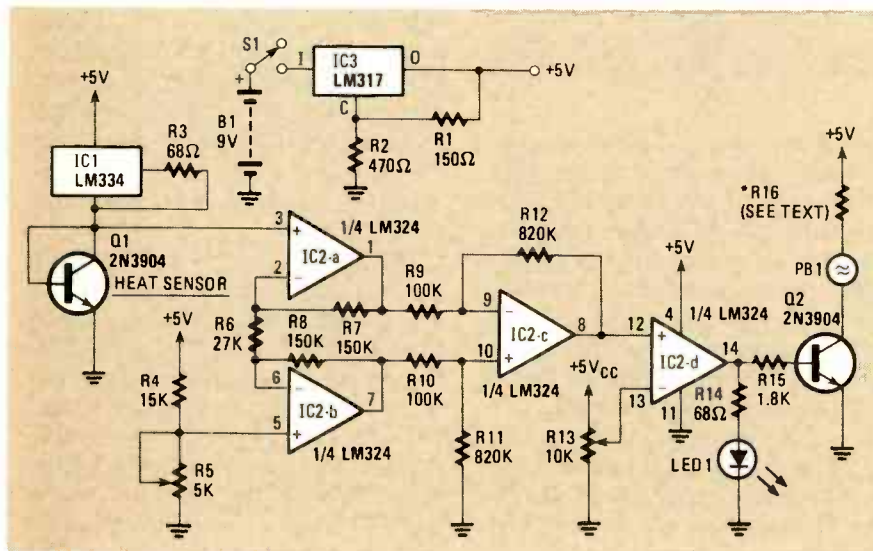

FIG. 1

MANY ELECTRONICS EXPERIMENTERS and servicemen have a habit of using their built-in heat sensors—fingers—to determine whether semiconductors are alive and well, or if they're just plain dead! While using your finger gets the job done (sometimes), you can also wind up with a pretty painful burn. Having become tired of toasting my fingers on overheated IC's and transistors, I set out to find a better way.

The result of that quest is shown in Fig. 1, the schematic of a heat-sensing circuit. Unlike fingers, that circuit can also be used to track down heating and cooling losses around windows and doors, or even around electrical outlets.

Heat-sensing circuit

The sensing element, Q1, is a 2N3904 general-purpose NPN transistor, although any general-purpose NPN unit in a TO-92 style case will do. That small plastic unit was chosen simply because larger units take longer to heat. Also, metal-cased transistors dissipate heat too rapidly, so that the silicon substrate may not have enough

time to react to the heat.

IC1 (LM334) supplies Q1 with a constant current that is independent of temperature. An LM324 quad op-amp, IC2, forms a high input-impedance differential amplifier (IC2-a, IC2-b, and IC2-c) with a gain of about 99. IC2-d is used as a voltage comparator.

When Q1 senses an rise or fall in temperature, the base-to-emitter voltage decreases. That decrease in voltage causes the input to IC2-a at pin 3 to deviate from the reference voltage that's fed to IC2-b at pin 5 (which is set by potentiometer R5).

The difference between the input and the reference is amplified by IC2-c. That amplified voltage is fed to IC2-d where it is compared to a control voltage set by potentiometer R13. The setting of R13 determines the threshold and is set at a point that's equal to the ambient temperature.

The output of IC2-d at pin 14 is fed to the base of transistor Q2. When the output of IC2-d is high, LED1 lights and Q2 turns on. With Q2 turned on, a ground path through the transistor is provided

for the buzzer (PB1).

The value of R16 depends on the type of LED and buzzer used. If a 3–12 volt buzzer is chosen, R16 may not be necessary. The proper operation of the circuit is heavily dependent on the supply voltage (ie., the two reference voltages), so the LM317 (IC3) programmable regulator is used. The values of R1 and R2 set the regulator output to 5 volts.

The circuit may be built on perforated construction board using point-to-point wiring. All compo-

NEW IDEAS

This column is devoted to new ideas, circuits, device applications, construction techniques, helpful hints, etc.

All published entries, upon publication, will earn \$25. In addition, for U.S. residents only, Panavise will donate their *model 333*—The Rapid Assembly Circuit Board Holder, having a retail price of \$39.95. It features an eight-position rotating adjustment, indexing at 45-degree increments, and six positive lock positions in the vertical plane, giving you a full ten-inch height adjustment for comfortable working.

I agree to the above terms, and grant **Radio-Electronics Magazine** the right to publish my idea and to subsequently republish my idea in collections or compilations of reprints of similar articles. I declare that the attached idea is my own original material and that its publication does not violate any other copyright. I also declare that this material has not been previously published.

Title of Idea

Signature

Print Name

Date

Street

City

State

Zip

Mail your idea along with this coupon to: **New Ideas Radio-Electronics**, 200 Park Ave. South, New York, NY 10003

nents, except Q1, are mounted on the board. Transistor Q1 is mounted at the tip of the heat-sensing probe.

Prepare the probe by first bending the leads of Q1 to a 90° angle. While keeping the leads separated, encapsulate them in epoxy, making sure that enough lead is protruding so that wires may be attached. Solder one piece of wire across the base and collector of the transistor, and a second wire to the emitter. Leaving Q1 sticking out, cover with flexible tubing. Now connect the probe to the circuit board.

To calibrate the circuit, simply adjust R5 (while monitoring with a voltmeter) for a reading of between 2.25 and 1.2 volts at pin 5 of IC2-b. After that's done, the circuit is ready for use.

Using the unit

To use the heat sniffer to determine if a CMOS IC is working, for example, bring the probe close to the IC. Then adjust R13 until LED1 goes out. Now touch the flat side

of Q1 to the IC. If the IC is working, the heat that it produces will cause LED1 to light and PB1 to sound. (Of course, some malfunctioning IC's will also produce a good amount of heat.)

With a little practice, you should be able to test any semiconductor in 5 seconds or less. Since resistors produce much more heat in operation than do semiconductors, they are easier to check. But, the test only shows whether the resistor is passing current—it does not indicate whether the resistor is still in tolerance and passing the *correct* current. If the resistor is open, it passes no current, so it will produce no heat, and all indicators will be off.

Testing for heating and cooling losses is accomplished in the same way. But don't forget that R13 must first be adjusted for ambient temperature.

All parts for the heat sniffer are common components, and should all be available from local electronics supply stores or through mail order.—Robert Pham

DRAWING BOARD

continued from page 109

memory you can find. If you want to change it, the period of the output pulse can be determined by this formula: $T = .77RC$.

It's generally a good design practice to make the write pulse as narrow as you can without making the operation of the memory any less than completely reliable. Since we're building a demonstration circuit, there's no reason to cut things that close, but by all means change the values. The pulse can't be too long.

Given the connections shown in Fig. 2-a binary 8 (1000) will generate a read, 9 generates a write, 10 (a binary A) disables the entire IC, and 13 (a binary D) disables only the outputs. All the keys up to 7 will put the IC to sleep, but be careful! To put the IC into the standby mode, things have to be done in a certain order. We'll cover that and other mysteries, and finish up next time. **R-E**

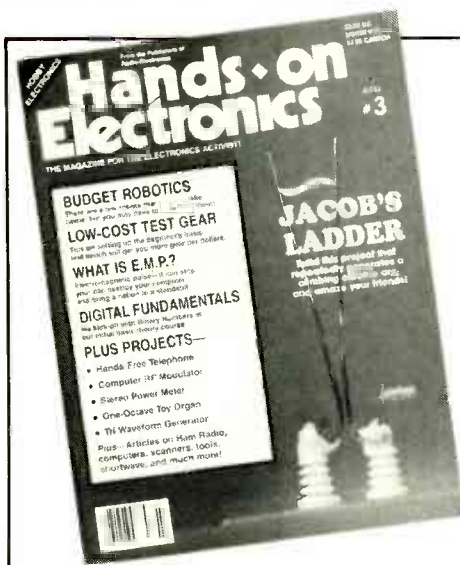

■ TO HELP YOU TO BE SURE that you don't miss any future issues of **Hands-on Electronics**—SUBSCRIPTIONS ARE NOW AVAILABLE!

■ YOU CAN HAVE THE NEXT FOUR ISSUES of **Hands-on Electronics** delivered directly to your home for only \$10.00. We pay the postage. If you want the next eight issues, you can even save a dollar off the newsstand price. Get eight issues for \$19.00

Get every issue! Subscribe Today!

■ IF YOU'RE THE KIND OF READER that doesn't want to wait, you can order your next copy of **Hands-on Electronics** now. **Hands-on Electronics** is crammed full of electronic projects that you won't be able to wait to build for yourself. You can expect top-notch digital projects, fun-to-play electronic games, valuable add-on computer projects, BCB and shortwave receivers, photographic/darkroom gadgets, devices to improve your car's performance, test equipment ideas, and more in every issue of **Hands-on Electronics**.

■ EVERY ISSUE OF **Hands-on Electronics**

will continue to contain a variety of construction articles to suit every taste. In addition, feature articles on electronics fundamentals, test equipment and tools will round out each issue. Of course, **Hands-on Electronics** will continue to provide new product and literature listings to keep you up to date on the latest developments in electronic technology.

■ GET IN ON THE ACTION! Order your next issue of **Hands-on Electronics** today. Use the convenient order coupon below. Be sure to send check or money order—no cash!

Use the order form below.

Hands-on Electronics SUBSCRIPTION

ARE55

I want to be sure I don't miss any issues. Send me the next four issues of **Hands-on Electronics** for \$10.00 starting with #4. Postage is free in U.S. For Canada add \$2.00. Foreign add \$7.00

I want to be sure I don't miss any issues and want to save \$1.00 too. Send me the next eight issues of **Hands-on Electronics** for \$19.00: starting with #4. Postage is free in U.S. For Canada add \$4.00. Foreign add \$14.00.

Send me _____ copies of **Hands-on Electronics** #4 at \$2.50 plus \$1.00 postage and handling for U.S., Canada and Mexico \$1.00 per copy. U.S. funds only.

Please print _____ Allow 6-8 weeks for the first issue to arrive.

(Name)

(Street Address)

(City)

(State)

(Zip)

Detach and mail today to:
HANDS-ON ELECTRONICS
SUBSCRIPTION DEPT.
P.O. BOX 338
MOUNT MORRIS, IL 61054

MAY 1985

STATE OF SOLID STATE



ROBERT F. SCOTT,
SEMICONDUCTOR EDITOR

A light dimmer

ELECTRONIC LIGHT DIMMERS HAVE BEEN used in the home and industry for a couple of decades. Typically, they are relatively simple devices with which the operator controls the level of illumination by using a potentiometer to vary the trigger-

ing angle of a triac or SCR that is wired in series with a lamp. The newest development in electronic light dimmers uses a "touch switch" to control the light—both to turn it on and off, and to select the brightness level.

The heart of the new circuit is the LS7237 monolithic PMOS touch-sensitive light dimmer and switch developed by LSI Computer Systems. The block diagram of the device is in Fig. 1, and a practical circuit using the device is shown in Fig. 2.

The output at pin 8 of the LS7237 is used to trigger a triac. The lamp brightness is, in turn, controlled by varying the output phase angle (triac triggering angle) with respect to the phase and frequency of the AC line.

The output at pin 8 is a low-level pulse of fixed duration (40 to 55 μ s) occurring every half-cycle of the AC line voltage. The phase angle (θ) of that pulse, with respect to the AC line, controls the lamp brightness. The phase angle can be varied by applying a low-level pulse to the SENSOR input (pin 5) or a high-level pulse to the SLAVE input (pin 6). That's done by touching the appropriate sensor plate. (When using the SLAVE input, you can use a mechanical push-button or the electronic switch and sensor plate as shown in Fig. 3).

The relationship between output pulse phase angle, light level, and brightness as a percentage of rated wattage is shown in Table 1. The circuit can be set up to operate in one of three different sequences of brightness by tying the MODE pin (pin 2) to a specific voltage level as shown in Table 2.

When power is first applied, the output comes up in the OFF state. Then each time the sensor plate is touched, the output steps to the next brightness level.

continued on page 116

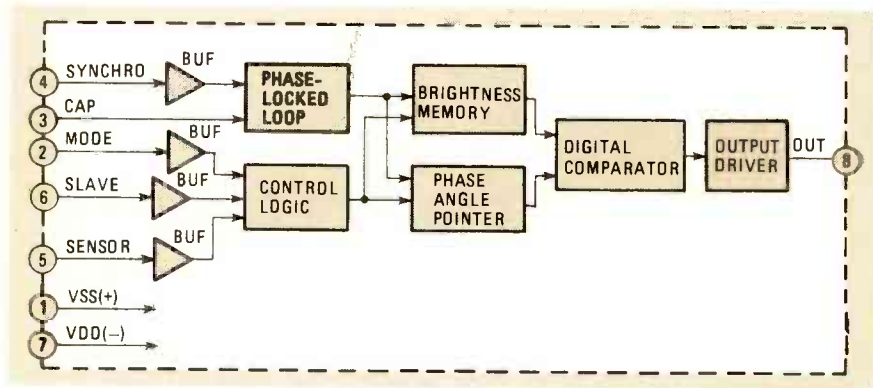

FIG. 1

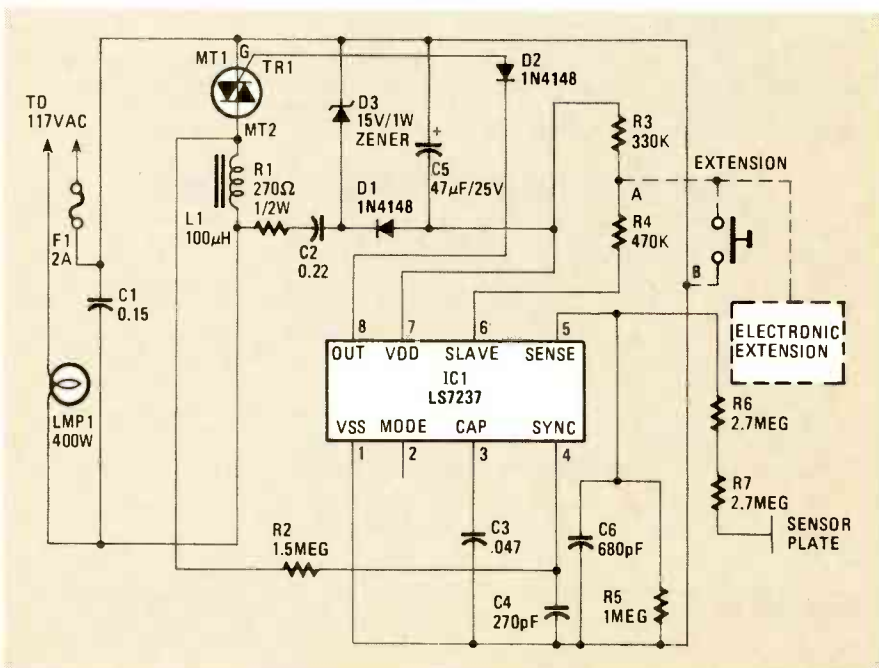

FIG. 2

FREE*

ADVICE

FOR EVERY ELECTRONICS TECHNICIAN!

Get the valuable information you need to keep up to date in today's rapidly changing electronics business with three new and expanded handbooks prepared as a service to the industry by the Consumer Electronics Group of the Electronic Industries Association. See the coupon below for complete ordering information on this "must" reading for electronics technicians.

TELEVISION INTERFERENCE HANDBOOK

Designed by professionals to help technicians identify the source of common television interference. Describes the latest procedures and remedies, including the design of frequency traps, to eliminate these problems.



INTERFERENCE HANDBOOK FOR AUDIO SYSTEMS

Written to assist today's technician identify common audio rectification interference. Outlines the proper methods for installation of circuit traps and modification techniques to eliminate these annoying conditions.

REPLACEMENT PARTS SOURCEBOOK

The definitive guide for ordering replacement parts from over 60 consumer electronics companies across the country...ranging from the relatively small company to industry giants. Ordering procedures are described, with exact names, addresses and phone numbers. Also includes suggested procedures for inventory control of service parts.

Send this coupon with your order to:

EIA/CONSUMER ELECTRONICS GROUP
Dept. PS, Box 19100
Washington, D.C. 20036

* There is a \$1.00 charge to cover postage and handling.

Enclosed is \$1.00 to cover postage and handling for the EIA/CONSUMER ELECTRONICS HANDBOOK(S) checked below.

- Replacement Parts Handbook
- Television Interference Handbook
- Interference Handbook for Audio Systems

Make check or money order payable to Consumer Electronics Group.

Name _____

Company _____

Street _____

City _____ State _____ Zip _____

SERVICE CLINIC



JACK DARR

Resurrecting a dead TV

ONE OF THE MOST COMMON PROBLEMS that a TV serviceman runs into is the dead set—no sound, no video...nothing. Many of us have a habit of thinking that the dead-set condition was a lot easier to correct in the "old days." In a sense, it was. But, if the right approach is taken, the newer sets are no more difficult to repair than the old tube-types were.

Repairing modern TV's

In the old days, a completely dead set usually meant that there was a fault of some kind in the power supply. But, what about the newer solid-state sets? Nothing has changed: When a set quits cold, it almost certain that some important power-supply component has packed it in. (Now, doesn't that sound just like the older ones?)

Of course, you'll find new things in the power supply, like pulse-width modulated circuits, but they're just as easy to service as any other circuit. By using the same testing procedure that you used for tube-type sets, you can find the trouble in no time at all. The only essential thing is to make sure that the horizontal oscillator is running.

Figure 1 is a block diagram of the Switched Mode Power Supply (SMPS) found in the Sylvania C3 color TV. The SMPS processes the horizontal signal for the sweep system, and drives high-voltage stages. It also drives a separate stage that provides all the low DC voltages for operation of the chassis.

In troubleshooting the SMPS, all you need to do is make a few quick

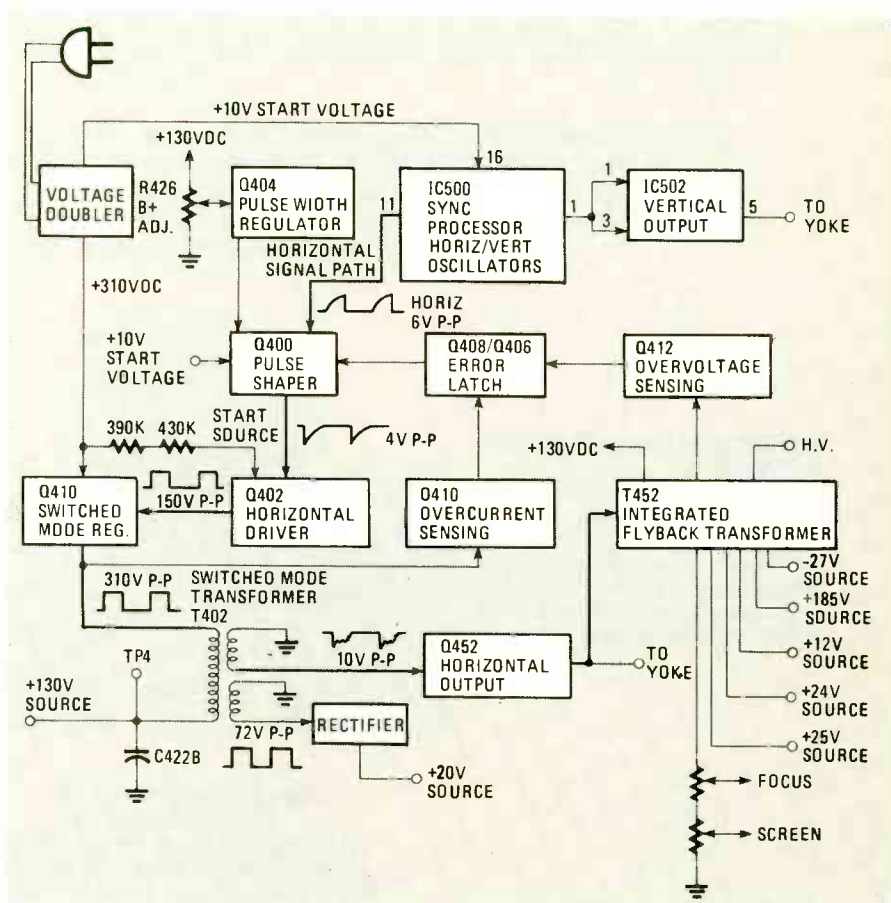

FIG.1

checks to see if the low voltages are present. If they are missing, first find out if the horizontal oscillator is running. (Here is where a scope comes in handy.) A malfunctioning or dead oscillator can cause all kinds of trouble.

The oscillators in pulse-width modulated supplies are usually fed a start voltage that "kicks" the oscillator into action. Once started, it keeps on going until a short pulse is applied to stop its operation. If you find that the oscillator is not doing its job, the problem

may be in the start circuit.

If you're unsure whether the problem is in the oscillator or the start circuit, there are two ways to check. First, you can monitor the start voltage at turn-on. If the pulse is missing, you have to trace it back to its source and find out why.

The other way of determining the cause of the malfunction is to try to start the oscillator with a battery; about 15–20 volts is sufficient. If you don't have a battery of the right voltage handy (which I never

do), a bias box can be used. A bias box is simply a small DC power-supply.

Using the external supply, check to see that the horizontal oscillator starts to run when the proper voltage is applied to it. And be sure that it continues operating after the start voltage is removed. If the oscillator performs properly, your start circuit is *not* working. Although you may find several variations of the start circuit, they are generally not complicated. Some of them simply charge a capacitor, and discharge it across the oscillator to provide the start voltage.

If there is a malfunction in the start circuit, you'll have to make sure that the DC voltages derived directly from the AC line are present. Usually there will be a half-wave or full-wave rectifier along with other components connected directly across the AC line.

In addition, many of the newer sets are not chassis types, so an isolation transformer should always be used.

Dead set causes

Perhaps the most common cause of a dead set is lightning. Solid-state sets are extremely vulnerable to sudden power surges in the AC line. If lightning strikes the power line anywhere within a mile of your home, large instantaneous peaks will be generated in the power supply. That's almost certain to damage transistors and any other solid-state device in the set.

Those surges can blow out several transistors at the same time. So, if you find a shorted transistor in the circuit, there is a good chance that there are several others nearby. Often a shorted component causes the next in the series to go down the tubes. (I think my record is eight at once, but one good jolt of lightning can do a lot more damage than that.)

Also look for signs of arcing around the AC line plug, antenna terminals, etc. If you find any indication of arcing you may be in for a never-ending search for damage of all kinds. But, for-

tunately (for city dwellers, that is) that type of damage is more often found in rural areas. That's because the power lines are in the open and are longer, so they make a much better target for lightning.

One thing that can be done to provide some degree of protection from power-line surges is to put a fast-acting Metal Oxide Varistor (MOV) across the line. By placing an MOV across the AC-line connection on the chassis, fairly-severe power surges can be attenuated before they get into the set.

Also, don't be lulled into thinking that *lightning arresters* stop lightning. Plenty of damage can be done in the few split microseconds before an arrester opens up.

When repairing any electronic device (not just TV's), always check the DC power supply first, since it's the stage where a part is most likely to be damaged. Also, it is a good idea to get used to checking everything: individual stages, components, and even the line cord. R-E

A.W. Sperry Instruments introduces

The 4½ digit DMM with the 3½ digit price.

Another A.W. Sperry Instruments first! Our new **AWS DM-7010** combines the precision of 4½ digit readings with all the most-wanted features you've been looking for. We've even included a built-in frequency counter (up to 200KHz)! With 9 functions and 33 ranges, the **AWS DM-7010's** expanded capability can't be beat!

And that's not all! Included among the special functions built into the **DM-7010's** small, self-contained housing are: conductance, diode test and an instant audible continuity check. The **DM-7010** has a basic DC Volt accuracy of 0.05% and loads of built-in safety features.

You'd expect to pay \$300 or more for an instrument boasting this kind of performance, yet the **AWS DM-7010** can be yours for a low **\$170!** Now there's no need to pay more for the accuracy and quality you need in a DMM.

For more information, call your distributor or A.W. Sperry Instruments, Inc., P.O. Box 9300, Smithtown, N.Y. 11787. **800-645-5398 Toll-Free** (N.Y., Hawaii, Alaska call collect 516-231-7050).

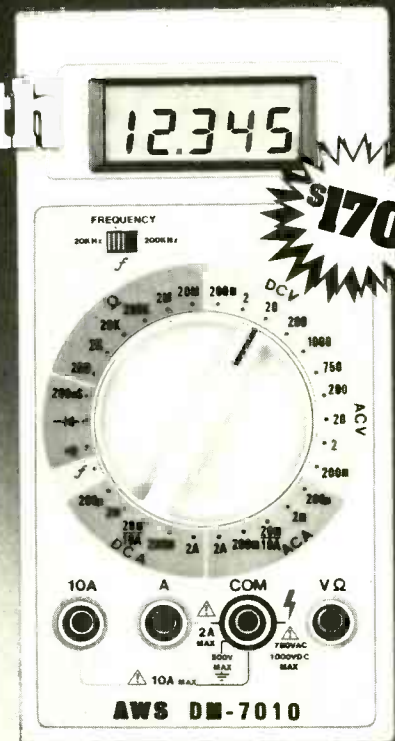

A.W. SPERRY INSTRUMENTS INC.

See Us at EDS '85, Booth D3

CIRCLE 50 ON FREE INFORMATION CARD

STATE OF SOLID STATE

continued from page 112

All input timings for the LS7237 are synchronized with the AC line when this 50/60-Hz source is tied to the SYNCHRO terminal (pin 4) through a suitable lowpass filter network (R2-C4).

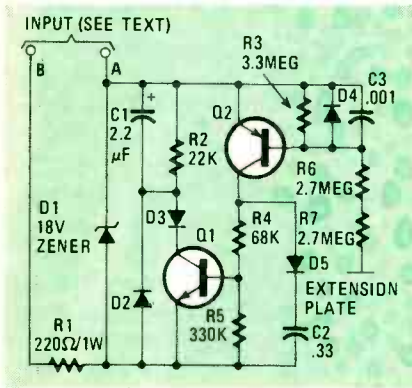

FIG. 3

Low-level negative-going pulses applied to pin 5 of the LS7237—the SENSE input—cause the circuit to step the lamp through the sequences of brightness as determined by the voltage on the MODE terminal. Output stepping occurs on the trailing edges of the input pulses.

The function of pin 6, the SLAVE input, is similar to the SENSE input except that it operates on positive-going pulses instead of negative ones. It is to be used when long extension cables are used between the sensor plate and the dimmer circuit. In such a case, the electronic extension and extension plate circuit, whose schematic is shown in Fig. 3, should be used.

A practical circuit

Let's now return to Fig. 2 and see how the components of the basic circuit function.

- Diode D1, R1, C2, C5, and Zener diode D3 deliver a regulated +15 volts to the V_{SS} terminal of the device.
- Network R2-C4 feeds a filtered 60-Hz signal into the device to synchronize the internal phase-locked loop (PLL) with the line frequency.
- Resistors R3 and R4 limit current in the event that the extension circuit is incorrectly polarized. When

TABLE 1

| Output phase angle (θ) | Brightness levels | Percent rated wattage |
|---------------------------------|-------------------|-----------------------|
| No output | Off | 0 |
| 45° | Night light | 9% |
| 70° | Mood light | 29% |
| 105° | Medium | 66% |
| 159° | Maximum | 99% |

TABLE 2

| Mode | Mode input | Brightness sequence |
|------|------------|------------------------------|
| 0 | V_{SS} | Off—Max—Off |
| 1 | V_{DD} | Off—Mood—Med—Max—Off |
| 2 | Floating | Off—Night Light—Mood—Med—Max |

the extension touch plate is not used, tie pin 6 directly to ground at pin 7.

- Resistor R5 sets the sensitivity of the sensor input. Select a value between 1 megohm and 5 megohms.
- Capacitor C3 is the filter for the internal PLL.
- Diode D2 limits the positive swing of the triac gate to $V_{SS} + 0.5$ volt. That positive swing may occur in some triacs when they are triggered.
- Inductor L1 and C1 form an RF filter to suppress RFI developed by the triac.

The LS7237 IC is available from the manufacturer, **LSI Computer Systems, Inc.**, 1235 Walt Whitman Road, Melville, NY 11741 at \$3.40 each in lots of 1 to 24 pieces. Be sure to add \$5.00 for shipping and handling. New York state residents add sales tax. A data sheet is available from the manufacturer upon request.

Semiconductor data book

The *RF and Power Semiconductors Data Book* from TRW contains over 600 pages of electrical specifications, performance parameters, and photographs of nearly 400 semiconductor devices. The semiconductor devices covered in the data book include Zener and Schottky diodes, microwave transistors, and hybrid amplifiers for CATV and VHF-UHF linear applications. A valuable aid in selecting a suitable device for a particular application. Available from Marketing Services, RF Devices Div., **TRW Electronic Components Group**, 14520 Aviation Blvd., Lawndale, CA 90260. R-E

EQUIPMENT REPORTS

continued from page 42

tion is also built into the unit.

About the only complaint we have with the B23A is its brief documentation. Mirage supplies a short pamphlet that describes how to set up the amplifier, but it treats you as if you were an appliance operator, as opposed to a radio amateur who might want to get inside the piece of equipment and work on it. There is a schematic diagram included, but there is no other technical information available. We only wish that they would include in the manual a section dealing with the theory of the B23A's operation.

Still, the Mirage B23A is a good unit. It has a one-year warranty on the final transistor package and a five-year warranty on the rest of the unit. So if you're an amateur in search of a good amplifier, take a look at the Mirage B23A, you'll like what you see. Oh, by the way, our first B23, which has a very low serial number is still working well after 4½ years. R-E

MOVING?

Don't miss a single copy of **Radio-Electronics**. Give us:

Six weeks' notice

Your old address and zip code

Your new address and zip code

ATTACH LABEL HERE

name (please print)

address

city state zip code

Mail to: Radio-Electronics
SUBSCRIPTION DEPT., P.O. BOX 2520,
BOULDER, COLO. 80322

ROBOT ARM

continued from page 53

To finish assembly of the system, mount the electronic interface in front of the *Armatron* on the base. Connect the motor leads to the interface. Finally, mount the battery packs to the base.

Software for control

The demonstration program, shown in Table 1, was written to direct the computer to move the robot arm automatically—first rotating the entire arm (joint 1), raising the shoulder (joint 2), bending the elbow (joint 3), bending the wrist (joint 4), rotating the wrist (joint 5), and closing the gripper (joint 6). After the robot does those steps, it will do them again—but in reverse. The demonstration program is written in BASIC. Pressing "D" from the keyboard will exercise the joints in sequence. Pressing "J" will result in the computer asking for a joint number from one to six. Pressing "F" or "R" will cause the joint to move forward or reverse respectively. Finally, pressing "S" stops the program.

That program, as well as the other to follow, uses the user port of the VIC-20 at memory location 37136. Since we are not inputting information, we must POKE the number 255 into memory location 37138 (POKE 37138,255). Each joint must be turned on for a different length of time in order to perform the demonstration. Those on-times are stored in arrays DF and DR and can be changed if you desire. Because the order in which the motor controllers were wired to the decoder was different than the order of the joints, a software transformation had to be made as indicated in data statement 3010.

The second program, shown in Table 3, controls the joints through the keyboard. Key "J" will ask for a joint number. Pressing keys "F" or "R" will move a joint forward or reverse as long as the key is being pressed. Pressing "S" will end the program.

PARTS LIST

Resistors

R1-R3—220 ohms, ¼ watt, 10%

Semiconductors

IC1-IC4, IC6-IC9—7404 hex inverter
IC5—74154 4-to-16 line decoder.
LED1-LED3—Standard red LED
Q1-Q12—2N2907

Other components and materials

S1—SPST switch
S2—SPDT switch
M1-M6—DC motors (6 volts)
B1-B11—1.5 volts, "D" cells
Armatron robot

Miscellaneous: Battery holders, motor shafts, IC sockets, breadboard, edge connector for your computer port, etc.

TABLE 1—AUTOMATIC DEMONSTRATION

```

0 REM * AUTOMATIC
  DEMONSTRATION OF ARM JOINT
  MOTIONS *
1 N=10
2 DIM F(6),R(6),L(6)
3 FOR J=1 TO 6:READ F(J):NEXT J
4 FOR J=1 TO 6: READ R(J):NEXT J
5 POKE 37138,255:POKE 37136,0
6 FOR J=1 TO 6:READ L(J):NEXT J
9 INPUT A$:IF A$="D" THEN 100
10 PRINT"INPUT JOINT NUMBER"
11 INPUT J
20 GET A$:IF A$=""THEN 20
21 IF A$="D"THEN 100
25 IF A$="F"THEN
  KF=L(J)*2-1:GOSUB 1000:
  GOTO 20
30 IF A$="R"THEN
  KR=L(J)*2:GOSUB 2000:GOTO 20
35 IF A$="J"THEN 10
40 IF A$="S"THEN END
45 GOTO 20
100 FOR I=1 TO 2
101 FOR J=1 TO 6
105 IF I=2 THEN 120
110 KF=2*L(J)-1:GOSUB 1000
115 GOTO 130
120 KR=2*L(J):GOSUB 2000
130 NEXT J
135 NEXT I
140 GOTO 10
1000 FOR T=1 TO N
1005 POKE 37136,KF
1010 FOR Z=1 TO F(J):NEXT Z
1015 POKE 37136,0
1020 FOR Z=1 TO 1:NEXT Z
1025 NEXT T
1030 RETURN
2000 FOR T=1 TO N
2005 POKE 37136,KR
2010 FOR Z=1 TO R(J):NEXT Z
2015 POKE 37136,0
2020 FOR Z=1 TO 1:NEXT Z
2025 NEXT T
2030 RETURN
3000 DATA 12, 12, 15, 15, 75, 75
3005 DATA 12, 12, 15, 15, 75, 75
3010 DATA 4, 5, 2, 1, 6, 3
  
```

The programs we've showed you so far have moved one joint at a time. However, it is possible to move more than one joint simultaneously. That's of interest to us because we, as humans, move our joints in what is known as *coordinated motion*. You can experiment with different combinations of joints to see what kind of overall motion can be achieved.

The controller circuit we showed you before would be of no use because only one line of the decoder can be active at a time. However, if your computer has an output port with 12 output lines, you can control the motors directly without the decoder. Remember, however, that if both the forward and reverse control lines for a motor go low at the same time, the transistors will be burned out. The circuit shown in Fig. 14 is a simple interface between the computer and motor controller that prevents that from happening.

TABLE 3—KEYBOARD CONTROL

```

0 REM * KEYBOARD CONTROL OF
  ARM JOINT MOTIONS *
1 POKE 37138,255:POKE 37136,0
2 DIM F(6),R(6)
3 FOR J=1 TO 6:READ F(J):NEXT J
4 FOR J=1 TO 6:READ R(J):NEXT J
5 PRINT"INPUT JOINT NUMBER"
10 INPUT J
11 IF J=4 THEN L=1
12 IF J=3 THEN L=2
13 IF J=6 THEN L=3
14 IF J=1 THEN L=4
15 IF J=2 THEN L=5
16 IF J=5 THEN L=6
17 KF=2*L-1:KR=2*L
20 GET A$:IF A$=""THEN 20
25 IF A$="F"THEN GOSUB 1000
26 IF A$="R"THEN GOSUB 2000
30 IF A$="S"THEN END
35 IF A$="J"THEN 5
40 GOTO 20
100 IF PEEK(197)<>42 THEN 111
106 POKE 37136,KF
107 FOR Z=1 TO F(J):NEXT Z
108 POKE 37136,0
109 FOR Z=1 TO 1:NEXT Z
110 GOTO 100
111 POKE 37136,0
115 RETURN
200 IF PEEK(197)<>10 THEN 211
206 POKE 37136,KR
207 FOR Z=1 TO R(J):NEXT Z
208 POKE 37136,0
209 FOR Z=1 TO 1:NEXT Z
210 GOTO 200
211 POKE 37136,0
215 RETURN
300 DATA 7, 7, 15, 15, 75, 75
310 DATA 12, 12, 12, 12, 75, 75
  
```

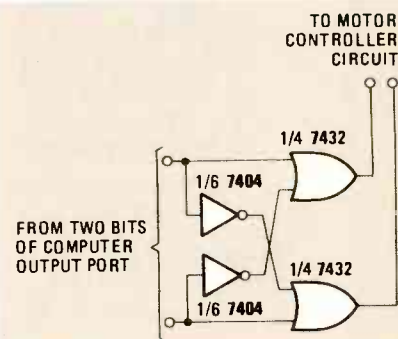

FIG. 14—IF YOUR OUTPUT PORT has enough lines to control the motors, then you can bypass the decoder. This circuit will make sure that you don't burn out your transistors. It should be wired between the output port and the inverters that drive the transistor switches.

Using your robot

When putting your robot to work, keep in mind the following rules that were proposed by Isaac Asimov, in 1950. 1) A robot may not harm a human being or allow a human being to be harmed. 2) A robot must obey the orders given it, unless the orders violate the first rule. 3) A robot must protect itself as long as it does not violate the first and second rules. Keep those rules in mind and have fun with your robot!

R-E

Learn micro-processing with the new
MICRO-PROFESSOR 1P

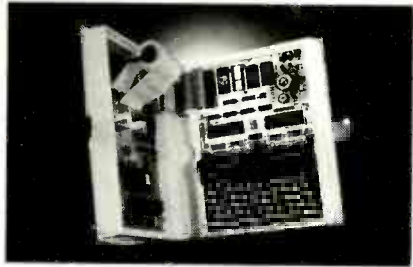

Students, engineers or technicians—
upgrade your micro-processing skills
with the new Micro-Professor 1P.

The MPF-1P features:

- extensive software support
- more built-in memory
- improved keyboard
- larger display

Three tutorial guides help cover all capabilities. The ideal training tool! MPF-1P will deliver you into the growing world of micro-processing. Invest now!

Plus—FREE GIFT Only **\$179.95**

Check this box for FREE
Z-80 Microprocessor
Programming and
Interfacing textbook when
you order within 7 days.
\$12.95 value. (Include
\$5.00 postage &
handling)



Dept. RE0585
14803 N.E. 40th
Redmond, WA 98052

For immediate action call TOLL FREE:

1-800-426-1044

Full money back guarantee.



CIRCLE 111 ON FREE INFORMATION CARD

SEE YOUR DEALER TODAY

FROM



**HERE'S A TIP
THAT'S PERFECT!**

**AM/FM AUTO RADIO
AND CB**

'Firestik' II
GOLDEN SERIES

**BARE-HANDS TUNABLE
"NO TOOLS NEEDED"
HIGH PERFORMANCE ANTENNAS**

ALSO ANTENNAS FOR
CORDLESS TELEPHONES
MONITOR SCANNERS

Dealer & Distributor Inquiries Invited
SEND FOR FREE CATALOG

Firestik® Antenna Company
2614 East Adams/Phoenix, AZ 85034

Name _____

Street _____

City _____

State _____ Zip _____

Serving the CB and
Communications Market Since 1962.

5-YEAR REPLACEMENT WARRANTY

CIRCLE 100 ON FREE INFORMATION CARD

RADIO-ELECTRONICS

CORDLESS PHONES

continued from page 80

narrow down the cause of a failure.

Ring test analysis

The ring test is performed by first inserting the telephone line into the telephone line simulator with ring generator attached (and plugging the cordless telephone power cord into an AC receptacle). Leave the portable unit in standby (on-hook). Next, set the ring generator-voltage to 100 volts RMS. The ringer (buzzer or speaker) on the portable unit of the cordless telephone should sound.

Let's see what that test shows us. In ringing, the 20-Hz ring generator applies a 20-Hz ring signal to the telephone line. The 20-Hz ring detector recognizes it and turns on the base-unit RF transmitter and modulates the RF carrier with a ring signal (typically, a frequency in the 700- to 1500-Hz range). The portable unit receiver detects the RF signal. A narrow-band filter detects the correct ring frequency and feeds an audio tone to the speaker. Many cordless telephones use the same speaker used in voice communication. However, some cordless telephones actually use a separate buzzer. If the telephone rings, all of those circuits are operating.

If the ring test is successful, gradually reduce the ring voltage and note the approximate voltage at which ringing stops. Some cordless telephones may ring with the ring voltage set below 45 volts, which is excellent. Most cordless telephones will stop ringing below about 45 volts, and should be considered normal. If the ringing threshold is higher than 45 volts, some additional troubleshooting checks should be made in the 20-Hz ring detector circuit of the base unit.

Most base units have a CALL button that can be pressed to ring the portable unit without the 20-Hz ring signal applied to the telephone line. If the ring test was not successful, press the CALL button on the base unit and note whether the ringer in the portable unit now sounds. The CALL button normally activates the base-unit RF transmitter and applies ring-signal modulation, causing the portable unit's ringer to sound. In that case, there is no ring signal applied to the telephone line and the ring detector circuit is not used.

If the ringer now sounds, we have isolated the problem to the telephone cord or the 20-Hz ring detector. If the ringer does not sound, we know that the base-unit RF transmitter or portable-unit receiver are probably the cause. The ring test procedure is summarized in Fig. 4. That's all we have room for now. Next time, we'll continue our look at troubleshooting cordless telephones by examining the rest of the operational tests.

R-E

BREATHING

continued from page 56

available spirometer makes use of a popular home computer and gives a printout of normal and measured values for over a dozen parameters. Many spirometers are portable and microprocessor controlled.

Artificial respiration

Electronically controlled respirators are available in most hospitals in this country to assist the breathing of persons who are unable to breathe on their own. Conditions that sometimes make artificial or assisted respiration necessary are head injury, drug overdose, heart failure, severe asthma attacks, pneumonia, chest injury, and anesthesia.

A respirator must provide a controlled volume of air over a reasonable time. Modern respirators allow you to control the volume of air, inspiratory time, expiratory time, maximum allowable pressure, percentage of inspired oxygen in the air, temperature, and humidity.

If the patient is breathing fairly well and just needs a little help, the respirator may "assist" breathing by adding a little extra volume to each breath taken. Or, the respirator may add an occasional deep breath. In other cases, the respirator may need to take over breathing completely.

The device known as the "iron lung" is not used much anymore. It caused inspiration to occur by applying a negative pressure to the outside of the chest wall. Exhalation was caused by the natural recoil force of the lungs when the pressure was returned to normal (normal, in this case, is the local atmospheric pressure). Taking of blood pressure, washing of the skin, and doing anything else that required contact with the body was done during exhalation when the pressure on the body surface was normal. That made any procedure difficult.

In the 1940's and 1950's "positive pressure ventilation" (blowing air into the lungs under pressure) became popular in anesthesia. That development paved the way for modern respiration techniques.

Most respirators in use today are attached to a tube that is inserted through the patient's nose or mouth and into the trachea. Positive pressure is applied to inflate the lungs. The pressure normally returns to normal during exhalation.

Respirators can be set so that the pressure does not drop all the way to atmospheric pressure, but instead returns to some positive pressure during exhalation. That allows more oxygen to be absorbed by the lungs and is called CPAP (Continuous Positive Airway Pressure) or PEEP (Positive End Expiratory Pressure). CPAP and PEEP requires less oxygen to be inspired to achieve a given level of oxygen in the blood.

R-E

POWER METER

continued from page 76

in Fig. 4.

Dry-transfer lettering may be used to mark power levels associated with each LED and give a professionally-finished appearance. It's also a good idea to mark the left and right output and input connectors as well.

Now run a single lead between all ground terminals of the output and input connectors to a ground point on the PC board. The "hot" terminals are connected as shown in Fig. 3.

The convenience outlets are wired together in parallel. The neutral terminals are connected to the green wire of the power cord; under no circumstances should neutral be connected to the PC board or chassis ground. Check the wiring and make sure all diodes, capacitors, and IC's are in the proper place and correctly oriented. Be especially careful about the power connections.

Test and calibration

With the power switch turned off, set S2 to the RUN position and plug in the power cord and turn on the power. LED 21, the protection lamp, should come on for a few seconds and then go out. As the LED goes out, you should hear the relay click as it closes.

Place S2 to the SET position. One left-channel LED should light. Adjusting R25 should change which LED is on. If the unit doesn't operate as expected, remove power immediately. To aid in troubleshooting, nominal operating voltages at various test points through out the circuit are shown in Fig. 1.

The only calibration necessary is done using R24 and R25. Note: For calibration, it is important that you know the continuous power-handling capability of the speakers to be connected; contact the manufacturer for that information.

Set R25 to about mid-range and turn R24 all the way in one direction until the relay opens and LED21 lights. Now rotate R24 all the way in other direction (the relay should close). With S2 still in the SET position, adjust R25 until the LED corresponding to the power handling capability of your speakers just turns on.

Wait several seconds and turn R24 until you hear the relay click open and you see LED21 turn on. Waiting several seconds ensures that the protection circuit turns on *only* after sustained high-power levels and not during large transients. Now set S2 to the RUN position, and the unit is ready for connection to your system.

Using the device

First, determine which speaker-output terminals are common between the left and right channels of your power ampli-

fier (usually the ground terminals). An ohmmeter may be helpful here. Then connect the common terminals of the protection circuit. Caution: The circuit should not be used with any amplifier that cannot accept common connection of the left and right speaker grounds. For most commercial amplifiers that's not a problem; but if you are unsure, consult your owner's manual or the amplifier's manufacturer.

Connect the positive (+) outputs of the amplifier to the left and right inputs on the unit. Occasionally the bottom-most LED on one or the other channel will remain lighted with no input to the speakers. If that happens, first disconnect the amplifier and ground the unit's inputs. If that turns the LED off, there may be a small amount of DC at your amplifier's output terminals.

Should that be the case, have your amplifier serviced immediately to save wear and tear on your speakers. If the LED stays on with the inputs grounded and S2 set to RUN, there may be a problem with Q1, Q2, or any one of diodes D1-D4. Normal variations among inexpensive components may cause that condition; the simplest solution is to replace those components in the affected channel.

While the unit should prevent most forms of speaker damage, *please* do not use it as an excuse to abandon all caution in using your stereo.

R-E

ELECTRONIC SALVAGE PARTS

Below Wholesale

Electronic Prices Slashed!

| | |
|-------------|----------------------|
| Condensors | Resistors |
| Capacitors | Speakers |
| IC's | Yokes |
| Transistors | Antenna Rods |
| Diodes | Fuses |
| Triplers | CATV |
| Controls | and Lots of Goodies! |

You name it, we've got it.
and cheaper

call or write for
free catalogue

E.S.P.

2706 Middle Country Road
Centereach, N.Y. 11720
(516) 467-9852 (800) 645-5030

CIRCLE 269 ON FREE INFORMATION CARD

Radio-Electronics REPRINT BOOKSTORE

- | | |
|--|---|
| <input type="checkbox"/> Build Your Own Satellite TV Receiver \$7.00 | <input type="checkbox"/> Special Projects (Spring 1981) \$4.50 |
| <input type="checkbox"/> 8-Ball Satellite TV Antenna \$5.00 | <input type="checkbox"/> Special Projects #4 (Summer 1982) \$4.50 |
| <input type="checkbox"/> Build Your Own Robot \$12.00 | <input type="checkbox"/> Special Projects #5 (Winter 1983) \$4.00 |
| <input type="checkbox"/> TV Descrambler (January, February 1981) \$3.00 | <input type="checkbox"/> Special Projects #6 (Spring 1983) \$4.00 |
| <input type="checkbox"/> Radio-Electronics back issues (1984) \$3.00 | <input type="checkbox"/> Special Projects #7 (Summer 83) NOT AVAILABLE |
| <input type="checkbox"/> Radio-Electronics back issues (1983) \$3.50 | <input type="checkbox"/> Special Projects #8 (Fall 83) NOT AVAILABLE |
| (January, February 1983 not available) | <input type="checkbox"/> Special Projects #10 (Spring 84) \$4.00 |
| Write in issues desired. | <input type="checkbox"/> Radio-Electronics Annual 1983 \$3.50 |
| <input type="checkbox"/> Radio-Electronics back issues (1982) \$3.50 | <input type="checkbox"/> Radio-Electronics Annual 1984 \$2.50 |
| Write in issues desired. | <input type="checkbox"/> How to Make PC Boards \$2.00 |
| <input type="checkbox"/> Radio-Electronics back issues (1981) \$4.00 | <input type="checkbox"/> All About Kits \$2.00 |
| (Jan., Feb., March, Dec. 1981 not available) | <input type="checkbox"/> Modern Electronics (Vol. 1. #1 \$2.25 |
| Write in issues desired. | April 1908) |
| <input type="checkbox"/> Etch your own PC boards \$3.00 | <input type="checkbox"/> Electro Importing Co. Catalog \$4.95 |
| <input type="checkbox"/> Hands On Electronics #1 \$3.00 | (1918) (176 pp) |
| <input type="checkbox"/> RE Annual '85 \$2.50 | <input type="checkbox"/> Low Frequency Receiving Techniques \$6.00 |
| To order any of the items indicated above, check off the ones | Building and using VLF Antennas |
| you want. Complete the order form below, include your pay- | <input type="checkbox"/> New ideas - 42 circuits for experimenters . \$3.50 |
| ment, check or money order (DO NOT SEND CASH), and mail | |
| to Radio-Electronics, Reprint Department, 200 Park Ave. | |
| South, New York, NY 10003. Please allow 4-6 weeks for | |
| delivery. | |

If you need a copy of an article that is in an issue we indicate is unavailable you can order it directly from us. We charge 50¢ per page. Indicate the issue (month & year), pages and article desired. Include payment in full, plus shipping and handling charge.

ARTICLE

PAGES MONTH YEAR

TOTAL PAGES @ 50¢ each TOTAL PRICE

MAIL TO: **Radio-Electronics**

Reprint Department, 200 Park Ave. South, New York, NY 10003

All payments must be in U.S. funds

| | |
|---|----|
| Total price of order | \$ |
| Sales Tax (New York State Residents only) | \$ |
| Shipping & Handling (U.S. & Canada only) (Includes FIRST CLASS POSTAGE) \$1.00 per item | \$ |
| All other countries (\$2.00 per item, sea mail) | \$ |
| (\$4.00 per item, air mail) | \$ |

Total Enclosed \$

Name _____

Address _____

City _____ State _____ Zip _____

If you thought growing up was tough, try growing up with Cerebral Palsy.

With early intervention and proper treatment, tens of thousands of children with Cerebral Palsy grow up to lead full, productive lives. At United Cerebral Palsy, we're working to give these kids whatever it takes for them to develop to their fullest potential. Braces to help them walk. Therapy to strengthen them. Recreational programs to build spirit.

Making childhood a time of growth, progress and hope is a pretty good cause. But we can't do it alone. Can we count on you?

UNITED CEREBRAL PALSY. Give till it helps.

SUPER LONG PLAY TAPE RECORDERS

10 Hour Model — \$95.00*
14 Hour Model — \$159.00*

Modified Panasonic Slimline. high quality. AC-DC Recorders provide 5 or 7 continuous hours of quality recording & playback on each side of cassette for a total of 10 or 14 hours depending on model. Built-in features include: • Voice level control, • Digital counter, etc. TDK DC 180 Cassette Furnished.

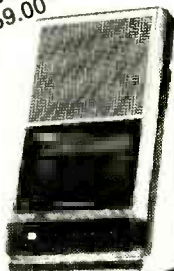

PHONE RECORDING ADAPTER

Records calls automatically. All Solid state connects to your telephone jack and tape recorder. Starts recording when phone is lifted. Stops when you hang up. \$24.50* FCC APPROVED

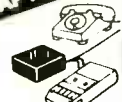

VOX VOICE ACTIVATED CONTROL SWITCH

Solid state. Self contained. Adjustable sensitivity. Voices or other sounds automatically activate and control recorder. Uses either recorder or remote mike. \$24.95*



*Add for ship & hdg. Phone Adapter & Vox \$1.50 ea. Recorders \$4.00 ea. Cal. Res. add tax. Mail order, VISA, M/C, COD's OK. Money Back Guarantee. Qty. disc. avail. Dealer Inquiries invited. Free data. AMC SALES INC. Dept A 9335Lubec St., Box 928, Downey, CA 90421 (213) 869-8519

RADIO-ELECTRONICS

120 CIRCLE 108 ON FREE INFORMATION CARD

DIGITAL IC'S

continued from page 96

is closed, however, the gate input is low.

Figure 18 shows the input/output waveforms for that circuit. From time t_1 to t_5 the switch is closed, so the circuit operates in the inverting mode. Thus, the output pulse is high when the input is high, and low when the input is low. From t_5 to t_9 , however, the switch is open, so the circuit operates in the inverting mode. Here, we see a high output for low inputs and vice-versa.

Figures 19, 20, 21, and 22 show two forms of electronic digital switch and

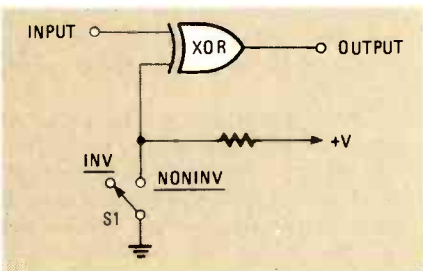

FIG. 17—THE SETTING OF SWITCH S1 determines whether this buffer is inverting or noninverting.

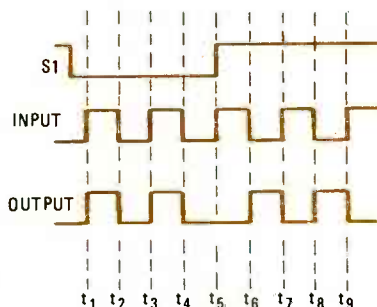

FIG. 18—THE INPUT AND OUTPUT WAVEFORMS for the circuit shown in Fig. 17.

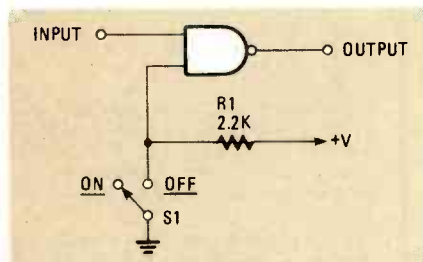

FIG. 19—AS LONG AS S1 is closed, the output of the NAND gate is kept high. When the switch is opened, the circuit acts as a simple inverter.

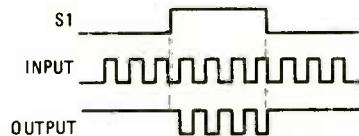

FIG. 20—THESE waveforms show the operation of the circuit shown in Fig. 19.

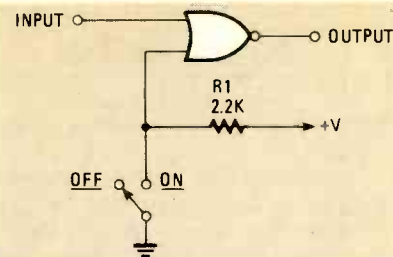

FIG. 21—HERE, when the switch is closed, the output of the circuit is kept low. When it is opened, the circuit acts as a noninverting buffer.

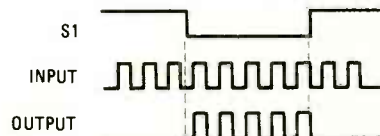

FIG. 22—NOTE THE DIFFERENCE in "polarity" between the output of this NOR-gate circuit, and the NAND-gate circuit of Figs. 19 and 20.

their associated input/output waveforms. The circuit in Fig. 19 is based on the NAND gate and is inverting, while that in Fig. 21 is based on the NOR gate and is noninverting. In both cases, one input of the gate is controlled by a switch, while the other serves as the signal input. In some cases, the switch and pull-up resistor are replaced by a logic level from some other circuit. Thus, our electronic switch can be controlled either manually or digitally.

The inverting circuit shown in Fig. 19 is based on the two-input NAND gate (such as the 7400). One input is connected to a grounding switch and a pull-up resistor. When S1 is closed, the NAND input is kept low so the output is held high. But when S1 is opened, the input is high and the output will follow the signal input in the manner of an inverter. Its operation can be seen by examining the input/output waveforms shown in Fig. 20.

Figure 21 shows a similar circuit using a NOR gate. Note that the "polarity" of the signals is reversed (reflecting the difference between NAND and NOR), but otherwise the operation is similar. The operation of the circuit can be seen by examining the input/output waveforms in Fig. 22.

Next time, we'll turn our attention to how to interface digital circuits to each other, and to the "outside world." R-E



"All right, what wise guy that fed it that sex program."

MARKET CENTER

BUSINESS OPPORTUNITIES

US \$8.00 including disk thousand name brand programs for Apple IBM-PC details, **RELIANT**, P.O. Box 33610, Sheungwan, Hong Kong.

MECHANICALLY inclined individuals desiring ownership of small electronics manufacturing business—without investment. Write: **BUSINESSES**, 92-R, Brighton 11th, Brooklyn, NY 11235.

BIG PROFITS

ELECTRONIC ASSEMBLY BUSINESS

Start home, spare time. Investment knowledge or experience unnecessary. **BIG DEMAND** assembling electronic devices. Sales handled by professionals. Unusual business opportunity.

FREE: Complete illustrated literature
BARTA, RE-O Box 248
Walnut Creek, Calif. 94597

CLASSIFIED AD ORDER FORM

To run your own classified ad, put one word on each of the lines below and send this form along with your check to:

Radio-Electronics Classified Ads, 200 Park Avenue South, N.Y., N.Y. 10003

PLEASE INDICATE in which category of classified advertising you wish your ad to appear. For special headings, there is a surcharge of **\$20.00**.

() Plans/Kits () Business Opportunities () For Sale
() Education/Instruction () Wanted () Satellite Television
()

Special Category: \$20.00

PLEASE PRINT EACH WORD SEPARATELY, IN BLOCK LETTERS.

(No refunds or credits for typesetting errors can be made unless you clearly print or type your copy.) Rates indicated are for standard style classified ads only. See below for additional charges for special ads. **Minimum: 15 words.**

| | | | | |
|--------------|--------------|--------------|--------------|--------------|
| 1 | 2 | 3 | 4 | 5 |
| 6 | 7 | 8 | 9 | 10 |
| 11 | 12 | 13 | 14 | 15 (\$37.50) |
| 16 (\$40.00) | 17 (\$42.50) | 18 (\$45.00) | 19 (\$47.50) | 20 (\$50.00) |
| 21 (\$52.50) | 22 (\$55.00) | 23 (\$57.50) | 24 (\$60.00) | 25 (\$62.50) |
| 26 (\$65.00) | 27 (\$67.50) | 28 (\$70.00) | 29 (\$72.50) | 30 (\$75.00) |
| 31 (\$77.50) | 32 (\$88.00) | 33 (\$82.50) | 34 (\$85.00) | 35 (\$87.50) |

We accept MasterCard and Visa for payment of orders. If you wish to use your credit card to pay for your ad fill in the following additional information (Sorry, no telephone orders can be accepted.):

Card Number

Expiration Date

Signature

IF YOU USE A BOX NUMBER YOU MUST INCLUDE YOUR PERMANENT ADDRESS AND PHONE NUMBER FOR OUR FILES. ADS SUBMITTED WITHOUT THIS INFORMATION WILL NOT BE ACCEPTED.

CLASSIFIED COMMERCIAL RATE: (for firms or individuals offering commercial products or services) \$2.50 per word prepaid (no charge for zip code)...**MINIMUM 15 WORDS.** 5% discount for same ad in 6 issues; 10% discount for same ad in 12 issues within one year; if prepaid. **NON-COMMERCIAL RATE:** (for individuals who want to buy or sell a personal item) \$2.00 per word, prepaid...no minimum. **ONLY FIRST WORD AND NAME** set in bold caps at no extra charge. Additional bold face (not available as all caps) **50¢ per word additional (20% premium).** Entire ad in boldface, **add 20% premium** to total price. **TINT SCREEN BEHIND ENTIRE AD: add 25% premium** to total price. **TINT SCREEN BEHIND ENTIRE AD PLUS ALL BOLD FACE AD: add 45% premium** to total price. **EXPANDED TYPE AD: \$3.75 per word prepaid.** All other items same as for **STANDARD COMMERCIAL RATE.** **TINT SCREEN BEHIND ENTIRE EXPANDED TYPE AD: add 25% premium** to total price. **TINT SCREEN BEHIND ENTIRE EXPANDED TYPE AD PLUS ALL BOLD FACE AD: add 45% premium** to total price. **DISPLAY ADS:** 1" x 2 1/4"—\$270.00; 2" x 2 1/4"—\$540.00; 3" x 2 1/4"—\$810.00. **General information:** Frequency rates and prepayment discounts are available. **ALL COPY SUBJECT TO PUBLISHERS APPROVAL. ADVERTISEMENTS USING P.O. BOX ADDRESS WILL NOT BE ACCEPTED UNTIL ADVERTISER SUPPLIES PUBLISHER WITH PERMANENT ADDRESS AND PHONE NUMBER.** Copy to be in our hands on the 15th of the third month preceding the date of the issue. (i.e., August issue copy must be received by May 15th). When normal closing date falls on Saturday, Sunday or Holiday, issue closes on preceding working day.

PROJECTION TV... Make \$\$\$'s assembling projectors...Easy...Results comparable to \$2,500.00 projectors...Your total cost less than \$20.00... **Plans, 8" lens & dealer's information \$17.50...** Illustrated information free... **MACROCOMA GIX**, Washington Crossing, PA 18977. Creditcard orders 24 hours (215) 736-2880.

BURGLAR alarms—booming business. Get in now. Information package \$2.00, **DYNAMIC SECURITY**, P.O. Box 1456-W, Grand Rapids, MI 49501.

EDUCATION & INSTRUCTION

F.C.C. Commercial General Radiotelephone License. Electronics home study. Fast, inexpensive! "Free" details. **COMMAND**, D-167, Box 2223, San Francisco, CA 94126.

POCKET computer user? Free sample! POCKET COMPUTER NEWSLETTER, Dept. RE, POB 232, Seymour, CT 06483.

FCC license test primer computer program. Learn General Radiotelephone License Q & A's the fun and easy way on the Apple II, IBM and Commodore PC's. Specify make and model, \$34.50. **ACETEST SYSTEMS**, PO Box 266, Savage, MN 55378.

BIG money hitech jobs. Learn electronics drafting. Details free. **GRAYTECH**, Box 924, Belchertown, MA 01007.

LEARN how to use a computer. Train at home in spare time! No previous experience needed! Learn computer programming, computer applications and operations...even computer games. Use hundreds of programs already available or learn to write your own. Experts explain everything in easy-to-understand language with step-by-step directions. Call for free facts! 1-800-862-6262, extension 56 or write **ICS COMPUTER SCHOOL**, Dept. DEC75, Scranton, PA 18515.

ATTENTION ELECTRONIC TECHNICIANS



Highly Effective Home Study BSEE Degree Program for Experienced Electronic Technicians
Our New Advanced Placement Program grants Credit for previous Schooling & Professional Experience. Advance Rapidly! Our 40th Year!
FREE DESCRIPTIVE LITERATURE!
Cook's Institute of Electronics Engineering
P.O. BOX 20345, JACKSON, MS 39209

MASTERCARD AND VISA are now accepted for payment of your advertising. Simply complete the form on the first page of the Market Center and we will bill.

LATEST computer books, Atari, Apple, Commodore, IBM languages, write **HENRY TORRALVO**, Box 46145, Philadelphia, PA 19160.

WANTED

INVENTIONS, ideas, new products wanted! Industry presentation/national exposition. Call free (1-800) 528-6050. Arizona, (1-800) 352-0458. X831.

OLD tubes unused and boxed. Send your stocklist. **TSUTOM YOSHIHARA**, C1-105, Deguchicho-34, Suita, Osaka 564, Japan.

REEL-TO-REEL TAPES

AMPX professional series open reel tape, 1800- or 2400-feet on 7-inch reels, used once. Case of 40, \$45.00. 10 1/2" x 3600 feet and cassettes available. MasterCard/Visa. **VALTECH ELECTRONICS**, Box 6-RE, Richboro, PA 18954 (215) 322-4866.

CABLE TV

DEALERS wanted: Channel 2, 3, and 4 notch filters. Money back guarantee. Send \$15.00 for sample and quantity price list. Specify channel(s). **GARY KURTZ**, P.O. Box 291394, Davie, FL 33329.

FINEST QUALITY SOLDER

SN 60/40 Rosin Core (RA)

| | | |
|-------------------------------------|---------|---|
| One lb. Reels | | |
| 16 swg. (.064) | \$7.95 |  |
| 18 swg. (.048) | \$8.45 | |
| 19 swg. (.040) | \$8.95 | |
| 20 swg. (.036) | \$9.45 | |
| 21 swg. (.032) | \$9.95 | |
| 1/2 lb. Reels | | |
| 22 swg. (.028) | \$5.95 | FREE Freight On All Orders Over \$25 |
| 24 swg. (.022) | \$7.95 | |
| SN 62 (2% Silver) Rosin Core | | Under \$25 add \$2.50 per order. Minimum order \$10. |
| 21 swg. (.031) | \$19.95 | |

FREE Desoldering Wick with each pound of solder

Check Money Order VISA
 MasterCard N.Y. State residents add appropriate sales tax.

SolderCraft™ Call TOLL FREE 800-645-4808
P.O. Box 668 R. Jencho, N.Y. 11753 in NYS (516) 334-2650

PLANS AND KITS

HI-FI speaker kits, auto speaker systems and speaker components from the world's finest manufacturers. For beginners and experts. Free literature. **A & S SPEAKERS**, Box 7462R, Denver, CO 80207 (303) 399-8609.

PROJECTION TV...Convert your TV to project 7 foot picture...Results comparable to \$2,500.00 projectors...Total cost less than \$30.00...Plans and 8" lens \$19.95...Illustrated information free. **MACROCOMA-GI**, Washington Crossing, PA 18977. Creditcard orders 24 hours, (215) 736-3979.

CATALOG: Hobby, radio broadcasting, CB, lowfiers. Transmitters, linears, active antennas, converters, scramblers, bugging devices, more! **PANAXIS**, Box 130-F5, Paradise, CA 95969.

DIGITAL Klock Kit plays 1-of-12 melodies each quarter hour. Displays time, date, and other features. Send \$2.50 for assembly plans and pricing to **KERBER KLOCK KO**, 36117 Hillcrest, Eastlake, OH 44094.

DESCRAMBLER plans. New design decodes gated sync suppressed signals—newest pilotless method. Circuit boards, most parts from Radio Shack. Detailed theory, drawings, schematics, instructions \$14.95 plus \$2.00 shipping. **DIRIJO CORP.**, Box 212, Lowell, NC 28098.

DIGITAL oscilloscope—build for \$200.00. Plans \$5.00. **MIKE MCGLINCHY**, 2280 California, Apt. #12, Mountain View, CA 94040.

QUALITY printed circuit boards. 15 cents sq-in. Free drilling. Quantity discounts, **INTERNATIONAL ENTERPRISE**, 6452 Hazel Circle, Simi Valley, CA 93063.

CABLE-TV Converters: Jerrold, Hamlin, SB-3, AN-3, Mini-Code, Zenith & more. UHF converters: Deluxe II Sine wave kits \$95.00, gated pulse add-on \$70.00. Complete units \$195.00 with gated pulse \$255.00. (Quantity discounts.) Repairs of all converters & cable boxes. Send S.A.S.E. (54 cents postage), or call for info. 1 (312) 637-4408. **HIGGINS ELECTRONICS**, 6014 W. Nelson, Chicago, IL 60634. No Illinois orders accepted.

KITS! Sound effects generator, capacitance meter, C64 drum machine, stereo scratch filter, and more. Semi-assembled and tested. Free literature. **GRAYCO**, 1024 Lancer, San Jose, CA 95129.

TV Stereo Decoder plans—This is not stereo simulation. Circuit actually decodes stereo signals transmitted by station. For additional information, send S.A.S.E. to **SOKOLOWSKI**, P.O. Box 150, Elmont, NY 11003.

TUBES — OVER 2000 TYPES!
DISCOUNT PRICES

Parts, supplies, and literature for tube type radios, including early and hard-to-find tubes.
 Send \$1.00 for 24 page wholesale catalog.

ANTIQUE ELECTRONIC SUPPLY
 1725 W. University • Tempe, Arizona 85281 • (602) 894-9503

EASY to build curve tracer—connects to oscilloscope. Tests components in or out of circuit. Plans \$3.00. **G.J. ENTERPRISES**, P.O. Box 29, Mukwonago, WI 53149.

ROBOTICS—Inexpensive computer control, bare boards, kits, for ZX81, TS1000. **BUDGET ROBOTICS**, Box 18616, Tucson, AZ 85731.

TRIPLE output power supply for under \$50.00. 0-25v, 5v, 12v, all 1 Amp. Send \$9.95 for complete instructions and P.C. board to **CAS ELECTRONICS**, 1559-J Amar Road, Suite 457, West Covina, CA 91792.

800 megahertz converter, easy set-up, commonly available parts used on Scanner PRO 2020, plans \$7.95, send money order to **PAUL DANA**, 381 Woodstock Ave., Staten Island, NY 10301.

SATELLITE TELEVISION

SATELLITE-TV receiver breakthrough! Build your own system and save! Instruction manuals, schematics, circuit boards! Send stamped envelope: **XANDI**, Box 25647, Dept. 21L, Tempe, AZ 85282.

PCB for Satellite Stereo Project in October article is now only \$15.00. **JIM RHODES, INC.**, 1025 Ransome Lane, Kingsport, TN 37660.

SATELLITE Television information service. 104 channel program guide, existing satellites, satellite launchings next few years, basic system theory, recommended dish sizes, LNA's. Send \$2.50 to **SAT/FLORIDA INFO**, 2910 SE 19 Ave., Gainesville, FL 32601.

SATELLITE Locator Program; IBM-PC and compatibles. Aim your dish accurately, diskette, manual: \$15.00. **DMA SYSTEMS**, Box 606, Londonderry NH 03053.

SATELLITE systems \$595.00 up. Information \$1.00. **STARLINK, INC.**, 1122 Park Plaza, Suite 41, Huntsville, AL 35801.

NEW FOR '85
DATA CABLE PRODUCTS

AUGAT **PACKAGED PRODUCTS**

Visit us at **EDS** Booth Nos. A47, A49

The Single Source for Sockets, Alcoswitches, Knobs, Ribbon Cable Products, RDI Terminal Blocks, D-Subs, Edge Cards, Telecon, RS-232 & Co-Axial Cables, Gender Changers, UHF & BNC, Flat Cable, Accessories



1985 Catalogs Available

1985 Catalog features Sockets, Switches, Knobs, Ribbon Cable Products
Data Cable Products Catalog features D-Subs, Edge Cards, Telecon, RS-232 Cables, UHF & BNC, Flat Cable, Accessories
1985 Supplement features RDI Terminal Blocks

GUARANTEED SALE

AUGAT **PACKAGED PRODUCTS**

PREPAID* FREIGHT

Call these TOLL FREE numbers for the name of the distributor or sales rep nearest you.
Nationwide (800) 336-3613 / In Mass. (800) 428-5700
 P.O. Box 659, 40 Perry Avenue, Attleboro, MA 02703
Service Is Our Business No Order Too Small

DISK DRIVE SPECIAL: Remex #RFD 480 5 1/4 In. 2/3 Height. New In Box. 40 Track, DS-DD. Compare At Up To \$159 Ea. Our Price \$59.95 or Two For \$95.00. Limited Qty.

THE NEW ZRT-80
CRT TERMINAL BOARD!

A LOW COST Z-80 BASED SINGLE BOARD THAT ONLY NEEDS AN ASCII KEYBOARD, POWER SUPPLY, AND VIDEO MONITOR TO MAKE A COMPLETE CRT TERMINAL. USE AS A COMPUTER CONSOLE, OR WITH A MODEM FOR USE WITH ANY OF THE PHONE-LINE COMPUTER SERVICES.

FEATURES:

- * Uses a Z80A and 6845 CRT Controller for powerful video capabilities.
- * RS232 at 16 BAUD Rates from 75 to 19,200.
- * 24 x 80 standard format (60 Hz).
- * Optional formats from 24 x 80 (50 Hz) to 64 lines x 96 characters (60 Hz).
- * Higher density formats require up to 3 additional 2K x 8 6116 RAMS.
- * Uses N.S. INS 8250 BAUD Rate Gen. and USART combo IC.
- * 3 Terminal Emulation Modes which are Dip Switch selectable. These include the LSI-ADM3A, the Heath H-19, and the Beehive.
- * Composite or Split Video.
- * Any polarity of video or sync.
- * Inverse Video Capability.
- * Small Size: 6.5 x 9 inches.
- * Upper & lower case with descenders.
- * 7 x 9 Character Matrix.
- * Requires Par. ASCII keyboard.



BLANK PCB WITH 2716 CHAR. ROM, 2732 MON. ROM

\$49⁹⁵

SOURCE DISKETTE - ADD \$10

SET OF 2 CRYSTALS - ADD \$7.50

\$99⁹⁵ (COMPLETE KIT, # ZRT-80 2K VIDEO RAM)

WITH 8 IN. SOURCE DISK! (CP/M COMPATIBLE)

Digital Research Computers

P.O. BOX 461565R • GARLAND, TEXAS 75046 • (214) 225-2309

Call or write for a free catalog on Z-80 or 6809 Single Board Computers, SS-50 Boards, and other S-100 products.

TERMS: Add \$3.00 postage. We pay balance. Orders under \$15 add 75¢ handling. No C.O.D. We accept Visa and MasterCard. Texas Res. add 5-1/8% Tax. Foreign orders (except Canada) add 20% P & H. Orders over \$50 add 85¢ for insurance.

RADIO-ELECTRONICS

ENJOY SATELLITE TV

DO-IT-YOURSELF AND SAVE

Electronic Know-how not required.
Easy to build from our plans or kits.
Lowest prices on satellite electronics.
Send \$1 for catalog or \$8.95 for
"Consumer Guide to Satellite Television."
GFI-D14, Box 9108
Mail today to: **Missoula, MT 59807**



COMPLETE Satellite Systems starting at \$695.00.
For catalogue send \$5.00 to **N.E.S.**, P.O. Box 18175-R, Little Rock, AR 72219.

HOME Satellite Handbook has everything you need to know about Satellite Television. \$10.00, **H&G**, Box 422, Seaford, NY 11783.

SATELLITE television "get the facts before you buy", dish size/installation/programming/much more. For 224 page book & special prices, send \$12.95 to **GALACTIC SATELLITE**, 2769 Ave. 'A', White City, OR 97503. Free information.

WHOLESALE prices! Top brandname satellite products at rockbottom prices. Send for free price list. **VIDEOTECH**, 1107 W. Division, Mt. Vernon, WA 98273. (206) 424-4334.

SATELLITE reception systems at dealer prices. Limited lifetime warranty on dish. Contact: **SATELLITE TV OUTLET INC.** 4747 W. Tuscarawas Street, Canton, OH 44708. (216) 478-0440.

UNSCRAMBLE— Canadian & American satellites. Watch the good stuff. Plans \$19.95—boards & plans \$30.00—units completed \$298.00—kits available—details and order forms \$3.00. **SCRAMCO**, 8688 Royal Drive, Noblesville, IN 46060.

THIS IS A BOLDFACE EXPANDED AD. If you like this format, request it. Your cost is \$3.75 per word, plus 45% for the boldface and tint background.

Govt. SURPLUS ELECTRONIC EQUIPMENT CATALOG

New ITEMS . . . New BARGAINS!
FREE SEND TODAY FOR FREE COPY OF CATALOG WS-85 AND SUPPLEMENT • ADDRESS: DEPT RE

FAIR RADIO SALES
1016 E. EUREKA • Box 1105 • LIMA, OHIO • 45802

DO-IT-YOURSELF TV REPAIR

NEW!...Repair any TV...Easy. Anyone can do it. Write, **RESEARCH**, Rt. 3, Box 601 BR, Colville, WA 99114.

SCANNERS

JOIN 30,000 other scanner owners in the nation's largest not-for-profit association of scanner owners. Bi-monthly publication with tech tips, fascinating true stories, news of new listening adventures. Plus member benefit package including car rental discounts, no-extra-cost insurance coverage, free classified ad service, and more. Send just \$9.75 for 10-month trial membership to: **SCANNER ASSOCIATION OF NORTH AMERICA**, 240-A Fencil Lane, Hillside, IL 60162.

CABLE TV FILTERS

SUPER powered notch filters. Equivalent of cable company "cylinders". Eliminate undesirable signals. Any channel 2 through 8; 14(A) through 22(I). (Please specify.) Send \$20.00 each. **Money back guarantee.** Quantity discounts, **CATV**, Box 17621, Plantation, FL 33318.

CABLE-TV

DEALERS: CALL TODAY FOR INSTANT WHOLESALE PRICE QUOTE!

BONANZA!

| ITEM | PRICE |
|--|--------|
| RCA 36 CHANNEL CONVERTER (CH. 3 OUTPUT ONLY) | 29.95 |
| LCC-58 WIRELESS CONVERTER | 89.95 |
| JERROLD 450 WIRELESS CONVERTER (CH. 3 OUTPUT ONLY) | 105.95 |
| SB ADD-ON UNIT | 109.95 |
| MINICODE (N-12) | 109.95 |
| M-35B (CH. 3 OUTPUT ONLY) | 139.95 |
| MINICODE (N-12) VARISYNC | 119.95 |
| MLD-1200-3 (CALL IF CH. 2 OUTPUT) | 109.95 |
| ZENITH SSAVI CABLE READY | 225.00 |
| INTERFERENCE FILTERS - CH. 3 | 29.95 |
| JERROLD 400/450 REMOTE CONTROLLER | 29.95 |

SPECIFY CHANNEL 2 or 3 OUTPUT

| Quantity | Item | Output Channel | Price Each | TOTAL PRICE |
|----------|------|----------------|------------------------------|-------------|
| | | | | |
| | | | | |
| | | | | |
| | | | | |
| | | | | |
| | | | SUBTOTAL | |
| | | | Shipping Add \$3.00 per unit | |
| | | | COD & Credit Cards — Add 5% | |
| | | | TOTAL | |

Prices subject to change without notice.

PLEASE PRINT

Name _____
Address _____ City _____
State _____ Zip _____ Phone Number (____) _____
 Cashier's Check Money Order COD Visa Mastercard
Acct # _____ Exp. Date _____
Signature _____

FOR OUR RECORDS:

DECLARATION OF AUTHORIZED USE — I, the undersigned, do hereby declare under penalty of perjury that the products purchased will only be used on cable TV systems with proper authorization from local officials or cable company officials in accordance with all applicable federal and state laws.

Dated: _____ Signed: _____

Pacific Cable Company, Inc.

7325½ RESEDA BLVD. • RESEDA, CA 91335

(818) 346-5071 • *No Collect Calls* • (818) 716-5140

IMPORTANT: WHEN CALLING FOR INFORMATION —

Please have the make and model # of the equipment used in your area. *Thank You*

UNLOCK THE POWER OF YOUR TIMEX OR SINCLAIR COMPUTER

We can help you realize your computer's potential without spending a fortune!

Ask about our Floppy Drive Interface

CALL or Write for free catalog to:

Research Service Labs
P O Box 19124 OKC, OK 73144
(405) 745-9322

Phone hrs: 9-9 M,Th 9-5 Tu,W,F

MASTERCARD AND VISA are now accepted for payment of your advertising. Simply complete the form on the first page of the Market Center and we will bill.

INVENTORS!

CAN you profit from your idea? Call us today regarding the marketing of your invention, or write for your free information package. Over a decade of service. **AMERICAN INVENTORS CORPORATION**, 82 Broad Street, Dept. RE, Westfield, MA 01086, (413) 568-3753 (Not an answering service.) A fee based marketing company, offices nationwide.

FCC LICENSE TRAINING

EARN \$600.00+ week! Get your "F.C.C. General Radiotelephone License." Electronics home study. Fast, inexpensive! "Free" details. **COMMAND**, D-168, Box 2223, San Francisco, CA 94126.



WRITE FOR MCGEE'S

SPEAKER & ELECTRONICS CATALOG

1001 BARGAINS IN SPEAKERS

Tel: 1 (816) 842 5092

1901 MCGEE STREET KANSAS CITY, MO. 64108

PRINTED CIRCUIT BOARDS

PRINTED circuit boards. 8" x 10" max. Send us your positive, any size (please specify), thru component side artwork, along with a certified check or money order for \$15.00 & \$3.00 shipping, and we will send you a fiberglass board, with your artwork, the same day. Send us your hole specs, we'll drill it for free. Double sided boards, \$30.00. **EJS LABORATORY**, 11908 Detroit Ave., Cleveland, OH 44107, (216) 529-1611.

PRINTED circuit boards, double sided with plated through holes or single sided. No set up charge. **CAUDILL INC.**, 205 East Westwood Ave., Highpoint, NC 27622, (919) 884-0229.

THIS IS AN EXPANDED TYPE AD. Notice how it stands out on this page. To get your ad set in this type style mark your classified ad order, "Expanded-type ad," and calculate your cost at \$3.75 per word.

EPROM PROGRAMMING

HOBBYISTS: EPROM's sold with your programmer installed. Listing provided. Fast service. Write or call: **ROMULUS MICROCONTROL**, Box 8669, Rockville, MD 20856, (301) 540-8863.

Your ad could be selling merchandise for you in this space. The price is a remarkable \$250. To place your order, call any **Radio-Electronics** salesman: Stan Levitan (212) 777-6400, Marvin Green (818) 986-2001, Ralph Berger (312) 446-1444.

FOR SALE

CABLE-TV Secrets—the outlaw publication the cable companies tried to ban. HBO, Movie Channel, Showtime, descramblers, converters, etc. Suppliers list included. \$8.95. **CABLE FACTS**, Box 711-R, Pataskala, OH 43062.

RESISTORS 1/4W&1/2W 5% 3 cents. 1% metal films, precision custom wirewounds, \$1.00 refundable to: **JR INDUSTRIES**, 5834-B Swancreek, Toledo, OH 43614.

FREE catalog featuring scanner accessories, carrier/subcarrier detectors, voice scramblers, unusual kits. **CAPRI ELECTRONICS**, Route 1R, Canon, GA 30520.

The Intelligence Library—Restricted technical information & books on **electronic surveillance, surveillance-device schematics, lock-picking, investigation, weapons, identification documents, covert sciences**, etc. The best selection available. **Free brochures.** **MENTOR**, (Dept. Z), 135-53 No. Blvd., Flushing, NY 11354.

CABLE television, copy of Federal laws \$10.00. **ROBERTS**, P.O. Box 63/6025, Margate, FL 33063.

DIGITALKER Speech Synthesizer has 136 word vocabulary. Interfaces with parallel port of your computer. PCB and plans \$12.00. **JIM RHODES, INC.**, 1025 Ransome Lane, Kingsport, TN 37660.

WHOLESALE F-59 cable connector \$80.00/1000. Free MATV catalog, S.A.S.E. (212) 897-0509, D&WR, 68-12 110 Street, Flushing, NY 11375.

MICROWAVE TV ANTENNA SYSTEMS

Freq. 2.1 to 2.7 GHz . 34 db Gain +



COMPLETE SYSTEMS:
(as Pictured)

Commercial 40"
Rod Style \$99.95
Parabolic 20"
Dish Style \$79.95

COMPONENTS

Down Converters
(either style) \$34.95
Power Supplies \$24.95
(12V to 16V. DC+)

LIFETIME LIMITED WARRANTY PARTS & LABOR

Data Info (Plans) \$ 9.95

CALL OR WRITE FOR KITS, PARTS, OR MORE INFORMATION

Shipping & Handling Add \$5.00
We Repair Most Types Down Converters & Power Supplies

Phillips-Tech Electronics
P.O. Box 34772
Phoenix, AZ 85087
(602) 947-7700
Special Quantity Pricing Dealers Wanted.



MICRO MART

508 Central Ave
Westfield, N.J. 07090
(201) 654-6008

UHF-TV PREAMP

(As featured in Radio Electronics March/May articles, 1982)

This inexpensive antenna mounted preamp can add more than 25 db of gain to your system. Lots of satisfied customers and repeat orders for this high quality kit, which includes all component parts, PC BD, Case, Power Supply and Balun \$34.50 Assembled Version \$57.50

- DISPLAY/TV/CATIME SET SWITCHES/DATA-4.95
- LIQUID COOLANT/NOISE LEVEL REJECTOR \$41.00
- EMI ESH ANTENNOMIIVE OR ANI EWIIV LEVEL APPLICATIONS. INCLUDES PC BRD. ALL PARTS. 8 INSTRUCTIONS. \$7.95. PROJECT CASE \$2
- POTS: 1 MEG. LINEAR TAPER..... 371.00
- DIP SWITCH- 3 POSITION..... 1071.00
- MOTION DETECTOR BOARDS-82 EACH..... 2710.00
- MOTION DETECTOR IC'S IULNUZ23213/2. 20/810
- BLACK, PLASTIC PROJECT BOX FOR ABOVE-1.95
- EXTENSIVE CONSTRUCTION ARTICLE FOR DET. \$1
- 1,000 PC RESISTOR ASS'T-130 VALUES/124-#3
- 7810B VOLTAGE REGULATORS..... 1071.00
- .22uF 50V MONOLITHICS..... 2071.00
- 4.7uF 40V RADIAL..... 1571.00
- TRIM POTS-POTER PT10W, HDR, 3/8" MIX/MATCH, 100 OHM, 1K, 10K, 25K, 50K, 100K, 200K..... 471.00
- LM1310'S..... 271.00
- CD4047..... 99
- LR5504ULN2272..... 2071.00
- 40K PIN-7 PIN STRIP-300/4.00, 1,000/4.00
- MX5308..... 1071.00
- LED MOUNTING CLIPS/RINGS..... 1371.00
- ZENER DIODES- 20V I.V. GLASS..... 1071.00
- IN4007'S..... 2071.00
- 2EN11M IV REPLACEMENT ICS SPECIAL \$1 EACH
- 221-42, 221-43, 221-45, 221-48, 221-69, 221-79, 221-87, 221-96, 221-104, 221-105, 221-106
- 221-140/INDUSTRY REPLACEMENT#845)..... 4.90
- REPLACEMENT #844(CA3217), 28 PIN IC..... 8.90
- 25C1128/TOSHIBA- HORIZ. OUTPUT..... 1.95
- 3.57954MHz COLOR BURST CRYSTAL..... 1.08
- 2732 EPROM..... 2.75
- TRANSFORMERS- 9.3V ZAMP..... 1.50
- ADJUSTABLE COIL OBBM..... 2.50
- ADJUSTABLE COIL 7-12uH..... 2.50
- 22uG & 27uG WIRE..... 50 1.00
- CHIP CAPS- SET OF 4.2 EACH \$2.743, 39/1.00
- ZENER DIODES- 13V I.V. GLASS..... 1071.00
- BNC T- CONNECTOR (AMPHENOLUG-274)-.95
- MINIATURE GEAR MOTOR/ADDP04..... 271.00
- 5,600uF 25V LYTIC (COMPUTER GRADE) 371.00
- 11F 50V MONOLITHIC..... 1071.00
- 22/44 PIN CONNECTOR FUPH7212-44N1..... 271.00
- LM565. PRIME, HOUSE#850505..... 271.00
- AMHETP10-A.C. AMPERESS..... 4.98
- LM339 (PRIME)..... 85
- LM339 (PRIME)..... 85
- # 20 UHF ANTI-INDOOR POLE MT. OUTDOOR M1
- # 2 INDOOR WALL SPEC. INC HRDWR, RGS9 9.95
- VOLTAGE REGULATORS 170-220V MAY BE POS/NEG
- 20 ADJ. UNWARRANTED YOU TEST/HOBBY \$1

TERMS: MICRO-MART accepts Visa, MC and telephone COD's. Minimum order \$10.00. Shipping—U.S. orders, \$2.00. Canada and other countries \$3.50 (includes ins.) Shipping rate adjusted where applicable. NJ residents add 6% sales tax.

MICRO-CONTROLLER BOARD (Kit/\$119.50)

MICRO-MART • 508 CENTRAL AVE., WESTFIELD, NJ 07090 • (201) 654-6008

MCM ELECTRONICS

WE HAVE WHAT YOU NEED AT
THE PRICES YOU WANT!

CALL TOLL FREE
1-800-543-4330

(IN OHIO: 1-800-762-4315)



TENMAR®
**DROP PROOF
DIGITAL
MULTIMETER**

■ DC Input Impedance 10M ohm
■ Shock-mounted LCD display
■ Overload protection ■ Auto
polarity ■ Backed by our 2-year
limited warranty ■ For more
specifications see MCM catalog
#9, page 124

#72-057 **\$2995**
\$33.80 each (2-up)



TENMAR®
**15 MHz DUAL TRACE
BATTERY OPERATED
OSCILLOSCOPE**

■ Two High Quality 10:1 Probes
Included ■ Backed by our 2-year Limited
Warranty ■ Internal rechargeable batteries
provide 2 hours of continuous operation
without the need for any outside power
source. ■ For specifications see Supplement
#4 of Catalog #9.

#72-335 **\$54995**

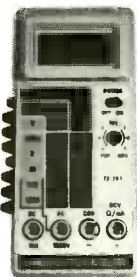

TENMAR®
**3 1/2 DIGIT LDC
MULTIMETER**

■ DC Input Impedance 10M ohm
■ Diode and HFE transistor tests
■ Overload protection ■ Auto
polarity ■ Backed by our 2-year
limited warranty ■ For more
specifications see MCM catalog
#9, page 118

#72-050 **\$3680**
\$39.80 (1-9) (10-up)

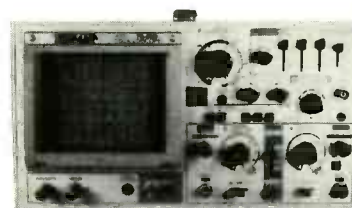

TENMAR®
**35 MHz DUAL TRACE
OSCILLOSCOPE**

■ Two High Quality 10:1 probes included
■ Backed by our 2-year limited warranty
■ For specifications see MCM catalog
#9, page 118

#72-330 **\$56900**



TENMAR®
**DIGITAL
CAPACITANCE
METER**

■ Measures capacitors from 0.1pF
to 1999mFd ■ Accuracy 0.5%
typical ■ Fuse protected
■ Checks capacitors in and out
of circuit ■ Backed by our 2-year
limited warranty ■ For more
specifications see MCM catalog
#9, page 118

#72-040 **\$5495**
\$59.80 each (2-up)

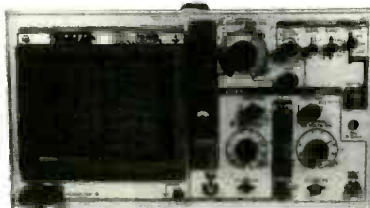

TENMAR®
**20 MHz DUAL TRACE
OSCILLOSCOPE**

■ Two High Quality 10:1 probes included
■ Backed by our 2-year limited warranty
■ For specifications see MCM catalog
#9, page 118

#72-320 **\$38995**

PORT SWITCHES

Eliminates the need to plug and unplug cables when
you need to use a different printer or CRT. Enables
you to easily access one printer from different
computers, or access multiple printers from one
computer with the turn of a switch. Two different
models:

25 pin RS232 female type: Connect up to 4
peripherals to a single I/O port.

36 pin Centronics type: Connect up to 2 printers or
modems to a single port. All 36 conductors are
switched pin for pin.

(no mixed quantities)



#83-600
RS232 type

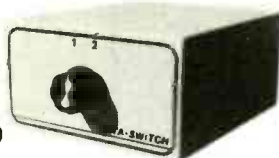

#83-610
36-pin
Centronics type

\$74.80 (1-3)

\$6995
(4-up)

**BE SURE TO CALL
FOR YOUR FREE
132
PAGE
CATALOG!
OVER
5,000
ITEMS!**



We have the Largest
Selection of Original
Japanese Semiconductors
in the Country!

We Also Have... a full line of test equipment,
computer accessories, telephone accessories,
speakers, television parts, flybacks, yokes, switches,
fuses, lamps capacitors, resistors, cartridges, styli,
wire, CATV equipment, and many more. **Over 5,000
items AT THE LOWEST PRICES AROUND!**

Terms:



- \$10 minimum order. \$1.00 charge for orders
under \$10.
- \$20 minimum charge card order.
- Orders shipped UPS C.O.D.
- Most orders shipped within 24 hours.
- Sales office open 8:30 am to 6:00 pm. Saturdays
10:00 am to 3 pm. EST.
- For prepaid orders add \$2.50 for shipping and
handling.
- Should shipping & handling charges exceed \$2.50,
the balance due will be sent C.O.D.



**MCM
ELECTRONICS**
858 East Congress Park Drive
Centerville, Ohio 45459
513-434-0031

SOURCE NO. RE-9

CIRCLE 87 ON FREE INFORMATION CARD



YOUR ELECTRONIC COMPONENTS CENTER

TOLL FREE: 1-800-343-0874

SPRING '85 CATALOG

NAME ADDRESS CITY STATE ZIP CODE

MAIL COUPON TO:

USA: P.O. Box 9100 Westborough, Mass. 01581 CANADA: 5651 Ferner St. Montreal, Quebec H4P 1N1

SERVICE - ORDERS PROCESSED IN 24 HOURS QUALITY - CURRENT DATE CODES • LEADING MFR'S. SAVINGS - VOLUME DISCOUNTS • TOLL FREE NO. SELF SERVE - STORES ARE OPEN AT 8:00 AM

SEMICONDUCTORS • PASSIVE COMPONENTS • DATA BOOKS CRYSTALS • CHEMICALS • POWER SUPPLIES • HARDWARE TEST INSTRUMENTS • BREADBOARDING • SOCKETS • SOLDER SWITCHES • MICROCOMPUTERS • TOOLS • TRANSFORMERS • KITS WIRE & CABLE • HEAT SINKS • RELAYS • FANS • CAPACITORS

7400

74LS

Table with columns: ACT #, Pkg Qty, Pkg Price, ACT #, Pkg Qty, Pkg Price, ACT #, Pkg Qty, Pkg Price, ACT #, Pkg Qty, Pkg Price. Lists various electronic components and their prices.

74S

74F SERIES FAST

Table with columns: ACT #, Pkg Qty, Pkg Price, ACT #, Pkg Qty, Pkg Price, ACT #, Pkg Qty, Pkg Price, ACT #, Pkg Qty, Pkg Price. Lists various electronic components and their prices.

Partial listing only • Call us for your complete requirements

ORDERING INFORMATION Use only the 5 digit ACT # when ordering. Some packages contain multiples other than one. Please note that these multiples will not be broken. Pkg's Quantity is One (1) unless otherwise indicated. Minimum Order \$10.00 Plus \$3.75 Postage & Handling

MAIL ORDERS U.S. P.O. Box 9100 Westborough, Mass. 01581 (617) 366-0200 TOLL FREE 1-800-343-0874 CANADA 5651 Ferner St. Montreal, Quebec H4P 1N1 (514) 731-7444 TOLL FREE 1-800-361-0844

CONVENIENT SELF SERVE ELECTRONIC STORES LOCATED AT: U.S. WESTBOROUGH, Mass. 133 Flanders Rd. (617) 366-9884 BELLEVUE, Wash. 13107 Northrup Way (206) 881-8191 MONTREAL, Quebec 1022 Metcalfe Rd. (416) 977-7692

CANADA DOWNSVIEW 86 St. Rogers Rd. (416) 630-0100 OTTAWA (613) 728-7900 TORONTO 14 Carleton St. (416) 977-7692

VANCOUVER 3212 Kingsway (604) 438-3321 STORES OPEN FROM 8:00 A.M.

THIS IS AN EXPANDED-TYPE AD WITH A TINT SCREEN. See how it jumps out on the page. To order your ad in this format calculate the cost at \$3.75 per word for the expanded-type and add 25% for the tint background.

MASTERCARD AND VISA are now accepted for payment of your advertising. Simply complete the form on the first page of the Market Center and we will bill.

TI-99/4A software/hardware bargains. Hard-to-find items. Huge selection. Fast service. Free catalog. DYNA, Box 690, Hicksville, NY 11801.

TUBES, new, unused. Send self-addressed, stamped envelope for list. FALA ELECTRONICS, Box 1376-2, Milwaukee, WI 53201.

FREE Automotive Security Catalog. Largest selection available. Do-it-yourself pagers, alarms, hood/locks, glass detectors. Allow 4 weeks for delivery, or for rush send \$1.00. AUTOMOTIVE SECURITY EQUIPMENT COMPANY, Dept. 1, P.O. Box 382, Plainville, NY 11803.

INDIVIDUAL photofact folders. No. 1 to no. 1400, \$3.00 postpaid. LBT, 414 Chestnut Lane, East Meadow, NY 11554.

DESCRAMBLERS for downconverters. High gain. Send \$2.00. RB ELECTRONICS, P.O. Box 643, Kalamazoo, MI 49005.

TOKO coil set (four) \$8.00. BFQ85 substitute transistor \$2.00. JIM RHODES, INC., 1025 Ransome Lane, Kingsport, TN 37660.

TOKO coils and printed circuits. Quantity discounts. JIM RHODES, INC., 1025 Ransome Lane, Kingsport, TN 37660.

ELECTRONICS catalog. Over 4,500 items. Parts & components. Everything needed by the hobbyist or technician. \$2.00 postage & handling (States only), refundable with first \$15.00 order. T & M ELECTRONICS, Dept. R, 472 East Main Street, Patchogue, NY 11772, (516) 289-2520.

CORDESS-phone interference? We've got the answer. Have a radar speeding ticket? We can help. Home phone extension in your car. You can have it. 50 page color catalog airmailed \$3.00. DBE, P.O. Drawer G, Waikiki, HI 96815, MC VISA orders (808) 395-7458.

CABLE-TV converters, police radar detectors, and scanners. Send \$1.00 for catalog. GREAT LAKES COMM., INC., 1717 4 Mile Rd. N.E., Grand Rapids, MI 49505.

TRANS-AM ELECTRONICS. Special this month: Keypress Keyboard \$19.95. Power supply plus and minus 12-15 volt 3 amp \$29.95. 2 Digit Display with driver \$2.95. Visa and M/C. 383 Canal, NYC, NY 10013, (212) 226-3893.

WANTED:, Cash for old tubes, speakers, amplifiers. Western Electric, RCA, Cunningham, McIntosh, Marantz, Quad, Tannoy, JBL, Altec, Dynaco, Leak, (713) 728-4343. MAURY, 11122 Atwell, Houston, TX 77096.

DISCOUNT components—unusal items. Free flyer. ELECTRONIX LTD., 3214 South Norton, Sioux Falls, SD 57105.

POLICE descramblers for scanners, telephone devices, etc. Free catalog. KRYSAL KITS, Box 445, Bentonville, AR 72712.

VIDEO Hook-Up Diagram Manual—shows how to hook-up TV, VCR, satellite, stereos, multi-sets. \$6.00. NORTHSTAR VIDEO SERVICES, Dept. R, P.O. Box 1992, Hollywood, FL 33020.

UHF descrambler, gated and sinewave. Lowest price semikit. Free information. VISTA, 717 Front St., Lisle, IL 60532.

Your ad could be selling merchandise for you in this space. The price is a remarkable \$250. To place your order, call any Radio-Electronics salesman: Stan Levitan (212) 777-6400, Marvin Green (818) 986-2001, Ralph Berger (312) 446-1444.

Radio Shack Parts Place[®]

The Store for Builders. Over 1000 Items in Stock!

Power Transformers 120 VAC Primaries

| Type | Volts | Current | Cat. No. | Each |
|------------|---------|---------|----------|------|
| Miniature | 6.3 | 300 mA | 273-1384 | 2.59 |
| Miniature | 12.6 | 300 mA | 273-1385 | 2.79 |
| Miniature | 25.2 | 300 mA | 273-1386 | 3.49 |
| Miniature | 12.6 CT | 450 mA | 273-1365 | 3.59 |
| Miniature | 25.2 CT | 450 mA | 273-1366 | 3.99 |
| Standard | 6.3 | 1.2 A | 273-1351 | 3.99 |
| Standard | 12.6 CT | 1.2 A | 273-1352 | 4.99 |
| Standard | 25.2 | 1.2 A | 273-1353 | 5.99 |
| Heavy-Duty | 12.6 CT | 3.0 A | 273-1511 | 5.99 |
| Heavy-Duty | 25.2 CT | 2.0 A | 273-1512 | 6.29 |
| Heavy-Duty | 18.0 CT | 2.0 A | 273-1515 | 6.99 |

CT = Center Tap

1/4-Watt, 5% Resistors

Pkg. of 5 **39¢**

| Ohms | Cat. No. | Ohms | Cat. No. |
|------|----------|--------|----------|
| 10 | 271-1301 | 10k | 271-1335 |
| 100 | 271-1311 | 15k | 271-1337 |
| 150 | 271-1312 | 22k | 271-1339 |
| 220 | 271-1313 | 27k | 271-1340 |
| 270 | 271-1314 | 33k | 271-1341 |
| 330 | 271-1315 | 47k | 271-1342 |
| 470 | 271-1317 | 68k | 271-1345 |
| 1k | 271-1321 | 100k | 271-1347 |
| 1.8k | 271-1324 | 220k | 271-1350 |
| 2.2k | 271-1325 | 470k | 271-1354 |
| 3.3k | 271-1328 | 1 meg | 271-1356 |
| 4.7k | 271-1330 | 10 meg | 271-1365 |
| 6.8k | 271-1333 | | |

Axial-Lead Electrolytic Capacitors

- Factory-Fresh
- Highest Quality

| μF | WVDC | Cat. No. | Each |
|------|------|----------|------|
| 4.7 | 35 | 272-1012 | .49 |
| 10 | 35 | 272-1013 | .59 |
| 22 | 35 | 272-1014 | .69 |
| 47 | 35 | 272-1015 | .69 |
| 100 | 35 | 272-1016 | .79 |
| 220 | 35 | 272-1017 | .89 |
| 470 | 35 | 272-1018 | .99 |
| 1000 | 35 | 272-1019 | 1.59 |
| 2200 | 35 | 272-1020 | 2.49 |
| 4700 | 35 | 272-1022 | 3.59 |

MOV Transient Protectors

Protect computers and sensitive electronics from damaging power-line "spikes".

| Power Diss. | Cat. No. | Each |
|-------------|----------|------|
| 600 mW | 276-570 | 1.59 |
| 1 watt | 276-568 | 1.69 |

Heavy-Duty Relays

Contacts Rated **549**
10 Amps at
125 VAC
Each

DPDT. For plug-in use or soldering. Size: 1^{5/8} x 1 x ^{3/4}".

| Coil | Cat. No. |
|-------------------|----------|
| 12 VDC, 160-Ohm | 275-218 |
| 120 VAC, 4500-Ohm | 275-217 |

Socket for Above. 275-220 . . . 1.49

Replacement Transistors

| Type | Cat. No. | Each |
|----------|----------|---------------|
| 2N1305 | PNP | 276-2007 1.19 |
| MPS2222A | NPN | 276-2009 .79 |
| PN2484 | NPN | 276-2010 .89 |
| MPS3904 | NPN | 276-2016 .69 |
| TIP31 | NPN | 276-2017 .99 |
| TIP3055 | NPN | 276-2020 1.59 |
| MPS2907 | PNP | 276-2023 .79 |
| MJE34 | PNP | 276-2027 1.49 |
| 2N3053 | NPN | 276-2030 .99 |
| MPS3638 | PNP | 276-2032 .79 |
| TIP120 | NPN | 276-2068 1.29 |
| 2N3055 | NPN | 276-2041 1.99 |
| MJ2955 | PNP | 276-2043 2.19 |
| 2N4401 | NPN | 276-2058 .59 |
| MPSA42 | NPN | 276-2061 .69 |
| 2N3819 | N-FET | 276-2035 .99 |
| MPF102 | N-FET | 276-2062 .99 |
| IRF511 | V-FET | 276-2072 2.59 |
| IRFD123 | V-FET | 276-2073 1.49 |
| 2SC1308 | NPN | 276-2055 7.95 |

Semiconductor Reference Guide

349

1985 Edition. Exclusive substitution section lists over 80,000 semiconductor types and their low-cost Radio Shack equivalents. Plus data on Archer[®] ICs, SCRs, LEDs diodes and more. Over 200 pages. 276-4008 3.49



VisiCalc for Your TRS-80

NEW! 9⁹⁵

This new book helps you take advantage of the time-saving features of VisiCalc. Over 150 illustrations show the VisiCalc screen at every step. You'll learn the program's commands, how to set up a spreadsheet, and how to use VisiCalc's powerful recalculation features to get instant answers to "what if" questions. 249 pages. 62-2315 9.95



4000-Series CMOS ICs

With Pin-Out and Specs

| Type | Cat. No. | Each |
|------|----------|------|
| 4001 | 276-2401 | .99 |
| 4011 | 276-2411 | .99 |
| 4013 | 276-2413 | 1.19 |
| 4017 | 276-2417 | 1.49 |
| 4049 | 276-2449 | 1.19 |
| 4066 | 276-2466 | 1.19 |

TTL Digital ICs

With Pin-Out and Specs

| Type | Cat. No. | Each |
|------|----------|------|
| 7400 | 276-1801 | .89 |
| 7404 | 276-1802 | .99 |
| 7408 | 276-1822 | 1.29 |
| 7447 | 276-1805 | 1.59 |
| 7490 | 276-1808 | 1.09 |

Operational Amplifiers

| Type | Cat. No. | Each |
|--------|-------------------|------|
| 741 | (Single) 276-007 | .89 |
| MC1458 | (Dual) 276-038 | .99 |
| LM324 | (Quad) 276-1711 | 1.29 |
| TL082 | (Dual) 276-1715 | 1.89 |
| LM339 | (Quad) 276-1712 | 1.49 |
| TLC271 | (Single) 276-1748 | 1.59 |
| TLC272 | (Dual) 276-1749 | 2.19 |
| TLC274 | (Quad) 276-1750 | 2.99 |

SPO256-AL2 Voice Synthesizer IC. Uses a program stored in its built-in 16K ROM to synthesize natural sounding speech. Easy to interface with most computers. 28-pin DIP with detailed data. Requires external components, not incl. 276-1784 12.95

16K Dynamic RAM 8-Pack SPECIAL PURCHASE!

Pkg. of 8 **7⁹⁵**

4116. Highest quality and factory-fresh. 250 ns access. Why gamble with (and wait for) mail-order RAMs? Upgrade your computer now at huge savings! 276-2503 8/7.95

SPECIAL PURCHASE! Continuity Tester Chassis



Circuit continuity produces a warbling tone. Possible uses: doorbell, security alarm, moisture sensor, capacitor/diode checker and more. Great experimenter's item at a bargain price! 9V battery extra. 277-1014 1.95

Computer Keyboard With Schematic



Made for TI 99/4 computer. Very high quality unencoded QWERTY board has 48 full-stroke keys, 15-pin connector. Hurry! #277-1017 2.95

Fold-Up Autoranging LCD Multimeter

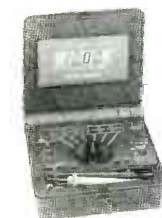

79⁹⁵

Our Best!
The DVM
That "Thinks"

You choose the function and it selects the correct range and polarity for you. Features a jumbo 1^{1/16}" display. "Beep" continuity function and diode/semiconductor junction test. Handy pushbutton ohms zero adjust. Automatic power-off conserves batteries. With leads, manual. Batteries extra. 22-193 79.95

Over 1000 items in stock: Binding posts, Books, Breadboards, Buzzers, Capacitors, Chokes, Clips, Connectors, Fuses, Hardware, ICs, Jacks, Knobs, Lamps, Multimeters, PC Boards, Plugs, Rectifiers, Relays, Resistors, Switches, Tools, Transformers, Transistors, Wire, Zener Diodes, and more!

Radio Shack

A DIVISION OF TANDY CORPORATION

Prices apply at participating Radio Shack stores and dealers

Do Kay

COMPUTER PRODUCTS, Inc.

APPLE ACCESSORIES

80 Column Apple II+ ... 149.95
 80 Column Apple IIE ... 129.95
 Z80 Apple II+ 89.00
 Z80 Apple IIE 89.00
 16K Card 39.95
 Cooling Fan 38.95
 Power Supply 74.95
 Joystick 29.95
 RF Modulator 13.95
 Disk Drive 199.00
 Controller Card 59.95
 Paddles 7.95

Reg. Power Supply Model 4A/PS (99/4)

3 DC Outputs:

12V @ .4A, +5V @ 1.1A
 -5V @ .2A Highly Filtered

6.95



MEMORY EXPANSION KIT



4164 150ns
 9 for \$29.97

ORDER TOLL FREE

(800)
 538-8800

(CALIFORNIA RESIDENTS)

(800)
 848-8008



Telex: 756440

VISIT OUR RETAIL STORE

2100 De La Cruz Blvd.
 Santa Clara, CA 95050
 (408) 988-0697

CB MODIFICATIONS

Increase channels, range, privacy! We specialize in frequency expanders, speech processors, FM converters, PLL & slider tricks, how-to books, plans, kits. Expert mail-in repairs & conversions. 16-page catalog \$2.

CBC INTERNATIONAL, P.O. BOX 31500RE,
 PHOENIX, AZ 85046 (602) 996-8700

CABLE CONVERTERS & DESCRAMBLERS

HAMLIN OAK JERROLD SCIENTIFIC SYLVANIA ZENITH

ALL TYPES OF CABLE TV EQUIPMENT
 MICROWAVE ANTENNAS & ACCESSORIES

— FREE ILLUSTRATED BROCHURE —

— CALL OR WRITE —
 H.M.R. SALES
 221 E. CAMELBACK # 1
 PHOENIX, AZ 85012
 (602) 993-0398



TUBES \$2.49. Large inventory including rare types. S.A.S.E. brings lists. **ADNF**, 6690 7 Mile, S. Lyon, MI 48178.

CABLE-TV, converters, & VCR's. Unlock the mystery of recording one channel while watching another. \$4.95/diagrams instructions: **ADDITIONAL OUTLET CORP.**, 1041 W. Commercial Blvd., Ft. Lauderdale, FL 33309.

EPROM programming, low rates. Details: **RICHARD ASHLAW**, Rt. 1, Box 163, St. Regis Fls, NY 12980.

PC-2 & Sharp PC-1500 owners: floppy disk emulator for your cassette files. **A/MP**, Box 78533, L.A., CA 90016.

SCIENTIFIC Atlanta new descrambler for 8500 series boxes. Receive all channels, send \$2.00. **A.T.S.**, Box 316, Auburn, MA 01501. (617) 832-2339.

TUBES, hard-to-find. Send self-addressed stamped envelope for list. **AUDIO VIDEO STOP**, 7477 Village Parkway, Dublin, CA 94568.

CABLE and Subscription-TV secret manual. Build your own descramblers, converters—HBO, Showtime, Movie Channel, UHF, latest theory, schematics, instructions, suppliers. Send \$8.95 to **CABLETRONICS**, Box 30502R, Bethesda, MD 20814.

CABLE-TV products. Jerrold, Hamlin, and Oak converters. Send \$3.00 for information. **ADDITIONAL OUTLET CORP.**, 1041 W. Commercial Blvd., Ft. Lauderdale, FL 33309.

FREE IC when you order our catalog for \$1.00, to the first 1,000 requests. Check these prices: 74LS 164 - 50 cents, 7400 - 13 cents, 74LS 145 - 48 cents, 7408 - 14 cents, 7415 - 45 cents, 74LS 279 - 16 cents, 7447 - 23 cents, CD40105BE - \$1.00 + postage & handling. Limited quantities. All IC's are new. **COMPUTER REPAIRS**, 246 W. Garfield, Freeport, IL 61032.

BELDEN RG6/U coaxial cable, #9058. This is the best, Duobond II/Braid/Duobond Plus. Normally available in 1000 ft. rolls only. Three incredible shields. Foil over foam core gives 100% shielding. 77% aluminum braid. Foil wrapped over the two inner shields (Duobond Plus). 100 ft. \$24.00, 200 ft. or more 10% discount. Crimp Connectors for RG6/U cable with attached 1/2" crimp ring, (with purchase of cable only). 10 for \$3.00, 50 for \$9.00, 100 for \$15.00, check or money order. Postpaid. (609) 877-7480. **DANIELSON ELECTRONICS**, 6 Garnet Lane, Willingboro, NJ 08046.

TECHNICA 140/channel cable converter fully remote sound and video unit only \$149.00. Jerrold LCC 58 converter only \$79.00, Jerrold DRZ 450 converter 90/channel auto tuning only \$89.00. All units carry full manufacturers warranty, specials while they last. For catalogue send \$3.00. Thanks. **REDCOAT ELECTRONICS**, P.O. Box 28504, Jamaica, NY 11428, (718) 459-5088.

FREE catalog. Electronic electrical parts, tools, controls, switches, relays, tech books, manuals. **JS CHRISTIANSON INC.**, 120 Oser Ave., Hauppauge, NY 11788.

CANADIANS. Pay-TV and Satellite Descrambling Manual. Technical. Covers all areas. Complete with schematics and sources. 54 pages \$11.95. **SHO-JIKI ELECTRONICS CORP.** 1327 Niagara St., Niagara Falls, NY 14303. COD's call (716) 282-1001.

THE BEST PLACE to BUY, SELL or TRADE NEW and USED EQUIPMENT
NUTS & VOLTS MAGAZINE
 BOX 1111-E • PLACENTIA, CA 92670
 (714) 632-7721
 Join Thousands of Readers Nationwide Every Month
ONE YEAR U.S. SUBSCRIPTIONS
 \$10.00 - 3rd Class • \$15.00 - 1st Class
 \$35.00 - Lifetime - 3rd Class

NUTS & VOLTS
 HMM GEAR
 COMPUTERS
 SOFTWARE
 SCANNERS • OPTICS
 TEST EQUIPMENT
 MICROWAVE
 SATELLITE
 AUDIO VISUAL
 NEW PRODUCTS
 COMPONENTS • KITS
 ANTIQUE ELECT.
 PUBLICATIONS
 PLANS • SERVICES

NEW...Convert any portable television into a giant five foot picture screen. Guaranteed. Only \$24.50. **QUEEN ENTERPRISES**, P.O. Box 159, Toronto, Ontario M6M 4Z2.

TELEVISION-circuit panels, tuners, transformers, tubes, speakers. Free list. Quality used electronics parts. Low low prices. **RANDYS RADIO**, Rt. 1, Arcadia, IA 51430.

CIRCUIT boards; best rates, prototype-production. **RYLE ENG.**, 15466 Los Gatos Blvd. No. 109-191, Los Gatos, CA 95030. (408) 736-0800.

FISH-caller, solid state, call and gather any kind of fish: sea and river. Working set - \$45.00 postpaid or \$5.00, plans and information. **JOHDIC TAKANO**, P.O. Box SM 160, Manila, Philippines 2806.

COLOR monitor RGB 14" distributor closeout originally sold for \$599.00 now \$169.00 delivered, IBM-PC and Apple III compatible with mod. card and cable additional \$29.95. Brochure on request. **UDO CORPORATION**, 282 Main Street, Salem N.H. 03079.













BURGLAR alarm warning stickers deter burglars and vandalism. Bright red stating warning alarm system electronically protected. 5(five) for \$3.00, **HIGH TECH INSTALLATIONS**, 442 Adams Street, Freeland, PA 18224.

Don't let your lungs go to pot.





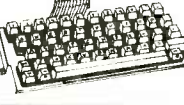
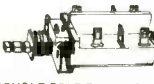





AMERICAN LUNG ASSOCIATION
 The Christmas Seal People®

Space contributed by the publisher as a public service

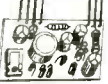
WE HAVE QUALITY PARTS, DISCOUNT PRICES AND FAST SHIPPING!

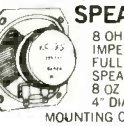
| | | | | |
|--|---|--|--|--|
| TRANSFORMERS  120 volt primaries 5.6 VOLTS @ 750 MA \$3.00 6 VOLTS @ 150 MA \$1.25 12 VCT @ 200 MA \$2.00 18 V @ 650 MA \$3.50 18 VOLTS @ 1 AMP \$4.50 24 VOLTS @ 250 MA \$2.50 24 VCT @ 1 AMP \$4.50 | LINE CORDS  TWO WIRE 6' 18ga TWO WIRE 3 FOR \$1.00 THREE WIRE 8 FOOT 18ga THREE WIRE \$2.00 EACH | MIKE CONNECTOR  5 CONDUCTOR IN-LINE PLUG AND CHASSIS MOUNT JACK. TWIST LOCK STYLE, SAME AS SWITCHCRAFT 12CL5M. \$2.50 PER SET | 7 CONDUCTOR RIBBON CABLE  SPECTRA-STRIP RED MARKER STRIP. 28 GA STRANDED WIRE. \$5.00 PER ROLL (100 FT.) | REVERBERATION UNIT  ACCUTRONICS COIL SPRING TYPE UNITS. USED IN ELECTRONIC ORGANS TO PROVIDE ACOUSTIC DELAY SOUND EFFECTS. INPUT IMPEDANCE 8 OHMS. OUTPUT IMPEDANCE 2250 OHMS. 4 1/2" x 16 1/4" x 1 1/2". \$7.50 EACH |
| WALL TRANSFORMER ALL ARE 115 VAC PLUG IN  4 VDC @ 70 MA \$2.00 9 VAC @ 1 AMP \$3.00 12.5 VAC @ 265 MA \$2.50 17 VAC @ 500 MA \$4.00 24 VAC @ 250 MA \$3.00 | MULTI-SWITCHES 3 STATION NON-INTERLOCKING 3 - 2PDT SWITCHES EACH OPERATES INDEPENDENTLY. 1 1/4" BETWEEN MOUNTING CENTERS. \$1.75 EACH 5 STATION INTERLOCKING MADE BY ALPS 3 - 2PDT AND 2 - 6PDT SWITCHES ON FULLY INTERLOCKING ASSEMBLY. 3/4" BETWEEN MOUNTING CENTERS. \$2.50 EACH | METER 0 - 15 V.D.C.  THIS 2-1/4" SQUARE METER MEASURES 0-15 VDC. \$4.50 EACH | 2K 10 TURN MULTI-TURN POT SPECTROL #MOD 534-7161 \$5.00 EACH | SOUND AND VIDEO MODULATOR FOR T.I. COMPUTER  T.I. # UM1381-1. DESIGNED FOR USE WITH T.I. COMPUTERS. CAN BE USED WITH VIDEO SOURCES. BUILT IN 4/5 SWITCH CHANNEL 3 OR 4 SELECTION SWITCH. OPERATES ON 12 VDC. HOOK UP DIAGRAM INCLUDED. \$10.00 EACH |
| SPRING LEVER TERMINALS TWO COLOR CODED TERMINALS ON A STURDY 2 3/4" x 3 3/4" BAKELITE PLATE. GREAT FOR SPEAKER ENCLOSURES OR POWER SUPPLIES.  \$1.00 EACH 10 FOR \$9.00 | 5 STATION NON-INTERLOCKING SAME AS ABOVE, EXCEPT EACH SWITCH OPERATES INDEPENDENTLY. \$2.50 EACH | SUB-MINIATURE D TYPE CONNECTOR  SOLDER TYPE SUB-MINIATURE CONNECTORS USED FOR COMPUTER HOOK UPS. DB-15 PLUG \$2.75 DB-15 SOCKET \$4.00 DB-15 HOOD \$1.50 DB-25 PLUG \$2.75 DB-25 SOCKET \$3.50 DB-25 HOOD \$1.25 | ROTARY SWITCH 1 POLE 6 POSITION  1 1/4" DIA x 1 1/2" HIGH 75¢ EACH 10 for \$6.00 | 48 KEY ASSEMBLY FOR T.I. COMPUTER  NEW TEXAS INSTRUMENTS KEYBOARD. UNENCODED. 48 S.P.S.T. MECHANICAL SWITCHES. TERMINATES TO 15 PIN CONNECTOR. SOLID METAL FRAME 4" x 9". \$6.50 EACH 2 FOR \$11.00 |
| TI SWITCHING POWER SUPPLY TI # 1053214-2 COMPACT, WELL-REGULATED SWITCHING POWER SUPPLY DESIGNED TO POWER TEXAS INSTRUMENTS COMPUTER EQUIPMENT. INPUT: 14VAC-25 VAC AT 1A OUTPUT: +12VDC AT 350MA + 5VDC AT 1.2A -5VDC AT 200MA SIZE: 4 3/4" x 4 3/4" x 1 3/4" \$5.00 EACH | "PARALLEL" PRINTER CONNECTOR  SOLDER STYLE 36 PIN MALE USED ON "PARALLEL" DATA CABLES. \$5.50 EACH | PUSHBUTTON POWER SWITCH  DOUBLE POLE POWER SWITCH PUSH-ON, PUSH-OFF. \$1.00 EACH | EDGE CONNECTORS ALL ARE .156" SPACING 10 PIN EDGE CONNECTOR TRW #50-10-A-20 \$2.00 EACH | 120V INDICATOR  NEON INDICATOR. RATED 120 V 1/3 W. MOUNTS IN 5/16" HOLE. . . RED LENS 75¢ EACH 10 FOR \$7.00 100 FOR \$65.00 GEL CELL BATTERY  12 VDC @ 1.2 AMP HOUR 4" x 1 1/2" x 2 1/8" \$15.00 EACH |

FREE! → **SEND FOR** **NEW 1985** **48 PAGE CATALOG** ← **FREE!**

| | | | | | |
|--|---|---|---|---|---|
| 13.8 VOLT REGULATED POWER SUPPLY THESE ARE SOLID STATE FULLY REGULATED 13.8 VDC POWER SUPPLIES. ALL FEATURE 100% SOLID STATE CONSTRUCTION, FUSE PROTECTION, L.E.D. POWER INDICATOR 2 AMP CONSTANT, 4 AMP SURGE. UL LISTED \$18.00 EACH  | RELAYS SOLID STATE RELAY HEINEMANN ELECTRIC #101-5A 140-5 AMP CONTROL. 3-32VDC LOAD. 140VAC 5 AMPS SIZE. 2" X 1" X 3/8" HIGH \$5.00 EACH 10 FOR \$45.00  | COMPUTER GRADE CAPACITORS  2,000 mfd. 200 VDC 1 3/4" DIA. x 5" HIGH \$2.00 3,600 mfd. 40 VDC 1 3/8" DIA. x 3 3/4" HIGH \$1.00 6,400 mfd. 60 VDC 1 3/8" DIA. x 4 1/4" HIGH \$2.50 31,000 mfd. 15 VDC 1 3/4" DIA. x 4" HIGH \$2.50 72,000 mfd. 15 VDC 2" DIA. x 4 3/8" HIGH \$3.50 185,000 mfd. 6 VDC 2 1/2" DIA. x 4 1/2" HIGH \$1.50 CLAMPS TO FIT CAPACITORS 506 99. | SLIDE POTS  100K linear tape 2" LONG 75¢ EACH 500K TRAVEL taper 2 7/8" LONG 1 3/4" TRAVEL 75¢ EACH DUAL 100K audio taper 3 1/2" LONG 2 1/2" TRAVEL \$1.50 EACH | L.E.D.'S STANDARD JUMBO DIFFUSED RED 10 FOR \$1.50 GREEN 10 FOR \$2.00 YELLOW 10 FOR \$2.00 FLASHER LED 5 VOLT OPERATION RED JUMBO SIZE \$1.00 EACH BI POLAR LED 2 FOR \$1.70 LED HOLDERS TWO PIECE HOLDER FOR JUMBO LED 10 FOR 65¢ 200 FOR \$10.00 CLEAR CLIPLITE HOLDER MAKE LED A FANCY INDICATOR. CLEAR. 4 FOR \$1.00 | |
| DC CONVERTER  DESIGNED TO PROVIDE A STEADY ±5 VDC @ 240 MA FROM A BATTERY SUPPLY OF 3.5 TO 6.25V. 2 1/16" X 1 1/16" X 1 11/16" HIGH. \$1.50 EACH | IN4148 SPECIAL 45" SPACING P.C. LEADS 1000 FOR \$10.00 10,000 FOR \$585.00 | MINIATURE 6 VDC RELAY  SUPER SMALL SPDT RELAY. GOLD COBALT CONTACTS. RATED 1 AMP AT 30 VDC. HIGHLY SENSITIVE. TTL DIRECT DRIVE POSSIBLE. OPERATES FROM 4.3 TO 6 V. COIL RES. 220 OHM. 1 3/16" x 1 3/32" x 7/16" AROMAT # RSD-6V \$1.50 EACH 10 FOR \$13.50 | CRYSTALS CASE STYLE HC33/U COLORBURST 3579.545 KC \$3.50 EACH \$1.00 EACH METAL OXIDE VARISTOR G.E. # V822A12 50 VOLTS. NOMINAL D.C. VOLTAGE 5/8" DIAMETER. 2 FOR \$1.50 | MINIATURE TOGGLE SWITCHES ALL ARE RATED 5 AMPS @ 125 VAC S.P.D.T. (on-on) P.C. STYLE. NON-THREADED BUSHING 75¢ EACH 10 FOR \$7.00 S.P.D.T. (on-off-on) NON-THREADED BUSHING. P.C. STYLE 75¢ EACH 10 FOR \$7.00 | 3 1/2" SPEAKER  8 OHM IMPEDANCE. FULL RANGE SPEAKER. 8 OZ MAGNET 4" DIAGONAL MOUNTING CENTERS. \$2.50 EACH 10 FOR \$20.00 |
| TRANSISTORS 2N706 4 FOR \$1.00 2N2222A 3 FOR \$1.00 PN2222 4 FOR \$1.00 2N2904 3 FOR \$1.00 2N2905 3 FOR \$1.00 2N2907 3 FOR \$1.00 | KEY ASSEMBLY 5 KEY  CONTAINS 5 SINGLE-POLE NORMALLY OPEN SWITCHES. MEASURES 3 3/4" LONG \$1.00 EACH 6 KEY  CONTAINS 6 SINGLE-POLE NORMALLY OPEN SWITCHES. MEASURES 4 1/4" LONG \$1.25 EACH | 13 VDC RELAY  CONTACT. S.P.N.C. 10 AMP @ 120 VAC ENERGIZE COIL TO OPEN CONTACT... COIL: 13 VDC 650 OHMS SPECIAL PRICE \$1.00 EACH 4 PDT RELAY 14 pin style 3 amp contacts 24 volt d.c. or 120 volt a.c. coil Used but fully tested \$1.70 EACH specify coil voltage LARGE QUANTITIES AVAILABLE SOCKETS FOR RELAY 506 each | S.P.D.T. (on-on) SOLDER LUG TERMINALS \$1.00 EACH 10 FOR \$9.00 100 FOR \$80.00 S.P.D.T. (on-off-on) P.C. LUGS. THREADED BUSHING. \$1.00 EACH 10 FOR \$9.00 100 FOR \$80.00 D.P.D.T. (on-on) SOLDER LUG TERMINALS \$2.00 EACH 10 FOR \$19.00 100 FOR \$180.00 | SOLID STATE BUZZER STAR #5MB-06L. 6 VDC. TTL COMPATIBLE. \$1.00 EACH 10 FOR \$9.00  | |

TOLL FREE ORDERS ONLY
 1-800-826-5432 (ORDER ONLY)
 (IN CALIFORNIA: 1-800-258-6666)
 ALASKA, HAWAII, OR INFORMATION
 (213) 380-8000

ALL ELECTRONICS CORP.

905 S. VERMONT AVE. P.O. BOX 20406 LOS ANGELES, CA 90006
 6228 SEPULVEDA BLVD. VAN NUYS, CA 91411

QUANTITIES LIMITED
 MINIMUM ORDER \$10.00
 USA: \$3.00 SHIPPING
 FOREIGN ORDERS:
 INCLUDE SUFFICIENT SHIPPING
 CALIF. RES. ADD. 6 1/2%
 NO C.O.D.!

CIRCLE 107 ON FREE INFORMATION CARD

7400

Table of 7400 logic components including Part No., Pins, and Price.

74F00

Table of 74F00 fast CMOS logic components including Part No., Pins, Function, and Price.

74ALS00

Table of 74ALS00 low-power Schottky logic components including Part No., Pins, Function, and Price.

DISK CONTROLLERS

Table of disk controllers including Part No., Pins, Function, and Price.

MICROPROCESSOR COMPONENTS

Table of microprocessor components including Microprocessor Chips, Dynamic RAMs, and ROMs.

Digitalizer

DT1050 - Applications: Teaching aids, applications courses, advanced undergraduate laboratory, etc.

DT1057 - Express the DT1056 technology from 132 to over 280 words, incl. 2 MROMs and space.

INTERFIL

Table of Interfil components including Part No., Pins, Function, and Price.

74HC High Speed CMOS

Table of 74HC High Speed CMOS components including Part No., Pins, Function, and Price.

LINEAR

Table of linear components including Part No., Pins, Function, and Price.

30003 1982 Nat. Linear Data Book (1992 pages) \$11.95

74LS

Table of 74LS logic components including Part No., Pins, and Price.

74LS/PROMS

Table of 74LS/PROMS components including Part No., Pins, and Price.

CA-LINEAR

Table of CA-LINEAR components including Part No., Pins, and Price.

CD-CMOS

Table of CD-CMOS components including Part No., Pins, and Price.

500/300 CMOS SERIES

Table of 500/300 CMOS series components including Part No., Pins, Function, and Price.

SPECIAL FUNCTION

Table of special function components including Part No., Pins, Function, and Price.

Wrist Wraps

Table of wrist wraps including Part No., Pins, and Price.

Socket

Table of sockets including Part No., Pins, and Price.

Wrist Wraps

Table of wrist wraps including Part No., Pins, and Price.

Socket

Table of sockets including Part No., Pins, and Price.

Header Plugs

Table of header plugs including Part No., Pins, and Price.

Header Covers

Table of header covers including Part No., Pins, and Price.



510 Minimum Order - U.S. Funds Only CA Residents Add 6% Sales Tax Spec Sheets - 30¢ each Shipping: Add 5% plus \$1.50 Insurance Send \$1 postage for FREE 1985 Jameco Catalog Price Sheets Subject to Change Send stamped, self-addressed envelope to receive a Monthly Sales Flyer - FREE!

Jameco ELECTRONICS logo and address: 1355 SHOREWAY DR., BELMONT, CA 94002

Commodore® Accessories



RS232 Adapter for VIC-20 and Commodore 64

The JE232CM allows connection of standard serial RS232 printers, modems, etc. to your VIC-20 and C-64. A 4-pole switch allows the inversion of the 4 control lines. Complete installation and operation instructions included.

- Plugs into User Port • Provides Standard RS232 signal levels • Uses 8 signals (Transmit, Receive, Clear to Send, Request to Send, Data Terminal Ready, Data Set Ready).

JE232CM \$39.95

VOICE SYNTHESIZER FOR APPLE AND COMMODORE

Plug-In - Talking in Minutes!



JE520CM **JE520AP**

- Over 250 word vocabulary - affixes allow the formation of more than 500 words • Built-in amplifier, speaker, volume control, and audio jack • Reproduces a clear, natural male voice • Plug-in user ready with documentation and sample software • Case size: 7 1/4" L x 3 3/4" W x 1-3/8" H

APPLICATIONS:

- Security Warning
- Teaching
- Instrumentation
- Telecommunication
- Handicap Aid
- Games

| Part No. | Description | Price |
|----------|----------------------------|----------|
| JE520CM | For Commodore 64 & VIC-20 | \$114.95 |
| JE520AP | For Apple II, II+, and IIe | \$149.95 |

Computer Memory Expansion Kits

IBM PC, PC XT and Compatibles

Most of the popular Memory Boards (e.g. Quadram® Expansion Boards) allow you to add an additional 64K, 128K, 192K or 256K. The IBM64K Kit will populate these boards in 64K byte increments. The Kit is simple to install - just insert the 9 - 64K RAM chips in the provided sockets and set the 2 groups of switches. Complete conversion documentation included.

IBM64K (Nine 200ns 64K RAMS), \$33.49

IBM PC AT

Each kit comes complete with nine 128K dynamic RAMs and documentation for conversion.

IBM128K (Nine 250ns 128K RAMS), \$199.95

APPLE IIe

Extended 80-Column/64K RAM Card expands memory by 64K to give 128K when used with programs like VisiCalc™. Fully assembled and tested!

JE864, \$39.95

TRS-80 MODEL I, III

Each kit comes complete with eight MM5290 (JUPD41614116) 16K Dynamic RAMs and documentation for conversion. Model I: 16K equipped with Expansion Interface can be expanded to 48K with 2 Kils. Model III: can be expanded from 16K to 48K using 2 Kils. Each kit will expand computer by 16K increments.

| | | |
|----------|-------------------|--------|
| TRS-16K3 | 200ns (Model III) | \$6.29 |
| TRS-16K4 | 250ns (Model I) | \$5.49 |

TRS-80 MODEL IV & 4P

Easy to Install Kit comes complete with 8 sets of 4164N-20 (200ns) 64K Dynamic RAMs and conversion documentation. Converts TRS-80 Model IV computers from 16K to 64K. Also expands Model 4P from 64K to 128K.

TRS-64K-2, \$29.95
(Converts the Model IV from 16K to 64K or will expand the Model 4P from 64K to 128K)

TRS-64K2PAL (Model IV only), \$49.95
(8 - 4164's with PAL Chip to expand from 64K to 128K)

TRS-80 COLOR AND COLOR II

Easy to install kit comes complete with 8 each 4164N-20 (200ns) 64K Dynamic RAMs and documentation for conversion. Converts TRS-80 Color Computers with D, E, ET, F and NC circuit boards to 32K. Also converts TRS-80 Color Computer II to 64K. Flex DOS or OS-9 required to utilize full 64K RAM on all computers.

TRS-64K-2, \$29.95

DATASHIELD® Surge Protector

Eliminates voltage spikes and EMI/RFI noise before it can damage your equipment or cause data loss. 6-mo warranty. Power dissipation (100 microsecond), 2,000,000 cycles.

| Model | Description | Price |
|--------------|--|---------|
| MODEL 75 | 4 Sockets, On/Off Switch. | \$49.95 |
| MODEL 85 | 6 Sock., Super Filters, On/Off Switch. | \$59.95 |
| MODEL 100 | 6 Sock., Super Filters, Low Volt Alarm. | \$69.95 |
| MODEL 110AMS | 6 Sockets, Super Filters, Auto. Master Switch. | \$99.95 |

DATASHIELD® Back-Up Power Source

Protects your computer from back-outs, brown-outs, power surges and line noise. P11 & PC200 is designed for PCs with floppy disk memory, the XT300 for hard disk memory and the AT300 for multi-user systems. A typical compatible PC for each of these standbys will be supported for 15 to 25 minutes after power is lost. Weight: PC200 - 24 lbs. - (XT300 - 37.5 lbs.) - (AT300 - 33 lbs.) - (AT800 - 33 lbs.)

| | | |
|-------|-------------------|----------|
| PC200 | (200 Watt Rating) | \$299.95 |
| XT300 | (300 Watt Rating) | \$399.95 |
| AT300 | (500 Watt Rating) | \$699.95 |
| AT800 | (800 Watt Rating) | \$799.95 |

MasterCard **Jameco ELECTRONICS** **VISA®**

1355 SHOREWAY ROAD, BELMONT, CA 94002
5/85 PHONE ORDERS WELCOME - (415) 592-8097 - Telex: 176043

ProModem 1200 and Options

PROMETHEUS

Intelligent 300/1200 Baud Telephone Modem with Real Time Clock/Calendar

The ProModem™ is a Bell 212A (300/1200 baud) intelligent stand-alone modem. Full featured expandable modem • Standard features include Auto Answer and Auto Dial, Flow Commands, Programmable Intelligent Dialing, Touch Tone™ and Pulse Dialing & More • Hayes command set compatible plus an additional extended command set • Shown w/Alphanumeric display option

| Part No. | Description | Price |
|----------|--|----------|
| PM1200 | RS-232 Stand Alone Unit. | \$349.95 |
| PM1200A | Apple II, II+ and IIe Internal Unit. | \$369.95 |
| PM1200B | IBM PC and Compatible Internal Unit. | \$269.95 |
| PM1200BS | IBM PC & Comp. Int. Unit w/ProCom Software. | \$319.95 |
| MAC PAC | Macintosh Package. (Includes PM1200, Cable, & ProCom Software) | \$399.95 |

OPTIONS FOR ProModem 1200

| | | |
|---------|---|---------|
| PM-COM | (ProCom Communication Software). Please specify Operating System. | \$79.95 |
| PM-OP | (Options Processor). | \$79.95 |
| PMO-16K | (Options Processor Memory - 16K). | \$10.95 |
| PMO-32K | (Options Processor Memory - 32K). | \$20.95 |
| PMO-64K | (Options Processor Memory - 64K). | \$39.95 |
| PM-ALP | (Alphanumeric Display). | \$79.95 |

PM-Special (Includes Options Processor, 64K Memory and Alphanumeric Display). **\$189.95**

KEYBOARDS

Mitsumi 54-Key Unencoded All-Purpose Keyboard

- SPST keyswitches • 20 pin ribbon cable connection • Low profile keys • Features: cursor controls, control, caps (lock), function, enter and shift keys • Color (keycaps): grey • Wt.: 1 lb. • Pinout included

KB54, \$14.95

82-Key ASCII Cherry Keyboard

- 7-bit parallel ASCII • 11-key numeric keypad • Cursor keypad • SPST mechanical keyswitches • 4 illuminated keys • 26-pin header connector • Color: white • Size: 18 1/4" L x 6 1/2" W x 1 1/4" H • Spec included

KB8201, (1700 avail.), \$29.95

Apple Keyboard and Case for Apple II and II+

- Keyboard: 68 keys • 15-key keypad • Direct connection with 16-pin ribbon connector • 26 special functions • Size: 14 1/2" L x 5 1/2" W x 1 1/2" H
- Case: Accommodates KB-A68 • Pop-up lid for easy access • Fits power supply and motherboard too • Size: 15 1/2" W x 18" D x 4 1/4" H

| Part No. | Description | Price |
|----------|---|----------|
| KB-EA1 | Apple Keyboard and Case (pictured above). | \$134.95 |
| KB-A68 | 68-Key Apple Keyboard only. | \$79.95 |
| EAEC-1 | Expanded Apple Enclosure Case only. | \$9.95 |

POWER SUPPLIES

Power/Mate Corp. REGULATED POWER SUPPLY

- Input: 105-125/210-250 VAC at 47-63 Hz • Line regulation: -0.05% • Three mounting surfaces • Overvoltage protection • UL recognized • CSA certified

| Part No. | Output | Size | Weight | Price |
|----------|---------------|--------------------------------|--------|---------|
| EMA5/6B | 5V@3A/6V@2.5A | 4 1/2" L x 4" W x 2 1/2" H | 2 lbs. | \$29.95 |
| EMA5/6C | 5V@6A/6V@5A | 5 1/2" L x 4 1/2" W x 2 1/2" H | 4 lbs. | \$39.95 |

KEPCO/TDK 4-OUTPUT SWITCHING POWER SUPPLY

- Ideal for disk drive needs of CRT terminals, microcomputers and video games • Input: 115/230VAC, 50/60Hz • Output: +5V @ 5 Amp, +12V @ 1.8 Amp, +12V @ 2 Amp, -12V @ 0.5 Amp • UL recognized • CSA certified • Size: 7 1/4" L x 6 1/2" W x 1 1/4" H • Weight: 2 lbs.

\$59.95 each or MRM 174KF. 2 for \$99.95

Switching Power Supply for APPLE II, II+ & IIe™

- Can drive four floppy disk drives and up to eight expansion cards • Short circuit and overload protection • Fits inside Apple computer • Fully regulated +5V @ 5A, +12V @ 1.5A, -5V @ .5A, -12V @ .5A • Direct plug-in power cord included • Size: 9 1/2" L x 3 1/2" W x 2 1/4" H • Weight: 2 lbs

KHP4007 (SPS-109), \$59.95

4-CHANNEL SWITCHING POWER SUPPLY

- Microprocessor, mini-computer, terminal, medical equipment and process control applications • Input: 90-130VAC, 47-60Hz • Output: +5VDC @ 5A, -5VDC @ 1A, +12VDC @ 1A, -12VDC @ 1A • Line regulations: -0.2% • Ripple: 30mV p-p • Load regulation: ±1% • Overcurrent protection • Adj: 5V main output -10% • Size: 6 1/2" L x 1 1/2" W x 4-15/16" H • Weight: 1 1/2 lbs

FCS-604A, \$69.95

IBM PCXT EQUIVALENT 130 WATT POWER SUPPLY

- Input: 100V-130V/200V-260V selectable @ 47 to 63Hz • Output: +5VDC @ 15A, -5VDC @ 0.5A, +12VDC @ 4.2A, -12VDC @ 0.5A • Plug compatible connectors • Fits into IBM PC • Weight: 6 lbs.

IBM-PS, \$169.95

IBM PCXT EQUIVALENT 130 WATT POWER SUPPLY

• Input: 100V-130V/200V-260V selectable @ 47 to 63Hz • Output: +5VDC @ 15A, -5VDC @ 0.5A, +12VDC @ 4.2A, -12VDC @ 0.5A • Plug compatible connectors • Fits into IBM PC • Weight: 6 lbs.

IBM-PS, \$169.95

\$10 Minimum Order - U.S. Funds Only • CA Residents: Add 6% Sales Tax • Spec Sheets - 32¢ each Shipping: Add 5% plus \$1.50 Insurance • Send \$1 Postage for FREE 1985 Jameco Catalog • Prices Subject to Change • Send stamped, self-addressed envelope to receive a Monthly Sales Flyer - FREE!

MasterCard **Jameco ELECTRONICS** **VISA®**

1355 SHOREWAY ROAD, BELMONT, CA 94002
5/85 PHONE ORDERS WELCOME - (415) 592-8097 - Telex: 176043

Apple® Accessories

5 1/4" APPLE™ Direct Plug-In Compatible Disk Drive and Controller Card

The ADD-514 Disk Drive uses Shugart SA390 mechanics - 143K formatted storage • 35 tracks • Compatible with Apple Controller & ACC-1 Controller • The drive comes complete with connector and cable - just plug into your disk controller card • Size: 6" L x 3 3/4" W x 8-9/16" D • Weight: 4 1/2 lbs.

ADD-514 (Disk Drive), \$169.95
ACC-1 (Controller Card), \$49.95

More Apple Compatible Add-Ons...

| | | |
|---------|--------------------------------------|----------|
| APP-1 | (Cooling Fan with surge protection). | \$39.95 |
| KHP4007 | (Switching Power Supply). | \$59.95 |
| JE614 | (Numeric/Aux. Keypad for IIe). | \$59.95 |
| KB-A68 | (Keyboard w/Keypad for II & II+). | \$79.95 |
| MON-12G | (12" Green Monitor w/swivel stand). | \$99.95 |
| JE864 | (80 Col. +64K RAM for IIe). | \$99.95 |
| ADD-12 | (5 1/4" Half-Height Disk Drive). | \$179.95 |

ADDITIONAL APPLE™ ADD-ONS AVAILABLE

ARC-16K (16K RAM Card for Apple II & II+) **\$39.95**
AEB-2 (EPROM Burner for Apple II, II+ & IIe) **\$69.95**
Allows copy of standard EPROMS 2708, 2716, 2732, 2764

ASSC-1 (Super Serial Card for Apple II, II+ & IIe) **\$99.95**
ADD-1C (5 1/4" Half-Ht. Disk Drive for Apple IIc) **\$189.95**

DISK DRIVES

Documentation Included **Best Buy!**

| | | |
|----------|------------------------------|----------|
| MPIS15 | (MPI 5 1/4" SS full-ht.) | \$89.95 |
| RFD480 | (Remex 5 1/4" DS full-ht.) | \$109.95 |
| TM100-2 | (Tandon 5 1/4" DS full-ht.) | \$159.95 |
| FD55B | (Teac 5 1/4" DS half-ht.) | \$149.95 |
| SA455 | (Shugart 5 1/4" DS half-ht.) | \$159.95 |
| FDD100-8 | (Siemens 8" SS full-ht.) | \$119.95 |
| PCK-5 | (5 1/4" Power Cable Kit) | \$2.95 |
| PCK-8 | (8" Power Cable Kit) | \$3.95 |

UV-EPROM Eraser

8 Chips - 21 Minutes

Erases all EPROMs. Erases up to 8 chips within 21 minutes (1 chip in 15 minutes). Maintains constant exposure distance of one inch. Special conductive foam liner eliminates static buildup. Built-in safety lock to prevent UV exposure. Compact - only 9" L x 3.7" W x 2.6" H. Complete with holding tray for 8 chips.

DE-4 UV-EPROM Eraser, \$74.95
UVS-11EL Replacement Bulb, \$16.95

JE664 EPROM PROGRAMMER

See Our New IBM Communications Program!

24 & 28 PIN PACKAGES

8K to 64K EPROMs

REQUIRES NO ADDITIONAL SYSTEMS FOR OPERATION

Programs and validates EPROMs • Checks for properly erased EPROMs • Emulates PROMs or EPROMs • Loads data in RAM by keyboard • Changes data in RAM by keyboard • Loads RAM from an EPROM • 684 RAMs can be used for external microprocessor development • Compares EPROMs for content differences • Copies EPROMs • Input: 115VAC @ 60Hz • Assembled and tested • Size: 15 1/4" L x 8 1/2" W x 3 1/4" H • Wt: 5 1/2 lbs • 2716 Module included

JE664-A EPROM Programmer, \$995.00

JE665-RS232C INTERFACE OPTION - This option implements computer access to the JE664-A RAM, allowing computer to manipulate, store, and transfer EPROM data to and from the JE664. Sample program listing is supplied in MBASIC for CP/M computers. • Documentation provided to adapt the software to other computers with an RS232 port • Specs: 9600 Baud, 8-bit word, odd parity with 2 stop bits • Assembled and tested • 2716 Module included

JE664-ARS w/ JE665 Option, \$1195.00

JE664-ARS COMMUNICATION PROGRAM For IBM-PC or XT and Compatibles

- Fast compiled BASIC program • Easy to use, menu-driven • Print hard-copies of EPROM data • View data in HEX and ASCII

NEW! The JE664-ARS Communication Program was written for quick interfacing between the JE664-ARS EPROM Programmer and the IBM-PC computer and compatibles. Menu-driven program allows user to Load and Save EPROM data to and from the computer or floppy disk. Data entered by the computer can be viewed in Hex & ASCII formats. Printed hard-copies are also displayed in both formats. Program is ideal for keeping archives of tested EPROMs on disk. The program is compatible for all EPROMs listed with the JE664. Computer requirements: IBM-PC, XT (or etc.) with at least 128K RAM and one serial port. Optional: One parallel port for printer.

JE664-ARS-CP, \$49.95
JE664-ARS Communications Program (5 1/4" Disk and User's Instructions)

JE664-CP CABLE, \$29.95
Cable for IBM-PC to JE664-ARS Program (5' Shielded Cable Assembly)

JUMPER (Personality) MODULES - Jumper (Personality) Modules for 8K, 16K, 32K, and 64K EPROMs. Please specify EPROM and manufacturer

JUMPER (Personality) MODULE \$14.95 each

ADVANCED COMPUTER PRODUCTS, INC.

64K UPGRADE \$24.95

SINCE 1976

AT RAM \$22.95
256K RAM 15.95
84K RAM SET 24.95

1985 CATALOG Send \$1.00

APPLE COMPATIBLE PERIPHERALS

| | | | |
|-------------------------------|----------|------------------------------|----------|
| ALS CP/M 3.0 PLUS CARD | \$329.00 | BUFFERED GRAPPLER | \$189.95 |
| COEX RISK RAM CARD | 39.95 | GRAPPLER SUPER SERIAL | \$119.95 |
| COEX 84K PRINTER CARD w/CABLE | 49.95 | VIDEO 7 RGB I/O | 189.95 |
| COEX 80 COL EXT 64K CARD | 99.95 | APPLE II SERIAL CABLE | 39.95 |
| 15 IN PKASO I/O (IIe) | 139.95 | APPLE IIe KEYBOARD | 49.95 |
| KENNINGTON SYSTEM SAVER | 69.95 | Apple IIe POWER SUPPLY | 49.95 |
| KENNINGTON CP SAVER | 39.95 | Apple IIe IIIc CONTROLLER | 49.95 |
| KRAFT JOYSTICK | 39.95 | APPLE IIe COOLING FAN SYSTEM | 49.95 |
| MCT SPEED DEMON | 249.95 | STREET ECHO II SPEECH SYSTEM | 99.95 |
| MICROSOFT 2.86 SOFTCARD | 247.95 | TITAN ACCELER 84 II CARD | 449.95 |
| GRAPPLER PLUS | 119.95 | WIZARD 80 COLUMN CARD | 96.00 |

FARADAY IBM PC

CPU Board w/64K MS DOS Compatible \$349.95

ROCKWELL AIM

8502 Single Board Computer \$249.00

IBM PC HARDWARE

| | | | |
|--------------------------|----------|--------------------------|---------------|
| AST COMPOLIPS 64K | \$199.00 | KEYTRON 5160S1 | 156.00/199.00 |
| SIGMA MAXIMIZER 64K | 249.95 | MOUSE SYSTEMS MOUSE W/ W | 149.95 |
| SIGMA DISK CONTROLLER | 169.95 | TELEBOARD W/4K | 203.00 |
| HARD DISK CONTROLLER | 219.95 | TILT AND SWIRL STAND | 545.95 |
| 10 MB INTERNAL HARD DISK | 895.00 | TECOM CAPTAIN 64K | 319.00 |
| 10 MB EXTERNAL HARD DISK | 869.00 | CURTIS PC PEDESTAL | 39.00 |
| 15 MB INTERNAL HARD DISK | 849.00 | PGS OF QUADROCHE ADAPTOR | 9.00 |
| 15 MB EXTERNAL HARD DISK | 1049.00 | TILT AND SWIRL STAND | 21.00 |
| 80 WATT BOOSTER SUPPLY | 149.95 | EXTENSION CABLE IBM MONO | 38.00 |
| 130 WATT IBM SUPPLY | 159.95 | QUADROCH EXTENSION CABLE | 28.00 |
| PC COMPATIBLE KEYBOARD | 39.95 | IBM PC CHASSIS | 399.95 |
| IBM PC CHASSIS | 399.95 | PLANTRONICS "COLORLINE" | 389.95 |
| 10 MB INT TAPE STREAMER | 1150.00 | PERMIST MONO CARD | 49.00 |
| 15 MB INTERNAL HARD DISK | 189.00 | SAPPHIRE (PEACH) | 49.00 |
| PARADISE MONOCOLOR | 409.95 | PUBY (ORANGE) | 49.00 |
| HERCULES MONO CARD | 369.00 | COEX 384K MULTICARD w/CR | 199.00 |

PRINTERS

| | |
|-----------------------------|---------------|
| BROTHER HR-15PIS (10cps) | SAVE \$399.00 |
| BROTHER HR-25PIS (12cps) | SAVE \$99.00 |
| BROTHER HR-35PIS (30cps) | 89.00 |
| NEW BROTHER M2024 (24pin) | 1299.00 |
| COEX SPRINT (80cps) | SAVE 149.95 |
| EPSON RX-800/807F (10cps) | SAVE 150.00 |
| EPSON MX-800F (80cps) | SAVE 150.00 |
| EPSON FX-50 (160cps) | SAVE 150.00 |
| EPSON FX-100 (160cps) | SAVE 150.00 |
| MACINTOSH or IIc SERIAL I/O | 115.00 |
| OKIDATA 92P (160cps) | SAVE 399.95 |
| OKIDATA 93P (160cps) | 399.95 |
| OKIDATA 94P (200cps) | 775.00 |
| OKIDATA 2350P (350cps) | 1885.00 |
| TOSHIBA P-151 (24pin) | 1295.00 |
| STAR GEMINI 10K (100cps) | 329.00 |
| STAR GEMINI 10KPC | 329.00 |
| STAR GEMINI 15K | 379.00 |
| STAR GEMINI 15KPC | 449.00 |
| SPECIAL STAR SIX B0 THERMAL | 129.00 |
| NEC 6027A PORTABLE PRINTER | 369.95 |
| PANASONIC 1091 | SAVE 359.00 |

MONITORS

| | |
|--|----------|
| AMDEK 300A (GREEN) | \$139.95 |
| AMDEK 300B (AMBER) | 149.95 |
| AMDEK 310A (IBM AMBER) | 169.95 |
| CALL FOR COLOR & NEW MODELS | 499.95 |
| PGS HR 12 (IBM COLOR) | 69.95 |
| PGS SR 12 (IIc-RES) | 59.95 |
| PGS MAX 12 (IBM GREEN) | 129.95 |
| PGS DOUBLER BOARD | 227.00 |
| TAXAN 420 (IBM RES) | 399.00 |
| NIHON 1224/1236 | 89.95 |
| ZENITH ZW1311/135 | 74.95 |
| SANYO 6500 (MED RES) | 279.00 |
| SANYO 7500 (HARDY) | 379.00 |
| SANYO (LOOKALIKE) 12" AMBER SALE 74.95 | |

MODEMS

| | |
|---------------------------------------|----------|
| BIZCOMM "PC INTELLIMODEM" (INT) | \$348.85 |
| HAYES SMARTMODEM 1200 (EXT) | 489.95 |
| HAYES SMARTMODEM 1200B (INT) | 489.95 |
| HAYES SMARTMODEM 300 (EXT) | 209.95 |
| MICROCOMM APPLE IIc | 249.95 |
| PROMETHEUS 1200M (MACINTOSH) | 489.95 |
| PROMETHEUS 100M (PC EXT) | 459.95 |
| NOVATION EXPRESS I-2-3 | 389.95 |
| ATL COMMUNICATIONS SYSTEM | 419.95 |
| CMP COMEUP LOW COST MODEM (300) 49.95 | |

HARD DISKS

| | |
|--|----------|
| SEAGATE ST066 5Mb | \$209.00 |
| SEAGATE ST119 12MB | 449.00 |
| SEAGATE ST119 12MB | 449.00 |
| CM 10 15, 22Mb | 74.95 |
| RODME 10 15, 22Mb | 74.95 |
| SHUGART SA604 (5Mb) | 149.95 |
| SYQUEST REMOVABLE | Call |
| CALL FOR QUOTE ON HIGHER CAPACITY HARD DRIVES! | |

SUPER SAVER
SHUGART SA604 **HARD DISK**
5Mb \$149.95
NEW FACTORY \$149.95
Qty 10 139.95
Qty 100 129.95

DISK DRIVES

| | |
|-----------------|----------|
| TEAC 555 | \$129.95 |
| MITSUBISHI 4851 | 149.95 |
| SHUGART 455 | 124.95 |
| TDNORM TM100-2 | 169.95 |

IBM DISK DRIVES

| | |
|-----------------------|----------|
| SHUGART 801P | \$209.95 |
| SIEMENS FD100-B | 129.95 |
| SIEMENS FD200-B/DS/ID | 195.00 |
| MITS M289A | 129.95 |
| MITS M289B 1/4HI | 439.95 |
| TANDON 848 1/4HI | 369.95 |
| QMC 242 1/4HI | 399.95 |

DRIVE CABINETS

| | |
|-------------------------------------|---------|
| 5 1/4" CASE POWER SUPPLY | \$69.95 |
| 5 1/4" DUAL W/H w/POWER SUPPLY | 79.95 |
| 8" DUAL CASE w/POWER SUPPLY | 279.95 |
| 6" THINLINE DUAL w/POWER SUPPLY | 199.95 |
| 5 1/4" w/H HARD DISK w/POWER SUPPLY | 199.95 |
| 5 1/4" w/H HARD DISK | 199.95 |

APPLE DISK DRIVES

| | |
|--------------------------------|----------|
| APPLE IIc COMPATIBLE | \$174.95 |
| APPLE IIc COMPATIBLE w/HIGH | 199.95 |
| MICROSOFT APPLE IIc | 219.95 |
| APPLE IIc TO APPLE IIc ADAPTOR | 19.95 |
| APPLE IIc DISK CONTROLLER | 19.95 |

NOTICE TO DEALERS - We Will Pay Top Dollar For Your Excess Inventory

MAIL ORDER PRICING ONLY

6700

| | | | | | |
|----------|---------|-------|---------|------|---------|
| 68000 | \$48.95 | 68010 | \$ 2.95 | 6850 | \$ 3.25 |
| 68001-10 | 89.95 | 68011 | 6.75 | 6850 | 5.85 |
| 68002 | 2.90 | 68012 | 2.90 | 6860 | 7.90 |
| 68003 | 16.95 | 68013 | 14.50 | 6875 | 6.75 |
| 68004 | 14.50 | 68014 | 14.50 | 6880 | 2.70 |

6500

| | | | | | |
|-------|--------|------|--------|------|--------|
| 6502 | \$4.50 | 6504 | \$6.75 | 6522 | \$6.75 |
| 6503 | 8.50 | 6505 | 9.75 | 6532 | 9.50 |
| 6502B | 9.50 | 6520 | 4.25 | 6551 | 11.00 |

8000

| | | | | | |
|--------|---------|------|---------|------|---------|
| 8035 | \$ 5.75 | 8214 | \$ 3.75 | 8259 | \$ 6.75 |
| 8036 | 5.75 | 8216 | 3.75 | 8259 | 6.75 |
| 8080A | 4.50 | 8224 | 2.20 | 8275 | 26.80 |
| 8085A | 4.00 | 8228 | 1.50 | 8279 | 8.75 |
| 80085A | 9.95 | 8228 | 3.40 | 8282 | 6.75 |

Z-80

| | | | |
|----------|-------|-------|-------|
| Z80-CP | 2.95 | 4.35 | 0.50 |
| Z80-CTC | 3.75 | 4.75 | 12.25 |
| Z80-DART | 12.25 | 9.50 | 17.95 |
| Z80-DI/O | 12.25 | 12.25 | |
| Z80-DI/O | 11.95 | 12.25 | |

2.8MHz "A" 4.0MHz "B" 6.0MHz

| | | | |
|----------|-------|-------|-------|
| 280-CP | 2.95 | 4.35 | 0.50 |
| 280-CTC | 3.75 | 4.75 | 12.25 |
| 280-DART | 12.25 | 9.50 | 17.95 |
| 280-DI/O | 12.25 | 12.25 | |
| 280-DI/O | 11.95 | 12.25 | |

\$100 SALE ITEMS

| | | | | | |
|-------|---------|-------|---------|-------|---------|
| 28030 | \$34.95 | Z8001 | \$34.95 | Z8132 | \$32.95 |
| Z8030 | 34.95 | Z8002 | 34.95 | Z8671 | 37.95 |

DISK CONTROLLERS

| | | | | | |
|--------|---------|------|---------|------|---------|
| UP0765 | \$24.95 | 1797 | \$29.95 | 6843 | \$32.95 |
| 1771 | 15.95 | 2791 | 49.95 | 8272 | 24.95 |
| 1791 | 24.75 | 2793 | 49.95 | 1681 | 11.95 |
| 1793 | 28.50 | 2795 | 49.95 | 2143 | 12.95 |
| 1795 | 26.50 | 2797 | \$28.25 | 9218 | 12.95 |

CRT CONTROLLERS

| | | | | | |
|-------|---------|---------|----------|---------|---------|
| 6845 | \$14.95 | 8275 | \$28.50 | IMS9818 | \$39.50 |
| 6845 | 17.95 | 8276 | 7.95 | 8350 | 39.50 |
| 6847 | 11.95 | 8277 | 17.95 | 8545 | 11.95 |
| 46505 | 14.75 | NEC7201 | 21.95 | 8002 | 19.95 |
| 68047 | 24.50 | 50372 | Graphics | 36.95 | |

UARTS/UARTS

| | | | | | |
|-------|--------|--------|---------|---------|---------|
| 18028 | \$3.95 | 2350 | \$ 8.95 | IMM403 | \$ 8.75 |
| 1013A | 3.95 | 8250 | 10.00 | IMS5011 | 4.95 |
| 1015A | 8.75 | IMM402 | 7.75 | 2851 | 8.95 |

EPROMS

| | | | |
|--------------|---------|-----------------|---------|
| 1702 (1ms) | \$ 3.90 | 2732A-4 (450ns) | \$ 6.50 |
| 2700 (450ns) | 3.95 | 2732A-2 (250ns) | 12.50 |
| 2758 (1V) | 5.50 | 2732A-2 (50ns) | 12.50 |
| 2718 (450ns) | 7.75 | 2764 (450ns) | 12.50 |
| 2718 (250ns) | 5.50 | 2764 (250ns) | 7.50 |

OPTO ISOLATORS

| | | | |
|---------|---------|-------|---------|
| MCT-2 | \$ 1.50 | 4N33 | \$ 5.99 |
| MCT-6 | 1.99 | 4N33 | 1.25 |
| MCT-6 | 55 | 4N37 | 1.25 |
| MCA-255 | 1.99 | 4N38 | 29.99 |
| 4N27 | 6.95 | SPX33 | 7.99 |
| 4N28 | 6.99 | 4N25 | 51.00 |

STATIC RAMS

| | | | |
|----------------|--------|-------------------------|--------|
| 2101 (450ns) | \$2.29 | MK4118 | \$4.95 |
| 2102 (450ns) | 1.99 | TMK2018-2 (200ns) 4x10 | 21.00 |
| 2102 (1.5ns) | 1.99 | TMK2018-1E (150ns) 4x10 | 21.00 |
| 2102-2 (250ns) | 1.39 | TMK2018-1 (100ns) 8x10 | 21.00 |

EDGE CONNECTORS

| | | | |
|-----------|------|-----|--------|
| S100 ST | 1.99 | 100 | |
| S100 ST | 3.75 | 50 | \$3.25 |
| 44 Pin ST | 5.25 | 10 | 4.10 |
| 44 Pin ST | 2.95 | 80 | 2.75 |
| 44 Pin WW | 4.75 | 42 | 4.25 |
| 72 Pin ST | 8.50 | 10 | 8.00 |
| 72 Pin WW | 7.25 | 95 | |

D-SUBMINIATURE

| | | | |
|----------------|--------|---------------|------|
| DB25S (Female) | 1.24 | 25 | |
| DB25P (Male) | \$3.10 | \$2.90 | |
| Hood \$1.25 | | Mtg HW \$.99 | |
| DE37S (Female) | 5.95 | 55 | 5.75 |
| DE37P (Male) | 5.25 | 55 | 5.00 |
| Hood \$1.75 | | Mtg HW \$.99 | |
| DD50S (Female) | 5.95 | 55 | 5.85 |
| DD50P (Male) | 5.95 | 55 | 5.75 |

OTHER STYLES IN CATALOG

GAVILAN SPECIALS

| | |
|-------------------------------------|---------|
| 8 or 16 LINE CPU SUPPLIES | Call |
| 8 LINE BY 80 LCD DISPLAY | \$79.95 |
| 8 LINE BY 80 LCD DISPLAY | 39.95 |
| THERMAL PRINTER MECHANISM | 24.95 |
| GAVALAN KEYBOARDS | 14.95 |
| 8 1/2" x 11" THERMAL PAPER (500 sh) | 9.99 |
| PASCAL SOFTWARE w/MANUAL | 99.00 |
| 12 V DC BATTERY PACK | 16.95 |
| 20 MHz CRYSTAL OSCILLATOR | 3.99 |

SUPER SAVER IBM PC

Comp 512KB Disk Drive \$89.95

HI-TECH SPECIALS

| | |
|----------------------|---------|
| AMD7910 | \$29.95 |
| 300 8MB/DI MEDIUM IC | |

DATA ACQUISITION

| | | | | | |
|----------|---------|---------|--------|----------|---------|
| ADC0800 | \$14.95 | ADC0817 | \$9.75 | 140816 | \$19.95 |
| ADC0804 | 3.45 | ADC0800 | 4.75 | 140818 | 2.85 |
| DAC0800 | 1.90 | DAC0802 | 2.85 | DAC100 | 7.95 |
| DAC1000 | 3.50 | DAC1002 | 3.95 | DA08 | 6.50 |
| ADC0818 | 14.25 | DAC1022 | 5.85 | DAC01 | 9.95 |
| AD7623JN | 1.99 | LF353N | 1.99 | LF13201N | 1.99 |

CALL TOLL FREE

800-854-8230

TWIX 910-955-1565

CIRCLE 106 ON FREE INFORMATION CARD

NOW LIQUIDATING GAVILAN COMPUTER CALL FOR GAVILAN 8/16 LINE COMPUTERS See Below - GAVILAN SPECIALS

Corporate Buyers ... Call For Volume Quotes!

IF YOU DON'T SEE IT HERE CALL TOLL FREE

LINEAR

| | | | | | |
|---------|-------|--------|--------|--------|--------|
| LM1084H | 53.95 | NE990 | \$2.45 | LM3909 | 96 |
| LM3000 | 99 | NE992 | 2.70 | LM3914 | \$2.95 |
| LM3001 | 35 | LM709N | 55 | LM3915 | 2.95 |
| LM3002 | 1.99 | LM710N | 1.33 | LM3916 | 2.95 |
| LM3003 | 95 | | | | |

PARTIAL LISTING ONLY- PLEASE CALL OR WRITE FOR FREE CATALOG.

STATIC RAMS

| | | |
|-------------|--------------------------|---------|
| 2112 | 256x4 (450ns) | 2.99 |
| 2114 | 1024x4 (450ns) | 8/9.95 |
| 2114-25 | 1024x4 (250ns) | 8/10.95 |
| 2114L-4 | 1024x4 (450ns)(LP) | 8/12.95 |
| 2114L-3 | 1024x4 (300ns)(LP) | 8/13.45 |
| 2114L-2 | 1024x4 (200ns)(LP) | 8/13.95 |
| TMM2016-200 | 2048x8 (200ns) | 3.25 |
| TMM2016-150 | 2048x8 (150ns) | 3.75 |
| TMM2016-100 | 2048x8 (100ns) | 4.75 |
| HM6116-4 | 2048x8 (200ns)(cmos) | 3.69 |
| HM6116-3 | 2048x8 (150ns)(cmos) | 3.95 |
| HM6116LP-4 | 2048x8 (200ns)(cmos)(LP) | 3.95 |
| HM6116LP-3 | 2048x8 (150ns)(cmos)(LP) | 4.25 |
| HM6264P-15 | 8192x8 (150ns)(cmos)(LP) | 17.95 |

LP = Low Power

DYNAMIC RAMS

| | | |
|----------|---------------------|---------|
| 4116-250 | 16384x1 (250ns) | 8/6.95 |
| 4116-200 | 16384x1 (200ns) | 8/8.95 |
| 4116-150 | 16384x1 (150ns) | 8/10.95 |
| 4164-200 | 65536x1 (200ns)(5v) | 9/19.95 |
| 4164-150 | 65536x1 (150ns)(5v) | 9/21.95 |
| TMS4164 | 65536x1 (150ns)(5v) | 7.95 |

5v = Single 5 Volt Supply

EPROMS

| | | |
|----------|----------------------------|-------|
| 2708 | 1024x8 (450ns) | 3.95 |
| 2716 | 2048x8 (450ns)(5v) | 3.95 |
| 2716-1 | 2048x8 (350ns)(5v) | 4.95 |
| TMS2532 | 4096x8 (450ns)(5v) | 4.95 |
| 2732 | 4096x8 (450ns)(5v) | 4.25 |
| 2732A-4 | 4096x8 (400ns)(5v)(21vPGM) | 4.95 |
| 2732A-35 | 4096x8 (350ns)(5v)(21vPGM) | 4.95 |
| 2732A | 4096x8 (250ns)(5v)(21vPGM) | 6.95 |
| 2732A-2 | 4096x8 (200ns)(5v)(21vPGM) | 10.95 |
| 2764 | 8192x8 (450ns)(5v) | 4.95 |
| 2764-250 | 8192x8 (250ns)(5v) | 5.25 |
| 2764-200 | 8192x8 (200ns)(5v) | 8.95 |
| 27128 | 16384x8 (250ns)(5v) | 13.95 |
| 27256 | 32768x8 (250ns)(5v) | 29.95 |

5v = Single 5 Volt Supply
21vPGM = Program at 21 Volts

SPECTRONICS CORPORATION EPROM ERASERS

| | Timer | Chip Capacity | Intensity (uW/Cm ²) | |
|--------|-------|---------------|---------------------------------|--------|
| PE-14 | | 9 | 8,000 | 83.00 |
| PE-14T | X | 9 | 8,000 | 119.00 |
| PE-24T | X | 9 | 9,600 | 175.00 |

8000

| | |
|---------|--------|
| 8035 | 5.95 |
| 8039 | 5.95 |
| 8080 | 3.95 |
| 8085 | 4.95 |
| 8085A-2 | 11.95 |
| 8087-3 | 129.00 |
| 8087-6 | 119.00 |
| 8088 | 19.95 |
| 8155 | 6.95 |
| 8155-2 | 7.95 |
| 8156 | 6.95 |
| 8748 | 24.95 |
| 8755 | 24.95 |

8200

| | |
|--------|-------|
| 8203 | 39.95 |
| 8205 | 3.50 |
| 8212 | 1.80 |
| 8216 | 1.75 |
| 8228 | 3.49 |
| 8237-5 | 15.95 |
| 8243 | 4.45 |
| 8245 | 10.95 |
| 8251A | 4.49 |
| 8253 | 6.95 |
| 8253-5 | 7.95 |
| 8255 | 4.49 |
| 8255-5 | 5.25 |
| 8259 | 6.90 |
| 8259-5 | 7.50 |
| 8272 | 19.95 |
| 8275 | 29.95 |
| 8279 | 6.95 |
| 8282 | 6.50 |
| 8284 | 5.50 |
| 8286 | 6.50 |
| 8288 | 14.95 |

Z80

2.5 Mhz

| | |
|-----------|------|
| Z80-CPU | 2.49 |
| Z80-CTC | 2.95 |
| Z80-PIO | 2.95 |
| Z80-SIO/0 | 9.95 |

4.0 Mhz

| | |
|------------|-------|
| Z80A-CPU | 2.49 |
| Z80A-CTC | 3.95 |
| Z80A-DART | 8.95 |
| Z80A-PIO | 3.95 |
| Z80A-SIO/0 | 10.95 |

6.0 Mhz

| | |
|----------|------|
| Z80B-CPU | 8.95 |
|----------|------|

6500

| | |
|-------|-------|
| 6502 | 4.95 |
| 6520 | 2.95 |
| 6522 | 5.49 |
| 6532 | 9.95 |
| 6551 | 9.95 |
| 6502A | 5.95 |
| 6522A | 9.95 |
| 6551A | 11.95 |

6800

| | |
|---------|-------|
| 68000-8 | 39.95 |
| 6800 | 2.95 |
| 6802 | 7.95 |
| 6809 | 8.95 |
| 6809E | 8.95 |
| 6821 | 2.95 |
| 6845 | 12.95 |
| 6850 | 3.25 |
| 6883 | 22.95 |

DISK CONTR

| | |
|--------|-------|
| 1771 | 15.95 |
| 1791 | 23.95 |
| 1793 | 23.95 |
| UPD765 | 19.95 |

INTERFACE

| | |
|--------|------|
| 8T26 | 1.59 |
| 8T28 | 1.98 |
| DM8131 | 2.95 |
| DP8304 | 2.29 |

CLOCK CHIPS

| | |
|---------|------|
| MM5314 | 4.95 |
| MM5369 | 1.95 |
| MM5817 | 8.95 |
| MSM5832 | 3.95 |

DATA ACQ.

| | |
|----------|------|
| ADC0804 | 3.49 |
| ADC0809 | 4.49 |
| ADC0817 | 9.95 |
| DAC0808 | 2.95 |
| MC1408L8 | 2.95 |

SOUND CHIPS

| | |
|----------|-------|
| 76477 | 3.95 |
| 76488 | 5.95 |
| AY3-8910 | 12.95 |
| SSI263 | 39.95 |

74LS00

| | | | |
|---------|------|----------|------|
| 74LS00 | .24 | 74LS157 | .65 |
| 74LS01 | .25 | 74LS158 | .59 |
| 74LS02 | .25 | 74LS160 | .69 |
| 74LS03 | .25 | 74LS161 | .65 |
| 74LS04 | .24 | 74LS163 | .65 |
| 74LS05 | .25 | 74LS164 | .69 |
| 74LS08 | .28 | 74LS165 | .95 |
| 74LS09 | .29 | 74LS166 | 1.95 |
| 74LS10 | .25 | 74LS169 | 1.75 |
| 74LS11 | .35 | 74LS173 | .69 |
| 74LS12 | .35 | 74LS174 | .55 |
| 74LS13 | .45 | 74LS191 | .89 |
| 74LS14 | .59 | 74LS192 | .79 |
| 74LS20 | .25 | 74LS193 | .79 |
| 74LS21 | .29 | 74LS194 | .69 |
| 74LS26 | .29 | 74LS195 | .69 |
| 74LS27 | .29 | 74LS197 | .79 |
| 74LS32 | .29 | 74LS221 | .89 |
| 74LS33 | .55 | 74LS240 | .95 |
| 74LS37 | .35 | 74LS241 | .99 |
| 74LS38 | .35 | 74LS242 | .99 |
| 74LS40 | .25 | 74LS243 | .99 |
| 74LS42 | .49 | 74LS244 | 1.29 |
| 74LS47 | .75 | 74LS245 | 1.49 |
| 74LS51 | .25 | 74LS251 | .59 |
| 74LS73 | .39 | 74LS253 | .59 |
| 74LS74 | .35 | 74LS257 | .59 |
| 74LS75 | .39 | 74LS258 | .59 |
| 74LS76 | .39 | 74LS259 | 2.75 |
| 74LS85 | .69 | 74LS260 | .55 |
| 74LS86 | .39 | 74LS266 | .55 |
| 74LS90 | .55 | 74LS279 | .49 |
| 74LS92 | .55 | 74LS280 | 1.98 |
| 74LS93 | .55 | 74LS283 | .69 |
| 74LS107 | .39 | 74LS290 | .89 |
| 74LS109 | .39 | 74LS293 | .89 |
| 74LS112 | .39 | 74LS299 | 1.75 |
| 74LS122 | .45 | 74LS323 | 3.50 |
| 74LS123 | .79 | 74LS365 | .49 |
| 74LS124 | 2.90 | 74LS367 | .45 |
| 74LS125 | .49 | 74LS368 | .45 |
| 74LS126 | .49 | 74LS373 | 1.39 |
| 74LS132 | .59 | 74LS374 | 1.39 |
| 74LS136 | .39 | 74LS377 | 1.39 |
| 74LS138 | .55 | 74LS390 | 1.19 |
| 74LS139 | .55 | 74LS393 | 1.19 |
| 74LS145 | 1.20 | 74LS640 | 2.20 |
| 74LS148 | 1.35 | 74LS645 | 2.20 |
| 74LS151 | .55 | 74LS670 | 1.49 |
| 74LS153 | .55 | 74LS682 | 3.20 |
| 74LS154 | 1.90 | 74LS688 | 2.40 |
| 74LS155 | .69 | 81LS95 | 1.49 |
| 74LS156 | .69 | 25LS2521 | 2.80 |

7400

| | | | |
|------|------|-------|------|
| 7400 | .19 | 7492 | .50 |
| 7401 | .19 | 7493 | .35 |
| 7402 | .19 | 74100 | 1.75 |
| 7403 | .19 | 74107 | .30 |
| 7404 | .19 | 74116 | 1.55 |
| 7405 | .25 | 74121 | .29 |
| 7406 | .29 | 74122 | .45 |
| 7407 | .29 | 74123 | .49 |
| 7408 | .24 | 74125 | .45 |
| 7409 | .19 | 74126 | .45 |
| 7410 | .19 | 74132 | .45 |
| 7411 | .25 | 74145 | .60 |
| 7413 | .35 | 74148 | 1.20 |
| 7414 | .49 | 74150 | 1.35 |
| 7416 | .25 | 74151 | .55 |
| 7417 | .19 | 74153 | .55 |
| 7420 | .19 | 74154 | 1.25 |
| 7421 | .35 | 74155 | .75 |
| 7425 | .29 | 74157 | .55 |
| 7427 | .29 | 74159 | 1.65 |
| 7430 | .19 | 74161 | .69 |
| 7432 | .29 | 74163 | .69 |
| 7437 | .29 | 74164 | .85 |
| 7438 | .29 | 74165 | .85 |
| 7442 | .49 | 74166 | 1.00 |
| 7445 | .69 | 74173 | .75 |
| 7447 | .69 | 74174 | .89 |
| 7448 | .69 | 74175 | .89 |
| 7473 | .34 | 74185 | 2.00 |
| 7474 | .33 | 74192 | .79 |
| 7475 | .45 | 74193 | .79 |
| 7476 | .35 | 74194 | .85 |
| 7483 | .50 | 74259 | 2.25 |
| 7485 | .59 | 74367 | .65 |
| 7489 | 2.15 | 74368 | .65 |
| 7490 | .35 | 74393 | 1.35 |

74S00

| | |
|--------|------|
| 74S00 | .32 |
| 74S02 | .35 |
| 74S04 | .35 |
| 74S05 | .35 |
| 74S08 | .35 |
| 74S10 | .35 |
| 74S11 | .35 |
| 74S20 | .35 |
| 74S32 | .35 |
| 74S37 | .88 |
| 74S74 | .50 |
| 74S86 | .50 |
| 74S112 | .50 |
| 74S124 | 2.75 |
| 74S132 | 1.24 |
| 74S133 | .45 |
| 74S138 | .85 |
| 74S139 | .85 |
| 74S140 | .55 |
| 74S151 | .95 |
| 74S153 | .95 |
| 74S157 | .95 |
| 74S158 | .95 |
| 74S161 | 1.95 |
| 74S163 | 1.95 |
| 74S174 | .95 |
| 74S175 | .95 |
| 74S240 | 2.20 |
| 74S241 | 2.20 |
| 74S244 | 2.20 |
| 74S280 | 1.95 |
| 74S287 | 1.90 |
| 74S288 | 1.90 |
| 74S373 | 2.45 |
| 74S374 | 2.45 |
| 74S471 | 4.95 |

★★★★HIGH-TECH★★★★

μPD765 FLOPPY DISK CONTROLLER

- * AS USED IN IBM PC
- * SUPPORTS UP TO FOUR 5 1/4" OR 8" DISK DRIVES
- * SINGLE OR DOUBLE DENSITY, SINGLE OR DOUBLE SIDED
- * DMA OR NON-DMA OPERATION

\$19.95

★★★★SPOTLIGHT★★★★

CRYSTALS

| | |
|-----------|------|
| 32.768Khz | 1.95 |
| 1.0Mhz | 3.95 |
| 1.8432 | 3.95 |
| 2.0 | 2.95 |
| 2.4576 | 2.95 |
| 3.579545 | 2.95 |
| 4.0 | 2.95 |
| 5.0 | 2.95 |
| 5.0688 | 2.95 |
| 6.0 | 2.95 |
| 6.144 | 2.95 |
| 8.0 | 2.95 |
| 10.738635 | 2.95 |
| 14.31818 | 2.95 |
| 15.0 | 2.95 |
| 16.0 | 2.95 |
| 17.430 | 2.95 |
| 18.432 | 2.95 |
| 20.0 | 2.95 |

UARTS

| | |
|----------|------|
| AY5-1013 | 3.95 |
| AY3-1015 | 6.95 |
| TR1602 | 3.95 |
| LM339 | 8.95 |
| LM348 | 9.95 |
| LM350K | 4.95 |

BIT-RATE GENERATORS

| | |
|---------|-------|
| BR1941 | 11.95 |
| 4702 | 12.95 |
| COM8116 | 10.95 |
| 14411 | 11.95 |

MISC.

| | |
|--------------|-------|
| 3242 | 7.95 |
| MC3470 | 4.95 |
| MC3487 | 2.95 |
| AY5-3600 PRO | 11.95 |
| HD46505SP | 15.95 |
| CRT5027 | 19.95 |

LINEAR

| | | | |
|--------|------|---------|------|
| TL084 | 2.19 | NE564 | 2.95 |
| LM301 | .34 | LM565 | .99 |
| LM307 | .45 | LM566 | 1.49 |
| LM308 | .69 | NE592 | .98 |
| LM309K | 1.25 | LM733 | .98 |
| LM310 | 1.75 | LM741 | .35 |
| LM311 | .64 | LM747 | .69 |
| LM317T | 1.19 | LM1310 | 1.49 |
| LM317K | 3.95 | MC1330 | 1.69 |
| LM318 | 1.49 | MC1372 | 6.95 |
| LM323K | 4.95 | LM1458 | .59 |
| LM324 | .59 | LM1488 | .69 |
| LM331 | 3.95 | LM1489 | .69 |
| LM334 | 1.19 | LM1496 | .85 |
| LM335 | 1.40 | LM1800 | 2.37 |
| LM336 | 1.75 | LM1812 | 8.25 |
| LM337T | 1.95 | LM1889 | 1.95 |
| LM338K | 3.95 | ULN2003 | 1.29 |
| LM339 | .99 | XR2206 | 3.75 |
| LM348 | .99 | XR2211 | |

PARTIAL LISTING ONLY- PLEASE CALL OR WRITE FOR FREE CATALOG.

CAPACITORS

| ELECTROLYTIC | | | | | |
|--------------|---------|-------|-----|-----|--|
| RADIAL | | AXIAL | | | |
| 47uf | 50v .14 | 10 | 50v | .16 | |
| 10 | 50v .15 | 22 | 16v | .14 | |
| 47 | 35v .18 | 47 | 50v | .20 | |
| 100 | 16v .18 | 100 | 15v | .20 | |
| 220 | 35v .20 | 150 | 25v | .25 | |

50v MONOLITHIC

| | | | |
|-------|-----|-----|-----|
| .01uf | .14 | .1 | .18 |
| .047 | .15 | .47 | .25 |

50v DISC

| | | | |
|------|-----|--------|-----|
| 10pf | .05 | 470 | .05 |
| 22 | .05 | 560 | .05 |
| 25 | .05 | 680 | .05 |
| 27 | .05 | 820 | .05 |
| 33 | .05 | .001uf | .05 |
| 47 | .05 | .0015 | .05 |
| 56 | .05 | .0022 | .05 |
| 68 | .05 | .005 | .05 |
| 82 | .05 | .01 | .07 |
| 100 | .05 | .02 | .07 |
| 220 | .05 | .05 | .07 |
| 330 | .05 | .1 | .12 |

BYPASS CAPS

| | | |
|------------|-----|-----------|
| .01uf disc | 50v | 100/6.00 |
| .1uf disc | 12v | 100/8.00 |
| .01uf mono | 50v | 100/12.00 |
| .1uf mono | 50v | 100/15.00 |

IC SOCKETS

| | | |
|-------------------------------------|------|------|
| 8 pin ST | .13 | .11 |
| 14 pin ST | .15 | .12 |
| 16 pin ST | .17 | .13 |
| 18 pin ST | .20 | .18 |
| 20 pin ST | .29 | .27 |
| 22 pin ST | .30 | .27 |
| 24 pin ST | .30 | .27 |
| 28 pin ST | .40 | .32 |
| 40 pin ST | .49 | .39 |
| 64 pin ST | 4.25 | call |
| ST=SOLDERTAIL | | |
| 8 pin WW | .59 | .49 |
| 14 pin WW | .69 | .52 |
| 16 pin WW | .69 | .58 |
| 18 pin WW | .99 | .90 |
| 20 pin WW | 1.09 | .98 |
| 22 pin WW | 1.39 | 1.28 |
| 24 pin WW | 1.49 | 1.35 |
| 28 pin WW | 1.69 | 1.49 |
| 40 pin WW | 1.99 | 1.80 |
| WW=WIREWARP | | |
| 16 pin ZIF | 4.95 | call |
| 24 pin ZIF | 5.95 | call |
| 28 pin ZIF | 6.95 | call |
| ZIF=TEXTTOOL (Zero Insertion Force) | | |

ACCESORIES & PERIPHERALS

FOR IBM

| | |
|---------------------------------------|--------|
| MAXIMIZER Memory Multifunction | 259.95 |
| HAYES SMARTMODEM 1200B | 419.95 |
| 130W POWER SUPPLY | 159.95 |
| TEAC FD-55B 1/2 Ht. Disk Drive, DS/DD | 129.95 |
| MPI-B52 5 1/4" FDD, DS/DD | 109.95 |
| PROTOTYPE CARD | 27.95 |
| PROTOTYPE CARD With Decoding | 29.95 |

FOR APPLE

| | |
|--|--------|
| JDR 16K RAM CARD | 39.95 |
| EPROM PROGRAMMER RP525 | 79.95 |
| PRINTMAX Parallel printer interface | 49.95 |
| BAL-500 1/2 Ht. Disk Drive, Teac Mechanism | 169.95 |
| BAL-525 1/2 Ht. Disk Drive, Alps Mechanism | 139.95 |
| MITAC AD-1 Full Height, Shugart Mechanism | 179.95 |
| DISK CONTROLLER CARD | 49.95 |
| VIEWMAX-80 80 Column For Apple II+ | 159.95 |
| VIEWMAX-80e 80 Column For Apple IIe | 129.95 |
| THUNDERCLOCK Official PRODOS Clock | 129.95 |
| KRAFT JOYSTICK | 39.95 |
| 60W POWER SUPPLY | 49.95 |

MISCELLANEOUS

| | |
|--|--------|
| ZENITH ZVM-123 15 MHz Green Monitor | 105.00 |
| NEC JB1201M 20 MHz Green Monitor | 169.00 |
| BMC BM-AU9191U Comp. 13" Color Monitor | 279.00 |
| BMC BX-80 PRINTER | 199.95 |
| NASHUA DISKETTES SS/SD Box of 10 | 19.95 |
| VERBATIM DATALIFE DISKETTES DS/DD | 34.95 |
| DISKETTE FILE Holds 70 Diskettes | 9.95 |

BARGAIN HUNTERS CORNER

DYNAMIC RAMS

| | | | |
|-------|------|-------|---------|
| 41256 | 256K | 200ns | \$10.95 |
| 4164 | 64K | 200ns | \$19.95 |

STATIC RAMS

| | | | |
|---------|------|-------|--------------|
| HM6264 | 8Kx8 | 150ns | CMOS \$17.95 |
| TMM2016 | 2Kx8 | 200ns | \$3.25 |
| HM6116 | 2Kx8 | 200ns | CMOS \$3.69 |

EPROMS

| | | | |
|-------|-------|-------|---------|
| 27128 | 16Kx8 | 250ns | \$13.95 |
| 2764 | 9Kx8 | 450ns | \$4.95 |
| 2732 | 4Kx8 | 450ns | \$4.25 |

MATH CO-PROCESSOR CHIPS

| | | |
|--------|-------|----------|
| 8087-3 | INTEL | \$129.00 |
| 8087-6 | INTEL | \$119.00 |

SPECIALS ENDS 4/30/85

SWITCHING POWER SUPPLIES

| PS-ASTECC | PS-3 |
|--------------------|----------------|
| MODEL AA 21110 | ASTECC AA11190 |
| +12V @ 2A | +5V @ 4A |
| -12V @ .1A | +12V @ 2.5A |
| +5V @ 2.5A or | -5V @ .25A |
| 5A if 12V not used | -12V @ .30A |
| 19.95 | 39.95 |

5 1/4" DISK DRIVES

| | | |
|--------------------|---------|--------|
| TANDON TM100-2 | DS/DD | 159.95 |
| SHUGART SA400L | SS/DD | 199.95 |
| MPI B52 | DS/DD | 109.95 |
| TEAC FD55B 1/2 Ht. | DS/DD | 129.95 |
| TEAC FD55F 1/2 Ht. | DS/Quad | 139.95 |

8" DISK DRIVES

| | | |
|-----------------|-------|--------|
| SIEMENS FD200-8 | DS/DD | 180.00 |
| SIEMENS FD100-8 | SS/DD | 129.00 |

BEST SELLING IDC CONN.

| RIBBON HEADER SOCKETS | | | |
|-----------------------|------|--------|------|
| IDS 20 | 2.25 | IDS 40 | 1.99 |
| IDS 26 | 1.39 | IDS 50 | 2.25 |
| IDS 34 | 1.59 | | |

RIBBON EDGE CARDS

| | | | |
|--------|------|--------|------|
| IDE 20 | 2.25 | IDE 40 | 3.80 |
| IDE 26 | 2.65 | IDE 50 | 3.95 |
| IDE 34 | 2.75 | | |

LIGHT EMITTING DIODES

| JUMBO DISPLAYS | | | |
|----------------|------|--------|---------------------|
| | 1.99 | 100-up | |
| RED | .10 | .09 | MAN-72 CA .3" .99 |
| GREEN | .18 | .15 | MAN-74 CC .3" .99 |
| YELLOW | .18 | .15 | FND-500 CC .5" 1.49 |
| | | | FND-507 CA .5" 1.49 |

DISKETTE FILE

\$8.95 IF PURCHASED WITH 50 DISKETTES OR MORE \$9.95 if purchased alone

- * SMOKED ACRYLIC CASE WITH SIX INDEXED DIVIDERS
- * RUGGED, HIGH QUALITY CONSTRUCTION
- * HOLDS 70 5 1/4" DISKETTES, WITH ROOM TO SPARE



NASHUA DISKETTES 5 1/4" SOFT SECTOR

DOUBLE SIDED, DOUBLE DENSITY WITH HUB RINGS
BULK PACKAGED IN FACTORY SEALED BAGS OF 50. INCLUDES DISKETTE SLEEVES AND WRITE PROTECT TABS. IDEAL FOR SCHOOLS, CLUBS, AND USERS GROUPS. THIS IS A SPECIAL PURCHASE, SO QUANTITIES ARE LIMITED. 5 YEAR WARRANTY.

\$1.39 ea. QTY 250 \$1.49 ea. QTY 100 \$1.59 ea. QTY 50

D-SUBMINIATURE

| DESCRIPTION | ORDER BY | CONTACTS | | | | |
|--------------|----------|----------|------|------|------|------|
| | | 9 | 15 | 25 | 37 | |
| SOLDER CUPS | MALE | DBxxP | 1.19 | 1.59 | 1.90 | 2.85 |
| | FEMALE | DBxxS | 1.50 | 1.85 | 2.25 | 3.90 |
| RT. ANGLE | MALE | DBxxPR | 1.65 | 2.20 | 3.00 | 4.83 |
| PC SOLDERS | FEMALE | DBxxSR | 2.18 | 3.03 | 3.00 | 6.19 |
| IDC | MALE | IDBxxP | 2.95 | 3.90 | 4.75 | 6.95 |
| RIBBON CABLE | FEMALE | IDBxxS | 3.25 | 4.29 | 5.25 | 7.95 |
| HOODS | BLACK | HOOD-B | ... | ... | .99 | ... |
| | GREY | HOOD | .89 | .99 | .99 | 1.09 |

MOUNTING HARDWARE-\$1.00
FOR ORDERING INSTRUCTIONS, SEE IDC CONN. ABOVE.

9000

| | |
|------|------|
| 9334 | 2.50 |
| 9368 | 3.95 |
| 9602 | 1.50 |

INTERSIL

| | |
|---------|-------|
| ICL7107 | 12.95 |
| ICL7660 | 2.95 |
| ICL8038 | 3.95 |

DIP SWITCHES

| | |
|------------|-----|
| 4 position | .85 |
| 6 position | .90 |
| 7 position | .95 |
| 8 position | .95 |

TRANSISTORS

| | | | |
|--------|----|--------|-----|
| 2N2222 | 25 | PN2907 | .13 |
| PN2222 | 10 | 2N3055 | .79 |
| 2N2905 | 50 | 2N3904 | .10 |
| 2N2907 | 25 | 2N3906 | .10 |

DISCRETE

| | | |
|--------|--------------------|---------|
| 1N751 | 5.1v zener | .25 |
| 1N759 | 12.0v zener | .25 |
| 1N4148 | (1N914) switching | 25/1.00 |
| 1N4004 | 400PIV rectifier | 10/1.00 |
| KBP02 | 200PIV 1.5a bridge | .45 |
| 4N33 | OPTO-ISOLATOR | 1.75 |

RIBBON CABLE

| CONTACTS | SINGLE COLOR | | COLOR CODED | |
|----------|--------------|------|-------------|-------|
| | 1' | 10' | 1' | 10' |
| 25 | .45 | 4.00 | 1.32 | 11.80 |
| 34 | .61 | 5.40 | 1.65 | 14.50 |
| 50 | .89 | 7.50 | 2.50 | 22.00 |

36 PIN CENTRONICS

| | |
|------------------------------|------|
| CEN36 MALE SOLDER CUP | 7.95 |
| IDCEN36 MALE RIBBON CABLE | 8.95 |
| IDCEN36F FEMALE RIBBON CABLE | 8.95 |

VOLTAGE

REGULATORS

| | | | |
|--------|-----|--------|------|
| 7805T | .75 | 7915T | .85 |
| 78M05C | .35 | 7805K | 1.39 |
| 7808T | .75 | 78H05K | 9.95 |
| 7812T | .75 | 7812K | 1.39 |
| 7815T | .75 | 7912K | 1.49 |
| 7824T | .85 | 78L05 | .69 |
| 7905T | .85 | 79L05 | .79 |
| 7912T | .85 | 79L12 | .79 |

C, T-TO-220, K-TO-3, L-TO-92

CMOS

| | | | | | | | |
|------|-----|------|-----|------|------|--------|------|
| 4001 | .25 | 4027 | .45 | 4066 | .39 | 4538 | 1.95 |
| 4002 | .25 | 4028 | .69 | 4069 | .29 | 4543 | 1.19 |
| 4011 | .25 | 4029 | .79 | 4070 | .35 | 4553 | 5.79 |
| 4012 | .25 | 4040 | .75 | 4071 | .29 | 4584 | .75 |
| 4013 | .38 | 4042 | .69 | 4081 | .29 | 74C00 | .35 |
| 4015 | .39 | 4046 | .85 | 4082 | .29 | 74C04 | .35 |
| 4016 | .39 | 4047 | .95 | 4093 | .49 | 74C14 | .59 |
| 4017 | .69 | 4049 | .35 | 4503 | .65 | 74C74 | .65 |
| 4018 | .79 | 4050 | .35 | 4511 | .85 | 74C906 | .95 |
| 4020 | .75 | 4051 | .79 | 4518 | .89 | 74C922 | 4.49 |
| 4023 | .29 | 4053 | .79 | 4520 | .79 | 74C923 | 4.95 |
| 4024 | .65 | 4060 | .89 | 4528 | 1.19 | 74C926 | 7.95 |



ORDER TOLL FREE

800-538-5000

800-662-6279 (CA)



© Copyright 1985 JDR Microdevices

CIRCLE 113 ON FREE INFORMATION CARD

AMAZING DEVICES

PERSONAL DEFENSE AND PROPERTY PROTECTION UTILIZE SPACE AGE TECHNOLOGY.
CAUTION: THESE DEVICES CAN BE HAZARDOUS AND MAY SOON BE ILLEGAL.

PHASORS

POCKET PAIN FIELD GENERATOR — IPG50
Assembled..... \$64.50
IPG5..... Plans..... \$8.00 IPG5K..... Kit/Plans..... \$44.50

PHASOR PAIN FIELD CROWD CONTROLLER — PPF10
Assembled..... \$250.00
PPF1..... Plans..... \$15.00 PPF1K..... Kit/Plans..... \$175.00

BLASTER - Provides a plasma discharge capable of puncturing a can. Produces a 100,000 WATT PULSE.

BL510 ASSEMBLED..... \$89.50
BL51..... PLANS..... \$10.00 BL51K..... KIT/PLANS..... \$69.50

PLASMA STUN GUN - Very intimidating and effective 5 to 10 feet 100,000 VOLTS
ITM10..... ASSEMBLED..... \$99.50
ITM1..... PLANS..... \$10.00 ITM1K..... KIT/PLANS..... \$69.50

RUBY LASER RAY GUN — Intense visible red beam burns and welds hardest of metals. **MAY BE HAZARDOUS.**

RUB3 All Parts Available for Completing Device \$15.00
CARBON DIOXIDE BURNING, CUTTING LASER — Produces a continuous beam of high energy. **MAY BE HAZARDOUS.**

LC5 All Parts Available for Completing Device. \$15.00
VISIBLE LASER LIGHT GUN — produces intense red beam for sighting, spotting, etc. Hand held complete.

LGU3, Plans..\$10.00 (Kit & Assembled Units Available)
IR PULSED LASER RIFLE — Produces 15-30 watt infra-red pulses at 200 2000 per sec.

LRG3 All Parts & Diodes Available..... \$10.00
BEGINNERS LOW POWER VISIBLE LASER — Choice of red, yellow, green — provides an excellent source of monochromatic light.

LHC2..... Plans..... \$5.00 LHC2K..... Kit..... \$34.50

SNOOPER PHONE — Allows user to call his premises and listen in without phone ever ringing.
SNP20..... Assembled..... \$89.50
SNP2..... Plans..... \$9.00 SNP2K..... Plans/Kit..... \$59.50

LONG RANGE WIRELESS MIKE — Miniature device clearly transmits well over one mile. Super sensitive, powerful.

MFT1..... Plans..... \$7.00 MFT1K..... Plans/Kit..... \$49.50

WIRELESS TELEPHONE TRANSMITTER — Transmits both sides of phone conversation over one mile, shuts off automatically.

VWPM5..... Plans..... \$8.00 VWPM5K..... Plans/Kit..... \$39.50

TALK & TELL AUTOMATIC TELEPHONE RECORDING DEVICE — Great for monitoring telephone use.
TAT20..... Assembled..... \$24.50
TAT2..... Plans..... \$5.00 TAT2K..... Plans/Kit..... \$14.50

Our phone is open for orders anytime. Technicians are available 9-11 a.m., Mon-Thurs for those needing assistance or information. Send \$1.00 for catalog of hundreds more similar devices. Send check, cash, MO, Visa, MC, COD to: **INFORMATION UNLIMITED**
DEPT RR, P.O. Box 716, Amherst, N. H. 03031 Tel: 603-673-4730

CIRCLE 72 ON FREE INFORMATION CARD

THE BEST PRICES

5 1/4" TOP QUALITY DISKS \$5/DD, fully guar. 10/88.60
COMPUTER MONITORS, 12" crn, rfe, repairable minor prob \$5
1 1/4" DISK JACKETS, white generic, 12/81, 12/81
COMPUTER PAPER 11" x 17", 50 sheets, 3000/case \$29
AS ABOVE, LETTER QUAL, CLEAN PER, 2600/case \$29
SATISFACTION GUARANTEED OR YOUR MONEY BACK!!
SHARGAT 901, like B01, \$5/DD B1, rfe, guar, and, \$49
5 MBYTE MINIMINICHESTERS, rfe, guar, nds alignment 888
DAK KEYBOARD SWITCHES, SPST-HO 20/81
ROBERT CURR, SEW, 11/81 \$1, 8/81 \$4
2 SIDE COPPER CLAD, FR4 20x8" B8, 10/87
HAND HELD LOGIC PROBE, LPI, detects 1-shot, low rate, \$19
SOLAR CELLS 4" 1500mA \$3.50, 5" 1000mA \$2.50
BANANA JACKS, Ht Smith #1509 8/81 100/89
25AMP 200VTV RECTIFIER, 2/81, 2/81 \$2/81
HEAVY DUTY HEATSINK, FOUR 10-3/16 size 4x6.5x1.25", 3/81
DELAY LINES, your choice 75, 100, 200ns 2/81
MULTI-PHASE, 110V, 1/81 \$1, 1/81 \$4
3 MUFFIN FANS ON A RACK, 110V, rfe \$9
TELEPHONE HANDSETS, brown, modular, new, Bell type #1
TELEPHONE RETAIL PROJECT BOXES, 2.5x2.5x1.25", 4/81
ASSTD IC'S, mixed types, lots of good numbers!! 20/81
ASSTD MINI-TOGGLES/PADDLES 5/81
SPDT MINI-TOGGLE, 110V, 1/81 \$1, 1/81 \$2
ALCO I-POLE 8-POSITION MINI ROTARY \$1
10 AMP POWER ROCKER SWITCH, wired, new 4/81
4 HAND JACKETED TELEPHONE WIRES, 24ga., 50ft/81 \$2
2 COND TWISTED WIRE, AMG20 stranded, 50ft/81 \$0.50
SO LD STATE TIME DELAY RELAY DPDT, 10A contacts \$2.95
DPST NO RELAY 12VDC coil, 30A contacts \$1
3PDT RELAY, 12VDC coil, 10A contacts \$1
DPST-NO RELAY 208V coil, 25A contacts \$1
DPST-NO HEAVY DUTY LINE COILS, 6 AMG18, 7/81
3 COND STEREO PLUGS 1/4" RIGHT ANG 7/81 \$4
FUSES, 305 (AGC) 1/2, 1, 2, 6 Amp, 25/81
SLO-TO FUSES, 2AG IND, 1/2, or 1 Amp, 10/81
CLAIREX CELLS CO3, 1/2, 1/2, 1/2, 1/2, 1/2, 8/81
EMI FILTERS: 2 amp: \$1.95; 3 amp \$2.95
2-5V LAMPS, screw in, round bulb 10/81
DISC CAPACITORS, 0.1uF, 100V, 50¢/100 \$1
ALLIGATOR CLIPS W/BOOTS 1-red, 1-blk, 1" 29¢pr; 2" \$4.9¢pr.
5V BATTERY SNAPS, insulated, w/wire leads 10/81
16 PIN FEMALE DIN CONNECTORS, All 25¢/100 thru \$12
SOVIV BRIDGE RECTIFIERS, 2A 3/81; 6A 2/81; 25A 1/81
15,000uF 25V ELECTROLYTIC CAPACITORS, axial, 4/81
4" CABLE TIES, locking 20/81
1N4148 SWITCHING DIODES 20/81
2K2055 AUDIO MPN POWER TRANSISTORS 2/81
EPROMS, +5V rfe 2764: \$3.50, 2732: \$3, 2716 or 2708: \$1.99
DYNAMIC RAMS rfe, 4116-200ns: \$42, 4164-150ns: \$2.22
7804: \$3, 5101 or 2: \$18; P10: \$45; DMS: \$7.50
SEE NEXT LAST OR NEXT MONTH'S AD FOR FULL LIST!
IC SOCKETS, 14, 16, 22, 24, or 40 pin solder tail, 1¢-A-PIN!
16 PIN WIREWRAP IC SOCKETS, 2-level, 6/81
6 VOLT 450MAH RECHARGEABLE BATTERY, sealed, \$3
INSULATED SOLDERLESS TIPS, 5/32" push-on fee. AMG14-16.
5/32" push-on fee. AMG18-22; 3/32" push-on AMG24-26; 20/81
ASSTD BIPOLAR TRANSISTORS, some on price list
ASSTD COMPUTER GRADE CAPACITORS 4/81
LOOK AUDIO POTS 1/4" 4/81
PULSE TRANSFORMERS 6/81
12 VOLT 1 WATT ZENER 8/81
STOCK ON CABLE CLAMPS 20/81
RACK PANELS, 1x4, 1x6, 1x8, 1x12, 1x16, 1x24
HEATSINK-15A SOVIV BRIDGE 1/81
ASST ROTRY SWITCHES 4/81
1 MEG SLIDE POTS 4/81
ASSTD LAMPS 20/81
DB-50 CONN., female \$1
8 POS DIP SWITCHES 2/81
ASST ROTRY SWITCHES 4/81

HOW TO ORDER: Order by phone or mail, or at our retail store, pay by **MC, Visa, Amex, COD check, mfn order \$20.** Include approx tax for shipping, bal refunded. **GUARANTEED SATISFACTION OR YOUR MONEY BACK** within 30 days of receipt. Send for our **FREE FLYER** or circle reader service. (rfe returned from equipment)

20 HURLEY ST.
UNITECH CAMBRIDGE, MA 02141
TEL: (617) "UNI-TECH"

CIRCLE 264 ON FREE INFORMATION CARD

NICAD BATTERY ZAPPER KIT
This is one of the most useful and money saving kits you can buy! The Nicad Zapper kit repairs those nicads that you no longer use because they won't recharge. Many nicads quit taking a charge after a period of time because they grow internal "whiskers". The only way to make them take a charge again is to "blow" these "whiskers". This small kit operates from 6VDC (4 AA cells, etc.), and produces 300VDC which it applies momentarily to the nicad to "blow the whiskers" without damaging the battery. Repairs about 90% of nicads in sizes from AA to C cells. After zapping, the nicad is ready to be fully charged again and again (just like it did when it was new). The nicad zapper produces absolutely amazing results! Stop throwing out those expensive nicads! The kit comes with all parts, PC board and instructions (less batteries and case).
C6278 \$14.95

STYLISH CASE
Here's the new way to make that professional looking project. Ultra-stylish black case with chrome edged front bezel. Complete with screws. Size: 2 1/2" x 3 1/2" x 1 1/2".
C6252 \$4.95

120 VAC Xenon Strobe Kit
C3071 \$10.95

BOX OF ELECTRONICS
Super surprise of resistors, capacitors, IC's, transistors, sub-assemblies, diodes, switches, pn's, etc. in a 6" x 6" x 3" box. Lots of " goodies ". Note: because of shipping costs we can ship this in UPS.
C6282 \$10.00

2732 EPROM
Blank Hitachi 450NSEC Eprom
C6299 \$1.49 C4972 \$2.95

SEND FOR YOUR FREE COPY OF OUR 1985 CATALOG LISTING:

*Over 70 electronic kits which include parts and pc board!
*A million dollars worth of hand held games at giveaway prices!
*Tremendous electronic bargains!

CHANNEY electronics inc.
P.O. BOX 27038
DENVER, COLORADO 80227

- Minimum AD Order: \$9.00
- Please include \$2.00 for postage (UPS)
- VISA MC accepted
- Phone orders are welcome

Send for our free catalog of unique items

CIRCLE 109 ON FREE INFORMATION CARD

DON'T BLAME THE SOFTWARE!

Our Isolators eliminate equipment interaction, clean up interference, curb damaging power line spikes and lightning bursts.



ISO-1 ISOLATOR
3 isolated sockets; quality spike suppression; basic protection. . . \$81.95

ISO-3 SUPER-ISOLATOR
3 dual isolated sockets; suppressor; commercial protection. . . \$122.95

ISO-17 MAGNUM ISOLATOR
4 quad isolated sockets; suppressor; laboratory grade protection. . . \$213.95

ESP. Electronic Specialists, Inc.
171 S. Main, Natick, MA 01760 (817) 655-1532
Toll Free Order Desk 1-800-225-4878
MasterCard, VISA, American Express

CIRCLE 60 ON FREE INFORMATION CARD

ACTIVE RECEIVING ANTENNA

Gives excellent reception, 50 KHz to 30 MHz.

New MFJ-1024 Active Receiving Antenna mounts outdoors away from electrical noise for maximum signal. Gives excellent reception of 50 KHz to 30 MHz signals. Equivalent to wire hundreds of feet long. Use any SWL, MW, BCB, VLF or Ham receiver. High dynamic range RF amplifier. 54 in. whip. 50 foot coax. 20 dB attenuator prevents receiver overload. Switch between two receivers. Select auxiliary or active antenna. Gain control. "ON" LED. Remote unit, 3x2x4 in. Control, 6x2x5 in. 12 VDC or 110 VAC with optional adapter, MFJ-1312, \$9.95.

\$129.95 (+\$4.00 shipping)

Order from MFJ and try it. If not delighted, return within 30 days for refund (less shipping). One year unconditional guarantee. Order today. Call TOLL FREE 800-647-1800. Charge VISA, MC. Or mail check, money order. Write for free catalog. Over 100 products.

CALL TOLL FREE 800-647-1800
Call 601-323-5869 in Miss., outside continental USA, tech/order/repair info. TELEX 53-4590.

MFJ ENTERPRISES, INCORPORATED
Box 494, Mississippi State, MS 39762

CIRCLE 105 ON FREE INFORMATION CARD

ELECTRONIC COMPONENTS

MOUSER ELECTRONICS
PURCHASING MANUAL NO. 842
120 PRODUCTS
160 PAGE
FREE CATALOG

MANUFACTURERS OF QUALITY ELECTRONIC COMPONENTS

- BATTERY CLIPS & HOLDERS
- CABLE SETS • CONNECTORS • CAPACITORS
- DISPLAYS • LEDs • FUSES • JACKS & PLUGS
- KNOBS • LAMPS • POTENTIOMETERS
- RF COILS • RELAYS • RESISTORS
- SWITCHES • SEMICONDUCTORS • SPEAKERS
- TEST EQUIPMENT • TRANSFORMERS • TOOLS
- WIRE & CABLE

OVER 15,000 DIFFERENT ITEMS IN STOCK!

- Sales and Order Desk Open from 6:00 a.m. (PST)
- TERMS: C.O.D. Visa, MasterCard (Open Accounts Available)
- Phone and Mail Orders Welcome
- Catalogs Mailed Outside USA
- Send \$2.00

MOUSER ELECTRONICS
11433 WOODSIDE AVE. SANTEE, CA 92071
PHONE: (619) 449-2222 TWX: 910-331-1175

CIRCLE 117 ON FREE INFORMATION CARD

RAMSEY

THE FIRST NAME IN ELECTRONIC TEST GEAR

NEW



20 MHz DUAL TRACE OSCILLOSCOPE

Unsurpassed quality at an unbeatable price, the Ramsey oscilloscope compares to others costing hundreds more. Features include a component testing circuit for resistor, capacitor, digital circuit and diode testing • TV video sync filter • wide bandwidth & high sensitivity • internal graticule • front panel trace rotator • Z axis • high sensitivity x-y mode • regulated power supply • built-in calibrator • rock solid rigging

\$399⁹⁵*
high quality hook on probes included

*USA—Add \$10.00 per unit for postage, overseas orders add 15% of total order for insured surface mail.

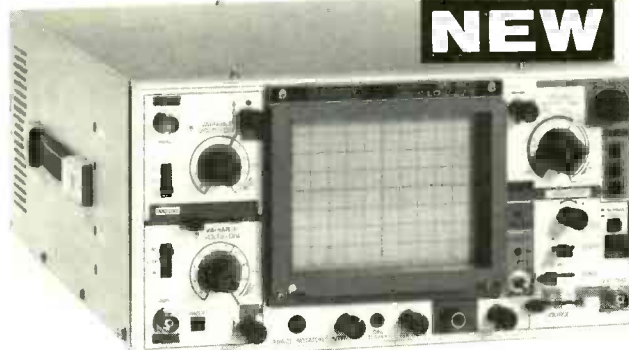

45 MHz DUAL SWEEP OSCILLOSCOPE

The Ramsey 625 is a dual time base, delayed sweep unit that includes a built-in signal delay line to permit clear viewing during very short rise times of high frequency waveforms. Other features include, variable trigger holdoff • 20 calibrated sweep time ranges from 0.5 s/div to 0.2 μs/div • fully adjustable sweep time • X5 sweep magnification • five trigger sources, CH1, CH2, LINE EXTERNAL and INTERNAL (V mode) • front panel x-y operation, Z axis input • sum difference of CH1, and CH2 waveforms displayed as single trace • sweep gate and sweep output • auto focus • single sweep

\$799⁹⁵*
high quality hook on probes included

*Same as unit to left.

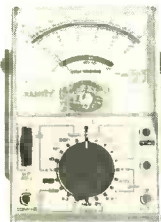

RAMSEY D-1100 VOM MULTITESTER

Compact and reliable, designed to service a wide variety of equipment. Features include • mirror back scale • double-jeweled precision moving coil • double overload protection • an ideal low cost unit for the beginner or as a spare back-up unit.

\$19⁹⁵ test leads and battery included



NEW RAMSEY 1200 VOM MULTITESTER

Check transistors, diodes and LEDs with this professional quality meter. Other features include: decibel scale • 20K volt metering system • 3 1/2" mirrored scale • polarity switch • 20 measuring ranges • safety probes • high impact plastic case

\$24⁹⁵ test leads and battery included

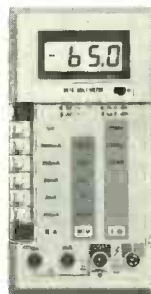

RAMSEY D-3100 DIGITAL MULTIMETER

Reliable, accurate digital measurements at an amazingly low cost • in-line color coded push buttons, speeds range selection • abs plastic tilt stand • recessed input jacks • overload protection on all ranges • 3 1/2 digit LCD display with auto zero, auto polarity & low BAT indicator

\$49⁹⁵ test leads and battery included

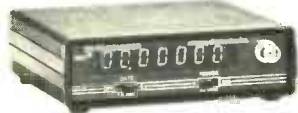

CT-70 7 DIGIT 525 MHz COUNTER

Lab quality at a breakthrough price. Features • 3 frequency ranges each with pre amp • dual selectable gate times • gate activity indicator • 50mV @ 150 MHz typical sensitivity • wide frequency range • 1 ppm accuracy

\$119⁹⁵ wired includes AC adapter

CT-70 kit \$99.95
BP-4 nicad pack 8.95



CT-90 9 DIGIT 600 MHz COUNTER

The most versatile for less than \$300. Features 3 selectable gate times • 9 digits • gate indicator • display hold • 25mV @ 150 MHz typical sensitivity • 10 MHz timebase for WWV calibration • 1 ppm accuracy

\$149⁹⁵ wired includes AC adapter

CT-90 kit \$129.95
OV-1 0.1 PPM oven timebase 59.95
BP-4 nicad pack 8.95



CT-125 9 DIGIT 1.2 GHz COUNTER

A 9 digit counter that will outperform units costing hundreds more. • gate indicator • 24mV @ 150 MHz typical sensitivity • 9 digit display • 1 ppm accuracy • display hold • dual inputs with preamps

\$169⁹⁵ wired includes AC adapter

BP-4 nicad pack 8.95



CT-50 8 DIGIT 600 MHz COUNTER

A versatile lab bench counter with optional receive frequency adapter, which turns the CT-50 into a digital readout for most any receiver • 25 mV @ 150 MHz typical sensitivity • 8 digit display • 1 ppm accuracy

\$169⁹⁵ wired

CT-50 kit \$139.95
RA-1 receiver adapter kit 14.95



DM-700 DIGITAL MULTIMETER

Professional quality at a hobbyist price. Features include 26 different ranges and 5 functions • 3 1/2 digit, 1/2 inch LED display • automatic decimal placement • automatic polarity

\$119⁹⁵ wired includes AC adapter

DM-700 kit \$99.95
MP-1 probe set 4.95



PS-2 AUDIO MULTIPLIER

The PS-2 is handy for high resolution audio resolution measurements, multiplies UP in frequency • great for PL tone measurements • multiplies by 10 or 100 • 0.01 Hz resolution & built-in signal preamp/conditioner

\$49⁹⁵ wired

PS-2 kit \$39.95



PR-2 COUNTER PREAMP

The PR-2 is ideal for measuring weak signals from 10 to 1,000 MHz • flat 25 db gain • BNC connectors • great for shifting RF • ideal receiver/TV preamp

\$44⁹⁵ wired includes AC adapter

PR-2 kit \$34.95



PS-1B 600 MHz PRESCALER

Extends the range of your present counter to 600 MHz • 2 stage preamp • divide by 10 circuitry • sensitivity: 25mV @ 150 MHz • BNC connectors • drives any counter

\$59⁹⁵ wired includes AC adapter

PS-1B kit \$49.95

ACCESSORIES FOR RAMSEY COUNTERS

- Telescopic whip antenna—BNC plug \$ 8.95
- High impedance probe, light loading 16.95
- Low pass probe, audio use 16.95
- Direct probe, general purpose use 13.95
- Tilt bail, for CT-70, 90, 125 3.95



PHONE ORDERS CALL
716-586-3950
TELEX 466735 RAMSEY CI

TERMS: • satisfaction guaranteed • examine for 10 days; if not pleased, return in original form for refund • add 6% for shipping and insurance to a maximum of \$10.00 • overseas add 15% for surface mail • CDD add \$2.50 (CDD in USA only) • orders under \$15.00 add \$1.50 • NY residents add 7% sales tax • 90 day parts warranty on all kits • 1 year parts & labor warranty on all wired units.



RAMSEY ELECTRONICS, INC.
2575 Baird Rd.
Penfield, N.Y. 14626

SPARTAN Electronics Inc



CALL (516) 499-9500
6094 Jericho Tpke.
Commack, N.Y. 11725

CTC9R.

Philips Remote Cable Converter

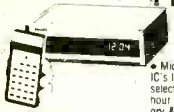

Micro computer technology • Quartz controlled IC's lock in picture & prevent drift • 60 channel selections • Programmable time on & off • 24 hour LED digital clock • Favorite channel memory & recall plus scan • Wireless hand held "infra-red" transmitter system • Automatic line tune • Adaptable to any brand television • One year warranty service.

\$129.95

Jerrod 58 Channel Wireless Remote Converter \$84.95
Jerrod 36 Channel Remote CATV Converter w/on/off Fine Tuning \$74.95

CABLES

RS232 male-male 6' pins 1-8 & 20 14.95

RS232 to Centronics 6' parallel printer cable 21.95

REFURBISHED MONITORS

9" and 12" Bell & Howells or GBC Commercial Grade as low as \$10.00 off with a purchase of 2 refurbished monitors

\$39.95



RS232 TRANSMISSION LINE TESTER

Features: 1 All 25 Signal lines accessible. Dual Color. Red/Green.

Accessories: 1 Cable 10' male to Female Extension Jumper Set 6 Straight 1 T-Jumper Vinyl Case.

\$169.95



POCKET TECHNOLOGY INC. 10 MHz LogicScope 136

10 MHz Real Time Hand-held
50-100 NS Glitch Catcher
True Dual Trace
Two 200 Element LED Displays
50-100 Bit Waveform Memories
3 Input Channels (A, B, T)
9 Volt Batteries AC Operation
Light Weight, Hand Held
Audio Functions



CALL IN STOCK

The Next Logical Step in Test Instrumentation

The LogicScope 136 combines the function of Logic Analyzer and Oscilloscope Technology and weighs only 1.15 pounds!

BEFORE YOU PAY \$\$ FOR A TELEPHONE SERVICE CALL, TEST IT YOURSELF

Telephone Line Analyze Model #1042



— Tests telephone line functions that affect telephone operation
— Verifies line and ring voltage levels
— Checks condition of telephone line from central office to user's telephone jack
— Verifies telephone line polarity that can affect polarity sensitive telephones

\$19.95



PROFESSIONAL TELEPHONE PRODUCT TESTER

Features: MODEL 1045

• Provides basic operation-tests for corded and cordless telephones, answering machines, and automatic dialers
• Checks telephone line cords and handsets cords for continuity, shorts and intermits
• Verifies number dialed and redial for pulse or touch-tone telephones
• Provides low and normal level ring test sequence
• Verifies that voice and DTMF (Dual Tone Multiple Frequency) tones are above minimum required level

\$335.95



• Can be used by the consumer without the aid of a salesperson—an easy-to-follow instruction card is provided with the tester
• Can be used by the salesperson to demonstrate operation and features of telephone products and to screen returns before making an exchange

Dealers Welcome

VISA MC BAC Amex All above prices include 3% cash discount C O D money order check Add for

Volume Discounts
Min Order \$25.00 Shipping to 75.00 \$2.50
International shipping Add 76.00 to 250.00 \$4.50
Prices subject to change 251.00 to 500.00 \$6.00
without notice, 501.00 to 750.00 \$8.50
COD 2.00 Extra Add shipping for monitors 751.00 to 1000.00 \$12.00
Over 1000.00 \$12.50

(516) 499-9500 Mon Th Tu W F Sa

499-9500 9-8 9-6 9:30-5

CIRCLE 75 ON FREE INFORMATION CARD

ADVERTISING INDEX

RADIO-ELECTRONICS does not assume any responsibility for errors that may appear in the index below.

| Free Information Number | Page | | Page |
|-------------------------|---------------------------------|------------|--------------------------|
| 263 | A.I.S. Satellite | 102 | 260 New-Tone Electronics |
| 50 | A.W. Sperry | 115 | 89 PTS |
| 108 | AMC Sales | 120 | — Pacific Cable |
| 76 | AP Products | 23 | 90 Paia |
| — | Active Electronics | 126 | 253 PanaVise |
| — | Advance Electronics | 33,34,35 | 68,274,297, Philips ECG |
| 106 | Advanced Computer Products | 132 | 298,299 |
| 107 | All Electronics | 129 | 116 Philips Tech |
| 72 | Amazing Devices | 136 | — Phoenix Electronics |
| 84 | Appliance Service | 103 | 125 Power Plus |
| 52 | Augat | 122 | 267 Quietrole |
| 77 | B&K Precision | CV3 | 254 RAG Electronics |
| 53 | BUYUS | 103 | — RCA D&SP |
| — | Barta | 121 | 78 Radio Shack |
| 98 | Beckman Instruments | 24,25 | 70 Ramsey |
| — | CIE | 38 | 257 Regency |
| 109 | Chaney | 136 | 73 Sintec |
| 54 | Chemtronics | 28 | 75 Spartan Electronics |
| — | Command Productions | 107 | — Tektronix |
| 79 | Communications Electronics | 2 | — Texas Instruments |
| — | Coop's Satellite Digest | 15 | 264 Unitech |
| 255 | DICK SMITH ELECTRONICS | 57-72 | 271 Wavetek |
| 266,272 | Deco Industries | 102,103 | |
| 256 | Diehl Engineering | 106 | |
| 82 | Digi-Key | 133 | |
| — | Digital Research Computers | 122 | |
| 57 | Digitron | 104 | |
| 110 | Dokay | 128 | |
| — | Educacal Publications | 47 | |
| — | Elec. Industry Association | 113 | |
| 269 | Electronic Salvage Parts | 119 | |
| 60 | Electronic Specialists | 136 | |
| 261 | Electronics Book Club | 7 | |
| 120 | Elephant Electronics | 103 | |
| 111 | Etronix | 118 | |
| 100 | Firestik II | 118 | |
| 251 | Fluke Manufacturing | 5 | |
| — | Fordham Radio | 13,37, CV4 | |
| 252 | Galaxy | 103 | |
| 265 | Gemini Electronics | CD2 | |
| — | Grantham College of Engineering | 48 | |
| 86,262 | Heath | 17,89,91 | |
| 113 | JDR Microdevices | 134,135 | |
| 114 | Jameco | 130,131 | |
| 124 | James Walter Satellite Rec. | 103 | |
| 115 | Jensen Tools | 103 | |
| 258 | Kepro Circuit Systems | 46 | |
| 273 | Logical Technologies | 102 | |
| 87 | MCM Audio | 125 | |
| 105 | MFJ | 136 | |
| — | McGraw Hill Book Club | 29 | |
| 67 | McIntosh Labs | 16 | |
| 270 | Micro-Mart | 124 | |
| 117 | Mouser | 136 | |
| — | NRI | 8 | |
| — | NTS | 18 | |

Gernsback Publications, Inc.
200 Park Ave. South
New York, NY 10003
(212) 777-6400
Chairman of the Board:
M. Harvey Gernsback
President: Larry Steckler

ADVERTISING SALES 212-777-6400

Larry Steckler
publisher
Shelli Weinman
advertising associate
Arline Fishman
advertising coordinator
Lisa Strassman
credit manager
Donna Sala
credit associate
Naomi Matten
advertising assistant

Sales Offices

EAST/SOUTHEAST

Stanley Levitan
Radio-Electronics
200 Park Ave. South
New York, NY 10003
212-428-6037, 212-777-6400

MIDWEST/Texas/Arkansas/Okla.

Ralph Bergen
Radio-Electronics
540 Frontage Road—Suite 325
Northfield, IL 60093
312-446-1444

PACIFIC COAST/ Mountain States

Marvin Green
Radio-Electronics
15335 Morrison St.—Suite 227
Sherman Oaks, CA 91403
818-986-2001

New from B&K-PRECISION, for telephone service, test and repair

COMPLETE TELEPHONE PRODUCT ANALYZER. A total self-contained system for diagnostic testing, servicing and calibration of corded and cordless telephones, answering machines and automatic dialers. Performs every test you'll ever need to test and repair any phone product including verification of pulse and touch-tone numbers, measurement of frequency error and modulation deviation. **MODEL 1050 \$1695**



MODEL 1050 \$1695

CORDLESS TELEPHONE TESTER. Provides full servicing and calibration capability for base and portable phone units. All of test and measurement functions. Replaces expensive FM generators and modulation monitors, yet performs all tests required for cordless phone system analysis and repair, including full frequency testing and alignment. Generates all prior and recently approved frequencies. **MODEL 1047 \$895**



MODEL 1047 \$895



MODEL 1045 \$395

TELEPHONE PRODUCT TESTER. For in-store consumer or service use. Tests handset cord, phone line cord, dial/record functions, voice and dial number levels, ring function and voice quality of corded and cordless phones, answering machines and automatic dialers. **MODEL 1045 \$395**



MODEL 1042 \$19.95

TELEPHONE LINE ANALYZER. Quickly identifies a problem as external or in the phone itself. Tests for condition of external phone line, phone line cord, ring and line voltage levels and polarity. Easy to use, no batteries or external power needed. **MODEL 1042 \$19.95**

These test instruments cover every possible level of service required for telephone products. They are equally useful for training. The instruction manuals provided offer a comprehensive course of training for service personnel and students. Call your nearest B&K-PRECISION distributor for off-the-shelf-delivery or additional information—or contact B&K-PRECISION.

B&K PRECISION DYNASCAN CORPORATION

6460 West Cortland Street • Chicago, Illinois 60635 • 312 889-9087

International Sales: 6460 W. Cortland St., Chicago, IL 60635
 Canadian Sales: Atlas Electronics, Ontario
 South and Central American Sales: Empire Exporters, Plainville, NY 11803

CIRCLE 77 ON FREE INFORMATION CARD

PERFORMANCE

SCOPE HAND-HELD DIGITAL CAPACITANCE and MULTIMETERS

- 0.5% DC Accuracy
- Highest Quality
- Highest Performance
- Lowest Prices

THE ULTIMATE TEST



Model DCM-602
\$7995

Digital Capacitance Meter

8 ranges with full scale values to 2000 μF

FEATURES • Broad test range - 1 pF to 2000 μF • LSI circuit provides high reliability and durability • Lower power consumption • Clear readout even in bright light • Crystal time base • Easy to operate, compact, lightweight • Protected from charged capacitors • Frequency range - 800 Hz to 8 Hz



Model DVM-634
\$4875

7 functions, 32 ranges.
Transistor measurement included.

Digital Multimeters

- DC Voltage 100 μV - 1000 V
- AC Voltage 100 μV - 750 V
- AC/DC Current 200 μA - 10 Amps
- Resistance 20 Megohms
- Capacitance (DVM 636/638) 1 pF - 20 μF



Model DVM-638
\$7995

11 functions, 38 ranges.
Includes logic level detector, audible visual continuity, capacitance and conductance measurement.



Model DVM-636
\$6275

8 functions, 37 ranges.
Capacitance measurement included.

FEATURES • Overload Protection • Auto-decimal LCD readout • Polarity Indication • 3000 hour battery life with 9V transistor battery • Low battery indication

Charge it with VISA/MASTERCARD. Money orders, checks accepted. C.O.D.'s require 25% deposit.

Fordham

260 Motor Parkway, Hauppauge, NY 11788

Toll Free
800-645-9518
In NY State 800-832-1446

Service and Shipping Charge Schedule

| FOR ORDERS | ADD |
|----------------|---------|
| \$25-250 | \$4.50 |
| \$251-500 | \$6.50 |
| \$501-750 | \$8.50 |
| \$751-1,000 | \$12.50 |
| \$1,001 and up | \$15.00 |