

\$1.25 ■ JULY 1979

Radio-^{IND}Electronics®

THE MAGAZINE FOR NEW IDEAS IN ELECTRONICS

VIDEODISC CIRCUITRY

What's inside

NEW DC AUDIO AMPS

Deliver ultra-wide response

PC BOARDS

How to make your own

DIGITAL THERMOMETER

°F and °C with 0.1° resolution

R.E.A.L. SOUND LAB

Yamaha top-of-the-line receiver

SWITCHING POWER SUPPLIES

How to design your own

Build this
HEART RATE MONITOR
Direct readout unit

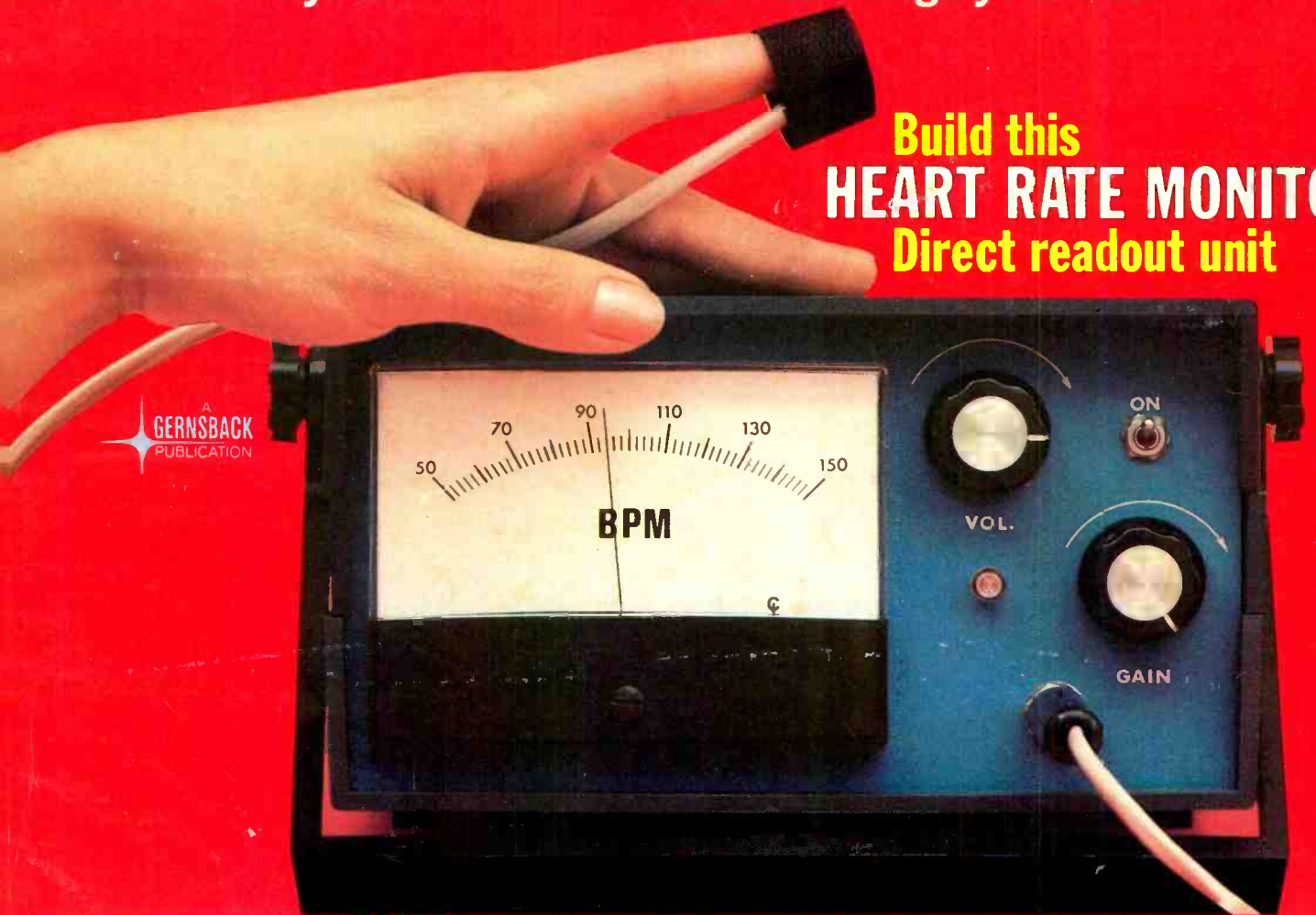

A
GERNSBACK
PUBLICATION



PLUS

- ★ **TEMP MEASUREMENT**
Clue in servicing
- ★ **AUDIO TEST STATION**

- ★ **HOBBY CORNER**
New twist for digital clocks
- ★ **SERVICE CLINIC**
Beware of intermittents

PULSEMAKER

It's a digital signal injector. And it thinks for itself.

It may look like a logic probe... but our DP-1 Digital Pulser is a lot more unique. This handheld, circuit-powered instrument is actually a miniature pulse generator built to speed digital troubleshooting.

Touch it to a circuit, and CP-1 automatically senses the logic state. So when you push the button, out comes one perfect pulse—preset to the logic family you're working with—of the proper polarity to force the state the other way. Hold the button down for a second and it starts injecting a 100pps pulse train. With all the punch you need—up to 100 mA.

Think what a help that can be when your logic circuit is doing something illogical. (And just in case you do something illogical, we've included reverse-polarity and short-circuit protection, as well.)

It's smart to save time with a DP-1. At \$74.95*, it's a smart buy, too.

Smarter tools for testing and design.

CONTINENTAL SPECIALTIES CORPORATION



70 Fulton Terrace, New Haven, CT 06509 (203) 624-3103, TWX 710-465-1227
OTHER OFFICES: San Francisco: (415) 421-8872, TWX 910-372-7992
Europe: CSC UK LTD,PHONE Saffron-Walden 0799-21682, TLX 817477
Canada: Len Fentler Ltd., Ontario

Call toll-free for details **1-800-243-6077**

*Suggested U.S. resale. Available at selected local distributors.
Prices, specifications subject to change without notice.
© 1979 Continental Specialties Corporation

CIRCLE 16 ON FREE INFORMATION CARD

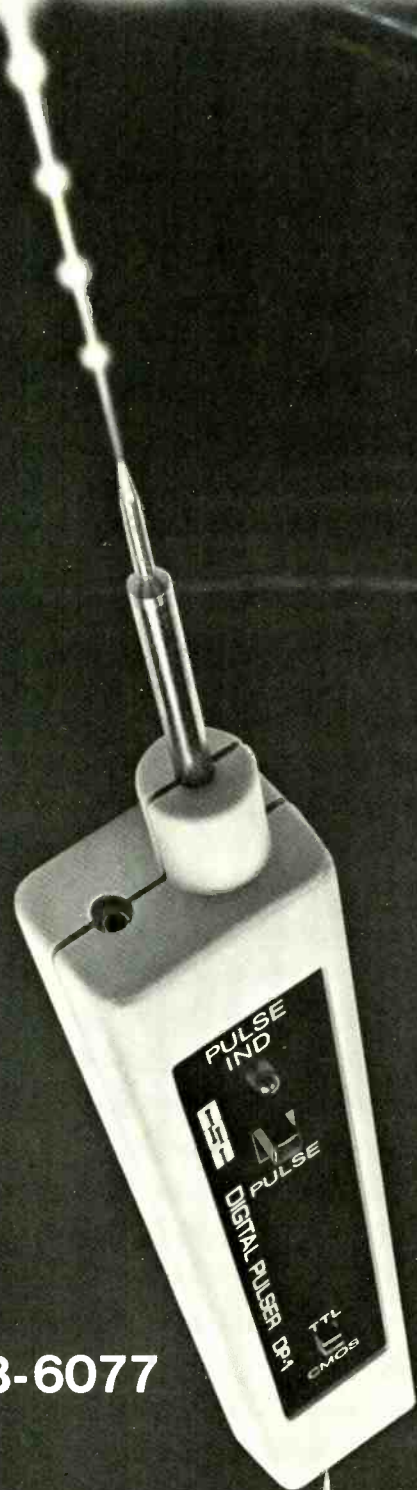

Don't take our word for it.

"We can heartily recommend the Superboard II computer system for the beginner who wants to get into microcomputers with a minimum of cost. Moreover, this is a 'real' computer with full expandability."

Popular Electronics March, 1979

"(Their) new Challenger 1P weighs in at \$279 and provides a remarkable amount of computing for this incredible price."

Kilobaud Microcomputing February, 1979

"Over the past four years we have taken delivery on over 25 computer systems. Only two have worked totally glitch free and without adjustment as they came out of the carton: The Tektronic 4051 (at \$7,000 the most expensive computer we tested) and the Ohio Scientific Superboard II (at \$279 the least expensive) . . . The Superboard II and companion C1P deserve your serious consideration."

Creative Computing January, 1979

"The Superboard II and its fully dressed companion the Challenger 1P series incorporate all the fundamental necessities of a personal computer at a very attractive price. With the expansion capabilities provided, this series becomes a very formidable competitor in the home computer area."

Interface Age April, 1979

"The graphics available permit some really dramatic effects and are relatively simple to program . . . The fact that the system can be easily expanded to include a floppy means that while you are starting out with a low-cost minimal system, you don't have to throw it away when you are ready to go on to more complex computer functions. Everything is there that you need; you simply build on to what you already have. You don't have to worry about trading off existing equipment to get the system that will really do what you want it to do. At \$279, Superboard II is a tough act to follow."

Radio Electronics June, 1979

"The Superboard II is an excellent choice for the personal computer enthusiast on a budget."

Byte May, 1979

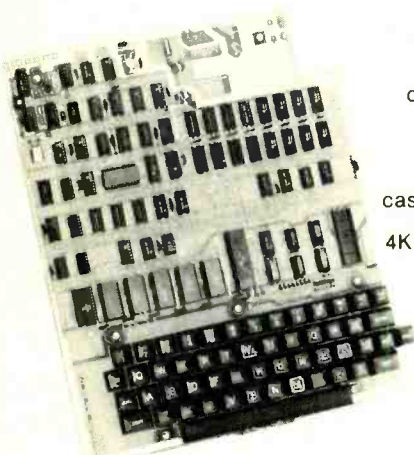

SUPERBOARD II **\$279.00**

The world's first complete computer system on a board including full keyboard, video display, audio cassette interface, 8K BASIC-in-ROM and 4K RAM. Expandable. Requires +5V at 3 amp power supply.



C1P \$349.00

Complete with enclosure and power supply. All features of Superboard II. Easy to expand to more memory and floppy disk.



C1P MF \$995.00
The first floppy disk based computer system the world has ever seen for under \$1,000. 8K BASIC-in-ROM, 12K RAM. Expandable to 32K RAM.

OHIO SCIENTIFIC

1333 S. CHILLICOTHE RD., AURORA, OHIO 44202 (216) 562-3101

See your Ohio Scientific dealer for full details.

CIRCLE 5 ON FREE INFORMATION CARD

DATA PRECISION Model 935 DIGITAL MULTIMETER

\$149



- **ACCURATE** — basic 0.1% DC accuracy — better than that of many bench/lab DMM's.

- **VERSATILE** — all the functions and ranges you need...29 in all: volts & amps, AC & DC switchable HI & Lo ohms.

- **ECONOMICAL** — operates up to 200 hours on a standard 9V alkaline battery.

- **TOUGH** — built to take rough everyday field usage and electrical overload... yet maintain its calibration.

- **HANDY** — easy to hold, to carry, to use, to read...

- **RELIABLE** — backed by a full 2-year warranty.

ALSO AVAILABLE —
Model 938

0.1 • 3½-digit CAPACITANCE METER,
only \$149. Ask for details.

Order Toll-Free: Call 800-223-0474

BASIC SPECIFICATIONS

- 24 Measurement Ranges:
 - 100μV—1000VDC, 5 ranges, ±0.1% Accuracy
 - 100μV—700VAC, 5 ranges, ±0.5% Accuracy
 - 1μA—2A DC, 4 ranges, ±0.5% Accuracy
 - 1μA—2A AC, 4 ranges, ±0.75% Accuracy
 - 100mΩ—20MΩ, 6 ranges, 0.1—0.3% Accuracy
- 3½-Digit, ½" Liquid-Crystal Readout
- Automatic Polarity Indication
- Automatic Overload Indication
- Automatic Low-Battery Indication
- Optional Battery Eliminator Available, for 120VAC ±10%, 50—60Hz line operation
- 6¾"L. x 3½"W. x 1½"H. Weighs 11 oz.

CIRCLE 69 ON FREE INFORMATION CARD

ADVANCE ELECTRONICS

54 W. 45th Street, New York, N.Y. 10036, (212) 687-2224



PLEASE SEND ME:

- Model 935 DMM @ \$149.00
- CS11 20-amp Current Shunt @ \$20.00
- CC35 Vinyl Carrying Case @ \$7.00
- BE9 Battery Eliminator (120VAC, 50—60Hz) @ \$15.00

Payment Enclosed Bill my: Master Charge Visa
Add \$3.00 to cover postage and handling. N.Y. residents add sales tax.

Account # _____ Exp. Date _____

Name _____

Address _____

City, State, Zip _____

Radio-Electronics®

THE MAGAZINE FOR NEW IDEAS IN ELECTRONICS

Electronics publishers since 1908

JULY 1979 Vol. 50 No. 7

BUILD ONE

- 35 **Heart Rate Monitor**
Provides a direct readout of your pulse rate in beats-per-minute.
by **Mark C. Worley**
- 42 **Digital Thermometer**
With a 3½-digit LED display this device measures temperature in Celsius and Fahrenheit to 0.1 degree resolution.
By **Bill Owen**
- 54 **Audio Test Station**
Concluding article provides the step-by-step calibration procedures.
by **Ray Davison**

VIDEO

- 39 **Videodisc—A Look At The Circuitry**
Part 2—What's inside the new videodisc players
by **Larry Steckler**
- 74 **Service Clinic**
Intermittents can cause strange symptoms
by **Jack Darr**
- 74 **Service Questions**
R-E's Service Editor solves technician problems.

AUDIO

- 47 **DC Amplifiers**
New audio amplifier circuitry provides ultra-wide frequency response.
by **Len Feldman**
- 50 **R.E.A.L Sound Lab Tests Yamaha CR-2040 Receiver**
Top-of-the-line receiver rates excellent

TECHNOLOGY

- 4 **Looking Ahead**
Tomorrow's news today
by **Dave Lachenbruch**
- 58 **Make Your Own PC Boards**
A look at the tools and techniques.
by **James Temple**
- 61 **Switching Power Supplies**
How to design your own
by **L. Steven Cheairs**
- 64 **Secret Weapon Against Tough Dogs**
Temperature measurement helps localize faults
by **Henk Onstee and Stu Rauch**
- 66 **Hobby Corner**
Modification for digital clocks provide long delay alarm.
by **Earl "Doc" Savage, K4SDS**
- 68 **State-Of-Solid-State**
New A/D converter fast enough to digitize video signals
by **Karl Savon**

EQUIPMENT

- 24 **Graymark Model 540 Binary Clock**
- 25 **BSR System X10 AC Remote Control**
- 26 **RCA COSMAC Evaluation Kit**

DEPARTMENTS

- | | | | |
|-----|-----------------------|----|-----------------|
| 112 | Advertising Index | 90 | Market Center |
| 76 | Computer Products | 88 | New Literature |
| 6 | Editorial | 78 | New Products |
| 113 | Free Information Card | 85 | Stereo Products |
| 12 | Letters | | |

ON THE COVER

Using an infrared sensor that clips to your finger, this Heart Rate Monitor provides a direct readout of your pulse rate in beats-per-minute. It also "beeps" to provide an audible indication. Sounds interesting? Read about it starting on page 35.

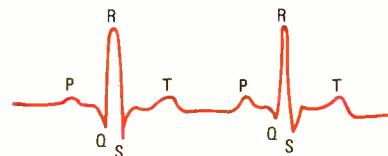

HEART WAVEFORM is detected by Heart Rate Monitor circuit to provide a direct readout in beats-per-minute. To see how it works, turn to page 35.



COMPLEX WAVEFORMS are needed to compare the performance of DC amplifiers. To find out why, turn to page 47.

Radio-Electronics, Published monthly by Gernsback Publications, Inc., 200 Park Avenue South, New York, NY 10003. Phone: 212-777-6400. Controlled Circulation Postage Paid at Concord, NH. One-year subscription rate: U.S.A. and U.S. possessions, \$9.98, Canada, \$12.98. Other countries, \$14.98. Single copies \$1.25. © 1979 by Gernsback Publications, Inc. All rights reserved. Printed in U.S.A. (ISSN 0033-7862)

Subscription Service: Mail all subscription orders, changes, correspondence and Postmaster Notices of undelivered copies (Form 3579) to Radio-Electronics Subscription Service, Box 2520, Boulder, CO 80322.

A stamped self-addressed envelope must accompany all submitted manuscripts and/or artwork or photographs if their return is desired should they be rejected. We disclaim any responsibility for the loss or damage of manuscripts and/or artwork or photographs while in our possession or otherwise.

As a service to readers, Radio-Electronics publishes available plans or information relating to newsworthy products, techniques and scientific and technological developments. Because of possible variances in the quality and condition of materials and workmanship used by readers, Radio-Electronics disclaims any responsibility for the safe and proper functioning of reader-built projects based upon or from plans or information published in this magazine.

Looking ahead

Videodisc jockeying: With one videodisc system on the market in limited quantities (Philips/MCA/Magnavision) and one promised for late 1980 or 1981, it would appear that there would be little room for additional systems. Although many different systems have been demonstrated in the past, it has been tacitly acknowledged that Philips and RCA would fight it out between themselves for the upcoming videodisc market. Of course, this left the Japanese without an entry in videodiscs, but because of their preoccupation with videotape at the present time, some knowledgeable industry sources assumed the Japanese would sit this one out and, when the proper time came, adopt either the Philips (optical) or the RCA (capacitance) system. But Japan's biggest consumer electronics manufacturer, Matsushita, apparently feels the stakes are too high to wait passively. Matsushita's earlier videodisc system, called "Visc," could easily have been brought into compatibility with RCA's capacitance system, and most observers thought it would be.

It was surprising, therefore, when, at a very late stage in the game, Matsushita introduced a new videodisc system and pointedly said it was ready for production. The new "Visc-O-Pac" is a variable-speed disc that can store at least two hours on two sides of a 9-inch-diameter record. The speed varies from 300 rpm at the outside of the disc to 700 near the center. Like the original Visc, the new system uses grooved discs and reads them out mechanically with a "twist stylus" that translates the disc's hills and dales to variations in torque. The new disc is packed in a transparent case that is automatically removed when the record is played and restored when playing is complete. RCA's SelectaVision discs are 12 inches in diameter and revolve at a constant 450 rpm. Each one is packed in a plastic caddy, which is slid into the changer and pulled out.

An RCA spokesman says SelectaVision's design is "frozen" and won't be changed to compromise with the new Matsushita system. If Matsushita really intends to introduce a third "standard," it could have a rough road since both RCA and MCA have been lining up programming for the capacitance and optical systems, respectively, and Matsushita would appear to be well behind in this activity. Matsushita would be a formidable ally for either proponent, and both the Philips/MCA and RCA camps are trying to determine whether it really will seriously pursue a third system or whether Matsushita is using Visc-O-Pac to improve its bargaining position or is trying to delay the videodisc market to avoid cutting into the videocassette boom.

Eight shows, one channel: Borrowing liberally from other people's inventions, RCA Americom, which operates Satcom satellites, is proposing a new transmission system to the Armed Forces Radio & Television Service that will make possible simultaneous reception of TV shows. AFRTS, which operates about 150 TV stations at U.S. military bases on foreign soil, currently does most of its programming by videocassettes shipped from the U.S. RCA proposes to supply two TV channels, five full 15-kHz

audio channels and an on-screen teletext channel, carrying them all on a single satellite channel. They would be beamed directly via Satcom to U.S. bases in the Western Hemisphere and relayed to Intelsat to serve U.S. troops elsewhere.

The two-channels-in-one are derived from an invention by CBS and Thomson-CSF called STRAP, or Vidiplex, which interweaves two separate TV pictures using alternate fields of each picture. The missing fields are reconstructed at the receiving end from information contained in adjacent fields. Four of the five audio channels are digitally encoded into the television picture by a process called DATE (digital audio for TV) developed by the Public Broadcasting System. The teletext channel is carried in the TV signal's vertical interval.

Pocket 'brains': The successor to the pocket calculator almost certainly will be the hand-held memory or micro-computer or whatever you want to call it—it's so new there's no generic name for it yet. The trend started with the pocket "memo pad" that could store about 30 phone numbers or whatever you wanted to store in it. Now memories have been sharply expanded, and two hand-held "language translators" have come on the market at almost exactly the same time. Called the Lexicon and the Craig M100, they are made by different companies but both are presumably based on the same Mostek IC. They both sell in the \$200 range and contain alphanumeric keyboards, doing double duty as calculators and metric converters.

Although there are differences between the two, let's discuss the Craig as probably "typical" of this new type of device. Initially, finger-sized program cartridges are available for English, French, German, Spanish and Japanese. Three cartridges can be loaded into the battery-operated unit at one time, and translations can be made from any one to any other. Each cartridge has a "vocabulary" of 1,500 words or phrases. In addition, 50 commonly used phrases are listed on the back of the translator, with a code number for each. You just type the code number on the translator and the foreign equivalent appears on the fluorescent display that holds up to 16 letters but can accommodate more with a right-to-left crawl similar to that on a movie theater marquee display. Any of 1,500 words may be entered on the keyboard for translation to any language whose cartridge is inserted in the machine. In addition, the unit helps correct spelling, works as a language quiz machine and fulfills other language-learning functions.

While the first generation of these machines helps accomplish the obviously important function of language translation, future cartridges will fulfill other needs. Recipe storage, dictionary synonyms and calorie counting come to mind immediately—and undoubtedly there will be more. According to Craig, a near-future generation of the machine will be programmable, making it an important device for storage of personal information.

DAVID LACHENBRUCH
CONTRIBUTING EDITOR

LOW TIM MAKES THE LISTENING DIFFERENT.

COMPARABLE AMPLIFIERS DO SOUND DIFFERENT

Choosing the best amplifier for your audio system involves comparing specs, features and, of course, price. But ultimately, if you love music, you should base your decision on the way an amplifier sounds when reproducing music.

Two amplifiers may have identical power ratings and virtually no Total Harmonic Distortion, but can sound very different: one clean and clear, the other harsh and metallic. The difference you hear is Transient Intermodulation Distortion (TIM, for short). The real effects of TIM on music, however, have only recently been recognized, since TIM does not show up in even the most accurate traditional laboratory measurements.

Measurements for THD are made with smooth, repetitive signals (sine waves). Music, on the other hand, presents an amplifier with a series of non-repeating, pulsive, "transient" signals, as illustrated below.

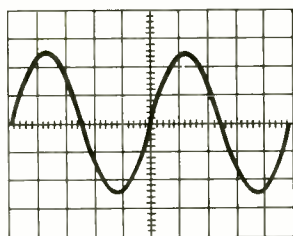

SINE WAVES

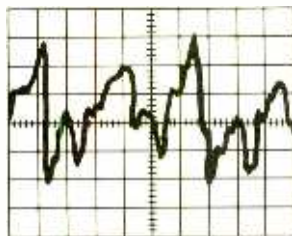

DYNAMIC MUSIC SIGNALS

An amplifier that cannot faithfully follow the sharp transients demanded by music may have very low THD, but very high TIM.

WHAT CAUSES TIM?

It has been discovered that TIM distortion in an amplifier is caused by an insufficient slew rate — the engineer's term for an amplifier's ability to handle the high power, high frequency signals a musical transient presents. Poor slew rate in conventional amplifiers is most often caused by the very mechanism used to reduce THD, namely, the addition of negative feedback. Put more simply, in conventionally-designed power amplifiers, the more negative feedback you use, the lower will be the THD (which is good), but the higher will be the TIM (which is not so good).

It took Sansui, and a whole new approach to amplifier design, to solve the high-frequency slew-rate problems of TIM without compromising our superbly low THD specifications.

THE SANSUI SOLUTION

The most important step in the solution was to "speed up" (increase the frequency response of) the basic amplifier — even before negative feedback is applied — by using Sansui's own patent-pending DD/DC (Diamond Differential/Direct-Coupled)



AU-919 DD/DC AMPLIFIER

circuit. The DD/DC circuitry includes a sophisticated "lag + lag-lead" dual compensation system, more often found in instrumentation amplifiers than hi-fi products, which maintains stability without decreasing frequency response. With DD/DC, the amplifier can instantly supply the enormous negative feedback current demanded by transients, without restricting the slew rate, so without introducing TIM.

How well our unique circuitry succeeds in eliminating TIM, while maintaining extraordinarily-low levels of THD is shown in these comparative curves. The Sansui AU-919 amplifier (bottom curve) is rated at 110 watts per channel, min. RMS, both channels into 8 ohms from 10Hz to 20,000Hz, with no more than 0.008% total harmonic distortion.

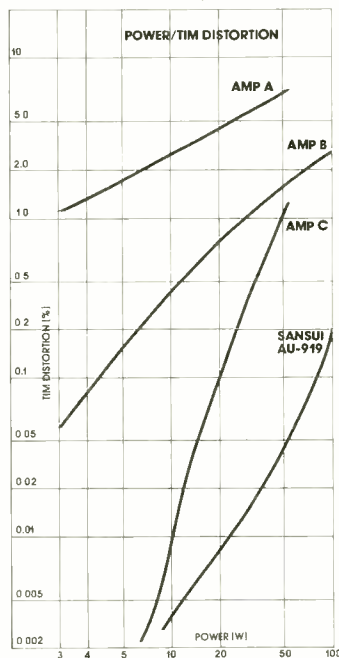

Power output vs. TIM distortion curves for the Sansui AU-919 and competitive amplifiers. Derived using the TIM measurement method described in a paper presented at the 63rd Convention of the AES May, 1979; available from Sansui on request.

LET YOUR EARS BE THE JUDGE

Instruments and circuit-design analysis are fine in their place, which is the laboratory. But you listen to music in your home; and we're confident that you will hear the difference in musical clarity that a Sansui amplifier makes. Your local Sansui authorized dealer can demonstrate all the convincing reasons for choosing Sansui.

SANSUI ELECTRONICS CORP.

Lyndhurst, New Jersey 07071 • Gardena, Ca. 90247
 Sansui Electric Co., Ltd., Tokyo, Japan
 Sansui Audio Europe S.A., Antwerp, Belgium
 In Canada, Electronic Distributors





A Call For New Ideas

Every magazine has an editorial policy. It provides the guidance that determines the subject matter that is covered on a monthly basis.

The editorial policy of **Radio-Electronics** is quite basic. We sum it up in one sentence and place it on the front cover each and every month, right below our logo. It reads: "*The Magazine for New Ideas in Electronics.*"

Simple? Sure, but oh how difficult to achieve. It means that we maintain contact with the engineering departments of the semiconductor houses, research labs, key manufacturers as well as various industry sources. We go right to the source, then sift out the best ideas and present them in the best way we know how, either as an application note, a construction or tutorial article, etc.

Certainly a percentage of the new ideas come from you, our reader. But the percentage is small. Too small. This could be interpreted to mean that our readers are basically idealess. This is surprising, as it has been our contention for many years that you, our reader, the electronics activist, are a vast untapped reservoir of new ideas. Why then, haven't we seen more of your ideas? We feel that the problem comes down to the fact that it is just too much of a pain to write an article about the ideas that you have. Let's face it; writing a three- or four-page article is downright difficult.

We now think we've found a solution. It's a new column and you guessed it, it's called New Ideas. It will consist of just about anything innovative. It could be a new circuit, IC application, gadget, or even an innovative use for a new component, a new way to hook up your test equipment, or a new or faster way to lay out or etch your PC boards.

Submitting your idea is easy, but it must include an illustration. If it is a new application of a component or a better circuit approach to something that has already been done, include a schematic or a pictorial drawing. You can draw it freehand, but be sure that it is legible. If we use it we'll have it redrawn by our illustrators. Otherwise, a photograph (black and white and in focus, please) will suffice.

The written description is also a lot easier than a full-length article; a maximum of four and a minimum of two typewritten pages, double-spaced. The first paragraph should describe your New Idea. Next, explain why it is innovative. The rest of the text should be a detailed explanation that includes any necessary information your fellow readers will need to be able to actually use it. Keep the words simple.

Submitting the idea is a matter of snipping out the coupon, filling it out, signing it and mailing it with your idea to us. The coupon contains some legal copyright jargon which gives us your permission to publish it. If we don't publish it we'll return all of the material to you.

If we do publish your New Idea, you'll see your name in print and we'll send you a check for \$25. So now what's your excuse? We know you have the ideas. Get up off your . . . er . . . laurels and write them up.

ART KLEIMAN
Managing Editor

Radio-Electronics®

Hugo Gernsback (1884-1967) founder
M. Harvey Gernsback, editor-in-chief and publisher
Larry Steckler, KTX-3644, CET, editor
Arthur Kleiman, KTZ-3288, managing editor
Robert F. Scott, CET, W2PWG, KXK-8533, technical editor
Sonia Greenbaum, copy editor
Jack Darr, CET service editor
Leonard Feldman, contributing high-fidelity editor
Karl Savon, semiconductor editor
Herb Freidman, communications editor
David Lachenbruch, contributing editor
Earl "Doc" Savage, K4SDS, hobby editor
Ruby Yee, production manager
Robert A. W. Lowndes, production associate
Marie J. Stolfi, production assistant
Harriet I. Matysko, circulation director
Arline R. Bailey, advertising coordinator

Cover design by Louis G. Rubsam
Cover photo by Mel Small

Radio Electronics is a member of the *Institute of High Fidelity* and is indexed in *Applied Science & Technology Index* and *Readers Guide to Periodical Literature*.

NEW IDEAS

All published entries will earn \$25 upon publication. Selections will be made at the sole discretion of the editorial staff of **Radio-Electronics**.

I agree to the above terms and grant **Radio-Electronics** Magazine the right to publish my idea. I declare that the attached idea is my own original material and that its publication does not violate any other copyright. I also declare that this material had not been previously published.

Title of Idea

Signature

Print Name

Date

Street

City

State

ZIP

Mail your idea along with this coupon to:

New Ideas
Radio-Electronics
200 Park Ave. South
New York, NY 10003



We confess.

To sell an advanced DMM for under \$70 we had to cut corners.



And we sure did! First, we cut off the dealer's mark-up. Then we shaved off the overhead costs of national sales offices and warehouses. Finally, as if that wasn't enough, we even cut out the high labor costs of factory assembly lines.

All in all, we cut over \$100-worth of corners! But not a single one that affected the quality and performance of our new DMM.

Don't let our low price fool you!

Because Sabtronics sells factory-direct — without all the hidden charges a dealer would track on — we can offer the superior 2010A DMM kit for a surprisingly low \$69.95. Surprising because you get the accuracy, features and performance you'd expect from the high priced units.

The 2010A offers you the long-term accuracy of a laser-trimmed resistor network, an ultra-stable band-gap reference element and single chip LSI circuitry — all in a compact, rugged, human-engineered housing. With 31 ranges and 6 functions, you can measure AC and DC volts from 100 μ V to 1000V; AC and DC current from 0.1 μ A to a surprisingly high 10A; resistance from 0.1 Ω to 20 M Ω . Typical DCV and Ohms accuracy is 0.1% \pm 1 digit. And you see these precise readings on a bright, 3 $\frac{1}{2}$ -digit

LED display with automatic decimal placement and large, 9mm numerals.

Of course, that's what you'd expect from a quality DMM. But we've even added more features for extra convenience, flexibility and reduction of human error.

- Unique X10 Multiplier Switch — gives you convenient push-button selection to the next higher decade range. Hi-Lo Power Ohms capability gives you three high-ohms ranges that supply enough voltage to turn on a silicon junction for diode and transistor testing. For in-circuit resistance measurement without turning on a semiconductor junction, you use the three low-ohms ranges.
- Wide Frequency Response — 40Hz to 40kHz bandwidth lets you measure audio through ultra-sonic AC signals.
- Touch and Hold Capability — with optional probe, retains readings for as long as you wish. You can make measurements in hard-

to-reach places without taking your eyes off the probe tip or stopping to record data.

- Plus More — Auto Polarity, Auto Zero, Overrange indication and fully overload protected on all ranges.

And, although designed for benchtop use, the sleek, compact 2010A is powered by 4 "C" cells (not included), bringing wide-range lab performance to the field when you need it.

You save either way.

Your 2010A DMM kit comes complete with easy-to-follow assembly instructions, all parts (including high-impact case), and test leads. You can complete assembly in a single evening. However, for a slight additional fee, Sabtronics will ship your 2010A factory-assembled and calibrated: at \$99.50 it's still an incomparable value!

Whether you're a professional or hobbyist, if quality and accuracy are important — and padded prices aren't — you should inspect the 2010A DMM for yourself. If you're not completely satisfied, return it in its original condition within 10 days for a prompt and courteous refund of purchase price. Call us with your MasterCharge or Visa order today, or simply fill out the convenient order form.

Making Performance Affordable

sabtronics INTERNATIONAL INC.

13426 Floyd Circle M/S 35 • Dallas, Texas 75243
Telephone 214/783-0994



Brief Specifications

DC Volts: 100 μ V to 1000V in 5 ranges

AC Volts: 100 μ V to 1000V in 5 ranges

DC Current: 0.1 μ A to 10 A in 6 ranges

AC Current: 0.1 μ A to 10 A in 6 ranges

Resistance: 0.1 Ω to 20 M Ω in 6 ranges

Diode Test Current: 0.1 μ A, 10 μ A, 1mA

ACV Frequency Response: 40Hz to 40kHz

Input Impedance: 10 M Ω on ACV and DCV

Overload Protection: 1200 VDC or RMS on all voltage ranges except 250 VDC or RMS on 200mV and 2V AC ranges. Fuse protected on ohms and mA ranges.

Power Requirement: 4.5 to 6.5 VDC (4 "C" cells) optional NiCd batteries or AC adapter/charger

Display: 0.36" (9.2mm) Digits reading to \pm 1999

Size: 8"W x 6.5"D x 3"H (203 x 165 x 76 mm)

Weight: 1.5 lbs. (0.68kg.) excl. battery

To: Sabtronics International, Inc. 13426 Floyd Circle M/S 35, Dallas, TX 75243

Please send me . . .

_____ Model 2010A Digital Multimeter kit(s) @ \$69.95 plus \$4.00† shipping and handling each	\$ _____
_____ Model 2010A Digital Multimeter Assembled @ \$99.50 plus \$4.00† shipping and handling each	\$ _____
_____ # AC-115 AC adapter/charger(s) @ \$7.50 each	\$ _____
_____ # NB-120 NiCd Battery set(s) @ \$17.00/set	\$ _____
_____ # THP-20 Touch and Hold Probe(s) @ \$18.00 each	\$ _____
_____ For delivery in Texas, add 5% Sales Tax	\$ _____
TOTAL	\$ _____

I enclose check money order for
or, please charge to my Visa MasterCharge: Code # _____

Account No. _____ Expiration Date: _____

Name _____

Street _____ Apt. _____

City _____ State _____ Zip _____

†Continental U.S. only AK, HI & PR \$5.00 Canada: \$6.50 Foreign: \$19.00 Airmail

Everybody's making money selling microcomputers. Somebody's going to make money servicing them.

New NRI Home Study Course Shows You How to Make Money Servicing, Repairing,
and Programming Personal and Small Business Computers



Seems like every time you turn around, somebody comes along with a new computer for home or business use. And what's made it all possible is the amazing microprocessor, the tiny little chip that's a computer in itself.

Using this new technology, the industry is offering compact, affordable computers that will handle things like payrolls, billing, inventory, and other jobs for businesses of every size...perform household functions including budgeting, environmental systems control, indexing recipes, and more. And thousands of hobbyists are already owners, experimenting and developing their own programs.

Growing Demand for Computer Technicians

This is only one of the growth factors influencing the increasing opportunities for qualified computer technicians. The U.S. Department of Labor projects over a 100% increase in job openings for the decade through 1985. Most of them *new* jobs created by the expanding world of the computer.

Learn at Home in Your Spare Time

NRI can train you for this exciting, rewarding field. Train you at home to service not only microcomputers, but their larger brothers, too. Train you at your convenience, with clearly written "bite-size" lessons that you do evenings or weekends, without going to classes or quitting your present job.

Assemble Your Own Microcomputer

NRI training goes far beyond theory. It includes practical experience, too. As you progress, you perform meaningful experiments building and studying electronic circuits on the NRI Discovery Lab.[®] You assemble test instruments that include a transistorized volt-ohm meter and a CMOS digital frequency counter...instruments you learn on, use later in your work.



And you build your own microcomputer. Each step of construction advances your knowledge, gives you deeper insights into this amazing world that's upon us.

This is the only microcomputer designed for learning. It looks, operates, and performs just like the finest of its kind...actually does more than many commercial units. But NRI engineers have designed components and planned the assembly procedure so it demonstrates important principles, gives you working experience in detecting and correcting problems.

And that's what NRI training is all about.



Other Opportunities in Electronics

Since 1914, before commercial radio was even on the air, NRI has been the way to learn new electronics skills. Today's modern offerings include, in addition to three different computer courses, TV/Audio/Video Systems Servicing, with training on the only designed-for-learning 25" diagonal color TV, with state-of-the-art computer programming. Or, check out our Complete Communications Course, preparing you to enter this booming field servicing, installing, and repairing equipment like microwave, broadcast, CB, shortwave radio, paging, radar, and more.

Mail Postage-Paid Card for Free Catalog No Salesman Will Call

Send today for your free copy of our 100-page, full-color catalog. It describes all of our electronics courses in detail, showing kits, equipment, and lesson plans. Look it over at your convenience, then decide how NRI can help you make the most of your talents. There's no obligation and no salesman will ever call or bother you. With more than a million students and unmatched experience in home training, NRI gives you the most in training for new opportunity! If card has been removed, write to:



NRI Schools
McGraw-Hill Continuing
Education Center
3939 Wisconsin Avenue
Washington, D.C. 20016

letters

SOLVING THE ENERGY CRISIS?

It seems to me that the big challenge for electronics in the immediate future is—energy. So, here's an impossible idea:

High school physics taught us that matter and energy are interchangeable. More to the point, one gram of matter is interchangeable with an enormous quantity of energy . . . in other words, if you could convert one gram of matter into energy with 100% efficiency you could light up New York for a year.

For practical purposes, 100% conversion does not exist. The most efficient conversion process to date (atomic reaction) involves huge quantities of energy from very little fuel. The problem, then, is to come up with a way to produce a technique of matter-to-energy conversion which is almost completely efficient, controllable and suitable for use with abundant and cheap materials.

We have all learned that matter must occupy volume. Clearly then, it must become something other than matter, and all

that is left is energy. Therefore, let's postulate that if you squeeze something hard enough it will interchange its volume for an equivalent quantity of energy.

The problem lies in squeezing hard enough. You obviously also don't want to squeeze too much matter at a time or the energy produced becomes difficult to control. Therefore, perhaps sufficient pressure could be obtained by two rapidly moving, very small particles colliding with each other.

The machinery necessary to do this could be based on the particle accelerator, a device that uses switched magnetic fields to accelerate atomic particles. The device could be toroidal, but a linear setup would be more practical since it would not involve changing the direction of the particles we wish to impact. In other words, build a junior-sized atom smasher.

It would be shaped as a tube several miles long so that it can achieve the velocities required for the densities being used. It will be airtight because you want to evacu-

ate the atmosphere from inside it so that the rapidly moving particle will not encounter friction from the gas molecules and incinerate itself. Induction coils will be spaced out along the length of the tube; their magnetic fields will move the matter around. Also used will be sensing coils and some deflection coils (their function will be described later on).

To derive the flux densities required to do the job, some heavy currents will have to flow through the induction coils. To do this without generating excessive heat, the coil resistance must be negligible. The tube must be encased in a jacket inside which a supercoolant can be injected.

At the terminal end of the accelerator will be a structure containing a black-bodied oven, the walls of which contain pipes through which water or some other heat-exchanging liquid can pass to extract the heat of the impact and remove it so it can be converted to electricity. Beyond the oven structure is a second accelerator

continued on page 14

Another reason to join RCA's QT Parts Program! You get four free information packages every year.



RCA's QT-150 Parts Program is better than ever!

Registered dealers receive four free information mailings per year through RCA's Direct Information Service program.

Quarterly mailings include:

- Complete Dealer Price Book — RCA Consumer Parts • Latest Price Supplement • RCA Drawing Number to Stock Number Cross Reference • Color TV Module Cross Reference • B&W TV Module Cross Reference • Dealer QT Inventory Control Form; and many other useful publications.

To join, contact your RCA Distributor and register as a QT Dealer. You will receive your package of 150 of the most-needed, fastest-moving parts to repair older TV sets.

You will also receive your first quarterly information package. Every information mailing will include the latest price publication, plus additional information about RCA Parts required in your servicing business.

Don't forget, your QT Parts inventory program has automated annual drop-ship updating for your convenience. A special QT Parts Rack is also available to save time and space.

Call your RCA Distributor or write to RCA Distributor and Special Products Division, Deptford, N.J. 08096.

RCA QT Parts

ANNOUNCING AMERICA'S ONLY LAND, SEA AND AIR SCANNER.

Only the incredible, new, no-crystal Bearcat 220 Scanner tunes in all the real excitement of the entire AM aircraft band—plus every FM public service frequency—with pushbutton ease.



Now.
Tune in all the real excitement of the wild blue yonder, at the touch of a button.

The new, no-crystal Bearcat 220 Scanner searches and tunes in the entire aircraft band. Jets at 30,000 feet. All the tense tower talk. Everything is pre-programmed in space-age memory banks.

Only the 7-band Bearcat 220 Scanner also brings home every public service frequency, too. Pre-programmed Marine frequencies. Police action. Fire calls. Weather warnings. You name it.

The new Bearcat 220 has all the features and quality Bearcat Scanners are famous for. Track tuning. Decimal display readout. Automatic Search. Selective Scan Display. Automatic squelch and lockout. Priority. And much, much more.

After all, Bearcat invented Scanning. And we'll stop at nothing to bring you all the excitement—of land, sea, and air.

BEARCAT® 220 SCANNER

Follow the leader to real excitement.

Electra

Copyright 1979 Electra Company • Division of Masco Corp. of Indiana • 300 East County Line Road, Cumberland, Indiana 46229

CIRCLE 54 ON FREE INFORMATION CARD

LETTERS

continued from page 12

tube, the mirror image of the first.

Here's the procedure: Place a particle of matter at each end of the tube, suck out all the air and cool everything down with liquid nitrogen, helium or some other coolant. Switch the power on and off for each of the inductance coils in sequence so as to cause the particles to accelerate toward each other. They enter the black-bodied oven via two small ports and collide. If the acceleration is sufficient to produce the required pressure to cause the particles to become greater than their greatest possible density (to interchange themselves with energy) what results is a very small, very hot ball of

raw power. Those elements that can radiate through a vacuum (i.e., light) will do so and will be converted to heat upon reaching the oven. The rest will be contained in the ball. It can then be tapped by allowing a measured air pressure into the oven. The heat can be used to produce steam.

Now, here come the electronics. We need a humdinger of a real fast computer to determine when the coils are to be switched on and off, or the particles will not accelerate sufficiently. It must also keep both particles in the dead center of the tubes or they won't intercept each other. To do this, it will have to sense the position of the particle and adjust it with the deflection yokes. Furthermore, the computer will have to adjust for any differences in the relative velocities of the two approaching

particles, so that they collide dead center in the black-bodied oven. Perhaps the logic of this computer could be created with LSI tunnel diodes because tunnel diodes can switch very fast and the LSI techniques can reduce the distances the pulse must travel, and thus the delay.

You'll also need a new semiconductor device—a mega-thyristor, perhaps—that can switch thousands of amps at thousands of volts extremely quickly. Printed circuit boards for the control circuitry will be available shortly (!); check your local dealers for a few miles of surplus reinforced 9-inch glass pipe and a couple of hundred gallons of liquid helium. The coils can be hand-wound with No. 000 magnet wire.

STEVE RIMMER
Markham, Canada

TUNER TEST COMPARISONS

The June 1978 issue of **Radio-Electronics** contained a test on the Luxman *model R-1120* receiver. The same model was tested by *Stereo Review* (another reputable hi-fi magazine). The results were published in *Stereo Review's* September 1978 issue. However, the results between the two tests were quite different in some respects.

The greatest difference appeared in the channel separation readings of the tuner section. According to **Radio-Electronics'** stereo performance measurements, the channel separation at 100 Hz was a very high 60 dB (superb), while Hirsch-Houck Labs obtained only something like 42 dB up to 500 Hz. Furthermore, their description of the channel separation vs. frequency makes me think that they have been testing a downright different receiver.

Also, there is a difference (I am not saying error) between their readings of the harmonic distortion of the amplifier section. At 1 watt and 1 kHz, **Radio-Electronics** gives 0.03%, while Hirsch-Houck Labs offer only 0.01%. As someone who works in this field, it is hard for me to believe that the results of these two tests represent both extremes of the performance tolerances of this particular Luxman receiver. If this is so (in spite of my disbelief), there is no point in claiming channel separation or anything else with an accuracy of decibels (sometimes even tenths of dB's). The same applies to all measurements. A more obvious reason why Hirsch-Houck Labs received lower separation readings is that the stereo decoder adjustments were not tuned to their optimum, as they were in the unit tested by **Radio-Electronics**.

You may have noted that, in bringing up the issue of the discrepancies between test results published by the two magazines, I have based everything on the fact that both tests are completely valid. Should a test report reveal the very best readings or the worst? Or something in between? Which would be most useful to the consumer who is thinking of buying the Luxman *model R-1120* since the particular unit he gets can have a low-frequency channel separation anywhere (or outside of) 42 dB and 60 dB?

I don't know which one of the two tests was made first, but **Radio-Electronics** published its results in the June issue, whereas *Stereo Review* included its report in the September issue, thereby being the

continued on page 16

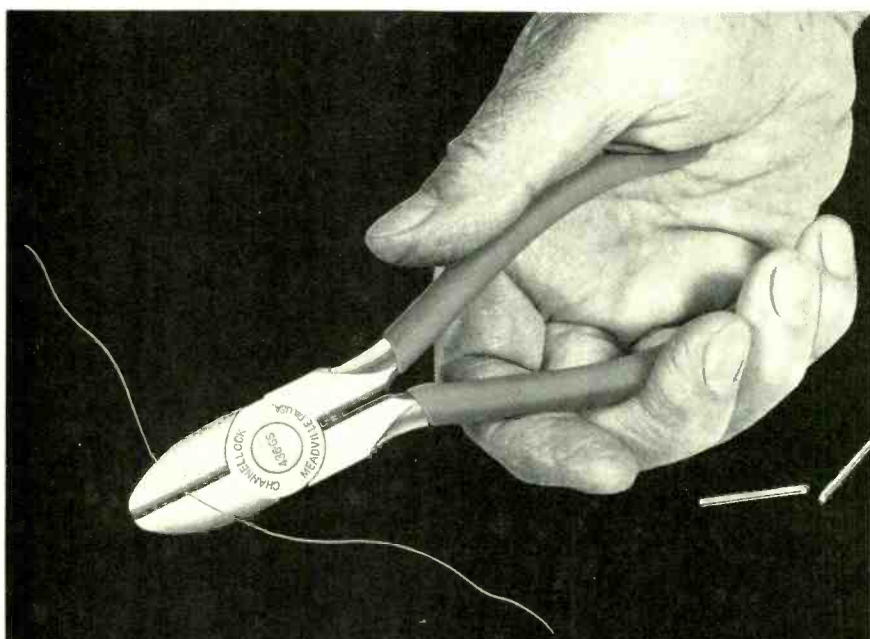

Sharp Enough To Cut A Human Hair...

Tough Enough To Cut Piano Wire

A precision cutting tool with muscle to match. Perfectly mated cutting edges, hand honed, scientifically hardened. Jaw-opener coiled spring, a great help on repetitive jobs. Drop forged, fine polished, top quality steel. Blue dipped plastic comfort grips. In brief, the extras that reward you for insisting on hand tools by CHANNELLOCK.

CHANNELLOCK, INC., • Meadville, Pa. 16335

CHAN NEL LOCK

No. 436 GS Diagonal Cutter



Send For Our Free Catalog

CIRCLE 8 ON FREE INFORMATION CARD

NEW!

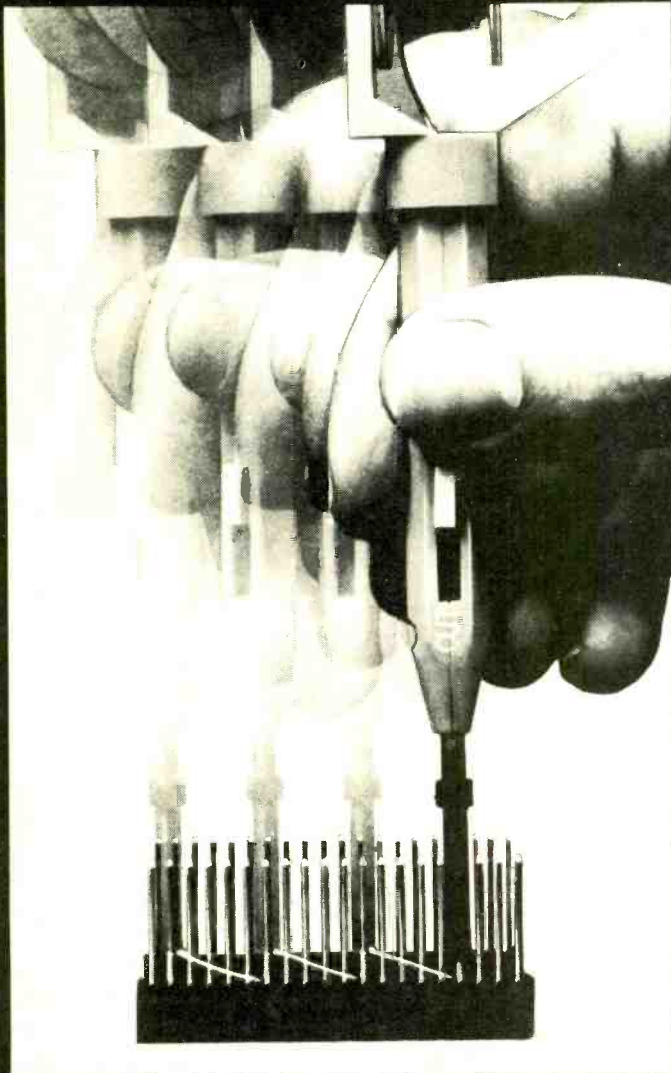

**WHY CUT?
WHY STRIP?
WHY SLIT?**

WHY NOT...

JUST WRAP™



U.S.A.
FOREIGN
PATENTS
PENDING

- AWG 30 Wire
- .025" Square Posts
- Daisy Chain or Point To Point
- No Stripping or Slitting Required
-JUST WRAP™.....
- Built In Cut Off
- Easy Loading of Wire
- Available Wire Colors:
Blue, White, Red & Yellow

\$14.95*

JUST WRAP TOOL WITH ONE 50 FT. ROLL OF WIRE		
COLOR	PART NO.	U.S. LIST PRICE
BLUE	JW-1-B	\$14.95
WHITE	JW-1-W	14.95
YELLOW	JW-1-Y	14.95
RED	JW-1-R	14.95
REPLACEMENT ROLL OF WIRE 50 FT.		
BLUE	R-JW-B	2.98
WHITE	R-JW-W	2.98
YELLOW	R-JW-Y	2.98
RED	R-JW-R	2.98

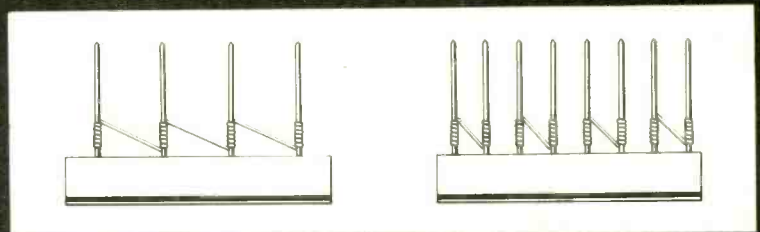

DAISY CHAIN

POINT TO POINT



OK MACHINE & TOOL CORPORATION 3455 CONNER ST., BRONX, N.Y. 10475 (212) 994-6600/TELEX 125091

*MINIMUM BILLING \$25.00 / ADD SHIPPING CHARGE \$2.00 / NEW YORK CITY / STATE RESIDENTS ADD APPLICABLE TAX.

CIRCLE 32 ON FREE INFORMATION CARD

LETTERS

continued from page 14

later of the two. Anyway, I think that *Stereo Review* failed to give the correct information by publishing the test results of the receiver, the tuner circuits of which were not correctly adjusted. **Radio-Electronics** published its results several months earlier, from which *Stereo Review* could have noticed there was something wrong with its test results. Nobody has commented on this matter—neither the readers nor the magazine's editorial staff to date.

Returning to the question of what is best and most useful for the consumer, it is clear that such a discrepancy between the tests of the same product is nothing but confus-

ing. Anyone can find a somewhat similar case by comparing the test reports of the Harman/Kardon *Citation 16*, published in both magazines.

The problems associated with modern FM tuner measurements are not unknown to me. The quality of tuners seems to outperform their test equipment to a greater and greater extent. One such aspect is the measurement of the channel separation. I assume that in both tests, the Sound Technology model 1000A stereo signal generator was used for the channel-separation measurement. This fine equipment, however, is claimed to give a separation of 50 dB from 50 Hz to 8 kHz, so a separation of 60 dB at 100 Hz achieved by the Luxman model R-1120 receiver should be very near the limit of the test signal itself.

Some of the newest stereo decoder IC's using the PLL (Phase-Locked Loop) technique are capable of maintaining a separation of around 60 dB throughout the audio frequency band, so it can be expected that the present stereo signal generators are inadequate for the stereo separation measurement of tuners in the very near future. Because I am faced with this problem so often, I came to think, why not measure the separation with the dynamic signals instead of the static sinewave as a modulating signal? It could be done by tone bursts, for instance. A dynamic test signal could reveal some deficiencies of the tuner circuits that are not readily detected by using the static signals. Furthermore, since the music signal to be received contains transients and is dynamic in nature, the use of a dynamic test signal in the tests is highly justified.

If for any reason it would be more appropriate to go on testing the stereo performance in an ordinary manner, then it might be a good idea to shift from using a so-called switching-type multiplex generator (which the Sound Generator model 1000A is) to a matrix-type generator. Then, test signal separation values of 55 dB or more from 20 Hz–15 kHz are available.

LEO BACKMAN
Helsinki, Finland

*If you will examine the actual separation response curve of the FM section of the model R-1120 stereo receiver as shown in the test report, you will note that maximum separation of this particular sample receiver occurred almost exactly at 100 Hz. Admittedly, this is most unusual since in most receivers and tuners we test, maximum separation occurs at mid-frequencies and tends to decrease as one approaches the low- and high-frequency extremes. Nevertheless, our policy is to report our readings as we find them in the specific sample tested. In fact, the results obtained by Hirsch-Houck Laboratories and published in *Stereo Review* are probably more typical of an average receiver.*

As for your more philosophical questions, may I say that stereo separation in excess of 30–35 dB is rather academic in any case. The "high" numbers that we report and that many manufacturers boast about are largely an exercise in engineering perfection and will not audibly improve the stereo image. My own feeling is that "superb specs" are an indirect indication of serious engineering efforts and do have an indirect (if not an audible) relationship to the quality of a given piece of equipment. I am sure that as a practitioner in this field you are also aware that especially at low frequencies, actual channel separation becomes even less important since bass tones, as reproduced in a listening room, are largely nondirectional.

As for the test equipment both Hirsch-Houck Labs and we use, you are correct that the guaranteed separation capability of the Sound Technology model 1000A is 50 dB, but my own unit is known to be capable of providing an FM stereo signal that has separation in excess of 60 dB across the audio frequency band. Just as home audio equipment varies slightly in specs, so do individual pieces of test equipment.

continued on page 22

THE BENCH-TYPE DMM'S FROM SOAR ... THEY FIT YOUR BUDGET AND ALL OF YOUR NEEDS.

High accuracy, dependability, five function modes, 3½ and 4½ digit displays, auto ranging, automatic zero adjustment, automatic polarity indication, battery operation or optional AC to DC adapters—these are just some of the features that make SOAR's bench-type DMM's different and better.

Take our MC-545. It's priced below \$290, and it measures DC voltages to 1000 V, AC voltages to 750 V, DC and AC current to 1000 mA, and resistance to 20 meg. Maximum indication is 19999 or -19999. It also comes with an optional BCD output (8, 4, 2, 1) for connecting the multimeter between a CPU and a digital recorder.

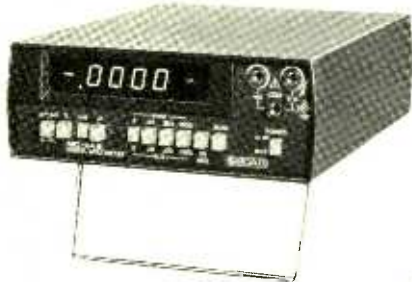

And then we have the top of the line—the MC-546. It has most of the features of the 545 plus auto ranging.

◀MC-546

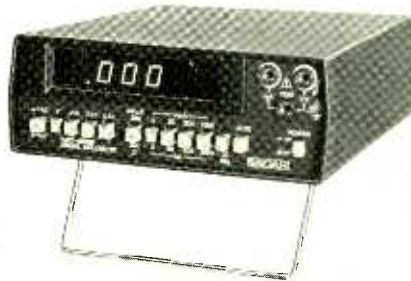

If a 3½ digit display satisfies your requirements, consider the MC-535 or MC-536. They have HI-LO Ohm switches for all ranges, and prices start at \$199.95.

MC-536▶

To get the full story, call or write for a free catalog on SOAR's entire line of dependable and economical test instruments.



SOAR ELECTRONICS (U.S.A.) CORP.
200 13TH AVENUE
RONKONKOMA, NEW YORK 11779
TEL. (516) 981-6444 / TELEX 144638

CIRCLE 49 ON FREE INFORMATION CARD

Automotive "brain" astounds the experts, puts both computer and cruise control at your fingertips!

For the first time ever, you can put a true computer in your car, truck or RV which gives you the most effective and functional cruise control ever designed, plus complete trip computing, fuel management system, and a remarkably accurate quartz crystal time system. It is called CompuCruise™.

So simple a child can operate, the new CompuCruise combines latest computer technology with state-of-the-art reliability in a package which will not likely be available on new cars for years to come.

CRUISE CONTROL WITH A MEMORY, UNIQUE SEEK-AND-HOLD CAPABILITY.

CompuCruise remarkable cruise control performs in a totally different manner than any other unit because it is more than a simple speed maintaining device. With CompuCruise, you establish your desired cruising speed even before you reach the highway and activate the system any time by simply pressing a button. CompuCruise then seeks and maintains the desired speed until you override or shut off the system. You resume cruise control again at any time by pressing the same button. CompuCruise, unlike most vacuum-mechanical systems, is fully electronic, more accurate and more reliable than any other unit you can buy.

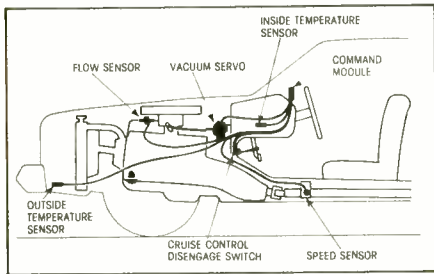

AIRLINE PILOTS COMPARE COMPUCRUISE™ TO SOPHISTICATED AVIONICS EQUIPMENT.

Similar to types of computers used on modern airliners, the CompuCruise slim panel-mounted control module contains a digital readout and back-lighted control buttons, both readily visible in the dark. By quickly learned systems of inquiry, the driver can elicit virtually any informa-

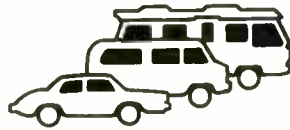

tion relating to time, distance, fuel and performance of his vehicle.

There are a number of digital-type instruments on the market which can be purchased for your car, purporting to provide functional data on performance, but all are basically calculators, operating on fixed information provided by the driver.

CompuCruise is a true computer, operating from automatic data sensors which constantly react to changing conditions, automatically recomputing vital data every second. Each function operates independently, with data displayed and updated constantly until you change your request of the computer.

Fuel management takes on new significance because CompuCruise tells you the most effective driving speeds, the type and brand of gasoline most suitable for your vehicle. It will tell you the effects of different types of tires and different tire pressures, road conditions, and engine tune-up condition. You can get instantaneous computations on current gas mileage, fuel required to arrival, and actual fuel remaining.

Battery condition can be checked regularly, saving you from the potential embarrassment of being stranded without warning.

TYPICAL DATA:

- ✓ Cruise Control
- ✓ Time, E.T., Lap Timer, Alarm
- ✓ Time, Distance, Fuel to Arrival
- ✓ Time, Distance, Fuel to Empty
- ✓ Time, Distance and Fuel on Trip
- ✓ Current or Average MPG, GPH
- ✓ Fuel Used, Distance since Fillup
- ✓ Current and Average Vehicle Speed
- ✓ Inside, Outside or Coolant Temperature
- ✓ Battery Voltage
- ✓ English or Metric Display

COMPUCRUISE™ DIGITAL QUARTZ CRYSTAL TIME SYSTEM IS INCREDIBLE.

CompuCruise digital time system performs four independent time functions encompassing (a) stop watch and lap timer functions, (b) hours, minutes and seconds, (c) alarm or warning function, and (d) trip time indicator. The time system operates full time, whether your vehicle is operating or not. It will even wake you up after a short roadside nap.



YOUR COMPUCRUISE IS SMART! IF YOU PUSH THE WRONG BUTTON IT WILL LET YOU KNOW BY DISPLAYING "ERROR".

COMPUCRUISE™ WORKS ON FOREIGN OR AMERICAN CARS; IS PRICED FOR THE AVERAGE MAN'S BUDGET

You do-it-yourselfers can readily install the unit, but complete and detailed instructions are also included for the automotive service facility. CompuCruise units are fully operable on most foreign or American cars, trucks or RV's. At \$199.95 the unit is only a few dollars more than the cost of cruise control alone on most vehicles, yet offers a whole new world of computerized management functions.

This is an exclusive system, fully warranted for 90 days from installation, delivered to you complete with all required hardware. You need only basic tools for the total job.

When you receive your unit, inspect it completely. If you are not 100% satisfied, return the complete unit before installation and your money will be refunded without question.

TO ORDER YOUR UNIT, complete the coupon below, enclosing \$199.95 (ADD \$5.50 if front-wheel drive). This covers all shipping, insurance and handling costs. Your unit will be shipped within three weeks.

NOTE: Mountable on foreign or domestic vehicles including standard trans. **EXCEPT FOR DIESEL OR FUEL INJECTED ENGINES.**

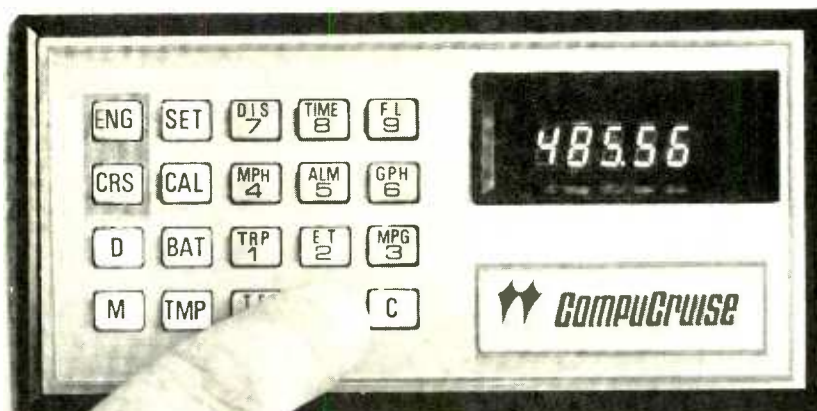

(415) 838-8060

Technically competent personnel available to answer your questions.



COMPUCRUISE

CIRCLE 17 ON FREE INFORMATION CARD

TO: ZEMCO, Inc. (415) 838-8060
12907 Alcosta Blvd.
San Ramon, Ca. 94583

Ship _____ CompuCruise™ units @ \$199.95
Model 44 (WITH CRUISE CONTROL)
Add \$5.50 for front-drive

Ship _____ CompuCruise™ Units @ \$159.95
Model 41 (WITHOUT CRUISE CONTROL)
Add \$5.50 for front-drive

Total enclosed: \$ _____
(CA residents add Sales Tax)

Charge to my _____ Master Charge _____ Visa _____

Card Number _____

Date Expires _____

Signature _____

Make vehicle: _____

Name: _____

Address: _____

City: _____ State & Zip _____

“If you’re going to learn electronics, you might as well learn it right!”

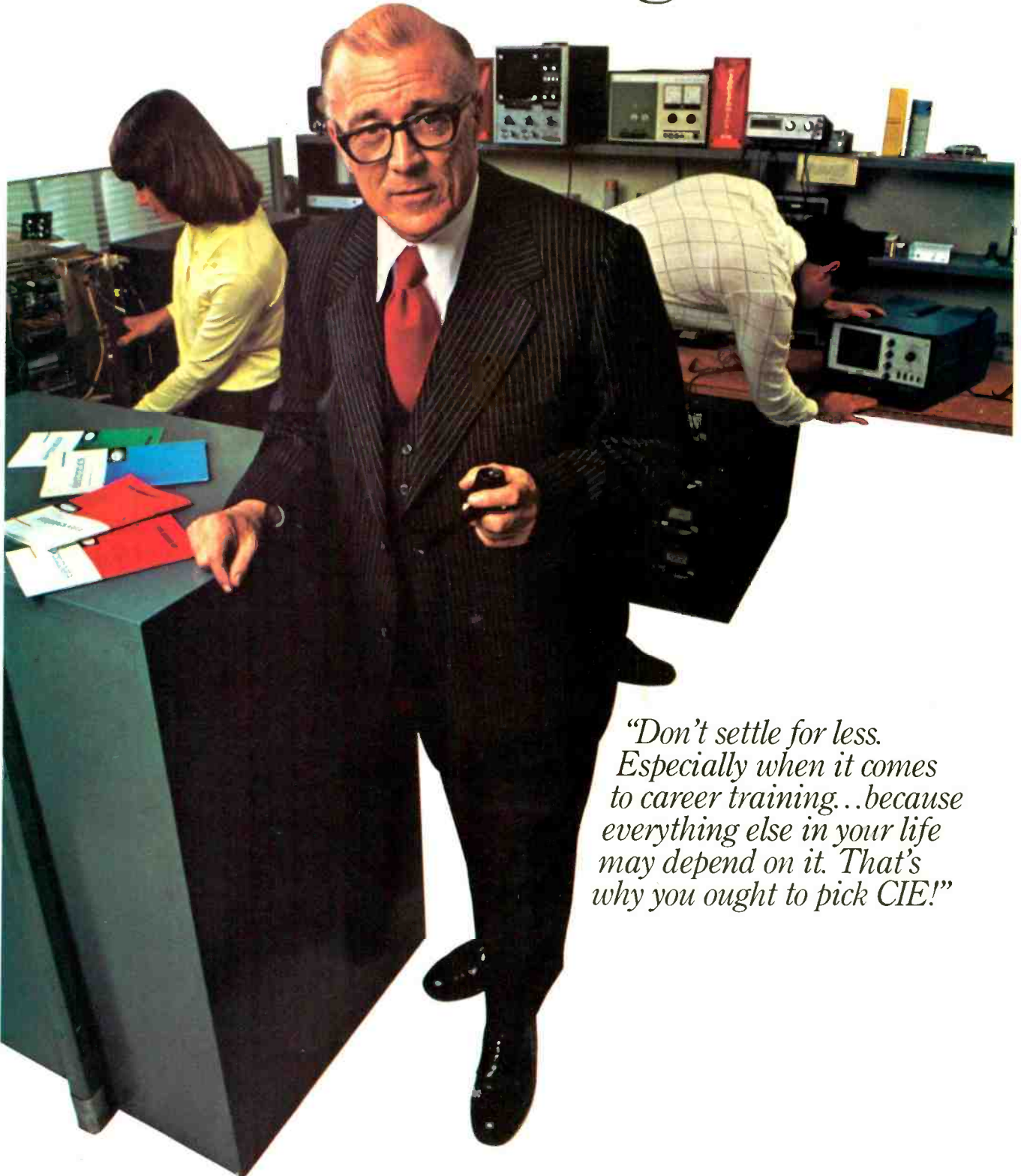

“Don’t settle for less. Especially when it comes to career training...because everything else in your life may depend on it. That’s why you ought to pick CIE!”

You've probably seen advertisements from other electronics schools. Maybe you think they're all the same. They're not!

CIE is the largest independent home study school in the world that specializes exclusively in electronics.

Meet the Electronics Specialists.

When you pick an electronics school, you're getting ready to invest some time and money. And your whole future depends on the education you get in return.

That's why it makes so much sense to go with number one... with the specialists... with CIE!

There's no such thing as bargain education.

If you talked with some of our graduates, chances are you'd find a lot of them shopped around for their training. Not for the lowest priced but for the best. They pretty much knew what was available when they picked CIE as number one.

We don't promise you the moon. We do promise you a proven way to build valuable career skills. The CIE faculty and staff are dedicated to that. When you graduate, your diploma shows employers you know what you're about. Today, it's pretty hard to put a price on that.

Because we're specialists, we have to stay ahead.

At CIE, we've got a position of leadership to maintain. Here are some of the ways we hang onto it...

Our step-by-step learning includes "hands-on" training.

At CIE, we believe theory is important. And our famous Auto-Programmed® Lessons teach you the principles in logical steps.

But professionals need more than theory. That's why some of our courses train you to use tools of the trade like a 5 MHz triggered-sweep, solid-state oscilloscope you build yourself—and use to practice troubleshooting. Or a beauty of a 19-inch diagonal Zenith solid-state color TV you use to perform actual service operations.

Our specialists offer you personal attention.

Sometimes, you may even have a question about a specific lesson. Fine. Write it down and mail it in. Our experts will answer you promptly in writing. You may even get the specialized knowledge of all the CIE specialists. And the answer you get becomes a part of your permanent reference file. You may find this even better than having a classroom teacher.

Pick the pace that's right for you.

CIE understands people need to learn at their own pace. There's no pressure to keep up... no slow learners hold you back. If you're a beginner, you start with the basics. If you already know some electronics, you move ahead to your own level.

Enjoy the promptness of CIE's "same day" grading cycle.

When we receive your lesson before noon Monday through Saturday, we grade it and mail it back—the same day. You find out quickly how well you're doing!

CIE can prepare you for your FCC License.

For some electronics jobs, you must have your FCC License. For others, employers often consider it a mark in your favor. Either way, it's government-certified proof of your specific knowledge and skills!

More than half of CIE's courses prepare you to pass the government-administered exam. In continuing surveys, nearly 4 out of 5 CIE graduates who take the exam get their Licenses!

For professionals only.

CIE training is not for the hobbyist. It's for people who are willing to roll up their sleeves and go to work... to build a career. The work can be hard, sure. But the benefits are worth it.

Send for more details and a FREE school catalog.

Mail the card today. If it's gone, cut out and mail the coupon. You'll get a FREE school catalog plus complete information on independent home study. For your convenience, we'll try to have a CIE representative contact you to answer any questions you may have.

Mail the card or the coupon or write CIE (mentioning name and date of this magazine) at: 1776 East 17th Street, Cleveland, Ohio 44114.



Patterns shown on TV and oscilloscope screens are simulated.

CIE Cleveland Institute of Electronics, Inc.
 1776 East 17th Street, Cleveland, Ohio 44114
 Accredited Member National Home Study Council

YES... I want the best of everything! Send me my FREE CIE school catalog—including details about troubleshooting courses—plus my FREE package of home study information. RE-67

Print Name _____

Address _____ Apt. _____

City _____

State _____ Zip _____

Age _____ Phone (area code) _____

Check box for G.I. Bill information: Veteran Active Duty

MAIL TODAY!

corrective measures. 96 pp; 8½x11; softbound. 21423 \$4.95

use them properly and creatively. Many photos, diagrams, and charts. 368 pp; 5½x8½; softbound. 21037 \$10.50

Howard W. Sams & Co., Inc.

4300 West 62nd Street/Indianapolis, Indiana 46206

Mail to:
Howard W. Sams & Co., Inc.
 4300 West 62nd Street
 Indianapolis, IN 46268
 (317) 298-5564

JULY 1979
 21

JULY 1979
 23

LETTERS

continued from page 16

The importance of all these test reports is not so much the actual numbers obtained upon the test bench, but the overall impression that the reviewer is able to impart to the reader regarding the particu-

SUPERCONDUCTING COIL

It's too bad Mr. Ecklin (Letters, October, 1978) didn't elaborate on how charging and discharging a superconducting coil (or any coil for that matter) is going to solve the energy crisis.

While a superconducting coil is useful for storing energy, it does not create it. The

permanent magnets and some kind of magnetic shielding. A magnetic field is a conservative force field, like gravity. Energy cannot be extracted from it, only transformed. For example, mechanical energy, turning an armature of a generator whose coils are in a magnetic field, will be converted to electrical energy. But the electri-

equipment reports

Graymark Model 540 Binary Clock



CIRCLE 101 ON FREE INFORMATION CARD

IF YOU ARE TECHNICALLY ORIENTED AND would like to have a conversation piece with a purpose, the Graymark model 540 Binary Clock Kit should fit the bill. The clock is in an attractive simulated wood-grain plastic case measuring 7 W × 3 H × 4½ inches D, with a black and chrome-trimmed front panel. It

contains 11 integrated circuits (10 TTL IC's and 1 voltage regulator), 24 resistors, 6 capacitors, 2 power diodes, 1 signal diode, 18 light-emitting diodes (LED's), 2 transistors and a power transformer assembled to three PC boards. Three pushbutton switches on the back panel are used to set the time display.

The front PC board holds the 18 LED's arranged in five vertical columns, with either 3 or 4 LED's in each column, depending on the required count for that column. Each column indicates a measure of time, in a binary-coded-decimal (BCD) format. In each column the bottom LED represents the decimal count of 1; the next LED above it represents a count of 2; the next one above is 4; and the next one above (in three columns that have one) represents 8. Suppose the time is 11:05:29 (11 hours, 5 minutes, 29 seconds) as shown in the photograph. Since a lighted LED represents the decimal number just described, the five rows, reading from left to right, have the following LED's on during that second: column 1 (hours) 1, 2 & 8; column 2 (10's of

minutes) none; column 3 (minutes) 1 & 4; column 4 (10's of seconds) 2; column 5 (seconds) 8 & 1. It's fascinating to watch the seconds count in this unconventional manner, with the minutes advancing right on cue up to 11:59:59 and then repeating. (This clock does not display in a 24-hour format).

This may sound very complex to those of you who are unfamiliar with digital electronics; however, the Graymark instruction manual guides you through each stage step-by-step. This manual was written by George F. Martin, Graymark's director of engineering, and R.L. Kall of the engineering staff, and reflects considerable teaching experience. Those wanting the full value of an education in binary counting and TTL theory can assemble a small section of the kit, then test it (using a multimeter and oscilloscope), with the manual explaining how everything works. This is called Mode I. For those who just want to build the kit and don't have any particular interest in TTL theory, Mode II is provided. In Mode I, you perform all the printed steps; in

Now more than ever...



New RCA SK Solid State Replacement Guide

- Largest RCA SK Replacement Guide to date.
- Over 950 SK types replace over 153,000 domestic and foreign types.
- Everything you need under one cover for quick, easy, profitable servicing.
- The industry's only Guide to include SK numbers and the other leading numbering system.

The new 1979 RCA SK Solid State Replacement Guide has easy-to-find, easy-to-read information on RCA's full line of replacement transistors, rectifiers, thyristors, integrated circuits and high voltage triplers. Thousands of hours of engineering went into the preparation of this guide which covers consumer, commercial and industrial applications.

RCA SK Replacement Solid State

Mode II, you only read and perform the steps that are printed in red.

The manual is printed throughout in two colors, has over 100 explicit illustrations and diagrams and contains virtually no errors. (Exceptions: On page 34, step 5 refers to Fig. 49, but should refer to the foil side of the PC board; and on page 41, step 35 should be printed in red.) The operational theory of the clock is extremely detailed, and is accompanied by many block diagrams, charts, timing diagrams and even IC data sheets. A complete parts list and a schematic diagram of the clock are also included.

The PC boards and parts are all new and of top quality. The LED's seem to be graded for equal brightness, and an assembly aid is provided for their proper positioning and alignment. Every single component needed is included—even a nylon cable tie and solder. The PC boards are masked to avoid solder bridges, and parts locations are silk-screened on the component side of the boards to insure proper assembly. The only tools you'll need are a 20- to 30-watt soldering iron, a wire stripper, diagonal cutters, a Phillips-head screwdriver and long-nose pliers.

Constructing the kit is simple following the detailed step-by-step instructions, but it is time consuming. There are over 350 solder connections, 21 jumpers and 29 board-interconnecting wires. It took four hours to assemble (following the Mode II red instructions), and working slowly and carefully to avoid later problems. This care was rewarded by the clock working perfectly when plugged into the 110-VAC line. Time-setting is accomplished easily with the SLOW, FAST and HOLD switches once the time-readout format is understood. Count-

ing is controlled by the line frequency (either 50 Hz or 60 Hz, jumper-selected), so this clock provides long-term accuracy, since power companies keep a close tolerance on the average output frequency.

The *model 540* Binary Clock sells for \$39.95 in kit form including the manual (post-paid in the United States) from Graymark International, Inc., 1751 McGraw Ave., Dept. R-E, Irvine, CA 92714. Foreign orders add \$6 postage and handling. California residents add state and local taxes as applicable. The manual is available separately for \$2.

BSR System X10 AC Remote Control



CIRCLE 102 ON FREE INFORMATION CARD

HERE IS A REMOTE-CONTROL SYSTEM THAT gives you, at your fingertips, complete control of the lights and appliances in your home without getting involved in any special wiring. You use the house wiring as the signal-carrying system. For example, if you suddenly hear a strange noise downstairs, you push a button on

the control unit and it turns on the lights. With the *BSR System X10* light and appliance command console by your bedside or chairside, you can turn lights on and off, dim or brighten them at the touch of a button. You can even use the *System X10* to trigger a simple alarm device.

Using this system, you can literally operate almost every light and electrical appliance in your home without leaving your easy chair. That means you can turn air conditioners on and off, as well as TV's, stereos or lights. The basic system comes with a command console, appliance module and a couple of lamp modules. For less than \$100 it is possible to buy a *System X10*, including enough modules to control lights and appliances at up to four different locations. The command console, *model SC-311*, through its keyboard, permits remote control operation of lights or appliances in up to 16 separate locations. (By rotating a bottom of the control switch, more groups of 16 controlled switches can be provided.) It plugs into any AC wall outlet in the house and transmits FM command signals over the electrical wiring. Optionally available is a cordless controller, *model CC401*. It transmits signals to the ultrasonic command console over distances of as much as 30 feet. All functions of the command console are duplicated on the cordless controller.

The lamp module, *model LM501*, will control any incandescent lamp rated up to 300 watts. Functions include on and off, bright and dim.

The appliance module, *model AM601*, turns an appliance on or off; a TV, stereo, fan, etc. Maximum appliance ratings on a resistive load are 15 amp; motorload, 1/3 horsepower; incandescent lamp, 500 watts. A wall-switch module

... RCA SKs make it easy for you to offer reliable service at a profit.

New Numbering System

All SKs now feature, where applicable, the product numbers of the other leading system used by ECG,* REN and TM. For example, whenever an SK device replaces an ECG device, the ECG number is now part of the SK number. (SK 3444, a direct replacement for ECG 123A, is now listed as SK 3444/123A.) The new 1979 RCA SK Solid State Replacement Guide is the only guide you need. You can buy and install RCA SK devices with confidence that the replacement is right and the quality is right too.

Best of all, RCA Top of the Line quality means fewer costly call-backs and more profitable customer servicing for you. See your RCA SK distributor for all your solid state replacement needs and ask for your copy of the new authoritative RCA SK Replacement Guide, SPG 202X; or send your request with check or money order for \$1.50 to RCA Distributor and Special Products, P.O. Box 597, Woodbury, N.J. 08096.

*ECG is a trademark of GTE Sylvania



is also available. It looks like an ordinary wall switch, operates like one, installs like one, but can also be remotely controlled.

When we first looked at the unit, we wondered what would happen if we had one, an upstairs neighbor had one, or the guy next door had one; if his units would turn mine on, and if my units would turn his on. Obviously, if our signal gets into his apartment, it will. But BSR is just one little step ahead of us. There are 16 separate ranges that will automatically prevent overlap. A simple dial selector on the unit codes the letters A through P for those noninterfering signals.

I can't think of an easier way to remotely control electrical functions in anyone's home or apartment, and the price is surprisingly reasonable for what the equipment can do. This is one of those products among the many

we've tested that I am going to want for myself.

The *System X10* is available from Advanced Electronics, 54 W. 45 St., New York, NY 10036. **R-E**

RCA CDP18S020 COSMAC Evaluation Kit

THE RCA 1800 SERIES COSMAC MICROPROCESSOR and its associated family of devices have a couple of unique characteristics. First, because they are COS/MOS devices, the power drain is low, starting at the milliwatt level. Single-IC standby memory power is also in the low milliwatt range.

Second, the 1800 family tolerates an unusually wide power supply range—3 to 12 volts for



CIRCLE 103 ON FREE INFORMATION CARD

the CDP1802 with a 3.2-MHz clock. And the operating temperature range for the full-speed processor and certain memory products covers the full—55 to 125°C temperature range. This is important if your microprocessor-controlled gadget will form part of an automotive system.

The processor instruction set is based on a 16- × 16-bit scratch-pad organization that provides good programming flexibility.

The RCA CDP18S020 Evaluation Kit is a relatively inexpensive tool with which to learn about the RCA 1802, prototype a microcomputer system, or develop software. A 20-mA loop or RS232C terminal is normally required to use the Evaluation Kit, although a simple keyboard or switch interface can be designed. Board dimensions are 14 × 9.7 inches, including fully decoded prewired locations for expansion to 4096 bytes of random-access memory (RAM), and a 6- × 4-inch user area wired to accept standard DIP packages.

Three edge connectors provide access to the microprocessor pins and the user input-output (I/O) area, and connect to external power sources and peripheral devices. The kit comes with a 2-MHz crystal which, for the 16- and 24-clock-period instructions, calculates to 8-μs or 12-μs execution times. A 6.4-MHz oscillator reduces these values to 2.5 and 3.75 μs.

A 512-byte ROM is assigned address space from 8000 to 81FF and permanently stores the UT4 monitor program. A 32-word RAM starting at 8C00 is used by the utility program to store register contents. Two supplied RAM IC's fit into the first two locations in the 4K memory area for an initial 256-word user programming space.

System operation is controlled by three pushbuttons and a toggle switch. The RESET pushbutton initializes the CPU and control logic: RUN U (Run Utility) gives control to the ROM monitor program by starting execution at 8000. The RUN P (Run Program) pushbutton starts program execution at 0000, where the first user's program instruction is usually entered. The CONTINUOUS/STEP toggle switch lets the user choose between the normal clocked mode or single-cycle operation, where individual program steps can be dissected down to 2 machine or 3 machine cycles-per-instruction.

A series of 29 LED's display the status of the 16-bit memory address bus, the 8-bit data bus, the S0 and S1 processor state codes, the CLEAR and WAIT control signals, and the processor's Q flip-flop.

Bidirectional communications to a data terminal are provided by interface circuits that use the Q flip-flop for output and the EF4 flag to input the serial data. Detailed instructions show how to hook up to current loop terminals such as Teletypes, and to EIA RS232C interfaces such as Texas Instruments' Silent 700 terminal. Parallel 8-bit input and output ports are included in the kit.

External power supplies are required—of 5

SUBSCRIBE TODAY.



SAVE TIME AND MONEY EVERY MONTH.

Have Radio-Electronics delivered to your door every month, and be sure of getting your copy even if your local newsstand runs out. Save money too while you enjoy the best electronics magazine of all. Every page is packed with excitement and ideas, with news you won't want to miss, projects you'll want to build, servicing tips you'll want to learn, equipment test reports you'll want to read before you buy. Make sure you get it all, by making sure you get every issue of Radio-Electronics from now on. Check out the subscription offers on the coupon below—offers that can save you up to \$18.00 off the newsstand price—and check off the one you like best. Do it today, and get in on all the electronics excitement every month.

41G9

Mail to: Radio-Electronics

SUBSCRIPTION DEPT., P.O. BOX 2520, BOULDER, COLO. 80322

Name (please print)		
Address		
City	State	Zip Code

Indicate the offer you prefer:

- 1 Year—12 issues ONLY \$9.98
(You save \$5.02 off newsstand price.)
- 2 Years—24 issues ONLY \$19.00
(Save More! \$11.00 off newsstand price.)
- 3 Years—36 issues ONLY \$27.00
(Save Even More! Save \$18.00 off newsstand price.)

- Payment enclosed
- Bill me
- Check here if this is a new subscription.
- Check here if you are extending or renewing your subscription.

Extra Shipping: Canada \$3.00 per year, all other countries \$5.00 per year.

```

*MO 112233445566778899AABBCCDDEEFF;
100020 123456789ABCDE,
1029384756;
000F AFBECD
*?M0 30
0000 1122 3344 5566 7788 99AA BBCC DDEE FFAF;
0010 BECD 0000 0000 0000 0000 0000 0000;
0020 1234 5678 9ABC DE10 2938 4756 0000 0000
*?M20 10
0020 1234 5678 9ABC DE10 2938 4756 0000 0000
*?M8C00 20
8C00 D0D0 8C02 FF00 814F 9401 804A BD00 EF82;
8C10 FA24 FF66 FF02 7F00 80EF 0000 2800 8000
*$P
*$P0100

```

FIG. 1

volts at 600 mA, or 10 volts at 200 mA with a separate 5-volt 400-mA supply for the LED's.

Assembly

Kit assembly was pleasantly uneventful with the help of a high-quality, double-sided PC board with plated-through holes. Close PC runs are necessary on microcomputer boards, and careful soldering and inspection techniques are a must. Sockets are provided for the microprocessor and utility ROM IC's, but, as always, I recommend using additional sockets or *Molex* pins to mount some or all of the remaining 22 circuits.

The checkout procedures consists of measuring the resistance of the supply input leads, and loading and executing a four-instruction program that sets and resets flip-flop Q.

Figure 1 demonstrates the writing of data to memory, the reading of data from memory, and starting programs. The UT4 program recognizes three commands corresponding to each of these functions.

After pressing the RESET and RUN U push-buttons, type either a carriage return or a line feed depending on whether your terminal is connected for full-duplex or half-duplex operation. Full-duplex operation requires the computer to echo back characters typed on the keyboard to the printer, since the two terminal functions are completely isolated. Based on the first character typed, the utility program sets up to echo or not, and calculates the bit timing necessary to talk and listen to the terminal.

Figure 1 shows how the three-command repertoire works. First, you enter a program either from the keyboard or from punched paper or magnetic tape. The command !M is the write-memory command, which is immediately followed by the address where the input should be entered—in this case, 0 or 0000. The space after the 0 separates the address from the data. Next, the program instructions or data are entered in hexadecimal format, with each two characters accounting for a single memory word. In hexadecimal or base 16 format, additional symbols are needed for numbers between 10 to 15. Letters from A through F are used to represent 10 through 15 with a single symbol.

Spaces can be imbedded between words if desired. At the end of the line, you have a number of choices. In Fig. 1 the first line is terminated by a semicolon. This told the machine I wasn't finished yet, and that I will give a new address and more input. Everything else was ignored until the next hexadecimal

digit. I then added an extra line feed to make the printout more legible. On the second line I started to type 10 but decided I really wanted to enter more data starting at address 20. The system (being forgiving) only pays attention to the last four numbers entered, so I typed 0020 (or I could have typed 020 since one 0 was already there from the 10). I then hit the space bar and typed in the data.

This time I hit a comma at the end of the line that told the machine I still had more data to enter but wanted to continue on the next line. With the comma the data continues in sequence and a new address is not given.

At the end of the third line I decided to go back and fill in data starting at 000F; so I used the semicolon again.

Finally, at the end of line 4, I simply used a
continued on page 32

NEW FROM LEADER

High Performance, Low Cost, 10 MHz Oscilloscopes.



Model LB0-513
Single Trace
\$495 with probe.



Model LB0-514
Dual Trace
\$645 with probes.

1 mV Sensitivity. Complete Triggering and Display Controls. 8x10 cm CRT.



Send for Complete Data.
All Leader Instruments are Backed by a **Two Year Warranty!**

When Quality Counts...

LEADER
Instruments Corp.

151 Dupont Street, Plainview, N.Y. 11803

Regional Offices: Chicago & Los Angeles

East Coast: (516) 822-9300; West Coast: (213) 882-4335

Call Toll Free: (800) 645-7120 For the Name of Your Nearest Distributor.

CIRCLE 52 ON FREE INFORMATION CARD

Train with NTS for the MicroComputers, digital the first name



MicroComputers

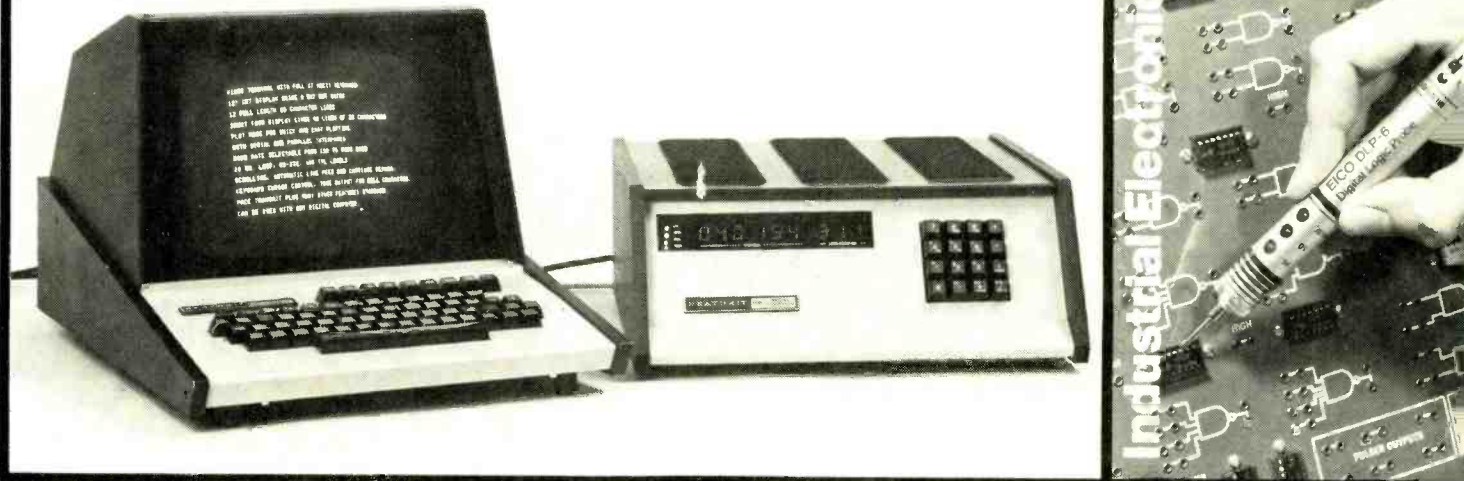

The world of electronics is daily becoming more challenging. Technology is growing more specialized, and the importance of digital systems increases every day. Test instruments, home entertainment units and industrial control systems are all going digital. And now, NTS training programs include a wider choice of solid-state and digital equipment than ever before offered in any home study course: Advanced NTS/Heath digital color TV (25" diagonal with optional programming capability), NTS/Heath microcomputer, digital test equipment, digital stereo receiver (70 watts per channel), NTS compu-trainer, plus much more state-of-the-art equipment to make your training exciting and relevant.

The equipment you receive with NTS training programs is selected to provide you with a solid

background in electronic systems. Kits and lessons are designed to work together to demonstrate electronic principles and applications. The kit-building not only shows you how electronic hardware functions, but how various circuit designs accomplish different purposes. Your lessons guide you through any number of experiments associated with many projects. This is the Project-Method, and it works. Step-by-step, you learn how and why digital electronics has become a part of our world, and the even bigger role it is sure to play in the future.

Whether you are looking for training in Consumer, Commercial, or Industrial electronics, NTS offers fourteen courses, some basic, many advanced, in several areas of electronics. An all-new full-color NTS catalog shows you what each course covers,

electronics of the future.

systems and more...from
in home study.



and every piece of equipment included.

Send for it today, and see for yourself what's really happening in electronics training technology at NTS. Find out how much has changed, and what new directions the field is taking. You'll probably want to be a part of it.

It's free. Just mail the card or coupon. Today.

**NO OBLIGATION. NO SALESMAN WILL CALL.
APPROVED FOR VETERAN TRAINING.**

NATIONAL  TECHNICAL SCHOOLS

TECHNICAL-TRADE TRAINING SINCE 1905
Resident and Home-Study Schools
4000 South Figueroa St., Los Angeles, Calif. 90037

NATIONAL TECHNICAL SCHOOLS Dept. 206-079
4000 South Figueroa Street, Los Angeles, California 90037

Please send FREE Color Catalog and Sample Lesson.

- Color TV Servicing
- B & W TV and Radio Servicing
- FCC License Course
- Electronic Communications
- Electronics Technology
- Audio Electronics Servicing
- Digital Electronics
- MicroComputers/MicroProcessors

Name _____

Address _____

Apartment Number _____ Age _____

City _____

State _____ Zip _____

Check if interested in G.I. Bill information.

Check if interested ONLY in classroom training in Los Angeles.



BUILD!

A P Terminal and Distribution Strips are ideal building blocks for your breadboarding.

Now you can put together as simple or as elaborate a breadboard as you want—and be sure of top quality all the way—and pay only for what you need. Using A P Terminal and Distribution Strips as modules is the world's most economical way to assemble full-performance solderless breadboards.

You know how our strips work. Your electronic components plug right into the spring clip terminals behind

each hole. You complete your circuits with ordinary solid wire jumpers—you don't need special patch cords. Terminals clip tight, make superb contact time after time. (They're noncorrosive copper alloy 770.)

These versatile building blocks come in a wide variety of shapes and sizes, and we include hardware and mounting templates with each strip. You get all the flexibility in the world.

Where? At your nearby A P Products dealer. Need the address? Phone (toll-free) 800-321-9668. And ask for the complete A P catalog, The Faster and Easier Book.



A P PRODUCTS INCORPORATED

Box 110-B • 72 Corwin Drive
Painesville, Ohio 44077
Tel. 216/354-2101
TWX: 810-425-2250

Faster and Easier is what we're all about.

carriage return, indicating I was through, and the machine responded with the prompt asterisk on the following line.

At this point, you're ready to check by reading out memory contents with the ?M command. Again, you use 0 as the starting address; however, the 30 is not data but the number of words in hexadecimal format to be typed out— $30_{16} = 3 \times 16 = 48_{10}$ words. The next three lines represent the response to that command. The first four columns display the starting address for each line followed by 16 words grouped by two's. The last byte on the 0000 line is the AF that I inserted at address 000F on line 4.

Note the format that the machine uses to output memory contents. The first two lines begin with addresses and end with semicolons, and the third line starts with an address (0020) and ends with a carriage return. This allows the data to be stored on tape in this format and then later be read back in using the compatible !M command.

The next group of lines demonstrate a memory dump of 10_{16} or 16_{10} words starting at 0020.

The UT4 monitor program uses a 32-byte RAM starting at 8C00 to store the 16 scratch-pad microprocessor registers. This feature is helpful in troubleshooting, but care must be used since certain registers are modified by the system. The program cannot be restarted from an intermediate point after being interrupted by inserting an idle instruction unless the registers are restored.

The next three lines in Fig. 1 show how the register RAM is printed out with the ?M8C00 20 command. Characters R0 and R7 are displayed on the line prefixed by 8C00, and R8 through RF on the line starting with 8C10.

Command \$P starts program execution. If no address is given, execution begins wherever the program counter is set, usually at 0000. Otherwise, the program is started at the address typed immediately after \$P.

A large loose-leaf binder comes with the kit. It includes detailed sections on kit assembly, design and operation of the system, the utility program (including listing), application notes on I/O and control, software and memory.

The CDP18S20 evaluation Kit is priced at \$249 and is available from RCA Solid State Division, Somerville, NJ 08876, or from RCA Solid State distributors.

R-E



"No matter what the project he's working on is supposed to be—it ends up being a light dimmer."

LX303

ALL THE MOST WANTED FEATURES AT A MOST WANTED PRICE...

- BIG 1/2" HIGH LCD DISPLAY
- USE INDOORS OR OUT
- 200 HOUR 9V BATTERY LIFE
- AUTO ZERO, POLARITY, OVERRANGE INDICATION
- 100 mV DC F.S. SENSITIVITY
- 19 RANGES AND FUNCTIONS



Removable cover stores test lead set furnished as part of the unit.



Available accessories include AC adapter, padded vinyl carrying case, 40KV DC probe, 10 Amp DC shunt.



X10 DCV probe adapter available for protecting input up to 10KV



\$74.95
ONLY
HICKOK

THE HICKOK ELECTRICAL INSTRUMENT CO.
10514 Dupont Avenue - Cleveland, Ohio 44108
(216) 541-8060 • TWX: 810-421-8286

Here is the handful of accuracy you've been waiting for. Hand-somely encased. Compact. Efficient. Only 12 ounces. Hickok's exciting, new LX 303, 3 1/2 digit Mini-Multimeter with high quality components, one year guarantee and rugged Cyclo-lac® case offers features previously found only in expensive units... at a price under \$75.00! So why wait any longer? The amazing LX 303 is here, NOW! Another American made test equipment breakthrough from Hickok, The Value Innovator. Order today!

CIRCLE 48 ON FREE INFORMATION CARD

See your local Hickok distributor or order below

SPECIFICATIONS:

DC VOLTS (5 RANGES): 0.1mV to 1000V Accuracy $\pm 0.5\%$ rdg $\pm 0.5\%$ f.s.; Input impd: 10M Ω ; Max. input 1kV except 500V on 200mV range
AC VOLTS (40Hz to 5kHz): 0.1V to 600V; Accuracy: $\pm 1.0\%$ rdg $\pm 0.5\%$ f.s. (-2dB max. at 5kHz); Max. input: 600V.

RESISTANCE (6 LOW POWER RANGES): 0.1 Ω to 20M Ω ; Accuracy: $\pm 0.5\%$ rdg $\pm 0.5\%$ f.s. ($\pm 1.5\%$ rdg on 20M Ω range); input protected to 120VAC all ranges.

DC CURRENT (6 RANGES): .01nA to 100mA Accuracy: $\pm 1.0\%$ rdg $\pm 0.5\%$ f.s.

DIMENSIONS AND WEIGHT: 5-7/8" x 3-3/8" x 1-3/4", 12 oz.; POWER: 9V batt. (not incl.) or Hickok AC adapter; READ RATE: 3/sec. OPERATING TEMPERATURE: 0°-50°C.

ADVANCE ELECTRONICS

TO ORDER CALL TOLL FREE
800-223-0474

54 West 45th Street, New York, NY. 10036 212-687-2224

PLEASE SEND ME

_____ Hickok LX303 Digital Multimeters @ 74.95 ea.
 _____ RC-3 AC Adapter, 115VAC (220VAC avail.) @ 7.50 ea.
 _____ CC-3 Deluxe Carrying Case @ 7.50 ea.
 _____ VP-10 X10 DCV Probe Adapter @ 14.95 ea.
 _____ CS-1 10A DC Current Shunt @ 14.95 ea.
 _____ VP-40 40 KV DC Probe @ 35.00 ea.

Payment encl. Bill my: Master Charge VISA

Account # _____ Exp. Date _____

Name _____

Address _____

City _____ State _____ Zip _____

Add \$3.00 Postage and Handling, N.Y. residents add sales tax.

RE-7

GE HAS PUBLISHED A SEQUEL TO YOUR FAVORITE BOOK.



Especially if you're replacing semi-conductors. Even then, you may never read all of this 416-page catalog, but you'll find yourself referring to it every day.

This year's edition is expanded to give you quick&easy cross reference data on high voltage triplers . . . more parts identification charts . . . application charts for an "instant view" of transistor specifications.

As before, our unique parts ID numbering system—which no one else in the

industry offers—tells you at a glance almost all you need to know when making a replacement. For instance, GE5ZD3.3 stands for a 5-watt, 3.3-volt zener diode by General Electric. Simple enough?

For your free copy of this valuable addition to your service shelf, see your authorized GE distributor today.

This could be the best book you'll never stop reading this year.

WE'RE AT YOUR SERVICE.

Tube Products Department—Owensboro, Kentucky 42301

GENERAL  ELECTRIC

Heart Rate MONITOR



An instantenous check on heart-rate activity is essential when engaging in meditation, Yoga or an exercise program for health and physical fitness. This cardiotech provides a direct readout of your heart rate.

MARK C. WORLEY

THE CARDIOTACH IS AN ADVANCED, SOLID-state design useful for experimental or clinical monitoring of the human heart rate. The term "cardiotach" is derived from the Greek word *kardia*, meaning heart, and the Greek word *takhos*, meaning speed. Thus, *cardiotach* literally means heart speed or heart rate.

Research has shown that the heart rate is generally proportional to the body's level of tension, excitement or anxiety; therefore, a slower heart rate can be used as an indicator of the degree of relaxation. For those practicing various methods of meditation or tension-reducing relaxation, the Cardiotech can be useful for displaying the relative degree of calmness.

Experimenters and clinical technicians can use it as a response indicator of anxiety states or relaxation responses to such external stimuli as words, music, odors, visual displays, etc. The pulse rate increase is usually quite rapid in response to anxiety-producing stimuli and can be a more accurate indicator of the body's state than verbal responses. This is one reason why a heart rate monitor usually forms part of a polygraph or "lie detector."

Often, during relaxation-training sessions, an aural indicator can disturb the state of relaxation for the participants.

The Cardiotech has a front panel meter that provides a visual indication of the heart rate.

For those physical fitness enthusiasts who might want to monitor heart rate in relation to physical stress, the Cardiotech could be useful, too. It is not, however, a portable (battery-operated) instrument, and is subject to false readings from muscle and sensor movements. Therefore, its best application might be as a before-and-after measurement while comfortably seated or otherwise stationary.

In addition, it's fun and satisfies your curiosity to know your heart rate and see the meter display it directly in BPM (Beats Per Minute).

Design objectives in devising the Cardiotech were to use inexpensive, readily available components, provide an accuracy of at least $\pm 5\%$ and avoid potential shock hazard. All these criteria were met far beyond expectations. The accuracy of the instrument, depending upon meter linearity, is better than 5%, the unit costs less than \$100 to build, and all the components, except for the sensor, can be obtained from mail-order distributors.

Circuit description

The circuit senses each heartbeat via an infrared optocoupler/sensor and triggers

on the "R"-wave, which is the largest-amplitude signal found in the heartbeat waveform (see Fig. 1). Because of this, it was decided to simply use amplitude discrimination in order to have the R-wave trigger the tachometer circuit. Thus, the circuit directly displays the R-wave repetition rate.

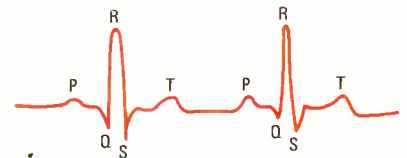

FIG. 1—HIGH AMPLITUDE PULSE of the heartbeat waveform.

Figure 2 is the block diagram of the Cardiotech circuit; Fig. 3 is the complete schematic diagram. The circuit is divided into eight basic sections: sensor, bandpass amplifier, Schmitt trigger, charge pump, meter circuit, beep-tone generator, calibrator and power supply. We'll consider the operation of each section in turn and see how they all combine into one instrument.

1. The sensor is an infrared reflective sensor (manufactured by Optron, Inc., 1201 Tappan Circle, Carrollton, TX 75006) containing an infrared emitting diode and an infrared sensitive phototransistor that are shielded from each other

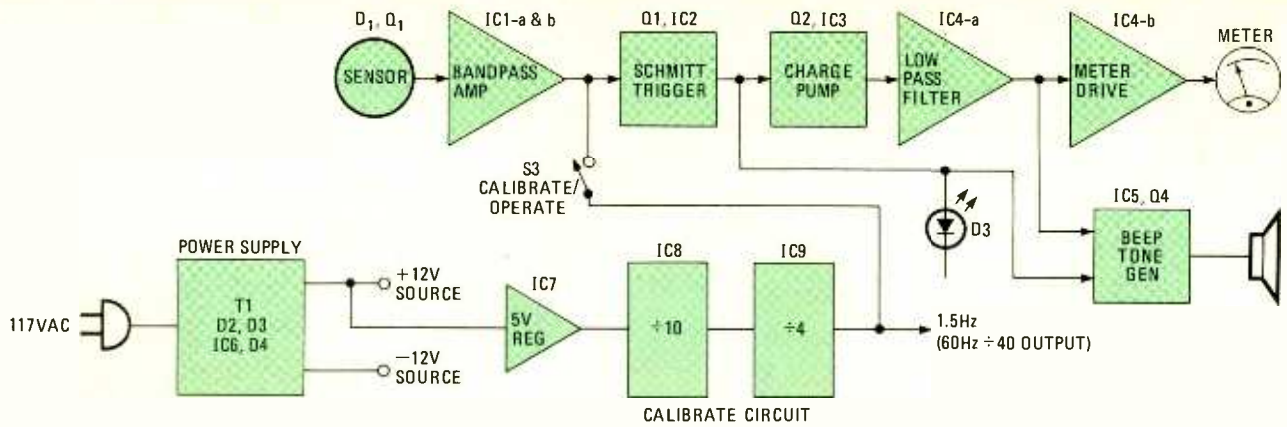

FIG. 2—BLOCK DIAGRAM of the cardiotech. Infrared optoelectronic sensor detects pulses in blood flowing close to the skin surface and interprets each pulse as a heartbeat.

by a barrier (see Fig. 4). The transparent cover allows the infrared emission to be coupled back to the transistor via reflection or conduction from a nearby surface. In this application the transparent face of the optocoupler is held against the skin. As blood pulses through the body, the infrared-sensitive phototransistor re-

sponds to the varying levels of infrared skin transmissivity caused by the changing blood volume with each heartbeat. The phototransistor, Q1, senses and amplifies the signal for further amplification by IC1.

2. The bandpass amplifier, IC1, amplifies the signal within the range of about

0.5 Hz to 6 Hz to reduce 60-Hz hum and other noise-source problems. It is a non-inverting amplifier with the variable gain controlled by sensitivity potentiometer R9. Resistor R10 is an end-mounted resistor that is used as a scope test point for the electrocardiogram signal.

3. The Schmitt trigger, IC2, is trig-

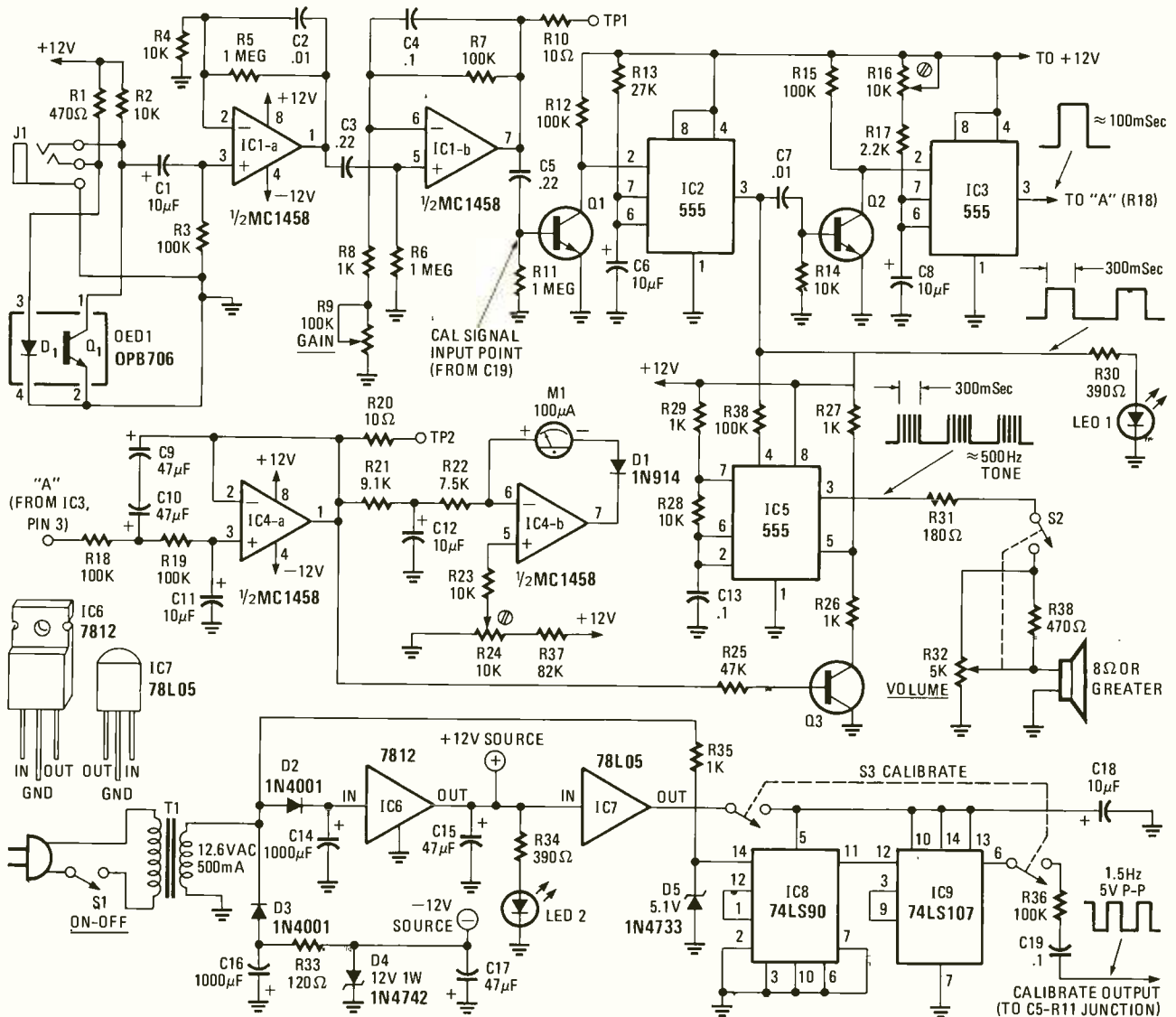

*Q1, Q2, Q3-2N2926 OR 2N3904

FIG. 3—SCHEMATIC of the Heart Rate Monitor. If you desire, rather than hardwiring opto-sensor OED1 to front-panel jack J1 as shown in the diagram, you can add a male plug to the opto-sensor cable and plug it into J1. If you opt to leave the cable hardwired, you can eliminate jack J1.

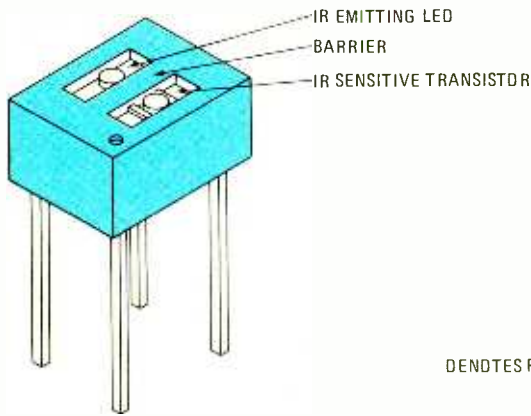

FIG. 4—CONSTRUCTION and pinout for the OPB-706 infrared reflective sensor.

gered by a negative pulse from Q2 to produce a 300- μ s squarewave that helps eliminate multiple triggering on both the R- and T-waveforms. The pulse is also used to light LED1 and trigger the beep generator IC.

4. **The charge pump, IC3,** produces a 100- μ s pulse each time it's triggered by a heartbeat signal from IC2. Resistor R17 is an internal calibration potentiometer that adjusts the width of the pulse. The actual pulse width is dependent upon the circuit values and tolerances in the low-pass filter circuit. Quality components are a must in this part of the circuit in order to maintain stability.

5. **The low-pass filter, IC4,** is used to smooth the 100-ms pulses into a DC voltage that is proportional to the heart rate. This voltage can be measured at R20, which is an end-mounted resistor used as a test point during calibration. Integrated circuit 4-b is a voltage-to-current converter used to drive meter M1. Input resistors R21 and R22 filter and scale the meter drive circuit to produce a 60- μ A current in the feedback path of IC4-b, its internal resistance and any thermal resistance changes will have no effect upon the

current through it. Diode D1 prevents reverse meter current, and since it also is in the feedback path, it has no other effect on the meter. Resistor R24 is used to cancel offset voltages and to position the meter needle during calibration. Resistors R21 and R22 are selected for a series resistance of 16,660 ohms, resulting in a 60- μ A-per-volt scaling of IC4-b's meter drive circuit. (The meter is intended to be calibrated with 0 μ A as 50 BPM, 20 μ A as 70 BPM and so on, with 100 μ A as 150 BPM. If a 50- μ A meter is used, R21 and R22 must be doubled in value to equal a total resistance of 33,330

ohms.)

The charge pump and filter circuit are designed to provide 1-volt DC to IC4-b at 60 BPM (or 1 Hz) and to increase that voltage linearly with an increase in frequency. This results in a 60- μ A change through the meter when the heart rate increases from 60 BPM to 120 BPM.

6. **The beep-tone generator, IC5,** produces a 300-ms beep with each heartbeat. The generator operates in a keyed and modulated mode controlled by IC2 and Q3. As long as pin 4 is kept low, IC5 does not oscillate. When IC2 pin 3 goes high, it allows IC5 to produce a tone for the duration of the pulse of IC2. The frequency, or pitch, of the tone from IC5 increases with an increased heart rate and vice versa. The voltage on pin 1 of IC4-a varies the conduction of Q3, which, in turn, varies the trip point of IC5 and its operating frequency. The response of Q3 is not linear, but it does vary noticeably with the heart rate. If this feature is not desired, eliminate R25-R27 and Q3. No jumper connections are needed; just leave IC5 pin 5 disconnected.

7. **The calibrator circuit, IC7-IC9,** generates a 1.5-Hz (or 90-BPM) squarewave that is derived from the 60-Hz line frequency. It is used to initially calibrate the Cardiotach and for later recalibration

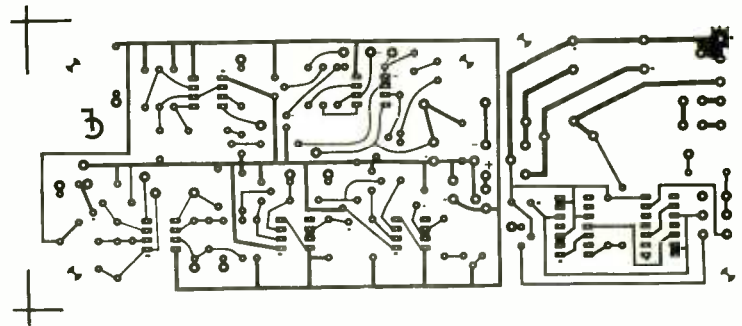

FIG. 5—FOIL PATTERN for the printed-circuit board used in making the cardiotach. The board may be cut in two and the pieces wired separately. Pattern is shown half-size.

Resistors 1/4 watt, 10%, unless otherwise specified

Resistors

- R1—470 ohms, 1/2 watt
- R2, R4, R14, R23, R28—10,000 ohms
- R3, R7, R12, R15, R18, R19, R36, R38—100,000 ohms
- R5, R6, R11—1 megohm
- R8, R26, R27, R29, R35—1000 ohms
- R9—100,000-ohm linear pot (sensitivity control)
- R10, R20—10 ohms, 1/2 watt (test points 1 & 2)
- R13—27,000 ohms
- R16, R24—10,000-ohm trimmer
- R17—2200 ohms
- R21—9100 ohms, 1%
- R22—7500 ohms, 1%
- R25—47,000 ohms
- R30—390 ohms
- R31—180 ohms
- R32—5000-ohm, audio taper pot with switch
- R33—120 ohms, 1/2 watt
- R34—390 ohms, 1/2 watt

PARTS LIST

- R37—82,000 ohms
- R38—470 ohms
- Capacitors**
- C1, C6, C11, C12, C18—10 μ F, 16 volts, electrolytic
- C2, C7—.01 μ F, ceramic
- C3, C5—.22 μ F, 50 volts, Mylar
- C4, C13, C19—.01 μ F, 50 volts, Mylar
- C8—10 μ F, tantalum
- C9, C10, C15, C17—47 μ F, 16 volts, electrolytic
- C14, C16—1000 μ F, 16 volts, electrolytic
- Miscellaneous**
- OED1—OPB706 (Optron)
- D1—1N914
- D2, D3—1N4001
- D4—1N4742, 12-volt, 1-watt Zener diode
- LED1, LED2—Visible red LED (LED 2 not used in prototype)
- D5—1N4733, 5.1-volt, 1-watt Zener diode
- Q1, Q2, Q3—2N2926, 2N3904, or equal
- IC1, IC4—MC1458 or 5558
- IC2, IC3, IC5—NE555
- IC6—7812 or LM340T-12

- IC7—78L05
 - IC8—74LS90
 - IC9—74LS107
 - S1—SPST toggle on/off switch
 - S2—SPST switch (forms part of R32)
 - S3—DPDT mini PC-mount slide switch
 - M1—100- μ A, 4 1/4-inch meter
 - T1—12.6 VAC at 500 mA, or greater
- Cabinet plus assorted hardware, knobs, etc.

The author, Mark C. Worley, 3504 Minerva, Flint, MI 48504, has the following available: Meter with separate dial overlay \$22.50; G-10 etched and drilled PC board \$12.00; Optron type OPB706 sensor only, not complete assembly, \$6.50. A kit of the three items listed here is \$37.50. All prices are postpaid.

The enclosure is available from Tracewell Enclosures, Inc., 7032 Worthington-Galena Road, Columbus, OH 43058. Model H457, \$18.95 plus \$2.00 shipping and handling. Will be shipped UPS collect upon request. For further details call 1-800-848-4525.

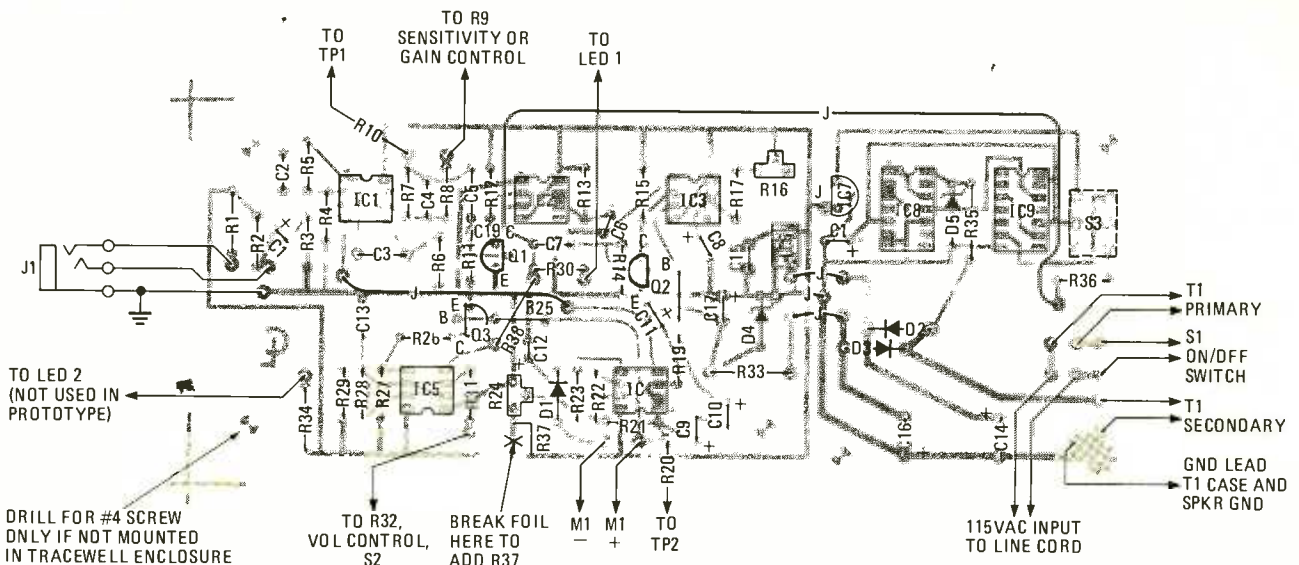

FIG. 6—HOW PARTS ARE PLACED on the PC board. Note pads that are used for making connections to meter and other parts that are not mounted directly on the board.

checks. Regulator IC7 is a low-current 5-volt regulator used to power the circuit; IC8 and IC9 together divide the 60-Hz frequency by 40 to yield a 1.5-Hz output; and R35 and D5 limit and square the 60-Hz sinewave into suitable digital levels for TTL IC's. Standard TTL IC's can be used instead of L or LS TTL types, but at an increased current drain from the nominal 10 to 12 mA.

8. **The power supply** is a straightforward, half-wave, dual-polarity supply. The +12-volt current drain is less than 100 mA, while the -12-volt drain is less than 10 mA, thus eliminating the need for more elaborate rectification or filtering. Voltage regulator IC6 is a standard, three-terminal unit, and D6 is a 500-mW or 1-watt, 12-volt Zener diode.

Circuit assembly

Assembling the Cardiotach is straightforward and easy with a printed-circuit board. Assembly can be done on perforated board, but it is not recommended because of the numerous circuit connections to be made. Figure 5 shows the foil pattern of the PC board. Figure 6 shows where parts are positioned.

The PC board is designed to be versatile. It can be left at its full size of 7½ × 3 inches, or cut into two boards, 5 × 3 inches and 2½ × 3 inches. The larger size is designed to fit into an enclosure that has built-in PC board slots to hold the board. I used the case manufactured by Tracewell Enclosures, Inc., described in the Parts List, but any enclosure that can accommodate the PC boards and transformer should work all right.

Begin by installing the two jumpers located near the middle of the board (so you won't forget them). The remainder of the components can be installed in any order you prefer. IC sockets are optional but a good idea. Make sure to install all diodes, capacitors, etc., with the proper polarity. A dot on the PC board is adjacent to pin 1 of the IC's and the positive end of all polarized capacitors. If you use the full-sized board, also install short jumpers from positive to positive (+ to +), from negative to negative (- to -), and the ground between the main board and the calibrator/power-supply board. If the PC board is cut in two and mounted separately, the jumpers will of course have to be longer. Additionally, run a

CONDUCTIVE FOAM CUSHION SURROUNDING SENSOR

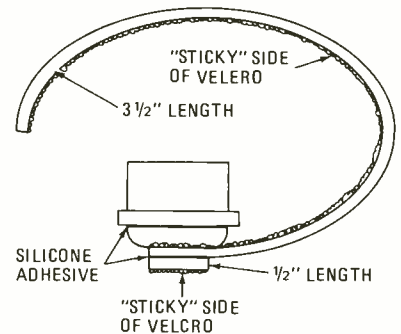
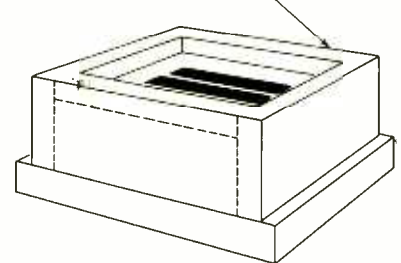

FIG. 7—HOW THE SENSOR IS ASSEMBLED. Connecting circuit leads are not shown.

jumper between the output of the calibrator, R36, and the junction of C5 and R11.

Install the board (or boards) with the necessary connections to the input jack, gain potentiometer, meter, etc., in the enclosure.

Assemble the sensor as shown in Fig. 7, using a small piece of perforated board measuring ¼ × ¼ inch. Note that pins 2 and 4 (Fig. 4) of the sensor are jumpered. Use shielded two-conductor cable or jacketed, flexible three-conductor cable; a 3- to 4-foot-long section is sufficient. Connect a stereo phone plug to one end of the piece of cable and the sensor assembly to the other end. A piece of conductive foam plastic of the type used to protect MOS devices can act as a cushion and as a

continued on page 82



FIG. 8—METER SCALE can be photographed full-size or cut from the pages of this magazine and cemented directly onto the face of a 4½-inch 100µA meter.

Videodisc!

A Look at the circuitry

Part 2—An in-depth look at the signal processing circuitry in Magnavox's new videodisc player. It even includes a circuit that automatically compensates for dropouts.

LARRY STECKER
EDITOR

WHEN YOU GET STARTED LOOKING INTO A VIDEO DISC PLAYER, you are suddenly shocked by the kinds of circuits you've never seen before. The more interesting ones, we'll run through here. Let's start by taking a look at the signal processing circuits.

As described in our introductory article last month, a laser beam scans the surface of the videodisc in the Magnavision player. To keep that beam following the right program track, three photodiodes are arranged to detect proper orientation of the laser beam. These photodiodes and their associated preamp module are physically located on the slide assembly. A block diagram of this circuit is in Fig. 1.

The preamp provides reverse bias to all the diodes. The output from diodes A, B, C and D are applied to a summing circuit where $A + B$ and $C + D$ are produced. These two signals are now applied to still another summing circuit and amplifier to create the total FM signal: $(A + B) + (C + D)$. The pairs are also fed to a different circuit to produce the focus error voltage: $(A + B) - (C + D)$.

The output from photodiodes E and F is applied to another amplifier. It produces the true radial error voltage. This voltage is high-frequency emphasized to create another radial error voltage called "radial error with high-frequency compensation." We'll look at how both of these signals are used when we examine the servo circuitry, but, for now, we will continue to look at

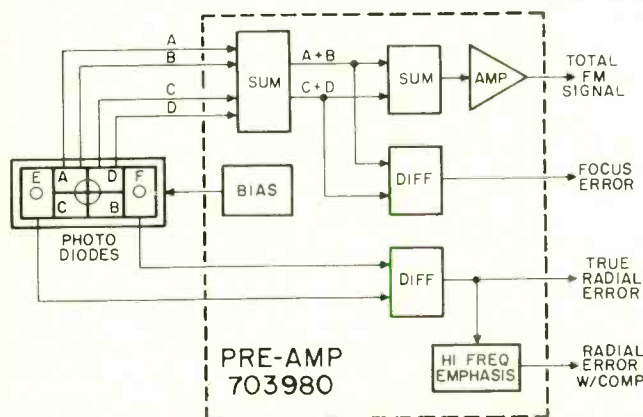

FIG. 1—PHOTODIODES AND PREAMP MODULE are located on the slide assembly. The preamp provides reverse bias to all diodes.

the total FM signal from the photodiodes.

This signal is passed on to the signal-processing circuits on the video/servo panel. A block diagram of this circuit is shown in Fig. 2. A high-frequency amplifier splitter separates the sound FM from the video FM. The sound FM is fed to two frequency-sensitive stages: the 2.8-MHz sound II demodulator, and the 2.3-MHz sound I demodulator. These stages serve as FM detectors and retrieve the audio signals from their respective carriers. The two resulting audio signals are applied to an electronic switch network that applies either one or both of the signals to the VHF modulator. The sound button on the front panel of the player determines which audio signals are used.

The video FM, an 8-MHz signal, is applied to video demodulator I. The demodulator extracts the composite video signal from the carrier. This signal is then amplified by the video amplifier and applied to the VHF modulator. The digital logic for the picture number is removed from the composite video signal by the clipper/decoder circuit. Here the logic is decoded and converted to the picture number video signal. This signal is also amplified by the video amplifier and applied to the VHF modulator. The VHF modulator takes both the audio and video and impresses them onto the required channel 3 or channel 4 RF frequencies. The resulting RF signal is connected to the antenna terminals of the TV set through an antenna switch box.

The video decoder creates a DC voltage that is proportional

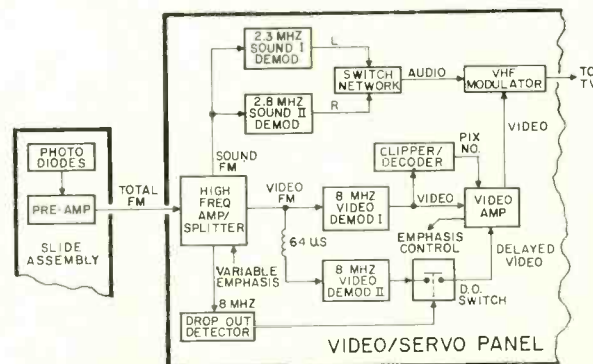

FIG. 2—SIGNAL PROCESSING. Simple block diagram shows all of the circuit elements involved.

to burst amplitude. This voltage is called emphasis control because it is applied to the high-frequency amplifier to emphasize the high frequencies when playing the tracks that are near the inner diameter of the videodisc. The high-frequency emphasis effect decreases as the program progresses toward the outer diameter. This control is required because the pits are more closely spaced at the inner diameter and, therefore, result in reduced high-frequency response. This circuit compensates for that reduced response.

The 8-MHz FM signal is applied to a dropout detector circuit. When a bad spot on the videodisc is encountered, the 8-MHz signal disappears and the dropout detector senses its absence. The 8-MHz signal is also applied through the 64- μ s delay line (the time period of one horizontal line) to video demodulator II. When a dropout occurs, the dropout detector activates the electronic dropout switch. It then applies the previous horizontal line in place of the one that was dropped out. The result on the screen is two successive horizontal scan lines with the same video information.

All signal-processing circuitry is located on the video/serbo board. The total FM signal from the preamp module is applied to the high-frequency processor module as shown in Fig. 3. The RF amplifier amplifies the entire signal. Gain control R3002 sets the correct amplitude output. The output from the RF amplifier is fed to the input of the sound FM amplifier. This input is tuned and, therefore, passes only the 2.3-MHz and 2.8-MHz sound carriers. Both of the amplified sound carriers

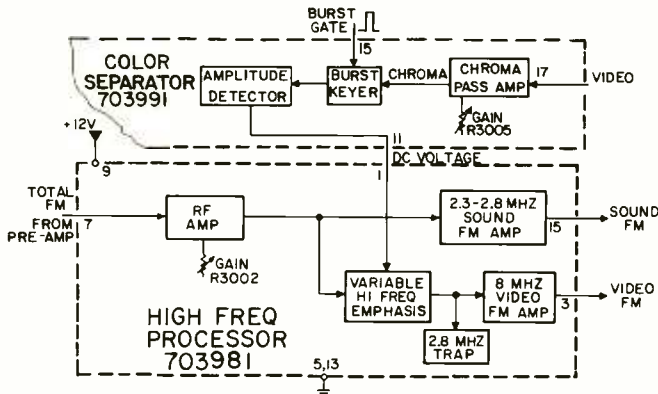

FIG. 3—FM SIGNAL PROCESSING CIRCUIT uses the signals provided by the preamp.

appear at pin 15 of the FM amplifier.

As we pointed out earlier, the high-frequency portion of the RF signal taken off the videodisc has less amplitude at the inside of the videodisc than the same signal taken off at the outer diameters. The variable high-frequency emphasis network is used to level out the high-frequency response over the entire surface of the videodisc. This circuit is controlled by a DC voltage at pin 1. The control voltage at pin 1 is directly proportional to the 3.58-MHz burst amplitude of the composite video signal. The color separator module removes the burst from the video signal by keying the burst separator with the horizontal rate burst gate pulse at pin 15. The amplitude detector creates a DC voltage that is proportional to the burst amplitude.

As the DC voltage at pin 1 decreases, the high-frequency response increases. The net effect is to boost the high frequencies at the inside of the videodisc. The video FM amplifier boosts the 8-MHz video FM signal and applies it to pin 3 of the module. The 2.8-MHz trap removes any remaining channel II sound carrier at this point.

The sound circuits

The sound FM signal is processed in two modules as shown in Fig. 4. It is applied to the 2.3-MHz FM demodulator on the sound demodulator I module. The demodulator output is the left-channel audio signal. This left-channel signal is applied to the electronic switch on the sound demodulator I module.

The 2.8-MHz FM demodulator on sound demodulator II also

receives the sound FM signal. The resulting right-channel audio signal from the demodulator is also applied to a switch.

The switches are controlled by DC voltages at pin 15. In the diagram they are shown in their normal position with neither channel muted. The left-channel audio from the demodulator passes through the electronic switch and out through the left audio-output jack. It also passes through pin 7 of the modules and into the adder stage on the sound demodulator II module. The right-channel audio signal from the 2.8-MHz FM demodu-

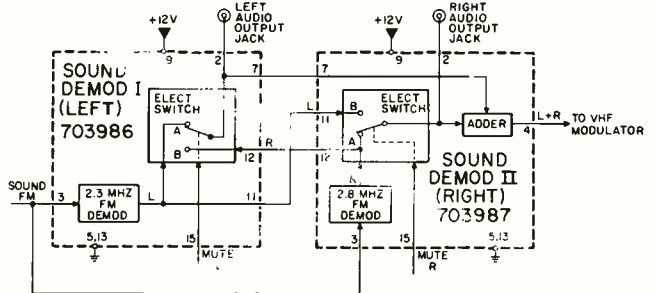

FIG. 4—SOUND SIGNAL PROCESSING CIRCUIT consists of two sound demodulator modules.

lator is also applied to the adder as well as to the right audio-output jack through its electronic switch. Thus, the output of the adder is L + R audio. This sum signal is applied to the VHF modulator to produce the sound carrier.

If the left channel is muted by the user depressing the front panel sound I button, the voltage on pin 15 of the sound demodulator I module goes high (+5 volts) and switches the electronic switch to position B. The left audio is now disconnected and goes nowhere. The right audio signal is routed to the left audio-output jack and also through pin 7 to the adder. Therefore, the right audio signal appears at both adder inputs and at both rear-panel audio-output jacks. The output of the adder is right channel only and the TV will now produce only right-channel sound.

Video circuits

The 8-MHz video FM signal from the high-frequency-processor module is applied to the 8-MHz video FM amplifier through pin 3 on the dropout detector, as shown in Fig. 5. The trap removes any 2.3-MHz sound carrier still present at this point. The amplifier delivers two outputs—one at pin 15 and one at pin 17. The output at pin 17 is passed through a 64- μ s delay line. It delays the signal by one horizontal scan line.

The undelayed video FM is applied to the dropout detector. The output of this stage is a voltage at pin 7. As long as the dropout detector senses the 8-MHz signal, it maintains an output of about 1 VDC at pin 7. If the high-frequency signal should "drop out" momentarily (caused by a videodisc defect),

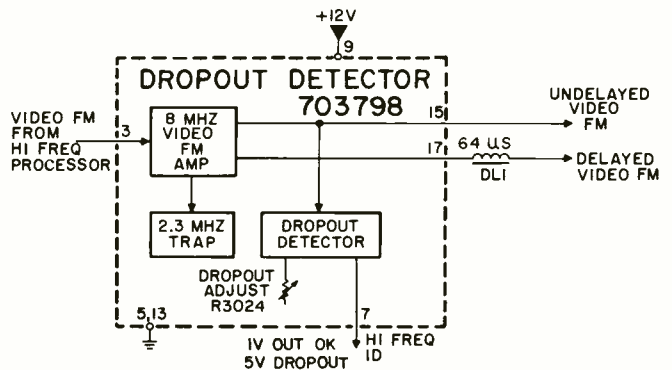

FIG. 5—DROPOUT DETECTION CIRCUIT spots signal dropouts and automatically fills those gaps.

the output at pin 7 goes high to about 5 VDC. The DROPOUT ADJUST potentiometer, R3024, sets the actual amount of time the high frequency must be absent before the dropout detector responds. The output at pin 7 is the high-frequency identifica-

tion voltage. It will be used later in other circuits.

The video FM and the delayed video FM signals are both applied to a demodulator module, as shown in Fig. 6. The video demodulator I module receives the undelayed video FM signal and applies it to the FM demodulator stage at pin 15. The composite video output of the demodulator appears at a test point on pin 1 and is applied to the video amplifier. This amplifier has a frequency response extending to 4.2 MHz.

The amplifier's gain is controlled by R3013. The output from pin 4 is applied through DL3, a 540-ns delay line, to pin 4 of the video demodulator II module. Here the composite video signal is applied to point A of the electronic dropout switch.

The 64- μ s delayed video FM signal is applied through pin 17 to the FM demodulator stage on the video demodulator II module. Its composite video output appears at a test point on pin 1 and is applied to the video amplifier. The frequency response of this amplifier is rolled off at 2.6 MHz because the 64- μ s delay line cannot pass signals above that frequency. As a result, dropout corrections are in black and white. The effect is not noticeable on the screen however.

Resistor R3013 controls the gain of the video amplifier. The video output is applied to point B of the electronic dropout

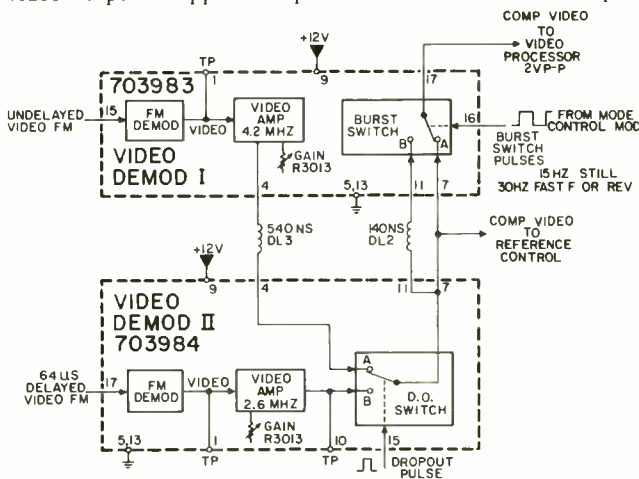

FIG. 6—VIDEO FM SIGNAL PROCESSING CIRCUIT is made up of two separate video demodulator circuit modules.

switch and can be monitored at the test point on pin 10.

The electronic dropout switch receives 540-ns delayed video on point A and one line delayed (64 μ s) composite video on point B. The voltage at pin 15 determines which of these signals is applied to the electronic burst switch. The voltage at pin 15 is the high-frequency identification voltage from the dropout detector module. When a dropout occurs, the voltage goes high and creates a dropout pulse for the duration of the dropout. The dropout switch is normally in position A and receives the undelayed video (540 ns). However, when a dropout pulse is present, the dropout switch moves to position B and receives the delayed video (64 μ s). The selected signal leaves at pins 7 and 11.

The 540-ns delay line compensates for the dropout response time. About 540 ns is required for the dropout circuitry to respond to the actual dropout. Thus, the "undelayed" video is actually delayed by 540 ns. When a dropout occurs the undelayed video remains present at position A of the dropout switch for 540 ns and gives the dropout circuit time to switch in the delayed video. The actual time difference between the two video signals is 64 μ s minus 540 ns. This equals about 63.5 μ s.

The electronic burst switch on the video demodulator II module is used to maintain the 180° phase difference in the 3.58-MHz chroma signal from frame to frame during special modes of operation, such as still picture, reverse, fast forward and slow motion. The chroma signal is normally 180° out of phase from track to track on the videodisc. This chroma relationship is also true from frame to frame on normal TV broadcasts since it is standard NTSC format. The purpose is to cancel 3.58-MHz interference in the picture.

However, when the same track (frame) is being played over

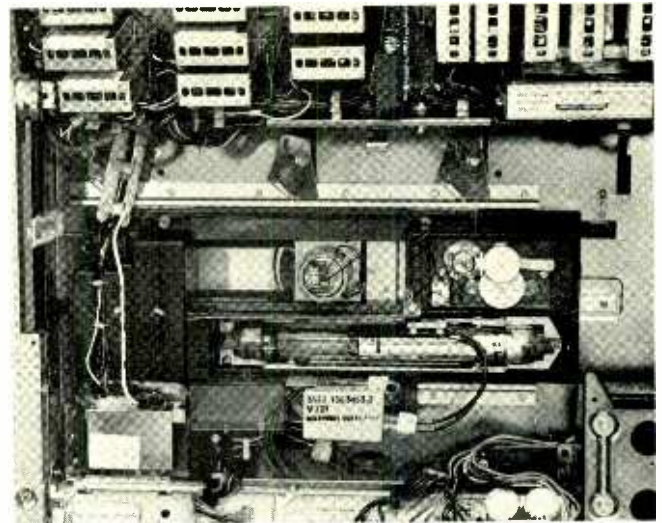

INSIDE THE VIDEODISC PLAYER. The laser tube is visible in the center of the photo. At the top are some of the many plug-in modules.

and over, such as during still-picture operation, the chroma signal would not be 180° out of phase from frame to frame. To introduce this phase difference, the signal is delayed by 140 ns every other revolution during still picture. The 140-ns delay line, DL2, is equivalent to 1/2 of a 3.58-MHz period.

The electronic burst switches delay line DL2 in or out depending on the burst switch pulses at pin 16. These pulses come from the mode control module. During normal play, no pulses are present, the burst switch remains in position A, and the 140-ns delay line is not in the circuit. During still picture, the burst switch pulses are at a 15-Hz rate. As a result, the burst switch is in position B for 1/30th of a second (one frame) and in position A for 29/30th of a second. During reverse play and fast forward, the burst switch pulses are at 30 Hz because only one half of each track is read at a time. The burst switch is then in position B for 1/2 revolution (1/60th of a second) and position A for the other half revolution.

The resultant composite video signal is coupled out of the module at pin 17 where it is sent to the video processor module. The composite video at pin 7 is identical to the signal at pin 17 except it lacks the burst switch correction. This signal is sent to the reference control module.

The video signal from the electronic burst switch is coupled to the first video amplifier in the video processor module at pin 17, as shown in Fig. 7. The video blanking input at pin 16 blanks the video signal during the return of the light beam to the inside of the videodisc and also during initial turn-on. The video signal from the amplifier is processed by the DC clamp circuit. It clamps the video signal to the correct DC level. The clamp adjust control, R3029, can vary this DC level. The DC clamp is driven by a horizontal rate clamp-gate pulse at pin 15. The DC level is corrected during each horizontal blanking interval.

Composite video is clipped in the reference control module by the amp/clipper stage. The resultant clipped video contains the digital code that represents the picture number. This code is applied to a decoder on the mode control module. The video generator actually creates the video signal for the picture number. A video signal is also generated that provides the grey background behind the picture numbers on the screen.

These video signals are applied to the second video amplifier and then to the VHF modulator. The composite video signal is also applied to the rear-panel monitor jack.

The VHF modulator, Fig. 8, receives the composite video signal and the audio signal. These signals modulate the RF carrier in the RF modulator stage. The RF modulator is an oscillator that delivers an RF signal on VHF TV channel 3 or 4. If the channel selector switch connects to ground, channel 3 is generated. If the switch connects to 12V, channel 4 is generated.

A simplified diagram of the antenna switch box is shown in

continued on page 89

Precision Digital Thermometer

BILL OWEN*

THE PRECISION DIGITAL THERMOMETER described in this article uses large-scale integrated circuitry and laser-trimmed temperature transducers to achieve state-of-the-art temperature-sensing capabilities. The two switch-selectable probes can be connected through hundreds of feet of cable to provide accurate temperature sensing in remote areas. Celsius or Fahrenheit measurement is switch-selectable with 0.1° resolution, with an accuracy better than ±0.5 °C (1.2 °F) over a -50° to +150°C range (-60° to 200 °F). Table 1 shows the digital thermometer specifications.

The digital thermometer can operate from a 117-volt to 9-volt plug transformer, 12-volt automotive or marine battery systems or from internal rechargeable NiCad batteries for portable operation.

This thermometer has the range, flexibility and accuracy necessary for many useful applications, including

- A weather station with indoor/outdoor monitoring capability
- In a ham installation to report local temperature
- Medical or veterinary use
- Troubleshooting air conditioning and heating systems
- Aquarium monitoring
- Hothouse/greenhouse monitoring
- Monitoring solar-energy collectors
- Monitoring incubators
- Fresh and salt water fishing
- On the electronics bench to check semiconductor case temperature; measure crystal oven temperature; etc.
- Glass-fiber mixing
- General laboratory use, setting water baths, ovens, etc.
- Photographic and darkroom use

There are many more applications where this digital thermometer can replace mechanical thermometers and provide better

resolution, accuracy and readability.

The heart of the thermometer is the AD590K temperature sensor. This sensor is an IC that, when connected to a voltage source, produces an output current proportional to temperature. The output current is equal to 1 µA per-degree-Kelvin. The Kelvin degree is equal in size to the Celsius degree; however, the Kelvin temperature scale is offset 273.2° higher than the Celsius scale, with 0°K (-273.2°C) called absolute zero. Absolute zero is the coldest possible temperature where molecular motion is at a minimum. The relationship between the Kelvin, Celsius and Fahrenheit scales is as follows:

$$T^{\circ}\text{C} = T^{\circ}\text{K} - 273.2^{\circ}$$

$$T^{\circ}\text{F} = \frac{9}{5} (T^{\circ}\text{C}) + 32^{\circ}$$

$$T^{\circ}\text{F} = \frac{9}{5} (T^{\circ}\text{K} - 273.2) + 32^{\circ}$$

There is also a little-used Rankine temperature scale that starts at absolute zero with Fahrenheit-size degrees and is offset 459.7° from the Fahrenheit scale. Rankine-to-Fahrenheit conversion is as follows:

$$T^{\circ}\text{F} = T^{\circ}\text{R} - 459.7^{\circ}$$

When the output current of the AD590K is passed through the appropriate value-scaling resistor, the resulting output voltage is proportional to the Kelvin or Rankine temperature, as shown in Fig. 1. The scaling resistors can be combined as shown in Fig. 2 so that °K or °R can be switch-selectable and read from a voltmeter. To generate an output voltage that is proportional to the more common Celsius and Fahrenheit scales, we need to subtract 2.732 volts from the °K output

TABLE 1—DIGITAL THERMOMETER SPECIFICATIONS

Range	-50°—+150°Celsius -60°—+200°Fahrenheit
Resolution	0.1°C 0.1°F
Sensor Linearity	±0.5°C, from -55° to +150°C
Meter Error	±1 count = ±0.1°C or F
Accuracy	Linearity error + calibration error + meter error
Probe Inputs	Two, switch-selectable
Sensor Probe	Number: 2 Type: temperature-dependent current source Response time: 3.4 seconds to reach 63.2% of step change in temperature in stirred liquid bath Voltage standoff: ±200V from sensor case to either active lead Cable length: 10 feet (can be extended to several hundred feet) Connector type: RCA phono plug
Meter Operating Temperature Range	0°—50°C
Display	3½, 0.43-inch-high, high-intensity red LED digits
Size	1¼ H × 4¼ W × 5¼ inches D
Weight	14 oz. (20 oz. with batteries and charger)
Input Power	9-14 volts AC or DC, 175 mA, 1.7 watts

*Product Engineer, Optoelectronics, Inc.

This easy-to-build electronic thermometer provides a resolution of 0.1 degree with unusually rapid response time. Two switch selectable sensor probes can be used for accurate measurements from remote areas.

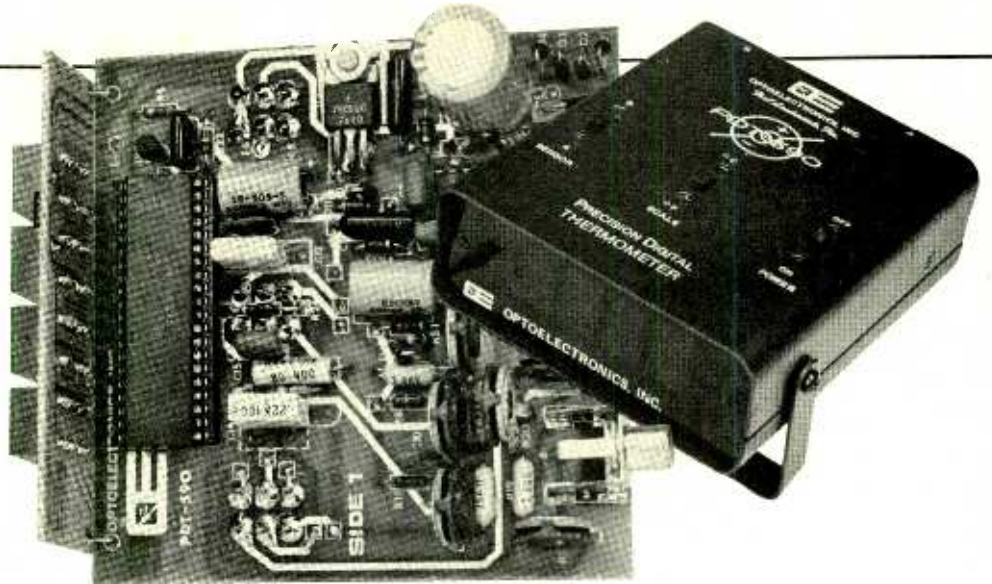

and 4.597 volts from the °R output, as shown in Fig. 2. This is accomplished by having the voltmeter measure the difference between the scaled output voltage and the appropriate reference voltage.

The reference voltages must be very stable, so a 6.9-volt-precision, integrated-circuit Zener (IC7, LM329DZ) is used with appropriate resistor dividers. Figure 3 shows the complete temperature-to-voltage circuit with Celsius-to-Fahrenheit and sensor switches. Trimmer resistors are used to calibrate the temperature sensors and to precisely adjust the reference voltages.

The selected temperature sensor's Celsius or Fahrenheit output voltage is measured by a 3½-digit digital voltmeter (DVM). The DVM has a -1,999-volt to +1,999-volt range, and so when the scaled output voltage falls below the reference voltage, a negative temperature is indicated. Because the input voltage is 10 mV-per-degree Celsius or Fahrenheit, the decimal point is placed between the 1-mV and 10-mV digits to obtain a degree C or degree F readout.

The complete schematic is shown in Fig. 4. The DVM is built around Intersil's 7107 analog-to-digital (A/D) converter IC. The 7107 uses the dual-slope

integration method of conversion, and has autozero and a true differential input (it measures the net difference between voltages applied to its input-high and input-low terminals).

The A/D converter contains amplifiers, buffers, analog switches, a comparator, a clock oscillator, counters, latches and LED segment drivers. In the first

part of a measurement cycle, the A/D converter internally shorts the inputs and charges autozero capacitor C15 to compensate for the amplifier and integrator offset voltages. In the next phase, the integrator output voltage increases at a rate that is proportional to the unknown input voltage for a fixed number of clock pulses. In the final phase, the integrator

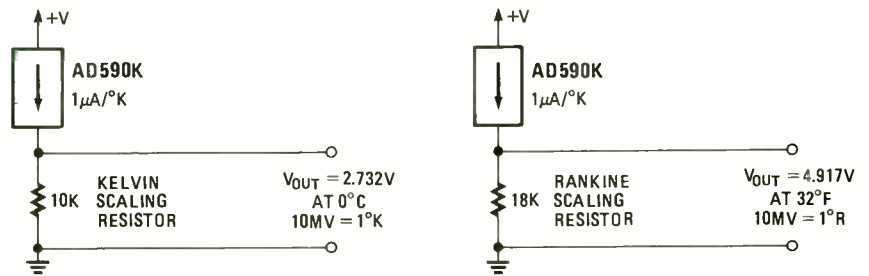

FIG. 1—TEMPERATURE-DERIVED CURRENT flows through scaling resistors to develop voltages proportional to Rankine and Kelvin temperatures.

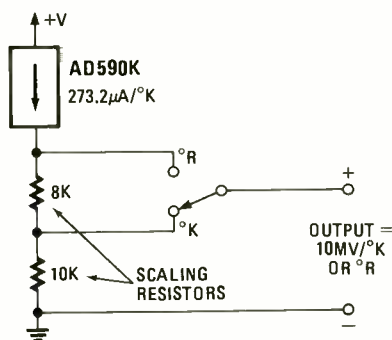

FIG. 2—SCALING RESISTOR adjusted to give Kelvin- and Rankine-proportional voltages.

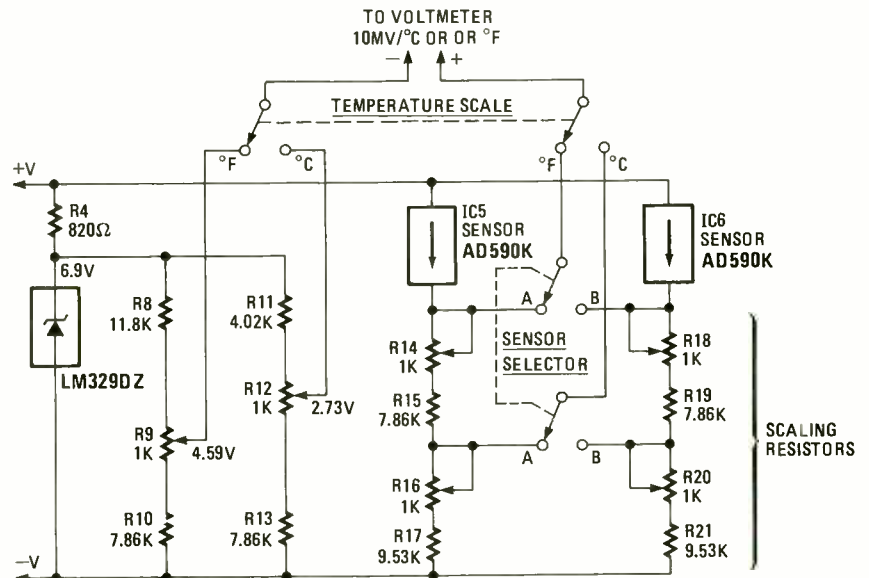

FIG. 3—REFERENCE VOLTAGES, derived from a 6.9-volt precision source, are used to produce temperature-dependent voltages corresponding to Centigrade and Fahrenheit scales.

output voltage is decreased at a rate that is proportional to the reference voltage stored on reference capacitor C12. The number of clock pulses required for the integrator to reach 0 volt is counted and displayed. If the unknown voltage is integrated for 1000 counts, and if it requires 1000 counts during the final phase to reach 0 (using a 1-volt reference), then 1000 is displayed corresponding to 1.000 volt.

Resistor R22 and capacitor C13 are connected to the internal oscillator to generate a frequency of 48 kHz, which is divided by 4 before being used. Maxi-

mum 60-Hz rejection is achieved by having the integration period be an integral multiple of the line frequency. Three conversions-per-second are performed with the 48-kHz clock frequency.

Accuracy with the dual-slope A/D converter is achieved without using precision resistors or capacitors. Integration capacitor C14, autozero capacitor C15 and reference capacitor C12 must have low leakage characteristics as well as low dielectric adsorption. Polypropylene film, Mylar and polycarbonate capacitors are recommended for their excellent dielectric properties.

Although the A/D converter has an on-chip voltage reference, the LM329DZ reference voltage is more stable because it is not subject to internal heating caused by the LED segment drivers. The 1-volt reference is externally supplied from a resistive divider across the LM329DZ precision Zener.

The circuit requires a +5.6- as well as a -5-volt power supply. The 9 to 14 volts AC or DC input supply is rectified and filtered by D1-D4 and C1. The 7805 voltage regulator supplies the +5 volts. The 555 timer (IC2) operates the astable mode and generates a 2-kHz squarewave

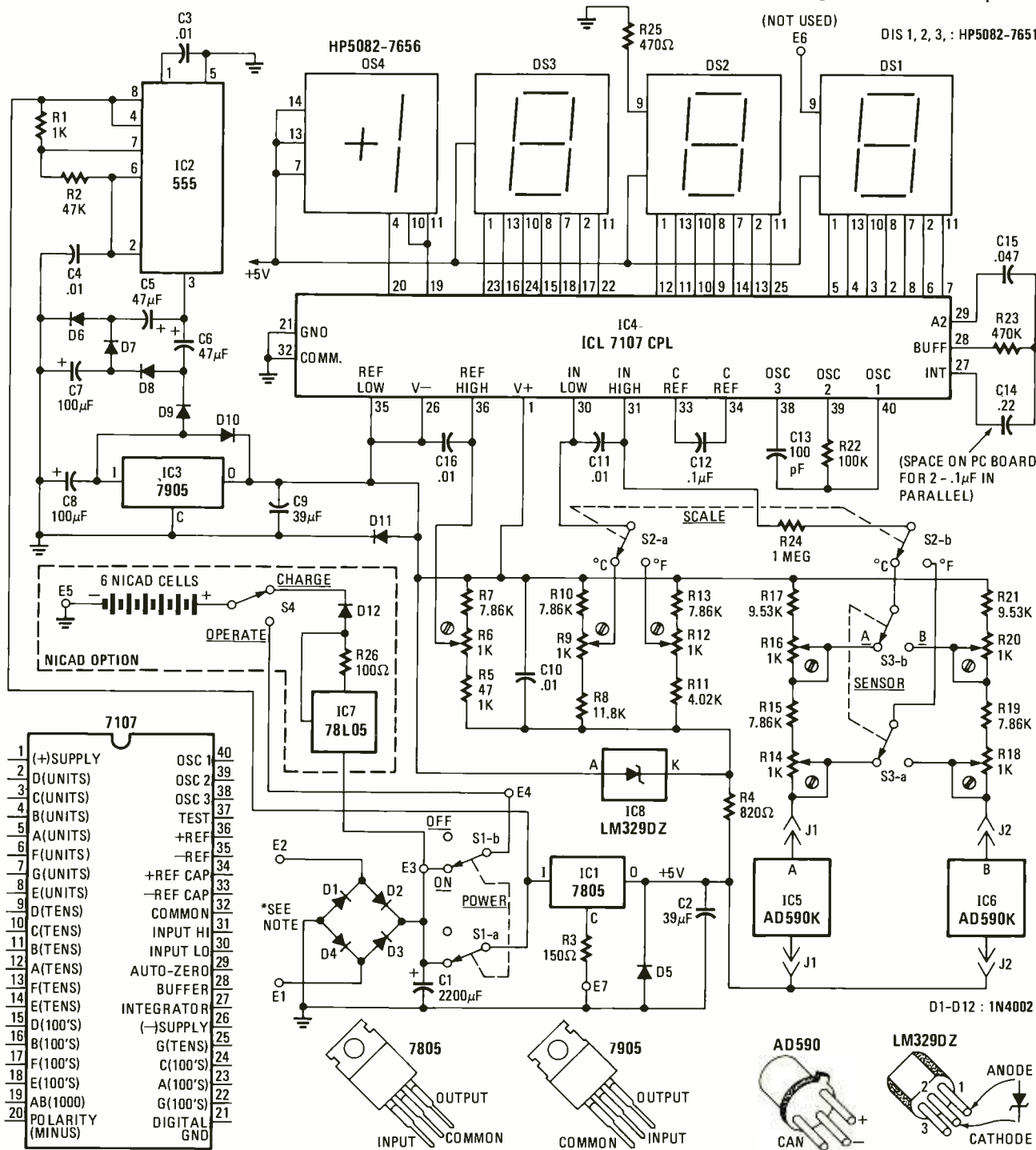

FIG. 4—THE DIGITAL THERMOMETER is designed around a 3½-digit A/D converter. The 555 timer IC generates a pulse train that is voltage-doubled and rectified for the negative supply.

that is voltage-doubled and clamped to produce the negative supply voltage that is regulated by 7905 regulator IC3.

Construction

Assembly is simple and straightforward; the PC foil patterns are shown in Figs. 5, 6 and 7, and parts placement is shown in Figs. 8, 9 and 10. Insert and solder all components referring to the parts list and Fig. 8. Start with the resistors and diodes, working your way up to the larger items. Note that some components are installed on the side of the main PC board opposite the other components, as in Fig. 9. Many components are top-soldered or soldered on both sides of the PC board wherever the PC foil surrounds a component lead. There are several feed-through locations (indicated by a \square in the parts layout) where a short piece of wire clipped from a component lead is inserted through a hole and soldered to the PC foil on both sides of the board.

The 7905 voltage regulator is installed on side 1 of the main PC board, and the 7805 voltage regulator is installed on side 2, using mica insulators and an insulating

nylon machine screw. The three 7805 leads must be bent straight down about 1/4 inch away from the regulator body, and soldered and clipped before the 7905 leads are soldered. Clip the excess 7805 leads close to the PC board so that they do not touch the 7905 leads.

The LED digits are soldered to the display board as shown in Fig. 10. After completing the PC boards, place a 3/4-inch piece of excess resistor lead in main PC board locations b and e, and solder them in place so that one-half the lead length extends from each side of the board. Bend these wires forward and insert the ends of wire b into locations a and c, and insert wire e into locations d and f on the display board. Solder the wires after carefully aligning the two PC boards so that they are at right angles, with all foil fingers exactly matching. There are two sets of foil semicircles that can be used as indicators to check the alignment. After re-checking alignment, solder the 26 mating foil fingers together.

Secure the three slide switches to the cabinet top with small flat-head screws. Put the main PC board on the switch lugs

and check the positioning with the rear panel, front panel and cabinet top in place. Solder the 18 slide-switch lugs to the main PC board.

Power-input jack J3 is mounted on the rear panel using shoulder washers and nylon spacers. Check to make sure that there is no continuity between the power jack and the rear panel. Use stranded hookup wire to connect the power-jack bracket and center pin to PC board locations E1 and E2.

Probe construction

Remove the case leads from the AD590K temperature sensors. Cut the

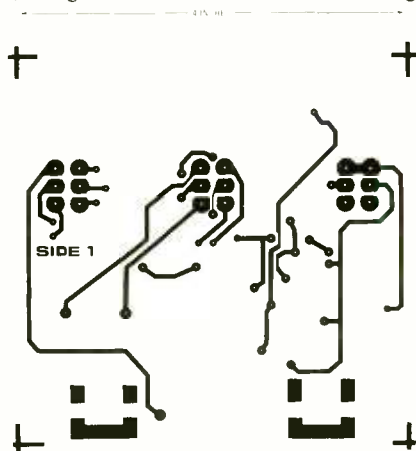

FIG. 5—FOIL PATTERN for the components side of the PC board. Approximately half size.

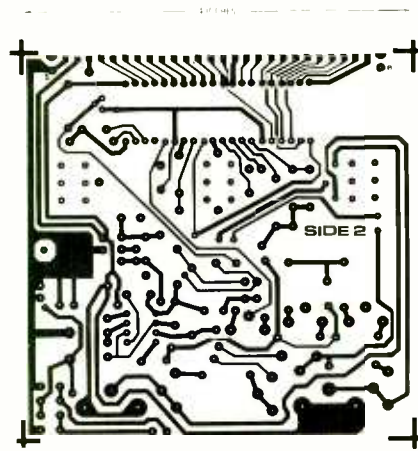

FIG. 6—PATTERN for side-2 of the board. Only a few parts are mounted on this side.

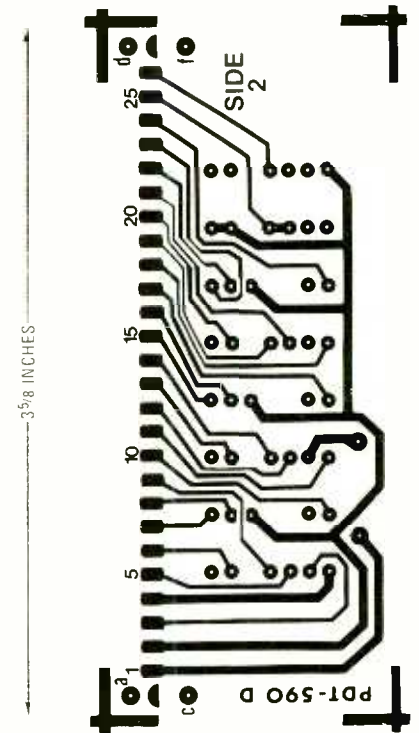

FIG. 7—DISPLAY BOARD uses this pattern with edge pads to mate with those on main board.

PARTS LIST

Resistors, 1/4 Watt, 5% unless otherwise noted

- R1—1000 ohms
- R2, R5—47,000 ohms
- R3—150 ohms
- R4—820 ohms
- R6, R9, R12, R14, R16, R18, R20—1000 ohms, vertical-mount, trimmer potentiometer
- R7, R10, R13, R15, R19—7860 ohms, 1%
- R8—11,800 ohms, 1%
- R11—4020 ohms, 1%
- R17, R21—9530 ohms, 1%
- R22—100,000 ohms
- R23—470,000 ohms
- R24—1 megohm
- R25—470 ohms
- R26—100 ohms

Capacitors

- C1—2200 μ F, 16 volts, electrolytic
- C2, C9—39 μ F, 10 volts, tantalum
- C3, C10, C16—.01 μ F, ceramic disc
- C4, C11—.01 μ F polyester
- C5, C6—47 μ F, 16 volts, electrolytic
- C7, C8—100 μ F, 25 volts, electrolytic

- C12—0.1 μ F, Mylar
 - C13—100 pF, dipped mica
 - C14—0.22 μ F, polyester
 - C15—.047 μ F, polypropylene
- #### Semiconductors
- D1—D13—1N4002
 - DIS1—DIS3—HP5082-7651, 7-segment LED display, common anode, right-hand decimal point, high-efficiency RED
 - DIS4—HP5082-7656 universal overflow display, ± 1 , right-hand decimal point
 - IC1—7805, +5-volt regulator
 - IC2—NE555 timer
 - IC3—7905, -5-volt regulator
 - IC4—ICL7107CPL, 3 1/2-digit CMOS A/D converter (Intersil)
 - IC5, IC6—AD590K, temperature sensor (Analog Devices)
 - IC7—LM329DZ precision Zener, 6.9 volts
- #### Miscellaneous
- S1—S3—miniature slide switch, DPDT
 - S4—miniature toggle switch, SPDT
 - Power transformer, 9 volts AC, 300 mA, plug-type with molded plug
 - Socket, 40 pins, DIP

- Socket, 8 pins, DIP
- J1, J2—phono jacks, PC mount
- J3—pin-type power receptacle to match power transformer
- Case, assorted hardware

The following kits for the digital thermometer are available from Optoelectronics, Inc., 5821 N.E. 14th Ave., Ft. Lauderdale, FL 33334:

The complete kit for the PDT-590 digital thermometer (includes cabinet, power supply, two probes and all parts except optional NiCad battery and charger) \$99.95. The PDT-590/WT, wired and tested \$159.95.

Rechargeable battery option NI-CAD-590 includes batteries, holder, mounting hardware, switch and charging circuit (used in kit and factory-wired models) \$25.00. Set of PC boards and switches PCB-590 \$19.95. Extra probe kit P-590K \$12.00; extra assembled probe P-590 \$15.00.

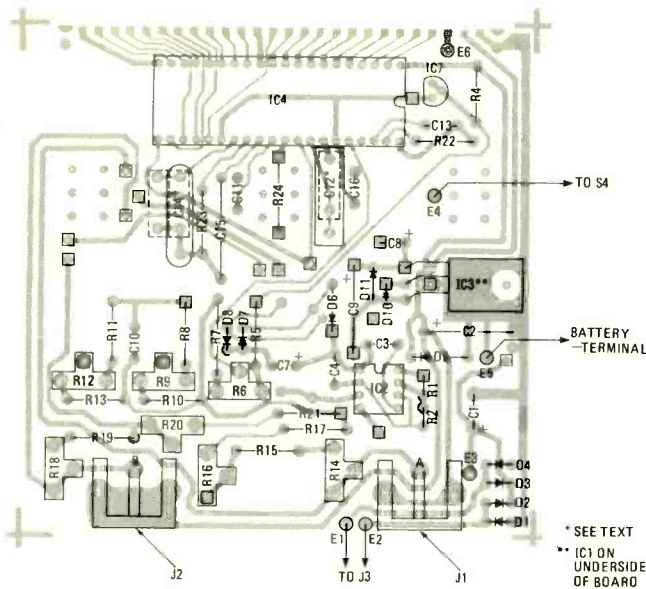

FIG. 8—PARTS PLACEMENT DIAGRAM showing locations of most of the components. Note that IC3 and IC1 are back-to-back.

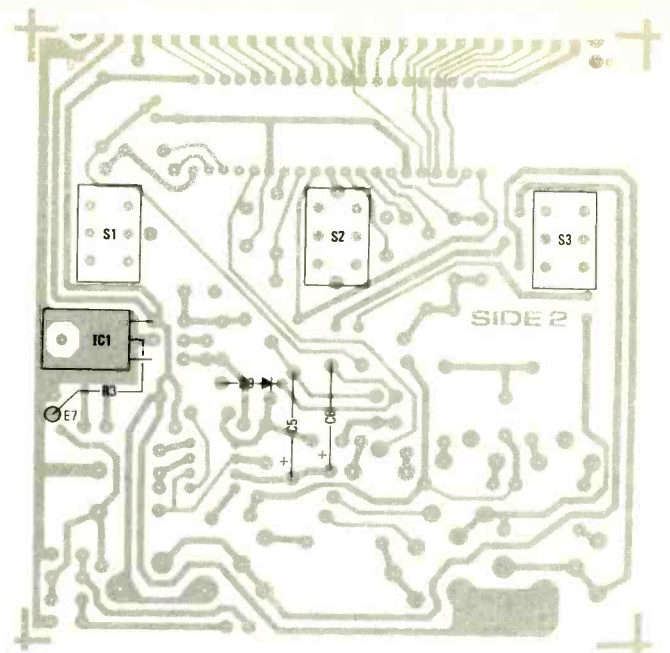

FIG. 9—SLIDE SWITCHES and a few other parts are mounted on side-2 of the main PC board.

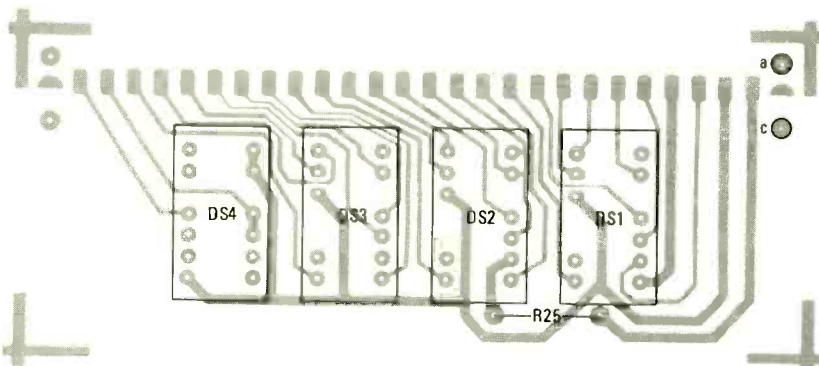

FIG. 10—PLACEMENT OF SEVEN-SEGMENT READOUTS on the display PC board. Be sure that the readouts are right-side up and that DS4 is in correct position.

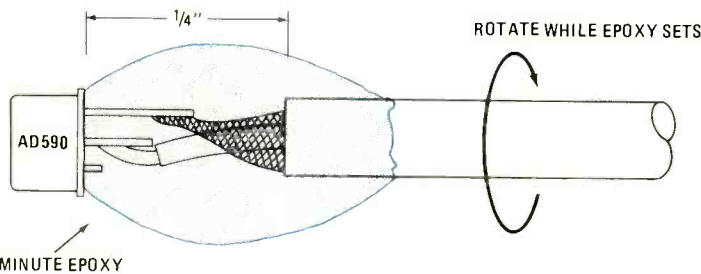

FIG. 11—HOW TEMPERATURE PROBES ARE CONSTRUCTED. Note that clear quick-setting epoxy cement is used to insulate and seal the sensor connections.

positive and negative leads back to 1/4 inch in length and tin them. Remove 1/4 inch of insulation from the end of the probe cable, and twist and tin the shield and the center conductor wires. Solder the shield to the sensor's positive lead and the center conductor to its negative lead.

Clear-drying five-minute epoxy cement should be used to waterproof the sensors. Thoroughly mix some epoxy and apply it around the solder connections on the sensor while rotating the cable (see Fig. 11) while the epoxy sets.

Calibration

After completing the sensor probes, plug them into the instrument and apply power to the circuit. Even without cali-

bration requires a DVM to set the reference voltages. Connect the negative DVM lead to pin 2 of the 7905 voltage regulator (IC3) and the positive lead to ground, and then check for 5 volts ± 0.25 volt. Next, connect the positive DVM lead to pin 2 of the 7805 regulator and check for 10.6 volts to 11 volts. If the voltage is below 10.6 then increase R3 to 180 ohms or 200 ohms to raise the positive supply voltage.

With the negative DVM lead on pin 2 of the 7905 voltage regulator, connect the positive lead to the center lug of trimmer resistor R6 and adjust R6 for 1.000 volt. Next, connect the positive lead to the center lug of trimmer R9 and adjust R9 for a 2.73-volt measurement. Then, connect the positive lead to the center lug of R12, and adjust R12 for 4.59 volts.

The sensor probes are easily calibrated using the boiling point and freezing point of water for reference. To achieve $\pm 0.6^\circ\text{C}$ accuracy (or better), the sensor probes should be calibrated at both points and the error should be evenly split between them. For instance, if the meter is adjusted to read 0.0°C at the freezing

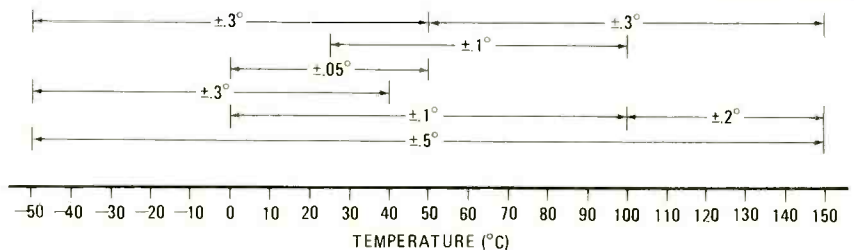

FIG. 12—SENSOR NONLINEARITY of the PDT-590 digital thermometer improves over reduced temperature ranges. Note that linearity is as good as $\pm 0.05^\circ$ between 0° and 50°C .

bration the display count should increase as the sensor responds to the heat from your hand. Label one probe "Sensor A" and the other "Sensor B," and do not unplug or interchange them during calibration.

point of water and 101.0° at the boiling point of water, then the error will be $+1^\circ\text{C}$. The error would be $\pm 0.5^\circ\text{C}$ if the meter were readjusted to read -0.5°C at the freezing point and 100.5°C at the

continued on page 83

Understanding DC Amplifiers

Ultra-wide frequency response and reduced harmonic and transient intermodulation distortion are some of the advantages of DC amplifiers. Here's a look at how these relatively new amplifiers work

LEN FELDMAN
CONTRIBUTING HI-FI EDITOR

DURING THE PAST TWO YEARS OR SO, SEVERAL manufacturers of audio amplifiers have been offering so-called DC amplifiers to demanding audiophiles. The choice of "DC" as a name for this new type of audio amplifier is perhaps unfortunate. In earlier days, that abbreviation, at least as

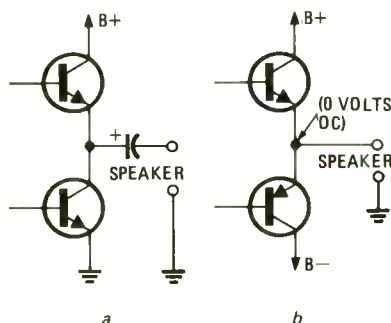

FIG. 1—CAPACITOR-COUPLED OUTPUT stage is shown in a DC amplifier output stage eliminates coupling capacitor by using a dual power supply and complimentary NPN and PNP output transistors.

it applied to audio equipment, meant direct-coupled.

The transition from capacitor-coupled output circuitry (Fig. 1-a) to audio output stages that could be connected directly to the loudspeaker load (Fig. 1-b) was made relatively simple by using suitable complementary NPN and PNP high-powered output transistors and dual-polarity power supplies. By establishing a 0 DC volts condition at the junction of the two output transistors, it was possible

to deliver AC power to the load without applying DC voltage. Such a DC voltage would, of course, damage speaker voice coils if appreciable direct current flowed. At the very least, the presence of a small amount of DC voltage would offset the position of the speaker cone and cause nonlinear operation.

Nowadays, when audio manufacturers refer to DC amplifiers, they mean a new type of amplifier capable of amplifying signals of extremely low frequency—theoretically, down to 0 hertz or DC. It can be argued that since there is no musical content in any program source that goes to 0 hertz, there is no point in designing an amplifier that actually can amplify DC signals. After all, even the lowest note on a giant pipe organ is a relatively high 16 Hz, and attempts to capture the sound of that low note deliver it as more of a vibration that we feel rather than hear.

Indeed, some manufacturers define a DC amplifier not so much as one that can amplify "down to 0 hertz," but rather one that has no low-frequency time constants in any of its negative-feedback circuits. Figure 2-a shows a conventional negative-feedback loop; while Fig. 2-b shows how negative feedback is applied in so-called DC amplifiers. While the capacitor in the feedback network is eliminated, there may still be coupling capacitors elsewhere in the signal path.

Generally, an integrated amplifier (consisting of a preamplifier/equalizer

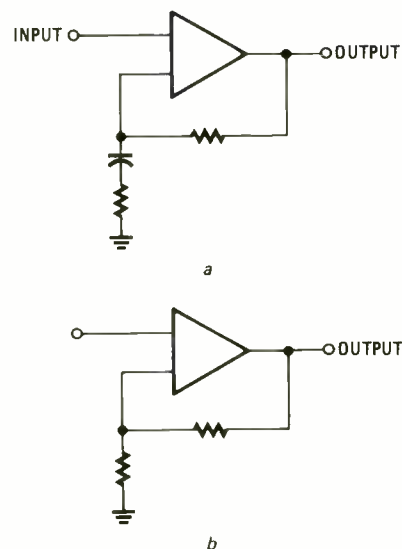

FIG. 2—CONVENTIONAL AMPLIFIER uses capacitor in feedback loop as shown in a. DC amplifier eliminates capacitor as shown in b.

stage, a tone control section and a power amplifier section) may have one or all of its sections designed in a DC configuration, and manufacturers would still label the product as a DC amplifier.

Why design a DC amplifier?

Amplification of direct-current signals is not required in the reproduction of musical signals. The purposes of designing a DC amplifier are threefold:

1. To establish a constant driving

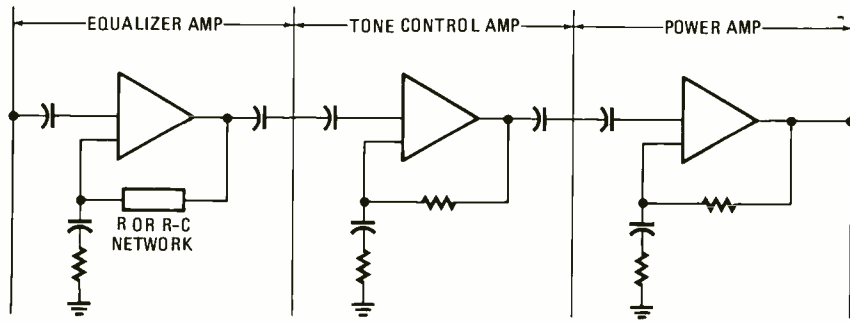

FIG. 3—INTEGRATED DC AMPLIFIER may still have capacitors in the signal path.

power-versus-frequency relationship between the amplifier and its loudspeakers, or between the phono cartridge and the preamplifier/equalizer section over a very wide frequency range.

2. To eliminate capacitors, which can generate their own harmonic distortion components, from all signal paths, including the negative-feedback loop, as much as possible.
3. To improve the waveform transmission characteristics of the amplifier, including the phase and time relationships inherent in complex signals and, thereby, to also reduce transient intermodulation distortion (TIM).

Eliminating capacitors

In an integrated amplifier without output capacitors there may still be as many as eight capacitors in the signal path, as shown in Fig. 3. The large-capacitance electrolytics used previously in output stages are the most likely to degrade sound quality since they can behave as nonlinear impedances even when properly polarized. Such capacitors are likely to affect the coupling between speakers and cartridges and the amplifier. It is no wonder, then, that they were the first to be eliminated in modern amplifiers.

In theory, it is possible to design an amplifier having no capacitors at all. However, in practice this may be difficult and, in some cases, undesirable. If a very small amount of direct current is produced by a signal source (for instance, a tuner having a slightly leaky output capacitor, or a tape deck having the same problem), this current will be amplified by the gain factor of the entire integrated amplifier (often by 30 dB or more) and appears as a DC voltage at the speakers, which could easily destroy an expensive loudspeaker system. For this reason, a few coupling capacitors remain necessary in integrated amplifier design.

Different companies have approached the DC amplifier design problem in different ways. Figure 4 shows some of these approaches. In Fig. 4-a, only the power amplifier uses a pure, capacitor-less "DC design." Using such a DC design in the power amplifier has the advantage of providing excellent damping factors at low frequencies, which, in turn, provides well-defined and tight bass reproduction.

For optimum overall sound reproduction, this design approach requires a fairly heavy-duty power supply. This design approach is incorporated in Sansui's *model AU-707*, *model AU-607*, *model AU-717* and *model AU-515* amplifiers, as well as *Technics* by Panasonic, *models SU-8080* and *SU-8075*.

Figure 4-b shows another approach that involves a DC power amplifier, plus a preamplifier/equalizer in which the input capacitor has also been eliminated. This method permits extremely low-level, low-frequency signals to be applied directly from the phono cartridge into the first

preamplifier stage without passing through a coupling capacitor. Since a cartridge can be considered to be a voltage generator, the preamplifier/equalizer usually uses an FET because of its voltage-amplifying capability. Using an FET as a first stage has the advantage of not requiring any bias voltage. Although there is a difference in the signal-to-noise ratio between an FET and a conventional bipolar transistor phono-input circuit when it is measured under short-circuit input conditions, the FET circuit provides an excellent signal-to-noise ratio during actual operation when a phono cartridge is connected. This anomaly, incidentally, prompted the IHF committee, which was involved in producing new standards of amplifier measurement, to specify a more realistic termination of the phono inputs of an amplifier or preamplifier when making signal-to-noise measurements. The phono input termination specified in the new standards consists of a 500-mH, $\pm 10\%$ inductor in series with a 1000-ohm, $\pm 10\%$ resistor and a 125-pF, $\pm 10\%$ capacitor in parallel with the L-C circuit.

Amplifiers using the design approach

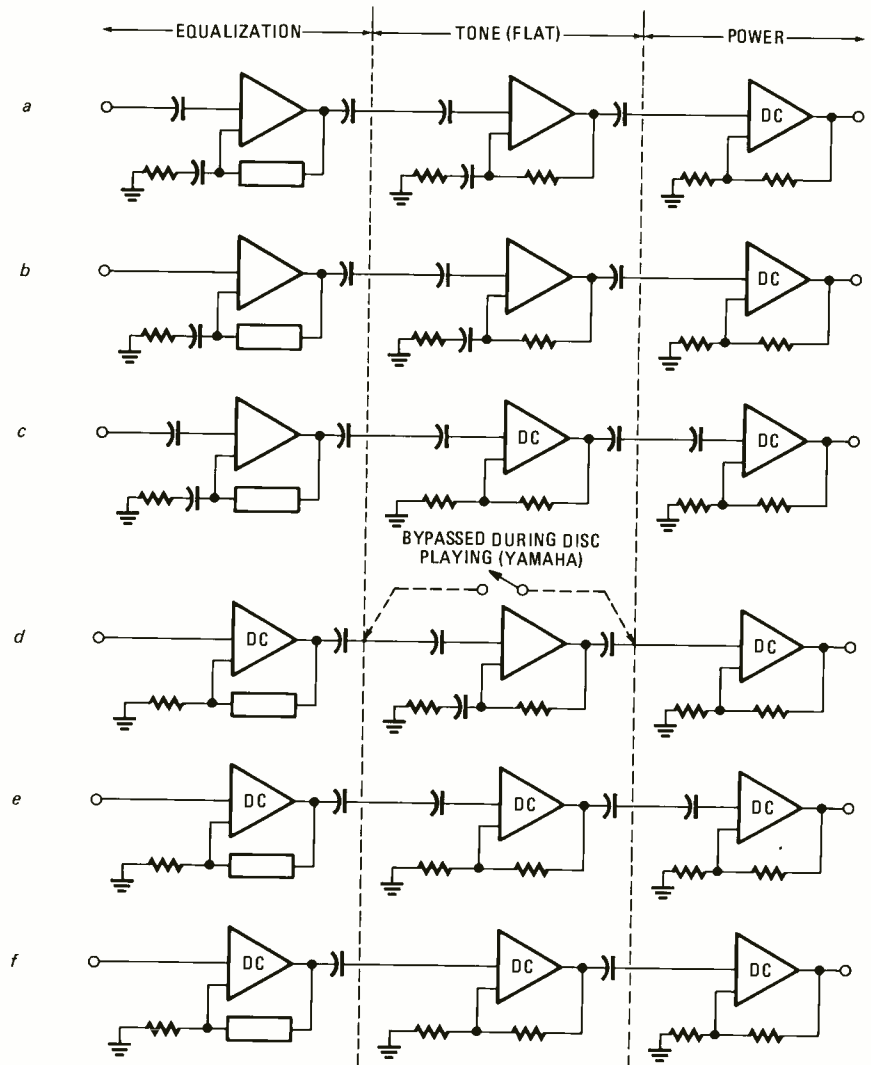

FIG. 4—DESIGN VARIATIONS in DC amplifiers that are currently being produced by different manufacturers.

shown in Fig. 4-b include Kenwood's *model KA-7300D*, *model KA-7100D* and *model KA-8100*, except that the input capacitor to the tone-control section is eliminated.

In Fig. 4-c, both the power and the tone-control amplifier stages have eliminated the capacitor in the feedback loop, and, while the output capacitor has been eliminated from the power stage, input and output capacitors are still present in each of the separate sections, forming a low-frequency time-constant circuit. This design approach is used in Pioneer's *model A-004* integrated amplifier.

Figure 4-d shows both the preamplifier/equalizer and power amplifier stages are DC-designed and have eliminated input-capacitor coupling. The design emphasis is on optimum input coupling for the phono cartridge and optimum output coupling to the loudspeakers. Amplifiers from different manufacturers using this approach show variations, which may result from different views regarding sound quality, physical performance and cost-performance considerations.

For example, the Onkyo *model A-708* and *model A-705* use an equalizer circuit that is divided into two sections, as shown in Fig. 5. A negative-feedback circuit is used for equalizing low frequencies, while an R-C circuit is used to rolloff the high frequencies in accordance with RIAA equalization requirements.

In the Yamaha *model A-1*, power-amplifier gain is increased during the record playing, and the input-capacitorless, DC-designed equalizer is directly coupled to the power section, as shown by the dotted lines in Fig. 4-d. In this instance, only one coupling capacitor is introduced into the signal path. On the other hand, when the tone-control amplifier is introduced into the circuit, the signals pass through a capacitor-coupled tone-control section.

In the case of Sony's variation of this design (as presented in their *model TA-F6B*), when the DC equalizer is used, the amount of feedback in the DC range is partially restricted to obtain additional stability. A small-value capacitor remains in the negative-feedback loop. This design is often referred to as a "DC feedback type." Similarly, in the case of JVC's *model JA-S41*, a capacitor remains in the negative-feedback loop of the preamplifier/equalizer for shunting the DC feedback.

In Fig. 4-e, all stages DC-designed in their feedback networks, but coupling capacitors are still used in the tone-control and power-amplifier stages. An example of this design is Pioneer's *model A-006*.

Finally, Fig. 4-f shows a design in which all the stages have eliminated capacitors in the feedback loops, and all input capacitors to the various sections have also been eliminated. According to JVC (whose *model JA-S77* and *model*

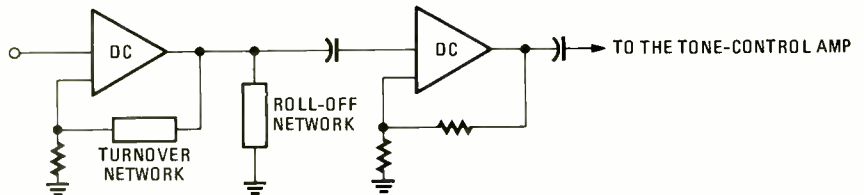

FIG. 5—TWO-STAGE EQUALIZER circuit is used by Onkyo in their *model A-708* and *A-705*.

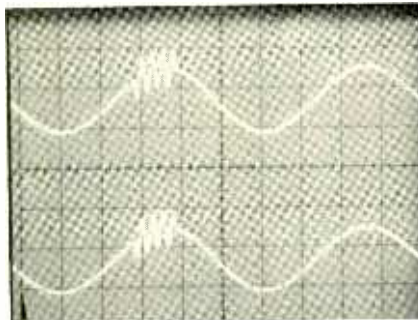

FIG. 6—DC AMPLIFIER is evaluated using a 400-Hz tone-burst riding on a 20-Hz sine wave (upper trace) as the input signal. Output from DC amplifier (lower trace) shows little phase shift.

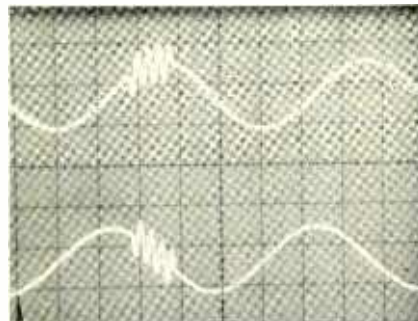

FIG. 7—DC AMPLIFIER with different design scheme than the amplifier in Fig. 6 is evaluated using the same input waveform (upper trace). Output waveform shows phase-shift of 400-Hz component.

JA-S55 use this approach), this represents the best compromise short of totally removing all capacitors in the signal path. The output capacitors remaining in the circuit (between the equalizer and flat amplifier and between the flat amplifier and the power amplifier) are designed for a minimum low-frequency time constant.

Comparing waveforms

When comparing a DC amplifier (or, more correctly, a fully DC-coupled section of such an amplifier) with an AC-coupled amplifier, it is easy to note differences in the output by using a squarewave input signal. The "tilt" of the output squarewave delivered by the AC amplifier indicates the amount of phase shift in the amplifier's low-frequency range.

In comparing different DC amplifier designs, however, using a simple squarewave input signal may not show such obvious output differences at all. Accordingly, more complex input waveforms more easily show up these minor differences. For example, imagine that a 400-Hz tone burst were superimposed upon a 20-Hz sine wave. When using such a

waveform to compare two DC amplifier designs such as those shown in Fig. 4-b and Fig. 4-f, such differences are easily found. (See Figs. 6 and 7.)

The scope photo of Fig. 6 shows that when the Fig. 4-f design is used, the 400-Hz burst appears at the same relative position in the output waveform with respect to the 20-Hz low-frequency component in the composite signal. Using another amplifier which is designed according to the scheme shown in Fig. 4-b and using the same input waveform (shown by the upper trace in both Figs. 6 and 7), the scope photo of Fig. 7 shows that the 20-Hz component in the output (lower) trace has been displaced in time with respect to the 400-Hz tone burst.

Many audio theorists suggest that such subtle differences in time-phase relationships are detectable by the human ear, even though all frequencies are ultimately reproduced at their correct relative amplitudes. Others argue just as vehemently that such phase differences are undetectable by the human ear. Nevertheless, early reactions to the new breed of DC amplifiers seem to indicate that they do sound audibly better during critical listening tests. Each manufacturer will undoubtedly approach the DC design problem from his own point of view, and it is still up to the consumer to decide which of all these new amplifiers sounds best and reproduces sound that most closely approximates the original live music performance.

R-E

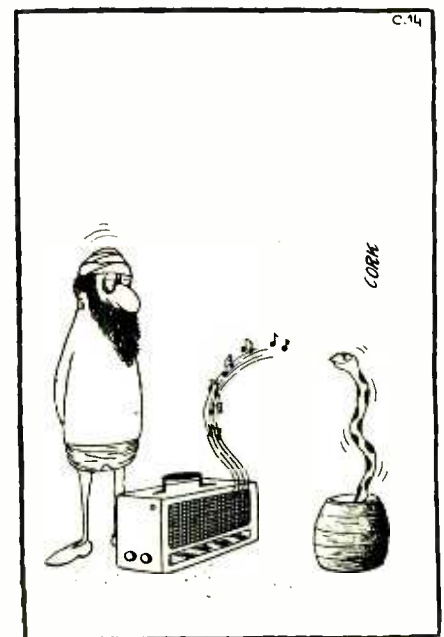

Radio-Electronics Audio Lab Tests

Yamaha Model CR-2040 AM/FM Receiver

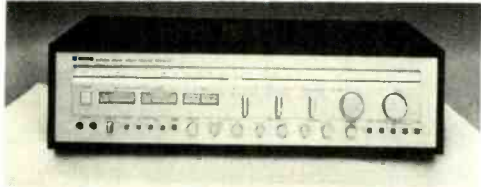

1
CIRCLE 106 ON FREE INFORMATION CARD

LEN FELDMAN
CONTRIBUTING HI-FI EDITOR

A SENSIBLY ORGANIZED, ELEGANTLY STYLED and sleekly proportioned front panel is what impresses you first about Yamaha's 1979-1980 top-of-the-line receiver, the *model CR-2040*.

The receiver is housed in an ebony wood-grained cabinet (included in the retail price). A horizontally oriented mid-section of the front panel (shown in Fig. 1) protrudes slightly for a three-dimensional effect, and contains a square-shaped POWER switch, three VU meters, a recording output selector switch, input and phono selector switches, a master volume control and a tuning knob. The center meter serves a dual function: It acts as a signal-strength meter or as a power-output meter for

the right-hand channel, complementing its companion meter on the left, which indicates left-channel power in watts. The meter on the right is used for FM center-channel tuning.

The fully independent RECORD SELECTOR and INPUT SELECTOR switches enable you to feed any program source to the tape-output jacks, while the INPUT SELECTOR switch chooses the program source that will be connected to the speakers. The PHONO SELECTOR switch chooses any of four load-resistance values for the cartridge, and, in addition, selects a moving-coil (MC) preamplifier circuit that lets you use low-output cartridges without having to add a matching transformer or pre-preamplifier ("head amp").

RADIO-ELECTRONICS AUDIO LAB

R.E.A.L. SOUND

RATES

YAMAHA CR-2040 RECEIVER

EXCELLENT

Copyright © Gernsback Publications Inc., 1979



MANUFACTURER'S PUBLISHED SPECIFICATIONS:

FM TUNER:

Usable Sensitivity (mono): 1.6 μ V (9.8 dBf). **50-dB Quieting:** mono, 3.2 μ V (15.3 dBf); stereo, 35 μ V (36.1 dBf). **S/N Ratio:** mono, 90 dB; stereo, 84 dB. **Capture Ratio:** 1.5 dB. **Selectivity (DX/local):** 82/48 dB. **IF and Spurious Rejection:** 100 dB. **Image Rejection:** 80 dB. **AM Rejection:** 60 dB. **Frequency Response:** 30 Hz to 15 kHz, +0.4, -1.0 dB. **THD (mono):** 0.07% at 100 Hz & 1 kHz; 0.1% at 6 kHz. **THD (stereo):** 0.09% at 100 Hz & 1 kHz; 0.15% at 6 kHz. **Stereo Separation:** 50 dB at 1 kHz and 100 Hz; 45 dB at 10 kHz. **Subcarrier Rejection:** 70 dB. **Muting Sensitivity:** 5 μ V (19.2 dBf). **Auto/DX Switching Sensitivity:** 35 μ V (39.2 dBf).

AM TUNER:

Usable Sensitivity: 15 μ V. **Selectivity:** 30 dB. **S/N Ratio:** 50 dB. **THD:** 0.4%. **Image Rejection:** 40 dB. **IF Rejection:** 35 dB. **Spurious Rejection:** 60 dB.

AMPLIFIER:

Power Output: 120 watts-per-channel, 8 ohms (140 watts-per-channel, 4 ohms), 20 Hz to 20 kHz. **Rated THD:** 0.02%. **Damping Factor:** 40. **IM Distortion:** 0.02%. **Frequency Response (all inputs):** 20 Hz to 20 kHz, \pm 0.2 dB. **Input Sensitivity:** MC phono, 100 μ V; MM phono, 2.5 mV; high level, 120 mV. **S/N Ratio:** ("A"-weighted, referenced to full output): phono MC, 88 dB, referenced to 500 μ V; phono MM, 95 dB, referenced to 10 mV; high level, 100 dB. **Bass and Treble Range (see text):** \pm 10 dB. **Midrange Control:** \pm 6 dB. **Low Filter Cutoff:** -3 dB at 25 Hz. **High Filter Cutoff:** -3 dB at 6 kHz or 10 kHz. **Loudness Control Range:** 20 dB. **Audio Muting:** 20 dB.

GENERAL SPECIFICATIONS:

Power Consumption: 600 watts, 120 volts 60 Hz. **Dimensions:** 22 $\frac{3}{16}$ " W \times 6 $\frac{1}{16}$ " H \times 16 inches D. **Weight:** 44 lbs., 14 oz. **Suggested (Approximate) Retail Price:** \$850.

The top of the panel contains a softly illuminated pair of frequency AM and FM scales, to the left of which are a red power-on light, a green half-power light, and a red overload light that illuminates whenever the amplifier is driven beyond its rated output capability. Six small indicator lights to the right of the frequency scales illuminate to show AM reception, stereo FM reception, activation of an automatic FM-blend circuit, local or DX FM operation, and activation of Yamaha's special OTS (Optimum Tuning System) tuning circuit.

All the less-used controls are placed along the bottom edge of the panel. These controls include two phone jacks, a speaker selector switch, eight small rotary knobs and ten push-buttons. The five pushbuttons on the left select the center-meter functions (power or signal strength), low-cut or high-cut filtering, and a 20-dB audio muting feature. Five pushbuttons on the lower right select mono/stereo modes, interpose an adaptor circuit interruption point, choose either of two FM IF modes (local or auto-local), activate or defeat the muting and OTS feature, and select FM or AM reception. Outermost of the eight remaining rotary controls handle loudness and balance. The loudness control alters the gain settings by 20 dB, is continuously variable (introducing loudness compensation as the control is rotated) and is entirely independent of the master volume control. In using these controls, the listener adjusts any program source to "life-like" loudness levels using the *master* volume control. Then, if softer-than-lifelike levels are desired, you simply reduce the setting on the *loudness* control, which then introduces precise loudness compensation over the available 20-dB

range. Thus, proper loudness is obtained regardless of speaker efficiency, room acoustics, program-source level or any of the other variables that usually make conventional tapped-volume-control loudness systems all but useless.

The six remaining rotary controls take care of bass, treble and mid-range tone adjustments. Here also, Yamaha has gone far beyond what is normally found on most receivers. Each tone control has a companion control that determines its turnover frequency (in the case of the BASS and TREBLE controls) or its center frequency (in the case of the midrange or PRESENCE control).

The turnover point of the treble control may be varied from 2 kHz to 10 kHz, while that of the BASS control may range from 100 Hz to 500 Hz, and the center frequency of the midrange control can be varied from 1 kHz to 6 kHz. This control versatility comes very close to that of a true parametric equalizer, and, as far as we know, is not found on any other integrated receivers to date.

The rear panel of the model CR-2040 contains spring-loaded, color-coded terminals for speaker connections. Also included are the usual phono and high-level input jacks, tape-input and tape-output jacks, a pair of preamplifier-out jacks, and jacks for the adaptor circuit to connect noise-reduction units, expanders, time-delay devices, etc. It is also possible to connect a tape deck to the preamplifier-out terminals if you want to pre-equalize (tone-control) signals for recording. A view of the rear panel is shown in Fig. 2.

Balanced 300-ohm FM antenna terminals plus an AM antenna and ground terminal are also provided, as is an unusual "indoor" AM antenna, shown in Fig. 3. This true loop anten-



3

na proved to be somewhat more sensitive than the usual straight "stick" type, and it can be mounted on the rear panel or on any convenient nearby surface since its bracket is coated with self-adhesive material. While a 75-ohm coaxial connector is provided for unbalanced FM transmission lines, the connector is a nonstandard unit. Yamaha supplies a mating male connector that can be easily attached to incoming coaxial cable without any soldering. Three convenience AC receptacles are also included; one switched, two unswitched. Figure 4 shows how additional high-fidelity components could be combined with the Yamaha model CR-2040.

Construction and circuitry

An internal view of the chassis is shown in Fig. 5. An unusual feature of the layout is the use of flexible cables that couple several of the front-panel controls to multiple-position slide switches that are physically close to the circuits they handle, thereby reducing the possibility of hum-and-noise pickup. A substantial section of the chassis contains large heat-sink structures housing the power transistors, while

TABLE 1
RADIO-ELECTRONICS PRODUCT TEST REPORT

Manufacturer: **Yamaha**

Model: **CR-2040**

FM PERFORMANCE MEASUREMENTS

SENSITIVITY, NOISE AND FREEDOM FROM INTERFERENCE	R-E Measurement	R-E Evaluation
IHF sensitivity, mono (μ V) (dBf)	1.9 (10.8)	Good
Sensitivity, stereo (μ V) (dBf)	4.2 (17.7)	Very good
50-dB quieting signal, mono (μ V) (dBf)	2.4 (12.8)	Excellent
50-dB quieting signal, stereo (μ V) (dBf)	33.0 (35.6)	Excellent
Maximum S/N ratio, mono (dB)	86	Superb
Maximum S/N ratio, stereo (dB)	75 (See text)	Superb
Capture ratio (dB)	1.4	Good
AM suppression (dB)	61	Very good
Image rejection (dB)	80	Very good
IF rejection (dB)	100+	Superb
Spurious rejection (dB)	100+	Superb
Alternate channel selectivity (dB)	83/50 (local)	Excellent
FIDELITY AND DISTORTION MEASUREMENTS		
Frequency response, 50 Hz to 15 kHz (\pm dB)	0.3	Excellent
Harmonic distortion, 1 kHz, mono (%)	0.045	Superb
Harmonic distortion, 1 kHz, stereo (%)	0.045	Superb
Harmonic distortion, 100 Hz, mono (%)	0.055	Superb
Harmonic distortion, 100 Hz, stereo (%)	0.055	Superb
Harmonic distortion, 6 kHz, mono (%)	0.12	Excellent
Harmonic distortion, 6 kHz, stereo (%)	0.12	Excellent
Distortion at 50-dB quieting, mono (%)	0.75	Good
Distortion at 50-dB quieting, stereo (%)	0.28	Very good
STEREO PERFORMANCE MEASUREMENTS		
Stereo threshold (μ V) (dBf)	3.0 (14.7)	Very good
Separation, 1 kHz (dB)	55	Superb
Separation, 100 Hz (dB)	53	Superb
Separation, 10 kHz (dB)	44	Superb
MISCELLANEOUS MEASUREMENTS		
Muting threshold (μ V) (dBf)	5.0 (19.2)	Very good
Dial calibration accuracy (\pm kHz at MHz)	50 at 108	Excellent
EVALUATION OF CONTROLS, DESIGN, CONSTRUCTION		
Control layout		Superb
Ease of tuning		Very good
Accuracy of meters or other tuning aids		Excellent
Usefulness of other controls		Excellent
Construction and internal layout		Excellent
Ease of servicing		Good
Evaluation of extra features, if any		Excellent
OVERALL FM PERFORMANCE RATING		Excellent

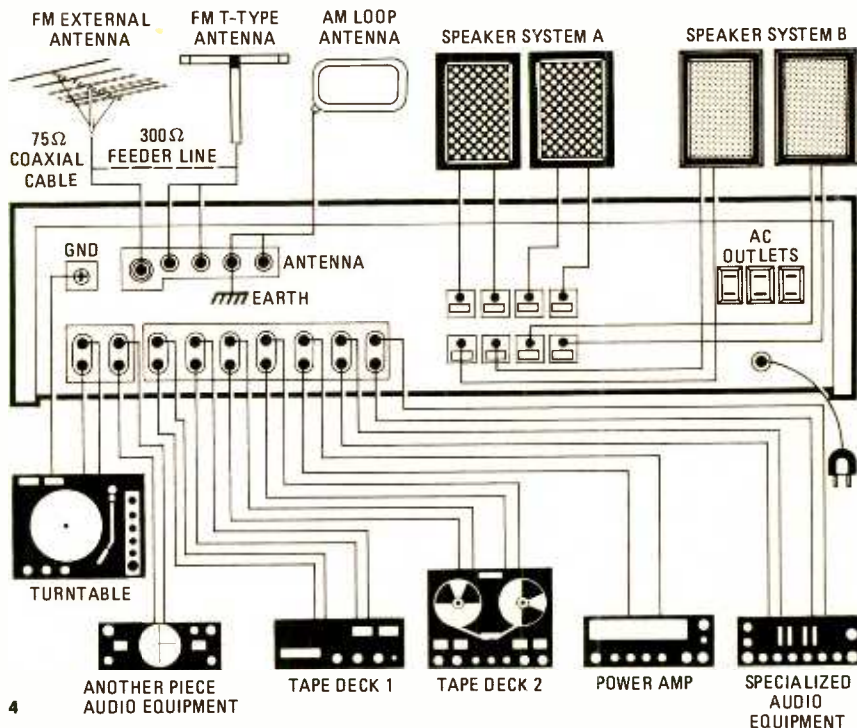

4

tuner circuits and preamplifier stages are as far removed from the power transformer as possible.

The FM front end uses a four-section tuning capacitor and is equipped with a junction FET for the RF amplifier stage. The IF section operates in two modes (the "local" or wide-band mode and the "DX" or narrow-band mode for high selectivity). Three uniresonance ceramic filters, one discrete transistor stage and a six-stage differential IC amplifier with current limiter are used in the local mode, while two additional ceramic filters and a second differential amplifier are used in the DX mode.

An auto-DX circuit activates the IF operat-

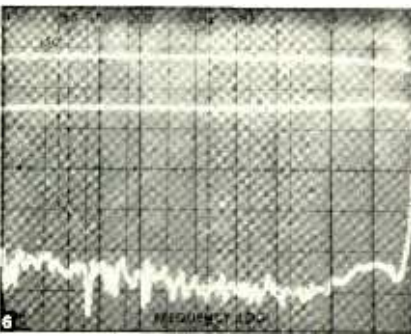

ing mode, depending upon the amount of noise and interference present in the received signal. In addition, if stereo signal strength is low, a multiplexed blend circuit automatically reduces noise while sacrificing stereo FM separation. The AFC circuitry (OTS) is defeated when the tuning knob is touched during tuning, but it locks the local oscillator "on frequency" once the desired signal is tuned in and the knob is released. When the OTS is activated, this also activates the muting circuit to eliminate interstation noise when tuning.

The stereo decoder contains a phase-locked-loop demodulator plus a tracking pilot-signal canceller that removes residual 19-kHz signal before it reaches the demodulator. This special circuit even takes into consideration any minor variations in the 19-kHz level that are transmitted by the station (pilot signals may legally range from 8% to 10% of total modulation), thus tracking both the level and the phase of the incoming pilot signal. This canceller circuit makes it possible to achieve excellent high-frequency response in stereo FM, since "brute force" filtering of the 19-kHz signal (which often degrades response in the 10-kHz to 15-kHz range) is not required after decoding.

The elaborate tone controls use low-noise IC's with "gyrator," or simulated L-C circuits that are immune to hum pickup. The phono section uses five low-noise transistors-per-channel, and the equalization-feedback resistors have a 1% tolerance, while the equivalent

TABLE 2

RADIO-ELECTRONICS PRODUCT TEST REPORT

Manufacturer: Yamaha

Model: CR-2040

AMPLIFIER PERFORMANCE MEASUREMENTS

	R-E Measurement	R-E Evaluation
POWER OUTPUT CAPABILITY		
RMS power/channel, 8-ohms, 1 kHz (watts)	145.3	Excellent
RMS power/channel, 8-ohms, 20 Hz (watts)	140.0	Superb
RMS power/channel, 8-ohms, 20 kHz (watts)	148.7	Excellent
RMS power/channel, 4-ohms, 1 kHz (watts)	205.0	Excellent
RMS power/channel, 4-ohms, 20 Hz (watts)	N/A	N/A
RMS power/channel, 4-ohms, 20 kHz (watts)	N/A	N/A
Frequency limits for rated output (Hz-kHz)	10-40	Excellent
Dynamic headroom (dB)	1.2	Nonrated
DISTORTION MEASUREMENTS		
Harmonic distortion at rated output, 1 kHz (%)	0.0029	Superb
Intermodulation distortion, rated output (%)	0.0025	Superb
Harmonic distortion at 1-watt output, 1 kHz (%)	0.008	Excellent
Intermodulation distortion at 1-watt output (%)	0.01	Excellent
DAMPING FACTOR AT 8 OHMS, 50 Hz	50	Very good
PHONO PREAMPLIFIER MEASUREMENTS		
Frequency response (RIAA ± dB)	+0, -0.2	Excellent
Maximum input before overload (mV)	275 (33 for MC)	Superb
Hum/noise, "A"-weighted, referenced to 1-watt or 0.5-volt output, for 5-mV input (dB)	81.5 (73 for MC)	Excellent
HIGH LEVEL INPUT MEASUREMENTS		
Frequency response (Hz-kHz, ± dB)	3.5-80, 3	Excellent
Hum/noise ("A"-weighted) referenced to 0.5-volt or 1-watt output, 0.5-volt input (dB)	83	Excellent
Residual noise ("A"-weighted) minimum volume, referenced to 1-watt output	84	Very good
TONAL COMPENSATION MEASUREMENTS		
Action of bass and treble controls	See Fig. 8	Superb
Action of secondary tone controls	See Fig. 9	Superb
Action of high- and low-cut filters	See Fig. 10	Fair
COMPONENT MATCHING MEASUREMENTS		
Input sensitivity, phono 1/phono 2, referenced to 1-watt or 0.5-volt output (mV)	0.19/7.6 μV	
Input sensitivity, high level, referenced to 1-watt or 0.5-volt output (mV)	12.0	
Output level, tape outputs, at rated output (mV)	120	
Output level, headphone jack, at rated output (mV or mW)	N/A	
EVALUATION OF CONTROLS, CONSTRUCTION AND DESIGN		
Adequacy of program source and monitor switching		Excellent
Adequacy of input facilities		Excellent
Front panel layout		Superb
Action of controls and switches		Very good
Design and construction		Excellent
Ease of servicing		Good
OVERALL AMPLIFIER PERFORMANCE RATING		Excellent

capacitors have a 2% tolerance. The extra head amplifier stage uses an additional low-noise IC for the required additional gain.

The entire power amplifier is direct-current, direct-coupled. It contains three stages: the first consists of a current-mirror differential amplifier; the second is a Darlington-connected, constant-current-loaded predriver stage; and the third, the output, comprises three-stage Darlington-connected complementary push-pull stages.

FM measurements

Table 1 summarizes measurements made for the FM tuner. Aside from the fact that the tuner did not quite meet its monophonic usable-sensitivity specifications (of minor importance) all remaining measurements were as good or considerably better than claimed. Because our test equipment is not able to measure a 90-dB signal-to-noise ratio in mono or an 84-dB signal-to-noise ratio in stereo, we will have to take Yamaha's word on those claims. The S/N readings we did obtain were superb and were no doubt limited by our equipment.

Figure 6 shows the FM stereo frequency

response and separation (shown in the lower trace). The center trace shows what happens when the multiplex-blend circuit is automatically introduced because of low stereo-signal strengths. Under those circumstances, separation across the entire frequency band decreases to not much more than 10 dB. Such a low separation level still manages to offer some degree of stereo effect, but the advantage is that noise is vastly reduced, making it possible to listen to such signals *in stereo* without having to endure unbearable background noise levels. In our listening tests we discovered that many of the stereo signals that would have had to be switched to the monophonic mode on sets not provided with the multiplex-blend feature were quite listenable with this circuit operating. The vertical scale in the scope photo of Fig. 6 (and in all other scope photos in this report) is 10 dB-per-division. Both mono and stereo FM distortion levels are so low that we wonder whether again our measurement capability was limited by the test equipment instead of the receiver itself. For all we know, the actual THD values for the Yamaha model CR-2040 may even be a bit better than those shown in Table 1.

The AM section uses minimal circuitry (only a two-section tuning capacitor), and the frequency response (shown in Fig. 7) is about as poor as that found in most high-fidelity receivers. Sensitivity, when we used the supplied antenna loop, was quite good, however, as were the signal-to-noise ratio (50 dB as claimed) and the distortion reading (it measured 0.5% for 30% modulation).

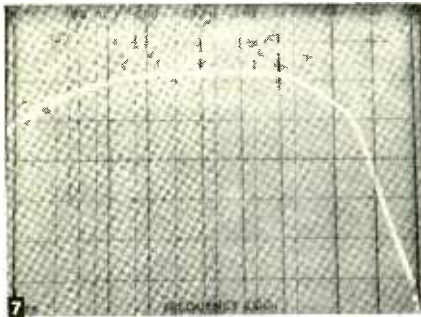

Amplifier measurements

Table 2 shows the results of measurements on the power amplifier and control sections. Yamaha has been extremely conservative in rating the power output at 120 watts-per-channel. The unit could easily have been rated as a 140-watt-per-channel unit (into 8 ohms) and have still complied fully with the Federal Trade Commission Rule on power disclosure for audio amplifiers. Note also that the referenced or rated harmonic distortion level is a mere 0.02%.

The input-sensitivity and signal-to-noise values shown in Table 2 cannot be compared directly with published claims, since we now use IHF Standard reference levels and weighting networks. Nonetheless, a comparison with other top-quality units using IHF standards shows that the noise levels of the *model CR-2040* are extremely low, even when the higher-gain moving-coil phono inputs are used. If you want to use an MC cartridge, the savings that accrue from having a built-in "head amp" are quite substantial. The high phono-overload capability of the preamplifier (for both the MM and MC modes) is particularly worthwhile if you plan to play some of the new direct-to-disc recordings that typically contain higher groove velocities (i.e., modulation levels) than commercially mass-produced discs.

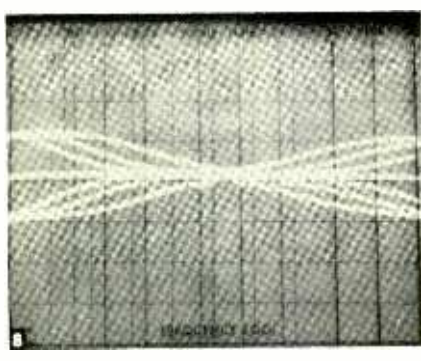

Figures 8 and 9 show the flexible six-control tone setup. We have plotted only three possible turnover frequency settings for each control (for the BASS and TREBLE controls in Fig. 8; for the midrange in Fig. 9). But a limitless number of intermediate settings could have been achieved for each of these controls.

TABLE 3 RADIO-ELECTRONICS PRODUCT TEST REPORT

Manufacturer: Yamaha

Model: CR-2040

OVERALL PRODUCT ANALYSIS

Retail price	\$850 (approximate)
Price category	High
Price/performance ratio	Excellent
Styling and appearance	Superb
Sound quality	Excellent
Mechanical performance	Excellent

Comments: There is no technical reason why an all-in-one stereo receiver should not perform fully as well as separate components, and there is no better proof of this than the measured and listened-to results of the Yamaha *model CR-2040*. The controls are extremely sophisticated, and the tone controls, in particular, are more flexible and precise than those found on most of the costlier separate preamplifiers and integrated amplifiers. We believe that its power-output rating is about as high as anyone would want in an all-in-one component, and Yamaha's emphasis on performance and versatility as opposed to ever-greater power ratings makes a lot of sense. The emphasis on actual-user specifications (such as the NDCR ratings) is also a progressive step forward, though with the new IHF Amplifier Standards now in force, we hope that the company will "adjust" their various reference levels to fit the new standards.

The sound quality delivered by a pair of high-quality speakers hooked up to the receiver is audibly better than that produced by Yamaha's earlier receivers, and that's saying quite a lot. The introduction of an all-DC-coupled power amplifier has resulted in improved sound. The distortion levels of the FM tuner rival those of the amplifier and place severe limits on our otherwise state-of-the-art lab-test equipment. Yamaha has borrowed some of the circuit designs from their separate tuners and integrated amplifiers to achieve this level of performance. We have been impressed with Yamaha's philosophy of carrying major features on all their units, from the most expensive to the lower-powered receivers. We hope that they will follow this approach in the rest of the 1979-1980 line since increasing speaker efficiencies are prompting consumers to select lower-powered receivers as central components of their stereo systems. Because the *model CR-2040* is the "flagship" of Yamaha's new receiver line, they have spared no effort in equipping it with every imaginable feature.

At its suggested retail price, the new Yamaha receiver performs as well or better than many of last year's models (including their own) that retail for as much or even more. The *model CR-2040* is as close to a dream receiver as the high-fi industry has achieved to date.

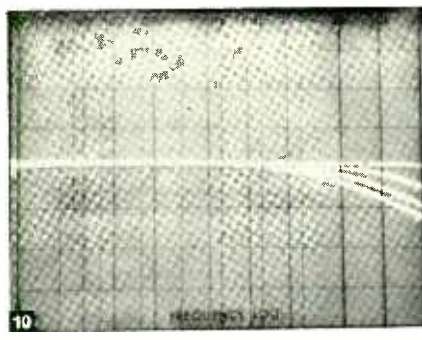
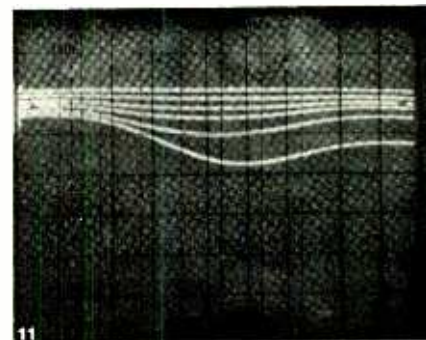
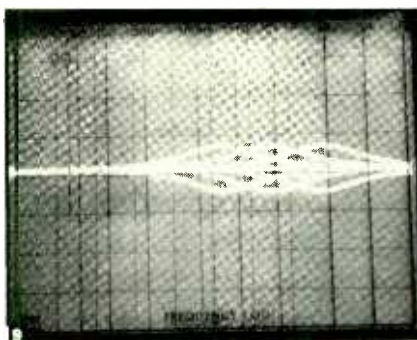

High-cut filter response is shown in Fig. 10, in which three traces (in addition to flat response) are shown, since both filter pushbuttons can be depressed either simultaneously or individually.

Figure 11 shows overall frequency response as the separate loudness control is varied over its entire range (approximately 20 dB). Note that this variation in loudness level and tonal response is achieved without changing the

master volume control setting.

Summary

Table 3 contains an overall product evaluation along with our summary comments regarding the listening and handling qualities.

Yamaha obviously believes that today, those who purchase a higher-powered receiver are no longer casual listeners but require every bit as much flexibility and versatility in an integrated component as do audiophiles selecting separate components. In the past such versatility has often meant compromises in the sound. That is definitely not the case with the *model CR-2040*. You will probably agree with us that it is difficult if not impossible to detect any difference in sound between this receiver and much higher-priced separate components having an amplifier with an equivalent power-output.

When we first began testing and using the *CR-2040*, we were asked to guess its suggested retail price (the final price had not yet been fixed). We ventured a guess that turned out to be \$200 more than Yamaha's final suggested retail price. Need we say more?

R-E

Audio Test Station

PART 5—The utility and overall accuracy of the Audio Test Station will depend on the skill and care used in its calibration. This article “walks you, step-by-step,” through the calibration process.

RAY DAVISON

IF YOU HAVE COMPLETED THE AUDIO TEST System, your next step is proper calibration so you can take full advantage of its many features. Calibration steps will be performed stage-by-stage so the precision of the sections calibrated during the initial stages can be used in later procedures. Figure 16 shows the locations of the various trimmers that you will be adjusting.

Timebase calibration

Connect a reasonably well calibrated scope to jack J1. (The scope is the only calibration standard that we will be using and it is assumed that amplitude calibrations are not critical for most applications.)

Set the scope input to DC.

Set all trimmer resistors to their center positions. See Fig. 16.

Turn on power switches S1 and S2.

Set R5 to TRIANGLE and S8 to NOT INVERT.

Set R3 to maximum and R4 to 0.

Set S3 to 1 kHz.

Set S4 to SYMMETRICAL and R1 to its lower position.

The scope should show a clean triangle wave at about 1 kHz.

Set R8 to 0—make sure R4 is still at 0.

Adjust R232 for zero offset.

Set R3 to maximum.

Adjust R227 for 16 volts P-P.

Adjust R240 for zero offset.

Switch S5 to SQUAREWAVE.

Adjust R223 for approximately 16 volts P-P and R222 for approximately zero offset. These two controls will be readjusted later.

Switch the scope input to AC.

Adjust R212 for slight clipping.

Adjust R213 for a symmetrical waveform.

When the scope is set to AC, adjusting R213 will cause the average level of the waveform to shift. Symmetry is reached when the positive-going and negative-going peaks are *exactly* the same distance from the center line on the scope.

Adjust R212 for minimum sinewave distortion.

A sinewave plotted on the face of the scope screen is a valuable aid in completing this step in the calibration. (An 8 × 8 cm clear plastic overlay (Fig. 17) is available from Fidelity Sound.) Naturally, if you have access to a harmonic distortion analyzer, you can use it in adjusting for minimum distortion.

Adjust R223 for 16 volts P-P output.

Switch the scope to DC input.

Adjust R222 for zero offset.

Set S5 to TRIANGLE.

Check the waveform quality at each position of S3. At the 10K position the waveform will be distorted; however, this is not too important because this position is used only to trigger the pulse generator.

For initial checks on the low-frequency ranges, set R1 to 100F. Any deviation from strict linearity indicates capacitor leakage. A slight curvature of the waveform is acceptable for most applications. However, if curving is severe, the circuit may not oscillate at all at low currents.

For testing at the lowest positions of S3, set the scope's horizontal timebase for external sweep. This will produce just a vertical trace. Follow the oscillator through a couple of cycles to insure that there is no excessive leakage. At the .002 position of S3 a single cycle takes approximately 8 minutes. If the scope beam stops while approaching one peak, in-

crease R1 slightly to increase the charging current. The beam should advance slightly. This action indicates excessive leakage in the capacitor involved. Increasing R1 beyond some point should cause oscillations to resume. **Replace the faulty capacitor.**

Set R3 to maximum.

Set S9 to MANUAL.

Set R4 to 0.

Set R206 to 0 output.

Move R4 to +5 volts.

Set R209 for +8 volts output.

Move R4 to -5 volts.

The output should be approximately -8 volts. This is simply a functional check. Trimmers R206 and R209 will be fine-tuned later.

Sweep generator calibration

Waveforms: Most of the circuitry is identical to that used in the timebase section and the same calibration procedure applies. The output levels and symmetry proceeds from the output (J4) back. That is, set R7 to zero and adjust R534 for 0 volts DC level. Now, set R7 to maximum, S13 to NOT BLANK, and adjust the trimmers between oscillator IC502 and switch S14.

The only difference in this area is that R513 must be adjusted; whereas its counterpart in the timebase is fixed. Interaction between R510 and R513 is rather subtle. It is not enough to adjust each independently for minimum distortion. Often, by actually increasing the distortion with one of these pots, readjustment of the other pot results in lower distortion.

The optimum calibration procedure requires a harmonic distortion analyzer and a dual-trace scope. First, a sinewave is

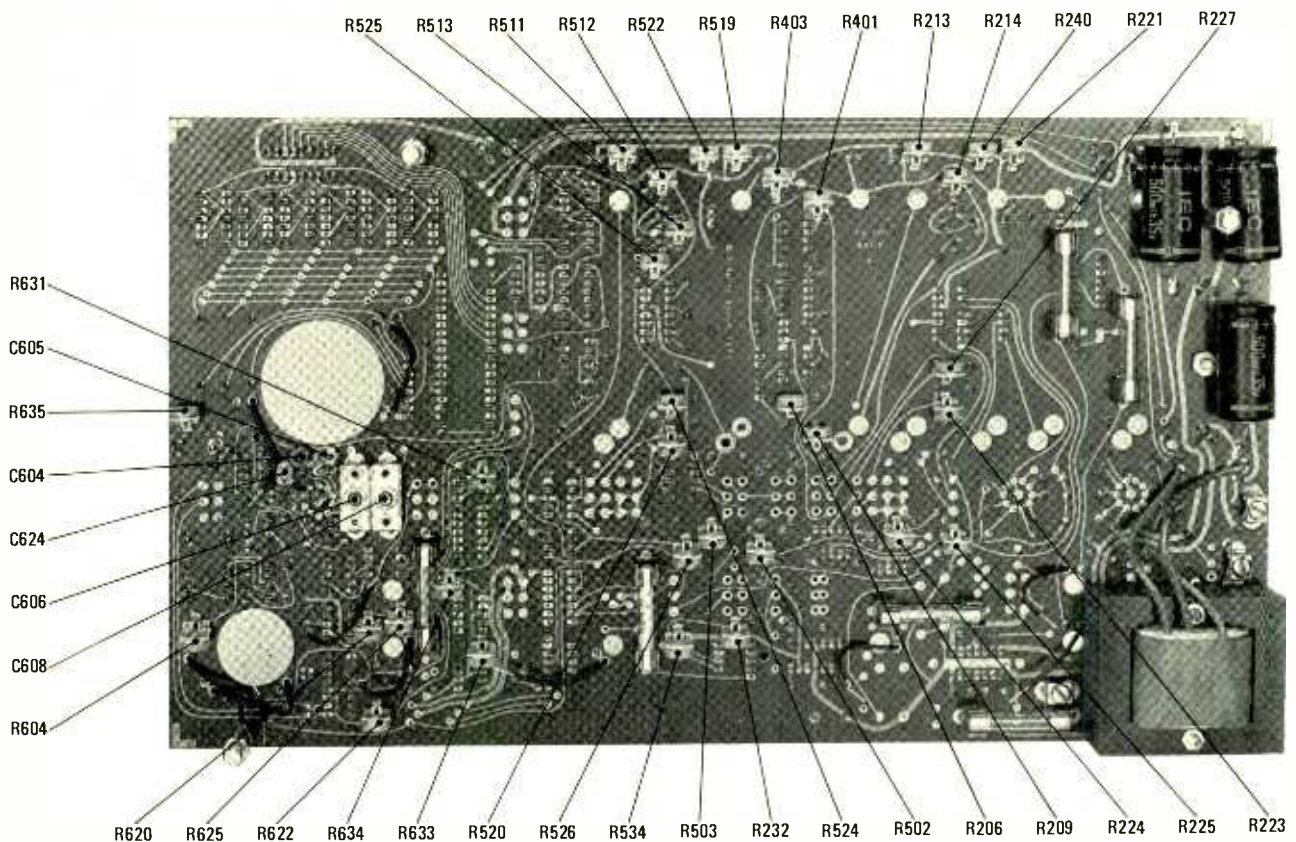

FIG. 16—VIEW OF THE BACK SIDE OF THE PC BOARD showing the locations of the fuses, a couple of large capacitors and, most important of all, the locations of the trimmer capacitors and trimmer resistors. Their placement simplifies calibration.

mathematically plotted on the face of the scope tube (the sinewave pattern (Fig. 17) available from Fidelity Sound may be fastened to the tube screen) and the output of the AF sweep generator is adjusted so that the period and amplitude correspond to the peaks and zero-crossings of the plotted sinewave.

This same signal is simultaneously fed to the input of the distortion analyzer. The output of the distortion analyzer is applied to the second trace of the scope.

The first adjustments are made with a screwdriver in each hand. Simultaneously, adjust R510 and R513 to provide the best visual fit between the generator waveform and the plotted pattern. Watching the output of the distortion analyzer as you make the adjustments will help you understand the interaction of these two controls. The final adjustments are made while watching the meter on the distortion analyzer. However, if there is a noticeable deviation between the generator output and the reference waveform, it indicates that a further improvement is possible.

A simpler, but less precise, test is to use a single-trace scope with a sinewave pattern superimposed on the screen. A visual match between the plotted and generated waveforms will produce a signal having distortion components that are low enough to be insignificant in frequency-response measurements.

Calibrating the manual frequency sweep involves both the timebase and

audio sweep generator sections since either can be used to provide a manual frequency sweep of the audio sweep generator. Earlier, we set aside fine-tuning of the manual timebase. We will take that up now.

This procedure uses the frequency counter as the calibration standard for the sweep circuit. It is the voltage levels that will be calibrated so the frequency counter can be considered as being a digital voltmeter. Proceed as follows:

Set S11 to MANUAL.

Sweep R6 through its maximum travel and check the end-point frequencies.

Adjust R502 and R503 for the desired end-points.

R503 sets the total sweep width; R502 affects mainly the low-frequency end-point.

Connect the scope to the output of IC501.

Set the vertical amplifier for 1 volt-per-division and adjust the trace for one division from the top of the screen with no input.

Run R6 through its full range and note the end-point voltage levels.

Set the timebase frequency to 1 kHz.

Set S4 to SYMMETRICAL and S9 to SWEEP.

Set S12 to LINEAR and S11 to SWEEP.

You should now see a triangle wave that can be positioned and scaled by R10 and R11 so its peaks correspond to the end-point voltages developed by sweeping R6 through its full travel.

Switch S12 to LOG.

Run R8—the front panel HIGH LOG set control—to the end of its travel at maximum sweep width. Now back off 3 turns.

Plot an antilog function (Fig. 18) on the scope screen and align the generated waveforms with the pattern. To provide a stable overlap of the generated and plotted patterns, you will find it helpful to sync the scope from the triangle output of the timebase generator. Use the manual trigger level rather than auto. Also, try switching S8 to INVERT. If your scope has a dual-trace feature, try it. The peak of the antilog function is easy to locate; the low point of the valley is not. The method used here makes it easy to establish the end-points of the antilog function.

Adjust R401 and R403 so that the antilog waveform has approximately the same span as that provided by R11 sweep voltage without clipping at the peaks.

Use the scope's vertical attenuator to fit the generated waveform to the plotted antilog function.

Adjust R401 and R403 for the best visual match between the generated and plotted waveforms. Note the effect each movement of each pot has on the generated waveform.

This completes the rough adjustment of the antilog waveform. Fine-tuning comes later.

At this point, everything is at least approximately calibrated so that the timebase will sweep the audio sweep gen-

erator either manually or automatically in linear and logarithmic modes. Now, to calibrate the manual sweep control.

Set S3 to 100 and R1 to its lowest position.

Set S4 to the SYMMETRICAL (upper) position.

Set S9 to SWEEP.

At this point we will use the audio sweep generator and the counter as a digital voltmeter. The sweep generator then acts as a voltage-to-frequency converter. This will be used to match the manual and sweep modes of the timebase. The log sweep has the greatest resolution at low frequencies and the linear sweep has the greatest resolution at the high end; so this is the way we will set them up.

Set the scope horizontal amplifier to EXTERNAL INPUT.

Apply the timebase triangle waveform to the scope's vertical and horizontal inputs simultaneously. If a line is traced from lower left to upper left across the screen, this indicates that a *positive* voltage drives the scope beam toward the *right*. Similarly, a line from upper left to lower right shows that a positive horizontal input voltage drives the beam toward the *left*. In this case, throw S8 to INVERT so the trace extends across the screen from lower left to upper right. This insures that frequency-response plots will have the low-frequency end at the left and the high-frequency end on the right.

Set R4 to 0.

Switch S3 to 10 Hz. Use R3 to establish a 10-cm sweep. (It may be necessary to use the scope's expanded-sweep mode.)

Switch S3 to .002.

Set S22 to 1/2 SEC.

With the beam traveling left-to-right and the counter increasing in frequency and with S12 set for linear operation, note the end-points of the beam and the highest frequency attained.

As the beam is returning to the left side of the screen and the frequency of the audio sweep generator is decreasing (S12 in the LOG position), note the turn-around point of the beam and the lowest frequency reached on the frequency counter. Note that it is possible to interpolate fractions of a hertz by observing the "bobble" of the counter between two frequencies. If, for instance, it "bobbles" between 20 and 21 Hz every time the counter refreshes (every half second) the frequency is 20.5 Hz. Or, if the reading stays on one number longer than the other, the frequency is closest to that figure.

Repeat the slow sweep a couple of times to confirm the end-point frequencies. (Remember to switch S12 as the trace switches directions.)

Set S9 to MANUAL.

Sweep R4 through its full travel. The frequency of the audio sweep generator should track R4.

Set S12 to LOG and drop R4 to its lowest position. Note the frequency of the audio generator.

Adjust R206 and R209, in the timebase section, so that R4, as it is moved through its travel range and S12 is switched, produces the same end-point frequencies as those produced during the automatic-sweep mode. Trimmer R209 establishes the total sweep width and R206 sets the center point. When these trimmers are properly set, R4, with S9 in the MANUAL position, will produce the same sweep as the triangle timebase did with S9 and the sweep mode.

Set S9 to MANUAL.

Sweep the scope horizontal amplifier by running R4 through its full range. Make sure that when R4 is at its end-points, the beam is on an end vertical line.

Switch S12 to LINEAR.

Set R4 to 0.

Adjust R11 for the desired center frequency.

Move R4 to its lowest position.

Set R10—through the front panel—for the desired low-frequency limit.

Move R4 to its upper position.

Check for the desired high-frequency limits. Several readjustments of R10 and R11 may be necessary.

Adjust R9 to the extreme low-frequency end and then back off 3 turns.

Run R4 through its full travel.

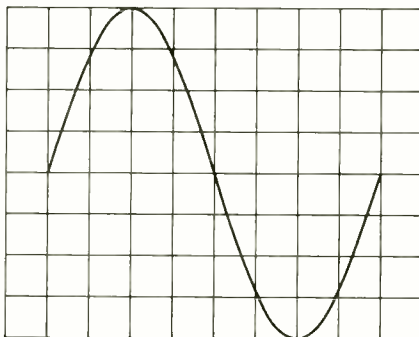

FIG. 17—SINE FUNCTION can be plotted on the CRT screen and used to adjust the sweep generator for minimum distortion.

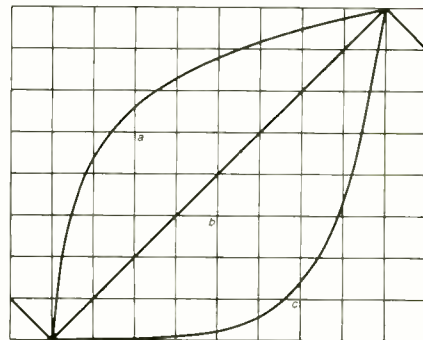

FIG. 18—CALIBRATION WAVEFORMS. Log function is shown in *a*, triangular wave is shown in *b* and antilog function is shown in *c*.

Watch the beam as it moves horizontally across the scope screen. Stop at each vertical centimeter division and note the frequency. A perfect log sweep will have the frequencies indicated in Table 1.

Adjust R401 and R403 for the best fit at the frequencies listed.

It is important to be able to occasionally look at the waveform at the output of

TABLE 1

cm	Hz
0	20
1	40
2	80
3	160
4	320
5	640
6	1280
7	2560
8	5120
9	10240
10	20480

IC501 as was done when the first approximate adjustments of R401 and R403 were made. This is because it is easy to grossly misadjust R401 and R403 and keeping an eye on the waveform at the

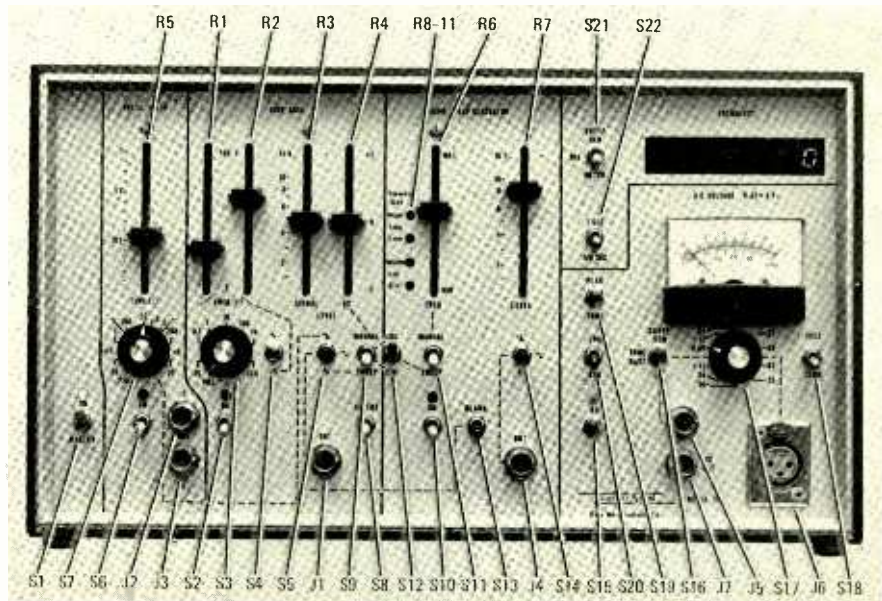

LOCATIONS AND DESIGNATIONS of the controls mounted on the front panel.

output of IC501 will make fine adjustments more precise.

With S9 on SWEEP, run R4 to its lowest position. Set the desired low-frequency end-point by adjusting R9.

Move R4 to its upper position and set the upper frequency end-point with R8.

Recheck the lower end-point.

Voltmeter adjustments

Start by calibrating the input attenuator.

Set S16 to TIMEBASE.

Set S3 to 1K.

Set S5 to SINEWAVE.

Set METER RANGE SWITCH S17 to -24 dB.

Monitor the output of IC610 with the scope.

Set R4 to 0.

Set R3 to produce 3 to 4 volts peak at the output of IC610.

Move R1 through its full travel.

Adjust trimmer capacitor C604 for minimum deviation from the 1-kHz level.

Repeat the steps outlined above to adjust the appropriate compensating capacitors for the -12 through +24 dB positions of S17.

Apply a 1-kHz sinewave simultaneously to pins 2 and 3 of mike jack J6.

Set S17 to -72dB.

Monitor the output of IC610 while adjusting trimmer resistor R604 for minimum output. This adjusts the common-mode rejection for the mike preamp.

AC to DC converter

The following procedure is for setting up the AC-to-DC converters:

Set the METER RANGE SWITCH (S17) to 0 dB.

Set S16 to TIMEBASE.

Adjust the timebase section for a 1-kHz 4-volt peak sinewave at the output of IC610.

Set S19 to PEAK.

Monitor the output of IC605 with the scope. It should display a full-wave rectified sinewave.

Adjust R620 for equal amplitude in both halves of the waveform.

Adjust R625 for approximately 4 volts peak.

Check to be sure that it is possible for each half of the waveform to reach at least 4 volts peak without clipping.

Increase the timebase frequency to 100 kHz while checking the rectified sinewave. Some degradation of the valleys is acceptable; however, the peaks should not be affected.

Reduce R3 to 0.

Adjust R622 for 0 volt at the output of IC609.

Adjust R3 so the output of IC609 is exactly 4 volts peak.

Adjust R625 so the output of IC609 is 4 volts DC.

Monitor the signal at the arm of S19.

Place S19 in the TRMS (true RMS).

The DC voltage should drop to approximately 2.8 volts. Now, reduce the timebase frequency to around 20 Hz.

With S18 in the FAST position, a definite droop should be noted when S19 is at PEAK. An approximately equal amount of ripple should be noted when S19 is set returned to TRMS.

Placing S18 in the SLOW position should significantly reduce both the droop and the ripple.

Log converter

The procedure for calibrating the log converter is as follows:

Set the timebase for a 1-kHz triangle waveform.

Set R3 for 4 volts P-P (peak to peak).

Set R4 to +2 volts. This will produce a triangle wave between 0 and 4 volts.

Set S16 to EXTERNAL with nothing connected to jack J5. There should be 0 volt at the output of S19.

Connect the output of J1 through a 10K resistor to the output end of R628, the input of IC607.

Set the scope timebase so that half of the triangle wave cuts diagonally across an 8 x 8 centimeter grid.

Monitor the output at J7. If possible, use a dual-trace scope so the input and output of the log converter can be observed simultaneously.

Plot an 8 x 8 centimeter log function on the face of the scope screen (see Fig. 18) or use the preplotted transparency mentioned earlier.

Adjust trimmer resistors R631, R633, R634 and R636 for the best fit of the output at J7 to the plotted log pattern.

Trimmer R631 adjusts the total range of the log function as evident by the sharpness of the knee. Trimmer R633 adjusts the DC offset so that a zero volt input produces a zero volt output. Trimmer R634 is used to adjust the overall gain so a 4-volt input produces a 4-volt output.

Remove the timebase signal and the 10K resistor.

Turn off the timebase generator.

Set S16 to SWEEP GEN.

Set S11 to MANUAL.

Set R6 to approximately 1 kHz.

Set S19 to PEAK.

Set S20 to LINEAR.

Set R7 for 8 volts P-P.

The signal at J7 should read 4 volts.

Set R7 for 0 volt.

The voltage at J7 should read 0.

Set S20 to LOG.

Adjust R633, if necessary, to keep the voltage reading at J7 at zero.

Switch S20 to LINEAR.

The output of J7 should be 4 volts. If it is not, touch up R634.

Adjust R635 for 100% meter deflection.

Well, that wraps up the calibration procedure. Next month we will conclude this series with some hints and application notes on using the Audio Test System. **R-E**

NEW TECHNICIANS ASSOCIATION

The Board of Directors of the new Electronics Technicians Association (ETA) has appointed Dick Glass of Indianapolis as President of the not-for-profit professional association. Dick Glass has been deeply involved in association activities in the consumer electronics field in the past, having served as Executive Vice President of NEA and NESDA; President of NEA three times; President of the Indianapolis Television Technicians Association; director of the Certified Electronics Technician program; Director of Training for the NEA/U.S. Labor Dept. Apprenticeship Training program in 1967-68; publisher of *ServiceShop* magazine; and an instructor in the PSM business management schools of NESDA.

Mr. Glass resigned from his position with NESDA in 1977 and has since operated his own service management consulting firm; authored numerous trade publication articles and has taught electronics technology



DICK GLASS

at ITT Technical Institute.

Dick stated that ETA is a national association of electronics technicians. Membership is open to all of the technicians engaged in this profession.

Ron Crow, former IS CET executive, is a native of Iowa and now the chairman of the ETA division for educators: the Electronics Educators Association. He holds a BS degree from Iowa State University in Electrical Engineering. In addition to his work as executive director of IS CET from 1971 to 1978, he has worked at Gulliver's in Des Moines, Iowa, as a service technician; at G.E. in Utica, New York, and at St. Paul, Minnesota, as a design engineer. He is presently also an instructor and department head at Iowa State University. He is a member of the Iowa Association of Lifelong Learning. He is also co-author of the Howard W. Sams publication: "Study Guide for Associate CET Exams." **R-E**

Make Your Own PC Boards

Whether you design your own circuits and printed-circuit boards or fabricate the boards using patterns published in magazine articles, here are some hints that'll help with your next project.

JAMES E. TEMPLE

ARE YOU STILL BUILDING YOUR PROJECTS BY USING THE OLD rats-nest type of point-to-point wiring? Are you still reluctant to tackle construction projects when a commercial printed circuit board is not available? If the answer to both questions is yes, then you seem to lack the skill to make your own PC boards from scratch.

By now you have certainly discovered the method of photocopying directly from a magazine page, and transferring the foil pattern to the board. This method makes it easy to form your own boards for the project. It is an excellent method if you have the time and patience to use it but it only works if the projects you want to build are the ones from magazine articles. But what if you want to design your own projects, or add improvements to the preprinted foil patterns? If you don't know how to make your own PC boards or to lay out the PC board itself, you are limited.

Over the past several years, I have developed PC construction skills to make my own project boards. All my PC construction is accomplished on a one-to-one basis. That is, in most cases you will only require one or two printed circuit boards. You are probably not going to offer the boards for sale. What you're looking for is a reliable and sturdy base for your project, and if repairs are necessary, the circuit board will not fall apart. Besides if your pet project is a good one, you may want to write an article on it for publication. Submitting the project built around PC boards is far better than a point-to-point wiring method that is hard to copy and show in an article.

I want to emphasize that designing your own boards is not a difficult skill to master. And with a PC board, the project is reliable, repairs are easier to handle and tracing problems is much simpler too. If you've ever tried to troubleshoot a rats-nest project, you know this is in itself a major headache. After all, you must build it right the first time or you won't get it right at all. With PC boards, troubleshooting is easier, and you can make changes if the circuit requires it. Once you have developed board-making skills, photocopying methods are just a step away.

Printed circuit etchants

Perhaps one reason that many hobbyists do not attempt to make their own PC boards is because they are afraid of the etchant chemicals. Ferric chloride is the only safe etchant to use on the hobby level. It is a mild acid that works well on copper, but it can leave terrible stains if spilled onto the floor or on your clothes. The solution is to do your etching in a work area where it won't matter if a spill happens, and wear old clothes. Plus, make sure you read the instructions.

Important: Never use metal trays to do your etching in, particularly aluminum. Always use glass or heavy plastic etching trays. These specialty trays are not expensive. When you consider that many household chemicals (lye, cleaning solutions, etc.) must also be handled in a similar manner, the ferric chloride etchant is no more dangerous than any of them when treated properly. When small children are around, the chemicals should be locked up securely. The safe handling of any chemical results from understanding what the chemical is and how it is used.

When you work with ferric-chloride etchant (and stay away from others unless you know what you are doing) cover the floor with old newspapers. Keep a plastic pail filled with water nearby to wash off the PC board after etching is finished, and to wash out the etching trays. Immediately after etching a board, take the time to pour the etchant into a second plastic bottle. Do not mix the used and unused etchant. Clean and dry the etchant tray. Secure the chemicals and lock them up if necessary.

What about the disposal of the final used-up etchant? If you have copper pipes in your home, **do not dump them into the plumbing system.** Store the used-up etchant in an old plastic or glass container and check in your community for chemical disposal areas. If you must dispose of the etchant in your plumbing system, be sure to dilute the etchant extremely well. Several gallons of water to about a pint of etchant will dilute the etchant safely for disposal. Also, flush the pipe system with several gallons more of water. It is completely safe to dispose of etchant in this manner; the solution is extremely diluted and harmless to plumbing. Other than these two safety precautions, using, storing and disposing of the chemical should offer no problems.

Etch-resist lacquer paint and the lacquer remover (solvent) are the chemicals used to apply etch-resist to copper boards. Safety measures are the same as for any other type of solvent used around the house. Make sure your work area has adequate ventilation when finished boards are cleaned. And again store the solvent away where it is safe from small hands.

The chemicals used in photocopying your designs are a spray to sensitize the boards and the developing solutions. You must read the instructions for these materials. Spraying your own boards requires a dark, well-ventilated area. The fumes from these sensitizing sprays are about as heavy as any lacquer spray, and except for the odors of the fumes, there should be no unusual problems.

Commercial presensitized boards are available for photocopying techniques. Only glass or metal trays should be used with the developing solution for an exposed board. Other than working in a well-ventilated area, you should have no problems in handling the developers used in the process.



THE TYPE 650 PHOTO-ETCH KIT by Injectorell contains all materials needed to layout and etch boards up to 3 by 4 inches.



PRINTED-CIRCUIT KIT NO. 22-297, from GC Electronics is what you need to make PC boards using the negative method.

Basic tools

The first consideration in PC board techniques are the tools you will need for working quickly and accurately. A drill is required to drill the boards—not the 1/4-inch handyman's type of drill but a quality hobby drill. The Dremel drill with its many accessories is the best. This drill has a built-in speed control. Low speeds are preferable when using quality carbide bits for drilling fine holes into the board. You should also consider purchasing only the better-quality accessories—cutters, buffers, reamers, etc. They pay for themselves over a period of time because you won't need to buy replacements as often. The Dremel line is excellent and readily available.

Carbide drill bits, rather than steel drill bits, are a better choice for doing PC work because they outlast steel bits. They have a higher initial cost, but really save money over a period of time. The best bit sizes are the No. 58 for holes to mount sockets into, and the No. 65 for direct-mounting and soldering DIP IC packages. Other sizes also come in handy: the 1/32 and the 1/16 are good to have.

The carbide bits tend to be brittle when compared with steel bits. So, do not use excessive pressure on the tool or bit when drilling the board. Let the bit do the work, making sure to guide it in a straight downward motion. I've used one bit for over several months, that translates into several thousand PC board holes. The bits do last if handled correctly. If you are not sure of your skill at first, perhaps you should use the steel bits until you develop confidence.

Steel bits don't break as readily as the carbide bits, but they do become dull quickly from the PC boards. A steel bit also leaves copper burrs that must be cleaned up before you can use the board. The rule here is to use the steel bits until you have developed the feel for board drilling. Then, switch to the carbide bits for future work. Dremel has a special chuck for the numbered drill bit sizes; make sure to obtain this chuck along with your drill.

You will find that some type of PC board magnification is useful when drilling or applying the etch resistant. Hobby magnifiers are readily available. There is a type of magnifier that is placed over the head similar to a pair of glasses. What appears as a very small hole to the naked eye becomes quite large when you use a hobby magnifier.

A good close light on the work area is needed when working with the head-type magnifiers. If your budget allows, obtain the type of fluorescent light fixture that has a built-in 4-inch-diameter magnifying surface. This is a standard fixture; art and

hobby stores carry it, or you can buy it from Lafayette Stores. It represents an expense of about \$50, but if you are serious about doing your own PC work, this type of hobby light cannot be measured in terms of dollars. For beginners, try the headset from Radio Shack (about \$7), then consider a fluorescent magnifying light fixture at a future date. A magnifying type of hobby fixture does make a major difference in the long run.

Along with the hand hobby drill, the numbered bits and the magnifier as basic tools, you must consider your work surface for drilling the PC boards. I recommend using a 12-inch by 12-inch, tightly pressed cork board, about 1/8-inch thick. Lumber suppliers carry these boards. When drilling, place the PC board flat on the cork surface. When you drill through the PC board, the bit will not have a hard surface to come in contact with, and there is less chance of breaking the bit.

You should also have the ordinary hobby tools for your electronic work. A small vise, a hobby anvil, tack hammers, center punches, reamers, pliers, etc. Don't skimp on quality in the tools you collect.

An excellent addition to your tool collection is an *Xacto* knife set, usually sold with three holders and an assortment of knife blades. The No. 5 and No. 17 blades are handy for PC board work. There's also an *Xacto* hobby sawblade. This is a fine-toothed saw that cuts a 1/32-inch width and can be used to cut the PC boards apart. The *Xacto* hobby sand block also comes in handy for smoothing an edge of a board.

Art supplies

Once you have started your hobby tool collection, and have added the basic drill, bits, knives, and lighting instruments, you should give some thought to the art supplies that are needed.

Of course, the basic necessities are a drawing board and drafting instruments. Here's a tip that can save money and allows you to have an excellent drawing table. Let's assume that you do have a desk of some sort to hold your drawing supplies. This desk should be separate from your basic work area. It should have several drawers to hold your supplies. To this desk you can add your drawing board for all the schematics and logic diagrams you will be making. Consider a drawing board with a metal-edge guide, about 25 inches wide to 30 or 36 inches long. Costs will be around \$20 to \$25 for the drawing board.

Obtain a pair of hinges, not too large, with a removable type of pin. Insert the hinges into the bottom of the drawing board, and line them up with the edge of the desk. Screw the hinges into the desk edge. Taking out the hinge pins permits the draw-

ing board to be removed from the desk surface. You can replace the board when you make your drawings. You can use a box beneath the back edge of the board to angle it to suit your needs. You have not only saved the costs of a separate drawing table and boards, you have created a convertible drawing table or desk work area.

In the area of drafting and art supplies, it is possible to skip somewhat. A wooden T-square is just as good as a \$15 steel one, and costs about \$2. A drafting pencil costs about \$2 and uses a fine .005-inch-thick lead. Why bother with standard wooden drawing pencils and sharpeners with a lead this fine? Angles, templates and other drafting tools can be standard, rather than fancy, instruments. Quality erasers should be used, and a brush is useful to clean up the work area.

If you are going to make ink drawings of your own positives or negatives for PC copy work, then get the best pens. *Pelikan* pen sets with various nibs are best, and can be used with a China-type of permanent ink. This China ink, by the way, adheres to plastic film and Mylar film; it is permanent and extremely dense.

You should also have quality bond paper and drawing paper. Layout bond paper is good and holds ink well. For fine layout work use vellum papers. A supply of clear plastic film is handy for overlays. On these clear films, the permanent-type marker pens work well, but I find the lines a little thick. Use various colors (red, black, green) for overlay work.

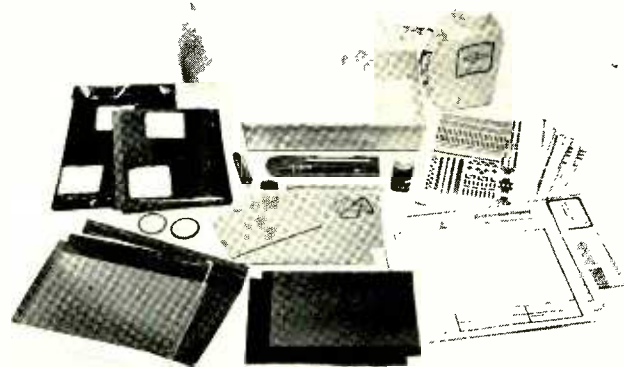

POSITIVE PHOTORESIST etched circuit kit, Vector Electronics 32XA-1, includes photo-sensitized copper-clad boards, artwork patterns and all other materials needed to make seven PC boards.

For those who want to specialize in photocopy work, Mylar film is the best-quality (albeit expensive) film to work with. Once the layout is placed on Mylar film, photocopies are easily obtained. To date I have used clear film, but I understand that the opaque film is invisible to a black ultraviolet light for copy work. Films with grid lines, with a 0.1-inch spacing, are available but costs are high.

Graph paper can be used for the initial layout; use 10 lines to the inch, and you will have a perfect layout for all the IC components for your board. Transferring this layout to a film overlay (if a two-sided board is contemplated) gives you a permanent basic drawing, with an overlay film for the top and bottom sides to check against your PC board lines.

I suggest that you visit a good art and drafting supply store and ask if they have inexpensive starter sets. If you do not have drafting experience, consider a do-it-yourself book on the subject. Try your hand at your own drawings. These drawing skills come naturally. Even the cavemen learned to draw; so can you. It's just a matter of doing it, and good materials can only help.

Drafting aids

Many manufacturers offer electronic drafting aids—from templates of symbols to IC pad layouts; these come in $\times 1$, $\times 2$

and $\times 4$ sizes. For your hobby work, the $\times 1$ size can be used. Direct drawings of a $\times 4$ size are for military specifications but require photoreduction to a $\times 1$ size; this is too costly for hobby work. Direct dry transfers from letters, numbers, electronic symbols, IC pads, etc., are also available.

Bishop Graphics is a major supplier of drawing and drafting aids. The Digi-Key Corporation catalog shows that there are over 16,000 different Bishop Drafting supplies. The 14-lead and 16-lead IC pads are a handy item, but they tend to be expensive if a lot of IC pads are needed in the layout drawing. The 0.10 lines of a draftsman ruler provide the centers of the IC leads, and you can draw the IC pads directly. A $\times 1$ template does provide the pad for copying directly to the drawing, but a fine-lead pencil must be used to draw the lines.

As for the supplies needed for the actual PC board itself, a good etch-resist lacquer is important. The Radio Shack resist lacquer is good, but you may have to thin it out with some solvent. Use a fine artist's brush—the 00000 size for very fine lines and a 000 brush for general PC lines. When these brushes are used with the lacquer resist, they will wear out, so have several on hand; lacquer is rough on the bristles. Also brushes as fine as this do not hold a great deal of resist on them, and a line of about $\frac{1}{2}$ inch is usually the longest line you can draw directly. A 2-inch-long line will then be applied in four strokes. Merely drawing a pencil guideline also helps.

When you consider any PC board layout, you will note that most of the lines are straight and very few curves are involved. The IC DIP packages permit a layout using straight lines, which are merely the connecting lines between the various IC pads. By getting the feel of the brush and the resist lacquer and applying the resist in short strokes, any size line can be made. Remember, you have laid out the interconnecting lines on paper, and you are only copying these lines on the PC board by using the resist paint. This is why a film overlay comes in handy—to check on the line drawings made on the copper board.

Using a brush and resist paint is not the only way that you can draw in the pads and the lines. Bishop Graphics also offers direct transfer of etch-resist pads, plus a fine line that comes in tape form. It is applied between the contact points, cut and pressed firmly to the board. These direct resist-material transfers are fine for a one-shot PC board but are not reusable. They are not expensive to use, but some skill should be developed in handling them. The trick is to have a dry, clean copper PC board. If the material does not stick firmly to the board, it is useless.

Radio Shack has a resist-type of pen that can apply a fine line to the copper PC board. In a pinch you can use a black pen to make the resist line to the board, but I find these lines tend to undercut. Of all three methods for direct transfer to a PC board, I recommend using the brush and resist method.

The brush and resist method allows you to apply very fine lines to the PC boards. If a line is too thick, you can easily thin it down by cutting the dried lacquer paint with an *Xacto* knife blade. Lines as thin as $\frac{1}{64}$ hold up well in the etchant, and undercutting of these lines has been minimal for me.

The whole point of the PC board method you choose is that the lines on the copper board must resist the etchant and not be undercut or etched away during the time that the board is exposed to the ferric-chloride etchant. If the etch-resist is not holding up to the etching of the board and the foil is being etched away under the resist material, you must develop another method or perfect the one you have chosen to work with.

From the drawing stage to the laying-in of the PC board resist material to the finished board, you should encounter no major problems once you have practiced your skills. And as soon as you have mastered these skills, you should be able to make circuits of any size or complexity. By starting small, making small circuit boards and adding to your skills, you can master the methods you have chosen. I use the brush and resist direct-application method, but it took a period of time to master. I will try to pass on some of the techniques and time savers I use in future article but the skills you will have to master yourself. You can do it!

R-E

conductor (see Fig. 1). This can be represented as the circuit shown in Fig. 2, with the heat source as a voltage generator, and the temperature probe as a high-impedance voltmeter.

The substrate on which the semiconductor is mounted is a good insulator and is represented by a high resistance. Heat losses through radiation from the enclosure are represented by a resistance, and the heat capacitance of the enclosure by a capacitor. The temperature probe has similar losses; the object is to reduce these losses to a minimum. Figure 1 also shows the design of a typical probe, with a temperature element mounted in a metal tip, isolated thermally from the rest of the probe.

Again there are heat capacitance and resistive heat losses, and a resistance attributable to the temperature gradient across the tip. One further problem is trying to make a good thermal contact with the object being measured, so contact resistance also has to be noted.

An efficient design

The design of a probe has to take all these points into account. The probe tip must be as small as possible to reduce heat resistance and capacitance to a minimum, and it must be well insulated from the rest of the probe, to reduce heat losses. The probe wires should be good conductors, and very thin to prevent internal heat losses.

The response time of a probe is usually specified as the time taken to reach 66% of the measured temperature—typical figures would be 5 to 20 seconds. A more useful figure is the time taken to reach 99% of the final temperature, which for digital instruments should be fast, and should be less than 10 seconds, or better than 1 second for 66%.

To get this speed there must be low contact resistance between probe and object, low probe-tip heat capacitance, minimum tip volume, low connection resistance between tip surface and the temperature element, low capacitance of the temperature element, and the insulation between tip and probe must be very good to avoid heat leakage. In other words the requirements for good temperature reproduction and fast response are similar.



AN ACCURATE TEMPERATURE CHECK is necessary when servicing household appliances such as a clothes dryer

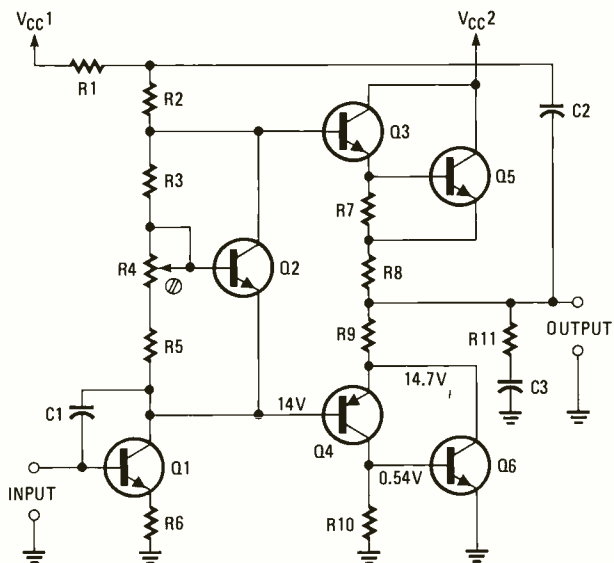

FIG. 3—TEMPERATURE PROBES can locate the area of a fault in a circuit, but other measurements are then necessary to pinpoint the malfunctioning component.

An example of an instrument that meets these requirements is a digital multimeter from Philips—the *model PM 2513*—which includes a temperature measuring facility that checks temperatures from -60 to $+200$ degrees Celsius. High accuracy and the advantages of custom design in the LSI circuits have meant that modern digital multimeters have a place in engineering circles similar to that of an electronic calculator in general use.

The LSI circuitry in the multimeter controls both the analog-to-digital conversion and the numeric display, as well as being able to measure current, voltage and resistance. The temperature sensor in the probe is a resistive element varying in value from approximately 27 ohms at -60°C to approximately 62 ohms at $+200^{\circ}\text{C}$.

Temperature checking

Temperature checking is necessary in general servicing for any appliance where temperature is a target—high or low. Freezers, refrigerators, air conditioning, washing machines and dishwashers all need temperature regulation. In more general electrical servicing fields, temperature checks are necessary on motors, bearings and power switch contacts to locate problems before they become serious—thus insuring long life.

A design and service tool

Many equipment faults are due to overheating. An amplifier producing 1 watt of useful power consumes several watts. This extra power has to be dissipated as heat. Most components have a limited temperature range, so temperature checking is essential to locate and remove unwanted hot spots. Some form of temperature measurement is essential in the design stage, to insure the correct rating of components, heat sinks and ventilation.

Temperature measurement is also useful in servicing, as mentioned earlier. But in this case the temperature information is indirect. A component overheating—be it transistor, resistor, or any other circuit element—is not always a direct indication of which component is at fault.

Take the amplifier circuit in Fig. 3. The correct bias voltages for transistor Q4 are as shown. Any variations in the bias voltages can lead to overheating, but the cause could be anything from a simple fault in the transistor, through a fault in resistors R8, R9 or R10, to faults in components Q1, Q2 or Q3.

The temperature probe will locate only the area of the fault. Measurements of voltage levels, current and resistance are then necessary for accurate fault location. The combination of temperature measurement and the other functions of a normal multimeter make the *model PM 2513* a flexible tool. **R-E**

See The Newest In Quality Electronics You



Custom Car Accessories like the Heathkit GC-1406 Digital Quartz Car Clock shown, or its companion car clock with trip timer and stopwatch functions for the rally enthusiast, are easy and fun to build. And you have the quality and dependability in custom car accessories you can show-off with pride. Now you can choose one of these fine car clocks, a windshield wiper delay, a deluxe mobile siren and P.A. system, an ultrasonic intrusion alarm, an electronic speed control or a cab-to-camper intercomm — all in money-saving kit form you can build, service and install yourself.

A Super-Accurate Digital Alarm. The ideal choice for a 'first kit' — with snooze feature, AM and PM indicator, 12 or 24 hr. format and pleasant green-blue digital display. Budget priced, too!



A Doorbell That Plays Your Favorite Tune! A fun way to greet guests with any 16-note tune you program — and you can even add remote speakers!

Low-Cost Home Security with this Heathkit GD-600 Photoelectric Lamp Switch. Turns your lamp on at dusk — off at daylight, for that 'lived-in' look when you're away from home.

Super Coinshooter! The GD-1190 is Heath's finest metal locator with adjustable discrimination and push-button tuning that rejects junk and finds coins.

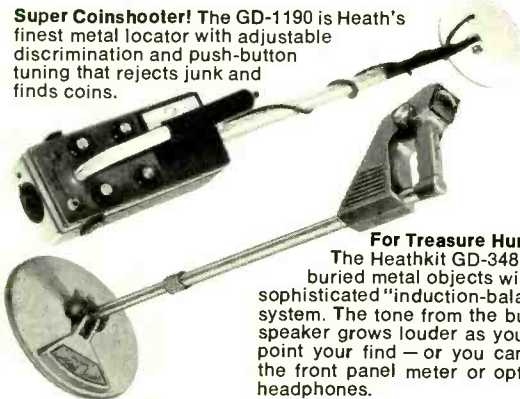

For Treasure Hunters!

The Heathkit GD-348 finds buried metal objects with its sophisticated "induction-balance" system. The tone from the built-in speaker grows louder as you pinpoint your find — or you can use the front panel meter or optional headphones.

Learn To Service and Maintain Your Car's Electrical System with this newest Heathkit Automotive Electrical Continuing Education Program. Think of the money you'll save when you really understand how your car's electrical system works and how you can service it. This 4-part self-learning program takes you through electrical principles, starting and charging systems and accessories and body electrical...all at your own pace and at lowest cost.



Learn How To Use Electronic Test Instruments with this new Heathkit self-learning program. A progressive 4-part program using Heath's famous programmed instruction with audio and visual aids for maximum efficiency. Learn to use electronic meters, oscilloscopes, frequency generators and special measuring instruments.

Radio Control Gear You Can Depend On! From the leader in R/C development. See this new 8-channel, open gimbal transmitter with Heath's instant plug-in frequency change feature...all Heath firsts!...plus sensational savings on complete systems and R/C Starter Sets.

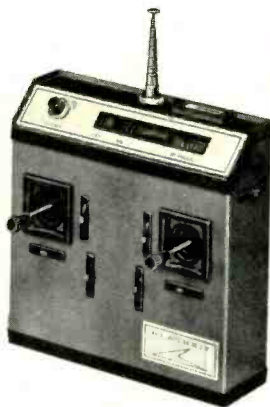

Build Your Own Custom Stereo And Get Heath Quality Plus System Savings! Choose from Heath's complete line of quality audio products for the kind of custom sound reproduction you want...from the newest and finest professional rack-mounted components to a full range of super-value components including: receivers, tuners, amplifiers, pre-amps., custom control systems, speakers, and name-brand turntables and cartridges — all available individually at low catalog prices or at money-saving system discounts.

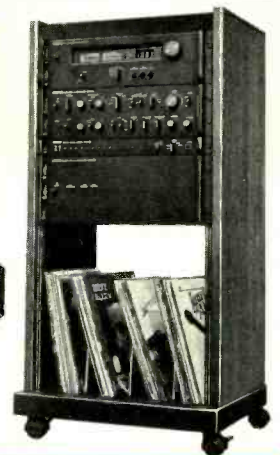

Choose from the nearly 400 quality Heathkit products for home or business, including the world's finest values in amateur radio equipment, complete personal computing systems and educational programs

Every Heathkit product is backed by world-famous technical service and counsel-plus sales and service facilities at 54 Heathkit Electronic Centers* coast-to-coast (*units of Schlumberger Products Corporation). See the white pages of your phone directory for the center nearest you.

Can Build Yourself...All In This Big

FREE

HEATHKIT® CATALOG!

Have you seen a real computerized, digital home weather station ... or a precision electronic scale for your bathroom ... or advanced educational programs that let you learn electronics or automotive maintenance at home ... or a totally broadband amateur radio transceiver ... or the world's only programmable color TV with fully automatic antenna rotor? If you haven't, send for a free Heathkit Catalog.



You'll see nearly 400 unique electronic products — the latest technology, the newest features, the best values. The kind of quality products Heath Company has been offering for some 60 years! It's fascinating reading. But the excitement doesn't stop there.

These sophisticated products are easy to build kits. Illustrated step-by-step instructions guide you and detailed explanations help you learn how the product works from the inside out. It's fun, easy and educational.



SEND FOR YOUR FREE COPY TODAY!

FREE CATALOG

HEATH
Schlumberger

Heath Company, Dept. 020-550
Benton Harbor, Michigan 49022

Please send me my FREE Heathkit Catalog.
I am not currently receiving catalogs.

Name _____

Address _____

City _____ State _____

CL-704 _____ Zip _____

...all in this
FREE CATALOG—
get yours now!

If coupon is missing, write
Heath Company, Dept. 020-550
Benton Harbor, Michigan 49022

CIRCLE 100 ON FREE INFORMATION CARD

service clinic

Be aware of intermittents: they can cause some strange symptoms.

JACK DARR, SERVICE EDITOR

EVER SINCE TECHNICIANS GOT INTO THE service business they have been plagued by problems. Probably the most annoying is the intermittent. Anyone who claims never to have had any trouble with an intermittent just opened the shop that morning and hasn't had any business yet!

Over the years, I have tried to find and identify as many types of intermittents as possible (via reports from the field), and bring them to your attention. As we all know, there are quite a few of them that are chronic. This means that the same symptom shows up in several chassis of a given make and model. And I'm sure you can all think of some dandy examples.

I've just heard of a new one that sounds very interesting. A friend and fellow technician, Leon Caldwell (Caldwell TV, Mena, AR) found the identical problem in three sets of the same make and model. We therefore felt justified in calling the trouble chronic! (And since this article was written, Leon has found a fourth set.)

Troubles

The symptom is a bright horizontal line in the raster, about one-third of the way down from the top of the screen. This results from several scanning lines being piled on top of each other; there is a blank space above and below the bright line.

On set No. 1, my friend tried replacing the vertical IC—IC302. This "fixed" it. Back in the shop, he found another set (set No. 2) with the same problem. He tried putting in the IC he had taken out of set No. 1, and it worked! On set No. 3, the next day, because he was getting suspicious he simply pulled IC302 out of the socket and pushed it back. This cleared up the problem.

Further investigation on set No. 3 showed that moving the convergence plug/socket would cause the symptom to appear and disappear, as would pushing on the PC board. When he took the chassis out, he saw quite a few suspicious-looking solder joints. Repairing all these joints cleared up the problem. Back at the shop again, the set No. 2 chassis was pulled to reveal the same problem.

There seemed to be enough solder on the joints. In some cases, the component leads hadn't been pushed far enough through the board to make a good joint. A (voluntary) callback to set No. 1 revealed the same problem, which was "redone."

According to my friend Leon, the worst offenders are the four long rectangular ground lances going through the PC board on the right-hand side (from the top). The foil used on these boards is quite thin and the board is flexible. Pushing and pulling on the board showed up more bad joints. We decided that the reason for the reaction in set No. 1 was that pulling IC302 out of the socket and putting it back had exerted enough pressure on the board to "make" some of the bad joints (at least temporarily).

The sets described here are Wards Airlines, chassis Nos. GGY-16218A, GGY-16218B and GGY-16231A and B. They are stamped or labelled "Made in Juarez, Mexico." If you experience this problem or any others in any of these chassis, it would be a good idea to examine all the solder joints on the underside of the board, especially around those ground lances.

Not long ago, I received a letter asking about a completely unknown TV set, manufactured in Singapore or somewhere in the Far East. This set was sold by a New Orleans discount distributor. No data could be located on it at all. Several months later, the technician wrote saying, "I got tired looking at the thing on my bench and jerked it out of the cabinet. Looking it over, there were bad solder joints all over the place! So many that I kept track; finally remade 47 of them! Now the blankety-blank thing is working!" A warning note on this appeared in "Reader Questions" a while ago, but repetition never hurts.

Another difficulty that turns up regularly is contact problems in modular sets. If this happens, make sure to check *all contacts* on the module involved. Try taking the module out and putting it back. If doing this clears up your symptom or changes the symptoms at all, check those contacts. Clean and tighten all contact springs, etc. If you suspect a

certain module and replacing the module clears up the trouble, always try putting the old one back and see what happens. I believe this is why factory service people complain that technicians are sending back perfectly good modules!

One manufacturer (whose name I've forgotten, luckily) sent out a bulletin on a certain chassis with a contact problem. The recommended fix was to *solder* that contact!

I hope that this will help somewhat in alerting you to some of these problems so that you can do something about it. Knowing these things can save both you and your customers money. **R-E**

service questions

ERRATIC SYNC

The syncs were quite erratic in this GE CD chassis. It looked like a defective sync separator was causing the problem. When the picture locked in, there was a slight shift to the right in sync. After some checking, the 39K resistor R251 was found to have greatly increased in value. This reduced the amplitude of the horizontal-sync pulse to the AFC unit. This in turn caused sync and AGC problems.

Thanks to Leon Caldwell, Caldwell TV, Mena, AR.

CORRECTION NOTED

I recently wrote J. G. of Tucson, AZ, that I couldn't find a substitute for Ambassador flyback No. A-29056-A. At the time, this was correct.

Mr. William J. Utterbach, Cupertino, CA, sent me a Thordarson flyer, in which the A-29056-A Ambassador flyback is listed as a FLY-265 Thordarson. Thanks very much; I am always happy to be corrected in cases like this.

LOW DC VOLTAGES

The DC voltages in this Magnavox model T991 are all very low, except for the +150-volt source. Is this a scan-derived DC power supply? There's no picture and no sound.—J. R., Detroit, MI.

The DC power supply on this set *does* use scan-derived voltages. From the readings you're getting it seems that the hori-

continued on page 84



PROFESSIONAL SELF-STUDY MICROCOMPUTER TRAINING

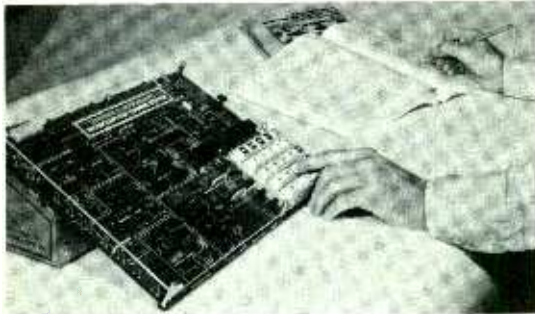

What the workbook/text teaches you:

- Fundamentals of Microcomputer Hardware and Architecture
- Fundamentals of Microcomputer Software
- How to Load and Execute Programs
- Program Flow and Program Loops
- Program Specification and Design
- Program Modules and Subroutines
- Logic and Bit Manipulation
- I/O Programming – parallel/serial
- How to Use a Programmable I/O Device
- Interrupt Handling (vectored/priority)
- Organizing Data in PROM and RAM Memory
- Advanced Math Routines
- Advanced I/O – Block Data and DMA Use

What the Training Microcomputer Includes:

1. Microcomputer and Power Supply
2. 8080A Microprocessor and Control Logic
3. Erasable PROM Memory (Containing the Educational Monitor Program) – 1024 Bytes Expandable On-Board to 8K Bytes
4. 2048 Bytes of RAM Memory Expandable to 4K Bytes
5. Programmable I/O Including Three 8-Bit Ports
6. Direct Memory Access (DMA) Channel
7. Audio Cassette Interface for Easy Program Storage and Retrieval
8. On-Board 8-Digit LED Display
9. On-Board Keyboard for Program and Data Entry
10. Space for User's Hardware Additions
11. Power Supply with Capacity for Off-the-Board Devices as Well

Expandable

... using the optional S-100 Bus Interconnect Board, the Microcomputer Training System permits interfacing with a variety of RAM and PROM memory modules, CRT terminals, TV monitors, printers, floppy disks and other peripheral devices. With an expanded system you may add disk operating systems, text editors and assemblers, and high-level languages such as BASIC, PASCAL and PL/M.

Advanced Training

... available with the Self-Study Microcomputer Interface Training Course, which builds on the material of the Microcomputer Software/Hardware Training Course to develop advanced Input/Output techniques and applications for process control and other types of real-time, microcomputer-controlled operations.

This Self-Study course is designed for people who really need to know how microcomputers work at the fundamental, detailed hardware/software level. The course has been delivered to thousands of professional engineers and scientists at organizations such as Bell Labs, DEC, GE, GM, IBM and Xerox, and to hundreds of serious amateurs as well.

What this training course is:

- A detailed 750-PAGE WORKBOOK/TEXT (available in English or French)
- A FULLY ASSEMBLED and TESTED microcomputer
- A COMPLETE SYSTEM with Keyboard, Display, Audio Cassette Interface and Power Supply
- Based on the 8080A MICROPROCESSOR
- Designed to TEACH microcomputer software and hardware from fundamentals through advanced concepts
- EXPANDABLE – optional S-100 Bus Interconnect Board permits easy addition of CRT's, printers, floppy disks, and other peripherals.

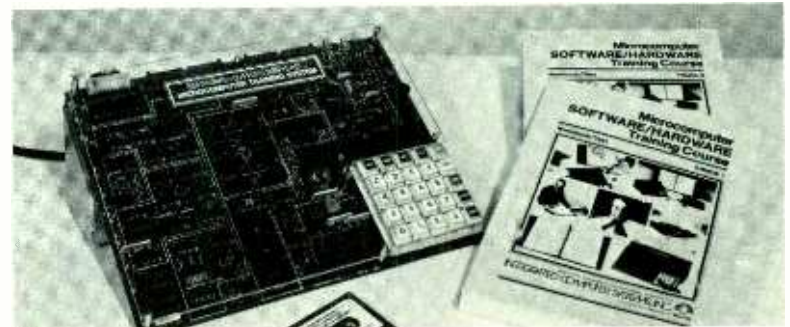

About Integrated Computer Systems

Founded in 1974 by professionals in engineering and applied computer sciences, our company objective is to provide advanced technical education of the highest quality, both through intensive short courses (public and private) and self-study programs. Our educational services are available throughout North America and Europe in a broad range of high-technology areas.



INTEGRATED COMPUTER SYSTEMS, INC.
3304 Pico Boulevard / P.O. Box 5339
Santa Monica, California 90405 USA
Telephone: (213) 450-2060 / FAX: 910-343-6965

LOS ANGELES • WASHINGTON, D.C. • BRUSSELS • PARIS • LONDON • MUNICH

PLEASE FILL OUT THIS
COUPON AND MAIL TO:

Please send
free catalog.

Please send _____ Self-Study Microcomputer Software/Hardware Training Course(s) @ \$695.00 (U.S.) each in U.S.A. or Canada. Please contact ICSP Brussels office at (02) 762.60.00 for European prices.

Name _____

Job Title _____ Bldg. No. _____
or Mailstop _____

Company _____
If paying by credit card:

Address _____

City _____ State/Province/ _____ Postal
Country _____ Code _____

computer products

More information on new products is available from manufacturers of items identified by a Free Information number. Free Information Card is inside the back cover.

DISC DRIVE SYSTEM is a dual-drive floppy-disc system that comes assembled and is S-100, Z-80, 8080 and IBM-compatible. System consists of



CIRCLE 121 ON FREE INFORMATION CARD two 8-inch drives; a Tarbell controller with 4-drive capability and on-board PROM bootstrap loader

for CP/M assembler; power supply; interface; cables; and cooling fan. The drives offer full 250K-byte storage-per-drive, 3.3K bytes-per-track, 8-ms track-to-track access time and 211-ms average access time. Recommended for use with DOS CP/M assembler, text editor and debugger. System sells for \$1995.—**Electro Analytic Systems, Inc.**, Box 102, Ledgewood, NJ 07852.

S-100 BUS ADAPTER/MOTHERBOARD, model 8100, is available as a kit or assembled, and allows interfacing S-100 based devices to a TRS-80 computer to provide memory expansion and extended I/O capabilities. Built-in 6-slot motherboard can be set on a tabletop and is connected to the TRS-80 via a ribbon cable; optional on-board support circuitry and sockets are available for 16K dynamic RAM. Also available are optional on-board I/O interfaces for serial and parallel I/O; serial interface provides RS232 or 20-mA current loop with software-programmable baud rate,

model control lines, word length, stop bits, etc., to on-board D8-25 connector. Jumpers can be used to drive printers or to interface to larger computers or modems. The board contains 2



CIRCLE 122 ON FREE INFORMATION CARD

latched 8-bit parallel input and output ports with standard 22/44 pin-edge connector. Prices: basic unit including S-100 bus interface and edge connector/card guide, manual, cable—\$185, kit; \$245, assembled; other connectors and card guides \$45, kit; \$75 assembled; RAM support option, \$45, kit; \$75, assembled; I/O option, \$85, kit; \$115, assembled.—**HUH Electronics**, 1429 Maple St., San Mateo, CA 94402. R-E



Clever Kleps

Test probes designed by your needs—Push to seize, push to release (all Kleps spring loaded).

- Kleps 10.** Boathook clamp grips wires, lugs, terminals. Accepts banana plug or bare wire lead. 4¾" long. \$1.59
- Kleps 20.** Same, but 7" long. \$1.69
- Kleps 30.** Completely flexible. Forked-tongue gripper. Accepts banana plug or bare lead. 6" long. \$1.99
- Kleps 40.** Completely flexible. 3-segment automatic collet firmly grips wire ends, PC-board terminals, connector pins. Accepts banana plug or plain wire. 6¼" long. \$2.89
- Kleps 1.** Economy Kleps for light line work (not lab quality). Meshing claws. 4½" long. \$1.09
- Prof 10.** Versatile test prod. Solder connection. Molded phenolic. Doubles as scribing tool. "Bunch" pin fits banana jack. Phone tip. 5½" long. \$.99

All in red or black - specify. (Add 50¢ postage and handling). Write for complete catalog of - test probes, plugs, sockets, connectors, earphones, headsets, miniature components.

Available through your local distributor, or write to:

RYE INDUSTRIES INC.
129 Spencer Place, Mamaroneck, N.Y. 10543
In Canada: Rye Industries (Canada) Ltd.
CIRCLE 27 ON FREE INFORMATION CARD

EIGHT INSTRUMENTS IN ONE

- Out-of-Circuit Transistor Analyzer
- Dynamic In-Circuit Transistor & Radio Tester
- Signal Generator
- Signal Tracer • Voltmeter
- Milliammeter
- Battery Tester
- Diode Checker

Transistor Analyzer Model 212
Factory Wired & Tested—\$32.71
Easy-to-Assemble Kit—\$21.79

YOU DON'T NEED A BENCH FULL OF EQUIPMENT TO TEST TRANSISTOR RADIOS! All the facilities you need to check the transistors themselves — and the radios or other circuits in which they are used — have been ingeniously engineered into the compact, 6-inch high case of the Model 212. It's the transistor radio troubleshooter with all the features found only in more expensive units. Find defective transistors and circuit troubles speedily with a single, streamlined instrument instead of an elaborate hook-up.

Features:
Checks all transistor types — high or low power. Checks DC current gain (beta) to 200 in 3 ranges. Checks leakage. Universal test socket accepts different base configurations. Identifies unknown transistors as NPN or PNP.

Dynamic test for all transistors as signal amplifiers (oscillator check), in or out of circuit. Develops test signal for AF, IF, or RF circuits. Signal traces all circuits. Checks condition of diodes. Measures battery or other transistor-circuit power-supply voltages on 12-volt scale. No external power source needed. Measures circuit drain or other DC currents to 80 milliamperes. Supplied with three external leads for in-circuit testing and a pair of test leads for measuring voltage and current. Comes complete with instruction manual and transistor listing.

EMC, 625 Broadway, New York 12, N. Y.

Send me **FREE** catalog of the complete value-packed EMC line, and name of local distributor.

NAME _____ RE-7

ADDRESS _____

CITY _____ ZONE _____ STATE _____

EMC

ELECTRONIC MEASUREMENTS CORP.
625 Broadway, New York, N.Y. 10012

PLUG IT IN AND TAKE COMMAND



X-10 Remote Control For Lights and Appliances

NO WIRES NO HASSLES

System X-10 requires no special wiring or complicated installation. Simply plug the Command Console into your wall outlet in any desired location in your home. Plug each lamp or appliance into the appropriate module and then plug that module into any wall outlet. Any number of command consoles may be used in a single system.

TOTAL CONVENIENCE

With System X-10 at your side, you can operate almost every light and electrical appliance in your home without leaving the comfort of your easy chair. Imagine turning on a TV set or stereo; even dimming a light in the next room without moving from your chair.

It may sound like one of those electronic devices found in a spy thriller, but you can have one today.

And how many times have you left a light or an electrical appliance on overnight simply because you were too tired or too lazy to turn it off? Think of the money you can save on electric bills with System X-10. Turn off heaters or appliances from any location in your home without a lot of running around.

MICROPROCESSOR BASED DESIGN

The BSR X-10 System uses the latest digital techniques for trouble-free operation. Digital pulse codes are sent through the power lines to assure reliable control throughout the system. Amazingly compact; the command console is only 4 3/4" X 3 1/2" X 3 1/2"

LAMP MODULE

Each module will control any incandescent lamp rated up to 300 watts from control signals received from the Command Console. Functions include on and off, brighten and dim. UL listed.

APPLIANCE MODULE

Each module receives signals from the Command Console to turn appliances on and off; such as TV, stereo, fan, etc. Maximum appliance ratings: Resistive load—150 wats., Motor load—1/3 HP, Incandescent Lamp—500 wats. UL listed.

WALL SWITCH MODULE NOW AVAILABLE

Receives signals from the Command Console to control incandescent lamps normally operated by a wall switch up to 500 wats. Installs just like any normal wall switch. Functions include on and off by remote or local control and brighten and dim by remote control. UL listed.

GETTING STARTED

Basic starter kit includes: 1—Command Console, 2—Lamp Modules, 1—Appliance Module. Only \$87.95 plus \$3.00 shipping and handling. Extra Lamp and Appliance Modules \$16.00 each. Wall switch modules also \$16.00 each. Extra Command Consoles \$39.95 each.

ADVANCE ELECTRONICS

54 West 45 Street New York, N.Y. 10036

To order—use this coupon or call
TOLL FREE HOT LINE
800-223-0474

—IN NEW YORK STATE #12-667-2224

Please send me
 _____ BSR X-10 System 4 piece starter kit @ \$87.95 set
 _____ Lamp Modules @ \$16.00 each
 _____ Appliance Modules @ \$16.00 each
 _____ Wall Switch Modules @ \$16.00 each
 _____ Command Consoles @ \$39.95 each

Payment enclosed Bill my MASTER CHARGE VISA

Acct. # _____ Exp. Date _____

Name _____

Address _____

City _____ State _____ Zip _____

Add \$3.00 Shipping and Handling. N.Y.S. Res. add sales tax.

Get A GNOME the original micro-synthesizer

John Simonton's time-proven design provides two envelope generators VCA, VCO & VCF in a low cost, easy to use package.

Use alone with its built-in ribbon controller or modify to use with guitar, electronic piano, polytonic keyboards, etc. The perfect introduction to electronic music and best of all, the Gnome is only \$59.95 in easy to assemble kit form. Is it any wonder why we've sold thousands?

() Send GNOME MICRO-SYNTHESIZER Kit (\$59.95 plus \$2.00 postage)
 () GNOME MICRO-SYNTHESIZER (Fully Assembled) \$100.00 plus \$2 postage
 () Send FREE CATALOG

name: _____
 address: _____
 city: _____ state: _____ zip: _____

BAC/VISA MC card no. _____
FAIA DEPT. 7-R
 1020 W. WILSHIRE, OKLAHOMA CITY, OK 73116

CIRCLE 22 ON FREE INFORMATION CARD

Put Professional Knowledge and a COLLEGE DEGREE in your Electronics Career through HOME STUDY



Earn Your DEGREE by correspondence, while continuing your present job. No commuting to class. Study at your own pace. Learn from complete and explicit lesson materials, with additional assistance from our home-study instructors. Advance as fast as you wish, but take all the time you need to master each topic.

The Grantham electronics degree program begins with basics, leads first to the A.S.E.T. degree, and then to the B.S.E.T. degree. Our free bulletin gives complete details of the program itself, the degrees awarded, the requirements for each degree, and how to enroll. (We are located at 2500 S. LaCienega Bl., Los Angeles, Calif.) Write to our mailing address shown below for Bulletin R-79.

Grantham College of Engineering
 P. O. Box 35499
 Los Angeles, California 90035

Worldwide Career Training thru Home Study
CIRCLE 64 ON FREE INFORMATION CARD

new products

More information on new products is available from manufacturers of items identified by a Free Information number. Free Information Card is inside the back cover.

DIGITAL MULTIMETER, model 3030A, is a 7-function, 3 1/2-digit instrument that offers true RMS response over a 20-Hz-50-kHz bandwidth, plus 10-milliohm, 10-mV and 10-nA resolution. The unit measures AC/DC voltages from 20 mV to 1200 volts; AC/DC current from 20 μA to 2 A; resistance from 20 ohms to 20 megohms; and has a 60-dB level range. Features include EMI shield-

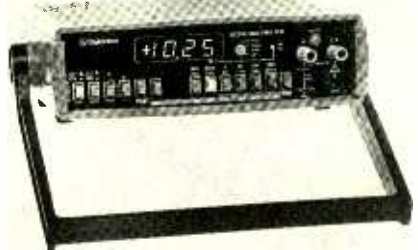

CIRCLE 151 ON FREE INFORMATION CARD

ing, ohmmeter circuit functions on all ranges; front-panel zero-adjust control; and bright orange 0.43-inch LED display. All ranges are overload-protected. An optional rechargeable battery pack is available; other options include 100/120/220/240-volt operation and BCD output, probes, carrying case and rack-mounting. The model 3030A comes in a rugged plastic case, weighs 3 lb., 8 oz., measures 8 1/4 W × 8 1/4 D × 2 1/4-inches H. Prices: model 3030A, \$365; battery pack, \$45.—**Ballantine Laboratories, Inc.**, Box 37, Boonton, NJ 07005.

MULTIPLE-OUTPUT POWER SUPPLY, model 1650, is designed for solid-state equipment, and provides three isolated outputs: 5 VDC, 5A, and two 25 VDC (A and B supplies) at 0.5A. Automat-



CIRCLE 152 ON FREE INFORMATION CARD

ic-tracking feature controls supply B when supply A output is varied; is PWM-controlled via an opto-isolator. Other features include automatic current limiting and complete overload protection on all ranges and outputs. Suggested retail price: \$275.—**B&K-PRECISION**, Dynascan Corp., 6460 W. Cortland St., Chicago, IL 60635.

ELECTRONIC IGNITION SYSTEM, Mark 10 model Z, is designed specifically for 4-cycle engines and provides a capacitive discharge pulse both in front of and in addition to regular spark pulse. Reduces need for tuneups, improves

spark-plug life, acceleration and idle. Weather-, shock- and vibration-proof, the completely as-



CIRCLE 153 ON FREE INFORMATION CARD

sembled model Z installs easily. Price: \$69.95.—**Delta Products, Inc.**, Box 1147, Grand Junction, CO 81501.

NYLON TIE & WIRE CONNECTORS, "E" Pak Merchandiser, is an assortment of nylon ties and wire connectors packed in see-through bags and



CIRCLE 154 ON FREE INFORMATION CARD

mounted on a 24 × 28-inch panel. Display contains 5 packs each of 4 nylon-tie sizes, reusable ties, two assortment packs, and 5 each of 3 sizes of wire connectors, color-coded for size. Stock numbers are listed on the back of each pack.—**Vaco Products Co.**, 1510 Skokie Blvd., Northbrook, IL 60062. **R-E**

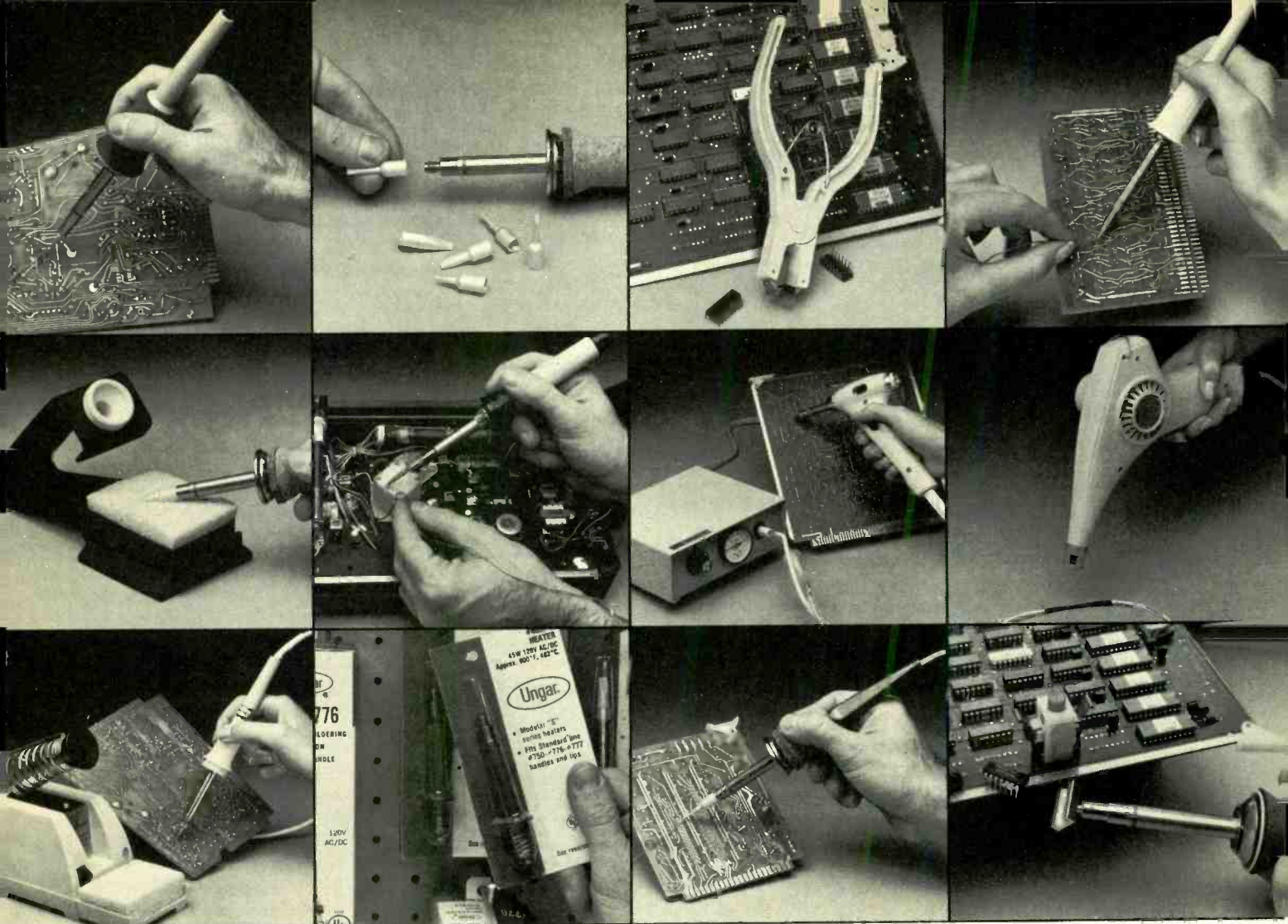

Surprised? Don't be. Because today, Ungar has one of the broadest, most complete lines of soldering and desoldering equipment and accessories in the business. Product by product, you'll find application-oriented designs that let you neatly handle any job that may come along.

Take, for example, the Ungar soldering irons. Modularly designed to give you a complete choice of handles, heaters and tips. You get the versatility you need. And fast, easy, economical on-line replacements. Plus, the

right tool for every job — micro-electronics, bench or field service, repairs of energized circuits, compatibility with sensitive components.

Or consider Hot Vac® 2000. A revolutionary new design in desoldering tools. Lightweight. Pistol-grip. Easy to clean. Extra long life tips. And try our versatile, lightweight Heat Gun on your assemblies and repairs.

There's an Ungar tool for



special jobs too. Like our highly sophisticated Ungarmatic® Soldering Station. And special kits for desoldering DIPs and ICs.

The point is, where there's solder, there's Ungar. Tools and accessories that let you handle every job. Drop us a line and we'll send you our new catalog. It's free. And it includes everything you need for successful soldering. Except the solder. For our complete catalog, write to Ungar, Division of Eldon Industries, Inc., P.O. Box 6005, Compton, CA 90220 (213) 774-5950.

The Only Thing We Don't Make Is The Solder.

CIRCLE 31 ON FREE INFORMATION CARD

PTS...the NEW name you need to know for semiconductors!

Transistors...SCRs...
ICs...diodes...rectifiers...
zeners...the same components
we use for our module and tuner
rebuilding. A high quality line of
profit-builders for the servicing technician/dealer!
Ask for a complete price list at any PTS tuner/module
servicenter.

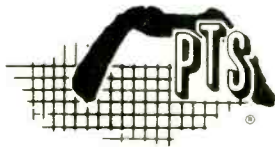

PTS ELECTRONICS, INC.
The Only Name You Need To Know

CIRCLE 46 ON FREE INFORMATION CARD

THIS VISE IS CATCHING.

Catch PanaVise. It tilts, turns and rotates your work exactly where you want. Add our new Tray! It catches small parts you drop, separates tools, and keeps parts sorted. The Tray's wide 8 1/4" diameter of cast metal gives 'no-tip' stability, and has 6 slip resistant neoprene feet. Catch all the PanaVise combinations at your distributors now. Write for FREE brochure and distributor list.

PANA VISE®

Dept. CE 11
2850 29th St.
Long Beach, CA 90806



Shown:
#315 Circuit Board Holder,
#300 Base, #312 Tray Base Mount.

CIRCLE 65 ON FREE INFORMATION CARD

STATE OF SOLID STATE *continued from page 68*

changes, each comparator responds and produces an output signal indicating whether that particular voltage sample is above or below its respective reference voltage. The 255 comparators produce a unique digital 255-bit output word corresponding to each of the possible 256 input levels. For example, when the input voltage is at -1 volt, midway in the input range, the top 128 comparators are switched off and the lower ones are switched on, producing a code of 128 zeroes and 127 ones. This coded information is compacted into an 8-bit word by the 255-to-8-bit encoder. Reduction of the digital word length is possible since 256 (2^8) levels can be completely distinguished by 8 bits.

The TDC1007J digitizes an analog signal at clock rates from DC to 30 megasamples-per-second (MSPS). It accurately samples signals up to 7 MHz without an external sample-and-hold amplifier. The comparator 3-dB bandwidth is 40 MHz. The system clock is applied to the convert strobe terminal and samples the input during positive clock transitions. Two additional control leads, NMINV and NLINV, permit the selection of binary, complemented binary, offset 2's complement and inverted 2's complement.

The maximum input capacitance of the converter is 300 pF, which although it is similar to that provided by 75-ohm coaxial cable, should be driven from a low-impedance source follower because of the capacitance's nonlinearity and DC bias. Both ends of the reference-voltage divider are brought out to pins to give you a choice of operating level. It is possible to run the converter with less than 1 volt across the divider, but some performance specifications may be degraded as a result. Reference voltages V_{RT} and V_{RB} are selected to set the first and 255th threshold levels. Center tap resistor R_T is provided so that the upper or lower divider half can be trimmed with an external resistor to permit linearity compensation for the extended-temperature version. Compensation is not necessary over the 0 to 70°C temperature range.

The TDC1007PCB video A/D converter edge-connected evaluation board is designed for easy set-up and hands-on experience. Included with the board are the TDC1007J A/D converter IC, voltage regulators and an analog input buffer amplifier with a gain of -2 and a 1000-ohm input impedance. The evaluation board accepts and digitizes a 1-volt, peak-to-peak, 75-ohm signal. Complete layouts and schematic diagrams are given in the preliminary data sheet.

The TDC1007J is packaged in a 64-pin DIP rated for 2 watts power dissipation. For information, write TRW LSI Products, P.O. Box 1125, Redondo Beach, CA 90278.

R-E

NEXT BEST THING TO BEING THERE!



With your own tutor, electronics naturally seems easier, more understandable. Now these unique training aids bring you friendly, over-the-shoulder, hands-on guidance, as if you had an expert right beside you. All planned and prepared in our effective Easi-Way™ teaching style. Only face-to-face instruction could be more personal. Nothing else like these...anywhere!

Two Forest Belt's Service Training MONOGRAPHS:

"TRIGGERED OSCILLOSCOPES—Four Hours to Familiarity"

Sit down in front of your triggered scope 30 minutes a day, and go through carefully organized exercises. In less than two weeks, you can truly UNDERSTAND how your scope displays signal waveforms; where to set the knobs and switches; what waveshapes mean; what to do when you can't seem to get a display on your scope. End up feeling comfortable and self-assured with any triggered oscilloscope.

Order 48A - \$12.50 postpaid

P.S.—The above title is available also as a Forest Belt's **SELF-TRAINER KIT**: two audio cassettes plus a dozen sets of Worksheets (for a group).

Order 48K - \$79.50 postpaid

Additional Worksheets Order 48W - Ten for \$25.50

"Easi-Way™ Solutions for Electronics Math and Formulas"

Spend a half-hour each day with your inexpensive scientific calculator (many models under \$40). Learn quickly to solve electronic formulas without knowing algebra, Thorough Easi-Read™ explanations, plus dozens of planned examples and exercises for you to work yourself. Shows you how to deal with Ohm's Law, Kirchhoff's Laws, series and parallel circuits, reactance, impedance, resonance, decibels, and plenty more. Handle complex math easier than you ever thought possible.

Order 28A - \$12.50 postpaid

Scientific Calculator Order 28SC \$35.50 postpaid

Enclosed in my \$ _____ check or money order (outside U.S., add 20% to all prices). Please ship:

_____ MONOGRAPH 28A "Easi-Way™ Solutions for Electronics Math and Formulas" @ \$12.50 each

_____ Scientific Calculator 28SC (suits use with 28A) @ \$35.50 each

_____ MONOGRAPH 48A "TRIGGERED OSCILLOSCOPES—Four Hours to Familiarity" @ \$12.50 each

_____ SELF-TRAINER KIT 48K "TRIGGERED OSCILLOSCOPES—Four Hours to Familiarity" @ \$79.50 each kit

_____ Additional Worksheets 48W (for larger groups to use with KIT) @ \$25.50 for ten

My name is _____ Age _____

Address _____ Phone _____

City _____ State _____ Zip Code _____

Forest Belt's Service Training MONOGRAPHS
Box 68120 Indianapolis IN 46268

FREQUENCY COUNTERS



COMPARE B&K-PRECISION TO H-P...

	B&K-PRECISION 1850	H-P 5383A
Range	5Hz-520MHz	10Hz-520MHz
Gate time	auto	manual
Sensitivity	50mV	50mV
Period Meas.	YES	NO
Stability	±1PPM (0-50°C)	±2.5PPM (0-40°C)
Digits	6	9
520MHz Resol.	1Hz	1Hz
AC-DC	YES	AC-ONLY
PRICE	\$480	\$650

You'll choose B&K-PRECISION!

FEATURES

TCXO time base...Internal time-base output on rear panel...Period measurement from 5Hz to 1MHz...Leading zero suppression...Handle tilt/stand adjusts to four viewing angles or folds behind the case...Bright 0.43" tall LED readout...No warm-up time required...Covers all major land mobile bands including the new "T" band...Operates on 117 or 234VAC, or 12VDC...Well protected input circuitry.

Available for immediate delivery at your local distributor.

BK PRECISION
DYNASCAN CORPORATION

6460 West Cortland Street
Chicago, Illinois 60635 • 312/889-9087

In Canada: Atlas Electronics, Ontario
Intl. Sls: Empire Exporters, Inc., 270 Newtown Road,
Plainville, L.I., NY 11803

CIRCLE 57 ON FREE INFORMATION CARD

HEART RATE MONITOR

continued from page 38

convenient means of grounding your finger to circuit ground. This is accomplished by connecting a short, bare wire to pins 2 and 4, bending it around and pushing it into the conductive foam after it has been glued to the perforated board. This ground connection will considerably reduce the capacitive coupling of AC hum into the sensor assembly. Now attach some self-stick Velcro material as shown in Fig. 7 with silicone adhesive and allow to dry thoroughly.

If you use a 4 1/4-inch meter as suggested, the meter overlay (Fig. 8) can be cut out and glued with rubber cement to the face of the meter. This will result in a neat, professional-appearing project. Use extreme care when disassembling the meter to prevent damage to the delicate meter movement and needle.

In the prototype Cardiotach, the on/off indicator LED, D7, was not used; this LED is optional and can be omitted if you wish. If the LED is not used, eliminate R34 from the PC board.

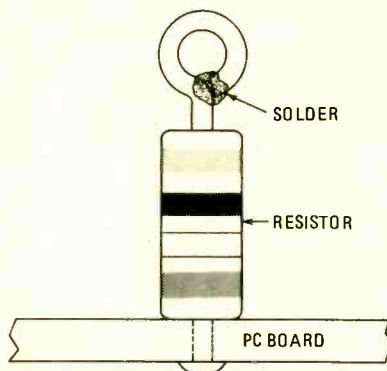

DETAIL OF RESISTORS R10 & R20 AS USED FOR TEST POINTS 1 & 2

FIG. 9—TEST POINTS consist of 10-ohm, 1/2-watt resistors soldered upright on the board.

(An experienced builder NEVER marks or covers a meter scale. Instead, he turns the dial plate over and cements the new scale on the back.—*Editor*)

Resistors R10 and R20 are end-mounted, 1/2-watt resistors at test points 1 and 2. Cut the lead on one end of each resistor to 1/2 inch and form it into a loop, then solder the other end of the resistor snugly against the PC board as in Fig. 9. Any low-value resistor can be used or even a piece of bare wire; however, a resistor tends to be a sturdier test point.

Resistor R37 was added after the PC board was designed. You will have to break the foil between the +12V supply and trimmer R24 to add the resistor. You can omit R37, but then it becomes a little tricky to adjust R24 properly.

A DPDT switch and calibration resistor could be added to the meter to connect it to test point 2 during calibration. This would eliminate the need for a separate meter during calibration. An

18K resistor, plus the internal meter resistance, would roughly allow the meter to read 2 volts full scale. Using an additional meter, you could determine where to place the calibration mark on the meter face.

After assembly is complete and all connections are carefully checked, the unit can be calibrated.

Calibration and check-out

With the cover off, apply power to the Cardiotach, but don't plug in the sensor assembly. Place switch S3 in the calibrate position. LED1 should start flashing, and the beep tone should be heard if it is turned on. Connect a voltmeter to TP2 and adjust R16 to exactly 1.5 volts DC. The filtering action of IC4-a will slow down the action of R16. Adjust the control a little at a time and wait for the meter to reach its final value before readjusting the control. Now adjust R24 so that the meter reads 90 BPM. The Cardiotach is now calibrated. Set S3 back into the operate position and plug in the sensor assembly.

Attach the sensor to your index or middle finger, placing it against the finger pad, and wrap the self-stick straps around your finger moderately tightly. Your finger should not feel uncomfortable or cold due to excessive tightness, nor should the sensor be loose enough to slip around. Adjust the sensitivity control upward from the minimum until the LED starts flashing and beep tones are heard, then set the control a little beyond that point. After from four to six heartbeats, the meter should begin to move upward. It will overshoot, then settle back down to the correct measurement. Double triggering, and the resulting high meter reading, is usually caused by the excessive gain that results from an improperly set sensitivity control and from 60-Hz hum. If the sensitivity control doesn't seem to be causing the problem, shield the sensor from any direct AC-operated light source. Multiple triggering can also result if the power supply goes out of regulation. This can be caused by an underrated transformer or too much beep-tone volume. The beep tone is intended to be low in volume so it won't be obtrusive. Changing the value of R31 for higher volume may result in too much current drain from the +12V supply and feedback into the rest of the circuitry.

Some people with chronically cold, dry fingers may have difficulty using the Cardiotach. In these cases the sensor can be used on the earlobe, or on the back of the hand, arm or other surface that has better circulation. Adhesive tape can be used to hold the sensor in place.

One final word. The Cardiotach is a useful instrument for biofeedback and simple heart-rate monitoring. It is NOT a diagnostic device, nor is it designed to effect any cures. Medical problems are best left to the professionals. R-E

DIGITAL THERMOMETER

Continued from page 46

boiling point. This method of equalizing the error over the temperature range is sometimes referred to as "splitting the rock."

Place both sensors in a pot of mineral-free water (distilled if necessary), and after it is freely boiling, adjust R16 for Sensor A and R20 for Sensor B for 100.0°C. (R14 and R18 should be set at mid-range.) If you are very far above sea level, then it may be necessary to make an altitude correction.

For the freezing point of water, mix crushed ice with an equal amount of cold water. Stir the mixture for several minutes; you should observe the temperature reach a low point and stabilize for several minutes when equilibrium is reached. If it measures right on 0.0°C, then you are finished with calibration. If the temperature is below 0.0°C, then adjust trimmers R16 and R20 until the amount of error is reduced by a half—"splitting the rock."

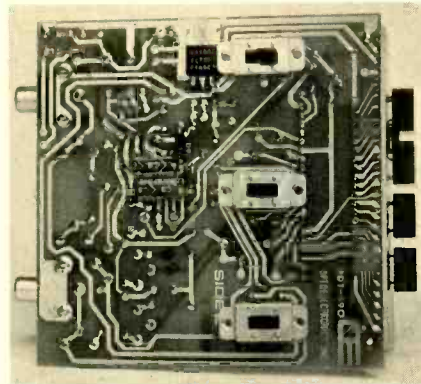

SWITCHES are mounted on Side 2 of the PC board and protrude through top of the case.

Next, place the sensors in tap water and allow them to come to equilibrium at room temperature. Use the conversion equations and calculate the Fahrenheit temperature from the indicated Celsius temperature. Adjust R14 and R18 for the correct Fahrenheit temperature.

Figure 12 shows the sensor linearity error over several different temperature spans. In order to achieve these accuracies over reduced spans, an accurate thermometer with 0.1°C resolution must be used to calibrate the sensors at each end of the selected span. An accurate clinical thermometer can be used over the clinical range; however, note that it tends to integrate the temperature from the tissue with which it is in contact along its length, while the AD590K measures the temperature of the point it contacts.

Accurate glass thermometers with 0.1° resolution are available from most laboratory supply distributors for under \$25; however, they are very fragile and require that a specific length of thermometer be immersed for accurate measurements. The glass thermometer should be used in a well-stirred water bath in order to calibrate the sensor probes.

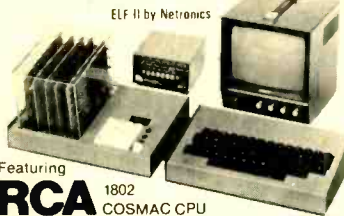

Featuring

RCA 1802 COSMAC CPU

Own a powerful home computer system, starting for just \$99.95—a price that gets you up and running the very first night... with your own TV for a video display. \$99.95 ELF II includes RCA 1802 8-bit microprocessor addressable to 64k bytes with DMA, interrupt, 16 registers, ALU, 256 byte RAM, full hex keyboard, two digit hex output display, stable crystal clock for timing purposes, RCA 1861 video IC to display your programs on any video monitor or TV screen and 5-slot plug-in expansion bus (less connectors) to expand ELF II into a giant!

ELF II Explodes Into A Giant!

Master ELF II's \$99.95 capabilities, then expand with GIANT BOARD... LIGHT BOARD... 4k RAM BOARDS... TINY BASIC... ASCII KEYBOARD... KLUGE PEN... ELF-BUG MONITOR... COLOR GRAPHICS & MUSIC SYSTEM... TEXT EDITOR... ASSEMBLER... DISASSEMBLER... VIDEO DISPLAY BOARD... and—

More Breakthroughs Coming Soon!

Soon to be introduced, ELF II special application kits that give you the hardware and software you need to use ELF II for specialized purposes such as a telephone dialer, industrial controller, home photography, security system, police alert, motor controller, station output monitor on a conveyor belt assembly line, and some new, super-fantastic games!

Also coming soon: PROM Programmer, A/D, D/A Converter, Controller Board... and more! Unlike some heavily advertised hobby computers, ELF II doesn't limit you to pre-recorded programs. With ELF II you learn computing from the ground up... from machine language to assembly language to BASIC... in quick, clear and easy steps. ELF II is a powerful computing tool, but one that you can master with the same ease you once mastered a slide rule or pocket calculator.

Master This Computer In A Flash!

Regardless of how minimal your computer background is now, you can learn to program an ELF II in almost no time at all. Our *Short Course On Microprocessor & Computer Programming*—written in non-technical language—guides you through each of the RCA COSMAC 1802's capabilities, so you'll understand everything ELF II can do... and how to get ELF II to do it! Don't worry if you've been stumped by computer books before. The *Short Course* represents a major advance in literary clarity in the computer field. You don't have to be a computer engineer in order to understand it. Keyed to ELF II, it's loaded with "hands-on" illustrations. When you're finished with the *Short Course*, neither ELF II nor the RCA 1802 will hold any mysteries for you.

In fact, not only will you now be able to use a personal computer creatively, you'll also be able to read magazines such as *BYTE*, *INTERFACE AGE*, *POPULAR ELECTRONICS* and *PERSONAL COMPUTING* and fully understand the articles. And, you'll understand how to expand ELF II to give you the exact capabilities you need!

If you work with large computers, ELF II and the *Short Course* will help you understand what they're doing.

Get Started For Just \$99.95, Complete!

\$99.95 ELF II includes all the hardware and software you need to start writing and running programs at home, displaying video graphics on your TV screen and designing circuits using a microprocessor—the very first night—even if you've never used a computer before.

ELF II connects directly to the video input of your TV set, without any additional hardware. Or, with an \$8.95 RF modulator (see coupon below), you can connect ELF II to your TV's antenna terminals instead.

ELF II has been designed to play all the video games you want, including a fascinating new target/missile gun game that was developed specifically for ELF II. But games are only the icing on the cake. The real value of ELF II is that it gives you a chance to write machine language programs—and machine language is the fundamental language of all computers. Of course, machine language is only a starting point. You can also program ELF II with assembly language and tiny BASIC. But ELF II's machine language capability gives you a chance to develop a working knowledge of computers that you can't get from running only

Write and run programs—the very first night—even if you've never used a computer before!

You're up and running with video graphics for just \$99.95 — then use low cost add-ons to create your own personal system that rivals home computers sold for 5-times ELF II's low price!

pre-recorded tape cassettes.

ELF II Gives You The Power To Make Things Happen!

Expanded, ELF II can give you more power to make things happen in the real world than heavily advertised home computers that sell for a lot more money. Thanks to an ongoing commitment to develop the RCA 1802 for home computer use, the ELF II products—being introduced by Neronics—keep you right on the outer fringe of today's small computer technology. It's a perfect computer for engineering, business, industrial, scientific and personal applications.

Plug in the **GIANT BOARD** to record and play back programs, edit and debug programs, communicate with remote devices and make things happen in the outside world. Add **Kluge** (prototyping) Board and you can use ELF II to solve special problems such as operating a complex alarm system or controlling a printing press. Add **4k RAM Boards** to write longer programs, store more information and solve more sophisticated problems.

ELF II adds already include the ELF II Light Pen and the amazing ELF-BUG Monitor—two extremely recent breakthroughs that have not yet been duplicated by any other manufacturer.

The ELF-BUG Monitor lets you debug programs with lightning speed because the key to debugging is to know what's inside the registers of the microprocessor. And, with the ELF-BUG Monitor, instead of single stepping through your programs, you can now display the entire contents of the registers on your TV screen. You find out immediately what's going on and can make any necessary changes.

The incredible ELF II Light Pen lets you write or draw anything you want on a TV screen with just a wave of the "magic wand." Neronics has also introduced the ELF II Color Graphics & Music System—more breakthroughs that ELF II owners were the first to enjoy!

ELF II Tiny BASIC

Ultimately, ELF II understands only machine language—the fundamental coding required by all computers. But, to simplify your relationship with ELF II, we've introduced an ELF II Tiny BASIC that makes communicating with ELF II a breeze.

Tiny BASIC saves you the time of having to code your individual instructions in machine language for ELF II. Instead, you simply type instructions on a keyboard—PRINT, RUN, LOAD, ETC. Your Tiny BASIC program automatically translates them into machine language for ELF II. Then it translates ELF II's output back into simple words and symbols for you.

Now Available! Text Editor, Assembler, Disassembler And A New Video Display Board!

The Text Editor gives you word processing ability and the ability to edit programs or text while it is displayed on your video monitor. Lines and characters may be quickly inserted, deleted or changed. Add a printer and ELF II can type letters for you—error free—plus print names and addresses from your mailing list!

ELF II's Assembler translates assembly language programs into hexadecimal machine code for ELF II use. The Assembler features mnemonic abbreviations rather than numerics so that the instructions on your programs are easier to read—this is a big help in catching errors.

ELF II's Disassembler takes machine code programs and produces assembly language source listings. This helps you understand the programs you are working with—and improve them when required.

The new ELF II Video Display Board lets you generate a sharp, professional 32 or 64 character by 16 line upper and lower case display on your TV screen or video monitor—dramatically improving your unexpanded \$99.95 ELF II. When you get into longer programs, the Video Display Board is a real blessing!

Ask Not What Your Computer Can Do... But WHAT CAN IT DO FOR YOU?

Don't be trapped into buying an expensive dinosaur, simply because you can afford it. ELF II is more advanced and more fun to use than big name computers that cost a lot more money. With ELF II you learn to write and run your own programs. You're not just a keypunch operator. No matter what your interests are, ELF II is the fastest way to get into computing. Order from the coupon below!

Neronics R&D Ltd., Dept RE7
333 Litchfield Road, New Milford, CT 06776

Yes! I want my own computer! Please rush me—

RCA COSMAC ELF II kit at \$99.95 plus \$3 postage and handling; requires 6.3 to 8 volt AC power

Deluxe Metal Cabinet with Plexiglas dust cover for ELF II \$29.95 plus \$2.50 p&h

I am also enclosing payment (including postage & handling) for the items checked below!

I want my ELF II wired and tested with power supply, RCA 1802 User's Manual and Short Course—all for just \$149.95 plus \$3 p&h

PHONE ORDERS ACCEPTED!
Call (203) 354-9375

Total Enclosed \$ _____
(Conn. res. add. tax)

CHARGE IT! Exp. Date _____
 Visa Master Charge
(Bank # _____)

Account # _____

ALSO AVAILABLE FOR ELF II—

GIANT BOARD™ kit with CASSETTE I/O RS 232 C I/O 1/0 8 bit I/O decoders for 1.1 sec. rate I/O instructions and a system monitor/editor. \$39.95 plus \$2 p&h

Kluge (Prototyping) Board accepts up to .16 IC's \$17.00 plus \$1 p&h

4k Static RAM kit. Addressable to any 4k page to 4kx \$89.95 plus \$3 p&h

Light pen 86-pin connectors (one required for each pin) \$5.70 plus .50 p&h

Expansion Power Supply (required when adding 4k RAM) \$34.95 plus \$2 p&h

Professional ASCII Keyboard kit with 128 ASCII upper/lower case set, 96 printable characters, onboard regulator, parity logic selection and choice of 4 hand-changing signals, to mate with almost any computer. \$54.95 plus \$2 p&h

Deluxe metal cabinet for ASCII Keyboard, \$19.95 plus \$2.50 p&h

Video Display Board kit lets you generate a sharp, professional 32 or 64 character by 16 line upper and lower case display on your TV screen or video monitor—dramatically improving your unexpanded \$99.95 ELF II. Includes inside ASCII Keyboard cabinet. \$89.95 plus \$2 p&h

ELF II Tiny BASIC on cassette tape. Commands include SAVE, LOAD, X, C. \$19.95 plus \$2 p&h

26 variables A-Z, E1, IF/THEN, INPUT, PRINT, GO TO, GO SUB, RETURN, END, REM, CLEAR, LIST, RUN, PLOT, PEEK, POKE, Kongs, fully documented and includes alphanumeric generator required to display alphanumeric characters directly on your TV screen with out additional hardware. Also plays tick tack toe, a jigsaw drawing game that uses ELF II's hex keyboard as a joy stick, 4 memory required. \$14.95 plus \$2 p&h

Tom Pittman's Short Course on ELF II \$5.00 postpaid

ELF-BUG™ Deluxe System Monitor on cassette tape. Allows displaying the contents of all registers on your TV at any point in your program. Also displays 24 bytes of memory with full addresses, blinking cursor and auto scrolling. A must for the serious programmer! \$14.95 postpaid

Text Editor on cassette tape gives you the ability to insert, delete or edit lines and words from your programs while they are displayed on your video monitor. (Add printer and you can use ELF II to type error-free letters plus insert names and addresses from your mailing list.) \$19.95 postpaid

Assembler on cassette tape translates assembly language programs into hexadecimal machine code for ELF II use. Mnemonic abbreviations for instructions (rather than numerics) make programs easier to read and help prevent errors. \$19.95 postpaid

Disassembler on cassette tape takes machine code programs and produces assembly language source listings to help you understand and improve your programs \$19.95 on cassette tape

SAVE \$9.90—Text Editor, Assembler & Disassembler purchased together, only \$49.95! (Requires Video Display Board plus 4k memory.)

ELF II Light Pen, assembled & tested. \$7.95 plus \$1 p&h

ELF II Color Graphics & Music System Board kit \$49.95 plus \$2 p&h

ELF II connects directly to the video input of your TV set, without additional hardware. Order RF Modulator, \$8.95 postpaid.

Coming Soon: A/D, D/A Converter, Controller Board and more!

Name _____

Address _____

City _____

State _____ Zip _____

DEALER INQUIRIES INVITED

CIRCLE 44 ON FREE INFORMATION CARD

SERVICE QUESTIONS

continued from page 74

zontal oscillator is not running, which means no DC voltages can be developed. There's a starter circuit in this oscillator that applies a DC pulse on the oscillator until it starts.

In this chassis, the circuit is in the +159-volt line (activated when the switch is turned on) which is dropped through the 12K resistor, R229, to pin 10 of the horizontal module. This voltage feeds the oscillator. When the oscillator starts, diode D1, connected to the +24-volt line from the scan-derived supply, is reverse-biased. The oscillator is fed from the flyback circuit, just as soon as it conducts. Check all components in this area, as well as the oscillator itself, which could be bad.

MORE DOUBLE TROUBLE

I enjoyed the "Double-Trouble" story in the July 1978 Service Clinic.

I had a similar problem a long time ago on a 1960 Zenith black-and-white set. The customer complaint was there was no video, no sound. The B+ line and high voltage are both OK. There was a 2.0-volt signal at the video detector test point. A signal on the video-amplifier grid; nothing on the plate. Hmm . . . there was no DC voltage on video-amplifier screen. The B+ was good; so was the dropping

resistor (but hot). The screen read ground. I clipped the connections but it still read ground on the lead from the dropping resistor.

Finally, I traced this to one stud on a terminal strip (the kind of strip with the studs on top of the chassis). I looked on top of the chassis and . . . someone had dropped a ring into the set. It had hit the terminal strip and the B+ line had welded it to ground. So I removed the ring; the set now plays!

DC VOLTAGE PROBLEMS

I have an Admiral T3L6 chassis with a blown fuse. When I changed the fuse, I got +159 volts but none of the other DC voltages. I do not know where to go from here.—T. T., Brooklyn, NY.

Go to the horizontal-output stage. All the low DC voltages in this chassis are developed by rectifying pulses from the flyback. Check the horizontal-output and oscillator/driver transistors, and all the diodes connected to the flybacks for shorts. This set may have been hit by lightning. Check it over carefully for signs of other damage, such as blown resistors or PC conductors.

HEIGHT/LINEARITY PROBLEM

I'm losing about an inch of raster from the top and bottom on this Admiral model 6K1668-3. I thought this would be easy. But, after checking the circuit thoroughly

and finding all OK, I'm not so sure any more! The cathode and grid voltages are slightly off. There must be something I'm missing! What is it?—E. D., Tappan, NY.

In a typical vertical output tube circuit for many color sets, there is a little 50- μ F electrolytic capacitor in the output stage cathode. If it goes bad it can cause all different kinds of trouble.

The big headache is that in this chassis the capacitor itself is not on the chassis, it's over on the convergence board! Because even the schematic shows it's apparently not there, we overlook it. As this capacitor seems to be the only component you haven't changed, try testing it.

OHMMETER CAN TEST SCR'S

Several readers have written to ask if an SCR can be tested with an ohmmeter the same way that transistors can. Trying this test out showed that you can use an ohmmeter, at least with smaller SCR's. First, measure the SCR from the anode to the cathode. This should show an open circuit in both directions. Now, connect the positive lead of the ohmmeter to the anode and short the gate terminal to the anode (where the positive lead is located). This should turn the SCR on. The larger SCR's won't latch on but will conduct (either polarity) when the gate is shorted to the anode.

You can definitely check SCR's for shorts, just as you'd check a diode. **R-E**



Full Features \$850
... Yet Portable includes probes and front cover

Say "Hello" to an excitingly new 15 lb., 15 MHz 'scope. Smart looking and really convenient — only 5 1/2" high yet features a large, bright 10cm x 8cm rectangular CRT.

Check this capability: Versatile triggering in excess of 25MHz, 2mV sensitivity, differential mode, and much more.

Quality? You Bet! Backed by Exclusive Gould 2-yr. warranty. It's a winner! Call us for the full story on the OS255.

For free brochure call: TOLL FREE NUMBER (800) 325-6400
 In Missouri (800) 342-6600

Gould Inc., Instruments Division
 3631 Perkins Ave., Cleveland, OH 44114

GOULD
 An Electrical/Electronics Company

CIRCLE 47 ON FREE INFORMATION CARD

TUNE in with DAVIS FREQUENCY COUNTERS

NOW . . . for the FIRST TIME
 RECEIVE FREQUENCY ADAPTER
 ONLY **4995**

7208 10 Hz to 600 MHz MINI COUNTER

- All Metal Cabinet
- 8 Digit 4 LED Readout
- 115V or 12V Operation
- 1 & 1 Sec. Gate Times
- Automatic DP
- Stable Crystal Timebase ± 1 ppm. C

7208 Kit	14995	7208A Assembled	\$199.95
Options:		Prop. Crystal Oven (OCXO) ± 1 ppm 10 ³ to 50 ³ C	\$39.95
		Ni-Cad Battery, Built-in with charger	\$39.95
		Handle	\$5.00
		VHF-UHF Preamp	\$10.00
		240V	\$10.00
		Receive Frequency Adapter	\$49.95

*OCXO - achieve superior frequency stability through the use of proportional control oven which maintains the crystal at a stable temperature.

CALL FACTORY DIRECT

1-716-874-5848

TERMS: Add \$3.00 shipping to U.S. & Canada. Other countries add 10% to total price. N.Y. State residents add 7% sales tax. C.O.D. Fee \$1.00. P.O. accepted from rated companies.

DAVIS

DAVIS ELECTRONICS

636 Sheridan Drive
 Tonawanda, New York 14150
 (716) 874-5848



CIRCLE 41 ON FREE INFORMATION CARD



PHILIPS

BK PRECISION

LEADER

FLUKE

TRIPLETT

VIZ formerly **NSA**

DATA PRECISION



Non-Linear Systems

DORIC

HICKOK

Simpson

FLUKE

DIGITAL MULTIMETERS

NEW 8022A

- Extensive overload and transient protection
- Rugged construction
- Hi/Lo power ohms for in-circuit resistance and diode testing
- 10 MΩ input impedance doesn't load circuit
- 200 hour battery life — low battery indicator
- Large LCD readout — 2000 counts
- 1 year calibration cycle
- One-hand operation

NOW \$129.

BASIC SPECIFICATIONS

	DC Volts	AC Volts	DC Current	AC Current	Ohms
Range	0.2-1000V	0.2-750V	0.002-2A	0.002-2A	200Ω-20 MΩ
Resolution	100 μV	100 μV	1 μA	1 μA	0.1Ω
Accuracy*	(0.25 + 1)	(1.1 + 2)*	(0.75 + 1)	(1.5 + 2)*	(0.2 + 1)*

FLUKE

DIGITAL MULTIMETERS

8020A NOW 0.1% Basic dc accuracy

- 26 Ranges—5 Functions plus New Conductance Function for up to 10,000 MΩ Leakage Measurements
- Extensive Overload and Transient Protection
- Rugged Construction—2 Year Warranty
- Hi/Lo Power Ohms for In-circuit Resistance and Diode Testing
- 10 MΩ AC/DC Input Impedance Doesn't Load Circuit
- 200 Hour, 9V-Battery Life—Low Battery Indicator
- Large LCD Readout—2000 Counts
- 0.1% Basic dc accuracy
- One Hand Operation
- Complete with Battery and Test Leads

The new Fluke 8020A continues the standard of excellence set by the highly successful 8000A multimeter family. Many features set the 8020A apart as a truly exceptional instrument. Twenty-four ranges and 5 functions include measuring capability up to 1000V dc, 750V ac, 2A ac/dc and 20 MΩ. Hi/Lo ohms are included for in-circuit resistance and diode test capability. In addition, a new Conductance function allows resistance and leakage measurements up to 10,000 MΩ, a must for circuit board work and component checking.

The 8020A has been designed with the user in mind and features exclusive one-hand operation. For harsh service environments, the 8020A has a ruggedized case and extensive overload/transient protection backed up by a 1-year warranty. Long term stability (1-year calibration cycle) is excellent with only three cal adjustments. Up to 200 hours of continuous operation can be expected from a single 9V alkaline battery.

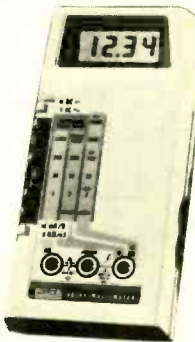

\$169.

FREE CASE WITH 8020A

New Portable Digital Capacitance Meter



BK PRECISION

Reg. price \$130.

\$109.95

MODEL

820

- Measures capacitance from 0.3pF to 1 Farad
- Resolves to 0.1pF
- 10 ranges for accuracy and resolution
- 4 digit easy-to-read LED display
- 0.5% accuracy
- Specialized insertion jacks or banana jacks
- Fuse protected
- Uses either rechargeable or disposable batteries
- Overrange indication

MASTERCARD
VISA

THE TEST EQUIPMENT SPECIALISTS

**TOLL FREE HOT LINE
800-223-0474**

54 West 45 Street, New York, N.Y. 10036 212-687-2224

**ADVANCE
ELECTRONICS**

LBO-515

25MHz Dual Trace/Dual Time Base Scope with Variable Delay



LEADER
Instruments Corp

\$1175.

REG \$1395

- Built-in variable delay circuitry — 1μ Sec to 5 Sec.
- 5mV/Div. Vertical Sensitivity
- Rectangular, 8 x 10Div CRT with internal graticule.
- Selectable synchronization, automatic, normal, single trace and reset modes.
- 14nSec rise time
- Trigger CH-1 or CH-2
- H.F. filter plus TV sync. assures stable displays.

New Sweep/Function Generator



MODEL
3020 BK PRECISION

- Four instruments in one package—sweep generator, function generator, pulse generator, tone-burst generator
- Covers 0.02Hz-20MHz
- 1000:1 tuning range
- Low distortion high-accuracy outputs
- Three-step attenuator plus warmer control
- Internal linear and log sweeps
- Tone-burst output is front-panel or externally programmable

Regular price \$325. **\$269.95**

LEADER
Instruments Corp

\$149.95

REG \$180

**LTC-906
Transistor Checker**



- Automatically checks transistors, FET's, diodes, good/bad, in or out of circuit.
- Automatically identifies Germanium or Silicon.
- Automatically identifies emitter base and collector.
- LED display plus audible tone indication.
- Absolute meter readout of Hfe, Bve and Leakage current.

INTERNATIONAL FM-2400CH

FREQUENCY METER FOR TESTING MOBILE TRANSMITTERS AND RECEIVERS

• Portable • Solid State • Rechargeable Batteries

The **FM-2400CH** provides an accurate frequency standard for testing and adjustment of mobile transmitters and receivers at predetermined frequencies.

The FM-2400CH with its extended range covers 25 to 1000 MHz.

The frequencies can be those of the radio frequency channels of operation and/or the intermediate frequencies of the receiver between 5 MHz and 40 MHz.

Frequency stability: $\pm .0005\%$ from $+50^\circ$ to $+104^\circ\text{F}$.

Frequency stability with built-in thermometer and temperature corrected charts: $\pm .00025\%$ from $+25^\circ$ to $+125^\circ$ (.000125% special 450 MHz crystals available).

- Tests Predetermined Frequencies 25 to 1000 MHz
- Extended Range Covers 950 MHz Band
- Pin Diode Attenuator for Full Range Coverage as Signal Generator
- Measures FM Deviation

FM-2400CH (meter only) Cat. No. 035320	\$627.72
RF crystals (with temperature correction)	26.26 ea.
RF crystals (less temperature correction)	19.93 ea.
IF crystals	catalog price



INTERNATIONAL CRYSTAL MFG. CO., INC.
10 North Lee / Oklahoma City, Okla. 73102

CIRCLE 58 ON FREE INFORMATION CARD

For faster service

USE ZIP CODE

on all mail



More information on new lit is available from the manufacturers of items identified by a Free Information number. Use the Free Information Card inside the back cover of this issue.

COMPUTER GUIDE, *Getting Started with Computers*, lists 25 resources, books and periodicals to help the personal computer owner learn about his system. It is designed for the novice as well as experienced programmers and electronics engineers, with separate sections devoted to each level of proficiency. The booklet also includes an up-to-date buyers guide, and surveys and recommends computer systems tailored to individual needs.—NCE/CompuMart, Inc., P.O. Box 8610, Ann Arbor, MI 48107.

CIRCLE 141 ON FREE INFORMATION CARD

ELECTRONIC PRODUCTS CATALOG contains 48 pages of new and useful electronic products, components and equipment, all at bargain prices. Includes such items as special phone equipment, a laminating machine, a digital clock, a solid-state color TV chassis, a radar detector, plus hundreds of other discounted items. The catalog features a special 16-page insert offering quantity discounts to and volume users.—ETCO Electronics Corp., Dept. 077, North Country Shopping Center, Plattsburgh, NY 12901.

CIRCLE 142 ON FREE INFORMATION CARD

TOOLS & HARDWARE CATALOG, *Catalog 179*, contains 196 pages of hand and power tools for the hobbyist and technician. Also included among the items listed are voltmeters, radar detectors, wire and cable strippers, TV antennas, CB radios and accessories, telephone amplifiers, and many, many more. Order form and handy index are included. \$1 refundable with first order.—U.S. General Supply Corp., Dept. R.E., 100 General Place, Jericho, NY 11753.

DIGITAL STORAGE SCOPES, *Bulletin 449-5*, contains 6 illustrated pages covering two dual-trace oscilloscopes providing infinite storage time. The *model OS4000* is a 10-MHz dual-trace scope; the *model OS41000* offers X-Y capability. Complete specs are given.—Gould, Inc., Instruments Div., 3631 Perkins Ave., Cleveland, OH 44114.

CIRCLE 143 ON FREE INFORMATION CARD

ELECTRONIC PRODUCTS BROCHURE, *1979 Distributor Short Form Catalog*, contains 12 pages summarizing technical specs and order information for resistor networks, trimmer pots, turns-counting dials, LCD's and planar gas discharge displays. Complete list of manufacturer's distributors is included.—Beckman Instruments, Inc., Technical Information Dept., 2500 Harbor Blvd., Fullerton, CA 92634.

CIRCLE 144 ON FREE INFORMATION CARD

MICROCOMPUTER BOOK CATALOG lists 150 books designed to help users understand and operate their personal computer systems, and includes material geared to both the neophyte and the experienced computer operator.—BITS, INC., Dept. 41, 25 Route 101 West, Peterborough, NH 03458.

CIRCLE 145 ON FREE INFORMATION CARD

THE GOVERNMENT CAN DO EVERYTHING THE UNITED WAY DOES. ONLY THEY WRAP IT UP FOR YOU IN NICE RED RIBBON. MILES AND MILES OF IT.



One of the best things about United Way is not what it does, but what it doesn't do.

For instance, because United Way is run almost entirely by volunteers, it is able to return an amazing 89% of every dollar to people who need it. That means less than 11% goes for administrative costs.

So it doesn't waste your money.

And because United Way is re-created each year with a combination of old and new volunteers, it doesn't become over encumbered with huge staffs of people who might actually get in the way of progress.

So it doesn't strangle you in red tape.

All of which means that because of what United Way doesn't do, it can do a much better job at what it does do.

Helping people.



Thanks to you it works. For all of us.
A Public Service of The Register & The Advertising Council

VIDEODISC

continued from page 41

Fig. 9. The signal from the VHF modulator rides a 10 VDC level. When the player is switched on, the 10 VDC appears and switches on diode D1 through R1. The signal is thus coupled through C2 and the balun to the TV set's antenna terminal of the TV.

In addition, relay K1 is energized and the normally closed contacts are held open, thereby disconnecting the external VHF antenna. When the player is off, the 10 VDC is absent, K1 is de-energized and its contacts close. The external VHF antenna

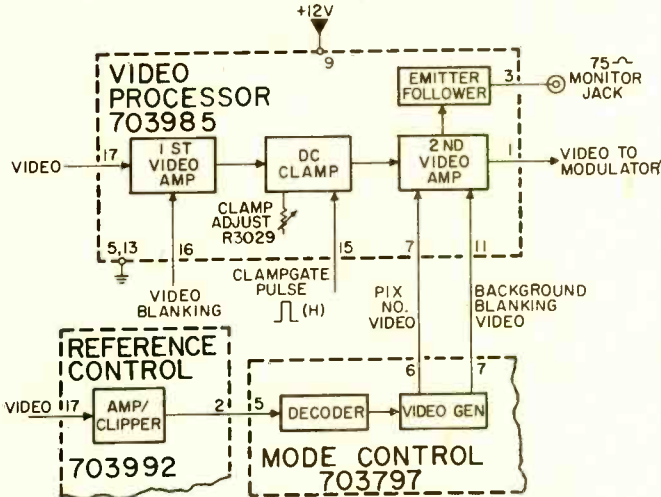

FIG. 7—COMPOSITE VIDEO SIGNAL PROCESSING CIRCUIT is made up of a video processor, mode control and reference control modules.

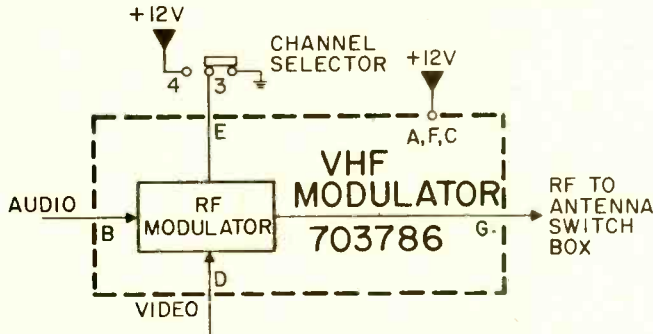

FIG. 8—RF SIGNAL MODULATOR takes the signal from the player, modulates a channel 3 or 4 RF signal and feeds that signal to the TV set's antenna terminals through an antenna switch box.

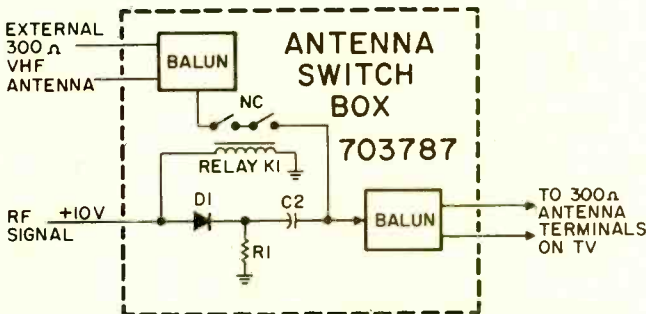

FIG. 9—ANTENNA SWITCH BOX connects videodisc player to TV antenna terminals. It acts automatically and prevents videodisc signals from getting to the TV antenna.

is now coupled through both baluns to the TV set.

Relay K1 uses two contacts in series to maintain proper isolation, a minimum of 60 dB. The player will operate properly on channel 3 or 4 even if a medium-strength signal is already present at the external VHF antenna on those channels.

That's the end of our coverage of the Magnavision videodisc player. A complete Magnavision manual for the model VH8000 can be purchased from Magnavox, Service Training Department, Fort Wayne, IN 46804. R-E

Nobody does it better than VIZ

The Everything Scope

Dual Trace WO-555 \$750

AVAILABLE NOW!

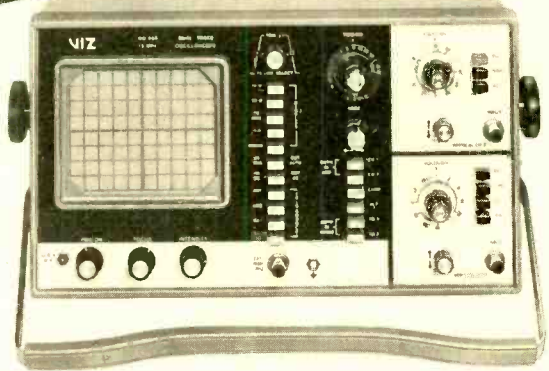

The 15MHz scope with more accuracy, convenience, versatility and a broader voltage capability (DC thru 600V) than several others costing more money. View channels A or B, A and B, A + B or A - B with calibrated X-Y capability through 15MHz. Built-in delay line allows for viewing the full input waveform so information such as "undershoot and overshoot" can be seen and analyzed. Unique simplified trig hold and adjustment control with LED indicators show trig polarity at a glance. Two direct/X10 LoCap probes are supplied.

The Everything Scope

Single Trace WO-527A \$525

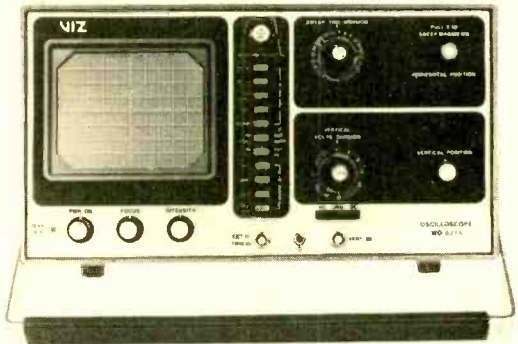

The ideal scope for most industrial, laboratory, educational and servicing applications. Frequency response DC to 15MHz. Rise time 23 nsec. Sensitivity 10mV/cm P-P. Ultrastable trig action with simplified level adjustment and LED polarity indicators. One direct/X10 LoCap probe supplied.

See your local VIZ distributor or write VIZ

VIZ Test Instruments Group
335 E. Price St., Philadelphia, PA 19144

The VoltOhmyst company

market center

CLASSIFIED COMMERCIAL RATE (for firms or individuals offering commercial products or services) **\$1.50 per word (no charge for zip code)** . . . minimum 15 words.

NONCOMMERCIAL RATE (for individuals who want to buy or sell personal items) **85¢ per word** . . . no minimum.

ONLY FIRST WORD AND NAME set in bold caps. Additional bold face (not available as all caps) at 10¢ per word. Payment must accompany all ads except those placed by accredited advertising agencies. 5% discount for 6 issues, 10% for 12 issues within one year, if paid in advance. All copy subject to publisher's approval. Advertisements using P.O. Box address will not be accepted until advertiser supplies publisher with permanent address and phone number. Copy to be in our hands on the 26th of the third month preceding the date of the issue (i.e., August issue closes May 26). When normal closing date falls on Saturday, Sunday, or a holiday, issue closes on preceding working day.

FOR SALE

FREE catalog (anglais). IC's, semi's. **CORONET ELECTRONICS**, 649A Notre Dame W., Montreal, Que., Canada, H3C 1H8. US inquiries.

RADIO & TV tubes 36¢ each. One year guaranteed. Plus many unusual electronic bargains. Free catalog. **CORNELL**, 4217-E University, San Diego, Calif. 92105

TEST equipment catalog listing used Tektronix, HP and GR equipment at bargain prices. Price \$1.00 refundable with first order. **PTI**, Box 8699, White Bear Lake, MN 55110

NAME brand test equipment. Guaranteed discounts up to 50%. Free catalog. **SALEN ELECTRONICS**, Box 82-M, Skokie, IL 60077

FREE catalog of new merchandise, at great prices. IC's, semi's and more. **KEY ELECTRONICS**, Box 3506-RE, Schenectady, NY 12303

PRINTED-circuit boards, reasonable. Also, artwork, prototypes, designs, fabrication and testing. **MICROCON INC.**, Box 43, Glenview, IL 60025

PRINTED circuit boards! 1 to 1000. Your artwork, positive, negative, or magazine example. Quick delivery, reasonable prices, quantity discounts. **RICHARD ALLRAN**, Box 974, Dept. B, Waynesville, NC 28786

RCA, Zenith original TV parts. Dealer prices, fast service. Send part and model numbers. **L.I. ELECTRONICS**, 981 Sunrise Hwy., Bayshore, NY 11706, 516-666-7360

RESISTORS. 1/2-watt resistors, popular sizes, 3 cents each. **MILLIKAN SURPLUS**, 5118 Jason, Houston, TX 77096

MATCH your skills against people from all over the world with our computer games by mail. **WIZARDS ARSENAL**, Box 20183, Lansing, MI 48901

YOUR PHONE CALLS ON TAPE

Record incoming and outgoing calls automatically with this all solid state unit connected to your telephone jack and tape recorder. Starts recording when phone is lifted. Stops when you hang up, making a permanent record. Easily installed. No extra monthly phone charges. FCC APPROVED
2-1/4 x 1-3/4 x 3/4 **\$24.50***

VOX VOICE ACTIVATED CONTROL SWITCH

Self contained solid state. Excellent adjustable sensitivity. Recorder activated by voices or other sounds. Uses recorder mike or remote mike. Great for home, business, etc. **\$24.95***

FCC APPROVED AMAZING ELECTRONIC MICRO MINI MIKE

Among world's smallest, solid state, self contained WIRELESS MIKE. Mercury Bat. furn. Picks up most sounds and transmits without wires up to 300 ft. thru FM Radio. Tuneable. Use as mike, ampl., alarm & alert system, baby sitter, hot line, etc. (*Plus \$1.00 Pstg. & Hdg.) Money back guarantee. California residents add tax. Free data. Mail order. Visa, M/C, Cod's o.k. Quantity discount available. AMC Sales, Dept. 19, 9335 Lubec St., Box 928, Downey, Calif. 90241 Phone (213) 869-8519
\$18.95*
2-1/4 x 3/4 x 1/2"

HIGHLY PROFITABLE ONE-MAN ELECTRONIC FACTORY

Investment unnecessary, knowledge not required, sales handled by professionals. Ideal home business. Write today for facts! **Postcard will do. Barta-RE-S, Box 248, Walnut Creek, CA 94597.**

INVENTORS

FREE information on offering your invention for sale. **KESSLER SALES CORPORATION**, C-316, Fremont, OH 43420

BUSINESS OPPORTUNITIES

MECHANICALLY inclined individuals desiring ownership of Small Electronics Manufacturing Business—without investment. Write: **BUSINESSES**, 92-R, Brighton 11th, Brooklyn, NY 11235

SATELLITE TV GET 50 CHANNELS!

It's all true! No matter where you live receive movies, sports, pay television, sports from around the world! 24-hour programming. Crystal clear reception! For complete information, sources and design information, send \$7.95.
SPACECOAST RESEARCH
Dept. B, P.O. Box 442, Altamonte Springs, FL 32701

PASS FCC EXAMS

The Original FCC Tests-Answers exam manual that prepares you at home for FCC First and Second class Radiotelephone licenses. Newly revised multiple-choice exams cover all areas tested on the actual FCC exam. Plus "Self Study" Ability Test. Proven! \$9.95 postpaid. Moneyback Guarantee.

COMMAND PRODUCTIONS Radio Engineering Division P.O. Box 26348 E San Francisco, CA 94126

To run your own classified ad, put one word on each of the lines below and send this form along with your check for \$1.50 per word (minimum 15 words) to:

Radio-Electronics, 200 Park Avenue South, N.Y., N.Y. 10003

ORDER FORM

PLEASE INDICATE in which category of classified advertising you wish your ad to appear. For special headings, there is a surcharge of \$10.

() Plans/Kits () Business Opportunities () For Sale
() Education/Instruction () Wanted ()

Special Category: \$10

(PLEASE PRINT EACH WORD SEPARATELY, IN BLOCK LETTERS.)

1	2	3	4	5
6	7	8	9	10
11	12	13	14	15
16	17	18	19	20
21	22	23	24	25
26	27	28	29	30
31	32	33	34	35

TRS-80 E.S. SERIAL I/O

- Can input into basic
- Can use LIST and LPRINT to output, or output continuously
- RS-232 compatible
- Can be used with or without the expansion bus
- On board switch selectable baud rates of 110, 150, 300, 600, 1200, 2400, parity or no parity odd or even, 5 to 8 data bits, and 1 or 2 stop bits. O.T.R. line
- Requires +5, -12 VDC
- Board only \$19.95 Part No. 8010, with parts \$59.95 Part No. 8010A, assembled \$79.95 Part No. 8010C. No connectors provided, see below.



EIA/RS-232 connector Part No. DB25P \$6.00, with 9', B conductor cable \$10.95 Part No. DB25P9.



3' ribbon cable with attached connectors to fit TRS-80 and our serial board \$19.95 Part No. 3CAB40.

MODEM

- Type 103
- Full or half duplex
- Works up to 300 baud
- Originate or Answer
- No coils, only low cost components
- TTL input and output-serial
- Connect 8 Ω speaker and crystal mic. directly to board
- Uses XR FSK demodulator
- Requires +5 volts
- Board only \$7.60 Part No. 109, with parts \$27.50 Part No. 109A



VERBATIM MINIDISK



Box of 10

\$29.95

APPLE II SERIAL I/O INTERFACE



Baud rate is continuously adjustable from 0 to 30,000

- Plugs into any peripheral connector
- Low current drain. RS-232 input and output
- On board switch selectable 5 to 8 data bits, 1 or 2 stop bits, and parity or no parity either odd or even
- Jumper selectable address
- SOFTWARE
- Input and Output routine from monitor or BASIC to teletype or other serial printer
- Program for using an Apple II for a video or an intelligent terminal.
- Also can output in correspondence code to interface with some electrics.
- Also watches DTR
- Board only \$15.00 Part No. 2, with parts \$42.00 Part No. 2A, assembled \$62.00 Part No. 2C

8K EPROM PIIECON

Saves programs on PROM permanently (until erased via UV light) up to 8K bytes. Programs may be directly run from the program saver such as fixed routines or assemblers.

- S-100 bus compatible
- Room for 8K bytes of EPROM non-volatile memory (2708's).
- On-board PROM programming
- Address relocation of each 4K of memory to any 4K boundary within 64K
- Power on jump and reset jump option for "turnkey" systems and computers without a front panel
- Program saver software available
- Solder mask both sides
- Full silkscreen for easy assembly.
- Program saver software in 1 2708 EPROM \$25. Bare board \$35 including custom coil, board with parts but no EPROMS \$139, with 4 EPROMS \$179, with 8 EPROMS \$219.

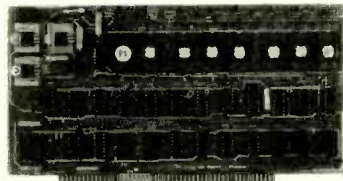

WAMECO INC. wmc inc.

FDC-1 FLOPPY CONTROLLER BOARD will drive shugart, pertek, remic 5" & 8" drives up to 8 drives, on board PROM with power boot up, will operate with CPM (not included). PCB \$42.95

FPB-1 Front Panel. (Finally) AMSA size hex displays. Byte or instruction single step. PCB \$42.95

MEM-1A 8Kx8 fully buffered, S-100, uses 2102 type RAMS. PCB \$24.95, \$168 Kit

QMB-12 MOTHER BOARD, 13 slot, terminated, S-100 board only \$34.95 \$89.95 Kit

CPU-1 8080A Processor board S-100 with 8 level vector interrupt. PCB \$25.95 \$89.95 Kit

RTC-1 Realtime clock board. Two independent interrupts. Software programmable. PCB \$25.95, \$60.95 Kit

EPM-1 1702A 4K EPROM card PCB \$25.95 \$49.95 with parts less EPROMS

EPM-2 2708/2716 16K/32K EPROM card PCB \$24.95 \$49.95 with parts less EPROMS

QMB-9 MOTHER BOARD. Short Version of QMB-12. 9 Slots PCB \$30.95 \$67.95 Kit

MEM-2 16Kx8 Fully Buffered 2114 Board PCB \$25.95, \$269.95 Kit

T.V. TYPEWRITER

- Stand alone TVT
- 32 char/line, 16 lines, modifications for 64 char/line included
- Parallel ASCII (TTL) input
- Video output
- 1K on board memory
- Output for computer controlled cursor
- Auto scroll
- Non-destructive cursor
- Cursor inputs: up, down, left, right, home, EOL, EDS
- Scroll up, down
- Requires +5 volts at 1.5 amps, and -12 volts at 30 mA
- All 7400, TTL chips
- Char. gen. 2513
- Upper case only
- Board only \$39.00 Part No. 106, with parts \$145.00 Part No. 106A



UART & BAUD RATE GENERATOR

- Converts serial to parallel and parallel to serial
- Low cost on board baud rate generator
- Baud rates: 110, 150, 300, 600, 1200, and 2400
- Low power drain +5 volts and -12 volts required
- TTL compatible
- All characters contain a start bit, 5 to 8 data bits, 1 or 2 stop bits, and either odd or even parity.
- All connections go to a 44 pin gold plated edge connector
- Board only \$12.00 Part No. 101, with parts \$35.00 Part No. 101A, 44 pin edge connector \$4.00 Part No. 44P



TAPE INTERFACE

- Play and record Kansas City Standard tapes
- Converts a low cost tape recorder to a digital recorder
- Works up to 1200 baud
- Digital in and out are TTL-serial
- Output of board connects to mic. in of recorder
- Earphone of recorder connects to input on board
- No coils
- Requires +5 volts, low power drain
- Board only \$7.60 Part No. 111, with parts \$27.50 Part No. 111A

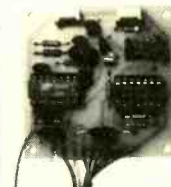

HEX ENCODED KEYBOARD

E.S. This HEX keyboard has 19 keys, 16 encoded with 3 user definable. The encoded TTL outputs, 8-4-2-1 and STROBE are debounced and available in true and complement form. Four onboard LEDs indicate the HEX code generated for each key depression. The board requires a single +5 volt supply. Board only \$15.00 Part No. HEX-3, with parts \$49.95 Part No. HEX-3A. 44 pin edge connector \$4.00 Part No. 44P.



RS-232/TTL INTERFACE

- Converts TTL to RS-232, and converts RS-232 to TTL
- Two separate circuits
- Requires -12 and +12 volts
- All connections go to a 10 pin gold plated edge connector
- Board only \$4.50 Part No. 232, with parts \$7.00 Part No. 232A. 10 Pin edge connector \$3.00 Part No. 10P

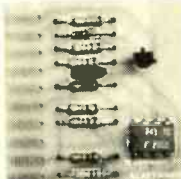

RS-232/TTY INTERFACE

- Converts RS-232 to 20mA current loop, and 20mA current loop to RS-232
- Two separate circuits
- Requires +12 and -12 volts
- Board only \$4.50 Part No. 600, with parts \$7.00 Part No. 600A



S-100 BUS ACTIVE TERMINATOR

Board only \$14.95 Part No. 900, with parts \$24.95 Part No. 900A



DC POWER SUPPLY

- Board supplies a regulated +5 volts at 3 amps., +12, -12, and -5 volts at 1 amp.
- Power required is 8 volts AC at 3 amps., and 24 volts AC C.T. at 1.5 amps.
- Board only \$12.50 Part No. 6085, with parts excluding transformers \$42.50 Part No. 6085A



To Order:

Mention part number, description, and price. In USA, shipping paid for orders accompanied by check, money order, or Master Charge, BankAmericard, or VISA number, expiration date and signature. Shipping charges added to C.O.D. orders. California residents add 6.5% for tax. Outside USA add 10% for air mail postage and handling, no C.O.D.'s. Checks and money orders must be payable in US dollars. Parts kits include sockets for all ICs, components, and circuit board. Documentation is included with all products. Prices are in US dollars. No open accounts. To eliminate tariff in Canada boxes are marked "Computer Parts." Dealer inquiries invited. 24 Hour Order Line: (408) 226-4064



For free catalog including parts lists and schematics, send a self-addressed stamped envelope.

ELECTRONIC SYSTEMS

Dept. RE7, P. O. Box 21638, San Jose, CA USA 95151

SPEAKER INFORMATION KIT

Get 70 pages of speaker facts, specs, construction tips plus info on our raw speakers, crossovers and a line of 9 quality hi-fi speaker system kits. We'll send you our full-color catalog; plus **How to Hook Up Your System**, an exhaustive step-by-step treatise on hi-fi system installation; and our **Speaker Operating Manual**, chock full of facts on how to get the most from any speaker system. For Free. Even if you don't buy from us we want you to have the facts. That's how we got to be the world's largest manufacturer of speaker kits.

Send to:
Speakerlab, Dept. 7-RE
 735 N. Northlake
 Seattle, WA 98103



EDUCATION & INSTRUCTION

TELEPHONE bugged? Don't be Watergated! Countermeasures brochure \$1.00. **NEGEYE LABORATORIES**, Box 547-RE, Pennsboro, WV 26415

UNIVERSITY degrees by mail! Bachelors, Masters, Ph.D's . . . Free revealing details. **COUNSELLING**, Box 317-RE6, Tustin, CA 92680

UNDERSTAND digital electronics. Programmed learning courses. Design of Digital Systems, 6 volumes, only \$19.95. Digital Computer Logic, 4 volumes, \$14.95. Both \$29.95. Free details. **GFN INDUSTRIES**, Bldg. 7-20, 203 Loudon Road, Concord, NH 03301

ASTONISH your friends with magic, E.S.P., card tricks you can do. Details: **LANGEN**, Box 191-CA, Downsview, ONT, M3M 3A3

Burglar - Fire - Smoke Alarm Catalog

• Billions of dollars lost annually due to lack of protective warning alarms.

FREE CATALOG Shows you how to protect your home, business and person. Wholesale prices. Do-it-yourself. Free engineering service.



Burdex Security Co.

Box 82802 RE-079 Lincoln, Ne. 68501

PLANS & KITS

SCANNER users—build many useful accessories. Free kit catalog. **CAPRI ELECTRONICS**, Route 1R, Canon, GA 30520

SAVE 50%. Build your own speaker system. Write for catalog: **McGEE RADIO**, 1901 McGee, Kansas City, MO 64108

CONSTRUCTION plans for profitable business ideas. Catalog \$1.00. **GARLING**, 438 N. Garfield Street, Lombard, IL 60148

PRINTED circuit boards from your sketch or artwork. Affordable prices. Also fun kit projects. Free details. **DANOCINTHS INC.**, Box 261, Westland, MI 48185

OUT smart burglar: makes your home look lived in even when on vacation. Plans include circuit, diagram, description, printed-circuit board pattern. Rush \$4.65 to: **DANOCINTHS INC.**, Box 261, Westland MI 48185

TELEPHONE plans. Answerer, hold button, dialers, speakerphone, eleven more. All for \$6.00. **110 NE555** projects. Freq./cap. meters, dual tracer, triggered sweep, electronic ignition, alarms, more. All for \$6.00. **GILDER**, 2022-79th, Brooklyn, NY 11214

CHARGE! Build your own negative-ion generator and save! Plans \$5.00. **LUNATRIX**, Box 891, Yucalpa, CA 92399

MECHANICALLY INCLINED INDIVIDUALS

Assemble electronic devices in your home. Be your own boss. Get started in spare time. Little experience, Knowledge or Investment Necessary. Expect big profits: \$300 - \$600/Wk. Possible. Write for free literature telling how.

ELECTRONIC DEVELOPMENT LAB
 Box 1560R, Pinellas Park, FL 33565

PICTURE TUBE MACHINE
 We buy and sell NEW and USED CRT rebuilding machinery. COMPLETE TRAINING. Buy with CONFIDENCE from the ORIGINAL MFR.

For complete details send name, address, zip to:

LAKESIDE INDUSTRIES
 4071 N. Elston Avenue
 Chicago, Ill. 60618
 Phone: 312-583-6565

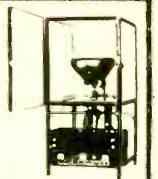

AMAZING ELECTRONIC PROJECTS and PRODUCTS:

Lasers Super Powered, Burning, Cutting, Rifle, Pistol. Pocket. See in Dark—Shotgun Directional Mike—Unscramblers—Giant Tesla—Stunwand—TV Disrupter—Energy Producing, Surveillance, Detection, Electrifying, Ultrasonic, CB, Auto and Mech. Devices, Hundreds More—All New Plus INFO UNLTD PARTS SERVICE. Catalog \$1. Information Unlimited, Dept. R8 Box 716 Amherst, N.H. 03031.



BIG SCREEN OSCILLOSCOPE

Converted from ANY Size TV Set... Hams, Technicians, Hobbyists, Broadcasters. Minor, inexpensive changes convert TV set to super-sensitive testing device. No electronic experience needed. Follow clear cut plans. Fully illustrated. Use in workshop, lab, school, etc. Any size screen . . . Any size TV set . . .

Complete Set of Plans . . . \$4 (INCL. 50¢ FOR POST & HANDLING)
MILICO IND., DEPT. OP-03, BOX 91, KOSSE, TX 76653

Delta Burglar ALARM

Featured in April Radio Electronics and Popular Mechanics Magazines! Elementary Electronics, Too!

DELTA MOTION DETECTOR. This device detects any motion or movement for a minimum distance of 8-ft. The secret is in the ultra-complex custom LSI chip, which combines the latest in linear & digital circuitry. The device is completely self-contained, in a case 6 x 3 x 2 1/4", and operates from four "AA" NiCad batteries. Nothing else is needed, for the device to perform its basic function, motion detection. When motion or movement is detected, a "whoop" alarm is sounded. The **MOTION DETECTOR** is designed to provide either an audible or silent alarm. The silent alarm is controlled by a timer, which delays the alarm up to 30 seconds. The silent alarm activates a relay, whose contacts are brought out to plug, and will activate ANY device, such as siren, horn, tape recorder, telephone dialer, etc.

W-H-O-O-P!!

\$24.50

Delta No.	Description	Sale
5611R	Complete motion detector kit (less batteries)	\$24.50
1072R	Motion Detector Chip only, with data	8.95
5611R	P.C. boards, set of 2	6.50
5288R	"AA" NiCad Batteries, set of 4	4.50
5636R	Battery charger for above	5.95
5635R	Completely assembled kit w/batteries & charger	69.50

Motion & FIRE Detector!

RESISTOR PAC

\$3 per pac

3 Dacs \$8.00

Fantastic assortment of ALLEN BRADLEY and STACKPOLE resistors. . . 1/8W, 1/4W, 1/2W, 1W and 2W resistors. All with full length leads. Yes, assorted values. All for less than 2 cents per resistor. Color code for easy identification of resistors is included. TOTAL of 160 pieces. A must for your workbench and lab kits. No. 8899R

WAVETEK 2250 ANTENUATORS

EACH No. 5670W

MODEL: 50100-2 Rotary Attenuator
Attenuation: 0-100 db in 20 db steps
Rotation: Increasing attenuation in CCW direction. 6 position -45° throw, with stops at each end of rotation.
Impedance: > 50 ohms
Insertion Loss: > 0.5db
Range: DC to 1 GHz
Power: 0.5 watts
Accuracy: ± 0.5 db from DC to 500 MHz
 ± 1.0 db from 500 MHz to 1 GHz
RF Connectors: SMA Jack receptacle
Size: 1 7/8" diam. x 3 7/16" long.

ORIGINAL COST over \$100, each!

COMPUTER GRADE CAPACITOR SALE...

AS LOW AS **\$2.75**

COMPUTER GRADE capacitors have just about disappeared from the market. We have come across a highly desirable lot. All in the new small size configuration. All are either GENERAL ELECTRIC or SPRAGUE Powerlytic. 5 values.

Delta Mfd	diam.	Sale	4 for
2780R	5800 40V 1 3/8" x 3 1/8"	\$2.75	\$10
2781R	8400 40V 2" x 3 1/8"	\$3.25	\$12
2782R	12000 40V 2" x 4"	\$3.50	\$13
2783R	19000 40V 2" x 4"	\$4.00	\$15
2784R	2500 75V 1 3/8" x 4 1/4"	\$3.50	\$13

Tested 'AA' NICAADS 98¢

SPECIAL-BY-MAIL OFFER

Brand new - slight imperfections on case!

Delta No.	Type	Ampere Hours	Dimen.	SALE
5688R	1/3A	170	.619dia.x.680	.78
5686R	1/3A	200	.619dia.x.758	.88
5676R	AA	500	.645dia.x1.83	.98
5689R	AA	550	.687dia.x1.98	.98
5680R	Sub C	1.2	.865dia.x1.645	1.58
5677R	C	2.0	1.06 dia.x1.87	2.08
5687R	C	2.0	1.028dia.x1.85	1.98
5679R	1/2D	2.3	1.305dia.x1.975	1.98
5678R	D	4.0	1.308dia.x2.28	2.78

BUTTON CELLS

Delta No.	Type	Ampere Hours	Dimen.	Sale
5688R	1.2 .05	.895dia.x.205	.58	
5683R	1.2 .15	.985dia.x.275	.68	
5684R	1.2 .22	1.36 dia.x.207	.78	
5682R	1.2 .22	1.36 dia.x.308	.88	
5681R	1.2 .22	1.61 dia.x.320	.98	

100% Guaranteed—Rechargeable
 *Have tabs to permit soldering. **buttons on both ends.

Limited Quantities
5V 75 AMP REGULATED POWER SUPPLY

By POWERTEC - month over \$200. Can run a complete computer system! 16" x 19" x 4 1/2". Wt. 35 lbs. No. 5642R

master charge
 HANKAM, RICARD
VISA

REDUCED TO **\$79**

No. 5642R

NEW MAIL-ORDER ADDRESS

FREE DELTA ELECTRONICS

120-PG. 'SURPLUS' CATALOG

176 SECOND AVE. WALTHAM, MASS. 02154

TEL. (617) 388-4705

When in our area, northeastern Mass. or southern N.H. visit our retail at 7 Oakland St., Amesbury, Mass.

CIRCLE 11 ON FREE INFORMATION CARD

Radio Shack: No. 1 Parts Place

Low Prices and New Items Everyday!

Top-quality devices, fully functional, carefully inspected. Guaranteed to meet all specifications, both electrically and mechanically. All are made by well-known American manufacturers, and all have to pass manufacturer's quality control procedures. These are not rejects, not fallouts, not seconds. In fact, there are none better on the market! Always count on Radio Shack for the finest quality electronic parts!

TTL and CMOS Logic ICs

Full-Spec Devices
Direct from
Motorola and
National Semiconductor



Type	Cat. No.	ONLY
7400	276-1801	35¢
7402	276-1811	39¢
7404	276-1802	35¢
7406	276-1821	49¢
7410	276-1807	39¢
7413	276-1815	79¢
7420	276-1809	39¢
7427	276-1823	49¢
7432	276-1824	49¢
7441	276-1804	99¢
7447	276-1805	99¢
7448	276-1816	99¢
7451	276-1825	39¢
7473	276-1803	49¢
7474	276-1818	49¢
7475	276-1806	79¢
7476	276-1813	59¢
7485	276-1826	1.19
7486	276-1827	49¢
7490	276-1808	79¢
7492	276-1819	69¢
74123	276-1817	99¢
74145	276-1828	1.19
74150	276-1829	1.39
74154	276-1834	1.29
74192	276-1831	1.19
74193	276-1820	1.19
74194	276-1832	1.19
74196	276-1833	1.29
4001	276-2401	49¢
4011	276-2411	49¢
4012	276-2412	69¢
4013	276-2413	89¢
4017	276-2417	1.49
4020	276-2420	1.49
4021	276-2421	1.49
4023	276-2423	69¢
4027	276-2427	89¢
4028	276-2428	1.29
4046	276-2446	1.69
4049	276-2449	69¢
4050	276-2450	69¢
4051	276-2451	1.49
4066	276-2466	99¢
4070	276-2470	69¢
4511	276-2447	1.69
4518	276-2490	1.49
4543	276-2491	1.89

SN-76477 Sound/Music Synthesizer IC



2.99 Featured in Oct. Popular Electronics

Creates almost any type of sound — music to "gunshots"! Built-in audio amp. Includes 2 VCO's, LF osc., noise gen., filter, 2 mixers, envelope modulator, logic circuit. 28-pin DIP. With data/applications circuits. 276-1765 2.99

Mercury Tilt Switch

- Hermetically Sealed
- Perfect for Alarm Circuits



89¢ Actual Size!

Subminiature position-detecting switch for use in projects or special applications. Switch is normally closed when upright, opens when tilted more than 45°. Rated 100mA at 24VDC. 275-025 89¢

15 Ceramic Trimmers

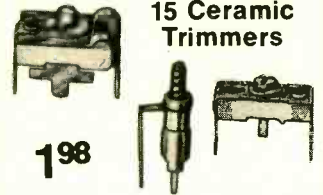

1.98

Assorted low-loss RF trimmer capacitors. May include both compression and piston types rated up to 500VDC with maximum capacity values of 3 to 100 pF. 272-805 Pkg. of 15/1.98

Top-Quality IC and PCB Accessories



- Ⓐ PC Board. Mounts two 14 or 16-pin ICs or sockets for bread boarding. Copper clad. 2 1/2 x 5 x 1 1/16". 276-151 2.99
- Ⓑ PC Board. Mounts single 14 or 16-pin IC or socket. 276-024 Pkg. of 2/99¢ 3.99
- Ⓒ 16-Pin IC Test Clip. 276-1951 1.29
- Ⓓ 16-Pin DIP Header. With snap-on cover. 276-1980 1.99
- Ⓔ 8-Position DIP Switch. 275-1301 1.49
- 4-Position DIP Switch. (Not shown.) 275-1304 1.49
- Ⓕ Vertical 16-pin Socket. For LED displays. 276-1986 1.49
- Ⓖ 16-Pin DIP Jumper Cable. 18" long. 276-1976 3.99

DPDT Dual Inline Relay

4.49

Fits Std. 14-Pin IC Socket



Subminiature relay is designed for use with TTL or CMOS circuitry. Contacts rated 1A at 125VAC. Coil requires 5VDC. Coil resistance, 50 ohms. 275-215 4.49

MC14553 3-Digit BCD Counter IC

For Low-Cost Digital Readout

CMOS chip replaces over 8 separate IC's in a digital display circuit. Input pulse shaping. Master reset pin. 16-pin DIP. 276-2498 2.99

RAM Memory ICs

Under 450 nS Access Time

2102 1024 x 1 Array. Low-cost static memory chip. 16-pin DIP. Buy 8 and save! 276-2501 2.49 Ea. or 8/14.95
2114L 1024 x 4 Array. NMOS static RAM. 18-pin DIP. 276-2504 12.95

SALE Handheld 6-Digit Frequency Counter

Reg. 99.95 **69.95**

- Lead Zero Blanking
- 100 Hz Up to 45 MHz
- kHz and MHz Decimals

Accuracy is 3 ppm at 25°C or less than 10 Hz at 10 MHz. Overload-protected 1-meg input. Sensitivity, 30 mV up to 30 MHz. 3x4 1/2". With mini-rod antenna, leads, case, instructions. Requires 9V battery. 22-351 Sale 69.95
AC Adapter. U.L. listed. 65-731 4.95



Digital IC Logic Probe 24.95

Multi-Logic Family Compatibility from 5-15VDC

Detects one-shot low repetition rate, narrow pulses scopes miss. Combines level detector, pulse detector and pulse stretcher. HI-LED indicates logic "1", Lo-LED is logic "0". Pulse LED displays pulse transitions to 300 nanoseconds, blinks at 3 Hz for high-frequency signals (up to 1.5 MHz). With cables. 22-300 24.95



Custom Printed Circuit Board Kit

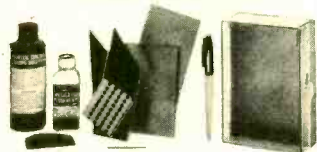

Everything you need for making high-quality custom PC boards. 276-1576 7.95
Extra Resist Pen. 276-1530 1.29
Extra Etching Solution. 276-1535 2.19

Computer Data Manuals & Semiconductor Handbook

- Ⓐ Intel 8080/8085 Programming Manual. Handy reference for programming with Intel's assembly language. 62-1377 3.95
- Ⓑ Intel Memory Design Handbook. Explains use of Intel's memory components and support circuits in systems. 62-1378 3.95
- Ⓒ Intel Data Catalog. 928 pages of specifications on most of Intel's standard microcomputer-related products. 62-1379 4.95
- Ⓓ Semiconductor Reference and Application Handbook. Complete specs and applications for popular IC transistors, diodes. 276-4002 1.95

NEW LEDs

- Tri-Color
- Red Flasher



Ⓐ Displays red, green, yellow. Uniform light output of 0.6 mcd. Forward voltage: 2.2VDC. Max. current: 25mA. T1-3/4 case style. 276-035 1.39
Ⓑ Operates directly from 5VDC power source. Pulse rate: 3Hz. Max. current: 20mA at 5VDC. 276-036 1.29



Digital Project Accessories

- Ⓐ Bezel with Lens. High-contrast filter for LED displays. 3/8" x 1" lens opening. 270-301 3.95
- Ⓑ Deluxe Molded Display Case. Red lens. Mount up to four 0.6" or eight 0.3" LED digits. With brackets. 1 1/4" x 3 3/8" x 4 7/16". 270-285 3.95
- Ⓒ MA 1003 Clock Case. For car clock modules. Accepts 3 pushbutton switches (not inc.). With brackets, blue lens. 3 1/2 x 2 1/2 x 2". 270-303 5.95

Molded Connectors



Rated 8A @ 250V. Standard .093" pin diameter.

Fig	Pins	Type	Cat No	Each	Fig	Pins	Type	Cat No	Each
A	4	Male	274-224	99¢	B	4	Female	274-234	99¢
A	6	Male	274-226	1.19	B	6	Female	274-236	1.19
A	9	Male	274-229	1.39	B	9	Female	274-239	1.39
A	12	Male	274-232	1.49	B	12	Female	274-242	1.49

2-Pin Male & Female. (Not shown) 274-222 Pair 89¢

WHY WAIT FOR MAIL ORDER DELIVERY?
IN STOCK NOW AT OUR STORE NEAR YOU!

Radio Shack®

A DIVISION OF TANDY CORPORATION • FORT WORTH, TEXAS 76102
OVER 7000 LOCATIONS IN NINE COUNTRIES

Prices may vary at individual stores and dealers

CIRCLE 4 ON FREE INFORMATION CARD

THE MOST ADVANCED TIMEPIECE OF ITS KIND IN THE WORLD!

LCD Quartz Alarm Chronograph with calendar and dual time zone! Watch is the same as Seiko but you pay a lot more for the name! Features:



- 24 hour alarm
- Chronograph counts up to 12 hrs., 59 mins. 59.9 sec.
- Precision of chrono up to 1/10 sec indicated by 10 moving arrows!!
- Lap time (with chrono running uninterrupted)
- Time displays by LCD for hour, min, sec, day, date of the week and AM/PM.
- Calendar gives out date-day
- Dual time zone for any two cities of the world at your own choice.
- With light switch to allow you to see the time in the dark!

\$65.50

ONE YEAR FULL WARRANTY!

JUMBO 1" LED ALARM CLOCK MODULE

- Assembled — not a kit!
- 1" 4 digits red LED display
 - 12 hours real time format
 - 24 hours alarm audio output (just add speaker)
 - Power failure indicator
 - Count down timer 59 mins.
 - 12-16V AC 50/60 Hz inPut
 - 10 min. snooze control.



\$8.50 EACH

P CM 701

Transformer \$1.75

NEW MARK III 9 Steps 4 Colors LED VU



Stereo level indicator kit with arc-shape display panel!! This Mark III LED level indicator is a new design PC board with an arc-shape 4 colors LED display (change color from red, yellow, green and the peak output indicated by rose red). The power range is very large, from -30dB to +5dB. The Mark III indicator is applicable to 1 watt - 200 watts amplifier operating voltage is 3V - 9V DC at max 400 MA. The circuit uses 10 LEDs per channel. It is very easy to connect to the amplifier. Just hook up with the speaker output!

IN KIT FORM \$18.50

ELECTRONIC DUAL SPEAKER PROTECTOR

Cut off when circuit is shorted or over-load to protect your amplifier as well as your speakers. A must for OCL circuits.



KIT FORM \$8.75 EA.

FM WIRELESS MIC KIT

It is not a pack of cigarettes. It is a new FM wireless mic kit! New design PC board fits into a plastic cigarette box (case included). Uses a condenser microphone to allow you to have a better response in sound pick-up. Transmits up to 350 ft.! With an LED indicator to signal the unit is on.



P MM 2 KIT FORM \$7.95

PLASTIC PROJECT BOX

The popular low-cost way to house your electronic experiments. With a copper-clad PC board cover, it allows you to have the circuits made right on top of the box.



Small size 2 7/8" x 2 1/4" x 1 3/8" 0.80 EACH
Large size 4" x 3" x 1 5/8" 1.25 EACH

DIGITAL AUTO SECURITY SYSTEM

4 DIGITS PERSONAL CODE!!



- proximity triggered
- voltage triggered
- mechanically triggered

3-WAY PROTECTION!

This alarm protects you and itself! Entering protected area will set it off, sounding your car horn or siren you add. Any change in voltage will also trigger the alarm into action. If cables within passenger compartment are cut, the unit protects itself by sounding the alarm.

SPECIAL \$19.95

ALL UNITS FACTORY ASSEMBLED AND TESTED—NOT A KIT!

TIMATRON RACK MOUNT TYPE CABINETS!



All are of aluminum and machine made to very high-precision quality with sleek, black anodized finish. Front panels come blank and undrilled to allow you to make panels of your own design. For large

quantity orders Formula International will silk-screen print and drill panel holes at a minimal extra charge.

SIZE	PRICE
19" (W) x 2 1/2" (H) x 12" (D)	\$36.85
19" (W) x 4" (H) x 12" (D)	45.25
19" (W) x 8" (H) x 20" (D)	72.00
16" (W) x 2 1/2" (H) x 8" (D)	26.50
16" (W) x 4" (H) x 8" (D)	33.45
9 1/2" (W) x 2 1/2" (H) x 12" (D)	33.45
9 1/2" (W) x 4" (H) x 12" (D)	24.50
9 1/2" (W) x 4" (H) x 8" (D)	30.25

HICKOK LX303 DIGITAL LCD MULTIMETER



- 3 1/2 digits display
 - 200 hours 9V battery life
 - Auto zero; polarity; overrange indication
 - 100MV DC F.S. sensitivity
 - 19 ranges and functions
 - D.C. volt: 0.1 MV to 1000 V
 - A.C. volt: 0.1 V to 600 V
 - Resistance: 0.1Ω to 20 MΩ
 - D.C. current: 0.01 A to 100 MA
- OUR PRICE \$71.45

GREEN COLOR 0.6" LED ALARM CLOCK



- 24 hr. alarm
- 10 min. snooze time
- AM/PM indicator
- Power interrupt indication
- Green color 0.6" display
- 110V AC 60Hz input
- Factory assembled, NOT A KIT \$17.50 EACH

LCD CLOCK MODULE!

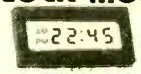

- 0.5" LCD 4 digits display
- X'tal controlled circuits
- D.C. powered (1.5V battery)
- 12 hr. or 24 hr. display
- 24 hr alarm set
- 60 min. countdown timer
- On board dual back up lights
- Dual time zone display
- Stop watch function

NIC1200 (12 hr) \$24.50 EA.
NIC2400 (24 hr) \$26.50 EA.

UNIVERSAL PROTOBOARDS "CIRCUIT FIT"

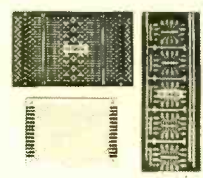
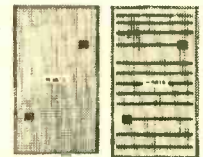

All Boards are made of High Quality G10 Fiberglass and Phenolic. Pre-drilled in .042" diameter holes on 0.1" centers with tin plated copper eyelets and finger edge connectors (single sided) to allow any kind of standard components to fit board.

Part No.	Size	Holes	Price	
			Fiberglass	Phenolic
U.S.P 723	2" x 2.8"	529	\$ 1.27	\$ 50
U.S.P 724	2.8" x 3.7"	750	2.42	80
U.S.P 725	3.7" x 5.5"	1500	4.89	1.38
U.S.P 728	7" x 9.6"	6240	19.50	10.40
H-5812	3 1/2" x 6"			1.70
H-5816	3 1/2" x 6"			1.70
H-5606	3" x 5"			1.50
H-5602	2 1/2" x 6 1/2"			1.50

BUTTON CELL



NI-CD RECHARGEABLE BATTERIES
225MA/hr 1.2V per cell
7/8" x 3/8"
Single Cell 1.2V \$1.20
4 cells stack 4.8V \$4.80
5 cells stack 6V \$6.00

special voltage order accepted at \$1.30 per cell rate

60W + 60W

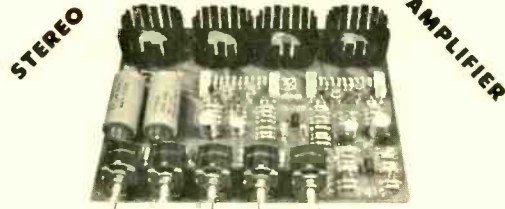

COMPLETED UNIT—NOT A KIT!

OCL pre amp. & power stereo amp. with bass, middle, treble 3-way tone control. Fully assembled and tested, ready to work. Total harmonic distortion less than 0.5% at full power. Output maximum is 60 watts per channel at 8Ω. Power supply is 24 - 36V AC or DC. Complete unit

Assembled \$49.50 ea.

Power transformer \$ 8.50 ea.

22W + 22W STEREO HYBRID AMPLIFIER KIT

It Works in 12V D.C. As Well! Kit includes 1 PC SANYO STK-024 stereo power amp. IC LM 1458 as pre amp, all other electronic parts, PC Board, all control pots and special heat sink for hybrid. Power transformer not included. It produces ultra hi-fi output up to 44 watts (22 watts per channel) yet gives out less than 0.1% total harmonic distortion between 100Mz and 10KHz.

\$32.50 PER KIT

POWER TRANSFORMER \$6.50 EACH

SUPER 15 WATT AUDIO AMP KIT



ONLY \$23.50 each

Uses STK-015 Hybrid Power Amp
Kit includes: STK-015 Hybrid IC, power supply with power transformer, front Amp with tone control, all electronic parts as well as PC Board. Less than 0.5% harmonic distortion at full power 1/2dB response from 20-100,000 Hz. This amplifier has QUASI-Complementary class B output. Output max is watt (10 watt RMS) at 4Ω.

MINI ELECTRONIC ORGAN KIT

PET-102 (25 KEYS)



The kit contains all electronic and mechanical parts, key boards, speaker, switches and PC Board as well as the wooden cabinet. Ideal for school project or gift to children interested in electronics. Uses 6V C size x 4 battery (not included). \$38.50

MANY SOUND DECISIONS!



\$3.60 EACH

Solid state sound indicator operating voltage 6V DC 30mA. Small size approximately 1/4" x 1 1/4".
Model EB2116 (Continuous)
Model EB2126 (Slow Pulse)
Model EB2136 (Fast Pulse)



Continuous

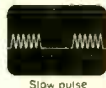

Slow pulse



Fast pulse

1Watt AUDIO AMP

All parts are pre assembled on a mini PC Board
Supply Voltage 6 ~ 9V D.C.
SPECIAL PRICE \$1.95 ea.

"FISHER" 30 WATT STEREO AMP

MAIN AMP (15W X 2)
Kit includes 2 Dcs. Fisher PA 301 Hybrid IC all electronic parts with PC Board. Power supply ± 16V DC (not included). Power band with (KF 1% ± 3dB). Voltage gain 33dB. 20KHz ~ 20KHz.
Super Buy Only \$18.50

5W AUDIO AMP KIT

2 LM 380 with Volume Control
Power Supply 6 ~ 18V DC
ONLY \$6.00 EACH

WE FOUND THE CASE FOR THE FM MIC!

Small nice looking aluminum case size like a pack of cigarettes. It is an intercom. Audio amp inside with a mic jack, a mini toggle sw on top, can be used for many projects. We give you the circuit data as well.
VERY SPECIAL PRICE 2 for \$4.99

Sub-Mini Size
CONDENSER MICROPHONE
FET Transistor Built-in \$2.50 each

ELECTRONIC ALARM SIREN

COMPLETE UNIT
Ideal for use as an Alarm Unit or hookup to your car back up to make a reverse indicator.
Light Output up to 130db
Voltage Supply 6 ~ 12V \$7.50

SOUND ACTIVATED SWITCH

All parts soldered on a PC Board
SCR will turn on relay, buzzer or trigger alarm circuit for 2 ~ 10 sec. (adjustable)
Ideal for use as door alarm, sound controller toys and many other projects.
Sensitivity voltage 4.5V ~ 9V D.C.
\$1.75 ea./2 for \$3.00

LINEAR SLIDE POT

500KΩ SINGLE
Metal Case 3" Long
2 FOR \$1.20

Rechargeable
NI-CD Batteries Pak
6AA NI-CD in a flat pack gives you a total of 7.2V 450MA output
\$5.25 PER PACK

BATTERY POWERED FLUORESCENT LANTERN

FEATURES
• Circuitry designed for operation by high efficient, high power silicon transistor which enable illumination maintain in a standard level even the battery supply drops to a certain low voltage.
• 9" 6W cool/daylight miniature fluorescent tube.
• 8 x 1.5V UM-1 (size D) dry cell battery.
• Easy sliding door for changing batteries.
• Stainless reflector with wide angle increasing illumination of the lantern

\$10.50 EACH
MODEL 888 R

PROFESSIONAL CASE

for our 0-30V Power Supply. It is a nice looking metal cast case with giant 4" volt/amp meter; output blinding post and fuse holder, on/off switch and line cord!
ONLY \$21.50 EA.



CASE 030

POWER SUPPLY KIT

0-30V D.C. REGULATED
Uses UA723 and ZN3055 Power TR output can be adjusted from 0-30V, 2 AMP. Complete with PC board and all electronic parts.
0-30 POWER SUPPLY \$10.50 each
Transformer for Power Supply, 2AMP 24V x 2 \$8.50



12V DC MINI RELAY

6V SPDT 2AMP 1.30
12V SPDT 3AMP 1.60
12V DPDT 2AMP 2.50
12V 4PDT 3AMP 3.50



5 AMP 5VDC

3 Terminals
Positive Voltage Regulator
Hard to find! Fairchild 78H05To-3 Package, Input 8.5 - 20V DC Output +5V DC 5AMP Load Regulation 1%.
Only \$8.75 ea



ELECTRONIC SWITCH KIT

CONDENSER TYPE
Touch On Touch Off
uses 7473 I.C. and 12V relay
\$5.50 each



ULTRA SONIC SWITCH KIT

Kit includes the Ultra Sonic Transducers, 2 PC Boards for transmitter and receiver. All electronic parts and instructions. Easy to build and a lot of uses such as remote control for TV, garage door, alarm system or counter. Unit operated by 9-12 DC.
\$15.50



SOUND GENERATOR I.C.

TI76477
Creates almost any type of sound—gun shot, explosion, train, car crash, star war, birds, organ ext. A built-in audio amplifier provides high level output. Operates from one 9V battery, 28 pin dip; we supply the datas.
\$2.90 EACH



HARD TO FIND!! 12V 4PDT RELAY

3 Amp Contact
\$3.50 Each



TRANSFORMERS

ALL 117 VOLT INPUT
30V 4AMP \$7.50 EA.
36V CT 3AMP \$8.50 EA.
48V CT 3AMP \$8.50 EA.
24V CT 3AMP \$6.50 EA.
24V CT 0.5AMP \$1.80 EA.
12V CT 0.5AMP \$1.80 EA.
12V CT 120MA \$1.25 EA.



AC POWER SUPPLY

Wall Type Transformer
12V AC Output 200MA \$2.75 EA.
16V CT AC Output 100MA \$2.10 EA.
6V DC Output 120MA \$1.90 EA.
12V DC Output 100MA \$1.90 EA.



PROFESSIONAL PANEL METERS

A. 0-50UA 8.50 ea
B. 0-30VDC 8.50 ea
C. 0-50VDC 8.50 ea
D. 0-3ADC 9.00 ea
E. 0-100VDC 9.00 ea



Type MU-52E
All meters white face with black scales. Plastic cover.

BECKMAN FET LIQUID CRYSTAL DISPLAY

Overall size 2" x 1.2" 0-5" characters reflective type



737-01

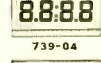

739-04



739-03

Model 737-01 — for clock 4 digits with PM, alarm, snooze, colon indicators.

Model 739-04 — for panel meter 4 digits.

Model 739-03 — for panel meter 3 1/2 digits with ± sign and over range indicator.

All displays include zeber connectors and front bezel. With data sheets.
Your choice—any model \$7.50 EACH

FLUORESCENT LIGHT DRIVER KIT

12V DC POWERED
Lights up 8 ~ 15 Watt
Fluorescent Light Tubes
Ideal for camper, outdoor Auto or Boat



Kit includes high voltage coil, power transistor, heat sink, all other electronic parts and PC Board, light tube not included!
WITH CASE ONLY \$6.50 PER KIT

HEAVY DUTY CLIP LEADS

10 pairs — 5 colors
Alligator clips on a 22" long lead. Ideal \$2.20/pack for any testing.



MINI-SIZED I.C. AM RADIO

Size smaller than a box of matches! Receives all AM stations Batteries and ear phone included

Only \$10.50

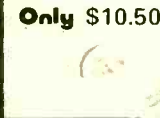

NUMERIC AND HEXADECIMAL LED DISPLAY WITH LOGIC

HP 5082 - 7300
• 4 x 7 Dot Matrix 0.4" Digit
• With On Board Decoder/Driver and Memory.
• TTL Compatible
• BCD Input
SPECIAL \$9.90 Each

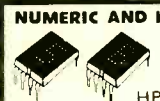

GIANT SIZE VU METER

1MA movement 3 1/2" scale length. Scale in VU -20db to +3db. Meter face 5 1/8" x 2 3/8" with a "smoke" plastic cover.

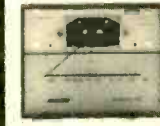

SPECIAL \$8.50 Each

PUSH-BUTTON SWITCH

N/Open Contact
Color: Red, White, Blue, Green, Black. 3/1.00
N/Close also 50c ea.
LARGE QTY. AVAILABLE



SOLID STATE ELECTRONIC BUZZER

Mini size 1 1/2" x 1 1/2" x 1/2"
Supply voltage 1.5V ~ 12V
Ideal for Alarm or Tone Indicator \$1.50 each









FORMULA INTERNATIONAL INC. 7/79

		SHIPPING AND HANDLING CHARGES	
		Under \$50.00 purchase	Over \$50.00 purchase
Inside California		10%	10%
Outside Calif. (includes Mexico & Canada)		15%	15%
Overseas		25%	20%

Minimum Order \$10.00/Calif. Residents Add 6% Sales Tax
Phone Orders Accepted on Visa or MC ONLY, NO C.O.D./Store Hours 10-7 Mon. thru Sat.

12603 CRENSHAW BLVD., HAWTHORNE, CA 90250
PHONE: (213) 973-1921 • (213) 679-5162

Send \$1.00 For Detailed Catalogue

<p>BEST PRICE IN THE COUNTRY! RCA 1000 OHMS PER VOLT MULTIMETER</p>  <p>\$7.88 WW-539A</p> <ul style="list-style-type: none"> EASY TO READ COLOR-CODED METER POCKET SIZED - GOES ANYWHERE PRECISION PARTS USED TO INSURE ACCURACY COMPLETE WITH TEST LEADS 	<p>DIGITAL CALENDAR CLOCK COMPLETE WITH MOTOR AND TIMER</p>  <p>\$4.95 120 V 5 WATTS</p> <p>DISPLAYS HOURS MINUTES DAY DATE</p>	<p>AP POWERACE ALL-CIRCUIT EVALUATORS WITH POWER</p>  <p>POWERACE 101 General purpose model for prototyping all types of circuits. \$84.95 POWERACE 102 Complete digital prototyping lab w/FREE built-in logic probe. \$114.95 POWERACE 103 Triple output power supply for prototyping both linear and digital circuits. \$124.95</p> <ul style="list-style-type: none"> Breadboard elements accept all DIP sizes 1680 Solderless, plug-in tie points Short-circuit proof fused power supplies 	<p>VACO® wiring & crimping tool does it all</p> <ul style="list-style-type: none"> Strips wire Crimps all terminals Cuts wire Cuts bolts  <p>\$5.49 # 1963 REGULAR \$11.22</p> <p>This is the Wiring and Crimping Tool that does it all. It slices 6 sizes of bolts (4-40, 5-40, 6-32, 8-32, 10-32, and 10-24). It strips wire (22-10 gauge). It crimps all terminals (both insulated and non-insulated). Conveniently located wire cutter at tip of jaws, cuts wire precisely, easily.</p>
<p>BELL & HOWELL PARABOLIC MICROPHONE Complete with Stand and Plug</p>  <p>Tape office conferences and school lectures</p> <p>\$5.95 SOLD FOR \$23.95</p>	<p>GENERAL ELECTRIC TIMER FEATURES HOUR AND MINUTE DISPLAY WITH ALUMINUM FRONT PANEL COMPLETE WITH RELAYS AND AC MOTOR</p> <p>PROTECT YOUR ELECTRONIC EQUIPMENT WITH THIS AUTOMATIC TURN-OFF TIMER</p> <p>\$4.95 MODEL 3AS</p>  <p>120 V 60 cy.</p>	<p>SAVE ON BATTERIES MULTI-VOLTAGE AC ADAPTOR 300 mA 3, 4.5, 6, 7.5, 9, 12 V</p> <p>4-WAY PLUG \$3.99</p>	<p>ITC® ELECTRONIC SUPERMARKET 2772 W. Olympic Blvd. Los Angeles, CA 90006 (213) 388-0621</p> <p>Minimum Order \$5.00 Please add \$2.00 postage and handling. California residents add 6% Sales Tax VISA/Mastercharge: state number, expiration date, and signature OEM and Institutional inquiries invited.</p>
<p>LENS-LIGHT ILLUMINATING MAGNIFIER A must for PC work.</p> <p>\$1.99</p>	<p>2 WATT SOLID-STATE AMPLIFIER all parts pre-assembled on a mini PC board ITC EXCLUSIVE! 99¢</p> <p>WELLER 25 WATT FEATHERWEIGHT SOLDERING IRON WITH REPLACEABLE TIPS. Designed for hobbyists and technicians SLASHED TO \$5.99</p>		

CIRCLE 33 ON FREE INFORMATION CARD

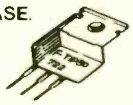
<p>FAIRCHILD RED LED LAMPS #FLV507 Medium Size. Clear Case. RED EMITTING. These are not retested off-spec units as sold by some of our competition. These are factory prime, first quality, new units</p> <p>10 FOR \$1.19 50 FOR \$4.95</p> <p>"WE BOUGHT 250,000 PCS."</p>	<p>NATIONAL SEMICONDUCTOR MILITARY TIME FORMAT! MA1008D BRAND NEW!</p> <p>JUMBO CLOCK MODULE</p>  <p>ASSEMBLED, NOT A KIT!</p> <p>\$4.95 \$7.95 REG. \$9.95</p> <p>ADD \$1.95 FOR AC XFMR</p> <p>ZULU 50% OFF SALE!</p> <p>PERFECT FOR USE WITH A TIMEBASE.</p> <p>COMPARE AT UP TO TWICE OUR PRICE! MANUFACTURER'S CLOSEOUT!</p>		
<p>"THE COLOSSUS" FAIRCHILD SUPER JUMBO LED READOUT A full .80 inch character. The biggest readout we have ever sold! Super efficient. Compare at up to \$2.95 each from others! YOUR CHOICE \$1.49 EA FND 847 Common Anode FND 850 Common Cathode (6 for \$6.95)</p>	<p>16K DYNAMIC RAM CHIP WORKS IN TRS-80 OR APPLE II 16K X 1 Bits. 16 Pin Package. Same as Mostek 4116-4. 250 NS access. 410 NS cycle time. Our best price yet for this state of the art RAM. 32K and 64K RAM boards using this chip are readily available. These are new, fully guaranteed devices by a major mfg. VERY LIMITED STOCK! "MAGAZINE SPECIAL" — 8 For \$79.50</p>	<p>EXPERIMENTER'S CRYSTAL 262.144KHZ. This frequency is 2 to the 18th power. Easily divided down to any power of 2, and even to 1HZ. New by CTS-Knight. A \$5 value. \$1.25 each 4.00 MHZ — \$1.75</p>	<p>MINI PROJECT CASE Black Molded Plastic 2 1/4 x 1 1/2 x 2 in. Has open front, with mounting ears so unit can be easily attached to auto dash, etc. Case has molded card guides for mounting PC Board inside. Perfect for digital clocks, car burglar alarms, or almost any electronic project. Can also be used for encapsulating circuits or modules. 75¢ each Super Special Purchase!</p>
<p>FAIRCHILD PNP "SUPER TRANSISTOR" 2N4402 TO-92 Plastic Silicon PNP Driver High Current VCEO-40 HFE-50 to 150 at 150 MA FT-150 MHZ A super BEEFED-UP Version of the 2N3906 8 FOR \$1</p>	<p>G.I. FULL WAVE BRIDGE 4 AMP 600 PIV 3/4 In. Square With Lugs, #LM-1 75¢ ea. 3 For \$2</p>	<p>MOTOROLA POWER TRIAC TO-220 CASE 15 AMP 400 PRV SPECIAL: 89¢ each 5 FOR \$3.95</p>	<p>COMPLEMENTARY POWER TRANSISTORS SILICON NPN AND PNP. TO-220 CASE. VCEO - 40V PD - 30 WATTS FOR AUDIO POWER AMPS, ETC. TIP29 - NPN TIP30 - PNP YOUR CHOICE 3 FOR \$1</p> 
<p>FET SALE! 2N4304. Brand New N Channel. Junction Fet. BVGD0-30V IDSS-15 MA Typ. 1500 uMHOS. TO-18 Plastic Case. Mfg. by Teledyne. 6 FOR \$1</p>	<p>EXPERIMENTER'S HEATING PLATE Large Manufacturers Surplus. 5 1/4 x 10 1/2 In. Made of 3/8 in. tempered glass with heating element laminated on back. Works off 120 VAC. Protected by thermostat and two thermal fuses. Rated 120 Watts. Use for any heating applications. Perfect for heating ferric chloride to increase PC board etching efficiency. Units are brand new, non-submersible. WHILE THEY LAST — \$2.99 each</p>	<p>SONY 30 WATT AUDIO AMP MODULE #STK-056. 30 WATTS SUPER CLEAN AUDIO. 20 HZ to 100 KHZ ± 2 DB. HYBRID, SILICON, SELF-CONTAINED MODULE. ONLY 1 3/4 x 2 1/2 IN. WITH DATA. COMPARE AT UP TO TWICE OUR PRICE! \$9.99 EACH</p>	
<p>Digital Research Corporation (OF TEXAS) P.O. BOX 401247A GARLAND, TEXAS 75040 • (214) 271-2461</p> <p>TERMS: Add 30¢ postage, we pay balance. Orders under \$15 add 75¢ handling. No C.O.D. We accept Visa, Mastercharge, and American Express cards. Tex. Res. add 5% Tax. Foreign orders (except Canada) add 20% P & H. 90 Day Money Back Guarantee on all items.</p>			

Active Electronic Sales Corp.

EPROM'S

Special of the Month

1702A-6 ~~\$6.95~~ \$4.45
256 x 8 1.5 uS

2708 \$9.95
1K x 8 450 NS

MOS Static RAM's

Part No.	Price
2101 1K 22 PIN	\$2.45 \$2.39
2102LFPC 1K 350NS (Low Power)	\$1.19 \$1.14
2102-1PC 1K 450NS	\$99 0.94
2114 4K (1K x 4) 300NS	\$6.99 \$6.75
2114 4K (1K x 4) 450NS	\$6.50

MOS Dynamic RAM's

Part No.	Price
4K 4027 4K (4K x 1) 300NS 16 PIN	\$2.95
16K 416-3 16K (16Kx1) 200NS 16PIN	\$9.95
16K 416-5 16K (16Kx1) 300NS 16PIN	\$7.95

UART's

Part No.	Price
AY5-1013A	\$4.50 \$4.25
AY3-1015	\$5.50 \$5.25

1K CMOS RAM

Part No.	Price
5101 450NS (Low Power)	\$4.95 \$4.50

L.E.D. LAMPS

LED209	T-1 3mm Red	.09
LED211	T-1 3mm Green	.14
LED212	T-1 3mm Yellow	.13
LED220	T-1-3/4 5mm Red	.11
LED222	T-1-3/4 5mm Green	.15
LED224	T-1-3/4 5mm Yellow	.14



DISPLAYS

FND357	375' Common Cathode	\$1.85	\$1.09
FND500	500' Common Cathode	\$1.80	\$1.09
FND507	500' Common Anode	\$1.80	\$1.09
FND567	500' Common Anode	\$1.80	\$1.29
DL747	630' Common Anode	\$2.85	\$2.49
DL704	300' Common Cathode	\$1.80	\$1.29
DL707	300' Common Anode	\$1.80	\$1.29

ISOLATORS

TIL112	Opto Isolator 1500V	\$0.85	\$0.49
MCT6	Dual Opto Isolator 1500V	\$1.80	\$1.29

MICROCOMPUTER BOARDS

SYM-1 MICROCOMPUTER BOARD

- Hardware compatibility with KIM-1
- Standard interfaces include audio cassette with remote control both 8 bytes second (KIM) and 185 bytes second (SYM-1) cassette formats. TTY and RS232 system expansion bus. TV KB expansion board interface. four I/O buffers and an oscilloscope single line display.
- Single +5V power requirements.

SYM-1 \$329.00

NEC MICROCOMPUTER TK-80A

- The TK 80A is a complete microcomputer on a board based on the industry standard 8080A. The board has both 1K RAM and 1K Electrically Erasable PROM expandable to 4K x 8 and 8K x 8 respectively on-board. It also features 300 or 1200 baud cassette interface, the Kansas City type and three 8-Bit Programmable I/O Ports (24 lines). Keypad with 25 real keys not a glorified calculator keypad and 8 big bright LEDs for display are also included.

TK-80A \$299.00



Rockwell International AIM65

AIM 65 features on-board thermal printer and alphanumeric display and a terminal-style keyboard. It has an addressing capability up to 65K bytes, and comes with a user-dedicated 1K RAM. Two installed 4K ROMs hold a powerful Advanced Interface Monitor program and three spare sockets are included to expand on-board ROM or PROM up to 20K bytes. An Application Connector provides for attaching a TTY and one or two audio cassette recorders, and gives external access to the user-dedicated General Purpose I/O lines. Also included as standard are a comprehensive AIM 65 User's Manual, a handy pocket reference card, an R6500 Hardware Manual, an R6500 Programming Manual and an AIM 65 schematic. AIM 65 is packaged on two compact modules. The circuit module is 12 inches wide and 10 inches long, the keyboard module is 12 inches wide and 4 inches long. They are connected by a detachable cable.

AIM65 \$375.00

MULTIBUS MEMORY

LARGE SCALE MULTIBUS MEMORY MEMORY ONLY

SIZE (BYTES)	MUPRO PRODUCT NUMBER	INTEL EQUIV PART NUMBER	PRICE
16K	MBC-016/8	SBC-016	\$ 715
32K	MBC-032/8	SBC-032	1125
48K	MBC-048/8	SBC-048	1475
64K	MBC-064/8	SBC-064	1795
32K	MBC-032/16	SBC-032	1125
64K	MBC-064/16	SBC-064	1795

MICROPROCESSOR CHIPS CPU's

Part No.	Price
8080A	5.50
8085	12.95
6800	7.95

INTERFACE SUPPORT CIRCUITS

Part No.	Price	Part No.	Price
8212	1.98	8255	4.95
8214	3.95	8257	10.95
8216	1.98	8259	14.95
8224	2.75		
8226	1.98	6810	3.95
8228	3.98	6820	3.95
8238	3.98	6821	3.95
8251	5.50	6850	4.95
8253	14.95	6852	4.95



Zilog

Z80-CTC	\$10.90
Z80A-CTC	\$13.10
Z80-DMA	\$32.20
Z80-SIO/0	\$45.00
Z80A-SIO/0	\$50.00
Z80-CPU	\$13.60
Z80A-CPU	\$16.20
Z80-SIO/1	\$45.00
Z80A-SIO/1	\$50.00
Z80-PIO	\$10.90
Z80A-PIO	\$13.10
Z80-SIO/2	\$45.00
Z80A-SIO/2	\$50.00

Features.....

BRAND NEW! 1979 IC MASTER 2500 pages

Complete integrated circuit data selector. Master guide to the latest I.C.'s including microprocessors and consumer circuits. Free Quarterly Updates

\$39.95



Texas Instruments Low Profile Sockets

Finest Quality Socket available in the world. Nobody can match Texas Instruments quality — a unique combination of I.C. technology and multi-metal expertise.

Over one million pieces in stock.

Contacts	Price	Contacts	Price
8 PIN	.08	22 PIN	.22
14 PIN	.12	24 PIN	.24
16 PIN	.14	28 PIN	.28
18 PIN	.18	40 PIN	.40
20 PIN	.20		



LINEAR I.C.'S

LM324N	.49	Quad Op Amp	
LM339N	.49	Quad Comparator	
LM555N-8	.29	Timer	
LM556N-14	.59	Dual Timer	
LM723CN	.36	Voltage Regulator	
LM723CH	.39	Voltage Regulator	
LM741CH	.37	Op Amp	
LM741CN-8	.24	Op Amp	
LM1458N-3	.49	Dual Op Amp	
RC4558N-8	.45	Dual Op Amp	

Active Electronic Sales Corp.

P.O. BOX 1035 FRAMINGHAM, MASSACHUSETTS 01701

Over-the-counter sales, 12 Mercer Rd., Natick, Mass 01760
Behind Zayres on Rte. 9
Telephone Orders & Enquiries (617) 879-0077

MINIMUM ORDER \$10.00 • ADD \$2.00 TO COVER POSTAGE & HANDLING

Foreign customers please remit payment on an international bank draft or international postal money order in American dollars.

IN CANADA

5651 FERRIER ST MONTREAL, QUEBEC H4P 2K5 Tel: (514) 735-6425	4800 DUFFERIN ST DOWNSVIEW, ONTARIO M3M 5S9 Tel: (416) 661-1115
---	--

BAXTER CENTRE
1050 BAXTER ROAD
OTTAWA, ONTARIO
K2C 3P2
Tel: (613) 820-9471

VANCOUVER OPENING
SUMMER 1979



**HIGH STABILITY
CRYSTALS FOR
FREQUENCY** 
OR TIME 
**USE THE BEST
BUY
JAN CRYSTALS**

- CB
 - CB standard
 - 2 meter
 - Scanners
 - Amateur Bands
 - General Communication
 - Industry
 - Marine VHF
 - Micro processor crystals
- Send 10¢ for our latest catalog.
Write or phone for more details.

Jan Crystals
2400 Crystal Drive
Ft. Myers, Florida 33907
all phones (813) 936-2397

easy to charge



CIRCLE 24 ON FREE INFORMATION CARD

FREE KIT Catalog

AUTORANGE DIGITAL CAP-METER KIT. Still the best for only \$74.95 contains TEST & EXPERIMENTER'S EQUIP.
Phone 415-447-3433
Write or Phone for FREE CATALOG. Average 1 minute Saturday call is 21¢.

DAGE SCIENTIFIC INSTRUMENTS
BOX 1054R LIVERMORE CA 94550

**TEST YOUR
E.Q.**

(Economics Quotient)

Write for a free booklet.
"Economics"
Pueblo, Colorado 81009.

The American Economic System.
We should all learn more about it.



A public service message of
This Magazine & The Advertising Council
& US Department of Commerce

**You Are Not
ALONE!**



If you think that being in business makes you INDEPENDENT, think again! Consumerists and government agencies are your silent - but greedy - partners; AND THEIR SHARE COMES FIRST; even if you don't make a profit.

WELL, YOU DON'T HAVE TO FACE THEM BY YOURSELF

JOIN NESDA
AND YOUR LOCAL & STATE ASSOCIATIONS

Send for more information to:

NESDA, 1715 Expo Lane
Indianapolis, IN 46224



CIRCLE 71 ON FREE INFORMATION CARD

7400 TTL

7400	.16
7404	.10
7405	.19
7410	.10
7412	.25
7413	.40
7416	.25
7420	.20
7425	.28
7426	.28
7427	.25
7430	.20
7437	.24
7438	.24
7440	.20
7445	.75
7451	.20
7454	.20
7474	.35
7475	.49
7483	.58
7485	.78
7486	.35
7489	1.80
7490	.43
7492	.42
7493	.42
7495	.65
74107	.35
74123	.49
74141	.78
74151	.58
74155	.75
74160	.86
74165	.86
74175	.75
74190	.75
74181	1.85
74195	.65

MISC TTL

74504	.35
74505	.35
74550	.35
745153	1.95
745181	2.75

P1103A
1024 X1 Dynamic RAM
42c

700ns \$6.25
2708
1024 X 8 EPROM
250ns \$8.50

74S201 ★★
256 X1 Static RAM
\$1.95 50 ns ★★

ULN2001
High current Drivers.
Darlingtons 75c

MC1458P
Dual Op-Amp
24c

in depth **555**
TIMER
28c

8038C
VCO Waveform Gen.
w/sine 99c

QYS LIMITED
82S115
512 X 8 PROM 60ns
\$4.75

LINEAR

LM300H	.78
LM301N	.35
LM305H	.60
LM306H/N	1.50
LM307H/N	.35
LM308N	.95
LM309K	1.25
LM310N	1.10
LM311N	.85
LM320TS	1.25
LM320T12	1.25
LM320T15	1.25
LM322N	1.75
LM323K	5.75
LM340TS	1.25
LM340T12	1.25
LM340T15	1.25
LM556	.89
LM566	1.65
LM711N/N	.39
LM723N	.55
LM725H	1.75
LM733N	.95
LM741N/H	.35
LM747N	.78
LM749N	.85
LM3900	.46
78H05	6.95
SG45C1	1.95

TRANSISTORS

2N2222A	5/1.00
2N2907P	5/1.00
2N3055	.85
2N3904	5/1.00
2N3906	5/1.00
2N4401	5/1.00
2N4403	5/1.00
1N32955	1.20
1N323055	1.00

DIODES

1N914	15/1.00
1N4003	12/1.00
1N4005	10/1.00
1N4007	10/1.00
1N4148	15/1.00

READ THIS!



AND
PUT UP TO
\$18

IN
YOUR
POCKET

You can save up to \$18 when you subscribe to Radio-Electronics—and have the best electronics magazine of all delivered to your home, often before it runs out on the newsstands! Every page of every issue is packed with electronics news and excitement you won't want to miss. Make sure you get every issue, and save money, too. Mail the money-saving coupon below today. Get all the excitement, every month.

SUBSCRIBE TO RADIO-ELECTRONICS

40G9

Mail to: **Radio-Electronics**

SUBSCRIPTION DEPT., P.O. BOX 2520, BOULDER, COLO. 80322

Name (please print)
Address
City State Zip Code

Indicate the offer you prefer:

- 1 Year—12 issues ONLY \$9.98 (You save \$5.02 off newsstand price.)
 - 2 Years—24 issues ONLY \$19.00 (Save More! \$11.00 off newsstand price.)
 - 3 Years—36 issues ONLY \$27.00 (Save Even More! Save \$18.00 off newsstand price.)
- Extra Shipping: Canada \$3.00 per year, all other countries \$5.00 per year.

- Payment enclosed
- Bill me
- Check here if this is a new subscription.
- Check here if you are extending or renewing your subscription.

COMPUTER COMPONENTS
1973 South State College-Anaheim, Calif.92806

Visa- MasterCharge
Check or M.O.
No COD

(714) 937-0641

Minimum Order—10.00
Add 1.00 for Frt.
Cal. Res. add 6%

CIRCLE 26 ON FREE INFORMATION CARD



FREQUENCY COUNTER KIT

Outstanding Performance

Incredible Price **\$89.95**

CT-50

The CT-50 is a versatile and precision frequency counter which will measure frequencies to 60 MHz and up to 600 MHz with the CT-600 option. Large Scale Integration, CMOS circuitry and solid state display technology have enabled this counter to match performance found in units selling for over three times as much. Low power consumption (typically 300-400 ma) makes the CT-50 ideal for portable battery operation. Features of the CT-50 include: large 8 digit LED display, RF shielded all metal case, easy pushbutton operation, automatic decimal point, fully socketed IC chips and input protection to 50 volts to insure against accidental burnout or overload. And, the best feature of all is the easy assembly. Clear, step by step instructions guide you to a finished unit you can rely on. **Order your today!**

CT-50, 60 mHz counter kit
 CT-50WT, 60 mHz counter, wired and tested
 CT-600, 600 mHz scaler option, add

\$89.95
159.95
29.95

CB-1, Color TV calibrator-stabilizer
 DP-1, DC probe, general purpose probe
 HP-1, High impedance probe, non-loadin

\$14.35
12.35
15.35

SPECIFICATIONS:

Frequency range: 6 Hz to 65 mHz, 600 mHz with CT-600
 Resolution: 10 Hz @ 0.1 sec gate, 1 Hz @ 1 sec gate
 Readout: 8 digit, 0.4" high LED, direct readout in mHz
 Accuracy: adjustable to 0.5 ppm
 Stability: 2.0 ppm over 10 to 40 C temperature compensated
 Input: BNC, 1 megohm 20 pF direct, 50 ohm with CT-600
 Overload: 50VAC maximum all modes
 Sensitivity: less than 25 mV @ 65 mHz, 50-150 mV to 600 mHz
 Power: 1.0 VAC 5 Watts or 12 VDC @ 400 ma
 Size: 6" x 4" x 2", high quality aluminum case, 2 lbs
 CS: 13 units, all socketed

CAR CLOCK



The UN-KIT, only 5 solder connections

Here's a super looking, rugged and accurate auto clock which is a snap to build and install. Clock movement is completely assembled—you only solder 3 wires and 2 switches, takes about 15 minutes! Display is bright green with automatic brightness control photocell—assures you of a highly readable display, day or night. Comes in a satin finish anodized aluminum case which can be attached 5 different ways using 2 sided tape. Choice of silver, black or gold case (specify).
 DC-3 kit, 12 hour format **\$22.95**
 DC-3 wired and tested **\$29.95**
 110V AC adapter **\$5.95**

Under dash car clock



12/24 hour clock in a beautiful plastic case features 6 jumbo RED LEDs, high accuracy (1min/mo), easy 3 wire hookup, display blanks with ignition, and super instructions. Optional dimmer automatically adjusts display to ambient light level.
 DC-11 clock with mtg bracket **\$27.95**
 DM-1 dimmer adapter **2.50**

PRESCALER



Extend the range of your counter to 600 mHz. Works with any counter. Includes 2 transistor pre-amp to give super sens, typically 20 mV at 150 mHz. Specify +10 or +100 ratio.
 PS-1B, 600 mHz prescaler **\$59.95**
 PS-1BK, 600 mHz prescaler kit **49.95**

OP-AMP SPECIAL

741 mini dip **12/\$2.00**
 B1-FET, mini dip, 741 type **10/\$2.00**

VIDEO TERMINAL

A completely self-contained, stand alone video terminal card. Requires only an ASCII keyboard and TV set to become a complete terminal unit. Two units available, common features are: single 5V supply, XTAL controlled sync and baud rates (to 9600), complete computer and keyboard control of cursor, Parity error control and display, Accepts and generates serial ASCII plus parallel keyboard input. The 3216 is 32 char. by 16 lines, 2 pages with memory scrolling feature. The 6416 is 64 char. by 16 lines, with scrolling, upper and lower case (optional) and has RS-232 and 20ma loop interfaces on board. Kits include sockets and complete documentation.
 RE 3216, terminal card **\$149.95**
 RE 6416, terminal card **189.95**
 Lower Case option, 6416 only **13.95**
 Power Supply Kit **14.95**
 Video/RF Modulator, VD-1 **6.95**
 Assembled, tested units, add **60.00**

CALENDAR ALARM CLOCK

The clock that's got it all! 6-5" LEDs, 12/24 hour, snooze, 24 hour alarm, 4 year calendar, battery backup, and lots more. The super 7001 chip is used. Size 5x4x2 inches.
 Complete kit, less case (not available) **\$34.95**
 DC-9

30 Watt 2 mtr PWR AMP

Simple Class C power amp features 8 times power gain. 1 W in for 8 out, 2 in for 15 out, 4 W in for 30 out. Max output of 35 W, incredible value, complete with all parts, less case and T-R relay.
 PA-1, 30 W pwr amp kit **\$22.95**
 TR-1, RF sensed T-R relay kit **6.95**

FM MINI MIKE KIT



A super, high performance FM wireless mike kit! Transmits a stable signal up to 300 yards with exceptional audio quality by means of its built in electret mike. Kit includes case, mike, on-off switch, antenna, battery and super instructions. This is the finest unit available.

FM-3 kit **\$12.95**
 FM-3 wired and tested **16.95**

CLOCK KITS



our Best Seller
 your Best Deal

Try your hand at building the finest looking clock on the market. Its satin finish anodized aluminum case looks great anywhere, while six 4" LED digits provide a highly readable display. This is a complete kit, no extras needed, and it only takes 1-2 hours to assemble. Your choice of case colors: silver, gold, bronze, black, blue (specify).
 Clock kit, 12/24 hour, DC-5 **\$22.95**
 Clock with 10 min. ID timer, 12/24 hour, DC-10 **27.95**
 Alarm clock, 12 hour only, DC-8 **24.95**
 12V DC car clock, DC-7 **27.95**
 For wired and tested clocks add \$10.00 to kit price.

Hard to find PARTS

LINEAR ICs	REGULATORS
301	\$ 35
324	11 50
380	11 25
380-8	75
555	45
556	85
566	115
567	125
1458	50
3900	50
CMOS ICs	74500
4011	20
4013	35
4046	185
4049	40
4518	125
5369	75
TTL ICs	74500
4011	20
4013	35
4046	185
4049	40
4518	125
5369	75
TRANSISTORS	
2N3904 type	10/ 00
2N3906 type	10/ 00
NPN 30W Fwr	3/ 00
PNP 30W Pwr	3/ 00
2N3055	60
UJT 2N2646 type	3/ 2 00
FET MPF1C2 type	3/ 2 00
UMF 2N5179 type	3/ 2 00
MRF-238 RF	1/ 95
SOCKETS	
8 pin	10/ 2 00
14 pin	10/ 2 00
16 pin	10/ 2 00
24 pin	4/ 2 00
28 pin	4/ 2 00
40 pin	3/ 2 00
4511	65
309K	50
309K	80
7805	85
78L05	25
7905	1 25
7812	85
7912	1 25
7815	85
7815	85
74500	35
7447	65
7475	50
7490	50
74196TI	1 35
SPECIAL ICs	
11C90	13 50
10116	1 25
4511	2 00
5314	2 95
5375AB	2 95
7001	6 50
4059 + N	9 00
7208	17 95
LEDs	
Jumbo red	8 1 00
Jumbo green	6 1 00
Jumbo yellow	6 1 00
Mini red	8 1 00
Micro red	8 1 00
BiPolar	75
FERRITE BEADS	
With info, specs	5 1 00
6 hole balun	5 1 00

Ramsey's famous MINI-KITS

FM WIRELESS MIKE KIT

Transmits up to 300' to any FM broadcast radio, uses any type of mike. Runs on 3 to 9V. Type FM-2 has added sensitive mike preamp stage.
 FM-1 kit **\$2.95** FM-2 kit **\$4.95**

VIDEO MODULATOR KIT

Converts any TV to video monitor. Super stable, tunable over ch. 4-6. Runs on 5-15V, accepts std video signal. Best unit on the market!
 Complete kit, VD-1 **\$6.95**

SUPER SLEUTH

A super sensitive amplifier which will pick up a pin drop at 15 feet! Great for monitoring baby's room or as general purpose amplifier. Full 2 W rms output, runs on 6 to 15 volts, uses 8-45 ohm speaker.
 Complete kit, BN-9 **\$5.95**

COLOR ORGAN/MUSIC LIGHTS

See music come alive! 3 different lights flicker with music. One light for lows, one for the mid-range and one for the highs. Each channel individually adjustable, and drives up to 300W. Great for parties, band music, nite clubs and more.
 Complete kit, ML-1 **\$7.95**

tone DECODER

A complete tone decoder on a single PC board. Features: 400-5000 Hz adjustable range via 20 turn pot, voltage regulation, 567 IC. Useful for touch-tone decoding, tone burst detection, FSK etc. Can also be used as a stable tone encoder. Runs on 5 to 12 volts.
 Complete kit, TD-1 **\$5.95**

POWER SUPPLY KIT

Complete triple regulated power supply provides variable 6 to 18 volts at 200 ma and +5V at 1 Amp. Excellent load regulation, good filtering and small size. Less transformers, requires 6.3V @ 1 A and 24 VCT.
 Complete kit, PS-3LT **\$6.95**

LED Blinky KIT

A great attention getter which alternately flashes 2 jumbo LEDs. Use for name badges, buttons, warning panel lights, anything! Runs on 3 to 15 volts.
 Complete kit, BL-1 **\$2.95**

WHISPER LIGHT KIT

An interesting kit, small mike picks up sounds and converts them to light. The louder the sound the brighter the light. Completely self-contained, includes mike, runs on 110VAC, controls up to 300 watts.
 Complete kit, WL-1 **\$6.95**

SIREN KIT

Produces upward and downward wail characteristic of a police siren. 5W peak audio output, runs on 3-15 volts, uses 3-45 ohm speaker.
 Complete kit, SM-3 **\$2.95**

ramsey electronics

BOX 4072, ROCHESTER, N.Y. 14610

PHONE ORDERS CALL

(716) 271-6487



TERMS: Satisfaction guaranteed or money refunded. C.O.D. add \$1.50. Minimum order, \$3.00. Orders under \$10.00, add \$.75. Add 5% for postage, insurance, handling. Overseas, add 15%. NY residents, add 7% tax.

MICRO MART

552 Summit Ave.
Westfield, N.J. 07090
(201) 654-6008

TTL		7403 -12	74H53 -20
74H04	-20	7474	-25
7427	-18	7482	-50
7429	-29	7492	-25
7432	-20	74145	-40
7437	-20	74151	-50
7438	-15	74180	-50
74H38	-20	74193	-60
7439	-25	8235	-50
7442	-30	8266	-20
7445	-50	8563	-50
7447	-35	8815	-25
7451	-16	75324	-75
LINEAR			
LM 233K	4.00	LM 1303	70
LM 3001	70	LM 1304	95
LM 301AN	30	LM 1305	1.15
LM 307H	50	LM 1307	60
LM 307	30	LM 1307E	30
LM 308H	85	LM 1310	1.75
LM 308	85	LM 1391	2.00
LM 310	80	LM 1414	1.50
LM 311	80	LM 1800	70
LM 317K	2.75	LM 1808	2.50
LM 318H	1.10	LM 1820	2.50
LM 320K-15	1.10	LM 1828	2.00
LM 320K-12	1.10	LM 1830	2.25
LM 324	1.10	LM 1841	2.50
LM 325	1.35	LM 1848	2.00
LM 3391	1.00	LM 1889	2.50
LM 340K-12	1.00	LM 2111	1.15
LM 341P-12	80	LM 2113	1.75
LM 343H	3.50	LM 2907	2.00
LM 373	2.50	LM 2917	2.00
LM 377	2.00	LM 3046	60
LM 380	1.00	LM 3054	1.50
LM 381	1.25	LM 3064	2.00
LM 384	1.20	LM 3065	2.50
LM 386	1.20	LM 3067	2.50
LM 389	1.20	LM 3070	2.50
LM 390	1.65	LM 3071	2.50
LM 746	2.50	LM 3075	1.25
LM 748CN	3.0	LM 3089	1.25
Voltage Regulators			
7805, 7805T, 7812T, 7905T, 7912T	... \$1.25 each		

"REVOLUTIONARY NEW CHIP"
LIQUID LEVEL DETECTOR CHIP (R-484A)
Contains an on-board oscillator/amplifier, & power driver. Can drive siren or alarm directly. Can monitor basement moisture, etc. A myriad of applications. Specs & application notes included—\$7.50, 2/\$12.00 Complete Kit (additional parts & case)—\$15.00

RADIATION DETECTOR—not a kit
1st time offered—safeguard your home!
This device monitors microwave ovens & color TV's. Accurately calibrated to meet strict government radiation exposure standards. \$35.00

MOTION DETECTORS
(specs included)
\$4.00
3 1/4" x 2 x 1 1/4" case with mtng tabs \$2.00

LED'S
Please specify color & size—Jumbo, Medium, Small
Green, 7/1.00 Yellow, 7/1.00 Red, 10/1.00
100/13.00 100/13.00 100/9.00

OPERATIONAL AMPLIFIERS
UA 741's — \$25

BRIDGES
1 1/2 Amp/50, 6 Amp/\$2.00, 25 Amp/\$1.50

REED SWITCH
1/2", 10/\$1.00

IN 4148's (ITT), 30/\$1.00

CONDENSER MIKE — \$1.50

TO-5 Case TRANSISTOR SOCKETS, 5/\$1.00

6.3V, 1.2 Amp Transformer — \$1.25

Self Adhesive Rubber Bumpers — 25 for \$1.00

AUDIO CABLE: #24, 2 conductor \$1.00/100 ft.

HARDWARE
4-40x1/4", 1/2 screws-1,000 pcs. ass't/\$3.50
6-32x1/4", 1/2 screws-1,000 pcs. ass't/\$4.00

ELECTROLYTICS
100 of 10V/25, 470 of 10V/25, 3200 of 25V/50

Terms: MICRO-MART accepts Visa, MC, and telephone COD'S. Foreign orders \$50.00 minimum plus shipping-US funds only. Orders under \$10.00 include \$2.00 for shipping/handling. All components guaranteed or money refunded. Immediate shipping. N.J. residents add 5% sales tax.
MICRO-MART • 552 SUMMIT AVE., WESTFIELD, N.J. 07090 • (201) 654-6008

CIRCLE 42 ON FREE INFORMATION CARD

REGULATED POWER SUPPLIES	
POWER SYSTEMS # PS1111 115-230V 50/60 cy. in 5v DC at 35A out 6" x 16 1/2" x 15 1/2" 26 lbs. shipping weight \$55.00	
POWER SYSTEMS # PS1106 115-230V 50/60 cy. in 12v DC at 15A out 5 1/2" x 16 1/2" x 5 1/2" 19 lbs. shipping weight. \$49.00 (OV PROTECT)	
CMOS (DIODE CLAMPED)	
4001 - 20 4019 - 37 4049 - 40 74C73 - 65	4002 - 20 4020 - 90 4050 - 40 74C74 - 45
4007 - 18 4021 - 90 4051 - 30 74C86 - 40	4009 - 37 4022 - 90 4053 - 110 74C83 - 75
4010 - 37 4023 - 18 4055 - 125 74C151 - 140	4011 - 20 4024 - 75 4066 - 70 74C160 - 1.05
4012 - 20 4025 - 18 4071 - 20 74C161 - 1.05	4014 - 75 4027 - 80 4072 - 21 74C174 - 1.05
4015 - 75 4028 - 80 4072 - 21 74C174 - 1.05	4016 - 37 4029 - 95 4076 - 97 74C191 - 48
4017 - 1.05 4030 - 33 4521 - 70 74C902 - 48	4018 - 90 4035 - 97 74C02 - 22 74C914 - 1.20
4042 - 65 74C09 - 22	4044 - 65 74C10 - 22
1488 8252Z INTERFACE \$1.40	
1489 8252Z INTERFACE 1.25 UPD4014 4K STAT HAM 9.95	
2008 7805T STAT SW 1.35 4163 4164 9.95	
2512 CHAINING GND. L.P. 6.75 5280 21018 4K DYN HAM 3.40	
2518-HEX 32 BIT SW 7.20 7M5 4050L 3.90	
7032 STATIC SHIFTER BIC 1.95 8204 8K PROM 4.95	
7108 BR. EPROM 4Kx16 12.95 82523 1.95	
7M5 4050NL 2.95 825126 1.95	
7M5 3008 HC 80 BITS D.P.R. 1.35 825129 4.25 2.75	
7716 ITT 35.95 4Y5 1013 VAC 5.75	
7103 (1480u) 1.95 TR16028 4.95	
7103 (1480u) 1.95 825126 4.95	
MMS220K x1 DYN 3.45 CONVHEIT 7.95	
M44000P 1.95 PT 14828 P5A1 6.95	
7101 1254 -4 STATIC 2.45 8080A 0.95	
7111 1256 -4 STATIC 3.45 8274 2.95	
7112 1256 -4 STATIC 2.75 8274 2.95	
7114K 2AT RAM (480u) 8.50	
8130 2.95	81380 2.75 8834 2.25 8838 2.75
8131 2.95	8838 2.95 8837 2.25
CRYSTALS \$3.45 ea.	
2000 MHz	7.45
4000 MHz	1.35
5000 MHz	1.35
6000 MHz	1.35
8000 MHz	1.35
10,000 MHz	1.35
20,000 MHz	1.35
RIBBON CABLE	
7.45 (IC OR CODED)	
#30 WIRE	
26 cond. .50/100 feet	
40 cond. .75/100 feet	
50 cond. .90/100 feet	
CTS 206-8 eight position dip switch \$1.60	
CTS 206-4 four position dip switch \$1.45	
LIGHT ACTIVATED SCR'S to 18, 200V, 1A. . . \$7.00	
SILICON SOLAR CELLS	
2" diameter 4V at 1 AMP \$10.00	
4" diameter 4V at 1 AMP \$10.00	
FND 359 C.C. 4" x 5.00	
FCS 8024 4 digit \$5.00	
C.C. 8" display \$5.00	
FND 503 C.C. 5" x 8.50	
FND 510 C.A. 5" x 8.50	
DL 704 3" C.C. x 8.50	
DL 704 C.A. 3" x 7.50	
C.C. 8" display \$5.00	
HP3400 8" C.C. \$1.95	
HP3405 8" C.A. \$1.95	

PRINTED CIRCUIT BOARD	
4" x 6" DOUBLE SIDED EPOXY BOARD 1/16" thick \$6.00 ea. 512/\$2.60	
7 WATT LD-65 LASER DIODE IR \$8.95	
2N 3820 P FET	\$ 45
2N 5457 N FET	\$ 45
2N2646 UJT	\$ 45
EE 900 TRIGGER DIODES	4 \$ 1.00
2N 6028 PHOT. UJT	\$ 65
MINIATURE MULTI-TURN TRIM POTS	
100, 1K, 2K, 5K, 10K, 20K, 50K,	
200K, 1Meg, 2Meg, \$.75 each 3/52.00	
CHARGED COUPLE DEVICES	
CCD 201C 100x100 Image Sensor \$95.00	
CCD 202C 100x100 Image Sensor \$145.00	
VERIFAX PC BOARD \$16.95	
Our new Prototyping is a hi density 4 1/2" x 6 1/2" single sided 1/16" epoxy board. It will hold 40, 24, 16 (34 units), 14 - 8 pin IC's. There are three buses, +5V, ground and a floating bus. There is a pad for a TO-220 regulator. There is a 22 pin edge connector with 156" spacing.	
FP 100 PHOTO TRANS \$ 50	
RED, YELLOW GREEN \$ 50	
LARGE LED'S 6/\$1.00	
TIL-118 OPTO-ISOLATOR \$ 75	
MCT-6 OPTO ISOLATOR \$ 80	
1 WATT ZENERS: 3.3, 4.7, 5.1, 5.6, 9.1, 10, 12, 15, 18, or 22V 6/\$1.00	
MCM 6571A 7 x 9 character gen. \$ 10.75	
UNIVERSAL 4Kx8 MEMORY BOARD KIT \$69.95	
32-2102 1 fully buffered, 16 address lines, on board decoding for any use of 64 pages, standard 44 pin bus, may be made with F-8 & KIM	

Silicon Power Rectifiers	
PRV 1A 3A 12A 50A 125A 240A	
100 06 14 35 90 3/70 5.00	
200 07 20 40 130 4.25 6.50	
400 09 25 65 150 6.50 9.50	
600 11 30 80 2.00 8.50 12.50	
800 15 35 1.00 2.50 10.50 16.50	
1000 20 45 1.25 3.00 12.50 20.00	
SAD 1024 a REDICOM 1024 stage analog Bucket Brigade shift register. \$14.95	
IN 4148 (IN914) 15/\$1.00	
.1 of 25V ceramic caps 16/\$1.00, 50/\$2.00/100	
RS232	
DB 25P male \$2.95	
DB 25F female \$3.50	
HOODS \$1.50	
REGULATORS	
323K 5V 3A \$ 5.75	340K 12, 15, 309K \$1.10
723 \$1.10	or 24 V \$1.10
723 \$1.10	or 5, 6, 8, 12
320T \$1.10	15, 18 or 24V 1.10
5, 12, or 15 V	78 MG \$1.35
	79 MG \$1.35

TRANSISTOR SPECIALS	
2N6233 NPN SWITCHING POWER	\$ 1.95
MRP8004 a CBF Tr transistor NPN	\$.75
2N3772 NPN S/T O 3	\$ 1.00
2N1546 PNP GE TO-3	\$.75
2N4908 PNP Si TO 3	\$ 1.00
2N5086 PNP S/T O 92	4 \$ 1.00
2N3137 NPN Si RF	\$.55
2N3919 NPN Si TO 3 RF	\$ 1.50
2N1420 NPN Si TO 5	3/\$ 1.00
2N1767 NPN Si TO 66	\$.70
2N2222 NPN Si TO 18	5 \$ 1.00
2N3055 NPN Si TO 3	\$.50
2N3904 NPN Si TO 92	6/\$ 1.00
2N3906 NPN Si TO 92	6/\$ 1.00
2N5296 NPN Si TO 220	\$.50
2N1629 PNP Si TO 220	\$.55
2N3638 PNP Si TO 5	5 \$ 1.00
MPSA 13 NPN Si TO 92	4/\$ 1.00

TLI IC SERIES	
7400 15 7448 58 75601 70	
7401 15 7474 78 74154 94	
7402 15 7473 78 74157 55	
7403 15 7474 78 74161 80	
7404 18 7475 45 74161 55	
7405 18 7476 30 74163 55	
7406 22 7480 55 74164 85	
7407 18 7483 95 74165 95	
7409 18 7485 87 74173 120	
7410 15 7488 78 74174 95	
7411 18 7489 125 74175 95	
7412 18 7490 42 74176 75	
7413 36 7491 56 74177 75	
7414 60 7492 43 74180 65	
7416 22 7483 43 74181 180	
7417 25 7484 67 74190 100	
7420 18 7495 65 74191 85	
7425 30 7498 65 74192 79	
7426 22 74107 28 74193 79	
7427 20 74121 35 74195 85	
7430 18 74122 40 74195 80	
7432 22 74123 45 74196 86	
7433 22 74126 40 74197 80	
7438 22 74128 40 74202 55	
7440 18 74145 65 74208 90	
7441 20 74146 110 74208 82	
7442 45 74150 100 74209 120	
7445 65 74151 61 74222 150	
	74153 61 74226 150
DATA CASSETTES 1/2 HR \$.95	
14 pin headers 3/\$1.00	
MMS387AA \$5.95	
MTA 206 DPDT \$7.50	
MMS369 \$3.75	
NO. 30 WIRE WRAP WIRE SINGLE STRAND 100' \$1.40	

ALCO MINIATURE TOGGLE SWITCHES	
MTA 106 SPDT	\$.95
MTA 206 DPDT	\$ 1.70
MTA 206 P-DPDT CENTER OFF	\$ 1.85
MSD 206 P-DPDT CENTER OFF LEVER SWITCH	\$ 1.85

Full Wave Bridges	
PRV 2A 6A 25A	
100 200 75 1.25 2.00	
400 .95 1.50 3.00	
600 1.20 1.75 4.00	
DIP SOCKETS	
8 PIN 1.27 24 PIN .35	
14 PIN 2.00 28 PIN .50	
16 PIN 2.20 40 PIN .60	
18 PIN 2.50	
SANKEN AUDIO POWER AMPS	
S-1010 G 10 WATTS \$ 7.80	
S-1020 G 20 WATTS \$15.70	
S-1050 G 50 WATTS \$28.50	
TANTALUM CAPACITORS	
.22UF 35V 5/51.00 6.8UF 35V 4/51.00	
47UF 35V 5/51.00 100UF 10V \$ 25	
68UF 35V 5/51.00 22UF 25V \$ 40	
1UF 35V 5/51.00 15UF 35V 3/51.00	
2.2UF 20V 5/51.00 30UF 6V 5/51.00	
3.3UF 20V 4/51.00 33UF 20V \$ 40	
4.7UF 15V 5/51.00 47UF 20V \$ 35	
68UF 15V \$ 5.00	
74LS SERIES	
74LS00	74LS130
74LS02	74LS138
74LS03	74LS151
74LS04	74LS155
74LS05	74LS160
74LS08	74LS161
74LS09	74LS162
74LS10	74LS163
74LS11	74LS164
74LS12	74LS165
74LS13	74LS166
74LS14	74LS167
74LS15	74LS168
74LS16	74LS169
74LS17	74LS170
74LS18	74LS171
74LS19	74LS172
74LS20	74LS173
74LS21	74LS174

HICKOK TEST INSTRUMENTS

HICKOK New Digital Mini-Multimeter

**Lowest
Price**

MODEL LX303

- Big 1/2" high LCD display
- Use indoors or out
- 200 hour 9V battery life
- Auto zero, Polarity, Overrange Indication
- 100 mV DC F.S. sensitivity
- 19 ranges and functions



Call TOLL FREE
(800) 645-9518

In N.Y. State call (516) 752-0050

**"We Will Beat Any
Advertised Price"**

Oscilloscopes

30 MHz Dual Trace
MODEL 532

Reg. \$995.00
Our Price **\$845.75** incl. probes

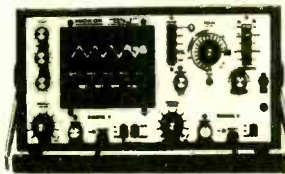
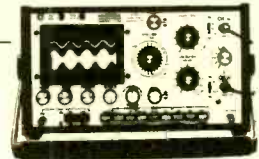

15 MHz Dual Trace
MODEL 517

Reg. \$695.00
Our Price **\$590.00** incl. probes

**15 MHz
Triggered Sweep**

MODEL 515

Reg. \$495.00
Our Price **\$425.75** incl. probes

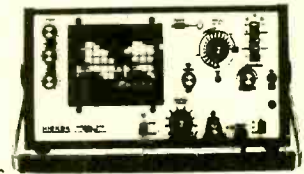

Before you buy, check our prices...

FORDHAM

YOUR ONE STOP DISCOUNT CENTER
Master Charge, Bank Americard, Visa, C.O.D.'s accepted.

FREE

Send for new 1979 catalog of over 3,000 items ... 164 pages of test equipment, CB tools, tubes, components and electronic supplies.

RADIO SUPPLY CO., INC.
855R Conklin St.
Farmingdale, N.Y. 11735

ADD \$3.00 TO COVER
SHIPPING, HANDLING
& INSURANCE. N.Y.
Res. add approx.
sales tax.

**Sinclair
PDM35 digital MultiMeter**

- 3 1/2 digit resolution
- Sharp, bright LED display
- Automatic polarity selection
- All purpose versatility

Reg. \$59.95 **\$52.95**



**SENCORE
TV-VTR-MATV
and Video Analyzer**



Model VA48
\$875.00 Reg. \$975.00

CONTINENTAL SPECIALTIES

100 MHz 8-Digit Counter \$119.00

- 20 Hz-100 MHz Range • 8" LED Display • Fully Automatic
- Includes 100 IPE chip (included) tube, manual

Now Available **PS500 500MHZ Prescaler \$52.95**

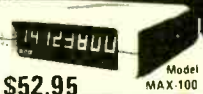

**BK PRECISION 3 1/2-Digit
Portable DMM**

- Overhead Protected • Battery or AC Operation • 3" high LED Display
- Auto Zeroing

Model 2800 **\$85**

comes complete with test leads, operating manual and spare fuse
Model 2810 **\$110.50**



**Ungar
Heat Gun**
Reg. \$65.00
\$46.50



Weller Xcelite
Service Master Attache Style
Tool Kit
Model 99SM
\$42.95

Tool Cases
MODEL TC-100/ST
Reg. \$283.00
\$269.95

Roll Kit
Model 99PR
\$15.95

**BK PRECISION Digital
Capacitance Meter**



Reg. \$130.00
\$110.50 Model 820

Logic Monitor
• Automatically displays static and dynamic logic • Works with DTL, TTL, TTL and CMOS • 16 LED display
• Circuit powered design
Model LM-1 **\$52.95** complete

**CODE-4-PHONE
Telephone
Answering
Devices**
Wremote
Command
Model 1400 **\$199.95**

**BSR Changer
Accessories**
Model
BSR-128 **\$24.95**

**WAHL
NEW ISO-TIP
"Quick Charge"**
1 2 units
Model 7500 Cordless
Soldering Iron **\$17.95**
Model 5800 Thermal Spr.
Circuit Tester **\$22.50**

**ISORTIP
60
3-Way
Speaker**
20 oz. ceramic magnet
Model 7800 **\$14.95**

**BK PRECISION 15MHz
3" Dual Portable
Trace
Scope**
Model 1432P
Reg. \$780.00
\$663.
with probes

**NLS 15 MHz Mini
Oscilloscope**
Model MS 15

Reg. \$318.00
\$269.95

- Battery or line operation
- Automatic and line sync modes
- Power consumption: less than 15 W

NOW AVAILABLE
Dual Trace Version
Model MS 215 Reg. \$435.00 **\$369.95**



CS Logic Probe
Model LP-1
\$40.00

- Compact, circuit powered
- Detects pulses as short as 50 nSec.
- Multi-family compatibility: DTL, TTL, HTL, CMOS

**SENCORE
POCKET CRICKET
TRANSISTOR/FET TESTER**
Reg. \$125.00
\$99.95
TF 40



**LEADER
Instruments Corp.
20 MHz.
Dual Trace**
Model LBD-508
• Add, subtract modes on CH 1 & CH-2
• Front panel X-Y operation
• 17.5 nSec rise time
with accessories
Reg. \$769.95
\$654.50



**BK PRECISION
SUPER
SPECIAL**
Model 1827

**platt
Attach
Tool
Case
with 2
Removable Pallets**
Model 600T
Reg. \$89.00
\$65.00

**In-Dash
AM/FM 8 Track
Stereo**
C-777
\$52.50

**AM/FM
Cassette
Stereo**
CAS 888
\$57.50

**HICKOK
Function
Generator**
Model 1270
\$169.15

**BK PRECISION
Sub-
stitution
Box \$51**
Model 2910

**Weller
Controlled
Output
Soldering
Station**
check our prices
\$45.00
Reg. \$75.00
Model WTCP-N

**FREE
1979
Catalog**

**Auto Stereo 40 Watt
Power Booster
POW-40** Reg. \$39.95 **\$24.95**

**VOM Multimeters
20K ohm/v \$19.95
1K ohm/v \$9.95**



**30MHz
Portable
Frequency
Counter**
Reg. \$120.00
\$59.95

**"We Will Beat Any
Advertised Price"**

Call TOLL FREE
(800) 645-9518 For N.Y. State call
(516) 752-0050
Master Charge • Bank Americard
• COD • Check • Money Order
Add \$3.00 for shipping and insurance
C.O.D.'s Extra New York State
residents add approx sales tax

FORDHAM
855R Conklin St. Farmingdale, N.Y. 11735

BULLET ELECTRONICS

P. O. BOX 401244R
GARLAND, TX 75040
214/278-3553

SE-01 SOUND EFFECTS KIT

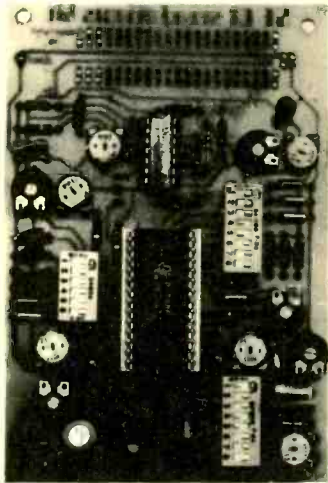

- ALL PARTS
- COMPLETE INSTRUCTIONS
- QUALITY PLATED & DRILLED BOARD
- IC SPECS INCLUDED
- RUNS ON ONE 9-VOLT BATTERY
- SMALL 3 1/2" x 5"
- **\$16.95** LESS SPEAKER & BATTERY
- 76477 CHIP IS INCLUDED. EXTRA CHIPS \$2.95 EACH

OTHERS WILL SELL YOU THE CHIP, BUT ONLY BULLET CAN FURNISH YOU A COMPLETE KIT OF ALL THE PARTS YOU NEED TO PUT THE T.I. 76477 SOUND CHIP THROUGH ITS PAGES! WE INCLUDE SPECS AND PROGRAMMING CHARTS. YOU WILL BE AMAZED AT THE THOUSANDS OF SOUND EFFECTS YOU CAN PRODUCE WITH OUR KIT! MAKE PHASOR GUN, STEAM TRAIN, GUNSHOT AND OTHER SOUNDS. BOARD HAS AUXILIARY PULSE GENERATOR, COMPARATOR AND MULTIPLEX OSC FOR EVEN MORE VERSATILITY.

NEW!

7 WATT AUDIO AMP KIT

SMALL, SINGLE HYBRID IC AND COMPONENTS FIT ON A 2" x 3" PC BOARD (INCLUDED). RUNS ON 12 VDC. GREAT FOR ANY PROJECT THAT NEEDS AN INEXPENSIVE AMP. LESS THAN 3% THD @ 5 WATTS. COMPATIBLE WITH SE-01 SOUND KIT.

\$5.95

6 DIGIT AUTO/VAN CLOCK

- LARGE 1/2" CHARACTERS (LED)
- QUARTZ XTAL TIMEBASE
- ALARM & SNOOZE OPTIONS
- NOISE FILTERING
- EASY TO ASSEMBLE
- 4 1/8" x 3" x 1 1/2"
- DRILLED & PLATED PC BOARDS

COMPLETE KIT
12 VDC

\$16.95

ULTRASONIC RELAY KIT

INVISIBLE BEAM WORKS LIKE A PHOTO ELECTRIC EYE. USE UP TO 25 FT. APART. COMPLETE KIT. ALL PARTS & PC BOARDS.

\$21.50

- NO COD'S
- SEND CHECK, M.O., M.C. OR VISA #
- ADD 5% FOR SHIPPING
- CATALOG FREE UPON REQUEST
- ORDERS UNDER \$10 ADD 75c
- TEX. RESIDENTS ADD 5% SALES TAX
- FOREIGN ADD 10%

PARTS

301 OP AMP 8 LEAD CAN	3/1.00
723 VOLT REG. 10 LEAD CAN	.50
*13741 FET INPUT 741 MINI DIP	3/1.10
30.000 @ 15V COMPUTER GRADE	2.10
2N4400 NPN GEN. PURPOSE	8/1.00
2N4402 PNP COMPLIMENT	8/1.00
2N6028 P.U.T. W/SPECS	.50
LM380 2W AUDIO IC W/SPECS	1.09
LM377 DUAL LM380 W/SPECS	2.50
*7815 VOLT REG. 1A 15V	.69
*725 LOW NOISE OP AMP	.99
IL-1 OPTO ISOLATOR MINI DIP	.60
*MEM 631 DUAL GATE MOSFET. DIODE PROTECTED. SIMILAR TO 40673	.50
MV1624 VARICAP DIODE 10 PFD	.49
1N4003 1A 200V DIODE	15/1.00
TIP30 TAB PNP POWER	3/1.00
*MC1351P FM IF. DISC IC	.50

*INDICATES ITEM IS "HOUSE NUMBERED"

LED'S

JUMBO GREEN	4/.89
JUMBO RED	5/.89
MEDIUM RED (1/8")	.15
MEDIUM GRN OR YELLOW	.16

WHEEL OF FORTUNE KIT

POPULAR GAME DEVICE USES LEDs, TRANSISTORS AND IC TO GIVE THE EFFECT OF A BRIGHT RED BALL SPINNING AROUND NUMBERS. UNIT EMITS A CLICKING SOUND AS BALL SPINS AND FINALLY STOPS ON A NUMBER. KIT COMES WITH ALL PARTS, PC BOARD AND FACEPLATE. CASE AND 9V BATTERY NOT INCLUDED.



\$8.99

Crystal 14.04 Mhz Oscillator
IC clock oscillator
C23289 **\$1.98**

V.O.X.
Solid state Voice Operated Switch Complete and as member With schematic **99c**

LED PANEL MOUNTING HITS
13 for \$1

MICRO-MINIATURE ROTARY SWITCH
1 POLE 2 POSITION **79c**

SEND FOR YOUR FREE CATALOG

Electronic Warning Flasher Kit

This battery operated device continuously emits bursts of intense light. Great safety device for bicycle riders, skiers, hikers, boaters & campers. Comes complete w/ all electronic parts, quality glass epoxy PC board & easy to understand instructions. Uses high-output xenon flash tube which flashes 2 times per second when batteries are fresh. Operates continuously for 12 hours on 2 alkaline "C" batteries. You need only to supply the batteries and, if desired, a battery holder & case.



C23207 **\$6.95**

Strobe Light Kit

6 MV TRIGGER COILS
required to "fire" xenon flash tubes **89c**

SLA-1
7 SEGMENT COMMON ANGLE SELECTOR CHARACTER HEIGHT .33". PERM. SEALED Pkg. 4 for **\$2.00**

PHOTOFLASH CAPS
350 mf 330V **1.00**
720 mf 360V **1.50**
1600 mf 360V **\$2.25**

JUMBO RED LED
FROSTED WHITE LENS
10 for **\$1**
C23778

STROBE TUBE ASST.
Brand new factory prime strobe tubes. Assortment of 5 strobe tubes, w/ schematics **\$3.00**

HIGHLY POLISHED REFLECTOR
FOR STROBE TUBES
C23451 **\$2.49**

CHANEY electronics

- Minimum order \$5.00
- Please include \$1 for postage
- Visa, MC and COD accepted.
- Phone orders are welcome.

P.O. BOX 27038, DENVER, CO. 80227 Ph: (303) 781-5750

Send for our FREE GIANT CATALOG of unique items!

Now, more than ever
...Men who KNOW say...



IS THE ANSWER

HELP NATESA HELP YOU
BY DOING YOUR PART

Are YOU the operator of an ethical, professional caliber tv-radio-home electronics service business?

Write for details on how you can gain great benefits and participate in the destinies of this great industry.

NATESA
5908 South Troy Street
Chicago, Illinois 60629

CIRCLE 70 ON FREE INFORMATION CARD

SEND FOR YOUR FREE TEK-EL CATALOG
Complete Listings of IC, Transistors, Capacitors, Resistors and readouts along with migr. closets and surplus material.
• Hobbyist • Experimenter • Wholesale & Dealer inquiries invited

THREE ELEMENT 120VAC CORNING HOT PLATE 1/8" TEXTURED GLASS SURFACE RATED AT 120 WATTS BUILT IN THERMOSTAT

A THERMIONIC UNIQUILITY at a bargain price! Brand new top quality, multi-purpose hotplate generates up to 150° C from three 3" (dia) circular elements. Granular Finish Corning glass promotes the most even thermal distribution. Neon safety lamp is triggered by the built in thermostat and glows bright orange thru the glass... as a reminder that the unit is on. THE APPLICATION list is so numerous that we leave it up to you and your imagination.
Cat. No. 102-RE Wt. 1 lb. Price \$3.95

THERE is now a better way to measure or monitor mechanical motion with magnetically-activated "HALL EFFECT" integrated circuits.

Available exclusively at Tek-El. The unique device is actually a non-mechanical digital switch mounted in a TO-92 style package. APPLICATIONS are unlimited, keyboards, and security devices, etc. Supplied with app notes and spec sheets.
Cat. No. 100-RE Wt. 1 oz. Price \$1.49
10 for \$12.00

COD'S MAY BE PHONED!
TERMS: Add Postage
RATED: Net 30
PHONE: (617) 631-7434 9:00 A.M. to 4:30 P.M.
MINIMUM ORDER: \$10
Mastercharge and Visa accepted.
When ordering, always use catalog number, type no., the name of the magazine you are ordering from and the month.



TEK-EL Corp.
P.O. Box 761R
Marblehead, Mass.
01945

CIRCLE 40 ON FREE INFORMATION CARD

AVAILABLE NOW!

ONLY \$3.95
Add \$1.00 for shipping

JAPANESE TRANSISTOR SUBSTITUTION MANUAL



An invaluable Japanese to Japanese substitution guide for approximately 3000 transistors

- Covers the 2SA 2SD 2SC and 2SD series
- Introduction includes a guide to understanding Japanese transistors
- A 90 page 8 1/2 by 11 soft cover book

PARTS PROCUREMENT PROBLEMS

FUJI-SVEA Has the Largest Inventory of Original Japanese Parts Anywhere

Seeking Original Japanese Replacement Parts for CB, TV and Stereo Repair Use?

TYPE	25-UP	10-24	1-9	TYPE	25-UP	10-24	1-9	TYPE	25-UP	10-24	1-9	TYPE	25-UP	10-24	1-9	TYPE	25-UP	10-24	1-9
2SA 473	45	55	60	2SB 346	30	35	40	2SC 693F	20	27	30	2SC 1226A	50	55	60	2SD 234	60	70	.80
2SA 483	2.00	2.20	2.50	2SB 367	1.10	1.25	1.40	2SC 696	1.00	1.20	1.30	2SC 1237	1.80	2.00	2.25	2SD 235	60	70	.80
2SA 484	1.50	1.75	1.95	2SB 368B	1.80	2.00	2.25	2SC 708	1.30	1.45	1.60	2SC 1239	2.20	2.70	2.90	2SD 261	35	40	.45
2SA 485	1.40	1.60	1.80	2SB 379	70	80	90	2SC 710	20	27	30	2SC 1279	50	55	60	2SD 287	2.50	2.70	2.90
2SA 489	1.10	1.25	1.40	2SB 381	30	35	40	2SC 711	20	27	30	2SC 1306	1.30	1.45	1.60	2SD 300	4.50	5.00	5.60
2SA 490	70	80	90	2SB 400	30	35	40	2SC 712	20	27	30	2SC 1307	1.90	2.10	2.40	2SD 313	60	70	.80
2SA 493	45	53	59	2SB 405	30	35	40	2SC 715	30	35	40	2SC 1310	20	27	30	2SD 315	60	70	.80
2SA 495	30	35	40	2SB 407	80	90	100	2SC 717	35	40	45	2SC 1312	20	27	30	2SD 320	60	70	.80
2SA 496	50	64	70	2SB 415	30	35	40	2SC 727	1.00	1.20	1.30	2SC 1313G	20	27	30	2SD 330	60	70	.80
2SA 497	1.00	1.20	1.30	2SB 434	80	90	100	2SC 730	3.00	3.20	3.40	2SC 1316	4.20	4.40	4.90	2SD 350	3.80	4.00	4.40
2SA 505	50	64	70	2SB 437	90	1.10	1.20	2SC 731	2.50	2.70	2.90	2SC 1317	20	27	30	2SD 380	5.20	5.40	5.95
2SA 509	30	35	40	2SB 440	40	53	59	2SC 732	20	27	30	2SC 1318	35	40	45	2SD 381	85	100	1.10
2SA 525	50	64	70	2SB 449	1.30	1.45	1.60	2SC 733	20	27	30	2SC 1325A	6.50	6.90	7.60	2SD 424	3.80	4.00	4.40
2SA 530	1.50	1.70	1.90	2SB 461	90	1.10	1.20	2SC 734	20	27	30	2SC 1327	20	27	30	2SD 425	2.90	3.20	3.40
2SA 537A	1.50	1.70	1.90	2SB 463	90	1.10	1.20	2SC 735	20	27	30	2SC 1330	50	55	60	2SD 426	3.10	3.30	3.60
2SA 539	40	45	50	2SB 471	1.10	1.25	1.40	2SC 738	20	27	30	2SC 1342	45	53	59	2SD 525	1.80	2.00	2.25
2SA 545	45	53	59	2SB 472	2.10	2.50	2.80	2SC 756	1.50	1.80	2.00	2SC 1344	45	53	59	2SD 526	60	70	.80
2SA 551	30	35	40	2SB 473	80	90	100	2SC 756A	1.50	1.80	2.00	2SC 1358	4.20	4.40	4.90	2SK 19BL	50	55	60
2SA 562	30	35	40	2SB 474	70	80	90	2SC 772	30	35	40	2SC 1359	30	35	40	3SK 229	1.40	1.60	1.80
2SA 564A	20	27	30	2SB 481	90	1.10	1.20	2SC 773	35	40	45	2SC 1360	50	55	60	3SK 39	350	400	450
2SA 565	70	80	90	2SB 492	60	70	80	2SC 774	1.00	1.20	1.30	2SC 1362	35	40	45	3SK 40	1.90	2.10	2.40
2SA 566	2.50	2.70	3.00	2SB 507	80	90	100	2SC 775	1.40	1.60	1.80	2SC 1364	35	40	45	3SK 41	1.30	1.45	1.60
2SA 606	1.00	1.20	1.30	2SB 509	1.10	1.20	1.30	2SC 776	2.00	2.20	2.50	2SC 1377	3.20	3.40	3.70	3SK 45	1.30	1.45	1.60
2SA 607	1.10	1.25	1.40	2SB 511	70	80	90	2SC 777	3.00	3.25	3.50	2SC 1383	30	35	40	AN 203	1.40	1.60	1.80
2SA 624	70	80	90	2SB 514	70	80	90	2SC 778	2.90	3.20	3.40	2SC 1384	35	40	45	AN 214Q	1.50	1.70	1.90
2SA 627	3.10	3.30	3.60	2SB 523	70	80	90	2SC 781	1.90	2.10	2.40	2SC 1396	45	53	59	AN 239	4.20	4.40	4.90
2SA 628	30	35	40	2SB 526C	70	80	90	2SC 783	2.10	2.50	2.80	2SC 1400	35	40	45	AN 247	2.50	2.70	3.00
2SA 634	40	45	50	2SB 527	90	1.10	1.20	2SC 784	20	27	30	2SC 1402	3.00	3.20	3.40	AN 274	1.50	1.75	1.95
2SA 640	30	35	40	2SB 528D	70	80	90	2SC 785	35	40	45	2SC 1403	3.20	3.40	3.70	AN 313	3.00	3.20	3.40
2SA 642	30	35	40	2SB 529	70	80	90	2SC 789	80	90	100	2SC 1407	50	55	60	AN 315	1.80	2.00	2.25
2SA 643	30	35	40	2SB 530	3.20	3.40	3.70	2SC 790	80	90	100	2SC 1419	60	70	80	BA 511A	1.80	2.00	2.25
2SA 653	1.90	2.10	2.40	2SB 531	1.80	2.00	2.25	2SC 793	2.00	2.20	2.50	2SC 1444	1.60	1.80	2.00	BA 521	1.90	2.10	2.40
2SA 659	35	40	45	2SB 536	1.00	1.20	1.30	2SC 795	2.00	2.20	2.50	2SC 1445	2.50	2.70	2.90	HA 1151	1.50	1.75	1.95
2SA 661	50	64	70	2SB 537	1.00	1.20	1.30	2SC 799	2.00	2.20	2.50	2SC 1447	60	70	80	HA 1156W	1.60	1.80	2.00
2SA 663	3.65	3.80	4.25	2SB 539	3.20	3.40	3.70	2SC 829	20	27	30	2SC 1448	70	80	90	HA 1306W	2.00	2.20	2.50
2SA 666	35	40	45	2SB 541	3.20	3.40	3.70	2SC 830H	2.50	2.70	3.00	2SC 1449	60	70	80	HA 1339	2.50	2.70	3.00
2SA 671	80	90	100	2SB 554	5.00	6.00	6.60	2SC 838	35	40	45	2SC 1451	1.00	1.10	1.20	HA 1339A	2.50	2.70	3.00
2SA 672	30	35	40	2SB 556	3.20	3.40	3.70	2SC 839	30	35	40	2SC 1454	3.20	3.40	3.70	HA 1366W	2.50	2.70	3.00
2SA 673	35	40	45	2SB 557	2.10	2.50	2.80	2SC 853	70	80	90	2SC 1475	80	90	100	HA 1366WR	2.50	2.70	3.00
2SA 678	35	40	45	2SB 561B	35	40	45	2SC 867A	3.20	3.40	3.70	2SC 1478	50	55	60	LA 4031P	1.80	2.00	2.25
2SA 679	4.20	4.40	4.90	2SB 565	1.10	1.40	1.50	2SC 870	35	40	45	2SC 1509	50	55	60	LA 4032P	1.80	2.00	2.25
2SA 680	4.20	4.40	4.90	2SB 595	1.10	1.40	1.50	2SC 871	35	40	45	2SC 1567	60	70	80	LA 4051P	1.80	2.00	2.25
2SA 682	80	90	100	2SB 596	1.10	1.40	1.50	2SC 895	4.20	4.40	4.90	2SC 1567A	60	70	80	LA 4051P	1.80	2.00	2.25
2SA 683	30	35	40	2SB 600	5.00	6.00	6.60	2SC 897	2.00	2.20	2.50	2SC 1584	6.00	6.30	7.00	LA 4400Y	2.00	2.20	2.50
2SA 684	35	40	45	2SC 183	40	53	59	2SC 898	2.50	2.70	3.00	2SC 1624	60	70	80	LA 4420	2.00	2.20	2.50
2SA 695	40	53	59	2SC 184	40	53	59	2SC 900	20	27	30	2SC 1626	60	70	80	LD 3001	2.00	2.20	2.50
2SA 697	40	53	59	2SC 281	30	35	40	2SC 923	20	27	30	2SC 1628	60	70	80	MT5 1513L	2.00	2.20	2.50
2SA 699A	50	64	70	2SC 283	40	53	59	2SC 929	20	27	30	2SC 1647	70	80	90	STK 01	3.80	4.00	4.40
2SA 705	40	53	59	2SC 284	80	90	100	2SC 930	20	27	30	2SC 1667	3.00	3.20	3.40	STK 015	4.20	4.40	4.90
2SA 706	85	100	1.10	2SC 317	40	53	59	2SC 945	20	27	30	2SC 1669	90	1.00	1.10	STK 435	4.50	5.00	5.60
2SA 715	60	70	80	2SC 352A	2.00	2.20	2.50	2SC 959	1.00	1.20	1.30	2SC 1674	30	35	40	STK 490	7.90	8.00	8.80
2SA 719	30	35	40	2SC 353A	1.40	1.60	1.80	2SC 971	70	80	90	2SC 1675	20	27	30	TA 7045M	2.00	2.20	2.50
2SA 720	30	35	40	2SC 367	60	70	80	2SC 982	70	80	90	2SC 1678	1.10	1.25	1.40	TA 7051P	2.00	2.20	2.50
2SA 725	30	35	40	2SC 369	30	35	40	2SC 988	50	64	70	2SC 1679	3.00	3.20	3.40	TA 7061AP	90	1.10	1.20
2SA 726	30	35	40	2SC 370	20	27	30	2SC 993	35	40	45	2SC 1681	30	35	40	TA 7062P	1.10	1.25	1.40
2SA 733	20	27	30	2SC 371	30	35	40	2SC 1000	35	40	45	2SC 1682	30	35	40	TA 7203P	2.50	2.70	2.90
2SA 738	40	53	59	2SC 372	20	27	30	2SC 1012	1.20	1.40	1.50	2SC 1684	30	35	40	TA 7204P	2.00	2.20	2.50
2SA 740	1.50	1.70	1.90	2SC 373	30	35	40	2SC 1013	50	64	70	2SC 1687	40	45	50	TA 7205P	1.60	1.80	2.00
2SA 743A	85	100	1.10	2SC 375	30	35	40	2SC 1014	50	64	70	2SC 1688	35	40	45	TA 7222P	3.40	3.55	3.90
2SA 744	4.20	4.40	4.90	2SC 380	20	27	30	2SC 1017	80	90	100	2SC 1708	1.30	1.45	1.60	TA 7310P	1.30	1.45	1.60
2SA 745R	3.80	4.00	4.40	2SC 381	35	40	45	2SC 1018	60	70	80	2SC 1728	70	80	90	TBA 8105H	1.90	2.10	2.40
2SA 747	4.20	4.40	4.90	2SC 382	35	40	45	2SC 1030	1.80	2.10	2.40	2SC 1730	45	53	59	TC 5080P	5.00	5.20	5.60
2SA 748	70	80	90	2SC 383	35	40	45	2SC 1047	35	40	45	2SC 1756	50	55	60	TC 5081P	3.00	3.20	3.40
2SA 750	35	40	45	2SC 387A	35	40	45	2SC 1051	3.40	3.55	3.90	2SC 1760	70	80	90	TC 5082P	3.40	3.55	3.90
2SA 755	80	90	100	2SC 388A	40	53	59	2SC 1080	70	80	90	2SC 1816	1.50						



WE'VE GOT THE BUG, (THE NEW MOTOROLA TV BUG, THAT IS!)

By now you've probably read the article in June issue of Kilobaud about Motorola's new fantastic Miro Chroma 68. It is the latest in TV Bugs which enables you to hook up directly to your own standard color TV with the fewest of parts.

Micro Chroma 68 kit includes:
MC1372—Color TV video modulator.
MC6821—Peripheral interface adapter.
MC6808—Microprocessor with clock.
MC6846—Rom—I/O—Timer.
MC6847—Video display generator.
MC6850—Asynchronous communications interface adapter.

Also includes printed circuit board and data sheets on all above mentioned LSI.



\$129.⁹⁵

IN STOCK AND NOW AVAILABLE THROUGH AUSTIN ELECTRONICS.

AND WE'VE GOT THE PARTS KIT!

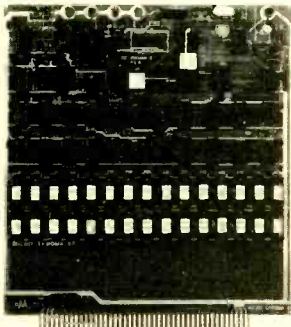

We at Austin Electronics went one step further and put together a parts kit of all support devices. These parts for the average enthusiast would be very difficult to find and expensive. We've made it easy and substantially less expensive.

Bug kit II comes complete with all components necessary for on board operation. Including (6) 2114 rams.

BUG KIT II.....\$149.95
MICRO CHROMA 68 KIT.....\$129.95
PC BOARD SEPARATE.....\$45.00
ADDITIONAL 2114 RAMS.....\$8.50
BUY THE MICRO CHROMA 68 AND THE BUG KIT II NOW SAVE \$15.00.

SEND FOR OUR NEW CATALOG WHICH INCLUDES GREAT BARGAINS ON ASCII KEYBOARDS, MODEMS, COMPUTER POWER SUPPLIES, ETC.

AUSTIN ELECTRONICS



1536 EAST ANDERSON LN.
SUITE E
AUSTIN, TEXAS 78752

TERMS: Check or money order, NO COD's. Texas residents add 5% sales tax. Overseas countries add \$5.00 for surface rates.

1-512-836-9677

CIRCLE 35 ON FREE INFORMATION CARD

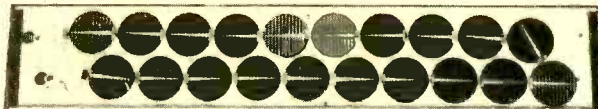

Electricity from the sun
GIANT 3 1/2 inch cell, delivers 1 amp \$8.50
Giant cell w/special motor & propellor \$10.25

SOLID STATE power supply 12 VDC 15 amp \$40.00
SOLID STATE power supply 5 VDC 35 amp \$50.00
Above supplies unused in original cartons. Operate from 115 volts AC 60 cycle. Made for computer work. Solid state, filtered, regulated, over voltage protected.

ULTRASONIC room alarm, intrusion detection with full data for hookup.....\$40.00

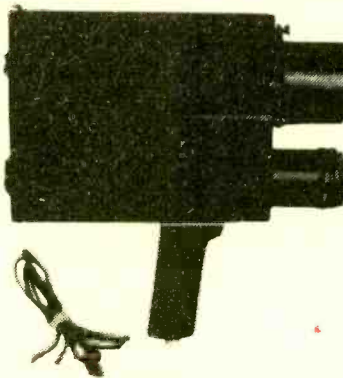

SEE IN THE DARK
IR viewer complete ready to operate. Guaranteed by the manufacturer. Portable, runs on lantern battery. New, see in total darkness. No shipments to Calif. Comes complete with built in IR source and adjustable focus lens.
SPL-21 \$199.00

All items FOB Lynn, Mass. Send for free 72 page catalog jam packed with goodies. Micro Processor Power Supplies Brand New 60% Discount. Send for List.

Meshna Inc., PO Box 62, E. Lynn, Mass. 01904

CIRCLE 43 ON FREE INFORMATION CARD

LEADER Test Instruments

OSCILLOSCOPES

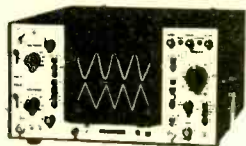

MODEL LBO-520

The 30 MHz Dual Trace Oscilloscope with Delay

- 5mV sensitivity.
- Built-in delay line.
- Single shot trigger (CH-1, CH-2).
- 5" P-D-A CRT assures brighter, sharper trace.
- 20 nSec/cm sweep capability plus 11.7 nSec rise time.

LIST PRICE: \$1050 OUR PRICE: **\$888**



MODEL LBO-515

25 MHz Dual Trace, Oscilloscope Delayed Sweep

- Sweep delay, continuously variable from 1 uSec to 5 Sec.
- 5 mV/Div. Vertical Sensitivity with ±3% acc.
- Rectangular CRT with internal graticule.
- 14 nSec rise time.
- CH-1 or 2 trigger; HF filter; and TV sync.

LIST PRICE: \$1395 OUR PRICE: **\$1180**



MODEL LBO-506

The 20 MHz Dual Trace Oscilloscope

- Add & subtract modes (with CH-2 invert).
- Front panel X-Y operation.
- 17.5 nanosec rise time.
- Automatic trigger from either channel, including TV sync.
- 10 mV sensitivity.

LIST PRICE \$769 OUR PRICE: **\$635**

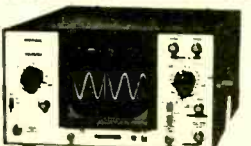

MODEL LBO-507

The 20 MHz Single Trace Triggered Oscilloscope

- Outstanding trigger sensitivity over entire operational range.
- 10 mV sensitivity and 17.4 nSec rise time.
- X5 magnification (±5%) delivers 100 nSec/cm maximum speed for easy, precise readings.

LIST PRICE: \$549 OUR PRICE: **\$455**



NEW DIGITAL MULTIMETERS



8022A

- 10,000 MΩ resistance meas with conductance function
- Extensive overload and transient protection
- Rugged construction — MIL-T-28800
- Hi/Lo power ohms for in-circuit resistance and diode testing
- 10 MΩ input impedance doesn't load circuit
- 200 hour battery life — low battery indicator
- Large LCD readout — 2000 counts
- 1 year calibration cycle — only 3 adjustments
- One-hand operation

OUR PRICE: **\$129**



8010A

OUR PRICE **\$239**

8012A

OUR PRICE **\$299**

- Large 3 1/2-Digit LCD's - view in any light
- Conductance function - resistance to 10,000 MΩ
- AC measurements to 50 kHz and higher
- True RMS for ac accuracy
- Touch-Hold probe for tricky places (Y8008)
- Diode test and low power ohms
- One year accuracy reduces calibration costs
- COMMON floatable to 500V
- Recessed jacks reduce shock hazard
- Current mode fuse protection to 600V
- Voltage mode transient protection to 6 kV
- Autozero and autopolarity
- AC or dc current to 10 amps with 8010A
- Resistance resolution to 0.001Ω with 8012A
- Built-in batteries and charger (Option -01)
- Rugged enough for field or bench

SEND FOR OUR CATALOG

Call TOLL FREE:

[800]526-2514 * [201]227-7720

AMPOWER INST., INC.

26 JUST ROAD, FAIRFIELD, N. J. 07006

THE MEASUREMENT SPECIALISTS
"WE SERVICE WHAT WE SELL"



Mastercharge
Bankamericard
and
COD Accepted
add \$3.00 to
cover shipping
handling insurance
N.J. res. add
5% tax.

FREE
TEST LEADS
WITH EVERY
ORDER

CALL
TODAY

CIRCLE 66 ON FREE INFORMATION CARD

MA1003 CLOCK AND CASE SPECIAL: \$19.95!

Easy to build: just add 12V DC and time-setting switches. Includes built-in crystal timebase — ideal for mobile and portable operation. Beautiful blue-green fluorescent readouts. Case includes filter and mounting hardware; available separately for \$5.95. MA1003 module available separately for \$16.50.

16K MEMORY EXPANSION CHIP SET \$109 (3/\$320)

For Radio Shack-80, Exidy Sorcerer, and Apple machines. Compare our features with similar chip sets: 250 ns access time, DIP shunts included, 1 year limited warranty, and easy-to-follow instructions that make memory expansion a snap — even for beginners.

★★★ POPULAR ICs ★★★ AT POPULAR PRICES

Low power 2102s for 2 MHz systems: 10/\$9.90. 1791 MOS LSI dual density disc controller from Western Digital: \$59 with pinout and data. 1771 single density controller: \$22.50. All parts offered on a while-they-last basis.

H8 EXTENDER BOARD KIT

Brand new from Mullen Computer Products. This kit really takes the hassle out of troubleshooting or testing the popular Heath H8 computer. Includes jumper links in supply lines for insertion of fuses, Ammeters, current limiters, etc.

\$39

TERMS: Cal res add tax. Allow 5% shipping, excess refunded; orders under \$15 add \$1 handling. VISA/Mastercharge* call 24 hr. order desk at (415) 562-0636. Prices good through cover month of magazine. COD OK with street address.



BILL GODBOUT ELECTRONICS
BOX 2355, OAKLAND AIRPORT, CA 94614

FREE FLYER: Our new flyer is filled with bargains for computer users, electronic musicians, experimenters, and mad scientists. Send us your name and address, we'll take care of the rest. For 1st class delivery include 41¢ in stamps.

CIRCLE 63 ON FREE INFORMATION CARD



save on gas!

Enjoy the benefits of 20% better gas mileage, quicker starting, elimination of tune-ups, reduced pollution, and 50,000 miles on plugs and points.

Update your car with a TIGER solid state electronic ignition system. Easily installed in 30 minutes . . . even on new cars.

Tiger 500 CD
Assembled \$49.95
Simplikit \$29.95

Postpaid USA.

Master Charge & Bank Americard accepted.



Phone (303) 243-5200
P.O. Box 1727

Grand Junction, Colorado 81501

CIRCLE 25 ON FREE INFORMATION CARD

HOUSE MARKED SPECIAL DARLINGTON POWER TRANSISTOR

16 Amps 60 Volts 150 Watts
Similar to MJ4030 PNP
MJ4033 NPN \$1.50 each
Specify NPN or PNP

HEAVY DUTY 12 VOLT RELAY
• Clear Plastic Enclosed
• 3 PDT
• 12 Amp Contacts \$3.00 each

3 AMP DIODES
• 100 PIV
• Axial Leads \$1.00 Package of 8

MERCURY SWITCH
60¢ each

ALCO MINIATURE SWITCH
• S P D T
• 6 Amps c 125 Volts \$1.15 each 10 for \$10.00

MAGNETICALLY ACTIVATED SWITCH
• N O W/Magnet Engaged
• Installs in 1/4" Hole
• Magnet Included 75¢ each

10 MEG POTS
• Standard 1/4 Watt Size
• 3/8" Long Shaft 1/4" Dia
4 for \$1.00
25 for \$5.00

10 K LINEAR SLIDE POTS
3" Long 75¢ each

MALLORY COMPUTER GRADE 150,000 MFD 15 VDC
• 3" Dia 5" High
• 18V Surge \$3.50 each

CORNELL DUBILIER TANTALUM CAPACITOR 150 MFD 30 VDC
• 3/4" Long 3/8" Dia
• Axial Leads 75¢ each

ALL ELECTRONICS CORP.

SEND FOR OUR FREE FLYER
905 S. Vermont Ave.
Los Angeles, CA 90006
(213) 380-8000
Store & Warehouse Hours
9 AM - 5 PM
Monday thru Friday

- Quantities Limited
- Min Order \$5.00
- Add \$1.50 Shipping USA
- Calif Res Add 6%
- Same Day Shipping with Cert Check or M/O

CIRCLE 37 ON FREE INFORMATION CARD

HOBBY WORLD
CALL TOLL FREE: (800) 423-5387
CA, HI, AK: (213) 886-9200

This Month's SPECIALS

Cat No.	Description	Price
1292	1979 IC MASTER, with updates	\$35.00
1147	VERBATIM DISKETTES, TRS-80,	
	Apple box of 10 for	\$27.00
1142	DATA CASSETTES, C-10, leaderless	10 for \$17.00
KR2376	ST KEYBOARD ENCODER ROM, ASCII	\$9.50
1340	TRANSIENT/EMI FILTER, 20Amp, Corcom 20B1	\$6.00
76477	COMPLEX SOUND GENERATOR IC.	\$2.75
1358	10 x 18" COPPER CLAD PC, two sided, 1 oz. C.	\$3.00
1150-14.3	74.31818 MHz CRYSTAL, 4x color burst.	\$2.00
1233	SWITCHING DIODES, 1N4148, factory prime 20 for	\$1.00
1339	TRANSFORMER, SV, 3A, with 15V 1/2 A.	\$3.00
1156	16K MEMORY ADD-ON, for TRS-80, Apple	\$65.00
1007	12V, 300mA TRANSFORMER, PC leads	\$ 75
1226	LINE CORDS, 6 ft., #18, with molded plug.	4 for \$1.00
1117	14 PIN IC SOCKETS, soldertail	6 for \$1.00
1117	16 PIN IC SOCKETS, soldertail	5 for \$1.00
1289	4 POS DIP SWITCH	\$1.25
1296	7 POS DIP SWITCH	\$1.40
1291	8 POS DIP SWITCH	\$1.60
1224	SOUND ACTIVATED SWITCH, (vox)	2 for \$1.00
1167	40 CONDUCTOR RIBBON CABLE	10 Ft. \$5.00
1337	MINI-XIKIE TUBES, Burroughs B5853-S1	2 for \$1.00
1378	AC RECEPTACLE, 2 prong, chassis mt	4 for \$1.00
1387	AC RECEPTACLE w/GND	
	3 prong, chassis mt	2 for \$1.00
1139	2N3904 TRANSISTOR EQUAL, npn, switching 8 for	\$1.00
1140	2N3906 TRANSISTOR EQUAL, pnp, switching 8 for	\$1.00
1150-18	18MHz CRYSTAL, .002% tol	\$3.00
1150-24	24MHz CRYSTAL, .002% tol	\$3.00
1150-36	36MHz CRYSTAL, .002% tol	\$3.00
7805T	LM340T-5, 5V, 1A VOLTAGE REGULATORS	2 for \$1.50

TTLs

7400 .15	7446 .75	74126 .40
7401 .20	7447 .65	74132 .65
7402 .20	7448 .75	74145 .65
7403 .20	7450 .20	74151 .60
7404 .20	7451 .20	74153 .60
7405 .20	7452 .20	74154 1.00
7406 .30	7454 .20	74155 .70
7407 .30	7460 .20	74157 .60
7408 .20	7470 .30	74160 .85
7409 .20	7472 .25	74161 .75
7410 .20	7473 .35	74163 .75
7413 .35	7474 .35	74165 .95
7414 .60	7475 .45	74166 1.25
7416 .25	7476 .35	74170 1.40
7417 .25	7481 .20	74173 1.10
7420 .20	7483 .60	74174 .85
7423 .25	7485 .75	74175 .70
7425 .25	7486 .35	74176 .80
7426 .25	7489 1.75	74177 .75
7427 .25	7490 .45	74180 .65
7430 .25	7491 .55	74181 1.75
7432 .25	7492 .45	74191 .95
7437 .25	7493 .45	74192 .75
7438 .25	7495 .65	74193 .75
7440 .20	7496 .65	74221 .85
7441 .70	74107 .35	74251 .80
7442 .50	74109 .55	74365 .65
7443 .50	74121 .35	74366 .65
7444 .25	74122 .40	74367 .65
7445 .75	74123 .60	74368 .65

Voltage Regulators

Type	Equal to	Voltage	Case	Price
7805K	LM340K-5	+5	TO-18	\$1.40
7812K	LM340K-12	+12	TO-18	1.40
7815K	LM340K-15	+15	TO-18	1.40
7805L	LM340L-5	+5	TO-220	.95
7812L	LM340L-12	+12	TO-220	.95
7815L	LM340L-15	+15	TO-220	.95
7818T	LM4018	+18	TO-220	.95
7824T	LM340T-24	+24	TO-220	.95

Send for FREE CATALOG
Featuring
The best selection of computer accessories add-ons, factory fresh IC's, led's, semi's, software, PC aids, prototyping aids, books, test equipment, and more! Always updated! Dozens of new products every issue!

19355 BUSINESS CTR DR 6R7
NORTHRIDGE, CA 91324

CIRCLE 53 ON FREE INFORMATION CARD

YOU'RE UNDER SURVEILLANCE!!

A HOST OF PEOPLE, AGENCIES, AND COMPUTERS ARE BUSY SPYING ON YOU AND YOUR BUSINESS EVERY DAY, OFTEN ILLEGALLY. . . .

HOW TO STOP IT OR DO IT BACK!



A Large Format (8 1/2" x 11") Quality Paperback, 240 Pages

BUGGING WIRETAPPING TAILING OPTICAL AND ELECTRONIC SURVEILLANCE SURREPTITIOUS ENTRY DETECTIVE TECHNIQUES WEAPONS COUNTERMEASURES

"A VIRTUAL ENCYCLOPEDIA ON SURVEILLANCE . . . EVERYTHING YOU'VE ALWAYS WANTED TO KNOW ABOUT SPYING."

PLAYBOY MAGAZINE

\$11.95 POSTPAID

With this order
FREE SHOPPING BOOKLET FOR DETECTIVES—plus other investigative materials.

QUIMTRONIX
Postpaid—P.O. Box 548-RE
Seattle, Washington 98111
CIRCLE 15 ON FREE INFORMATION CARD

CUSTOMERS THE WORLD OVER ARE CLAMORING FOR OUR GIANT

"ONE CENTERS"

A PENNY MORE GETS YOU TWO

SALE

Spectrol

"SKINNY-TRIMS" POTENTIOMETERS

SINGLE TURN FLAT Type-63
Cat. No. 92CU3866

3/8" square Single turn style Screw driver adjust 20% tolerance 0.5 Watt ratings, cermet construction, PC leads

10	1K	25K
20	2K	50K
50	2.5K	100K
100	5K	200K
200	10K	500K
500	20K	1Meg

2 FOR \$1.29
4 FOR \$1.30

ORDER BY CAT. NO. AND VALUE

25 AMP BRIDGE RECTIFIERS

PIV	SALE	2 FOR
25	1.25	1.24
50	1.95	1.94
100	2.25	2.24
200	2.95	2.94
400	3.50	3.51
600	4.25	4.26
800	4.95	4.94

Order No. 2273 & voltage

"CRIMP-ON" PL-259 COAX PLUG 2 for \$1.29

Quick, Easy, proper crimping. No Soldering! Strip insulation, squeeze. Mates to SO-239 For RG58/U - 50 ft. Cat. No. 92CU5696

4 for \$1.30

"THE FAT" MALLORY AA MERCURY BATTERY 2 for \$1.50

Cat. No. 92CU5679

1N4000 Epoxy Rectifiers

Cat. No.	Type	Volts	Size	IC SALE:
2377	1N4001	50	10 for	\$.75 20 for \$.76
2378	1N4002	100	10 for	.85 20 for .86
2379	1N4003	200	10 for	.95 20 for .96
2380	1N4004	400	10 for	1.19 20 for 1.20
2381	1N4005	600	10 for	1.39 20 for 1.40
2382	1N4006	800	10 for	1.49 20 for 1.50
2383	1N4007	1000	10 for	1.59 20 for 1.60

LEDS:
YOUR CHOICE 6 for \$1.29
*C SALE 12 for \$1.30
Order by Cat. No.

1788	MICRO TOPHAT RED
1789	MFD YELLOW STUBBY
1802	MICRO SINGLE PIN RED
2125	JUMBO RED
2130	JUMBO GREEN
2137	MICRO RED
2790	JUMBO RED CLEAR

3 ELEMENT 120 VAC HOTPLATE \$6.88 2 for \$6.89

This Top Quality, Multi Purpose Hotplate features Built-in Thermostat, Neon Red AC Indicator Lamp, and 1/8" Textured Glass Surface for even heat distribution. Generates up to 150°C. 120 watts. Use for photographic applications, laboratory work, aquarium heater, plants, etc. Size: 10-3/8" x 5-9/16" x 1-1/8". Wt. 1 lb. 2 oz.
Cat. No. 92CU5723

1 AMP 20 for 1000 VOLT MINI RECTIFIERS \$2.49

Famous 1N4007 epoxy rec.ifiers, marked with axial leads. 100% Free with axial leads. 100% of hobby uses.
Cat. No. 92CU2383

40 for \$2.50

- 6- OPTO-COUPLER, 1500V isolation, hobby material, u test (#2629A) 1.29 12 for 1.30
- 6- 2N915 UHF TO-18 TRANSISTORS (#1423) 1.29 12 for 1.30
- 75-MOLEX SOCKETS, Type M1938-4, makes 14 to 40 pin sockets (#1609) 1.29 150 for 1.30
- 6-CALCULATOR AC ADAPTOR JACK, standard threads 3 terminals (#2316) 1.29 12 for 1.30
- 50-TUBE SOCKETS, 4, 5, 6, 7 pin tubes, ass't (#3839) 1.29 100 for 1.30
- 40 CTS RESISTOR NETWORK, ass't styles and values, singles and dips, (#5699) 1.29 80 for 1.30
- 10-BULLET RECTIFIERS, 1.5 amp, 200V, axial (#84) 1.29 20 for 1.30
- 6-READOUTS, MAN-3, common cath. LED, the claw, RED (#3338) 1.29 12 for 1.30
- 8-LEDS, ass't sizes, shapes, red, green, yellow, amber (#3869) 1.29 16 for 1.30
- PHOTO FLASH ELECTRO, CAP, 600 MF (#360V/#3897) 1.29 2 for 1.30
- 4 MICRO SWITCH, plunger style, N.O. contacts, SPDT, solder tabs, (#5785) 1.29 8 for 1.30
- 10 TRANSISTOR/LED SOCKETS, 1/4" high, 3-pc leads, plastic base, (#5745) 1.29 20 for 1.30
- 5-SLIDE VOLUME CONTROLS, ass't of popular values, for HIFI (#2318) 1.29 10 for 1.30
- 10-D33021 TRANSISTORS, low power, silicon, hfe-60, TO-92 (#5627) 1.29 20 for 1.30
- 50 1/4 WATTERS, ass't value carbon resistors, some 5%ers, (#5797) 1.29 100 for 1.30
- 60-CERAMIC CAPS, incl. NPO's, neg. coef. #750's ass't values (#590) 1.29 120 for 1.30
- 10-T.V.F.M. SPLICERS, for 300 ohm shielded twin lead, Bakelite, (#5547) 1.29 20 for 1.30
- 30"-30 WIRE-WRAP WIRE, fits all tools and machines, continuous length, (#3803) 1.29 60 for 1.30
- 10-G.E. POWER TAB TRANSISTORS, D40N1, N2, some NS, TO-220 (#5629) 1.29 20 for 1.30
- 2-1/4" BLOCK TRIM POTS, 200K, 15-TURN PC leads, (#2535) 1.29 4 for 1.30
- 1-12VDC 5MIL REED RELAY, spst, N.O. 2200 ohms, 7/8" x 5/16" x 5/16" (#5515) 1.29 2 for 1.30
- 50-TEMP. COEFFICIENT VOLTAGE REF. DIODES, ass't volt, +50% (#5647) 1.29 100 for 1.30
- 6-SKINNY TRIM POTS, PRECISION, 50% yield (#3389) 1.29 24 for 1.30
- 60-PC-PRECUT, PRE-TINNED WIRE, various lengths and colors (#1971) 1.29 120 for 1.30
- 5-DUAL DIGIT READOUTS, HP, 5082 Type, Bubble Magnifier, (#5748) 1.29 10 for 1.30
- 4 CALCULATOR KEYBOARDS, 17 keys, up, multi-function, (#5777) 1.29 8 for 1.30
- 10-5K POTS, audio taper, plastic snap-in mounting (#5124) 1.29 20 for 1.30
- 10-1&2 MEG DUAL POTS, audio taper, snap-in mounting (#5125) 1.29 20 for 1.30
- 50-1 AMP ZENERS, wide ass't of values, untested (#1964) 1.29 100 for 1.30
- 12-SCR'S & TRIACS, 10 AMP, ass't values, untested (#2087) 1.29 24 for 1.30
- 3-QUAD RACS, 10 AMP, 100% prime, 50-100-200-400-TO-220 (#5048) 1.29 40 for 1.30
- 20-MINI RECTIFIERS, 1N4148, various lengths and colors (#1698) 1.29 6 for 1.30
- 10-2N3704 TRANSISTORS, silicon, TO-92 case, hfe-300 100% (#5625) 1.29 20 for 1.30
- 50-IF TRANSFORMERS, ass't sizes (#3549) 1.29 100 for 1.30
- 10-TV CHEATER CORD JACKS (#5519) 1.29 20 for 1.30
- 10-2N3705 TRANSISTORS, silicon, TO-92 case, hfe-150 100% (#5626) 1.29 20 for 1.30
- 4-1.5V SILVER OXIDE WATCH BATTERIES, specify: RW-15, 18 (#5063) 1.29 8 for 1.30
- 3-LED WATCH READOUTS, 3 1/2" digits, 7 seg, dim 1/2" x 1" (#5066) 1.29 6 for 1.30
- 100-RED BLOCK DISC CAPS, ass't values, 50% material (#1698) 1.29 200 for 1.30
- 10-INSTRUMENT KNOBS, ass't styles and colors, 1/2" shaft (#5121) 1.29 20 for 1.30
- 4-MIKE HOLDERS, for CB's and other mobile rigs (#5634) 1.29 8 for 1.30
- 50-1N4000 RECTIFIERS, ass't to 800V, u test (#2594) 1.29 100 for 1.30
- 20-UPRIGHT ELECTROS, ass't d values & capacitance, (#3226A) 1.29 40 for 1.30
- 1-UHF TUNER, solid state, standard type (#2927) 1.29 2 for 1.30
- 6-ITS A SNAP, 9 VDC BATT-clip, red n black lead (#2852) 1.29 12 for 1.30
- 8-1440 VOLT RED BALL RECTIFIERS, axial (#2590) 1.29 40 for 1.30
- 20-1N4148 RECTIFIER DIODES, 4 ass't, axial (#3000) 1.29 40 for 1.30
- 40-SQUARE DISC STYLE CHOKES, color coded (#3203) 1.29 80 for 1.30
- 30-TRANSISTORS TO92 2N4400 series, u test (#3291) 1.29 60 for 1.30
- 6-TRANSISTORS TRANSFORMERS, audio, inter, etc mini (#3295) 1.29 12 for 1.30
- 15-PRINTED CKT TRIMMER POTS, ass't values, etc (#3346) 1.29 30 for 1.30
- 7-2N3055 HOBBY NPN TRANSISTORS, TO-31 (#3771) 1.29 14 for 1.30

*Buy any item on this page and get 2nd item of the same cat. no. for only one penny!

- 25-DTL FAIRCHILD IC's, gates and flip flops, Dip, 100% (#3709) 1.29 50 for 1.30
- 1-24 VOLT 50 MIL. TRANSFORMER, 115V input, open frame, 1x1x2 3/4" (#5631) 1.29 2 for 1.30
- 5-SPST PUSHBUTTON SWITCHES, angle, plastic, mt. on-ony (#5635) 1.29 10 for 1.30
- 6-10 AMP QUAD RACS, hi-quality, copper plated, (#5694) 1.29 2 for 1.30
- 30-RADIO AND TV KNOBS, ass't styles, sizes (#217) 1.29 60 for 1.30
- 60-TUBULAR CAPACITORS, ass't. volts and sizes (#219) 1.29 120 for 1.30
- 4-ROCKER SWITCHES, DPDT, solder tab leads, (#3302) 1.29 8 for 1.30
- 50-POWER RESISTORS, 3.5, 7 w. axial, pop sizes (#228) 1.29 100 for 1.30
- \$25 SURPRISE, all kinds of parts in a pak! (#294) 1.29 2 for 1.30
- 12-PANEL SWITCHES, rotary, slide, toggle, etc (#295) 1.29 24 for 1.30
- 60-COILS AND CORES, resistors, color coded, ass't (#297) 1.29 120 for 1.30
- 60-TERMINAL STRIPS, up to 4 solder lugs (#334) 1.29 120 for 1.30
- 25-PLASTIC TRANSISTORS, untested and hobby, TO-92, TO-18, (#2604A) 1.29 50 for 1.30
- 50-MICA CAPACITORS, ass't values (#373) 1.29 100 for 1.30
- 10-SETS RCA PLUGS AND JACKS, phono (#402) 1.29 20 for 1.30
- 60 DISC CAPACITORS, ass't values long leads (#437) 1.29 20 for 1.30
- 20-TRANSISTOR ELECTRO'S, ass't up and (#453) 1.29 40 for 1.30
- 75-HALF WATTERS, resistors, color coded, ass't (#454) 1.29 150 for 1.30
- 35-SILVER MICAS, red backs, axial, ass't (#455) 1.29 70 for 1.30
- 4-PUSH BUTTON, SPST, PANEL, N.C. 125V, #1A (#5289) 1.29 8 for 1.30
- 100-GERMANIUM DIODES, axial leads, u test (#642) 1.29 200 for 1.30
- 100-STABISTORS, Regulator, sensing and computer, Axial, ex. yield (#3140) 1.29 200 for 1.30
- 100-PRINTED CIRCUIT 1/2 WATT RESISTORS, ass't (#1060) 1.29 24 for 1.30
- 12-TRANSISTOR SOCKETS, ass't npn and pnp types (#651) 1.29 20 for 1.30
- 50-2 AMP SILICON RECTIFIERS, axial, ass't V (#655) 1.29 24 for 1.30
- 50-POLYSTYRENE CAPS, plastic coded, prec. (#1052) 1.29 100 for 1.30
- 30-4" CABLE TIES, non-slip white plastic (#5217) 1.29 60 for 1.30
- 30-PC-HEAT SHRINK, ass't sizes, 50% shrinkage (#5248) 1.29 60 for 1.30
- 2-5-1V, 5%, 10W, STUD ZENER, DDO-4 case (#5287) 1.29 4 for 1.30
- 10-RCA PHONO JACKS, chassis mount, leflon base (#5119) 1.29 20 for 1.30
- 15-THERMISTORS, ass't types, styles & values (#2048) 1.29 30 for 1.30
- 4-5-DIGIT 7-SEGMENT READOUTS, in flak pak case (#5616) 1.29 50 for 1.30
- 25-METAL CAN TRANS., ass't prime, hobby, TO-18, TO-18, (#2603A) 1.29 2 for 1.30
- 1-FOTO-RETY N CHANCK, Crystals, 1-Sealed Emitter Transistors (#1169) 1.29 2 for 1.30
- 1-VOLTAGE REGULATOR, TO202 case, 12V 600MA (#1900) 1.29 2 for 1.30
- 2-3 DIGITS ON A DIP, LED, red, DL-331 (#1887) 1.29 4 for 1.30
- 3-MM5262 2K DYNAMIC RAM, specify type (#3459) 1.29 6 for 1.30
- 10-2N711 HIGH SPEED SWITCHING TRANSISTORS, TO18, npn (#3374) 1.29 20 for 1.30
- 1-15W HI POWER TRANSISTORS, 220V, npn, TO66 (#2797) 1.29 2 for 1.30
- 1-HEAVY DUTY LINE CORD, 8 ft., 2 cond, #18 gauge, black, (#5803) 1.29 2 for 1.30
- 1-NMS312 DIGITAL CLOCK CHIP, 100% (#1525) 1.29 2 for 1.30
- 2-MM5725 4 FUNCTION CALCULATOR CHIP, 100% (#2036) 1.29 4 for 1.30
- 25 PLASTIC TRANSISTORS, untested, TO-92, (#5731) 1.29 50 for 1.30
- 3-10 AMP 25V BRIDGE RECT., comb style (#2447) 1.29 6 for 1.30
- 1-ALLEN BRADLEY POT, 10K, 2-1/4 watts, lve-1, 2 1/2" shaft (#1748) 1.29 2 for 1.30
- 6-1 LINEAR SWITCHING TRANSISTORS, 2N2905, pnp, TO3 (#3375) 1.29 12 for 1.30
- 50-2 AMP CYLINDRICAL RECT., up to 1K, u test (#4006) 1.29 100 for 1.30
- 1-HEAVY DUTY LINE CORD, 2 cond, 6 ft., #18 gauge, white, (#5804) 1.29 2 for 1.30
- 10-DATA ENTRY SWITCHES, TO-18 metal case, (#1992) 1.29 20 for 1.30
- 10-DATA ENTRY SWITCHES, SPST, 1 amp, norm open 125V (#5321) 1.29 20 for 1.30
- 8-TRANSISTOR RADIO EARPHONES, 8 ohms imp'd (#2946) 1.29 16 for 1.30
- 15-FLUORESCENT OVERFLOW READOUT TUBES, w/leads (#3288) 1.29 30 for 1.30
- 2-ALUMINUM HEAT SINKS, for TO-220 (#5381) 1.29 4 for 1.30
- 1-2N5001 80V TRANSISTORS STUD (#2800) 1.29 2 for 1.30

"ONE PENNY MORE GETS YOU TWO"

MINI LECTROS

Plastic

MFD.	VOLTS	SALE	LEADS	2 FOR
25	15	.14	Axial	.15
25	25	.17	Axial	.18
25	50	.24	P.C.	.24
50	15	.17	Axial	.18
50	25	.19	Axial	.20
50	100	.21	Axial	.22
100	15	.23	Axial	.24
100	25	.25	P.C.	.26
100	50	.35	Axial	.36
100	100	.39	Axial	.40
200	15	.24	P.C.	.25
150	15	.23	Axial	.24
200	25	.32	P.C.	.33
250	16	.29	Axial	.30
250	25	.32	Axial	.33
250	50	.45	Axial	.46
300	15	.31	Axial	.32
300	25	.33	P.C.	.34
500	15	.33	P.C.	.34
500	25	.36	P.C.	.37
500	50	.39	Axial	.40
1000	15	.55	P.C.	.56

Order by Cat. No. 92CU5718 and Value



40 CHANNEL CB BOARD

Only \$9.99 2 for \$10

Poly Paks buys up factory close-out from Hy gain so you gain! Boards have Heatsealed 9 Watt Amp Chip, RF and Mod Transistors, and National Semi MM series P.L.I. May be used for 10 meter conversion see 8 month series "18 to 10" in 7/5 Mag. The parts alone make it an offer you can't refuse.
Cat. No. 92CU5680

MOTOROLA STYLE "SANDY DISC" 10 AMP RECTIFIERS

Heavy Sand Type Hermet Construction

PIV	SALE	2 FOR
25	.24	.25
50	.35	.36
100	.43	.44
200	.54	.55
400	.61	.62
600	.78	.80
800	.90	.91
1000	1.18	1.20

Cat. No. 92CU5677 (Specify voltage)

"BEEM-O-LIGHT" LASER DIODES

Rated @ 5.9 Watts Wavelength 904 nm \$5.99 2 for \$6

Cat. No. 92CU5508

LED WATCH GUTS

\$1.49 2 for \$1.50

(Ladies) Cat. No. 92CU515C (Men's) Cat. No. 92CU515B

HOW TO ORDER

When ordering, always use catalog number, type no., the name of the magazine you are ordering from and the month

POLY PAKS®

COU'S MAY BE PHONED! P.O. BOX 942-R7 SO. LYNNFIELD, MA 01940

Terms: Add Postage Rated: Net 30 Phone: (617) 245-3828 Retail: 16-18 Del Carmine St. MINIMUM ORDER: \$8 Wakefield, MA

CARBON FILM 1/4W-5% Resistors

OHMS	OHMS	OHMS	OHMS	OHMS	OHMS	OHMS	OHMS
2.7	11	47	200	820	3600	15K	62K
3.0	12	51	220	910	3900	16K	68K
3.3	13	56	240	1000	4300	18K	75K
3.6	15	62	270	1100	4700	20K	82K
3.9	16	68	300	1200	5100	22K	91K
4.3	18	75	330	1300	5600	24K	100K
4.7	20	82	360	1500	6200	27K	110K
5.1	22	91	390	1600	6800	30K	120K
5.6	24	100	430	1800	7500	33K	130K
6.2	27	110	470	2000	8200	36K	150K
6.8	30	120	510	2200	9100	39K	160K
7.5	33	130	560	2400	10K	43K	180K
8.2	36	150	620	2700	11K	47K	200K
9.1	39	160	680	3000	12K	51K	220K
10	43	180	750	3300	13K	56K	240K

HIGH QUALITY - LOW OEM PRICE
 5 for .25 10 for .40 100 \$1.60 - 1000
 one value one value 100 per value **\$14.**

CMOS BOARD \$2.95

CONTAINS:
 4553 3 digit decade counter
 4511 4-bit latch 7 seg. decoder
 driver for LED display
 4060 oscillator w/1/4 stage binary counter.
 4011 CMOS gate
 2 switches, resistors, capacitors.
 HP 2 digit LED display

RCA to 220 8A, 600V TRIAC ea. 99¢ ten-\$9.50 \$89/c

BISTABLE RELAY OPTO ISOLATOR Ge or Si SIGNAL DIODES

SPD 6VDC 200 ohm coils
 1 amp. 20 watt AC contacts
 Long life (10⁶ on/off)
 High speed (500 Hz)
 Hermetically sealed
 3/8x3/8x3/4" **\$2.95 ea.**

FC820 6 PIN DIP **69¢ ea.**

High quality, marked computer grade signal diodes. Leads trimmed for PCB mounting. **40¢ for \$2.**

VOICE ACTUATED SWITCH 95¢ ea.

COMPLETELY ASSEMBLED ON CONDUCTIVE BOARD AS SHOWN CONTAINING CRYSTAL MICROPHONE, OSC. CIRCUIT, TRANSISTOR AMPLIFIER AND 4 AMP SW. WHICH IS TURNED ON BY AUSTED FROM MICROPHONE. RESISTORS 5-15 VOICE FOR OPERATION.

MICROPHONE CAN BE REPLACED BY COIL PHOTOCELL FOR LIGHT ACTIVATION.

STACKPOLE 8 AMP DPDT snap action, high quality wide switch. 1 1/2" mounting center. **40¢ ea. \$3.10**

TRANSISTOR BONANZA

PRIME TO-92 PLASTIC TRANSISTORS FROM A MAJOR SEMI CONDUCTOR MANUFACTURER. THESE ARE FIRST QUALITY DEVICES MADE FOR A COMM. CENTER FROM THE WPN'S WAVE CUT AND FORMED LEADS (TO-5 SHAPE), AND THE PNP ARE FULL LENGTH LEADS. SPECIFY NPN OR PNP. 50 PER THE MINIMUM.

\$6 for 100 \$50-k

DIODE ARRAY
 10 1N914's
 20 pin PACKAGE WITH 10 PIN SPACES 1" IN TWO-STAGGED HOLES.
 25¢ each
 10 - \$2.25

CLAREX PHOTOCONDUCTIVE CELLS

SUPER SAVER

DIGITAL IC's

25047	1024 bit shift register	TO-99	\$6.80
56405	CMOS 3 input NOR gate	DIP	1.19
CM011	CMOS 2 input NAND gate		1.00
MC4015	TTL quad latch	MOTOROLA	1.00
75451	dual half-wired driver	(8)	1.50
MM5058	1024 bit static shift reg.	(8)	1.50
7402R	quad 2 input NOR TTL gate		1.12
7403R	3 input NAND gate		1.12
7492N	divide by 12 TTL counter		1.30
SP980	(DM838) NOR bus receiver		1.00
DM811	quad MOS buffer IC		1.50
9424	10/pwr dual SR flip flop		1.25
S270	pin compatible w/7400		1.10
7412B	(8270) 4 bit shift reg.		1.30
LU321	dual JK flip flop S1G.		1.25

LINEAR IC's

747	dual 741 op-amp		1.50
7706BPC	5k audio out/wheat sink		1.25
AR-1	(MC670) 1M out auto	(8)	1.40
LM300	precision regulator	TO-99	1.50
LM307	op-amp (Improved 741)		1.35
LM308A	micro/amp op-amp		1.00
w4715	w/4imp/100V/50 60MHz op/amp available in DIP(DIL) or TO99		2.00
MC1303	Motorola stereo amplifier DIP		2.00
w4716	programmable op-amp		1.00
LM309K	5V-1 AMP REGULATOR TO-3		1.00
7812K	+12-1 AMP REGULATOR TO-3		1.75
LS1412	LOWDRN +12-3 AMP REGULATOR TO-3 (removed from sockets full specifications guaranteed)		3.95
CA3079	zero crossing switch DIL		1.60
w4703	1M transistor array, epoxy TO99		3.00

MISC. IC's

11105	Fairchild 1.25Hz divide by 4 DIF scaler		39.00
95H90	Fairchild 300MHz decade ctr.		7.95
2708	1Kx8 bit EPROM 450NS		12.00
FC820	Fairchild opto/isolator DTL(6)		1.75

DIODES

SIGNAL "pak" of 40 prime Si or Ge signal diodes, leads are pre-trimmed for PCB board specify S1/Ge 40 min. each type \$2.00

1K3810	15 AMP 200 P10 stud w/holder		.70
1N4581	4.4V .0055 reverse leakage diode		.45
16V	Motorola 16V 5% 1M zener		.15

TRANSISTORS

Complementary 10 AMP TO-220 pwr. transistors. 2N6101 and GE D45H0 75/50W similar betas pair 1.25

MJE 1091 PWR Darlington TO220 60V, PNP. 1.00

70M Motorola 1.00

2N4304 N channel P-EET TO106 case .25

40327 RCA NPN 300V, 1 AMP, SW TO-5 .35

DA101 G.E. 300V, 1 AMP, SW TO-220 .30

M40033/AL6000 NPN/PNP darl. 100-16A ea 2.25

Tip 126 PNP TO220 darlington neg drvvr. .75

ZERO CROSSING SWITCH

IC powered 14 pin DIP
 IC VOLTAGE TO TRIAC/ TRIAC
 device. SCA CA3079
60¢ ea \$5-ten

DIP TRIMMER

12 TURN 1/4", 3/4", 1"
 5K or 200K only
 mfg. DALE
\$1.50 TEN FOR \$4

1/8 WATT RESISTORS

10 ea. .390, 1.8k, 3.9k, 6.8k, 11k, 43k, 68k, 240k - 5 percent tol.

80 FOR \$4

POTTER BRUMFIELD

TYPE K10P RELAY

4PDT 3AMP
 24VDC 650 ohms
 or
 120VAC 10.5MA
 please specify coil required. **\$1.75**

Numeric Display

1/4" Single Digit
 GaAsP LED

COMMON CATHODE WITH HEIGHT HANDED DECIMAL
 0 DIGIT IS IN 7-SEG PANEL WITH
 HIGHLY LEGIBLE BRIGHT RED CHARACTER
 EXCELLENT READABILITY OVER A WIDE
 VIEWING ANGLE - 15mm PER DIGIT AT TYPICAL
 BUSINESS LEVELS

65¢ each - 10 for \$5.95

VARO SEMICONDUCTOR

10 AMP 50V 1V104
 .90 ea. 10 for \$7.50 100-\$65

PO BOX 41778 SEND FOR FREE FLYER TODAY

Sacramento California 95841

\$5 minimum order, add \$1 handling charge to orders less than \$10. We pay post or UPS on domestic orders over \$10. BAC, MC and VISA accepted. \$15 minimum and shipping is added. open accounts accepted from government entities and large retail firms. SAME DAY SHIPMENT - telephone (916) 334 2161 4811 Myrtle Avenue, Sacramento, CA 95841

ADVERTISING INDEX

RADIO-ELECTRONICS does not assume any responsibility for errors that may appear in the index below.

Free Information Number Page

—	AMC Sales	90
56	A P Products, Inc.	32
10	Aaron-Gavin Instruments	85
19	Active Electronics	97
23	Advanced Computer Products	105
69	Advance Electronics	2, 77, 87
37	All Electronics	110
30	American Antenna	Cov. 4
66	Ampower	108
35	Austin Electronics	108
57	B & K Precision Dynascan Co.	82
60	Babylon Electronics	112
—	Karel Barta	90
—	Bullet Electronics	106
—	Burdex Security	92
—	Chaney Electronics	106
8	Chanellock	14
—	C I E—Cleveland Institute of Electronics	18-21
—	Command Productions	90
26	Computer Components	98
16 & 29	Continental Specialties	Cov. 2 & 67
—	Dage Scientific	98
41	Davis Electronics	84
11	Delta Electronics	92
3	Digi-Key	104
—	Digital Research Corporation	96
54	Electra Company	13
—	Electronic Development Lab	92
—	E M C—Electronic Measurements	76
36	Electronic Supermarket	100
—	Electronic Systems	91
61 & 62	Fluke	69
38	Fordham Radio Supply	101
—	Forest Belt's Training Workshop	81
12 & 13	Formula International	94-95
—	Fuji-Svea	107
—	General Electric	34
63	Godbout Electronics	110
47	Gould, Inc.—Instruments Div.	86
64	Grantham College of Engineering	78
100	Heath	70-73
48	Hickok Electrical Instruments	33
53	Hobby World	110
33	ITC—Electronic Supermarket	96
67	Information Unlimited	92
67	Integrated Computer Systems	75
67	International Crystal Mfg. Co.	88
6 & 7	Jameco Electronics	102-103
24	Jan Crystal	98
—	Lakeside Industries	92
52	Leader	27
43	Meshna	108
42	Micro Mart	100
70	Millco Industries	92
70	Natesa	106
—	National Radio Institute (NRI) Div. of McGraw-Hill	8-11
—	National Technical Schools	28-31
71	Nesda	98
44	Netronics	83
32	O.K. Machine & Tool	15
5	Ohio Scientific	1
20	Optoelectronics	Cov. 3
22	PAIA	78
46	P T S Electronics	80
65	Panavise	80
18	Poly Paks	111
21	Quest	109
15	Quimtronix	110
—	RCA	12, 24-25
4	Radio Shack	93
39	Ramsey Electronics	99
27	Rye Industries	76
—	Sabtronics	7
—	Howard W. Sams & Co.	23
68	Sansui	5
49	Soar	16
9	Solid State Sales	100
59	Southwest Technical Products	85
—	Spacecoast Research	90
—	Speakerlab, Inc.	92
51	Sprague Products	22
14	Tab Books	86
40	Tek-El Corp.	106
25	Tri-Star	110
31	Ungar—Div. of Eldon Industries	79
34	Vector	84
—	V.I.Z. Mfg.	89
28	Versi Electronics	67
17	Zemco	17

Perform a death-defying act.



Exercise regularly.

American Heart Association
 We're Fighting For Your Life

MOVING?

Don't miss a single copy of **Radio-Electronics**. Give us:

Six weeks' notice

Your old address and zip code

Your new address and zip code

ATTACH LABEL HERE

name (please print) _____

address _____

city state zip code _____

Mail to: Radio-Electronics
 SUBSCRIPTION DEPT., P.O. BOX 2520,
 BOULDER, COLO. 80322

BABYLON ORDER ELECTRONICS NOW!

CIRCLE 60 ON FREE INFORMATION CARD

Double Guarantee

GUARANTEE I:
The K40 Speech Processor is guaranteed to outperform any microphone it replaces or return it for a complete and full refund within 7 days from the K40 Dealer that installed and tuned it.

GUARANTEE II:
Unconditionally guaranteed for 12 months. Guaranteed against cracking, chipping, or rusting. Guaranteed against mechanical failure. Guaranteed against electrical failure. No exclusions. No gimmicks. For a full 12 months.

It's its own computer—it automatically monitors your speech and adjusts it in micro-second increments pumping so much db gain into your speech that you get 400% more power than a standard mike.

PROCESSES SPEECH WITH A COMPUTER CIRCUIT!

Molded four-pole internal magnet clamps instantly to any steel surface. Steering column, metal dash, roof top, or the side of your CB radio. No groping for your mounting clip.

CLIPS ANYWHERE WITHOUT A CLIP!



A microphone so sensitive it will select your voice and process your speech no matter how close or far you are from the microphone.

SOUND SENSITIVE 2 INCHES OR 2 FEET!

Patented electronic storage system recharges while you listen to the radio. It provides a fresh electrical charge every time you squeeze the trigger. You never replace batteries.

FRESH CHARGE WITH NO BATTERIES!

Pull the Processor directly to your mouth and speak directly into the mic. The Processor adjusts to your voice—and blanks out all the cab noise while you're speaking. Automatically.

NOISE CANCELLING

Switch up for a high-pitched transmission for cutting congested city traffic. Switch down for a mellow base in open, uncluttered rural areas.

TWO MICS WITH ONE SWITCH!

Speech Processor. So unique it's patented. So good its guaranteed to out-perform any microphone on any radio.

The K40

THE K40 SPEECH PROCESSOR

CIRCLE 30 ON FREE INFORMATION CARD

American Antenna Equip., IL 60120, suggested retail.

\$42.50*

All New! REAL STATE OF THE ART

DIGITAL INSTRUMENTATION FROM OPTOELECTRONICS, INC.

Designed and assembled at Ft. Lauderdale, Florida U.S.A.

TWO NEW AC-DC- BATTERY PORTABLE COUNTERS

- OPTO-8000.1A** 10Hz to 600MHz Frequency Counter
 • Precision TCXO time base 0.1PPM Stability 17-40°C • Super Sensitivity with preamps in both HI-Z & 50 Ohm inputs <10 mV to 150 MHz <50 mV @ 600 MHz
 • Auto Decimal Point • Aluminum Case • Socketed IC's • Three position attenuator: X1, X10, X100 (avoids false counting)

- #OPTO-8000.1A Factory Assembled - 2 Year Guarantee \$329.95
 #OPTO-8000.1AK Kit Form - 1 Year Parts Guarantee \$279.95
 #NI-CAD-80 Ni-CAD Battery Pack (Installs in case) \$ 19.95

OPTO-7000 10 Hz to 600 MHz Miniature Counter

- XTAL (TCXO) Time Base ±.08PPM/°C Standard • Aluminum Case • HI-Z & 50 Ohm inputs
 • 1 Sec. & 1/10 Sec. Gate times • Auto Dec. Pt. • Built-in Prescaler and Preamps Standard
 #OPTO-7000 Factory Assembled - 1 Year Guarantee \$139.95
 #OPTO-7000K Kit Form \$ 4.95
 #NI-CAD-70 NI-CAD Battery Pack and Charger Circuitry \$ 19.95
 #TCXO-70 Optional Precision TCXO Time Base 0.1PPM, 17-40°C \$ 79.95

CM-1000 Digital Capacitance Meter

- Featured Sept. 1978 Radio Electronics Magazine • Measures from 1 pf to 9999 ufd. • 4 Jumbo LED 6" Digits • Aluminum Case • Accuracy of .1 % less one digit
 #CM-1000 Factory Assembled \$179.95 #P-1000 Probe \$6.95
 #CM-1000K Kit Form \$129.95 #P-1000K Probe Kit \$3.95

T-100 Precision Thermometer

- For Use with Digital Voltmeter • Output: 10 mv per Degree • Switchable: Fahrenheit/Celsius
 • Resolution to .01" with 4 1/2 Digit Meter • Requires two 9V Batteries - not included
 • T-100 Factory Assembled & Calibrated \$59.95 # T-100K Kit Form \$39.95
 #D-450, Antenna, Rubber Duck, RF Pickup, 450 MHz \$12.50
 #D-146 Antenna, Rubber Duck, 146.MHz \$12.50
 #RA-BNC Right-Angle BNC Adapter for Above Antennas \$ 2.95

PROBES:

- #P-100 50 Ohm, 1X Direct Connection RF Probe 13.95
 #P-101 Lo-Pass, Attenuates RF at audio frequencies 16.95
 #P-102 HI-Z, 2X High impedance, general purpose 16.95



TERMS: Orders to U.S. and Canada add 5% to maximum of \$10.00 per order for shipping, handling and insurance. To all other countries, add 10% of total order. Florida residents add 4% state tax. C.O.D. Fee: \$1.00. Personal checks must clear before merchandise is shipped.



CIRCLE 20 ON FREE INFORMATION CARD

Factory Direct - Phone Orders
 (305) 771-2050 • 771-2051

OPTOELECTRONICS, INC.
 5821 N.E. 14th Avenue, Fort Lauderdale, Florida 33334

