

HOW TO TROUBLESHOOT VCR's

\$1.25 ■ APRIL 1979

Radio-^{IND}Electronics

THE MAGAZINE FOR NEW IDEAS IN ELECTRONICS

Build this versatile
BURGLAR ALARM
It protects your
valuables and your family

Audio breakthrough
MAGNETIC AMPLIFIER
Revolutionary circuit
you've never seen before

Troubleshooting
COMMUNICATION
RECEIVERS
Step-by-step technique

- PLUS**
- ★ Motion Detector Security Alarm
 - ★ Equipment Reports
 - ★ 2 Hi-Fi Test Reports
From R-E's Audio Lab
 - ★ Service Clinic
 - ★ Hobby Corner

Special for April
3 UNIQUE PROJECTS
Easy to build and very unusual

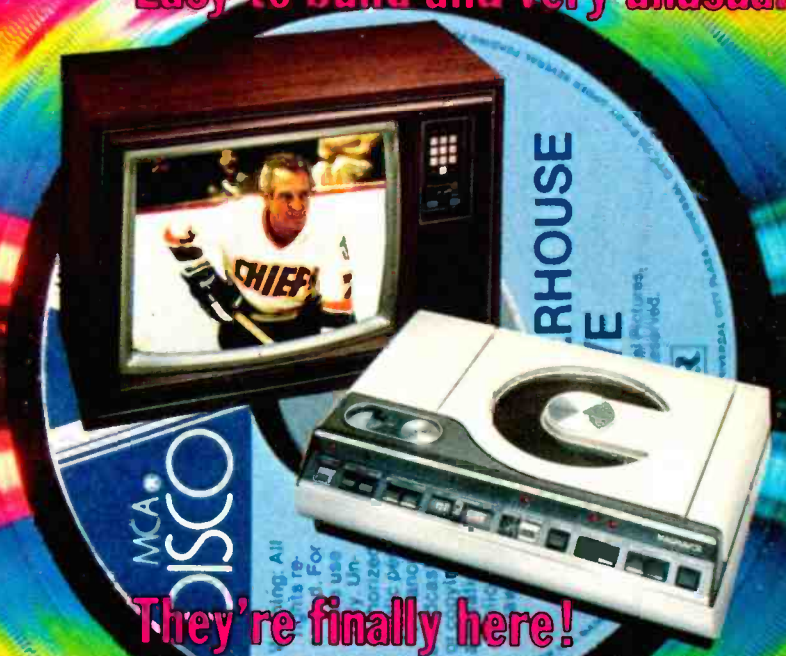

They're finally here!
2 VIDEODISC SYSTEMS
See how they work



A
GERNSBACK
PUBLICATION

Spend less. Test more.

Integrated circuits are very private devices. When something goes wrong, they just don't work. Which is tough enough when part or all of *one* IC goes bad. But often worse, because a single bad IC usually means a large, complex system that won't function properly.

Until now, you could spend a lot of money and time—and still only be guessing what was happening at any point in a logic system.



Logic Probe LP-1. Captures pulses as fast as 50 nanoseconds, to 10MHz. Latching memory. Bargain-priced at only \$44.95*

CSC puts troubleshooting at your fingertips. Now, there's a quicker, surer, less expensive way to get the information you need. CSC multi-family Logic Probes. Their LEDs light to show you at a glance the logic state at any point—and more. Catch fast pulses, even store them if you like. A flashing light signals pulse trains. And you can even approximate the duty cycle of asymmetrical waveforms.

Nothing could be simpler. No complex

settings, no sync, no wait. A switch selects the proper logic family. The probes derive their



Logic Probe LP-2. All the basic features of LP-1, with pulses as fast as 300 nanoseconds, to 1.5MHz. Doesn't have LP-1's memory feature... but features even lower price: \$24.95*

power from the circuit under test. High input impedance prevents circuit loading. And all you do is touch the tip to any pin, pad or path for an instant picture of circuit conditions.

Laboratory quality. Economy price.

High speed. High precision. Even memory. CSC Logic Probes deliver all the performance you need for design, development, debugging and servicing. Making digital work less of a chore, more of a bargain. CSC for yourself!



Logic Probe LP-3. Five times the speed of LP-1 at less than twice the price. Captures pulses as narrow as 10 nanoseconds, to over 50MHz. Latching memory. The new value standard. at \$69.95*.

CONTINENTAL SPECIALTIES CORPORATION



Corporate Headquarters:
Continental Specialties Corporation, 70 Fulton Terrace, Box 1942, New Haven, CT 06509.
351 California St., San Francisco, CA 94104 (415) 421-8872, TWX 910-372-7992.
Europe, Africa, Mid-East: CSC UK LTD.
Shire Hill Industrial Estate, Units 1 and 2 Saffron Walden, Essex CB 11 3AQ.
Telephone: SAFFRON WALDEN 21682. Telex: 817477.
Canada: Len Finkler Ltd., Ontario.

800-243-6077

© Copyright 1979 Continental Specialties Corporation.

*Manufacturer's suggested U.S. resale. Prices, specifications subject to change without notice.

CIRCLE 25 ON FREE INFORMATION CARD

www.americanradiohistory.com

Here it is at last... **THE FIRST
FLOPPY DISK BASED COMPUTER
FOR UNDER \$1000**



The C1P MF
\$995

- Complete mini-floppy computer system
- 10K ROM and 12K RAM
- Instant program and data retrieval

The Challenger 1P Mini-disk system features Ohio Scientific's ultra-fast BASIC-in-ROM, full graphics display capability and a large library of instant loading personal applications software on mini-floppies including programs for entertainment, education, personal finance, small business and now *home control!*



The C1P MF configuration is very powerful. However, to meet your growth needs it can be directly expanded to 32K static RAM and a second floppy by simply plugging these options in. It also supports a printer, modem, real time clock and AC remote interface as well as the OS-65D V3.0 development oriented operating system.

**Or Start with the C1P
CASSETTE BASED
Computer for just \$349.**

The cassette based Challenger 1P offers the same great features of the mini-disk system including a large software library except it has 4K RAM and conservative program retrieval time. Once familiar with personal computers, you'll be anxious to expand your system to the more powerful C1P MF.

You can move up to mini-disk performance at any time by adding more memory and the disk drive. Contact your local Ohio Scientific dealer or the factory today.

*Both systems require a video monitor, modified TV or RF converter and home television for operation. Ohio Scientific offers the AC-3 combination 12" black and white TV/monitor for use with either system at \$115.00 retail.

All prices, suggested retail.

OHIO SCIENTIFIC

1333 S. CHILLICOTHE RD., AURORA, OHIO 44202 (216) 562-3101

CIRCLE 10 ON FREE INFORMATION CARD

GOULD PROFESSIONAL OSCILLOSCOPES AT PRICES YOU CAN AFFORD.

Whatever your interest in electronics, you know that a quality oscilloscope with a broad range of features and functions can make your work a lot easier. Gould oscilloscopes are built to solve your problems and priced so you can afford the professional equipment you need right now. All are complete, ready for use, including passive probes, input leads and a comprehensive maintenance and operation manual.



OS245A

List Price \$595.00

The OS245A is a compact, dual trace instrument with a 10MHz bandwidth and 5mV/div sensitivity. It has exceptional trigger performance and a full compliment of facilities for industrial, educational, and field service applications.

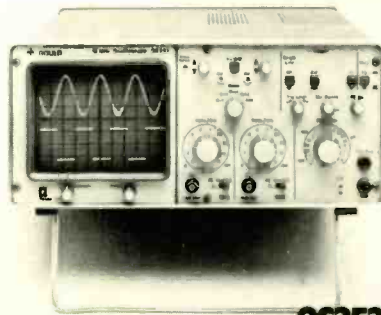

OS253

List Price \$695.00

The OS253 is a 12MHz dual-channel scope with all the features of the OS245A plus a larger display area, more sensitivity and channel sum and difference.

The dual trace OS255 weighs only 15 lbs. yet offers features normally found in more expensive instruments such as flexible triggering facilities and 2mV/cm sensitivity across its full 15MHz bandwidth.



OS255

List Price \$795.00

The dual beam OS260 gives true representation of two separate signals on the same time frame without beam chopping or alternating. Features include a high brightness CRT operating at 10kV

allowing a clear display of all waveforms.



OS260

List Price \$995.00

For additional information on this exciting new line of sensibly priced, professional oscilloscopes or for sales locations in your area: call toll free (800) 325-6400 Ext. 77. In Missouri call (800) 342-6600.

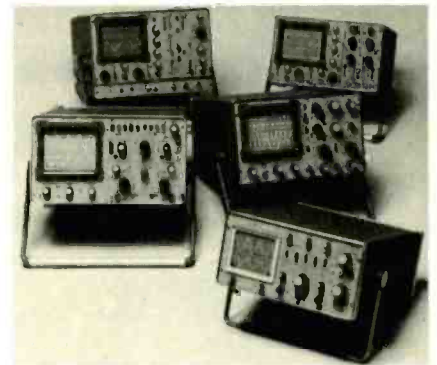

Gould also manufactures an additional line of general purpose oscilloscopes for industrial, scientific and laboratory applications.



CIRCLE 11 ON FREE INFORMATION CARD

Radio-Electronics®

THE MAGAZINE FOR NEW IDEAS IN ELECTRONICS

Electronics publishers since 1908

APRIL 1979 Vol. 50 No. 4

SPECIAL FEATURE	37	Videodisc Is Here! 2 systems—they are not compatible. See how they work.		
	<hr/>			
VCR SERVICING	57	Forest Belt Tells What You Need To Know About VCR's		
	58	What Will You Do About VCR's?		
	59	VCR Tools & Instruments		
	62	Servicing VCR's—A Fundamental Approach		
	64	Where To Learn		
<hr/>				
BUILD ONE OF THESE	40	Intrusion Protection System Stop burglars fast—as soon as they enter.		
	44	Motion Detector Light-sensing IC spots nearby movement.		
	48	Three Special Projects For April 1. 1- One-Station Intercom. 2- Solar-Powered Night Light. 3- Single-Shot Logic Indicator With Memory.		
	<hr/>			
GENERAL ELECTRONICS	4	Looking Ahead Tomorrow's news today.		
	66	Troubleshooting Communications Receivers How to use the test gear needed for this job.		
	70	Hobby Corner Identifying unmarked transformers.		
<hr/>				
STEREO HI-FI PRO SOUND	50	Magnetic Field Amplifier—A New Technology in Sound It can't be true, but it is; and it works. We tell how.		
	53	R.E.A.L. Sound Lab Tests Nikko Preamp & Amplifier Nikko Beta II Preamp/Alpha II Power Amp earns a "Very Good."		
	55	R.E.A.L. Sound Lab Tests Realistic SCT-30 Cassette Deck "Excellent" is the overall sound quality rating from our lab.		
<hr/>				
TELEVISION	47	How Comb Filters Work The way it's used by Magnavox.		
	76	Jack Darr's Service Clinic Tuners that use solid-state bandswitches.		
	78	Service Questions R-E's Service Editor solves technician problems.		
<hr/>				
EQUIPMENT REPORTS	26	Lab Science Model VLA-1000 Logic Analyzer		
	34	Data Precision Model 248 DMM		
	35	Apple Computer ROM Card		
<hr/>				
DEPARTMENTS	110	Advertising Index	16	Letters
	14	Advertising Offices	89	Market Center
	85	Books	6	New & Timely
	74	Communications Products	88	New Literature
	14	Editorial	82	New Products
	111	Free Information Card		

ON THE COVER

Videodisc by Magnavox. The background is the MCA optical videodisc itself. The player is superimposed. At the top right you can see it in action. At the bottom the disc is being inserted. For more information on this system as well as the RCA system turn to page 37.

(Cover photos supplied by Magnavox)



THIS IS ONE OF THREE marvelous construction projects specially designed just for April 1, 1979. The one shown here is a one-station intercom. For full construction details along with two more turn now to page 48.

Radio-Electronics, Published monthly by Gernsback Publications, Inc., 200 Park Avenue South, New York, NY 10003. Phone: 212-777-6400. Second-class postage paid at New York, NY and additional mailing offices. One-year subscription rate: U.S.A. and U.S. possessions, \$9.98. Canada, \$12.98. Other countries, \$14.98. Single copies \$1.25. © 1979 by Gernsback Publications, Inc. All rights reserved. Printed in U.S.A. (ISSN 0033-7862)

Subscription Service: Mail all subscription orders, changes, correspondence and Postmaster Notices of undelivered copies (Form 3579) to Radio-Electronics Subscription Service, Box 2520, Boulder, CO 80322.

A stamped self-addressed envelope must accompany all submitted manuscripts and/or artwork or photographs if their return is desired should they be rejected. We disclaim any responsibility for the loss or damage of manuscripts and/or artwork or photographs while in our possession or otherwise.

As a service to readers, Radio-Electronics publishes available plans or information relating to newsworthy products, techniques and scientific and technological developments. Because of possible variances in the quality and condition of materials and workmanship used by readers, Radio-Electronics disclaims any responsibility for the safe and proper functioning of reader-built projects based upon or from plans or information published in this magazine.

Looking ahead

New records: Official EIA figures confirm that 1978 was the best year in history for video products. A total of 10,236,000 color TV sets were sold in the United States, beating the previous record of 9,263,000 by almost a million units. Black-and-white TV sales enjoyed a renaissance, totaling 6,064,000, the highest figure since 1973. The total color-plus-monochrome figure of 16,301,000 was exceeded only once in history (in 1972). Sales of home videocassette recorders in 1978, at 402,000, almost doubled those of 1977 (estimated at about 210,000).

Take two: It's not bad enough to watch one TV show—now they're asking us to watch two or more at the same time. "Picture-in-a-picture" TV systems, the sensation of 1977 in European television (see **Radio-Electronics**, December 1977), is finally coming to the U.S. via Japan. Sharp has introduced a new 17-inch television console in which a 4-inch black-and-white picture is superimposed in one corner of the color screen, permitting the viewing of two shows at once. Either picture may be changed—or the two pictures may be interchanged—by means of a wireless remote control. By the time you read this, it should be available here for around \$1,000.

An alternative to picture-in-picture is a three-screen TV, by the Taiwan manufacturer Sampo, which has one 19-inch color tube and two 5-inch black-and-white screens—separate, not superimposed—to permit you to keep up with three shows at the same time. While this approach perhaps isn't quite as ingenious as picture-in-picture, at least the little picture doesn't block your view of the big picture, the price is lower, and the small black-and-white pictures have better resolution than the superimposed picture of the picture-in-a-picture sets.

These multi-picture sets presumably have the greatest appeal to people with videocassette recorders who may be watching one show and taping another, and would like to have a little peek at the show they're taping and not watching. As an alternative to picture-in-a-picture, you could buy a small under-\$100 monochrome set and put it on top of your color set. Science marches on!

RCA's videodisc system: Just one month after the Magnavision optical videodisc system went on limited sale in Atlanta, Georgia (see **Radio-Electronics**, March 1979), RCA capped more than a decade of development with a decision to go ahead with manufacture and marketing of its own videodisc system. RCA's president, Edgar Griffiths, had maintained that the see-hear disc system would get the green light only after three conditions were met: (1) A player which could retail at \$400 or less. (2) A simply produced, uncoated disc which could play for two hours. (3) Enough programming to support the launch of the system. Griffiths now says all three have been met. He gave no timetable for marketing, but company sources indicated that late 1980 was a reasonable target.

The RCA system uses a grooved disc with a stylus that serves as one plate of a variable capacitor—the disc is the other, revolving at 450 rpm. Each disc is enclosed in a protective plastic caddy and is automatically removed

when the caddy is inserted in the player. The player is extremely simple, has only four controls—including "live scan" (for location of a specific segment visually without loss of sync) and a feature that permits automatic repeat of a short segment of programming. The optical player, on the other hand, sells for \$695, has an exact-frame-location feature, infinitely variable slow or fast motion in both reverse and forward modes, stop-motion and other deluxe features. The grooveless disc is "read" by a laser beam, so theoretically there is no record wear. The optical discs, which permit slow and fast motion as well as exact frame location, provide one hour's play time (30 minutes per side), while a long-playing optical disc (one hour per side) is designed for movies and lacks many of the special features. The optical discs sell for about \$6 to \$16; RCA says capacitance records will be \$10 to \$17. So the stage is now set for a battle between two incompatible videodisc systems, each with a different approach: The optical system (Philips and MCA) with a wearproof record and many deluxe features, vs. the capacitance (RCA) system, which aims strictly at low cost and simplicity with no special features.

NOTE: The optical system, which made its market debut in Atlanta, is spreading next to the Seattle-Tacoma market, then will gradually go nationwide, but probably won't be available everywhere until some time in 1980, maybe even 1981. Early in 1980, Pioneer is expected to begin marketing an optical disc player compatible with Magnavox's Magnavision (Philips-MCA) unit.

Games to computers: The so-called "home computer" was a failure—an el floppo—in 1978. The so-called personal computer did quite well, but a survey by the prestigious Arthur D. Little Co. showed that only 5 percent of the buyers of these instruments could be classified as "consumers"—that is, those who didn't have either a small-business or hobbyist interest. This failure to involve everyday folks in computers has prompted a complete change in strategy by manufacturers. The idea now is to hook 'em on fun and games, and introduce computer functions gradually. Magnavox explored this approach with its highly sophisticated *Odyssey II* with alphanumeric keyboard and plenty of game cartridges, including one entitled "Introduction to Computer Programming" (that's a game?).

Bally, which still hasn't decided whether to chuck the whole video game bit, made one last try with an add-on to its video game, including an alphanumeric keyboard and a completely new computer language called *Grafix* using simple English words. Toy manufacturer Mattel has just entered both the video game and computer field with a system called *Intellivision*, which starts as a game and ends up as a computer. Atari, has introduced two computers as an expansion of its games. After two years of unsuccessful attempts to sell computers to consumers, manufacturers this year are attempting to sugarcoat them as just slightly more sophisticated games that happen to solve household problems.

DAVE LACHENBRUCH
CONTRIBUTING EDITOR

Own the World's most perfect watch...

The only "PURE-SOLAR" timepiece in existence. Guaranteed to outperform any watch sold today... or costs you nothing!

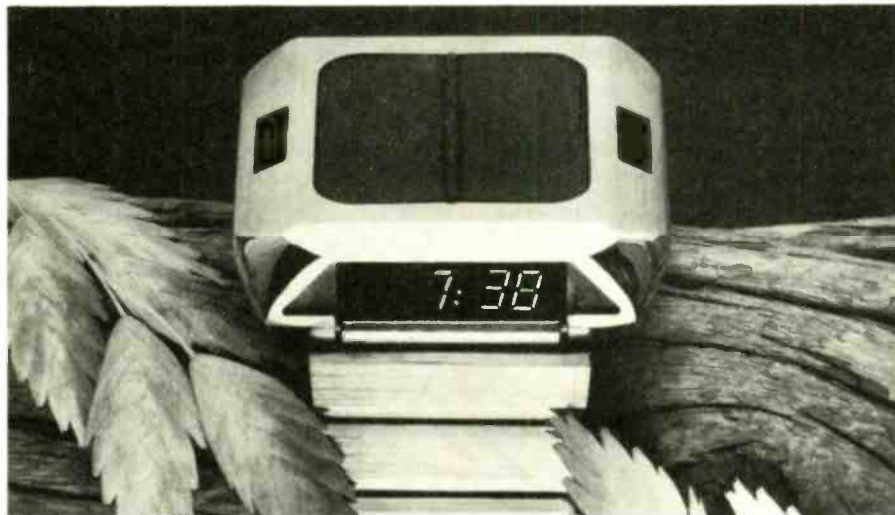

The Sunwatch... never needs batteries... accurate to within 1 second per month... virtually indestructible, beautifully styled sport/dress watch.

An engineering/design breakthrough in space-age timekeeping technology... that now makes all other watches obsolete: ■ 100% sun-powered, no batteries that need replacing. ■ Clearly visible by day or night. ■ Unique side-window view, simplifies reading. ■ Built-in computer calendar — no need to ever re-set the watch (Not even in 31-day months and leap years!) ■ Unprecedented accuracy — you program the Sunwatch's computer to stay accurate within 1-second per month!

A "State-Of-The-Art" timepiece that combines solar age energy efficiency with a unique feeling of futuristic elegance and beauty. 10 years ago the Sunwatch was an idea, years ahead of its time, on the drawing board of Roger Riehl, a noted expert in solar energy, integrated circuitry, and computer chip technology. As a result of these years of costly and extensive research, Mr. Riehl's dream of a perfect watch has been realized, and this is now available through the Starshine Group, a California-based marketing organization specializing in unique, innovative products.

The objective in producing the Sunwatch was to put an end to all the difficulties other watches create. For instance, with the Sunwatch you will never have to worry about accuracy again. For the rest of your life, you will know you are on time — almost to the second! You will also never again stop to check the time only to find that your watch batteries are dead. The Sunwatch powered by stored light energy, never needs a battery replacement.

Another important feature is that you don't have to strain your eyes to read the numbers in bright sun or dark rooms as with other digital and conventional watches. The Sunwatch has 4 built-in varying light intensities which automatically adjust to the immediate light conditions, making it easy to read at all times, day or night. These necessities of correct timekeeping are now possible for the first time with this remarkable achievement in watch design.

Technical Data & Special Features:

■ **Tiny silicon solar power cells** are the incredible power source; they are constantly being energized from natural sunlight or even an ordinary light bulb while you are wearing your watch. The watch operates on this stored light energy and will work even after being kept in a drawer or suitcase for several days. However, should storage in darkness for a long period result in the watch losing its charge, a few hours in the sun (or overnight under a lamp) will charge it back up to normal. (Note: If this happens and the watch display loses its charge due to a long period of darkness, the internal operation continues on keeping the same accurate time. Therefore upon re-charging the watch, the display readout will show the correct, up-to-date time, just as if the watch

had never lost its charge. This is because the display will automatically shut off at low charge levels, leaving enough energy to continue the internal time-keeping functions.)

■ **No Resetting Needed Until 2100 A.D.!** Thanks to its own specialized **Micro-Circuit Computer**, the Sunwatch is electronically programmed to display the correct month and day with NO resetting for the next 123 years! (Of course, in 2 or 3 seconds, you can easily change the time [or any other display] at your option, should you need to change time zones, etc.)

■ **Permanently Sealed Lexan Module**, protected by U.S. and Foreign Patents until 1992, encapsulates all energy cells, solar panels, quartz crystals, Computer-On-A-Chip, Readouts, etc. This hermetically-sealed watch module is also filled with a special gelatin which absorbs tremendous shock, making the Sunwatch virtually the Most Indestructible Watch Ever.

■ **Completely Waterproof** (You can safely suspend it in boiling water for 30 minutes!) It's because of the permanent lexan seal mentioned above.

■ **Shock Resistant to 5000 G's** (You can literally crash it into a rug-surfaced brick wall at 90 M.P.H. without noticeable effect!)

Free Custom Engraving: At your request, each watch will be hand-engraved with your name (or any name you specify) to label and personalize it yours for a lifetime.



Limited Warranty Is Your Protection. The Sunwatch is covered by a 2 year limited warranty issued by Riehl Time Corporation (Manufacturer of the Synchronor 2100), and included with your watch. A copy of the warranty may also be obtained free of charge by writing to Starshine Group, 924 Anacapa St., Santa Barbara, Calif. 93101. This warranty gives you specific legal rights, and you may also have other rights which vary from state to state.

Never Needs Batteries. Tiny silicon solar cells gather and store energy from sunlight, daylight, even an ordinary lightbulb. What a relief never to replace batteries!



No Resetting — Ever. Micro circuit computer is programmed to display the correct month and day with no resetting until 2100 A.D.

■ **Temperature and Pressure Resistant** Freeze Sunwatch in a block of ice for a year or wear in 750 feet deep without damage.)

■ **Natural Side-View Window** lets you tell the *time, day, and date* without twisting your arm into an obvious, awkward position.

■ **Continuous Seconds Display** — Useful for pulse-taking, stopwatch timing, etc.

4 Different Readout Modes: Mode #1... Displays the time in hours and minutes (as shown). **Mode #2...** Displays the month and day in numerical form (i.e., 3-13 for March 13). **Mode #3...** Displays the day of the week (alpha form) and the seconds counting off (i.e., TU: 48 for Tuesday, and 48 seconds after the minute display in Mode #1). **Mode #4...** Displays the leap year status, and the programmable speed calibration setting that the watch is currently set at. (i.e., 23.45. The first digit "2" means that this current year is 2 years after the most recent leap year. The next 3 digits tell you that your Sunwatch is operating at a speed setting of 3.45. This setting can be changed by you in just seconds to anywhere between a range of 0:00 to 7:77. This allows you to adjust your watch speed to compensate for local climatic and magnetic conditions, etc. After a little experimentation you will soon find the proper setting to keep your Sunwatch accurate to within an unprecedented one second per month. (That's 5 times better than the latest Quartz Accutron!)

The exciting Sunwatch offers split-second accuracy based on solar energy and advanced design features, all packaged in a striking, contemporary styled timepiece that is virtually indestructible even under the most severe conditions. The Perfect Watch of a lifetime for Business People, Professionals, Teachers, Athletes, etc.

The Philosophy behind the Watch and this advertisement... Our objective is to acquaint you in a straight-forward manner, with the honest facts and features of a timepiece that we (and several thousand current Sunwatch owners) genuinely believe to be the most advanced, most practical watch in production today. We have attempted to tell you as much as possible about the Sunwatch because we know it sometimes can be difficult to make an intelligent purchasing decision of this importance, from just a few words and pictures.

Should you decide to try wearing and using one, we will engrave your name on it at no charge, and send it to you by United Parcel Service (or USPS if UPS doesn't service your area). You then have 2 weeks to literally "try it on for size" and see for yourself how incredible this watch actually is. If you decide you don't care to keep it for any reason, you can return it to us within 2 weeks of receipt for a prompt refund, or a credit to your charge card.

Credit Card Orders Call Toll Free 1-800-235-6945, ext. 1045. Calif. Residents Call: 805-966-7187.

Note: Thousands of earlier models of this "pure-solar" timepiece have been sold nationwide for as high as \$500 or more. Recent cost reductions in certain components now make the watch much more affordable (see coupon below) and one of the best timekeeping investments you can make today.

Starshine Group.

924 Anacapa St. Dept. 738, Santa Barbara, CA 93101

Please rush me _____ Sunwatch(es) in smart, slimly-styled stainless steel — for only \$129.95 each. I will wear the watch for 15 days; then if not completely satisfied may return it for a full refund of purchase price (less shipping charge). Please add \$3.95 per watch shipping & insurance.

Please send me _____ Sunwatch(es), gold plated with matching band — only \$159.95 each. If not completely satisfied, return it for a full refund of purchase price (less shipping charge). Please add \$3.95 per watch shipping and insurance.

Enclosed is \$_____ Check or Money Order (Calif. residents add 6% sales tax).

American Express VISA (BankAmericard)
 Master Charge Diner's Club Carte Blanche

Credit Card # _____ M.C. Bank # _____
Issue Date _____ Exp. Date _____

Signature _____
Name to be engraved _____
Name _____

Address _____
City/State/Zip _____

© 1978 Starshine Inc.

Microwave surveillance system may be causing health hazards

Several U.S. retail stores have been installing antishopping devices based on low-level microwave radiation, and their use has begun to make some individuals and governmental agencies nervous about the potential radiation hazards they pose.

The stores' antishopping system involves placing a tag on an item that, if not first removed by a cashier or clerk, will be detected by microwaves generated by devices positioned on either side of an exit, thus triggering an alarm bell. The radiation emitted by these detectors passes through individuals harmlessly, asserted David St. Lawrence, of Sensormatic Electronics Corporation, Deerfield, FL, which manufactures detectors.

Mr. Lawrence added that Stanford Research Institute of California conducted "a very thorough study of our systems under normal operating conditions to insure that everything we've said about our systems was absolutely true." Replying to criticism that microwave radiation could have a harmful effect on persons with implanted heart pacemakers or on pregnant women, Mr. Lawrence explained that battery-powered pacemakers were basically magnetic devices and were "not at all affected" by low-level radiation. Neither would this radiation cause harm to pregnant women or to children.

The stores in question, while declining to discuss the electronic detectors in detail, believe the systems are effective and insist that the radiation is not hazardous. The microwaves are less intense, they point out, than normal AM radio waves. However, one retail workers' union on the East Coast has resolved not to allow its members to work in stores where such systems are in effect. And the General Accounting Office, the Congressional watchdog agency, is increasingly concerned that the Federal government has not been informing the public about microwave radiation hazards. It urges that a standard be adopted to determine the permissible levels of such radiation. Presumably such guidelines would be also applied to such popular devices as microwave ovens, garage door openers, antitheft alarms, etc.

Public asked opinion on radar detectors

Two recent polls conducted by the news media in Indiana and Louisiana has shown that the public has definite opinions on the legality/illegality of radar detectors.

In answer to a proposal made by Indiana's State Police Superintendent to outlaw radar detectors, Electrolert, Inc., manufacturers of the *Fuzzbuster*, held a widely publicized news conference rebutting the superintendent's charges. Indianapolis TV

viewers were polled by phone (via a local TV station) to 1) "vote" on whether radar detectors should be outlawed or not, and 2) express their views and comments on the issue. Out of a total 2560 responses, 64% were in favor of radar detectors, 36% were not.

In Baton Rouge, the city's *States-Times* newspaper also conducted a telephone survey on the issue; out of 231 residents polled, 51% opposed any anti-radar detector legislation; about 44% approved; and 5% had no opinion. The Louisiana Highway Patrol had just come out in favor of a version of the anti-radar detector legislation presently operating in the state of Virginia.

Neutrinos—new communications medium?

A group of scientists from Western Washington University have concluded an experiment which they believe demonstrates that neutrinos, nuclear particles without mass or electromagnetic quality, can be used to transmit messages through the earth. Dr. Peter Kotzer, leader of the team, asserts that the technique will eventually enable global communications even with submarines without the need for satellite relay stations, since neutrinos can pass through the earth without interference from other matter.

In fact, neutrinos not only can pass through the earth, but also the solar system and the entire universe without ever colliding with interstellar dust or other material. Because they have no mass or electric charge, the problems involved in tracing these particles are enormous. A small number of the neutrinos, however, do collide with atomic particles. This results in a secondary "shower" of particles called "mu mesons," which, in turn, combine with other matter to form tiny flashes of light called Cerenkov scintillation. These flashes are measured and a rough estimate can then be made of the total number of neutrinos that could have caused them.

Dr. Kotzer and his team were able to construct a unique "telescope" that could "see" the beam of nuclear particles emitted by an accelerator at Fermi National Laboratory in Batavia, IL. The Fermilab accelerator produces a beam of positively charged protons, which the lab uses for its own experiments. The particles then are allowed to be discharged harmlessly into a hill outside the lab. It is these particles the university scientific team was able to detect.

RCA communications satellite will provide more channels

RCA's communications satellite, Satcom I, will expand its channel availability to provide more cable TV programs nation-

wide. About a year ago, only four of Satcom's 18 channels were used—now all channels are spoken for, with leases running up to 10 years (at a cost of \$1.3 million per year for the time used). The demand for satellite channels—known as transponders—has been so great that RCA plans to launch another communications satellite in the near future. It is predicted that all of the new satellite's 24 transponders will be claimed even before it gets off the ground.

This appears to indicate that the demand for cable TV is growing by leaps and bounds, which, in turn, means more programming will be available. The types of programs planned include news and sports channels, a full-time UPI voice-and-picture news channel, all-day nonviolent children's programming, and a channel that will provide continuous coverage of Congressional sessions. Some of the companies that will be providing the new programming are Home Box Office, Warner Communications, Reuters, Ltd., plus other networks that plan to offer various religious programs.

FCC condemns police use of jammers as radar units

The Federal Communications Commission, acting on complaints and inquiries from motorists, has warned police departments countrywide to discontinue using what the Commission terms jamming devices in their continuing war against radar detectors.

Arlan Van Doorn of the Commission's safety and special radio services bureau says that a new device purchased for traffic enforcement was being used as a radar-detector jammer, and further describes it as a transmitting unit, not a genuine radar device. The device in question was originally designed to warn highway repair crews working in areas with obstructed views (i.e., a hill or a road curve) that they must get off the road. The device is actually not a radar device, it is a transmitter that motorists have claimed is being placed on cars, or on poles—and left unattended.

Experimental light-powered telephone devised by Bell Labs

Bell Telephone Laboratories has devised an experimental telephone equipped with a photodetector that can receive and transmit light signals over one fiber lightguide. The photodetector converts more than half the light power it receives to electrical energy, which powers the phone as well as carrying a full range of telecommunications signals.

The photodetector can detect incoming light pulses at one wavelength and transmit outgoing signals on another wavelength. The actual optical-to-electrical power con-

continued on page 13

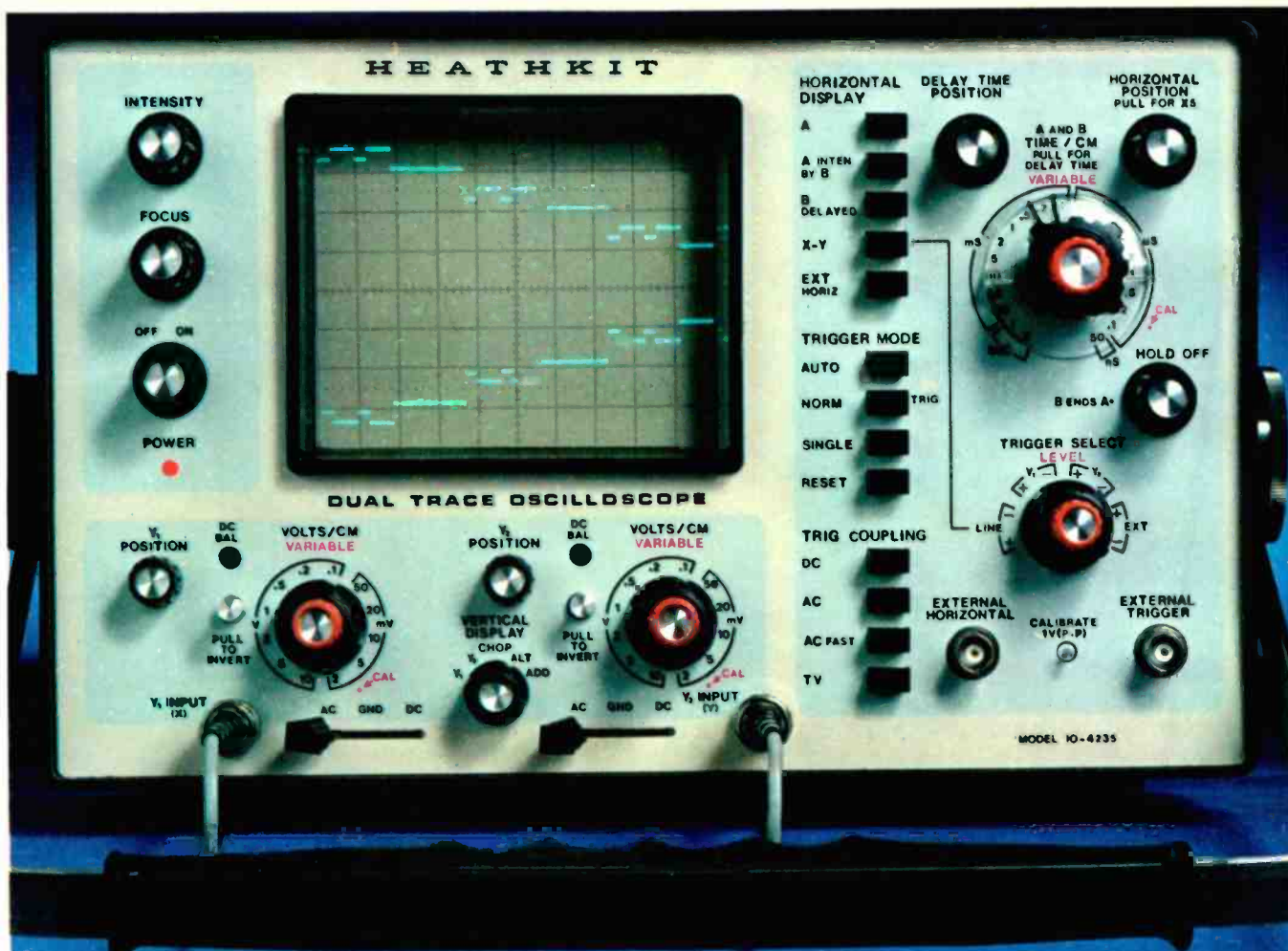

**NOW...
LABORATORY QUALITY AT SERVICE BENCH PRICES**

The most sophisticated scope ever offered in money-saving kit form: the new Heathkit IO-4235! Compare its features...compare prices...and you'll move up to the IO-4235

- DC-35 MHz response with smooth roll-off beyond 50 MHz
- Dual trace — study two signals simultaneously
- Delayed sweep — observe any section of a waveform — magnified as needed
- Fast sweep speeds from 50 nS/cm to 0.2 sec/cm, plus X5 expansion for effective speed of 10 nS/cm at the highest sweep rate
- TV triggering for jitter-free display
- 2 mV/cm to 10 V/cm vertical sensitivity
- Algebraic ADD with ability to invert Y₁ or Y₂
- Internal graticule for parallax-free measurements

**NEW
HEATHKIT®
DC-35 MHz
DUAL TRACE
DELAYED SWEEP
OSCILLOSCOPE**

• 10 kV post-acceleration voltage — fastest, brightest display in any Heathkit oscilloscope ever
All these features and more, in a scope that's surprisingly easy to build and maintain! Circuit boards swing out for easy access to components even while the scope is operating. You can make minor service adjustments quickly and easily — should that ever be necessary. This Heathkit scope is one of the best values today...and for years to come!

Kit IO-4235....just \$869.95
Also available factory assembled and tested....\$1195.00

Prices are mail order net F.O.B., Benton Harbor, Michigan. Prices and specifications subject to change without notice.

FREE HEATHKIT CATALOG!

Send for your FREE Catalog with full descriptions of the IO-4235 and all the other exciting new Heathkit exclusives!

Write to: Heath Company, Dept. 020-522
Benton Harbor MI 49022

GX-361

Learn to service Communications/CB with NRI's Complete

Learn design, installation and maintenance of commercial, amateur or CB communications equipment.

There are more than 25 million CB sets out there, millions more two-way radios, walkie-talkies, and other communications apparatus in use by business, industry, government, police and fire departments, and individuals. That means a lot of service and maintenance jobs... and NRI can train you at home to fill one of these openings. NRI's Complete Communications Course covers all types of two-way radio equipment... AM and FM transmission and reception, television broadcasting, microwave systems, radar principles, marine electronics, mobile communications, and aircraft electronics. And NRI guarantees you will pass the exam for the commercial FCC Radiotelephone License you need to perform most servicing work, or your tuition will be refunded in full. This money-back



Some designed-for-learning equipment you get.



agreement is good for six months after completion of your course.

Learn on your own 2-meter, digitally synthesized VHF transceiver.

You'll learn to service all types of communications equipment as you assemble your own VHF transceiver. NRI engineers have designed it, not only as a commercial-quality, high-performance unit, but as a unique "power-on" training tool to give you actual bench experience with the principles needed to service CB, commercial, and amateur equipment.

Then we help you get your FCC Amateur License so you can go on the air.

The complete course includes 48 lessons, 9 special reference texts, and 10 training kits. Included are your own electronics Discovery Lab,TM

antenna applications lab, CMOS digital frequency counter, and an optical transmission system. You'll learn at home, at your own convenience, earning your FCC license and the preparation you need for the communications field of your choice. Mail the postage-paid card today.

TMTrademark McGraw Hill.

CB specialist course also offered.

If you prefer, you can concentrate on the booming field of CB radio with NRI's special course in CB servicing. You get 37 lessons, 8 reference texts and plenty of hands-on training with your own 40-channel CB, AC power supply, and multi-meter. Also included are 14 coaching units to make it easy to get your commercial Radiotelephone FCC License... required for you to test and service communications equipment.

equipment at home... Communications Course.

Or get into TV and audio servicing

NRI can train you at home to service TV equipment and audio systems. Choose from five courses that go up to our 48-lesson Master Color TV/Audio Course. With it you get 14 kits for practical bench training and demonstrations, including NRI's exclusive, designed-for-learning, 25" diagonal solid state color TV, 4-channel audio system complete with speakers, and professional instruments you build and use for learning and earning. It's proven, effective training that's helped thousands of pros already. And it's the best value offered in the field. NRI's bite-size lessons speed learning, exclusive



"Power-On" training makes it real. Send card for free catalog.

NRI instructor/engineers

Each NRI student is assigned his own course instructor. He's there to help you over any rough spots, explain problems, and give you the advice you need as you progress toward your future. And he knows what he's talking about, because he was more than likely involved in the design of your course or some of the NRI equipment you use. NRI instructors are practical, experienced people who really know their field and do their best to pass their knowledge on to you.

You get more for your money from NRI.

NRI employs no salesman, pays no commissions. We pass the savings on to you in reduced tuition, top-quality professional equipment, and reliable testing instruments necessary for a successful career. You can pay hundreds of dollars more at other schools, but you can't get better training.

Learn computer electronics

NRI trains you at home on a real digital computer.

Qualified technicians are urgently needed for careers in the rapidly growing field of computer and digital electronics... and NRI trains you at home on the real thing.

As part of your training, you actually assemble a working digital computer with expanded memory, define and flow chart programs, code your program, store it along with data in the memory bank. It's just one of the 10 hands-on training kits you receive. You also build and use your own TVOM; experiment with NRI's exclusive electronics lab. It's the quickest and best way to learn and start a new career in trouble-shooting digital computers. Send the card today.

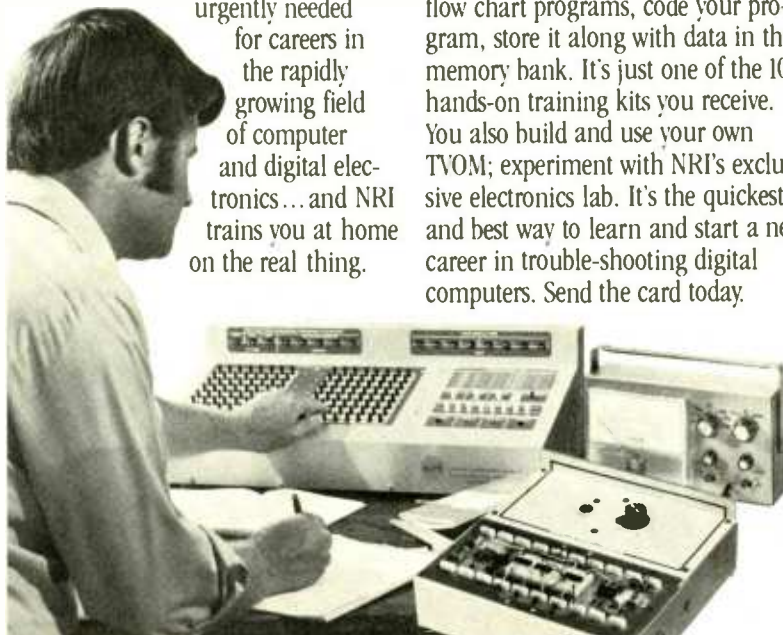

Free catalog...

No salesman will call.

Get your free catalog and discover why NRI is the leader in home technical training with over a million students, over 60 years experience in helping people build new careers. Mail the card today and get started on your new future. If card has been removed, write to:



NRI SCHOOLS

McGraw Hill Center
for Continuing Education
3939 Wisconsin Avenue
Washington, D.C. 20016

ALL NEW AND ADVANCED DMM

by Sabtronics
for only \$89.50



Designed and made in U.S.A.

The new and advanced Sabtronics Model 2010A is absolutely amazing... it gives you more performance, features and accuracy at a price no other Digital Multimeter can approach. It is versatile and rugged, for bench and portable use, with laboratory standard accuracy.

Greater Long-Term Accuracy

State-of-the-Art design features include a laser-trimmed decade resistor network and an ultra-stable band-gap reference element to insure long-term accuracy. Basic DCV and Ohms accuracy is 0.1% ±1 Digit, guaranteed for one year. With 31 ranges and 6 functions you can measure AC and DC volts from 100 μV to 1000V; AC and DC current from 0.1 μA to 10 A; resistance from 0.1 Ω to 20 MΩ.

Unique X10 Multiplier Switch

This exclusive feature of the Model 2010A gives you a convenient means of selecting the next higher decade range. The Hi-Lo Power Ohms capability gives you three High-ohm ranges that supply enough voltage to turn on a silicon junction for diode or transistor testing. Measure in-circuit component resistance with three Low-ohm ranges.

Touch and Hold Capability

The optional touch and hold probe allows you to make measurements in hard-to-reach places without taking your eyes off the probe tip. A button on the probe retains the display reading after the probe tip is removed from the test point.

Other Important Features

This quality instrument includes an ACV Frequency Response of 40 Hz to 40 kHz, automatic polarity, automatic zero, automatic decimal point, overrange indication, and overload protection on all functions and ranges. The bright LED display gives readings to ±1999 and is easy to read in dim light or bright light.

Reliability and Performance at Low Cost

The Model 2010A is factory tested, calibrated and is supplied complete with test leads, probes and detailed operating manual. A full compliment of optional accessories is available to increase the versatility of your 2010A DMM. Because you buy factory direct, you get this high-quality, full performance instrument at an incredibly low price of only \$89.50.

Brief Specifications

DC Volts: 100 μV to 1000V in 5 ranges
AC Volts: 100 μV to 1000V in 5 ranges
DC Current: 0.1 μA to 10 A in 6 ranges
AC Current: 0.1 μA to 10 A in 6 ranges
Resistance: 0.1 Ω to 20 MΩ in 6 ranges
Diode Test Current: 0.1 μA, 10 μA, 1 mA
ACV Frequency Response: 40Hz to 40kHz
Input Impedance: 10 MΩ on ACV and DCV
Overload Protection: 1200 VDC or RMS on all voltage ranges except 250 VDC or RMS on 100mV and 1 V AC ranges. Fuse protected on ohms and mA ranges.
Power Requirement: 4.5 to 6.5 VDC (4 "C" cells) optional NiCd batteries or AC adapter/charger
Display: 0.36" (9.2mm) Digits reading to ±1999
Size: 8"W x 6.5"D x 3"H (203 x 165 x 76 mm)
Weight: 1.5 lbs. (0.68kg.) excl. battery

(Batteries not included)

Orders Yours Today

Call us with your Mastercharge or Visa order or use the convenient order form to take advantage of this special introductory offer.

Making Performance Affordable

sabtronics 

13426 Floyd Circle M/S 35 · Dallas, Texas 75243
Telephone 214/783-0994

To: Sabtronics International, Inc., 13426 Floyd Circle M/S 35, Dallas, TX 75243

PLEASE SEND ME THE FOLLOWING:

_____ Model 2010A Digital Multimeter(s)	@\$89.50	\$ _____
_____ AC Adapter/Charger(s)	@\$ 7.50	\$ _____
_____ Nickel-Cadmium Battery sets	@\$17.00	\$ _____
_____ Touch-and Hold Probes	@\$18.00	\$ _____
_____ For delivery in Texas, add Sales Tax		\$ _____
_____ Shipping, Handling and Insurance per unit \$4.00*		\$ _____

Check enclosed Money Order, or bill my Master Charge Visa **TOTAL \$ _____**

Account No. _____ Expiry Date _____

Name _____

Street _____

City _____ State _____ Zip _____

*Continental U.S. only. AK, HI & PR, \$5.00. Canada: \$6.50. Foreign: \$19.00 Airmail.

RE-4

version efficiency in this exchange was determined in lab experiments to be 56% at a 0.81- μ m wavelength.

Because one small semiconductor laser chip provides enough energy, not only for communications but to activate the phone's components, a light-powered phone will need no power source such as a wall outlet or self-contained battery.

The experimental phone also converts periodic laser light bursts to electrical pulses that "ring" the call alert. The "ringing" device is an electroacoustical tone containing a thin piezoelectric active element which is triggered by an alternating electrical voltage that causes it to vibrate.

Sony technical training tapes for Betamax now available

Service technicians can now learn how to operate and repair any Sony *Betamax* VTR simply by watching one of Sony's Technical Training Tapes. The full-color programs come in a series of eight videocassettes, with each tape running between 30 and 45 minutes. They contain complete operation and servicing data, including all major block diagrams, waveforms, schematics and circuit theory. Some of the topics covered include technical overview, luminance signal processing, servosystem, troubleshooting and tapehead replacement.

To obtain information on any stage of repair, etc., just select the appropriate cassette, put it into a *Betamax*, and press the PLAY pushbutton. Each taped series comes with a supplementary publication showing all the diagrams displayed on the tapes, plus some that are not contained in the service manual. The cost of each tape is \$24. For further information, write Sony Corporation, Training Tape Production, 700 West Artesia Boulevard, Compton, CA 90220.

U.S. asks FCC for 200 new AM stations

In January, 1979, Henry Geller, chief of the U.S. Commerce Department's telecommunications bureau and communications policy administrator for President Carter, announced that the Administration had asked the FCC to start proceedings that would eventually create 700 new AM radio stations in addition to low-power TV stations (the latter proposal is already under FCC study). An earlier proposal by the Commission planned to create 125 additional AM stations by removing the existing 25 clear-channel 50-kilowatt stations.

Additional AM stations could be added by reducing the spacing between the present assigned frequencies from 10 kHz to 9 kHz, as is already being done in Europe and Africa. At present, in the U.S. there are 4500 AM and 4000 FM stations, with many

isolated areas not receiving any facilities at all. It is felt that reduced frequency spacing would allow not only new stations to exist, but would permit special-interest groups to originate programs, encourage local station ownership and provide for uniformity of broadcast technology.

Mr. Geller added that he believes that these policies if realized, "would help create healthy competition in the broadcast media."

VICA team wins medal, honorable mentions at skills meet

The Vocational Industrial Clubs of America (VICA) recently sent a 10-member team to the International Skills Competition in Korea. The team distinguished itself by winning one bronze medal and three honorable mention awards.

The bronze medallist was David Classen, Freeport, TX (auto mechanics); the three honorable mentions went to Edgar Anna, Smithville, OH (welding); Raymond Coleman, Richmond, VA (industrial wiring); and Mark Bauer, Washington, MI (machine drafting).

The team was chosen in an earlier runoff competition from among the winners of the 1977 U.S. Skill Olympics. Among the other team members were Neal Sedell, Vancouver, WA (industrial electronics) and Richard Lomax, Camden, DE (radio and TV repair).

Compucolor Corp. forms users' group/and newsletter

A users' group and a monthly newsletter have been created by Compucolor Corporation, manufacturers of the *Compucolor II* home computer. The purpose of the group will be to exchange programs and ideas, and to assure a new *Compucolor II* owner that he is "not abandoned after he makes his purchase," according to Dave Deans, marketing vice president.

The newsletter, *ColorCue*, will serve as a sounding board for the latest information on programming and computer features. The company has also announced that it will accept for sale or trade any software contributions from members; users can then trade for other programs. For further information, contact Joy Baker, Compucolor Corporation, P.O. Box 569, Norcross, GA 30071.

ITA minimum standards report for audiocassettes now available

Copies of the recently published *Official ITA Documents for Minimum Standards of Audio Tape Products*, complete with final revision, can be obtained from International Tape Association, Inc., 10 West 66th Street, New York, NY 10023.

The ITA standards report contains specifications for 90-minute audio cassettes; standard magnetic audio cassettes and as-

sociated hardware; standard audio eight-track cartridges; and also provides duplication guidelines for eight-track cartridges and four-track cassettes.

IHF asks FCC to set date on AM stereo ruling

The Institute of High Fidelity, on behalf of its member manufacturers of hi-fi products, filed comments with the Federal Communications Commission, requesting the FCC to set an effective date for the actual implementation of AM stereo.

In its comment, the IHF stated, "an effective date for the rule would help protect the consumer from being disappointed in purchasing AM Stereo tuners and/or receiver equipment for which the ability to receive AM Stereo signals would not be realized for a lengthy period of time." It was stressed that this would in no way "limit the production and sale of AM Stereo equipment . . . but would lead to an orderly market transition for manufacturers."

It was suggested that a reasonable effective date for the rule would be six months from the time the rule is published in its final, official form.

Nonprofit videocassette club widens its membership

The American Video Tape Library (AVTL) is a nonprofit club that operates a lending library of popular films on videocassette for its membership. The club, which started on a limited basis in several western cities, is now extending its membership drive to reach owners of VCR's across the country. According to the club's managing director, Nancy B. Payne, "AVTL is the cheapest way the VTR owner can see commercially produced features rather than spending \$50 to \$75 to buy them." Club membership involves an initial fee of \$49.95, plus \$5 a month to cover mailing, tape repair and maintenance, and administrative expenses.

AVTL boasts over 100 different titles, with access to 400 others. For further information, write AVTL, 6650 South Broadway, Littleton, CO 80121, or phone toll-free 1-800-525-7487.

First TV multiplex broadcasts aired in Japan

In September, 1978, Japan's Nippon Television Network Corporation inaugurated the first TV sound multiplex broadcast in that country with a news program in both Japanese and English. This program was followed in October by similar entertainment and news programs broadcast in stereo by other Japanese stations. In both instances, the programs were aired only in the Tokyo and Osaka areas; Japanese stations look forward to nationwide multiplex broadcasts in the spring of 1980. R-E

Today's Greatest Bargain

Electronics . . . from the smallest diode to the largest computer system you can find . . . is the greatest price bargain you can buy today. It's also the greatest example of what technology can do.

Do you remember the first RCA black and white TV's? I do. I remember the \$500 massive 10-inch RCA table model that my father brought home one summer evening. Today, for about the same kind of dollars (in number), we watch a 25-inch color set. The programs haven't gotten much better, but in 1959 dollars, the new color set costs less than \$200 and that's a bargain! In the same period of time, the family car has gone from \$1500 to \$6000.

Or how about that fantastic stereo system you listen to? Sure, it cost you better than \$1000. But that's a bargain too. The old hi-fi (low-fi?) system of the late 40's was limited to 6L6's in the output stages, had distortion levels of 3% or more and cost, in a wood cabinet console, about \$700.

And what about that \$2500 projection color set you bought last week? By 1982 you'll probably buy one for only \$1000. The videotape player that cost \$1500 last year is already selling for as little as \$695. And the video disc systems that are being introduced this year for \$695 will probably cost as little as \$400 by 1982.

Why are electronic devices almost the only items to stand fast in the face of inflation? In one word, the answer is "*TECHNOLOGY.*"

Advances in the world of electronics are coming so fast it is almost impossible to keep up with them. And just what is lurking around the next corner is too fantastic to imagine; is so fantastic that your wildest guesses are probably not wild enough.

A few months back I asked readers what they thought the next important consumer electronics product would be. I did not get even one response that indicated some device that did not already exist. Now I'm asking again. But this time dream a little. Share with me your ideas about the products and the world of electronics. Tell me what devices you think we will have in 1990. That's only 12 years away.

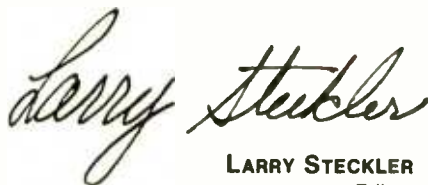
LARRY STECKLER
Editor

Radio-Electronics®

Hugo Gernsback (1884-1967) founder

M. Harvey Gernsback, editor-in-chief and publisher

Larry Steckler, KTX-3644, CET, editor

Arthur Kleiman, KTZ-3288, managing editor

Robert F. Scott, CET, W2PWG, KXX-8533, technical editor

Sonia Greenbaum, copy editor

Jack Darr, CET service editor

Leonard Feldman contributing high-fidelity editor

Karl Savon, semiconductor editor

David Lachenbruch, contributing editor

Earl "Doc" Savage, K4SDS, hobby editor

Ruby Yee, production manager

Harriet I. Matysko, circulation director

Arline R. Bailey, advertising coordinator

Cover design by Louis G. Rubsamen

Radio Electronics is a member of the *Institute of High Fidelity* and is indexed in *Applied Science & Technology Index* and *Readers Guide to Periodical Literature*.

Gernsback Publications, Inc.
200 Park Ave. S., New York, NY 10003
(212) 777-6400
President: M. Harvey Gernsback
Vice President: Larry Steckler
Treasurer: Carol A. Gernsback
Secretary: Bertina Baer

ADVERTISING SALES

Paul McGinnis
Director of Marketing

EAST

Stanley Levitan
Radio-Electronics
200 Park Ave. South
New York, NY 10003
(212) 777-6400

MIDWEST/Texas/Arkansas/Okla.

Ralph Bergen
The Ralph Bergen Co.
540 Frontage Road—Suite 361-A
Northfield, Illinois 60093
(312) 446-1444

PACIFIC COAST Mountain States

Jay Eisenberg
J.E. Publishers Representative Co.,
8732 Sunset Blvd.,
4th Floor,
Los Angeles, CA 90069
(213) 659-3810
Sales Mart Building
1485 Bayshore Blvd., Box 140
San Francisco, CA 94124
(415) 467-0125





Charles Varble, Jr.,
Chart Television, St. Ann, MO 63074

**“I don’t compromise
the quality of my service...
or the quality of the parts I use.”**

Your reputation is our reputation

Tube Products Department • Owensboro, Kentucky 42301

GENERAL  ELECTRIC

letters

ELECTRONIC EQUATION

Electronic anti-gravity is as old as the lodestone. Due to the orbits and spins of electrons in the atoms of lodestones, they LIFT iron objects, overcoming gravity. Since a magnetic field will not penetrate a superconductor (sc), all we have to figure out is how to turn one on and off with less energy than the iron receives when the lodestone lifts it.

Today, with euphemisms such as superluminal velocity, we need to understand exactly what causes Doppler (d) even in a vacuum, or our road to the future will not only be long but rough.

The roots of all science (and of **Radio-Electronics**) lie in Maxwell's equation, $c=wf$. Assume $d=wf=c$, where w is the wavelength at an electromagnetic source (s), and f is the frequency at an observer (o). When s and o close, d is positive and wf is greater than c , or superluminal. When s and o open, d is negative. When there is no relative motion, d is zero, or back to our roots— $c=wf$. Thus, c (and all other forces

at a distance) is a constant only to s , picks up the radial velocity of s , and can travel to any o at speeds, up to superluminal.

Note—in the past we always used the equation $c=wf$ only at the s or only at the o , but never at both simultaneously. Thus, we always get the same value for c , but have proved nothing because we have never explained how we get Doppler even in a vacuum.

JOHN W. ECKLIN
Alexandria, VA

LONG-DURATION IC TIMERS

After several days trying to locate the XR-2250 and XR-2260 IC's referred to in the July 1978 article on IC timers by Joseph Carr, we discovered that, according to Exar sales representatives, XR-2260 had been cancelled after the poor sales showing of XR-2250 (it actually never left the drawing board), and only two XR-2250 IC's were in stock in Dallas on a replacement basis.

BOB MONAGHAN
Dallas, TX

With respect to the availability of the XR-2240, XR-2250 and XR-2260 timers mentioned in Joseph Carr's article on page 61 of the July issue, the fourth paragraph mentions that the Intersil 8240, 8250 and 8260 are equivalents. A call to Exar sales manager Brooks Hamilton revealed that the XR-2240 is available off-the-shelf, the XR-2250 was discontinued about 18 months ago, and the XR-2260 was never manufactured in production quantities.

Intersil says that the 8240, 8250 and 8260 are available; the 8240 and 8260 are immediate-delivery off-the-shelf items, and the 8250 can be shipped within three weeks of the order.

In addition, the Motorola MC14541 is equivalent to the XR-2240 and is readily available, as is the Calctro JA-1214—Editor.

IC TESTER VARIATION

The diagram shows a variation on how to build the IC tester (see "Build A Digital IC" continued on page 23

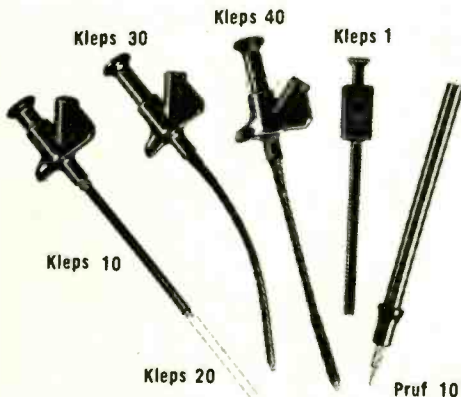

Clever Kleps

Test probes designed by your needs — Push to seize, push to release (all Kleps spring loaded).

Kleps 10. Boathook clamp grips wires, lugs, terminals. Accepts banana plug or bare wire lead. 4¾" long. \$1.59

Kleps 20. Same, but 7" long. \$1.69

Kleps 30. Completely flexible. Forked-tongue gripper. Accepts banana plug or bare lead. 6" long. \$1.99

Kleps 40. Completely flexible. 3-segment automatic collet firmly grips wire ends, PC-board terminals, connector pins. Accepts banana plug or plain wire. 6¼" long. \$2.89

Kleps 1. Economy Kleps for light line work (not lab quality). Meshing claws. 4½" long. \$1.09

Prof 10. Versatile test prod. Solder connection. Molded phenolic. Doubles as scribing tool. "Bunch" pin fits banana jack. Phone tip. 5½" long. \$.99

All in red or black - specify. (Add 50¢ postage and handling).

Write for complete catalog of - test probes, plugs, sockets, connectors, earphones, headsets, miniature components.

Available through your local distributor, or write to:

RYE INDUSTRIES INC.

131 Spencer Place, Mamaroneck, N.Y. 10543

In Canada: Rye Industries (Canada) Ltd.

CIRCLE 27 ON FREE INFORMATION CARD



No matter what you have to carry Platt can get a handle on it.



Platt introduces the all-purpose case.

Platt has designed a line of cases to transport safely and display attractively a wide variety of products: mini-computers, test equipment, calculators, cameras, microphones, CB's, cassette players, and aerosols, to name a few.

They come in tough, lightweight ABS Thermoplastic. Or a patented soft/molded case that features the good looks of a soft case with the rugged construction of a molded case.

Inside there's 3 pieces of die cut, shock absorbent polyfoam that can easily be cut to firmly house and protect just about any product.

Contact us for complete information on Platt's fine line of industrial cases.

platt

Cases for business and industry.
2301 S. Prairie Ave., Chicago, Ill. 60616 (312) 225-6670

CIRCLE 54 ON FREE INFORMATION CARD

LX303

ALL THE MOST WANTED FEATURES AT A MOST WANTED PRICE...

- BIG 1/2" HIGH LCD DISPLAY
- USE INDOORS OR OUT
- 200 HOUR 9V BATTERY LIFE
- AUTO ZERO, POLARITY, OVERRANGE INDICATION
- 100 mV DC F.S. SENSITIVITY
- 19 RANGES AND FUNCTIONS



Removable cover stores test lead set furnished as part of the unit.



Available accessories include AC adapter, padded vinyl carrying case, 40KV DC probe, 10 Amp DC shunt.



X10 DCV probe adapter available for protecting input up to 10KV.



\$74.95
ONLY
HICKOK

THE HICKOK ELECTRICAL INSTRUMENT CO.
10514 Dupont Avenue • Cleveland, Ohio 44108
(216) 541-8060 • TWX: 810-421-8286

Here is the handful of accuracy you've been waiting for. Hand-somely encased. Compact. Efficient. Only 12 ounces. Hickok's exciting, new LX 303, 3 1/2 digit Mini-Multimeter with high quality components, one year guarantee and rugged Cyclocac® case offers features previously found only in expensive units... at a price under \$75.00! So why wait any longer? The amazing LX 303 is here, NOW! Another American made test equipment breakthrough from Hickok, The Value Innovator. Order today!

See your local Hickok distributor or order below

SPECIFICATIONS:

DC VOLTS (5 RANGES): 0.1mV to 1000V; Accuracy $\pm 0.5\%$ rdg $\pm 0.5\%$ f.s.; Input impd: 10M Ω ; Max. input 1kV except 500V on 200mV range.

AC VOLTS (40Hz to 5kHz): 0.1V to 600V; Accuracy: $\pm 1.0\%$ rdg $\pm 0.5\%$ f.s. (-2dB max. at 5kHz); Max. input: 600V.

RESISTANCE (6 LOW POWER RANGES): 0.1 Ω to 20M Ω ; Accuracy: $\pm 0.5\%$ rdg $\pm 0.5\%$ f.s. ($\pm 1.5\%$ rdg on 20M Ω range); input protected to 120VAC all ranges.

DC CURRENT (6 RANGES): 0.1nA to 100mA; Accuracy: $\pm 1.0\%$ rdg $\pm 0.5\%$ f.s.

DIMENSIONS AND WEIGHT: 5-7/8" x 3-3/8" x 1-3/4", 12 oz.; **POWER:** 9V batt. (not incl.) or Hickok AC adapter; **READ RATE:** 3/sec. **OPERATING TEMPERATURE:** 0°-50°C.

ADVANCE ELECTRONICS

TO ORDER CALL TOLL FREE
800-223-0474

54 West 45th Street, New York, NY 10036 212-687-2224

PLEASE SEND ME

- _____ Hickok LX303 Digital Multimeters @ 74.95 ea.
- _____ RC-3 AC Adapter, 115VAC (220VAC avail.) @ 7.50 ea.
- _____ CC-3 Deluxe Carrying Case @ 7.50 ea.
- _____ VP-10 >10 DCV Probe Adapter @ 14.95 ea.
- _____ CS-1 10A DC Current Shunt @ 14.95 ea.
- _____ VP-40 40 KV DC Probe @ 35.00 ea.

Payment enc Bill my: Master Charge VISA

Account # _____ Exp. Date _____

Name _____

Address _____

City _____ State _____ Zip _____

Add \$3.00 Postage and Handling, N.Y. residents add sales tax.

CIRCLE 48 ON FREE INFORMATION CARD

www.americanradiohistory.com

“If you’re going to learn electronics, you might as well learn it right!”

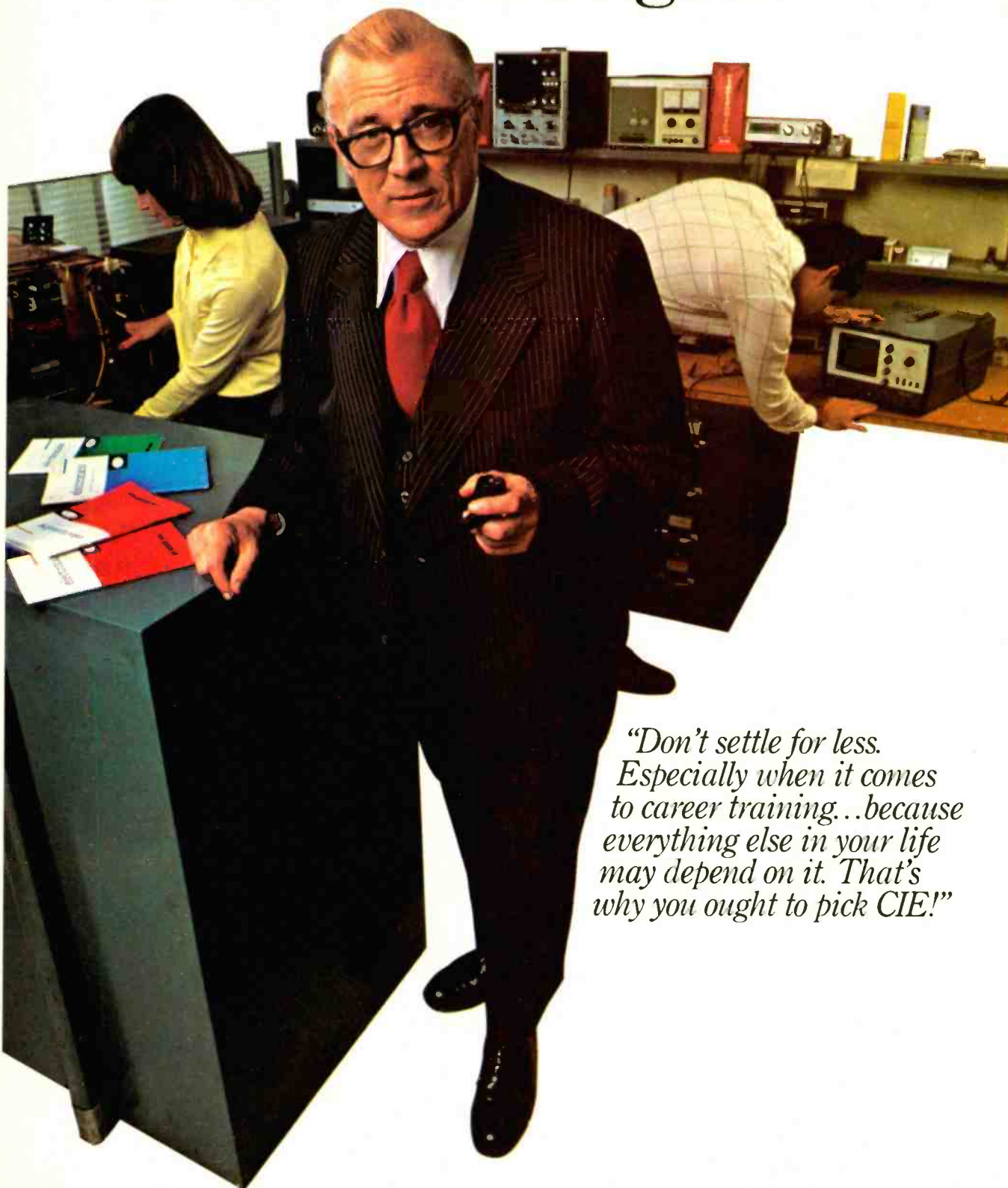

*“Don’t settle for less.
Especially when it comes
to career training...because
everything else in your life
may depend on it. That’s
why you ought to pick CIE!”*

You've probably seen advertisements from other electronics schools. Maybe you think they're all the same. They're not!

CIE is the largest independent home study school in the world that specializes exclusively in electronics.

...

Meet the Electronics Specialists.

When you pick an electronics school, you're getting ready to invest some time and money. And your whole future depends on the education you get in return.

That's why it makes so much sense to go with number one... with the specialists... with CIE!

There's no such thing as bargain education.

If you talked with some of our graduates, chances are you'd find a lot of them shopped around for their training. Not for the lowest priced but for the best. They pretty much knew what was available when they picked CIE as number one.

We don't promise you the moon. We do promise you a proven way to build valuable career skills. The CIE faculty and staff are dedicated to that. When you graduate, your diploma shows employers you know what you're about. Today, it's pretty hard to put a price on that.

Because we're specialists, we have to stay ahead.

At CIE, we've got a position of leadership to maintain. Here are some of the ways we hang onto it...

Our step-by-step learning includes "hands-on" training.

At CIE, we believe theory is important. And our famous Auto-Programmed® Lessons teach you the principles in logical steps.

But professionals need more than theory. That's why some of our courses train you to use tools of the trade like a 5 MHz triggered-sweep, solid-state oscilloscope you build yourself - and use to practice troubleshooting. Or a beauty of a 19-inch diagonal Zenith solid-state color TV you use to perform actual service operations.

Our specialists offer you personal attention.

Sometimes, you may even have a question about a specific lesson. Fine. Write it down and mail it in. Our experts will answer you promptly in writing. You may even get the specialized knowledge of all the CIE specialists. And the answer you get becomes a part of your permanent reference file. You may find this even better than having a classroom teacher.

Pick the pace that's right for you.

CIE understands people need to learn at their own pace. There's no pressure to keep up... no slow learners hold you back. If you're a beginner, you start with the basics. If you already know some electronics, you move ahead to your own level.

Enjoy the promptness of CIE's "same day" grading cycle.

When we receive your lesson before noon Monday through Saturday, we grade it and mail it back - the same day. You find out quickly how well you're doing!

CIE can prepare you for your FCC License.

For some electronics jobs, you must have your FCC License. For others, employers often consider it a mark in your favor. Either way, it's government-certified proof of your specific knowledge and skills!

More than half of CIE's courses prepare you to pass the government-administered exam. In continuing surveys, nearly 4 out of 5 CIE graduates who take the exam get their Licenses!

For professionals only.

CIE training is not for the hobbyist. It's for people who are willing to roll up their sleeves and go to work... to build a career. The work can be hard, sure. But the benefits are worth it.

Send for more details and a FREE school catalog.

Mail the card today. If it's gone, cut out and mail the coupon. You'll get a FREE school catalog plus complete information on independent home study. For your convenience, we'll try to have a CIE representative contact you to answer any questions you may have.

Mail the card or the coupon or write CIE (mentioning name and date of this magazine) at: 1776 East 17th Street, Cleveland, Ohio 44114.



Patterns shown on TV and oscilloscope screens are simulated.

CIE **Cleveland Institute of Electronics, Inc.**
 1776 East 17th Street, Cleveland, Ohio 44114
 Accredited Member National Home Study Council

YES... I want the best of everything! Send me my FREE CIE school catalog - including details about troubleshooting courses - plus my FREE package of home study information. RE-61

Print Name _____

Address _____ Apt. _____

City _____

State _____ Zip _____

Age _____ Phone (area code) _____

Check box for G.I. Bill information: Veteran Active Duty

MAIL TODAY!

All New!

REAL STATE OF THE ART

DIGITAL INSTRUMENTATION FROM OPTOELECTRONICS, INC.

TWO NEW AC-DC BATTERY PORTABLE COUNTERS

- OPTO-8000 1A** 10Hz to 600MHz Frequency Counter
 - Precision TCXO time base 0.1PPM Stability 17-40°C
 - Super Sensitivity with preamps in both HI-Z & 50 Ohm inputs <10 mV to 150 MHz <50 mV @ 600 MHz
 - Auto Decimal Point
 - Aluminum Case
 - Socketed IC's
 - Three position attenuator: X1, X10, X100 (avoids false counting)
- OPTO-8000 1A** Factory Assembled - 2 Year Guarantee \$329.95
- OPTO-8000 1AK** Kit Form - 1 Year Parts Guarantee \$279.95
- NI-CAD-90** NI-CAD Battery Pack (installs in case) \$ 19.95

OPTO-7000 10 Hz to 600 MHz Miniature Counter

- XTAL (TCXO) Time Base \pm 08PPM/°C Standard
- Aluminum Case
- HI-Z & 50 Ohm inputs
- 1 Sec. & 1/10 Sec. Gate times
- Auto Dec. Pt.
- Built-in Prescaler and Preamps Standard

- OPTO-7000** Factory Assembled - 1 Year Guarantee \$139.95
- OPTO-7000K** Kit Form \$99.95
- AC-70** AC Power Pak \$ 4.95
- NI-CAD** Battery Pack and Charger Circuitry \$ 19.95
- TCXO-70** Optional Precision TCXO Time Base 0.1PPM, 17-40°C \$ 79.95

CM-1000 Digital Capacitance Meter

- Featured Sept. 1978 Radio Electronics Magazine
- Measures from 1 pf to 9999 ufd.
- 4 Jumbo LED
- 6" Digits
- Aluminum Case
- Accuracy of .1% less one digit

- CM-1000** Factory Assembled \$179.95
- CM-1000K** Kit Form \$129.95
- P-1000K** Probe Kit \$6.95
- P-1000K** Probe Kit \$3.95

T-100 Precision Thermometer

- For Use with Digital Voltmeter
- Output: 10 mv per Degree
- Switchable: Fahrenheit/Celsius
- Resolution to .01° with 4 1/2 Digit Meter
- Requires two 9V Batteries - not included

- T-100** Factory Assembled & Calibrated \$59.95
- T-100K** Kit Form \$39.95

#D-450, Antenna, Rubber Duck, RF Pickup, 450 MHz

- D-146** Antenna, Rubber Duck, 146 MHz \$12.50
- RA-BNC** Right-Angle BNC Adapter for Above Antennas \$ 2.95

PROBES

- P-100** 50 Ohm, 1X Direct Connection RF Probe \$3.95
- P-101** Lo-Pass, Attenuates RF at audio frequencies \$6.95
- P-102** HI-Z, 2X High Impedance, general purpose \$16.95



TERMS: Orders to U.S. and Canada add 5% to maximum of \$10.00 per order for shipping, handling and insurance. To all other countries, add 10% of total order. Florida residents add 4% state tax. C.O.D. Fee: \$1.00. Personal checks must clear before merchandise is shipped.

Factory Direct - Phone Orders
 (305) 771-2050 • 771-2051



OPTOELECTRONICS, INC.
 5821 N.E. 14th Avenue, Fort Lauderdale, Florida 33334

CIRCLE 6 ON FREE INFORMATION CARD



LETTERS

continued from page 16

Identifier/Tester," June, 1977, p. 44).

I have found it to be simpler and less costly to build than the one in the article. All parts are hobby-type components that were ordered from surplus suppliers except for wire-wrap sockets SK1 through SK4 (16-pin DIP sockets). The cost of building the unit was less than \$6, using new wire-wrap sockets and a Radio-Shack chassis.

The same testing procedures found in your article still apply. However, I did find that a digital frequency generator did help when testing counter IC's. Even if you do not publish the diagram, I believe it would help some people if they knew that the 75492 IC saves using 16 transistors and resistors.

JAMES W. NICKOLS III
Biloxi, MS

FUTURE ELECTRONICS IDEAS

As you requested in the September issue of **Radio-Electronics**, I am writing you some of my "visions" of future electronics.

First, a video console connected to the human brain, via a special type of "motorist helmet," that would project on a TV screen any selected "good old memories." It could even permit you to create and view your own movie as you let your imagination roam.

Second, the same "helmet" could be used with an audio console that would

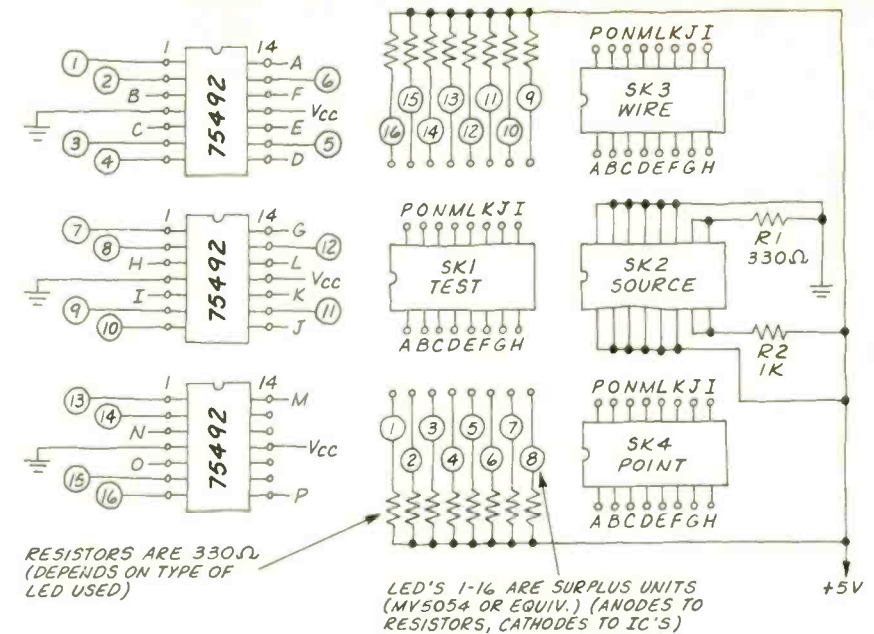

serve to reproduce all your thoughts and musical inspirations and record them at the same time.

This type of versatile electronics would be very welcome in any populated living room or backyard. It could serve to find out what the baby was crying for: his bottle, food, a fresh diaper, etc.

Keep up the good work and information in your magazine.

SERGE FORGET
Pte. Gatineau, Canada

TWO USERS GROUPS FORMED

I would like to draw your readers' attention to the formation of two new Users Groups in San Antonio, TX: The Xitan Users Group and the Z Users Group. Both organizations will focus on exchange of information, services and products both produced or compatible with Xitan and the Z family microprocessors (the latter including Z-8, Z-80, Z-8000, Mostek 3880).

Each group plans to publish a newsletter
continued on page 24

TOTALLY PORTABLE...

\$3400—TOTAL RELIABILITY!

- Measure or generate 10 kHz to 1000 MHz
- Fully synthesized
- Monitor FM deviation 0-6 kHz or 0-1.5 kHz
- AM/FM modulation 50-6000 Hz
- Audio signal-generator output
- Decade frequency-standard output
- FM deviation-meter scope output
- Accuracy ±.00005%
- Private tone filter
- Calibrated output in dB and uV
- Antenna included
- Weight only 22 pounds
- Operates on 115/220 VAC, 50-400 Hz; 12 VDC, or optional battery pack. Only 6W
- Leasing available

**...LAMPKIN'S 107C
COMMUNICATION SERVICE
MONITOR DELIVERS
EVERYTHING WE CLAIM.**



**...WE HAVE DELIVERED EVERYTHING WE CLAIM SINCE 1932.
HONESTLY! FOR LESS THAN YOU'D EXPECT.**



LAMPKIN LABORATORIES INC. P.O. Box 9048 • Brandenton, Fla. 33506
In Fla. 813-792-5566 Collect

**800-237-9477
(Toll Free)**

CIRCLE 49 ON FREE INFORMATION CARD

INCLUDES VIDEO
INTERFACE

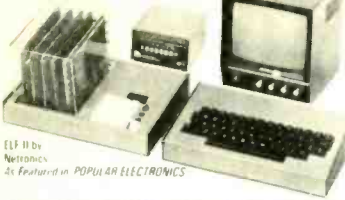

ELF II by
Netronics
As Featured in POPULAR ELECTRONICS

Now Available • Text Editor, Assembler & Disassembler!

ELF II

Featuring the 1802
RCA COSMAC
microprocessor/mini-
COMPUTER ONLY \$99⁹⁵

Now available! Text Editor, Assembler, Disassembler and a new Video Display Board!

The TEXT EDITOR gives you word processing ability and the ability to edit assembly language programs while they are displayed on your video monitor. Lines and characters may be quickly inserted, deleted or changed. Add a printer and ELF II can type letters for you—error free—plus insert names and addresses from your mailing list!

ELF II's ASSEMBLER translates assembly language programs into hexadecimal machine code for ELF II use. The Assembler features mnemonic abbreviations rather than numerics so that the instructions on your programs are easier to read—this is a big help in catching errors.

ELF II's DISASSEMBLER takes machine code programs and produces assembly language source listings. This helps you understand the programs you are working with and improve them when required.

The new ELF II Video Display Board lets you generate a sharp, professional 32 or 64 character by 16 line upper and lower case display on your tv screen or video monitor—dramatically improving your unexpanded \$99.95 ELF II. When you get into longer programs, the Video Display Board is a real blessing!

Get Your Hands On A Computer That Grows As Fast As Your Own Understanding!

Stop reading about computers and get your hands on one! With ELF II and our new Short Course On Microprocessor & Computer Programming, by Tom Pittman, you can master computers in no time at all! ELF II can execute all 91 RCA 1802 commands. The Short Course quickly teaches you how to use each of these capabilities.

ELF II's \$99.95 price includes video output—so you can display alphanumerics and graphics on your tv screen or video monitor. You can also enjoy video games including a fascinating new target/missile gun game that was developed specifically for ELF II.

But games are only the icing on the cake. ELF II is a small but powerful computer. It gives you a highly effective learning tool for only \$99.95—then expands as your understanding of computers grows.

If you want power to solve real world problems, ELF II has a lot more to offer than "famous name" computers selling for many times ELF II's low price. ELF II adds on are among the most sophisticated on the market today at any price! No wonder IEEE chapters plus hundreds of universities and major corporations now use ELF II to introduce students and employees to microprocessor computing.

Start working with the incredibly versatile and fool-proof ELF II and you'll understand why!

More Powerful Than Your College Degree!

A knowledge of computers may soon be more important to your earning power than a college degree. It doesn't matter whether you're a scientist, engineer, businessman or professional. Understand computers and you can command MONEY!

Master This Computer In A Flash!

Regardless of how minimal your computer background is now, you can learn to program an ELF II in almost no time at all. Our Short Course On Microprocessor & Computer Programming was written in non-technical language and it leads you through each of the RCA COSMAC 1802's capabilities, so you'll understand everything ELF II can do... and how to get ELF II to do it! Don't worry if you've been stumped by computer books before. The Short Course represents a major advance in literary clarity in the computer field. You don't have to be a computer engineer in order to understand it.

Keyed to ELF II, it's loaded with "hands on" illustrations. When you're finished with the Short Course, neither ELF II nor the RCA 1802 cpu will hold any mysteries for you.

In fact, not only will you be able to use a personal computer creatively, you'll also be able to read magazines such as BYTE, INTERFACE AGE, POPULAR

ELECTRONICS and PERSONAL COMPUTING and understand the articles.

If you work with large computers, ELF II and our Short Course will help you to understand what makes them tick.

Get Started For Just \$99.95. Complete!

ELF II was developed as a trainer for engineers, hobbyists, technicians and students. Yet it offers advanced features not yet available elsewhere at any price.

With ELF II you learn to use machine language, the fundamental language of all computers. (Higher level languages such as FORTRAN and BASIC must be translated into machine language before a computer can understand them.) With ELF II you build a solid foundation in computers so you'll really know what you're doing.

For \$99.95 your ELF II also includes video output and you can connect it directly to the video input of your tv set without additional hardware. Or, with an \$8.95 RF modulator, you can connect ELF II to your tv's antenna terminals instead.

ELF II's 5-card expansion bus (connectors not included) lets you expand ELF II as your needs grow. If you're an engineer or hobbyist, you can also use ELF II as a counter, alarm, lock, thermostat, timer, telephone dialer or for countless other applications.

ELF II Expands Into A Giant!

Once you've mastered computer fundamentals, ELF II can give you more power to make things happen in the real world than famous name computers that would cost you a lot more money! Thanks to the ongoing RCA 1802 research and development by Netronics, ELF II can now be expanded with some of the most technically advanced small computer add-ons on the market.

Plug in the GIANT BOARD™ to record and play back programs, edit and debug programs, communicate with remote devices and make things happen in the outside world. Add Kluge Board and you can use ELF II to solve special problems such as operating a more complex alarm system or controlling a printing press. Add 4k RAM Boards to write longer programs, store more information and solve more sophisticated problems.

Expanded, ELF II is perfect for engineering, business, industrial, scientific and personal applications. No other small computer is backed by such an advanced research and development program!

ELF II add-ons already include the ELF II Light Pen and the amazing ELF Bug™ Monitor—two extremely recent breakthroughs that have not yet been duplicated by any other manufacturer.

The ELF Bug™ Monitor lets you debug programs with lightning speed because the key to debugging is to know what's inside the registers of the microprocessor. And, with the ELF-BUG™ Monitor, instead of single stepping through your program, you can now display the entire contents of the registers on your tv screen. You find out immediately what's going on and can make any necessary changes.

The incredible ELF II Light Pen lets you write or draw anything you want on a tv screen with just a wave of the "magic wand." Netronics has also introduced the ELF II Color Graphics & Music System—more breakthroughs that ELF II owners were the first to enjoy!

ELF II Tiny BASIC

Like all computers, ELF II understands only machine language—the language computers use to talk to each other. But, to make life easier for you, we've developed an ELF II Tiny BASIC that lets you talk with ELF II in simple words that can be typed out on a keyboard such as PRINT, RUN and LOAD.

Ask Not What Your Computer Can Do... But WHAT CAN IT DO FOR YOU?

Don't be trapped into buying an expensive dinosaur, simply because you can afford it. ELF II is more advanced and more fun to use than big name computers that cost a lot more money. With ELF II you learn to write and run your own programs. You're not just a keypunch operator. No matter what your particular interests are, ELF II is the fastest way to get into computers. Order from the coupon below!

LETTERS

continued from page 23

to exchange information on modifications, extensions and product evaluations; applications programs; criteria for selecting chips; proposed Z-8000 bus standards, etc.

To belong to either group costs \$5 a year, and further information can be obtained from Xitan Users Group or Z Users Group, 1015 Navarro, San Antonio, TX 78205.

JON D. ROLAND
San Antonio, TX

A COMPUTER IN EVERY HOME

I'm taking issue with your statement that it is total nonsense to have a central control computer for the home.

You are losing sight of the fact that it is more important how and from where you can control than what you are controlling, and this is where a central unit can become cost-effective and convenient. Imagine the cost and use of your phone if you were not able to use the phone company's central units; do you realize the cost of installing 300,000,000 phone wires to each phone you had installed?

The Ghost system is as easy to use as a phone dial—even easier since you only dial 3 digits.

The only equipment the average user ever need see is the 16-button keypad that provides full access to all the power of the House Operating System. The Gimix Relay Driver Boards are used to control the electrical devices connected to the system, and the Gimix Opto board can be used to connect to sensors.

Most important is the human engineering of the House Operating System. We have put every effort into designing it so that you will find it an aid in running your house or plant, not a barrier. Commands are simple and easily remembered. You customize the system to fit your needs—not adapt to fit a rigid, predefined system. Simplicity has been a prime design goal, so that the use of the House Operating System quickly becomes automatic. Only the commands needed immediately have to be learned to run the system; no long training is necessary.

With the Ghost system you don't need a CRT, but can use an open TV channel—or doesn't your John Q. Public watch the tube? Floppy discs are necessary only for mass storage options such as recipe and address files, but not for control.

As far as installation is concerned, does John Q. Public install his own TV antenna? The future of the computer industry is in having service technicians do for John Q. what he can't or won't do for himself.

It was not long ago that the TV and hi-fi industries were in their infancy. Please don't turn off your readers in our industry's childhood... we need these future service technicians to serve John Q.

RICHARD DON
Gimix, Inc.
Chicago, IL

Now let's get some reader opinions. Total computer-controlled home or individual dedicated microprocessors. Send your postcard today—Edltor R-E

Netronics R&D Ltd., Dept RE-4
333 Litchfield Road, New Milford, CT 06776

Yes! I want my own computer! Please rush me—

kit at \$99.95 plus \$3 postage and handling (requires 6.3 to 8 volt AC power supply)

Power Supply (required) \$4.95 postpaid
 RCA 1802 User's Manual \$5 postpaid
 Tom Pittman's Short Course On Microprocessor & Computer Programming reaches you all about everything there is to know about ELF II or any RCA 1802 computer. Written in non-technical language. It's a learning breakthrough for engineers and laymen alike. \$5 postpaid.

Deluxe Metal Cabinet with Plexiglas dust cover for ELF II \$29.95 plus \$2.50 p&h
 I am also enclosing payment (including postage & handling) for the items checked below!

I want my ELF II wired and tested with power supply, RCA 1802 User's Manual and Short Course—all for just \$149.95 plus \$3 p&h

RCA COSMAC 1802's capabilities, so you'll understand everything ELF II can do... and how to get ELF II to do it! Don't worry if you've been stumped by computer books before. The Short Course represents a major advance in literary clarity in the computer field. You don't have to be a computer engineer in order to understand it.

Keyed to ELF II, it's loaded with "hands on" illustrations. When you're finished with the Short Course, neither ELF II nor the RCA 1802 cpu will hold any mysteries for you.

In fact, not only will you be able to use a personal computer creatively, you'll also be able to read magazines such as BYTE, INTERFACE AGE, POPULAR

PHONE ORDERS ACCEPTED!
Call (203) 354-9375

Total Enclosed \$ _____
(Conn. res. add tax)

CHARGE IT! Exp. Date _____
 Visa Master Charge _____
(Bank # _____)

Account # _____

GIANT BOARD™ kit with cassette I/O, RS 232 C/TX I/O, 8-bit P I/O decoders for 14 separate I/O instructions and a system monitor/editor. \$39.95 plus \$2 p&h
 Kluge (Prototype) Board accepts up to 36 IC's \$17.00 plus \$1 p&h
 4k Static RAM kit. Addressable to any 4k page to 64k. \$89.95 plus \$3 p&h
 Gold Plated 86-pin connectors (one required for each plug-in board). \$5.70 ea. postpaid
 Expansion Power Supply (required when adding 4k RAM). \$34.95 plus \$2 p&h
 Professional ASCII Keyboard kit with 128 ASCII upper/lower case set, 96 printable characters, onboard regulator, parity logic selection and choice of 4 hand-shaking signals to mate with almost any computer. \$64.95 plus \$2 p&h
 Deluxe metal cabinet for ASCII Keyboard. \$19.95 plus \$2.50 p&h
 Video Display Board kit lets you generate a sharp, professional 32 or 64 character by 16 line upper and lower case display on your tv screen or video monitor—dramatically improving your unexpanded \$99.95 ELF II. Fits inside ASCII Keyboard cabinet. \$89.95 plus \$2 p&h
 ELF II Tiny BASIC on cassette tape. Commands include SAVE, LOAD, =, X, =, !
 26 variables A-Z, LET, IF/THEN, INPUT, PRINT, GO TO, GO SUB, RETURN, END, REM, CLEAR, LIST, RUN, PLOT, PEEK, POKE. Comes fully documented and includes alphanumeric generator required to display alphanumeric characters directly on your tv screen without additional hardware. Also plays lock-the-top plus a drawing game that uses ELF II's hex-keyboard as a joy stick. 4k memory required. \$14.95 postpaid
 Tom Pittman's Short Course on Tiny Basic for ELF II \$5 postpaid
 ELF-BUG™ Deluxe System Monitor on cassette tape allows displaying the contents of all registers on your tv, at any point in your program. Also displays 24 bytes of memory with full addresses; blinking cursor and auto scrolling. A must for the serious programmer! \$14.95 postpaid
 Text Editor on cassette tape gives you the ability to insert, delete or edit lines and words from your programs while they are displayed on your video monitor. (Add printer and you can use ELF II to type error-free letters plus insert names and addresses from your mailing list.) \$19.95 postpaid
 Assembler on cassette tape translates assembly language programs into hexadecimal machine code for ELF II use. Mnemonic abbreviations for instructions (rather than numerics) make programs easier to read and help prevent errors. \$19.95 postpaid
 Disassembler on cassette tape takes machine code programs and produces assembly language source listings to help you understand and improve your programs. \$19.95 on cassette tape
SAVE \$9.90—Text Editor, Assembler & Disassembler purchased together, only \$49.95! (Require Video Display Board plus 4k memory.)
 ELF II Light Pen, assembled & tested. \$7.95 plus \$1 p&h
 ELF II Color Graphics & Music System Board kit \$49.95 plus \$2 p&h
 ELF II connects directly to the video input of your tv set without additional hardware. To connect ELF II to your antenna terminals instead, order RF Modulator. \$8.95 postpaid
Coming Soon: A-D, D-A Converter, Controller Board and more!

Print Name _____
Address _____
City _____
State _____ Zip _____

DEALER INQUIRIES INVITED

CIRCLE 44 ON FREE INFORMATION CARD

TUNER SERVICE



CORPORATION

SAME DAY SERVICE



ONE YEAR GUARANTEE

The Company of Independent Professionals

Better Quality — Personal Attention — Faster Service

TSC PROVIDES YOU WITH A COMPLETE SERVICE FOR ALL YOUR TELEVISION TUNER REQUIREMENTS



SUBSTITUNER

TUNER REPAIRS

EXACT REPLACEMENT

UNIVERSAL REPLACEMENT

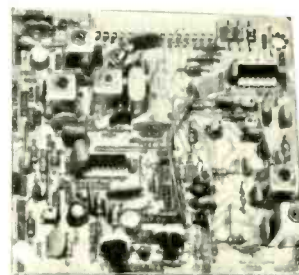

MODULES

HEADQUARTERS.....	BLOOMINGTON, INDIANA 47401.....	537 South Walnut Street.....	Tel. 812/334-0411
ALABAMA.....	BIRMINGHAM, ALABAMA 35212.....	5623 1st Avenue N.....	Tel. 205/592-9150
ARKANSAS.....	LITTLE ROCK, ARKANSAS 72204.....	4200-C Asher Avenue.....	Tel. 501/661-0393
CALIFORNIA.....	MODESTO, CALIF. 95351.....	123 Phoenix Avenue.....	Tel. 209/521-8051
	NATIONAL CITY, CALIF. 92050.....	117 East 8th Street.....	Tel. 714/477-8746
	NORTH HOLLYWOOD, CALIF. 91601.....	10654 Magnolia Boulevard.....	Tel. 213/769-2720
	SAN MATEO, CALIF. 94402.....	600 S. Amphlett Boulevard.....	Tel. 415/348-3292
FLORIDA.....	TAMPA, FLORIDA 33606.....	1505 Cypress Street.....	Tel. 813/253-0324
	FT. LAUDERDALE, FLORIDA 33309.....	3841 N.W. 9th Avenue.....	Tel. 305/566-4882
GEORGIA.....	ATLANTA, GEORGIA 30310.....	646 Evans Street S.W.....	Tel. 404/758-2232
ILLINOIS.....	URBANA, ILLINOIS 61801.....	908 East Main Street.....	Tel. 217/384-2052
	SKOKIE, ILLINOIS 60076.....	5110 West Brown Street.....	Tel. 312/675-0230
INDIANA.....	INDIANAPOLIS, INDIANA 46204.....	112 West St. Clair Street.....	Tel. 317/632-3493
	SOUTH BEND, INDIANA 46619.....	2010 Western Avenue.....	Tel. 219/288-8918
KENTUCKY.....	LOUISVILLE, KENTUCKY 40217.....	#7 Dahlem Ctr. 826 Eastern Pkwy.....	Tel. 502/452-1191
LOUISIANA.....	SHREVEPORT, LOUISIANA 71104.....	2423 Southern Ave.....	Tel. 318/221-3027
MASSACHUSETTS.....	SPRINGFIELD, MASSACHUSETTS 01109.....	144 Boston Rd.....	Tel. 413/788-8206
MISSOURI.....	ST. LOUIS, MISSOURI 63132.....	2577 Page Avenue.....	Tel. 314/821-0633
NEVADA.....	LAS VEGAS, NEVADA 89102.....	1114 South Casino Center Blvd.....	Tel. 702/384-4235
NEW JERSEY.....	TRENTON, NEW JERSEY 08638.....	1139 Pennsylvania Avenue.....	Tel. 609/393-0999
	JERSEY CITY, NEW JERSEY 07307.....	454 Central Avenue.....	Tel. 201/792-3730
NEW YORK.....	ROCHESTER, NEW YORK 14606.....	25 Howard Road.....	Tel. 716/647-9180
NORTH CAROLINA.....	GREENSBORO, N. CAROLINA 27405.....	2914 East Market Street.....	Tel. 919/273-6276
OHIO.....	CLEVELAND, OHIO 44109.....	4525 Pearl Road.....	Tel. 216/741-2314
OREGON.....	PORTLAND, OREGON 97210.....	1732 N.W. 25th Ave., P.O. Box 10141.....	Tel. 503/222-9059
PENNSYLVANIA.....	PITTSBURGH, PENNSYLVANIA 15209.....	515 Grant Avenue.....	Tel. 412/821-4004
TEXAS.....	DALLAS, TEXAS 75218.....	11540 Garland Road.....	Tel. 214/327-8413
CANADA.....	ST. LAURENT, QUEBEC H4N-2L7.....	305 Decarie Boulevard.....	Tel. 514/748-8803
	CALGARY, ALBERTA T2H-1Y3.....	P.O. Box 5823, Station "A".....	Tel. 403/243-0971

If you want to branch out into the TV Tuner Repair Business write to the Bloomington Headquarters about a franchise.

CIRCLE 29 ON FREE INFORMATION CARD
www.americanradiohistory.com

equipment reports

Lab Science Model VLA-1000 Logic Analyzer



CIRCLE 143 ON FREE INFORMATION CARD

A FULL-BLOWN LOGIC ANALYZER IS A VERY expensive piece of equipment, with some name-brand models selling for \$5000 or so. There are some special models that cost around \$2000, and some really sophisticated ones that are close to \$10,000. Lab Science sells the *model VLA-1000* logic analyzer for \$595. Their design philosophy has been to eliminate

the nonessential features.

Logic analyzers take a digital picture of the data presented on several parallel data-bus lines, and store it in a semiconductor memory for later analysis. When the input levels rise or fall through preset input thresholds, the data is recognized as ones or zeros and stored in memory cells. Memory contents can be accessed later and converted to oscilloscope displays for convenient analysis.

The *model VLA-1000* is a 16-channel analyzer that uses 16 data input leads plus additional clock and ground leads. The 17 active leads interface to Schmitt triggers that switch at 0.8 volt and 1.6 volts. More expensive instruments include a choice of input thresholds to interface with logic families other than TTL. Some include threshold adjustment potentiometers where individual inputs or groups of inputs can be tailored for special requirements. Lab Science has wired the input connector so that the 16 data leads can be reversed by simply turning the connector end for end. Usually it is easy to confuse the most-significant bits with the least-significant bits due

both to pure error and to inconsistencies in the numbering of bit positions. To solve this problem, the *model VLA-1000* analyzer uses a 20-pin connector to interface the 18 leads so that the two end pins on each side are clock and ground.

The analyzer operates with input signals from DC through 10 MHz. It does not include an internal clock, and for those cases where you want to use the analyzer asynchronously or simply make a sampled measurement, an external clock source must be connected.

The memory itself consists of 256 bits arranged as sixteen 16-bit words. The trigger circuitry allows a selected parallel synchronization bit pattern to be recognized and recorded at the end, middle or beginning of the 16-word burst stored by the analyzer. The trigger word is selected by setting 16 switches to their zero, one or "don't-care" positions. Up to 9999 clock pulses or trigger-event intervals can be counted before storing the data. For economy, the same switches used for the sync setup are also used for the delay count. The delay is

continued on page 32

Assemble your own Schober Organ —the Musical Fun Machine!

Once upon a time the organ was a big, ponderous instrument used only for religious services and, now and then, for concerts. There is nothing wrong with that kind of organ. The better modern instruments (like Schober Organs) can be used that way and often are.

But most of today's organs—again very definitely including Schober Organs—are owned by people who simply want to have a good time with music in their own living rooms. They have found that a good electronic organ can make music more fun than anything else!

An organ is easy to play. Tone pours out as long as you hold down keys (sounds don't die away like piano notes); so you have plenty of time to think about what comes next. And you learn the notes of a piece just once; but you can make it sound different every time you play it, just by fooling with the many kinds of controls every good organ has. There's no way you can damage anything. But the changes and effects you can get will never cease to intrigue you and absorb your interest.

Don't worry if you can't play a note. Most people learn to play *after* buying an organ, because the organ is the instrument

adults enjoy learning—and the one with which they have real success!

Owning a Schober Organ is a double-barreled pleasure, because *you assemble it yourself*—with the clearest set of instructions and the most complete customer support in the industry. The parts are the best. And Schober's unique designs, specifically created for kit builders, require no previous knowledge. If you know electronics you'll work faster—but not better. The result is an instrument that would cost thousands more in a store, and a pride of accomplishment you couldn't buy at any price!



•••••

- Schober Organ Corp., Dept. RE-184
- 43 W. 61st St., New York NY 10023
- [] Send me Schober Organ Catalog.
- [] I enclose \$1 for Demo Record.
- _____
- Name _____
- _____
- Address _____
- _____
- City, State, Zip _____
-

CIRCLE 37 ON FREE INFORMATION CARD



Get every excitement-packed issue of Radio-Electronics delivered to your door. And save money, too—up to \$18 off newsstand prices! Use the handy coupon and subscribe today!

Mail to: Radio-Electronics
SUBSCRIPTION DEPT., P.O. BOX 2520,
BOULDER, COLO. 80323 (please print)

Name		
Address		
City	State	Zip Code

Indicate the offer you prefer:

- 1 Year—12 issues ONLY \$9.98 (You save \$5.00 off newsstand price.)
- 2 Years—24 issues ONLY \$19.00 (Save More! \$11.00 off newsstand price.)
- 3 Years—36 issues ONLY \$27.00 (Save Even More! Save \$18.00 off newsstand price.)
- Payment enclosed Bill me
- Check here if this is a new subscription.
- Check here if you are extending or renewing your subscription.

Extra Shipping: Canada \$3.00 per year, all other countries \$5.00 per year.

40B9

If you don't see your kind of electronic pliers here, look again,

Xcelite® makes them all.

Xcelite, long acknowledged as the world's first family of electronic hand tools, now includes a greatly expanded line of solid joint pliers and cutters. All the pliers you'll ever need, and more. Because new designs are continually added as new electronic products are born.

The present range extends through 38 patterns and sizes including 13 new models for miniature electronics. Made in U.S.A. by the latest technology and quality controls, in one of the world's most modern electronic hand tools plants, Xcelite pliers set the standards for the industry. Yet the same advanced production techniques make them competitively priced.

Typical of the features that single out Xcelite quality are coil spring openers, polished heads, cleanly milled and perfectly aligned jaws, hand-honed and mated cutting edges, exceptional strength and performance provided by forged alloy steel construction, precision machining and scientific proportioning. Handles are designed for maximum leverage and convenience, with plastic coated "Cushion-Grip" for added comfort.

Styles? What else could you possibly need: standard, midget, and taper nose diagonals; standard, very fine and extra thin needle nose; long and short nose; long, short and midget chain nose, with and without side cutters; side cutting; short flat nose; round nose; tip cutter wiring; cutting and looping; short nose tip cutting; thin bent nose; midget semi and full flush cutting; diagonal full flush cutting; and stainless diagonal cutting.

You don't know what you can do with pliers until you know what Xcelite pliers can do for you. See your distributor and let him update you.



The Cooper Group
Electronics Division

WELLER® • VISS® • XCELITE®
P.O. BOX 728, APEX, NORTH CAROLINA 27502, 919/362-7511

CIRCLE 12 ON FREE INFORMATION CARD

Train with NTS for the MicroComputers, digital the first name



MicroComputers



The world of electronics is daily becoming more challenging. Technology is growing more specialized, and the importance of digital systems increases every day. Test instruments, home entertainment units and industrial control systems are all going digital. And now, NTS training programs include a wider choice of solid-state and digital equipment than ever before offered in any home study course: Advanced NTS/Heath digital color TV (25" diagonal with optional programming capability), NTS/Heath microcomputer, digital test equipment, digital stereo receiver (70 watts per channel), NTS compu-trainer, plus much more state-of-the-art equipment to make your training exciting and relevant.

The equipment you receive with NTS training programs is selected to provide you with a solid

background in electronic systems. Kits and lessons are designed to work together to demonstrate electronic principles and applications. The kit-building not only shows you how electronic hardware functions, but how various circuit designs accomplish different purposes. Your lessons guide you through any number of experiments associated with many projects. This is the Project-Method, and it works. Step-by-step, you learn how and why digital electronics has become a part of our world, and the even bigger role it is sure to play in the future.

Whether you are looking for training in Consumer, Commercial, or Industrial electronics, NTS offers fourteen courses, some basic, many advanced, in several areas of electronics. An all-new full-color NTS catalog shows you what each course covers,

electronics of the future.

systems and more...from
in home study.



**Test
Instruments**



Simulated TV Reception



**Basic
Electronics**



and every piece of equipment included.

Send for it today, and see for yourself what's really happening in electronics training technology at NTS. Find out how much has changed, and what new directions the field is taking. You'll probably want to be a part of it.

It's free. Just mail the card or coupon. Today.

**NO OBLIGATION. NO SALESMAN WILL CALL.
APPROVED FOR VETERAN TRAINING.**

NATIONAL TECHNICAL SCHOOLS

TECHNICAL-TRADE TRAINING SINCE 1905
Resident and Home-Study Schools
4000 South Figueroa St., Los Angeles, Calif. 90037

NATIONAL TECHNICAL SCHOOLS Dept. 206-049

4000 South Figueroa Street, Los Angeles, California 90037

Please send FREE Color Catalog and Sample Lesson.

- Color TV Servicing
- B & W TV and Radio Servicing
- FCC License Course
- Electronic Communications
- Electronics Technology
- Audio Electronics Servicing
- Digital Electronics
- MicroComputers/MicroProcessors

Name _____

Address _____

Apartment Number _____ Age _____

City _____

State _____ Zip _____

Check if interested In G.I. Bill information.

Check if interested ONLY in classroom training in Los Angeles.

loaded with the momentary-action delay load switch. The 16 switches are BCD-encoded to cover the 9999 count-delay range.

If you just want to observe changes in input data rather than capture a single-event sequence, the instrument has a repetitive trigger mode. At adjustable time increments, the trigger-recognition circuitry is rearmed and awaits the next trigger event.

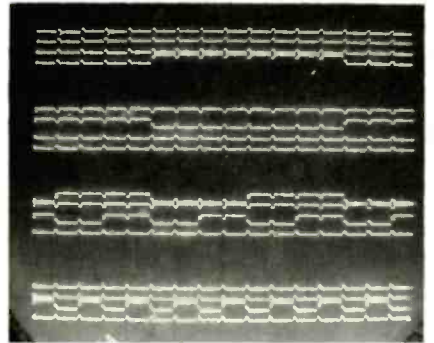

FIG. 1

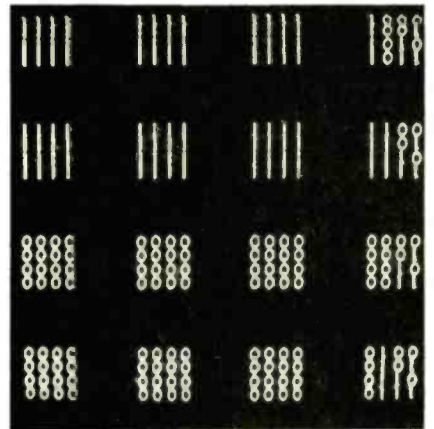

FIG. 2

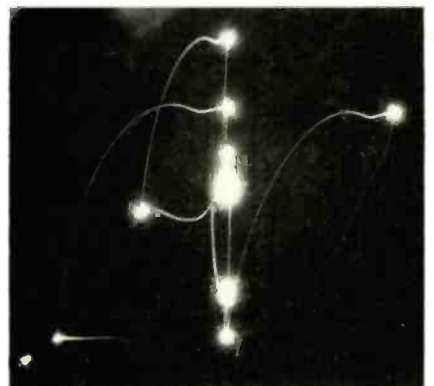
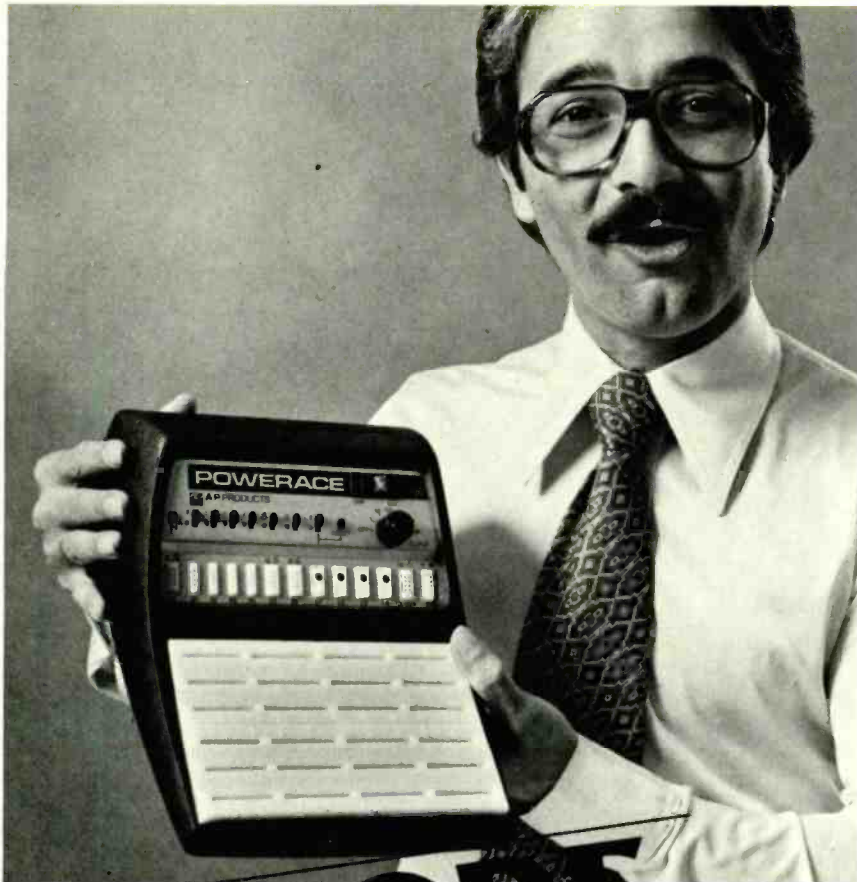

FIG. 3

Data display includes all common modes. The waveshape mode resembles a 16-channel chopped oscilloscope display (see Fig. 1). Actually, the data is read in a parallel fashion so the display does not include the irregularities of chopped or alternate displays. The traces are arranged as four groups of four horizontal traces each; they are exclusive-OR'ed with the clock transitions to display timing ticks. Designers examining microprocessor

continued on page 34



MORE.

This A P power breadboard includes a pulse detector, complete with memory.

Now that you're ready to build and test more sophisticated circuits, you've found the right breadboard.

Our Model 102 A P POWERACE, for instance, gives you a complete digital prototyping lab in one compact package.

It will detect positive or negative-going pulses as short as 10 nanoseconds—and keep them on-tap for you in its memory. This, combined with its 3 logic indicators, gives you a built-in logic probe.

Like our other power breadboards, the 102 has 16 distribution buses of 25 tie-points per bus to jumper in groups as needed and use for voltage and ground distribution, reset lines, clock lines, shift command, etc. And 1,680 tie-point terminals for plugging in circuit components and jumper wires.

With an A P POWERACE, you will prototype any type of electronic circuit faster and easier than you ever thought possible.

Your A P dealer has the details. Where? We'll tell you. Call (toll-free) 800-321-9668. And ask for the complete A P catalog, The Faster and Easier Book.



AP PRODUCTS INCORPORATED

Box 110 • 72 Corwin Drive
Painesville, Ohio 44077
Tel. 216/354-2101
TWX: 810-425-2250

Faster and Easier is what we're all about.

CIRCLE 47 ON FREE INFORMATION CARD

There's only one way to have the newest and most unique top-value electronic products...choose and build from the nearly 400 fascinating kits you'll find in this new

FREE HEATHKIT® CATALOG!



See the world's first Electronic Weather Computer. It indicates, stores and retrieves all temperature, pressure and wind data...even computes wind chill factors for home, farm or office.



See the very finest, most advanced oscilloscope Heath has ever developed. Compare this DC-35 MHz Dual Trace, Delayed Sweep Scope with others costing hundreds of dollars more.



See the new GC-1415 deluxe Digital Car Clock with trip timer and stopwatch. Useful and practical for car, van or truck.

The R/C'er's dream — Heath's Pack 17 8-channel open gimbal R/C transmitter with instant plug-in frequencies...at big kit savings!



A super coin-shooter! Heath's 'Cointrack' Metal Locator with adjustable discrimination and pushbutton tuning.



See the first and the best electronic digital bathroom scale with a strain-gauge transducer like the most expensive laboratory scales.



See the world's first and finest fully computerized and programmable color TV that lets you program an entire evening's viewing.



See Heath's newest and finest 'rack-mount' series of audio components — professional performance for discriminating audiophiles and music lovers who want the best.

Plus hundreds of top-performing, value-priced electronic kit products for home, hobby or business. See the most powerful personal computer systems you can buy with complete software and peripherals. See the Heathkit Continuing Education Self-Learning Programs in Basic and Advanced Electronics, Automotive Electrical, Test Instruments and Novice and General Amateur Radio Licenses — the most efficient and economical way to stay on top of our electronics world! **FILL-IN COUPON AND SEND TODAY.**

If coupon is missing, write Heath Co., Dept. 020-520, Benton Harbor MI 49022.

Every Heathkit product is backed by world-famous technical service and counsel — plus sales and service facilities at 54 Heathkit Electronic Centers* coast-to-coast (*units of Schlumberger Products Corporation). See the white pages of your phone directory for the center nearest you.

SEND FOR YOUR FREE COPY TODAY!

HEATH Schlumberger	Heath Company, Dept. 020-520 Benton Harbor, Michigan 49022
Please send me my FREE Heathkit Catalog. I am not now receiving your catalogs.	
Name _____	
Address _____	
City _____	State _____
CL-689	Zip _____

FREE CATALOG

CIRCLE 100 ON FREE INFORMATION CARD

EQUIPMENT REPORTS

continued from page 32

buses, or the IEEE-488 instrumentation bus, will find the data-domain mode useful. In this mode, the data is displayed as ones and zeros written numerically on the oscilloscope screen. Again, the words are formatted horizontally by four groups of four words each, and further horizontal grouping by fours add clarity (see Fig. 2). The instrument does not include octal or hexadecimal readouts as many of the more elaborate units do.

The map mode displays a dot for each active 16-bit address within a 65,536-bit field (see Fig. 3). This is useful, for example, in testing digital logic systems where common faults are equated with distinctive dot patterns and can

be quickly recognized subjectively.

A fourth, dual-trace D/A mode is included that requires using a dual-trace oscilloscope. The 16 bits are divided into two groups of eight, and each is converted to an analog voltage by a D/A converter. The output display consists of two traces, each with its own particular series of stepped voltages (see Fig. 4).

Unbalanced vertical and balanced horizontal outputs are used to connect the *model VLA-1000* to most oscilloscopes; blanking is not required.

The unit measures 6 × 12 × 8 inches, and although the specification sheet states it weighs 10 pounds, our test model weighed significantly less. The analyzer consists of two right-angle-mounted PC boards containing all components, and can be easily disassembled for troubleshooting.

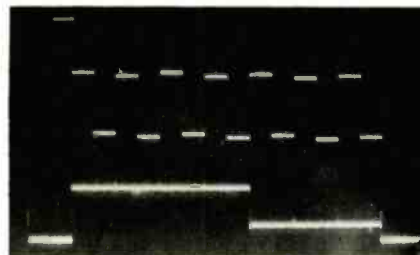

FIG. 4

If you do much digital or microprocessor work that warrants using a logic analyzer, but you cannot afford a full-featured analyzer, carefully examine the handful of limitations of this unit. If, for your requirements, the limitations of the unit are insignificant or can be easily overcome, you should seriously consider the *model VLA-1000*.

The comprehensive manual includes a complete schematic diagram, a parts list, detailed operating instructions, timing diagrams for popular microprocessors, and suggests where the synchronization clock signal should be taken. The *model VLA-1000* can be ordered from Lab Science, P.O. Box 1972, Boulder, CO 80306. **R-E**

Data Precision Model 248 DMM



CIRCLE 144 ON FREE INFORMATION CARD

DATA PRECISION CORPORATION (AUDUBON Road, Wakefield, MA 01880) manufacturer of digital multimeters, has developed the *model 248*. The company claims it is the first mini-DMM to give true RMS readings of AC voltages and currents from 30 Hz up to 20 kHz, as well as providing high accuracy and sensitivity. The DMM has a basic accuracy of ±0.05%, which makes it very useful in precision applications.

The *model 248* measures DC voltages from ±10 μV to 1000 volts in five ranges, DC current from ±10 nA (nanoamperes) up to ±2A and AC volts and current (in the same five ranges) from 10 nA to 2A. Resistance can be measured from 100 milliohms up to 20 megohms. The overload protection is amazing.

The *model 248* is a 4.5-digit instrument with large LED readouts. All ranges are set up in the standard 0-1 order, with 100% over-range capability on all but the 1000-volt range. The maximum reading on each range is 1.999, then it goes into overrange. This is indicated by the display being blanked out, except for the decimal point, and by the DC polarity indicator.

This thoroughly tested instrument comes complete with a copy of its Final Acceptance Report. Actual readings on all ranges are shown, with the accuracy as claimed. After this test, the unit is "burned in" by placing it in an 45°C oven and running it for 8 hours; the key tests on all ranges are then repeated. Note the very small variations, or none at all!

If you read the fine print on this report, it'll



Sprague gives you MORE with LESS

YOU DON'T HAVE TO BUY A STACK TO STOCK UP.

Six Extended-Range Twist-Lok® Capacitors will give you all you need to replace O.E.M. twist-mounting electrolytics in as many as 100 different ratings. Sometimes more. Just how many depends on which six Type TVLU capacitors you pick up. Or maybe you'll want a full dozen to cut down on phone and road time between you and your distributor.

These capacitors come in 299 different capacitance, voltage and case-size combinations for replacing

over 2,000 existing can-type capacitors in entertainment and commercial applications requiring twist-prong mounting, wire-wrap terminals, or circuit board snap-in mounting.

Order Extended-Range Twist-Lok® Capacitors from your Sprague Distributor... or write for Catalog / Cross-Reference Guide K-403A to the Sprague Products Company, 81 Marshall St., North Adams, Mass. 01247.

RADIO-ELECTRONICS

SPRAGUE PRODUCTS COMPANY Distributors' Division of Sprague Electric Co.

THE FOREMOST SUPPLIER OF ELECTRONIC COMPONENTS

CIRCLE 33 ON FREE INFORMATION CARD



scare you. The first test reads: "Pick it up and hold it 1/2 inches over a horizontal wooden surface, then drop it." The next test is worse: Set to the 100-mV range and then apply 1000 volts to the input terminals for 2 seconds! After this, you feed in the specified test voltages and log the readings. On the unit I used, I got a reading of 100 mV on the 100-mV range, and on the 1000-volt range, the unit read 1000.1 volts.

The resistance range tests are almost as scary. First, apply 250 volts 60-Hz AC to the input on the 1000-ohm range for 2 seconds. Then check all ranges for the rated accuracy. All these tests are referenced to U.S. Bureau of Standards ratings and standards, and a Certificate of Conformance is furnished with each unit.

The model 248 runs on a single NiCad battery. A plug-in charger plus test leads, complete with clips, are included. The whole unit, charger and all, can be carried in a neat zippered traveling case. The test leads plug into protected jacks on the right-hand side of the case, and the charger plugs into the back. Each unit carries a full one-year warranty against any defects.

If the decimal point blinks, this indicates there are five minutes of accurate operation left before you must recharge the battery. If the charger is left plugged in during bench operation, the battery is kept at full charge. The model 248 will then run for 6 hours of in-spec operation before a recharge is needed. The charger recharges the unit overnight or in 12 hours.

The instruction manual contains full operating and recalibration data. All calibration adjustments are easily accessible by removing the case; the calibration points are all located in a row along the bottom of the chassis.

Zeroing and polarity indication are fully automatic. Most of the logic components are in a single LSI IC; the RMS-to-DC conversion is performed with a calculating-converter LSI module. The model 248's basic design is very similar to that of its predecessor, the model 245. For an accurate, rugged and reliable piece of test equipment, its price is well within reason at \$345. **R-E**

Apple Computer Applesoft ROM card

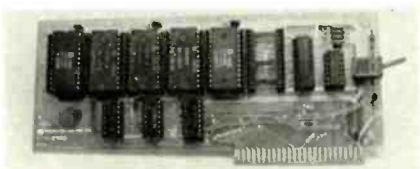

CIRCLE 145 ON FREE INFORMATION CARD

ONE OF THE LATEST ADDITIONS TO THE APPLE II line (Apple Computer, Inc., 10260 Bandley Drive, Cupertino, CA 95014) is the Applesoft ROM Card (part # A2B0009X). This plug-in board contains the newer version of Apple's floating-point BASIC (Applesoft II) completely in ROM. Thus, when this BASIC version is installed, it is always in the machine at power-on (no more waiting 90 seconds to load from the cassette tape), and, equally important, it cannot be wiped out inadvertently by the user's program. Of course it also frees the 10K of RAM that the cassette or disc version normally occupies, as well as 10K of
continued on page 86

How do you really use a multimeter?

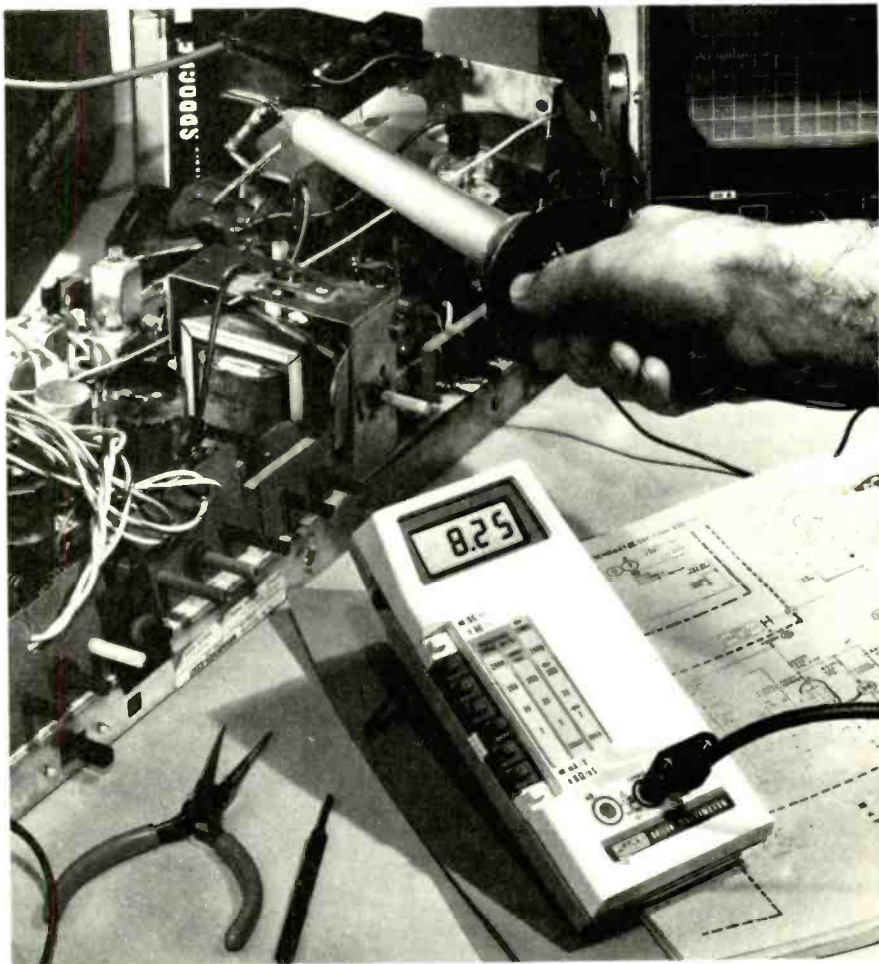

Usually at your bench, in the shop, shared with others. And, if it's a Fluke multimeter, you use it with confidence.

Now you can carry that same bench precision on the job. Introducing the new Fluke 8020A DMM for only \$169.

This rugged beauty packs more field-valuable features than any other DMM available, at any price. And that means field versatility when you need it most.

The 8020A has six resistance ranges, including a 20 megohm range for those special high-resistance TV components. Plus, you can measure focus dividers, pcb and capacitor leakage clear up to 10,000 megohms with the new conductance function. And conductance allows you to measure transistor beta—unique

with the 8020A.

Ever damaged your meter in the fly-back circuit? Rest easy. The 8020A is MOV-protected to 6000V against hidden spikes and transients.

Your 8020A comes with a full-year warranty, with worldwide service backup. Regardless of what happens to it, we'll fix it inexpensively and quickly, making the 8020A a truly cost-effective investment.

FLUKE

8020A DMM \$169.

212-687-2224

THE TEST EQUIPMENT SPECIALISTS

**TOLL FREE HOT LINE
800-223-0474**

54 West 45 Street, New York, N.Y. 10036

**ADVANCE
ELECTRONICS**



TOP BANANA SINCE 1951.

In 1951, our faith in the future was a lot bigger than our finances. We started with less than \$1,000 in a "factory" smaller than a 2-car garage.

But there was one thing we thought we could do better than anybody — design and make banana plugs. A lot of people agreed, and we prospered.

As time went by, we improved upon our own pioneering work. Pomona Electronics became synonymous with quality banana plugs.

Today, we're still the top banana. And we manufacture more than 640 other top quality products industry professionals know and trust.

We even have a big factory, now that we're a division of prestigious International Telephone and Telegraph Corporation.

Most important, ITT Pomona Electronics hasn't forgotten the ideals that helped create great banana plugs.

Because we don't ever want to become just one of the "bunch," ITT Pomona Electronics, 1500 East Ninth Street, Pomona, CA 91766 • Phone: (714) 623-3463 • TWX: 910-581-3822

AVAILABLE THROUGH YOUR FAVORITE
ELECTRONIC PARTS DISTRIBUTOR

FREE 1979 YEARBOOK CATALOG

Contains 100 pages of adapters, cable assemblies, jacks, plugs, boxes, sockets, connectors, jumpers, clips, probes, patch cords, wire, and much more. Yours free upon request. See our pages in EEM.



Pomona Electronics **ITT**

CIRCLE 34 ON FREE INFORMATION CARD

Videodisc!

Two systems have been announced—one uses an optical videodisc; the other a capacitive disc. Here's an introductory look at how they work and compare.

LARRY STECKLER
EDITOR

IT HAS BEEN A LONG TIME COMING, BUT THE FABLED VIDEO DISC is finally here. The very first players using the Philips optical system, complete with built-in laser for scanning the disc, went on sale in Atlanta, Georgia on December 15, 1978. That handful of equipment sold out, at \$695 each, that very same day. In February 1979 another group of videodisc players were offered for sale in Seattle, Washington—it was another sellout.

The players have been introduced by Magnavox Consumer Electronics, the United States subsidiary of the North American Philips Company. The optical videodisc system was developed by Phillips and is being marketed under the trade name of Magnavision. Program material for the new players is also ready now. MCA has a catalog of more than 200 discs including everything from cooking lessons, to sports events, to recent full-length movies. A half-hour disc costs about \$5.95 and a two-hour motion picture about \$15.95.

A competitive system (no equipment is yet available for sale) has been announced by RCA. This system is a capacitive disc—is not compatible with the Philips system—and the discs cannot be interchanged. There are already indications that some other manufacturers may adopt the RCA system. So far it looks like Panasonic and JVC have joined with RCA and their system. However, since the Magnavision system is already available we will talk about it first. Let's start by answering the question: What is a videodisc?

For the Philips system it is simply a pre-recorded disc that looks very much like a long-playing phonograph record that delivers visual and audio signals to a standard television set. It can be replayed again and again without wear or deterioration. Some discs play up to two hours of color—or black and white—programming with stereo sound. Others can be played frame by frame for still presen-

tations or stop action. There are two playback modes.

When the Magnavision player is operating in the standard play mode, the videodisc rotates at 1800 rpm and provides one separate image on each revolution. A disc can be played normally at 30 frames per second or in slow motion, backwards or freeze-frame mode. All frames are individually coded with index numbers and can be selected quickly by the player's random-access feature.

In the Magnavision system there are two modes for playing videodiscs. In the extended-play mode, the videodisc will play up to 60 minutes per side for a total of two hours. In the standard-play mode, the disc will play up to 30 minutes per side for a total playing time of 60 minutes.

To play the Magnavision videodisc, a compact video player is used. It is about the size of a phonograph turntable and is attached to the television set through its antenna system.

Pictures appear on the television screen with a quality claimed to be better than even a cable hook-up can provide. My viewing time was limited, so I can only say that pictures I watched were clean, clear and bright—at least equal to the very best broadcast TV. As the audio quality of the disc is much better than the audio system in the average TV set, sound fidelity can be improved by hooking up the player's audio to the owner's stereo system.

A laser beam is used to scan the videodisc. As a result no stylus ever touches the disc and repeated handling or use cannot wear out or diminish videodisc quality. A thin plastic coating on the surface of the disc protects the program from fingerprints, dust or surface scratches.

Every Magnavision videodisc is composed of thousands of circular tracks that form a continuous spiral from the inside of the videodisc to the outside. These tracks are

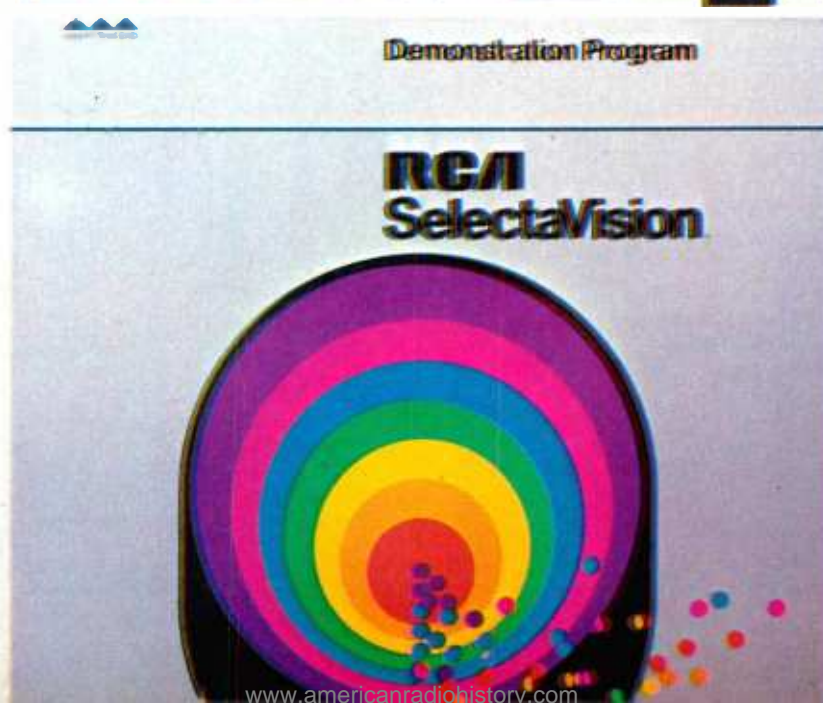
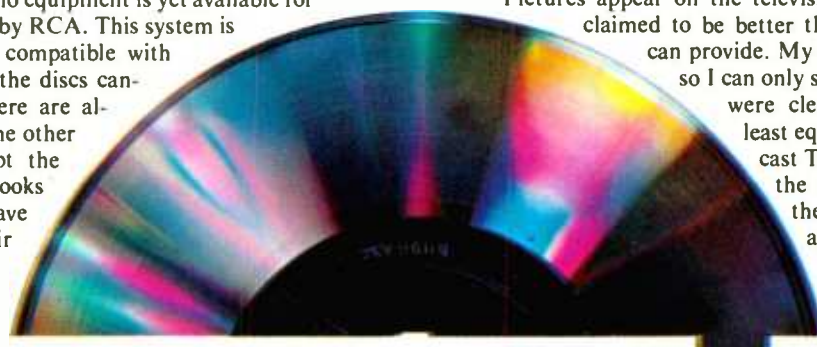

analogous to grooves in an ordinary audio record. However, these tracks are not "grooves". Instead they consist of microscopic pits that are actually minute indentations in the videodisc material. You can see an enlarged view of this in Figure 1. Note that this diagram shows the width of a single track as well as the track pitch or space between tracks. The dimensions are given in microns. (A micron is one millionth of a meter.) The length of the pits and the spacing between them determines the intelligence on the videodisc.

The information encoded on the optical videodisc is the resultant of three FM signals. These signals are 8.1-MHz FM modulated with composite video (including chroma); 2.3-MHz FM modulated with channel 1 sound; and 2.8-MHz FM modulated with channel 2 sound. Each of the sound carriers has a maximum deviation of 100 kHz. The bandpass of the 8.1-MHz video carrier extends from down below 4 MHz to above 12 MHz so that all necessary side bands can be included. Each of the sound FM signals pulse-width modulates the 8.1-MHz video FM to create the actual resultant signals that is encoded on the videodisc.

The optical system

The heart of the Magnavision player is the laser and optical components. Figure 2 shows the path traveled by the laser light beam. The first optical element is the RASTER GRATE. This device is a piece of glass with several fine horizontal lines etched in it. It divides the main beam into three beams—one above and one below the main beam. The secondary beams are slightly smaller and dimmer than the main beam. (Actually, the RASTER GRATE creates more than three beams, but the others are so dim that they can be ignored.)

The center beam is used to read the tracks on the disc, while the two adjacent beams are used for radial tracking. The next element is the SPOT LENS. It focuses the beam to the correct size so that the beam spot on the disc will be the correct size. The FIXED ANGLE MIRRORS merely fold the beam around so the optics of the player can be kept compact.

The WOLLASTON PRISM is the next optical component in the light path. This type of prism has a special characteristic—it is designed to bend light in a direction determined by the polarity of the light beam passing through it. Thus, vertically polarized light is bent in the opposite direction of horizontally polarized light. This characteristic is important when separating the reflected beam from the transmitter beam.

As the beam leaves the left end of the prism it passes through the POLARITY CONVERTER. The main purpose of this device is to change the vertically polarized beam into a circularly polarized beam. It now reflects off the RADIAL and TANGENTIAL MIRRORS into the OBJECTIVE LENS.

LENS. This lens is similar to a microscope and focuses the beam into a tiny spot on the surface of videodisc pits.

Now the beam reflects off the surface of the pits. At this point it becomes intensity modulated because the light reflected from inside a pit is less bright than the light reflected from the surface between the pits. This action occurs because the pits have a depth equal to $\frac{1}{4}$ the wavelength (90°) of the red laser light. Since the light wave takes $\frac{1}{4}$ of the wavelength going into the pit and another $\frac{1}{4}$ wavelength coming out, it is $\frac{1}{2}$ wavelength (180°) out of phase with the light at the surface of the pits. A cancellation effect

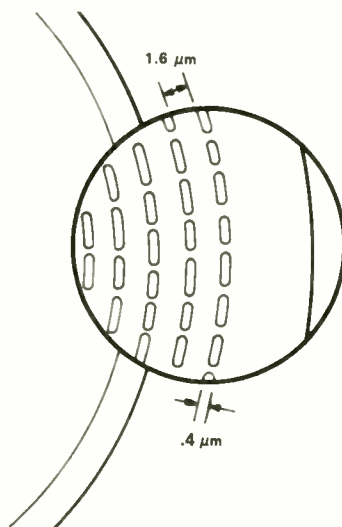

FIG. 1—MICRO PITS IN THE SURFACE of the video-disc carry the encoded video and stereo audio information.

takes place that reduces the intensity of the beam as a pit passes through.

The reflected beam follows the identical path, except in reverse, all the way back to the Wollaston prism. However, on this return trip the light wave is circularly polarized oppositely from what it was because the beam is traveling in the



MAGNAVISION PLAYER WITH the lid up. The unit cannot be turned on until the lid is closed.

opposite direction. As a result, the beam is changed to horizontally polarized light as it passes back through the polarity converter. Thus, vertically polarized light comes out of the left end of the WOLLASTON PRISM, but horizontally polarized light goes into the left end of the Wollaston prism.

As a result of this polarity difference, the prism bends the reflected beam downward as it exits the right end of the prism. The incident beam and the reflected beam are now separated. The reflected beam angles around the fixed angle mirrors, passes through the cylinder lens and lands on the photo diodes.

Remember that the light bundle landing on the diodes actually contains three beams. These beams landing on the diodes generate the FM signal, the focus error voltage and the radial tracking error voltage.

The FM Signal is now fed to circuitry that translates it back into a video signal with two channels of audio. The focus error and radial tracking error signals keep the beam in the proper groove. A much more complete article will appear next month going into a more comprehensive description of how these signals are used to produce slow-motion and stop-frame action. In addition we will look at some of the actual circuitry involved.

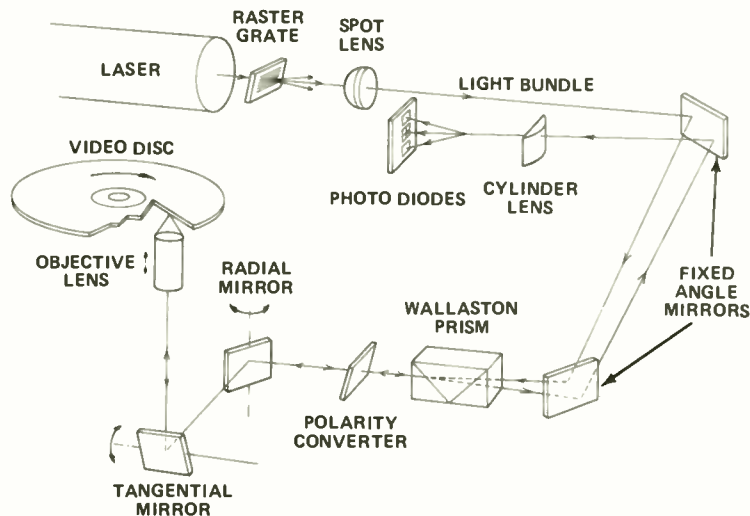
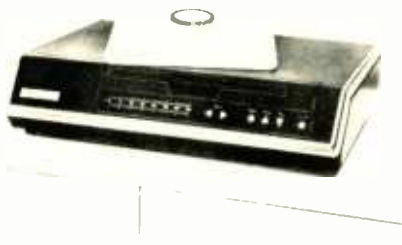

FIG. 2—OPTICAL SYSTEM USED IN MAGNAVISION disc player. The text explains how the laser beam scans the disc and is then converted into picture and sound.



EARLY RCA DISC PLAYER. The new unit may no longer look like this one, but no photos are available of the new player at this time.

RCA's capacitive disc

In a completely different way, RCA has put together its videodisc. Picture quality, as judged in a limited viewing test looks just as good as the Magnavision system. At some later date, when I've had the opportunity to have spent a lot more time watching and comparing quality in an "at home" atmosphere I'll pass along some comparative comments. But for now, the picture quality of the two systems is about the same.

The RCA videodisc can store two hours of recorded picture and stereo sound on a disc—one hour on each side of the 12-inch disc. A spiral "V"-shaped groove guides the diamond pickup stylus as the disc rotates at 450 rpm. Fig. 3 shows the grooved surface of the disc and the tip of the stylus tracking in the groove. Information representing the luminance, chroma, and audio signals is contained in transverse slots of varying width and periodicity impressed into the bottom of the groove.

The tip of a thin metallic electrode on the flat tailing edge of the stylus serves as a capacitance probe for the recovery of the signal. The conductive surface of the disc serves as the other plate of the "capacitor". As the disc rotates and the stylus tracks along the groove, the capacitance variations caused by the passing of the signal-bearing indentations under the stylus tip are sensed. These signals are converted to video and audio information and the unit plays back through a conventional TV set.

The capacitive pickup does require the use of a conductive disc. In an earlier version this was done by applying a conductive coating over the surface of the disc. In the latest version a conductive plastic is used in the manufacture of the disc and the coating is no longer needed.

A buried subcarrier encoding system is used to take best advantage of the capacitance pickup in terms of picture quality and disc playing time. It is based on the use of an FM carrier for the video information and separate FM carriers for the audio information in a single track. The buried subcarrier encoding allows the color signal to be handled in the same channel as the luminance, produces a very

high quality color picture, and allows a low video carrier frequency. A direct benefit of the low carrier frequency is long playing time, since the limitation is usually the shortest reproducible wavelength.

The stylus

Since the RCA disc is a grooved disc, it is vital that the stylus track properly in the groove. The basic tracking problem in the RCA videodisc is quite similar to that encountered in audio players. The tracking forces are applied vertically, primarily by the spring metal flylead that connects to the tip of the stylus support arm.

Also, since there is a groove and a stylus the life of the stylus is important. Figure 4 shows the stylus used. Note the keel-shaped protrusion on the bottom of the V. Since the keel has relatively straight sides, its width will not increase as it wears. Therefore, its initial width can

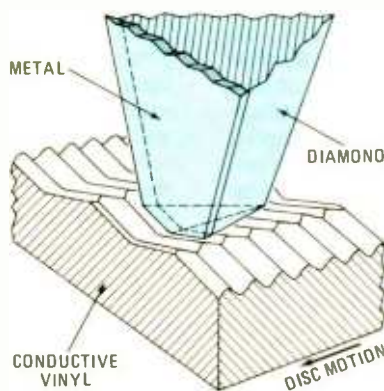

FIG. 3—CAPACITIVE STYLUS forms one half of the capacitor. The conductive disc is the other half of the system.

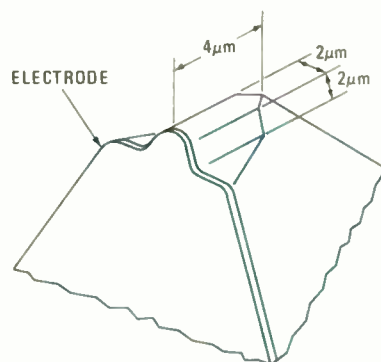

FIG. 4—STYLUS SHAPE IS CRITICAL for proper performance and life. Shown here is the optimum recommended by RCA.

be made almost equal to that of signal elements in the groove. With this kind of geometry, life is primarily a function of how high the keel can be made before it becomes fragile.

The length of the keel is also important. Here the limitation is the lift-off of the electrode when playing a warped disc as the shoe becomes too long. Many experiments have shown that the dimension shown in Fig. 4 is optimum.

The remaining key dimension is the "prow" angle. This is the angle that the leading edge of the stylus makes with the disc. If the angle is too steep the tip may become fragile. In addition, while some fine debris is pushed out of the way, some tends to wrap around the tip lifting it out of the groove. If the angle is too shallow, the tip becomes stronger and critical wrap-around is reduced, but the tip will not push as much debris out of the way and will tend to lift to ride over it causing loss of signal pickup. RCA has found that an angle of about 30° is a good compromise.

One of the problems in any videodisc is that since the rpm is constant, the performance at the inside of the disc is inferior to performance at the outside of the disc. However, the RCA system has been designed to give high quality even at the inner radius, which is reached only after 60 minutes of playing time. This means, of course, that the performance of most of the disc is better than the designated minimum.

Where do we go from here.

Naturally, the real test of the video disc is in the market place. The RCA system, which is expected to sell for \$495 is \$200 less expensive than the Magnavision system. But it may not be able to provide slow motion or stop motion.

The real question is whether a customer will pay \$200 more for slow and stop motion. And this depends upon how the user intends to use his player. If he is going to watch motion pictures or his favorite singing star or his favorite jazz band, stop motion doesn't have very much value. But if the consumer intends to learn to tie fishing flies, or to cook quiche, the frame by frame viewing becomes vital. It's even more important for a picture by picture tour of an art museum. Both the optical and the capacitance systems appear to be functional, reliable and workable. It is my personal feeling that the availability of software, records to put on the player, will be a more important consideration to the consumer than the type of system.

Videodisc or videotape

Both videodisc and videotape have a place in the consumer market just as audio tape and audio discs coexist. If a user has no need to record, he doesn't need the added cost of a recorder. Just the same, there are bound to be many users who will have both disc and tape systems and use each one as it is best suited.

When we couple videodisc and videotape and large screen projection TV, we come up with an entertainment medium that bears only a faint resemblance to the early TV's. The new sets are coming close to matching the dreams of those early experimenters, but it's still a way to flat screens and 3-D pictures.

Another output can be used to turn on emergency lighting in the event of a power failure. Use the interface circuit shown in Fig. 6 to turn on up to three parallel-connected, 6-volt lantern bulbs around the house. During a power failure, the alarm will also sound softly; the volume can be adjusted by R7 (Fig. 1). Or R7 and D3 can be omitted, which will result in no audio alarm signal for the power-failure condition (the audio alarm will *still sound* if a burglar enters during the power failure). If no power-failure indication of any sort is desired (i.e., no lantern bulbs or warning tone) just omit R8, R9, D5, Q12, Q13, and R10, in addition to R7 and D3.

The alarm system remains active even during power failures

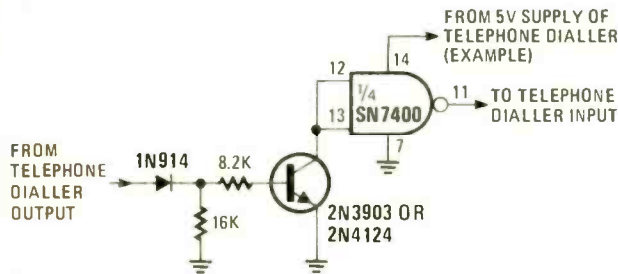

FIG. 4—INTERFACE for logic-1 dialer option.

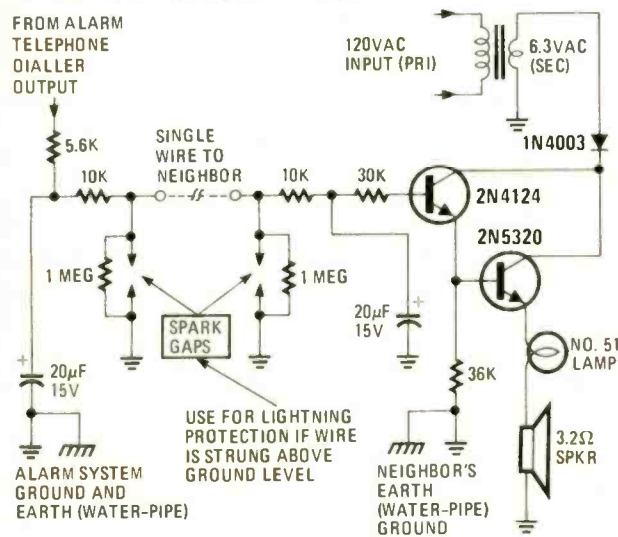

FIG. 5—REMOTE ALARM can be placed in neighbor's home.

as a result of a circuit that automatically switches the unit over to an internal battery pack (use any 10- to 14-volt battery supply). If NiCad batteries are used (the system requires eight each, in series), they must be fully charged upon installation by temporarily paralleling R11 with 82 ohms (1 watt) for 10 hours, and then removing the 82 ohms across R11, allowing a steady, permanent trickle charge (of about 10 to 15 mA) to leak into the batteries. If power is interrupted for very long periods of time (more than two days), or if the alarm is being transported, the battery pack should be disconnected by removing its associated fuse. My unit uses a self-contained NiCad battery pack, but any battery can be used as long as it has the proper voltage and current capability. Remove R11 if dry cells (or lantern batteries) are used.

Mount the entire system in a safe place, where a burglar cannot easily reset the alarm or disconnect the wires to the speaker or battery.

How it works

Let's assume that all your windows are wired with foil strips, which, if broken, will open-circuit. All foil-stripped windows

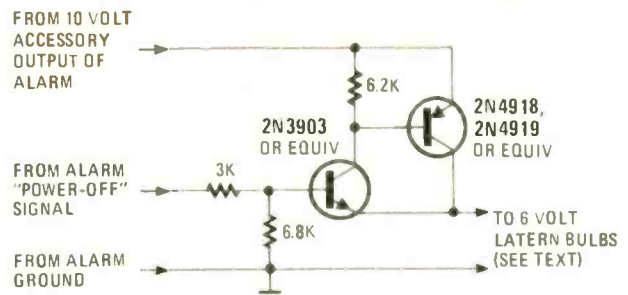

FIG. 6—EMERGENCY LIGHTING is turned on by this circuit.

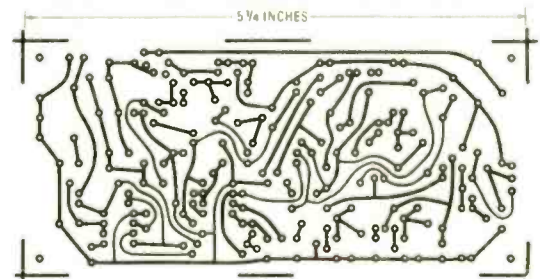

FIG. 7—FOIL PATTERN is shown half size.

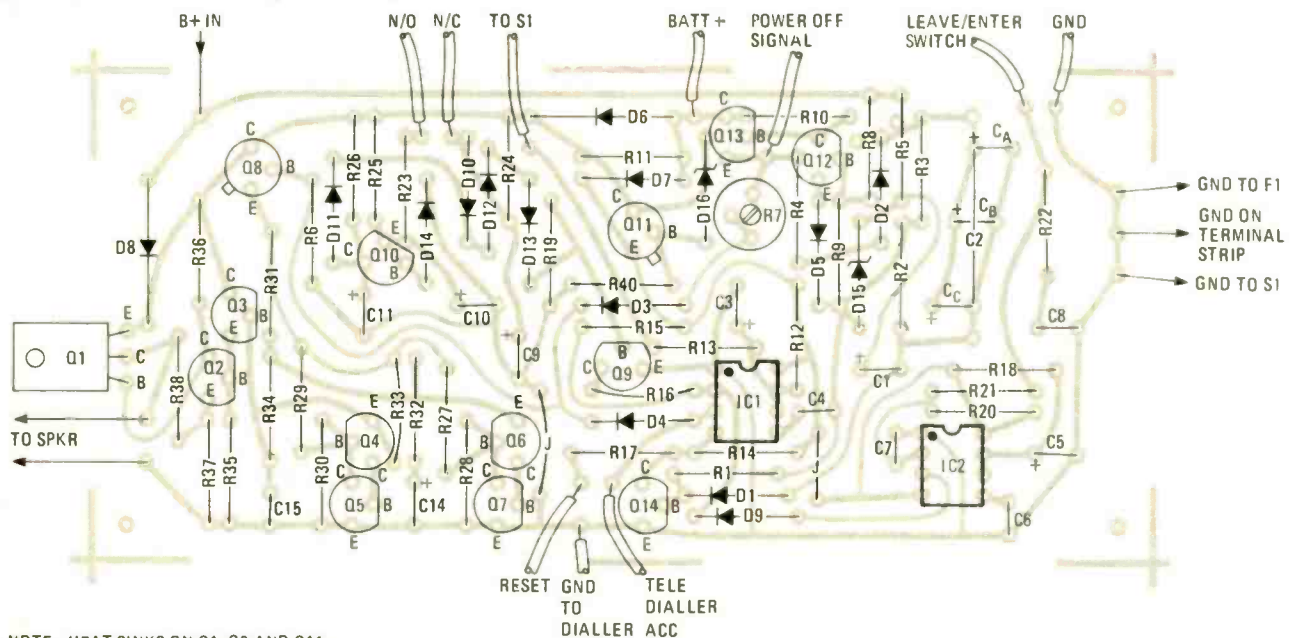

FIG. 8—COMPONENT LAYOUT for the PC board. Parts are inexpensive and easy to obtain.

PARTS LIST

Resistors 1/2 watt, 20% or better

R1, R3, R34—27,000 ohms
 R2—15,000 ohms
 R4, R21—1000 ohms
 R5—7500 ohms
 R6—30,000 ohms, see text
 R7—20,000-ohm trimmer pot, 1/2 watt or higher
 R8—39,000 ohms
 R9—8200 ohms
 R10, R13–R15, R20, R24, R26, R33, R35, R40—10,000 ohms
 R11—620 ohms
 R12, R18—1.2 megohms
 R16—2000 ohms
 R17, R38—100 ohms
 R19—47,000 ohms
 R22—39 ohms
 R23—62 ohms
 R25—20,000 ohms
 R27–R30—110 ohms
 R31—4700 ohms
 R32—10 ohms
 R36—1800 ohms
 R37—33 ohms
 R39—470 ohms, 2 watts, carbon

Capacitors

C1—20 μ F, 10 volts, radial-lead electrolytic or tantalum
 C2—100 μ F, 12 volts, axial-lead electrolytic or three 33- μ F tantalums in parallel
 C3—47 or 50 μ F, 16 volts, radial-lead electrolytic or tantalum
 C4, C6, C7—.01 μ F, 50 volts, ceramic disc
 C5—22 μ F, 16 volts, radial-lead electrolytic or tantalum

C8—4.7 μ F, 16 volts, radial-lead electrolytic or tantalum
 C9—4.7 μ F, 6 volts, radial-lead electrolytic or tantalum
 C10—6.8 μ F, 6 volts, radial-lead electrolytic or tantalum
 C11—47 μ F, 6 volts, radial-lead electrolytic or tantalum
 C12, C13—1000 μ F, 25 volts, axial-lead electrolytic or one 2000- μ F computer-grade electrolytic
 C14—47 μ F, 10 volts, radial-lead electrolytic
 C15—0.1 μ F, 50 volts, ceramic disc

Semiconductors

D1–D5, D9–D14—1N914 high-speed switching diode
 D6, D8—silicon rectifier diode, 2 amps or higher, pigtail leads
 D7—1N4001, 1N4002, 1N4003 or similar 1-amp silicon diode
 D15—Zener diode, any rating between 6.0 and 8.2 volts
 D16—1N5230 or similar 4.7-volt Zener diode
 IC1, IC2—NE555 or LM555 timer
 Q1—2N4918, 2N4919, 2N6490 or equal
 Q2, Q3, Q5, Q7—2N3392, 2N3903, 2N3904 or equal
 Q4, Q6—2N3905, 2N3906, 2N2907, 2N4126 or equal
 Q8, Q11—2N5320 or 2N3053 NPN, 5 watts, TO-5 case
 Q9, Q10, Q12–Q14—2N4124, 2N3903, 2N3904 or equal
 RECT—full-wave rectifier bridge, 2 amps, 100 PIV, Varo VJ447 or similar

Miscellaneous

T1—power transformer, 12-volt 2-amp secondary, Stancor P-8130 or equal
 S1—SPST miniature toggle switch
 S2—SPST toggle or pushbutton switch
 S3—see text
 Binding-post strips, terminal lugs, screws, nuts, lockwashers, line cord, pilot lamp (optional), speaker (see text), chassis and case.

are, therefore, considered normally closed sensors and should be wired *in series* with other such sensors; and the overall series-connected arrangement must connect to the normally closed input of the alarm. (If no normally closed sensors are used, the normally closed input must be grounded to the alarm ground.) Then, IC1 will trigger, either as a one-shot (if mode switch S1 is in the **MOMENTARY** position) or as a bistable flip-flop (if S1 is in the **STEADY** position), if a normally open sensor (from, say, the front door entrance) closes (i.e., shorts). This will enable the "whoop-whoop" oscillator power source, Q8. However, if a signal of intent to enter or exit is sent to the enter-exit input (by momentarily closing S3), which triggers IC2 high, then IC1 would be prevented from triggering until IC2 "times out." The **RESET** switch, S2, can be either a momentary-action or positive-action switch. If a positive-action switch is used, the alarm will be inhibited as long as the switch is closed, except for the power-failure warning tone. The loudness of the power-failure warning tone is adjustable by varying resistor R7, which varies the DC voltage applied to the oscillator power lead. If a greater adjustment range for R7 is desired, lower the value of R6 to 10K. When installing the alarm system, check with local authorities. Some limit the duration of alarm signals.

When AC power is interrupted, C12 and C13 discharge rapidly through R39; this rapidly decreasing voltage is applied to Q12 by voltage divider R8 and R9. When the voltage at the base of Q12 is less than about 1.2 volts, Q12 comes out of conduction (turns off) and the emitter of Q13 goes high. This enables the lantern bulbs (if used) and resets IC1 through R4, D2, C2, D1 and Q14. Capacitor C2 gradually charges through R2 and R3, so that the reset condition does not become permanent, owing to current steering away from the base of Q14 after about 7 seconds. Similarly, when AC power is applied or restored, capacitor C1 resets IC1 by charging into the base of Q14 and tapering off after a few seconds due to R2. Zener diode D15 assures that power-supply ripple will not cause a false reset of IC1. Resistor R1 further enhances the noise immunity of the automatic reset circuit by keeping a low base-impedance for Q14, which also allows this transistor to have a moderate I_{CBO} leakage (this allows you to use grab bag silicon transistors). Resistor R19 serves a similar purpose for transistor Q9. Capacitors C11 and C10 enhance the power-line (60-Hz) pick-up

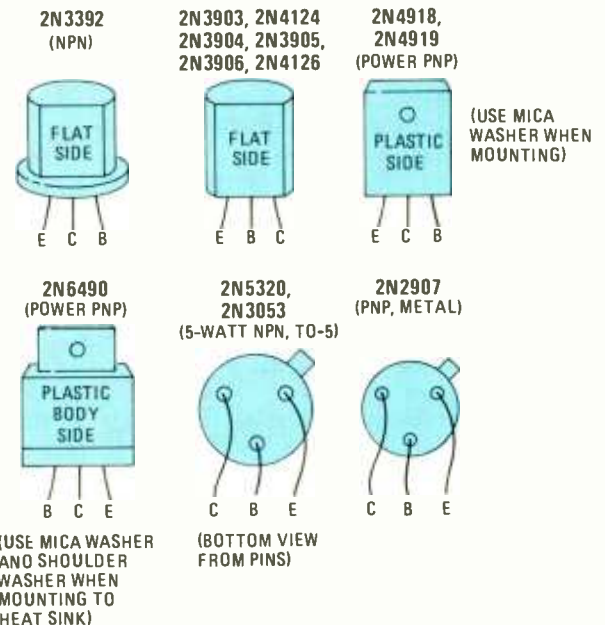

FIG. 9—PINOUTS for the optional transistors.

immunity of the sensing circuits; this allows nonshielded wire to be used for both the normally open and normally closed inputs.

The schematic in Fig. 1 and the large number of discrete semiconductors make this alarm system appear much more complex and more costly than it really is. Several transistor types are given for each application. This gives you the opportunity to use inexpensive types available from the sources advertised in the back of this issue.

The foil pattern for the relatively simple PC board is shown in Fig. 7. The components layout is shown in Fig. 8. If you cannot reproduce the foil pattern exactly, you could try making your own layout. The only really critical points are in the pin positions for IC1 and IC2. All the other components have flexible leads that can be cut and positioned as necessary. Check the transistor pinouts in Fig. 9.

Protect Your Valuables— Light Sensitive Security Alert

Unique IC that includes a photodiode and lens makes this security alarm very sensitive to any movement in its vicinity. Movement in any direction causes diffused shadows that trigger the detector.

MELVIN WEISS

HARDLY A DAY PASSES THAT A SMALL segment of the population—complacent until now—is not made aware of the need for increased security in the home or place of business. This ever-increasing interest in security and security devices has led to the development of a number of different systems. Most of these were based on ultrasonics, interrupted light beams (visible or IR), normally open and normally closed switches, and conductive tapes. All except the simplest use one or more IC's as the alarm generator and for timing in various phases of operation.

Recently a unique type of IC motion detector was developed for use in security systems. This device is based on LSI technology and includes both linear and digital circuitry in its operation.

This motion detector operates on a change in light level. This is not to be confused with the system that requires a light transmitter and receiver and operates only when the light beam is completely interrupted to produce a 100% change in the level of light falling on the receiver. The light sensor used here can detect a change in light as little as $\pm 5\%$ and does not require a separate light source.

The advantage of this system is that triggering results when any motion in the immediate vicinity causes either the direct or reflected light to change as little as 5%. This change may be in either direction; more light or less light. The system operates in light levels varying over a range of 1000 to 1; from as low as 0.1

candlepower, quite dark, to 100 candlepower—quite bright.

The light sensor is contained in a molded clear plastic DIP housing so that light can reach an internal photodiode detector. A molded lens is mounted over the package to improve the sensitivity at low light levels.

The lens and the hole (aperture) in the side of the case are positioned so the photodiode gathers light in the shape of a cone. The lens gathers light in such a manner that the light sensor covers a 2-foot circle at a distance of around 8 feet. Figure 1 is the block diagram of the D1072 light sensor IC. Light falling on photodiode D1 causes a voltage to be developed at its output. Motion within the diode's field of view changes the light

level, thus producing changes in the output voltage. Capacitor C1, connected between terminals 6 and 7, couples the voltage changes to amplifiers A2 and A3. Capacitors C1 and C3 are parts of a filter network to detect low-frequency voltage changes (motion) while C2 attenuates higher frequencies, thus making the device immune to flicker inherent in lamps operating from AC sources.

The gain of amplifiers A2 and A3 along with the log characteristic of A1 provides a signal that will trigger the internal detector when the change in light exceeds $\pm 5\%$. The trigger produces a short tone burst from the internal generator. Capacitor C5 determines the frequency of the tone generated by the voltage-controlled oscillator (VCO) while C4

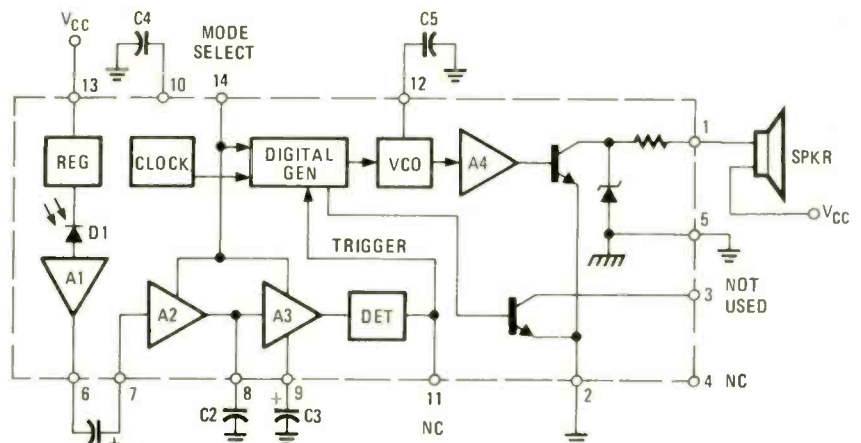
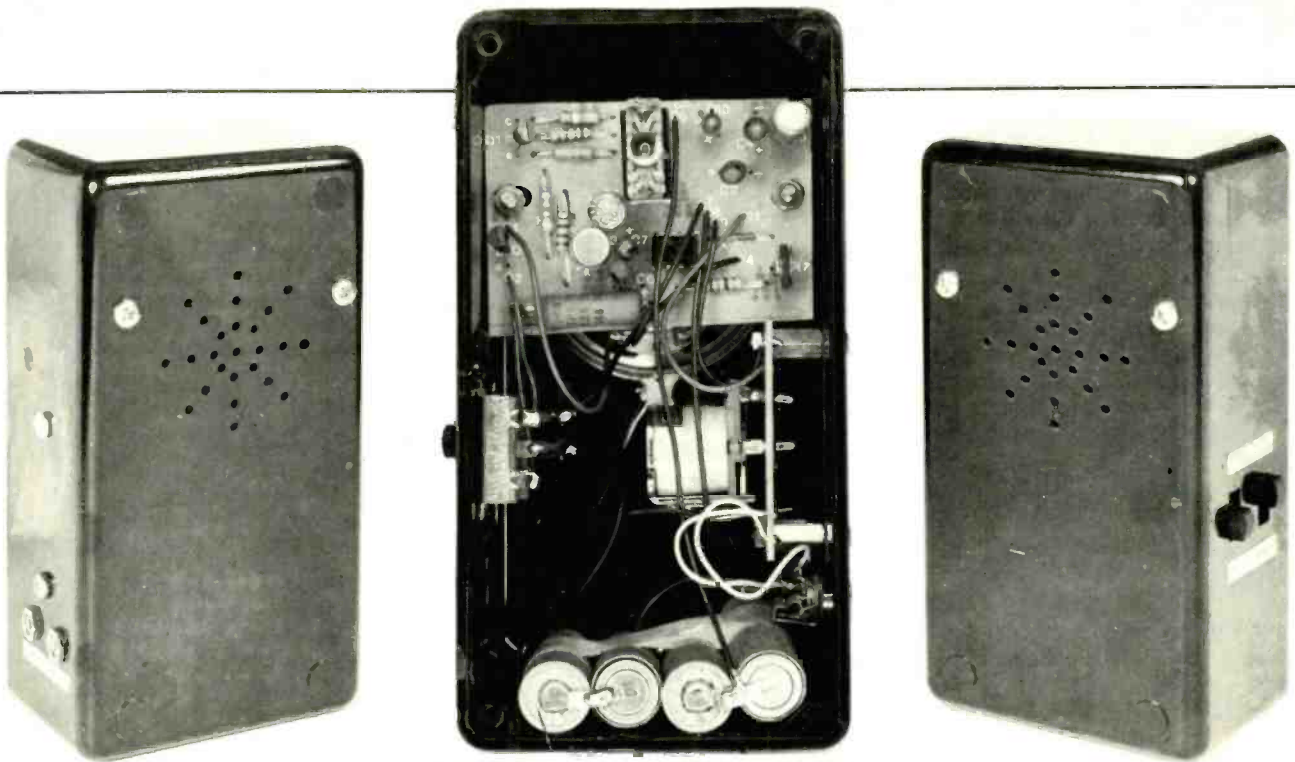

FIG. 1—BLOCK DIAGRAM of the D1072 motion-detector IC. A few capacitors, a speaker and power source are all that it requires in the simplest form of the alarm.



THREE VIEWS of the compact detector. Left-front view is at left, right-front view at right and rear interior view is above.

determines the ramp rate (rate of change) of the VCO's tone.

The alarm, when triggered, continues for around 4 to 12 seconds, depending on circuit components, and is best described as a "whoop." At the end of the alarm period, the light condition is sampled. If the light is still changing, the audible alarm continues. If the light level has stabilized—not necessarily at its previous

level—the alarm stops and the circuit resets to detect the next change in light. (The D1072 operates from a *change* in light intensity and cannot operate reliably in very dark applications. For dark applications, use an invisible IR source; either LED or filtered incandescent.)

The circuit

The schematic of the complete motion

detector is in Fig. 2. Transistors Q1 and Q2 form a small audio amplifier for increasing the tone burst level. Switch S1 grounds the emitter of Q2 when in the AUDIO alarm mode and the cathode of the SCR when in the REMOTE alarm mode.

In the silent remote mode, triggering is the same as in the audible mode, but instead of starting the audible alarm, a 555 timer is triggered. The timer has a range of 5 to 30 seconds and drives a relay. The relay closes and locks in at the end of the selected delay period. The closed relay contacts trigger whatever external alarm that is connected through jack J1. The external device remains active until the ON-OFF switch is turned to the OFF position. The motion detector then resets itself.

The time delay, adjustable by R7, is included so when the device is used in a security system, the operator has a chance to disable the alarm before it goes off.

The second jack is for recharging the four internal size "AA" NiCad cells. When fully charged, these cells operate the motion detector for about 48 hours. They will recharge overnight or 12 to 14 hours when completely run down. The complete device is small enough to be considered portable when operating on its internal batteries. A permanent installation may be made using the charger as a permanent power supply.

Construction

The motion detector is constructed on two PC boards. One PC board contains

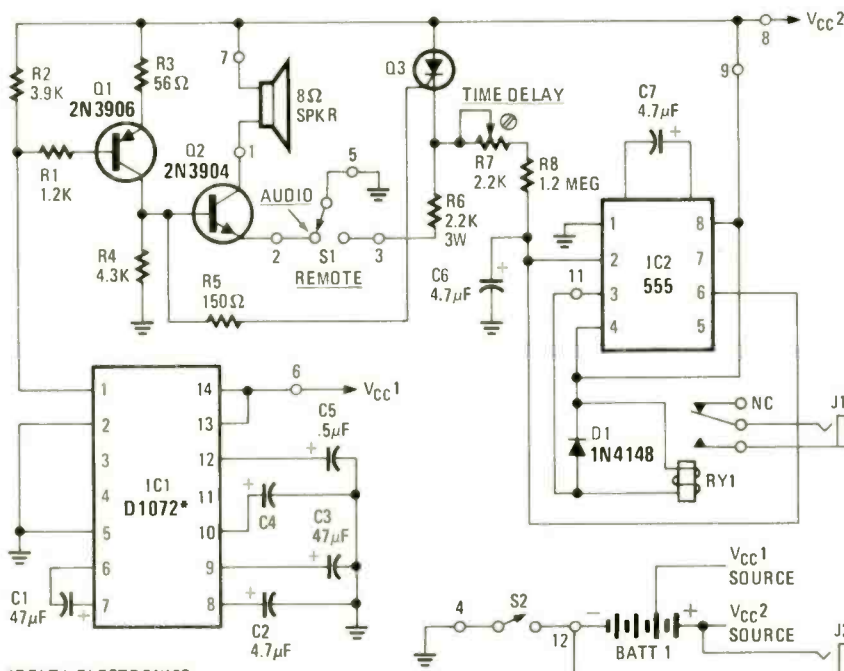

*DELTA ELECTRONICS

FIG. 2—COMPLETE SCHEMATIC of the motion-detector alarm. Features include adjustable time delay, a remote-alarm option and increased output power for the "whoop-whoop" alarm.

the IC motion detector, the various external capacitors and the small AF amplifier. The foil pattern for this board is shown in Fig. 3 and the parts placement is shown in Fig. 4. Mounting the components is straightforward except for IC1, which is mounted in a wire-wrap type 16-pin socket. Mount the socket so there is a 3/8-inch space between its bottom surface and the board.

The second board contains the relay whose contacts are brought out through J1 so an external device such as a siren, tape recorder, or telephone dialer can be activated. The foil pattern for this board is shown in Fig. 5 and the parts placement is shown in Fig. 6.

The alarm is housed in a plastic instrument case 6-inches high and 3 1/4-inches deep. Figure 7 shows the holes on three sides of the case. The detector PC board is mounted with 6-32 X 1 1/2-inch bolts

NOTE: TERMINAL 10 NOT USED

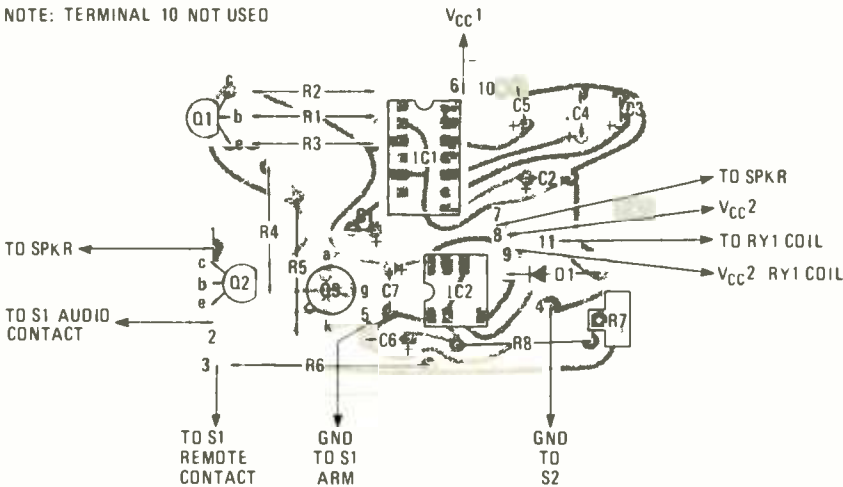

FIG. 4—COMPONENT SIDE OF THE MAIN PC BOARD. The numbered solder pads correspond to similarly numbered terminal points on Fig. 2.

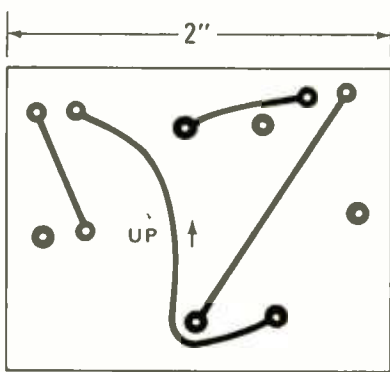

FIG. 5—FULL-SIZE PATTERN for the foil side of the relay board. Relay mounts as in Fig. 6.

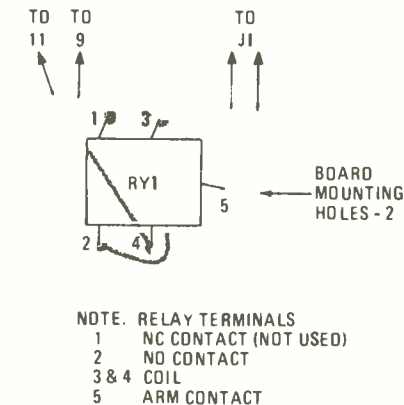

FIG. 6—THE RELAY on the board with leads indicating connections to other components.

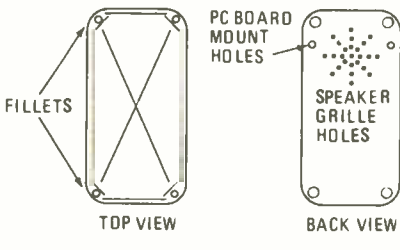

FIG. 7—VIEWS OF FOUR SURFACES of the case. Compare these with photos on preceding page and you'll have an idea as to how it all goes together.

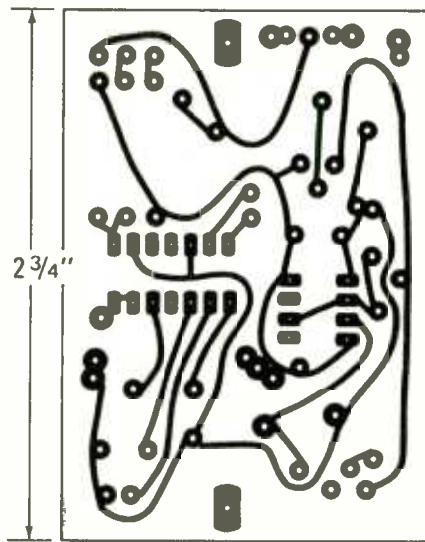

FIG. 3—FOIL PATTERN for the main PC board shown full size.

PARTS LIST

All resistors 1/4 watt, 5% unless otherwise noted

- R1—1200 ohms
- R2—3900 ohms
- R3—56 ohms
- R4—4300 ohms
- R5—150 ohms
- R6—2200 ohms, 3 watts
- R7—2.2 megohms, trimmer
- R8—1.2 megohms
- C1, C3—47 μ F, 10 volts electrolytic
- C2, C4, C6, C7—4.7 μ F, 16 volts tantalum
- C5—.5 μ F
- D1—1N4148
- Q1—2N3906
- Q2—2N3904
- Q3—SCR, 50 volts PIV
- IC1—D1072 motion detector (Delta Electronics, \$8.95)
- IC2—555 timer
- S1—SPDT slide switch
- S2—SPST slide switch
- RY1—SPST relay, 18-ohm, 60-mA coil, (Delta Electronics 6514R, \$2.75)
- J1, J2—miniature open-circuit jacks
- BATT1—4 NiCad "AA" cells

The following are available from Delta Electronics, PO Box 2, Amesbury, MA 01913:

Complete kit (less batteries), No. 5611W \$24.95.

Completely assembled motion detector with batteries and charger, No. 5635W \$69.50. Motion detector IC with data sheet, No. 1072W \$8.95. Set of two etched and drilled PC boards, No. 5611W \$6.50. Battery charger, No. 5636W \$5.95. Relay No. 6514R \$2.75.

Include \$1.50 postage and handling with all orders. Massachusetts residents add state and local taxes where applicable.

and 1/16-inch spacers. The speaker is placed on the back surface so it touches the two PC board spacers. Dabs of quick-setting epoxy cement hold the speaker in place. Similarly, the two switches are epoxied in place.

The relay board is mounted on 6-32 X 1/4-inch screws held in place by a pair of threaded 1/16-inch spacers. A pair of 6-32 nuts hold the board in place. The aperture for the photodiode lens is drilled in the cover. It is a 1/16-inch-diameter hole and is 1 1/4-inch in from the left side and 1 1/4-inch down from the top.

The motion detector is now ready for operation. Place it in any area with an ambient light level that is within its operating range (0.1 to 100 candle power.) Turn the ON-OFF switch to ON. The alarm will sound for 4 to 12 seconds as the system adjusts for the prevailing light level. Once the sound stops, the system is in the "guard" mode and any change in light level greater than $\pm 5\%$ sets off the alarm. Any motion within the cone of surveillance causes the alarm to sound. This cone is a minimum of 8 feet long. At a distance of 8 feet, it is 2 feet in diameter.

R-E

The Magnavox Comb Filter

A CLASSIC PROBLEM IN COLOR TV RECEIVER design has been the separation of luminance and chrominance signals, and the reduction of cross interference between them. Luminance and chrominance signals share the same frequency spectrum; the luminance signal energy is between DC and the 4.5-MHz sound carrier, and the chrominance signal has sidebands centered around the 3.58-MHz subcarrier. Bandpass filters are generally used to separate the peaked chroma signal, and low-pass filters separate the video signal from the composite signal. Magnavox has used a comb-filter technique in its new 25-inch *model T815*, and 19-inch *model T809 Touch-Tune* and *STAR* receivers; this technique separates the two signal components with a minimum of degradation to each.

Figure 1 shows an elemental comb filter. It consists of a time-delay element and a subtractor for combining the input



FIG. 1—ELEMENTAL COMB FILTER.

signal with the delay line output. For TV systems, the line is designed for a delay time equal to one horizontal line, or 63.6 μ s (from 1 to 15,734 Hz). For any particular frequency-input sinewave, the delay line produces an output signal shifted in phase with an angle equivalent to the delay time. If the input signal is a 15,734-Hz sinewave, the delay line retards the input wave by a full cycle or 360 degrees, so that the input and output of the line look exactly the same at any time. When the two signals are subtracted as shown in Fig. 1, since both signals are equal the comb-filter output is zero. In fact, the output is zero for any frequency that is a multiple of the horizontal line rate. At twice the line frequency, for example, a 63.6- μ s delay represents a delay of two complete cycles; so again the output is in phase or duplicates the input, and the comb-filter output is zero. As the input frequency changes away from multiples of the line rate, the output signal increases. The filter response therefore has peaks and nulls similar to the teeth and separations of a comb.

Figure 2 is a phasor diagram showing the comb-filter principle from a different perspective. The phasor V_{in} represents the

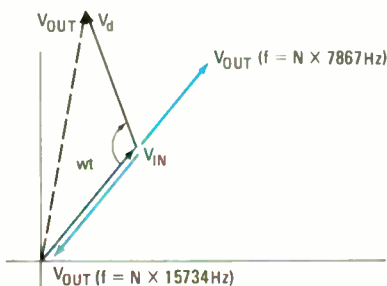

FIG. 2—COMB FILTER phasor diagram.

input signal and rotates around the origin at the input frequency. The second phasor, V_d , represents the contribution of the delay line output, which rotates along with V_{in} , maintaining a fixed angle with respect to V_{in} . When the input is a multiple of the horizontal rate, the two phasors oppose each other so that the output is at the origin or zero. As the frequency changes, the phasors unfold and the resultant phasor, V_{out} , increases in length. Note in particular that the output phasor reaches a maximum when the angle between V_{in} and V_d is 180 degrees, which happens at multiples of 7867 Hz, or one-half the line rate.

In a TV signal with little or no vertical change from field to field, picture data is concentrated in frequency bands centered around line-rate multiples, as shown in Fig. 3. It is no accident that the chroma subcarrier frequency, 3,579,485 Hz, is the 455th multiple of one-half the line

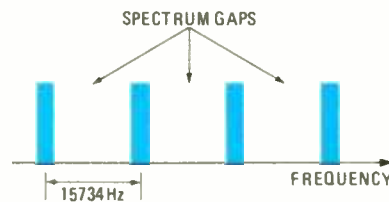

FIG. 3—CONCENTRATION OF LUMINANCE information in a vertically correlated picture.

frequency. The developers of compatible color TV recognized that there were gaps between the luminance spectrum components into which the chroma signals could be inserted without requiring additional signal bandwidth. The chroma energy is therefore contained in bands centered around the 3.58-MHz subcarrier, and separated by gaps that are equal to one-half the horizontal line rate. Figure 4 shows the combined luminance and

chrominance spectrum, emphasizing these concepts.

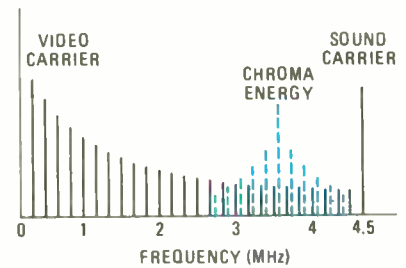

FIG. 4—CHROMA AND LUMINANCE interleaving.

In conventional TV systems that use a bandpass filter to separate the chroma from the video signals, the interspaced luminance signals remain to produce interference in the detailed picture areas. To minimize chroma in the luminance channel that can create interference patterns, the video amplifier uses a 3.58-MHz L-C trap that has the undesirable effect of limiting the high end of the video frequency band to about 3 MHz. The result is a loss of resolution and high-detail video.

Figure 5 is the block diagram of the Magnavox comb-filter system. The lower portion of the diagram that produces the chroma output is similar to that of Fig. 1, but includes the practical elements of an amplifier to compensate for the delay line loss, and an attenuator in the direct signal path equalizes signal levels at the subtraction point.

One of the unique features of the Magnavox comb-filter module is that it contains no service adjustments. The net result of this state-of-the-art filtering technique is a 25% increase in horizontal resolution from 260 to 330 lines, and the reduction of disturbing dot patterns and "barber pole" cross-color effects. **R-E**

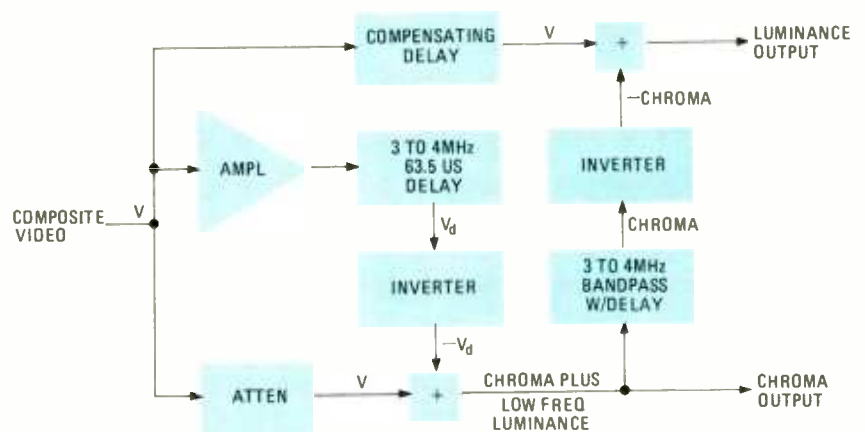

FIG. 5—COMB FILTER OPERATION.

3 Unique Projects

Looking for electronic projects to occupy a few evenings? If so, consider one or two of these unique circuits. Study the text and diagrams carefully to insure completion.

MARTIN BRADLEY WEINSTEIN
AND JOSEPH GARTMAN

ONE-STATION INTERCOM



HERE'S A DELUXE SINGLE-STATION INTERCOM that incorporates many of the features usually seen only on the very most expensive commercial sets, yet its simpler single-station design enables you to build it for almost half the cost.

The unit incorporates a commercially styled telephone handset, complete with a push-to-talk button in its shank. The associated power and control junction box, connected at the other end of the commercially styled flexible retracting coiled cord, provides not only the power necessary to run the intercom, but current limiting, a PRIVACY switch, and a uniquely wired Tri-Status LED.

Looking at the circuit shown in Fig. 1, the battery provides current only when the push-to-talk bar is depressed—thus

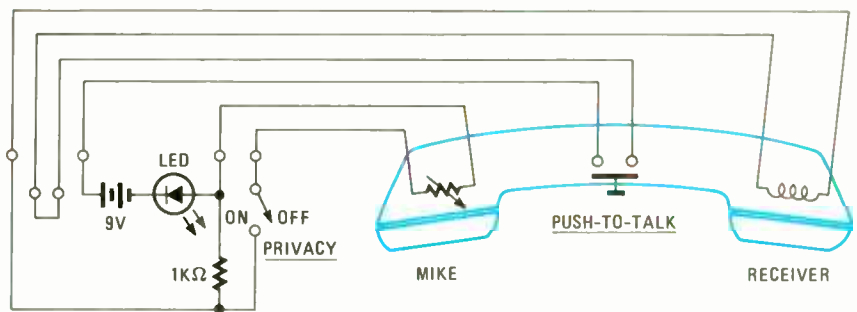

FIG. 1—ONE-STATION INTERCOM is powered by a 9-volt transistor battery and has an LED status indicator.

providing excellent battery life. The battery, earpiece, 1K resistor and LED comprise the complete circuit with the PRIVACY switch open (mike not connected). This assures that audio present in the room does not leak into the earpiece circuit. It also makes the 1K resistor the brightness-setting element for the LED.

With the PRIVACY switch closed (in other words, in the *normal* operating mode), the microphone is connected in parallel with the 1K resistor. Since this is a carbon mike, its resistance varies in value with impressed audio. Please note that in carbon mike elements, the carbon granules can occasionally pack, thus yielding poor audio quality. A few sharp raps of the knuckles will usually clear this up.

Since the parallel combination of two resistors is always lower in resistance than the resistance of either resistor alone, closing the PRIVACY switch causes the LED to glow more brightly. So the single LED, with its off-on-bright Tri-Status modes, not only signals a push-to-talk

PARTS LIST FOR INTERCOM

- 1—telephone handset with push-to-talk switch
- 1—SPST toggle switch
- 1—9-volt transistor radio battery
- 1—jumbo size LED, red or your favorite color
- 1—1000-ohm resistor, $\frac{1}{4}$ watt to 5 watts.
- Miscellaneous hookup wire, phone cradle.

(and confirms battery vitality), it also indicates the status of the PRIVACY switch.

The audio provided by the combination of components shown is adequate even for the moderately hard of hearing. You may want to try substituting other component values, or the battery voltage.

The One-Station Intercom is suggested for use in high security and government applications, and for people with a genuine need for a better way to talk to themselves.

The circuit we built was constructed using a set of APR-1 experimenter's tools.

SINGLE SHOT LOGIC INDICATOR WITH MEMORY

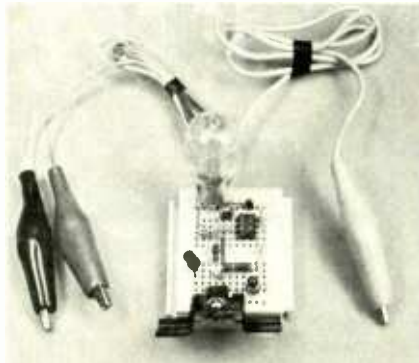

HERE'S A CIRCUIT THAT COMBINES THE 555, a VMOS FET and some unusual electronics to provide a pulse indicator you can't ignore.

A careful look at the circuit shown in Fig. 2 will show that the NE555 and the 2N3394 power transistor are plugged in so as to short themselves out.

This particular circuit configuration was chosen to reduce the likelihood of static damage to these components. Inductors L1 and L2 are waveshaping components that are included because good textbook design deems their inclusion necessary. Although the circuit will function without these components, they tend to increase the likelihood of repair.

As a testimony to good circuit design, a DC supply of virtually any size will power the circuit through the alligator clip leads. The LED confirms application of power.

The actual switching function neces-

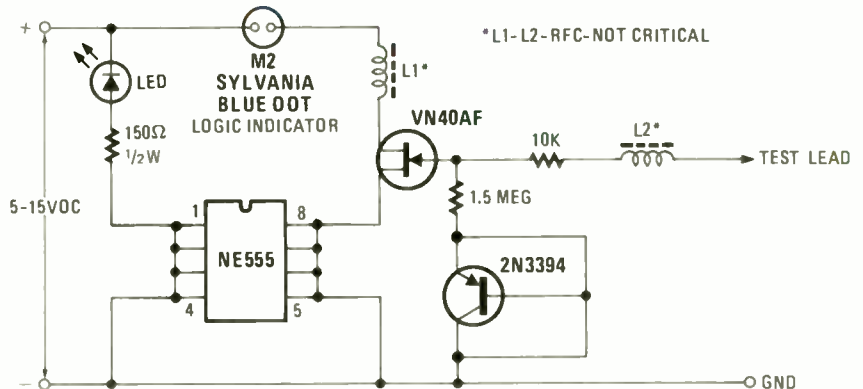

FIG. 2—LOGIC INDICATOR produces a visible indication that's hard to ignore.

sary to drive indicator lamp I1 is provided by the VN40AF VMOS FET. VMOS is a relatively new FET technology that cuts grooves into the semiconductor substrate to allow greatly increased output currents. Still, its input is very, very sensitive and triggers quite easily at CMOS levels.

In this circuit, of course, the shape of the pulse being awaited is inconsequential, since the VN40AF does not need to turn fully on. Also, its high (greater than 1 megohm) input impedance will allow it to trigger even from exceptionally weak pulses.

The unique output indicator lamp is a Sylvania *Blue Dot* flashbulb. It is the use of this indicator which gives the circuit both its unique one-shot characteristic and its memory capability. When triggered, the indicator (I1) will emit a brief but unforgettable stream of visible photons. After triggering, the characteristic

PARTS LIST FOR LOGIC INDICATOR

- 1—LED indicator, red, green or yellow
- 1—resistor, 150 ohms, 1/2 watt,
- 1—resistor, 1.5 megohm, 1/4 watt
- 1—resistor, 10,000 ohms 1/4 watt
- 2—inductors, L1-L2, optional. 0.25 μH to 88 mH.
- 1—NE555 IC timer, see text
- 1—2N3394 PNP transistor, see text
- 1—VN40AF VMOS FET transistor
- 1—logic indicator, Sylvania M2 *Blue Dot* or equal with holder

blue dot on the bulb will no longer be blue; this is the memory indicator.

Other indications may also be apparent. The shape of the lamp's glass envelope, for example, may distort. And the clear plastic envelope surrounding the glass may become translucent, as compared to its original transparency.

SOLAR POWERED NIGHT LIGHT

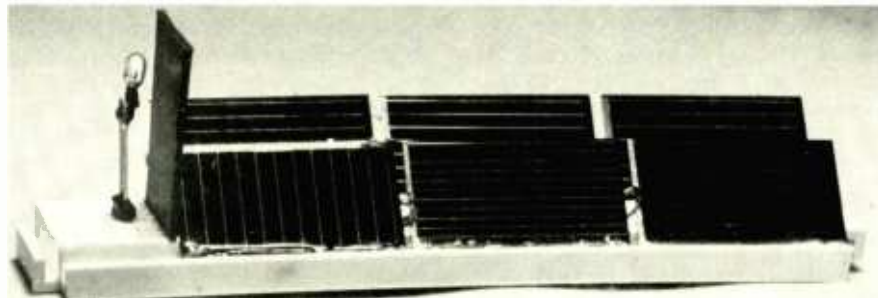

AS ALTERNATIVE ENERGY SOURCES BECOME more and more important to our future, even the little niceties of life may have to adapt. Here is one adaptation we can try now to get us ready for tomorrow.

This simple circuit is a Solar-Powered Night Light. The six solar cells produce about 1/2-volt each in bright sunlight. Here, they are connected in series to provide 3 volts. The solar cells are made on very thin, very fragile glass and can

break if not properly and carefully handled. A small incandescent lamp completes the circuit.

In bright sunlight, the small lamp glows quite vigorously. But since the efficiency of this circuit is low, a small black card helps make its glow visible.

Barring a nearby nova, the solar cells are not likely to stress the lamp enough to ever burn it out, so this device should continue to operate for a very, very long time without attention or maintenance.

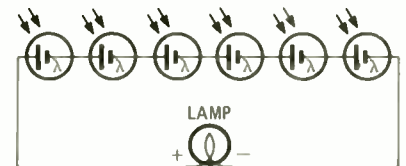

FIG. 3—SOLAR-POWERED NIGHT LIGHT will help reduce energy demands.

PARTS LIST FOR SOLAR-POWERED NIGHT LIGHT

- 6—0.5-volt solar cells
- 1—3-volt flashlight bulb

While hardly giving enough light to illuminate a room, the small lamp is actually quite adequate for many night light purposes. More pragmatically, it can be used when it is not needed as a primary source of illumination during those nights when the sun is shining bright enough to light it.

R-E

AUDIO BREAKTHROUGH !

Magnetic Field

An entirely new concept in power amplifier design makes possible an audio amplifier that has high power, low weight and eliminates the power transformer, large capacitors and many other common components.

LEN FELDMAN
CONTRIBUTING HI-FI EDITOR

A FEW WEEKS AGO I HAD THE PLEASURE OF entertaining Robert W. Carver at my laboratory. If his name is unfamiliar to you, it was Bob Carver who started the Phase Linear Corporation and who developed the first high-powered stereo amplifier for home use that sold for (as he puts it) "less than a dollar per watt."

Recently, Mr. Carver decided to form a new company. And no sooner had the Carver Corporation been formed than we began to hear rumours about a "new" kind of audio amplifier known as a Magnetic Field Amplifier. At the time of his visit to my lab, he was still busy making sure that the new amplifier circuitry was properly protected at the U.S. Patent Office. All he would tell me then was that the amplifier would *not* require a power transformer or extensive heat-sinking. There would be no need for large-filter electrolytic capacitors. The amplifier would weigh around 12 pounds, would be highly efficient and would deliver 200 watts-per-channel at very low distortion. The projected retail price—around \$300!

Had anyone else come along with this tale I would have labeled him an incurable dreamer. However, knowing Mr. Carver's earlier achievements in amplifier design, I made him promise that as soon as he was able to disclose more circuit details, he would allow me to describe the circuitry in *Radio-Electronics*. True to his word, Mr. Carver sent me a fairly complete description of how his Magnetic Field Amplifier works, and what follows is pretty much the inventor's own de-

scription of his new audio amplification technique.

Magnetic field amplifier

The concept behind the magnetic amplifier can best be understood by referring to Fig. 1. A pair of SCR's identified in Fig. 1 as the SCAN SCR and the RAMP SCR feed amplitude-modulated current into a specially constructed transformer called a magnetic cavity. The magnetic-cavity transformer is similar to an ordinary AM detector transformer found in AM radio sets. However, there are two important differences: First, the windings are arranged so that an output occurs during the *collapse* of the magnetic field instead of during its buildup. Second, it is designed as a very high-powered AM detector transformer instead of the microwatt detector generally found in radio sets. The output of the magnetic cavity is a full wave rectified by a pair of 3-amp (30-amp peak) diodes to form a conjugate pair of time-varying audio voltages. In its most simplified form, the loudspeaker is connected across the conjugate voltages and bidirectional audio current flows in the voice-coil windings.

SCR modulator operation

Figure 1 shows the main components of the SCR modulator circuitry. The action of the scan SCR, the ramp SCR, the scan diode and the commutation diode, together with L1, L2 and C1, produces an amplitude-modulated current that corresponds to the incoming audio signal in the primary winding of

magnetic-cavity transformer MC1. The peak magnitude of the current depends upon the amplitude of the incoming audio voltage. This current is pumped into the primary of MC1 during a period of time called the ramp interval. Then, the energy contained in the field of MC1 is coupled to the secondary winding and onto the speaker during a period of time called the scan interval. In general, the scan interval is shorter than the ramp interval, but during full-power operation, the ramp and scan intervals are identical.

Figure 2 shows the ramp and scan periods are composed of four timing intervals. At time t_2 , the magnetic field has already been established in the cavity and is beginning to collapse. The collapsing field generates a decaying current, i_1 , which decays to 0 when the energy in the field associated with the primary winding is depleted at time t_3 . During the scan interval prior to t_3 , the scan SCR is made ready to conduct by applying a positive voltage step from the control logic. However, the scan SCR does not conduct until a forward bias is also supplied between its anode and cathode.

At time t_3 , current is no longer maintained by cavity inductance since the stored energy was transferred to the secondary of MC1 and to the load. The direction of the current is then reversed and the scan diode becomes reverse-biased. At this moment, the scan SCR is forward-biased and current flows as shown in Fig. 3.

The ramp interval operates in a manner similar to that of the scan interval. Ener-

Amplifier

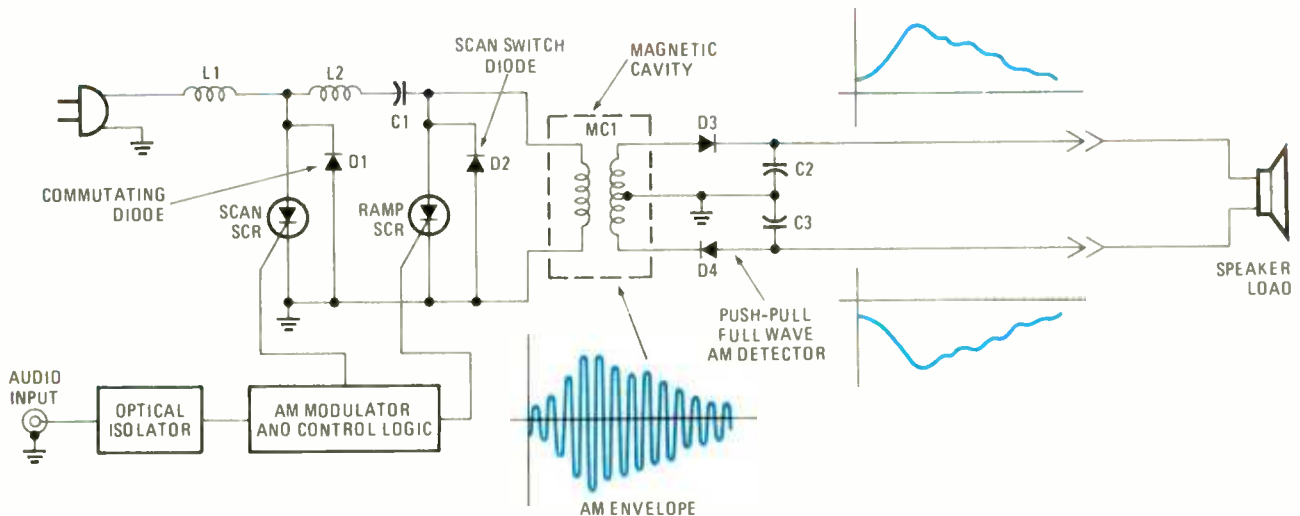

FIG. 1—THE MAGNETIC AMPLIFIER contains a magnetic cavity transformer that is driven with amplitude-modulated current. The output signal is derived from an AM detector.

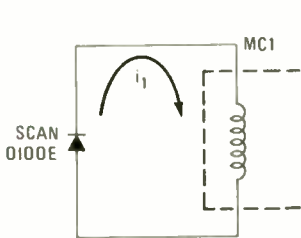

FIG. 2—DURING THE SCAN INTERVAL from t_1 to t_2 , current flows through the scan diode and decays to zero.

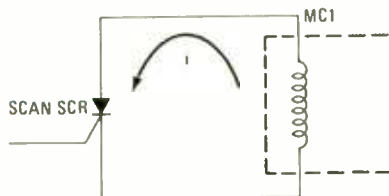
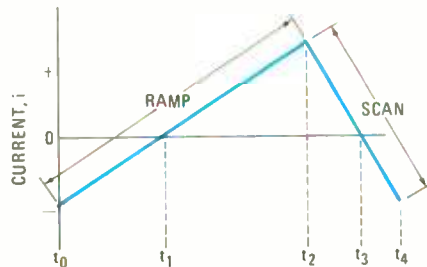

FIG. 3—THE SCAN SCR conducts during the scan interval from t_1 to t_2 .

gy that is stored in the magnetic cavity is shuttled about L1, L2, C1 and the load under the control of the logic section.

The combined ramp and scan periods depend upon the amplitude and frequency of the incoming audio signal.

AM detector operation

The speaker load could simply be con-

nected directly across the conjugate voltages at the output of the detector. However, this simple approach would yield very poor performance that would be inadequate for any high-fidelity applications. The frequency response would be poor, with high-frequency power output dropping rapidly above 6 kHz, and virtually no undistorted output power available at 10 kHz or above. In addition, excessive commutation noise at the output would impart a very high noise level to the amplifier, based upon modern high-fidelity performance standards. Finally, harmonic distortion would be about 8% at 400 Hz at all power levels. All these problems are solved by incorporating a more sophisticated AM detector that uses

negative feedback to increase bandwidth and lessen the noise and distortion.

Operation of the AM detector can be understood by referring to Fig. 4. The audio output is taken at the output (emitter) of Q1 for positive-going signals and at Q2 for negative-going signals. At low frequencies (e.g., 400 Hz), Q1 and Q2 essentially act as switches, except that a small voltage across the devices is developed by the combined action of the incoming audio and feedback signals applied to the input of A1. Because of the high loop gain of A1, this low voltage is just the right amount so that the output follows the input precisely. In this manner, distortion is reduced to less than 0.1%.

At high frequencies (e.g., 15 kHz), the modulator is unable to produce a varying high-frequency output. Nevertheless, it does produce a voltage with a DC component. This output voltage is filtered by C2 and C3 to form a DC voltage with a high-frequency ripple as the detector tries to follow the modulator commands.

Under these conditions, the action of Q1, Q2 and A1 resembles that of a conventional audio-output stage. In other words, the DC voltage developed across

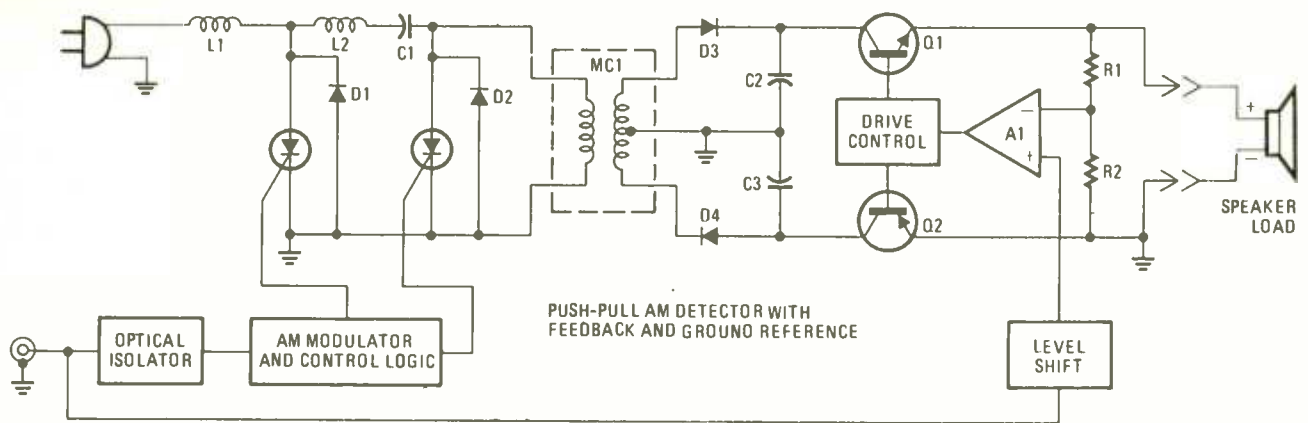

FIG. 4—A PUSH-PULL AM DETECTOR with negative feedback is incorporated into the amplifier to increase bandwidth and reduce distortion.

C2 and C3 is used to power Q1 and Q2 as a standard amplifier. Transistors Q1 and Q2 then deliver low-distortion high-frequency power to the loudspeaker load. In this mode of operation, the amplifier's efficiency is considerably reduced and, in the limiting case, is no better than that of a conventional amplifier. Mr. Carver points out, however, that the spectral-energy distribution of music signals is such that much less power is required at the high-frequency audio range than is required at mid- and low-frequencies. So, under music listening conditions, the overall efficiency of the amplifier remains very high, and it runs cool to the touch even when delivering music signals whose peaks reach the rated output level.

If a high-frequency test tone is applied to the amplifier, full power output will be delivered, but the amplifier will become quite hot to the touch. If excessive temperatures are reached, a built-in thermal-protection circuit causes shutdown to prevent any damage to the amplifier.

Since the circuit has negative feedback that forces the output to follow the input signals, it rejects the commutation noise generated in earlier parts of the circuit through the same mechanism whereby it reduces harmonic distortion.

Performance as a hi-fi amplifier

The Magnetic Field Amplifier will be small, powerful and lightweight (about 12 lb.). Mr. Carver says "it can be carried about by a human being of average physical dimensions." In conformance with Federal Trade Commission requirements, its power output rating will be 200 watts-per-channel (with both channels driven) into 8-ohm loads at any frequency from 20 Hz to 20 kHz with no more than 0.08% total harmonic distortion. The A-weighted signal-to-noise ratio claimed for the amplifier will be greater than 100 dB below its rated output, and the input sensitivity for full rated output will be 1.5 volts RMS.

The amplifier will also be equipped

with an LED display having VU ballistics that will display output power-per-channel and cover a 50-dB dynamic range. It has been several weeks since I first learned of the Magnetic Field Amplifier, but in Mr. Carver's latest communication to me, he still insists that this new technology can be offered as a finished product for a suggested retail price of around \$300. Even if the price does have to go up as the new amplifier enters the marketplace (and our experience has shown that the best-laid plans of audio engineers are often upset by economic realities), if the amplifier that finally emerges performs as well as promised, it could very well constitute a major breakthrough in amplifier design that could send other audio manufacturers scurrying back to their laboratories. And you can all be sure of one thing: Just as soon as I can get my hands on a test unit of the Magnetic Field Amplifier, I will put it through its paces and report the findings in a future issue of **Radio-Electronics**. **R-E**

PIONEERS IN RADIO

Edouard Branly

FRED SHUNAMAN

PROFESSOR EDOUARD BRANLY IS BEST known as the inventor of the coherer, that "tube of filings" that was for many years the only really useful detector of radio-waves. Yet it appears that, in the course of investigating his coherer, Branly set up the first organized experiment in radio transmission, some years before Popov and Marconi attempted their first transmission.

In his studies of the resistance of powdered metals, Branly noted that his results were erratic and unexplainable at times. Around 1888, he discovered the source of his trouble—nearby electrical discharges reduced the resistance of the powdered-metals. Branly then enclosed the metal powders in tubes with plugs at the ends, and tried different metals plus various degrees of compression and coarseness of grain structure. Using the

combination that was the most efficient detector of electrical discharges, he arranged a semipublic demonstration on November 15, 1890.

At the time, Professor Branly was teaching in a Catholic scientific institute in Paris. The building, located at junction of the rue Vaugirard and the rue de Rennes, was L-shaped; and he arranged his experiment in two rooms of the building whose windows were in sight of each other across a courtyard. One room held his transmitter, a Leyden jar (in other experiments he used a spark coil). Branly, with his tube of filings, (*tube des limailles*) was in the other. As Branly signaled through the window, his assistant, Gendron, activated the transmitter, producing a spark. Branly immediately detected it, using a receiver containing his coherer in series with a battery and a

galvanometer. Tapping the table with a small mallet, Branly "decohered" the filings. He received several signals on cue to his assistant.

Nine days after this demonstration he communicated his results to the Academy of Sciences, which then published them. They were also described in an article in two French publications, *Les Cosmos*, March 14, 1891 (in which Branly writes of using metals rods to increase the range) and *Lumiere Electrique*, May 16, 1891.

Professor Branly was certain that his experiments published in several "revues", were probably read by Popov, Marconi and other experimenters. It may well be, then, that Marconi's message: "Mr. Marconi sends M. Branly his respectful compliments by wireless telegraph across the Channel, this excellent result being due in part to the remarkable works of M. Branly," then considered by Americans to refer to the only accomplishment of Branly's that they knew of, the coherer, actually referred primarily to his experiments in transmitting and receiving electrical waves. **R-E**

Radio-Electronics Audio Lab Tests

Nikko Beta II Preamp/ Alpha II Power Amp



1
CIRCLE 126 ON FREE INFORMATION CARD

NIKKO AUDIO MAINTAINS THAT 1978 PROMISES to be the "Year of Nikko Audio," and, judging by the pair of audio components we have just finished testing, they may be right. The Nikko line has been around for several years, but, for one reason or another, has not gained the wide acceptance of other lines of audio equipment. Now, with a greatly expanded line of products, the company hopes to change all that. We chose to combine our test reports on the new *model Alpha II* power amplifier and the *model Beta II* preamplifier/control unit because these components are ideally matched for each other both in appearance and in performance level. We understand that there is (you guessed it) a *model Gamma I* stereo FM tuner that can be added to this audio pair for a complete three-piece electronic-component system. Perhaps at some future date we will have an opportunity to test that unit as well.

The *model Alpha II* and the *model Beta II* are both designed for standard 19-inch rack mounting, as shown in Fig. 1. Although the *model Alpha II* heat sinks are positioned at the rear of the amplifier (and therefore extend beyond the depth of the *model Beta II* preamp shown stacked above the amplifier), ventilating slots on the top surface of the amplifier permit any transformer heat to escape; we would therefore recommend that some nominal amount of spacing be used if you stack two units as shown. Of course, you could always position the amplifier above the preamplifier if closer spacing is required.

The *model Beta II* front panel has a power ON/OFF toggle switch on the left-hand side. Step-type BASS and TREBLE controls come next and are arranged so that when the knobs are at their mid-position, tone-control circuitry is

defeated. Next comes the BALANCE control, adjacent to which is a large, 42-detent master VOLUME control accurately calibrated in dB. A tape selector switch has positions for SOURCE,

monitoring of either tape-deck circuit and dubbing from either connected tape deck to the other. Pushbutton switches are provided for 20-dB audio muting and for inserting a subsonic filter. A three-position switch selects phono-input resistances of 22,000, 47,000 or 100,000 ohms, while a four-position program SELECTOR switch on the far right chooses AUX, TUNER, or either of two phono inputs.

The color-matched front panel of the *model Alpha II* is equipped with two large, illuminated VU output meters, calibrated both in dB and in watts across an 8-ohm load. The sensitivity of these meters can be adjusted over a wide range (from 0 dB equals 100 watts to 0



2

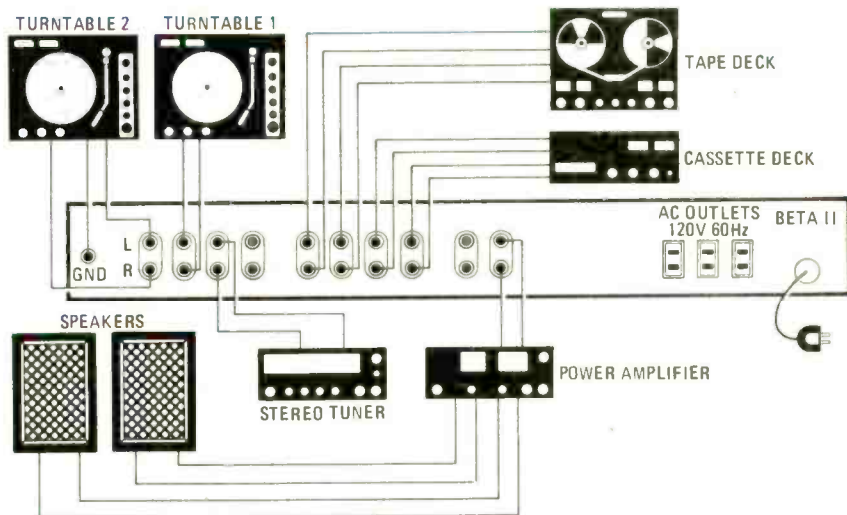

3

MANUFACTURER'S PUBLISHED SPECIFICATIONS:

ALPHA II:

Rated Power Output: 110 watts-per-channel, 15 Hz to 20 kHz, into 8-ohm loads, continuous power. **Harmonic Distortion:** 0.03%. **IM Distortion:** 0.03%. **Frequency Response:** 5 Hz to 100 kHz, -1 dB. **Damping Factor:** 70. **Input Sensitivity:** 1.0 volt. **S/N Ratio (IHF A-weighted):** 110 dB. **Phase Response:** ± 10 degrees from 20 Hz to 30 kHz at 1 watt. **Power Consumption:** 450 watts. **Dimensions:** 18¹/₂ W × 5¹/₂ H × 12¹/₂-inches D. **Weight:** 29.7 lb. **Suggested Retail Price:** \$420.

BETA II:

Rated Output Level: 1.0 volt. **Input Sensitivity:** phono 1 & 2, 2.5 mV; high-level inputs, 150 mV. **Frequency Response:** phono (RIAA), ± 0.2 dB; high level, -1 dB, 10 Hz to 100 kHz. **S/N Ratio IHF A-Weighted:** phono, 77 dB; high level, 100 dB. **Total Harmonic Distortion (At Rated Output):** less than 0.007%. **Phono Overload:** 250 mV at 1 kHz. **Bass Control Range:** ± 10 dB at 70 Hz. **Treble Control Range:** ± 10 dB at 10 kHz. **Subsonic Filter Cutoff Frequency:** 15 Hz. **Power Requirements:** 11 watts. **Dimensions:** 18¹/₂ W × 2³/₂ H × 10-inches D. **Weight:** 9.9 lb. **Suggested Retail Price:** \$210.

dB equals approximately 0.4 watts) by pressing two meter range pushbuttons (to the left of the meters) singly or together for a total of four ranges (0 dB, -8 dB, -12 dB and -24 dB). This arrangement permits you to gauge output levels accurately even at low listening levels, or when using high-efficiency speakers not normally requiring the high power output levels of the amplifier.

A power ON/OFF toggle switch and a speaker selector switch are located to the right of the front panel. The speaker selector switch not only selects main, remote or both sets of connected speakers, it also has an OFF position. Since the *Model Beta II* preamplifier features twin pairs of output jacks, you can connect its signal output to a second power amplifier and

then turn off the speakers connected to the *model Alpha II*, if required. This feature is necessary since the *model Alpha II* possesses no input-level control of its own.

Figure 2 shows the rear panels of both units. The push-type speaker terminals and input jacks of the *model Alpha II* amplifier are flanked by identical massive heat sinks (one for each channel) onto which are mounted the power-output transistors. In addition to the required low-level and high-level input jacks, tape-in and tape-out jacks, and the two pairs of main output jacks, the rear panel of the *model Beta II* preamplifier is equipped with a chassis ground terminal and three convenience AC outlets (two switched, one unswitched). When the two units are used together, you would connect the power cord of the *model Alpha II* to one of the switched receptacles on the *model Beta II* so that turning on the preamplifier would simultaneously turn on the power amplifier. Figure 3 shows a typical system hookup using the *Beta II*. In addition to the components shown, a second pair of speakers can also be connected to the power amplifier.

Laboratory measurements

The Nikko *model Alpha II* amplifier and *model Beta II* preamplifier were tested separately in our lab. For all subsequent listening tests, they were used together, as a total-component system, to drive both the low- and high-efficiency speakers that we use as reference standards.

Table 1 contains a summary of our measured results for the *model Alpha II* amplifier. The power output for this unit far exceeded published ratings at mid-frequencies, and surpassed them by a wide margin even at the low-frequency and high-frequency extremes. The amplifier does not have an FTC power rating for 4-ohm loads, and, in fact, does not deliver much more power at that low impedance than it does with its rated 8-ohm loads. Full power output (110 watts-per-channel into 8 ohms) is obtainable over a frequency range from 12 Hz to 21 kHz for the rated distortion figure of 0.03%. Both the total harmonic distortion and IM distortion are considerably lower than the rated value at nominal full power-output levels at all frequencies within the audible bandwidth. The overall frequency response at low power-output levels, while falling short of the wideband claims, nevertheless extended from a subsonic 5 Hz all the way out to 70 kHz.

Table 2 summarizes measured results obtained for the matching *model Beta II* preamplifier. In our samples, the gain of the *model Beta II* was somewhat lower than claimed. As a result, a 4-mV input level was required to produce a rated 1.0-volt output from the main output terminals. Since the *model Alpha II*'s sensitivity (for full rated output) measured exactly 1.0 volt, that means that (in our case at least), higher-output phono cartridges would be necessary if normal master volume control settings are to be used on the preamplifier. Lower-output phono cartridges would require unusually high clockwise settings of this control. This disparity, which also showed up in the high-level inputs (a 250-mV sensitivity instead of the claimed 150 mV) will be less significant in the case of tuner or auxiliary inputs, since most tuners and auxiliary components (tape decks or TV audio) deliver more than 250 mV.

RIAA equalization was extremely accurate, as shown by the normalized sweep-response curve of Fig. 4. In this spectrum-analyzer sweep, the vertical sensitivity was set for only 2

TABLE 1
RADIO-ELECTRONICS PRODUCT TEST REPORT

Manufacturer: Nikko

Model: Alpha II

POWER AMPLIFIER PERFORMANCE MEASUREMENTS

	R-E Measurement	R-E Evaluation
POWER OUTPUT CAPABILITY		
RMS power/channel, 8-ohms, 1 kHz (watts)	124.0	Excellent
RMS power/channel, 8-ohms, 20 Hz (watts)	118.0	Excellent
RMS power/channel, 8-ohms, 20 kHz (watts)	118.0	Very good
RMS power/channel, 4-ohms, 1 kHz (watts)	N/A	
RMS power/channel, 4-ohms, 20 Hz (watts)	N/A	
RMS power/channel, 4-ohms, 20 kHz (watts)	N/A	
Frequency limits for rated output (Hz-kHz)	12-21	Very good
DISTORTION MEASUREMENTS		
Harmonic distortion at rated output, 1 kHz (%)	0.008	Superb
Intermodulation distortion, rated output (%)	0.01	Excellent
Harmonic distortion at 1-watt output, 1 kHz (%)	0.01	Excellent
Intermodulation distortion at 1-watt output (%)	0.03	Very good
DAMPING FACTOR, AT 8 OHMS	86	Excellent
MISCELLANEOUS MEASUREMENTS		
Input sensitivity (V)	1.0	
Signal-to-noise ratio (IHF A-weighted) (dB)	110	Excellent
Frequency response (Hz to kHz, \pm 1 dB)	5-70	Very good
OVERALL POWER AMPLIFIER PERFORMANCE RATING		Excellent

TABLE 2
RADIO-ELECTRONICS PRODUCT TEST REPORT

Manufacturer: Nikko

Model: Beta II

PREAMPLIFIER PERFORMANCE MEASUREMENTS

	R-E Measurements	R-E Evaluation
RATED OUTPUT LEVEL REFERENCE: 1.0 volt		
PHONO PREAMPLIFIER MEASUREMENTS		
Frequency response (RIAA \pm dB)	0.2	Superb
Maximum input before overload (mV)	300	Excellent
Hum/noise referred to full output (dB) (A-weighted) (at rated input sensitivity)	77	Very good
HIGH LEVEL INPUT MEASUREMENTS		
Frequency response (Hz-kHz, \pm dB)	8-40, 1.0	Excellent
Hum/noise referred to full output (dB) (A-weighted)	89	Very good
Residual hum/noise (minimum volume) (dB) (A-weighted)	92	Good
TONAL COMPENSATION MEASUREMENTS		
Action of bass and treble controls	See Fig. 6	Very good
Action of secondary tone controls	N/A	N/A
Action of low frequency filter(s)	N/A	Good
Action of high frequency filter(s)	N/A	N/A
COMPONENT MATCHING MEASUREMENTS		
Input sensitivity, phono 1/phono 2 (mV)	4.0/4.0	
Input sensitivity, auxiliary input(s) (mV)	250	
Input sensitivity, tape input(s) (mV)	250	
Output level, tape output(s) (mV)	250	
Output level, headphone jack(s) (V or mW)	N/A	
EVALUATION OF CONTROLS, CONSTRUCTION AND DESIGN		
Adequacy of program source and monitor switching		Very good
Adequacy of input facilities		Excellent
Arrangement of controls (panel layout)		Excellent
Action of controls and switches		Very good
Design and construction		Excellent
Ease of servicing		Very good
OVERALL PREAMPLIFIER PERFORMANCE RATING		Very good

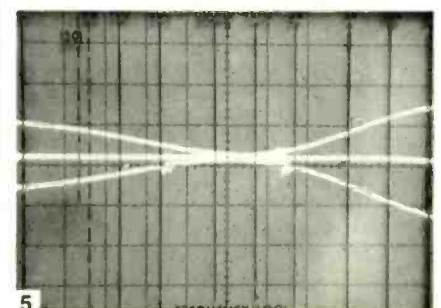
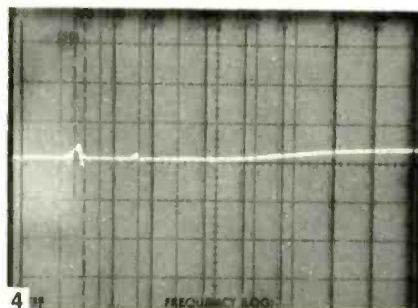

dB-per-vertical-division. The deviation from exact RIAA response was no greater than 0.2 dB at any frequency from 20 Hz to 20 kHz. The phono signal-to-noise ratio measured 77 dB (IHF A-weighted) and phono-overload capability was a high 300 mV.

Tone-control range of the BASS and TREBLE controls is shown in the scope photo of Fig. 5, taken directly from the display on our spectrum analyzer.

Summary

Table 3 presents an overall evaluation of the *model Alpha II* and *model Beta II*, as well as our summary comments. While Nikko, like so many other hi-fi component manufacturers, tends to overuse the word "professional" in describing the *model Alpha II* and *model Beta II* (actually, professional units usually contain balanced 600-ohm inputs and outputs, XLR connectors and more, none of which are contained in these units), they offer excellent value for the nonprofessional, but nevertheless serious-minded, audiophile.

R-E

TABLE 3

Manufacturer: Nikko

Model: Alpha II & Beta II

OVERALL PRODUCT ANALYSIS

Retail price	\$600 (\$400 for amp, \$200 for preamp)
Price category	Low/medium
Price/performance ratio	Excellent
Styling and appearance	Excellent
Sound quality	Very good
Mechanical performance	Very good

Comments: This handsome pair of components puts to rest the notion that high-quality separates must necessarily be very expensive. Nikko's success with their higher-powered *model Alpha I* amplifier (with twice the power of the *model Alpha II*) and its matching *model Beta I* preamplifier (with slightly better specs and a few more control features) must have encouraged them to produce an equally good-looking pair of components that just naturally fit together. The price tag of \$630 for a 110-watt-per-channel power amplifier and a companion preamplifier control chassis is quite low, especially when you consider the level of performance provided by the combination. Of course, there are a few niceties missing. For example, there is no way to listen to headphones with this combination. And, although dubbing as well as tape monitoring are provided for either of two tape decks, it is not possible to choose monitoring of either deck during the dubbing process. In our sample units, the preamplifier gain was a bit lower than claimed, which necessitated setting the volume control rather high when using lower-output cartridges.

As far as sound quality is concerned, the *model Alpha II/Beta II* combination is a real winner.

Radio-Electronics Audio Lab Tests

Realistic SCT-30 Cassette Deck

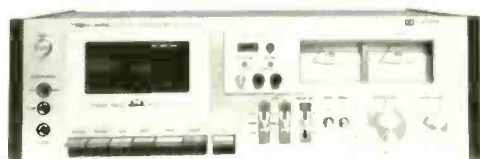

CIRCLE 127 ON FREE INFORMATION CARD

ONE QUICK LOOK AT THE FRONT PANEL OF the Realistic *model SCT-30* stereo cassette deck (distributed by Radio Shack outlets throughout the U.S.) tells you that the stereo cassette deck has come a long way since it was first introduced by Philips of The Netherlands nearly 15 years ago.

The front panel of this front-loading deck is equipped with just about every feature the serious recordist would want in a home cassette deck.

Figure 1 shows that the front panel has a POWER on-off pushbutton at the extreme upper left, below which are left and right microphone inputs plus a phone jack. When a single microphone is plugged into the left-channel microphone jack, a full-width monophonic track is recorded automatically. The cassette compartment door swings open gently when the EJECT pushbutton is pressed, and the cassette transport features a dual-capstan drive system as well as a three-head erase, record and playback head arrangement. The record and play heads are actually contained in a single-head package, so that no alignment is required between record and play-head gaps.

Perhaps the most important and unusual

control on the entire unit is on the rear panel rather than on the front. This control is a bias FINE-TUNE adjust control that provides additional continuous variation of bias current over and above the three fixed settings of the three-position bias switch on the front panel. When making critical recordings, the bias should be adjusted specifically to suit the actual brand and type of tape used.

The owner's manual suggests a simple but effective method to make this adjustment in the absence of any test equipment. You simply record some FM interstation noise on a cassette (this type of noise is close to random white noise since it contains all audio frequencies). Then, while switching successively between source and tape (by using the front-panel source/tape switch), you adjust the vernier bias control until both source and recorded noise sound identical, or as close as possible.

Performance measurements

Since this tape deck has specific settings for three basic types of tapes, we used three types in testing, instead of our usual two. We used TDK type AD (for standard, ferric low-noise tape), TDK type SA (as a substitute for CrO₂)

and 3M *Scotch* ferric-chrome tape (*Master III*). Basic frequency-response limits and other measurements are shown in Table 1, but the results require some explanation.

The fine-tune bias control arrived in our lab set to its mid-position. It was an optimum setting for the ferric-oxide TDK AD tape; the record/play response for that sample is shown in Fig. 2.

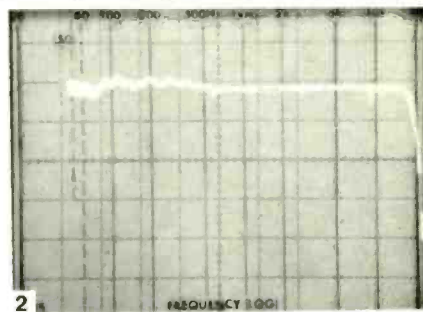

2

When we tried to plot the response curve for the ferric-chrome tape sample (after resetting the front-panel-bias and equalization switches), we were startled to discover that response began to fall off at around 5 kHz (see the lower trace of Fig. 3). Using the rear-panel bias vernier control, we were easily able to restore a reasonably good high frequency response (see the upper trace of Fig. 3) without degrading the tape sample's distortion characteristics.

The same situation held true when we first plotted our record/play response for the TDK SA tape. The first results of this test are shown in Fig. 4; while Fig. 5 shows the response range

MANUFACTURER'S PUBLISHED SPECIFICATIONS:

Frequency Response: (standard tape), 30 Hz–15 kHz, ± 3 dB; (CrO₂ tape), 30 Hz–16 kHz, ± 3 dB; (ferri-chrome tape), 30 Hz–15.5 kHz, ± 3 dB. **S/N Ratio** (CrO₂, with Dolby On, CCIR-Weighted): 61 dB. **Distortion at 0 VU Level:** 0.9%. **Cross-Talk:** 60 dB. **Wow and Flutter:** less than 0.06% WRMS. **Erase Ratio:** 70 dB. **Input Sensitivity:** Mike, 0.3 mV. **Line In (Auxiliary):** 80 mV. **Output Levels (Preamplifier):** 0.55 volt, adjustable. **DIN Out:** 0.25 volt maximum. **Bias Frequency:** 105 kHz. **Fast Rewind Time:** 125 seconds (for C-60 cassette). **Power Requirements:** 120 VAC, 60 Hz 15 watts. **Dimensions:** 18 W × 5 1/8 H × 10 inches D; **Weight:** 16 1/2 lb. **Suggested Retail Price:** \$379.95.

that can be obtained by varying the vernier bias control from one extreme to the other while the front-panel bias switch is set to the Chrome tape position. When the bias control is set to obtain flat response to beyond 16 kHz

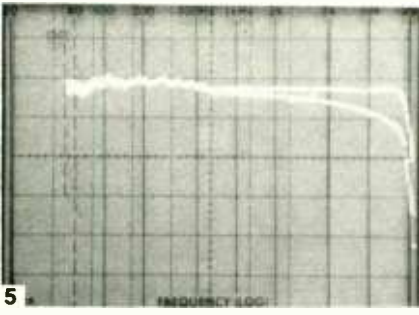
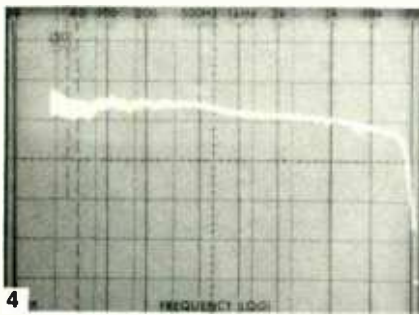
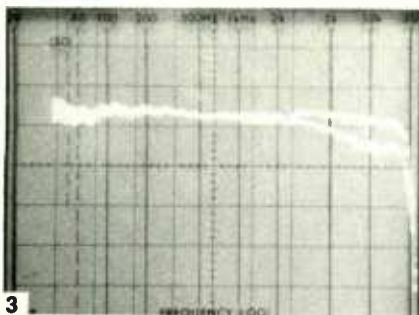

(not the values shown in Table 1), the harmonic-distortion content of the test tape increased to 1.4% for a 0 VU record level (from the previously measured 1.1%) and to 2.3% at a ± 3 -dB record level (compared with the previously measured 2.0%). You therefore have the option of extending overall response slightly at the expense of harmonic distortion. This option is generally available on professional studio machines, but few home cassette recorders provide this degree of flexibility.

Signal-to-noise values shown in Table 1 (for each tape type) correspond to readings that were obtained before the bias control was reset for optimum response and therefore suffered a bit when that adjustment was made.

Wow-and-flutter measurements were about the lowest we have read for any home stereo cassette deck. Even the unweighted (RMS) wow-and-flutter value was a low 0.07%.

Summary

The overall product evaluation is found in Table 2, together with our summary comments. Generally, serious audiophiles have always eyed so-called "store brand" high-fidelity products with some suspicion. In the case of the *model SCT-30*, however, we believe it compares favorably with other top-brand stereo cassette decks in its price class and offers a better value than some.

R-E

**TABLE 1
RADIO-ELECTRONICS PRODUCT TEST REPORT**

Manufacturer: Realistic		Model: SCT-30
CASSETTE TAPE DECK MEASUREMENTS		
FREQUENCY RESPONSE MEASUREMENTS	R-E Measurements	R-E Evaluation
Frequency response, standard tape (Hz-kHz \pm dB)	20-15.7, 3.0	Excellent
Frequency response, CRO ₂ tape (Hz-kHz \pm dB)	20-14.5, 3.0	(Good) see text
Frequency response, other (see text) (Hz-kHz \pm dB)	20-16.0, 3.0	See text
	See figs. 3,4,5,6	
DISTORTION MEASUREMENTS (RECORD/PLAY)	AD/SA/FeCr	
Harmonic distortion at -3 VU (1 kHz) (%)	0.9/0.7/1.2	Excellent
Harmonic distortion at 0 VU (1 kHz) (%)	0.9/1.1/1.5	Very good
Harmonic distortion at +3 VU (1 kHz) (%)	1.2/2.0/2.3	Very good
Level for 3% total harmonic distortion (dB)	+7/+7/+5	Excellent
SIGNAL-TO-NOISE RATIO MEASUREMENTS		
Standard tape, Dolby off (dB) ("A"-weighted)	58	Excellent
Standard tape, Dolby on (dB) ("A"-weighted)	65	Excellent
CRO ₂ tape, Dolby off (dB) ("A"-weighted)	63	Excellent
CRO ₂ tape, Dolby on (dB) ("A"-weighted)	69	Excellent
FeCr tape, Dolby off/on (dB) ("A"-weighted)	59/65	Very good
MECHANICAL PERFORMANCE MEASUREMENTS		
Wow and flutter (% WRMS)	0.05	Superb
Fast wind and rewind time, C-60 (seconds)	100	Fair
COMPONENT MATCHING CHARACTERISTICS		
Microphone input sensitivity (mV)	0.3	
Line input sensitivity (mV)	75	
Line output level (mV)	480	
Phone output level (mV)	38.7 (8 ohms)	
Bias frequency (kHz)	105	
TRANSPORT MECHANISM EVALUATION		
Action of transport controls		Very good
Absence of mechanical noise		Excellent
Tape head accessibility		Good
Construction and internal layout		Very good
Evaluation of extra features, if any		Excellent
CONTROL EVALUATION		
Level indicator(s)		Excellent
Level control action		Good
Adequacy of controls		Excellent
Evaluation of extra controls		Excellent
OVERALL TAPE DECK PERFORMANCE RATING		Excellent

**TABLE 2
RADIO-ELECTRONICS PRODUCT TEST REPORT**

Manufacturer: Realistic		Model: SCT-30
OVERALL PRODUCT ANALYSIS		
Retail price		\$379.95
Price category		Medium
Price/performance ratio		Superb
Styling and appearance		Very good
Sound quality		Excellent
Mechanical performance		Excellent

Comments: The first three-headed cassette deck that we ever tested sold for nearly \$1000. Prices for such machines have now come down drastically, which proves that today's high-fidelity components offer greater value (even in the face of the shrinking dollar) than ever before. The *Realistic model SCT-30* certainly qualifies in this regard. Not only does its three-headed configuration provide continuous monitoring of recorded results (perhaps even more important in a cassette deck than in an open-reel machine, because of the former's limited dynamic range), but it allows you to adjust all critical taping parameters so that the machine is optimized for any brand or type of tape used.

The one feature this machine lacks is a line/microphone mixing capability, although the serious recordist would likely want to purchase a separate line/microphone mixer in any event. Tape wow-and-flutter was remarkably low for a machine of this type and price category, and the use of a double head (record and play) in a single tape-head package eliminates the need for any complex azimuth alignment procedures normally associated with three-headed cassette machines. It also reduces the lag-time between the actual recording and its monitored playback version. The dual capstan construction is undoubtedly responsible for the smooth tape motion we measured, but transport lever controls are also smooth-operating and extremely reliable as well as fool-proof.

Since Dolby circuitry had to be incorporated in this deck in any case, Radio Shack wisely included an option that permits you to use the Dolby-decode circuitry as an adjunct to FM listening during Dolby broadcasts. All this, plus dual-Dolby calibration and vernier bias adjustment in an under-\$400.00 machine makes the *Realistic model SCT-30* a real winner.

Forest Belt tells . . .

What You Need To Know About Troubleshooting Video Cassette Recorders

TO HEAR SOME MANUFACTURERS, YOU WOULD BELIEVE that home video recorders have already become a new boom product. While "boom" may be an optimistic evaluation, video cassette recorders (VCR's) have definitely captured the imagination of many consumers, who have plunked down \$1000 or more for a VCR and a few blank video cassettes. With prices well below that now, and with color cameras becoming less costly, a definite market is forming.

Along with sales must come repairs and maintenance. As with color TV in the early 1950's, a major sales inducement is the knowledge that technical help can be found quickly and conveniently.

As you may know, troubleshooting a video tape recorder bears only a casual resemblance to servicing an audio recorder. There's truly a lot to learn about video cassette recorders on your way to real understanding. But, on the other hand, VCR's won't stump you. All they consist of is electronic circuits, sprinkled with a generous dash of mechanical systems.

You'll find this combination of mechanics and electronics rather elaborate. There's nothing to match it in past consumer electronics servicing. You must keep a lot of information in mind when you analyze almost any VCR operation. However, any reasonably competent technician can do it.

This Special Section brings you face to face with video cassette recorders. If you're going to sell VCR's, and service them, you'll want to know what you're getting into. What expenditures in time, effort and money will you have to make?

If your decision is "go," you have little time to waste. VCR's are already here.

What Will You Do About VCR's?

Whether you want to sell, service or simply use one, you should understand how they work, how to operate them properly and the different types that are available.

FOREST BELT

INEVITABLY THE QUESTION COMES UP: How do you plan to participate in the future market for home video recording? After all, you're in electronics, which alone means you have some of the experience required. If consumer electronics is your bag, you're already in on the ground floor.

It must be admitted, video tape recorders are not for everybody. They are a unique product, whether you want to use them, sell them, or service them. You may find (as I do) that it is an enticing challenge to learn to understand these intricate mechanisms. Rest assured that technicians who ultimately take care of VCR's will not be ordinary folk. A high degree of technology goes into video cassette recorders produced for the home market.

Moreover, there's pleasure in bringing a new and different entertainment medium to your customers, not to mention profits. Video cassette recorders for home use are comparatively expensive. Whoever sells VCR's successfully can expect satisfying financial returns.

Manufacturers of VCR's report (as is customary with new products) "not many service problems." However, they refer chiefly to in-warranty breakdowns. Outside of the warranty, the toughest problem so far is finding someone equipped and qualified to troubleshoot the VCR's. And, of course, that's where you come in if you're so inclined.

A video cassette recorder *does* develop troubles, and, since it costs a great deal, a customer is less likely than usual to balk at sensible (profitable) repair fees.

Beyond doubt, the most natural way to grow familiar with a VCR is to own one and use it. Put it through every pace shown in the instruction booklet. Invent some innovative uses yourself. Record some programs with a TV set as monitor, and without any monitor. Get the feel of operating a video camera.

THE MAIN VCR FORMATS

	Beta (Sony)		VHS (Matsushita)	
Companies	Aiwa Pioneer Sanyo (also V-Cord) Sears, Roebuck Sony Toshiba Zenith		Akai General Electric Hitachi JVC Magnavox Curtis Mathes MGA Montgomery Ward Panasonic J.C. Penney Quasar (also VX-2000) RCA Sharp Sylvania	
	1 Hr	2 Hr	2 Hr	4 Hr
Tape Speed (ips) (mm/s)	1 $\frac{3}{4}$ 40	7 $\frac{7}{16}$ 20	1 $\frac{5}{16}$ 33.35	2 $\frac{1}{32}$ 16.67
Writing Speed (ft/s)	22.63		19	
Video head gap (microns)	Beta 1-60	Beta 2-40	VHS2 - 60	VHS4 - 39
Track overlap (microns)	none	11	none	10
Azimuth	$\pm 7^\circ$		$\pm 6^\circ$	
Cassette size (in)	3 $\frac{3}{4}$ × 6 $\frac{1}{8}$ × 1		4 × 7 $\frac{1}{2}$ × 1	
Tape lengths	250, 500, 750* feet		125, 250 meters	
Type loading	B (beta) by Phillips		M—by Sony	
RECORDING FREQS:				
Luminance FM	3.5 to 4.8 MHz		3.4 to 4.4 MHz	
Chroma-under subcarrier	688.363 kHz		629.36kHz	
Audio-direct (Hz)	50-10,000	50-8,000	100-8,000	100-6,000

*New 750-ft cassette allows 1 $\frac{1}{2}$ or 3 hr on Beta units

Learn what kind of lighting a color camera demands.

Another question is which VCR format should you choose. Of the several you may encounter, only two presently deserve close attention for home use. Three other types are already being phased out, and one or two newer formats lack serious acceptance.

Concentrate on the two standard formats: *Beta-2*, manufactured by Sony, and *VHS-4*, made by JVC (Matsushita). A large number of television manufacturers have chosen either of these formats for their own VCR products (see Table 1, which also lists characteristics of some other formats).

If you expect to go into VCR servicing in a big way, obtain one model in each format. Future articles will tell you what you must know to feel comfortable with the innards of both types. It helps to have working units at hand as you learn.

Servicing a VCR

So far, VCR sales have been limited; in 1978 fewer than a half-million units were sold. But more are being sold every month. The 1978 Christmas season saw a substantial jump in VCR sales, plus a lot of accessories.

For service during the warranty period, most manufacturers provide some backup repair. Authorized repair centers are not numerous, but they do exist around the country. Warranty

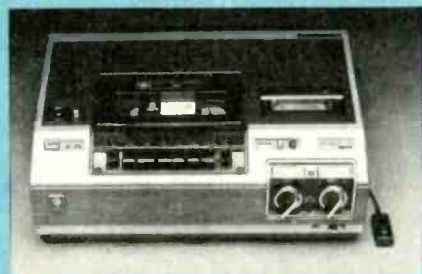

GENERAL ELECTRIC VHS VCR

service may not always be convenient except in large cities, but it is available.

Your VCR customer should rely on you for service, in or out of warranty. He'll want you to make the arrangements for service, even if you don't provide it on-premises. If you plan to charge him for handling and shipping in or out of warranty, make that clear at the time of the sale. Put it in writing, signed by you and the customer.

For all the above reasons, you may prefer to handle the servicing in your own shop. Training is available (see page 68). Tools and equipment require only a modest investment, if you're already providing television service. Video cassette recorders require a certain attitude and approach. The following pages take up these considerations; and may definitely influence your choice — to service or not to service.

VCR Tools And Instruments

*A look at the equipment
you will need to service VCR's*

IF VIDEO CASSETTE RECORDERS ARE new to you, your first inclination might be to assume you can work on a VCR using the same equipment you do on TV sets. In part, that's true. Certain instruments and tools suit both types of troubleshooting. However, VCR technology places certain demands on you that you don't encounter with TV receivers.

Anyone thinking about taking on VCR servicing should expect to spend a bit of money on test instruments. How much depends on what equipment you already own. Let's take this one step at a time and discuss what you really need.

Mechanical cleaning/adjusting

Several major VCR suppliers offer a kit of tools for making mechanical adjustments. Fortunately, the circuits inside all VCR's are very similar — at least within each format. The tools for servicing an RCA VCR work equally well for a Magnavox or any other VHS machine. (RCA Part No. 199049, priced just over \$500, includes test/alignment tape and all mechanical jigs and tools.) So do Zenith tools fit most Sony Beta-2 units. The differences between units are mostly in the cabinet fastenings or the like.

Certain hex-type hardware in either format is made in metric size. Plan to invest early in a set of small metric-size wrenches. Even coil slugs have metric openings, and the correct alignment tools are part of the prepackaged servicing kit for each type of VCR.



ALIGNMENT and troubleshooting that includes the video heads calls for a prerecorded cassette that manufacturers make available (at a price) to servicers.

Vital positioning fixtures for cassette holders are an absolute necessity. A tool kit for VHS recorders includes torque gauges and a tension scale, all vital for critical tape-transport adjustments. If any of these adjustments is out of tolerance, the entire machine can shut down. The Beta-format servicing package from Zenith includes a torque-measuring cassette. This cassette is a bit easier to use than torque gauges, but, of course, it doesn't fit VHS machines. A few special screwdrivers can round out your collection of nonstandard tools.

Routine maintenance of a video cassette recorder includes cleaning. Heads and tape-path components must have oxides, dust and film swabbed off every 500 hours of operation.

Cleaning kits are available. Or you can buy your own supply of long-stem cotton swabs and *Freon TF* solvent (don't use alcohol). A soft, lintless patch such as that available at some drug stores in the baby-goods department is recommended for cleaning larger sections; but not the tape heads.

Cleaning drive parts is a must for trouble-free operation. Drive wheels, pulleys and rubber belts seem to attract grime. Even mild slippage can seriously degrade performance, or even shut the machine down. Also plan on replacing rubber belts every thousand hours or thereabouts.

Finally, most critical of all, in the mechanical portions of a machine, is lubrication. It's critical in three ways: in the lubricant you use, how much, and where you apply it. I recommend that you buy lubricant kits for both Beta-2 and VHS-4 types of VCR's. RCA sells a VHS lube kit (RCA Part No. 199050) for under \$20.

Follow the VCR manufacturers' lubricating instructions carefully. If you lubricate correctly, this will avoid adding technician-induced troubles to any others.

General test equipment

The instrument used most in VCR servicing is a digital multimeter. Some service data of course calls for a VTVM



NARROW TOLERANCES of some voltages in VCR servicing recommend at least a 3½-digit multimeter.

and some for a VOM. Your own preference should really influence your choice. However, many voltage tolerances are rather close in VCR electronics. In those instances, you are best served by an accurate DMM.

You measure DC voltages mostly. The only time you might want to use an analog-type meter is when you have a zero-center adjustment to make. Even that's easy enough with a digital meter that has automatic zeroing and polarity reversal.

You need an RF-IF alignment setup about as often as you do in ordinary TV receivers, perhaps even less. Video cassette recorder tuners and IF strips are state-of-the-art designs — some tuners are the new digitally tuned type. Not much alignment will be called for. But when the VCR does need it, make sure to use *good-quality*, not inexpensive, alignment gear.

An audio signal generator comes in handy. Some Beta-format adjustments require it. It's also useful for tracing audio-track problems, whether in dubbed-over material or in the regular voice-recording channel.

In addition, there are some specific instruments you simply cannot do without. One is a really good oscilloscope. Another is a color video generator. A frequency counter is probably an instrument you've never used, at least not in TV servicing. You need one for VCR troubleshooting. Because frequency counters are so important, we'll take a look at them and their requirements separately.



NEW TO TELEVISION servicing, frequency counter occupies important place in VCR troubleshooting.

Last, although far from least, you need a test cassette for both types of VCR. The cassettes prepared by the manufacturers are expensive, but are worth every cent of their \$100-or-so price. You cannot match them yourself without lab-grade signal sources.

RCA's VHS test/alignment cassette can be used on any VHS machine. Its tape contains several minutes each of carefully prescribed test signals. These signals include monochrome video patterns; EIA-type NTSC color-bar patterns; a series of multibursts at 0.5 MHz, 1 MHz, 2 MHz, 3 MHz and 4 MHz, for checking frequency response; control tracks for standard-play (SP) and long-play (LP); plus sound with some of the signal patterns.

For Beta-format machines, the Zenith test/alignment cassette contains 5 minutes of a 75% (saturation) NTSC color-bar pattern; 5 minutes of a monochrome test pattern, half of that time combined with a 333-Hz audio and the rest with a 5000-Hz tone. All this is recorded at the two-hour or LP speed. The cassette then continues (in the one-hour mode) with another 5 minutes of color bars with 3000-Hz sound; 5 minutes of monochrome with 7000-Hz sound; and, finally, a swept RF test signal for making certain video frequency-response tests.

Using an oscilloscope

Whatever your feeling about oscilloscopes for TV servicing, do not try to repair a VCR without a good triggered oscilloscope. If you don't use one, you will not get very far in your work. If you don't really know how to use a dual-trace triggered oscilloscope, learn how right away.

(Editor's note: The May 1978 issue of Radio-Electronics published an entire section called "What You Need To Know About Triggered Oscilloscopes." Back issues are available for \$1.50 each. Request the May 1978 issue. Also you can get a Service Training Monograph entitled "Triggered Oscilloscopes — Four Hours to Familiarity," that teaches you how to use a basic triggered scope. You can obtain it for \$12.50 postpaid from Forest Belt, Box 68120, Indianapolis, IN 46268.)

The oscilloscope you use for VCR work must be a dual-trace instrument. It should have a bandwidth capability of 15 MHz or greater; a 5-mV-per-division sensitivity (or better); and an X-Y feature that is easy to set up because you will occasionally have to arrange a vector display.

The manner in which the scope is triggered is important. You must be able to trigger it internally from either channel and, of course, externally. For some video tracing, a built-in TV integrator is a must, so you can use internal triggering for video frames. Or, if the



SENCORE INSTRUMENT has its own video and color bar patterns, plus multiburst for frequency response tests.

HF-Reject feature has a cutoff point somewhere below 12 kHz or so, you can manage all right with that.

I prefer a triggered scope that allows a manual choice between alternated-trace switching and chopped modes. Some scopes make this choice automatic, ganged with timebase switching.

Some scopes even allow you to choose triggering, during alternated-trace switching, from both channels — that is, from first one and then the other as the traces switch. This is the most versatile arrangement, since it facilitates stabilizing two waveforms that are not necessarily at the same frequency or repetition rate.

Look for lots of little factors in the scope you buy:

1. Graticule illumination.
2. A beam that's bright enough at fast sweep speeds without degrading the focus.
3. Tight round beam size for displaying the cleanest detail in complex waveforms.
4. Distinct, definite triggering control.
5. Operating controls on the front panel grouped logically instead of helter-skelter.
6. Stable warmup without position changes in the traces beyond the first two or three minutes.
7. Accurate timebase calibrations and accurate Y-axis calibrations.



DUAL-TRACE oscilloscope, with bandwidth 15 MHz or more, is needed for VCR troubleshooting and adjustments.



DELAYED TRIGGER feature in more expensive oscilloscopes enables viewing waveforms you could not otherwise display.

One feature that really helps during certain VCR servicing procedures, although you can manage without it, is the *delayed trigger*. This feature makes a scope more expensive; delayed-trigger sweep is what I would term an advanced feature. Not every technician even knows how to use it. However, delayed-trigger operation can offer distinct advantages because it lets you observe portions of a waveform that you cannot view any other way.

If you're buying a new triggered scope and can afford the extra cost, buy a scope that has delayed trigger. You won't regret it. If you don't have the extra cash, you can purchase any good dual-trace scope such as the one described. You cannot service video cassette recorders without one.

Color video generator

Most VCR makers recommend an NTSC-type color video signal for checking out their units. They generate an EIA-standard color-bar pattern.

On a TV screen, this color-bar pattern contains eight bars of color across the top half of the screen. The chroma of these eight bars is phased to create white, yellow, cyan, green, magenta, red, blue and black from left to right. Chroma saturation has been carefully set to 75%.

The bottom half of the screen displays one bar of chroma with Q-phase, one in minus-I phase, then a block of 100% white for reference (often termed

a *window* or a *superpulse*), and a block of reference black. The photographs show how this signal looks on a TV screen, and how one line and one frame appear on an oscilloscope.

An advantage of the NTSC signal is that most of the VCR manufacturers have produced their service data using this kind of signal. It's what test cassettes include for the chroma-bars portion of the tape. (But *do not* depend on the test cassette for troubleshooting; the few minutes of chroma on a test tape does not last long enough for most diagnosis. Also the tape wears fast; use it only for adjustments where tape heads and playback system are involved.)

Generators of keyed-rainbow patterns are more numerous and generally less expensive. There's no good reason not to use one except that the service data shows NTSC patterns. However, that need not deter anyone who is familiar with keyed-rainbow patterns and phases. A keyed rainbow is actually easier to interpret in vectorscope displays. All that's missing is the stairstep luminance pattern that an NTSC generator provides. Keyed-



MOST VCR DATA shows waveforms based on what's called NTSC color bar, which is actually an Electronic Industries Association standard test pattern.

rainbow displays impart a certain type of luminance information, but not gray-scale data.

A new type of video generator, the Sencore model VA48 Video Analyzer, generates unique color and monochrome patterns for video repair, such as a multiburst, useful for response evaluation and adjustments in a VCR.

You have to learn to interpret these unfamiliar patterns and waveforms, but the manuals and guides accompanying the instrument explain how.

When you can afford one, you will probably want an NTSC generator. There are only a few models presently available; but others are being readied, according to test instrument manufacturers. In the meantime, don't let the lack of one keep you from troubleshooting VCR's.

Frequency counter

Here's an instrument that may be new to you. If you have only worked on TV sets, you probably don't own a frequency counter. You may never have used one, but you need a frequency counter for certain VCR measurements and alignments.

Avoid low-cost models. Accuracy and dependability are important. For VCR's, you need at least a 7-digit frequency counter. An 8-digit model would be better, but is generally more costly.

The frequency counter's sensitivity ought to lie in the vicinity of 20 mV RMS. This means a weaker signal

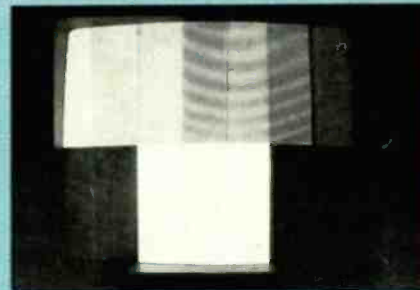

TOP ROW of bars, with chroma shut off, makes gray scale. Large white window forms reference for video peaks; black square reaches to sync tips.

might not give a stable count of the frequency fed in. Most signals you'll measure are stronger than 20 mV.

The counter's frequency range need not be extensive. One that extends beyond 30 MHz can be used for CB troubleshooting. A frequency counter that extends even higher can be used in checking out various FM two-way fre-

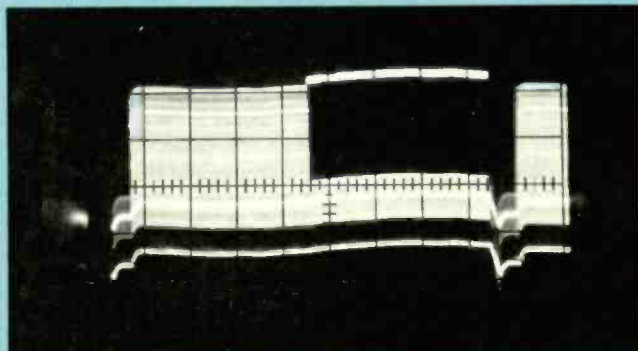

WAVEFORMS generated by NTSC/EIA color bar pattern. Left pattern is triggered at frame rate. Right is triggered at horizontal line time, and

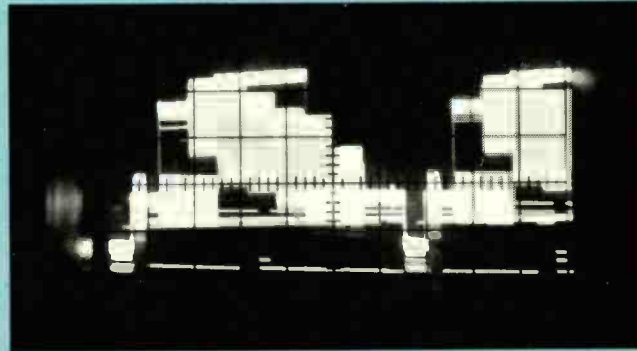

shows overlapping result of lines in upper and lower portions of the test pattern.

quency bands. However, for troubleshooting VCR's, a range to 20 MHz or 30 MHz is adequate.

Next to sensitivity, the accuracy of a frequency counter is its most important characteristic. Accuracy should be no worse than 0.0005%, which is 5 PPM, plus or minus one least-significant digit (usually 1 Hz).

Check the specs of any frequency

counter you're interested in. If they meet the criteria listed above, you can easily check the accuracy by comparing its count to a TV-station-controlled horizontal-sync rate. (During color programs, this rate is 15,734 Hz; it makes a good standard reference.)

Obviously VCR troubleshooting requires specific equipment. Don't fool yourself into thinking you can make do

without the stipulated test equipment.

The requirements are not overwhelming. Top-notch service technicians have most of these instruments anyway. You should also, and know how to use them. If you don't it's easy to learn how. If these test instruments seem too complicated for you, then video cassette recorders will be too; but that is truly doubtful.

Servicing VCR's - a fundamental approach

5 easy steps to troubleshooting VCR's—
a detailed look at each step and what is required.

THERE'S NO DOUBT ABOUT IT, VIDEO cassette recorders are complicated. But any reasonably competent technician can learn to service them. Whatever their complexities, VCR's respond readily to knowledgeable, logical troubleshooting. Two things are needed: an understanding of how a VCR operates, and a logical troubleshooting system.

Other issues of *Radio-Electronics* have mentioned my system of troubleshooting called Easi-Way Servicing. This planned method consists of five steps that take you smoothly to the source of trouble — the actual defective component.

Easi-Way Servicing is as much a way of thinking as a way of doing things. You can adapt this sort of reasoning to mechanical systems as easily as to electronic systems, which is necessary in VCR servicing. A VCR contains a diverse mixture of electronics, mechanics and unusual combinations of the two. So . . . let's use the Easi-Way Servicing approach to VCR troubleshooting.

Five easy steps

First, divide a piece of electronic equipment according to its various functions. A VCR, for example, has eight basic functions that take place inside the deck:

1. Power supplies.
2. Threading/unthreading the tape.
3. Tape transport — mechanical.
4. Tape transport — speed control.
5. Tape heads' speed/position control.
6. Electronic to electronic (E-E) —

camera or off the air, through VCR to monitor.

7. Recording electronics — video/chroma/sound.

8. Playback electronics — video/chroma/sound.

These functions all interrelate in several ways. Nonetheless, each is a recognizable individual function in and of itself. Only a familiarity with VCR operation can prepare you to identify each function accurately. You accomplish that by understanding how each fits into the overall operation of a VCR deck.

Step One: Analyze the Inoperative Function — In this first step, you attempt to operate the machine and then analyze which functions or operations fail to perform as they should.

Right away the first complication arises. Several functions in a VCR, as in other electronic equipment, depend on other functions. For example, if any of the power supplies are inoperative, very little else can operate.

Often, finding several functions inoperative directs you to which one actually contains the fault. And very likely, it's the first function in the chain of interdependent operations. As you gain experience with how a VCR works, you'll develop a "feel" for which function is most likely at fault when several quit working.

The word *analyze* simply means that you study the attempt at normal operation, noting what fails to work. Sometimes you use test instruments to verify your analysis. Again taking the power

supply as an example, a digital multimeter tells quickly which voltages are alive and which are missing or incorrect. Or, suppose the tape deck plays a prerecorded tape OK, but your customer finds it difficult to make a cassette of his own. Analysis suggests there's a fault in the recording electronics. (The symptom actually tells you even more, but we'll discuss that further along.)

The object of this preliminary analysis is to weed out and to eliminate from your troubleshooting efforts those functions that are working OK. Thus, you won't waste time searching for trouble where there is none.

Step Two: Diagnose the Affected Section — In this second step, you must recognize that each function occurs because of certain sections. In electronic functions (as I have defined them), *sections* are large blocks of circuitry that handle one or two specific signals. Mechanical functions can be broken down into *operations* instead of sections. Let's look at some examples of both.

In the playback electronics function, for instance, a section is devoted to the chroma portion of the playback signal. Another section deals with luminance signals. Still another section processes sound from the audio track of the cassette you're playing back. Another section deals with the control track. Each of these sections handles a specific signal in a particular way.

In considering mechanical functions, various operations fall under the func-

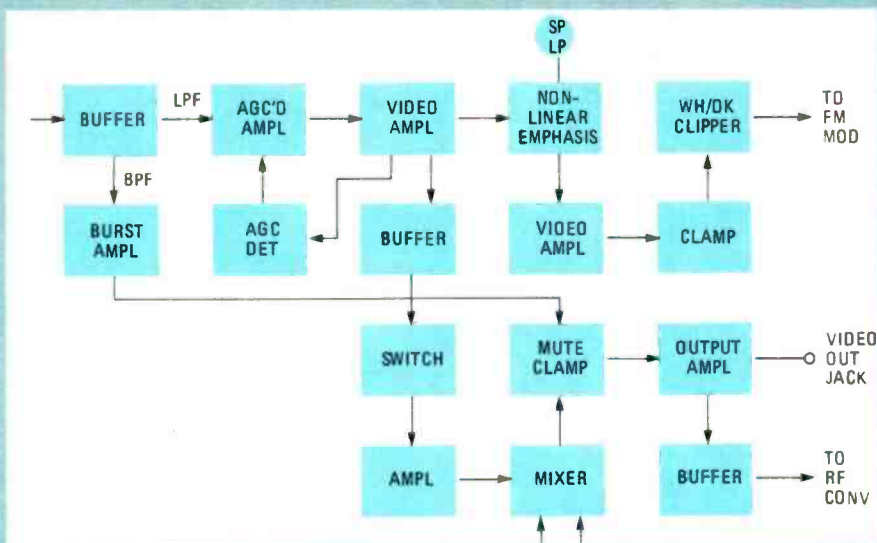

FROM CAMERA or built-in tuner to FM modulator, these stages process luminance portion of signal for VCR, and hence is called the luminance section.

tion called *tape drive* or *tape transport*. Certain mechanisms operate only when the tape is being transported forward for *playback* or *record*. Others operate for the *rewind* function, and still another set for the *fast-forward* function. On recorders that have a *pause* feature, this function brings more mechanisms into play. Each operation can be considered separately as a "division" of the overall tape-transport function.

You can restate Step Two for mechanisms, by substituting the word *operation* for *section*. (It would then read: *Step Two: Diagnose the Affected Operation.*)

The thinking method stays the same for both cases. You simply divide the function up into its component sections or operations, and decide which is missing or failing to accomplish what is expected of it.

Step Three: Locate the Faulty Stage — When you think about troubleshooting, imagine the sections divided into stages. Your goal is to isolate the single stage that is faulty to avoid wasting time troubleshooting other stages unnecessarily.

As before, there are many interrelationships among these stages. A certain knowledge of how much (or little) one stage depends on others can lead you fairly directly to what you're looking for.

To recognize some examples of stages within a section, consider what you find in the luminance section of the record function. For *Easi-Way Servicing*, I define a stage as a transistor or transistors (or a tube), and the components and wiring around it; a stage processes in some way the signal(s) that dominates the section.

Figure 1 is a partial block diagram of the luminance section in the record function. Sometimes there is more than one "active" component in a stage, and in some instances there are none

(unless you consider a diode, delay line, or special filter an active component).

All these stages process video signals. It is beyond the scope of this article to go into detail on how all this, or any other stage in the luminance section, works. This quick run-through aims only to give you some idea of how to think in terms of stages.

A signal from the camera, or from the tuner/IF/demodulator section of the VCR deck, feeds into a buffer-amp stage. A bandpass filter picks out chroma signals and sends them on to the chroma section.

A low-pass filter blocks the chroma and feeds video and sync signals to a group of three stages that control the video level: a video amplifier, an AGC detector and an AGC-controlled amplifier. The object of these stages of course is to stabilize the level of video (or luminance or Y-signal, whichever you prefer to call it) that is fed on to succeeding stages.

As is often the case in modern electronic equipment, several stages fit inside a single integrated circuit. This shouldn't bother your troubleshooting, but you should recognize that they are situated inside the IC.

After the signal leaves the video amplifier, it goes through a system of pre-emphasis. The standard-play (SP) or long-play (LP) switch is sometimes called the 2H/4H switch because in the VHS-4 format it sets the machine for either two-hour or four-hour recording. This switch determines how much pre-emphasis is applied.

The signal goes through more stages, also inside an IC. Then, the signal is clipped both in the white (video) direction and in the black (sync) direction. Finally, this pre-emphasized video signal, which is being held at a precise amplitude, goes to the FM demodulator — a different section.

Meanwhile, the video signal is also

taking another path called the electronic-to-electronic (E-E) path. A buffer feeds it through a RECORD-PLAYBACK switch.

In the record function, the signal goes through an amplifier, some mixers (which happen to mix the color and sync signals back in) and an output amplifier. In between, a muting clamp stage blocks this signal path whenever a particular operating mode (such as Pause) demands it.

The restored signal goes to two outputs. One output is a video output jack on the back of the set. This allows a studio-type video monitor to be used. The other output goes to an RF modulator or converter, which lets you monitor the recording signal with an ordinary color TV receiver.

As you have probably figured out, signal tracing with an oscilloscope can locate any faulty stage in this section. A scope shows whether the AGC works properly. It lets you find a stage anywhere along the way that blocks the video or Y-signal. It can find whether the mute stage works as it should. It lets you test the clipper stages.

In other words, an oscilloscope is the best test instrument for locating a faulty stage in a section like this. Of course, other instruments and techniques may suit other sections better.

Step Four: Isolate the Troubled Circuit — Stages consist of circuits; some of them are DC circuits, and some are signal circuits. A few, in certain sections and stages, are AC power circuits.

Any stage has an input and an output circuit, and it can have more than one of each. A transistor stage has DC supply circuits for the emitter, base and collector. It may be associated with tuned, R-C timing, delay or feedback circuits.

An IC, in addition to incorporating many stages and circuits, must connect to input and output circuits and at least one DC supply circuit. You will also find ground circuits, decoupling or bypass circuits, and capacitor or transformer coupling circuits. Sometimes control circuits are outside of an IC, or in conjunction with some transistor or diode.

How you isolate any troubled circuit depends greatly on what the circuit is supposed to do. Your oscilloscope is good to use for signal circuits, and it also works in AC power circuits. For DC circuits, in general, you should use a digital multimeter, using it either as a voltmeter or an ohmmeter.

In order to understand this better, take a look at the diagram in Fig. 2. At random, I have selected a transistor stage from the automatic LP/SP section of a VHS deck.

These switching stages are activated manually by the SP/LP switch. When

Where To

Since guidance is often necessary VCR's, its essential to know where available training. Here's a few tips

TRAINING IS A VITAL KEY, SINCE VERY few can learn how to troubleshoot a VCR without some help and guidance.

Where can you get such help? Although the VCR is a comparatively new product, there are several ways to put yourself on top of this potentially thriving service opportunity. Here are a few possibilities:

1. First, acquire a VCR of your own. Some manufacturers won't even offer training or service data until they know you own a unit. This practice is not a way to sell more VCR tape decks. It merely recognizes the fact that familiarity with the instrument is necessary. VCR's are not simple to understand, and you must see them operate.

Once you have a VCR, use it. Study all the different things it can do, and how it must be hooked up and manipulated to accomplish them. Then you will be able to recognize the customer's mistakes from the machine's faults.

Remove the top and observe what goes on in the mechanisms inside the VCR. At this early stage, don't take anything apart because putting it back together may be — and often is — critical. You will find there is no substitute for this experience.

2. One obvious way to learn is through reading magazine articles and books on VCR operation. The only trouble with this is that not many articles, and even fewer books, have been written on the subject. Two future "What You Need To Know" Sections in *Radio-Electronics* deal in detail with troubleshooting VCR decks; one will cover the VHS-4 format; the other, the Beta-2 format.

3. A recent issue of *Sencore News* (published by Sencore, the test equipment manufacturers) describes how video cassette recorders work. The articles tell how to use the Sencore model VA48 Video Analyzer for troubleshooting VCR equipment. Sencore will provide you with a copy of the publication; just send in your name and address, and mention this article in *Radio-Electronics*.

4. Future issues of the *Service Training Monographs* will deal with video cassette recorder troubleshooting. The *Monographs* are obtained by subscription. The price of a subscription to the

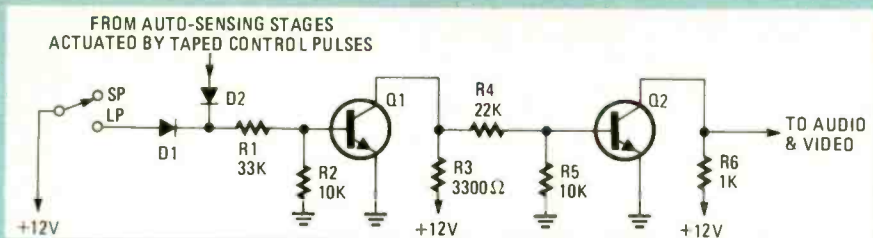

TWO DC-COUPLED stages for switching between long-play and standard-play show how circuits make up stages.

you turn the switch to the Long-Play mode, 12 volts DC forward-biases diode D1 and places a positive voltage at the base of Q1. This voltage forward-biases Q1 and brings its collector low. A low forward bias on Q2 has the opposite effect, making the Q2 collector go high.

This sequence reverses when you switch to the Standard-Play mode. Voltage is removed from D1, the collector of Q1 goes high, thus biasing Q2 heavily forward. The Q2 collector goes low, which signals other stages and sections in the VCR to operate in the faster-speed mode.

During playback, it doesn't matter in what position you place the LP/SP switch. A DC voltage, developed from control-track sensing stages and applied through D2, takes over control of Q1.

The input circuit of Q1 consists of the switch, D1 and the two resistors connected at the base. Since these stages are DC amplifiers, no signals are involved, and there is no need for capacitors or coils as input coupling devices. The output circuit of Q1 has R3 as the load, R4 as the coupling resistor and R5 as the input load resistor for Q2. The output load circuit for Q2 is R6.

Direct-current supply circuits for Q1 and Q2 are equally easy to see. Both transistors have their emitters grounded. Both are fed collector voltage through a series supply resistor (which is the load circuit when you think in input-output terms). The base bias circuit for Q1 involves R1 and R2 as well as whichever diode is operating. The base bias for Q2 is set by the divider circuit, which consists of R3, R4 and R5, with Q1 as a variable "resistor." You can also consider R2 and R5 as base-return paths or circuits.

Step Five: Pinpoint the Defective Component — When you reach this final step, your work is almost over. Once you identify the problem circuit, it is only a matter of moments to pin down the defective part — usually.

How you test components depends on your own preference. Some pinpoint faulty transistors, diodes, resistors and even leaky capacitors with DC voltage measurements. Occasionally that's not possible, but it works well in most circuits.

Others use a component substitution

method. This is not practical however when the component is expensive.

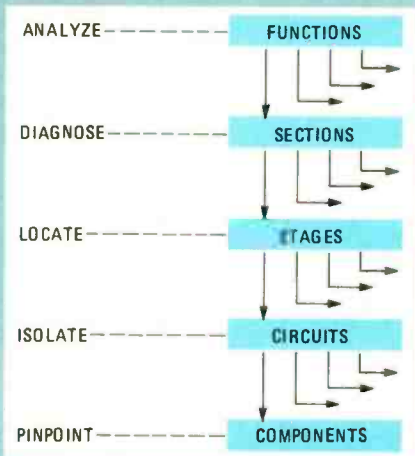

For an IC, checking out a defect may seem difficult. Your best bet lies in using a four-step test procedure:

1. Check all incoming signals with your oscilloscope. If various modes of operation or functions are involved, test in each of them.

2. Test all signal outputs from the IC.

3. Measure DC voltages that should be applied to the IC. In particular, make sure the main V_{cc} voltage is applied.

4. Verify that DC output voltages or levels are correct.

From this procedure, you can be sure that if all signals and DC voltages go in OK but some don't emerge as they should, the IC or its connections are faulty.

Warning: Make sure you have traced all the interrelationships that occur in and around IC's. For example, one IC in the head-wheel drive section appears to be defective if certain current feedback stages don't work as they should. Certain stages in the IC are curtailed, and as a result, certain outputs and other inputs are fouled up. Because all this can become rather complex, it is important to understand what's necessary for a particular stage or IC to work properly.

Summary

This represents a definite usable technique for troubleshooting VCR's. While we have not tried to familiarize you with actual VCR systems, more specific details of important sections and functions will be discussed in future issues.

Learn

in learning to troubleshoot
to go to get the best
on going about it the right way.

Modern Video Servicing category, some issues of which deal with TV troubleshooting, is \$65 (for six *Monograph* issues) after January 1, 1979. Just write Box 68120, Indianapolis, IN 46268.

A few selected Forest Belt Training Programs are being put on audio cassettes, with worksheets for group training. These are called Self-Trainer Kits, write to the above address for titles and prices.



QUASAR VH5000 VCR

5. A few VCR manufacturers have training material, but, so far, it's not easy to get hold of these materials. Your best bet would be to ask a local dealer who handles the brand of VCR you're interested in. Table 00 lists some well-known brands.



RCA Selectelevision

Manufacturer's service data consists mainly of schematics and diagrams, along with PC-board layouts. Key adjustments are described. The most helpful contain detailed circuit descriptions, but not many do. Unless you are a warranty service dealer, you may have to be persistent to get this data. Work through your VCR dealer whenever possible.

Independent service technicians can purchase RCA service data for the VBT200 video cassette recorder for \$19.95. The address is RCA Consumer Electronics Group, Technical Publications Dept. I-450, 600 North Sherman Drive, Indianapolis, IN 46201.

Sony has prepared a set of video tapes that describe how to service their Beta-format machines. The tapes are

expensive (as videotaped instruction always is) but they offer a painless way to learn. For information, write Sony Corporation, Service Dept., 47-47 Van Dam Street, Long Island City, NY 11101.

6. Howard W. Sams & Company, Inc., has a new *PhotoFact* specialized series for VCR's. There are six volumes to date:

- VCR-1 Sony SL7200, A
- VCR-2 RCA VBT200
- VCR-3 Zenith JR9000P, W
- VCR-4 Magnavox VH8200BR01
- VCR-5 JVC
- VCR-6 Panasonic

The best feature of this series is the easy-to-follow Sams *Standard Notation* schematics; photos that indicate parts, adjustments and circuit test points on the PC boards; and the parts substitution lists (where substitution is possible). If your dealer doesn't have



MAGNAVOX VHS VCR

them, you can order them direct. Send \$17.95 per volume to Howard W. Sams & Company, Inc., Dept. FBRE, Box 558, Indianapolis, IN 46206.

7. The Electronic Industries Association trained several college instructors last year how to service various VCR formats. These instructors, in turn, taught selected vocational school, high school and other college instructors.

To find out who in your region is VCR-qualified, call up your local schools. If they have no information, write EIA Consumer Electronics Group, 2001 Eye Street NW, Washington, DC 20006, to find out which university nearest you sent an instructor to the Summer 1978 Instructors Training Program. Then, write that university, care of the electronics department, and ask if any of your local schools sent instructors to their subsequent VCR training seminars.



PUBLICATIONS that offer VCR servicing help. Clockwise from top left: Forest Belt's *Service Training MONOGRAPHS*; Howard W. Sams *PhotoFact* Special VCR Series; Issue of *Sencore News*.

Troubleshooting Communications Receivers

The continuation of an earlier discussion on selecting and operating RF generators and other equipment used in servicing and aligning communications receivers.

FOREST BELT

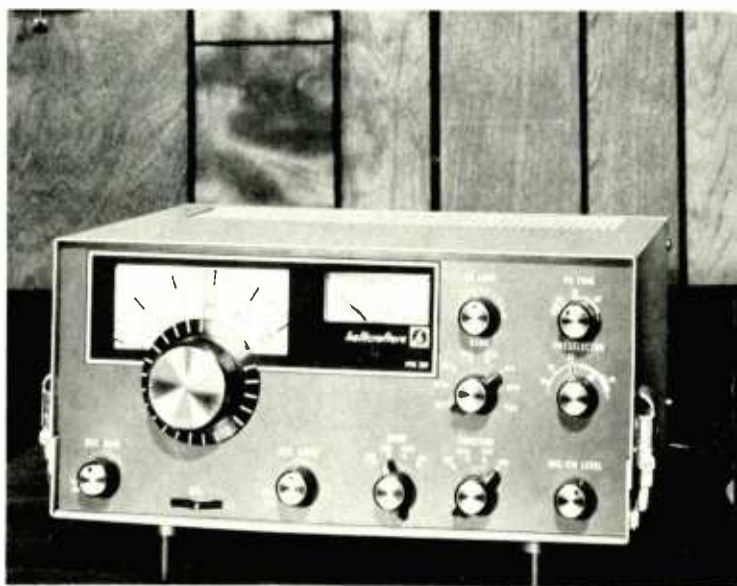

IN THE FEBRUARY 1979 ISSUE, WE DISCUSSED how to use signal generators in troubleshooting a communications receiver and looked specifically at the FM detector and limiter circuits. This month we continue the discussion with RF and IF troubleshooting, RF alignment and the oscillator stages.

RF and IF troubleshooting

When you get around to checking the RF and high-IF circuits of a communications receiver, you can manage most of the troubleshooting using a highly accurate and stable signal generator. If your generator's accuracy is not digital-close, add a frequency counter. You'll see why, shortly.

In troubleshooting, check the high-IF stages first. Figure 1 shows the block diagram of these stages in a double-conversion receiver. The procedure is simple.

First, make sure the discriminator is calibrated (see the February 1979 issue). Now meter the discriminator. Set your accurate signal generator precisely for the high IF; and feed the signal into the base or input circuit of the first mixer.

Next, find the frequency adjustment

for the *second* oscillator, if there is one. It is usually a small trimmer capacitor. Using discriminator metering as your indicator, adjust the crystal of the second oscillator for a precise zero-center reading. Caution—this is correct only if your signal generator is producing an extremely accurate high-IF signal.

With a less costly signal generator, proceed in a different manner. Forget about discriminator metering; just connect your frequency counter to the output of the second oscillator. Then, adjust the crystal trimmer for a frequency count that is precisely correct to produce the low IF when mixed with the high IF.

If this frequency is not listed with the crystal, you can find out what it is by subtracting the low IF value from the high IF value. For example, with a high IF of 10.7 MHz and a low IF of 455 kHz, subtract 455 from 10,700 (both in kilohertz). The crystal should hold the second oscillator precisely at 10.245 MHz. A 7-digit counter reads 1024500 when you have the trimmer exactly right.

Once the second oscillator is correct, you can depend on a zero discriminator reading to verify the accuracy of your signal generator setting.

Shift your metering now to the limiter. Reduce the signal level enough to keep the limiter reading somewhat less than maximum. But use sufficient input signal to produce some quieting and a noticeable limiter reading. Now, adjust your high-IF coils for a maximum reading at the limiter test point. Reduce signal as needed to avoid a flattening out of the meter reading.

Once the IF coils are peaked, use the filter-checking procedure described earlier to check high-IF crystal filters. If your generator has decade frequency controls, flip the switch for 2 kHz above and 2 kHz below the center frequency (10.7 MHz in this example). Note the noise level increase on both sides of center frequency; they should be about equal.

This noise level balance is the best way to assess filter action, short of running a sweep-response curve. A defective crystal or ceramic filter often has a response that is extremely tilted at its center frequency. Otherwise, a filter shows up bad simply by not passing along any signal at all. This is easy to determine by using your signal generator to inject a signal before and after the filter.

If convenient, observe the limiter meter reading as you flip the frequency 2 kHz above and below the center frequency. Both the noise level and the limiter reading can help you discern whether or not the filters are "centered" as they should be.

RF alignment/troubleshooting

Servicing the RF section in a dual-conversion receiver is much the same as for the high-IF section. You set the first

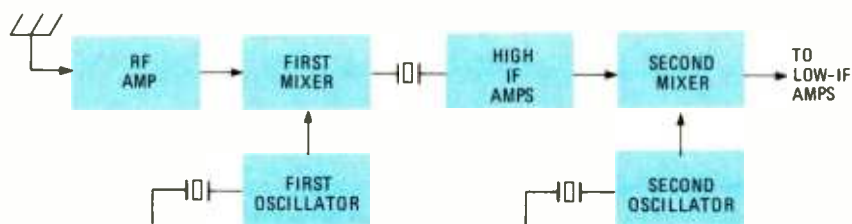

FIG. 1—ORDINARY DUAL-CONVERSION RECEIVER lends itself readily to RF and IF troubleshooting by alignment.

oscillator, peak the multipliers (if there are any) and finally adjust the RF stages. As usual, any discrepancy detected in making these adjustments provides the quickest clue to the source of trouble.

Figure 2 shows the schematic of the RF and high-IF stages. The coils and trimmers indicate how many adjustments a receiver may require.

Adjustment 1: Set the second oscillator frequency if the crystal has a trimmer. If not, just use a frequency counter to check that this frequency is nearly correct; in this case, within 0.001%.

Suppose the high IF is 5.5 MHz. Subtract 455 kHz. The second oscillator must run at 5045 kHz. At a tolerance of 0.001%, your frequency counter should measure an oscillator frequency somewhere between 5044.949 kHz and 5045.050 kHz. Adjustments 2 and 3 are for high-IF peaking, using the limiter as an indicator.

For the RF section, use the same procedure as before, depending on whether your generator is highly accurate or just an ordinary model. However, the unit must be very stable, or you will waste time trying to keep the frequency close enough for accurate adjustments. Feed the RF signal into the antenna jack.

The Fig. 2 receiver is a multiple-frequency unit, with four first-oscillator adjustments: adjustments 4 through 7. If your generator is not highly accurate, use your frequency counter to adjust the crystal frequency. The service manual should show each crystal frequency.

If you don't happen to know the frequencies, you can figure them out if you know the frequency to be received and the multiplier factor if there is a multiplier stage. The procedure goes like this:

Subtract the high IF (in MHz) from the frequency to be received, which should also be in MHz carried at least to three decimal places. Then, divide that mixer-injection frequency by the multiplier factor. This gives you the actual frequency the oscillator must generate.

Using an example from the Fig. 2 receiver, figure out the crystal frequency for receiving 155.370 MHz. The intermediate frequency is 5.500 MHz. Subtract that value from 155.370 MHz. The injection frequency for the mixer, therefore, is 149.870 MHz. Multipliers in this particular receiver work at $\times 4$ and $\times 3$. So, divide the injection frequency by 12. The oscillator must run at a frequency just barely above 12.489 MHz.

In fact, it is important that the oscillator be even more accurate than that, since you have calculated the frequency only to within kHz (12.489 MHz is 12,489 kHz). Your frequency counter should deliver even better resolution. Therefore, carry the division result to six decimal places; or all the way down to within one Hertz of exact oscillator frequency. If carried to that precision, the oscillator should run at 12.489166 MHz. A 7-digit frequency counter will read 12.48916 MHz or 12.48917 MHz.

Setting the oscillator by this method produces reasonably accurate results. Later, you will learn how to "net" the receiver into the system where it is operated to refine the accuracy even further.

A highly accurate, digitally locked signal generator lets you set the first oscillator in the receiver using the previously calibrated discriminator as an indicator.

For the example given above, simply feed in a highly accurate 155.370-MHz signal. Adjust the first-oscillator frequency trimmer in the receiver for a precise

zero reading at the discriminator. Use a strong signal, so that the receiver limiters are driven to full limiting. If you've performed your earlier adjustments correctly, this brings the receiver close to its final frequency. Using any method, set the oscillator on each frequency to be received.

Next, reduce the RF input level from the generator enough that the limiters no longer limit fully. You can always tell when this happens because a bit of receiver-circuit noise becomes audible, and the limiter reading drops below maximum.

Connect your meter to the limiter test point. Set the receiver frequency selector to whatever frequency is closest to the midway point between the highest and lowest frequency. Set the generator for that frequency.

Adjust the oscillator-output coils (none are shown in Fig. 2) for a maximum limiter reading; and make this adjustment for all the multiplier coils. In Fig. 2, this is shown as adjustments 8, 9, 10 and 11. Peaking the coils sends more signal to the first mixer, and ultimately also to the low-IF section. This is why the limiter reading can be used as an alignment indicator for these multipliers.

Incidentally, note that the second multiplier "stage" evolves around a diode. This is simply a nonlinear device to clip the RF cycles and create harmonics. The tuned circuits you adjust (9, 10 and 11 in Fig. 2) peak the third harmonic. The first multiplier and coil (adjustment 8) build up the fourth harmonic of the oscillator signal. Together, they form a $\times 12$ multiplier.

As always, during these adjustments, reduce the signal-generator output level to the point where you can keep working with a less-than-maximum limiter read-

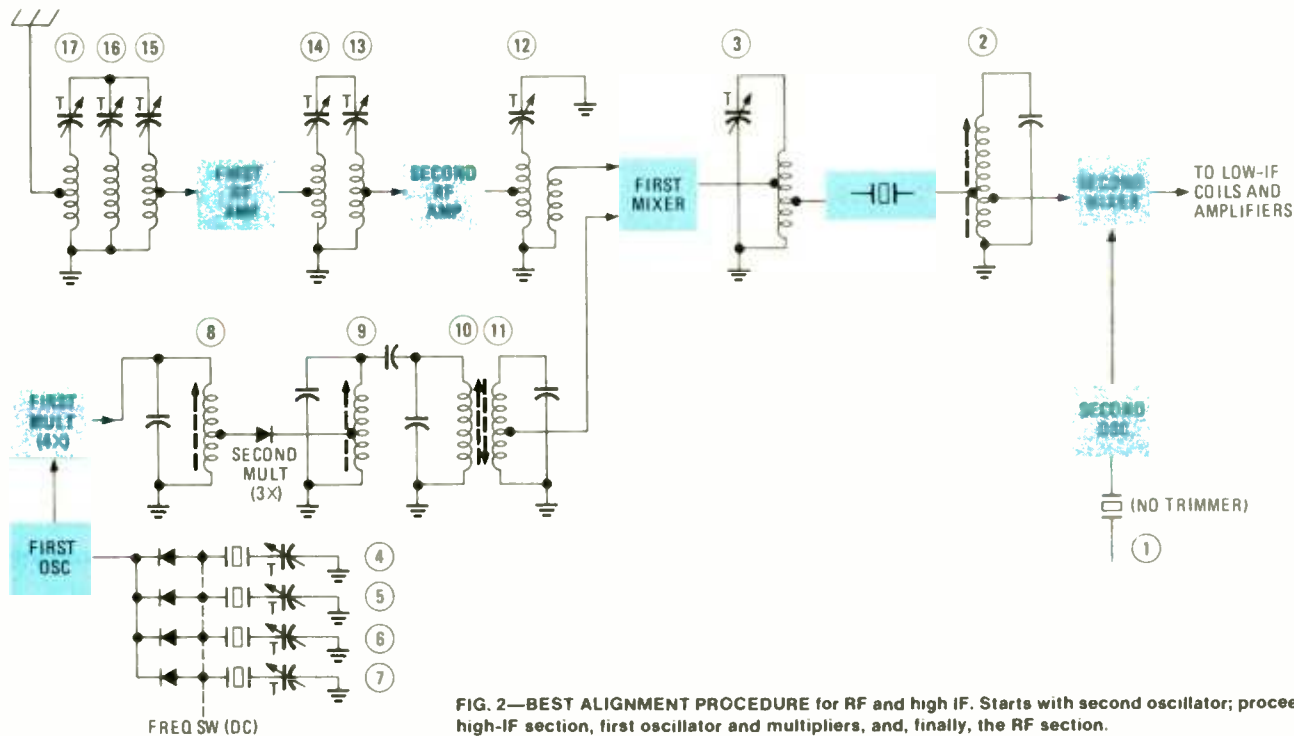

FIG. 2—BEST ALIGNMENT PROCEDURE for RF and high IF. Starts with second oscillator; proceed to high-IF section, first oscillator and multipliers, and, finally, the RF section.

ing. That way, adjustments won't be so broad. If an adjustment doesn't show sharp "peaking," look for trouble thereabouts. The cause of mistuning or lack of tuning could be a defective coil, a faulty decoupling capacitor—or even a leaky transistor in some instances.

Don't worry about any slight pulling effect the oscillator-output coils may have on frequency. This effect is very minor, and it will be corrected during final adjustments later on.

Finally, peak all the RF coils, working backward from the mixer. The generator and the receiver frequency should still be set for the frequency nearest the center of those the receiver will handle. The limiter metering point is your indicator, and the generator's output level should be kept low enough to show up as distinct peaks on the meter.

Oscillator hints

Some have trouble diagnosing faults in oscillator stages. Here are a few hints that may speed up your repairs on a defective oscillator.

Only rarely does a faulty crystal *kill* an oscillator; usually, a crystal slides off-frequency.

A dead oscillator, or one that drops out intermittently—especially on low or high voltages—can usually be traced to a transistor with too much collector-base leakage. If you feel insecure in your ability to analyze transistor voltages, use a transistor checker. Or substitute a transistor you know has high forward-reverse ratios between collector-base and emitter-base. For oscillators at VHF frequencies, you cannot allow much transistor leakage to occur.



WAVETEK MODEL 3002

If you are not sure the oscillator is at fault, there are two good places for injection troubleshooting.

First, you can set your signal generator to the injection frequency for the first mixer. The injection frequency is found by subtracting the high IF from the frequency you expect to receive. Keep your injection signal unmodulated, of course.

If mixer injection brings the receiver to life, lower the generator frequency to whatever the oscillator should emit. Feed that signal to the input side of the multipliers. Multiplication should raise the frequency to the right injection frequency for the first mixer. That, too, should

bring the receiver to life—if the multipliers are OK.

If the oscillator is really dead, check the transistor as described earlier. You can use a transistor checker or substitute a known good transistor.

If you believe the transistor is all right, measure to make sure it has somewhere near its proper DC collector voltage; measure again for its proper base voltage and emitter voltage.

Make sure that the crystal is sitting correctly in its socket. If you suspect the crystal is faulty, try another one (any frequency) to see if the oscillator starts up.

Identify the oscillator feedback path, (if this is not done via internal-transistor capacitance) and determine that this path is OK.

Here's how: Disconnect the feedback capacitor. Feed a correct signal from your



CUSHMAN MODEL CE-4B

generator to the base of the oscillator transistor. Then, using a frequency counter or wideband oscilloscope, verify that the transistor at least can amplify a signal. If it does, the feedback capacitor should couple the signal to the frequency counter or oscilloscope. If that occurs normally, the trouble probably lies elsewhere.

As a last resort, substitute new feedback capacitors. If the capacitors were to change value severely, it would upset the feedback ratio, and either prevent oscillation or make oscillation erratic.

Tuning up system receivers

Once every six months or once a year, or on whatever cycle you perform preventive maintenance, you should tune up *all* system receivers. This is performed using the base transmitter as a signal source. You should also net-in every receiver after repairing it for the best possible system performance.

Always use the main base transmitter as the signal source. Make certain it has been frequency-checked and set with a frequency meter or counter that was recently calibrated against WWV standards.

Meter the discriminator or demodulator of each receiver. While the base signal is being transmitted, precisely adjust the receiver's first oscillator trimmer for an exact zero-center demodulator reading. Zeroing all the receivers this way, using the same transmitter, allows them to deliver highest clarity and sensitivity.

Follow this procedure for each fre-

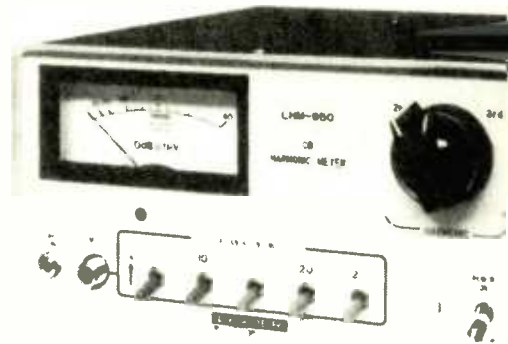

LEADER LHM-950

quency a receiver handles. If a system has base-to-mobile and mobile-to-mobile frequencies, select one mobile transmitter as the signal source for all the others, and for the base receiver. Make sure the transmitter is frequency-checked and set precisely. Then, adjust all the other receivers in the system for zero discriminator at that frequency.

Note: When you perform this procedure periodically, look out for any receiver that indicates a discriminator reading that is seriously off-zero. Ordinarily, over a year's duration, drift should be insignificant. A really noticeable shift indicates that a crystal is beginning to drift in the first or second oscillator, or that the discriminator itself is developing trouble. Pull that particular receiver in for a thorough going-over.

This kind of thoughtful preventive care heads off many serious problems. You will often find a problem before it shows up. R-E

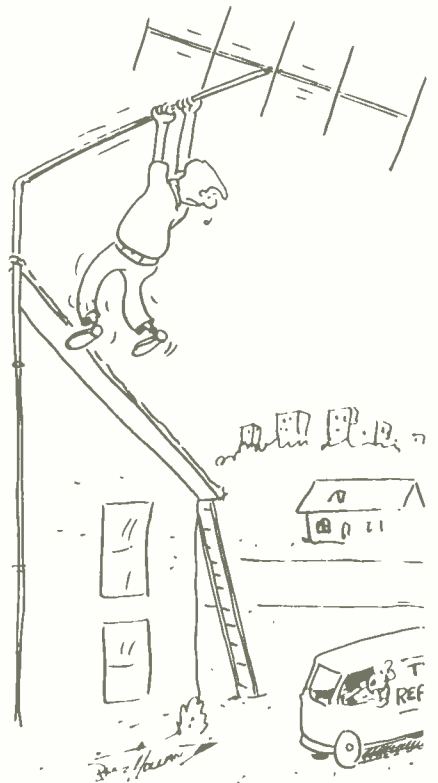

Ben's Hardware didn't have a 20-foot ladder. Want me to try Teely's Hardware?

For cost effective capacitance measurement



One C-meter stands out of the darkness— the \$130 B&K-PRECISION 820

For about one-third the cost of the most popular digital capacitance meter, you can own five times more measurement capability. The new B&K-PRECISION 820 reads all the way to 1 Farad, in ten ranges. With 0.5% accuracy, the 820 resolves to 0.1pF for a maximum count of 9999.

The 820 keeps on going in freezing cold to blistering 100 degree heat, making it ideal for field use. The bright LED display is easily readable under all lighting conditions. It has the versatility needed for any application and the durability to stay on the job. The 820 can be powered by disposable batteries or optional rechargeable batteries.

Unlike many specialized instruments, the 820 has almost unlimited applications in engineering, production line work, QC, education and field service. First time users are quickly discovering that the number of time-saving applications exceed their original expectations. For example, you can measure unmarked capacitors... Verify capacitor tolerance... Measure cable capacitance... Select and match capacitors for critical circuit applications... Sample production components for quality assurance... Measure capacitance of complex series-parallel capacitor networks... Set trimmer capacitors to specific amounts of capacity... Check capacitance in switches and other components.

*You can start discovering
your own applications today by seeing
your local distributor for immediate delivery.*

B&K PRECISION DYNASCAN CORPORATION

6460 W. Cortland Street • Chicago, IL 60635 • 312/889-9087

In Canada Atlas Electronics Ontario
International Sales Empire Exporters, Inc. 270 Newtown Road Plainview L.I. N.Y. 11803

CIRCLE 45 ON FREE INFORMATION CARD

www.americanradiohistory.com

HOBBY CORNER

How to determine the voltage and current rating of unmarked transformers.

EARL "DOC" SAVAGE, K4SDS, HOBBY EDITOR

HAVE YOU EVER REACHED INTO YOUR "junkbox" and found a power transformer with the tag missing? You probably have a marking system something like mine. When transformers are new or when I salvage them from old equipment, I identify the leads with tags, or write on the transformer with a waterproof marker. But tags come off, and some markers are more "waterproof" than others.

Whether because of missing tags or markings, or because the transformer was borrowed from someone who neglected to mark it, I usually end up with unmarked transformers. You have probably discovered that slapping 120 VAC on just any old leads can cause real fireworks. Don't do that, but don't throw the transformers out either. You can figure out which lead is which by applying a little logic.

The great majority of power transformers are low-voltage types for solid-state power supplies. We'll concentrate on these in this article, but you can use the same principles to identify high-voltage transformers as well.

First, you may find some numbers printed on the transformer. Unfortunately, these are seldom manufacturers' identification numbers. More often than not, they are "house numbers" placed there for the benefit of the bulk purchaser who was putting them into equipment. You might get lucky and match your numbers to those listed in a catalog, but the chances are slim and I wouldn't waste any time trying.

Second, you could check the *color* of the insulation on the lead wires (if any). If there are colors and you can decide what they are, you may be able to match them up with the old color code given in most electronics data books and handbooks. However, I have found the wrong colors are used so frequently that I don't trust them any more.

My approach is to disregard numbers, colors, and even wire size, and proceed right to the identification process. Here's how I do it, step by step:

The first task is to mark each lead with a temporary number since it is easy to lose track of which leads you just tried. I use a small piece of masking tape with a number written on it.

Second, you should find out which leads are connected to each other through the same windings. You can use an ohmmeter or just a battery and flashlight bulb to check this. Touch the leads in various combinations until each lead has been identified as being connected to at least one other lead. Of course, since there are no "one-lead windings," if you find such a situation, this tells you that there is a burned or broken winding in there.

Make sure to write down what leads are connected to each other as you go along. Unless you make notes, it is hard to keep track of more than four leads. For example, you might find something like this: leads 1 and 6; 2 and 3; and 4, 5 and 7. After you have this information, draw out the transformer windings and label the leads according to your findings.

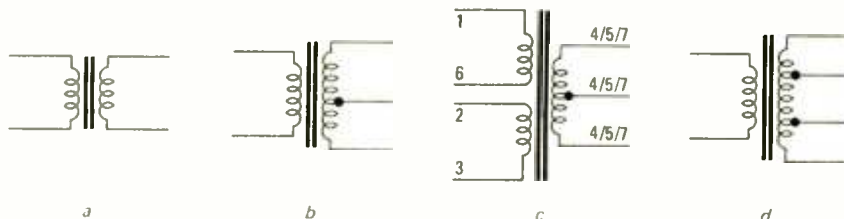

FIG. 1

Some of the more common types are shown in Fig. 1. The transformer shown in Fig. 1-c is labeled for the example given in the above paragraph. Note that at this stage, we don't know which winding is the primary (120 VAC), or which number belongs to each lead of the tapped winding. We can figure that the winding with the center tap is a secondary winding because that is almost always the case.

The next identification step is not really necessary. It may make you feel a little more comfortable but don't worry about omitting it. This optional step is to measure the resistance of the windings you have identified. With an ohmmeter as found in the typical VOM, you won't learn much because the lowest meter scale is far too large, but perhaps a hunch will help.

A primary winding usually shows a DC resistance in tens of ohms—say, 15 or 20 ohms and maybe up to 90 or 100 ohms. A

low-voltage secondary shows a lower resistance—from less than 1 up to several ohms. To add to the confusion, the primary of one transformer can be less than the secondary of another. In spite of the fact that you can *almost* count on the primary having a higher resistance than the secondary, I recommend making one more test before throwing 120 volts on any winding. Incidentally, if your measurements are very different from the ones described here, be careful because you may have some other kind of transformer—an interstage or an audio transformer, etc.

The next identification step makes use of the following fact: The *ratio* of voltages on the various windings of a transformer will be almost the same regardless of the absolute value applied to one winding. Knowing this, I apply a *low* voltage to what I *think* is a secondary winding of the unknown transformer. Usually, I use approximately 3 VAC from one-half of a

6.3-VAC center-tapped transformer. Note that this is AC voltage because transformers don't work on DC.

With 3 VAC applied to a probable secondary, measure the output of the other winding or windings. If one or more of these measurements is extremely small—much less than 1 volt—you are using the primary winding or another high-voltage winding. In this case, switch to another pair of wires so that the voltages are large enough to measure. Make a chart of the wire numbers and your measurements. In the case of our sample transformer, the chart would look like the one shown in Table 1.

Now, figuring that the highest voltage is on the primary, let's call leads 2 and 3 the leads to the 120-volt winding and write that data on the chart. (Note that the identification information shown in parenthesis in the chart was added after all measurements were made.) Call 55 volts one-half of 120 volts—at this point,

don't worry about a few volts one way or the other because there are several areas where inaccuracies can creep in.

TABLE 1

Leads	Reading	Identification
1&6	3V	test input (6V)
2&3	55V	(primary, 120V)
4&5	6V	(4&5 = 12V) (7 = CT)
4&7	3V	
7&5	3V	

Since the 55- to 120-volt relationship is 1:2, so are all the others. Thus, we multiply the readings by 2 and write 6 volts in for leads 1 and 6, and 12 volts for leads 4 and 5. Because lead 7 is obviously in the middle of (and connected to) leads 4 and 5, it must be the center tap of the 12-volt winding.

Of course, there are many other possible combinations of measurements on any given transformer. All you have to do is to follow the same procedure. To help you further, Table 2 shows some common readings when applying 3 volts.

You will notice that accumulated errors of measurement and approximations can mask the differences in 10-volt and 12-volt windings, for example. This should be of no concern because you have identified the 120-VAC primary.

At this point you are ready to apply 120 VAC to the primary winding. Exercise extreme caution—these voltages and currents can kill! Do *not* depend upon a steady hand or upon insulation alone. Always disconnect a power circuit before touching it.

(EXTREME CAUTION IS THE WORD when applying voltage to the windings of an unknown transformer. Add another dose of caution if the transformer being tested has long wire leads that may accidentally touch each other, or a metal tool or surface of the workbench. And, no matter how tempted you are to clip the test leads on to a "secondary" winding before applying the AC power to the "primary," DON'T DO IT! When voltage is first applied, transient voltages high enough to burn out the meter movement, blow multiplier resistors and fuse switch contacts, can develop across an unloaded "secondary.")

Set your meter to its highest AC range, then apply AC to your "primary." Now, touch the test prods to the leads of the winding being metered. Reduce the meter voltage range step-by-step until you get a voltage reading in the upper one-third section of the scale. — *Editor*

The 120 VAC applied to the primary should come through an isolation transformer (two 120-volt windings). If you don't have an isolation transformer, you can make one by putting two filament or low-power transformers back-to-back (see the August 1978 "Hobby Corner"

TABLE 2

Primary Reads	Multiply By	To Get Primary	Applied Winding Is	Multiply all windings by same number
240V	1/2	120V	1.5V	
120V	1	120V	3V	
60V	2	120V	6.3V	
30V	4	120V	12.6V	
20V	6	120V	18V	
15V	8	120V	24V	

All computations approximate

for details). In any case, the 120 volts should come through a fuse—a 1/4-amp or so will do. With the primary fully powered, it is then a simple matter to measure the actual output voltage(s).

The only remaining question about your unknown transformer is its power-handling capacity or current (ampere) rating. Unfortunately, there is no way that you can readily determine this accurately, but there are some guidelines that can help you figure out the rating.

The best way to obtain a close approximation of the rating is to put the transformer in a power-supply circuit and actually measure the current output. Keep your finger on the transformer case to judge its temperature. If it feels warm, this is normal—you are not drawing too much current and, perhaps, you can draw even more. If the transformer begins to get uncomfortably hot you have reached

or exceeded its current rating.

You could rig up a variable load and increase it slowly as you measure the current and judge the temperature. If you do, increase the current very slowly to give the temperature a chance to reach the outside of the transformer case and to stabilize at each increase. It is best to start at a conservative rating based upon transformer size. It is quite possible to overload the transformer and burn up a winding before the excessive temperature can reach the outside where you can feel it.

Well, there you have the basic info on low-voltage power transformers. Now you can get those unknowns out of your junkbox and use them to build some useful power supplies. If you need help in choosing the other components for your supplies, you can refer to the September 1978 "Hobby Corner." **R-E**

**For
faster
service**

**USE
ZIP
CODE**

**on
all
mail**

The most complete I/O interface available for S-100 systems.

the SWITCHBOARD™

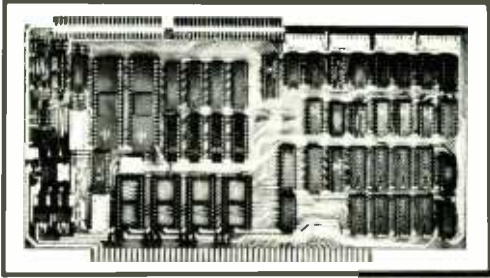

The SwitchBoard™ interface provides 4 parallel ports and 2 RS232/TTY serial ports. Plus strobe and attention ports. Plus, on-board facilities for 4K of optional static RAM and 4K of user-supplied EPROM (sockets provided).

And every port is switch-programmable for total flexibility in interfacing complex peripherals . . . such as 12-bit daisywheel printers.

In kit form, it's just \$199. \$259 assembled. 2114 4K static RAM option \$70.

A product of Morrow's Micro-Stuff for

**Thinker
Toys™**

1201 10th St.,
Berkeley, CA 94710

Ask your local computer shop to place your order for you.

CIRCLE 21 ON FREE INFORMATION CARD



PHILIPS

HICKOK



DORIC



Non-Linear Systems



DIGITAL MULTIMETERS

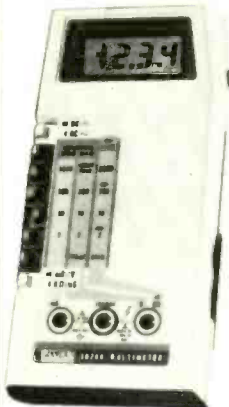

8020A

- 26 Ranges—5 Functions plus New Conductance Function for up to 10,000 MΩ Leakage Measurements
- Extensive Overload and Transient Protection
- Rugged Construction—1 Year Warranty
- Hi/Low Power Ohms for In-circuit Resistance and Diode Testing
- 10 MΩ AC/DC Input Impedance Doesn't Load Circuit
- 200 Hour, 9V-Battery Life—Low Battery Indicator
- Large LCD Readout—2000 Counts
- 1 Year Calibration Cycle—Only 3 Adjustments
- One Hand Operation
- Complete with Battery and Test Leads

The new Fluke 8020A continues the standard of excellence set by the highly successful 8000A multimeter family. Many features set the 8020A apart as a truly exceptional instrument. Twenty-four ranges and 5 functions include measuring capability up to 1000V ac, 750V ac, 2A ac/dc and 20 MΩ HI/LO ohms are included for in-circuit resistance and diode test capability. In addition, a new Conductance function allows resistance and leakage measurements up to 10,000 MΩ, a must for circuit board work and component checking.

The 8020A has been designed with the user in mind and features exclusive one-hand operation. For harsh service environments, the 8020A has a ruggedized case and extensive overload/transient protection backed up by a 1-year warranty. Long term stability (1-year calibration cycle) is excellent with only three cal adjustments. Up to 200 hours of continuous operation can be expected from a single 9V alkaline battery.

BASIC SPECIFICATIONS

	DC Volts	AC Volts	DC Current	AC Current	Ohms	Conductance
Range	0.2 1000V	0.2 750V	0.002 2A	0.002 2A	200Ω 20 MΩ	200 nS 2 mS
Resolution	100 μV	100 μV	1 μA	1 μA	0.1Ω	0.1 nS
Accuracy	(0.25 + 1%)	(0.75 + 2%)	(0.75 + 1%)	(1.5 + 2%)	(0.2 + 1%)	(0.3 + 1%)

\$169.



DIGITAL MULTIMETERS

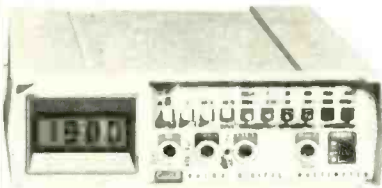

8010A and 8012A

- Large 3 1/2-Digit LCD's - view in any light
- Conductance function - resistance to 10,000 MΩ
- AC measurements to 50 kHz and higher
- True RMS for AC accuracy
- Touch-Hold probe for tricky points (Y8008)
- Diode test and low power ohms
- One year accuracy reduces calibration costs
- COMMON floatable to 500V
- Recessed jacks reduce shock hazard
- Current mode fuse protection to 800V
- Voltage mode transient protection to 6 kV
- Autozero and auto polarity
- AC or DC current to 10 amps with 8010A
- Resistance resolution to 0.001Ω with 8012A
- Built-in batteries and charger (Option -01)
- Rugged enough for field or bench



MULTIFUNCTION COUNTERS

1900A, 1910A, 1911A, and 1912A

LCR-740 Transistorized LCR Bridge



\$269.95

Regular price \$320.

- Highly accurate 3 unit digital readout.
- Measures inductance (L), Capacitance (C), and Resistance (R), within ±0.5% accuracy.
- Operates on one 9V battery



New Sweep/Function Generator



MODEL 3020 **BK PRECISION**

- Four instruments in one package—sweep generator, function generator, pulse generator, tone-burst generator
- Covers 0.02Hz-2MHz
- 1000:1 tuning range
- Low-distortion high-accuracy outputs
- Three-step attenuator plus vernier control
- Internal linear and log sweeps
- Tone-burst output is front panel or externally programmable

Regular price \$325. **\$269.95**

New Portable Digital Capacitance Meter



Reg. price \$130.
\$109.95

MODEL 820

- Measures capacitance from 8 pF to 1 Farad
- Resolves to 0.1 pF
- 10 ranges for accuracy and resolution
- 4 digit easy-to-read LED display
- 0.5% accuracy
- Special lead insertion jacks or banana jacks
- Fuse Protected
- Uses either rechargeable or disposable batteries
- Overrange indication



Solid-State RF Signal Generator

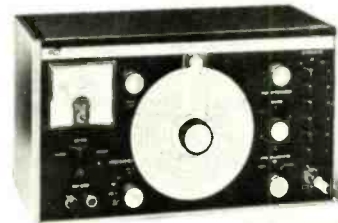

MODEL E2000

- 100kHz to 54MHz coverage in 5 fundamental bands and harmonics to 215MHz
- Completely shielded RF output with modulation percent metering and variable monitored attenuation usable to less than 1 μV
- Built-in 100kHz and 1MHz crystal calibration system
- Easy setting 2-color 8" anti-backlash vernier dial

\$249.95

Regular price \$300. **BK PRECISION**

3-1/2 Digit DMM with .5% Accuracy

MODEL 2810

- 3 1/2 digit easy to read LED display
- 0.5% DC accuracy typical
- 100:1, 81/2 resolution
- 10 ohm range and control to zero lead resistance
- Selectable High/Low-power ohms on four ranges
- Auto zeroing

\$109.95

Regular price \$130.



Laboratory Power Supplies

MODEL 1650

- Functions as three separate power supplies
- 5VDC, 14.8Vdc output
- Top separate 0-25VDC outputs at 1.5A

Reg. price \$275
\$229.95

MODEL 1601

- Isolated 5-50VDC, continuously variable, 0-2A in four ranges
- Fully automatic shut-down, adjustable current limit

Reg. price \$265.
\$224.95

New Low Distortion Function Generator



MODEL 3010 **BK PRECISION**

- Generates sine, square and triangle waveforms
- Variable amplitude and fixed TTL square-wave outputs
- 0.1 Hz to 1 MHz in six ranges
- Push button range and function selection
- Typical sine wave distortion under 0.5% from 0.1 Hz to 100 kHz
- Variable DC offset for engineering applications
- VCO external input for sweep-frequency tests

Regular price \$175. **\$149.95**

Simpson

TRIPLETT

BK PRECISION

VIZ formerly RCA

LEADER

DATA PRECISION

Dual-Trace 5" 30MHz Triggered Scope...



MODEL 1474

- Rise time 15.7 ns or less
- Built-in signal delay line permits view of leading edge of high frequency pulse rise time
- Triggers on signals up to 50 MHz
- 5mV/cm vertical sensitivity
- Mode automatically shifts between CHOP and ALTERNATE as you change sweep time
- Checks most digital logic circuitry, including ECL
- High accuracy ten position vertical input attenuator
- Flat response with smooth rolloff past 30 MHz
- PDA CRT with P31 phosphor
- Built-in high and low-pass filters
- Maintains calibration accuracy from over 105-110 VAC and 200-280 VAC
- 20 calibrated sweeps—0.2 μs/cm—0.5 μs/cm
- Differential input capability
- Algebraic addition and subtraction
- Built-in RF detector for modulation envelope display
- Illuminated graticule

QUANTITIES LIMITED

\$799.⁹⁵

Probes not included in price.

BK PRECISION

30MHz Dual Trace with Delay Line

LEADER Instruments Corp.

LBO-520

\$889.⁹⁵

Regular price \$1050.



- Single Shot Trigger on CH-1 & CH-2 helps capture transient phenomena without guesswork or time wasting double checks
- Built-in 120nSec delay line simplifies viewing of leading edge of pulse or pulse train
- 5mV/cm sensitivity facilitates accurate signal viewing from low level sources
- 20nS/cm sweep capability, 11.7nSec rise time for observation of the fastest signals.
- 5 PDA CRT assures bright, sharp trace at all sweep speeds
- Z Axis modulation
- Numerous applications—VTR, microprocessors, computers, production, laboratory and field service.

20MHz Dual Trace

LBO-508

\$639.⁹⁵

Regular price \$770.



- Automatic trigger from CH-1 or CH-2, including TV synch
- Add & subtract modes, (with CH-2 invert) for quick analysis of signals, amplitude, etc.
- Automatic select, in dual mode, of alternate & chop
- Front panel, pushbutton, X-Y operation for phase shift, analysis, sweep alignment
- 10mV vertical sensitivity with ±3% accuracy
- 17.5 nanosec Rise Time for easy viewing of high speed pulses.
- Horizontal format, 5 CRT, 8x10 Div, with bright, effective display.
- Logically grouped, convenient, front panel controls facilitate quick, easy operation

LEADER Instruments Corp.



Non-Linear Systems

BATTERY OPERATED

MS-215

Reg. price \$435.

\$359.⁹⁵

15 megahertz

QUANTITIES LIMITED

MS-15

Reg. price \$318.

\$269.⁹⁵

PORTABLE OSCILLOSCOPES

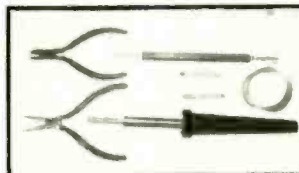

FREE TOOLS

With the purchase of \$750 or more you get these quality tools worth over \$34 : WELLER 25 watt soldering iron kit, (SP23K) XCELITE 4" cutters and 4" pliers. (54, 41CG)

Offer ends April 31, 1979
Shipping not included in prices.

5MHz Solid State 3" Oscilloscope



MODEL 1403A

- 5 MHz with high sensitivity
- For production lines, schools, field service work, hobbyists
- CB modulation monitor
- Ultra-compact and lightweight, goes anywhere!
- Use the 1403A to release more expensive scopes from monitoring applications
- Vertical sensitivity of 10mV/division
- High brightness CRT and smoked-glass graticule
- Can be externally synced
- Direct deflection terminals for waveform display up to 450MHz
- Z-axis input for intensity modulation



\$214.⁹⁵

Regular price \$255.

BK PRECISION

New 15MHz portable 3" dual-trace scope



BK PRECISION

MODEL 1432

- 15MHz bandwidth with smooth roll-off; usable response extends beyond 30MHz
- 2mV/div. vertical sensitivity
- Operates on 117VAC, 230 VAC, 12VDC or optional internal battery pack
- Fully regulated high- and low-voltage supplies
- Algebraic addition and subtraction of Channel A and B input signals
- Nineteen calibrated sweep ranges cover 0.5 microsecond to 0.5 second
- TTL Compatible Z-axis input
- Compact size: measures only 5.5 x 8.25 x 16.3"
- Includes two slim-body 10' direct probes and accessory tips
- Built-in sync separators

\$699.⁹⁵

Regular price \$840.

THE TEST EQUIPMENT SPECIALISTS

MASTER CHARGE VISA

TOLL FREE HOT LINE
800-223-0474

ADVANCE ELECTRONICS

54 WEST 45th STREET, NEW YORK, N.Y. 10036 212-687-2224

Put Professional Knowledge and a
COLLEGE DEGREE

in your Electronics Career through

**HOME
STUDY**

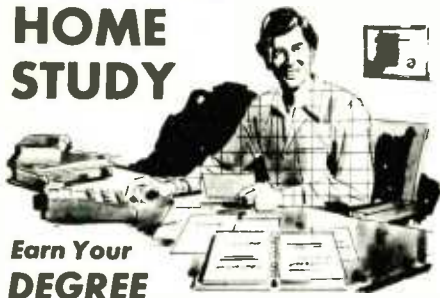

**Earn Your
DEGREE**

by correspondence, while continuing your present job. No commuting to class. Study at your own pace. Learn from complete and explicit lesson materials, with additional assistance from our home-study instructors. Advance as fast as you wish, but take all the time you need to master each topic.

The Grantham electronics degree program begins with basics, leads first to the A.S.E.T. degree, and then to the B.S.E.T. degree. Our free bulletin gives complete details of the program itself, the degrees awarded, the requirements for each degree, and how to enroll. (We are located at 2500 S. LaCienega Bl., Los Angeles, Calif.) Write to our mailing address shown below for Bulletin R-79.

Grantham College of Engineering
P. O. Box 35499
Los Angeles, California 90035

Worldwide Career Training thru Home Study
CIRCLE 56 ON FREE INFORMATION CARD

**9 reasons why
the real pros
prefer Endeco
desoldering
irons**



- Operates at 120v. 40w. Idles at 20w for longer tip life
- Flexible, burn resistant Neoprene cord set
- Cool, unbreakable polycarbonate handle
- Exclusive bracket insures alignment, prevents damage
- Safety light in handle tells when it's on
- Stainless steel construction
- Temperature control. Low, high or off
- Eight tip sizes. Comes with .063 I.D.
- Converts to soldering iron with 1/4" shank type tip

See your distributor or write

Enterprise Development Corp.

5127 E. 65th St. • Indianapolis IN 46220
PHONE (317) 251-1231

CIRCLE 62 ON FREE INFORMATION CARD

communications products

More information on communications products is available from manufacturers of items identified by a Free Information number. Free Information Card is inside the back cover.

TRUNK-MOUNT CB ANTENNA, Auto-Match, is self-tuning and designed for both 23- and 40-channel operation. Stainless-steel antenna system measures signals at antenna feed point and correctively tunes for maximum performance and



CIRCLE 135 ON FREE INFORMATION CARD

minimum VSWR. Antenna remains tuned automatically during channel switching and any adverse atmospheric conditions. Suggested list price: \$79.95.—GTE Sylvania, CB Marketing Dept., 100 First Ave., Waltham, MA 02154.

F CONNECTORS AND CRIMP TOOL, models 1224, 1225 and model CR-596, provide secure coax cable connections. Model 1224 is for 59U cable and model 1225 is for 6U cable. Ridged 1/2-inch crimp rings provide even distribution of shield pressure and improved shielding performance. Hex crimp tool, model CR-596, is light-

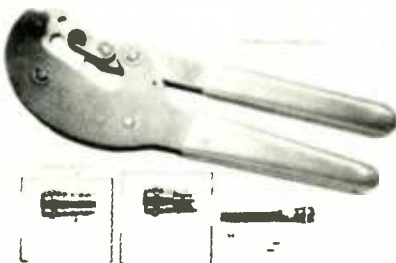

CIRCLE 136 ON FREE INFORMATION CARD

weight and suitable for "one-hand" operation. Also available are an adapter for 11U coax cable, model 11VSF, and a splice barrel, model 11SP. List prices: model CR-596 tool, \$24.99; model 1224 connectors, \$.39; model 1225 connectors, \$.40; model 11SP, \$3.50; model 11VSF, \$1.79.—RMS Electronics, Inc., 50 Antin Place, Bronx, NY 10462.

LORAN C RECEIVER SYSTEM, model TI 9000A, is a fully automatic and microprocessor-controlled unit providing keyboard data entry. Features include programmed time-difference display, cycle-track point verification, warning indicators and time-difference store/recall function. Also included are bright gas-discharge display (visible under all light conditions); low S/N ratio

warning; Loran C station blink signal; time-difference secondary acquisition/reacquisition capability; and separate TI 9101 remote control.

The receiver automatically searches, acquires and tracks all available stations simultaneously. Depending on mode selected, time differences can be displayed sequentially with 5-second up-



CIRCLE 137 ON FREE INFORMATION CARD

date rate. Front-panel switches control on/off functions and display brightness. Power consumption is 18 watts on 12 VDC, with optional adapter providing 110 VAC or 25-35 VDC operation. Suggested retail price: \$2095.—Texas Instruments, Inc., P.O. Box 226080, Dallas, TX 75266.

RF WATTMETERS, Ham-Mate models 4360 and 4362, measure forward or reflected transmission line power. They are used with CW, AM, FM, and SSB ham transmitters. Dual-range meters are calibrated for both high and lower power, and can be kept in-line for continuous monitoring. Specifications: the model 4360 (HF) has a 1.8-30-MHz frequency range (200-2000 watts); the model 4362 (VHF) has a 140-180-MHz frequency range (25-250 watts). Both meters have a rotatable sensing element and a 20-dB (100:1) minimum directivity. Both meters measure 3 1/4" X 6 X 3 1/4-



CIRCLE 138 ON FREE INFORMATION CARD

inches and weigh 1 lb. Suggested retail price: \$94.—Bird Electronic Corp., 30303 Aurora Rd., Cleveland (Solon), OH 44139.

Automotive "brain" astounds the experts, puts both computer and cruise control at your fingertips!

For the first time ever, you can put a true computer in your car, truck or RV which gives you the most effective and functional cruise control ever designed, plus complete trip computing, fuel management system, and a remarkably accurate quartz crystal time system. It is called CompuCruise™.

So simple a child can operate, the new CompuCruise combines latest computer technology with state-of-the-art reliability in a package which will not likely be available on new cars for years to come.

CRUISE CONTROL WITH A MEMORY, UNIQUE SEEK-AND-HOLD CAPABILITY.

CompuCruise remarkable cruise control performs in a totally different manner than any other unit because it is more than a simple speed maintaining device. With CompuCruise, you establish your desired cruising speed even before you reach the highway and activate the system any time by simply pressing a button. CompuCruise then seeks and maintains the desired speed until you override or shut off the system. You resume cruise control again at any time by pressing the same button. CompuCruise, unlike most vacuum-mechanical systems, is fully electronic, more accurate and more reliable than any other unit you can buy.

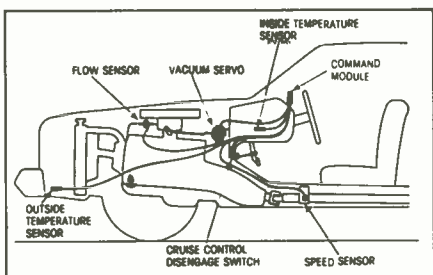

AIRLINE PILOTS COMPARE COMPUCRUISE™ TO SOPHISTICATED AVIONICS EQUIPMENT.

Similar to types of computers used on modern airliners, the CompuCruise slim panel-mounted control module contains a digital readout and back-lighted control buttons, both readily visible in the dark. By quickly learned systems of inquiry, the driver can elicit virtually any informa-



tion relating to time, distance, fuel and performance of his vehicle.

There are a number of digital-type instruments on the market which can be purchased for your car, purporting to provide functional data on performance, but all are basically calculators, operating on fixed information provided by the driver.

CompuCruise is a true computer, operating from automatic data sensors which constantly react to changing conditions, automatically recomputing vital data every second. Each function operates independently, with data displayed and updated constantly until you change your request of the computer.

Fuel management takes on new significance because CompuCruise tells you the most effective driving speeds, the type and brand of gasoline most suitable for your vehicle. It will tell you the effects of different types of tires and different tire pressures, road conditions, and engine tune-up condition. You can get instantaneous computations on current gas mileage, fuel required to arrival, and actual fuel remaining.

Battery condition can be checked regularly, saving you from the potential embarrassment of being stranded without warning.

TYPICAL DATA:

- ✓ Cruise Control
- ✓ Time, E.T., Lap Timer, Alarm
- ✓ Time, Distance, Fuel to Arrival
- ✓ Time, Distance, Fuel to Empty
- ✓ Time, Distance and Fuel on Trip
- ✓ Current or Average MPG, GPH
- ✓ Fuel Used, Distance since Fillup
- ✓ Current and Average Vehicle Speed
- ✓ Inside, Outside or Coolant Temperature
- ✓ Battery Voltage
- ✓ English or Metric Display

COMPUCRUISE™ DIGITAL QUARTZ CRYSTAL TIME SYSTEM IS INCREDIBLE.

CompuCruise digital time system performs four independent time functions encompassing (a) stop watch and lap timer functions, (b) hours, minutes and seconds, (c) alarm or warning function, and (d) trip time indicator. The time system operates full time, whether your vehicle is operating or not. It will even wake you up after a short roadside nap.



YOUR COMPUCRUISE IS SMART! IF YOU PUSH THE WRONG BUTTON IT WILL LET YOU KNOW BY DISPLAYING "ERROR".

COMPUCRUISE™ WORKS ON FOREIGN OR AMERICAN CARS; IS PRICED FOR THE AVERAGE MAN'S BUDGET

You do-it-yourselfers can readily install the unit, but complete and detailed instructions are also included for the automotive service facility. CompuCruise units are fully operable on most foreign or American cars, trucks or RV's. At \$199.95 the unit is only a few dollars more than the cost of cruise control alone on most vehicles, yet offers a whole new world of computerized management functions.

This is an exclusive system, fully warranted for 90 days from installation, delivered to you complete with all required hardware. You need only basic tools for the total job.

When you receive your unit, inspect it completely. If you are not 100% satisfied, return the complete unit before installation and your money will be refunded without question.

TO ORDER YOUR UNIT, complete the coupon below, enclosing \$199.95 (ADD \$5.50 if front-wheel drive). This covers all shipping, insurance and handling costs. Your unit will be shipped within three weeks.

NOTE: Mountable on foreign or domestic vehicles including standard trans. EXCEPT FOR DIESEL OR FUEL INJECTED ENGINES.

TO: ZEMCO, Inc. (415) 935-4960
1136 Saranap Avenue
Walnut Creek, CA 94595

Ship _____ CompuCruise™ units @ \$199.95
Model 44 (WITH CRUISE CONTROL)
 Add \$5.50 for front-drive

Ship _____ CompuCruise™ Units @ \$159.95
Model 41 (WITHOUT CRUISE CONTROL)
 Add \$5.50 for front-drive

Total enclosed: \$ _____
(CA residents add Sales Tax)

Charge to my _____ Master Charge _____ Visa _____

Card Number _____

Date Expires _____

Signature _____

Make vehicle: _____

Name: _____

Address: _____

City: _____ State & Zip _____



(415) 935-4960

Technically competent personnel available to answer your questions.



COMPUCRUISE

CIRCLE 52 ON FREE INFORMATION CARD

www.americanradiohistory.com

service clinic

Tuners that use solid-state bandswitches are easy to repair if you know how.

JACK DARR, SERVICE EDITOR

ALL-ELECTRONIC TV TUNERS ARE SHOWING up in more and more sets. One of the things the manufacturers needed to make these work was some kind of a "switch that wasn't a switch." Many switches are needed, and, for obvious reasons, manufacturers didn't want to use the mechanical types. Anyone who has ever cleaned a TV tuner can easily see why. So, they found a new use for diodes. By this time, everyone must have realized the analogy—a diode in full conduction is a closed switch, and a cut-off diode is an open switch. It works.

One popular use for these diodes is in bandswitches, as shown in Fig. 1 (courtesy of Quasar's *Technical Training Manual* for the *Compumatic* model TS-961/962). The oscillator coil is tapped. The entire coil tunes over the low-VHF TV channels, and the top half only will cover the high-frequency (VHF) channels. A varactor diode does the actual tuning.

For low-band operation, with the diode as shown in Fig. 1, a negative voltage is applied to the anode. The diode is cut off, creating an open circuit. To switch to the high-frequency band, a positive voltage is applied to the anode. The diode conducts, and shunts the capacitor from the tap of the coil to ground. This makes the tap a good ground for high-frequency RF, and the bottom half of the coil is shorted out.

To change from VHF to UHF, more switching diodes can be used to turn the B+ voltage off on the low-band oscillator (leaving the RF and mixer stages to act as amplifiers), and to turn the UHF tuner on. There are also logic IC's that are used for this purpose.

Several tuning voltages may be needed for the different frequency bands. Generally, one tuning voltage is used for low-band VHF, another for high-band VHF, and one more for the UHF band. For example, let's say the low-band tuning voltage is 0-10, the high-band is 10-20 volts, and UHF is a higher voltage. These values serve only as illustration. You should check the schematic for the actual voltages used in any particular set. These values are critical.

So, all this leads us to make some nice simple tests when there is trouble in the

tuner. For example, if the set receives low-band but no high-band stations, check the switching voltage on the diode to make sure it is correct, and that it changes in polarity when a high-band station is selected. If the voltage is correct, the diode is open. If only high-band VHF is being received, the diode may be shorted. Either problem could also be due to incorrect switching voltages. Go back to the source of this voltage and check. This will usually be a separate regulator module, etc.

voltage limits must be. Many service manuals show the normal voltage range for given frequency bands, sometimes for each channel. If the receiver is obviously on the wrong channel but will tune to different channels, the tuning voltage is off-value. As with most DC voltages in solid-state sets, these voltages are tightly regulated. Check the voltage regulator to see where the problem is. Incidentally, don't overlook the possibility of a poor contact between the regulator module and the DC voltage supply. This can cause a complex problem, but one with a simple solution!

Several sets now do not have the familiar off-on switch. A triac may be taking

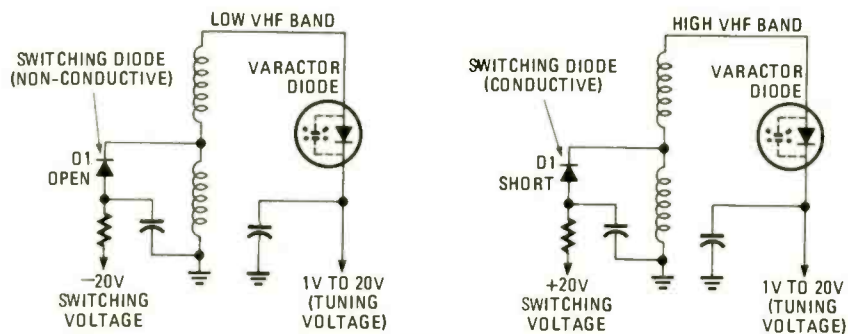

FIG. 1

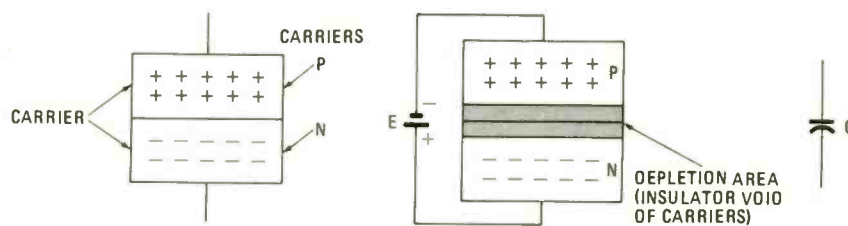

FIG. 2

The tuning varactor is a special type of diode. With zero voltage across the junction, each side of the junction acts as one plate of a capacitor. Applying a reverse bias to the varactor cuts it off more tightly, and creates an area in which there are no current carriers of any kind; this area is an insulator and becomes the dielectric of the capacitor. With the plates farther apart, the capacitance is less, and the frequency is higher. The greater the reverse bias, the farther apart the plates are (see Fig. 2).

To repeat, the first test should be to read the tuning voltage. No, correction! The first step should be to read the schematic and determine what the tuning-

its place; this device is basically two SCR's back-to-back with a common gate. If AC is applied to the anodes, along with a gate voltage, both sides will conduct on alternate halves of the input AC voltage. In this condition, the triac is a closed switch. The gate voltage needed is quite small, and is provided in many different ways. One set (Quasar) uses an optical coupler driven by the control IC's. Other sets use IC's to switch a low voltage to the triac gate.

Testing is simple: If the set stays on all the time, check to see if the triac is shorted and if there is proper gate voltage. If the gate voltage is on all the time, this

continued on page 78

"HOT" NEW BOOKS FOR MICRO-COMPUTER PROS!

The latest in micro-computer books that people waited in line to buy!
Now available by mail for the first time.

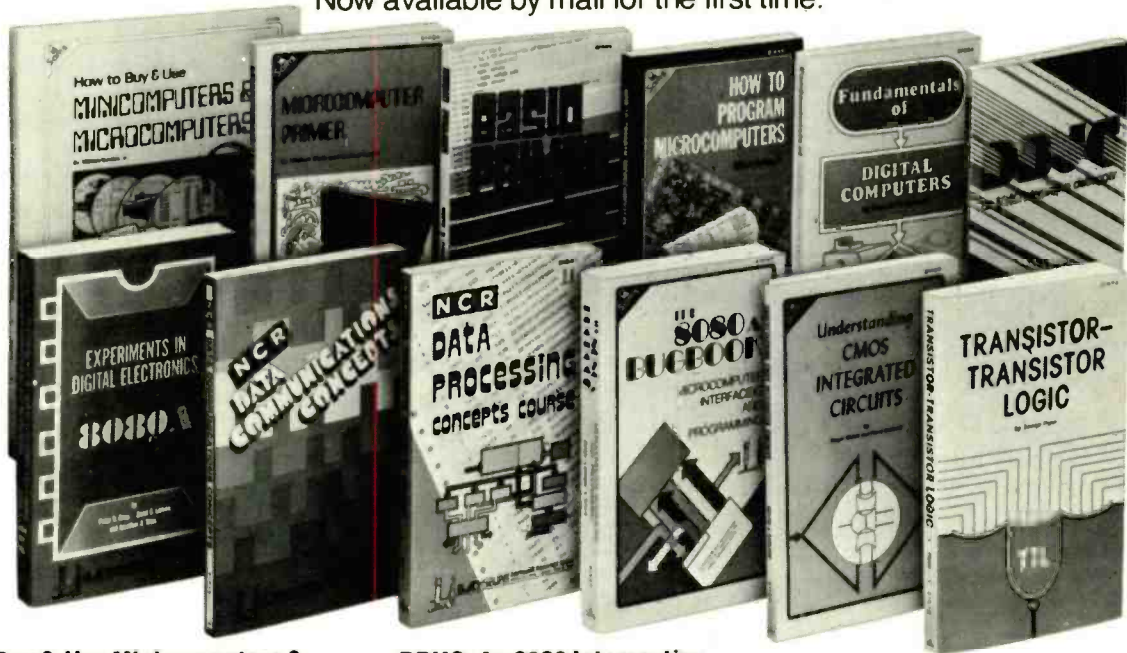

How to Buy & Use Minicomputers & Microcomputers

By W. Barden, Jr.

Explores the basics; covers hardware, software, peripheral devices, programming languages & techniques; use for fun or profit! 240 pgs. #21351 ... \$9.95

Microcomputer Primer

By M. Waite & M. Pardee

Explains it all: central processing unit, memory, input/output interfaces, programs. Discusses well-known models & shows how to program your own. 224 pgs. #21404 ... \$7.95

Basic Primer

By M. Waite & M. Pardee

Covers BASIC fundamentals, program control, organization, functions & variations. With a game program & data on numbering systems & ASCII character codes. 192 pgs. #21586 ... \$8.95

How to Program Microcomputers

By W. Barden, Jr.

Examines assembly-language programming of 8080, MC6800 & MCS6502 models. Explains concepts, operation & architecture. With precanned operations. 256 pgs. #21459 ... \$8.95

Fundamentals of Digital Computers (2nd Ed.)

By D. Spencer

Explains computers, programming, hardware, BASIC, FORTRAN & COBOL languages, advanced concepts & computer center operation. 320 pgs. #21534 ... \$9.95.

The 8080A Bugbook®: Microcomputer Interfacing and Programming

By Rony, Larsen & Titus

Emphasizes the computer as a controller. Covers principals & 4 basic tasks of computer interfacing. BUGBOOK® is a registered trademark of E&L Instruments, Inc., Derby, Conn. 06418. 416 pgs. #21447 ... \$10.50

DBUG: An 8080 Interpretive Debugger

By C. Titus & J. Titus

How to use DBUG (a software debugging package) to develop & test programs. With documented hexadecimal & octal listings. 112 pgs. #21536 ... \$4.95

Introductory Experiments in Digital Electronics and 8080A Microcomputer Programming and Interfacing

By Rony, Larsen & Titus

Covers basic gates thru microcomputer interrupts, with hardware & software examples. Experiments re: breadboarding, circuits, etc. over 416 pgs. each. Book 1: #21550 ... \$12.95. Book 2: #21551 ... \$10.95. Both: #21552 ... \$20.95

NCR Data Communications Concepts

By NCR Corp.

Explores concepts, techniques & limitations of data communications: telephone-based & others. 208 pgs. #21548 ... \$6.95

NCR Data Processing Concepts Course

By NCR Corp.

Intro to data processing, computers & digital logic. Covers input/output devices, memories, control. 256 pgs. #21547 ... \$7.95

Understanding CMOS Integrated Circuits (2nd Ed.)

By R. Melen & H. Garland

Begins with basic digital ICs; covers semiconductor physics, CMOS fabrication technology & design, & advanced CMOS applications. 144 pgs. #21598 ... \$5.95

Transistor-Transistor Logic (2nd Ed.)

By G. Flynn

Discusses digital logic & different types of logic circuits used in the TTL functional class. With block diagrams, schematics, logic truth tables. 288 pgs. #21572 ... \$6.95

SAVE 10% when you order 3 or more!

Examine any book(s) at NO RISK for 15 Days!

315

Clip Out-Mail Today!

YES—Please send me the book(s) indicated below. If I'm not completely satisfied, I may return any or all within 15 days of receipt for full credit or refund. Add sales tax where applicable.

21351 21447 21534 21552
 21404 21536 21548 21547
 21586 21550 21598
 21459 21551 21572

I have checked 3 or more titles and deducted my 10% savings.

Name _____ (Please Print)

Address _____

City _____

State _____ Zip Code _____ Total: \$ _____

Check Money Order Master Charge

Visa/BankAmericard

Exp. Date _____

Account No.: _____

Interbank No.: _____ (Master Charge only)

Signature: _____

Minimum credit card purchase: \$10.00 MA52

MAIL TO: **Howard W. Sams & Co., Inc.**

4300 W. 62nd St.

Indianapolis, IN 46206

Prices subject to change 6 months after issue date.

HOLD IT!

Anywhere you want it.

PanaVise tilts, turns, rotates. One quick turn of the control knob and you securely position your work exactly where you want it. Holds firmly but gently the most delicate electronic parts and P. C. boards.

Whether you're into building home electronics, trouble shooting, or professional servicing... you'll wonder how you got along without this modestly priced 'extra hand.'

Model 396 Wide Opening PanaVise shown. An ingenious variety of other interchangeable bases, holders and accessories also available. See your electronics distributor, or write for FREE brochure.

PANA VISE® Dept. CE2
2850 29th St., Long Beach, CA 90806

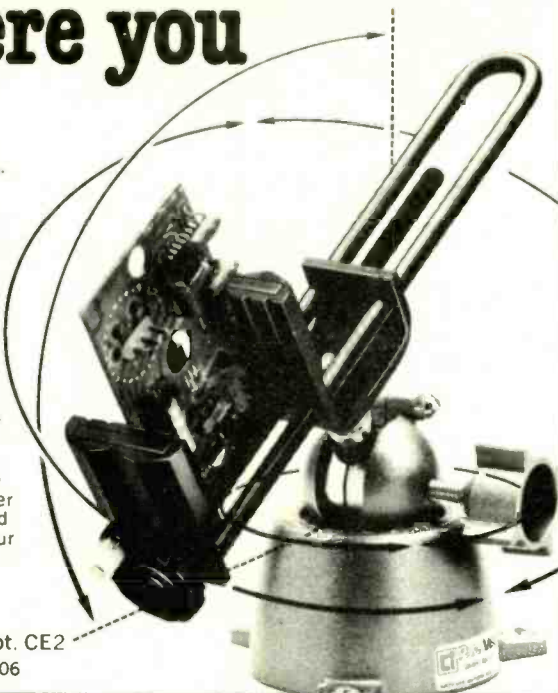

CIRCLE 59 ON FREE INFORMATION CARD

SERVICE CLINIC

continued from page 76

means there's a fault in the control circuitry. If the set won't turn on at all, check for proper gate voltage. If this reads OK, the triac may be open. Both conditions cause the same problem.

The Quasar manual mentioned earlier shows that a microprocessor is used to control bandswitching, channel tuning, on-off and other functions.

The bandswitching and VHF/UHF switching is handled by driver transistors controlled by the microprocessor. With some added circuitry (including a PLL) the microprocessor controls the tuner frequency by reading the frequency of the desired channel and then developing a DC tuning voltage that will place the set exactly on-channel. If there is a bandswitching problem, check the driver transistors to make sure they have the correct DC voltages and react normally. The manual describes the whole process completely, which makes for fascinating reading!

Keep the tests simple and functional, and you won't have any serious problems with these electronic tuners. Just make sure that all the DC voltage values are right on the button because they are extremely critical.

R-E

service questions

SYNC PROBLEMS

I had a horizontal-sync problem in this model XAM 9T75, which developed two or three pictures on the screen at once. I changed the diode AFC unit; no help. I checked the capacitors; same result. I finally bridged the same size capacitor across C3 between the sync separator and the AFC diodes. Now the set works perfectly! I didn't take the original capacitor out. Can you explain what happened?—L. P., Potomac, Md.

The original C3 was completely open and out of the circuit. However, this is just a sync coupler and very small. By bridging it you were able to get the horizontal sync through to the AFC.

BLOWN DIODES

This Sylvania model CX5160W-1 came in with diode SC530 shorted and resistor R532 burned. I replaced the diode with ECG-116, and the resistor too. The set played for five minutes then went off. Replacing the diode with a higher-rated one blew the new one and R532 again! I need help!—W. S., Lewistown, PA.

This sounds like such a familiar problem! The schematic shows this diode is used on the flyback as a low-voltage DC power supply. You CAN'T use stock sili-

continued on page 80

The world of electronics gee-wizardry



-YOURS FREE.

32-pages of test instruments — from the latest digital multimeters to the famous EICO scopes. Security systems. Automotive and hobbyist products. Kits and assembled. EICO quality. EICO value. For FREE catalog, check reader service card or send 75¢ for first class mail.

EICO® 108 New South Road
Hicksville, N.Y. 11801

ADVANCED Electronic Music Products

...effects devices to computer controlled modular synthesizers. Select from experimenter's kits, step-by-step product kits or fully assembled professional equipment.



FREE color catalog

RAIA ELECTRONICS, INC.
1020 W. Wilshire Blvd., Oklahoma City, OK 73116

SEND FREE CATALOG TO:

name _____
address _____
city _____ state _____ zip _____

RAIA ELECTRONICS, DEPT. 4-R
1020 W. WILSHIRE BLVD., OKLAHOMA CITY, OK 73116

CIRCLE 31 ON FREE INFORMATION CARD

CIRCLE 51 ON FREE INFORMATION CARD

SWITCHES CRYSTALS CONNECTORS HEAT SINKS FUSEHOLDERS TEST CLIPS BOOKS KITS DIP JUMPERS CABLE ASSEMBLIES SWITCHES CRYSTALS CONNECTORS HEAT SINKS

SWITCHES CRYSTALS CONNECTORS HEAT SINKS FUSEHOLDERS TEST CLIPS BOOKS KITS DIP JUMPERS CABLE ASSEMBLIES SWITCHES CRYSTALS CONNECTORS HEAT SINKS

Jim-pak[®]

electronic components

One-Stop Component Center

EXCITING NEW KITS!!

Regulated Power Supply

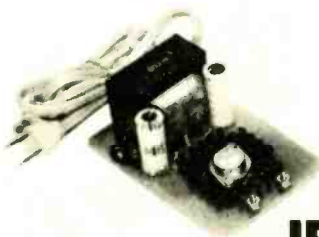

- ★ Uses LM 309K
- ★ Heat sink provided
- ★ P.C. board construction
- ★ Provides a solid 1 amp @ 5V
- ★ Includes components, hardware and instructions
- ★ Size: 3-1/2" x 5" x 2" high

JE200 5v 1amp

Function Generator Kit



- ★ Provides 3 basic waveforms: sine, triangle & square wave
- ★ Frequency range from 1 Hz to 100K Hz
- ★ Output amplitude from 0-volts to over 6 volts (peak to peak)
- ★ Uses a 12V supply or a ± 6V split supply
- ★ Includes chip, P.C. board, components and instructions.

JE2206B

4-Digit Clock Kit



- ★ Bright .357" ht. red display
- ★ Sequential flashing colon
- ★ 12 or 24 hour operation
- ★ Extruded aluminum case (black)
- ★ Pressure switches for hours, minutes and hold functions
- ★ Includes all components case and wall transformer
- ★ Size: 3-1/4" x 1-3/4" x 1-1/4"

JE730

NOW!!! OVER 300 AUTHORIZED DISTRIBUTORS . . . HERE'S JUST A SAMPLING:

ALABAMA Mobile Lafayette Radio Electronics	ILLINOIS (Continued) Oak Park Spectronics Inc.	NEBRASKA (Continued) Omaha Heathkit Electronic Center	TENNESSEE (Continued) Knoxville Byte Shop
ALASKA Anchorage TV Mart	Rockford Imperial Computer Systems	Omaha Omaha Computer Store	Nashville Electra Distributing Co.
ARIZONA Yuma Yuma Electronics	Schaumburg Data Domain	Las Vegas Century 23	TEXAS Amarillo Computer Encounters Inc.
CALIFORNIA Bellflower Earl's Hobby Shop	INDIANA East Chicago Acro Electronics Corp.	NEW JERSEY Bricktown Radio Shack Associate Store	Dallas CompusShop
Berkeley Al Lasher Electronics	IOWA Indianola Electronix Limited	Cherry Hill The Computer Emporium	Houston Altair Computer Center
Mission Viejo Tower Electronics Corp.	KANSAS Wichita Amateur Radio	Pompton Lake Computer Corner	Houston CompusShop
Monterey Zackit	KENTUCKY Lexington Equipment Company	San Antonio Typetronic Computer Store	San Antonio Interactive Computers
Oceanside Electronic Center	LOUISIANA Baton Rouge Pelican Electronics	UTAH Midvale Heathkit Electronic Center	Supply Inc.
Palo Alto Zack Electronics	Houma Pelican Electronics	Provo Alpine Electronic Supply Co.	VIRGINIA Alexandria Computer Hardware Store
Pasadena Dow Radio Inc.	Metairie Pelican Electronics	NEW MEXICO Las Cruces Mannie's Electronic Supply	Alexandria Heathkit Electronic Center
Sacramento Heathkit Electronic Center	MARYLAND Churchville Churchville Electronics	NEW YORK Endwell Computer Tree Inc.	Charlottesville Lafayette Radio
Sacramento Zackit	Damascus Damascus CB	Kingston Greylock Electronics	Hampton Lafayette Radio
San Carlos J & H Outlet Store	La Vale J & M Electronics	New York Computer Mart of New York	Norfolk Avec Electronics Corp.
San Diego Radio Shack A.S.C.	Rockville Computer Workshop	Troy Trojan Electronics	Richmond Avec Electronics Corp.
San Fernando San Fernando Electronics	Rockville Heathkit Electronic Center	Utica Am-Com Electronics	Roanoke The Computer Place
San Francisco Zack Electronics	Towson Baynesville Electronics Inc.	NORTH CAROLINA Boone Alpha Digital Systems	Virginia Beach Heathkit Electronic Center
San Jose United Radio & TV Supply	MASSACHUSETTS Pittsfield Pittsfield Radio Co. Inc.	Durham Futureworld	WASHINGTON Longview Progress Electronics
San Luis Obispo Mid-State	Waltham Computer Mart Inc.	Greensboro Byte Shop	Longview Ron's Electronics
Santa Ana Electronic Supply	Worcester RM Electronics Inc.	Raleigh Byte Shop of Raleigh	Moses Lake Riverview Electronics
Santa Cruz Quality Electronics	MICHIGAN Clawson Radio Supply & Engineering	NORTH DAKOTA Fargo The Computer Company	Paico Amateur Radio Supply
Santa Maria Caps Electronics	Detroit Heathkit Electronic Center	OHIO Bucyrus Mead Electronics	Seattle C-Conn
Santa Monica Mission Control	Flint Hobby Electronic Center	Cincinnati Heathkit Electronic Center	Spokane Empire Electronics
Savannah Byte Shop	Lansing Fulton Radio Supply Co.	Columbus Heathkit Electronic Center	Tacoma Personal Computers
Sunnyvale Sunnyvale Electronics	Midland Computronix Corp.	Dayton Altair Computer Center	WEST VIRGINIA Morgantown Electro Distributing Co.
Vallejo Zackit	Mt. Clemens The Computer Store	Dayton Universal Amateur Radio	Wheeling Lafayette Radio
Walnut Creek Byte Shop	Niles Niles Radio Supply	Portland Oregon Ham Sales	WISCONSIN West Allis Olson Electronics
COLORADO Aurora Com Co Electronics	MINNESOTA Duluth Northwest Radio of Duluth	Portland Portland Radio Supply	CANADA Alberta (Calgary) The Computer Shop
CONNECTICUT Bridgeport Bridgeport Computer	Hoboken Heathkit Electronic Center	Salem Computer Pathways	Ontario (Willowdale) Home Computer
FLORIDA Ft. Lauderdale Computers For You	St. Paul Heathkit Electronic Center	PENNSYLVANIA Hershey Microcomputer Systems Inc.	Quebec (Montreal) Wang's Microcenter
GEORGIA Atlanta Atlanta Computer Mart	MISSOURI El Dorado Springs Beckman Electronics	York G.Y.C. Company	ENGLAND Berkshire New-Bear Computing Store
HAWAII Honolulu Integrated Circuit Supply	MONTANA Billings Conley Radio Supply	OREGON Albany Oregon Ham Sales	Guam Marrinas Electronics
IDAHO Idaho Falls Audiotronics	Bozeman Electronic Service & Dist.	Coos Bay Herrick Electronics	PANAMA Panama City Sonitel, S.A.
ILLINOIS Evanston Itty Blitty Machine Co.	NEBRASKA Lincoln Altair Computer Center	Portland Portland Radio Supply	Singapore Inter-trade (PTE) Ltd.
Evanston Tri-State Electronic Corp.	Lincoln Scott Electronic Supply Inc.	Salem Computer Pathways	
Groveland Mayer Electronics		OKLAHOMA Oklahoma City Bits, Bytes & Micros	
Mount Prospect Tri-State Electronic Corp.		Portland Computer Pathways	

ASK YOUR ELECTRONICS STORE TO STOCK JIM-PAK[®] TODAY!!!

JIM-PAK[®] • 1021 HOWARD AVENUE, SAN CARLOS, CALIFORNIA 94070 • (415) 592-8097

SERVICE QUESTIONS

continued from page 78

con diodes for this kind of service. You must use a fast-recovery type—RCA SK-3175, ECG-519 or ECG-525. Any time you see a circuit fed from a flyback pulse, use this type of diode and it will work.

SPEAKER HOOKUPS

Can you please tell me how to hook up two or three 8-ohm speakers so that the 8-ohm impedance can be kept?—G. G., Worthington, PA.

There is no way you can combine two or three 8-ohm speakers and come out with an 8-ohm impedance.

However, if you add one more 8-ohm

speaker (to make four speakers) you can. Tie each pair in series; then each one will have a 16-ohm impedance. Now, tie your two series in parallel, and there you are—8 ohms again! (Plus you add another tweeter, etc.)

ODD VERTICAL SWEEP

This Catalina black-and-white model 122-3030 has a really odd problem. The picture appears only on the bottom third of the screen, and is upside down and backwards! I can't figure this. Help!—J. N., Houston, TX.

The crystal ball says you have probably got *massive foldover*; this does cause the bottom part of the picture to appear upside down, etc.

In your letter you say the yoke checks

out. However, look closely: the vertical yoke is connected in parallel, which is unusual for a vertical yoke! If one-half is open, you would still get continuity but a very odd vertical scan. Trace the vertical yoke connections, and take one loose so that each winding can be checked separately.

AGC PROBLEM

I've got an AGC problem in this TV. There's —26 volts on the 4HS8 AGC plate that seems to be killing the IF. This should read +30 volts. Other DC voltages seem to be close. When I scope the AGC plate, a high waveform with a peculiar shape appears at vertical frequency. If I ground the AGC plate and place +30 volts on the AGC, I get a picture. What is this?—R. C., Corona CA.

(He sent me a partial copy of the schematic but forgot to inform me what make TV set it was!)

If you can override the AGC and get a picture this proves this is undoubtedly AGC trouble. You do seem to have the keying pulse on the AGC plate, judging from the amplitude of that waveform. (Scope this plate at *horizontal* frequency!)

Check the 3.9-megohm resistor on the AGC line that goes from there to the B+280-volt line. This is to keep the AGC line from being driven too far negative. I think you'll find this is open. R-E

in portable multimeters, compare our features, our quality, our price!

Analogue, LED, and LCD—SOAR has the battery-operated multimeters for your application: the engineering and test lab, the field service technician, the small repair shop, and the radio hobbyist. Just take a look at some of the features of our instruments.

ME-221 ANALOG MULTIMETER

It's drop-proof—the taut band absorbs shocks to 50 G's, and the meter movement is made in the U.S.A. Rugged and versatile, this multimeter has no equal at our price—\$30.00



ME-521DX DIGITAL MULTIMETER

This truly portable (12.7 oz.) 3½-digit LED precision instrument has a HI-LO switch for all ranges, five function modes, and an accuracy of 0.5% (typical). Price—\$115.00



ME-523 DIGITAL MULTIMETER

For the price, this is the best multimeter on the market today. It presents the function mode right on the LCD display, has a HI-LO switch for all ranges, an extremely long battery life, and an accuracy of 0.25% (typical). And all this for a price of \$150.00



And let's not forget our workhorse ME-522. It has almost all the features of the 523, but at an even lower price—\$135.00

Contact us TODAY for more details on SOAR's portable multimeters—and why not also inquire about our complete line of bench-type, tilt view DMM's.



SOAR ELECTRONICS (U.S.A.) CORP.
200 13TH AVENUE
RONKONKOMA, NEW YORK 11779
TEL. (516) 981-6444/TELEX 144638

CIRCLE 63 ON FREE INFORMATION CARD

FREE SWTP
CATALOG
Audio—Computers
Instruments
Kits & Assembled



Southwest Technical Products Corporation
219 W. RHAPSODY
SAN ANTONIO, TEXAS 78216

CIRCLE 61 ON FREE INFORMATION CARD

NEXT BEST THING TO BEING THERE!



With your own tutor, electronics naturally seems easier, more understandable. Now these unique training aids bring you friendly, over-the-shoulder, hands-on guidance, as if you had an expert right beside you. All planned and prepared in our effective Easi-Way™ teaching style. Only face-to-face instruction could be more personal. Nothing else like these...anywhere!

Two Forest Belt's Service Training MONOGRAPHS:

"TRIGGERED OSCILLOSCOPES—Four Hours to Familiarity"

Sit down in front of your triggered scope 30 minutes a day, and go through carefully organized exercises. In less than two weeks, you can truly UNDERSTAND how your scope displays signal waveforms; where to set the knobs and switches; what waveshapes mean; what to do when you can't seem to get a display on your scope. End up feeling comfortable and self-assured with any triggered oscilloscope.

Order 48A - \$12.50 postpaid

P.S.—The above title is available also as a Forest Belt's **SELF-TRAINER KIT**: two audio cassettes plus a dozen sets of Worksheets (for a group).

Order 48K - \$ 79.50 postpaid

Additional Worksheets Order 48W - Ten for \$ 25.50

"Easi-Way™ Solutions for Electronics Math and Formulas"

Spend a half-hour each day with your inexpensive scientific calculator (many models under \$40). Learn quickly to solve electronic formulas without knowing algebra, Thorough Easi-Read™ explanations, plus dozens of planned examples and exercises for you to work yourself. Shows you how to deal with Ohm's Law, Kirchhoff's Laws, series and parallel circuits, reactance, impedance, resonance, decibels, and plenty more. Handle complex math easier than you ever thought possible.

Order 28A - \$ 12.50 postpaid

Scientific Calculator Order 28SC \$ 35.50 postpaid

Enclosed in my \$ _____ check or money order (outside U.S., add 20% to all prices). Please ship:

_____ MONOGRAPH 28A "Easi-Way™ Solutions for Electronics Math and Formulas" @ \$ 12.50 each

_____ Scientific Calculator 28SC (suits use with 28A) @ \$ 35.50 each

_____ MONOGRAPH 48A "TRIGGERED OSCILLOSCOPES—Four Hours to Familiarity" @ \$ 12.50 each

_____ SELF-TRAINER KIT 48K "TRIGGERED OSCILLOSCOPES—Four Hours to Familiarity" @ \$ 79.50 each kit

_____ Additional Worksheets 48W (for larger groups to use with KIT) @ \$ 25.50 for ten

My name is _____ Age _____

Address _____ Phone _____

City _____ State _____ Zip Code _____

Forest Belt's Service Training MONOGRAPHS
Box 68120 Indianapolis IN 46268

The best speaker kit isn't a kit at all!

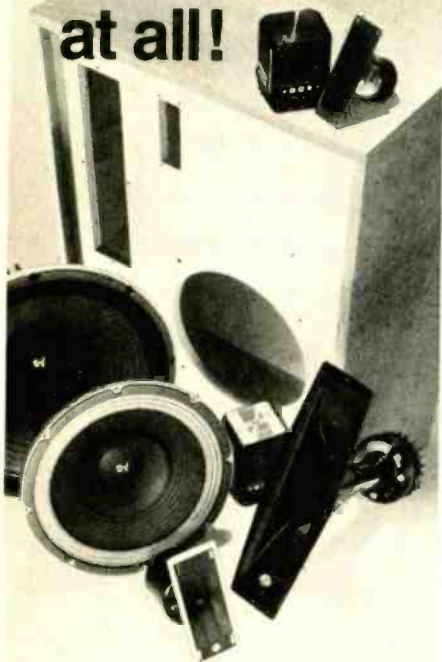

The best speaker kit is a system designed by Electro-Voice that allows you to choose your own level of performance; from a studio monitor to a modest bookshelf system, from a wide selection of woofers, tweeters, mid-range drivers and crossovers.

Then Electro-Voice provides detailed plans on how to construct the enclosures designed specifically for the drivers you chose.

Only Electro-Voice gives you all the options. But, then, Electro-Voice is known for their superb quality speakers — not for kits.

To get your component speaker catalog and construction plans package, just send \$1.00 to Electro-Voice Component Speaker Systems, 600 Cecil St., Buchanan, MI 49107.



600 Cecil Street, Buchanan, Michigan 49107

Electro-Voice Component Speaker Systems, 600 Cecil St., Buchanan, MI 49107.

Please send me _____
E-V component speaker packages.

I have enclosed \$1.00 for each package ordered.

Name _____

Address _____

City/State/Zip _____

RE-4-79

new products

More information on new products is available from manufacturers of items identified by a Free Information number. Free Information Card is inside the back cover.

MICROWAVE LEAKAGE DETECTOR, Guard-Rod, is designed for home or business use prior to authorized service checks. Portable, hand-held instrument does not require batteries or outside power source. The device is moved along top of

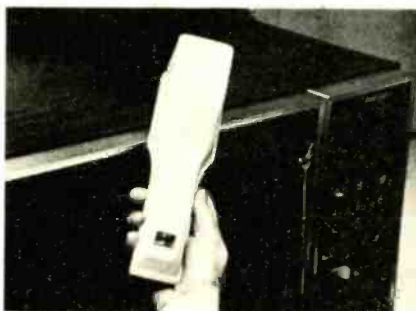

CIRCLE 127 ON FREE INFORMATION CARD

stove; if meter pointer moves to red portion of scale this indicates excessive leakage. Unit comes with instructions and costs \$19.95 (plus state and local taxes as applicable).—Tanray Associates, Inc., Box 99, Elberon, NJ 07740.

TOOL SETS. One *Super 3* set contains one each of A316-4, A416-4 and P2 screwdrivers (1/16-inch, 1/4-inch and No. 2 Phillips); the other *Super 3* set holds one each of S8, S10 and S11 nutdrivers



CIRCLE 128 ON FREE INFORMATION CARD

(1/4-inch, 9/16-inch and 11/32-inch, respectively). Both come carded for display, and are available from distributors.—Vaco Products Co., 1510 Skokie Blvd., Northbrook, IL 60062.

SWEEP-FUNCTION GENERATOR, model 737, produces triangle, sine and squarewaves and pulses over a 0.0001-Hz–30-MHz frequency range; provides minimum pulse widths of 17 ns, 15 volts P-P into 50 ohms and risetimes less than 10 ns. Unit's two trigger modes can be used to produce signal pulses or bursts. Three trigger modes can be selected; manual, external or an internal ramp/step generator. The frequency

range can be varied over a 1000:1 ratio by varying the input voltage to an internal summing amplifier; this voltage can be supplied via the



CIRCLE 129 ON FREE INFORMATION CARD

external VCF input or the internal ramp/step generator.

The *model 737* contains start and stop frequency dials, each containing inner and outer dials—the outer single-turn dial has a linear/log scale that can vary the frequency over a three decade range; the inner dial is a 12-position switch used to select the frequency range and either the linear or the log mode for the outer dial. LED's indicate the frequency mode selected. The ramp/step generator pushbuttons are used to sweep and step frequencies, and create pulse or burst waveforms. The ramp/step generator operates over a 1- μ s to 1000-second range. Additional front-panel controls handle variable symmetry, sync output selection and the trigger level. The *model 737* sells for \$1295 FOB.—Exact Electronics, Inc., 455 S. E. 2nd Ave., Hillsboro, OR 97123.

ELECTRONIC BLOCK KITS, EX-Kit models EX-60, EX-100, EX-150, use snap-together blocks to create up to 150 different projects, including an AM radio, amplifier, Morse code oscillator circuit, sound-lever meter and basic computer circuits. Easy-to-assemble kits include building blocks, crystal earphone, accessory wires and manual. No soldering, wiring or mechanical connections required. Components are identified by electrical symbol and value. Power is supplied by 6-volt



CIRCLE 130 ON FREE INFORMATION CARD

batteries, and each kit comes in a rugged plastic case with handle. Suggested retail prices: *model EX-60*, \$44.95; *model EX-100*, \$46.95; *model EX-150*, \$69.95.—Distributors, Takahashi International, 1426-B Richey, Santa Ana, CA 92705.

DUAL-TRACE OSCILLOSCOPE/DMM, model 305, is a portable dual-function instrument. The oscilloscope offers a sensitivity of 5 mV-per-division and a 5-MHz bandwidth with a sweep speed range from 1 μ s-per-division to 50 ms-per-division. Other oscilloscope features include front-panel X-Y operation; Channel 1 and Channel 2 alternate, chop and add modes; Channel 1 and Channel 2 triggered with polarity inversion; and X10 magnification.



CIRCLE 146 ON FREE INFORMATION CARD

The autoranging DMM measures voltages in 4 ranges from 2 volts to 1000 VDC (700 VAC), and resistance from 2000 ohms to 2 megohms ($\pm 0.6\%$ accuracy).

The model 305 operates on AC, DC or built-in battery pack. It comes with probes and carrying case; measures 4.4 X 9.3 X 14.2 inches; weighs 10 lb.; and is priced at \$1725.—Tektronix, Inc., P.O. Box 500, Beaverton, OR 97077.

520-MHz FREQUENCY COUNTER, model PM6664-01, offers 8-digit LED display and full operation to 80 MHz with 1-Hz resolution. Features automatic continuously variable input sensitivity from 20 mV (100 Hz–520 MHz) to 1 volt.



CIRCLE 147 ON FREE INFORMATION CARD

Resolution is 1 Hz up to 80 MHz and 10 Hz above 80 MHz. The unit weighs 3.2 lb and measures 5.75 X 1.75 X 8.7 inches, and sells for \$545.—Philips Test and Measuring Instruments, Inc., 85 McKee Dr., Mahwah, NJ 07403.

3-MHz LINEAR/LOG SWEEP FUNCTION GENERATOR, model 1600, provides linear or log sweeps with separate start-stop controls. The generator operates over a frequency range of 0.2 Hz to 3 MHz, and generates sinewaves, squarewaves, triangle waves, ramps and pulse strings. Among the 14 operational modes are included



CIRCLE 148 ON FREE INFORMATION CARD

continuous, gated, triggered, pulsed, swept, triggered-sweep, gated-sweep, hold-sweep-hold,

sweep-hold burst and external voltage control. The main output is adjustable from less than 5 mV to 20 volts P-P, with a 50-ohm output impedance. The variable DC offset is from -10 volts to +10 volts. Suggested retail price: \$695.—Krohn-Hite Corp., Avon Industrial Park, Avon, MA 02322.

PROJECTION TV KIT, model Q-12, comes complete with a 12-inch Quasar color TV set. Also provided are an adjustable two-element F1.3 lens system and lens-hood assembly. Adjustable



CIRCLE 149 ON FREE INFORMATION CARD

stand with wheels only needs 4 mounting screws; complete kit sells for \$425. High-efficiency viewing screens are also available.—Miami Flock Equipment Co., Inc., Optical Div., 304 N.E. 79th St., Miami, FL 33138.

METAL TUBE HOLDER, Tube-Wringer, simplifies

FREE
SHOP SUPPLIES

NATCAM
catalog
Shipping center for small and precision tools

A fine selection of small tools, measuring instruments, hard-to-find items for shop, home and lab. Convenient one-stop shopping for technicians, engineers, craftsmen, hobbyists. Major credit cards accepted, satisfaction assured. Get your NATCAM catalog today.

National Camera, Inc.
2000 West Union Ave., Dept. GBF
Englewood CO 80110 USA

CIRCLE 13 ON FREE INFORMATION CARD

**This is easy—
anyone can solder—
WITH
KESTER SOLDER**

**Handymen! Hobbyists!
DO-IT-YOURSELFERS!**

Let Kester Solder aid you in your home repairs or hobbies. For that household item that needs repairing — a radio, TV, model train, jewelry, appliances, minor electrical repairs, plumbing, etc. — Save money — repair it yourself. Soldering with Kester is a simple, inexpensive way to permanently join two metals.

When you Solder go "First Class" — use Kester Solder.

For valuable soldering information send self-addressed stamped envelope to Kester for a FREE Copy of "Soldering Simplified".

KESTER SOLDER
Litton 4201 WRIGHTWOOD AVENUE/CHICAGO, ILLINOIS 60639

CIRCLE 22 ON FREE INFORMATION CARD

INTERNATIONAL FM-2400CH

FREQUENCY METER FOR TESTING MOBILE TRANSMITTERS AND RECEIVERS

• Portable • Solid State • Rechargeable Batteries

The FM-2400CH provides an accurate frequency standard for testing and adjustment of mobile transmitters and receivers at predetermined frequencies.

The FM-2400CH with its extended range covers 25 to 1000 MHz.

The frequencies can be those of the radio frequency channels of operation and/or the intermediate frequencies of the receiver between 5 MHz and 40 MHz.

Frequency stability: $\pm 0.0005\%$ from $+50^\circ$ to $+104^\circ\text{F}$.

Frequency stability with built-in thermometer and temperature corrected charts: $\pm 0.00025\%$ from $+25^\circ$ to $+125^\circ$ (.000125% special 450 MHz crystals available).

- Tests Predetermined Frequencies 25 to 1000 MHz
- Extended Range Covers 950 MHz Band
- Pin Diode Attenuator for Full Range Coverage as Signal Generator
- Measures FM Deviation

FM-2400CH (meter only) Cat. No. 035320	\$627.72
RF crystals (with temperature correction)	26.26 ea.
RF crystals (less temperature correction)	19.93 ea.
IF crystals	catalog price



INTERNATIONAL CRYSTAL MFG. CO., INC.
10 North Lee / Oklahoma City, Okla. 73102

CIRCLE 67 ON FREE INFORMATION CARD

Make America smarter.
Give to the college of your choice.

Council for Financial Aid to Education, Inc.
680 Fifth Avenue New York, N.Y. 10019



handling tube-packaged silicones by extruding them directly from the tube through any size opening created by the nozzle. The tool accommodates all sizes of plastic and metal tubes, eliminates metal tube creasing, seals tube breaks, and holds flexible tubes firmly. A separate fixture for mounting the Tube-Wringer to walls, posts or



CIRCLE 150 ON FREE INFORMATION CARD

horizontal work surfaces is available.—Gill Mechanical Co., P.O. Box 5529, Eugene, OR 97405.

WHERE ELSE BUT DAVIS?



100% quality, 50% saving:

500 MHz and 1 GHz Counters with built-in preamp

Series CTR-2A Frequency Counters exceed the highest quality standards demanded by electronics industries, communications, ham radio, research labs, technicians, and service. Yet cost only half the price of other commercial counters. How does Davis do it? Advanced design and production techniques. That's the Davis difference. One year warranty on assembled units, 90-day on kit components.

2 RANGES: 500 MHz Kit \$249.95 Assembled \$349.95 1 GHz Kit \$399.95 Assembled \$549.95

- Preamp 10 mv @ 150 MHz
- 8 Digit 3" LED Display
- High Stability TCXO ± 1 ppm
- Oven Controlled Crystal ± 5 ppm (Opt. @ \$49.95)
- Period Measurement (Opt. @ \$15.00)
- Input Diode Protected
- Selectable Gate Times, .1 & 1 sec.

OPTIONS: 43" LED 10 sec. Time Base \$ 5.00
12 V/DC 10.00 Handle 10.00

Order direct from factory. Add \$3.00 for shipping, \$1.00 extra for C.O.D., and 7% sales tax in N. Y. State. Payment by check (certified for C.O.D.), money order, Master Charge, VISA. Credit-rated company P.O. accepted. Money back guarantee if returned in good condition in 10 days. Kits returnable only unassembled.

For more information, request FREE DESCRIPTIVE LITERATURE, or for in-depth preview, send \$5.00 for 32-page INSTRUCTION MANUAL. Detailed, illustrated. Credited against purchase of either unit.



DISTRIBUTOR INQUIRIES INVITED

Affordable quality is the Davis difference.

DAVIS ELECTRONICS

636 Sheridan Drive, Tonawanda, N.Y. 14150 • 716/874-5848

CIRCLE 20 ON FREE INFORMATION CARD

books

STAR SHIP SIMULATION, by Roger Garrett. dilithium Press, 30 N.W. 23rd Pl., Portland, OR 97210. 122 pp. 5 1/4 X 8 1/4 in. Softcover \$6.95.

Simulation, the representation of physical systems and phenomena by computers, models or other equipment, can be performed on a small computer. This book describes the design and implementation of a software simulation; each design step is carefully defined, then the program structure is outlined. Chapter 3 deals with the Star Ship simulation project itself; Chapter 4 discusses the implementation of the program. A simple glossary of terms is in the back.

UNDERSTANDING CALCULATOR MATH, Texas Instruments Learning Center. Texas Instruments, Inc., Box 3640, M.S. 84, Dallas, TX 75285. 225 pp. 5 1/4 X 8 1/4 in. pp. Softcover \$3.95.

This book covers the basic data, formulas, facts and mathematical tools needed to use a calculator more effectively. It is written in simple, nontechnical language and provides a "keystroke by keystroke" explanation of all the functions on a handheld calculator with their home/office applications. There's a section on puzzles and games, and several tables and a bibliography appear in the back of the book.

RADIO ANGELS, by Paul Jerome Stack. The Ham Radio Publishing Group, Greenville, NH 03048. 172 pp. 5 1/4 X 8 1/4 in. Softcover \$3.95.

Many times during the course of a disaster (or near-disaster) the ham operator is the only link to the outside world. Whether during an earthquake in Nicaragua or an epidemic in Africa, the heroic efforts of amateur radio operators have resulted in many lives being saved. This book tells their stories. Chapter 7 describes a proposal for a ham radio jump team for rescue operations; and there is a glossary of radio terms in the back of the book.

HOW TO MODIFY OLD TELEPHONES. A. M. Gray, Inc., 11004 E. 40 Highway, Box 9710, Kansas City, MO 64137. 26 pp. 8 1/4 X 11 in. Softcover \$6.95, plus 50¢ postage.

This book shows you how to convert your antique telephone into a working instrument that is compatible with modern telephone systems. It is written in layman's terms, and gives complete easy-to-follow directions on how to convert two main types of antique phones: the wooden magneto wall phone of the late 1800's and the brass "candlestick" type of the 20's. The text is accompanied by simple illustrations; names and addresses of necessary components are listed in the back.

TRIGGERED OSCILLOSCOPES—FOUR HOURS TO FAMILIARITY, by Forest Belt. Forest Belt's Service Training Monographs, P.O. Box 68120, Indianapolis, IN 46268. 8 1/4 X 11 in. 33 pp. Softcover \$12.50 ppd.

This Service Training Monograph is a series of actual training sessions that aid in understanding how to operate an oscilloscope. It is the first of a group of such sessions designed specifically for video, communications and industrial technicians. Explanations, illustrations, examples and exercises have been grouped logically to proceed smoothly to a thorough comprehension of oscilloscopes, using the *Easi-Way* method that lets you view scope displays and manipulate the controls yourself.

THE BUGBOOK VII, by Jonathan A. Titus, Christopher A. Titus, Peter R. Rony and David G. Larsen. E&L Instruments, Inc., 61 First St., Derby, CT 06418. 284 pp. 6 X 9 in. Softcover \$8.50.

This seventh in the *Bugbook* series provides an in-depth look at how 8080-based computers are interfaced to real-world analog devices. It contains practical hardware and software analog conversion techniques; nine experiments in waveform generation, data acquisition and CRT display control are included in the back. Chapter 1 deals with interfacing to D/A converters; other chapters compare software interrupts and real-time clocks in data acquisitions; sample-and-hold circuits and multiplexer devices; and miscellaneous conversion techniques.

THE SEMICONDUCTOR MEMORY BOOK, by Intel Marketing Communications. Wiley-Interscience, Div. John Wiley & Sons, Inc., 1 Wiley Drive, Somerset, NJ 08873. 524 pp. 8 1/4 X 11 in. Softcover \$14.95.

State-of-the-art semiconductor memories are lower in cost, higher in density, have a faster access and cycle time, greater reliability and more modular than core memories. This book examines in great detail the three main categories of MOS-technology semiconductor memories—RAM, ROM and serial—and discusses design, configuration and environmental applicability for each type. The text is accompanied by many graphs and tables and schematic diagrams, and an index appears in the back of the book. **R-E**

Equip yourself with the best.

PTS 8001 Component Analyzer

Solid state component tester works in or out of the circuit. Simple hook-up to any standard oscilloscope. High, medium and low range switch for matching the impedance of the component being tested.



PTS DG-1 Digital Power Supply

External variable power supply for substituting voltages in televisions, stereos, radios, computers, microprocessors, appliances, CB equipment, telephone equipment, electronic cash registers, security systems and other electronic devices.



PTS DG-4 Voltage Control Center/ Digital Power Supply

Independently produces four variable DC supply voltages. Excellent for substituting critical control voltages for TV electronic/varactor tuners. All units come in vinyl cabinet in optional walnut, black or blue and carry a one year limited warranty.



These products available from any PTS stocking distributor as well as PTS tuner/module servicers. Check the yellow pages for the servicer nearest you.

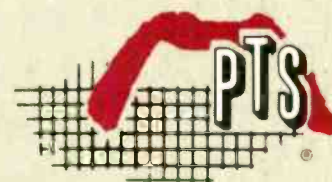

PTS ELECTRONICS, INC.
The Only Name You Need To Know

CIRCLE 66 ON FREE INFORMATION CARD

Nobody does it better than VIZ

NEW SIGNALYST™ Color Bar Generator

Model WR-515B \$249

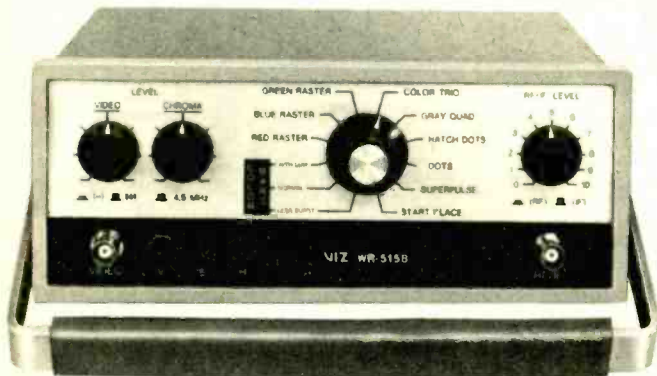

EVERY COLOR TV TEST SIGNAL YOU NEED. A PRICE NOBODY ELSE CAN MATCH.

There's absolutely nothing else on the market like this new VIZ Color Bar Signalyst. Use it to service TV sets, video recorders, CATV, MATV, CCTV, etc. Compact enough to carry with you on house calls. Complete enough for every shop test—at a price you can afford. Look what it does for you:

Patterns supplied. Superpulse; regular color bars; color bars with luminance; color bars less burst; red, green or blue primary color rasters; color trio; gray quad; hatchdots; dots—all with progressive or interlaced scanning and 4.5 megahertz sound carrier.

Outputs. Video (pos. or neg. polarity) 0-1.7 volts into 75 ohm line. RF and IF continuously adjustable from snow-low 20 microvolts to 200,000 microvolts (enough to drive a whole hotel full of TV sets). All outputs crystal controlled.

Scope triggers. Two separate 3.7 V peak-to-peak pulses for H & V trigger.

Comes complete with 75 ohm output cable and 300 ohm snap-on head and excellent text on application.

See your local VIZ distributor.

VIZ Test Equipment Group

335 E. Price St., Philadelphia, PA 19144

The VoltOhmyst company

RADIO-ELECTRONICS

86

The American Economic System
We should all learn more about it.

A public service message of
The Magazine & the Advertising Council
& the U.S. Department of Commerce



EQUIPMENT REPORTS

continued from page 35

space on each disc. In addition, the board has hardware and software selection capability between Integer BASIC and Applesoft II.

A small toggle switch protrudes from the board and is accessible from the rear of the Apple II without having to remove its cover. This switch selects the BASIC that is initiated by the normal control-B command. However, this selection can be overridden by software addressing of two locations. Thus, for example, when retrieving an Applesoft program from the disc, the DOS automatically selects the Applesoft ROM Card before loading the program. As with the original on-board ROM in the Apple II computer, the Applesoft firmware board contains an extra (empty) socket for future ROM expansion.

Applesoft II is a fairly comprehensive BASIC interpreter written by Microsoft. It includes extensive graphic commands to match the Apple II's 16-color low-resolution and four-color high-resolution graphic capabilities. Also included are such additional commands as HOME (cursor), INVERSE, FLASH, SPEED, and ON ERR GO TO. Data matrices can now also be STORE'd and RECALL'ed from the cassette.

If the firmware board is installed in an Apple II system with a disc, it offers one more convenience: FP and INT commands to switch between floating-point Applesoft II and Integer BASIC. The Applesoft ROM board makes an excellent addition to the Apple II computer. It costs \$200; a bit expensive but worth it if you take into account the RAM savings it affords.

R-E

THE BIG PLUS + Graphic Equalizer

ASSEMBLED
\$189.95

KIT
\$99.95



LOADED with Quality Features!

- Stereo . . . Eleven Bands Per Channel • Extremely Low Noise & Distortion • LED Peak Indicators • Center Detent ("flat") sliders • Built-in "record" Switching • Line and Microphone Level Inputs/Outputs • Regulated Power Supply • Fully Guaranteed • Horizontal or Vertical Cabinets • Kit or Fully Assembled • Plus Much, Much More!

Absolutely equals or exceeds overall performance and features of any graphic equalizer made today!

AARON-GAVIN INSTRUMENTS, INC.

17231 Corla Avenue Tustin, California 92680

Yes! I've enclosed \$_____ RUSH me: assembled equalizers at \$189.95, p.p.d. cabinet send brochure
 unassembled equalizer kits at \$99.95, p.p.d. Horizontal (flat) Vertical (up-right)
 California residents include 6% sales tax Visa & Master Charge orders accepted

Name _____ Card No. _____
 Address _____ Exp. Date _____ Bank No. _____
 City _____ State _____ Zip _____

Dealer inquiries invited

CIRCLE 28 ON FREE INFORMATION CARD

ELECTRONICS BOOK CLUB invites you to take a copy of "THE POWER SUPPLY HANDBOOK" (list \$12.95)

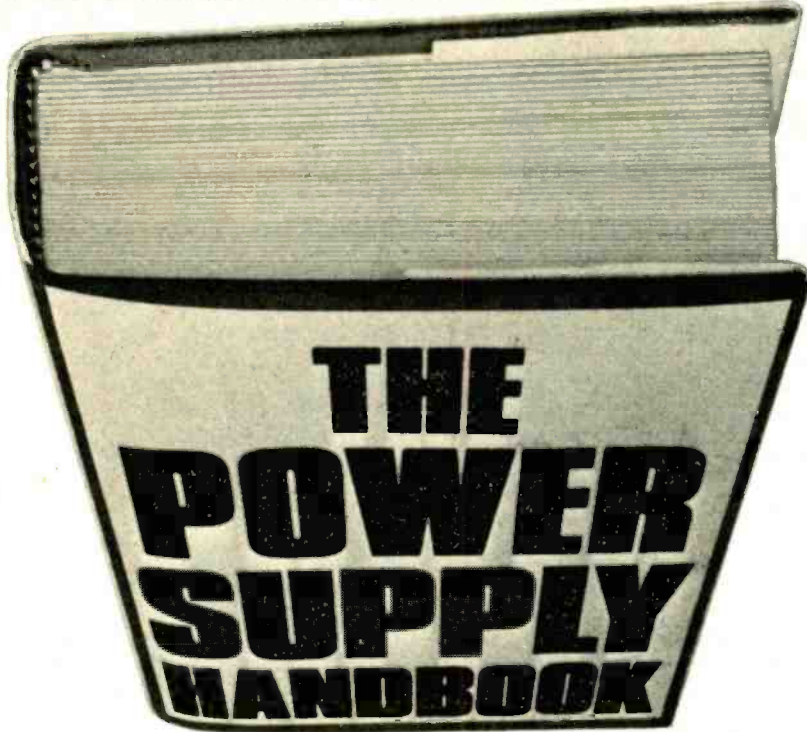

...with a Trial Membership in the Book Club that saves you 25% to 75% on a wide selection of electronics books

The Power Supply Handbook

A broad, rich, and varied collection of ready-to-build power sources for electronics technicians, hams, engineers, and hobbyists!

This is THE complete power supply book...the all-in-one Answerbook with ALL the data you need to build, design, test, and customize virtually any power supply system you want—from AC-to-DC converters to linear amplifier filament transformers, from simple dual-voltage systems to hefty 3000V DC powerhouses, from low-voltage units to precision 10,000V DC references, from sine wave inverters to failsafe superchargers! It contains 420 pages of solid how-to info, stripped clean of irrelevancies, packed with practical instructions on how to create just the unit you need for that special application. You get a brief course in power supply theory, some basic schooling in testing, a thorough guide to power supply design, and section after section of pretested power supply cir-

cuits you can build and modify. Projects like 13V mobile systems, 12V 20A brute supplies, voltage sextuplers for SSB, 115V 60 Hz sine wave inverters, regulated nicad chargers, precision 10,000V DC references, adjustable low-voltage regulated supplies, 117V AC to 24V DC converters, and lots of special-purpose AC supplies. And precisely because this manual is so comprehensive, you'll be able to build PS systems that are as good as any you can buy, systems that meet your specifications.

Probably the most remarkable thing about this volume is the sheer variety and quality of the projects it offers...each one is reliable, pretested, easy to build, and you can construct most of them from inexpensive salvaged or surplus parts. It would have to be a very unusual PS indeed not to be covered in this manual, for here you'll find everything from simple get-the-job-done units to highly refined adjustable supplies. Step-by-step instructions tell you how to put together voltage doublers for MOS LSI, super low-voltage supplies, 78MG voltage regulators, 13V supplies for mobile equipment, 110V 600 Hz inverters,

polarity changers, 12V to 300V converters, solid-state car alternator/regulators, silver-zinc cell battery chargers, zero to 30V lab supplies, simple four-voltage bench supplies, and many more. The projects come with all the data you need to insure flawless no-hitch construction—concise analyses of special circuits, easy-to-follow directions, detailed schematic diagrams, complete parts lists, and special discussions of construction safety precautions.

The scope of this handbook is broad—broad enough to include construction info on tested circuits that'll help you make the most of any power supply you put together—circuits that'll allow you to interface, modify, and test your own PS designs. The authors show you how to construct voltage splitters, IC protection circuits, smoke testers, two-terminal current limiters, voltage limit sensors, active voltage dividers, microfarad multipliers, capacitor rejuvenator-leakage testers, and many, many others. 420 pps., 292 illus. Hardbound. List \$12.95.

ELECTRONICS BOOK CLUB, Blue Ridge Summit, Pa. 17214

May we send you this practical time-and-money-saving book absolutely FREE as part of an unusual offer of a Trial Membership in Electronics Book Club.

Like all Club offerings, this is a quality hardbound volume, especially designed to help you increase your know-how, earning power, and enjoyment of electronics. Whatever your interest in electronics, you'll find Electronics Book Club offers practical, quality books that you can put to immediate use and benefit.

This extraordinary offer is intended to prove to you through your own experience, that these very real advantages can be yours...that it is possible to keep up with the literature published in your areas of interest, and to save substantially while so doing. As part of your Trial Membership, you need purchase as few as four books during the coming 12 months. You would probably buy at least this many anyway, without the substantial savings offered through Club Membership.

To start your Membership on these attractive terms, simply fill out and mail the coupon today. You will receive "The Power Supply Handbook" absolutely FREE. If you're not delighted, return the book within 10 days and your Trial Membership will be cancelled without any obligation whatsoever.

Facts About Club Membership

- "The Power Supply Handbook" lists for \$12.95. It is yours absolutely FREE with your Trial Membership.
- You will receive the Club News, describing the current Selection, Alternates, and other books, every 4 weeks (13x a year).
- If you want the Selection, do nothing, it will be sent to you automatically. If you do not wish to receive the Selection, or if you want to order one of the many Alternates offered, you simply give instructions on the reply form (and in the envelope) provided, and return it to us by the date specified. This date allows you at least 10 days in which to return the form. If, because of late mail delivery, you do not have 10 days to make a decision and so receive an unwanted Selection, you may return it at Club expense.
- To complete your Trial Membership, you need buy only four additional monthly Selections or Alternates during the next 12 months. You may cancel your Membership anytime after you purchase these four books.
- All books—including the Introductory Offer—are fully returnable after 10 days if you're not completely satisfied.
- All books are offered at low Member prices, plus a small postage and handling charge.
- Continuing Bonus: If you continue after this Trial Membership, you will earn a Dividend Certificate for every book you purchase. Three Certificates plus payment of the nominal sum of \$1.99 will entitle you to a valuable Book Dividend of your choice which you may choose from a list provided Members.

ELECTRONICS BOOK CLUB

Blue Ridge Summit, Pa. 17214

Please open my Trial Membership in ELECTRONICS BOOK CLUB and send my copy of "THE POWER SUPPLY HANDBOOK" ABSOLUTELY FREE! If not delighted, I may return the book within 10 days and have my Trial Membership cancelled. I agree to purchase at least four books during the next 12 months, after which I may cancel my Membership at any time.

Name _____ Phone _____

Address _____

City _____

State _____ Zip _____

(Valid for new Members only.)

RE-49

CIRCLE 8 ON FREE INFORMATION CARD

How do you really use a multimeter?

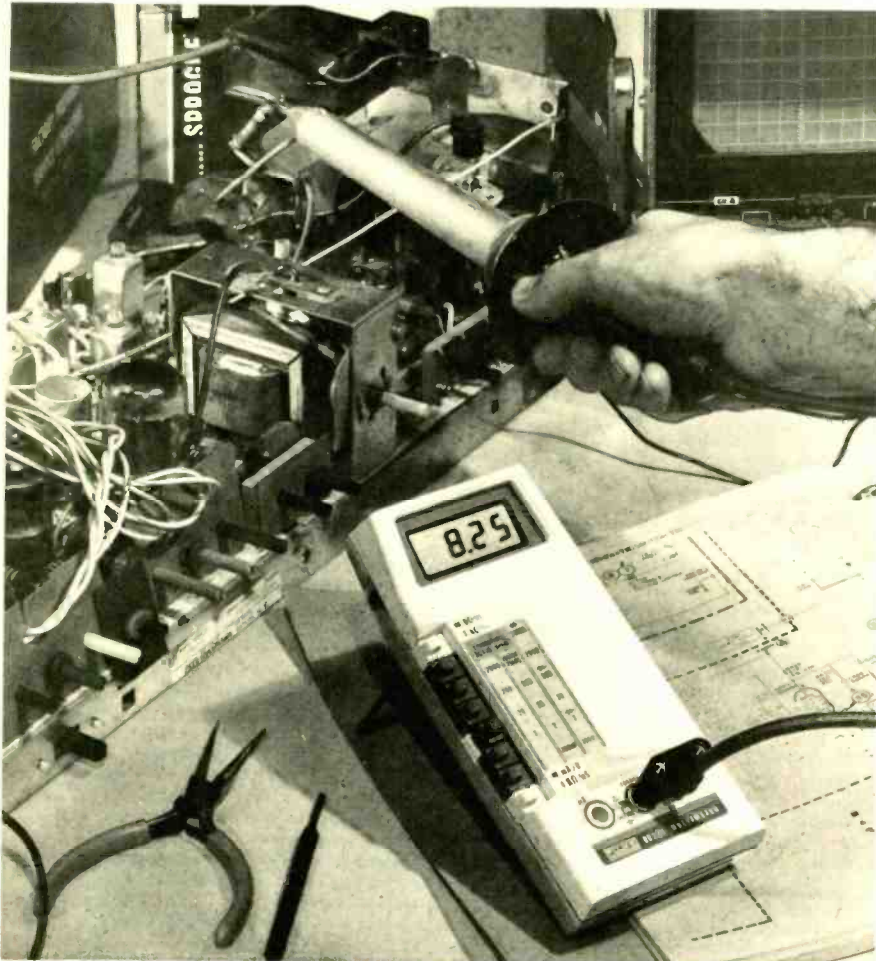

Usually at your bench, in the shop, shared with others. And, if it's a Fluke multimeter, you use it with confidence.

Now you can carry that same bench precision on the job. Introducing the new Fluke 8020A DMM for only \$169.

This rugged beauty packs more field-valuable features than any other DMM available, at any price. And that means field versatility when you need it most.

The 8020A has six resistance ranges, including a 20 megohm range for those special high-resistance TV components. Plus, you can measure focus dividers, pcb and capacitor leakage clear up to 10,000 megohms with the new conductance function. And conductance allows you to measure transistor beta—unique

with the 8020A.

Ever damaged your meter in the fly-back circuit? Rest easy. The 8020A is MOV-protected to 6000V against hidden spikes and transients.

Your 8020A comes with a full-year warranty, with worldwide service back-up. Regardless of what happens to it, we'll fix it inexpensively and quickly, making the 8020A a truly cost-effective investment.

Call (800) 426-0361*, toll free. We'll tell you the location of the closest Fluke office or distributor for the best value in DMMs around.

Price U.S. only.

*Alaska, Hawaii and Washington residents — please call (206) 774-2481.

The DMM for Home Electronics Experts.

2507-7207



CIRCLE 35 ON FREE INFORMATION CARD FOR LITERATURE

CIRCLE 70 ON FREE INFORMATION CARD FOR DEMONSTRATION

new lit

More information on new lit is available from the manufacturers of items identified by a Free Information number. Use the Free Information Card inside the back cover of this issue.

QUARTZ CRYSTAL CATALOG provides 16 pages of data and application notes on quartz crystals. General engineering and design characteristics are discussed and defined. Among the products listed are aircraft radio, CB, clock, custom-made, marine VHF/UHF and microprocessor crystals. Price: \$1.—**Crystek Crystals Corp.**, 1000 Crystal Dr., Fort Myers, FL 33901.

ELECTRONICS CATALOG, No. 19 Fall-Winter 1978, is a 116-page catalog specifically designed to meet the electronic-supply needs of experimenters and hobbyists. Among the many items listed are transistors, resistors, IC's, LED's, switches, computer supplies, semiconductors (SCR's, FET's, op-amps), a motion detector, and a *Videocube* RF oscillator/modulator, plus many more. An index, and order form and shipping instructions are included.—**Delta Electronics**, P.O. Box 2, Amesbury, MA 01913.

CIRCLE 123 ON FREE INFORMATION CARD

COMPUTER CATALOG, Computerogue Star-date: 1978, contains 44 pages of hardware, software and system components, including such manufacturers as IMSAI, Cromemco, Xitan, Exity, Commodore, and many more. Catalog also contains photos, graphics and specifications, in addition to prices, and two simplified order forms.—**Computer Enterprises**, Box 71, Fayetteville, NY 13066.

CIRCLE 124 ON FREE INFORMATION CARD

TEST EQUIPMENT AND BREADBOARDING CATALOG, The Breakthrough Book, 26 pages of the latest digital designs in frequency counters, CSC logic probes, IC test clips, breadboards, a solderless breadboard kit, and many more. Each product is described fully and complete technical specifications are given. Catalog contains separate price sheet and handy order form.—**Continental Specialties Corp.**, 70 Fulton Terrace, New Haven, CT 06506.

CIRCLE 125 ON FREE INFORMATION CARD

ELECTRONIC ENCLOSURES CATALOG, 10 pages, describes housing for meters, instruments, projects. Enclosures come in many sizes and materials (extruded aluminum, polyurethane). Photos are included, along with specifications for each type enclosure. A price list is included.—**Tracewell Enclosures Inc.**, 7032 Worthington Galena Rd., Columbus, OH 43085.

CIRCLE 126 ON FREE INFORMATION CARD

ELECTRONIC SUPPLY CATALOG contains 99 pages of discounted electronic instruments and components, from adapters to wire-wrap accessories. Featured are a dual-trace 10-MHz triggered oscilloscope, 8-track record/playback tape deck, and a 500-ohm omnidirectional mike element. Index and order blank included. Price: \$1.—**Edlie Electronics, Inc.**, 2700 Hempstead Turnpike, Levittown, NY 11756.

R-E

market center

CLASSIFIED COMMERCIAL RATE (for firms or individuals offering commercial products or services). \$1.50 per word (no charge for zip code) . . . minimum 15 words.

NONCOMMERCIAL RATE (for individuals who want to buy or sell personal items) 85¢ per word . . . no minimum.

ONLY FIRST WORD AND NAME set in bold caps. Additional bold face (not available as all caps) at 10¢ per word. Payment must accompany all ads except those placed by accredited advertising agencies. 5% discount for 6 issues, 10% for 12 issues within one year, if paid in advance. All copy subject to publisher's approval. Advertisements using P.O. Box address will not be accepted until advertiser supplies publisher with permanent address and phone number. Copy to be in our hands on the 26th of the third month preceding the date of the issue (i.e., August issue closes May 26). When normal closing date falls on Saturday, Sunday, or a holiday, issue closes on preceding working day.

BUSINESS OPPORTUNITIES

MECHANICALLY inclined individuals desiring ownership of Small Electronics Manufacturing Business—without investment. Write: **BUSINESSES**, 92-R, Brighton 11th, Brooklyn, NY 11235

VINYL's where the money is! Professionally repair, refinish, recolor furniture, luggage, car tops. Quick, easy. Two small \$20 jobs a day earn you \$1000 a month. Homes, cars, offices, restaurants, unlimited customers. Start earning after a few days practice. Sensational details free. **VIP**, 2013 Montrose, Chicago, IL 60618

GOVERNMENT SURPLUS

MANUALS for Govt. surplus radios, test sets, scopes. List 50¢ (coin). **BOOKS**, 7218 Roanne Drive, Washington, DC 20021

WANTED

RECEIVING and Industrial tubes including obsolete types. **TSUTOM YOSHIHARA**, 1-105, Deguchicho 34, Suita, Osaka 564, JAPAN

FOR SALE

FREE catalog (anglais). IC's, semi's. **CORONET ELECTRONICS**, 649A Notre Dame W., Montreal, Que. Canada, H3C 1H8. US inquiries.

RADIO & TV tubes 36¢ each. One year guaranteed. Plus many unusual electronic bargains. Free catalog. **CORNELL**, 4217-E University, San Diego, Calif. 92105

TEST equipment catalog listing used Tektronix, HP and GR equipment at bargain prices. Price \$1.00 refundable with first order. **PTI**, Box 8699, White Bear Lake, MN 55110

NAME brand test equipment. Guaranteed discounts up to 50%. Free catalog. **SALEN ELECTRONICS**, Box 82-M, Skokie, IL 60077

SELLING Rider's manuals, Sams' Photofacts, Supreme Publications, Original factory manuals. **BEITMAN**, Box 46, Highland Park, IL 60035

FANTASTIC T.V. facts booklet as seen on NBC television. \$1.00 . . . guaranteed. **DVS**, Box 912R, Smithtown, NY 11787

TOP quality speakers for home and car. Send postage stamp for list. **SQUIRES**, Maxatawny, PA 19538

To run your own classified ad, put one word on each of the lines below and send this form along with your check for \$1.50 per word (minimum 15 words) to:

Radio-Electronics, 200 Park Avenue South, N.Y., N.Y. 10003

ORDER FORM

PLEASE INDICATE in which category of classified advertising you wish your ad to appear. For special headings, there is a surcharge of \$10.

() Plans/Kits () Business Opportunities () For Sale
() Education/Instruction () Wanted ()

Special Category: \$10

(PLEASE PRINT EACH WORD SEPARATELY, IN BLOCK LETTERS.)

1	2	3	4	5
6	7	8	9	10
11	12	13	14	15
16	17	18	19	20
21	22	23	24	25
26	27	28	29	30
31	32	33	34	35

YOUR PHONE CALLS ON TAPE

Record incoming and outgoing calls automatically with this all solid state unit connected to your telephone jack and tape recorder. Starts recording when phone is lifted. Stops when you hang up, making a permanent record. Easily installed. No extra monthly phone charges. FCC APPROVED
2-1/4 x 1-3/4 x 3/4 **\$24.50***



VOX

VOICE ACTIVATED CONTROL SWITCH

Self contained solid state. Excellent adjustable sensitivity. Recorder activated by voice or other sounds. Uses recorder mike or remote mike. Great for home, business, etc.
\$24.95*



FCC APPROVED

AMAZING ELECTRONIC MICRO MINI MIKE



Among world's smallest, solid state, self contained WIRELESS MIKE Mercury Bat. furn. Picks up most sounds and transmits without wires up to 300 ft. thru FM Radio. Tuneable. Use as mike, amp, alarm & alert system, baby sitter, hot line, etc. (*Plus \$1.00 Pstg. & Hdg.) Money back guarantee. California residents add tax. Free data, Mail order. Visa, M/C, Cod's o.k. Quantity discount available. AMC Sales, Dept. 19, 9335 Lubec St. Box 928, Downey, Calif. 90241 Phone (213) 869-8519
\$18.95*
2-1/4 x 3/4 x 1/2

AMAZING ELECTRONIC PROJECTS and PRODUCTS:

Lasers Super Powered, Burning, Cutting, Rifle, Pistol. Pocket. See In Dark—Shotgun Directional Mike—Unscramblers—Giant Tesla—Stunwand—TV Disrupter—Energy Producing, Surveillance, Detection, Electrifying, Ultrasonic, CB, Auto and Mech. Devices, Hundreds More—All New Plus INFO UNLTD PARTS SERVICE. Catalog \$1. Information Unlimited, Dept. R8 Box 716 Amherst, N.H. 03031.

SOLAR equipment bargain catalog for the do it yourselfer. Contains latest in solar cells, differential controls, and all equipment related to solar energy. \$1.00. **EXTERNAL ENERGY**, BOX 643, Tempe, AZ 85281

TEKTRONIX 551 4-trace scope \$400. Heath: IG-12, IG-42, IG-62, IT-28, HM-2101. BC-221AA B & W 300. Write for details. **BOX 2181**, Boulder, CO 80306

INCREDIBLE Secret Money Machine demands your electronic skills. \$6.95 complete, guaranteed, and postpaid. **SYNERGETICS**, RE-7, Box 1112, Parker, AZ 85344. Visa accepted.

P.C. BOARDS, your artwork. No setup charge. \$45/sq in. single sided, \$60/sq in. double sided. Ohio residents add 4.5% sales tax. **DIGITRONICS**, P.O. Box 2494, Toledo, OH 43606

BANKRUPT stock—Sealectro badge readers. Security, programming uses. L/N \$45 up. **ESI**, 1258 Fitzgerald, San Francisco, CA 94124

Burglar • Fire • Smoke Alarm Catalog

• Billions of dollars lost annually due to lack of protective warning alarms.

FREE CATALOG Shows you how to protect your home, business and person. Wholesale prices. Do-it-yourself. Free engineering service.



Burdex Security Co.

Box 82802 RE-049 Lincoln, Ne. 68501

SPEAKER INFORMATION KIT

Get 70 pages of speaker facts, specs, construction tips plus info on our raw speakers, crossovers and a line of 9 quality hi-fi speaker system kits. We'll send you our full-color catalog, plus **How to Hook Up Your System**, an exhaustive step-by-step treatise on hi-fi system installation; and our **Speaker Operating Manual**, chock full of facts on how to get the most from any speaker system, for Free. Even if you don't buy from us we want you to have the facts. That's how we got to be the world's largest manufacturer of speaker kits.

Send to:
Speakerlab, Dept. 4-RE
 735 N. Northlake
 Seattle, WA 98103



No flame or loss pliers or tools required!!!

\$15.00

+ \$1.00 postage and handling
Jewelers — Hobbyists
 For Fun or \$\$\$

DO IT YOURSELF

Instructions included. Must be electroplated.

Use a toy railroad control, a doorbell battery or a car battery charger as a power source.

NOW!!! You can build and plate 14Kt, 18 Kt heavy abstract edges on any stone and create jewelry, plate baby shoes, baseballs, leaves, flowers, acorns, etc. Information and instruction sheets only \$1.00.

GOLD EDGE
 7117 3rd Ave. / Box P / Dept. RE
 Scottsdale, AZ 85251 (602) 994-5752

PLANS & KITS

LINEAR AMPLIFIER: Ham only 2-30 MHz, 100 watt, solid-state. **FREQUENCY COUNTER:** 300 MHz, miniportable/mobile, memory! **VOX-COMPRESSOR:** Splatter-free modulation booster. Construction plans \$3.00 each. All \$7.50! Many others, catalog with order. **PANAXIS PRODUCTIONS**, Box 130-F4, Paradise, CA 95969

SCANNER users—build many useful accessories. Free kit catalog. **CAPRI ELECTRONICS**, Route 1R, Canon, GA 30520

SAVE 50%. Build your own speaker system. Write for catalog: **McGEE RADIO**, 1901 McGee, Kansas City, MO 64108

CONSTRUCTION plans for profitable business ideas. Catalog \$1.00. **GARLING**, 438 N. Garfield Street, Lombard, IL 60148

PRINTED circuit boards from your sketch or artwork. Affordable prices. Also fun kit projects. Free details. **DANOCINTHS INC.**, Box 261, Westland, MI 48185

Featured in Radio Electronics

DELTA Burglar ALARM

\$24.50

MOTION DETECTOR

DELTA MOTION DETECTOR. This device detects any motion or movement for a minimum distance of 8-ft. The secret is in the ultra-compact custom LSI chip which combines the latest in linear & digital circuitry. The device is completely self-contained, in a case 6 x 3 x 2 1/4", and operates from four "AA" NiCad batteries. Nothing else is needed for the device to perform its basic function, motion detection. When motion or movement is detected, a "whoop" alarm is sounded. The MOTION DETECTOR is designed to provide either an audible or silent alarm. The silent alarm is controlled by a siren, which delays the alarm up to 30 seconds. The silent alarm activates a relay whose contacts are brought out to plug, and will activate ANY device, such as siren, horn, tape recorder, telephone dialer, etc.

The Motion Detector works on a CHANGE OF LIGHT. Any change of 5% or more, triggers the detector. Works within a range of 0.1 candlepower (almost dark), to 100 candlepower (quite bright), a range of 1000 to 1. NO external light source is needed.

When left in a darkened or semi-darkened room, the Motion Detector acts as a fantastic FIRE ALARM. The light from a single match, anywhere in the room, triggers the alarm, so that the device becomes an intrusion alarm and fire alarm, all in one.

Delta No.	Description	Sale
5611R	Complete motion detector kit (less batteries)	\$24.50
1072R	Motion Detector Chip only, with data	8.95
5611R	P.C. boards, set of 2	6.50
5288R	"AA" NiCad Batteries, set of 4	4.50
5636R	Battery charger for above	5.95
5635R	Completely assembled kit, w/batteries & charger	69.50

Enclose sufficient postage. Excess refunded.

BankAmericard VISA master charge

PASS FCC EXAMS

The Original FCC Tests Answers exam manual that prepares you at home for FCC First and Second class Radiotelephone licenses. Newly revised multiple choice exams cover all areas tested on the actual FCC exam. Plus "Self Study" Ability Test. Proven! \$9.95 postpaid. Money-back Guarantee.

COMMAND PRODUCTIONS
 Radio Engineering Division
 P.O. Box 26348 E
 San Francisco, CA 94126

CATALOGS

FREE catalog of new merchandise, at great prices. IC's, semi's and more. **KEY ELECTRONICS**, Box 3506-RE, Schenectady, NY 12303

DOLBY add-on encodes/decodes recordings, FM. Quality components, complete kit. Calibration tapes available. Comprehensive test report. **REA INTEGRX**, Box 747, Havertown, PA 19083

Big CATALOG

Write for Your Free Copy

Connectors

TRI-TEK Incorporated

7808 N. 27th Avenue
 Phoenix, Arizona 85021
 (602) 998-9352

KEEP KOOL WITH 1ST QUALITY BLOWERS

Rugged Construction! Powerful Air Flow! Whisper Quiet!

60 CFM Model 1C839 3030 rpm, 115V, 60 cy, 16 W, 42A. Wheel dia: 3" x 1 7/8". Input: 2 3/8" dia. Output: 2 1/8". Size: 5 13/16" H x 5 1/4" W. 3 lbs. **\$6.88** Sells for \$19.

100 CFM REDMOND Model AK2H143AX 3000 rpm, 115V, 60 cy, 61 W, 78A. Wheel dia: 3 1/2" x 1 3/4". Input: 3 5/8" dia. Output: 2 1/8". Hse. width: 2 1/4". 1 1/4". Wt. 5 lbs. **\$7.88** Sells for \$25.

100 CFM DAYTON Model 9C694 2870 rpm, 115V, 60 cy, 61 W, 74A. Wheel dia: 3 13/16" x 1 7/8". Input: 3 1/8" dia. Output: 2 1/8". Size: 5 13/16" H x 6 7/16" W x 6 5/16" D. Hse. width 2 1/4". With overload protection. Wt. 5 lbs. **\$7.88** Sells for \$24.70.

Tested Ni-Cads 'AA'

Exclusive at Delta... Buy now while supplies last... Our loss is your gain!

SPECIAL-BY-MAIL OFFER

Delta No.	Type	Ampere Hours	Dimen.	SALE
5688R	1 3/4A	1.70	.619 dia. x .768	.78
5686R+	1 3/4A	2.00	.619 dia. x .768	.88
5676R	AA	5.00	.665 dia. x 1.83	.98
5689R	AA	5.50	.687 dia. x 1.98	.98
5680R	Sub C	1.2	.865 dia. x 1.645	1.58
5677R	C	2.0	1.06 dia. x 1.87	2.08
5687R	C	2.0	1.028 dia. x 1.85	1.98
5679R	1 2D	2.3	1.308 dia. x 1.375	1.98
5678R	D	4.0	1.308 dia. x 2.28	2.78

98¢ EACH

G.E. SEALED BEAM SPOT LIGHT

Originally made for emergency lights — for wide angle flooding!

48¢ EACH

5693R - 12V
 5690R - 12V

Chrome plated housing, 6 or 12V. 12V Adj. mount & clamp. O.D. to 1 1/2". Wt. 1 lb.

Gold Plated Contacts
SUBMINIATURE P.B. SWITCHES

1129R Red
 1130R Black

48¢ EACH

Actual Size 5 for \$2.

SFST, momentary. Norm. open. 1/2A contact rating. 1/4" dia. Equivalent To \$1.35 Grayhill

100% Guaranteed—Rechargeable

*Have tabs to permit soldering. +=buttons on both ends.

FREE KIT Catalog

STOP! Take a minute & let us send our latest kit catalog. If you like, send us the name & address of a friend who may also be interested and we'll include to you our booklet "How to build electronic thermometer" EQUIP.

DAGE SCIENTIFIC INSTRUMENTS
 BOX 1054R LIVERMORE CA 94550

EDUCATION & INSTRUCTION

TELEPHONE bugged? Don't be Watergated! Countermeasures brochure \$1.00. **NEGEYE LABORATORIES**, Box 547-RE, Pennsboro, WV 26415

UNIVERSITY degrees by mail! Bachelors, Masters, Ph.D's... Free revealing details. **COUNSELLING**, Box 317-RE4, Tustin, CA 92680

ASTONISH your friends with magic, E.S.P., card tricks you can do. Details: **LANGEN**, Box 191-CA, Downsview, Ont, M3M 3A3

FCC EXAM QUESTIONS. First/second license \$8.95. Third/broadcast endorsement \$4.50. Revised guide guaranteed. Postpaid. **PANAXIS**, Box 130-F4X, Paradise, CA 95969

"Delta Power"

5 Volts @ 7 Amps
 +12 Volts @ 3 Amps
 -12 Volts @ 2 Amps
 40 Volts @ 100 mA
 Regulated

\$4888

LIMITED QUANTITY SPECIAL

Unbeatable value! Power supplies worth \$300 - \$350 ea. Built by famous computer mfr. where reliability & quality are a must. Size: 17 1/2" x 4 1/4" x 4 3/4". Wt. 16 lbs. **\$675R**

PLASTIC ELECTRICAL TAPE

88¢ 3/4" wide! 60-ft. long! Black vinyl, U/L listed. Worth \$1.40 roll elsewhere. **\$498R**

FREE DELTA ELECTRONICS

120-PG. SURPLUS CATALOG

P.O. BOX 2, DEPT. R
 7 OAKLAND ST.
 AMESBURY, MASS. 01913

TEL. (617) 388-4705

PRINTED CIRCUIT

Positive Acting Photo Resist, Carbide bits; Bubble etchers; Artwork; Epoxy Glass Boards.

Send stamp & address label for flyer

TRUMBULL
 833 Balra Dr., El Cerrito, CA 94530

RADIO-ELECTRONICS

When in our area, northeastern Mass. or southern N.H. visit our new showroom!

CIRCLE 3 ON FREE INFORMATION CARD

THE MOST ADVANCED TIMEPIECE OF ITS KIND IN THE WORLD!

LCD Quartz Alarm Chronograph with calendar and dual time zone!! Watch is the same as Seiko but you pay a lot more for the name! Features:



- * 24 hour alarm
- * Chronograph counts up to 12 hrs., 59 mins, 59.9 sec.
- * Precision of chrono up to 1/10 sec Indicated by 10 moving arrows!!
- * Lap time (with chrono running uninterrupted)
- * Time displays by LCD for hour, min, sec, day, date of the week and AM/PM.
- * Calendar gives out date-day
- * Dual time zone for any two cities of the world at your own choice.
- * With light switch to allow you to see the time in the dark!

\$65.50

ONE YEAR FULL WARRANTY!

JUMBO 1" LED ALARM CLOCK MODULE

Assembled - not a kit!

- Features:
- * 1" 4 digits red LED display
 - * 12 hours real time format
 - * 24 hours alarm audio output (just add speaker)
 - * Power failure indicator
 - * Count down timer 59 mins.
 - * 12-16V AC 50/60 Hz input
 - * 10 min. snooze control



\$8.50 EACH

PCBM 701

Transformer
\$1.75

NEW MARK III 9 Steps 4 Colors LED VU



Stereo level indicator kit with arc-shape display panel!! This Mark III LED level indicator is a new design PC board with an arc-shape 4 colors LED display (change color from red, yellow, green and the peak output indicated by rose red). The power range is very large, from -30dB to +5dB. The Mark III indicator is applicable to 1 watt - 200 watts amplifier operating voltage is 3V - 9V DC at max 400 MA. The circuit uses 10 LEDs per channel. It is very easy to connect to the amplifier. Just hook up with the speaker output!

IN KIT FORM \$17.50

ELECTRONIC DUAL SPEAKER PROTECTOR

Cut off when circuit is shorted or overload to protect your amplifier as well as your speakers. A must for OCL circuits.
KIT FORM \$8.75 EA.



FM WIRELESS MIC KIT

It is not a pack of cigarettes. It is a new FM wireless mic kit! New design PC board fits into a plastic cigarette box. (case included) Uses a condenser microphone to allow you to have a better response in sound pick-up. Transmits up to 350 ft! With an LED indicator to signal the unit is on.



KIT FORM \$7.95

GENERAL PURPOSE INSTRUMENT BOXES



All boxes are made of aluminum. Top is anodized black. Bottom is silver and comes with 4 rubber pedestals.

Part No.	Sizes	Price
FTA 421	4 1/8" (W) x 1 1/2" (H) x 2 7/8" (D)	\$2.10 ea.
FTA 452	4" (W) x 2" (H) x 5" (D)	3.50 ea.
FTA 572	5 3/8" (W) x 2 3/4" (H) x 7" (D)	4.95 ea.

ELECTRONIC DOOR GUARD

This is an advance unit using CMOS I.C. and digital parts. You simply mount the unit on the door and the magnetic switch will turn the unit on to make a charming "Ding-Dong" sound when someone comes in. A presettable 3-digit digital security system circuit allows you to set the unit on "guard" when an unexpected person opens the door. The siren alarm will sound and cannot turn off without the correct 3-digit combination. Uses 9V battery (included).
Completed unit, not a kit. \$29.50



TIMATRON RACK MOUNT TYPE CABINETS!



All are of aluminum and machine made to very high-precision quality with sleek, black anodized finish. Front panels come blank and undrilled to allow you to make panels of your own design. For large

quantity orders Formula International will silkscreen print and drill panel holes at a minimal extra charge.

SIZE	PRICE
19" (W) x 2 1/2" (H) x 12" (D)	\$36.85
19" (W) x 4" (H) x 12" (D)	45.25
19" (W) x 8" (H) x 20" (D)	72.00
16" (W) x 2 1/2" (H) x 8" (D)	26.50
16" (W) x 4" (H) x 8" (D)	33.45
9 1/2" (W) x 2 1/2" (H) x 12" (D)	33.45
9 1/2" (W) x 4" (H) x 12" (D)	24.50
9 1/2" (W) x 4" (H) x 8" (D)	30.25

9 STEPS LED LEVEL INDICATOR KIT



for most stereo amplifiers

This new project works as a pair of VU meter to indicate the output level of your amplifier from -20dB to +3dB. Kit includes all LED, transistors, electronic components, P.C. Board and instructions.

Easy to build and fun to see.

ONLY \$12.50 EA.

60W + 60W

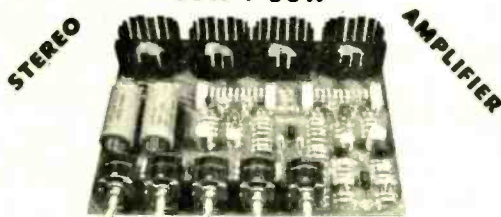

COMPLETED UNIT - NOT A KIT!

OCL pre amp. & power stereo amp. with bass, middle, treble 3-way tone control. Fully assembled and tested, ready to work. Total harmonic distortion less than 0.5% at full power. Output maximum is 60 watts per channel at 8Ω. Power supply is 24 - 36V AC or DC. Complete unit

*Kit form \$37.50 Assembled \$49.50 ea.
Power transformer \$ 8.50 ea.

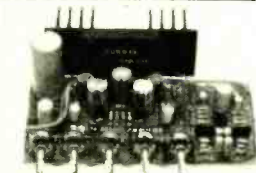

POWER TRANSFORMER \$6.50 EACH

22W + 22W STEREO HYBRID AMPLIFIER KIT

It Works in 12V D.C. As Well! Kit includes 1 PC SANYO STK-024 stereo power amp. IC LM 1458 as pre amp, all other electronic parts, PC Board, all control pots and special heat sink for hybrid. Power transformer not included. It produces ultra hi-fi output up to 44 watts (22 watts per channel) yet gives out less than 0.1% total harmonic distortion between 100Mz and 10KHz.

\$32.50 PER KIT

A NEW BOW + BOW COMPLETE STEREO AMPLIFIER

With all tone control and a new design. Bi-Fet Front Amp will be selling next month at \$72.50 ea.

Completed Unit, Not a Kit! Order Now.

SANYO HYBRID

Audio power amplifiers I.C. Max. hi-fi output power, minimum ext. components needed.



15 Watts	STK-028	\$ 8.50
23 Watts	STK-054	\$13.50
30 Watts	STK-056	\$17.50
50 Watts	STK-050	\$26.50
10W + 10W (stereo)	STK-040	\$14.50
15W + 15W (stereo)	STK-041	\$25.50
20W + 20W (stereo)	STK-043	\$31.50

*data sheet comes with purchase

UNIVERSAL PROTOBOARDS "CIRCUIT FIT"

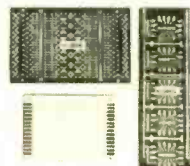
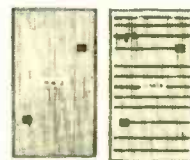

All Boards are made of High Quality G10 Fiberglass and Phenolic. Pre-drilled in .042" diameter holes on 0.1" centers with tin plated copper eyelet and finger edge connectors (single sided) to allow any kind of standard components to fit board.

Part No.	Size	Holes	Price	
			Fiberglass	Phenolic
U.S.P. 723	2" x 2.8"	529	\$ 1.27	\$.50
U.S.P. 724	2.8" x 3.7"	750	2.42	.80
U.S.P. 725	3.7" x 5.5"	1500	4.89	1.38
U.S.P. 728	7" x 9.6"	6240	19.50	10.40
H-5612	3 1/2" x 6"			1.70
H-5616	3 1/2" x 6"			1.70
H-5606	3 1/2" x 5"			1.50
H-5602	2 1/2" x 6 1/2"			1.50

ELECTRONIC WHEEL OF FORTUNE KIT

With 10 numbers split into black and white on dial. The LED turns when you hit the play switch, then it slows down and stops on one number. It sounds like a motor inside, but there is none. Lots of fun and easy to build. Kit comes with nice looking case, all electronic parts, P.C. Board and LEDs. Battery not included.



\$12.50

SUPER 15 WATT AUDIO AMP KIT

Uses STK-015 Hybrid Power Amp

Kit includes: STK-015 Hybrid IC, power supply with power transformer, front Amp with tone control, all electronic parts as well as PC Board. Less than 0.5% harmonic distortion at full power 1/2dB response from 20-100,000 Hz. This amplifier has QUASI-Complementary class B output. Output max is watt (10 watt RMS) at 4Ω.

ONLY \$23.50 each



MINI ELECTRONIC ORGAN KIT

PET-102 (25 KEYS)

The kit contains all electronic and mechanical parts, key boards, speaker, switches and PC Board as well as the wooden cabinet. Ideal for school project or gift to children Interested in electronics. Uses 6V C size x 4 battery (not included).

\$38.50



MANY SOUND DECISIONS!



\$3.60 EACH

Solid state sound indicator operating voltage 6V DC 30μA. Small size approximately 1/4" x 1 1/4".

Model EB2116 (Continuous)
Model EB2126 (Slow Pulse)
Model EB2136 (Fast Pulse)



Continuous



Slow pulse



Fast pulse

1Watt AUDIO AMP

All parts are pre assembled on a mini PC Board
Supply Voltage 6 ~ 9V D.C.
SPECIAL PRICE \$1.95 ea.



"FISHER" 30 WATT STEREO AMP

MAIN AMP (15W X2)

Kit Includes 2 pcs. Fisher PA 301 Hybrid IC all electronic parts with PC Board. Power supply: 16V DC (not included). Power band with (KF 1% ± 3dB). Voltage gain 33dB, 20KHz ~ 20KHz.

Super Buy Only \$18.50



5W AUDIO AMP KIT

2 LM 380 with Volume Control
Power Supply 6 ~ 18V DC

only \$5.00 ea.



TIMER KIT

Time Controlled from 1-100sec.
Ideal to be used as timer delay unit for burglar alarm, photo service, and other purposes.
Max. loading 110V, 2 AMP.
Supply voltage 12-18V DC.

\$11.50 each



FT-80 ELECTRONIC IC TIMER

ELECTRONIC ALARM SIREN

COMPLETE UNIT
Ideal for use as an Alarm Unit or hookup to your car back up to make a reverse indicator.
Light Output up to 1300cd
Voltage Supply 6 ~ 12V \$7.50



AU-999

SOUND ACTIVATED SWITCH

All parts completed on a PC Board
SCR will turn on relay, buzzer, or trigger other circuit for 2 ~ 10 sec. (adjustable)
Ideal for use as door alarm, sound controlled toys and many other projects.
Supply voltage 4.5V ~ 9V D.C.
\$1.75 ea./2 for \$3.00



LINEAR SLIDE POT

500KΩ SINGLE
Metal Case 3" Long
2 FOR \$1.20



DIGITAL ELECTRONIC LOCK KIT

for auto ignition, entry door, burglar alarm, etc.
4 Digits Programmable to CMOS I.C. Any Combination

\$6.50 ea.



400R RELAY and KEY PAD NOT INCLUDED

BATTERY POWERED FLUORESCENT LANTERN

FEATURES
• Circuitry designed for operation by high efficient, high power ultracon transistor which enable illumination maintain in a standard level even the battery supply drops to a certain low voltage.
• 9" 6W cool/daylight miniature fluorescent tube
• 8 x 1.5V UM-1 size D1 dry cell battery
• Easy sliding door for changing batteries
• Stainless reflector with wide angle increasing luminosity of the lantern.



\$10.50 EACH
MODEL 888 R

PROFESSIONAL CASE

for our 0-30V Power Supply. It is a nice looking metal cast case with giant 4" volt/amp meter; output blinding post and fuse holder, on/off switch and line cord!

ONLY \$21.50 EA.



CASE 030

POWER SUPPLY KIT

0-30V D.C. REGULATED
Uses UA723 and ZN3055 Power TR output can be adjusted from 0-30V, 2 AMP. Complete with PC board and all electronic parts.

0-30 POWER SUPPLY \$10.50 each



Transformer for Power Supply, 2AMP 24V x 2 \$8.50

12V DC MINI RELAY

6V	SPDT	2AMP	1.30
12V	SPDT	3AMP	1.60
12V	DPDT	2AMP	2.50
12V	4PDT	3AMP	3.50



5 AMP 5VDC

3 Terminals
Positive Voltage Regulator
Hard to find! Fairchild 78H05 to-3 Package, Input 8.5 - 20V DC Output +5V DC 5AMP Load Regulation 1%.

Only \$8.75 ea

ELECTRONIC SWITCH KIT

CONDENSER TYPE
Touch On Touch Off uses 7473 I.C. and 12V relay

\$5.50 each



ULTRA SONIC SWITCH KIT

Kit includes the Ultra Sonic Transducers, 2 PC Boards for transmitter and receiver. All electronic parts and instructions. Easy to build and a lot of uses such as remote control for TV, garage door, alarm system or counter. Unit operated by 9-12 DC.

\$15.50



ECO THUMBWHEEL SWITCHES

BCD OUTPUT 0-9

10 positions
3 digits with end and each digit section is detachable.
3 Digits only \$5.00

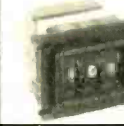

Sub Mini Size
PANEL METER
500 U.A.
ONLY \$1.20 ea

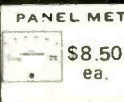

PANEL METER (D.C. Type)
Size 50MM X 66MM
White Face Type
\$8.50 ea.

0-50 U.A.	0-30V
0-1MA	0-50V
0-5MA	0-100V
	0-100MA

FM WIRELESS MIC KIT



This new model FM wireless MIC kit uses 3 high freq. transistors, works in the FM range (88-108 MHz). It transmits the sound wave fidelity clearly over long distances (up to 250 ft.). Kit comes with all electronic parts, P.C. Board and mini microphone!

\$6.95
EACH KIT

WE FOUND THE CASE FOR THE FM MIC!



Small nice looking aluminum case size like a pack of cigarettes. It is an Intercom. Audio amp inside with a mic jack, a mini toggle sw on top, can be used for many projects. We give you the circuit data as well.

VERY SPECIAL PRICE 2 for \$4.99

Sub-Mini Size CONDENSER MICROPHONE

\$2.50 each
FET Transistor Built-In



FLUORESCENT LIGHT DRIVER KIT

12V DC POWERED

Lights up 8 ~ 15 Watt
Fluorescent Light Tubes
Ideal for camper, outdoor Auto or Boat



Kit includes high voltage coil, power transistor, heat sink, all other electronic parts and PC Board, light tube not included!
WITH CASE ONLY \$6.50 PER KIT

HEAVY DUTY CLIP LEADS

10 pairs - 5 colors
Alligator clips on a 22" long lead. Ideal \$2.20/pack for any testing.

MINI-SIZED I.C. AM RADIO

Size smaller than a box of matches!
Receives all AM Stations
Batteries and ear phone included

Only \$10.50



TOGGLE SWITCH

Half size of submini toggle switch rated 3 amp 125V AC contact

M5 244	SPDT	1.00	0.90
M5 245	DPDT	1.20	1.10

LARGE QUANTITY AVAILABLE FOR OEM

SUBMINIATURES TOGGLE SWITCHES

SPDT	0.80	1.30 ea
DPDT	0.80	1.50 ea
3PDT	0.80	1.75 ea

Mini size Rocker Type
Also available at the same Price

MINI SIZE REED RELAY

Approx. 1" square
SPST Normal Open
Contact rated 1AMP
Coil 6 ~ 12V DC
All brand new by AMF
3 for \$2.00

PUSH-BUTTON SWITCH

N/Open Contact
Color: Red, White, Blue, Green, Black, 3/\$1.00
N/Close also
Available 50c ea.
LARGE QTY. AVAILABLE

SOLID STATE ELECTRONIC BUZZER

Mini size 1" x 3/4" x 1/2"
Supply voltage 1.5V - 12V
Ideal for Alarm or Tone Indicator
\$1.50 each

TRANSFORMERS

ALL 117 VOLT INPUT

30V	4AMP	\$7.50 EA.
36V CT	3AMP	\$8.50 EA.
48V CT	3AMP	\$8.50 EA.
24V CT	3AMP	\$8.50 EA.
24V CT	0.8AMP	\$1.80 EA.
12V CT	0.5AMP	\$1.80 EA.
12V CT	120MA	\$1.25 EA.

AC POWER SUPPLY

Wall Type Transformer

12V AC	Output	200MA	\$2.75 EA.
16V CT AC	Output	100MA	\$2.10 EA.
6V DC	Output	120MA	\$1.90 EA.
12V DC	Output	100MA	\$1.90 EA.

WIDE ANGLE PANEL METER

1 1/2" x 3/4"
IMA Full Scale
(Scale marks 0-100)
\$1.50 each



HOUR INDICATOR

This unit is 1 5/8" long operating volt age 4V D.C. will tell you how many hours your circuit or machine has been in service up to 100 hours.
Limited Quantity ONLY \$1.75 ea.

I.C. TEST CLIPS

Same as the E Z clips
With 20" Long Leads
In Black and Red Colors
\$2.75 per pair



MINIMUM ORDER \$10.00. California residents add 6% sales tax and 10% shipping.
Out of state add 15% of total purchase for shipping charges, out of USA and Overseas add 25% of total purchase.
SEND CHECK OR MONEY ORDER TO:

4/79



FORMULA INTERNATIONAL INC.

12603 CRENSHAW BOULEVARD • HAWTHORNE, CALIFORNIA 90250

For more information please call (213) 973-1921, (213) 679-5162

STORE HOURS 10-7 Monday - Saturday

SEND \$1.00 FOR DETAILED CATALOG





FREQUENCY COUNTER KIT

Outstanding Performance

Incredible Price **\$89⁹⁵**

CT-50

The CT-50 is a versatile and precision frequency counter which will measure frequencies to 60 MHz and up to 600 MHz with the CT-600 option. Large Scale Integration, CMOS circuitry and solid state display technology have enabled this counter to match performance found in units selling for over three times as much. Low power consumption (typically 300-400 ma) makes the CT-50 ideal for portable battery operation. Features of the CT-50 include: large 8 digit LED display, RF shielded all metal case, easy pushbutton operation, automatic decimal point, fully socketed IC chips and input protection to 50 volts to insure against accidental burnout or overload. And, the best feature of all is the easy assembly. Clear, step by step instructions guide you to a finished unit you can rely on. **Order your today!**

SPECIFICATIONS:

Frequency range: 6 Hz to 65 MHz; 600 MHz with CT-600
 Resolution: 10 Hz @ 0.1 sec gate; 1 Hz @ 1 sec gate
 Recount: 8 digit, 0.4" high LED, direct readout in MHz
 Accuracy: adjustable to 0.5 ppm
 Stability: 2.0 ppm over 10 to 40 °C temperature compensated
 Input: ENC 1 megohm, 20 pF direct; 50 ohm with CT-600
 Overload: 50VAC maximum, all modes
 Sensitivity: less than 25 mV to 65 MHz; 50-150 mV to 600 MHz
 Power: 110 VAC 5 Watts or 12 VDC @ 400 ma
 Size: 6" x 4" x 2"; high quality aluminum case, 2 lbs
 ICS: 13 units, all socketed

CT-50, 60 MHz counter kit	\$89.95	CB-1 Color TV calibrator stabilizer	\$14.95
CT-50WT, 60 MHz counter, wired and tested	\$159.95	DP-1 DC probe, general purpose probe	\$12.95
CT-600, 600 MHz scaler option, add	29.95	HP-1 High impedance probe, fan-loader	15.95

CAR CLOCK



The UN-KIT, only 5 solder connections

Here's a super looking, rugged and accurate auto clock, which is a snap to build and install! Clock movement is completely assembled—you only solder 3 wires and 2 switches, takes about 15 minutes! Display is bright green with automatic brightness control photocell—assures you of a highly readable display, day or night! Comes in a satin finish anodized aluminum case which can be attached 5 different ways using 2 sided tape. Choice of silver, black or gold case (specify).

DC-3 kit, 12 hour format	\$22.95
DC-3 wired and tested	\$29.95
110V AC adapter	\$5.95

Under dash car clock



12/24 hour clock in a beautiful plastic case features: 6 jumbo RED LEDs, high accuracy (1min/mo.), easy 3 wire hookup, display blanks with ignition, and super instructions. Optional dimmer automatically adjusts display to ambient light level.

DC-11 clock with mtg bracket	\$27.95
DM-1 dimmer adapter	2.50

PRESCALER



Extend the range of your counter to 600 MHz. Works with any counter. Includes 2 transistor pre-amp to give super sens, typically 20 mV at 150 MHz. Specify +10 or +100 ratio.

PS-1B, 600 MHz prescaler	\$59.95
PS-1BK, 600 MHz prescaler kit	49.95

OP-AMP SPECIAL

741 mini dip	12/\$2.00
B1-FET, mini dip, 741 type	10/\$2.00

VIDEO TERMINAL

A completely self-contained, stand alone video terminal card. Requires only an ASCII keyboard and TV set to become a complete terminal unit. Two units available, common features are: single 5V supply, XTAL controlled sync and baud rates (to 9600), complete computer and keyboard control of cursor, Parity error control and display. Accepts and generates serial ASCII plus parallel keyboard input. The 3216 is 32 char. by 16 lines, 2 pages with memory dump feature. The 6416 is 64 char. by 16 lines, with scrolling, upper and lower case (optional) and has RS-232 and 20ma loop interfaces on board. Kits include sockets and complete documentation.

RE 3216, terminal card	\$149.95
RE 6416, terminal card	189.95
Lower Case option, 6416 only	13.95
Power Supply Kit	14.95
Video/RF Modulator, VD-1	6.95
Assembled, tested units, add	60.00

CALENDAR ALARM CLOCK

The clock that's got it all: 6-5" LEDs, 12/24 hour, snooze, 24 hour alarm, 4 year calendar, battery backup, and lots more. The super 7001 chip is used. Size: 5x4x2 inches. Complete kit, less case (not available) DC-9

\$34.95

30 Watt 2 mtr PWR AMP

Simple Class C power amp features 8 times power gain, 1 W in for 8 out, 2 in for 15 out, 4 W in for 30 out. Max. output of 35 W. Incredible value, complete with all parts, less case and T-R relay.

PA-1, 30 W pwr amp kit	\$22.95
TR-1, RF sensed T-R relay kit	6.95

FM MINI MIKE KIT



A super high performance FM wireless mike kit. Transmits a stable signal up to 300 yards with exceptional audio quality by means of its built in electret mike. Kit includes case, mike, on-off switch, antenna, battery and super instructions. This is the finest unit available.

FM-3 kit	\$12.95
FM-3 wired and tested	16.95

CLOCK KITS



our Best Seller
your Best Deal

Try your hand at building the finest looking clock on the market. Its satin finish anodized aluminum case looks great anywhere, while six 4" LED digits provide a highly readable display. This is a complete kit, no extras needed, and it only takes 1-2 hours to assemble. Your choice of case colors: silver, gold, bronze, black, blue (specify).
 Clock kit, 12/24 hour, DC-5 **\$22.95**
 Clock with 10 min. ID timer, 12/24 hour, DC-10 **27.95**
 Alarm clock, 12 hour only, DC-8 **24.95**
 12V DC car clock, DC-7 **27.95**
 For wired and tested clocks add \$10.00 to kit price.

Hard to find PARTS

LINEAR ICs		REGULATORS	
3C1	\$ 35	*8MG	\$1.25
3C4	1.50	*23	.50
3E0	1.25	309K	.85
3E0-8	.75	*805	.85
5S5	.45	*8L05	.25
5S6	.85	*905	1.25
5E6	1.15	*812	.85
5E7	1.25	*912	1.25
1A58	.50	*815	.85
3E00	.50	TL ICs	
		4500	.35
CMOS ICs		447	.65
4011	.20	475	.50
4013	.35	490	.50
4046	1.85	490	.50
4049	.40	*419611	1.35
4918	1.25	SPECIAL ICs	
53E9	1.75	*1C90	13.50
		*0116	1.25
		4511	2.00
		4375A	2.95
		4375B	2.95
		7001	6.50
		4059 N	9.00
		7208	17.95
		LEDs	
		jumbo red	8 1.00
		jumbo green	6 1.00
		jumbo yellow	6 1.00
		mini red	8 1.00
		micro red	8 1.00
		BiPolar	.75
		FERRITE BEADS	
		with info. specs	15 1.00
		€ hole balun	5 1.00

Ramsey's famous MINI-KITS

FM WIRELESS MIKE KIT

Transmits up to 300' to any FM broadcast radio, uses any type of mike. Runs on 3 to 9V. Type FM-2 has added sensitive mike preamp stage.

FM-1 kit	\$2.95	FM-2 kit	\$4.95
----------	---------------	----------	---------------

VIDEO MODULATOR KIT

Converts any TV to video monitor. Super stable, tunable over ch. 4-6. Runs on 5-15V, accepts sid video signal. Best unit on the market!

Complete kit, VD-1	\$6.95
--------------------	---------------

SUPER SLEUTH

A super sensitive amplifier which will pick up a pin drop at 15 feet! Great for monitoring baby's room or as general purpose amplifier. Full 2 W rms output, runs on 6 to 15 volts, uses 8-45 ohm speaker.

Complete kit, BN-9	\$5.95
--------------------	---------------

COLOR ORGAN/MUSIC LIGHTS

See music come alive! 3 different lights flicker with music. One light for lows, one for the mid-range and one for the highs. Each channel individually adjustable, and drives up to 300W. Great for parties, band music, nightclub and more.

Complete kit, ML-1	\$7.95
--------------------	---------------

TONE DECODER

A complete tone decoder on a single PC board. Features: 400-5000 Hz adjustable range via 20 turn pot, voltage regulation, 567 IC. Useful for touch-tone decoding, tone burst detection, FSK, etc. Can also be used as a stable tone encoder. Runs on 5 to 12 volts.

Complete kit, TD-1	\$5.95
--------------------	---------------

POWER SUPPLY KIT

Complete triple regulated power supply provides variable 6 to 18 volts at 200 ma and +5V at 1 Amp. Excellent load regulation, good filtering and small size. Less transformers, requires 6.3V @ 1 A and 24 VCT.

Complete kit, PS-3LT	\$6.95
----------------------	---------------

LED BLINKY KIT

A great attention getter which alternately flashes 2 jumbo LEDs. Use for name badges, buttons, warning panel lights, anything! Runs on 3 to 15 volts.

Complete kit, BL-1	\$2.95
--------------------	---------------

WHISPER LIGHT KIT

An interesting kit, small mike picks up sounds and converts them to light. The louder the sound the brighter the light. Completely self-contained. Includes mike, runs on 110VAC, controls up to 300 watts.

Complete kit, WL-1	\$6.95
--------------------	---------------

SIREN KIT

Produces upward and downward wail characteristic of a police siren. 5 W peak audio output, runs on 3-15 volts, uses 3-45 ohm speaker.

Complete kit, SM-3	\$2.95
--------------------	---------------

ramsey electronics

PHONE ORDERS CALL (716) 271-6487



TERMS: Satisfaction guaranteed or money refunded. COD add \$1.50. Minimum order \$6.00. Orders under \$10.00 add \$7.50. Add 5% for postage, insurance, handling. Overseas add 15%. NY residents add 7% tax.

RADIO-ELECTRONICS

CIRCLE 36 ON FREE INFORMATION CARD

www.americanradiohistory.com

Radio Shack: No. 1 Parts Place

Low Prices and New Items Everyday!

Top-quality devices, fully functional, carefully inspected. Guaranteed to meet all specifications, both electrically and mechanically. All are made by well-known American manufacturers, and all have to pass manufacturer's quality control procedures. These are not rejects, not fallouts, not seconds. In fact, there are none better on the market! Always count on Radio Shack for the finest quality electronic parts!

TTL and CMOS Logic ICs

Full-Spec Devices
Direct from
Motorola and
National Semiconductor



Type	Cat No	ONLY
7400	276-1801	35¢
7402	276-1811	39¢
7404	276-1802	35¢
7406	276-1821	49¢
7410	276-1807	39¢
7413	276-1815	79¢
7420	276-1809	39¢
7427	276-1823	49¢
7432	276-1824	49¢
7441	276-1804	99¢
7447	276-1805	99¢
7448	276-1816	99¢
7451	276-1825	39¢
7473	276-1803	49¢
7474	276-1818	49¢
7475	276-1806	79¢
7476	276-1813	59¢
7485	276-1826	1.19
7486	276-1827	49¢
7490	276-1808	79¢
7492	276-1819	69¢
74123	276-1817	99¢
74145	276-1828	1.19
74150	276-1829	1.39
74154	276-1834	1.29
74192	276-1831	1.19
74193	276-1820	1.19
74194	276-1832	1.19
74196	276-1833	1.29
4001	276-2401	49¢
4011	276-2411	49¢
4012	276-2412	69¢
4013	276-2413	89¢
4017	276-2417	1.49
4020	276-2420	1.49
4021	276-2421	1.49
4023	276-2423	69¢
4027	276-2427	89¢
4028	276-2428	1.29
4046	276-2446	1.69
4049	276-2449	69¢
4050	276-2450	69¢
4051	276-2451	1.49
4066	276-2466	99¢
4070	276-2470	69¢
4511	276-2447	1.89
4518	276-2490	1.49
4543	276-2491	1.89

SN-76477 Sound/Music Synthesizer IC



299 Featured in Oct. Popular Electronics

Creates almost any type of sound — music to "gunshots!" Built-in audio amp. Includes 2 VCO's, LF osc., noise gen., filter, 2 mixers, envelope modulator, logic circuit. 28-pin DIP. With data/applications circuits. 276-1765 2.99

Analog Audio Delay IC MN 3002

1095



For Phase-Shifter, Reverb & Delay Circuits

"Bucket Brigade" device uses 512 shift registers to provide a continuously variable electronic delay for complex audio signals. Includes data sheet and applications circuits. 276-1760 10.95

Heat Sinks

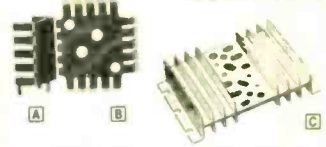

A TO-220. For PC board-mounted power semiconductors in TO-220 cases. Anodized aluminum. 79¢

B TO-3 Sink. For PC or chassis mtg. 276-1363 1.39

C Universal. Mounts 2 devices. accepts 9 case styles. 276-1361 2.69

Top-Quality IC and PCB Accessories

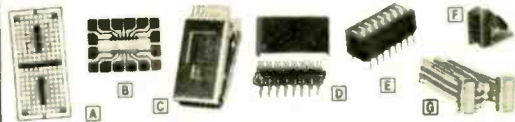

A PC Board. Mounts two 14 or 16-pin ICs or sockets for bread boarding. Copper clad. 2 1/2 x 5 1/2". 276-151 2.99

B PC Board. Mounts single 14 or 16-pin IC or socket. 276-024 Pkg. of 2/99¢

C 18-Pin IC Test Clip. 276-1951 3.99

D 16-Pin DIP Header. With snap-on cover. 276-1980 1.29

E S-Rocker. 16-Pin DIP Switch. 276-1301 1.99

F Vertical 16-Pin Socket. For LED displays. 276-1986 1.49

G 16-Pin DIP Jumper Cable. 18" long. 276-1776 3.99

Project Boxes

Aluminum Cover



The popular, low-cost way to house your electronic experiments.

3 1/2 x 2 1/4 x 1 1/2". 270-230 1.19

4 1/2 x 2 1/4 x 2". 270-231 1.29

5 1/2 x 2 1/4 x 1 1/2". 270-233 1.49

6 1/2 x 3 1/4 x 2". 270-627 1.79

7 1/2 x 4 1/4 x 2 1/4". 270-232 2.49

Miniature Hobby Motors



High-torque permanent magnet type. 1/16" dia. shaft.

A 12VDC. 350mA. 2x 1 1/2". 273-210 69¢

B 6-9VDC. 500mA. 1 1/2 x 3/4". 273-209 Pkg. of 2/99¢

8080A Microprocessor and Support Chips

New — 100% Prime



All With Full Data and Specs

8080A Microprocessor. 2 μs cycle time. 276-2510. 12.95
8208 Bus Driver. 8-bit bidirectional. 276-2508. 5.95
8154 128x8-Bit RAM I/O. 40-pin DIP. 276-2511. 9.95
8212 I/O Port. Data latch and buffer. 276-2512. 4.95
8224 Clock and Generator Driver. 276-2524. 3.95
8228 System Controller and Bus Driver. 276-2528. 6.95
8251 Programmable Communication Interface. 276-2551. 9.95
8255 Programmable Peripheral Interface. 276-2555. 9.95

RAM Memory ICs

Under 450 nS Access Time

2102 1024 x 1 Array. Low-cost static memory chip. 16-pin DIP. Buy 8 and save! 276-2501 2.49 Ea. or 8/14.95
2114L 1024 x 4 Array. NMOS static RAM. 18-pin DIP. 276-2504. 12.95

PC Potentiometers

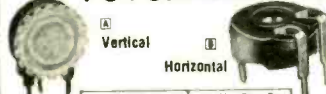

Ohms	1/4 W. (Fig A)		1/2 W. (Fig B)	
	Cat No	Ea	Cat No	Ea
500k	271-228	49¢	271-333	39¢
1k	271-227	49¢	271-332	39¢
5k	271-217	49¢	271-335	39¢
10k	271-218	49¢	271-336	39¢
25k	—	—	271-338	39¢
50k	271-219	49¢	—	—
100k	271-220	49¢	271-330	39¢
500k	271-221	49¢	—	—
1 Meg	271-229	49¢	—	—

Custom Printed Circuit Board Kit

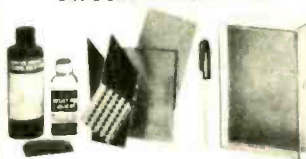

Everything you need for making high-quality custom PC boards.

276-1576 7.95

Extra Resist Pen. 276-1530 1.29

Extra Etching Solution. 276-1535 2.19

Molded Connectors



Molded nylon body. Each circuit rated 8A @ 250V. Standard .093" pin diameter.

A 4-Pin Male. 274-224 99¢

B 6-Pin Male. 274-226 1.19

C 9-Pin Male. 274-229 1.39

D 12-Pin Male. 274-232 1.49

E 4-Pin Female. 274-234 99¢

F 6-Pin Female. 274-236 1.19

G 9-Pin Female. 274-239 1.39

H 12-Pin Female. 274-242 1.49

2-Pin Male & Female. (Not Shown.) 274-222 Pair 69¢

IC Breadboard Sockets

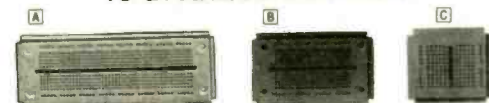

Modular boards snap together and feature standard 0.3" center. Accept 22 through 30-gauge solid hookup wire.

A 550 connections in 2 bus strips of 40 tie points each with 47 rows of 5 connected tie points. 2 1/2 x 6". 276-174 9.95

B 270 connections in 2 bus strips of 40 tie points each with 23 rows of 5 connected tie points. 2 1/2 x 3 3/4". 276-175 5.95

C Mini-Socket. 22 rows of 5 tie points each, plus 2 bus strips with 10 connections each. 2 1/2 x 1 1/2". 276-176 3.95

Digital Project Accessories



A Bezel with Lens. Special high contrast filter for LED displays. 3 3/8 x 1" lens opening. 270-301 3.95

B Deluxe Display Case. Sleek molded case with red lens — mount up to four 0.6" or eight 0.3" LED digits. With bracket. 1 1/2 x 3 3/8 x 4 7/16". 270-285. 3.95

C MA 1003 Clock Case. For automotive clock modules. Accepts 3 pushbutton switches (not included). With bracket. blue lens. 3 1/2 x 2 1/2 x 2". 270-303 5.95

Computer Data Manuals and Semiconductor Handbook

A Intel® 8080/8085 Programming Manual. Handy reference for programming with Intel's assembly language. 62-1377 3.95

B Intel Memory Design Handbook. Explains use of Intel's memory components and support circuits in systems. 62-1378 3.95

C Intel Data Catalog. 928 pages of specifications on most of Intel's standard microcomputer-related products. 62-1379 4.95

D Semiconductor Reference and Application Handbook. Complete specs and applications for popular IC transistors, diodes. 276-4002 1.95

MC14553 3-Digit BCD Counter IC

299



CMOS chip replaces over 8 separate IC's in a digital display circuit. Input pulse shaping. master reset pin. 16-pin DIP. 276-2498 2.99

WHY WAIT FOR MAIL ORDER DELIVERY?
IN STOCK NOW AT OUR STORE NEAR YOU!

Prices may vary at individual stores and dealers

Radio Shack®

A DIVISION OF TANDY CORPORATION • FORT WORTH, TEXAS 76102
OVER 7000 LOCATIONS IN NINE COUNTRIES

7400 TTL

Table listing various 7400 TTL integrated circuits such as SN7400N, SN7401N, SN7402N, etc., with their respective quantities and prices.

Jameco ELECTRONICS

Regulated Power Supply



- Uses LM 309K
• Heat sink provided
• P.C. board construction
• Provides a solid 1 amp @ 5V
• Includes components, hardware and instructions
• Size: 3-1/2" x 5" x 2" high

JE200 5v 1amp \$14.95

Kits

4-Digit Clock Kit

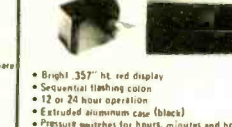

JE730 \$14.95

ALSO AVAILABLE: JE900 - Digital Stopwatch kit \$39.95, JE2206B Function Generator \$19.95, JE701 - 6 Digit Clock kit \$19.95, JE2206B Jumbo 6 digit Clock kit \$29.95

DISCRETE LEDES

Table listing discrete LEDs with specifications like diameter (200 dia, 125 dia, 188 dia, 170 dia, .085" dia), color (red, green, yellow, clear), and part numbers (XC556R, XC556G, etc.).

TIMEX T1001 LIQUID CRYSTAL DISPLAY

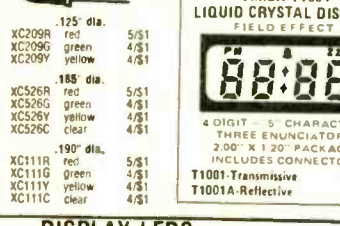

4 DIGIT 5 CHARACTERS THREE UNICODERS 2.00" x 1.20" PACKAGE INCLUDES CONNECTOR T1001-Transmissive \$7.95 T1001A-Reflective \$8.25

DISPLAY LEDES

Table listing display LEDs with columns for TYPE, POLARITY, HT, PRICE, and part numbers (MAN 1, MAN 2, etc.).

20% Discount 100 pcs combined order 75% - 1000 pcs combined order

C/MOS

Table listing C/MOS integrated circuits with part numbers (CD4001, CD4002, etc.) and prices.

74C00

Table listing 74C00 integrated circuits with part numbers (74C00, 74C01, etc.) and prices.

LINEAR

Table listing linear integrated circuits with part numbers (LM709N, LM300N, etc.) and prices.

74LS00TTL

Table listing 74LS00TTL integrated circuits with part numbers (74LS00, 74LS01, etc.) and prices.

TELEPHONE/KEYBOARD CHIPS

Table listing telephone/keyboard chips with part numbers (AY-5-9100, AY-5-9200, etc.) and prices.

ICM CHIPS

Table listing ICM chips with part numbers (ICM7045, ICM7205, etc.) and prices.

NMOS READ ONLY MEMORIES

Table listing NMOS ROMs with part numbers (MCM6571, MCM6574, etc.) and prices.

MISCELLANEOUS

Table listing miscellaneous components like relays, switches, and connectors with part numbers (TL074CN, TL1494CN, etc.) and prices.

TRONIX ISO-LIT 1

Photo Transistor Opto-Isolator (Same as MCT 2 or 4N25) \$2.99

TV GAME CHIP AND CRYSTAL

AT-3-8500-1 and 2 01 MHz Crystal (Chip & Crystal) includes score display, 6 games and select angles, etc. \$7.95/set

EXAR

Table listing EXAR integrated circuits with part numbers (XR205, XR210, etc.) and prices.

DIODES

Table listing diodes with columns for TYPE, VOLTS, W, PRICE, and part numbers (1N4746, 1N751, etc.).

SCR AND FW BRIDGE RECTIFIERS

Table listing SCR and FW bridge rectifiers with part numbers (C380, MDA 960-3, etc.) and prices.

TRANSISTORS

Table listing transistors with part numbers (C10681, MP4505, etc.) and prices.

RCA LINEAR

Table listing RCA linear integrated circuits with part numbers (CA3031T, CA3032T, etc.) and prices.

CALCULATOR CHIPS/DRIVERS

Table listing calculator chips/drivers with part numbers (MM5725, MM5726, etc.) and prices.

CLOCK CHIPS

Table listing clock chips with part numbers (MM5309, MM5312, etc.) and prices.

MOTOROLA

Table listing Motorola integrated circuits with part numbers (MC140817, MC14818, etc.) and prices.

IC SOLIDTAN - LOW PROFILE (TIN) SOCKETS

Table listing IC Solidtan sockets with part numbers (8 pin LP, 14 pin LP, etc.) and prices.

SOLEOART STANDARD (TIN)

Table listing Soleoart standard sockets with part numbers (14 pin ST, 16 pin ST, etc.) and prices.

SOLEOART STANDARD (GOLD)

Table listing Soleoart standard gold sockets with part numbers (24 pin SG, 16 pin SG, etc.) and prices.

WIRE WRAP SOCKETS (GOLD) LEVEL #3

Table listing wire wrap sockets with part numbers (8 pin WW, 10 pin WW, etc.) and prices.

1/4 WATT RESISTOR ASSORTMENTS - 5%

Table listing 1/4 watt resistor assortments with part numbers (ASST. 1, ASST. 2, etc.) and prices.

CAPACITOR CORNER

Table listing capacitors with columns for value, tolerance, and price (10 pf, 22 pf, etc.).

MINIATURE ALUMINUM ELECTROLYTIC CAPACITORS

Table listing miniature aluminum electrolytic capacitors with part numbers (47-50V, 100-50V, etc.) and prices.

Jameco ELECTRONICS logo and contact information: MAIL ORDER ELECTRONICS - WORLDWIDE, 1021 HOWARD AVENUE, SAN CARLOS, CA 94070, ADVERTISED PRICES GOOD THRU APRIL.

CIRCLE 17 ON FREE INFORMATION CARD

Transistor Checker

— Completely Assembled —
— Battery Operated —



The ASI Transistor Checker is capable of checking a wide range of transistor types, either "in circuit" or out of circuit. To operate, simply plug the transistor to be checked into the front panel socket, or connect it with the alligator clip test leads provided. The unit safely and automatically identifies low, medium and high power PNP and NPN transistors. Size: 3 1/2" x 6 1/4" x 2 1/2". "C" cell battery not included.

Trans-Check \$29.95 ea.

Custom Cables & Jumpers



DB 25 Series Cables

Part No.	Cable Length	Connectors	Price
DB25P-4-P	4 ft	2-DP25P	\$15.95 ea.
DB25P-4-S	4 ft	1-DP25P-1-25S	\$16.95 ea.
DB25S-4-S	4 ft	2-DP25S	\$17.95 ea.

Dip Jumpers

DJ14-1	1 ft	1-14 Pin	\$1.59 ea.
DJ16-1	1 ft	1-16 Pin	1.79 ea.
DJ24-1	1 ft	1-24 Pin	2.79 ea.
DJ14-1-14	1 ft	2-14 Pin	2.79 ea.
DJ16-1-16	1 ft	2-16 Pin	3.19 ea.
DJ24-1-24	1 ft	2-24 Pin	4.95 ea.

For Custom Cables & Jumpers See JAMECO 1979 Catalog for Pricing

CONNECTORS

25 Pin-D Subminiature

DB25P (as pictured)	PLUG (Meets RS232)	\$2.95
DB25S	SOCKET (Meets RS232)	\$3.50
DBS1226-1	Cable Cover for DB25P or DB25S	\$1.75

PRINTED CIRCUIT EDGE-CARD

156 Spacing-1in-Double Head Out - 1/4in-Double Head Out - 1/4in-054 to 070 P.C. Cards	Price
15/30	PINS (Solder Eyelet) \$1.95
18/36	PINS (Solder Eyelet) \$2.49
22/44	PINS (Solder Eyelet) \$2.95
50/100 (.100 Spacing)	PINS (Wire Wrap) \$6.95
50/100 (.125 Spacing)	PINS (Wire Wrap) R681-1 \$6.95



Solar Cells 2x2cm

- 0.4 volts
 - 100mA
 - 41 MW
- Can be added in series for higher voltage or parallel for higher current.
- #SC 2x2 \$1.95 ea. or 3/\$5.00

Magnetically Activated Switch

The 9250 0002 is a single pole normally closed switch. When the magnet is engaged, the circuit is open. This switch is only suitable for use in non-magnetic doors and windows.

#9250-0002 2/\$1.00

AC Wall Transformer

Ideal for use with clocks, power supplies or any other type of AC application.

Part No.	Input	Output	Price
AC 250	117V/60HZ	12 VAC 250mA	\$3.95
AC 500	117V/60HZ	12 VAC 500mA	\$4.95

REMOTE CONTROL TRANSMITTER & RECEIVER



\$19.95

INSTRUMENT/CLOCK CASE

This case is an injection molded unit that is ideal for uses such as DVM, COUNTER, or CLOCK cases. It has dimensions of 4 1/2" in length by 4" in width by 1 1/2" in height. It comes complete with a red bezel.

PART NO: IN-CC \$3.49 each

MICROPROCESSOR COMPONENTS

8080A/8080A SUPPORT DEVICES		MICROPROCESSOR MANUALS	
8080A	CPU	\$ 9.95	M-280 User Manual \$7.50
8214	8-Bit Input/Output	3.25	M-CDP1802 User Manual 7.50
8216	Priority Interrupt Control	5.95	M-2650 User Manual 5.00
8218	8-Direction Bus Driver	3.49	
8224	Clock Generator Driver	3.99	
8226	Bus Driver	3.99	
8228	System Controller/Bus Driver	5.95	
8238	System Controller	5.95	
8251	Prog. Counter 1.8 (USART)	7.95	
8253	Prog. Interval Timer	14.95	
8255	Prog. Periph. I/O (PPI)	9.95	
8257	Prog. DMA Control	19.95	
8259	Prog. Interrupt Controller	19.95	
8080/8080 SUPPORT DEVICES		ROMS	
MC6800	MPU	\$14.95	2102 1024x1 Static \$1.49
MC6802CP	MPU with Clock and Ram	24.95	2102 1024x1 Dynamic 95
MC6810AP	128x8 Static Ram	2.95	1024x1 Static 1.75
MC6821	Periph. Inter. Adapter (MC6820)	7.49	1024x1 Static 1.95
MC6828	Priority Interrupt Controller	12.95	256x4 Static MOS 4.95
MC6832LR	1024x8 Bit ROM (MC6830-8)	14.95	1024x4 Static 450ns 10.95
MC6850	Asynchronous Comm. Adapter	7.95	1024x4 Static 300ns 10.95
MC6852	Synchronous Serial Data Adapt.	9.95	214x1-3 1024x4 Static 300ns low power 11.95
MC6860	0-600 bps Digital MODEM	12.95	512 256x4 Static 4.95
MC6862	2400 bps Modem	14.95	512 256x4 Static 4.95
MC6880A	Quad 3-State Bus Trans. (MC6870)	2.75	7489 16K4 Static 1.75
MICROPROCESSOR CHIPS—MISCELLANEOUS		PROMS	
Z801780C1	CPU	\$14.95	1702A 2548 FAMOS \$5.95
Z801780-11	CPU	24.95	TMS2516 16K* EPROM/Intr. 2716 49.95
CDP1802	CPU	19.95	2716 16K* EPROM \$9.95
2650	MPU	19.95	2716 16K* EPROM 10.95
8035	8-Bit MPU w/ Clock, Ram, I/O lines	2.95	2716 16K* EPROM 29.95
PD805	16-Bit MPU w/ hardware multiply & divide	49.95	45H 48K* EPROM \$14.95
SHIFT REGISTERS		1702A 2548 FAMOS \$3.49	6301-117611 1024 Tristate Bipolar 2.95
MM500H	Dual 25 Bit Dynamic	5.50	6301-117621 256 Open C. Bipolar 2.95
MM503H	Dual 50 Bit Dynamic	5.50	6301-117631 3248 Open Collector 3.95
MM504H	Dual 16 Bit Static	5.50	825115 4096 Bipolar 19.95
MM506H	Dual 100 Bit Static	5.50	825123 3248 Tristate 3.95
MM510H	Dual 64 Bit Accumulator	8.95	74186 512 TTL Open Collector 3.95
MM516H	500x512 Bit Dynamic	5.50	74188 256 TTL Open Collector 2.95
2504T	1024 Dynamic	3.95	745287 1024 Static 2.95
2518	Hex 32 Bit Static	4.95	
2522	Dual 132 Bit Static	2.95	
2524	512 Static	9.95	
2525	1024 Dynamic	2.95	
2527	Dual 256 Bit Static	2.95	
2528	Dual 250 Static	4.00	
2529	Dual 240 Bit Static	4.00	
2532	Dual 80 Bit Static	2.95	
2533	1024 Static	2.95	
3341	Fifo	5.95	
7415670	4x4 Register File (TriState)	1.95	
UARTS			
A-Y-5-1011	80K 8AU0	5.95	

ESC CONTINENTAL SPECIALTIES PROTO BOARDS

Proto Board 203

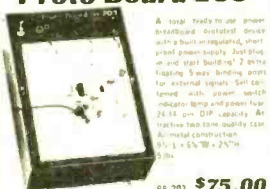

Model Number	L x W x H (Inches)	Price
PB-6	6.0 x 4.5 x 1.4	\$15.95
PB-100	6.0 x 4.5 x 1.4	\$19.95
PB-101	6.0 x 4.5 x 1.4	\$22.95

Proto Board 203A

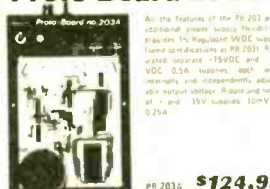

Model Number	L x W x H (Inches)	Price
PB-102	7.0 x 4.5 x 1.4	\$26.95
PB-103	9.0 x 6.0 x 1.4	\$44.95
PB-104	9.8 x 8.0 x 1.4	\$54.95

BK PRECISION 3 1/2-Digit Portable DMM

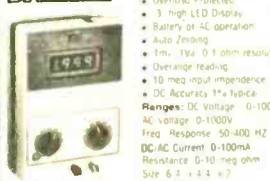

Model 2800 \$99.95
AC Adapter BC-28 \$9.00
Rechargeable Batteries BP-26 20.00
Carrying Case LC-28 7.50

ESC 100 MHz 8-Digit Counter

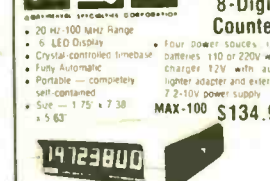

Model 100 — CLA \$3.95
Model 100 — CAI \$9.95

ESC Mini-Max 6 Digit 50MHz Frequency Counter

- Guaranteed frequency range of 100 Hz to 50 MHz
- Full 6 digit display with anti-gate window
- Fully automatic range, polarity, slope, trigger. Input level switching not required.
- Test-zero blanking—all zeros to the left of the first non-zero digit are blanked. Kilo Hertz and Mega Hertz decimal points automatically light up when the unit is turned on.
- Built in input overvoltage protection.
- Use 9V Battery or 110/220V power
- Complete with mini antenna.
- Lightweight — Only 8oz

MINI-MAX \$89.95

Accessories for Mini-Max

Part No.	Description	Price
MM-A4	Antenna	\$ 3.95
MM-C5	Carrying case	5.95
MM-IPC	Input cable with clip leads	3.95
MM-AC2	110V adapter	9.95
MM-AC3	220V adapter	9.95

\$10.00 Minimum Order — U.S. Funds Only
California Residents — Add 6% Sales Tax
Spec Sheets — 25¢
1979 Catalog Available—Send 41¢ stamp

NEW 1979 Catalog

Jameco ELECTRONICS

PHONE ORDERS WELCOME (415) 592-8097

MAIL ORDER ELECTRONICS — WORLDWIDE
1021 HOWARD AVENUE, SAN CARLOS, CA 94070
ADVERTISED PRICES GOOD THRU APRIL

The Incredible "Pennywhistle 103"



\$139.95 Kit Only

The Pennywhistle 103 is capable of recording data to and from audio tape without critical speed requirements for the recorder and it is able to communicate directly with another modem and terminal for telephone, hamming and communications. In addition, it is free of critical adjustments and is built with non-precision, readily available parts.

Data Transmission Method: Frequency-Shift Keying, Full Duplex, Inhibit Duplex, Variable

Maximum Data Rate: 300 Baud

Data Format: Asynchronous Serial (return to mark level required between each character)

Receive Channel Frequencies: 2025 Hz for space, 2225 Hz for mark, Switch selectable Low (Normal) = 1070 space, 1270 mark, High = 025 space, 2225 mark, 46 dbm acoustically coupled

Receive Sensitivity: 15 dbm nominal, adjustable from 6 dbm to 20 dbm

Transmit Level: 15 dbm nominal, adjustable from 6 dbm to 20 dbm

Receive Frequency Tolerance: Frequency reference automatically adjusts to allow for operation between 1850 Hz and 2400 Hz

Digital Data Interface: EIA RS-232C or 25, full current loop, receiver is auto-pulsed and non-polar

Power Requirements: 120 vac, single phase 10 Watts

Physical: All components mounted on a single 5" by 9" printed circuit board. All components included

Requires a VOM, Audio Oscillator, Frequency Counter and/or Oscilloscope to align

TRS-80 16K Conversion Kit

Expand your 4K TRS-80 System to 16K. Kit comes complete with:

- 8 each UPD416 (16K Dynamic Rams)
- Documentation for conversion

TRS-16K \$115.00

Special Offer - Order both your TRS-16K and the Sup'R MOD II Interface kit together (retail value \$144.95) for only \$139.95

COMPUTER CASSETTES

- 6 EACH 15 MINUTE HIGH QUALITY C-15 CASSETTES
- PLASTIC CASE INCLUDED
- 12 CASSETTE CAPACITY
- ADDITIONAL CASSETTES AVAILABLE #C-15-\$2.50 ea.

CAS-6 \$14.95



SUP 'R MOD II

UHF Channel 33 TV Interface Unit Kit

- Wide Band B/W or Color System
- Converts TV to Video Display for home computers, CCTV camera, Apple II, works with Comco Dazler, SOL-20, IRS-80, Challenger, etc.
- MOD II is pretuned to Channel 33 (UHF)
- Includes coaxial cable and antenna transformer.

MOD II \$29.95 Kit

RS-232 CONTROL CENTER

Plug in your modem, computer, terminal, printer, etc. and selectively control data flow.

- Same Control as Pennywhistle 103
- Fully self-contained
- Includes 2 master ports and 3 slave ports

PART NO. RS-232CC \$89.95 kit only



CASSETTE CONTROLLER

Ideal for use with the TRS 80 and others.

- Plug/Jack interface to any computer system requiring remote control of cassette functions.



#CC-100 \$29.50

63-Key Unencoded Keyboard



This is a 63-key, terminal keyboard newly manufactured by a large computer manufacturer. It is unencoded with SPST keys, unattached to any kind of PC board. A very solid molded plastic 13 x 4" base suits most application. IN STOCK \$29.95/each

Hexadecimal Unencoded Keypad

19-key pad includes 4-10 keys, ABCDEF and 2 optional keys and a shift key. \$10.95/each

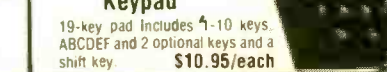

DIGI-KEY CORPORATION

Quality Electronic Components

TOLL FREE 1-800-346-5444

MINN., AK., HI. RESIDENTS 218-681-6674

DON'T FORGET OUR DISCOUNTS WHEN COMPARING PRICES

I.C.'S • RESISTORS • TRANSISTORS • CAPACITORS • DIODES • I.C. SOCKETS & PINS • SWITCHES • CLOCK MODULES • OPTOELECTRONICS • BREADBOARDING & TESTING DEVICES • DRAFTING SUPPLIES • DATA BOOKS • HEAT SINKS • WIRE • TOOLS... AND MORE... WRITE FOR FREE CATALOG

INTEGRATED CIRCUITS

7400	7401	7402	7403	7404	7405	7406	7407	7408	7409	7410	7411	7412	7413	7414	7415	7416	7417	7418	7419	7420	7421	7422	7423	7424	7425	7426	7427	7428	7429	7430	7431	7432	7433	7434	7435	7436	7437	7438	7439	7440	7441	7442	7443	7444	7445	7446	7447	7448	7449	7450	7451	7452	7453	7454	7455	7456	7457	7458	7459	7460	7461	7462	7463	7464	7465	7466	7467	7468	7469	7470	7471	7472	7473	7474	7475	7476	7477	7478	7479	7480	7481	7482	7483	7484	7485	7486	7487	7488	7489	7490	7491	7492	7493	7494	7495	7496	7497	7498	7499	7500
7400	7401	7402	7403	7404	7405	7406	7407	7408	7409	7410	7411	7412	7413	7414	7415	7416	7417	7418	7419	7420	7421	7422	7423	7424	7425	7426	7427	7428	7429	7430	7431	7432	7433	7434	7435	7436	7437	7438	7439	7440	7441	7442	7443	7444	7445	7446	7447	7448	7449	7450	7451	7452	7453	7454	7455	7456	7457	7458	7459	7460	7461	7462	7463	7464	7465	7466	7467	7468	7469	7470	7471	7472	7473	7474	7475	7476	7477	7478	7479	7480	7481	7482	7483	7484	7485	7486	7487	7488	7489	7490	7491	7492	7493	7494	7495	7496	7497	7498	7499	7500

I.C. Socket Prices Slashed

I.C. SOCKETS

BOTH SOLIDSTATE AND WIRE WRAP ARE THE SOLIDSTATE SOCKETS ARE LOW PROFILE WIRE WRAP SOCKETS ARE STANDARD PROFILE (LEVEL 1)

Part No.	Description	Price
14-1	8 Pin Socket Tab	0.08
14-2	8 Pin Socket Tab	0.08
14-3	16 Pin Socket Tab	0.16
14-4	16 Pin Socket Tab	0.16
14-5	16 Pin Socket Tab	0.16
14-6	20 Pin Socket Tab	0.20
14-7	20 Pin Socket Tab	0.20
14-8	24 Pin Socket Tab	0.24
14-9	24 Pin Socket Tab	0.24
14-10	18 Pin Wire Wrap	0.18
14-11	18 Pin Wire Wrap	0.18
14-12	24 Pin Wire Wrap	0.24
14-13	24 Pin Wire Wrap	0.24
14-14	20 Pin Wire Wrap	0.20
14-15	20 Pin Wire Wrap	0.20
14-16	16 Pin Wire Wrap	0.16
14-17	16 Pin Wire Wrap	0.16
14-18	8 Pin Wire Wrap	0.08
14-19	8 Pin Wire Wrap	0.08

THE "PROGRAMMABLE" CLOCK MODULE

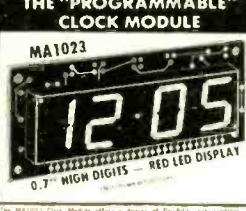

The MA1023 Clock Module offers a degree of flexibility not possible with conventional clock modules. It has been designed to manufacture high quality MA1023 Modules at a low price. The MA1023 Module is a unique and exciting new design. The MA1023 Module is easy to use. Simply connect the module to a power source and it will operate. The MA1023 Module is a unique and exciting new design. The MA1023 Module is easy to use. Simply connect the module to a power source and it will operate.

The "NIBBLER" A MICROCOMPUTER AT A MICROPRICE!

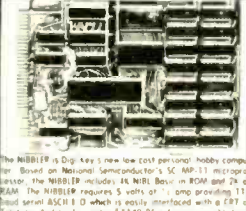

The NIBBLER is Dig-Key's new low cost personal hobby computer. Based on National Semiconductor's 5C AMP-11 microprocessor, the NIBBLER includes 4K NIBBLER Bytes in ROM and 2K of RAM. The NIBBLER requires 5 volts of power operating at 110 KHz. The NIBBLER is easy to use. Simply connect the module to a power source and it will operate.

PANASONIC ELECTROLYTIC CAPACITORS

Value	Radial Lead	Active Leads	Price
1000µF	10	10	1.00
1000µF	15	15	1.50
1000µF	20	20	2.00
1000µF	25	25	2.50
1000µF	30	30	3.00
1000µF	35	35	3.50
1000µF	40	40	4.00
1000µF	45	45	4.50
1000µF	50	50	5.00
1000µF	55	55	5.50
1000µF	60	60	6.00
1000µF	65	65	6.50
1000µF	70	70	7.00
1000µF	75	75	7.50
1000µF	80	80	8.00
1000µF	85	85	8.50
1000µF	90	90	9.00
1000µF	95	95	9.50
1000µF	100	100	10.00

MOLEX I.C. SOCKET PINS

Part No.	Description	Price
14-1	8 Pin Wire Wrap	0.08
14-2	8 Pin Wire Wrap	0.08
14-3	16 Pin Wire Wrap	0.16
14-4	16 Pin Wire Wrap	0.16
14-5	16 Pin Wire Wrap	0.16
14-6	20 Pin Wire Wrap	0.20
14-7	20 Pin Wire Wrap	0.20
14-8	24 Pin Wire Wrap	0.24
14-9	24 Pin Wire Wrap	0.24
14-10	18 Pin Wire Wrap	0.18
14-11	18 Pin Wire Wrap	0.18
14-12	24 Pin Wire Wrap	0.24
14-13	24 Pin Wire Wrap	0.24
14-14	20 Pin Wire Wrap	0.20
14-15	20 Pin Wire Wrap	0.20
14-16	16 Pin Wire Wrap	0.16
14-17	16 Pin Wire Wrap	0.16
14-18	8 Pin Wire Wrap	0.08
14-19	8 Pin Wire Wrap	0.08

WIRE WRAPPING WIRE

Part No.	Description	Price
14-1	8 Pin Wire Wrap	0.08
14-2	8 Pin Wire Wrap	0.08
14-3	16 Pin Wire Wrap	0.16
14-4	16 Pin Wire Wrap	0.16
14-5	16 Pin Wire Wrap	0.16
14-6	20 Pin Wire Wrap	0.20
14-7	20 Pin Wire Wrap	0.20
14-8	24 Pin Wire Wrap	0.24
14-9	24 Pin Wire Wrap	0.24
14-10	18 Pin Wire Wrap	0.18
14-11	18 Pin Wire Wrap	0.18
14-12	24 Pin Wire Wrap	0.24
14-13	24 Pin Wire Wrap	0.24
14-14	20 Pin Wire Wrap	0.20
14-15	20 Pin Wire Wrap	0.20
14-16	16 Pin Wire Wrap	0.16
14-17	16 Pin Wire Wrap	0.16
14-18	8 Pin Wire Wrap	0.08
14-19	8 Pin Wire Wrap	0.08

DATA BOOKS

Part No.	Description	Price
14-1	8 Pin Wire Wrap	0.08
14-2	8 Pin Wire Wrap	0.08
14-3	16 Pin Wire Wrap	0.16
14-4	16 Pin Wire Wrap	0.16
14-5	16 Pin Wire Wrap	0.16
14-6	20 Pin Wire Wrap	0.20
14-7	20 Pin Wire Wrap	0.20
14-8	24 Pin Wire Wrap	0.24
14-9	24 Pin Wire Wrap	0.24
14-10	18 Pin Wire Wrap	0.18
14-11	18 Pin Wire Wrap	0.18
14-12	24 Pin Wire Wrap	0.24
14-13	24 Pin Wire Wrap	0.24
14-14	20 Pin Wire Wrap	0.20
14-15	20 Pin Wire Wrap	0.20
14-16	16 Pin Wire Wrap	0.16
14-17	16 Pin Wire Wrap	0.16
14-18	8 Pin Wire Wrap	0.08
14-19	8 Pin Wire Wrap	0.08

PANASONIC METALIZED POLYESTER CAPACITORS

Value	Radial Lead	Active Leads	Price
1000µF	10	10	1.00
1000µF	15	15	1.50
1000µF	20	20	2.00
1000µF	25	25	2.50
1000µF	30	30	3.00
1000µF	35	35	3.50
1000µF	40	40	4.00
1000µF	45	45	4.50
1000µF	50	50	5.00
1000µF	55	55	5.50
1000µF	60	60	6.00
1000µF	65	65	6.50
1000µF	70	70	7.00
1000µF	75	75	7.50
1000µF	80	80	8.00
1000µF	85	85	8.50
1000µF	90	90	9.00
1000µF	95	95	9.50
1000µF	100	100	10.00

MICROPROCESSORS

Part No.	Description	Price
14-1	8 Pin Wire Wrap	0.08
14-2	8 Pin Wire Wrap	0.08
14-3	16 Pin Wire Wrap	0.16
14-4	16 Pin Wire Wrap	0.16
14-5	16 Pin Wire Wrap	0.16
14-6	20 Pin Wire Wrap	0.20
14-7	20 Pin Wire Wrap	0.20
14-8	24 Pin Wire Wrap	0.24
14-9	24 Pin Wire Wrap	0.24
14-10	18 Pin Wire Wrap	0.18
14-11	18 Pin Wire Wrap	0.18
14-12	24 Pin Wire Wrap	0.24
14-13	24 Pin Wire Wrap	0.24
14-14	20 Pin Wire Wrap	0.20
14-15	20 Pin Wire Wrap	0.20
14-16	16 Pin Wire Wrap	0.16
14-17	16 Pin Wire Wrap	0.16
14-18	8 Pin Wire Wrap	0.08
14-19	8 Pin Wire Wrap	0.08

STRIPPED WIRE

Part No.	Description	Price
14-1	8 Pin Wire Wrap	0.08
14-2	8 Pin Wire Wrap	0.08
14-3	16 Pin Wire Wrap	0.16
14-4	16 Pin Wire Wrap	0.16
14-5	16 Pin Wire Wrap	0.16
14-6	20 Pin Wire Wrap	0.20
14-7	20 Pin Wire Wrap	0.20
14-8	24 Pin Wire Wrap	0.24
14-9	24 Pin Wire Wrap	0.24
14-10	18 Pin Wire Wrap	0.18
14-11	18 Pin Wire Wrap	0.18
14-12	24 Pin Wire Wrap	0.24
14-13	24 Pin Wire Wrap	0.24
14-14	20 Pin Wire Wrap	0.20
14-15	20 Pin Wire Wrap	0.20
14-16	16 Pin Wire Wrap	0.16
14-17	16 Pin Wire Wrap	0.16
14-18	8 Pin Wire Wrap	0.08
14-19	8 Pin Wire Wrap	0.08

DIGI-KEY SWITCHING PANEL KIT MA1023



Part No. 5001E • Quick and Easy to Install!

DIGI-KEY CORPORATION BOOKSELLER!!!

NATIONAL SEMI CONDUCTOR DATA BOOKS
ADAM OSBORN MICROPROCESSOR SERIES
HOWARD W. SAMS
DIGITAL WORLD
AND INTRODUCING TAB BOOKS

PANASONIC METALIZED POLYESTER CAPACITORS

Value	Radial Lead	Active Leads	Price
1000µF	10	10	1.00
1000µF	15	15	1.50
1000µF	20	20	2.00
1000µF	25	25	2.50
1000µF	30	30	3.00
1000µF	35	35	3.50
1000µF	40	40	4.00
1000µF	45	45	4.50
1000µF	50	50	5.00
1000µF	55	55	5.50
1000µF	60	60	6.00
1000µF	65	65	6.50
1000µF	70	70	7.00
1000µF	75	75	7.50
1000µF	80	80	8.00
1000µF	85	85	8.50
1000µF	90	90	9.00
1000µF	95	95	9.50
1000µF	100	100	10.00

5% CARBON FILM RESISTORS

Part No.	Description	Price
14-1	8 Pin Wire Wrap	0.08
14-2	8 Pin Wire Wrap	0.08
14-3	16 Pin Wire Wrap	0.16
14-4	16 Pin Wire Wrap	0.16
14-5	16 Pin Wire Wrap	0.16
14-6	20 Pin Wire Wrap	0.20
14-7	20 Pin Wire Wrap	0.20
14-8	24 Pin Wire Wrap	0.24
14-9	24 Pin Wire Wrap	0.24
14-10	18 Pin Wire Wrap	0.18
14-11	18 Pin Wire Wrap	0.18
14-12	24 Pin Wire Wrap	0.24
14-13	24 Pin Wire Wrap	0.24
14-14	20 Pin Wire Wrap	0.20
14-15	20 Pin Wire Wrap	0.20
14-16	16 Pin Wire Wrap	0.16
14-17	16 Pin Wire Wrap	0.16
14-18	8 Pin Wire Wrap	0.08

Active Electronic Sales Corp.

Features.....

BRAND NEW!

JUST RELEASED
1979 IC MASTER
2500 pages



Complete integrated circuit data selector. Master guide to the latest I.C.'s including microprocessors and consumer circuits.

Free Quarterly Updates **\$39.95**

Texas Instruments Low Profile Sockets



Finest Quality Socket available in the world. Nobody can match Texas Instruments quality — a unique combination of I.C. technology and multi-metal expertise.

Over one million pieces in stock.

Contacts	Price	Contacts	Price
8 PIN	.08	22 PIN	.22
14 PIN	.12	24 PIN	.24
16 PIN	.14	28 PIN	.28
18 PIN	.18	40 PIN	.40
20 PIN	.20		

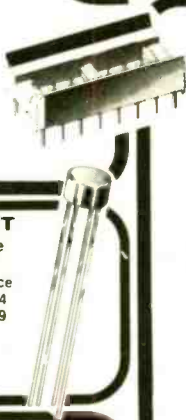

GENERAL INSTRUMENT

1 Amp Rectifiers (Epoxy)		1.5 Amp Single Phase Silicon Bridge Rectifiers	
Part No.	Price	Part No.	Price
1N4001	50V .029	W06M	600V .34
1N4002	100V .039	W08M	800V .39
1N4002	200V .045		
1N4004	400V .049		
1N4005	600V .055		
1N4006	800V .065		
1N4007	1000V .07		



SWITCHING DIODES

Part No.	Price
1N914 (100V 4NS)	.027
1N4148 (100V 4NS)	.027

L.E.D. LAMPS

LED209	T-1 3mm Red	.09
LED211	T-1 3mm Green	.14
LED212	T-1 3mm Yellow	.13
LED220	T-1-3/4 5mm Red	.11
LED222	T-1-3/4 5mm Green	.15
LED224	T-1-3/4 5mm Yellow	.14

MAJOR MANUFACTURER



CMOS I.C.'S

CD4000BE	17	CD4042BE	59	CD4515BE	\$1.95
CD4001BE	.17	CD4043BE	57	CD4516BE	.69
CD4002BE	17	CD4044BE	.55	CD4518BE	.79
CD4006BE	.87	CD4046BE	.99	CD4519BE	.47
CD4007BE	17	CD4049BE	33	CD4520BE	.69
CD4009BE	75	CD4050BE	33	CD4522BE	.99
CD4009BE	39	CD4051BE	54	CD4526BE	.99
CD4010BE	39	CD4052BE	54	CD4527BE	\$1.09
CD4011BE	17	CD4053BE	54	CD4528BE	.69
CD4012BE	17	CD4060BE	.99	CD4531BE	.74
CD4013BE	32	CD4066BE	44	CD4532BE	\$1.19
CD4014BE	.73	CD4068BE	21	CD4539BE	.99
CD4015BE	.69	CD4069BE	21	CD4543BE	\$1.39
CD4016BE	.35	CD4070BE	29	CD4555BE	.65
CD4017BE	.62	CD4071BE	21	CD4556BE	.65
CD4018BE	.69	CD4072BE	21	CD4581BE	\$2.25
CD4019BE	.39	CD4073BE	21	CD4582BE	.79
CD4020BE	.69	CD4075BE	21	CD4584BE	.60
CD4021BE	.69	CD4076BE	.79	CD4585BE	.90
CD4022BE	.69	CD4077BE	.25	40014PC	.59
CD4023BE	.17	CD4078BE	21	40085PC	\$1.09
CD4024BE	.49	CD4081BE	21	40097PC	.60
CD4025BE	.17	CD4082BE	21	40098PC	.60
CD4026BE	\$1.39	CD4085BE	.69	40160PC	.89
CD4027BE	.39	CD4086BE	.69	40161PC	.99
CD4028BE	.57	CD4093BE	.40	40162PC	.89
CD4029BE	.74	CD4104BE	\$2.25	40163PC	.99
CD4030BE	.35	CD4502BE	.85	40174PC	.89
CD4033BE	\$1.45	CD4508BE	\$2.25	40175PC	.89
CD4034BE	\$2.25	CD4510BE	.88	40192PC	\$1.19
CD4035BE	.64	CD4511BE	.99	40193PC	\$1.19
CD4040BE	.74	CD4512BE	.59	40194PC	\$1.10
CD4041BE	.74	CD4514BE	\$1.95	40195PC	\$1.10

MICROPROCESSOR CHIPS CPU's

Part No.	Price
8080A	5.95 5.50
6800	8.95 7.95

INTERFACE SUPPORT CIRCUITS

Part No.	Price	Part No.	Price
8212	1.98	8255	5.95
8214	4.95 3.95	8257	9.95
8216	1.98	8259	14.95
8224	2.75		
8226	1.98	6810	3.95 3.50
8228	4.75	6820	4.95 3.95
8238	4.75	6821	4.95 3.95
8251	5.95 4.95	6850	5.95 4.95
8253	14.95	6852	5.95 4.95



Z80-CTC	\$10.90	Z80-DMA	46.00 32.20
Z80A-CTC	\$13.10		
Z80-CPU	14.95 \$13.60	Z80-SIO/0	59.00 \$45.00
Z80A-CPU	24.95 \$16.20	Z80A-SIO/0	69.00 \$50.00
Z80-PIO	9.95 \$10.90	Z80-SIO/1	59.00 \$45.00
Z80A-PIO	11.95 \$13.10	Z80A-SIO/1	69.00 \$50.00

MOS Static RAM's

Part No.	Price
2102LFPC	\$1.19
1K 350NS (Low Power)	
2102-1PC	\$0.99
1K 450NS	
2114	\$7.50
4K (1K x 4) 300NS	
2114	\$6.50
4K (1K x 4) 450NS	

MOS Dynamic RAM's

Part No.	Price
4K 4027	\$2.95
4K (4K x 1) 300NS 16 PIN	
416-3	\$9.95
200NS	
416-5	\$7.95
300NS	

UART's

Part No.	Price
AY5-1013A	\$4.95
AY3-1015	\$5.95

1K CMOS RAM

Part No.	Price
5101	\$4.95
450NS (Low Power)	
5101	\$3.95
800NS	

LINEAR I.C.'S

LM324N	.49	Quad Op Amp
LM339N	.49	Quad Comparator
LM555N-8	.29	Timer
LM556N-14	.59	Dual Timer
LM723CN	.34	Voltage Regulator
LM723CH	.39	Voltage Regulator
LM741CH	.37	Op Amp
LM741CN-8	.24	Op Amp
LM1458N-8	.39	Dual Op Amp

VOLTAGE REGULATORS

PART NO.	UNIT PRICE	DESCRIPTION
LM323K	\$4.95	3 Amp 5 Volt Regulator
78H05KC	\$5.75	5 Amp 5 Volt Positive Regulator TO3
7800UC Series	.79	Positive Voltage Regulators (Plastic) 1 Amp 5, 6, 8, 12, 15, 18, 24 Volts
TO-220 / LM340T		
78M00HC Series	\$1.50	Positive Voltage Regulator 1/2 Amp 5, 6, 8, 12, 15, 18, 24 Volts
TO-5 / LM340H		
7800KC Series	\$1.60	Positive Voltage Regulator 1 Amp 5, 6, 8, 12, 15, 18, 24 Volts
TO-3 / LM340K		
78L00AWC Series	.29	Positive Voltage Regulator 100 MA 2.6, 5, 6.2, 8.2, 12, 15 Volts
TO-92		
7900UC Series	\$1.10	Negative Voltage Regulator 1 Amp 5, 6, 8, 12, 15, 18, 24 Volts
TO-220 / LM320T		
79M00HC Series	\$1.50	Negative Voltage Regulator 1/2 Amp 5, 6, 8, 12, 15, 20, 24 Volts
TO-5 / LM320H		
7900KC Series	\$1.95	Negative Voltage Regulator 1 Amp 5, 6, 8, 12, 15, 18, 24 Volts
TO-3 / LM320K		
78MGT2C	\$1.25	Dual In Line Adjustable 4 Terminal Positive Voltage Regulator
78GUI TO-220	\$1.45	1 Amp Adjustable Positive Voltage Regulator
78S40PC	\$2.50	Switching Regulator

All new major manufacturer production material offered. Largest variety of device types available anywhere.

Active Electronic Sales Corp.

P.O. BOX 1035 FRAMINGHAM, MASSACHUSETTS 01701

Over-the-counter sales,
12 Mercer Rd., Natick, Mass 01760
Behind Zayres on Rte. 9
Telephone Orders & Enquiries (617) 679-0077

IN CANADA 3 LOCATIONS

5651 FERRIER ST.
MONTREAL, QUEBEC
H4P 2K5
Tel: (514) 735-6425

4900 DUFFERIN ST.
DOWNSVIEW, ONTARIO
M3H 5S9
Tel: (416) 661-1115

MINIMUM ORDER \$10.00 • ADD \$2.00 TO COVER POSTAGE & HANDLING

Foreign customers please remit payment on an international bank draft or international postal money order in American dollars.

BAXTER CENTRE
1050 BAXTER ROAD
OTTAWA, ONTARIO
K2C 3P2
Tel: (613) 820-9471



NEW-TONE ELECTRONICS INTERNATIONAL

Original Japanese Replacement Parts for TV, Stereo and CB

25-UP 10-24 1-9			25-UP 10-24 1-9			25-UP 10-24 1-9			25-UP 10-24 1-9			25-UP 10-24 1-9			25-UP 10-24 1-9								
AN115	2.00	2.15	2.25	TA7061P	.85	1.05	1.15	UPD857C	7.90	8.30	9.40	25C458	.18	.23	.27	25C1096	.40	.50	.55	25C2029	1.45	1.75	1.95
AN214Q	1.45	1.65	1.85	TA7062P	1.05	1.20	1.35	UPD858C	5.90	6.20	6.90	25C460	.30	.35	.40	25C1114	3.30	3.50	3.70	25C2072	1.30	3.10	3.90
AN234	5.04	5.51	6.00	TA7063P	.55	.65	.75	UPD861C	7.80	8.20	9.30	25C481	.90	1.10	1.25	25C1166A	3.30	3.45	3.80	25C2076	.40	.55	.60
AN239	4.10	4.30	4.80	TA7074P	2.40	2.60	2.80	25A102	.20	.25	.30	25C482	.80	.95	1.10	25C1124	.75	.85	.95	25C2091	.80	1.00	1.10
AN247P	2.40	2.60	2.90	TA7089P	1.80	2.10	2.30	25A473	.45	.55	.60	25C485	.95	1.15	1.30	25C1127	.75	.85	.95	25C2092	1.70	1.90	2.10
AN274	1.40	1.65	1.85	TA7092P	9.50	10.00	10.50	25A484	1.20	1.40	1.60	25C495	.30	.40	.50	25C1162	.60	.70	.80	25C2098	2.90	3.10	3.35
AN313	2.90	3.10	3.30	TA7120P	.85	.95	1.05	25A495	.25	.30	.35	25C509	.25	.30	.35	25C1166	.20	.25	.30	25D72	.45	.60	.65
AN315	1.75	1.95	2.20	TA7139P	1.55	1.75	1.95	25A509	.30	.35	.40	25C5117	1.80	2.00	2.40	25C1172B	3.00	3.30	3.85	25D92	1.25	1.35	1.45
BA511A	1.60	1.80	2.05	TA7153P	5.70	5.90	6.10	25A562	.25	.30	.35	25C535	.25	.30	.35	25C1177	10.80	12.30	13.70	25C178	.85	.90	1.05
BA521	1.80	2.00	3.00	TA7203P	2.40	2.60	2.80	25A564	.25	.30	.35	25C620	.25	.30	.40	25C1209	.25	.30	.35	25D187	.30	.40	.45
HA1151	1.45	1.70	1.85	TA7204P	1.90	2.10	2.40	25A634	.35	.40	.45	25C632A	.30	.35	.40	25C1222	.20	.25	.30	25D218	2.40	2.60	2.90
HA1156W	1.55	1.75	1.95	TA7205P	1.50	1.70	1.90	25A636	.75	.95	1.15	25C634A	.30	.35	.40	25C1226A	.50	.55	.60	25D235	.55	.65	.75
HA1306W	1.90	2.10	2.40	TA7214P	4.10	4.30	4.50	25A643	.30	.35	.40	25C697A	2.65	2.95	3.20	25C1239	2.00	2.55	2.75	25D261	.30	.35	.40
HA1322	2.10	2.50	2.80	TA7215P	1.25	1.40	1.55	25A673	.30	.35	.40	25C710	.18	.25	.27	25C1306	1.30	1.45	1.60	25D267	2.45	2.65	2.85
HA1339A	2.40	2.60	2.90	TA7276P	3.85	6.00	6.20	25A678	.30	.35	.40	25C711	.18	.25	.27	25C1307	1.85	2.05	2.35	25D291	2.05	2.45	2.75
HA1342	2.50	2.70	3.00	TA7609P	4.00	4.32	4.80	25A683	.30	.35	.40	25C712	.18	.25	.27	25C1318	.30	.35	.40	25D313	.55	.65	.70
LA1222	1.50	1.55	1.60	TBA8105	2.75	2.97	3.30	25A684	.35	.40	.45	25C717	.30	.35	.40	25C1325	.25	.30	.35	25D325	.55	.65	.70
LA3101	3.45	3.60	3.75	TC5081P	2.90	3.10	3.30	25A695	.35	.40	.45	25C720	2.80	3.00	3.20	25C1330	.55	.65	.70	25D356	.65	.75	.85
LA4031P	1.75	1.95	2.20	TC5082P	3.30	3.45	3.80	25A699A	.40	.50	.60	25C732	.25	.30	.35	25C1331	.25	.30	.35	25D358	.65	.75	.85
LA4032P	1.75	1.95	2.20	TC5083P	7.54	8.02	8.50	25A706	.80	.95	1.05	25C734	.20	.25	.30	25C1332	.25	.30	.35	25D359	.75	.85	.95
LA4032S	2.25	2.40	2.55	UMIC001	4.10	4.30	4.80	25A720	.25	.30	.35	25C735	.20	.25	.30	25C1383	.25	.30	.35	25D375	.55	.65	.70
LA4400	1.85	2.05	2.35	UMIC002	4.10	4.30	4.80	25A745R	3.60	3.80	4.20	25C736	.20	.25	.30	25C1384	.25	.30	.35	25D391	.55	.65	.70
LD3141	1.70	1.80	1.90	UMIC003	4.10	4.30	4.80	25B22	.25	.30	.35	25C737	1.30	1.60	1.80	25C1424	2.60	2.70	2.80	25D427	1.75	1.95	2.20
LD3159	7.90	8.05	8.25	UMIC004	4.10	4.30	4.80	25B22	.25	.30	.35	25C761	.30	.32	.35	25C1448A	.60	.70	.80	25D525	7.00	1.00	1.10
MS1513L	2.00	2.20	2.50	UMIC005	4.10	4.30	4.80	25B47	.30	.40	.45	25C778	1.65	2.05	2.35	25C1475	.60	.70	.80	25D526	.55	.65	.75
MN3001	13.75	14.85	16.50	UMIC006	4.10	4.30	4.80	25B175	.20	.27	.30	25C781	1.85	2.05	2.35	25C1509	.40	.45	.50	25K19	.55	.65	.75
MN3002	9.62	10.40	11.55	UPC20C	2.00	2.40	2.50	25B186	.20	.27	.30	25C784	.25	.30	.35	25C1675	.20	.25	.30	25K22	.65	.75	.85
MN3003	5.87	6.34	7.04	UPC141C	2.14	2.32	2.50	25B187	.20	.27	.30	25C789	.75	.85	.95	25C1678	1.00	1.15	1.30	25K23A	.65	.75	.85
PLL01A	3.00	4.20	4.60	UPC157A	3.25	3.45	3.65	25B324	.25	.30	.35	25C793	1.90	2.10	2.40	25C1727	1.55	1.65	1.75	25K23B	.40	.45	.50
PLL02A	5.00	5.20	5.90	UPC394C	1.25	1.40	1.55	25B367	.85	.95	1.10	25C799	1.95	2.15	2.45	25C1728	.60	.70	.80	25K33	.55	.65	.75
PLL03A	7.60	8.00	8.80	UPC559A	1.25	1.40	1.55	25B405	.25	.30	.35	25C829	.20	.25	.30	25C1760	.65	.75	.85	25K34	.45	.55	.60
SC244A	6.24	7.02	7.80	UPC572C	3.45	3.55	3.65	25B407	.65	.80	.90	25C839	.25	.30	.35	25C1775	.30	.35	.40	25K41	.50	.55	.60
SG609	3.65	4.05	4.50	UPC574C	1.00	1.08	1.20	25B463	.80	1.00	1.10	25C867A	3.10	3.30	3.60	25C1816	1.35	1.60	1.80	25K45	.60	.65	.75
SG613	5.20	5.40	5.95	UPC575C2	1.25	1.40	1.55	25B474	.60	.70	.80	25C900	.20	.25	.30	25C1908	.25	.35	.40	25K46	1.35	1.55	1.75
SW5104	6.68	7.42	8.01	UPC576H	1.85	2.05	2.35	25B507	.70	.80	.90	25C920	2.70	3.00	3.20	25C1909	1.60	1.80	2.10	25K47	1.20	1.30	1.50
STK011	3.55	3.80	4.30	UPC592H2	.65	.75	.85	25B511	.60	.70	.85	25C945	.20	.25	.30	25C1945	4.30	4.80	5.20	25K48	1.70	2.00	2.30
STK013	7.40	7.80	8.60	UPC1001H2	1.85	2.05	2.35	25B597	1.60	1.85	2.30	25C1000BL	.30	.40	.45	25C1957	.50	.60	.70	25K49	.85	1.05	1.15
STK015	4.00	4.20	4.70	UPC1008C	4.10	4.30	4.80	25C183	.30	.40	.50	25C1013	.50	.60	.65	25C1969	3.40	3.80	4.20	25K50	1.25	1.40	1.55
STK050	23.10	25.98	28.86	UPC1020H	1.85	2.05	2.35	25C184	.30	.40	.50	25C1014	.45	.60	.65	25C1973	.60	.65	.70	25K51	1.25	1.40	1.55
STK415	7.10	7.60	8.10	UPC1025H	1.85	2.05	2.35	25C372	.18	.25	.28	25C1018	.50	.60	.70	25C1974	1.20	1.60	1.80	25K52	3.30	3.60	3.70
STK435	4.40	4.90	5.50	UPC1028H	1.40	1.62	1.80	25C373	.20	.25	.30	25C1030	1.70	2.00	2.30	25C1975	1.20	1.60	1.80	25K49	1.25	1.40	1.55
STK439	7.60	7.90	8.30	UPC1031H	2.52	2.74	2.96	25C380	.18	.25	.28	25C1159	2.90	3.10	3.30	25C2009	.70	.75	.80				
TA7058M	1.90	2.10	2.40	UPC1157H	2.90	3.10	3.30	25C381	.30	.35	.40	25C1056	4.30	4.50	4.70	25C2021	.50	.55	.60				
TA7055P	1.90	2.10	2.40	UPC1156H	1.85	2.05	2.35	25C387A	.27	.35	.40	25C1060	.65	.75	.85	25C2028	.45	.50	.55				
TA7060P	.65	.75	.85	UPD277C	8.70	8.90	9.10	25C394	.18	.23	.27												

Minimum Order \$10.00 - N.J. Residents add 5% Sales Tax.
We pay postage for prepaid orders of \$50.00 or more,
Under \$50.00, add \$1.00, Canada \$1.50.
Quantity Discount Prices: Ask for our complete price list.
Manufacturers' Inquiries welcome - All parts guaranteed.
Prices may change without notice. C.O.D. orders welcomed.

IMMEDIATE DELIVERY WITHIN 48 HOURS
ON ALL PARTS IN STOCK



NEW-TONE ELECTRONICS INTERNATIONAL
P.O. Box 1739, Bloomfield, N.J. 07003
New Jersey Phone: 201/748-5089
Monday thru Friday 8:30 to 5:30

TOLL FREE TELEPHONE
Nationwide 800/631-1250 Local 201/748-5089
In New York 212/732-1376

CIRCLE 39 ON FREE INFORMATION CARD

SEND FOR YOUR FREE TEK-EL CATALOG
Complete listings of IC Transistors, Capacitors, Resistors and readouts along with mixer toneunits and surplus materials.
Mohr's a Experimental & Scientific Wholesale Dealer, inquiries invited

LCD CLOCK and DISPLAYS

CLOCK KIT \$21.88
Uses the latest in space-age technology. Low current drain. Uses our K1077 mod. Quartz Crystal dependability.
Cat. No. K1091 Wt. 4 oz.

DISPLAY MODULE \$8.99
Originally designed for Times. \$25 factory cost. Requires 1/100 the power of LED's. Readout size .5" digits on a 2x1 3/8" crystal. Not multiplexed.
Cat. No. K1077 Wt. 4 oz.

WATCH DISPLAY \$2.88
Requires 30-32 Hz 45u wattle. 4 digits on a 1/2 1" Crystal.
Cat. No. K1119B Wt. 1 oz.
• DISPLAY SOCKET Wt. 1 oz. K1119B \$2.00

COD'S MAY BE PHONED! TAKE 10% OFF
TERMS: Add Postage EACH \$25 ORDER
RATED: Net 30
PHONE: (617) 245-9144 24 Hours!
MINIMUM ORDER: \$10

When ordering, always use catalog number, type no., the name of the magazine you are ordering from and the month.

TEK-EL Corp.
P.O. Box 761
Marblehead, Mass.
01945

CIRCLE 68 ON FREE INFORMATION CARD

CFR Associates, Inc.
Newton, N.H. 03858

DC/DC CONVERTER Outputs ±15 VDC @ 100mA, for +15 VDC input. Hi isolation, .05% reg'n. Only 2" square by 3/8" thick... \$19.00 ea.

SYNTHESIZER (MUSIC) VCO Only 1.5" square. Sawtooth & Sync outs are 10v P-P. 10Hz-10KHz, 1/2 Oct (exponential), plus linear input control responses. Needs ±15V @ 30mA. Ultra low drift. Over more than 60cycles w/dt.a. ... \$26.50 ea.

ANALOG DELAY IC Like SAD 1024A. Makes AUDIO DELAY in real time. With Data... \$17.95 ea.

ARTICLES & SYNTHESIS LITERATURE "TECH NOTES", our own R&D Newsletter. Featuring articles on building active filters, audio freq. shifters, VCO's, VCF's, flangers, chorus circuits, & other audio devices. Now in its 3rd volume.

TECH NOTES subscription (12 complete issues)... \$19.50

MATCHED FET SET Available in multiples of 2 after the first 4. These FETs are perfectly matched for use in AUDIO PHASE SHIFTERS. Two FETs give one 180° notch, and 4 FETs (1 set) give 2 notches. Build multi-stage "FAZORS" with B notches or more... \$6.95/set of 4
Additional Pairs of FET's are only... \$3.00, so 8 FET's are only... \$12.95

UNIVERSAL ACTIVE FILTER HYBRID Identical to Nat'l AF-100-ICJ. State-variable filter hybrid w/4 on-board op amps, capacitors, etc. A complete active filter with hipass, bandpass, lowpass, and notch outputs. Makes simple, low disto sine-wave oscillator. Easily tuned with 2 ext'l resistors or pots. Range DC-10KHz. With Data... \$6.95 ea.

"NON-LINEAR CIRCUITS H'BOOK" By Analog Devices. This is THE reference work on multipliers, dividers, log & anti-log ckt's... \$5.95 ea.

COMPLEMENTARY TO-220 POWER TRANSISTORS Prime, 2N6487/2N6490 and 2N5490/2N6109... \$1.49 ea.

IC MOTION DETECTOR This remarkable clear plastic IC 'senses' motion and sets off an external alarm circuitry. PLUS drives a small speaker directly. Think of the fantastic possibilities... Intrusion alarms, shoplifter alarms, object counters, and more. w/dt.a. ... Only \$6.95

TRIAD POWER TRANSFORMER Features 115/230VAC, 50/60 Hz primary, 24 VCT sec @ 1 amp. TRIAD FF-345X... \$4.50 ea.
4,000 mHz CRYSTAL .005 tolerance... \$2.49 ea.
5V, 50 WATT ZENER: TO-3 pkg., 10 amp capability... \$4.29 ea.

POWER TRANSISTORS 3055 TO-3 @ \$2.49 ea. 3772 TO-3, more power... 7.99 ea.

TBA-820 2 watt @ 12V power IC. With 2000 w/dt.a. ... \$1.05 ea.

COMPUTER GRADE ELECTROLYTIC: 40K mid @ 25 VDC, 40V surge... \$3.

MICRO MART

552 Summit Ave.
Westfield, N.J. 07090
(201) 654-6008

TTL	
7403 — 12	74H53 — 20
74H04 — 20	7474 — 25
7427 — 18	7482 — 50
7429 — 29	7492 — 35
7432 — 20	74145 — 40
7437 — 20	74151 — 50
7438 — 15	74180 — 50
7439 — 25	8235 — 50
7442 — 30	8266 — 20
7445 — 50	8563 — 50
7447 — 35	8815 — 25
7451 — 16	75324 — 75
LSI	
ICM 7107 DMM chip	\$15.00
MM 5369	\$2.95
11C90 Prescaler chip	\$16.00
Radio-TV Communications LINEAR IC'S	
ECG Replacement Series	
ECG 708/1.00	ECG 741/1.00
ECG 709/1.90	ECG 742/1.70
ECG 712/1.90	ECG 743/1.50
ECG 713/1.25	ECG 780/1.50
ECG 714/1.05	ECG 783/1.15
ECG 715/1.05	ECG 788/1.50
ECG 721/1.30	ECG 790/1.95
ECG 722/1.00	ECG 791/1.50
ECG 723/1.80	ECG 801/1.50
ECG 731/1.50	ECG 804/1.65
ECG 732/1.75	ECG 807/1.25
ECG 736/1.50	ECG 815/1.00
ECG 737/1.30	ECG 818/1.55
ECG 738/1.70	ECG 982/1.55
ECG 739/1.70	ECG 1061/2.00
ECG 740/1.30	ECG 1062/2.00
DEALER DISCOUNT - 15% - \$25 orders this category	
★ LM 377 — LM 380	★
MONTHLY SPECIAL	
2/2.00	5/4.00
DARLINGTON ARRAYS	
ULN 2001	ULN2003
ULN 2002	ULN2004
\$1.75 each any 4 for \$5.00	
Voltage Regulators	
7805, 7805T, 7812T, 7905T, 7912T	\$1.25 each

MOTION DETECTORS (specs included) \$3.00	
3" x 2 x 1 1/2" case with ming tabs/\$2.00	
RESISTOR ASSORTMENT includes 1/4W pre-formed leads 20 popular values. 1000 pcs./\$5.00	
CAPACITOR ASSORTMENT wide range of ceramics. 500 pcs./\$5.00	
OPERATIONAL AMPLIFIERS UA 741's — \$25	
DISPLAYS	
Jumbo Reds — 10/\$1.00, 100/\$9.00	
25 pack, assorted — \$3.00	
5' 7 seg. FND 500,501,503,507,510 — \$1.00 each	
BRIDGES	
1 1/2 Amp/.50, 6 Amp/\$2.00, 25 Amp/\$1.50	
IC SOCKETS	
8 pin/.15, 14 pin/.16, 16 pin/.18, 18 pin/.25, 24 pin/.35, 28 pin/.40, 40 pin/.50	
MOLEX PINS (7 pin/strip)	
500 for \$4.00	
1,000 for \$6.00	
REED SWITCH	
10/\$1.00	
IN 4148's (ITT): 30/\$1.00	
CONDENSER MIKE — \$1.50	
TO-5 Case TRANSISTOR SOCKETS, 5/\$1.00	
9V RADIO BATTERIES, 5/\$3.00	
6.3V, 1.2 Amp Transformer — \$1.25	
Self Adhesive Rubber Bumpers — 25 for \$1.00	
AUDIO CABLE: #24, 2 conductor \$1.00/100 ft.	
HARDWARE	
4-40x1/4, 1/2, 3/4 screws-1,000 pcs. ass'1/\$3.50	
6-32x1/4, 1/2, 3/4 screws-1,000 pcs. ass'1/\$4.00	
ELECTROLYTICS	
100 ul 10V/.25, 470 ul 10V/.25, 3200 ul 25V/.50	

Terms MICRO-MART accepts Visa, MC, and telephone C.O.D.'S. Foreign orders \$50.00 minimum plus shipping-US funds only. Orders under \$10.00 include \$2.00 for shipping/handling. All components guaranteed or money refunded. Immediate shipping. N.J. residents add 5% sales tax.
MICRO-MART • 552 SUMMIT AVE., WESTFIELD, N.J. 07090 • (201) 654-6008

CIRCLE 30 ON FREE INFORMATION CARD

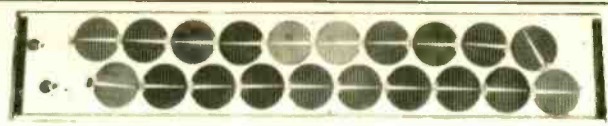

Electricity from the sun
GIANT 3 1/2 inch cell, delivers 1 amp \$8.50
Giant cell w/special motor & propellor \$10.25

SOLID STATE power supply 12 VDC 15 amp \$40.00
SOLID STATE power supply 5 VDC 35 amp \$50.00
Above supplies unused in original cartons. Operate from 115 volts AC 60 cycle. Made for computer work. Solid state, filtered, regulated, over voltage protected.

ULTRASONIC room alarm, intrusion detection with full data for hookup \$40.00

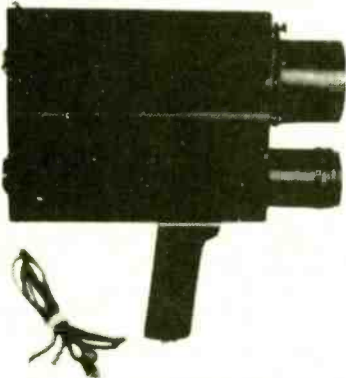

SEE IN THE DARK
IR viewer complete ready to operate. Guaranteed by the manufacturer. Portable, runs on lantern battery. New, see in total darkness. No shipments to Calif. Comes complete with built in IR source and adjustable focus lens.
SPL-21 \$199.00

All items FOB Lynn, Mass. Send for free 72 page catalog jam packed with goodies.
Micro Processor Power Supplies
Brand New 60% Discount. Send for List.
Meshna Inc., PO Box 62, E. Lynn, Mass. 01904

CIRCLE 42 ON FREE INFORMATION CARD

FAIRCHILD RED LED LAMPS

*FLV5057 Medium Size Clear Case REEMITTING These are not retested off-spec units as sold by some of our competition. These are factory prime, first quality, new units



10 FOR \$1.19
50 FOR \$4.95

"WE BOUGHT 250,000 PCS."

"THE COLOSSUS"

FAIRCHILD SUPER JUMBO LED READOUT

A full .80 inch character. The biggest readout we have ever sold! Super efficient. Compare at up to \$2.95 each from others!

YOUR CHOICE \$1.49 EA

FND 847 Common Anode

FND 850 Common Cathode

(6 for \$6.95)

NATIONAL SEMICONDUCTOR

NEW!

CAR CLOCK MODULE - #MA6008

\$6.99 each

Originally used by HYGAIN to indicate time and channel on an expensive C.B. Mini size, self contained module. Not a Kit. Four digits plus flashing indicator for seconds. Includes MM5369 and 3.58 MHZ crystal for super accurate time base. With hookup data.

INCLUDES CRYSTAL TIMEBASE!
WORKS ON 12 VDC!

MFGR's CLOSEOUT
LIMITED QTY.

16K DYNAMIC RAM CHIP

WORKS IN TRS-80 OR APPLE II

16K X 1 Bits 16 Pin Package. Same as Mostek 4116-4. 250 NS access. 410 NS cycle time. Our best price yet for this state of the art RAM. 32K and 64K RAM boards using this chip are readily available. These are new, fully guaranteed devices by a major mfg.

VERY LIMITED STOCK!

"MAGAZINE SPECIAL" — 8 For \$79.50

EXPERIMENTER'S CRYSTAL



262.144KHZ This frequency is 2 to the 18th power. Easily divided down to any power of 2, and even to 1HZ. New by CTS-Knight. A \$5 value.
\$1.25 each
4.00 MHZ — \$1.75

LAB-BENCH VARIABLE POWER SUPPLY KIT

5 to 20 VDC at 1 AMP. Short circuit protected by current limit. Uses IC regulator and 10 AMP Power Darlington. Very good regulation and low ripple. Kit includes PC Board, all parts, large heatsink and shielded transformer 50 MV. TYP. Regulation. \$15.99 KIT

FAIRCHILD PNP "SUPER TRANSISTOR"

2N4402 TO-92 Plastic Silicon PNP Driver High Current VCEO=40 HFE=50 to 150 at 150 MA FT=150 MHZ A Super BEEFED-UP Version of the 2N3906

8 FOR \$1

G.I. FULL WAVE BRIDGE

4 AMP 600 PIV
3/4 In. Square
With Lugs, #LM-1
75¢ ea. 3 For \$2

MOTOROLA POWER TRIAC

TO-220 CASE
15 AMP 400 PRV
SPECIAL 89¢ each
5 FOR \$3.95

COMPLEMENTARY POWER TRANSISTORS

SILICON NPN AND PNP. TO-220 CASE.
VCEO = 40V PD = 30 WATTS
FOR AUDIO POWER AMPS, ETC.
TIP29 - NPN
TIP30 - PNP

YOUR CHOICE
3 FOR \$1

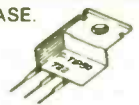

FET SALE!

2N4304 Brand New
N Channel Junction Fet
BVGD00-30V IDSS=15 MA Typ.
1500 uMHOS TO-18 Plastic
Case Mfg. by Teledyne.
6 FOR \$1

60 Hz CRYSTAL TIME BASE

\$4.95 (Complete Kit)
Uses MM5369 CMOS divider IC with high accuracy 3.579545 MHZ Crystal. Use with all MOS Clock Chips or Modules. Draws only 1.5 MA. All parts, data and PC Board included.

MALLORY COMPUTER GRADE CAPACITOR

30,000 MFD 15 WVDC
Small: 3 x 2 Inches
\$1.99 ea. 3 For \$4.99

RCA HAM & GOVERNMENT BAND CONVERTER KIT

LIMITED STOCK
Converts 134 to 150 MHZ FM to listen on regular AM Band. Complete kit, originally designed to sell for about twice our price. Includes P.C. Board, all parts and pre-punched aluminum enclosure! Precision tuning capacitor has coarse and fine control.
CLOSE OUT SPECIAL: \$5.99 KIT

Digital Research Corporation

(OF TEXAS)

P.O. BOX 401247B GARLAND, TEXAS 75040 • (214) 271-2461

TERMS: Add 30¢ postage, we pay balance. Orders under \$15 add 75¢ handling. No C.O.D. We accept Visa, MasterCard, and American Express cards. Tex. Res. add 5% Tax. Foreign orders (except Canada) add 20% P & H. 90 Day Money Back Guarantee on all items.

E.S. TRS-80 SERIAL I/O

● RS-232 compatible ● Can be used with or without the expansion bus ● On board switch selectable baud rates of 110, 150, 300, 600, 1200, 2400, parity or no parity odd or even, 5 to 8 data bits, and 1 or 2 stop bits, D.T.R. line. Board only \$19.95 Part No. 8010, with parts \$59.95 Part No. 8010A, assembled \$79.95 Part No. 8010C. No connectors provided, see below.

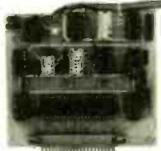

EIA/RS-232 connector Part No. DB25P \$6.00, with 9' B conductor cable \$10.95 Part No. DB25P9

3' ribbon cable with attached connectors to fit TRS-80 and our serial board \$19.95 Part No. 3CAB4D

HEX ENCODED KEYBOARD

E.S. This HEX keyboard has 19 keys, 16 encoded with 3 user definable. The encoded TTL outputs, 8-4-2-1 and STROBE are debounced and available in true and complement form. Four onboard LEDs indicate the HEX code generated for each key depression. The board requires a single +5 volt supply. Board only \$15.00 Part No. HEX-3, with parts \$49.95 Part No. HEX-3A. 44 pin edge connector \$4.00 Part No. 44P.

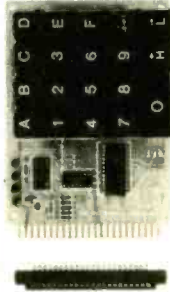

4K EPROM WMC inc

This board is designed to operate with any speed or power 1702A. Addressable in 4K byte increments and can be configured to occupy either 2K or 4K segments. It can be populated one memory chip at a time. Bare board \$30, board with parts \$200, assembled \$230. Part No. EPM-1



16K OR 32K EPROM WMC inc

Designed to operate with any speed or power 2708 or single voltage (+5V) 2716. Addressable in 4K increments and can occupy multiples of 4K. It can be populated one memory chip at a time. Has bank addressing and Phantom Disable. The board comes with an exclusive software program that can be placed in a 2708 or 2716 that will, when used in conjunction with a RAM memory board, check out every line on the EPM-2. Bare board \$30, board with parts with 2708 \$455, assembled \$485. Board with parts with 2716 \$1,225, assembled \$1,255. Part No. EPM-2

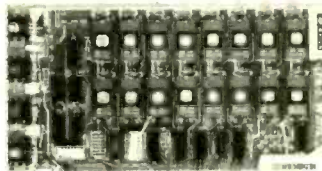

8080A CPU (With Eight Level Vector Interrupt Capability) WMC inc

Uses the 8080A and the 8224 clock chip. The crystal frequency used is 18 MHz and the vector interrupt chip is the 8214. The board will function normally without the interrupt circuitry. When the interrupt circuitry is built up, the board will respond to eight levels of interrupts. Designed to be a plug-in replacement for the IMSAI CPU board and will work in other computers with the appropriate modifications made to the ribbon cable connector pin out from the front panel. The board will work in systems without a front panel if the system has a PROM board that simulates the functions of the front panel. Bare board \$30, with parts \$185, assembled \$220. Part No. CPU-1

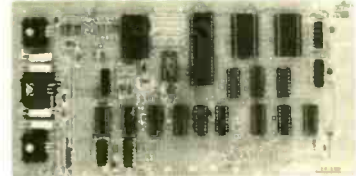

16K STATIC RAM WMC inc

Operates with any speed or power 2114. All input and output lines are fully buffered. Addressable in 4K byte increments. If the system has a front panel, the board will allow itself to be protected. If there is no front panel, the board will not allow itself to be protected. The board has Bank Address capability, Phantom Disable, MWRITE, and selectable wait states. Bare board \$30, board with parts \$665. Part No. MEM2

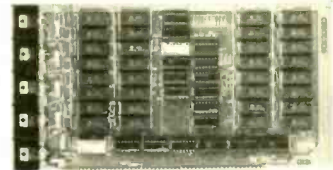

S-100 BUS ACTIVE TERMINATOR *

Board only \$14.95 Part No. 900, with parts \$24.95 Part No. 900A



9 AND 13 SLOT MOTHER BOARDS WMC inc

All traces are reflow solder covered and both sides are solder masked. The connectors used on these boards are the IMSAI™ type (.125" between pins, .250" between rows). Spacing between connectors is .750". All lines, except power and ground, have a passive RC network termination available. There is a kluge area available that will accept two 40 pin sockets and one 36 pin socket. The circuitry for supplying three separate regulated voltages to the kluge area is contained on the board. Part No. GMB-12 \$40 bare, \$105 kit, \$120 assembled. Part No. GMB-9 \$35 bare, \$90 kit, \$105 assembled.

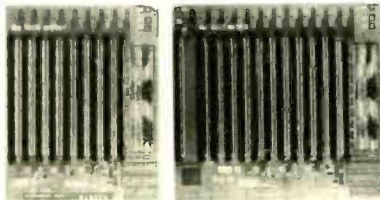

PIICEON 65K DYNAMIC RAM

Main memory for microcomputers, intelligent terminals, business systems, medical systems, and OEM systems. ● High density random access memory 48K bytes or 64K bytes ● Fully buffered ● S-100 bus compatible ● Low power (dynamic memory) ● Transparent refresh ● Digital delay line techniques for reliable operation ● Multiple boards allowed using hardware or software controlled bank select ● "Phantom" signal for RAM/ROM overlap ● All boards are fully tested prior to shipment. Operating System test and extensive bit pattern testing. ● Works directly in 8080A processors or Z-80 environment at 2MHz ● Currently used by industry ● 1 year warranty. Only available assembled and tested with 48K \$1,250 Part No. 48K, or with 65K \$1,475 Part No. 65K

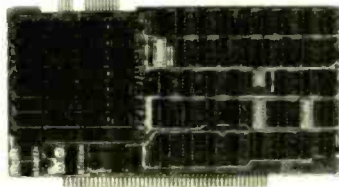

8K EPROM PIICEON

Saves programs on PROM permanently (until erased via UV light) up to 8K bytes. Programs may be directly run from the program saver such as fixed routines or assemblers. ● S-100 bus compatible ● Room for 8K bytes of EPROM non-volatile memory (2708's). ● On-board PROM programming ● Address relocation of each 4K or memory to any 4K boundary within 64K ● Power on jump and reset jump option for "turnkey" systems and computers without a front panel ● Program saver software available ● Solder mask both sides ● Full silkscreen for easy assembly. Program saver software in 1 2708 EPROM \$25. Bare board \$35 including custom coil, board with parts but no EPROMS \$139, with 4 EPROMS \$179, with 8 EPROMS \$219.

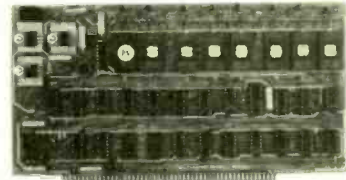

To Order:

Mention part number, description, and price. In USA, shipping paid for orders accompanied by check, money order, or Master Charge, BankAmericard, or VISA number, expiration date and signature. Shipping charges added to C.O.D. orders. California residents add 6.5% for tax. Outside USA add 10% for air mail postage and handling, no C.O.D.'s. Checks and money orders must be payable in US dollars. Parts kits include sockets for all ICs, components, and circuit board. Documentation is included with all products. Prices are in US dollars. No open accounts. To eliminate tariff in Canada boxes are marked "Computer Parts." Dealer inquiries invited. 24 Hour Order Line: (408) 226-4064



For free catalog including parts lists and schematics, send a self-addressed stamped envelope.

ELECTRONIC SYSTEMS

Dept. RE5, P. O. Box 21638, San Jose, CA USA 95151

INTEGRATED ELECTRONICS

540 Weddell Drive, #4, Sunnyvale, CA 94086 (408)734-8470

SN76477 Complex Sound Generator \$3.50
This is a programmable sound effect generator capable of producing a wide variety of sounds from high to low frequency. Using this chip & a small number of inexpensive parts, a variety of projects may be built. Spec sheets & application notes \$1.00

TL500 Analog Processor \$8.50
The TL500 contains all the active analog elements for an automatic zeroing and automatic polarity. It is a 13-bit dual-slope A/D converter that has true differential inputs. It requires 3 caps. & 2 resistors with no special matching or tolerances. It is designed for use with the TL502. Spec sheet \$.25

TL502 Digital Panel Meter L.D. \$7.50
This is a 4 1/2-digit Digital Panel Meter L.D. that is designed to interface with the TL500 analog processor. It provides base drive for external PNP digit & segment drivers providing direct interface with 7-segment display. Spec sheet \$.25

LD130 A/D Converter \$5.50
Single-reference voltage, auto zero and auto polarity. It is designed for Digital Voltmeters, Panel Meters, Digital Thermometers, Microprocessor Interfaces to Analog Signals, & General Instrumentation. 34-pg. Spec & Application notes \$2.50

MM5865 Programmable Stopwatch \$7.50
7-function Universal Timer and Stopwatch. Start/stop with elapse time, start/stop accumulative event time, split, sequential total elapse time, rally total elapse time, program up and down count. It uses 32.8 KHz crystal or external clock. Spec sheet & 10-page Application notes \$1.50

32.8 KHz Crystal \$4.00

Minimum order \$5.00 US currency. Check or money order only. Add 5% to cover shipping and handling charges. Calif. residents add 6% sales tax. Santa Clara County residents add 6.5% sales tax.

CIRCLE 58 ON FREE INFORMATION CARD

HOBBY WORLD

CALL TOLL FREE (800) 423-5387
CA, HI, AK, (213) 886-9200

TOP QUALITY, LO-COST SPECIALS

Order by Cat No. and description

Cat No.	Description	Price
1142	DATA CASSETTES, 10 min	2.00
1147	DISKETTE, 5 1/4" soft sector, TRS-80	3.25
1224	SCAND ACTIVATED SWITCH, vna	.50
1226	LINE COUPLER, 1/8" 2 cond w/ plug	.25
1033	2.7uf TANTALUM, 30V axial	.15
1031	22uf TANTALUM, 10V axial	.15
1007	3uf TANTALUM, 35V axial	.15
1233	1N648 SWITCHING DIODES, full lead	25 for 1.00
1012	TELETYPE TTL DATA CARD	1.50
21102-2	250sect 21102 RAM	1.50
1291	650sect 21102 RAM	.85
1289	8 POS ROCKER DP SWITCH	1.25
1020	100uf 25V uppr cap	.20
1156	TR-80 W/4 MEMORY ADD-ON KIT	95.00
1199	125-232 PRINTER INTERFACE	1.00
1225	3" READOUT, MAN 74 equal (P5748)	.75
1117	14 PIN SOLDER TAIL SOCKETS	.14
1117	16 PIN SOLDER TAIL SOCKETS	.16
1117	24 PIN SOLDER TAIL SOCKETS	.36
1001	1N4001 50V 1A RECTIFIER	20 for 1.00
1018	5.1V 1WATT ZENER	10 for 1.00
1018	12V 1WATT ZENER	10 for 1.00
1038	25 AMP 100 PPM "BUCKET" BRIDGE	1.50
1113	SCHEIDTGER BECK, genl type, 30W	1.50
1020	47uf 6.3V uppr lyle	10 for 1.00
1020	22uf 250V axial lyle	.15
1067	40 CONDUCT RIBBON CABLE per foot	1.00
1104	104 BIT, 2 parallel, 2 serial ports	140.00
1088	PRCHM PROGRAMMER 2704, 16, from OAI	275.00
1154	500 KBIT NUMBER COPY DRIVE, SA400	275.00
1031	5" READOUT, CC, FND-501	.75

COMPUCRUISE only \$165

Navigational computer for mobile use. Features cruise control, fuel management, trip computer, timer/counter, warns low fuel. Compensates for 1000 boards to metric, 44 functions. Mounts easily on dash. Easy to read bright blue digits. With installation instructions. Cat No. 1166

"LIFT-IT" PC DUPLICATING KIT \$25

Copy PC patterns from magazines quickly and easily! No additional materials required. No camera needed! With 10 x 12 sheet of film. We stock all refills with step-by-step instructions. Cat No. 1201

IC MASTER 1979 \$45

FACTORY FRESH PREMI IC'S LIDS, READOUTS, RECTIFIERS, ZENERS, TRS-80 ADD-ONS, 5 1/4" DISKETTS, PC AIDS, TEST EQUIPMENT, BOOKS, SOFTWARE, AND MORE

ORDER BY MAIL, PHONE, MAILORDER, VISA, C.O.D. OR 1 ADD \$15.00 FOR POSTAGE & HANDLING.

TRS-80 SOFTWARE CASSETTES

Cat No.	Description	Price
1093	SARGON CHESS B.	19.95
1041	STAR TREK B.	5.95
1036	SCRIP GAME SAMPLER, 1/8	5.95
1042	TAROT I, II	5.95
1079	CRIBbage I, II	9.95
1792	REAL TIME LUNAR LANDER B.	7.95
1195	BEAD CHALLENGER B.	4.95
1064	AIR RAID B.	4.95
1807	PILOT B.	4.95
1047	DITHED B.	1.95
1043	SMALL BUSINESS BOOKKEEPING B.	14.95
1051	DAILY BIRTHDAY PROGRAM B.	1.95
1049	MACRO TEST EDITOR B.	9.95
1016	INVENTORY MANAGER B.	1.95
1153	LDI-80, text editor B (32K)	19.95

SEND FOR FREE SPRING CATALOG FEATURING:

1935 BUSINESS CTR DR 6R4 NORTHRIDGE, CA 91324

CIRCLE 57 ON FREE INFORMATION CARD

REGULATED POWER SUPPLIES

POWER SYSTEMS # PS1111
115-230V 50/60 cy, 1n 5v DC at 35A out.
6"x 16"x 15 1/2" 26 lbs. shipping weight \$85.00

POWER SYSTEMS # PS1106
115-230V 50/60 cy, 1n 2v DC at 15A out.
11"x 16"x 5 1/2" 19 lbs. shipping weight. \$75.00 (OV PROTECT)

CMOS (DIODE CLAMPED)

4001	- 18 4015	- 37 4050	- 25 74C14	- 45
4006	- 18 4020	- 30 4063	- 110 74C83	- 1.15
4007	- 95 4011	- 90 4055	- 1.25 74C86	- .40
4008	- 18 4022	- 90 4066	- 70 74C93	- 75
4009	- 37 4023	- 18 4069	- 26 74C161	1.40
4010	- 37 4024	- 75 4071	- 18 74C150	1.05
4011	- 18 4025	- 18 4072	- 21 74C161	1.05
4012	- 18 4027	- 37 4076	- 97 74C174	1.05
4013	- 39 4028	- 80 4510	- 70 74C175	1.05
4014	- 75 4029	- 95 74C00	- 22 74C192	1.20
4015	- 75 4030	- 33 74C02	- 22 74C193	1.20
4016	- 29 4035	- 97 74C08	- 22 74C901	1.80
4017	- 1.06 4042	- 85 74C10	- 22 74C902	1.48
4018	- 90 4049	- 35 74C73	- 85 74C914	1.70

PRINTED CIRCUIT BOARD

4-1/2" x 6-1/2" SINGLE SIDED EPOXY BOARD 1/16" thick, unetched \$5/2.60

7 WATT LD 65 LASER DIODE 1R \$8.95

2N 3820 P FET \$ 45
2N 5457 N FET \$ 45
2N2646 UJT \$ 45
ER 900 TRIGGER DIODES 4 \$1.00
2N 6028 PNP UJT \$ 65

MINIATURE MULTI-TURN TRIM POT 100, 1K, 2K, 5K, 10K, 20K, 50K, 200K, 1M, 2Meg, \$7.5 each 3/2.00

CHARGED COUPLER DEVICES
CCD 201C 100x100 Image Sensor \$95.00
CCD 202C 100x100 Image Sensor \$145.00

VERIPAX PC BOARD \$4.00
This board is a 1/16" single sided paper epoxy board, 4" x 6 1/2" DRILLED and ETCHED which will hold up to 21 single 14 pin IC's or 8, 16, or LSI DIP IC's with buses for power supply connector.

FP 10 PHOTO TRANS \$.50
RED, YELLOW, GREEN, or AMBER
LARGE LED's, 2" \$6/1.00
TTL-118 OPTO-ISOLATOR \$.75
MCT-8 OPTO ISOLATOR \$.80
1 WATT ZENERS: 3.3, 4.7, 5.1, 5.6, 9.1, 10, 12, 15, 18, or 22V \$6/1.00
MCM 6571A 7 x 9 character font \$ 10.75

8130 - 2.95 8834 - 2.25
8131 - 2.95 8837 - 2.25
87380 - 2.25 8838 - 2.25
8830 - 2.95

Silicon Power Rectifiers

PRV 1A	3A	12A	50A	125A	240A	
100	06	14	30	80	370	5.00
200	07	20	35	1.16	4.95	6.00
400	09	25	50	1.40	6.50	9.50
600	11	30	70	1.80	8.50	12.50
800	15	35	90	2.30	10.50	16.50
1000	20	45	110	2.75	12.50	20.00

SAO 1024 PRECISION 1024 stage analog "Bucket Brigade" shift register. \$14.95

IN 4148 IIN9141 15/\$1.00

TRANSISTOR SPECIALS

2N6233-NPN SWITCHING POWER	\$ 1.95
MPF-8004 C BR RF Transistor NPN	\$ 1.00
2N1546 PNP GE TO-3	\$.75
2N4908 PNP Si TO-3	\$ 1.00
2N5086 PNP Si TO-92	4/5 1.00
2N3137 NPN Si RF	\$.55
2N3919 NPN Si TO-3 RF	\$ 1.50
2N1420 NPN Si TO-5	3/5 1.00
2N3276 NPN Si TO-66	\$.70
2N2222 NPN Si TO-18	5/5 1.00
2N3055 NPN Si TO-3	6/5 1.00
2N3904 NPN Si TO-92	6/5 1.00
2N3906 PNP Si TO-92	6/5 1.00
2N5296 NPN Si TO-220	\$.50
2N6109 PNP Si TO-220	\$.55
3N3638 PNP Si TO-5	5/5 1.00
MPSA 13 NPN Si	4/5 1.00

TTL IC SERIES

7400 - 18	7448 - 68	74153 - 81
7401 - 15	7449 - 68	74154 - 81
7402 - 15	7450 - 18	74155 - 88
7403 - 15	7472 - 25	74156 - 88
7404 - 16	7474 - 29	74157 - 88
7405 - 18	7476 - 30	74158 - 80
7406 - 18	7478 - 35	74159 - 88
7407 - 22	7479 - 35	74160 - 88
7408 - 26	7480 - 37	74161 - 95
7409 - 18	7481 - 45	74162 - 80
7410 - 18	7482 - 28	74163 - 100
7411 - 18	7483 - 28	74164 - 100
7412 - 18	7484 - 42	74165 - 80
7413 - 38	7485 - 55	74166 - 75
7414 - 80	7486 - 55	74167 - 75
7415 - 22	7487 - 42	74168 - 80
7416 - 25	7488 - 87	74169 - 100
7417 - 25	7489 - 85	74170 - 100
7418 - 27	7490 - 78	74171 - 78
7419 - 27	7491 - 90	74172 - 78
7420 - 27	7492 - 90	74173 - 80
7421 - 27	7493 - 80	74174 - 80
7422 - 27	7494 - 80	74175 - 80
7423 - 27	7495 - 80	74176 - 80
7424 - 27	7496 - 80	74177 - 80
7425 - 27	7497 - 80	74178 - 80
7426 - 27	7498 - 80	74179 - 80
7427 - 27	7499 - 80	74180 - 80
7428 - 27	7500 - 80	74181 - 80
7429 - 27	7501 - 80	74182 - 80
7430 - 27	7502 - 80	74183 - 80
7431 - 27	7503 - 80	74184 - 80
7432 - 27	7504 - 80	74185 - 80
7433 - 27	7505 - 80	74186 - 80
7434 - 27	7506 - 80	74187 - 80
7435 - 27	7507 - 80	74188 - 80
7436 - 27	7508 - 80	74189 - 80
7437 - 27	7509 - 80	74190 - 80
7438 - 27	7510 - 80	74191 - 80
7439 - 27	7511 - 80	74192 - 80
7440 - 27	7512 - 80	74193 - 80
7441 - 27	7513 - 80	74194 - 80
7442 - 27	7514 - 80	74195 - 80
7443 - 27	7515 - 80	74196 - 80
7444 - 27	7516 - 80	74197 - 80
7445 - 27	7517 - 80	74198 - 80
7446 - 27	7518 - 80	74199 - 80
7447 - 27	7519 - 80	74200 - 80

DATA CASSETTES 1/2 HR \$ 95

14 pin headers 3/\$1.00

MM 5387AA new clock chip which will directly drive LED's 12/24 hrs., 1 supply & alarm \$5.95

NO. 30 WIRE WRAP WIRE SINGLE STRAND 100' \$1.40

ALCO MINATURE TOGGLE SWITCHES

MTA 106 SPDT \$.95

MTA 206 DPDT \$ 1.70

MTA 206 P DPDT CENTER OFF \$ 1.85

MST 206 P DPDT CENTER OFF \$ 1.85

LEVER SWITCH \$ 1.85

Full Wave Bridges DIP SOCKETS

100	200	300	400	500	600
1.00	1.25	1.50	2.00	2.50	3.00
1.00	1.25	1.50	2.00	2.50	3.00
1.00	1.25	1.50	2.00	2.50	3.00
1.00	1.25	1.50	2.00	2.50	3.00
1.00	1.25	1.50	2.00	2.50	3.00
1.00	1.25	1.50	2.00	2.50	3.00

SANKEN AUDIO POWER AMPS
S: 1010 G 10 WATTS \$ 7.80
S: 1020 G 20 WATTS \$15.70
S: 1050 G 50 WATTS \$28.50

TANTALUM CAPACITORS
22UF 35V 5/31.00 6.8UF 50V 4/31.00
47UF 35V 5/8.00 10UF 10V \$ 25
68UF 35V 5/8.00 22UF 25V \$ 4.00
1UF 35V 5/1.00 15UF 35V 3/51.00
2.2UF 20V 5/1.00 30UF 6V 5/81.00
3.3UF 20V 4/51.00 33UF 20V \$ 4.00
4.7UF 15V 5/1.00 47UF 20V \$ 3.50
68UF 15V \$ 5.00

LINEAR CIRCUITS
LM 741 - 31 LM 318 - 84 LM 301/747 - 25
LM 307 - 30 LM 307 - 30
LM 308 - 35 LM 308 - 35
LM 311 - 35 LM 311 - 35
LM 318 - 70 LM 318 - 70
LM 324 - 70 LM 324 - 70
LM 339 - 110 LM 339 - 110
LM 358 - 70 LM 358 - 70
LM 370 - 110 LM 370 - 110
LM 380 - 95 LM 380 - 95
LM 377 - 1.65 LM 377 - 1.65
LM 390 - 25 LM 390 - 25
LM 392 - 1.25 LM 392 - 1.25
LM 395 - 1.00 LM 395 - 1.00
LM 396 - 1.00 LM 396 - 1.00
LM 397 - 1.00 LM 397 - 1.00
LM 398 - 1.00 LM 398 - 1.00
LM 399 - 1.00 LM 399 - 1.00
LM 400 - 1.00 LM 400 - 1.00
LM 401 - 1.00 LM 401 - 1.00
LM 402 - 1.00 LM 402 - 1.00
LM 403 - 1.00 LM 403 - 1.00
LM 404 - 1.00 LM 404 - 1.00
LM 405 - 1.00 LM 405 - 1.00
LM 406 - 1.00 LM 406 - 1.00
LM 407 - 1.00 LM 407 - 1.00
LM 408 - 1.00 LM 408 - 1.00
LM 409 - 1.00 LM 409 - 1.00
LM 410 - 1.00 LM 410 - 1.00
LM 411 - 1.00 LM 411 - 1.00
LM 412 - 1.00 LM 412 - 1.00
LM 413 - 1.00 LM 413 - 1.00
LM 414 - 1.00 LM 414 - 1.00
LM 415 - 1.00 LM 415 - 1.00
LM 416 - 1.00 LM 416 - 1.00
LM 417 - 1.00 LM 417 - 1.00
LM 418 - 1.00 LM 418 - 1.00
LM 419 - 1.00 LM 419 - 1.00
LM 420 - 1.00 LM 420 - 1.00
LM 421 - 1.00 LM 421 - 1.00
LM 422 - 1.00 LM 422 - 1.00
LM 423 - 1.00 LM 423 - 1.00
LM 424 - 1.00 LM 424 - 1.00
LM 425 - 1.00 LM 425 - 1.00
LM 426 - 1.00 LM 426 - 1.00
LM 427 - 1.00 LM 427 - 1.00
LM 428 - 1.00 LM 428 - 1.00
LM 429 - 1.00 LM 429 - 1.00
LM 430 - 1.00 LM 430 - 1.00
LM 431 - 1.00 LM 431 - 1.00
LM 432 - 1.00 LM 432 - 1.00
LM 433 - 1.00 LM 433 - 1.00
LM 434 - 1.00 LM 434 - 1.00
LM 435 - 1.00 LM 435 - 1.00
LM 436 - 1.00 LM 436 - 1.00
LM 437 - 1.00 LM 437 - 1.00
LM 438 - 1.00 LM 438 - 1.00
LM 439 - 1.00 LM 439 - 1.00
LM 440 - 1.00 LM 440 - 1.00
LM 441 - 1.00 LM 441 - 1.00
LM 442 - 1.00 LM 442 - 1.00
LM 443 - 1.00 LM 443 - 1.00
LM 444 - 1.00 LM 444 - 1.00
LM 445 - 1.00 LM 445 - 1.00
LM 446 - 1.00 LM 446 - 1.00
LM 447 - 1.00 LM 447 - 1.00
LM 448 - 1.00 LM 448 - 1.00
LM 449 - 1.00 LM 449 - 1.00
LM 450 - 1.00 LM 450 - 1.00
LM 451 - 1.00 LM 451 - 1.00
LM 452 - 1.00 LM 452 - 1.00
LM 453 - 1.00 LM 453 - 1.00
LM 454 - 1.00 LM 454 - 1.00
LM 455 - 1.00 LM 455 - 1.00
LM 456 - 1.00 LM 456 - 1.00
LM 457 - 1.00 LM 457 - 1.00
LM 458 - 1.00 LM 458 - 1.00
LM 459 - 1.00 LM 459 - 1.00
LM 460 - 1.00 LM 460 - 1.00
LM 461 - 1.00 LM 461 - 1.00
LM 462 - 1.00 LM 462 - 1.00
LM 463 - 1.00 LM 463 - 1.00
LM 464 - 1.00 LM 464 - 1.00
LM 465 - 1.00 LM 465 - 1.00
LM 466 - 1.00 LM 466 - 1.00
LM 467 - 1.00 LM 467 - 1.00
LM 4

ELECTRONIC SUPERMARKET

P.O. BOX 619 — (DEPT. R-4) LYNNFIELD, MASS. 01940
Phone orders (617) 532-2323 — Use your Charge Card - Visa-MC-AE
TERMS: Add Postage; No. C.O.D.'s — \$10.00 Minimum Order

BURGLAR ALARM BOARD \$2.88



Neat new closed-circuit alarm board will latch a relay if the alarm circuit is opened. This unit operates on 12-VDC at such a low price, it makes a perfect compact alarm component. With Data, Qty Ltd. Sh. Wt. 6 oz. 8K30267, \$2.88 5 for \$13.88. 8K30267, \$13.88/5

ASC11 KEYBOARD CONSOLE



LOOK!

GOOD TO EXCELLENT CONDITION
This Honeywell No. 7410093-001 ASC11 encoded microswitch data entry format keyboard. Comes with fully populated I.C. boards. Some 100 I.C.'s, 7100 & 71400 series, or some are dot matrix I.C.'s, LSI chips TMC 4907 — a 4 mhz crystal, a Mostek MK2002, plugs into a wire wrap board of 120 sockets. Also 2-large heat sinks, 4-2N3055 xistors, 2-2N3668, 4-jumper cables with dip plugs attached, 30 lamps No. 382 & other stuff. Power required for keyboard +5VDC, — 12VDC regulated. Pin out supplied for keyboard only. Keyboard in console is a complete assembly ASC11 enclosed & is easily removed to fit or use as is. The additional circuitry was used to drive status indicators. Format, program level, check & display etc. Console size: 19" wd. x 16" dp. x 8" hg. rear, front slopes to 2 3/4" hg. Sh. Wt. 16 Lbs. 8W0588, \$68.88 3 for \$188.88. 8W0588, \$188.88/3

COMPUTER STUFF

TTY . . . MO33 . . . ASR . . .	\$348.88
TTY . . . MD33 . . . KSR . . .	\$288.88
TTY . . . MD33 . . . RO . . .	\$248.88
TTY . . . MO35 . . . ASR . . .	\$448.88
TTY . . . MO35 . . . KSR . . .	\$388.88
OEC . . . PDP8M . . .	\$1488.88
*IBM .725 I/O—W/Keyboard	\$498.88
Singer MO70 Work Station I/O yours for only	\$298.88
Singer Petic 7-Track Key To Tape 4311 Com.	\$228.88
Singer Line Printer MD52	\$350.00
*Nova IBM Desk Top Term.	\$748.88
Nova/IBM Desk Top Terminal (ASC11)	\$888.88
Viatron System 21	\$495.00
IBM SELECTRIC (BALL) PRINTER	

POWER SUPPLY KITS

INPUT 115V 16HZ.



We supply all electrical and electronic parts, tools, & case.

Battery Charger 12VDC, 20A, 20 Lbs. 7C7005 (20A)	\$19.50
Battery Charger 12VDC, 15A, 15 Lbs. 9C0089 (15A)	\$14.50
Ni-Cad Battery Charger Kit, Super, Buy 1 Up to 25VDC, 500Ma, Sh. Wt. 5 Lbs. 7C70243	\$6.00
Logic P.S. Kit, 5V, 1A, Reg'ed, 6.00 7C70267	
5 to 24VDC Reg'ed & adjustable, 5 amp, Sh. Wt. 1 Lb. 6M160301	\$14.88

CALL DIRECTORS



3-Line 11 Line, with rotary dial, reconditioned. Please state choice!

Sh. Wt. 10 Lbs. 3 Line 8C0277	\$29.88
Sh. Wt. 15 Lbs. 11 Line 8C0550	\$69.88

ALSO: TOUCH TONE-PAY STATION TELEPHONES! 8C30273 \$69.88

CIRCLE 41 ON FREE INFORMATION CARD

Money Talks

Part of the money you give the American Cancer Society helps the International Association of Lymphogonectomists help thousands of people to learn to talk again after their voice boxes have been removed. Give to the American Cancer Society. American Cancer Society.

BREATHE REFRESHING "VITAMINS OF THE AIR" with an amazing **NEGATIVE ION GENERATOR**

ROOM-PORTABLE-CAR UNITS, TESTERS AND ACCESSORIES (Dealers Wanted)

Send \$1.00 for fascinating details to **GOLDEN ENTERPRISES, INC.** P.O. Box 1282-RE Glendale, Arizona 85311

HIGHLY PROFITABLE ONE-MAN ELECTRONIC FACTORY

Investment unnecessary, knowledge not required, sales handled by professionals. Ideal home business. Write today for facts! **Postcard will do. Barta-RE-P, Box 248, Walnut Creek, CA 94597.**

BIG SCREEN OSCILLOSCOPE

Converted from ANY Size TV Set... Hams, Technicians, Hobbyists, Broadcasters, Minus expensive changes convert TV set to super sensitive testing device. No electronic experience needed. Follow clear cut plans. Fully illustrated. Use in workshop, lab, school, etc. Any size screen. Any dze TV set... Complete Set of Plans... \$4 (INCL. 50 FOR POST. & HANDLING) MILLCO IND., DEPT. OP.03. BOX 91. KOSSE, TX. 76653

MECHANICALLY INCLINED INDIVIDUALS —WANTED—

Assemble electronic devices in your home. Get started in spare time. Experience. Knowledge or Investment Not Necessary. Expect big profits: \$300 - \$600/Wk. Possible. Write for free literature telling how **ELECTRONIC DEVELOPMENT LAB** Box 1560R, Pinellas Park, FL 33565

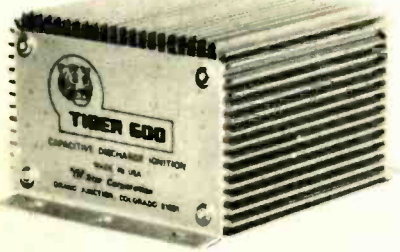

save on gas!

Enjoy the benefits of 20% better gas mileage, quicker starting, elimination of tune-ups, reduced pollution, and 50,000 miles on plugs and points.

Update your car with a TIGER solid state electronic ignition system. Easily installed in 30 minutes even on new cars.

Tiger 500 CD
Assembled \$49.95
Simplikit \$29.95

Postpaid USA.
Master Charge & BankAmericard accepted.

Tri-Star Corporation
Phone (303) 243-5200
P.O. Box 1727
Grand Junction, Colorado 81501
CIRCLE 14 ON FREE INFORMATION CARD

AMAZING EARADIO

THIS IS PROBABLY THE WORLD'S SMALLEST RADIO. IT WEIGHS ONLY 1/2 OUNCE AND IS WORN BEHIND THE EAR. CONTAINS AN IC AND SEVERAL DISCRETE DEVICES TO GIVE AN EQUIVALENT OF 12 TRANSISTORS. THE RADIO HAS A T.R.F. DESIGN OPERATING FROM 1 STANDARD SIZE 1.5V HEARING AID BATTERY (INCLUDED). IT PROVIDES GOOD VOLUME TO EARPHONE ON SEVERAL STATIONS IN METROPOLITAN AREAS. DOESN'T REQUIRE ANY ANTENNA, GROUND OR OTHER ADDITIONAL WIRES - FULLY SELF CONTAINED & TUNABLE. SIZE: 1 1/8" x 1 1/4" x 3/8".

\$5.95

Crystal 14.04 Mhz Oscillator

IC clock oscillator
C23289 \$1.98

SEND FOR YOUR FREE 1979 CATALOG

<p>MINI CRYSTAL OSCILLATOR \$1.25 MICROPROCESSOR \$1.00</p>	<p>BLACK SWITCH \$1.00</p>	<p>MICRO-TEMPERATURE SWITCH \$1.00</p>	<p>LASER 200 VOLT 3 AMP \$1.00</p>
---	----------------------------	--	------------------------------------

Electronic Warning Flasher Kit

This battery operated device continuously emits bursts of intense light. Great safety device for bicycle riders, skiers, hikers, boaters & campers. Comes complete w/ all electronic parts, quality glass epoxy P.C. board & easy to understand instructions. Uses high-output xenon flash tube which flashes 2 times per second when batteries are fresh. Operates continuously for 12 hours on 2 alkaline "C" batteries. You need only to supply the batteries and, if desired, a battery holder & case. C23207 \$6.95 (3 for \$18.00)

<p>Strobe Light Kit \$3.00</p>	<p>6 MV TRIGGER COILS 2 for \$1</p>	<p>Green Neon Same as NE2 but glows GREEN. Operates on 120V. 6 for \$1.00</p>	<p>PHOTOFAX CAPS 350 ml 330V 100 720 ml 360V 150 1600 ml 360V \$2.25</p>
--------------------------------	-------------------------------------	---	--

<p>STROBE TUBE ADJ. Brand new factory prime strobe tubes. Assortment of 5 strobe tubes, w/ schematics. C23280 \$3.00</p>	<p>MINIATURE REFLECTOR Appx. size: 1-7/16" L x 7/8" W x 3/4" D. C23227 \$1.00</p>
---	--

CHANEY electronics
P.O. BOX 27038, DENVER, CO. 80227 Ph. (303) 718-5750
Send for our FREE GIANT CATALOG of unique items.

TAPE DISCOUNTS

maxell

CASSETTES

UDXL I or II C-60	2.99
UDXL I or II C-90	2.49
UDC-60	2.99
UDC-90	2.99
LNC-46	1.29
LNC-80	1.49
LNC-90	2.39
LNC-120	3.29

8-TRACK

LN 46 8th	1.99
LN 60 8th	2.29
LN 90 8th	2.69
UD 46 8th	2.39
UD 90 8th	2.99

OPEN REEL

UD35-90 1800 x 7	\$ 79
UD-35-180 3800 x 10 1/2	15.99
LN50-60 1200 x 7	4.59
LN35-90 1800 x 7	4.99

MEMOREX

CASSETTES

C-60	2.19
C-90 3pk	3 for 5.48
C-120	4.50

8-TRACK

60 MIN 8 tk	2.99
90 " 8 tk 2pk	2 for 4.99

Minimum order 10 tapes

Lifetime Product Guarantee. Order Now! Orders shipped within 1-3 days. Please add \$2.00 for ship. & hdg. per 10 tapes. N.Y.S. residents add sales tax. NO COD'S. FREE CATALOG

CONSUMERS CO

P.O. Box 550 Dept. RE-4
Mt Vernon, N.Y. 10551 Phone: (914) 664-2909

CIRCLE 65 ON FREE INFORMATION CARD

AMERICA'S LARGEST SUPPLIER

of ORIGINAL Japanese Semi-Conductors
for CB, TV and Stereo Repair

We carry only genuine replacement parts

TYPE	25-UP	10-24	1-9	TYPE	25-UP	10-24	1-9	TYPE	25-UP	10-24	1-9	TYPE	25-UP	10-24	1-9
2SA 102	.20	.27	.30	2SC 696	1.00	1.20	1.30	2SD 234	.60	.70	.80	TA 7205P	1.60	1.80	2.00
2SA 234	.45	.53	.59	2SC 710	.20	.27	.30	2SD 235	.60	.70	.80	TA 7310P	1.30	1.45	1.60
2SA 473	.45	.53	.59	2SC 711	.20	.27	.30	2SD 261	.35	.40	.45	TBA 810SH	1.90	2.10	2.40
2SA 484	1.50	1.75	1.95	2SC 730	3.00	3.20	3.40	2SD 287	2.50	2.70	2.90	TC 5080P	5.00	5.20	5.80
2SA 495	.30	.35	.40	2SC 732	.20	.27	.30	2SD 313	.60	.70	.80	TC 5081P	3.00	3.20	3.40
2SA 497	1.00	1.20	1.30	2SC 735	.20	.27	.30	2SD 315	.60	.70	.80	TC 5082P	3.40	3.55	3.90
2SA 509	.30	.35	.40	2SC 756	1.50	1.80	2.00	2SD 325	.60	.70	.80	UHC 002	4.20	4.40	4.90
2SA 561	.30	.35	.40	2SC 756A	1.50	1.80	2.00	2SD 427	1.80	2.00	2.25	UHC 004	4.20	4.40	4.90
2SA 562	.30	.35	.40	2SC 781	1.90	2.10	2.40	2SD 525	.90	1.10	1.20	UHC 005	4.20	4.40	4.90
2SA 564A	.20	.27	.30	2SC 784	.30	.35	.40	2SD 526	.60	.70	.80	UPC 20C	2.10	2.50	2.80
2SA 634	.40	.45	.50	2SC 799	2.00	2.20	2.50	FET				UPC 563	1.90	2.10	2.40
2SA 643	.30	.40	.45	2SC 828	.20	.27	.30					UPC 575C2	1.30	1.45	1.60
2SA 673	.35	.40	.45	2SC 839	.30	.35	.40	UPC 576	1.90	2.10	2.40				
2SA 678	.35	.40	.45	2SC 867	3.20	3.40	3.70	UPC 592HZ	.70	.80	.90				
2SA 682	.80	.90	1.00	2SC 867A	3.20	3.40	3.70	UPC 1001	1.90	2.10	2.40				
2SA 683	.30	.35	.40	2SC 897	2.00	2.20	2.50	UPC 1008C	4.20	4.40	4.90				
2SA 684	.35	.40	.45	2SC 930	.20	.27	.30	UPC 1020H	1.90	2.10	2.40				
2SA 695	.40	.53	.59	2SC 945	.20	.27	.30	UPC 1025H	1.90	2.10	2.40				
2SA 699A	.50	.64	.70	2SC 983	.50	.64	.70	UPC 1154	2.00	2.20	2.50				
2SA 706	.85	1.00	1.10	2SC 959	1.10	1.20	1.30	UPC 1155	2.00	2.20	2.50				
2SA 719	.30	.35	.40	2SC 1000BL	.35	.40	.45	UPC 1156	1.90	2.10	2.40				
2SA 720	.30	.35	.40	2SC 1014	.50	.64	.70	UPC 14305	3.00	3.20	3.40				
2SA 733	.20	.27	.30	2SC 1018	.60	.70	.80	UPD 861	8.00	8.40	9.50				
2SA 747	4.20	4.40	4.90	2SC 1030C	1.80	2.10	2.40	UPD 857	8.00	8.40	9.50				
2SA 818	.70	.80	.90	2SC 1061	.70	.80	.90	UPD 858	6.00	6.30	7.00				
2SA 841	.20	.27	.30	2SC 1079	3.40	3.55	3.90	PLL 01A	3.00	4.20	4.60				
2SB				2SC 1096	.45	.55	.60	PLL 02A	5.00	5.30	5.90				
2SB 22	.30	.35	.40	2SC 1098	.50	.64	.70	PLL 03A	7.60	8.00	8.80				
2SB 54	.20	.27	.30	2SC 1111	2.10	2.50	2.80	DIODES				1S 84	.45	.55	.60
2SB 75	.35	.40	.45	2SC 1124	.80	.90	1.00					1S 332	.35	.40	.45
2SB 175	.20	.27	.30	2SC 1172B	3.20	3.60	3.95	1S 953	.16	.18	.20				
2SB 186	.20	.27	.30	2SC 1173	.50	.55	.60	1S 1007	.35	.40	.45				
2SB 324	.30	.35	.40	2SC 1226	.50	.55	.60	1S 1209	.35	.40	.45				
2SB 337	.70	.80	.90	2SC 1226A	.50	.55	.60	1S 1211	.35	.40	.45				
2SB 405	.30	.35	.40	2SC 1239	2.20	2.70	2.90	1S 1555	.20	.22	.25				
2SB 407	.80	.90	1.00	2SC 1306	1.30	1.45	1.60	1S 1588	.20	.22	.25				
2SB 434	.80	.90	1.00	2SC 1307	1.90	2.10	2.40	1S 1885	.16	.18	.20				
2SB 435	.90	1.10	1.20	2SC 1318	.35	.40	.45	1S 2076	.20	.22	.25				
2SB 463	.90	1.10	1.20	2SC 1383	.30	.35	.40	1S 2093	.35	.40	.45				
2SB 473	.80	.90	1.00	2SC 1384	.35	.40	.45	1S 2473	.16	.18	.20				
2SB 474	.70	.80	.90	2SC 1419	.60	.70	.80	1N 34	.12	.13	.15				
2SB 492	.60	.70	.80	2SC 1675	.20	.27	.30	1N 60	.12	.13	.15				
2SB 507	.80	.90	1.00	2SC 1678	1.10	1.25	1.40	10D 1	.30	.35	.40				
2SB 528D	.70	.80	.90	2SC 1728	.70	.80	.90	10D 10	.45	.55	.60				
2SB 595	1.10	1.40	1.50	2SC 1730	.45	.53	.59	V06B	.30	.35	.40				
2SB 596	1.10	1.40	1.50	2SC 1760	.70	.80	.90	ZENERS				WZ 071	.30	.33	.35
2SC				2SC 1816	1.50	1.75	1.95					WZ 075	.30	.33	.35
				2SC 1856	.50	.64	.70	2SC 1856	.50	.64	.70	WZ 090	.30	.33	.35
2SC 281	.30	.35	.40	2SC 1908	.30	.35	.40	WZ 120	.30	.33	.35				
2SC 372	.20	.27	.30	2SC 1909	1.80	2.00	2.25	WZ 192	.30	.33	.35				
2SC 373	.20	.27	.30	2SC 1945	4.50	5.00	5.60	MISC				SG 913	1.20	1.40	1.50
2SC 380	.20	.27	.30	2SC 1957	.60	.70	.80					TRLOS	.90	1.00	1.10
2SC 394	.20	.27	.30	2SC 1970	2.10	2.50	2.80	MPS 638	1.50	1.70	1.90				
2SC 458	.20	.27	.30	2SC 1978	5.40	6.00	6.60	IC				AN 214Q	1.30	1.70	1.90
2SC 495	.45	.55	.60	2SC 2028	.50	.64	.70					AN 239	4.20	4.40	4.90
2SC 509	.35	.40	.45	2SC 2029	1.50	1.80	2.00					AN 247	2.50	2.70	3.00
2SC 515A	.80	.90	1.00	2SC 2076	.50	.64	.70					AN 274	1.50	1.75	1.95
2SC 517	2.50	2.70	3.00	2SC 2091	.90	1.10	1.20					AN 313	3.00	3.20	3.40
2SC 535	.30	.35	.40	2SC 2092	1.80	2.00	2.25					AN 315	1.80	2.00	2.25
2SC 634A	.35	.40	.45	2SC 2166	1.40	1.60	1.80					BA 511A	1.80	2.00	2.25
2SD				2SD 72	.50	.64	.70					BA 521	1.90	2.10	2.40
				2SD 234	.60	.70	.80					HA 1151	1.50	1.75	1.95
2SD 235	.60	.70	.80	HA 1156	1.60	1.80	2.00								
2SD 261	.35	.40	.45	HA 1306W	2.00	2.20	2.50								
2SD 287	2.50	2.70	2.90	HA 1322	2.50	2.70	3.00								
2SD 313	.60	.70	.80	HA 1339	2.50	2.70	3.00								
2SD 315	.60	.70	.80	HA 1339A	2.50	2.70	3.00								
2SD 325	.60	.70	.80	HA 1366	2.50	2.70	2.90								
2SD 427	1.80	2.00	2.25	HA 1366W	2.50	2.70	2.90								
2SD 525	.90	1.10	1.20	HA 1366WR	2.50	2.70	2.90								
2SD 526	.60	.70	.80	LA 4031P	1.80	2.00	2.25								
TA				TA 7045M	2.00	2.20	2.50	LA 4032P	1.80	2.00	2.25				
				TA 7069P	.70	.80	.90	LA 4400	1.90	2.10	2.40				
				TA 7061P	.90	1.10	1.20	LA 4400Y	2.00	2.20	2.50				
				TA 7062P	1.10	1.25	1.40	LA 4420	2.00	2.20	2.50				
				TA 7089P	2.00	2.20	2.50	M51513L	2.00	2.20	2.50				
				TA 7202P	2.50	2.70	2.90	STK 011	3.80	4.00	4.40				
				TA 7203P	2.50	2.70	2.90	STK 013	7.60	8.00	8.80				
				TA 7204P	2.00	2.20	2.50	STK 015	4.20	4.40	4.90				
				TC				TC 5080P	5.00	5.20	5.80	STK 435	4.50	5.00	5.60
								TC 5081P	3.00	3.20	3.40	TC 5082P	3.40	3.55	3.90
TC 5082P	3.40	3.55	3.90					TC 5082P	3.40	3.55	3.90	TA 7069P	.70	.80	.90
TC 5082P	3.40	3.55	3.90					TC 5082P	3.40	3.55	3.90	TA 7061P	.90	1.10	1.20
TC 5082P	3.40	3.55	3.90					TC 5082P	3.40	3.55	3.90	TA 7062P	1.10	1.25	1.40
TC 5082P	3.40	3.55	3.90					TC 5082P	3.40	3.55	3.90	TA 7089P	2.00	2.20	2.50
TC 5082P	3.40	3.55	3.90					TC 5082P	3.40	3.55	3.90	TA 7202P	2.50	2.70	2.90
TC 5082P	3.40	3.55	3.90					TC 5082P	3.40	3.55	3.90	TA 7203P	2.50	2.70	2.90
TC 5082P	3.40	3.55	3.90					TC 5082P	3.40	3.55	3.90	TA 7204P	2.00	2.20	2.50
TC 5082P	3.40	3.55	3.90					TC 5082P	3.40	3.55	3.90				

Minimum order \$5.00. Add \$1.00 postage and handling. Ask for our complete price list when ordering. Overseas buyers. Manufacturers. Distributors or Dealer orders welcome. All parts are guaranteed against factory defects for one year. C.O.D. orders are welcome. 48-hour delivery.

ORDER TOLL FREE

Telex: 21-4732



Fuji-Svea®

EAST
Nationwide 800-543-1607
Ohio 800-582-1630
Mon-Fri 10:00 to 7:00 Saturday 10:00 to 5:00
P.O. Box 40325 • Cincinnati, Ohio 45240

WEST
Nationwide 800-543-1642
California (Call Collect) 213-533-1221
Mon-Fri 9:00 to 5:00 *Sat 9:00 to 3:00
P.O. Box 3375 • Torrance, California 90510

APRIL 1979

NEW!

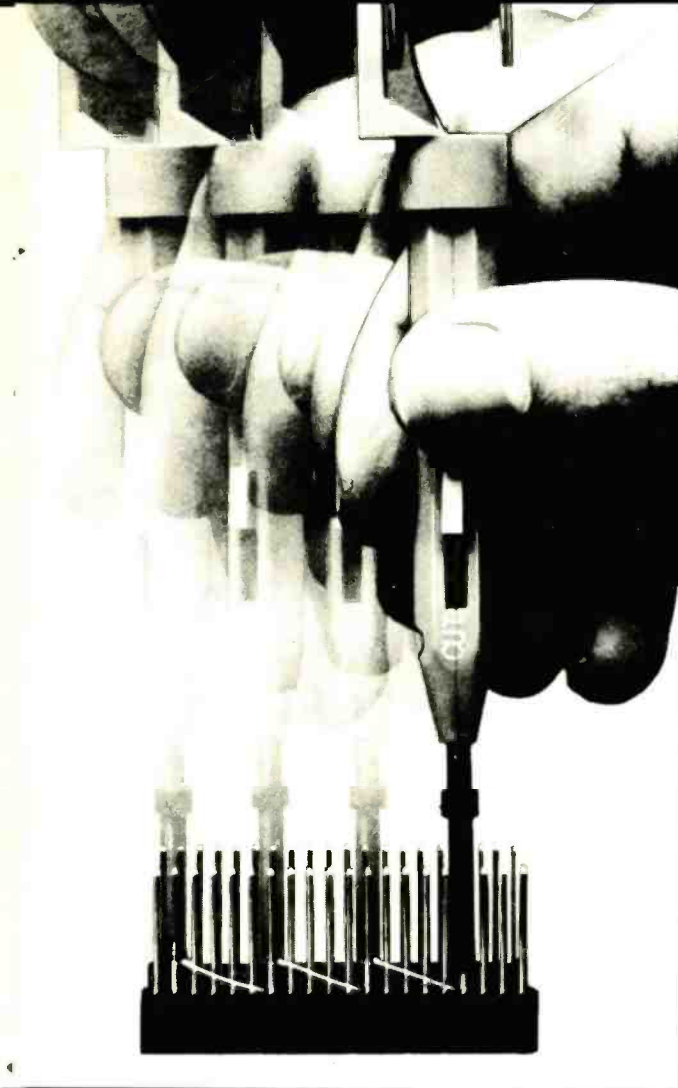

WHY CUT?
WHY STRIP?
WHY SLIT?

WHY NOT...

JUST WRAP™

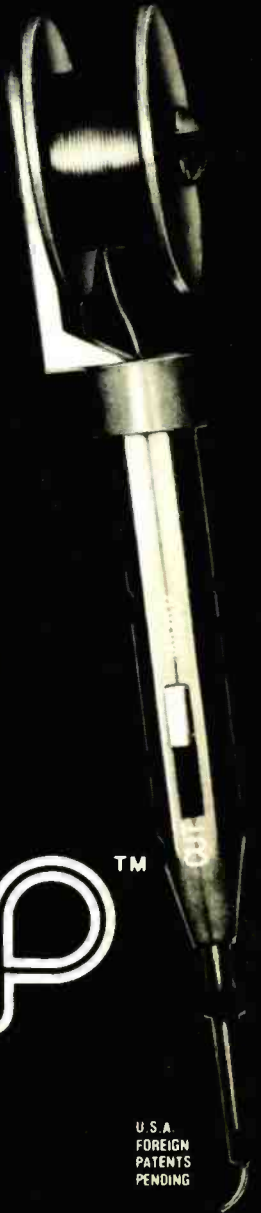

U.S.A.
FOREIGN
PATENTS
PENDING

- AWG 30 Wire
- .025" Square Posts
- Daisy Chain or Point To Point
- No Stripping or Slitting Required
-JUST WRAP™....
- Built In Cut Off
- Easy Loading of Wire
- Available Wire Colors:
Blue, White, Red & Yellow

\$14.95*

JUST WRAP TOOL WITH ONE 50 FT. ROLL OF WIRE		
COLOR	PART NO.	U.S. LIST PRICE
BLUE	JW-1-B	\$14.95
WHITE	JW-1-W	14.95
YELLOW	JW-1-Y	14.95
RED	JW-1-R	14.95
REPLACEMENT ROLL OF WIRE 50 FT.		
BLUE	R-JW-B	2.98
WHITE	R-JW-W	2.98
YELLOW	R-JW-Y	2.98
RED	R-JW-R	2.98

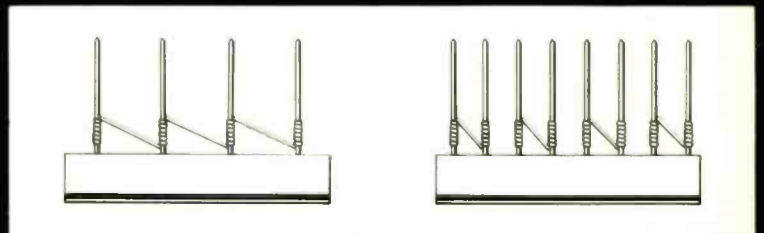

DAISY CHAIN

POINT TO POINT



OK MACHINE & TOOL CORPORATION 3455 CONNER ST., BRONX, N.Y. 10475 (212) 994-6600/TELEX 125091

*MINIMUM BILLING \$25.00 / ADD SHIPPING CHARGE \$2.00 / NEW YORK CITY / STATE RESIDENTS ADD APPLICABLE TAX.

CIRCLE 43 ON FREE INFORMATION CARD
www.americanradiohistory.com

New, K40 Magnamount: Grips like a grapple, actually improves transmission.



We double guarantee it.*

Exclusive Octopole Construction.



That's eight magnets set in eight different directions to give you a magnetic seal so complete and powerful, your antenna would stay up there if you could squeeze between two semis passing each other at 180 miles an hour. That's magnetic octopower.

* GUARANTEE I

Placed on the roof of a vehicle; properly tuned, the K40 Magnamount is guaranteed to transmit a further distance than a standard K40 without the Magnamount or you will receive a prompt and full refund from your K40 dealer who installed and tuned the Magnamount K40 for you.

* GUARANTEE II

Materials and workmanship are guaranteed for a full 12 months. Any part that fails to perform satisfactorily will be replaced absolutely free.

Exclusive K40 Flux Harmonics for Greater Transmission.

The magnetic radiation pattern was designed to match the K40 antenna radiation for greater distance than the standard K40. See our guarantee.

The facts: Physics and Physical.

1. Magnamount is a bigger, stronger magnet—in fact it's 8 bigger, stronger, magnets.
2. It doesn't just hold the K40 antenna, it helps it transmit further.
3. Remember the law of reciprocity. The antenna that transmits better, receives better.
4. It provides a flatter, lower SWR because the Magnamount is capacitance grounded.
5. It puts your $\frac{5}{8}$ wave K40 antenna securely in place in the most advantageous place to work against a ground plane—high and free from obstruction. That's square in the middle, right up on top.

\$15.95 buys it.

(SUGGESTED RETAIL)

K40 Magnamount.

American Antenna 1945 South Street Elgin, Illinois 60120

This professional CB equipment available only through Registered K40 Dealers!

CIRCLE 24 ON FREE INFORMATION CARD
www.americanradiohistory.com