

Radio-Electronics

THE MAGAZINE FOR NEW IDEAS IN ELECTRONICS

COVER STORY

SOLAR ENERGY CONTROL

A guide to interfacing and controlling solar energy panels. Story starts on page 35.

HI-FI SPEAKER SYSTEM

State-of-the-art time-compensated design you can build yourself for true hi-fi sound. Construction starts on page 38.

REMOTE TELEPHONE EAR

Easy to build telephone accessory lets you monitor the sounds in your home from a remote location. Turn to page 67.

NUMBER CRUNCHER

Math board for 1802-based microcomputers speeds execution time and saves memory. Construction details start on page 45.

TO THE RESCUE

...ions for the PROM make digital ...er. Story starts on page 43.

...r Own Computer Power Supply
...aker Cables Make a Difference?
...e Quality Tank Game
...ing Dynamic Headroom

...9000 Receiver
...h Peak Power Indicator
...er
...Corner
...ack Dan's Service Clinic

562024 DLS B0005W96 14 A DCT80
BY 5
H H BELSCHLAGER
NEW EGYPT NJ 08539
12 STA



GERNSBACK
PUBLICATION

vero

small enclosures

VEROBOX
PLASTIC

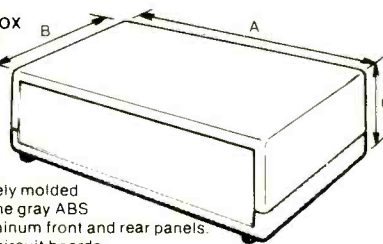

Attractively molded in two-tone gray ABS with aluminum front and rear panels. Accepts circuit boards horizontally or vertically.

ORDER CODE	A	B	C	PRICE
75-1238D	154	85	60	\$6.82
75-3008J	180	120	65	\$8.90
75-1411D	205	140	75	\$9.02

VEROCASE
PLASTIC

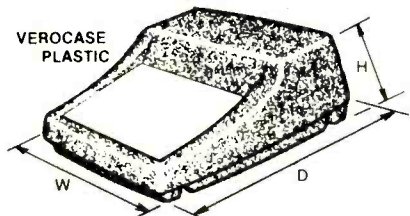

Vacuum formed from textured black ABS. Designed for instruments incorporating a keyboard and display. Anodized aluminum panel supplied for component mounting.

ORDER CODE	WIDTH	DEPTH	HEIGHT	PRICE
75-1800J	220	276	100	\$25.70
75-3960E	550	340	120	\$50.31

FLIP TOP BOX

Molded in one piece from black polypropylene to provide protective housing for pocket keyboard instruments or field test equipment. Anodized aluminum panel supplied.

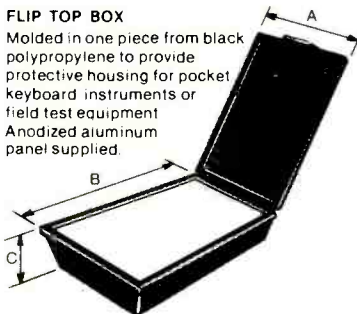

ORDER CODE	A	B	C	PRICE
75-3018C	75	130	22	\$5.76
75-3019J	127	196	32	\$7.50

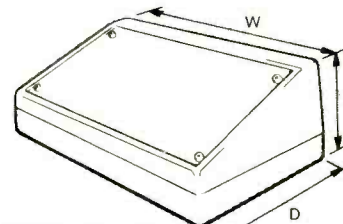

SLOPING FRONT BOX

Sloping front boxes. Two-tone gray with aluminum front panel. Provisions in base for circuit board or plate mounting.

ORDER CODE	WIDTH	DEPTH	HEIGHT	PRICE
75-1798K	171	121	75	\$10.94
65-2523E	220	156	100	\$11.74

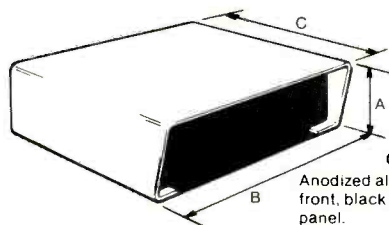

G SERIES CASES

Anodized aluminum cover with visor front, black base, front and rear panel.

ORDER CODE	A	B	C	PRICE
91-2672A	44.0	134.0	123.0	\$12.07
91-2673G	64.0	224.0	176.5	\$18.32

TILT LEG ASSEMBLY
FOR PLASTIC VEROBOX

A kit containing a tilt leg and four molded feet with rubber inserts which replace the existing box feet and raise the front panel to a convenient viewing angle.

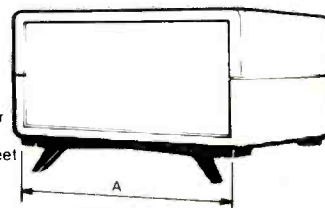

ORDER CODE	A	COMPATIBLE VEROBOX	PRICE
75-1493A	144	75-1238D	\$2.39
85-1494G	170	75-3008J	2.45
75-1492F	193	75-1411D	2.48

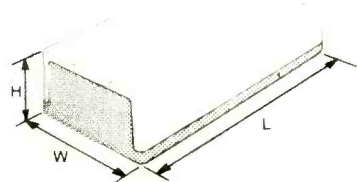

Two-tone gray boxes molded in high impact polystyrene. Lower section provided with threaded inserts for mounting components or circuit boards.

ORDER CODE	WIDTH	LENGTH	HEIGHT	PRICE
65-2514F	50	100	25	\$3.25
65-2518H	65	120	40	4.09
65-2520J	80	150	50	4.68

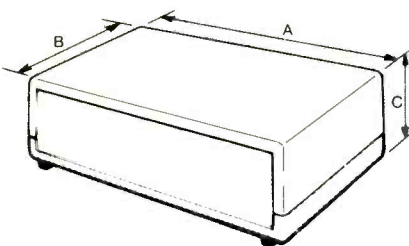

New additions to the series of two-tone gray ABS boxes with aluminum front and rear panels.

ORDER CODE	A	B	C	PRICE
75-2682L	125	65	30	\$5.24
75-2683F	125	65	40	6.08
75-2684A	125	65	50	6.79

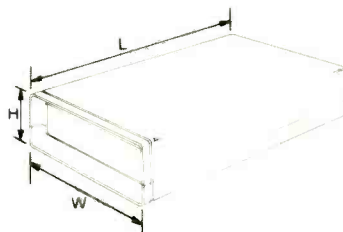

Attractive light gray boxes of high impact polystyrene come complete with anodized aluminum front panel and molded-in compartment for standard 9V battery.

ORDER CODE	WIDTH	LENGTH	HEIGHT	PRICE
65-2036H	68	110	33	\$5.78
65-2068B	92	155	45	8.90
65-2073K	138	190	68	12.09



Vero Electronics, Inc.

171 Bridge Road Hauppauge N Y 11787
Tel 516-234-0400 TWX 510-227-8890

No C.O.D.'s. Include \$1.50 for Shipping. with Check or Money Order.

The Age of Affordable Personal Computing Has Finally Arrived.

Ohio Scientific has made a major breakthrough in small computer technology which dramatically reduces the cost of personal computers. By use of custom LSI micro circuits, we have managed to put a complete ultra high performance computer and all necessary interfaces, including the keyboard and power supply, on a single printed circuit board. This new computer actually has more features and higher performance than some home or personal computers that are selling today for up to \$2000. It is more powerful than computer systems which cost over \$20,000 in the early 1970's.

This new machine can entertain your whole family with spectacular video games and cartoons, made possible by its ultra high resolution graphics and super fast BASIC. It can help you with your personal finances and budget planning, made possible by its decimal arithmetic ability and cassette data storage capabilities. It can assist you in school or industry as an ultra powerful scientific calculator, made possible by its advanced scientific

math functions and built-in "immediate" mode which allows complex problem solving without programming! This computer can actually entertain your children while it educates them in topics ranging from naming the Presidents of the United States to tutoring trigonometry all possible by its fast extended BASIC, graphics and data storage ability.

The machine can be economically expanded to assist in your business, remotely control your home, communicate with other computers and perform many other tasks via the broadest line of expansion accessories in the microcomputer industry.

This machine is super easy to use because it communicates naturally in BASIC, an English-like programming language. So you can easily instruct it or program it to do whatever you want, *but you don't have to*. You don't because it comes with a complete software library on cassette including programs for each application stated above. Ohio Scientific also offers you hundreds of inexpensive programs on ready-to-run cassettes. Program it yourself or just enjoy it, the choice is yours.

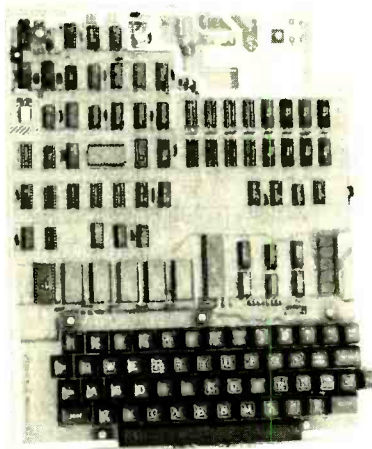

Ohio Scientific offers you this remarkable new computer two ways.

Challenger 1P \$349

Fully packaged with power supply. Just plug in a video monitor or TV through an RF converter to be up and running.



Superboard II \$279

For electronic buffs. Fully assembled and tested. Requires +5V. at 3 Amps and a video monitor or TV with RF converter to be up and running.

Standard Features

- Uses the ultra powerful 6502 microprocessor
- 8K Microsoft BASIC-in-ROM
Full feature BASIC runs faster than currently available personal computers and all 8080-based business computers.
- 4K static RAM on board expandable to 8K
- Full 53-key keyboard with upper/lower case and user programmability
- Kansas City standard audio cassette interface for high reliability
- Full machine code monitor and I/O utilities in ROM
- Direct access video display has 1K of dedicated memory (besides 4K user memory), features upper case, lower case, graphics and gaming characters for an effective screen resolution of up to 256 by 256 points. Normal TV's with overscan display about 24 rows of 24 characters; without overscan up to 30 X 30 characters.

Extras

- Available expander board features 24K static RAM (additional), dual mini-floppy interface, port adapter for printer and modem and an OSI 48 line expansion interface.
- Assembler/editor and extended machine code monitor available.

ORDER FORM

Order direct or from your local Ohio Scientific dealer.

- I'm interested. Send me information on your:
- Personal Computers Business Systems
- Send me a Superboard II \$279 enclosed
- Send me a Challenger 1P \$349 enclosed
- Include 4 more K of RAM (8K Total) \$69 more enclosed

Name _____

Address _____

City _____ State _____ Zip _____

Payment by: BAC (VISA) _____ Master Charge _____ Money Order _____

Credit Card Account # _____

Expires _____ Interbank # (Master Charge) _____

Ohio Residents add 4% Sales Tax

TOTAL CHARGED OR ENCLOSED _____

All orders shipped insured UPS unless otherwise requested. FOB Aurora, OH

Interested in a bigger system? Ohio Scientific offers 15 other models of microcomputer systems ranging from single board units to 74 million byte hard disk systems.

CIRCLE 36 ON FREE INFORMATION CARD

OHIO SCIENTIFIC

America's Largest Full Line Microcomputer Company

1333 S. Chillicothe Road • Aurora, Ohio 44202 (216) 562-3101

PIÈCE DE RÉSISTANCE



Sylvania, of course. And there are 594 more just as good. It's the most complete line of flameproof resistors in the industry.

Our flameproof resistors come in $\frac{1}{4}$, $\frac{1}{2}$, 1 and 2-watt sizes for use in home entertainment, communications, industrial equipment or any job requiring a fuse resistor. They can replace carbon composition, carbon film, metal film, wirewound and fuse resistors with tolerances of 2, 5, 10 or 20 percent. And noncombustible ceramic construction provides stable resistance plus indefinite shelf life.

All Sylvania flameproof resistors come in color-coded blister packs for easy identification. For a good look see your nearest distributor. You can find his location by contacting GTE Sylvania, Distributor and Special Markets Div., 1025 Westminister Drive, Williamsport, Pa. 17701.



SYLVANIA

CIRCLE 34 ON FREE INFORMATION CARD

Electronic
Components

GTE

Radio-Electronics®

THE MAGAZINE FOR NEW IDEAS IN ELECTRONICS

Electronics publishers since 1908

DECEMBER 1978 Vol. 49 No. 12

BUILD ONE OF THESE

- 35 **Solar Energy Controller**
A guide to interfacing and controlling solar energy panels.
- 38 **Time-Compensated Speaker System**
State-of-the-art design you can build yourself for true hi-fi sound.
- 45 **NOM Card For The 1802**
Number crunching math board for 1802-based microcomputers speeds execution time and saves memory.
- 67 **Remote Telephone Ear**
Lets you monitor the sounds in your home from a remote location.
- 74 **Tank**
Part II: Final details of this dedicated TV battle game.

DIGITAL ELECTRONICS

- 43 **Making PROM's Work For You**
New applications make digital circuits simpler.
- 56 **Designing Hobby Computer Power Supplies**
How to design and add a power supply for your S-100 mainframe.
- 63 **Digital Circuit Design**
Everything from combinational switching circuits and the Karnaugh map to the Quine-McCluskey method and sequential circuits.
- 78 **Computer Corner**
Software required to control an 8-channel analog signal monitor.

STEREO HI-FI PRO SOUND

- 49 **R-E Lab Tests Sansui G-9000 Receiver**
This 160-watt FM receiver rates excellent.
- 52 **R-E Lab Tests Lectrotech Peak Power Indicator**
A new add-on for your hi-fi.
- 53 **Dynamic Headroom**
A new amplifier measurement from the IHF—it tells why amplifiers with the same rated power may perform differently under varying signal levels.
- 60 **Hi-Fi Speaker Cables**
Ordinary speaker cables can adversely affect sound quality. An in-depth look at newly developed uniquely constructed cables and how well they solve this problem.

TELEVISION

- 80 **Jack Darr's Service Clinic**
Trouble with the color and how to localize the problem.
- 81 **Service Questions**
R-E's Service Editor solves reader problems.

GENERAL ELECTRONICS

- 4 **Looking Ahead**
Preview of tomorrow's news—today.
- 14 **Radar Speed Traps, Detectors, etc.**
Editorial
- 76 **Hobby Corner**
A look at clever reader solutions to radar problems including a rocket launching circuit, a super simple oscillator and a low voltage detector.

EQUIPMENT REPORTS

- 27 **Super Sleuth Descrambler**
- 32 **Continental Specialties LP-2 & DP-2 Logic Probes**

DEPARTMENTS

- | | |
|-------------------------------------|---------------------------|
| 130 Advertising Index | 103 Market Center |
| 14 Advertising Sales Offices | 6 New & Timely |
| 96 Computer Products | 94 New Products |
| 131 Free Information Card | 101 Next Month |
| 16 Letters | 98 Stereo Products |
| 100 New Books | |

SEASON'S GREETINGS

*The editors and staff
of Radio-Electronics
join in sending
holiday greetings and
our best wishes for
a happy new year*

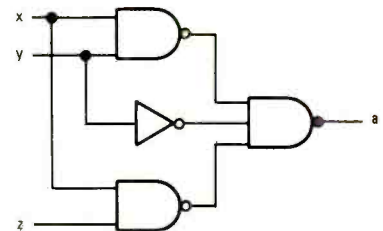

$$a = xy + xz + yz$$

DESIGNING DIGITAL CIRCUITS from scratch.
The step-by-step approach starts on page 63.

Radio-Electronics, Published monthly by Gernsback Publications, Inc., 200 Park Avenue South, New York, NY 10003. Phone: 212-777-6400. Second-class postage paid at New York, NY and additional mailing offices. One-year subscription rate: U.S.A. and U.S. possessions, \$9.98, Canada, \$12.98. Other countries, \$14.98. Single copies \$1.25. © 1978 by Gernsback Publications, Inc. All rights reserved. Printed in U.S.A.

Subscription Service: Mail all subscription orders, changes, correspondence and Postmaster Notices of undelivered copies (Form 3579) to Radio-Electronics Subscription Service, Box 2520, Boulder, CO 80322.

A stamped self-addressed envelope must accompany all submitted manuscripts and/or artwork or photographs if their return is desired should they be rejected. We disclaim any responsibility for the loss or damage of manuscripts and/or artwork or photographs while in our possession or otherwise.

As a service to readers, Radio-Electronics publishes available plans or information relating to newsworthy products, techniques and scientific and technological developments. Because of possible variances in the quality and condition of materials and workmanship used by readers, Radio-Electronics disclaims any responsibility for the safe and proper functioning of reader-built projects based upon or from plans or information published in this magazine.

Looking ahead

TV and hi-fi: Important developments are in the wind in the field of TV sound—a chain of events set in motion by the very limited use of satellites for domestic networking and followed by the telephone company's conversion of its intercity relay systems to diplexed sound (**Radio-Electronics**, July, 1978). Both relay systems now accommodate sound channels capable of a frequency response up to 15 kHz, compared with 5 kHz under AT&T's old system of transmitting TV sound by separate telephone line. Since last January, most network broadcasting (except for an occasional 16-mm movie) has been accompanied by noticeably better sound. But that's not all—AT&T's network lines now are capable of handling two discrete multiplexed sound channels, each with a frequency response out to 15 kHz.

This two-channel sound will be available with the TV signal as soon as a rate schedule is worked out by AT&T and approved by the FCC. There are no stereo TV sets, of course, and TV stations aren't allowed to transmit stereo sound signals—even if they were equipped to do so—so the first use of two-channel sound is likely to be for the simulcast FM-station sound accompanying TV music broadcasts. The diplexed signal along with the TV picture eliminates the complicated synchronizing and phasing processes that are needed when the stereo sound is networked separately from the picture, as traditional in network stereo simulcasts.

So now we have an interesting situation: Most TV broadcasting is accompanied by true hi-fi sound, but virtually no TV receivers are capable of passing it on to viewers. Network television is capable of transmitting stereo or other types of dual-sound signals, but stations aren't permitted to broadcast with dual sound. However, there are signs that this impasse will be broken. Most TV set manufacturers are now working on improved sound systems to take advantage of the better vibes coming from the stations. Don't expect hi-fi perfection, but starting with next spring's lines of sets, some models will offer wider frequency response, higher-powered amplifiers, bigger speakers and better baffling.

For those who can't wait for better TV sets to provide higher-quality sound, there will be a growing number of hi-fi video tuners and receivers, such as those now being developed by Pioneer and Wintec, both in direct response to the better sound offered by stations.

Will the next step be stereo sound? The whole subject is highly controversial, and many broadcasters, as well as some TV set manufacturers, will tell you at the drop of a decibel that stereo isn't suitable for TV—there's not enough music being broadcast, the picture is too small, and so forth. But there are exceptions in both ranks. Projection TV manufacturers are gung ho for stereo sound; as is the Public Broadcasting Service, whose associated stations originate many musical programs. Sylvania also hopes to take leadership among set manufacturers in pushing for stereo.

Even if broadcasters and manufacturers collectively don't want stereo, this doesn't mean they're against two-channel sound. Many approve of a system that was used in

Japan in 1970 (and about to be revived there). This system provides two completely discrete channels, and can be used for language translations, stereo or any other application in which two sound tracks can be used. The broadcasters—led by ABC-TV—see the dual-sound track concept as a winner in bilingual areas such as New York, southern California and Miami, where viewership is low among those whose primary language isn't English. Manufacturers certainly wouldn't mind producing TV sets with special circuitry for selecting sound Channel A, Channel B or stereo.

The next step is expected to be the formation of an industry committee to develop and test various two-track proposals before any proceeding by the FCC. It could take from three to five years before definitive standards are set for stereo and other dual-sound TV broadcasts but they do finally seem to be on the way. And the pressure for stereo won't be lessened in any way when videodiscs come on the market. Many of these discs will have stereo sound, and all videodisc recorders will have jacks for stereo inputs.

New VCR's: Home videocassette recorders are proliferating, with new, more versatile step-up units reaching the market this fall. Perhaps the most fascinating is a programmable unit made by Matsushita Electric and being marketed in two slightly different versions under the Magnavox and RCA brandnames, with other similar units to come. The new VCR takes maximum advantage of the four-hour-per-cassette recording mode of the VHS format. Using a built-in microprocessor, a fluorescent digital display and a 14-pushbutton varactor tuner, the new VCR may be programmed up to one week in advance to record four different shows, automatically turning on and off and switching channels. An optional mode of programming permits the recording of the same show every day of the week.

An interesting feature of the programmable VCR is "electronic indexing." A special electronic cue is placed on the tape at the start of each recording, whether the machine is in the manual or the programmed mode. The beginning of any program then may be located automatically by pushing the fast-forward button.

New VCR's in the Beta and VHS formats have been introduced for outdoor recording. The Sony and JVC units each weighs about 20 pounds. A rechargeable battery will operate the VCR and its associated color camera for one hour on a charge. Accessory tuners and timers are available for recording TV programs off the air.

A new VHS-format recorder by JVC lets you double your television viewing without increasing the amount of time you watch—that is, if you don't mind speeded-up action. A special remote-control switch plays tapes at double speed. Digital encoding keeps the sound at the proper pitch and comprehensible. The same unit provides a freeze-frame picture when the pause button is pressed. A new Hitachi VHS recorder also has the freeze-frame feature. With a new recording head, Hitachi claims a picture signal-to-noise ratio of 46 dB, which it says is the best of any home VCR.

DAVID LACHENBRUCH
CONTRIBUTING EDITOR

STATIC PROFITS? TUNE TO PTS

Tune in a clearer profit with four new profit-makers from PTS, and you'll discover four ways to higher profits with PTS.

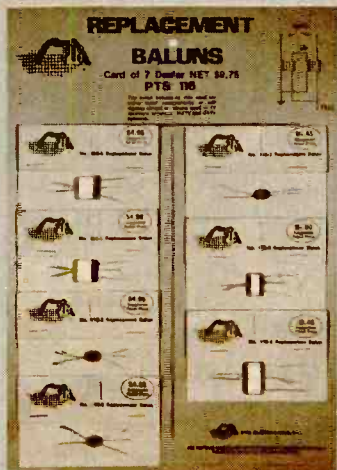

REPLACEMENT BALUNS

A new profit-maker from PTS that will more than pay for itself after you sell the first two baluns. Selection of seven replacements (five models) will replace most baluns found in TV sets, antenna systems, MATV or CATV systems.

Dealer Net. \$9.75.



PTS 8001 COMPONENT ANALYZER

This component test instrument works in or out of circuit. Simple hook-up to any standard oscilloscope. High, medium and low range switch for matching impedance.

Dealer Net \$54.95.



PTS DG-1 DIGITAL POWER SUPPLY

External power supply for substituting voltages in televisions, stereos, radios, computers, micro-processors, appliances, CBs and many other electronic units.

Dealer Net. \$114.95.



PTS DG-4 VOLTAGE CONTROL CENTER/DIGITAL POWER SUPPLY

Independently produces four variable DC supply voltages. Excellent for substituting critical control voltages for TV electronic/varactor tuners, and many other electronic products.

Dealer Net \$178.50.

TUNE ON TO MORE PROFIT, THE PTS WAY.

Now available from PTS stocking distributors or at any of the PTS' 42 company-owned Servicenters. Check the yellow pages for the one nearest you or contact:

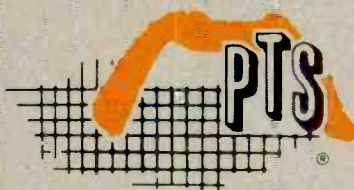

PTS ELECTRONICS, INC.

5233 S. HWY. 37 • P.O. 272 • BLOOMINGTON, IN 47401 • 812-824-9331

new & timely

Quartz analog watches tells time with "electronic hands"

Texas Instruments' completely electronic *Time Indicator* watch is an antimagnetic, shock-resistant LCD quartz analog watch that tells time without any moving parts, using "electronic hands." TI believes this design may provide the answer for those who want a watch without gears or other moving parts to wear out, yet need to see a visual time relationship.



TEXAS INSTRUMENTS new *Time Indicator* watches combine the advantages of both mechanical and digital watches.

The liquid crystal display that sweeps the face of the watch (in similar fashion to mechanical hands) is driven by an IC. Several timekeeping modes are available: hours/minutes; minutes/seconds; hours/minutes in another time zone; plus day and date; and a stopwatch gives the elapsed time in hours/minutes, minutes/seconds and seconds/10ths of seconds.

The watch is powered by a lithium-manganese dioxide battery and comes in two styles: round, in either white-gold or yellow-gold tone metal or square in either stainless steel or gold-tone metal; the strap can either be of leather or matching metal clasp bracelet. The watches range in price from \$275 to \$325.

50 Radio Shack Computer Centers to open in 1978-1979

Lewis Kornfeld, president of Tandy Corporation's Radio Shack Division, has announced that 50 new computer sales and service stores will open in 1978-1979; the new ventures will be called Radio Shack Computer Centers.

Although some of the Computer Centers will be located in new or existing Radio Shack stores, most will be separate operations in major market areas. According to Mr. Kornfeld, "their purpose will be to assist area Radio Shack stores in answering computer questions, closing sales and developing quantity sales (particularly of

Radio Shack's TRS-80 system), and peripheral systems to businesses and institutions."

The Centers will provide classroom areas to teach computer use and programming to customers. In addition to servicing Radio Shack computer products, the Centers will sell a variety of components, software and some hardware of brands other than the TRS-80 system.

Video inventions use liquid-crystal switches

Two new inventions use liquid-crystal optical transmission switches that can help reduce the size, price and power requirements of video cameras, screens and projectors.

The "Flying Hole Video Camera" and "Flying Hole Display and Projector" use a two-dimensional array of liquid-crystal switches operated so that all but one are opaque. This "hole" is moved around in a scanning pattern.

In the camera, the light that is transmitted through the hole is converted to electrical signals by a photo detector or color-sensitive photo detectors. In the projector and display, the light is projected through the hole by a light source or a group of color-sensitive light sources. Since the video projector/display does not require a cathode-ray tube, it is small and flat enough to be either wall-mounted or worn on the wrist. The inventions were announced by an independent Canadian inventor, Donald L. Orr.

Wrist device prints messages, aids handicapped

Canon, U.S.A., a subsidiary of Canon, Inc., Tokyo, has developed a small battery-operated wrist device that prints messages

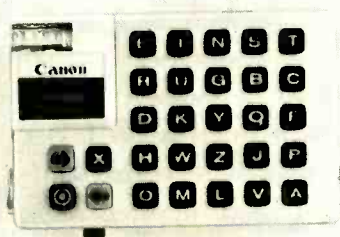

WRIST DEVICE, the *Communicator*, keyboard contains 26 letters, and shift, back and space keys to print messages at a 10 character-per-second speed. The device is a special fast communication aid for nonverbal, deaf and other handicapped persons.

on paper tape designed to provide fast communications for persons suffering from a variety of verbal or motor disabilities.

The device called the *Communicator* is

distributed by Telesensory Systems, Inc., 3408 Hillside Avenue, Palo Alto, CA 94304. It is as small as a pocket dictionary, weighs 11 ounces and can also be worn around the neck. Messages are printed on paper tape at a speed of 10 characters-per-second, with a tape storage capacity of 12,500 characters. The keyboard contains 26 alphabetical letters arranged according to frequency of use, plus it contains shift, back and space keys. Pressing the shift pushbutton allows numbers and symbols to be used, and vowels and consonants are differentiated by color. The *Communicator* sells for \$549.

Computerized information system is developed for Canadian TV viewers

Three Canadian firms, Bell Canada, Southam Press, Ltd., and Torstar Corporation have agreed to cosponsor a pilot demonstration of a data system that will provide information stored at a central computer and transmitted via telephone lines to TV viewers whose sets are connected to the computer center.

The data system (known generically as videotex) consists of a computer connected to a single TV set with an attached keyboard. Using the keyboard a viewer can retrieve preprogrammed data, which is then displayed on the screen either as words or graphically. A Bell Canada spokesman said that this pilot demonstration will be followed by a more extensive market study later in 1980, in which the computer will be connected to several home TV terminals. Suggested future applications for the system are in providing weather news, travel data, general news programs, entertainment and even some advertising.

NESDA/ISCET choose officers and distribute awards at 1978 NESC

Approximately 600 persons attended the August 1978 National Electronics Service Convention (NESC) in Portland, OR. Among the many scheduled events, including a trade show, seminars and many social functions, were both the NESDA and ISCET conventions.

The ISCET and NESDA agenda included the election of officers for 1978-1979, as follows:

For NESDA—president, Robert A. Villont; vice president, Warren Baker; secretary, West Correll; treasurer, George Simpson; and regional officers Ted Stackhouse, Dorothy Cicchetti, Joe Gately, Billy Williams, Art Nelson, Bill Abernathy, Keith Knos, Jack Kelly, Bill Lawler, and Dick Scott.

For ISCET—president, Jesse Leach (also serving ex-officio on the NESDA executive committee and council); vice chairman,

continued on page 12

We've done the impossible again! A versatile and superior frequency counter kit for only \$89.95



Now you can forget about price/performance trade-offs when you select a frequency counter. In Sabtronics' Model 8100 you get features you once expected to pay several hundreds of dollars for. But you pay only our low, low price of \$89.95!

Dare to Compare. This frequency counter, using LSI technology, has the performance and input characteristics you demand. Note the specifications: You will see that the frequency range is guaranteed all the way to 100 MHz; and a high or low input impedance allows you to select for high-frequency operation. And you'll see a sensitivity that holds well over the frequency range; convenient selectable gate-time for best resolution; and selectable attenuation; and even an optional pre-scaler. Note the highly accurate time base, and its excellent ageing and temperature characteristics. And a full 8-digit LED display with floating decimal point, leading zero suppression, and overflow indicator.

You would expect to find all these features together only on a much higher-priced instrument. But Sabtronics' advanced digital technology combines with your own skill — you assemble this kit from our easy-to-follow instructions — to make it possible for you to have this fine frequency counter at a fraction of what you would otherwise expect to pay.

Free 10-day trial

Examine the 8100 Frequency Counter Kit for 10 days. If not completely satisfied, return unassembled for full refund of \$89.95 purchase price.

sabtronics 
INTERNATIONAL INC.

13426 Floyd Circle • Dallas, Texas 75243
Telephone 214/783-0994

Brief Specifications

- Frequency Range: 20 Hz to 100 MHz guaranteed (10 Hz to 120 MHz typical)
- Sensitivity: 25 mV RMS, 20 Hz to 70 MHz (20 mV typical); 45 mV RMS, 70 MHz to 120 MHz (30 mV typical)
- Selectable Impedance: 1 MΩ at 25 pF, or 50 Ω
- Selectable Attenuation: X1, X10, or X100
- Accuracy: ± 1 Hz plus time-base accuracy
- Ageing rate: ± 5 ppm/yr
- Temperature stability: ± 10 ppm, 0° to 50°C
- Selectable Gate-time: 0.1 sec, 1 sec., or 10 sec.
- 8-digit LED display with floating D.P., overflow indication
- Input: 9-15 VDC, 350 mA (550 mA with optional prescaler)
- Input protection: 150 V RMS, 20 Hz to 10 kHz; 30 V RMS to 2 MHz; and 3 V RMS to 100 MHz
- Optional prescaler extends frequency range to 650 MHz. (Available soon)

To: Sabtronics International, Inc.
13426 Floyd Circle, Dallas, TX 75243

RE-12

Please send me _____ Sabtronics Model 8100
Frequency Counter Kit(s) at \$89.95 each \$ _____
Texas Residents add Sales Tax \$ _____
Shipping and handling, \$5.00 per unit
(USA only)* \$ _____
Payment enclosed \$ _____

Charge my Master Charge
Visa

Account No. _____ Exp. Date _____

Name _____

Street _____

City _____

State _____ Zip _____

*Canada \$6.50. All other countries \$19.00 Airmail.

**NRI training in TV
and Audio Servicing
keeps up with the
state of the art.
Now you can learn to
service video cassette
and disc systems.**

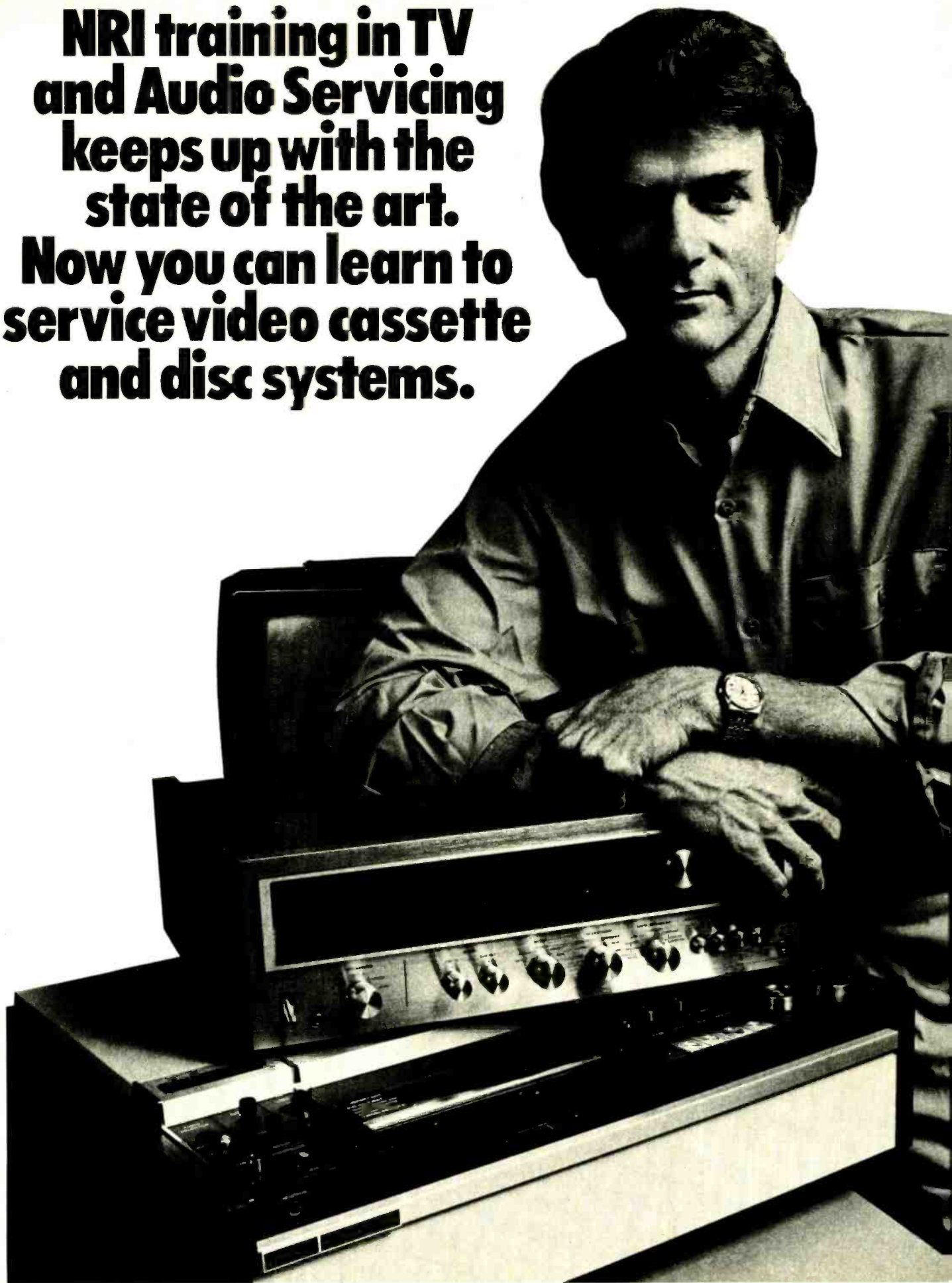



You build color TV, hi-fi, professional instruments.

Now, in addition to learning color TV and audio systems servicing, you get state-of-the-art lessons in maintaining and repairing video cassette recorders, playbacks and the amazing new video disc players, both mechanical and laser-beam types.

Learn at Home in Your Spare Time

And you learn right at home, at your own convenience, without quitting your job or going to night school. NRI "bite-size" lessons make learning easier...NRI "hands-on" training gives you practical bench experience as you progress. You not only get theory, you actually build and test electronic circuits, a complete audio system, even a color TV.

Build Color TV, 4-Channel Audio

As part of your training in NRI's Master Course in TV and Audio Servicing, you actually assemble and keep NRI's exclusive,

designed-for-learning 25" diagonal color TV. As you build it, you introduce and correct electronic faults, study circuits to gain a better understanding of what they're for and how they interface with others.

Likewise, as part of your audio training, you construct a 4-channel stereo amplifier and tuner, complete with cabinet and speakers. You even assemble professional-grade test instruments, so you know what makes them tick, too. Then you use them in your course, keep them for actual TV and audio servicing work.

NRI Includes the Instruments You Need

You start by building a transistorized volt-ohm meter which you use for basic training in electronic theory. Then you assemble a digital CMOS frequency counter for use with lessons in analog and digital circuitry, FM principles. You also get an integrated circuit TV pattern generator, and an advanced design solid-state 5" triggered-sweep oscilloscope. Use them for learning, then use them for earning.

NRI Training Works... Choice of the Pros

More than 60 years and a million students later, NRI is still first choice in home study schools. A national survey of successful TV repairmen shows that more than half have had home study training, and among them, it's NRI 3 to 1 over any other school. (Summary of survey on request.)

That's because you can't beat the training and you can't beat the value! For hundreds of dollars less than competing schools, NRI gives you both color TV and audio...and now includes training in video cassette and disc systems. Send for our free catalog and see for yourself why NRI works for you.

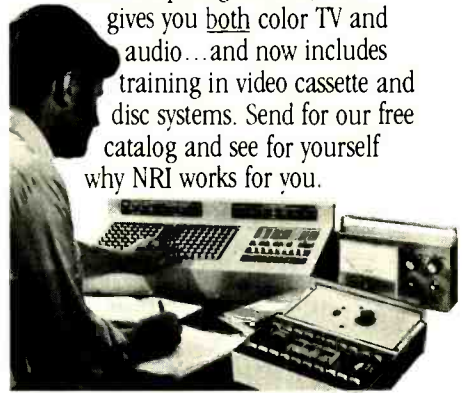

Other NRI training includes Computer Technology, Complete Communications Electronics.

Free Catalog... No Salesman Will Call

Our free 100-page catalog completely describes all the equipment and every lesson. You can choose from five different TV and audio courses. Or explore the opportunities in other NRI home study courses like Computer Technology, CB and Mobile Radio, Aircraft and Marine Radio, or Complete Communications. Send the postage-paid card today and get a head start on the state of the art.

If card has been removed, write to:



NRI-Schools
McGraw Hill Continuing
Education Center
3939 Wisconsin Ave.
Washington, D.C. 20016

Learn at home at your convenience.



new & timely

continued from page 6

Forest Belt; secretary, Leon Howland; and treasurer, George Sopocko.

Those present at the IS CET convention voted unanimously to return IS CET headquarters to NESDA facilities in Indianapolis. A Joint Internal Affairs Committee was appointed by IS CET and NESDA presidents to study and consider the question of IS CET/NESDA autonomy. A report, incorporating the results of an opinion survey taken among the respective bodies, will be presented at a joint IS CET/NESDA membership meeting in 1979. The committee is composed of IS CET members Herschel B. Lawhorn, Dorman L. McDonald and Larry Steckler (chairman), and NESDA members Warren Baker, Jack Kelly and Dick Scott.

Among other scheduled events was a NESDA awards banquet at which LeRoy Ragsdale, outgoing president, received both the "Man of the Year" award and the "NESDA Outstanding Officer" award. Other winners were Don Surrette, Leo Cloutier, Nolan Boone, Fred Schuneman, Warren Baker, Gene Dillingham, Ray McAllister, Keith Knos, and Morris Finneburgh, Sr.

Another NESC highlight was the induction into the Electronics Hall of Fame of two new members: Enos Rice (CES/CET) and (posthumously) the late Ralph Johnnot. Mr. Rice, who is 74 years old, was honored for his 44½ years in the service industry and for his long involvement in and support of NESC activities. The late Mr. Johnnot was cited for his long career in the service industry; for his many years as an officer with the California State Electronics Association; and for his part in the inception of the CET program and the Western States Conference.

The 1979 NESC will be held in Tucson, AZ, concurrently with the Arizona State Electronics Association Convention.

Integrated optical device has multiple applications

A small integrated optical device that can have multiple applications has been developed by Bell Labs. It can be used as a logic element in optical memories; a pulse shaper and limiter; an optical switch; a difference amplifier; and as an "optical triode."

Operating at extremely low power levels over a wide range of wavelengths, the device is an optical waveguide version of a nonlinear Fabry-Perot resonator whose nonlinear characteristics are produced by using a photodetector output to drive the resonator's electro-optical elements. Other features include acceptance of electrical or optical outputs; its nonlinearity can be modified using a nonlinear circuit; acceptance of multiple logic inputs; and multilevel operation.

The device is processed using standard IC techniques by diffusing titanium ions

onto an electro-optic lithium-niobate substrate. Incoming light rays are reflected back and forth between dielectric mirrors affixed to the cleaved ends of the substrate material. A beam splitter transmits a portion of this light to the detector whose output is used to create an electric field



BELL LABS integrated optical device is Fabry-Perot resonator formed by dielectric mirrors on the ends of the electro-optic lithium-niobate substrate material.

between the electrodes on the crystal that modulates the refractive index of the crystal and produces the nonlinear characteristics.

In multilevel operation or A/D conversion, a high gain is required in the feedback loop, providing as many as 15 transmission levels. With less feedback and the resonator tuned for transmission showing a hysteresis characteristic, the device functions as a memory element. When operated in a high-transmission state, its constant power output lets it operate as an optical limiter. In the "optical triode" mode, when the resonator is tuned to transmit an S-shaped waveform, power transmitted through the waveguide changes rapidly according to the output. A small degree of light at the detector produces a vast change in transmitted light; a weak light signal falling on the detector controls the transmission of a power light beam on the device.

Morizono, Leonard, Staes win SMPTE awards

The Society of Motion Picture and Television Engineers (SMPTE) awarded the 1978 David Sarnoff Gold Medal to Masahiko Morizono of Sony Corporation. Mr. Morizono, general manager of Sony's Video Products Division, was cited for his leadership and outstanding engineering accomplishments in developing TV electronic news gathering (ENG) equipment. Mr. Morizono's other achievements include the development of portable helical-scan VTR systems exhibiting high-calibre editing capabilities; plus the design and development of audio and instrumentation recorders, U-matic cassette recorders, time-base cor-

rectors, cameras and accessories.

SMPTE also presented its 1978 Journal award to Eugene Leonard, Da Vinci Systems Group, with honorable mention to K. Staes, Agfa-Gevaert N.V., for their paper published in the October and August 1977 SMPTE *Journal*, respectively.

The award was presented at the Society's annual Awards Presentation in October, 1978, at the Americana Hotel, New York City.

Zenith releases three-hour VCR, color cameras, tape

A three-hour video cassette recorder, two color cameras and a three-hour-format cassette tape are all part of Zenith Radio Corporation's new fall line.

The *model KR9000W* is a single-speed VCR that can record up to three hours of programming using Zenith's three-hour tape. The remote PAUSE switch lets you stop the tape in either playback or record modes, so that you can edit during recording or stop playback if you must leave the room. Other controls include a six-push-button keyboard, a clock/timer, UHF/VHF tuners, automatic fine tuning control, and a special tracking feature to handle variations in prerecorded tapes.



THREE-HOUR VIDEO CASSETTE RECORDER (*model KR9000W*) released by Zenith is a single-speed unit with built-in UHF/VHF tuners; timer; standard pushbutton controls; tracking switch; remote PAUSE control; and tape counter with memory.

The two color cameras for use with the VCR (*models KC1000* and *KC1250*) offer a number of significant features: the *model KC1000* has a pop-up viewfinder that matches the view angle of the 25-mm-long barrel lens designed to be used with a tri-electrode vidicon tube; a built-in mike; a remote PAUSE switch; plus adjustable temperature and brightness controls and an automatic light-level switch. The *model KC1250* (which incorporates all the features of the *model KC1000* color camera) also has a 6:1 Canon zoom lens incorporating a viewfinder with a 1½-inch black-and-white monitor screen. Suggested retail price range: \$2095—\$1395. **R-E**

Regulated Power Supply

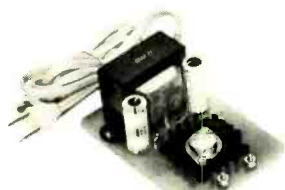

- ★ Uses LM 309K
- ★ Heat sink provided
- ★ P.C. board construction
- ★ Provides a solid 1 amp @ 5V
- ★ Includes components, hardware and instructions
- ★ Size: 3-1/2" x 5" x 2" high

JE200 5v 1amp \$14.95

Function Generator Kit



- ★ Provides 3 basic waveforms: sine, triangle & square wave
- ★ Frequency range from 1 Hz to 100K Hz
- ★ Output amplitude from 0-volts to over 6 volts (peak to peak)
- ★ Uses a 12V supply or a ± 6V split supply
- ★ Includes chip, P.C. board, components and instructions.

JE2206B \$19.95

Digital Stopwatch Kit



- ★ Use Intersil 7205 Chip
- ★ Plated thru double-sided P.C. Board
- ★ LED display (red)
- ★ Times to 59 min. 59.99 sec. with auto reset
- ★ Quartz crystal controlled
- ★ Three stopwatches in one: single event, split (cumulative) and taylor (sequential timing)
- ★ Uses 3 penlite batteries
- ★ Size: 4.5" x 2.15" x .90"

JE900 \$39.95

4-Digit Clock Kit



- ★ Bright .357" ht. red display
- ★ Sequential flashing colon
- ★ 12 or 24 hour operation
- ★ Extruded aluminum case (black)
- ★ Pressure switches for hours, minutes and hold functions
- ★ Includes all components, case and wall transformer
- ★ Size: 3-1/4" x 1-3/4" x 1-1/4"

JE730 \$14.95

6-Digit Clock Kit



- ★ Bright .300 ht. common cathode display
- ★ Uses MM5314 clock chip
- ★ Switches for hours, minutes and hold functions
- ★ Hours easily viewable to 20 feet
- ★ Simulated walnut case
- ★ 115 VAC operation
- ★ 12 or 24 hour operation
- ★ Includes all components, case and wall transformer
- ★ Size: 6-3/4" x 3-1/8" x 1-3/4"

JE701 \$19.95

Jumbo 6-Digit Clock Kit



- ★ Four .630" ht. and two .300" ht. common anode displays
- ★ Uses MM5314 clock chip
- ★ Switches for hours, minutes and hold functions
- ★ Hours easily viewable to 30 feet
- ★ Simulated walnut case
- ★ 115 VAC operation
- ★ 12 or 24 hour operation
- ★ Includes all components, case and wall transformer
- ★ Size: 6-3/4" x 3-1/8" x 1-3/4"

JE747 \$29.95

AVAILABLE AT YOUR LOCAL Jim-pak[®] DEALER TODAY !!
electronic components

For Dealer Information, write or phone JIM-PAK[®], 1021 Howard Avenue, San Carlos, California 94070 Ph. (415) 592-8097

Radars Speed Traps, Detectors and Countermeasures

Technology is a wonderful thing. It starts off by doing a job. We can use radar to identify speeders on the highways . . . those people who endanger the lives of others using American highways. It can also help increase the monies received by a municipality in traffic fines. And it's been with us for a long time now.

Recently, electronic countermeasures have become available to the public in the form of detectors that warn you when you near a radar trap. Government agencies have fought these devices in several ways—made them illegal in some states, used portable units, different frequencies. Here's the latest development . . . police departments are buying miniature low-power radar transmitters to sprinkle along the sides of the road to trigger those radar detectors. Maybe they hope that after you've run through three or four false alarms you'll ignore the real radar and contribute some dollars to the local budget. By the way, those transmitters are frequently made by the same people who make your radar detector.

Then comes the latest countermeasure, a nifty little radar transmitter for the motorist. According to the outfit offering it, you simply dial in the speed you want the radar trap to clock you at. Your transmitter then issues a signal that tells the police you're only going 30 MPH or whatever you select. We're deliberately not listing the name or address of the manufacturer since we don't think such a device is legal under FCC rules. Please don't write us for that information because we won't respond. But what we would like to know is what you think of such devices and can you dream up any that are even better.

Electronic countermeasures aren't new, but what a funny world it is when so many dollars are being spent in a battle with the traffic laws. Maybe some serious thought to raising the speed limits to a reasonable level would make more sense.



LARRY STECKLER
Editor

Radio-Electronics®

Hugo Gernsback (1884-1967) founder

M. Harvey Gernsback, editor-in-chief and publisher

Larry Steckler, KTX-3644, CET, editor

Arthur Kleiman, KTZ-3288, managing editor

Robert F. Scott, CET, W2PWG, KXK-8533, technical editor

Sonia Greenbaum, copy editor

Jack Darr, CET service editor

Leonard Feldman, contributing high-fidelity editor

Karl Savon, semiconductor editor

David Lachenbruch, contributing editor

Earl "Doc" Savage, K4SDS, hobby editor

Vincent P. Cicenia, production manager

Harriet I. Matysko, circulation director

Arline R. Bailey, advertising coordinator

Cover design by Louis G. Rubsamen

Cover photo by Bob Homan

Radio Electronics is a member of the *Institute of High Fidelity* and is indexed in *Applied Science & Technology Index* and *Readers Guide to Periodical Literature*.

Gernsback Publications, Inc.
200 Park Ave. S., New York, NY 10003
(212) 777-6400

President: M. Harvey Gernsback
Vice President: Larry Steckler
Treasurer: Carol A. Gernsback
Secretary: Bertina Baer

ADVERTISING SALES

Paul McGinnis
Director of Marketing

EAST

Stanley Levitan
Radio-Electronics
200 Park Ave. South
New York, NY 10003
(212) 777-6400

MIDWEST/Texas/Arkansas/Okla.

Ralph Bergen
The Ralph Bergen Co.
540 Frontage Road—Suite 361-A
Northfield, Illinois 60093
(312) 446-1444

PACIFIC COAST

Mountain States
Jay Eisenberg
J.E. Publishers Representative Co.,
8732 Sunset Blvd.,
4th Floor,
Los Angeles, CA 90069
(213) 659-3810
Sales Mart Building
1485 Bayshore Blvd., Box 140
San Francisco, CA 94124
(415) 467-0125



**ALL
NEW**

Real-State-of-the-Art

TWO NEW AC•DC•BATTERY PORTABLE COUNTERS

OPTO-8000 .1A 10Hz to 600 MHz — FREQUENCY COUNTER

- Precision TCXO time base 0.1 PPM Stability 17-40°C
- Super Sensitivity with preamps in both HI-Z & 50 Ohm inputs <10mV to 50MHz, 25 mV @ 150 MHz <50mV to 600MHz
- Auto Decimal Point • Aluminum Case • Socketed IC's
- Three position attenuator: X1, X10, X100 (avoids false counting)

#OPTO-8000.1A	Factory Assembled	\$329.95
#OPTO-8000.1AK	Kit Form	\$279.95
#NI-CAD-80	NI-CAD Battery Pack	\$ 19.95

OPTO-7000 10 Hz to 600 MHz MINIATURE COUNTER

- XTAL (TCXO) Time Base ± 0.08 PPM/°C
- Aluminum Case • HI-Z & 50 Ohm inputs
- 1 Sec. & 1/10 Sec. Gate times • Auto Dec. Pt.
- Built-in Prescaler and Preamps Standard

#OPTO-7000	Factory Assembled - 1 Year-Guar	..	\$139.95
#OPTO-7000K	Kit Form	99.95
#AC-70	AC Power Pack	4.95
#NI-CAD-70	NI-CAD Battery Pack	19.95
#TCXO-70	Precision TCXO Time Base <0.1PPM, 17-40°C	79.95

ACCESSORIES

PROBES:

#P-100	50 Ohm, 1X	\$13.95
#P-101	Lo-Pass	16.95
#P-102	H1-Z, 2X	16.95
# AP- 8015	UHF Counter Preamp 20 MHz to 600 MHz 15-50 DB Gain (Not Shown)	..	\$49.95/Kit \$39.95

#D-450 Antenna
Rubber Duck RF Pick-up 450 MHz ... \$12.50

#D-146 Same as above
146.5MHz \$12.50

#RA-BNC Right-Angle BNC Adapter for
above Antenna 2.95

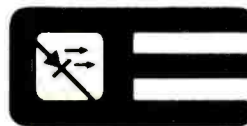

OPTOELECTRONICS, INC.

5821 NE 14 Avenue
Ft. Lauderdale, FL 33334
Phones: (305) 771-2050 771-2051

Phone orders accepted

ORDER FACTORY DIRECT — PHONE OR MAIL

TERMS: Orders to U.S. and Canada, add 5% to maximum of \$10.00 per order for shipping, handling and insurance. To all other countries, add 10% of total order. Florida residents add 4% state tax. C.O.D. fee: \$1.00. Personal checks must clear before merchandise is shipped.

CIRCLE 21 ON FREE INFORMATION CARD

letters

WHAT IS AN ELECTRONIC ENGINEER?

As an engineer and head of a growing organization, I often meet people who don't really know what an electronic engineer does. All too often these people visualize an engineer as "someone who sits in a cave and designs things." Nothing could be farther from the truth, and I'd like to dispel this myth.

As I see it, the electronic engineer has the job of creating new electronic equipment or devices using the latest technology and to be manufactured at the lowest cost. In short, his job is to make money for the company that employs him. Besides circuit design, you'll find the engineer assisting in all areas from design to final product. And he will often be there when the design is being upgraded!

To be more specific, a typical engineer can spend as little as 10% of his time on actual circuit design. (This depends on the project, of course!) The rest of his time is

spent assisting draftsmen in circuit-board layout, assisting in package design, writing specifications for the product, selecting components and materials for the production models—not to mention the building of the prototypes!

After the device is built on the production line, there are process-control problems to resolve, quality-control problems and more. Ever see 20,000 pieces of equipment roll off a production line—defective? This same engineer may step in and solve the problem—saving the company money. This is engineering in its finest hour, and an important distinction. You'll find most engineers in industry doing at least most of these things, and often much more. The engineer is rewarded with a sense of accomplishment, a modest salary and, if he's good, a chance at getting a management level job.

Now that you know what an engineer does, let's look at working with IC's. Actually, working with IC building blocks on

paper isn't too hard. The computer fans do this often, as can anyone with the IC handbook. I believe this sort of work should be called *designing*. It is different from *engineering* because the designer generally does not become involved with all the areas mentioned previously; at least this has been true of the "designers" I know. Also, an engineer designs a circuit by either selecting components known to best fit the job from past experience, or by using components of the latest design. This process requires an extensive knowledge of electronic circuitry, electronic components, plus manufacturing processes. All this expertise is necessary to build a project easily at the lowest cost . . . and cost is the name of the game in electronics today. None of the designers I know have the knowledge to optimize their circuitry. Also an extensive knowledge of electronics is important when the production line shuts down—an engineer would know how to start it up, a designer might not. And that's what sepa-

Double your capability.

The VIZ Supplists™

Power supplies with built-in circuit testing capability.

Only the VIZ Supplists let you power equipment and circuits *and* test dc voltage points, all with the same instrument.

The Supplists speed your work, help cut down bench clutter, and free VOMs for other jobs. And even with their extra testing capability, they cost less than most quality fully-regulated power supplies.



VIZ
7108



Single 0-50Vdc, 0-2A supply
with two 0-99.9V DC voltmeters
WP-705 \$240.00



Single 0-25Vdc, 0-4A supply
with two 0-99.9V DC voltmeters
WP-706 \$240.00



Dual Supplist
Two 0-25Vdc, 0-2A supplies
with two 0-99.9V DC voltmeters
WP-707 \$299.00



Triple Supplist
Two 0-20Vdc, 0-2A supplies
One 5Vdc (to 4A) fixed-output supply
with two 0-99.9V DC voltmeters
WP-708 \$333.00



The Circuit Tester line
Accuracy and stability assured

VIZ

VIZ Test Instruments Group 335 E. Price St. Philadelphia, PA 19144

CIRCLE 75 ON FREE INFORMATION CARD

rates the designers from the engineers—*knowledge and experience!*

If there are any doubters among the designers, let's see them design an 8-bit A/D converter for under \$5. It's been done—but not by designers. Cost is the reason; an IC block approach costs too much.

To sum up, I propose that the people who string IC's together should be called "designers," and people who do the same but have extensive knowledge about their product should be called "engineers."

GARY McCLELLAN

S-100 BUS COMPANIES

I recently received from you a list of companies dealing with the S-100 bus.

I was somewhat surprised to see that the list was only two pages long. And it didn't even include the manufacturers of the equipment I have running in my system. Therefore, I decided to do a bit of research on a small scale. I looked through just the February 1978 issue of *Interface Age* and the February 1978 issue of *Kilobaud*, and the only company I knew about that I couldn't find was PolyMorphic Systems, the manufacturer of my computer.

Therefore, I am including a list of the companies I found less the ones on your list, plus phone numbers. I've listed them in the order I found them:

Seattle Computer Products
16611 111th St. S.E.
Renton, WA 98055
(206) 255-0750

Alpha MicroSystems
17875 Skypark North
Irvine, CA 92714
(714) 957-1404

Space Byte Systems Group
1720 Pontius Ave., Suite 201
Los Angeles, CA 90025
(213) 468-8080

Paratronics, Inc.
800 Charcot Ave.
San Jose, CA 95131
(408) 263-2252

MECA
7026 O.W.S. Rd.
Yucca Valley, CA 92284
(714) 365-7686

Info 2000 Corporation
20630 South Leapwood Ave.
Carson, CA 90746
(213) 532-1702

Trace Electronics, Inc.
P.O. Box 3247
Hampden Station
Reading, PA 19604
(215) 779-3677

Forethought Products
P.O. Box 386-E
Coburg, OR 97401
(503) 485-8575

Wameco, Inc.
3107 Laneview Drive
San Jose, CA 95132
No telephone listing

continued on page 22



BUILD!

A P Terminal and Distribution Strips are ideal building blocks for your breadboarding.

Now you can put together as simple or as elaborate a breadboard as you want—and be sure of top quality all the way—and pay only for what you need. Using A P Terminal and Distribution Strips as modules is the world's most economical way to assemble full-performance solderless breadboards.

You know how our strips work. Your electronic components plug right into the spring clip terminals behind

each hole. You complete your circuits with ordinary solid wire jumpers—you don't need special patch cords. Terminals clip tight, make superb contact time after time. (They're noncorrosive copper alloy 770.)

These versatile building blocks come in a wide variety of shapes and sizes, and we include hardware and mounting templates with each strip. You get all the flexibility in the world.

Where? At your nearby A P Products dealer. Need the address? Phone (toll-free) 800-321-9668. And ask for the complete A P catalog, *The Faster and Easier Book*.



**A P PRODUCTS
INCORPORATED**

Box 110-B • 72 Corwin Drive
Painesville, Ohio 44077
Tel. 216/354-2101
TWX: 810-425-2250

Faster and Easier is what we're all about.

CIRCLE 70 ON FREE INFORMATION CARD



A new introductory Electronics



DESIGNING WITH TTL INTEGRATED CIRCUITS. By IC Applications Staff of Texas Instruments, Inc. 322 pp., 399 illus. For general, technical, and non-engineer managers, all the information you need to get the most out of TTL devices—their design, economics, features, performance, applications.
637/458 Pub. Pr., \$31.50 Club Pr., \$22.50

HANDBOOK OF OPERATIONAL AMPLIFIER CIRCUIT DESIGN. By D. F. Stout. Edited by M. Kaufman. 434 pp., 223 illus. Compact, concise, highly concentrated, and containing a storehouse of information, this one-stop volume will help you solve any op amp circuit problem!
617/97X Pub. Pr., \$29.65 Club Pr., \$17.50

DESIGNING WITH OPERATIONAL AMPLIFIERS, Applications Alternatives. By J.G. Graeme. 269 pp., 203 illus. You can now guarantee that every electronics decision you make will be easier, more productive, freer of error—and more consistently cost-effective! Topics include signal amplifiers, signal conditioners, absolute-value circuits, signal generators, computing circuits, data transmission circuits, and test and measurement circuits.
238/91X Pub. Pr., \$21.50 Club Pr., \$15.50

SEMICONDUCTOR ELECTRONICS DESIGN. By F. K. Manasse. 562 pp., illus. Today the microelectronics industry is going places faster than ever before. Are you going with it? To get and keep yourself completely up to date, you will do well to keep this volume nearby. Its chapters on design techniques are among the most complete and detailed ever published.
772/622 Pub. Pr., \$21.95 Club Pr., \$18.25

MICROPROCESSOR APPLICATIONS MANUAL. By Motorola Semiconductor Products, Inc. 720 pp., illus. Here's every piece of info you need to use MPU's to simplify your board layouts, lower your hardware costs, save precious time, design better and faster, and verify your designs from the start! Overflowing with illustrations!
435/278 Pub. Pr., \$32.50 Club Pr., \$24.00

STANDARD HANDBOOK OF ENGINEERING CALCULATIONS. By T.G. Hicks. Editor-in-Chief. 1,200 pp., 428 illus. Tells you *what* to do, *when* to do it, and *how* to do it—giving step-by-step solutions to the design and application problems that engineers encounter daily. Containing some 1,000 calculation procedures accompanied by worked-out numerical examples, it also features 4,000 related calculation procedures.
287/341 Pub. Pr., \$27.50 Club Pr., \$19.95

BE SURE TO CONSIDER THESE IMPORTANT TITLES AS WELL:

DIFFERENTIAL EQUATIONS FOR ENGINEERS. By T. M. Creese & R. M. Haralick. 135/10X Pub. Pr., \$17.50 Club Pr., \$13.50

APPROXIMATION METHODS FOR ELECTRONIC FILTER DESIGN. By R. W. Daniels. 153/086 Pub. Pr., \$31.50 Club Pr., \$19.50

MANAGEMENT OF ENGINEERING PROJECTS, 2/e. By V. G. Hajek. 255/342 Pub. Pr., \$16.95 Club Pr., \$12.50

HANDBOOK OF COMPONENTS FOR ELECTRONICS. By C. A. Harper. 266/824 Pub. Pr., \$39.50 Club Pr., \$28.50

ENGINEERING CIRCUIT ANALYSIS, 3/e. By W. Hayt & J. Kemmerly. 273/936 Pub. Pr., \$22.00 Club Pr., \$16.50

OPTOELECTRONIC APPLICATIONS MANUAL. By Hewlett-Packard. 286/051 Pub. Pr., \$22.50 Club Pr., \$16.50

DIGITAL COMPUTER ELECTRONICS. By A. P. Malvino. 398/615 Pub. Pr., \$14.95 Club Pr., \$10.95

A USER'S HANDBOOK OF D/A AND A/D CONVERTERS. By E. R. Hnatek. 767/149 Pub. Pr., \$24.95 Club Pr., \$18.50

HANDBOOK OF ENGINEERING FUNDAMENTALS, 3/e. By O. Eshbach & M. Souder. 769/842 Pub. Pr., \$31.50 Club Pr., \$24.95

COMPLETE GUIDE TO DIGITAL TEST EQUIPMENT. By W. Buchsbaum. 772/088 Pub. Pr., \$14.95 Club Pr., \$10.50

ELECTRONICS DESIGNERS' HANDBOOK. Edited by L. J. Giacoletto. 2nd Ed. 2,344 pp., 1,686 illus. Now doubled in size and with 90% of its material new, this famous classic (first edition by Landee, Davis, Albrecht) has been thoroughly revised and updated to give you not only the *how* and the *why* of all your design work but also the *how much* of every design step you take!
231/494 Pub. Pr., \$52.50 Club Pr., \$39.50

DIGITAL INTEGRATED CIRCUITS AND OPERATIONAL AMPLIFIER AND OPTOELECTRONIC CIRCUIT DESIGN. Edited by B. Norris. 206 pp., 400 illus. Having this vast amount of case-tested data, proven shortcuts, worked-out circuit designs, and circuit diagrams handy saves you valuable time for your other, more vital, areas of creative design—and cuts down costs in *all* areas!
637/539 Pub. Pr., \$19.50 Club Pr., \$14.50

CIRCUITS FOR ELECTRONICS ENGINEERS. Edited by S. Weber. 396 pp., 346 circuits. This book is filled with the circuits you need in 51 areas—from amplifiers to voltage regulators—arranged in alphabetical order and grouped for easy finding. Use them "as is" or adapt them. Each has been tested and proved in action.
191/573 Pub. Pr., \$19.50 Club Pr., \$16.00

MICROCOMPUTER-BASED DESIGN. By J. P. Peatman. 604 pp., 400 illus. Do all your best day-to-day and supercreative designs around today's microcomputers with the specific "how-to" help here! Big new printing has more pages, lots more new material, including data on such "hot" third generation micros as Intel 8048/8748, Zilog Z80, and a first and valuable overview of the Motorola 6809!
491/380 Pub. Pr., \$24.50 Club Pr., \$17.50

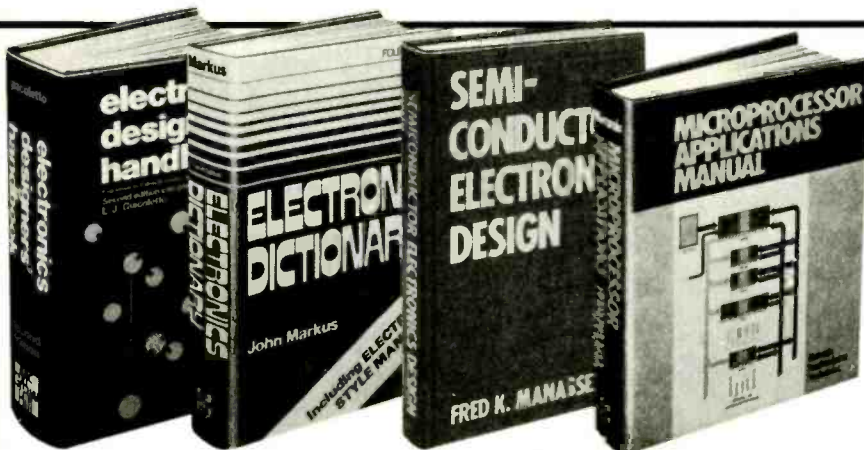

offer to new members of the and Control Engineers' Book Club

ELECTRONICS ENGINEER'S HANDBOOK. Editor-in-Chief, D. G. Fink. 2,104 pp., 2,026 illus. Huge in every sense, this instant-reference volume gives you every latest essential in the field, 2,100 formulas and equations, a 2,500-item bibliography, and every illustration you need to clarify all of modern electronics! 209/804 Pub. Pr., \$49.50 Club Pr., \$35.00

GUIDEBOOK OF ELECTRONIC CIRCUITS. By J. Markus. 1,018 pp., illus. Are you constantly on the lookout for circuits that will meet your needs? Here's a giant collection of them to use "as is" or to adapt to your own ideas. Complete with values. 404/453 Pub. Pr., \$33.50 Club Pr., \$25.00

PROFESSIONAL ENGINEERS' EXAMINATION QUESTIONS AND ANSWERS. By W. S. LaLonde, Jr., and W. J. Stack-Staikidis. 3rd Ed. 601 pp., 276 illus. Over 500 questions and complete answers—suitable for all states—prepare you for passing your exams for the E.I.T. certificate and your P.E. license. 360/936 Pub. Pr., \$19.50 Club Pr., \$14.50

DESIGN TECHNIQUES FOR ELECTRONICS ENGINEERS. Electronics Book Series. By ELECTRONICS Magazine. 370 pp., illus. The whole gamut of complex techniques required when you're designing a circuit or system is explained and shown in the superb collection of the "best of the best" from *Electronics* magazine. 191/581 Pub. Pr., \$19.50 Club Pr., \$16.50

HANDBOOK FOR ELECTRONICS ENGINEERING TECHNICIANS. By M. Kaufman and A. H. Seidman. 520 pp., 695 illus. Rely on this technician's godsend for all your work with analog and digital integrated and discrete circuits. Here are the stiff brush-up you want and the solutions to every possible problem. 334/013 Pub. Pr., \$23.50 Club Pr., \$16.50

MICROPROCESSORS & SMALL DIGITAL COMPUTER SYSTEMS FOR ENGINEERS & SCIENTISTS. By G. A. Korn. 390 pp. This exceptional book is your quick reference for expert advice on product selection, interfacing, and programming. Containing a huge variety of computer possibilities, system features, and costs, it's also a terrific tool for career updating. 353/670 Pub. Pr., \$27.50 Club Pr., \$18.95

ELECTRONICS DICTIONARY. Edited by John Markus. 4th Ed., 768 pp., 1,173 illus., 17,090 terms. With the new edition of this world-renowned dictionary you'll be able to quickly find the meaning and correct usage of any electronics term, no matter how obscure! 404/313 Pub. Pr., \$24.50 Club Pr., \$19.50

APPLIED ELECTROMAGNETICS. By M.A. Plonus. 615 pp., illus. A fascinating approach to theory through the use of totally up-to-date applications encountered in everyday situations. Covers solid-state electronics, physical electronics, linear and rotating machines, microwaves, and super-conductivity. 503/451 Pub. Pr., \$21.00 Club Pr., \$16.50

ELECTRONIC TROUBLESHOOTING, A Manual for Engineers and Technicians. By C.N. Herrick. 2nd Ed., 348 pp., illus. One of the best manuals ever published for engineers and technicians, this new edition moves you right along in practical steps from basics to more and more complex jobs. 784/639 Pub. Pr., \$16.95 Club Pr., \$14.25

MASTER OP-AMP APPLICATIONS HANDBOOK. By H.W. Fox. 467 pp., 320 illus. There's enough practical build-it information in this book to keep you breadboarding and experimenting and creating for years! It shows you how to put op amps to work in literally hundreds of different circuits, in hundreds of hardworking applications. 784/477 Pub. Pr., \$16.95 Club Pr., \$13.50

any one
of these great
professional books
for only **\$1.89**
values up
to \$52.50

Special \$1.89 bonus
book comes to you
with your first
club selection

ELECTRONICS AND CONTROL ENGINEERS' BOOK CLUB saves you both time and money!

Here is a professional book club designed to meet your on-the-job engineering needs by providing practical books in your field on a regular basis at below publisher prices. If you're missing out on important technical literature—if today's high cost of reading curbs the growth of your library—here's the solution to your problem.

The *Electronics and Control Engineers' Book Club* was organized for you, to provide an economical reading program that cannot fail to be of value. Administered by the McGraw-Hill Book Company, all books are chosen by qualified editors and consultants. Their understanding of the standards and values of the literature in your field guarantees the appropriateness of the selections.

How the club operates: Thirteen times a year you receive free of charge *The Electronics and Control Engineers' Book Club Bulletin*. This announces and describes the Club's featured book for that period as well as alternate selections available at special members' prices. If you want to examine the Club's featured selection, you do nothing. If you prefer one of the alternate selections—or if you want no book at all—you notify the Club by returning the card enclosed with each Bulletin.

As a Club member, you agree only to the purchase of four books (including your first selection) over a two-year period. Considering the many books published annually, there will surely be at least four you would want to own anyway. By joining the Club, you save both money and the trouble of searching for the best books.

MAIL COUPON TODAY

ELECTRONICS AND CONTROL ENGINEERS' BOOK CLUB
P.O. Box 582, Hightstown, New Jersey 08520

Please enroll me as a member and send me the two books indicated. I am to receive the bonus book at the introductory price of \$1.89 plus my first selection, plus tax, postage and handling. If not completely satisfied, I may return the books within 10 days and request that my membership be cancelled. If I keep the books, I agree to take a minimum of three additional books during the next two years at special Club prices (guaranteed 15% discount, often more). I will receive the Club Bulletin 13 times a year. If I want to examine the featured selection, I need take no action. It will be shipped automatically. If, however, I want an alternate selection—or no book at all—I simply notify the Club by returning the convenient card always enclosed. I will always have a minimum of ten days in which to return the card and you will credit my account fully, including postage, if this is not the case. Membership in the Club is continuous but cancellable by me at any time after the four-book purchase requirement has been filled. This order subject to acceptance by McGraw-Hill. Orders from outside the continental U.S. must be prepaid. All prices subject to change without notice. Offer good for new members only. Postage and handling charges are added to all subsequent shipments.

WRITE BELOW:

Code No. of \$1.89 book Code # of 1st selection

NAME

ADDRESS

CITY

STATE ZIP

EXTRA SAVINGS: Remit in full with your order, plus any local and state tax, and McGraw-Hill will pay all regular postage and handling charges.

E33366

CIRCLE 18 ON FREE INFORMATION CARD

www.americanradiohistory.com

LETTERS

continued from page 17

Digital Micro Systems
Box 1212
Orem, UT 84507

Electronic Systems, Inc.
P.O. Box 212
Burlingame, CA 94010
(408) 374-7951

Micro Designs, Inc.
499 Embarcadero
Oakland, CA 94606
(415) 465-1861

Realistic Controls Corp.
404 W. 35th St.
Davenport, IA 52806
(800) 553-1863

Integrand
8474 Avenue 296
Visalia, CA 93277
(205) 733-9288

Vandenberg Data Products
P.O. Box 2507
Santa Maria, CA 93454
(805) 937-7951

PolyMorphic Systems
460 Ward Drive

Santa Barbara, CA 93111
(805) 967-0468

I realize this list isn't quite complete, but I thought you should update your list. I would like to add that Vandenberg Data Products has the only 16K RAM board available for the S-100 bus for \$330, fully static (kit) and rated at 250 μ s, quite suitable for a Z-80. Anybody else's static RAM costs roughly double that. I am currently running 32K of their memory and am thinking hard about another 16K. All components in my system (except the TV) were built from kits.
MARCUS S. LEWIS
Omaha, NE

S-100 BUS ADDITIONS

I enjoyed the S-100 article (April 1978 issue, page 48) and S-100 bus listing. In the listing you asked to be informed of other S-100 products not listed.

CGRS Microtech manufactures three boards for the S-100:

1. The 6502 MPU Board—to our knowledge, this is the only S-100/6502 board for the S-100. It has been in production for 18 months and is working very well.

2. The T.I.M. II I/O Board—this is a "system monitor board" that provides ROM, RAM, and parallel and serial I/O ports.

3. The Multi-I/O Board—provides I/O for the Persci 1070 floppy-disc controller card as well as 4K of ROM, two parallel ports and two serial ports.

WILLIAM M. GOBLE
CGRS Microtech
P.O. Box 368
Southampton, PA
(215) 757-0284

WHERE ARE THE ELECTRONIC DESIGNERS?

I wish to respond to your June 1978 editorial entitled "Where Have All The Designers Gone?"

Electronic designers have always been wiring up "black boxes" to form new devices. What are resistors, transistors, capacitors, inductors, transformers, etc., but "black boxes"? A black box is simply a device with known characteristics.

The designer today uses IC's to reduce the amount of drudgery and cost in his designs. How would you like to redesign the NAND gate hundreds of times for each digital project? If every general-purpose IC (i.e., gates, op-amps, latches, etc.) had to be built from discrete components, a digital clock, stereo, CB radio and any other electronic device would cost much more than it now does.

In answer to the question, "What does an electronic designer do?" I think I am qualified to respond since I am an electronics engineer with IBM. My job is to design, oversee construction and debug electronic circuits. It also requires taking sometimes as many as 100 separate inputs and creating the proper responses at the proper time. I use digital IC's to create these circuits and do consider each circuit to be a new one.

This is designing, just as engineers in the 1950's designed using only transistors, tubes and other less-complicated devices.

I don't think it has slowed either the development or development time of new devices; it has simply made it economically

continued on page 24



PROFESSIONAL TOOL CASE

Interchangeable Screwdrivers, Nutdrivers, Other Tools and Handles —

- 99-1, 1-R, & 4-R Handles (regular, straight and Tee ratchets)
- 99X2 Square Adaptor
- 99X5 & X10 Extensions
- 99-38 & 39 Riemers
- 99-70 Awl/Scraper
- 99-125, 250, 312, & 811 Slotted Screw Blades
- 99-820, 821, & 822 Phillips Screw Blades
- Pliers, Wrenches, Cutters**
- 42H Straight Nose Seizer (S)
- 46C Adjustable Wrench (6")
- 50CG Midget Slip Joint Plier (5")
- 51CG Long Nose Plier (6-1/2")
- 53CG Utility Plier (7")

- 54CG & 66CG Diagonal Pliers (4" & 6")
- 57CG Needle Nose Plier (5 1/2")
- 59CG Chain Nose Plier (8")
- 86CG Electronic Snips
- 103-S Wire Stripper/Cutter
- K-22 Electrician's Knife

Sets & Kits

- 99-PS-40 Hex Socket Screwdriver Blade & Handle
- 99-PS-60 Bristol Multiple Spine Screwdriver Blades & Handle
- M-60 Mini Drivers
- PS-120 Compact Convertible Nutdrivers
- XL-75 Offset Ratchet Screwdrivers

600 Combination Screwdriver/Nutdriver Tool

- Screwdrivers**
- | | | |
|-----------------|--------|--------|
| Slotted Screws: | R-144 | R-3323 |
| | R-146 | R-5325 |
| | R-181 | S-388 |
| | R-184 | S-3161 |
| | R-3164 | S-5161 |
| | R-3166 | S-5166 |
- Phillips Screws:**
- | | | |
|--|---------|---------|
| | SX-101 | XST-101 |
| | XST-100 | XST-102 |
- Hex Socket:**
- | | |
|--|-----------------------|
| | P-18 & 19 (028 & 035) |
|--|-----------------------|
- Nutdrivers**
- | | |
|--|------------------------------|
| | HS-6, 8, 10, 11, 12, 14, 16, |
| | 18 Hollow Shaft |
| | 8M & 10M Magnetic |

MODEL TC-100

Larger, more elaborate of the two cases. Contains 41 individual tools, 16 Series 99 interchangeable screwdriver/nutdriver blades and handles, and 5 specialized screwdriver/nutdriver kits, as listed. Case (19-1/2" x 13-1/2" x 6-3/4") covered with attractive, tough, chestnut-brown, leather-grain Marvlon. Removable three-panel, hinged pallet and tray outfitted with elastic loops and transparent plastic pocket tool holders. Solid brass locks, latches, and hardware. Padded handle. Partitioned bottom compartment for other tools.

CHRISTMAS SPECIAL

\$269.95

Shipping not included.

Xcelite List price \$485.
Offer ends Feb. 28, 1979

THE TEST EQUIPMENT SPECIALISTS



TOLL FREE HOT LINE
800-223-0474



ADVANCE ELECTRONICS

54 West 45 Street New York, N.Y. 10036 212-687-2224

NTS trains you on tomorrow's equipment. Today.

Microcomputers, digital systems and more...
from the first name in home study.



Now NTS training programs include an even wider choice of solid-state digital equipment than ever before offered in any electronic home study course. Advanced NTS/Heath digital color TV (25" diagonal with optional programming capability), NTS/Heath digital computer, digital test equipment, digital stereo receiver (70 watts per channel) plus much more state-of-the-art equipment to make your training exciting and relevant. Learn servicing and maintenance easily with step-by-step Project Method lessons and kits.

An all-new full color catalog shows you exactly what each of the fourteen courses cover, and every piece of equipment you receive.

Send for it today and see for yourself what's really happening in electronics training technology at NTS. It's free. Just send the coupon.

**NO OBLIGATION. NO SALESMAN WILL CALL.
APPROVED FOR VETERAN TRAINING.**

NATIONAL TECHNICAL SCHOOLS

TECHNICAL-TRADE TRAINING SINCE 1905
Resident and Home-Study Schools
4000 South Figueroa St., Los Angeles, Calif. 90037

NATIONAL TECHNICAL SCHOOLS Dept. 206-128
4000 South Figueroa Street, Los Angeles, California 90037

Please send FREE Color Catalog and Sample Lesson.

- | | |
|---|---|
| <input type="checkbox"/> Color TV Servicing | <input type="checkbox"/> Electronics Technology |
| <input type="checkbox"/> B & W TV and Radio Servicing | <input type="checkbox"/> Audio Electronics Servicing |
| <input type="checkbox"/> FCC License Course | <input type="checkbox"/> Digital Electronics |
| <input type="checkbox"/> Electronic Communications | <input type="checkbox"/> MicroComputers/MicroProcessors |

Name _____

Address _____

Apartment Number _____ Age _____

City _____

State _____ Zip _____

Check if interested in G.I. Bill information.

Check if interested ONLY in classroom training in Los Angeles.

LETTERS

continued from page 22

feasible to develop more complicated products. For example, with IBM's Series III copier (yes, I know I'm biased), would so many functions have been possible without IC's? I think not.

Finally, an electronic designer is someone who extracts information from electrical signals (inputs) with electronic components, and who controls (via outputs) other devices with that information. The process of creating the device between the inputs and outputs (which, by the way, are usually defined before the design is begun) is electronic design.

DENNIS A. ROWE
Boulder, CO

With respect to your June 1978 editorial, I think that persons who use and apply integrated circuits are, indeed, designers. They may be using available devices to design something that is totally new, unique, and perhaps useful, too. I think that the IC has freed us to concentrate upon the task at hand without having to craft the tools that are necessary to accomplish it. Remember the days of the tube-based op-amp, the tube-based counters and flip-flops, etc.? They are gone, luckily.

If IC users aren't really designers, then neither are the solid-state physicists and semiconductor engineers, since all they are doing is moving around the same atoms in different ways. The silicon, gallium and

arsenic remain the same . . . the designers just do different things with them.
JONATHAN TITUS

In reply to your June editorial, I feel that the designer is still with us.

It seems to me that the designer's role has taken three different paths—on one path he devises all the IC's we use. On another path, he is a systems designer, responsible for the design of the complete complex system. And the third path is that of designing the new instrumentation used to service complex devices.

Today, the engineer can take the IC's and connect them together to make a circuit or simple electronic device.

I really don't envy the job of the instrumentation designer for he has to design instruments that are to be used repeatedly by people not in the electronics field. For example, automotive mechanics are finding more and more electronics in our modern cars. They cannot just exchange one module for another; because of increasing complexity, they must use instruments to troubleshoot the entire system to find the malfunction.

Twenty years ago, when I graduated from electronics school, we did not have very many test instruments. We could troubleshoot and repair just about everything electronic with an OS-8 oscilloscope, TS-352 VOM, TV-7 tube tester and BC-221 frequency meter.

I would hate to troubleshoot and repair

some of today's complex electronics systems with those Stone Age instruments. If you look at some modern instrumentation, you can see the designer has been busy. And there is always something new being released to make our jobs easier.

I feel that economics, not the integrated circuit, has slowed down the development of new electronic devices. The question is now when a new product is developed, is it to be made inexpensive enough to be disposable when it malfunctions or is it to be made repairable? And who will repair it? There are a few products on the market that are disposable because of their low cost—radios, LED watches and calculators. But now I feel that many manufacturers are taking a wait-and-see attitude before producing any more low-cost products.

JERRY W. CLARK
New Richmond, IN

HOME COMPUTERS

I have a hobby computer. I have not yet and probably never will wire it up to "run the house." Most household applications can be controlled just fine with a motor and cam for several operations per day. If I did "control the house" with my computer, I couldn't experiment with new programs since I might erase the household program.

What I really do with my computer is write game programs. After spending many hours writing and debugging the program, I

Vector

PLUGBORDS OFFER MORE. . .

- Unique time saving bus patterns
- Press-fit wrap-posts & solder terminals
- Many board and contact sizes



- Easy to wire hole and pad patterns
- .042" diameter holes on .1" grid
- P.C. plug or flexcable connections

4493-1 ANY DIP, \$16.95 Accepts all DIPs. Offset power and ground planes. 36/72 contacts. 4.5" x 9.6" (6.5" also available). 22/44 contacts also offered in both sizes.

8804 ANY DIP, \$21.95. Accepts all DIPs. Offset power and ground planes, 50/100 contacts spaced .125". S-100 size.*

4112-5 PAD BOARD, \$12.23. Pad per 3 holes. Ground plane on back-side. 4.5" x 4.5" or 4.5" x 6.5" or 4.5" x 9.6". 22/44 contacts spaced 0.156".

8802-1 PAD BOARD, \$21.95. Pad per 2 holes, each side, peripheral buses. 50/100 contacts spaced at .125", S-100 size.*

8801 PAD BOARD, \$19.95. Pad per each hole, each side, peripheral buses. 50/100 contacts at .125". S-100 size.*

8801-1, \$14.95. No pads — just holes. 50/100 contacts at .125". S-100 size.

*S-100 size is 5.3" high by 10" wide.

VECTOR ELECTRONIC COMPANY
12460 Gladstone Avenue
Sylmar, California 91342

Phone (213) 365-9661
TWX (910) 496-1539
Send for new data.

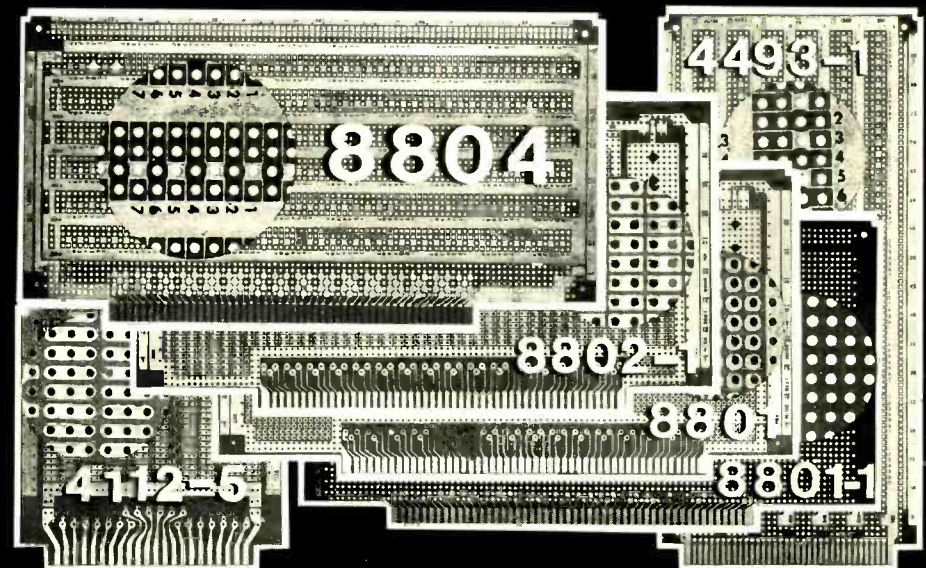

FULL LINE OF SUPPORTING PRODUCTS: Card cages and enclosures for all Plugboards, mating receptacles, interconnect products.

Prices subject to change without notice.



Patented Vector P184 Tool is three times faster for inter-connecting wrap-post designs. \$29.95.

Our toll-free number which can be used by customers outside of California is 800-423-5659

CIRCLE 68 ON FREE INFORMATION CARD

play the game a couple of times and start writing a new program.

I agree with you that the "Home Computer" is nonsense. The only application I might have for it is to balance my check-book. Even then I would pull out my pocket calculator.

Many people ask, "Well then, what good is your computer?" I guess the best answer is, "What good is your home TV set?"

E. MORRIS
Midland, MI

I do not own a hobby computer. I do have three hi-fi sets, a VCR, model railroad, darkroom and studio to support; so when I received several estimates of the cost of a computer system (\$8000) with enough memory and "crunch" to cross-reference my collection of 1000 LP records and songs into several categories, I bailed out.

I do know about computers since we use one to roll our film and tapes at the TV studio I work at. I also can remember anytime, anyplace that next month the real estate tax is due. I know how much I have in several savings and checking accounts. I don't need an expensive computer to remind me (if I happen to be near it), but if the price were \$200 for the system described above with a cassette, easily interchangeable programs, a video (or TV) monitor or hardcopy at additional cost, I might buy it.

I guess what I mean is I don't like to "play games" just for the sake of playing games, and if it takes possibly more time to program the computer to do a job than it might take to do the job the usual way, why bother? But if the cost of computers drops as it did with small calculators, we will have a different ball game.

DICK WARTENBERG
Brooklyn, NY

DARKROOM TIMER

With respect to my article in the July and August 1978 issues ("Build A Digital Timer for Your Darkroom"), the accuracy of the schematic was excellent. However, there were six errors that must be noted:

1. In the table shown in Fig. 3 that lists the power and ground connections for the IC's, I wrongly listed pins 14 and 7 as power and ground for IC13. The correct pins are 16 for power and 8 for ground.

2. In Fig. 3 again, an LED is missing between pins 10 and 1 of DIS4, but this is an internal LED contained within DIS4 as are the others.

3. The point at which S4 connects to the main PC board should be labeled "D."

4. The Parts List did not have numbers for the transistors. They can be any NPN silicon transistors whose beta is between 50 and 150, such as 2N2222, 2N957, etc.

5. The part number given for S1-S3 is incompatible with the PC board/front panel combination. The correct UID Electronics part numbers are: S1: RSW-0622-SD-BB-S-B1-BK; S2 and S3: RSW-0022-SD-BB-S-B1-BK.

6. One of the key cap part numbers should be 42-3100-03, not 40-3100-03. The "42" indicates double-width, which is what the "0" key cap is.

RAYMOND G. KOSTANTY

R-E

Q • Where should you start in your search for better sound?

A • At the beginning. With a new Audio-Technica Dual Magnet™ stereo phono cartridge.

Our AT12XE, for instance. Tracking smoothly at 1 to 1-3/4 grams, depending on your record player. Delivers smooth, peak-free response from 15 Hz to 28,000 Hz (better than most speakers available). With a minimum 24 dB of honest stereo separation at important mid frequencies, and 18 dB minimum separation even at the standard high-frequency 10 kHz test point. At just \$65 suggested list price, it's an outstanding value in these days of inflated prices.

Audio-Technica cartridges have been widely-acclaimed for their great sound, and for good reason. Our unique, patented* Dual Magnet construction provides a *separate* magnetic system for *each* stereo channel. A concept that insures excellent stereo separation, while lowering magnet mass. And the AT12XE features a tiny 0.3 x 0.7-mil nude-mounted elliptical diamond stylus on a thin-wall cantilever to further reduce moving mass where it counts. Each cartridge is individually assembled and tested to meet or exceed our rigid performance standards. As a result, the AT12XE is one of the great bargains of modern technology ...and a significant head start toward more beautiful sound.

Listen carefully at your Audio-Technica dealer's today.

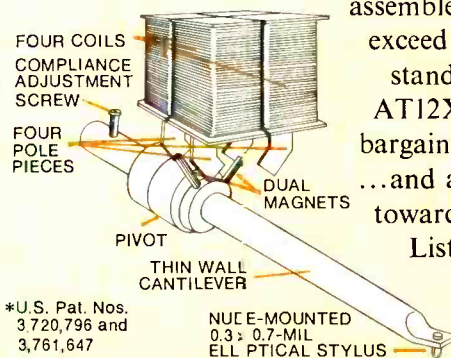
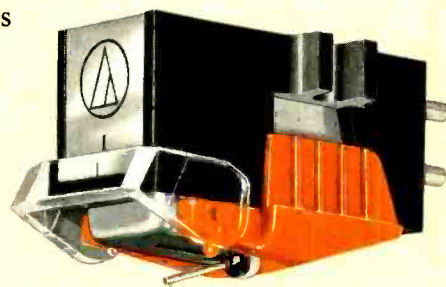

audio-technica
INNOVATION □ PRECISION □ INTEGRITY

AUDIO-TECHNICA U.S., INC., Dept. 128E, 33 Shiawassee Avenue, Fairlawn, Ohio 44313
in Canada: Superior Electronics, Inc.

CIRCLE 5 ON FREE INFORMATION CARD

equipment reports

Super Sleuth Descrambler

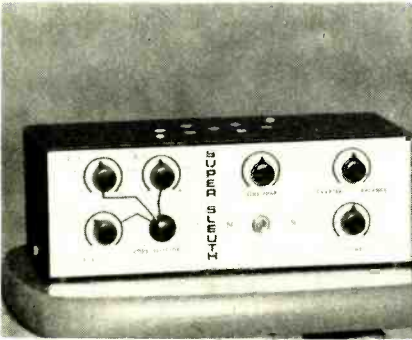

CIRCLE 118 ON FREE INFORMATION CARD

AS MORE AND MORE LAW-ENFORCEMENT CHANNELS are being monitored by unauthorized listeners using scanners, many agencies have attempted to improve voice security by using "scramblers." A scrambler is an audio frequency inverter. High frequencies become low

and low frequencies, high; the result is unintelligible.

The *Super Sleuth* descrambler is designed to reinvert audio signals to normal. It plugs into the external speaker jack of a scanner and is usually left switched to the normal mode. When conventional transmissions are received, the descrambler's internal speaker is connected directly to the scanner's speaker jack, and the descrambler circuitry is off. When a scrambled message is received, the *Super Sleuth* is switched to the scrambled mode, and an internal ring-demodulator circuit rearranges the inverted speech to normal speech.

The *Super Sleuth* is entirely self-contained, including eight internal AA batteries (not provided), and its three adjustable decoding controls are switch-selectable.

Many law-enforcement agencies use more than one audio code, switching codes at different times; the three switch-selectable controls allows the listener to individually adjust each control to correspond to a given code, and then leave it set so that rapid switch-selectable

decoding of the scrambled message is possible the next time it is encountered.

A FINE TUNE control allows an occasional adjustment of the audio for natural voice quality (however, it is seldom needed).

Since descramblers (and scramblers) inject an audio signal into their circuitry, that signal should be removed from the resultant audio output so that it doesn't cause annoying interference. The *Super Sleuth* has a CARRIER/BALANCE null control knob to accomplish this.

Finally, the volume control permits you to adjust the audio output to a comfortable listening level.

The *Super Sleuth* looks impressive, functions well and its audio quality is very natural. Although the top-mounted internal speaker would be inconvenient for under-dash mobile mounting, most listeners would probably use the unit next to a scanner in the home or office.

A 741 op-amp audio oscillator injects an
continued on page 32

CLIP AND STRIP

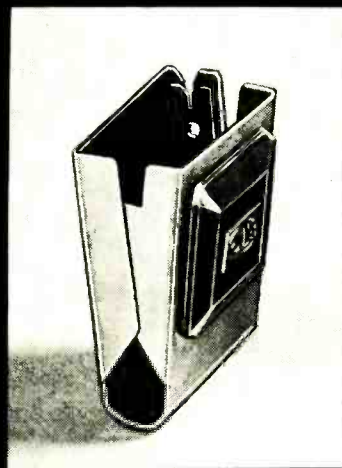

Model CAS-130

\$198

- CUTS AWG 30 WIRE TO DESIRED LENGTH
- STRIPS 1" OF INSULATION

MINIMUM BILLING \$25.00
ADD SHIPPING CHARGE \$2.00
NEW YORK STATE RESIDENTS
ADD APPLICABLE TAX



OK MACHINE & TOOL CORPORATION
3455 Conner St., Bronx, N.Y. 10475 • (212) 994-6600 • TELEX 125091

CIRCLE 20 ON FREE INFORMATION CARD

sophisticated soldering of space-age heat- & voltage-sensitive components

DEMANDS THE RELIABILITY OF

Weller® controlled output irons and stations

Modern, ultra-sophisticated electronic technology calls for totally dependable soldered connections. This requires not only sensing the soldering tip temperature, but applying and removing wattage at precisely the right moment to control the selected operating range of the iron.

That, in a nutshell, is what the Weller family of Controlled Output Soldering Equipment is all about. And that explains how it can avoid defects in soldered connections and damage to heat- and voltage-sensitive components and substrates, as well as deteriorating over-exposure from needlessly long soldering contact. In other words, dependence on the human element is eliminated. But there are other significant benefits from the Weller controlled output soldering technique. Soldering tips last longer. Much longer. And power consumption is less than that of uncontrolled irons.

What's the secret of Weller's controlled output? It's really no longer a secret. Today it's a time-proved principle: Closed loop, low voltage circuitry and a ferromagnetic sensor control temperature at a pre-selected range. Sounds simple? It is. That's why it's totally reliable!

Ready to meet the whole Weller Temperature Controlled family? This way, please for a brief introduction to the members presented below.

LINE VOLTAGE PORTABLE IRONS

Models W60 and W100: 60 and 100 watts. Operate from 120V outlet. Interchangeable 600, 700, and 800°F tips, grounded and non-grounded, available in 9 sizes. Optional de-soldering adaptor and non-heat-sinking tool holders.

COMPLETE SOLDERING AND DE-SOLDERING STATIONS

Include iron holder, tip-wiping sponge and receptacle, power on-off switch with indicator light, stepdown transformer dropping power to 24V in heating element, positive tip-grounding to prevent build-up of electrostatic charges that injure delicate components, non-burnable silicone rubber cord, and dozens of other Weller quality features.

Model WTCPN: Plug-in pencil soldering iron with comfort-cool heat shield, 17 available styles and sizes of interchangeable tips for 600, 700, and 800°F temperature control, integral tip storage tray. 120V, 60Hz, 60W. Optional de-soldering adaptor.

Model MP: For precision soldering of miniaturized electronics, especially PC work. Plug-in, true pencil shape 650 or 750°F iron with 1/8" diam. tips available in 8 sizes and styles. 120V, 60/40Hz, 22W.

Model DS100: De-soldering and re-soldering unit designed for PC board repair and re-work lines. Utilizes interchangeable 600, 700, and 800°F soldering tips and interchangeable 700 or 800°F de-soldering heads. Complete with footswitch, twin safety tool holder, vacuum adjustment gauge, and cleanable, replaceable see-thru solder collector. 8 de-soldering triplet sizes and 17 soldering tip styles (in 3 temps) available. Operates from factory air and line voltage.

Yes, of course, the entire family is UL listed and OSHA compliant. Now that you've been introduced, any leading electronic distributor will display the units and fill you in on all the features. For technical information and consultation, write the factory on your company letterhead.



The Cooper Group
Electronics Division

WELLER® · WISS® · XCELITE®

P.O. BOX 729, APEX, NORTH CAROLINA 27502, 919/362-751
CIRCLE 74 ON FREE INFORMATION CARD

At CIE, you get electronics career training from specialists.

If you're interested in learning how to fix air conditioners, service cars or install heating systems – talk to some other school. But if you're serious about electronics, come to CIE – The Electronics Specialists.

John E. Cunningham

**Special Projects Director
Cleveland Institute of Electronics**



My father always told me that there were certain advantages to putting all your eggs in one basket. "John," he said, "learn to do one important thing better than anyone else, and you'll always be in demand."

I believe he was right. Today is the age of specialization. And I think that's a very good thing.

Consider doctors. You wouldn't expect your family doctor to perform open heart surgery or your dentist to set a broken bone, either. Would you?

For these things, you'd want a specialist. And you'd trust him. Because you'd know if he weren't any good, he'd be out of business.

Why trust your education and career future to anything less than a specialist?

You shouldn't. And you certainly don't have to.

FACT: CIE is the largest independent home study school in the world that specializes exclusively in electronics.

We have to be good at it because we put all our eggs in one basket: electronics. If we hadn't done a good job, we'd have closed our doors long ago.

Specialists aren't for everyone.

I'll tell it to you straight. If you think electronics would make a nice hobby, check with other schools.

But if you think you have the cool — and want the training it takes — to make sure that a sound blackout during a prime time TV show will be corrected in seconds — then answer this ad. You'll probably find CIE has a course that's just right for you!

At CIE, we combine theory and practice. You learn the best of both.

Learning electronics is a lot more than memorizing a laundry list of facts about circuits and transistors. Electronics is interesting because it's based on some fairly recent scientific discoveries. It's built on ideas. So, look for a program that starts with ideas — and builds on them.

That's what happens with CIE's Auto-Programmed® Lessons. Each lesson uses world-famous "programmed learning" methods to teach you important principles. You explore them, master them completely... before you start to apply them!

But beyond theory, some of our courses come fully equipped with the electronics gear to actually let you perform hundreds of checking, testing and analyzing projects.

In fact, depending on the course you take, you'll do most of the basic things professionals do every day — things like servicing a beauty of a Zenith color TV set... or studying a variety of screen display patterns with the help of a color bar generator.

Plus there's a professional quality oscilloscope you build and use to "see" and "read" the characteristic waveform patterns of electronic equipment.

You work with experienced specialists.

When you send us a completed lesson, you can be sure it will be reviewed and graded by a trained electronics instructor, backed by a team of technical specialists. If you need specialized help, you get it fast... in writing from the faculty specialists best qualified to handle your question.

People who have known us a long time, think of us as the "FCC License School."

We don't mind. We have a fine record of preparing people to take... and pass... the government-administered FCC License exams. In fact, in continuing surveys nearly 4 out of 5 of our graduates who take

the exams get their Licenses. You may already know that an FCC License is needed for some careers in electronics — and it can be a valuable credential anytime.

Find out more! Mail this card for your FREE CATALOG today!

If the card is gone, cut out and mail the coupon.

I'll send you a copy of CIE's FREE school catalog, along with a complete package of independent home study information.

For your convenience, I'll try to arrange for a CIE representative to contact you to answer any questions you may have.

Remember, if you are serious about learning electronics... or building upon your present skills, your best bet is to go with the electronics specialists — CIE. Mail the card or coupon today or write CIE (and mention the name and date of this magazine), 1776 East 17th Street, Cleveland, Ohio 44114.



Patterns shown on TV and oscilloscope screens are simulated.

CIE Cleveland Institute of Electronics, Inc.

1776 East 17th Street, Cleveland, Ohio 44114

Accredited Member National Home Study Council

YES... John, I want to learn from the specialists in electronics — CIE. Send me my FREE CIE school catalog — including details about troubleshooting courses — plus my FREE package of home study information. RE-50

Print Name _____

Address _____ Apt. _____

City _____

State _____ Zip _____

Age _____ Phone (area code) _____

Check box for G.I. Bill information: Veteran Active Duty

Mail today!

EQUIPMENT REPORTS

continued from page 27

adjustable tone into a diode-bridge ring modulator (mixer), where it heterodynes with the inverted audio from the scanner's speaker-jack output. The difference frequency (in this case, normal unscrambled speech) is fed to an LM380N amplifier IC for up to two-watts audio output.

The *Super Sleuth* weighs only 2 lb. and measures 10 W × 3½ H × 5 inches D. Its power drain is 12 VDC at 25 to 300 mA depending upon audio-output level. The unit is available for \$79.95 from Krystal Kits, Box 445, Bentonville, AR 72712. **R-E**

Continental Specialties LP-2 and DP-2 Logic Probes

ALTHOUGH USING AN OSCILLOSCOPE AND EXPENSIVE logic analyzers to solve knotty troubleshooting problems is really best, logic probes save time in most situations. Using very few controls, the *models LP-2* and *DP-1* probes manufactured by Continental Specialties offer a combination of simple "go, no-go" testing and a high degree of diagnostic sophistication.

The *model LP-2* logic probe is a hand-held instrument that uses three LED indicators to display logic levels and pulse transitions via a dual-threshold window comparator and bipolar edge detector. The *model LP-2* probe is a less expensive version of the *model DP-1*; it has reduced frequency response, higher input im-

pedance, and it lacks a pulse-memory feature.

In the *model LP-2*, a single switch selects either DTL/TTL or CMOS/HTL levels. For static tests, the upper LED illuminates when the voltage at the probe tip is within the selected logic family's high-level range. The TTL and DTL logic 1 threshold is 2.25 volts ± 0.15 volt, and for CMOS and HTL, the threshold is 70% of the supply (V_{cc}) or higher. Similarly, the lower LED indicates logic levels within the low range. Logic 0 levels are 0.8 volt ± 0.1 volt for TTL/DTL, and 30% or less for CMOS/TTL. No LED illumination means there is an open circuit. Observing LED's near the probe tip is much simpler and less tiring than reading a voltmeter or oscilloscope screen, and then having to mentally translate that reading to

1 to 0 logic-level transition. A repetitive signal causes the indicator to illuminate constantly with an intensity that depends on duty cycle and frequency. Duty cycle is determined by observing the upper and lower LED's when the pulse light is lit. For example, if the upper LED illuminates, the signal is high most of the time and therefore consists of negative-going pulses. If both the upper and lower LED's have equal intensity, the duty cycle approaches 50% (or a squarewave).

Signals greater than 10 Hz but less than 100 kHz cause the LED to flash at a 10-Hz rate determined by the probe's 0.1-second pulse stretcher. With signals greater than 100 kHz and near 50% duty cycle, only the pulse LED is illuminated. The upper or lower LED's light as the waveform duty cycle deviates from symmetrical squarewave pulses at the higher frequencies.

The *model LP-2* operates with pulses as narrow as 300 ns and a maximum frequency of 1.5 MHz. Overload protection is effective up to 50 volts DC, or 117 volts AC, for 15 seconds. To use the probe, power must be provided through black and red clip leads that are connected to the power source supplying the circuit under test. The probe's drain is 30 mA at 5 volts and 40 mA at 15 volts; and the input impedance is 300,000 ohms.

Several accessories are available, including a 2.5-inch probe tip, hooks and adapters, and ground clips. The *model LP-2* can be used for troubleshooting an inoperative divider chain by quickly finding the defective binary stage. It could also be useful to determine the static and pulse logic conditions on IC terminals. Using this probe to examine a microprocessor's ad-

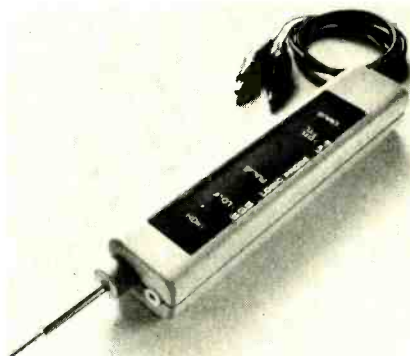

CIRCLE 119 ON FREE INFORMATION CARD

acceptable or abnormal limits.

The pulse indicator flashes for 0.1 second every time the input signal makes a 0 to 1, or a

Now! RCA offers you three time and money-saving options in Color TV Test Jigs.



dress leads could help pinpoint a grounded bus run when compared with the other active bus lines.



CIRCLE 120 ON FREE INFORMATION CARD

The *model DP-1* is a digital pulser probe with tristate output. It resembles the *model LP-2* physically, except it has only one LED pulse indicator plus a pulse-control pushbutton. A TTL/CMOS switch chooses output logic levels. The generator produces a single output pulse for each pushbutton operation. Depressing the pushbutton transmits a 100 pulse-per-second pulse train. Depending on the present logic level of the circuit area being probed, this produces differently formed logic pulses. If the probe senses a low logic level, it generates a positive-going pulse in an attempt to switch the logic-level state high. Conversely, if the logic level is high, the probe generates narrow negative-going pulses. Connecting the

probe to a variable-state point, such as a cross-connected feedback lead of a gate-wired flip-flop, generates a 50% duty cycle (continuous waveform).

In the TTL mode, the *model DP-1* produces a 1.5- μ s pulse with 100-ns risetime, and 500-ns storage and falltimes with a single TTL load. The storage and falltimes decrease with increased loading. The probe drives outputs as well as inputs, as long as the combined load is within the probe's 100-mA source and heat-sink capability.

The CMOS mode produces wider pulses for the higher-impedance (and generally slower) logic family. Pulse width is 10 μ s with a risetime under 100 ns, 8- μ s storage and falltimes with a 100K load, and sink and load capacity of 50 mA.

In both TTL and CMOS, the probe output is current-limited and generates continuous safety pulses into a short circuit. The LED indicator displays pulse-output states by flashing once for single pulse operation, and by constant illumination for continuous pulse-output trains.

If used with other logic probes such as the *model LP-2* or with a logic monitor that simultaneously displays all IC outputs, the *model DP-1* can test various types of logic devices. The probe is very useful in checking circuits that are only occasionally, or never activated. Using the logic pulser, these circuits can be activated repeatedly without elaborate test equipment and without disconnecting any auxiliary logic.

The *model DP-1* comes with a plug-in ground clip lead and the accessories that are available for the *model LP-2*. The output

impedance is greater than 300,000 ohms when the probe is in the open-output mode. And similar to the *model LP-2*, power is supplied to the *model LP-1* via color-coded clip leads, with less than 30 mA consumption.

The *model LP-2* sells for \$24.95 and the *model DP-1*, \$74.95. They are both available from Continental Specialties Corporation, 70 Fulton Terrace, P.O. Box 1942, New Haven, CT 06509.

R-E

Christmas Seals



Fight Lung Disease

Space contributed by the publisher as a public service

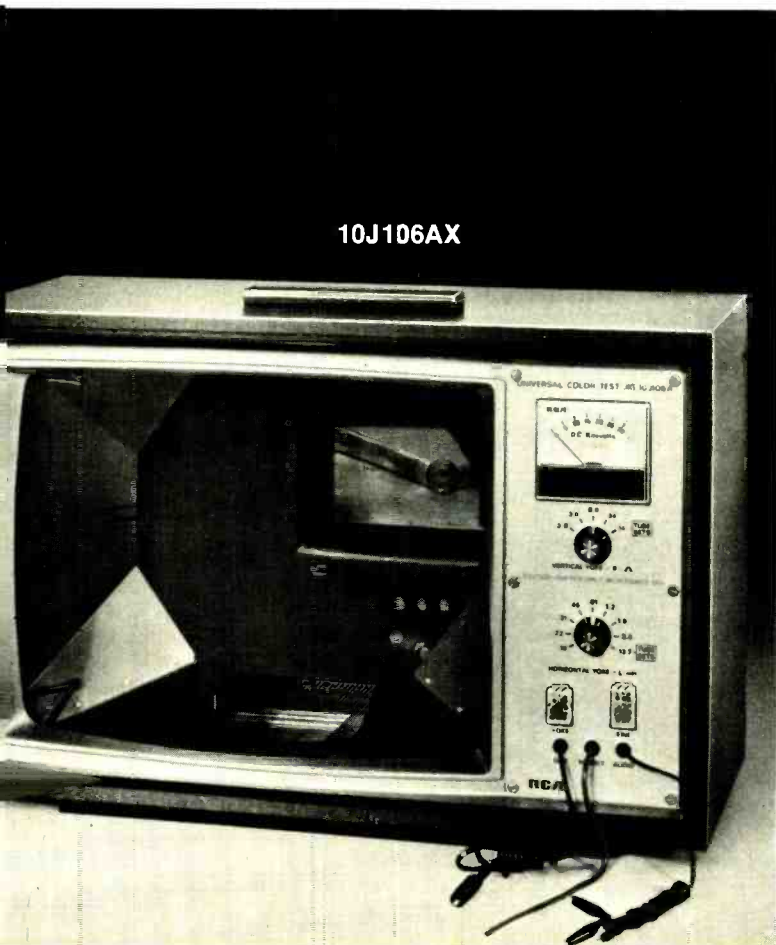

With the new RCA 10J106A Color TV Test Jig you can troubleshoot a TV chassis without bringing the cabinet and picture tube into the shop. The 10J106A helps you isolate picture tube or chassis malfunctions quickly, and without disturbing your customer's picture-tube alignment.

The 10J106A features a 19-inch shielded picture tube; built-in high voltage meter calibrated to 35 kV; two unique front-panel switches for easy changing of yoke impedances; and a built-in speaker. Yoke, picture tube socket, and high-voltage extension cables are supplied, plus a Set-Up Index and instruction book. With the 10J106A you can service thousands of sets whether tube, hybrid or solid-state — including Precision-in-Line types.

The new RCA 10J106AX Color TV Test Jig is exactly the same as the 10J106A except that it comes without a picture tube for those who prefer the economy of installing their own tube.

The RCA 10J107 Color TV Test Jig Adapter modernizes most older test jigs to perform like the 10J106A. And, if you're a do-it-yourselfer, you can build your own jig from a salvaged TV receiver.

See your RCA Distributor for all the details about which option suits you best. Or contact RCA Distributor and Special Products Division, Deptford, NJ 08096.

RCA Color TV
Test Jig

Performance and Price... there's no tradeoff in B&K-PRECISION scopes.

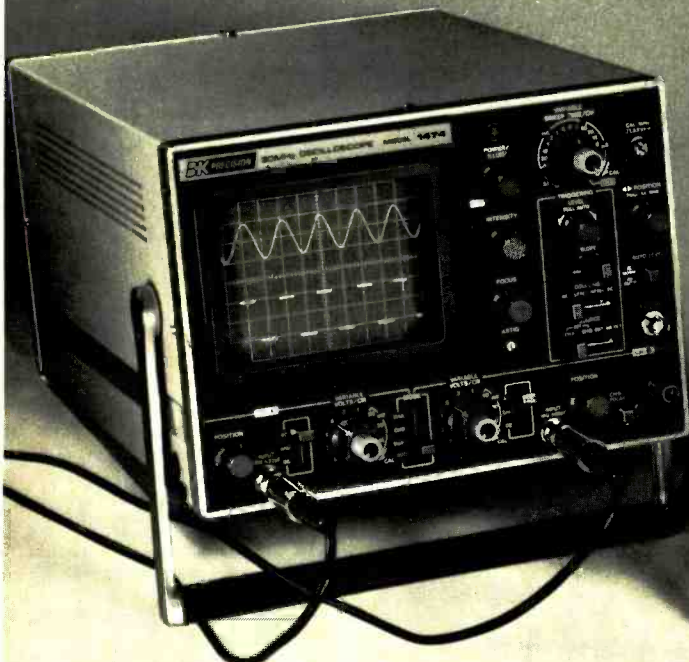

Model 1474 \$999 including probes



Model 1432 \$780 including probes

For field or lab work, Dynascan has a quality scope to fit your needs. B&K-PRECISION has taken a no-nonsense, cost-effective approach to oscilloscope design. Our scopes are rugged dependable instruments, designed to match the features and performance of far more expensive scopes, without matching their high prices. Typical of this approach is our Model 1474 30MHz dual-trace lab scope and our new Model 1432 15MHz portable dual-trace scope.



The B&K-PRECISION Model 1474 is the most cost-effective dual-trace scope available. No compromise features include a built-in signal-delay line, 25mV/cm sensitivity, switchable high- and low-pass triggering filters and a TTL compatible Z-axis input. Vertical response is typically down only -6dB at 49MHz. The 1474 is excellent for microprocessor work, as signal delay and the 30MHz minimum bandwidth allow you to examine short pulse waveforms.



The new Model 1432 portable dual-trace scope is one of our best values. This compact portable offers optional rechargeable battery pack and full lab-scope features. An automatic battery charger is built-in as a standard feature. Sensitivity is 2mV/division over a DC to 15MHz range. Bandwidth response is typically down only -6dB at 25MHz. Special features include algebraic addition and subtraction of two input signals, 19 calibrated sweep ranges and front-panel X-Y operation.

Off-the-shelf delivery is another of our features, and it's the one you can take advantage of first. We're so sure that B&K-PRECISION scopes will fill your needs, that we can offer a no-obligation, ten-day free trial. Contact your local B&K-PRECISION distributor for immediate delivery or a demonstration.

B&K PRECISION **DYNASCAN CORPORATION**

6460 West Cortland Street, Chicago, Illinois 60635 • 312 / 889-9087

In Canada: Atlas Electronics, Ontario • Int'l. Sls: Empire Exporters, Inc., 270 Newtown Road, Plainview, L.I., NY 11803

CIRCLE 60 ON FREE INFORMATION CARD

www.americanradiohistory.com

BUILD THIS

SOLAR

CONTROLLER

During the present energy crisis, the sun is in the running as the most viable alternate energy source. Here's how basic electronics can be adapted to solar heating in home and industry.

RODNEY A. KREUTER

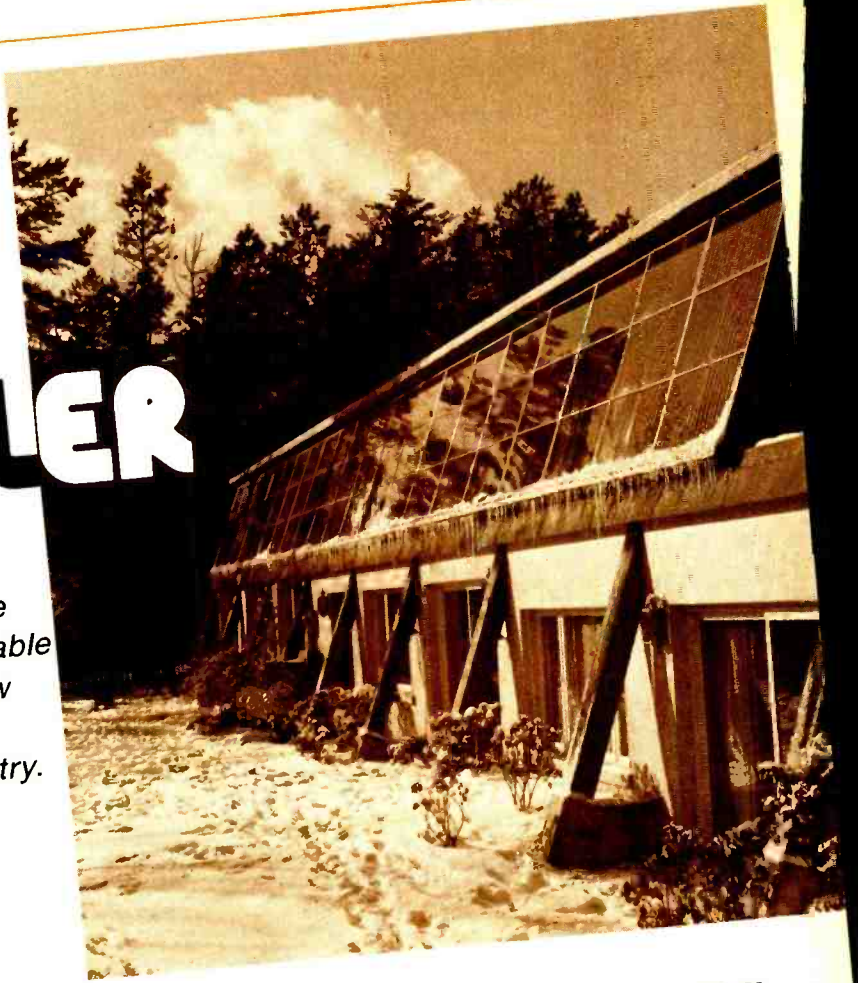

SOLAR ENERGY, IT SEEMS, HAS BECOME almost a universal interest. Companies offering solar collectors and associated hardware are springing up like glitches on a TTL breadboard. However, most companies sell complete systems and most "do-it-yourself" magazines concentrate on collectors or storage system. Very little information seems to be available concerning the instrumentation or control portion of the systems.

This article attempts to proceed one step further by providing an understanding of a simple instrumentation and control system. It is not meant to be a blow-by-blow construction guide because no two solar systems are quite the same. It is hoped that it will enable you to design a system that will meet your special needs.

Hot-water preheater

A good way to get started in solar energy is with a solar hot-water preheater. A substantial amount of the average utility bill goes to feed standard preheaters. Another advantage of a solar preheater is that the payback time is not too great and the cash outlay to get started is within reason.

A preheater is a rather straightforward device. All it does is warm up the cold-water inlet to an existing hot-water tank

so that the tank itself won't need as much energy to warm the water to the required temperature. (Note the phrase "as much.") A small solar collector in a less-than-ideal climate will not supply all your needs; it will, however, help save a great deal of energy.

Figure 1 is a diagram of a hot-water preheater system. Basically, what happens is that the sun warms a water-anti-freeze solution in loop 1. The pump sends the warmed solution around from the collector to a storage tank that is filled with colored water. (Colored water can be used to warn of leaks in the system.) The water in the storage tank heats up and, if the tank is well insulated, will stay warm for quite some time.

When cold water enters into loop 2, it gains heat from the storage tank and enters the hot-water heater. If the system has been well designed, the water will need just a little more energy to bring it to the necessary temperature.

The system sounds simple enough, doesn't it? Well, it has a few flaws! The sun will warm the collectors only if there is sufficient radiant energy. The storage tank will only absorb heat from loop 1 if loop 1 is warmer than the water in the storage tank. Loop 2 will be warmed only if the tank is warmer than the cold-water

inlet and the hot water tank isn't full. If you don't know what the temperature of each component is, you shouldn't waste the energy used by the pump. This brings us to the LM3911.

Temperature transducers

National Semiconductor's LM3911 and the LX5600 are temperature transducers; they provide an answer to most of our temperature-measuring problems. The output of the sensors is 10 mV-per-degree Kelvin. Don't let the word Kelvin concern you; the output can be modified to read any temperature scale, but for a one-time system, the Kelvin scale is as good as any other scale. If you must convert the formula, it is: $^{\circ}\text{C} = ^{\circ}\text{K} + 273$.

The working temperature of the LM3911 is -25°C to 85°C (-13°F to 185°F); while the LX5600 has a range of -55°C to 125°C (-67°F to 257°F). Except for their range and cost, the two devices are similar.

The operation of the transducers is quite simple: Two diodes operated at two different current levels produce a voltage difference between them that is proportional to their absolute temperatures (hence, Kelvin). The output of the transducers will be about 3 volts or so, depend-

fi
tt
n
vi
sy

DECEMBER 1978
35

Associates, Box 275,
Park Forest, IL 60466.

1978

37

ing on how hot the IC is. (Very simple indoor-outdoor analog thermometer you have a Zener diode from

called flakeboard and particle board) is recommended for strength and rigidity. You can use plywood, but voids in some plywood boards can be a nuisance when they appear at exposed edges. Oak or other hardwood bracing is necessary to further prevent cabinet vibration. To avoid counter-boring holes for each of the drivers, two different boards with different-size cutouts are glued together (see Fig. 4) and the base is constructed

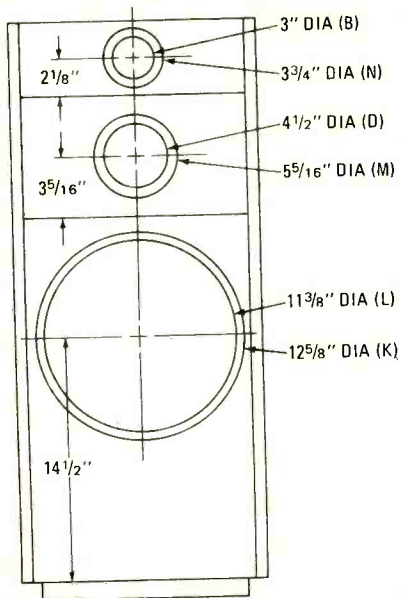

FIG. 4

from a common 2x4 (see Fig. 5). Before assembling the cabinet, cut all the required holes. Each piece should be checked for fit before it is glued and nailed in place. Check the cutouts for the speakers as well.

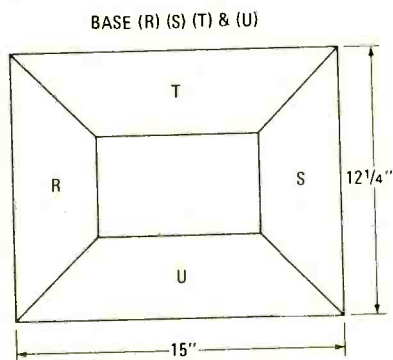

FIG. 5

Start assembling the cabinet by joining the woofer panel (shown as K in Fig. 1) to the bottom panel, F. Prior to gluing the panels together, three or four finishing nails should be hammered partway into the woofer panel. White glue should then be spread on both surfaces, the panels aligned properly and the nails driven into place.

Next, assemble one of the side panels (I or J). Nails can be partly driven into the side panel on two edges

before installing. Use white glue again, this time on the side of the woofer and bottom-panel assembly. Again, align the panels and drive the nails into place (see Fig. 6). These three panels form a rigid assembly that can be put aside for the glue to set.

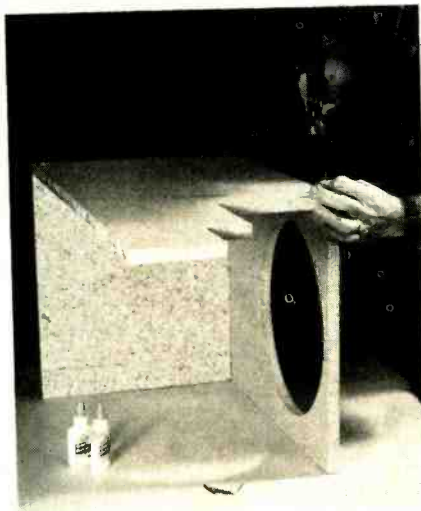

FIG. 6

Next, add the other side panel, which can be installed similarly (see Fig. 7). The remaining panels can be added, working toward the top of the enclosure. Continue to check each

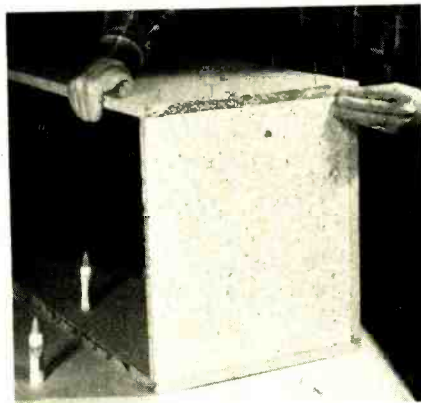

FIG. 7

part for fit before adding it to the assembly. The last major part to assemble is the back, H. Before installing the back permanently, be sure the woofer subpanel, L, and braces G, O and P are in place (see Fig. 8). Run a bead of glue around the joints in the woofer section to form a good seal. Finally, make sure the two 3/8-inch holes are drilled in panels C and E to allow passage of wires from the crossover network to the mid-range driver and tweeter circuits. After the back is installed, brace Q can be glued in place (see Fig. 9).

This completes the cabinet assembly. All the remaining components are installed from the outside. The cabinet can be completely finished at this time. I painted the entire enclosure with several coats of white vinyl Latex paint (see Fig. 10). Prior to painting,

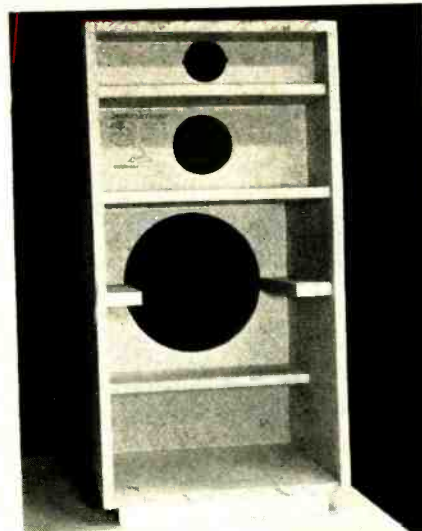

FIG. 8



FIG. 9



FIG. 10

you should fill all cracks with wood filler compound and sand the entire enclosure thoroughly.

Crossover

The heart of any good multi-way

SOLAR

CONTROLLER

During the present energy crisis, the sun is in the running as the most viable alternate energy source. Here's how basic electronics can be adapted to solar heating in home and industry.

RODNEY A. KREUTER

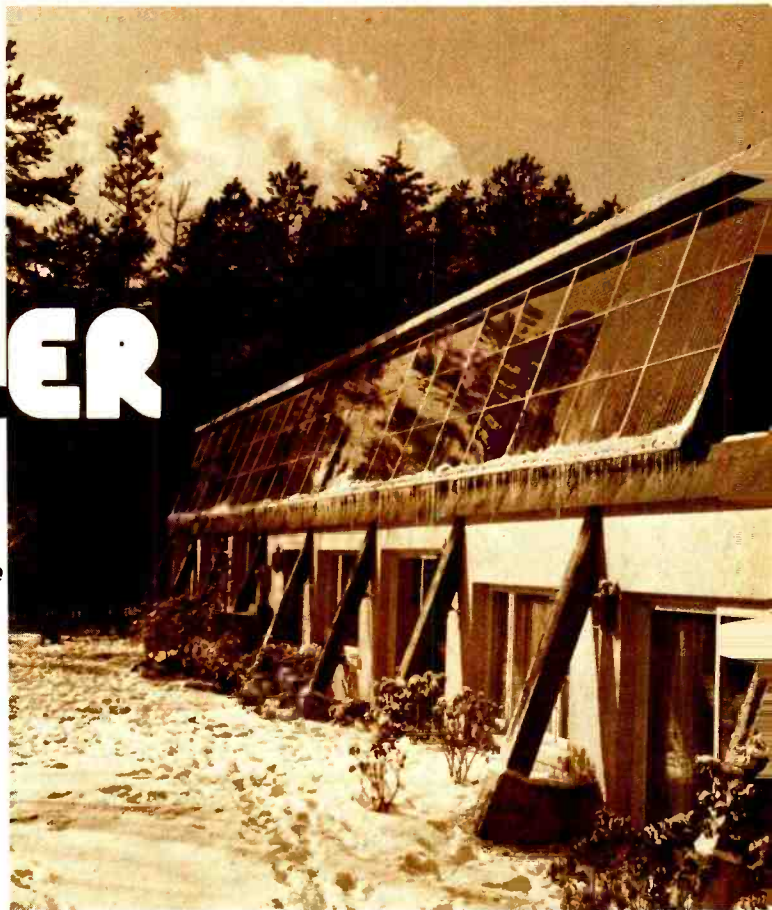

SOLAR ENERGY, IT SEEMS, HAS BECOME almost a universal interest. Companies offering solar collectors and associated hardware are springing up like glitches on a TTL breadboard. However, most companies sell complete systems and most "do-it-yourself" magazines concentrate on collectors or storage system. Very little information seems to be available concerning the instrumentation or control portion of the systems.

This article attempts to proceed one step further by providing an understanding of a simple instrumentation and control system. It is not meant to be a blow-by-blow construction guide because no two solar systems are quite the same. It is hoped that it will enable you to design a system that will meet your special needs.

Hot-water preheater

A good way to get started in solar energy is with a solar hot-water preheater. A substantial amount of the average utility bill goes to feed standard preheaters. Another advantage of a solar preheater is that the payback time is not too great and the cash outlay to get started is within reason.

A preheater is a rather straightforward device. All it does is warm up the cold-water inlet to an existing hot-water tank

so that the tank itself won't need as much energy to warm the water to the required temperature. (Note the phrase "as much.") A small solar collector in a less-than-ideal climate will not supply all your needs; it will, however, help save a great deal of energy.

Figure 1 is a diagram of a hot-water preheater system. Basically, what happens is that the sun warms a water-antifreeze solution in loop 1. The pump sends the warmed solution around from the collector to a storage tank that is filled with colored water. (Colored water can be used to warn of leaks in the system.) The water in the storage tank heats up and, if the tank is well insulated, will stay warm for quite some time.

When cold water enters into loop 2, it gains heat from the storage tank and enters the hot-water heater. If the system has been well designed, the water will need just a little more energy to bring it to the necessary temperature.

The system sounds simple enough, doesn't it? Well, it has a few flaws! The sun will warm the collectors only if there is sufficient radiant energy. The storage tank will only absorb heat from loop 1 if loop 1 is warmer than the water in the storage tank. Loop 2 will be warmed only if the tank is warmer than the cold-water

inlet and the hot water tank isn't full. If you don't know what the temperature of each component is, you shouldn't waste the energy used by the pump. This brings us to the LM3911.

Temperature transducers

National Semiconductor's LM3911 and the LX5600 are temperature transducers; they provide an answer to most of our temperature-measuring problems. The output of the sensors is 10 mV-per-degree Kelvin. Don't let the word Kelvin concern you; the output can be modified to read any temperature scale, but for a one-time system, the Kelvin scale is as good as any other scale. If you must convert the formula, it is: $^{\circ}\text{C} = ^{\circ}\text{K} + 273$.

The working temperature of the LM3911 is -25°C to 85°C (-13°F to 185°F); while the LX5600 has a range of -55°C to 125°C (-67°F to 257°F). Except for their range and cost, the two devices are similar.

The operation of the transducers is quite simple: Two diodes operated at two different current levels produce a voltage difference between them that is proportional to their absolute temperatures (hence, Kelvin). The output of the transducers will be about 3 volts or so, depend-

ing on how hot the IC is. (Very simple indoor-outdoor analog thermometer if you have a good VOM.)

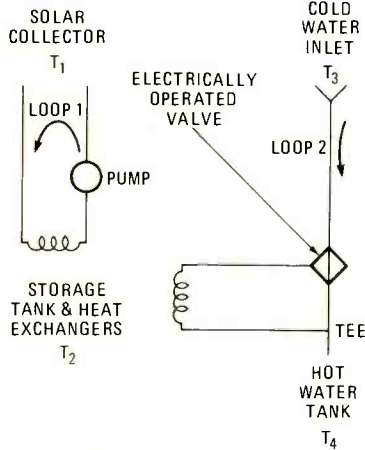

FIG. 1—BASIC SOLAR ENERGY hot-water pre-heater showing important temperature measuring points.

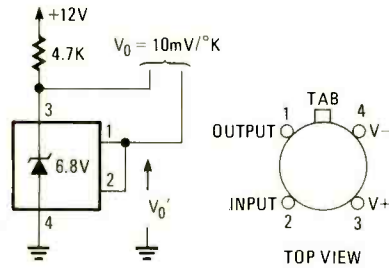

FIG. 2—BASIC SENSOR CONNECTION and pin location.

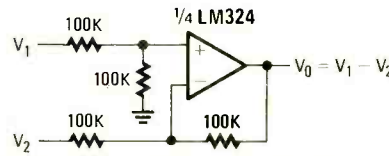

FIG. 3—DIFFERENTIAL AMPLIFIER; the power connections are not shown.

Figure 2 shows the basic connection and pin location of the transducers. Note that the output voltage of the devices is *not* referenced to ground but to pin 3.

Differential thermometer

It's useful to know the temperature of each component of the solar energy system, but it's not essential. What *is* essential is to know that component A is somewhat warmer than component B. This is the principle of the differential thermometer. The output of the thermometer is proportional to the difference of the two input temperatures. This requires a differential amplifier, which is easy to obtain using an op-amp such as the one shown in Fig. 3.

Note that the differential amplifier is based on two input voltages that are referenced to ground. Since the output of the transducers is not referenced to ground, this would seem to complicate the circuit somewhat. Luckily, there is a simple solution to this problem.

Referring to Fig. 2, note the 6.8-volt

Zener diode from pin 3 to ground. This Zener diode is internal to the transducer and maintains the voltage from pin 3 to ground at 6.8.

Since V_o increases at a rate of 10-mV-per $^{\circ}K$, and the sum of V_o and V'_o must equal 6.8 volts, V'_o must decrease at 10-mV-per $^{\circ}K$.

Using this data, we can arrive at the differential thermometer shown in Fig. 4. The output will be proportional to the difference between temperatures T_1 and T_2 and will rise as T_1 rises, assuming that T_2 remains constant. When T_1 equals T_2 , the output may not be exactly zero, because op-amps are not perfect and the 6.8-volt Zener diodes may not be exactly matched. This will not affect the operation of the circuit, and, as a matter of fact, may be used to an advantage. You should interchange the sensors if you don't get a small positive voltage (about 30 mV to 100 mV) when the sensors are at the same temperature.

Hysteresis

All control systems need some type of hysteresis, which is a type of "deadband" or buffer zone. For example, thermostats have a built-in hysteresis of about 2 $^{\circ}F$. Assume that the hysteresis is plus or minus 1 $^{\circ}F$ of the setting. If the thermostat is set at 68 $^{\circ}F$, the furnace will come on when the temperature falls to 67 $^{\circ}F$ and stay on until the temperature rises to 69 $^{\circ}F$. If no hysteresis was built into the system, the furnace would cycle on and off continuously.

The hysteresis in a solar system should be fairly large—5 $^{\circ}F$ to 10 $^{\circ}F$ is not unreasonable. Figure 5 shows a comparator that is used to provide an adjustable amount of hysteresis. The LED lights as a status indicator and alarm when the set amount of temperature difference has been attained.

Interfacing

At this point, the system monitors temperature, subtracts one temperature from another, compares this value to some preset value, and lights an LED if all the conditions are met. It still won't pump much water or close a valve.

Lighting an LED has a purpose other than just providing an output of the system. When devices must be operated

at 117 VAC, such as a pump or a motor, it is necessary to isolate the control system from the AC lines. By using an LED and a phototransistor sealed in a light-tight tube, a very high degree of isolation can be achieved. You can even use two LED's—one as an output and the other as part of the photocoupler.

A circuit that handles the control of

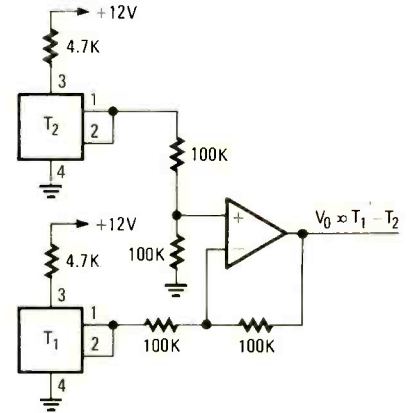

FIG. 4—DIFFERENTIAL THERMOMETER measures temperature difference.

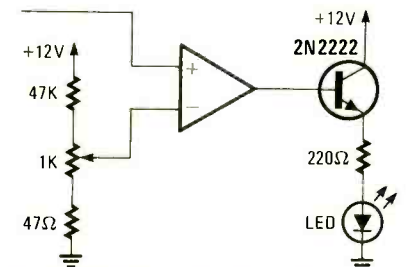

FIG. 5—COMPARATOR with hysteresis control.

the pump is shown in Fig. 6. The components might have to be scaled up or down depending on the amount of load current. And don't forget to heat-sink the triac.

Assembling the system

The complete control system is shown in Fig. 7. A regulated 12-volt power supply (see Fig. 8) is also necessary to power the system. The cost of such a supply is very low, so there is no reason to use an unregulated supply.

If you want to measure the actual temperature of one of the system components, you can use a good voltmeter.

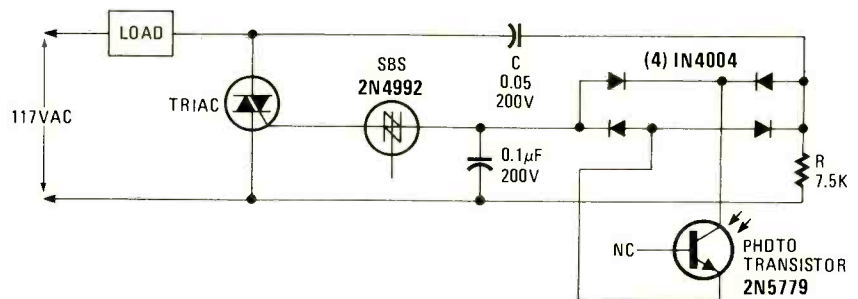

FIG. 6—LIGHT-CONTROLLED TRIAC circuit. For diac triggering, C = 0.22 μF , R = 10K. Substitute diac for 2N4992 (silicon bilateral switch) and phototransistor with V_{∞} of 80 volts or two 2N5779's connected in series.

First, measure voltage V_s of each sensor. This (V_s) is measured from pin 3 to ground and should read about 6.8 volts. Write it down for each sensor because it will not change but will be different for each one. Any time that you want to know the actual temperature, measure voltage V_o from the output to ground. The temperature can be found from: $^{\circ}\text{C} = 100 (V_s - V_o - 2.73)$.

A voltmeter, calibrated in degrees, can even be permanently installed in your system if you desire.

Next, you must consider the sensor. The LX5600 costs a little more than the LM3911, but it has an extended operating range and slightly better absolute accuracy. Naturally, the sensors must be thermally connected to the device to be monitored. A recommended technique would be to fabricate a heat sink that the sensor will slip into. (Use the T0-5 case.) The heat sink can then be mounted to the device. Grease the sensor with heat-sink compound (silicon grease) and slip it into the heat sink. This will prevent damage to the sensor. A solar collector should be monitored in the center if possible.

It will also be necessary to insulate and weatherproof the sensor leads. Some RTV insulation should work well. It may be possible to immerse the sensor in water if you are careful. The top of the case should have very little RTV on it to make sure it isn't thermally insulated. Another method would be to seal it in a test tube. Just make sure that the leads are well insulated.

Run shielded cable to your sensors to reduce noise pickup since open wire runs of longer than a few inches tend to produce too much noise.

Check the pump and valve specifications and choose the triac accordingly. Many different types of triacs are available, and most should work with this trigger system. Don't be afraid to experiment with different triac types.

Make sure that the phototransistor is

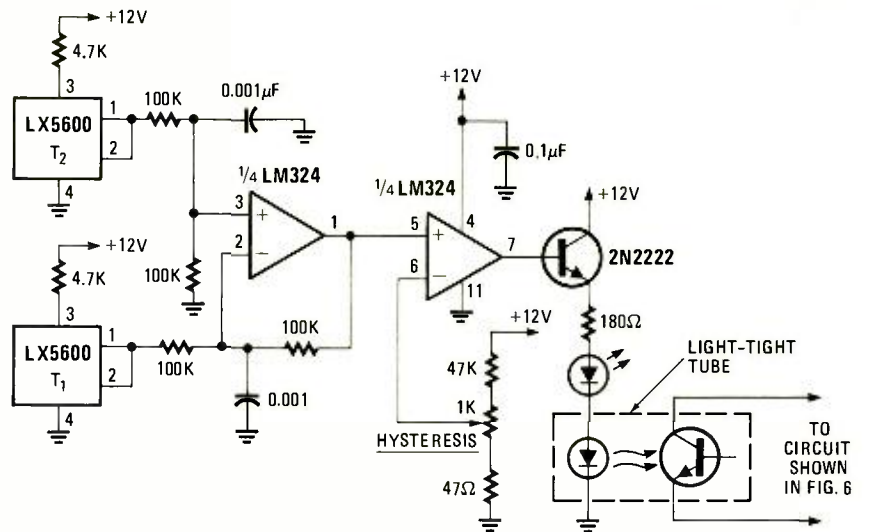

FIG. 7—SCHEMATIC DIAGRAM of complete control system. Note bypass capacitors for greater noise immunity and slight change of some component values. The LM324 contains four op-amps, so two complete loops could be handled by one IC.

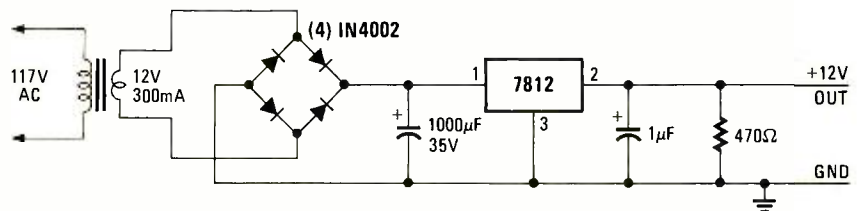

FIG. 8—12-VOLT POWER SUPPLY consists of bridge rectifier and regulator.

rated at 80 volts V_{ceo} or more if you plan to use a diac to trigger the triac. The silicon bilateral switch (shown in Fig. 6) might be hard to locate, although a GE semiconductor parts supplier should have it and the 2N5779 photo-Darlington transistor.

Calibrating the hysteresis control will be somewhat time-consuming. Allow one sensor to reach room temperature. This will represent the cooler component (storage tank). Feed this output into the noninverting input of the op-amp.

Prepare a warm water bath and place the other sensor in the bath (insulate the

leads). This represents the warmer component (the solar collector). Feed the output of this sensor into the inverting input of the op-amp.

Now use a good thermometer to measure each temperature. Rotate the hysteresis control until the LED lights up. At this point, mark down on the dial the difference between the two temperatures. Repeat this at least five times. The total range, with the component values given, will be from about 1°C to 20°C . Therefore, do not raise the temperature of the bath to any warmer than room temperature plus 20°C . **R-E**

Custom-built high-voltage Tesla coils now available

The Ultra High Voltage Division of Professional Sound Systems now manufactures a line of Tesla coils, kits and components that can be custom-built to fit individual needs. The coils are modular and symmetrically constructed, conservative in



design and can be used in high-voltage applications and for demonstrations.

There are 10 basic configurations from which to choose, with spark-discharge lengths ranging from 1.5 inches to over 15 feet. A full line of stock components is also available, from power-supply control consoles to oscillation transformer assemblies. All of these can also be tailored to a customer's special requirements. For information, write Professional Sound Systems, Ultra High Voltage Division, 4914 Baldwin Avenue, Temple City, CA 91780.

Report states service industry salaries are rising

It appears that salaries in the service industry are on the rise, according to a report entitled *Salaries and Related Matters in the Service Department—1978*, published by Abbott, Langer & Associates, Park Forest, IL.

For example, the report lists that the

average national service manager's salary is presently \$25,658 and that of field service representative, \$13,291. The report categorizes these and other job listings by type of product or service (also by the size of the service company or manufacturer involved), as well as containing data on various types of employers. More than 25,000 positions in over 200 organizations are listed, including salaries for national regional and local service managers; field service supervisors, engineers and senior representatives; parts managers; service training instructors; technical writing supervisors; and more. Employers represented include firms manufacturing business, electrical and communications equipment; consumer electronics; computers and allied products; and medical and scientific equipment.

The report is available for \$60 from Abbott, Langer & Associates, Box 275, Park Forest, IL 60466.

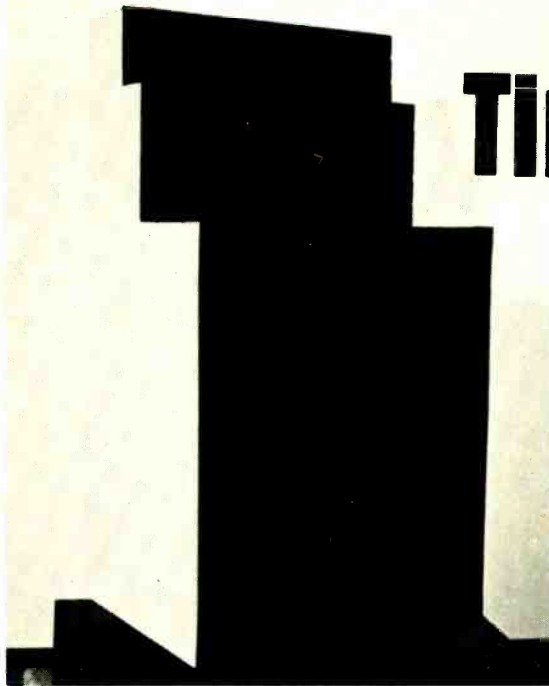

Time Compensated Hi-Fi Speaker System

THIS ARTICLE GIVES YOU AN OPPORTUNITY to keep up with the latest advances in loudspeaker design by showing how to build a pair of high-quality, time-compensated speakers for less than \$200.

Practically any multi-way speaker system can be improved by adjusting the drivers for signal arrival time. Sound from the high-frequency speakers usually arrives first. By moving the high-frequency speakers back, the sound from the woofer, mid-range driver and tweeter can be made to arrive at your listening position simultaneously. Many of the good sounds from electrostatic speakers can now be heard with nonelectrostatic systems. Time-compensation can help produce a smoother frequency response (compared with flat baffle mounting) by reducing interference between drivers at the crossover frequency. This also produces improved transient response as well as incredible depth and stereo imaging.

The secret of proper system design is to align the *acoustic center* of each driver, as seen from the side, so that they are in the same vertical plane. Each type and size of driver has its own effective acoustic center that can be located at either the voice coil, behind the coil, or in front of it.

To locate the acoustic centers and position them correctly relative to each other, I recommend using an oscilloscope, a Bruel & Kjaer condenser microphone and a bucket-brigade audio-delay line. Each driver selected for this system has very little shift of its acoustic center through its frequency range. The crossover network is adjusted for smooth frequency response. It also maintains a uniform time response when combined with

the driver time characteristics. Other kinds of drivers should not be substituted in this system since their time characteristics may not be the same.

Testing

The system should be tested for errors or a cold solder joint. Connect a 1½-volt battery across the input terminals, with the positive end going to the red terminal. The woofer cone should move out. Connect the system to your amplifier and put on FM interstation hiss. A distinct band of frequencies should be heard from each speaker—lows from the woofer, mid-frequencies from the mid-range and highs from the tweeter. These frequencies should be of approximately equal amplitude. The system can be fused with a 1½-amp normal-blow or fast-acting fuse.

The time-compensated system can be driven without stress by musical peaks of up to 100 watts. Of course, the continuous or RMS power rating of the drivers is less. Use an amplifier of 35 watts or more to avoid clipping on peaks. A severely clipping amplifier can damage the drivers and the crossover network.

Using the system

The best location for the speakers is on the floor against the long wall of the listening room. The distance between the speakers should be equal to or less than the distance from either speaker to your listening position. Avoid placing the speakers in the corners because this may provide too much bass and cause excessive room standing-wave problems. You may want to toe the speakers in toward the listening position to maintain the best

time response for each speaker.

Now, you are in for a real stereo treat. In playing various types of stereo material, you will notice an unusually well-defined stereo image. You will also notice this image will vary considerably from one recording to another. Recordings made with microphones close to the instruments may sound almost monophonic in the left and right channels. A solo instrument or voice will sound almost monophonic in the center. With the microphone placed farther back and adding more of the reverberant field, recordings will have an incredible spaciousness and an evenly spread stereo image.

I have made many true stereo recordings using only two omnidirectional microphones. The recordings range from katyids on a summer night to church choirs. The realism of these recordings is increased dramatically with the time-compensated system. Another benefit is in transient performance. Try guitar, harp, or harpsichord recordings; then try cymbals, triangles, or snare drums.

The high frequencies in this system have been adjusted for the smoothest response. Depending on how recordings are made, however, the high-frequency balance will seem to vary. The easiest and best way to compensate for this is to use the treble control: By varying the setting from 10 o'clock to 2 o'clock, you can adjust the frequency balance for the best sound in each recording.

Once you get hooked on the superior sound from the time-compensated speaker system, you won't settle for anything less from any other system.

Here's your chance to own a state-of-the-art stereo speaker system designed so the sounds from the three drivers reach your ears simultaneously. Build it for less than \$200 using ordinary hand tools.

ROGER H. RUSSELL

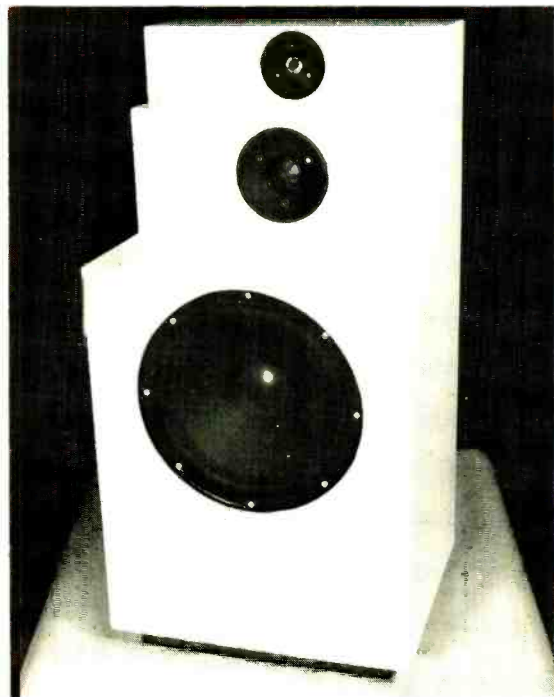

Cabinet construction

FOR CORRECT SIGNAL-ARRIVAL TIME, THE MID-range driver must be placed so that it is $7\frac{1}{8}$ inches back from the woofer. The tweeter must be placed so that it is $2\frac{1}{2}$ inches back from the mid-range. The result is a stepped-back arrangement whose construction is only slightly more complicated than that of a normal flat baffle design. The improvement in sound is well worth it. (Figs. 1, 2 and 3 are the construction

diagrams for the front, sides and back of the speaker cabinet.)

With careful layout, many of the parts for the pair of cabinets can be made from a single 4-foot by 8-foot sheet of wood. Some lumber yards have smaller sheets available at lower cost that can be used to construct the remainder of the cabinet. A portable circular saw, a saber saw, or even a handsaw can be used to cut the panels. Visible surfaces can be painted or covered with vinyl, or wood veneer can be used.

Three-quarter-inch chipboard (also

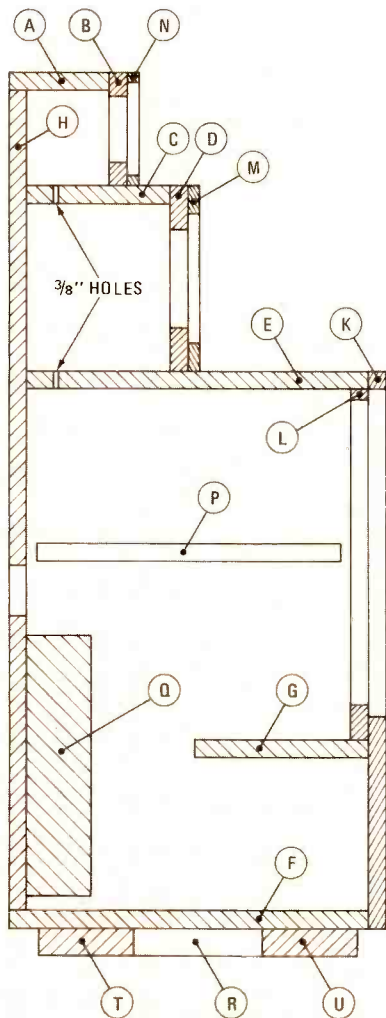

FIG. 1

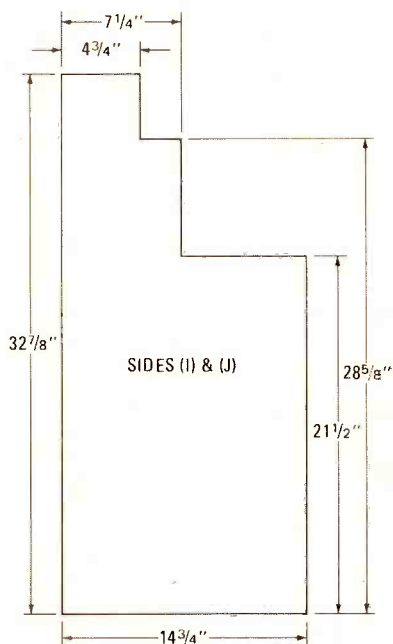

FIG. 2

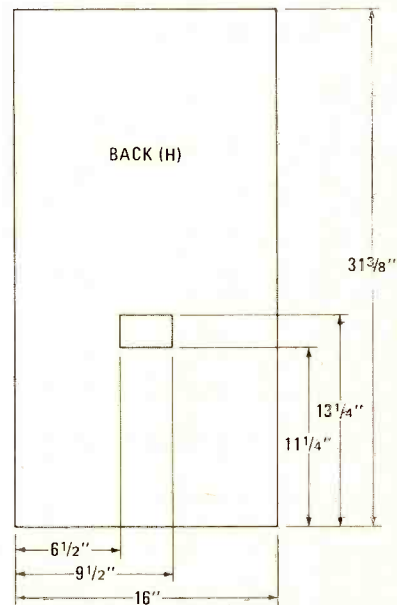

FIG. 3

called flakeboard and particle board) is recommended for strength and rigidity. You can use plywood, but voids in some plywood boards can be a nuisance when they appear at exposed edges. Oak or other hardwood bracing is necessary to further prevent cabinet vibration. To avoid counter-boring holes for each of the drivers, two different boards with different-size cutouts are glued together (see Fig. 4) and the base is constructed

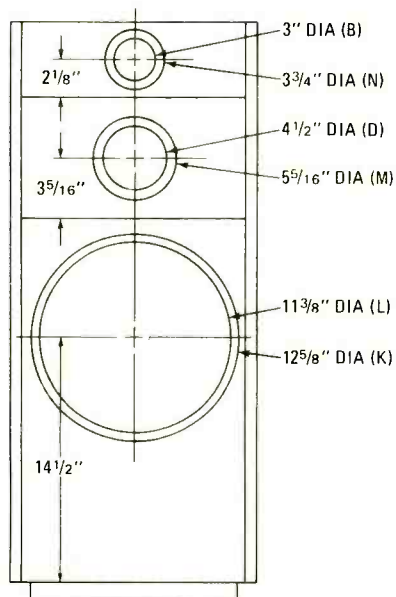

FIG. 4

from a common 2x4 (see Fig. 5). Before assembling the cabinet, cut all the required holes. Each piece should be checked for fit before it is glued and nailed in place. Check the cutouts for the speakers as well.

BASE (R) (S) (T) & (U)

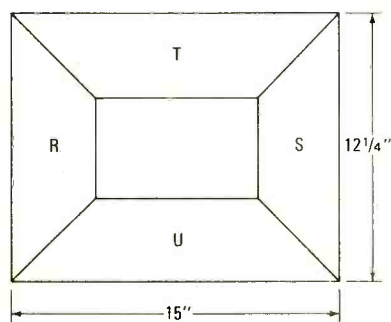

FIG. 5

Start assembling the cabinet by joining the woofer panel (shown as K in Fig. 1) to the bottom panel, F. Prior to gluing the panels together, three or four finishing nails should be hammered partway into the woofer panel. White glue should then be spread on both surfaces, the panels aligned properly and the nails driven into place.

Next, assemble one of the side panels (I or J). Nails can be partly driven into the side panel on two edges

before installing. Use white glue again, this time on the side of the woofer and bottom-panel assembly. Again, align the panels and drive the nails into place (see Fig. 6). These three panels form a rigid assembly that can be put aside for the glue to set.

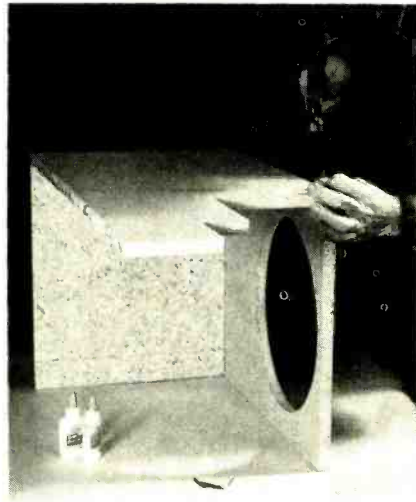

FIG. 6

Next, add the other side panel, which can be installed similarly (see Fig. 7). The remaining panels can be added, working toward the top of the enclosure. Continue to check each

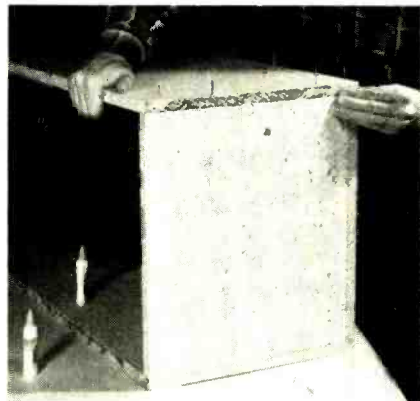

FIG. 7

part for fit before adding it to the assembly. The last major part to assemble is the back, H. Before installing the back permanently, be sure the woofer subpanel, L, and braces G, O and P are in place (see Fig. 8). Run a bead of glue around the joints in the woofer section to form a good seal. Finally, make sure the two 3/8-inch holes are drilled in panels C and E to allow passage of wires from the crossover network to the mid-range driver and tweeter circuits. After the back is installed, brace Q can be glued in place (see Fig. 9).

This completes the cabinet assembly. All the remaining components are installed from the outside. The cabinet can be completely finished at this time. I painted the entire enclosure with several coats of white vinyl Latex paint (see Fig. 10). Prior to painting,

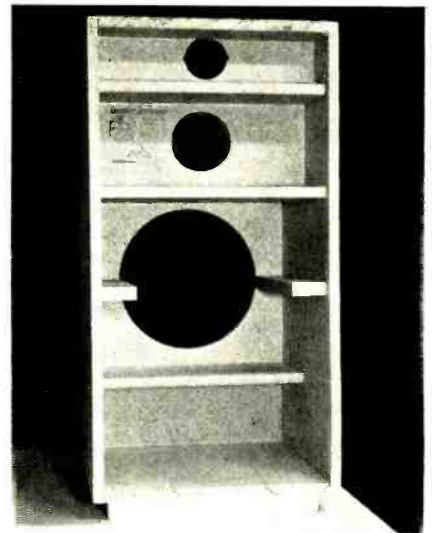

FIG. 8



FIG. 9

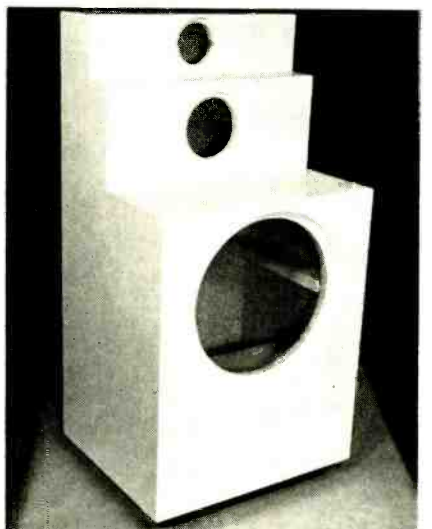

FIG. 10

you should fill all cracks with wood filler compound and sand the entire enclosure thoroughly.

Crossover

The heart of any good multi-way

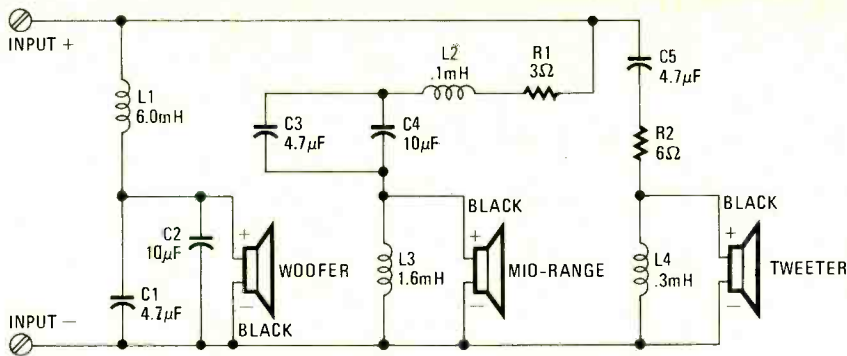

FIG. 11

form. Then scrape the insulation from the lead ends and tin the wires with solder.

The electrolytic-capacitor losses are sufficiently low not to affect the output of either the mid-range driver or tweeter. In the woofer and the mid-range circuit, 10- and 4.7- μ F capacitors are connected in parallel to produce a total capacitance close to 15 μ F. The resistors in series with the mid-range and tweeter are 5-watt "cinder-block" types. All components, particularly the 6-mH coil, should be

speaker system is the frequency-dividing network. Numerous listening tests as well as acoustic response measurements were made to insure that each speaker output complements the others closely in frequency range and amplitude. The frequency-dividing (crossover) network, (see Fig. 11) was adjusted for best performance using Norelco (Philips) drivers (Fig. 12).

The network board is made of $\frac{1}{2}$ -

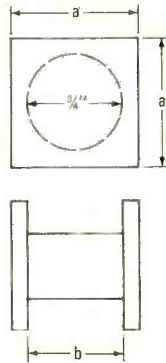

COIL	a	DOWEL LENGTH ^b	WIRE SIZE	NUMBER OF TURNS
L1-6.0mH	2½"	1½"	#18	675
L2-.1mH	1"	½"	#24	77
L3-1.6mH	1½"	1"	#22	338
L4-.3mH	1"	½"	#24	133

FIG. 14



FIG. 12

inch particle board and is 7 inches square. A push-type connector is mounted on the opposite side of the components (see Fig. 13) so that it will be in the hole in the enclosure's back

Masonite glued to $\frac{3}{4}$ -inch-diameter dowels. Three different coil forms are used for the four coils in the network, which are made of ordinary enameled magnet wire. The number of coil turns is based on "scramble" winding. This means neat orderly rows of turns are not necessary. However, windings should be kept reasonably tight. The finished 6-mH coil weighs about 1¼ lb. Gluing the ends of this coil form will not be sufficient. Drive brass screws through the faces into the dowel to be sure the coil form stays together.

Coils can be started by winding a few turns of wire around your finger and then taping this wire to one face of the coil form (Fig. 15). The coil can

well glued to the board to hold them in place and prevent vibration. I recommend using RTV silicone adhesive for this purpose.

Wiring of the board is a perfectly straightforward procedure using terminal strips and mounting hardware. Component placement is shown in Fig. 16. Number 20 stranded wire with color-coded insulation is adequate as leads to the speakers. Use black-colored wire for the negative lead on all the drivers. The following wire lengths should be used: the tweeter, 24 inches; the mid-range, 20 inches; and the woofer, 21 inches.

Final installation

Place caulking compound around the inside of the crossover opening in the back panel and then push the crossover panel into place. The compound holds the board while you center the terminal in the cutout. Start drilling $\frac{7}{64}$ -inch-diameter screw holes in the back of the cabinet using the holes in the crossover panel to locate them (see Fig. 13). Drill only partway into the cabinet back. Using No. 8 \times 1-inch sheet-metal screws, fasten the crossover panel in place. Dress the purple and black tweeter wires from the crossover through the $\frac{3}{8}$ -inch holes in E and C and out of the tweeter cutout. The orange and black wires go through the $\frac{3}{8}$ -inch hole in E and out of the mid-range driver cutout. Seal this $\frac{3}{8}$ -inch hole with caulking compound to create an airtight woofer compartment. The red and black woofer wires can be brought out and taped to the front of the cabinet.

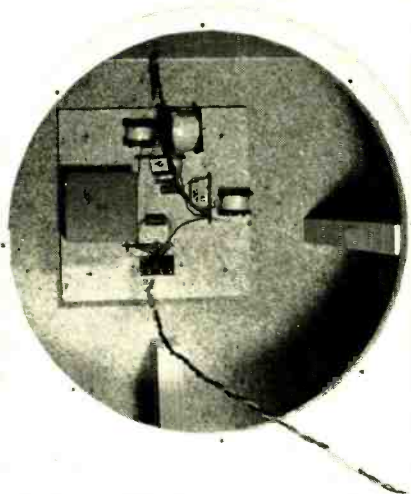

FIG. 13

panel (H). The four coils are wound as detailed in Fig. 14. Coil forms are made from squares of $\frac{1}{4}$ -inch thick



FIG. 15

then be wound. After the coil is wound, wrap tape around the turns to hold them in place. The tape holding the wire on one coil form face can then be removed and both leads cut off at a length of about 3 inches from the

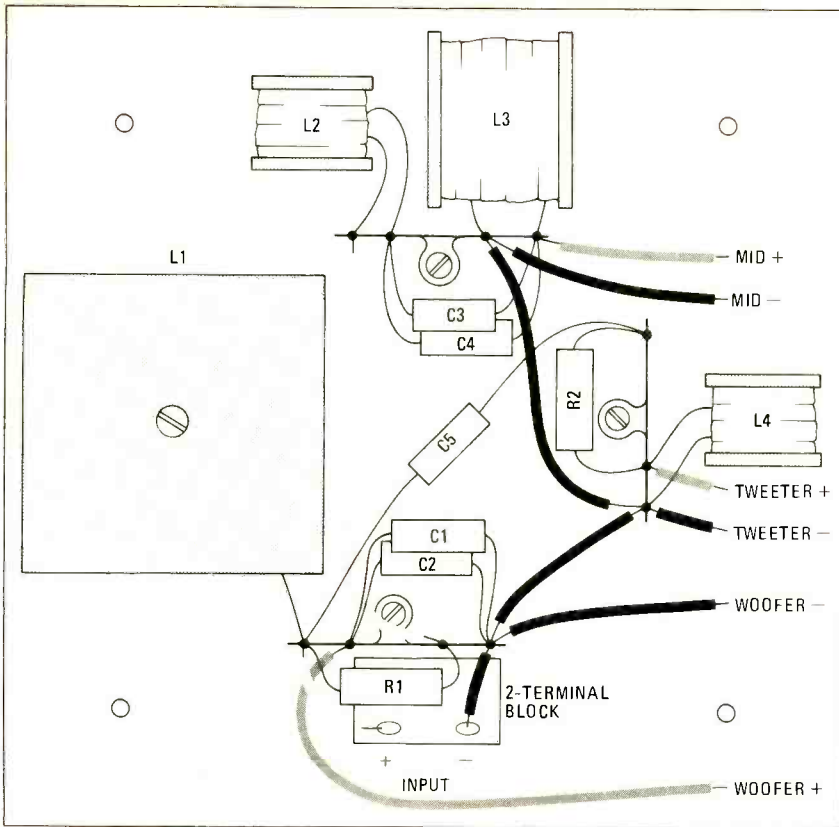

FIG. 16

With a driver in place, use the mounting holes as guides to drill the screw holes into the mounting board. For the mid-range driver and tweeter, use a $\frac{5}{64}$ -inch drill. The mounting holes for the woofer are $\frac{3}{64}$ inch.

Next, fill the woofer compartment with glass-fiber insulation material (Fig. 17). Ordinary pink home insulation material 2 or 3 inches thick can be

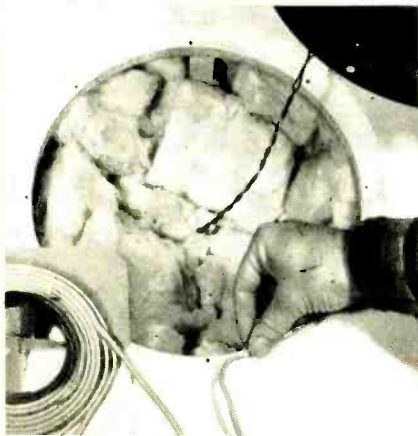

FIG. 17

used. A roll of this insulation costs less than the small packages of acoustic glass-fiber material needed to fill two systems. Insulation performance is the same or better, and you can use the remainder in your attic or under the hood of the family car.

Remove the vapor-barrier backing and cut the glass-fiber into small pieces. This will produce the smooth-

est bass response. Three-inch cubes will do nicely, although size is not too critical. Wear rubber gloves to avoid possible irritation to your hands. Fill the enclosure completely with loosely packed insulation material. And make sure to fill under the brace, G. No material is needed in the upper compartments because both the mid-range driver and the tweeters have sealed backs. The drivers can now be connected and installed.

Solder the color-coded wire to the positive terminal and the black wire to the negative lead. A red mark on or near the terminal indicates it is positive; if no mark appears, briefly connect a 1½-volt battery to the terminals. When the speaker diaphragm moves away from the magnet, the positive end of the battery is connected to the positive lead of the speaker. The mid-range driver and tweeter can be installed using No. 6 × ½-inch sheet-metal screws. The woofer can be installed with No. 10 × ¼-inch sheet-metal screws. Place caulking compound only around the woofer; it should be placed between the woofer basket and the woofer subpanel, L (see Fig. 18). Again, this insures a seal in the woofer compartments.

The foam grille can be cut and installed using the self-adhering strip that comes with the grille along with cutting instructions. Three grille packages are all that are needed to cover two systems. This completes the assembly.

R-E

SPEAKER SYSTEM PARTS LIST

The following items are available from McGee Radio & Electronic Corporation, 1901 McGee Street, Kansas City, MO 64108:

Part No. AD12250 W8: Two 12-inch Norelco woofers, two for \$77.

Part No. AD0211 SQ8: Two 2-inch soft-dome Norelco mid-ranges, \$19.95 each. (This part not in McGee catalog but available.)

Part No. AD0162 T8: Two 1-inch dome tweeters, \$9.95 each.

Two 3-ohm 5-watt resistors, \$.20 each.

Two 6-ohm 5-watt resistors, \$.49 each.

The following items are available from Radio Shack stores:

Part No. 272-999: Four 10-μF, 50-volt nonpolar capacitors, \$.99 each.

Part No. 272-998: Six 4.7-μF, 50-volt nonpolar capacitors, \$.89 each.

Part No. 274-688: Two 5-lug terminal-strip packs of 4, \$.69 each.

Part No. 274-621: Two terminal boards, \$.99 each.

Part No. 40-1951: Three foam grilles, \$5.95 each.

Miscellaneous: One roll of glass-fiber insulation (approximately \$5.95); two 4-foot by 8-foot sheets of ¾-inch particle board (\$17); five ½-lb (100-foot) rolls No. 18 magnet wire; two ¼-pound (93-foot) rolls No. 22 magnet wire; two ¼-pound (150-foot) rolls No. 24 magnet wire; white glue (\$1.79); eight No. 8 × 1-inch sheet-metal screws; 16 No. 10 × 1-inch sheet-metal screws; 14 No. 6 × ½-inch sheet-metal screws; 2 flat-head brass wood screws; hookup wire; solder; paint; caulking compound; hardwood bracing; 8-foot-long two-by-four; 1¼-inch finishing nails.

CABINET LUMBER DIMENSIONS

To construct the cabinet for the time-compensated speaker system, the following lumber should be purchased:

¼-inch-thick flakeboard:

Top panel (A): 3½ inches × 16 inches

Tweeter board (B): 4¼ inches × 16 inches

Tweeter bottom (C): 5½ inches × 16 inches

Mid-board (D): 7⅞ inches × 16 inches

Woofer top (E): 13¼ inches × 16 inches

Woofer bottom (F): 14 inches × 16 inches

Mid-brace (G): 6¾ inches × 16 inches

Back panel (H): 31⅞ inches × 16 inches

Side panels (I & J): 32⅞ inches × 14¼ inches (see Fig. 2)

Woofer board (K): 21½ inches × 16 inches

Woofer board (L): 13¼ inches × 16 inches

¾-inch-thick flakeboard:

Mid-board (M): 7⅞ inches × 16 inches

Tweeter board (N): 4¼ inches × 16 inches

¼-inch hardwood:

Braces (O & P): 12 inches × 2½ inches

Brace (Q): 10 inches × 2½ inches

2 × 4 inch fir:

Base (R & S): 12¼ inches

Base (T & U): 15 inches

Making PROM'S Work For You

The programmable read-only memory is becoming the workhouse of modern digital electronics and will play an ever-increasing role in your everyday activities. Here is what it's all about.

ROBERT H. PENOYER

THE PROM (PROGRAMMABLE READ-ONLY Memory) is increasingly being accepted as a circuit element. The electronic hobbyist or home computer owner should become familiar with this very useful device. Because there have been numerous articles written about both the PROM and the EPROM (Erasable PROM), this article will just briefly mention their theory of operation, and concentrate on the ways these devices can be put to use.

What is a PROM?

Figure 1 shows the basic configuration of a 16×4 -bit PROM; that is, there are 4 address lines, and, therefore, $2^4 = 16$ states can be represented. Each of these 16 states is decoded into a single control line that leads to a set of junctions in the memory array. These junctions are either closed or fused open depending upon how the PROM is programmed. The logic state of the junctions selected by the address decoder passes through the buffer and appears at the output. Figure 1 shows 4 output lines; thus, there are $2^4 \times 4$ or 16×4 junctions. This PROM can also be described as containing 16 words with 4 bits-per-word. There are as many words as there are address states. Therefore, if the PROM had eight address lines

and one output line, it would be a $2^8 \times 1$ -bit or a 256×1 -bit PROM, or containing 256 1-bit words.

Just as there are closed or fused-open junctions in a PROM array, the EPROM uses static charges on MOSFET transistors to achieve the effects of an open or closed junction. The charges on the MOSFET's can last for years or be erased in a few minutes by special ultraviolet lamps.

Using the PROM

The PROM serves two main purposes: First, a single PROM IC can replace an entire multiple-gate logic array. Say, for example, you needed a set of gates that would perform the function described in the truth table of Fig. 2. If standard gates were used, a complex network would result. Instead, let the four left-hand columns of Fig. 2 represent the address lines, and let the column on the right represent the output line of a 16×1 -bit PROM. Thus you would achieve the desired function using only a single IC. The result is a savings in wiring time, troubleshooting time and board space.

The second main use of a PROM is as a "look-up table." For example, suppose you wanted a counter to count in the sequence shown in the right-hand side of

Fig. 3. This could be extremely difficult to accomplish using ordinary logic. Instead, you can apply the output lines of an ordinary binary counter to the address lines of a PROM. Upon reaching any of the 16 possible states, the counter causes the internal logic of the PROM to "look up" the desired output state and pass it through its buffer to the output, according to the truth table. Only two IC's, a 4-bit binary counter and a PROM are needed to arrive at a rather complicated sequential output.

Another example of using a PROM as a look-up table is a Baudot to ASCII code translator. The Baudot code can act as the address for a PROM, and the PROM output can yield equivalent ASCII characters.

Propagation delay and access time

As with any logic device, propagation delays in PROM's are important, particularly so if a PROM's output lines are used to drive counters or clocked logic of any type.

A specifically limited amount of time is required to receive an address, decode it, drive a set of junctions in the PROM array and transmit the result through the buffers to the PROM output. This is called the PROM's access time, and is

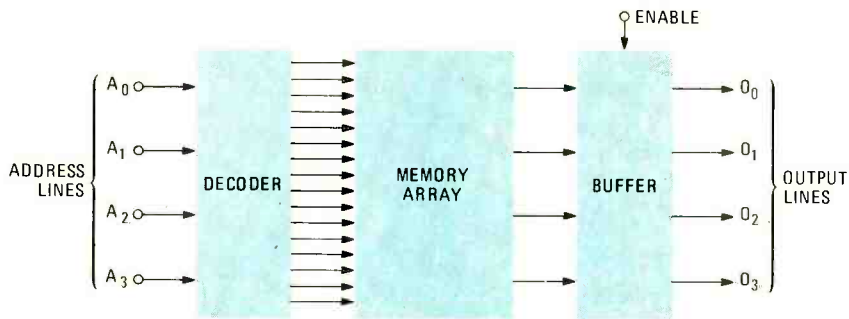

FIG. 1—PROM consists of an address decoder, output buffer and memory array.

A ₀	A ₁	A ₂	A ₃	F
0	0	0	0	1
0	0	0	1	1
0	0	1	0	0
0	0	1	1	0
0	1	0	0	0
0	1	0	1	0
0	1	1	0	1
0	1	1	1	1
1	0	0	0	0
1	0	0	1	1
1	0	1	0	1
1	0	1	1	1
1	1	0	0	0
1	1	0	1	0
1	1	1	0	1
1	1	1	1	0

FIG. 2—COMPLEX LOGIC FUNCTIONS such as the one shown in the above truth table can be easily handled by a PROM.

A ₀	A ₁	A ₂	A ₃	O ₀	O ₁	O ₂	O ₃
0	0	0	0	0	0	1	0
0	0	0	1	0	1	0	0
0	0	1	0	0	1	0	0
0	0	1	1	1	0	1	1
0	1	0	0	1	1	1	0
0	1	0	1	0	1	1	1
0	1	1	0	1	0	1	1
0	1	1	1	1	1	1	0
1	0	0	0	1	1	1	0
1	0	0	1	1	1	0	1
1	0	1	0	1	0	1	1
1	0	1	1	0	1	1	1
1	1	0	0	1	1	1	1
1	1	0	1	0	0	0	0
1	1	1	0	1	0	0	1
1	1	1	1	1	0	1	0

FIG. 3—COUNTERS with an unusual counting sequence can easily be designed using a PROM.

listed in the manufacturer's data sheet. During the access delay time, the state of the output lines on a PROM is unpredictable. A set of outputs can pass through several states during the transition from one address to the next. Therefore, if the outputs are driving clocked logic, the logic could receive undesired data. Obviously, this should not be allowed to happen. Luckily there are methods to get around this problem.

Buffer and latch isolation

As shown in Fig. 1, the output buffer of the PROM often has an enable control line. Typically, this enable line is used to select the device that is to be connected to a parallel bus system when many such tri-state devices are used. When enabled, the buffer outputs are at normal logic levels. When not enabled, the buffer outputs appear to be open circuits. If all the buffer output lines are pulled to +V

through, say, 10K resistors (in the case of TTL logic) then when the output lines are disabled they will be at a known high logic level. Therefore, no output line can go low unless that particular bit was programmed low and the PROM output was enabled. Thus, it is only necessary to disable the output when changing addresses. Using such an arrangement, no glitches appear at the output and low-going pulses appear only when desired. Figure 4 shows a typical circuit using this technique.

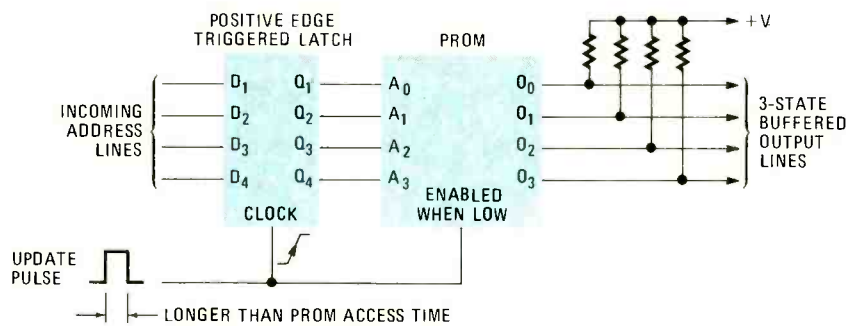

FIG. 4—DISABLING PROM during access time prevents glitches from appearing at the output.

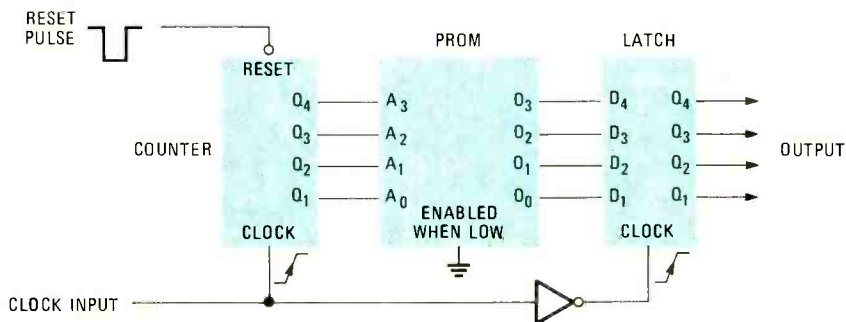

FIG. 5—CLOCK SIGNAL in synchronous circuits can be used to inhibit output during access time.

You can use a similar more desirable technique that requires no pull-up resistors on the buffered output lines. Let's say, for example, you want a circuit that counts as shown in the Fig. 3 truth table. Also assume that you could not arbitrarily allow the outputs to go high, as shown in Fig. 4.

Figure 5 shows an alternative technique: a synchronous binary counter drives the address lines of a PROM that is programmed according to the truth

table shown in Fig. 3. Therefore, as the counter passes through each binary state, the desired output appears on the PROM output lines. These lines are always enabled as shown in Fig. 5. Note that both the counter and the latch are triggered by positive-going clock edges, and there is an inverter in the latch clock line. This means that while the counter still triggers on the positive-going edge of the clock, the latch will trigger on the negative-going edge. This provides a delay of one-half clock period between the time the counter is updated and the resulting PROM output appears at the latch output. If the PROM access time is shorter than one-half clock period, its output will be settled by the time the latch uses it. The result is a clean accurate set of waveforms at the latch output.

PROM sources

PROM's and EPROM's are available in many configurations. Just check through manufacturers' catalogs for the type of PROM you need for your application. Sometimes the required number of

words and word length are not available and you have used a PROM with more words or bits than you need. In this case, you should consider the economics of wasting PROM capability.

Most large distributors can program a PROM for you if you purchase it from them. Find out all the necessary information before placing the order for your PROM; often the distributors will program the device for a small fee or at no additional cost.

R-E

NOM Card For The 1802

Add-on math board for an 1802-based microcomputer. Based on a number-crunching IC, this board speeds execution time, reduces software overhead and saves memory

L. STEVEN CHEAIRS

NOW THAT YOU HAVE YOUR RCA 1802-based microcomputer up and running, what do you do next? You might consider putting it to some serious work, but in doing so, you will probably run into the software wall. In other words, for most applications a good deal of programming will be required, and a good portion of it will be for mathematical operations. It's also a known fact that you can age very rapidly writing all the software needed to perform the required mathematical operations.

One alternative is to use hardware instead of software to perform these operations. The first idea I had was to use a scientific calculator IC. This would certainly reduce the software development time, leaving me only the interfacing to worry about. While this apparently solves the software problem, it creates a Pandora's box full of new ones.

First, most calculator IC's have on-chip debounce circuitry designed to solve the problems generated by multiple character entry due to noisy keyboard switches. This is a very positive feature for a calculator, but, unfortunately, it tends to slow a microprocessor down.

Second, a calculator IC in its natural habitat is interfaced to a keyboard via a set of multiplexed input/output (I/O) pins. This requires complex interfacing to convert incoming data into the signals necessary to imitate a keyboard switch. While this is not an impossible task, it is a bit messy.

Third, a calculator is designed to stand alone, not act as a slave processor for a microcomputer system. The data is outputted in a multiplexed 7-segment, non-TTL format. Multiplexing data is not only acceptable but desirable. On the other hand, a 7-segment format is not

exactly the easiest format for a computer to manipulate. It could of course be converted to a BCD (*Binary-Coded Decimal*) format by several methods, such as a software look-up table, or a PROM could be programmed to convert a minimum of five input lines into the four BCD output lines. Another point to consider is that the calculator IC's do not have the control lines required to interface it to the processor.

You could try another approach, such as dedicating a CPU and a ROM as a mathematical processor. National Semiconductors has done just that with its new

Number-Oriented Microprocessor (NOM). This special-purpose microprocessor, the MM57109, is available through distributors. This single IC will provide most, if not all, of the mathematical operations needed for any computer system. The software overhead is drastically reduced when this processor is used.

The MM57109

Figure 1 is the internal block diagram of the MM57109, showing both the signal lines and their point of origin. The internal register file is composed of five

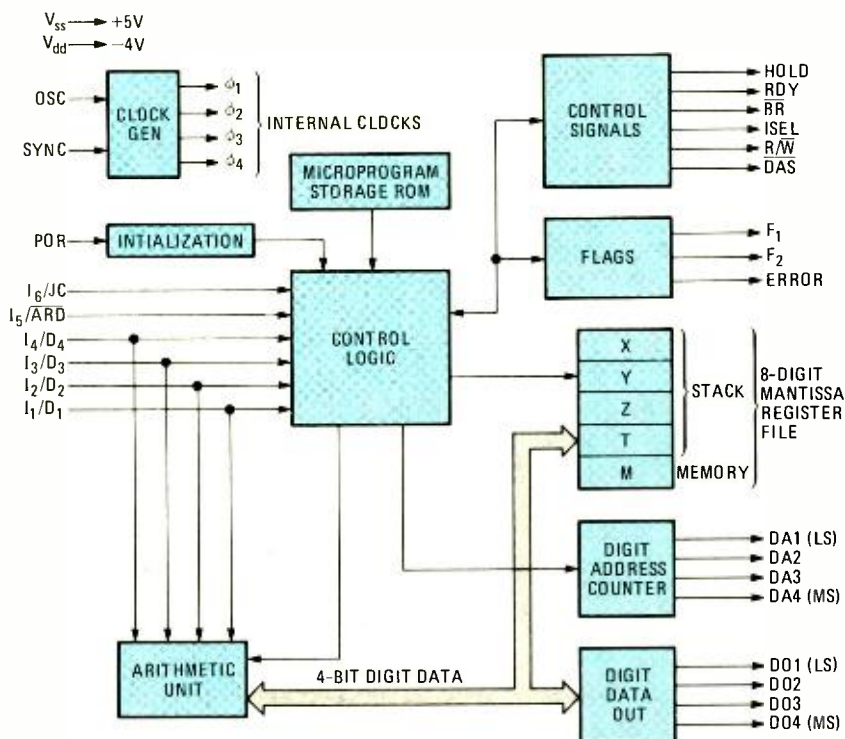

FIG. 1—BLOCK DIAGRAM OF THE MM57109 number-oriented microprocessor.

registers (X, Y, Z, T and M); each has eight mantissa digits, two exponent digits, a decimal-point position indicator, and the mantissa and exponent sign bits. The program-storage ROM stores about 1500 eight-bit micro-instruction words. The 6-bit-long program instructions enter through the $I_{1,6}$ -lines and are converted into a sequence of these micro-instructions. The BCD data words enter the control logic via the $I_{1,4}$ -lines.

Data is outputted, after receiving the OUT instruction, through the digit-data-out block. The digit-address-counter block sequences each digit during the I/O operations. The Read/Write control line is used during the OUT instruction to latch the data words into the interface register.

Figure 2 shows a table of the MM57109's important features. These features can be classified into four categories: scientific calculator-type instructions, I/O, branch control and interface.

Basically, the MM57109 looks like an RPN (Reverse Polish Notation) scientific calculator. The only major difference is in the I/O and control-interface circuitry. National Semiconductor engineers state that the MM57109 is a *modified* scientific

Instructions	Input/Output	Branch Control	Interface
RPN	HOLD for asynchronous and single step operation	Conditional and unconditional program branching	Single phase clock
1 to 8-digit mantissa	Asynchronous digit input instruction (AIN) with AIN ready (ADR) input	Increment/decrement branch on non-zero for program loops	Low power operation
2-digit exponent	Multidigit I/O instructions (IN, OUT)		Generation of I/O control signals
Four-register stack, one-memory location	Floating point or scientific notation		Separate digit input, output, and address bus
Trigonometric functions, logarithmic functions, Y^x , e^x , π , etc.	Programmable mantissa digit count for IN, OUT instructions		
Error Flag	Sense input and flag output		

FIG. 2—FEATURES OF THE MM57109 that are important to the NOM card constructor.

calculator. First, we'll take a look at the 1802-type interface; then, the instructions and programming techniques will be discussed. If you are not yet convinced that the MM57109 is the way to go, then look at Table 1. As stated earlier, the NOM is very easy to interface to almost any computer system. The MM57109 is

TABLE 1—Comparison of MM57109 to the Average Microprocessor and Calculator IC's

	MM57109	MICROPROCESSOR	CALCULATOR
Speed (math or I/O)	0.5–400 ms	0.5–500 ms	14–400 ms
Data length	Variable (1- to 8-digit mantissa)	Fixed	Fixed
Data format	Floating point, and scientific notation	Binary	Floating point, and scientific notation
I/O	Multidigit, asynchronous digit and single bit	Data bytes and single bit	Keyboard/display
Program	External ROM/PC, μ P or FIFO	External ROM, internal PC	Key sequence

PARTS LIST

All resistors 1/2 watt, 5% unless noted.

R1–R5, R17, R18—10,000 ohms
 R6—300 ohms, 1/2 watt
 R7—1000 ohms
 R8—18,000 ohms
 R9, R10, R12–R15—2000 ohms
 R11, R16—9100 ohms
 C1, C5—1- μ F, 35-volt, electrolytic
 C2, C3, C8, C11, C12—0.01- μ F, disc
 C4, C9, C10—100-pF, disc
 C6, C7—10- μ F, 20-volt, electrolytic
 D1—1N703 Zener diode (or equal), 3.9 volts
 IC1, IC2—4508, dual 4-bit latch
 IC3, IC13—4069, hex inverter
 IC4—4073, triple 3-input AND gate
 IC5, IC6, IC8—4013, dual D-type flip-flop
 IC7—4049, hex inverter buffer
 IC9—4528, BCD-to-decimal decoder/binary-to-octal decoder
 IC10—DS8800, dual TTL-to-MOS voltage

converter
 IC11—MM57109, NOM
 IC12—4072, dual 4-input OR gate
 S1–S4—DIP switch (8 SPST switches)
 Misc.—One 28-pin DIP socket for IC11, and a PC board.
 The following are available from Questar Engineering Co., 50 S. MacDonald St., Mesa, AZ 85202:
 PC board, predrilled and etched, \$33
 Complete kit of all parts, \$98
 Elf II to SB-44 converter card, \$6.95
 MM57109 NOM IC, \$18
 DS8800 TTL-to-MOS converter IC, \$6.45.
 Questar also has a PROM containing a subroutine that will perform all the power-up housekeeping and FIFO interface between the 1802 and the NOM. Also included on the PROM is a monitor-type software package, \$28.50.
 Note: The decision to use a dual 22-pin

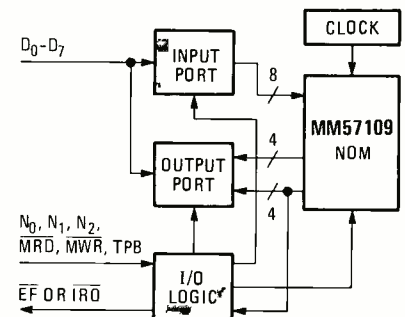

FIG. 3—1802 MICROPROCESSOR INTERFACE for the MM57109.

only one of two NOM interfaces that Questar Engineering is marketing; the other is for the S-100 bus.

Circuit operation

The basic circuit operation is shown in the block diagram of Fig. 3, while the complete schematic is shown in Fig. 4. The I/O signals (N_0 , N_1 , N_2 , TPB, MRD, MWR) from the 1802 are decoded, and are used to move data into and out of the NOM via two 8-bit data latches. One-half of the data output port, D_0 – D_3 , is the

card was based on the fact that this card has been a standard component of the electronic field for many years. The Vector-size card and hardware are readily available and less expensive than other components. There are a variety of other printed-circuit cards using this same bus, a few of which will be available in the future. These PC cards include a Vector-type graphic display that uses an oscilloscope as a display; a 2K-byte EROM/2K-byte low-power RAM card; and a nonvolatile 4K-byte RAM board; the EROM's are programmed in place on the card. This permits the EROM to be treated like a RAM, plus a program can be developed in RAM and transferred to EROM without unplugging any components. The program can then be executed immediately from the EROM.

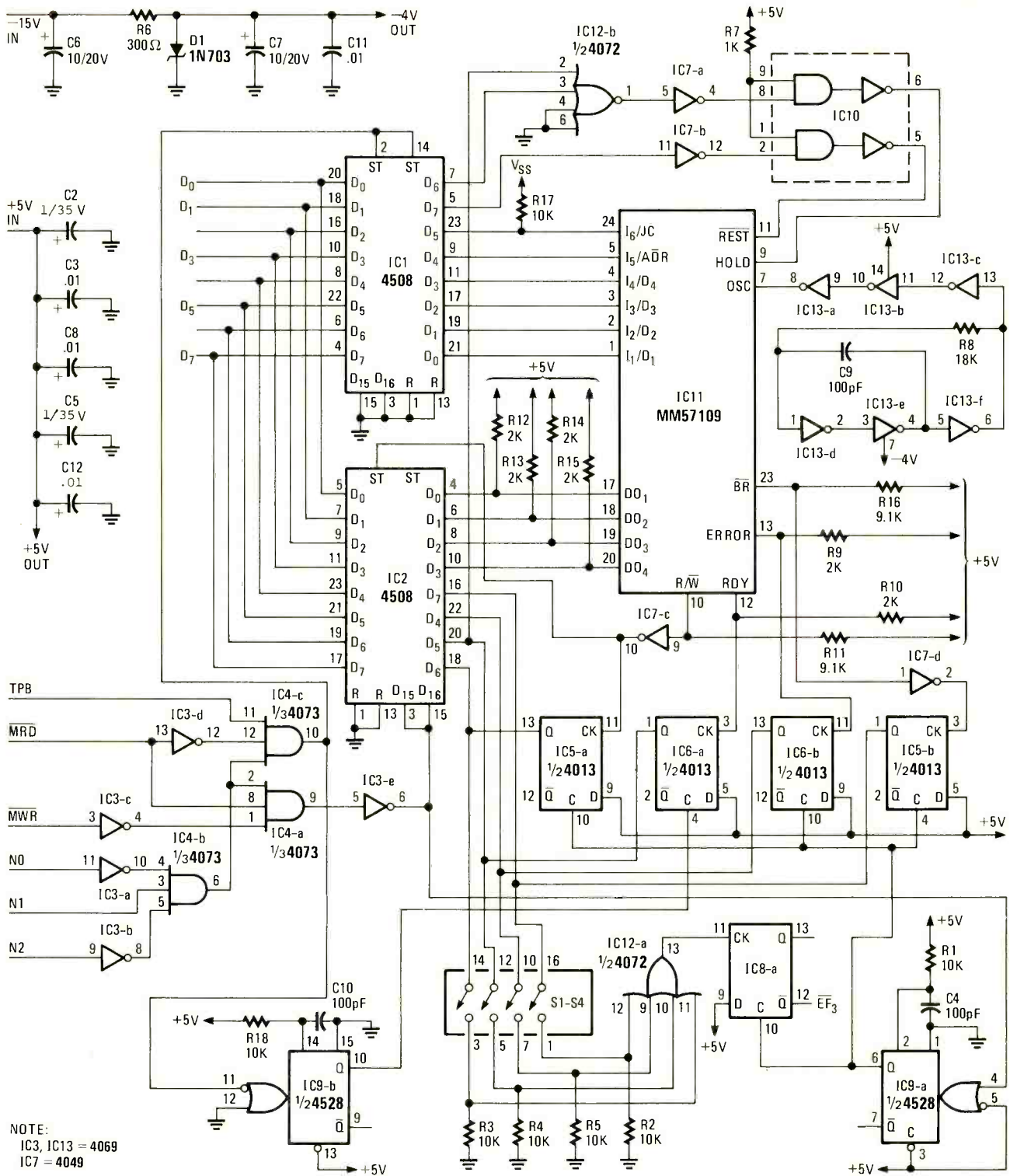

FIG. 4—COMPLETE SCHEMATIC FOR THE NOM interface. The top end of R17 goes to +5 volts which is equivalent to V_{SS} . The -4-volt level is equivalent to V_{od} .

BCD data from the NOM, while the other 4 bits are used to provide status information to the 1802 CPU. Note that the address counter digit from the NOM is not provided. This is because the address digit requires 4 bits of the I/O port (thus requiring a second output port). This may seem like a poor decision just to save one output port, but it is not. The output format of the NOM is defined by the internal architecture, and with a minor amount of software added to the 1802's program, the same informa-

tion may be derived. Figure 5 shows the data formats for both the scientific-notation mode and Fig. 6 shows the floating-point mode.

The other 4 data bits inform the 1802 of the NOM's status; also any of these 4 bits can be configured to output an active low signal, which should be used to set one of the event flags or initiate an interrupt. Bits D_0 - D_3 of the input port supply the instructions to pins I_1 - I_6 pins; input data is placed on the D_0 - D_3 lines and enters through I_0 - I_3 . The 1802 uses the

upper input data, bits D_6 and D_7 , to reset and/or halt the NOM. This data is shown in Fig. 7, along with port decoding information.

The control logic is actually quite simple; and in fact, the whole circuit is also very simple. It can be described in three parts—the *input decode*, the *NOM status register* and the *interrupt request circuitry*.

The input decode circuit is formed by IC3, IC4 and IC9-a. These IC's are used to decode \bar{N}_0 , \bar{N}_1 , \bar{N}_2 , MRD, and TPB

($\overline{N_0}, N_1, \overline{N_2}, MRD, TPB$), and to clock data and/or instruction into the input buffer. The product of $\overline{N_0}, N_1, \overline{N_2}, MRD$, and MWR ($\overline{N_0}, N_1, \overline{N_2}, MRD, MWR$) is used to enable the output buffers allowing status information and data from the DO_0 - DO_3 output of the NOM to be transferred to the 1802. One-shot IC9-a produces a pulse on the falling edge of control line N2, which is used to reset input-ready flip-flop IC6-a.

The NOM status register is formed by one-half of the output buffer, IC₂ (bits D_4 - D_7), and four D-type flip-flops along with two inverters. The least significant bit, D_4 , is the error flag; eight possible types of errors are shown in Table 2.

TABLE 2—Error Conditions of the MM57109 NOM

1. LN X and LOG X when X = 0
2. When any result is 10^{-99} or 10^{100}
3. When TAN $90^\circ, 270^\circ, 450^\circ$, etc.
4. SIN X, COS X, TAN X for X 9000°
5. SIN ⁻¹ X, COS ⁻¹ X for X 1 or X 10^{-50}
6. For SQRT X when X = 0
7. For /, INV, 1/X when X = 0
8. In the floating-point mode for the OUT instruction if the number of digits to the left of the decimal point is equal to the Mantissa Digit Count.

Whenever an error occurs, an ECLR (Error Flag Clear) instruction must be executed. The error flag can be tested at any time by the TERR instruction, a branch-type instruction (branches if ERROR = 1). The 1802 can also check this condition by reading the D_4 bit of the output port; this bit is reset after its access. Bit D_5 is the input-ready signal; it indicates the NOM is ready to execute the next instruction or to get the second word of a two-word instruction.

In order to permit asynchronous operation between the 1802 and the NOM on the rising edge of bit D_5 , the NOM is placed into a hold state, hold = 1. When flip-flop IC6-a is reset by control line N2 (as stated earlier, this occurs on the falling edge of control line N0, which is used to load new instructions into the input port) the NOM will execute the next instruction. When the user's program is informed by bit D_5 that the input is ready, then the program provides the next instruction to the NOM.

Bit D_6 is the output-ready signal. Upon receiving this information, the user program stores the data into a software FIFO—a table in memory that acts like a first-in/first-out memory. The reason that a software FIFO is needed is due to the method in which the NOM outputs data. An OUT instruction is sent to the NOM, which, in turn, causes the NOM to output the first digit. Ten microseconds later, the output-ready flip-flop is set, and the DO_1 - DO_4 output bits are clocked into the lower bits (D_0 - D_3) of the output port. This data must be read and

DA_4 - DA_1	IN: D_4 D_3 D_2 D_1
	OUT: DO_4 DO_3 DO_2 DO_1
0	Most Significant Exponent Digit
1	Least Significant Exponent Digit
2	Sign (Mantissa) 0 0 Sign (Exponent)
3	Unused
4	Most Significant Mantissa (Followed by Decimal Point)
·	·
·	·
Mantissa Digit Count + 3	Least Significant Mantissa Digit

FIG. 5—IN/OUT INSTRUCTIONS (Scientific Notation Mode).

DA_4 - DA_1	Decimal point position	IN: D_4 D_3 D_2 D_1
		OUT: DO_4 DO_3 DO_2 DO_1
2		Sign (Mantissa) 0 0 0
3		Decimal Point Position
4	11	Most Significant Mantissa Digit=0-9
·	·	·
·	·	·
Mantissa Digit Count + 3	12-Mantissa Digit Count	Least Significant Mantissa Digit=0-9

Where: DA_1 - DA_4 is the digit address
 DO_1 - DO_4 is the digit data out
 D_1 - D_4 is the digit data in

Also: The mantissa digit count is set by the SMDC instruction, initially it is equal to eight. For the sign of the mantissa zero represents positive and one represents negative. The sign of the exponent is equal to zero in the floating point mode. The decimal point position indicator is a value in the range from 11 down to (12-mantissa digit count), which indicates a digit, as given by the decimal point position indicator column in the table. The decimal point is located to the right of this digit.

FIG. 6—IN/OUT INSTRUCTIONS (Floating-Point Mode).

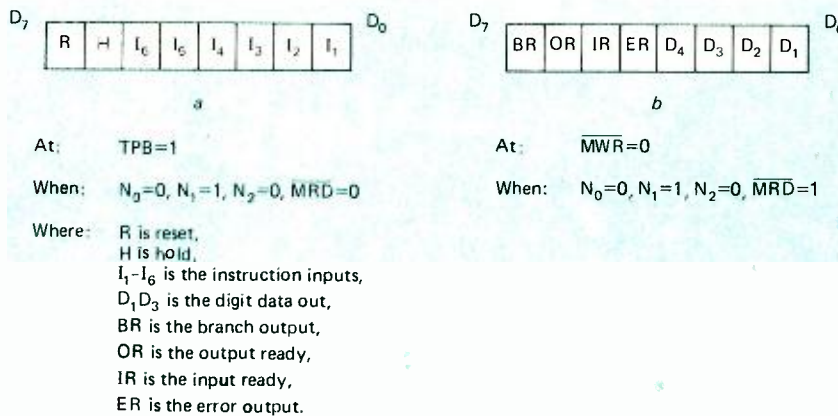

FIG. 7—PORT FORMAT. a) Input; b) Output.

the flip-flop cleared (by reading the port) within 140 μ s because the second digit will be outputted at that time. Every 140 μ s, a new digit will be made available, along with a data-ready signal, until the full number is outputted. The last bit, D_7 , is the branch signal. This signal indicates a program branch has been encountered; input ready is set during this signal.

The interrupt-request circuitry is formed by the 4-input OR gate, IC12-a, and the D-type flip-flop, IC8-b, along with a DIP switch and four pull-down resistors. The four status signals (error, input ready, output ready and branch) are connected to a 4-input OR gate via a set of SPST switches, along with the pull-down resistors. This permits any of the status

signals to clock a logic 1 into the D-type flip-flop, providing a total of 16 possible interrupt (or event-flag) conditions. For example, if you're only interested in knowing when the output is ready (this implies that no branch instructions are to be used, that the data/instructions inputted are free of errors, and sufficient time is allowed between instructions so that a new instruction can never be inputted in the middle of an instruction already being executed), then all but the output-ready switches are opened. Thus, a logic 1 is clocked into IC8-b only when the output-ready signal is active. The \overline{Q} output relays this information to the 1802 via either the \overline{IRQ} , or one of the four event flags (\overline{EF}_1 ,

continued on page 79

Radio-Electronics Tests Sansui G-9000 AM/FM Receiver

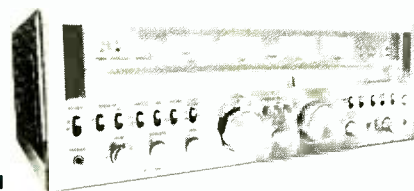

1
CIRCLE 104 ON FREE INFORMATION CARD

LEN FELDMAN
CONTRIBUTING HI-FI EDITOR

SANSUI'S TOP RECEIVERS THIS YEAR ALL feature a DC-configured power-amplifier section. This means that there are no input coupling capacitors to the power section, and that all capacitors in the feedback network have been eliminated. The advantages claimed for this circuitry are in improved transient response (lower transient intermodulation distortion) and a frequency response that goes right down to DC. The audible difference between an AC-coupled amplifier and a DC-coupled one may be subtle to inexperienced listeners, but serious audiophiles report somewhat cleaner and more accurate sound reproduction from such DC-configured circuits.

From our point of view, the Sansui *model G-9000* offers a good deal more than just a DC amplifier. The front panel, shown in Fig. 1, is loaded with features that will delight the audio buff seeking maximum control and flexibility. The light-colored, sloped frequency scales (the FM scale is linearly calibrated with markings at every 200 kHz) are surmounted by four well-illuminated meters, two of which are power-output meters, logarithmically calibrated from 0.1 watt to 300 watts (referred to 8-ohm loads). The other two meters are signal-strength and center-of-channel indicators for the tuner. To the left of the meters are four

indicator lights, two showing which speaker pair is activated; the other two serve as a power-on indicator and a "protector" indicator. The protector indicator flashes intermittently for a few seconds when the power is first turned on until voltages have been fully stabilized, after which sound is heard from the speakers.

Five indicator lights to the right of the meters denote the program source selected. A series of positive-feel toggle switches just below the dial area to the left handle power, speaker selection, bass and treble control turn-over frequencies (200 Hz or 400 Hz for the bass control, 3 kHz or 5 kHz for the treble), tone control defeat and -20 dB audio muting. Similar toggle switches to the right handle FM muting, stereo or mono listening modes, 25- μ s or 75- μ s de-emphasis, FM noise filter and wide or narrow bandwidth for the FM IF circuits. A microphone mixing level control and microphone input jack are located at the extreme lower right-hand side of the panel.

Major controls along the bottom of the front panel include BASS, TREBLE and MID-RANGE tone controls (each with fixed, detented steps for easy resetting), balance control, program SELECTOR switch and TAPE MONITOR switch (with positions for monitoring either of two connected tape decks or dubbing from one to another). Two massive knobs in the center of the panel take care of frequency tuning (the

smoothest-acting flywheel-dial arrangement we've ever experienced) and master volume-control settings. The volume control contains an index tab that can be set at preferred maximum listening levels. Its clutch-like action prevents the volume control from being accidentally turned to overload or excessive listening levels—a nice feature if there are young children in the house who might inadvertently turn the volume all the way up and destroy speaker voice coils in the process! Three square pushbuttons between these two large controls activate subsonic and high-cut filters as well as the loudness compensation circuits. A similar pushbutton near the program selector switch provides a third circuit-interruption point for the insertion of a four-channel adapter, graphic equalizer, audio time-delay unit, or a Dolby noise-reduction adapter. A headphone jack just below the POWER switch on the lower left completes the panel layout.

The rear panel of the *model G-9000* contains three AC convenience outlets (one switched, two unswitched). One of the most pleasing physical features of this receiver is how the input/output jacks and terminals are positioned. These connections are located in recessed areas in the *side* wood panels of the unit, rather than at the rear. All input and (tape-out) terminals, as well as AM and FM antenna terminals, can be reached from the right side of the unit, while two sets of spring-loaded speaker terminals, preamplifier-output/main amplifier-input terminals and a switch that separates the two major receiver sections electrically are located on the opposite side panel (see Fig. 2). A cleverly designed channel along each side of the unit keeps cables

MANUFACTURER'S PUBLISHED SPECIFICATIONS:

FM TUNER:

Usable Sensitivity: mono, 8.7 dBf (1.5 μ V); stereo, 15 dBf. **50-dB Quieting:** mono, 12.5 dBf; stereo, 34.0 dBf. **S/N Ratio:** mono, 80 dB; stereo, 76 dB. **Harmonic Distortion (wide):** mono, 0.06% at 1 kHz and 100 Hz; 0.08% at 6 kHz; stereo, 0.1% at 100 Hz and 6 kHz, 0.08% at 1 kHz. **Selectivity:** 90 dB (narrow); 55 dB (wide). **Capture Ratio:** 0.9 dB. **Image, IF and Spurious Rejection:** 110 dB. **Frequency Response:** 30 Hz to 15 kHz, +0.2, -1.0 dB. **Stereo Separation:** 50 dB at 1 kHz; 40 dB at 100 Hz and 10 kHz.

AM TUNER:

Usable Sensitivity: 300 μ V/M internal antenna. **Selectivity:** 30 dB. **S/N Ratio:** 50 dB. **Distortion:** 0.45%. **Image and IF Rejection:** 70 dB.

AMPLIFIER:

Power Output: 160 watts-per-channel into 4 or 8 ohms, 20 Hz to 20 kHz at no more than 0.03% total harmonic distortion. **IM Distortion:** 0.03%. **Damping Factor:** 60. **Frequency Response:** power amplifier section, DC to 200 kHz, +0, -3 dB; overall, auxiliary inputs, 5 Hz to 50 kHz, +0.2, -1.5 dB; phono, RIAA \pm 0.2 dB. **Input Sensitivity:** phono 1 & 2, 2.5 mV; high level, 150 mV; mike, 6.0 mV. **S/N Ratio:** phono, 78 dB ("A" weighted); high level, 95 dB. **Bass Control Range** (400-Hz turnover): \pm 10 dB at 50 Hz. **Treble Control Range** (1.5 kHz turnover): \pm 10 dB at 10 kHz. **Mid-Range:** \pm 5 dB at 1.5 kHz. **Subsonic Filter:** -3 dB at 16 Hz (6 dB-per-octave). **High-cut filter:** -3 dB at 3 kHz (6 dB-per-octave).

GENERAL SPECIFICATIONS:

Rated Power Consumption: 680 watts. **Dimensions:** 22 $\frac{1}{16}$ W \times 8 H \times 19 $\frac{1}{2}$ inches D. **Net Weight:** 59.3 lb. **Suggested Retail Price:** \$1050.



2

neatly tucked out of sight. This innovative arrangement makes installation extremely simple, especially for a large, heavy unit such as this one, which might be difficult to hook up if all connections had to be made at the rear panel.

No schematic diagram was supplied with our sample test unit, but it is clear from the receiver's internal layout (shown in Fig. 3) that

the huge toroidally wound power transformer has two separate secondary windings, each of which supplies power to a single channel; voltages are filtered separately by two pairs of large filter capacitors.

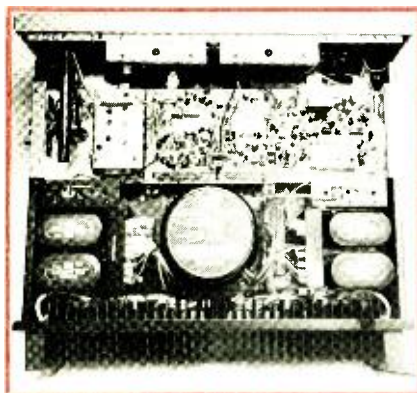

3

The power amplifier, as mentioned earlier, is a DC-coupled circuit from input to output, with no capacitors either in the signal path or in the overall negative-feedback loop. If components are connected directly to the main amplifier (by separating the preamplifier and main amplifier sections electrically), and if the outputs of those components contain any DC signal, the protection circuit immediately disconnects the speakers from the output stages. In that event, the switch separating the preamplifier output from the main-amplifier input has a third setting that introduces an input capacitor so that operation can be resumed.

FM measurements

Table 1 summarizes FM measurements made for the *model G-9000*. Where measurements differ between the wideband and narrowband positions, both sets of measurements are shown separated by a slash (/). For example, while 1-kHz mono distortion measured an incredibly low 0.03% in mono using the preferred wideband setting, when using the narrowband setting (used only if adjacent-channel interference is encountered in crowded FM listening areas), distortion increased to 0.15%.

Sansui evidently decided to make the narrowband IF response very narrow indeed because distortion rises markedly when this setting is used, particularly in the stereo mode. Wideband distortion readings, on the other hand, are among the lowest we've ever encountered for an FM tuner section or, for that matter, for a separate component tuner.

Separation capability of the *model G-9000* also varies depending upon whether the narrow or wideband settings are used. Figure 4 shows the frequency response of the left channel as well as crosstalk in the opposite channel (lower trace). The vertical scale is 10 dB-per-division, and we measured static separation of nearly 50



4

dB at mid-frequencies.

Note that our test equipment is now equipped to provide flat frequency-response readings (compared with the response readings shown in previous test reports that include the de-emphasis characteristics of the tuner) so the

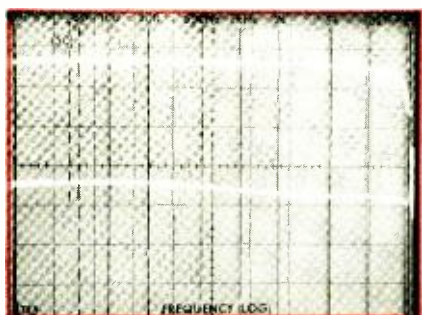

5

scope traces represent actual response.

When the narrowband setting is used, separation is somewhat diminished, as shown in Fig. 5, although overall frequency response remains unaltered and quite good.

In recent months, we have received requests to report on the AM sections of the tuners and receivers we test. While the harmonic distortion and signal-to-noise ratio measured for the

TABLE 1

RADIO-ELECTRONICS PRODUCT TEST REPORT

Manufacturer: Sansui

Model: G-9000

FM PERFORMANCE MEASUREMENTS

SENSITIVITY, NOISE AND FREEDOM FROM INTERFERENCE	R-E Measurement	R-E Evaluation
IHF sensitivity, mono (μV) (dBf)	1.5 (8.7)	Superb
Sensitivity, stereo (μV)	5.5 (20.0)	Very good
50-dB quieting signal, mono (μV)	1.5 (8.7)	Superb
50-dB quieting signal, stereo (μV)	18 (30.3)	Superb
Maximum S/N ratio, mono (dB)	80	Excellent
Maximum S/N ratio, stereo (dB)	76	Excellent
Capture ratio (dB)	1.0	Excellent
AM suppression (dB)	65	Excellent
Image rejection (dB)	100+	Superb
IF rejection (dB)	100+	Superb
Spurious rejection (dB)	100+	Superb
Alternate channel selectivity (dB)	92/53	Excellent

FIDELITY AND DISTORTION MEASUREMENTS

Frequency response, 50 Hz to 15 kHz (\pm dB)	+0, -1.5	Good
Harmonic distortion, 1 kHz, mono (%)	0.03/0.15	Superb
Harmonic distortion, 1 kHz, stereo (%)	0.06/0.5	Superb/see text
Harmonic distortion, 100 Hz, mono (%)	0.06/0.07	Superb
Harmonic distortion, 100 Hz, stereo (%)	0.09/0.7	Superb/see text
Harmonic distortion, 6 kHz, mono (%)	0.06/0.13	Superb
Harmonic distortion, 6 kHz, stereo (%)	0.10/0.45	Excellent
Distortion at 50-dB quieting, mono (%)	3.0/5.0	See text
Distortion at 50-dB quieting, stereo (%)	0.8/0.6	Good

STEREO PERFORMANCE MEASUREMENTS

Stereo threshold (μV) (dBf)	3.0 (14.8)	Very good
Separation, 1 kHz (dB)	48/36	Excellent
Separation, 100 Hz (dB)	43/34	Very good
Separation, 10 kHz (dB)	42/30	Excellent

MISCELLANEOUS MEASUREMENTS

Muting threshold (μV) (dBf)	4.5 (18.3)	Very good
Dial calibration accuracy (\pm kHz at MHz)	Perfect	Superb

EVALUATION OF CONTROLS, DESIGN, AND CONSTRUCTION

Control layout	Excellent
Ease of tuning	Very good
Accuracy of meters or other tuning aids	Superb
Usefulness of other controls	Good
Construction and internal layout	Excellent
Ease of servicing	Good
Evaluation of extra features, if any	Very good
OVERALL FM PERFORMANCE RATING	Excellent

AM section of the *model G-9000* were both within specifications, the AM frequency response (not specified by Sansui) was as poor as it is on most "hi-fi" receivers. To demonstrate this, we swept modulating frequencies much as we do for FM response measurements; the results (although hard to believe) are shown in the scope photo of Fig. 6. Perhaps Sansui and other manufacturers will pay more attention to

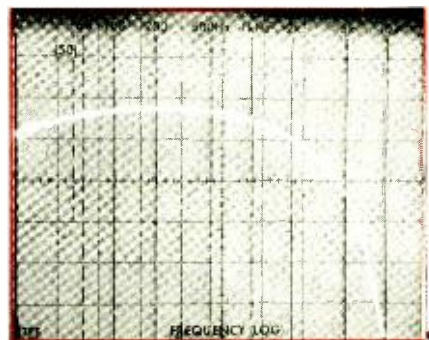

6

their AM bandwidth if and when stereo AM becomes a reality in the near future. For the moment, the less said about AM response in typical high-fidelity receivers and tuners the better.

Amplifier measurements

Table 2 lists amplifier measurements made on the *model G-9000*. The amplifier delivered more than its rated output at all frequencies before significant distortion was observed. The reason for the two power readings at 20 kHz (into 8-ohm loads) in Table 2 is because we were uncertain whether Sansui wishes to rate distortion at 0.02% or 0.03% (rather an academic point, since neither level of harmonic distortion would be audible). In any event, if the figure is 0.03%, the amplifier delivers greater than its 160-watt rating even at the 20-kHz extreme; if 0.02% is really the rated specification, it falls a bit short of the 160-watt mark at the high-frequency extreme.

We were pleased to find variable turnover tone controls on this high-powered, high-quality stereo receiver because the user then has much greater tone control capability. The range of tone controls using inner 400-Hz and 2.5-kHz turnovers is shown in Fig. 7, along

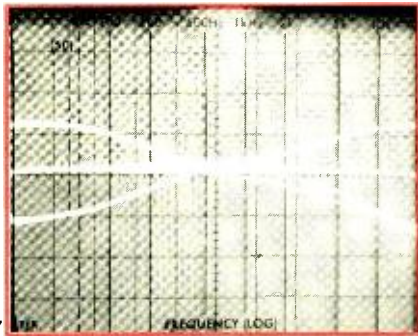

7

with the high-cut filter action. This filter, with its very moderate slope, clearly offers no advantages over treble-cut filters since the two curves almost coincide. Sansui could have provided a steeper slope (12 dB-per-octave) or at least raised the cutoff frequency of their high-cut filter.

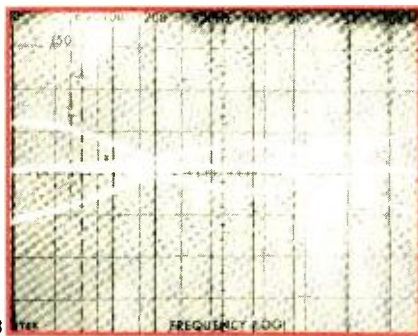

8

Figure 8 shows the bass and treble control range when the 200-Hz and 5-kHz turnover points are selected. Superimposed on these curves is the mid-range tone control range whose well-centered frequency provides the type of presence control action expected of it.

The loudness compensation circuit at various listening levels has a fairly typical response.

Summary

Table 3 contains our overall product evaluation along with our summary comments. We believe the Sansui *model G-9000* represents the most advanced circuit design yet seen in all-in-one receivers, and, considering what separate components offering the same quality, power and flexibility can cost, turns out to be very fairly priced.

R-E

TABLE 2
RADIO-ELECTRONICS PRODUCT TEST REPORT

Manufacturer: Sansui

Model: G-9000

AMPLIFIER PERFORMANCE MEASUREMENTS

	R-E Measurement	R-E Evaluation
POWER OUTPUT CAPABILITY		
RMS power/channel, 8-ohms, 1 kHz (watts)	174.8	Excellent
RMS power/channel, 8-ohms, 20 Hz (watts)	169.3	Excellent
RMS power/channel, 8-ohms, 20 kHz (watts)	158.0/162.0	See text
RMS power/channel, 4-ohms, 1 kHz (watts)	256.0	Excellent
RMS power/channel, 4-ohms, 20 Hz (watts)	232.0	Excellent
RMS power/channel, 4-ohms, 20 kHz (watts)	203.0	Very good
Frequency limits for rated output (Hz-kHz)	10-30	Good
DISTORTION MEASUREMENTS		
Harmonic distortion at rated output, 1 kHz (%)	0.006	Superb
Intermodulation distortion, rated output (%)	0.009	Superb
Harmonic distortion at 1-watt output, 1 kHz (%)	0.018	Very good
Intermodulation distortion at 1-watt output (%)	0.025	Excellent
DAMPING FACTOR, AT 8 OHMS	100	Excellent
PHONO PREAMPLIFIER MEASUREMENTS		
Frequency response (RIAA \pm dB)	+0, -0.5	Very good
Maximum input before overload (mV)	340	Superb
Hum/noise referred to full output (dB) (at rated input sensitivity)	78 ("A" weighted)	Excellent
HIGH LEVEL INPUT MEASUREMENTS		
Frequency response (Hz-kHz, \pm dB)	3-80, 3.0	Superb
Hum/noise referred to full output (dB)	93	Superb
Residual hum/noise (minimum volume) (dB)	102	Excellent
TONAL COMPENSATION MEASUREMENTS		
Action of bass and treble controls	See Fig. 7	Excellent
Action of secondary tone controls	See Fig. 8	Excellent
Action of low-frequency filter(s)		Excellent
Action of high-frequency filter(s)	See Fig. 8	Fair
COMPONENT MATCHING MEASUREMENTS		
Input sensitivity, phono 1/phono 2 (mV)	2.5/2.5	
Input sensitivity, auxiliary input(s) (mV)	150	
Input sensitivity, tape input(s) (mV)	150	
Output level, tape output(s) (mV)	150	
Output level, headphone jack(s) (V or mW)	100 mW	
EVALUATION OF CONTROLS, CONSTRUCTION AND DESIGN		
Adequacy of program source and monitor switching		Excellent
Adequacy of input facilities		Excellent
Arrangement of controls (panel layout)		Excellent
Action of controls and switches		Excellent
Design and construction		Very good
Ease of servicing		Good
OVERALL AMPLIFIER PERFORMANCE RATING		Excellent

TABLE 3
OVERALL PRODUCT ANALYSIS

Retail price	\$1050
Price category	High
Price/performance ratio	Excellent
Styling and appearance	Very good
Sound quality	Superb
Mechanical performance	Very good

Comments: If ever a manufacturer could boast that a receiver offers all the features and performance of high-priced separate components, Sansui has certainly earned that right with their *model G-9000*. The DC-amplifier configuration of the power section provides sound quality as good as any we have heard from the most sophisticated separate power amplifiers. To judge this quality, in our listening tests we used several mint-condition direct-to-disc recordings.

As for control flexibility, the *model G-9000* has it all; so much, in fact, that the front panel may seem somewhat intimidating on first use. Soon, however, the logical front-panel arrangement becomes familiar, and easy to use and enjoy.

Sansui was among the first to offer variable IF bandwidth for FM in a tuner, and they have extended that feature into this receiver. We found, however, that while the wide setting offers about the lowest distortion FM we've ever measured, the narrow position (useful when stations are very close together on the dial) is almost *too* narrow and should be avoided unless there is just no alternative for a desired incoming signal.

The well-calibrated power-output meters should insure against inadvertent overload and clipping, although that is hardly likely to happen because of the receiver's high power-output capability. Since many otherwise excellent speakers cannot handle the full power output of this receiver, prospective users are urged to check out the maximum power-handling capacity of the speakers they intend to use with it. The *model G-9000* is truly one of the best "component" systems we have ever checked.

Lectrotech Model PPI-400 Peak Power Indicator

LEN FELDMAN
CONTRIBUTING HI-FI EDITOR

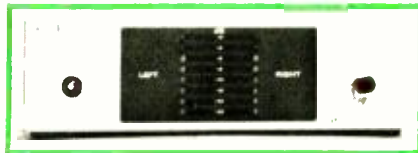

CIRCLE 105 ON FREE INFORMATION CARD

THE LECTROTECH MODEL PPI-400 PEAK-POWER indicator is an accessory device intended for connection either to the amplifier output terminals or to the speaker terminals of a high-fidelity component system. It indicates instantaneous peak-power output from a stereo amplifier by means of flashing LED's, each calibrated to light at a different input voltage to the unit.

The front panel of the model PPI-400 is shown in Fig. 1. The left side of the panel contains a pushbutton POWER on/off switch. The dark-colored center of the panel contains two vertical rows of LED's, calibrated from 0 dB at the top to -30 dB for the lowest indicator in each row. The bottom four LED's in each row are green, the next pair are yellow and the top two LED's in each row are red.

A selector switch on the right-hand side of the panel selects the sensitivity range of the indicators, as related to the nominal impedance of the speakers being used. For 4-ohm speakers, the six calibrated switch settings provide a power range (for 0-dB indications) from 25 watts to 600 watts-per-channel. For 8-ohm speakers, the ranges are from 12.5 watts to 400 watts; whereas for 16-ohm speakers, the power ranges from 6.25 watts to 200 watts. This arrangement demonstrates that the unit actually responds to input voltage rather than to true power input and, therefore, will not take into account any variations in speaker impedance with frequency. The device, therefore, displays errors depending upon a speaker's departure from nominal impedance at different audio frequencies.

A seventh selector switch setting permits you to calibrate the instrument to any desired 0-dB reference level other than those already provided. This switch position, labeled AUX on the panel, is calibrated by installing two appropriate resistors across two sets of terminals at the left of the rear panel that come supplied with jumpers. The jumpers are removed and resistors are substituted. You select the resistors in accordance with the formula, $R =$

TABLE 1
RADIO-ELECTRONICS PRODUCT TEST REPORT

Manufacturer: Lectrotech

Model: PPI-400

OVERALL PRODUCT ANALYSIS

Retail price	\$129.95
Price category	Medium
Price/performance ratio	Fair
Styling and appearance	Good
Sound quality	N/A
Mechanical performance	Good

Comments: Certainly this accessory device does what it is supposed to do with a fair degree of accuracy. It provides an approximate indication of instantaneous peak-power output from a stereo audio amplifier. The LED indicators do not suddenly light up or go out. Rather, there is a transitional region for each LED that spans between 2 dB and 3 dB. You must decide subjectively when a given LED is really lit. A vague area of indication that is 3 dB in amplitude represents a power difference of 2:1—which can be trying when you are judging whether or not your amplifier is going into clipping or not!

In addition, by just adding a bit more circuitry and switching, the model PPI-400 could have been made to read voltages that are typical of those applied to tape-deck inputs. Thus, the unit could have served as a peak indicator to augment most cassette or open-reel tape-deck VU meters. We are told by the people at Lectrotech that such a dual-purpose unit is evidently planned, but it will undoubtedly cost more than the single-purpose model PPI-400 we tested. Presently, the minimum sensitivity of 3.13 mW across 8 ohms is equivalent to 0.16 volt, somewhat more than is usually available at the record-out jacks of most amplifiers or receivers, and greater than the amount of drive usually required by most tape-deck line inputs.

If you want to know approximately how much power you are feeding to your loudspeakers at all times, the model PPI-400 will serve that purpose, and if your hi-fi component system is fairly expensive and lacks peak-power indication, the added cost of a device such as the model PPI-400 may not seem unreasonable—especially if it prevents speaker burnout even once in the life of your stereo system.

$2\sqrt{PZ} - 10$, where P is the desired power for 0-dB reference, Z is the loudspeaker impedance and R is the required resistor, in 1000 ohms.

This additional switch position makes it possible to calibrate and use the instrument with two monophonic amplifiers (for example, musical instrument amplifiers) even if the power-output rating of each amplifier is different (two different resistance values can be used).

Measurement and use tests

To test the model PPI-400 we hooked up a suitable amplifier with which to evaluate the unit.

Since the device is most useful in measuring short-term or instantaneous power, we used a variety of tone bursts to determine whether the LED's respond quickly enough to music-like transients. Specifically, we used the new test signal required in the dynamic headroom test of the recent IHF Amplifier Measurement

Standards (IHF-A-202). This signal consists of 20 ms of a 1-kHz test tone at full amplitude, followed by 480 ms of the same test frequency reduced by 20 dB. The signal's repetition rate is twice per second. Under these test conditions, a standard output meter reads approximately 12 dB below the full-amplitude value of the signal, while the LED's continued to read correct peak instantaneous power.

It was somewhat difficult to judge the accuracy of the device since individual LED's do not light up completely when triggered, but start dimly and then with increased signal amplitude, begin lighting up fully. The change in amplitude of applied voltage between the barely visible illumination of an LED and the full brightness of the same LED ranged from about 2 dB to 3 dB. It is possible, of course, to calibrate the model PPI-400 so that when the LED's are either barely lit or fully bright, this corresponds to the desired power level, but some eyeball judgment is necessary.

Summary

Our overall product evaluation, together with a summary of its usefulness, is shown in Table 1. The model PPI-400 is not a precision instrument, but then it is not very expensive for a device of this type. It could prove useful if you own an amplifier with higher power-output capabilities than your speakers can handle. Setting the 0-dB calibration point for the speakers' maximum power-handling value could protect the speakers against possible overdrive damage.

R-E

MANUFACTURER'S PUBLISHED SPECIFICATIONS:

Input Impedance: 20,000 ohms, minimum. **Accuracy:** ± 0.25 dB. **Frequency Response:** 20 Hz to greater than 20 kHz. **Maximum Input Power:** 1250 watts continuous at 8 ohms. **Minimum Input Sensitivity:** 3.13 mW at 8 ohms. **Loudspeaker Impedance Range:** 2 to 35 ohms. **Power Range and Impedance Combinations:** 18 plus auxiliary. **Dimensions:** 14 W \times 3 1/4 H \times 8 inches D. **Weight:** 3 1/2 lb. **Power Requirements:** 105 to 125 V, 50 to 60 Hz, 7 watts. **Suggested Retail Price:** \$129.95 (optional walnut cabinet, \$24.95 extra).

Understanding Dynamic Headroom

Dynamic headroom, a new addition to the Institute of High Fidelity amplifier measurement standards. Tells why amplifiers with the same rated power may perform differently under varying signal levels.

LEN FELDMAN
CONTRIBUTING HI-FI EDITOR

EVER SINCE THE FEDERAL TRADE COMMISSION issued its rule regarding disclosure of the power output ratings of audio amplifiers, manufacturers of high-fidelity amplifiers and receivers have been faced with a mixed blessing. On the one hand, the requirement that amplifier makers list the continuous power rating of their amplifiers has forced less-than-honest manufacturers to abandon such meaningless

power output terms as "peak power," "instantaneous peak power," "music power," "dynamic music power" and more. The continuous power rating, coupled with a statement of load impedance, power bandwidth (the frequency extremes over which the product will actually deliver its rated power) and harmonic distortion has enabled prospective buyers of audio amplifiers to compare brands

and models on a reasonably equal basis. This uniformity of specifications is all to the good.

On the other hand, it didn't take the experts long to conclude that two amplifiers that have exactly the same continuous power output rating (including the same power bandwidth and even the same rated harmonic distortion) may not necessarily deliver the same program *loudness* to identical speaker systems when fed with actual program signals. Obviously, to properly define the useful power output capability of an amplifier, more information is needed than the simple statement of "continuous power output" capability.

Power supply reserve

The reason for this can be found by examining the two power supply diagrams of Figs. 1 and 2. Note that both supplies have nominal output voltages of plus and minus 50 volts under no-load (no-signal) conditions. The alternate voltages (designated with an asterisk) are those that are present when the amplifier is delivering a large amount of current to the speaker loads. Under a full-load condition, the power supply shown in Fig. 1 delivers plus and minus 48 volts, while the power supply shown in Fig. 2 delivers a much lower output of only plus and minus 40 volts. What does this mean in terms of continuous power output capability?

Assuming that the output signal can swing over the entire peak-to-peak value of the power supply voltage, we see that in the case of the power supply of Fig. 1, a

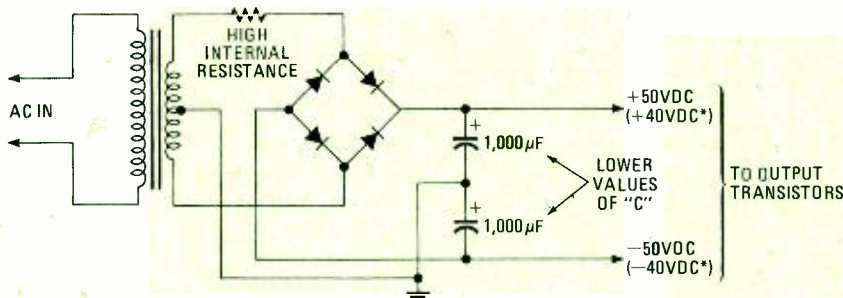
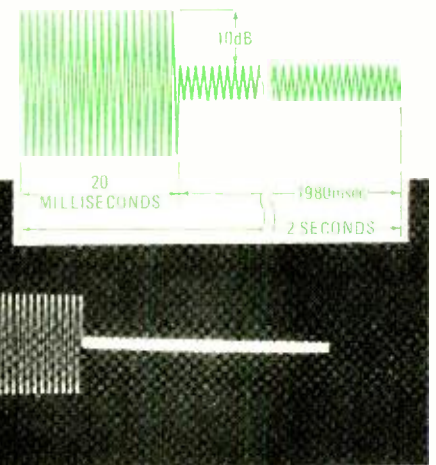

FIG. 1—POWER SUPPLY for hi-fi amplifier has large filter capacitors. There is little variation in output voltage between no-load and full-load conditions.

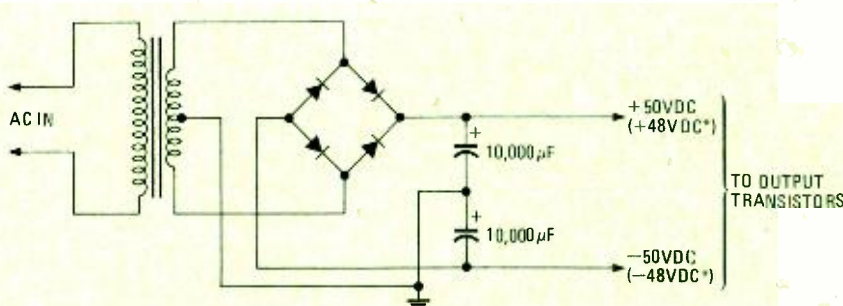

FIG. 2—POWER SUPPLY for hi-fi amplifier has small filter capacitors and a high internal resistance in either the transformer or bridge rectifiers. This supply delivers an output voltage with a wide variation between no-load and full-load conditions.

peak-to-peak swing of 96 volts is possible under full-load conditions. This corresponds to an RMS AC value of 33.94 volts (peak-to-peak value divided by 2.828, or multiplied by 0.5×0.707). The continuous power output of this first amplifier, before clipping, would be approximately 144 watts. ($P = E^2/Z$, where $E = 33.94$ volts and Z , the impedance, is assumed to be 8 ohms.)

Now let's calculate the continuous power output for the amplifier being powered by the supply shown in Fig. 2, where the available supply voltage has dropped to plus and minus 40 volts. The permissible peak-to-peak swing of the output signal voltage is 80 volts. This corresponds to an RMS value of only 28.29 volts, or an equivalent power across 8 ohm loads of 100.03 watts.

Thus we see that even though both power supplies (under no-load conditions) provide the same operating voltages to their associated amplifiers under no-signal (or low-signal) conditions, their maximum continuous power output ratings will differ substantially, with the amplifier powered by the supply shown in Fig. 2 able to deliver only 69% as much continuous power as the amplifier powered by the supply shown in Fig. 1.

Power supply regulation

There are several reasons why the voltage output of the supply shown in Fig. 2 dropped more quickly than the voltage delivered by the supply shown in Fig. 1. For one thing, its filter capacitors are of considerably lower value. The primary filter capacitors in such a supply act as a power or energy reservoir. The greater their value, the greater the amount of energy that can be stored in them. Note, too, that the primary and secondary windings of each of the power transformers used in the two supplies may have different internal resistances and, therefore, different AC voltage drops may appear across these windings before the AC voltages are ever rectified. The bridge rectifiers, too, may differ in internal resistance and may therefore develop greater voltage drops across their terminals as the current demand increases.

Short-term signals

If we were to apply a very short signal burst to each of the amplifiers associated with the power supplies, the situation would be quite different. If the signal burst were short enough, the filter capacitors would maintain their full (or nearly their full) charge for the duration of the short pulse and the available voltage at the power output stages of each amplifier would be very close to the no-load value of plus and minus 50 volts. Under these circumstances, each amplifier would be able to provide a peak-to-peak signal swing of 100 volts, which would correspond to a short-term power output of 156.3 watts!

These short-term musical signals are exactly what an amplifier is called upon to reproduce when it is hooked up to speakers and fed with program sources in a "real-world" high-fidelity system. No one (at least no one we know of) spends much time listening to continuous sine-wave test signals. Yet, if we were to be guided by the continuous power ratings of the two amplifiers used in our example, one would have a rating of just over 100 watts-per-channel while the other would be rated at 144 watts-per-channel. In auditioning these two amplifiers you might well conclude that the 100-watt unit (which would undoubtedly sell for less money than the higher powered model) "sounds" just as loud as the higher powered unit before audible clipping takes place.

At the present time, the Institute of High Fidelity is completing its work on a new amplifier measurement standard. One of the most important new measurements that is being incorporated in this new standard has been given the tentative name, Dynamic Headroom. This measurement seeks to take into account the wide discrepancies that may occur between the continuous power ratings of amplifiers and their ability to deliver power over the short terms typically required during music signal reproduction. In order to simulate these short-term conditions, studies were conducted by the IHF committee regarding the actual duty-cycle and power distribution of musical signals. A test signal was arrived at which, it is felt, approximates what an amplifier must be able to handle when reproducing typical music signals. This new test signal is shown in Fig. 3. It consists of a 1-kHz signal which is at an

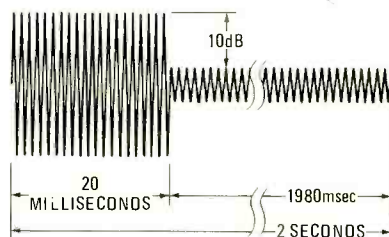

FIG. 3—NEW TEST SIGNAL for determining dynamic headroom of an amplifier. Signal consists of 1-kHz sinewaves with a 10 dB amplitude change.

arbitrary level for 20 milliseconds (twenty cycles of this signal will therefore appear) and the same frequency at an amplitude 10 dB lower for another 1980 milliseconds. This complex signal is repeated, therefore, every two seconds. A portion of the test signal is shown in the scope photo of Fig. 4.

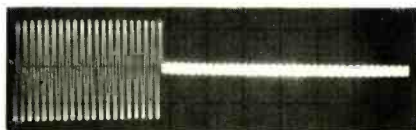

FIG. 4—NEW TEST SIGNAL as it would appear on an oscilloscope.

We decided to check out an amplifier to use this new test signal at the time in our lab at the time. The amplifier output rating was 100 watts. To confirm this, we wrote a test signal into the scope display so that our scope display would show the sinewaves reaching 40 volts (100 watts), as shown in Fig. 5.

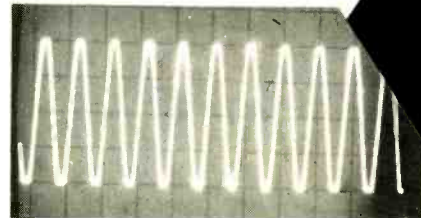

FIG. 5—CONTINUOUS POWER OUTPUT can be determined by determining the input level required to drive an amplifier into clipping with a 1-kHz input signal.

sponded to an RMS value of 14.14 volts, or just over 25 watts across an 8 ohm load.

Next, we applied a signal similar to that shown in Figs. 3 and 4. The oscilloscope's sweep rate was increased so that we might be able to examine the crests of the sinewaves during the 20-millisecond duration of the higher amplitude pulses.

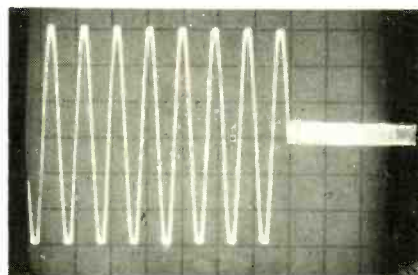

FIG. 6—OUTPUT OF AMPLIFIER that is being driven just to the point of clipping by new test signal.

Again, the gain was increased until evidence of clipping appeared, without changing the vertical sensitivity of the scope input. The results are shown in Fig. 6. Using our new test signal, the peak-to-peak amplitude of the sinewaves reached 60 volts. This corresponds to an RMS value of 21.22 volts, or a short-term power output capability of 56.27 watts!

Specifying dynamic headroom

The IHF Amplifier Standards Committee was faced with the problem of how best to specify the new measurement results. They could, of course, simply list a second power rating and call it "dynamic power." If that were to be done, however, the Federal Trade Commission requires that such a "secondary" power rating must be printed in the spec sheets (or in any advertising material) using

letters that are no greater than two-thirds the size of the letters used to specify the continuous power rating. In addition, the appearance of an alternate power rating in watts might, in time, lead to the same sort of confusion that arose years ago and that prompted the Federal Trade Commission to promulgate the power rule for audio amplifiers in the first place.

The committee therefore decided that Dynamic Headroom should be specified in terms of decibels *above* the rated continuous power. Not only does this get around the problem of having multiple (and confusing) wattage listings for the same amplifier, but it serves to give the potential purchaser some idea as to how much louder the amplifier will sound when reproducing music signals as compared with its ability to reproduce a continuous sinewave test tone.

In the example just taken from our actual measurements in the lab, since the short-term power was 56.27 watts and the continuous power rating was 25 watts, the ratio of those two numbers is 2.25, which translates to a Dynamic Headroom of 3.52 dB. Based upon our experience with a variety of amplifiers, that degree of Dynamic Headroom is very great indeed. Generally, you can expect the Dynamic Headroom of typical audio amplifiers to range from 0 dB to around 3.0 dB. A Dynamic Headroom of 0 dB would mean that the amplifier has a very stiff power supply—one whose voltage does not vary at all from “no-signal” to full-signal conditions. An amplifier with a Dynamic Headroom of 3 dB would be one with a very “soft” or poorly regulated power supply whose voltage drops by a factor of approximately 30% when full current is delivered to the load.

Checking dynamic headroom

You can check the dynamic headroom of your own amplifier or receiver even if you lack the test equipment needed to produce the special signal we have described. All you need is an accurately calibrated oscilloscope and an audio oscillator which can apply a single-tone 1-kHz signal to the high level inputs of your equipment. First, determine the amplitude of a 1-kHz output signal that causes the amplifier to barely clip. Record the amplitude in peak-to-peak volts, as observed on the scope. Then, apply a music signal to the set (either from a recording or from an FM tuner) and observe the new clipping level, which should be somewhat greater than that obtained during the first sinewave test. Even if your scope is not calibrated, you can still determine the Dynamic Headroom of your equipment quite accurately, in dB. For example, we used still another amplifier and, without regard to its continuous power rating, we applied a 1-kHz test tone until clipping occurred. We set the sensitivity of the vertical amplifier of the scope so that this amplitude occupied four divisions, vertically (see Fig. 7). Then, applying a music signal to the amplifier, we noted that at clipping, the vertical amplitude was 4.6 vertical divisions on the scope (positive peaks were about 3/10ths of a division higher than before, and so were negative clipped peaks). These results are shown in the scope photo of Fig. 8. To calculate the Dynamic Headroom of this amplifier, divide 4.6 by 4.0 to obtain a voltage ratio of 1.15. This corresponds to a dB difference of 1.21. So, the Dynamic Headroom of this amplifier is 1.21 dB.

The concept of Dynamic Headroom is

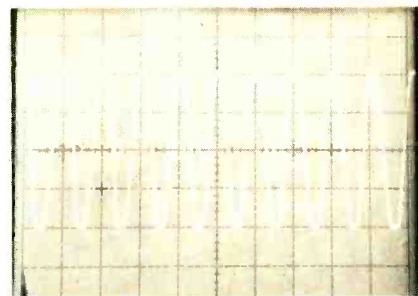

FIG. 7—AMPLIFIER'S DYNAMIC HEADROOM can be obtained by first determining the input level required to drive the amplifier into clipping with a 1-kHz input signal.

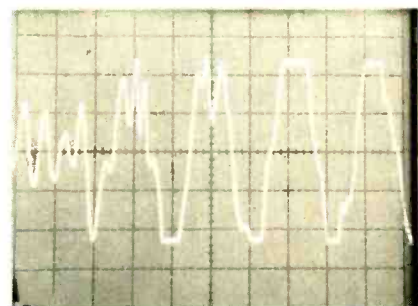

FIG. 8—CLIPPING LEVEL of program material is used to determine amplifier's dynamic headroom.

just one of the new measurement ideas which will be incorporated in the new IHF Amplifier Measurement Standards, but it is one which should help to clarify one of the seeming discrepancies which still exists when comparing the performance of similarly power-rated audio products that, under actual use, “sound different.” As soon as the members of the IHF approve of the entire new standard, we will detail the other important measurement techniques incorporated in that standard in a future article. **R-E**

Pioneer Electronics receives award for contribution to arts

U.S. Pioneer Electronics, a leading audio component manufacturer, was a first-time winner this year in the 12th annual “Business in the Arts” awards program, co-sponsored by *Forbes* magazine and the Business Committee for the Arts, a national organization that promotes greater business and industry involvement in the arts. The award this year was an original print by American artist Romare Bearden.

Pioneer was awarded its prize for a national campaign to raise funds for the Metropolitan Opera. Not only did the company match every dollar contributed by the general public and authorized Pioneer dealers, but obtained matching funds from the National Endowment for the Arts; this helped quadruple the original public donations. The company footed the bill for all advertising and promotional campaigns. A quarter of a million dollars was raised for the Met.

Electronic town meeting via 2-way cable TV

Upper Arlington, OH, a suburb of Columbus, recently experienced its first electron-

ic “town meeting of the air.” This was made possible by Warner Cable’s participatory two-way cable QUBE system, which allows viewers to express their opinions on the air on matters of public interest, such as municipal services, public utilities, etc., in their areas.

Here’s how QUBE works: Town officials, broadcasting live from QUBE’s TV studios, posed questions to which viewers responded by pressing a button on their home terminals, registering their opinions or criticisms. The results were then tabulated by a computer for display on home TV screens. A special hookup to the QUBE studios also made it possible for participants to phone in their own questions to the town officials. Random numbers were assigned so that no individual home was known or identified with the opinions expressed.

National satellite network transmits public service programs

This past September, the Public Service Satellite Consortium (PSSC) used Denver, CO, as the “launch site” of a new continuing education program transmitted via a communications satellite. This transmis-

sion was a pilot demonstration of the non-broadcast use of the public television satellite system.

The program was a special education presentation created for members of the American Dietetic Association who viewed it at more than 100 selected locations in eight major cities across the U.S. Pretaped portions of the program were linked up with a panel of experts in Denver, and the dietitians viewing it on screens in auditoriums, schools and hospitals could question the experts via telephone.

The signal was beamed to Western Union’s communications satellite Westar I, which then retransmitted it to public television stations in Anchorage, AK, San Diego, Indianapolis, Las Vegas, Columbus, OH, Cleveland, OH, Columbia SC and Spokane, WA.

According to the PSSC, this new satellite system will connect all PBS stations by the end of 1978. Because the system allows each station to receive up to four transmissions simultaneously, this will allow PBS to transmit nonbroadcast programs for its members, more than 100 nonprofit organizations and other nonprofit groups. The system is expected to be operative by early 1979. **R-E**

Hobby Computer

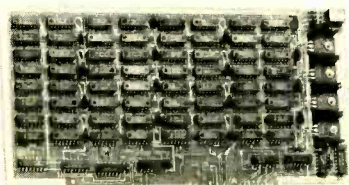

STATIC RAM MEMORY from Vector Graphic is designed for the S-100 bus structure. Four Motorola MC7805CP 3-terminal voltage-regulator IC's are along the right-hand edge.

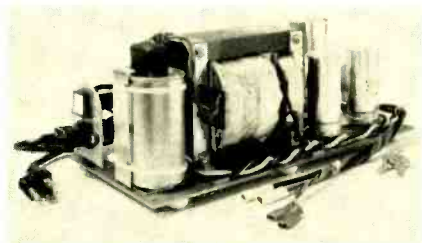

TYPICAL POWER SUPPLY for hobby computers has heavy power transformer and computer-grade electrolytic filter capacitors. The voltage regulators are mounted on the motherboard.

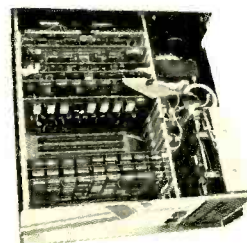

VECTOR model 1+ microcomputer has power supply along right side of cabinet. Cooling fan in right rear corner exhausts hot air.

The power supply is perhaps one of the most critical of all often used in microcomputer circuitry, operate from a DC supply be allowed to go above 5.6. This is the story of high-current power

MICROCOMPUTERS BUILT WITH THE S-100 BUS USE DISTRIBUTED regulation to supply +5 volts DC to the various circuits. Distributed regulation uses one or more three-terminal IC regulators (i.e., LM309, 7805, LM340-5) mounted on each printed circuit board. The main high-current power bus on the S-100 motherboard is unregulated +8 volts DC.

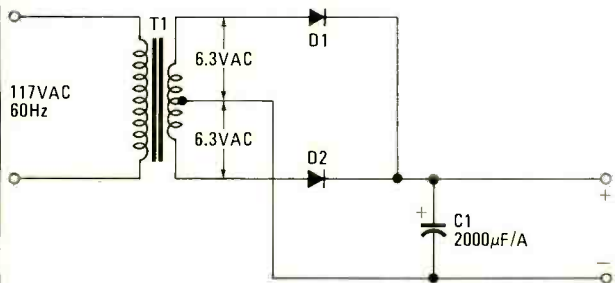

FIG. 1—SIMPLE FULL-WAVE RECTIFIER uses two diodes and a center-tapped transformer.

But certain other mainframes use +5 volts DC *regulated* on the main power distribution bus, and obtaining that type of supply at a reasonable cost is quite a chore! At current levels of around 5 amperes, you cannot use a simple three-terminal IC regulator. Finding a series-pass transistor able to handle the load current and possessing a *beta* high enough to allow use of the simple Zener-controlled base circuit type of regulator is almost

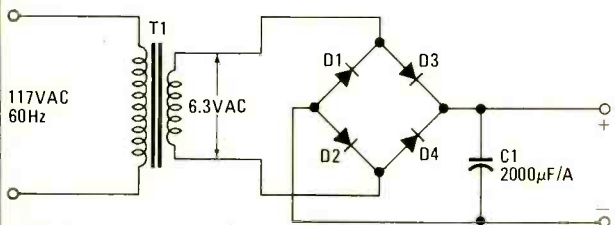

FIG. 2—BRIDGE RECTIFIER provides full-wave rectification.

impossible. In this article we will discuss several approaches to solving the problem of high-current supplies.

Pseudo-distributed system

The microcomputer kit I purchased recently uses a motherboard with the +5 volt DC and ground foil traces connected to the individual card-edge connectors. The total current demand of a fully populated motherboard is approximately 16 amperes. In trying to develop a power supply, one solution I tried with moderate success was to cut the +5-volt foil trace on the motherboard at strategic points, and then mount external three-terminal IC regulators nearby. One regulator served each section of the board. The three types mentioned earlier are suitable for current drains of 1 ampere in the TO-3 case, and 750 mA in the plastic case. The LM323 will handle 3 amperes, and the Lambda LAS-1905 will handle 5 amperes.

The pseudo-distributed system works well, but is sloppy. In some cases, this approach is made more difficult by the fact that not all motherboards are laid out in the nice straight lines of the S-100 bus! The +5-volt DC line may wander, breaking off at points, and then rejoining later on. These difficulties often force us to look at other alternatives.

Rectifiers and filters

In the regulator circuits to follow we will show only the regulator and associated circuitry, since this is where the main problem in design is. All these circuits will be preceded by a rectifier and filter circuit such as those shown in Figs. 1 and 2.

Both of the circuits shown in Figs. 1 and 2 are full-wave rectifiers, meaning that they make use of both alternations of the AC sinewave from the power mains. This type of rectifier is not only easier to filter (the traditional justification) but also results in a higher average DC output voltage, and requires less power (i.e., $V \times A$) from the transformer primary for any given load current.

The rectifier circuit in Fig. 1 uses two solid-state diodes and a center-tapped transformer. The center tap is taken as the

Power Supplies

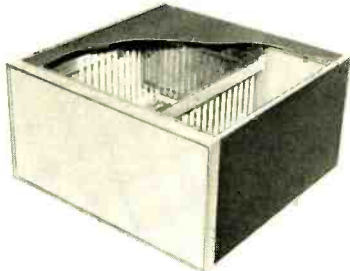

VECTOR'S VP2 ENCLOSURE permits you to design and house your own microcomputer. Card-guides are provided. Power supply can be installed in smaller compartment.

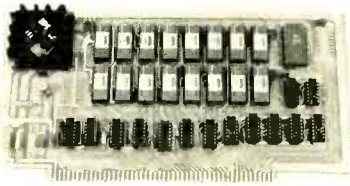

RAM MEMORY BOARD from Electronic Control Technology mates with S-100 bus. Type LM340T regulator IC's are on massive heat-sink in upper left corner.

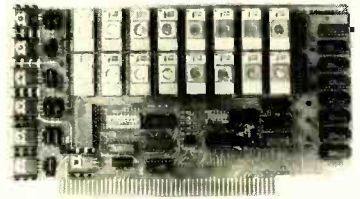

COMBINATION RAM AND ROM memory board is designed for S-100 bus configuration. Distributed voltage regulation uses six 3-terminal voltage-regulator IC's.

hobby computer components. TTL (Transistor-Transistor Logic) IC's, with a nominal level of 5 volts and a maximum level that must not supply regulation and how you can design and build your own supply.

JOSEPH J. CARR

common (or ground) terminal, while the positive output is taken from the junction of the two diode cathodes. The alternate circuit, shown in Fig. 2, is a bridge rectifier that can be made from four discrete diodes, or be purchased as a prepackaged bridge.

Almost all voltage regulator circuits require a DC input that is at least 2.5 volts higher than the rated output voltage. In our case, with +5-volts DC output, the DC input voltage should be not less than +7.5. In case you have wondered, this is probably the reason why Altair, the original S-100 bus designers, specified +8 volts for the main power bus. An ordinary 6.3-volt AC (RMS) filament transformer will deliver this potential when full-wave rectified and filtered. The filter will charge to $1.4 \times E_{RMS}$, which in this case is $1.4 \times 6.3 = 8.8$ volts. In most cases, a 6.3-volt high-current filament transformer is sufficient.

The standard 6.3-volt filament transformer is a good choice for use in a circuit such as Fig. 2 because the bridge rectifier uses the entire secondary. Keep in mind, however, that the transformer can deliver only half its rated current in the bridge configuration. In the case of Fig. 1, a 12.6-volt transformer will provide 6.3 volts AC either side of the center tap, so it is a good choice. It will deliver the same output potential as the bridge rectifier used with a 6.3-volt transformer, and will supply its rated current.

Fortunately, 6.3 and 12.6 volts AC are the filament ratings of many high-power transmitting tubes used in commercial and military transmitters. Many such transformers are still available on the surplus market, although the supply is down from its heights of only a few years ago. You should be able to save a considerable amount of money by checking the local electronic surplus outlets, ham friends (who tend to save such items), or by attending hamfests and auctions. If a push comes to a shove, or you have money to spend, then go to your local parts distributor and buy a new transformer outright. I have used several Triad types that are particularly useful because their tapped primary offers secondary AC voltages of either 6.3 or 7.5. Table 1 gives the type numbers and ratings.

The rectifier diodes or bridge-rectifier stacks should be rated to handle more current than is expected at full load, but keep in mind that they will tend to run very hot if operated at a point near their maximum ratings. It is preferable to select diodes with a 25 or 50 percent margin. For example, for a 20-ampere power supply select a 25- to 30-ampere diode. Also keep in mind that the minimum peak inverse voltage (PIV) rating must be not less than 2.82 times the applied RMS voltage. This is not too much of a problem in +5-volt circuits operated from 6.3-volt transformers, but is very definitely a factor at higher voltages. You cannot, for example, use a 25-volt PIV rectifier in a 12-volt DC supply!

TABLE 1—TYPICAL FILAMENT TRANSFORMERS

Triad No.	Secondary voltage	Amperes
F-22U	6.3VAC	20
F-24U	6.3/7.5 VAC	8
F-28U	6.3/7.5VAC	25
F-56X*	25.2 VAC	2.8

*Ideally suited to making the ± 12 volt regulated supplies needed for most microcomputers. Use a fullwave bridge and the transformer center tap to form two halfwave bridges. This supply will deliver up to 1 ampere at each voltage.

Capacitor C1 in Figs. 1 and 2 should have a capacitance of *not less* than 2000 μ F-per-ampere of load current. In a 20-ampere supply, then, the filter capacitor should be at least 40,000 μ F. It should have a DC working voltage rating of at least 15 volts (WVDC). I used an 80,000 μ F/15 WVDC capacitor in testing these circuits with a 15-ampere load. The 2000 μ F-per-ampere spec is a *minimum*, not an *optimum*, rating.

The 5-volt, 5-amp supply

The Lambda Electronics (515 Broad Hollow Rd., Melville, L.I., N.Y., 11746) model LAS-1905 is one of the most powerful

5-volt three-terminal IC regulators on the market; it has an output-current specification of 5 amperes!

Figure 3 shows a typical circuit using the LAS-1905. Note that this circuit is not too much different from other three-terminal IC regulator circuits. This regulator, however, has better protection than some less powerful and less costly versions. Some of the features more than justify its \$14 price tag. A block diagram of the internal circuitry is shown in Fig. 4. Note that it contains safe-area protection, thermal-overload

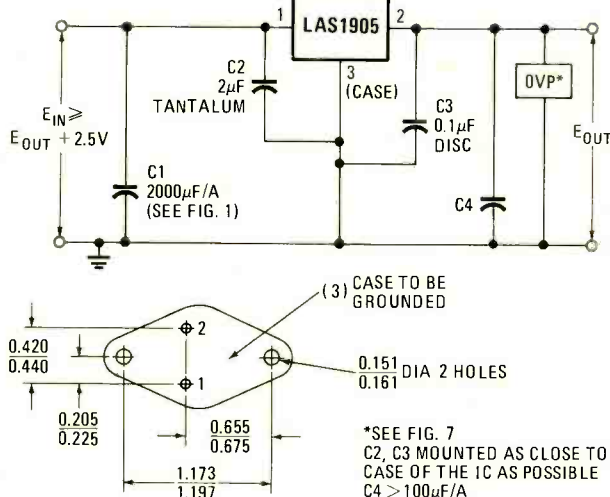

FIG. 3—THREE-TERMINAL IC REGULATOR provides 5 volts at 3 amperes.

protection and the all-important current-limiting protection.

The use of current-limiting is almost mandatory once the current level goes much over an ampere or two because of the damage short circuits can cause to printed-circuit traces and other components, including the power supply itself! As the current level increases, so does the possibility of vaporizing the main power bus in your mainframe! In my own Z-80 system, current-limiting saved the motherboard once when some of the protective foil that comes wrapped around 2102 memory IC's accidentally stuck to a printed-circuit card right where the +5-volt DC and ground terminals enter the board. Without the 10-ampere current-limiting circuitry then used in my supply (the circuit in Fig. 5), the tracks may well have vaporized!

The power supply regulator in Fig. 3 is especially useful for powering single-board computers that normally tax 3-ampere regulators, and wipe out 1-ampere types! Note that most regulators tend to offer deteriorated transient response near their full rated output current, so the extra margin of the LAS-1905 would prevent certain types of power-supply-induced "glitch."

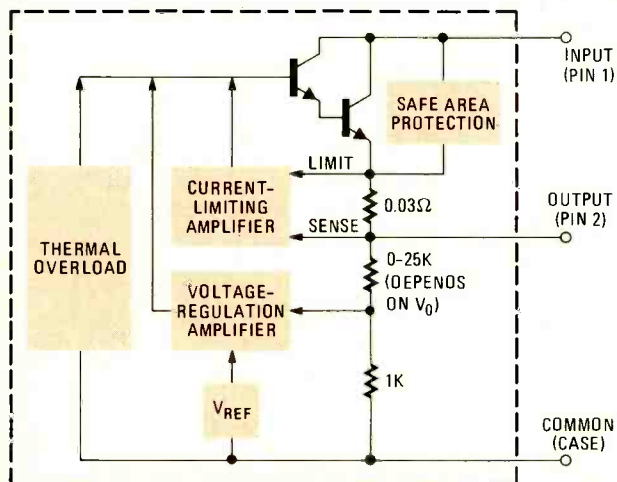

FIG. 4—INTERNAL CIRCUITRY of Lambda Electronics LAS-1905 three-terminal regulator.

Use the LAS-1905 for applications where an LM-323 might have to work close to its 3-ampere rated output current.

A 5-volt DC, 10-amp supply

Figure 5 shows a regulator circuit taken from the Motorola applications literature on their MC1469R voltage regulator IC. This circuit can deliver up to 10 amperes with the transistor shown and the 60-milliohm series resistor. The same circuit can deliver up to 15 volts DC for use with CB and ham transceivers if resistors R4 and R5 are changed appropriately. The output voltage is given (approximately) by the formula

$$E_{out} \approx 3.5 \times 1 + \frac{R4}{R5} - 0.6$$

Transistor Q2 and resistor R1 serve as the current-limiting circuit, and will shut down series-pass regulator Q1 if the voltage drop across R1 exceeds 0.6; the forward bias potential of Q2. The maximum output current, then, is set by resistor R1 and is equal to $0.6/R1$. In the case of our 10-ampere supply, R1 is 60 milliohms, i.e., 0.060 ohm. This is not a standard off-the-shelf value so it must be made. I used five 0.33-ohm auto radio fuse resistors, while a friend made one from magnet wire using the ohms/foot data given in the ITT *Radio Engineers Data Book* (Howard W. Sams & Co.).

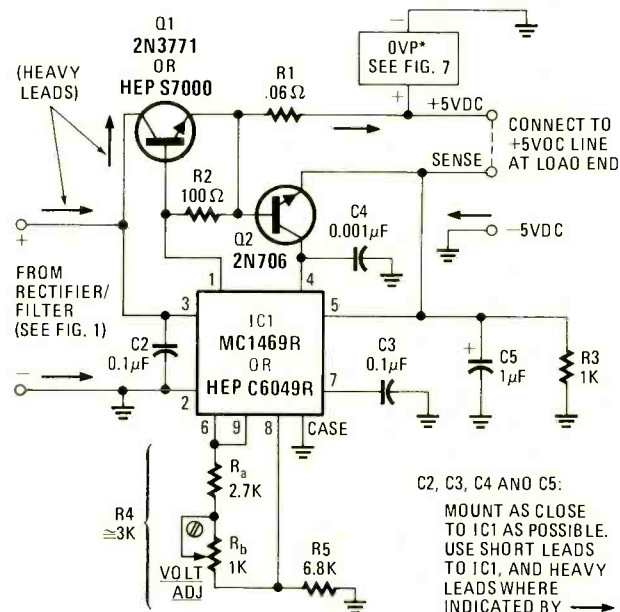

FIG. 5—10-AMPERE REGULATOR based on Motorola IC regulator and series-pass transistor.

The power supply in Fig. 5 uses a sense line. The MC1469R regulator is a feedback type that uses an error amplifier to compare the actual output voltage with an internal reference voltage. The sense terminal is the input to the internal error amplifier. In supplies that deliver more than 5 or 10 amperes, it is considered good engineering practice to run the sense line to the load separately from the main power bus. This arrangement allows the regulator to sense the voltage actually delivered to the load, rather than the regulator output voltage. If the main power bus is more than a few inches long, or if it is made of a marginally sized conductor, then the IR-drop due to current flow can be considerable. In one large-scale TTL project I built, this drop was almost 1 volt in an 18-inch line, and that can cause all kinds of trouble in ticklish TTL circuits! There are enough real problems in digital electronics without making more by poor power supply technique!

5-volt, 20- or 30-amp supply

The design and construction of a thermally stable, regulated, power supply able to deliver over 10 amperes or so is not an easy

chore. While it is easy to theorize on paper, you find that it is a long way from the design desk to the final product! Techniques that should have worked sometimes succumb to some unsuspected glitch or hitch that inevitably fouls up the works. In that case, it might be wise to use a 20- or 30-ampere hybrid voltage regulator such as the Lambda LAS-5205 (20 A) or LAS-7205 (30 A). Figure 6 shows a circuit based on these devices. Both of these modules contain all required circuitry to make a regulator circuit with complete current-limiting and thermal-overload protection.

These regulators have two heat-dissipating surfaces. The lower and larger of the two is thermally connected to the high-current series-pass transistors, while the upper is thermally

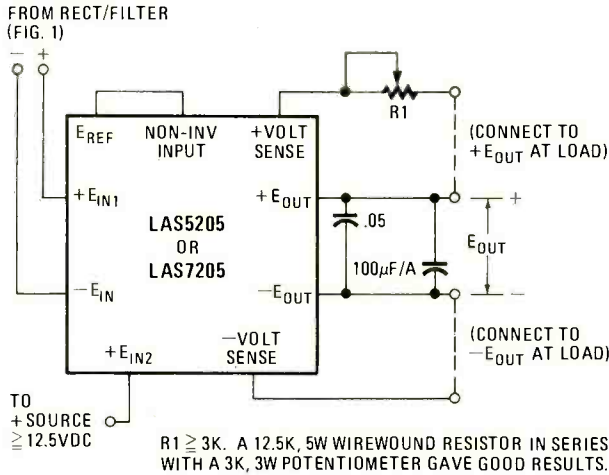
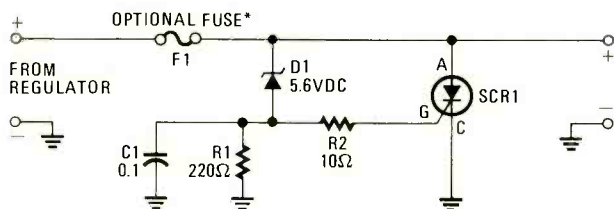

FIG. 6—HYBRID REGULATOR circuit and external components can be used to provide output currents in the 20- to 30-amp range.

connected to the regulator reference and control circuitry, affording a degree of thermal isolation for these circuits. The regulators also have two separate E_{in} terminals, labeled E_{in1} and E_{in2} in Fig. 6. Terminal E_{in1} is to the main series-pass transistor, and must be at a potential of 2.5 volts higher than E_o , or in this 5-volt example, 7.5 volts DC. The other terminal, E_{in2} , supplies the control circuitry and must be at a potential that is 7.5 volts greater than the output potential, or in this case, 12.5 volts. If the main, high-current, supply delivers a potential of 12.5 volts or more from the rectifier-filter, then E_{in1} and E_{in2} may be strapped together. But if an 8-volt DC high-current supply is used, then E_{in2} must be tied to some other source. In most microcomputers there is a +12-volt regulated supply, and this will usually be fed from a +15-volt unregulated source. Use the +5-volt terminal to supply E_{in2} in that case.



*SOME DESIGNERS USE A TRANSFORMER PRIMARY FUSE INSTEAD OF F1 TO ELIMINATE THE I X R DROP AT THE FUSE HOLDER.

FIG. 7—SCR CROWBAR using discrete components provides short-circuit protection.

The high cost of these hybrid modules may seem a little steep for amateur and hobbyist use, until one begins to price out commercial +5-volt, 20-ampere supplies. There is at least one on the market that will deliver the current and costs only \$115, but most run closer to \$200. The \$80 price of the LAS-5205 then seems less frightening, especially if you are able to scrounge or buy the transformer and filter capacitor from a surplus source. Note that 6.3- and 12.6-volt center-tapped transformers have a high "scroungability" quotient!

Overvoltage protection

All series-pass transistors work hard and tend to get very hot inside of the case. This heat tends to cause marginal transistors to give up and short out prematurely, which would place the full rectifier-filter voltage on the main power bus of your expensive computer. TTL IC's may well blow out with as little as 7 or 8 volts, so the short-prone series-pass transistor is a scenario for disaster! Your cabinetful of expensive microcomputer may well become a *silicone-to-carbon* converter in a quick hurry!!!

The way to protect your equipment from this type of disaster is to use an overvoltage-protection circuit such as the SCR crowbars of Figs. 7 and 8. The circuit in Fig. 7 uses discrete components, while the circuit in Fig. 8 is an IC version produced by Lambda.

The circuit in Fig. 7 uses a high-current SCR to blow the main bus fuse if an overvoltage condition is sensed. This brute force approach is probably the origin of the inelegant nickname "crowbar." Diode D1 is a 5.6-volt Zener, so it will not pass current as long as the output voltage is normal (i.e., +5 volts). But if the series-pass transistor goes bananas and places the +8

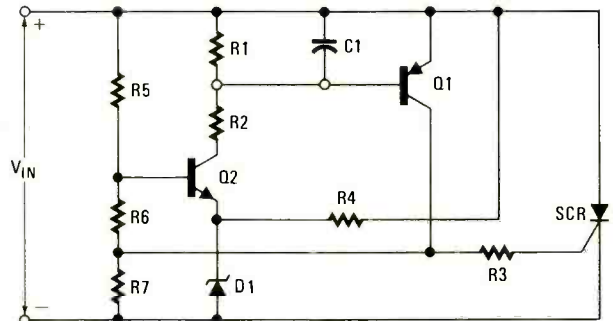

FIG. 8—CROWBAR PROTECTION circuit from Lambda Electronics is available in self-contained modules.

volts on the output, then D1 will conduct and pass current to the gate of SCR1. This current will turn on SCR1, creating a short circuit across the +5-volt line, thereby blowing the fuse. Not very elegant as circuits go, but it will save hundreds of dollars worth of circuitry in the event of a catastrophe. Select an SCR with a current rating considerably higher than the line current; a 30- to 50-ampere rating will do nicely.

I have used the 2-, 6- and 35-ampere Lambda two-terminal overvoltage protectors in various power supplies. In my main computer mainframe, an L-35-OV-5 is used as a reasonably priced alternative to the discrete circuit. The internal circuitry for these devices electronic crowbar is shown in Fig. 8 while the ratings of various 5-volt models (i.e. 6.6V trip point) are given in Table 2.

Transient protection

Lightning and other disturbances can create voltage transients close to 1000 volts on the primary side of your computer

TABLE 2—CROWBAR PROTECTION MODULES

Lambda Model No.	Current Rating*
L2-OV-5	2 amperes
L6-OV-5	6 amperes
L12-OV-5	12 amperes
L20-OV-5	20 amperes
L35-OV-5	35 amperes

*All models have a trip voltage of 6.6 volts

supply. One amateur computernik friend of mine lost over 20 TTL devices in a single thunderstorm! The General Electric MOV (metal-oxide varistors) offer some degree of protection against this type of damage. Check the GE literature for a suitable model for the current level expected.

continued on page 101

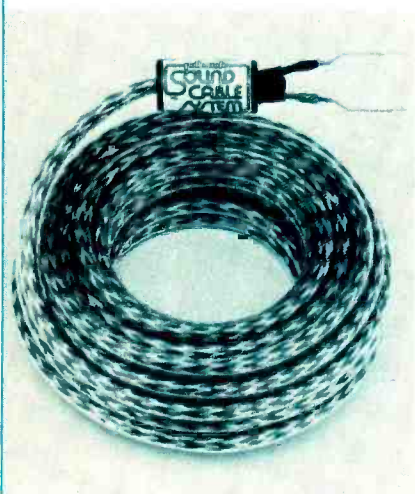

SPEAKER

how various types

Recently audio engineers have found that ordinary that a loudspeaker sounds. Newly developed

THERE IS A GROWING BODY OF OPINION in some audio circles that speaker cables have been neglected when considering the performance of a high-fidelity system. However, when one prominent speaker engineer was asked what part he felt cables contributed to speaker performance, his answer was: "Ever since I discovered that no one—not you, not I—can hear the difference between 10-kHz sinewaves and squarewaves, I've been cynical of the claims made by the ultra-wide band and no-phase-shift advocates." He was referring to the fact that research has shown that even the best-quality conventional speaker cable cannot pass a squarewave, and causes phase rotation at high frequencies.

Today's thinking has it that the inductance and capacitance of lamp cord (zip cord) should not present a problem in today's audio systems. However, it is generally conceded that for very long runs of speaker wire that is connected to low-impedance speakers, it might be necessary to artificially lower the cables' typical impedance. Therefore, if we assume there is no significant magnetic coupling to other cables capable of absorbing power in low-impedance circuits, there is no reason to believe that speaker cable should significantly affect frequency response.

If you visit some hi-fi stores today, you'll find an increasing number of so-called "super cables," such as Disc Washers' *Smog Lifters*, Polk's *Sound Cables*, Audio Source's *High Definition Cables*, M & K's *Mogami* cables, or the Fulton line of cables. These represent several different types. For instance, 140-strand braided cable (*Smog Lifters*); 10 pairs of braided insulated wires (Audio Source's *High Definition*); a stacked coaxial cable (M & K's *Mogami*); the Fulton cable, which is a very large paral-

lel multishroud type, or the Polk cable, which is also braided with a very fine intertwine. The price of these cables runs from 50 cents-per-foot to \$1.50-per-foot and more, making them considerably more expensive than conventional zip cord that costs 15 cents or less per foot. Zip cord is usually recommended by most audio stores and industry authorities.

It is stated in a typical amplifier instruction manual that No. 18 lamp cord is sufficient for normal lengths (to about 30 feet) between speaker and amplifier. However, No. 16 wire is generally recommended depending on distance. A leading speaker manufacturer has prepared a recommended connection-wire chart that is shown in Table 1.

The wire lengths listed in Table 1 were calculated on a maximum audible coloration of ± 0.5 dB. Following the guide lines provided, the most discerning listener will be unable to detect any coloration introduced by the speaker wire. Most listeners will not notice any effect even if wire lengths are increased as much as 50%.

Audio critics like Leonard Feldman, *Radio-Electronics'* Contributing High-Fidelity editor, have stated that the

damping factors of a good amplifier can be practically eliminated by a poor hook-up to the speakers, and you should play it safe by using heavy wire and making good connections. Even the finest cables can be rendered ineffective with poor connections.

Speaker designer Roy Cizek has emphasized in a series of articles and speeches to audio groups that "even the 'heavy' gauges No. 14 and No. 16 lamp cord are often insufficient." Mr. Cizek discovered that even small amounts of resistance can affect frequency response by destroying the effective damping of the amplifier-speaker system. He also pointed out the effects of a speaker-line fuse, and recommended using No. 12 or No. 10 wire.

Both Mr. Feldman and Mr. Cizek have pointed out that using heavier speaker wire should not be just the concern of the audiophile trying to extract the last bit of performance out of a hi-fi system. Most audio systems sold have 25 watts of amplifier power or less, and combined with a low-impedance speaker, certain wire lengths may throw away up to 30% or 40% of the amplifier power. As Mr. Cizek states, "contrary to common practice, it can be especially important to use heavier wire with smaller amplifiers or receivers, since they have low power output and low damping factors to begin with."

What the advocates of better cables point out is that many speakers are designed to provide good efficiency and transient response when effective damping is high. The low internal impedance of today's modern transistorized amplifiers reduces the amplifier's damping capability. With a low damping factor, the speaker continues to vibrate after the signal is cut off, which results in muddiness and overhang. Good speaker damp-

TABLE 1—Recommended Connection Wire

Maximum wire length (ft)	Wire gauge
30	18 gauge, zip cord (or two-conductor wire)
45	16 gauge, two-conductor wire
70	14 gauge, two-conductor wire

CABLES affect sound

speaker cables can adversely affect the way cables of unique construction solve the problem.

HARRY MAYNARD

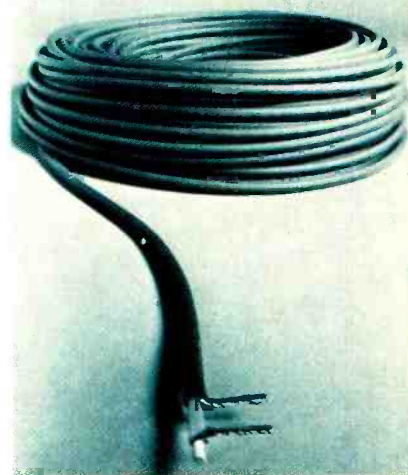

ing plays the same role as a shock absorber on a car, preventing the suspension system from overoscillating on a bumpy road. The damping factor of a good amplifier can be critical to reproducing sharp, clean transients and to the integrity of the bass.

Those who champion the new super cables claim that the damping factor can be rendered ineffective because the speaker impedance can be increased by up to two or three measurable ohms by using zip cord. The goal is to keep the impedance of the speaker cable low.

The damping factor is defined as the ratio between speaker impedance and amplifier output (or internal) impedance. Mr. Cizek's recommendation of No. 12 or No. 10 wire is based on the assumption that "if you decrease the effective damping factor by using a small wire and fuse in the line you tend to produce peaks in the frequency response corresponding to those in the impedance curve as well as poor response and increased ringing." (See Fig. 1.)

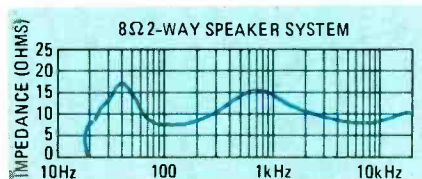

FIG. 1—SMALL WIRE DECREASES the effective damping factor and produces peaks in the frequency response.

Now the plot thickens. On several trips to Japan I discovered that leading Japanese companies presently offer for sale super cables of varying configurations; for example, J.V.C.'s *Super Cord* (sold only in Japan, not in the U. S.). You will also find Pioneer cable and several other brands. The merits of various cables is a topic of much discussion among Japanese

audiophiles, who are a match in their enthusiasm for high-quality audio with any audiophiles in the world. Much of the advanced research on the effect of speaker cable on hi-fi systems has been done in Japan.

Using a pair of J.V.C. *Super Cords*, my not-too-golden ears detected a significant improvement in sound quality coming through my speakers as compared with the No. 16 wire I had been using. I have since experienced the same improvement in sound quality with a wide variety of super cables compared with conventional cables.

Research conducted by J.V.C. showed that conventional cable could not pass a 100-kHz squarewave and that there was phase rotation. In addition, the magnetic fields of wires running parallel to each other set up what is known as self-inductance. Parallel wires create phantom channels to each other and round off high frequencies. In tests, several researchers have discovered this results in a loss of audio articulation.

In discussing the merits of super cable and various experiments conducted by J.V.C. and other electronics manufacturers, several leading Japanese executives admitted that there was much that the audio industry has yet to learn about the complex interfaces of different speaker cables and amplifier-speaker combinations. To condemn certain amplifiers because they do not perform properly with certain speakers is similar to condemning certain high-performance cars when given improper fuel—it is an unfair judgment.

Perhaps the most extensive research was performed by Kenwood in Japan in developing their *model L-07M* amplifier and *model L-07C* preamplifier. Discovering the effects of "the neglected cable," as described by Kenwood engineers, oc-

curred quite by chance. Kenwood feels that the super cables "have yielded improvements in sound quality on account of their superior transmission qualities," but this is only part of the picture. A speaker cable has to be considered an extension of the amplifier.

The problem is carefully defined and fully explained in the 47-page owners' manual (No. 7454859-0084-00) for the *model L-07M* amplifier and *model L-07C* preamplifier system. For those who wish to delve deeply into the complex interface problem of speaker/wire/amplifier, I strongly recommend getting this manual. We can only summarize its main points here.

Kenwood engineers, using very elaborate testing techniques, found that the speaker-cable impedance plays a significant role in high-frequency response and that the DC resistance contributes significantly to distortion (see Fig. 2). Furthermore, they claim that there is "surprisingly large distortion at the speaker inputs that is caused by speaker cables of even high quality and emphasizes the importance of solving this problem." (See Fig. 3.)

The importance of the neglected cable was discovered by measuring various energy losses for different lengths and kinds of cables. The greatest losses, even when using the best cables, could be held to from 0.5 dB to 0.6 dB below 10 kHz but there were still problems above 10 kHz. As described by Kenwood engineers, "when we made actual listening tests, we sensed there was something missing. It was like a bucket with a hole near the top and performance never went above the level of that hole.

"So our engineers devised a new test using a 30-kHz tone burst and measuring cable performance at the speaker terminals. They found that although the pulse

signal was perfect, there was a deformation of the waveform. The difference in wave height and overshoot is actually caused by the counter-electromotive force from the speaker, the result of greater resistance and weaker damping of the long cable. Fundamentally, even very low distortion, which cannot be measured, can be detected by our sense of hearing."

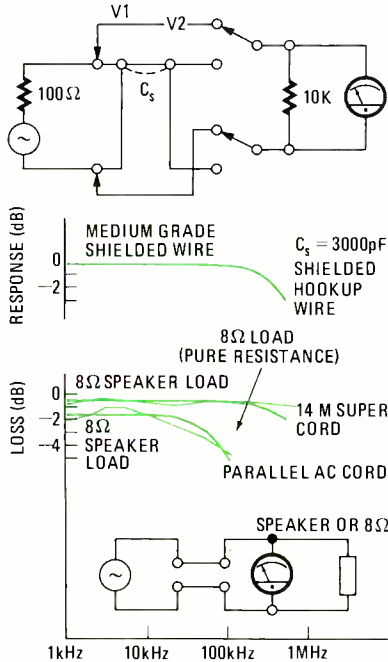

FIG. 2—SPEAKER-CABLE IMPEDANCE has a significant effect on high-frequency response.

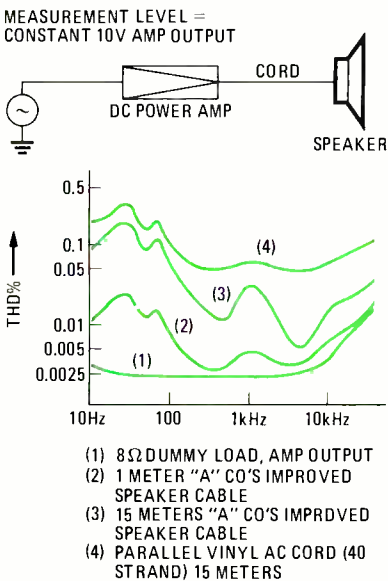

FIG. 3—SPEAKER CABLE CAN CAUSE surprisingly large distortion at the speaker inputs.

The most disturbing finding was that the amplifier should ideally be located much closer to the speakers—this is hardly reassuring for the millions who can't or find it inconvenient to do so. The farther the speaker is from the amplifier the slower the slew rate.

Obviously, to do away with the speaker

TABLE 2—Comparison of Audio Cable and Speaker Cord

	Audio cable	Speaker cord
Role	Voltage transmission	Power transmission
Transmitting impedance	10 ohms ~ 1000 ohms	Almost zero
Load conditions	20 ohms ~ 100,000 ohms. Changes somewhat with frequency and is constant without regard to signal level; slight input capacitance only; no reactance.	Indication 4 ~ 14 ohms. Changes considerably with frequency; changes with signal level; reactance component is large and complex; counterelectromotive force produced by speaker.
Effect on performance	Small	Large
Effect on tonal quality	Small	Large
Change with length	Small	Large
Extraneous induction	Easy	Difficult
Effect of cord characteristics	Since the load conditions other than component C are large, effect is small.	Components L, C and R have a large effect.

Note: In the past the quality of the system was not improved while pursuing the characteristics on the amplifier side because the dynamic characteristics with the speaker connected such as these were not considered. As shown in Fig. 7, the deterioration in distortion when the speaker is connected exceeded our imagination.

cable is impractical. Kenwood found however that their specially developed cable (not sold in the U. S.) could be used up to one meter (3.25 feet) from the speaker system, with virtually no effect on tonal quality. On the other hand, the audio cable between power amplifier and control amplifier can be long since it is merely a signal transmission line (see Table 2). I know some people who have suffered from RF problems, which they claimed was only eliminated by using specially constructed (expensive) audio cables like Verion, who might suggest that audio cables are important too. But that's another subject.

The Kenwood solution is obviously directed at the perfectionist audiophile (assuming you agree with their analysis of the problem). There are alternative solutions if you agree that the problem of transmission losses does exist and *can be heard*. If you don't like the price of the super cables, for less cost you can use the heaviest zip cord you can find, if your amplifier is not bothered by capacitance problems. Don't be afraid of reducing the size of the wire at the speaker terminals (by no more than half) so it will fit into spring-loaded speaker or amplifier terminals. But be careful, since the total resistance of the length of the wire must be considered.

If you believe that there is a problem of self-inductance, you'll usually find that the super cables are sold on a money-back basis. So if you don't hear a difference you can return them. Most of the special cables are sold by specific lengths and several have special tip ends that allow you to make excellent uniform connections.

For example, Disc Washers' *Smog Lifters*, shown in Fig. 4, have special plastic Y-finished tip ends that resist poten-

tial shorting, these cables sell for \$1.40-per-foot.

The M & K *Mogami* cable (sold for \$1.50-per-foot) must be debraided, and should not be tinned if splicing is neces-



FIG. 4—DISC WASHERS' *Smog Lifter* cables have special plastic tips.

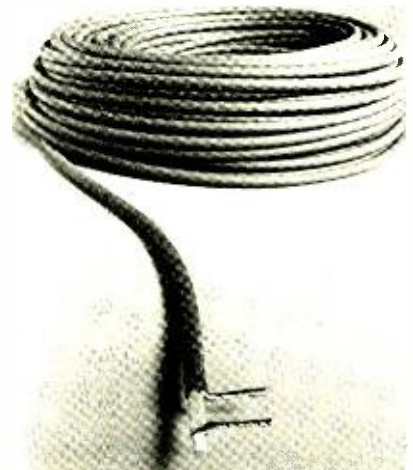

FIG. 5—M & K *MOGAMI* cable must be debraided; no tinning before splicing.

sary. (See Fig. 5.) A firm connection between the wire ends to be joined should be made before soldering. You are also warned to avoid speaker switches,

continued on page 93

How To Design Digital Circuits

Part 1—With digital circuitry becoming an increasingly important factor in our everyday lives, it's time that we learn how to design logic circuits. Get in on the start of this series as the author discusses digital logic design—beginning with Boolean algebra and Karnaugh maps.

JERRY WOOLSEY

TODAY'S ELECTRONICS HOBBYIST HAS available to him a previously undreamed-of assortment of hardware for his projects. Whereas 15 or 20 years ago electronics magazines ran construction articles on simple two- or three-tube circuits, using point-to-point wiring, the projects of today consist of computer CPU boards and computer terminals on complicated double-sided PC boards. Digital circuits are now appearing in almost everything electronic, including "linear" applications such as tuners, TV sets and synthesizers.

To enjoy fully the electronic technology of today, a hobbyist needs to know not only how to bias transistors and match impedances, but also how to analyze and design digital circuits. Although most experimenters can do this using brute-force methods, *there are some fairly simple methods for reducing the number of gates in*, and hence the complexity of, a digital circuit.

Digital electronics is the realization of Boolean algebra, and some knowledge of it is required to design a digital circuit. Since the subject of Boolean algebra has been covered in magazine articles as well as in many textbooks, it is assumed the reader has a fair knowledge of it, and is able to write his desired function in both equation and truth-table form. In this article, we will see how to apply the fundamentals of Boolean algebra to construct both parallel and series circuits from a truth table, and then *reduce the gates to the minimum needed*. Throughout this article, the AND function will be

implied between two variables if no operator is given between them, i.e., $x \cdot y$ will be written simply as xy .

Combinational switching circuits

A *combinational switching circuit* is a digital circuit whose output at any time is dependent only on its input at that time, regardless of any previous input or output. Thus, no "memory" circuits are included. (A flip-flop is considered a memory circuit.) The first part of this article is concerned only with these circuits.

A Boolean equation, no matter what form, can always be reduced or expanded to give an equation in either a sum-of-products (S-P) or product-of-sums (P-S) form. In the S-P form, the equation is an OR (sum) of several AND (product) groups. In the P-S form, the equation is an AND of several OR groups. As an example, take the following equation:

$$a = x(y + z) + y \quad (1)$$

This can be expanded by multiplying through the x to get

$$a = xy + xz + y \quad (S-P) \quad (2)$$

which is in S-P form, or may also be written in P-S form as

$$a = (x + y + z)(x + y + \bar{z})(\bar{x} + y + z) \quad (P-S) \quad (3)$$

A primitive implementation of equation 1 is shown in Fig. 1, using the S-P form of the equation. So we pick up the IC data book and notice one peculiar thing: almost all the gates available are NAND, with several AND, but few OR and NOR types. Why should this be so when most functions are written as strictly AND

and OR? To understand why, we can apply DeMorgan's theorem to equation 2. This theorem states that if we invert the individual members of one side of an equation, then change the signs between members from AND to OR and vice-versa, then invert the entire side of the equation, the equation is still true. To illustrate, let's apply this theorem to equation 2. First, we invert the individual members to obtain

$$a = \overline{xy} + \overline{xz} + \bar{y}$$

Now we change the signs between members and get

$$a = \overline{xy} \cdot \overline{xz} \cdot \bar{y}$$

Finally inverting the entire string, we get

$$a = \overline{\overline{xy} \cdot \overline{xz} \cdot \bar{y}}$$

This says that to obtain the result a , we NAND x and y , NAND x and z , INVERT y , and NAND the three results. Figure 2 shows the logic circuit. Thus, the NAND gates can perform the AND and OR functions. When a group of NAND gates feed another NAND gate, the first gates perform an AND function, and the gate they feed performs the OR function on each AND'ed group. We thus only need to keep a supply of NAND gates to realize any equation in S-P form. In this case, an extra inverter is needed, but inverted variables are often already available from another output, and even if not, this could be performed by a NAND, keeping the three input gates on one package.

It should be noted that the P-S form can be implemented in circuit form by using NOR gates, the first input gates

perform the OR function, and the second set of gates perform the AND function. However, P-S forms can always be expanded to S-P forms, so the remainder of the article will deal only with S-P forms.

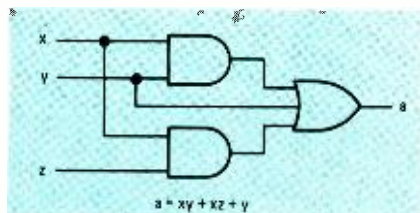

FIG. 1—LOGIC CIRCUIT that performs the Boolean algebra expression shown.

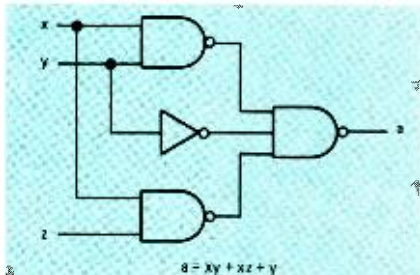

FIG. 2—NAND GATES can be used to perform the same function as shown in Fig. 1.

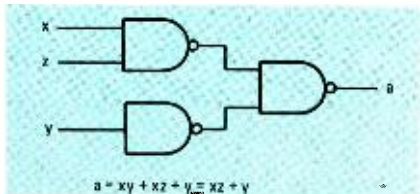

FIG. 3—SIMPLIFIED LOGIC CIRCUIT is equivalent to circuit shown in Fig. 2.

Using the theorems of Boolean algebra, it can be seen that equation 2 can be reduced to:

$$a = xz + y$$

This means that the circuit shown in Fig. 3 is equivalent to the one shown in Fig. 2. Obviously, this is much simpler, and can be done on only one IC.

Reduction of mathematical expressions by Boolean algebra theorems is tedious and often hit-and-miss. To alleviate the problem, we turn to a tool that eliminates much of the work.

The Karnaugh map

The Karnaugh map is simply a rearranged truth table that can readily give valuable information for circuit design and reduction. There are 2^n boxes in the map, where n is the number of inputs to the circuit. Each row and column is

numbered in binary, and the value in each box is the output of the circuit when the coordinates of the box are the input. The numbering of the columns starts at the left at zero, and is arranged such that the number of the next column to the right differs in only one bit position. Thus, 00 is followed by 01, which is followed by 11, which is followed by 10. The rows are numbered similarly. Figure 4 illustrates the numbering and the corresponding decimal coordinates of the boxes for functions with two, three and four inputs. Beyond four inputs, the Karnaugh map becomes too cumbersome, so other methods have been designed for these situations.

As an example, suppose a three-input circuit with inputs x, y and z were to produce a logic-1 output when $x = 0$ and $y = z = 1$. Then we would enter a 1 into the box numbered 3 in Fig. 4-b ($xyz = 011 = 3_{10}$). If a zero were to be produced when $x = y = 1$ and $z = 0$, the box numbered 6 would contain a zero. In certain cases, such as BCD circuits, some input combinations are meaningless (1010 is not a BCD number). In these instances, we enter a "d" in the appropriate box to indicate a "don't-care" condition. This tells us the output may be either 0 or 1 with the given input, since that input would never occur. This may be used to further aid in circuit reduction.

Figure 5-a shows the truth table for equation 1, and Fig. 5-b shows the Karnaugh map derived from it.

Now we come to the interesting property of the map. By definition of the structure of the map, any two adjacent boxes (horizontally or vertically, but not diagonally) differ in coordinates, i.e., in input conditions, by only one bit. For example, the boxes where $(x = 0, y = z = 1)$ and $(x = z = 0, y = 1)$ are adjacent, and differ in coordinates in only the z-input. This property also holds when "wrapped-around," i.e., the top right-hand box $(x = z = 0, y = 1)$ is adjacent to the top left-hand box $(x = y = z = 0)$, since they differ only in the y-bit of the coordinate. The same holds true for vertical wrap-around. Two of these adjacent boxes are said to form a 1-cube, since there are 2^1 boxes in the cube.

Now refer to Fig. 5-b. If we take two adjacent boxes that contain a 1, for example $(x = z = 1, y = 0)$ and $(x = y = z =$

$= 1)$, we find that the output of the circuit must be a 1 whenever $x = z = 1$, independent of the value of y. That is, whenever xz is true, the equation is true. Similarly, box $(x = 0, y = z = 1)$ and box $(x = z = 0, y = 1)$ are adjacent and contain ones, so we see that the output is true whenever $x = 0$ and $y = 1$, independent of z. Thus, $\bar{x}y$ being true will cause the equation to be true, or a 1 to be output. Taking all combinations of two adjacent boxes, both of which contain a 1, the following equation is derived

$$a = xz + \bar{x}y + xy + yz + y\bar{z}$$

which is equivalent to equation 1, but is obviously not reduced. The reason for this is that several conditions for an output have been duplicated by more than one term of the equation. For example, if $x = y = z = 1$ is entered, the three terms xy, xz and yz will all be true, causing the output to be true, but it is only necessary to have one term true to cause the output to be true. Thus, we have redundant members in the equation. If we take only three adjacent sets of boxes to cover all the 1-outputs, we can obtain the equation

$$a = xz + \bar{x}y + xy$$

Now all the boxes containing a 1 have been covered by at least one of the terms of the equation, which means that the equation is a true representation of the truth table. But the equation is still not completely simplified. If we look at the 1-cube (two adjacent boxes) consisting of $(x = 0, y = z = 1)$ and $(x = z = 0, y =$

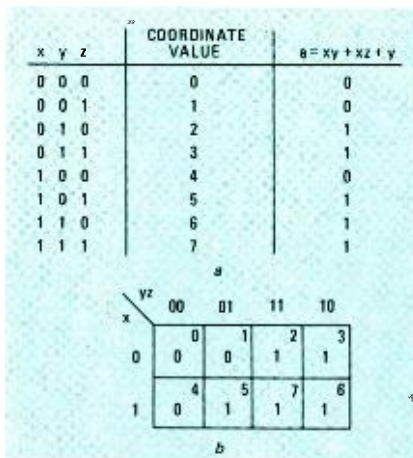

FIG. 5—TRUTH TABLE for equation $a = xy + xz + y$ is shown in a and resulting Karnaugh map derived from the truth table is shown in b.

1), and the 1-cube consisting of $(x = y = z = 1)$ and $(x = y = 1, z = 0)$, we see that the output of the function is always 1 whenever $y = 1$, regardless of the value of x or z. Thus, we have formed a 2-cube (2^2 boxes), and have found that $y = 1$ satisfies the conditions for generating a logic-1 output for each of the four boxes. Note that, in looking at the coordinates of each of these boxes, y is the only coordinate that does not change, and is always 1. We need now to cover only one more box where a logic-1 output is to be generated, box $(x = z = 1, y = 0)$. To do this, we

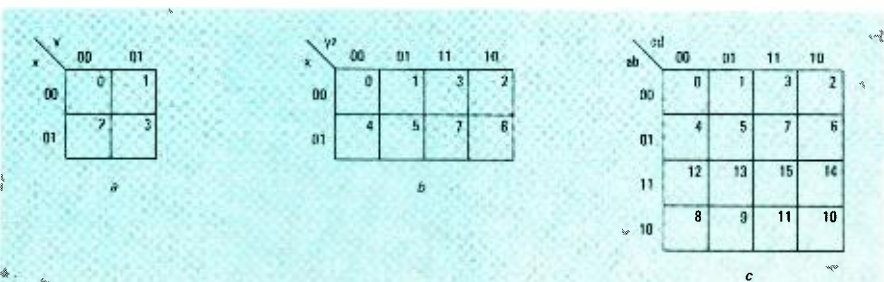

FIG. 4—KARNAUGH MAPS are used to simplify logic circuits. A Karnaugh map for a 2-input circuit is shown in a, 3-input circuit is shown in b and a 4-input circuit is shown in c.

could simply say we need $\bar{x}yz$ to be true for the output to be a logic 1, but we have another adjacent 1-labeled box ($x = y = z = 1$) and if we use this to form a 1-cube, that term of the equation reduces to xz , since a 1-output is independent of y if x and z are 1. Thus, we obtain

$$a = y + xz$$

as our final equation, and implement it as shown in Fig. 3.

When "d" (don't-care) outputs are specified, these are included as 1-outputs if it enables us to make larger cubes with other 1-outputs, hence simplifying the equation, or as 0-outputs if they are not used in making larger cubes.

Even larger cubes may be found in four-input functions. A 1-cube is two adjacent boxes containing either a 1 or "d"; a 2-cube is two adjacent 1-cubes (i.e., a 2×2 box or 4×1 horizontal or vertical row); and a 3-cube is two adjacent 2-cubes (i.e., a 4×2 horizontal or vertical box). If a map consists only of 1- and d-labeled boxes, the function is always true, or a constant 1.

The step-by-step procedure for circuit reduction, then, is as follows:

- 1) Draw the truth table, and fill in the boxes of the Karnaugh map with a 1, 0 or d, using the inputs as coordinates and the outputs as box entries. For example, see Figs. 6-a and 6-b.
- 2) Examine the map for any 3-cubes, i.e., a 4×2 box containing no zeroes. Don't forget to check for possible wrap-around. In Fig. 6, a 3-cube is formed by decimal coordinate boxes 0, 1, 2, 3, 4, 5, 6 and 7 (see Fig. 4-c). The coordinates abcd of these boxes are examined, and it is found that b, c and d take on all

a	b	c	d	OUTPUT	DECIMAL
0	0	0	0	1	0
0	0	0	1	1	1
0	0	1	0	d	2
0	0	1	1	1	3
0	1	0	0	d	4
0	1	0	1	1	5
0	1	1	0	1	6
0	1	1	1	d	7
1	0	0	0	1	8
1	0	0	1	0	9
1	0	1	0	1	10
1	0	1	1	0	11
1	1	0	0	0	12
1	1	0	1	d	13
1	1	1	0	0	14
1	1	1	1	1	15

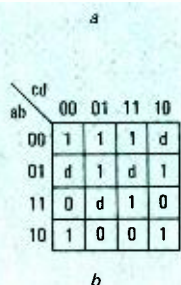

FIG. 6—TO SIMPLIFY a logic circuit, first draw a truth table that represents the circuit function as shown in a. Next, a Karnaugh map is derived from the truth table as shown in b.

values (0 and 1) while a is always 0. Thus, when $a = 0$, the output is always 1 independent of b, c and d, so one term of the final equation is simply \bar{a} . Place a check in each of the boxes of this 3-cube to indicate that they have been covered. When the coordinates of any of these boxes are input, the output will be 1 simply because \bar{a} is 1. The map now appears as in Fig. 7-a.

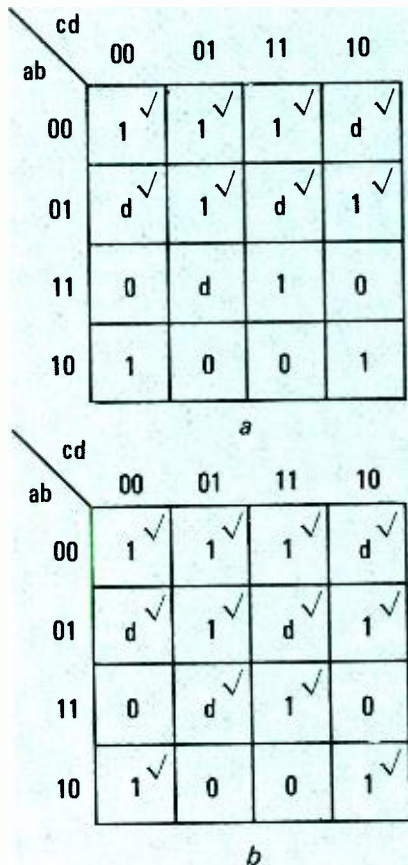

FIG. 7—KARNAUGH MAPS are reduced by first looking for a 3-cube (a 4×2 box containing no zeroes). When a 3-cube is found, check the individual boxes as shown in a. Next, look for 2-cubes and check these boxes as shown in b.

- 3) Examine the map for any 2-cubes, that is, any 2×2 or 4×1 box containing no zeroes, and at least one 1-labeled box not yet checked. In our example, decimal boxes 5, 7, 13 and 15 form such a cube. Examining the binary coordinates of these boxes, we find that b and d are always 1, while a and c may take on any value. Thus, our second term of the equation is bd , giving $f = \bar{a} +$

bd so far. Check off the boxes covered by the second term. Check for more 2-cubes. In the example, we have another 2-cube that is not so obvious, due to wrap-around. This is the cube containing decimal boxes 0, 2, 8 and 10. From the binary coordinates, we find b and d are always 0, while a and c can take on any value. Thus our next term for an output of 1 is $\bar{b}\bar{d} = 1$, and our function is now $f = \bar{a} + bd + \bar{b}\bar{d}$. Check off the boxes covered. The map now looks like Fig. 7-b.

- 4) Examine the map for any 1-cubes, i.e., two adjacent boxes each containing a 1 or a d that also contains one 1-labeled box not checked. Write down the nonvarying coordinates as a term of the function, and check for more 1-cubes. No 1-cubes remain in the example.
- 5) If any 1-labeled boxes remain unchecked, write down their coordinates as a term of the function. For example, if the box with coordinates ($a = 0, b = c = d = 1$) contained a 1 but was not yet checked off, we would write the coordinates as $\bar{a}bcd$ and insert it as a term in the equation. At the completion of this step, all boxes with a 1 in them should be checked off.
- 6) By inspection, make sure no cube is completely covered by other cubes. Each cube, no matter what size, must contain at least one 1-labeled box not contained in any other cube. If it does not, discard its corresponding term from the equation.
- 7) OR all the terms derived above to get the final reduced function. In our example we get:

$$f = \bar{a} + bd + \bar{b}\bar{d}$$

- 8) Feed each term into a NAND gate, and feed the outputs of the NAND gates to another NAND gate. The circuit is complete. See Fig. 8-a.

In searching for cubes to cover an unchecked 1-labeled box, the largest possible cube should be chosen, even if it covers other boxes already checked, so that the number of inputs to each gate is minimized.

Note that Fig. 8-a has \bar{a} as an input that simply gets inverted before going to the output gate. Instead of this, it would be simpler to feed a directly to the output gate, as in Fig. 8-b. Also note that the

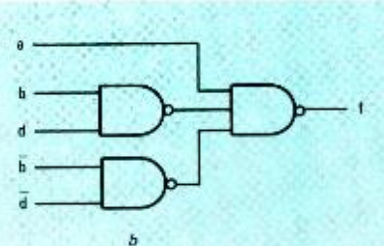
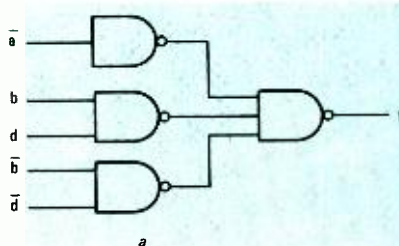

FIG. 8—LOGIC CIRCUIT is derived from reduced Karnaugh map and is shown in a. Inverter can be eliminated as shown in b.

output of the gate fed by bd cannot be used as input $b\bar{d}$ to the gate below it since $b\bar{d} \neq \bar{b}d$.

As was noted earlier, the Karnaugh map method is too difficult beyond four inputs. The designer has to start considering mirror-images, and mistakes are easily made. It also does not reduce the circuit fully if multiple outputs are desired, as in a BCD to seven-segment decoder. Fortunately, there is another fairly simple method to use in these cases.

Quine-McCluskey method

The Quine-McCluskey method works on the same principle as the Karnaugh map, but is performed in tabular form. As an example of this method, we will construct a circuit to produce a 1-output, called f , whenever a 2-bit number A , whose bits are designated as a_1 and a_2 , is larger than a 2-bit number B , whose bits are b_1 and b_2 . The truth table for this function is given in Fig. 9.

a_1	a_2	b_1	b_2	f
0	0	0	0	0
0	0	0	1	0
0	0	1	0	0
0	0	1	1	0
0	1	0	0	1
0	1	0	1	0
0	1	1	0	0
0	1	1	1	0
1	0	0	0	1
1	0	0	1	1
1	0	1	0	0
1	0	1	1	0
1	1	0	0	1
1	1	0	1	1
1	1	1	0	1
1	1	1	1	0

FIG. 9—QUINE-McCLUSKEY METHOD is used when a circuit with four or more inputs must be designed. First a truth table describing the circuit function is generated as shown.

NO. OF 1-BITS	INPUT (DECIMAL EQUIVALENT OF $a_1 a_2 b_1 b_2$)
1	4 8
2	9 12
3	13 14

FIG. 10—ADJACENT BOXES and cubes are determined in a table generated from the truth table shown in Fig. 9.

The Karnaugh map obviated adjacent boxes and cubes. In the Q-M method, we write down a table to help show adjacency (see Fig. 10). The decimal value of each set of inputs that will generate either a 1- or don't-care output is listed in ascending order in groups according to the number of 1-bits in the input. For example, $A = a_1 a_2 = 10$ and $B = b_1 b_2 = 01$ produces a 1-output, and the number of

1-bits in A and B is two, so a 9 ($a_1 a_2 b_1 b_2 = 1001$) is placed in the 2-bits group. Within each group, the decimal inputs are listed in ascending order. It can now be seen that two inputs producing a 1-output are adjacent, in the same sense as in the Karnaugh map, if three conditions are met:

- 1) The number of 1-bits of each input differs by exactly one.
- 2) The decimal input with the smaller number of 1-bits must be smaller than the input with the larger number of 1-bits.
- 3) The difference of the two decimal inputs must be a power of two.

According to condition 1, inputs listed in the 3-bit group can only be adjacent to inputs in the 2-bit or 4-bit groups; inputs in the 1-bit group can only be adjacent to inputs in the 0-bit or 2-bit groups, etc. This is consistent with the definition of adjacency being a difference in only one bit of the input.

According to condition 2, the decimal input 4 may be adjacent to decimal input 12, since 4, having fewer 1-bits than 12, is smaller than 12. If, for example, the decimal input 3 produced a 1-output, it would be placed in the 2-bits group, but could not be adjacent to 4, since it has more 1-bits but is less than 4. This would cause more than one bit in the input to be different.

Condition 3 is obvious, since only one input bit may differ for adjacency. If the difference of the two numbers is not a power of two, more than one bit differs.

NO. OF 1-BITS	INPUT	1-CUBES
1	4 ✓	4, 12 (8)
	8 ✓	
2	9 ✓	8, 9 (1) 8, 12 (4)
	12 ✓	
3	13 ✓	9, 13 (4) 12, 13 (1) 12, 14 (2)
	14 ✓	

FIG. 11—SIMPLIFICATION starts by listing the 1-cubes.

We now use these rules to make a third column, consisting of a list of adjacent boxes, or 1-cubes. We take the first input number in the table, 4, and check it for adjacency with the entries in the next bit group. Box 4 is not adjacent to 9, since the difference, 5, is not a power of two. Box 4 is, however, adjacent to 12, since the difference is 8, and 4 is less than 12. Thus, we enter into the third column the numbers 4 and 12 together, with their

difference in parentheses (see Fig. 11). Since the inputs 4 and 12 have been covered by a higher cube, we place a check next to them in the column labeled input.

The input 4 cannot be adjacent to any other bit group, so we look at input 8. Box 8 is adjacent to 9, since the difference is a power of two, so we enter the numbers and difference as a 1-cube and place a check next to the 8 and 9 inputs to indicate they have been covered by a higher cube. Box 8 is also adjacent to box 12, so we repeat the process for them. Since we are through checking the 1-bit group, we place a line under 8,12(4) in the 1-cube column and start checking the 2-bit group. Box 9 is adjacent to box 13 but not to box 14. Box 12 is also adjacent to box 13, as well as 14, and we are finished creating 1-cubes. The 1-cube column now contains a list of all the possible 1-cubes that could be extracted from the Karnaugh map. Since all the inputs in the input column have been checked off, they are all contained in higher cubes.

We now have two groups of 1-cubes, and use these to form 2-cubes. The same conditions hold for forming adjacent cubes, except now the numbers in parentheses must also match. Looking at the first 1-cube entry, 4,12(8), we see that it is not adjacent to any 1-cube in the second group, since none have an 8 in parentheses. Going to 8,9(1), we find an entry, 12,13(1) in the second group that has the same number in parentheses. Since the difference of 8 and 12 (or 9 and 13) is also a power of two, and 8 is less than 9 and in a lower group, we enter this in the next column as a 2-cube, and indicate both the first and second differences in parentheses. The two entries that formed this cube are checked, since they are covered by the higher cube (see Fig. 12).

Another entry, 8,12(4), is adjacent to the entry 9,13(4), so it is entered as a 2-cube and the separate 1-cubes are checked. However, this is identical to the previous 2-cube and is thus stricken. No further adjacency is found, and there are no more groups to check for adjacency, so the checking of the 1-cube column is complete.

We now go to the next column and continue until no adjacencies are found. The same rules are followed in each column, checking each entry against each

continued on page 92

NO. OF 1-BITS	INPUT	1-CUBES	2-CUBES
1	4 ✓	4, 12 (8) 8, 9 (1) ✓ 8, 12 (4) ✓	8, 9, 12, 13 (1, 4)
	8 ✓		
2	9 ✓	9, 13 (4) ✓ 12, 13 (1) ✓ 12, 14 (2)	
	12 ✓		
3	13 ✓		
	14 ✓		

FIG. 12—ALL 2-CUBES are listed. Second 2-cube is crossed off since it is covered by first entry.

REMOTE TELEPHONE EAR— Listen via Long Distance

*This device—the fourth in a series of phone gadgets—
lets you monitor sounds in your home or office
when you call your telephone from a remote location.*

JULES H. GILDER

IN THE APRIL AND MAY 1977 AND MAY 1978 issues, we showed how to construct add-on telephone accessories that let you turn on and turn off various household appliances by remote control, build a hands-off telephone amplifier and assemble an autodialer and cassette interface that dialed authorities or neighbors in case of a fire or intruders in your home.

If you were interested in these items, you'll flip over the Remote Ear that lets you dial your home phone and then listen for the sound of running water or a radio that was inadvertently left on. Or maybe you just want to check your house and see that everything is quiet and no one has broken into it.

The Remote Ear is an adaptation of the Teleswitch circuit (April 1977). It automatically connects a microphone and amplifier to the telephone so that you can monitor a remote location. As you will quickly see from the schematic, the Remote Ear uses the same type of signal detectors as the Teleswitch. However, instead of having controlled outlets to turn devices on and off, the Remote Ear has a small three-transistor amplifier connected to it.

This amplifier is identical to the one described in the Speakerphone circuit (May 1977). Its signal is very clear and audible. The output of the amplifier, which is located in the area that you want to monitor, is fed to a small speaker that is acoustically coupled to the telephone mouthpiece.

Since it is unlikely that remote listening will be done for long periods of time, the Remote Ear has a built-in timer that allows you to listen for about three minutes. Longer or shorter listening times

can be set by adjusting the timing resistor in the emitter circuit of unijunction transistor Q2.

About the circuit

Sound switch 1 and the unijunction timer that is associated with it (Q1) are the same as were used in the Teleswitch. Sound switch 2, however, is slightly modified. Instead of having one relay connected to the 2N3904 collector, there are two relays, RY2 and RY4.

The operation of the Remote Ear involves several steps. When the telephone rings the first time, sound switch 1 triggers and causes RY1 to close. This applies power to sound switch 2 and to the two timing circuits consisting of unijunction transistors Q1 and Q2.

If the phone rings more than once, within 20 seconds sound switch 2 triggers and RY2 closes. Contact RY2-1 disconnects the power from the first unijunction transistor timing circuit and from sound switch 1. This prevents the Remote Ear from being activated and makes it necessary to wait three minutes before the next attempt.

If, however, the phone rings only once, there is enough time for a charge to build up on C1 and for Q1 to trigger, activating RY3. When RY3 is activated it switches the RY2 coil out of the control circuit of sound switch 2 and replaces it with the RY4 coil.

The first time the telephone rings only once it arms the circuit. The next time the telephone rings it turns on the listening circuitry. This is done by sound switch 2 activating RY4, which, in turn, controls the amplifier and the answering solenoid.

Relay RY4 latches closed and is held in that position until a reset pulse from unijunction timer Q2 turns off the 2N3904 controlling RY2 and RY4 and unlatches SCR2.

The telephone is actually answered by a solenoid that pulls up when RY4 closes. This releases the cradle switch and answers the phone. The handset of the telephone is placed on the table alongside the telephone. The loudspeaker connected to the output of the amplifier is held next to the mouthpiece (rubber bands can be used). Thus, the sound picked up by the crystal microphone is amplified and acoustically coupled to the telephone.

After three minutes, or whatever time period you selected has elapsed, a reset pulse is generated and the bases of the control 2N3904's are brought to ground potential, turning these transistors off and unlatching the SCR's. The unit is now ready for its next monitoring period.

Construction

This project is constructed from four modular circuits. The first two circuits are sound switches identical to those built in the Teleswitch (April 1977). After the sound switches are built, they should be mounted in a metal chassis that is large enough to be placed under the telephone. A 5 × 9 × 2-inch aluminum chassis was used for the prototype. A 1/8-inch hole should be drilled where each of the crystal microphones is mounted so that sound will reach them more easily.

After the sound switch modules are mounted, assemble the control module using the circuit shown in the schematic. The circuit can be fabricated by wiring

the components on perforated board or you can design a printed circuit.

After the control module is completed, mount the board, using spacers, at any convenient spot under the chassis. The only component left to be mounted is the amplifier. The amplifier used here is identical to the one used for the Speakerphone. Mount this module also on the chassis, using spacers.

Once all four modules are mounted, do the relays. Now connect all the wires

solenoid until the fully extended plunger holds the cradle switch down. Attach the solenoid to the wooden support with two screws.

Now attach two conductors of conventional lamp cord to the two terminals on the solenoid. Then, insulate these terminals with electrical tape. Bring the lamp cord down the support, attaching it to the wood in several places with staples. Be careful that staples do not pierce the insulation of the wire, causing a short circuit.

radio. Place the speaker next to the telephone mouthpiece.

Ask a friend to call and let the telephone ring several times. On the first ring, RY1 should close. On the second ring, RY2 should close, opening RY1. After three minutes, a reset pulse from Q2 should reset the lower SCR opening, RY2.

After another three minutes have passed and RY2 has reset, have your friend call again, tell him to ring only

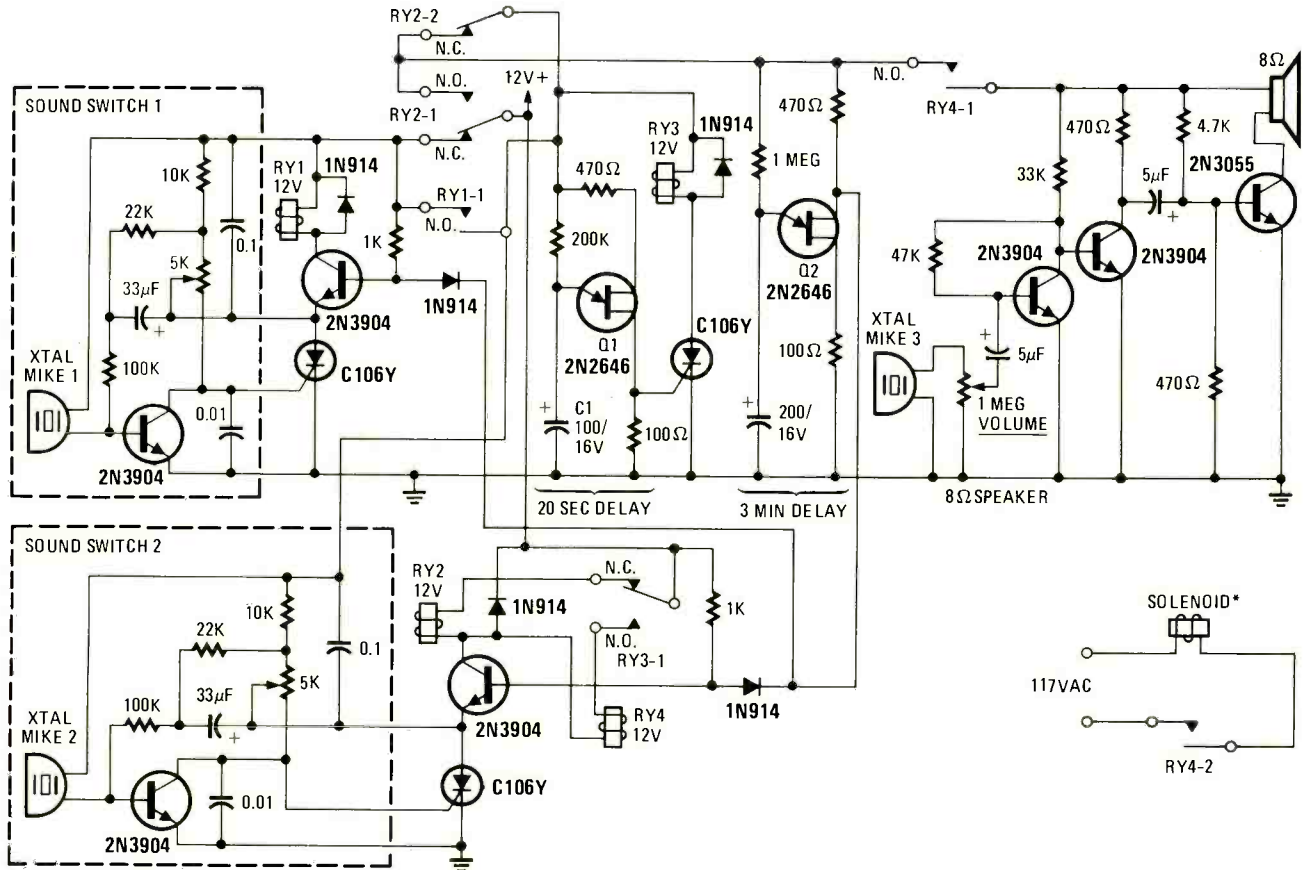

Fig. 1

from the modules and the relays that go together directly to the positive side of the supply. If an external battery is going to be used to supply power, connect these leads to a screw terminal that is insulated from the chassis. If the power supply described for the Teleswitch is used, connect the leads to the positive terminal of the supply. Do the same for all ground leads. Connect all remaining wires to their proper locations.

Cut a piece of 1 × 2-inch wood to a length of 10 inches. This will be used as a vertical support for the solenoid that will hold the phone in the unanswered position until the proper command signal is given. To position the arm, place the telephone on top of the phone cradle where the handset is normally placed. Mark the spot, because that is where you want to mount the arm, and mount the arm using at least two screws. Next, place the solenoid on the inside of the arm and take the handset off the telephone. Position the

Bring the wire into the bottom portion of the chassis through a grommet-lined hole and attach one of the two strands to one set of normally open contacts on RY4. Attach another piece of single-conductor lamp cord to the other contact of the set. This wire, along with the unused wire from the solenoid, will be connected to the AC line.

Mount two miniature jacks to the chassis for the microphone and the speaker. The speaker can be acoustically coupled to the telephone by simply holding it next to the telephone mouthpiece with a few rubber bands. The microphone should be located in the spot you want to monitor.

Installation and operation

Installing the Remote Ear simply requires placing the telephone on the chassis, removing the handset and allowing the solenoid to hold the cradle switch down. Now, place the microphone in the room you want to monitor and turn on the

once, and then call back 20 seconds later. On his second call, the phone should be answered automatically after the first ring. This is done by RY4, which becomes activated by sound switch 2 when the phone rings the second time. Relay RY4 closes the circuit to the solenoid and causes it to lift up, releasing the cradle switch of the telephone.

Relay RY4 was activated because after 20 seconds had elapsed, Q1 produced a pulse that activated RY3 and switched the power line from RY2 to RY4.

When the call is answered your friend should hear the radio playing. If he does not, check to make sure that the speaker is properly placed next to the mouthpiece of the telephone. Three minutes after the first ring, Q2 generates a reset pulse and releases RY4. This causes the solenoid to drop and hang the phone up. Simultaneously, it opens the circuit to the amplifier. The Remote Ear is now ready to use again.

R-E

We wrote the book(s)

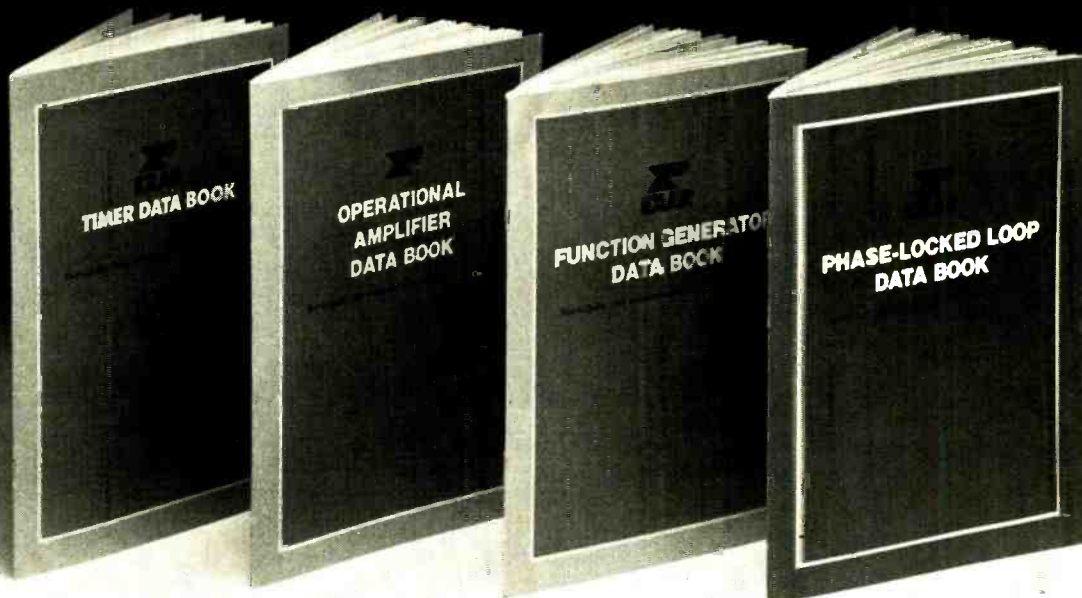

Exar designs and manufactures linear integrated circuits—custom, semicustom, and standards. We also make digital IC's such as our Darlington array drivers, and we are expert at putting both linear and digital functions on the same chip. No wonder then that we have innovated some of the most ingenious IC's on the market today and that we support our circuit families with a set of invaluable "Data Books."

For example, the Exar Timer Data Book describes our XR-2242 long-range timer, which provides delays from microseconds to years, and our L-555 micro-power timing circuit, capable of operating in remote locations for up to 1500 hours on two tiny NiCd batteries. Outstanding circuits like that, plus our broad line, make Exar your first source for timers.

But that's just a sample. Check our Phase-Locked Loop Data Book. This book is complete with PLL fundamentals, application notes, selection hints, plus specifications of some of the industry's most popular circuits like the 567 and our own new XR-2212. See why our PLL's may be the best in the industry.

The Exar Function Generator Data Book contains equally essential information on a circuit family that includes our XR-2206 with its outstanding stability of 20ppm/°C. The Exar Operational Amplifier Data Book covers the full range of op-amps from the standard 4558 all the way through the quad programmable BIFETS.

Whether you have yet moved up to specifying Exar circuits or not, you will find these new Exar Data Books an invaluable reference source. To purchase any of these technical Data Books and receive a free copy of the Exar Product Guide, use the coupon.

Please send me copies of the Exar Data Books indicated at your list price of \$1.75 each. My check or money order is enclosed.



- | | |
|---|--|
| <input type="checkbox"/> Exar Timer Data Book - 48 pages | <input type="checkbox"/> Exar Phase-Locked Loop Data Book - 74 pages |
| <input type="checkbox"/> Exar Function Generator Data Book - 52 pages | <input type="checkbox"/> Exar Operational Amplifier Data Book - 60 pages |
- Send all four data books at your special discount price of \$5.00.
 Send a free copy of your Product Guide.

Name _____ Title _____

Address _____ Phone _____

City _____ State _____ Zip _____



EXAR INTEGRATED SYSTEMS, INC., P.O. Box 62229,
Sunnyvale, California 94088 • Phone (408) 732-7970

ANNOUNCING ... A New CREI Program: Minicomputer & Microprocessor Technology Including A Microprocessor Laboratory

Now you can learn at home
the new technology that is
revolutionizing electronics

The microprocessor has ushered in the age of microtechnology and electronics will never again be the same. The microprocessor has made possible the placing of an entire computer on a silicon chip one quarter inch square. The microprocessor "miracle chip" is in the process of changing the world. Soon all technical personnel in electronics will have to understand and work with the microprocessor. It is invading virtually every area of electronics. And it is profoundly affecting your electronics career.

Brand New Program

CREI has a brand new program to help you learn how to work effectively with this revolutionary electronics development. CREI's new program in Minicomputer and Microprocessor Technology is designed to prepare you for this field by giving you the education and practical experience you need.

The program provides solid preparation in electronics engineering technology with a specialization in minicomputers and microprocessors. In addition, it includes a microprocessor laboratory which features a fully programmable microcomputer which utilizes the Motorola 6802 microprocessor chip. This is an extremely important element of your program.

Programming Essential

As you may well know, you must learn how to *program* the microprocessor in order to design, service or troubleshoot microprocessor electronic systems. There is only one effective way to learn this all-important skill of programming, and that is by actually *doing it*. CREI's new program gives you this opportunity as you work with the exciting microprocessor laboratory.

Programming Is Easy

With CREI's new program, learning the skill of programming is simple. Within a few hours you'll be programming the microprocessor and in a short time you'll learn how to program it in three languages: BASIC, assembly and machine languages. In addition, you will learn how to interface the microprocessor with other systems and to test and debug specialized programs.

Preparation at Home

Wide Choice of Programs

Please note, however, that CREI's new program is only one of 16 state-of-the-art programs in advanced electronic technology offered by CREI. So even if you choose not to specialize in micro-processor technology, CREI has an advanced electronics program to meet your needs.

With CREI, you may choose from any of the following areas of specialization in advanced electronics:

- Microprocessor Technology
- Computer Engineering
- Communications Engineering
- Digital Communications
- Electronic Systems
- Automatic Controls
- Industrial Electronics
- Television Engineering
- Microwave Engineering
- Cable Television
- Radar and Sonar
- Nuclear Instrumentation
- Satellite Communications
- Aeronautical and Navigational
- Solid State Theory
- Nuclear Engineering

Unique Lab Program

An exclusive option available with CREI programs in electronic engineering technology is CREI's unique Electronic Design Laboratory program. It gives you actual experience in designing practical electronic circuits. It also helps you to understand the theories of advanced electronics and gives you extensive experience in such areas as tests and measurements, breadboarding, prototype construction, circuit operation and behavior, characteristics of electronics components and how to apply integrated circuits. Only CREI offers this unique Lab Program.

Practical Engineering

CREI programs give you a practical engineering knowledge of electronics. That is, each part of your training is planned for your "use on the job." By using your training, you reinforce the learning process. And by demonstrating your increased knowledge to your employer, you may qualify for faster career advancement.

Free Book

There isn't room here to give you all of the facts about career opportunities in advanced electronics and how CREI prepares you for them. So we invite you to send for our free catalog. This fully illustrated, 56 page book describes in detail the programs, equipment and services of CREI.

Qualifications

You may be eligible to take a CREI college-level program in electronics if you are a high school graduate (or the true equivalent) and have previous training or experience in electronics. Program arrangements are available depending upon whether you have extensive or minimum experience in electronics.

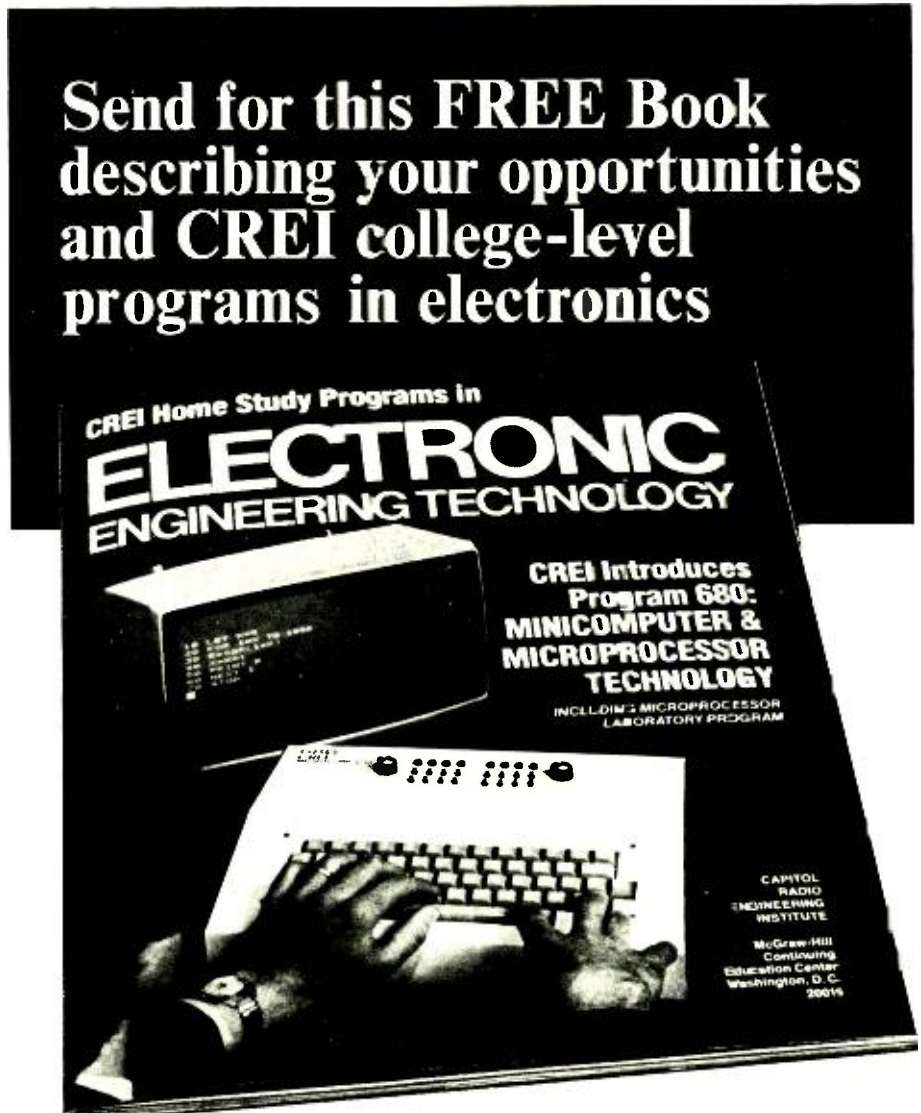

Mail card or write describing qualifications to

CREI **CAPITOL
RADIO
ENGINEERING
INSTITUTE**

McGraw-Hill Continuing Education Center
3939 Wisconsin Avenue Northwest
Washington, D.C. 20016

Accredited Member National Home Study Council

G.I. Bill

CREI programs are approved for training of veterans and servicemen under the G.I. Bill.



BUILD THIS

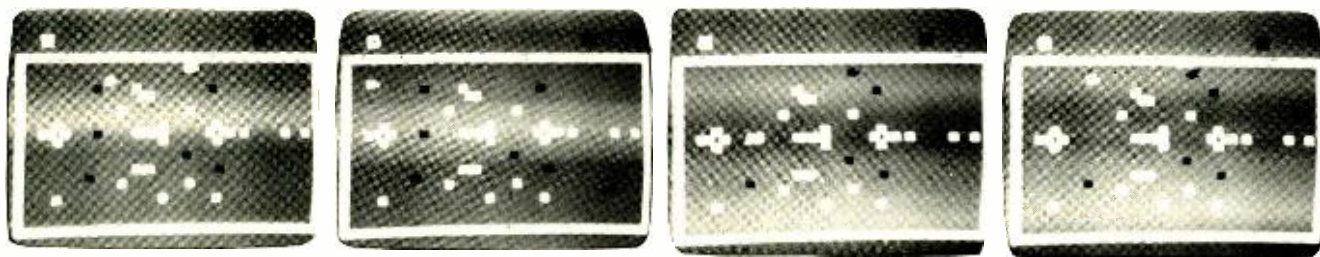

TANK

arcade quality TV game

Part 2. The object is to use your cannon to destroy your opponent first, but watch out for the land mines and anti-tank barriers. The circuit provides a composite video signal to your TV set and produces realistic sound

L. STEVEN CHEAIRS

LAST MONTH, WE PROVIDED THE COMPLETE schematic of the tank game and discussed in detail the circuit operation.

This month, the article concludes with the foil pattern, component placement diagram and construction details.

Building the game

Before beginning construction, you will need an etched and drilled PC board. You can use the foil pattern in Fig. 4 or purchase the board from the source listed in the parts list. Begin by installing the five jumpers on the drilled board (Fig. 5) and then solder all resistors, capacitors and IC sockets to the board. Next, solder in the diodes, transistors and the regulator IC.

Before proceeding, connect a 12-VAC transformer to the AC input; connect a DC voltmeter across the power-supply pins of the game IC; pin 1 is ground and pin 16 is $+V_{cc}$. Now, apply line power to the transformer—7 volts should be indicated on the meter. If 7 volts is not shown but some value close to it, then a new value for R1 or R2 can be chosen by trial-and-error. If the voltage is drastically different, then a circuit problem exists; use normal troubleshooting techniques to locate and repair the problem.

Next, install the CMOS IC's. Again apply power; using an oscilloscope, adjust

the amplitude of the clock at pin 19 of the LSI IC. Remove the power source and discharge the capacitor. Install the AY-3-8700-1 or AY-3-8710-1 IC; the circuit board is now complete. Wire the external components to the PC board (see Fig. 6) and install the unit into a case. If an RF modulator is used, it can be mounted in the case with the PC board or inside the TV set. One last note, the best results were obtained from the prototype with the TV set's contrast control turned up and the brightness control turned to medium-low.

Special considerations

There are several considerations that should be noted for the AY-3-8700-1. First, as the tanks rotate, the shape of their images will vary. Next, the border width will vary from integrated circuit to integrated circuit. Also, the mines could disappear upon interaction with the tanks. When a score is recorded the black tank rotates and the white does not. The 4-second delay makes this effect immaterial. If the tanks exit the screen area, sometimes they will disappear and never return.

For the AY-3-8710-1, the following considerations are important. Upon resetting of the game a random explosion may occur (it may be visible below the bottom

border). Also, during the game the gun of either tank may misfire; that is, shells may explode in a spot where the player is not aiming or the shell may not fire from the tank. These do not affect the normal events of the game.

It is possible for a tank to get trapped in a border. When this happens, the game is ended and the other tank is declared the winner. If the barrier interaction switch is

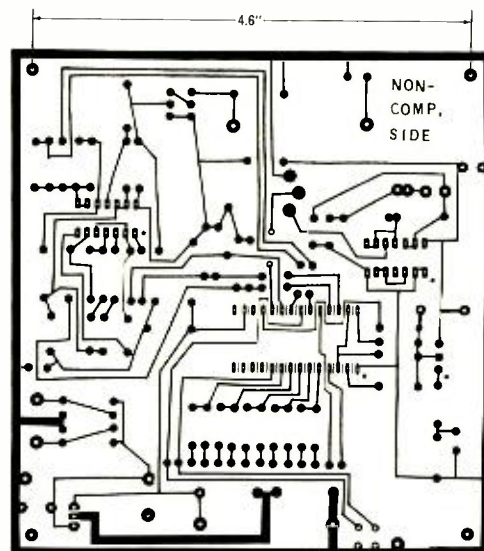

FIG. 4—FOIL PATTERN for the battle game PC board.

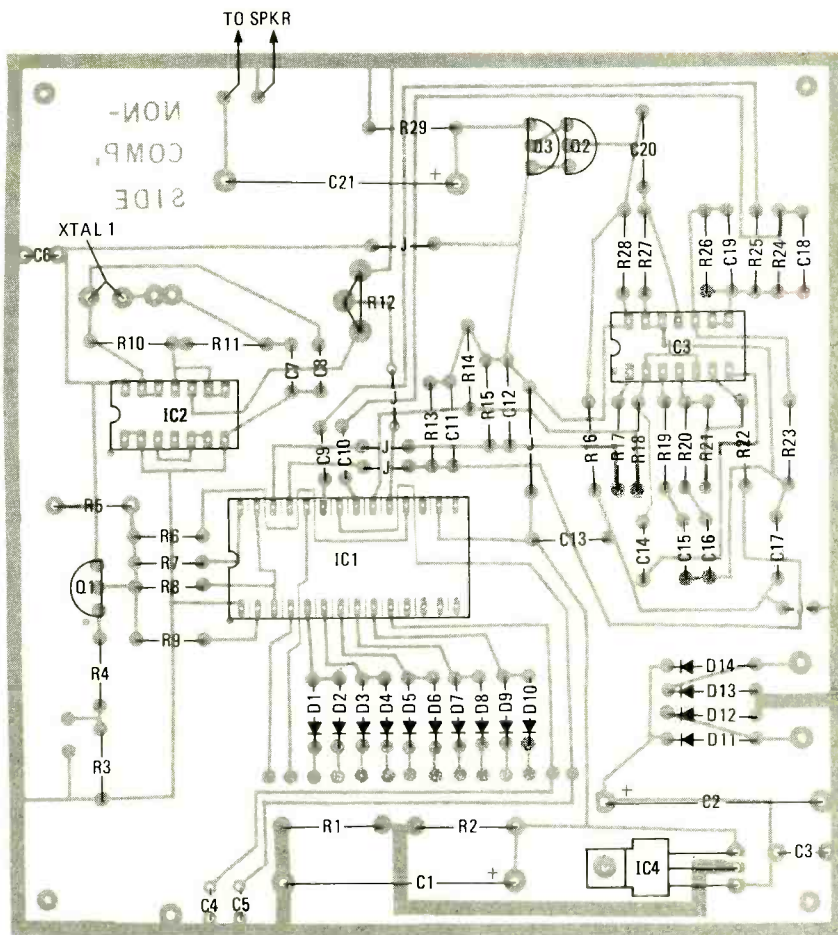

FIG. 5—COMPONENT LAYOUT showing positions of all on-board parts. Switches, speaker and power transformer are mounted in the case.

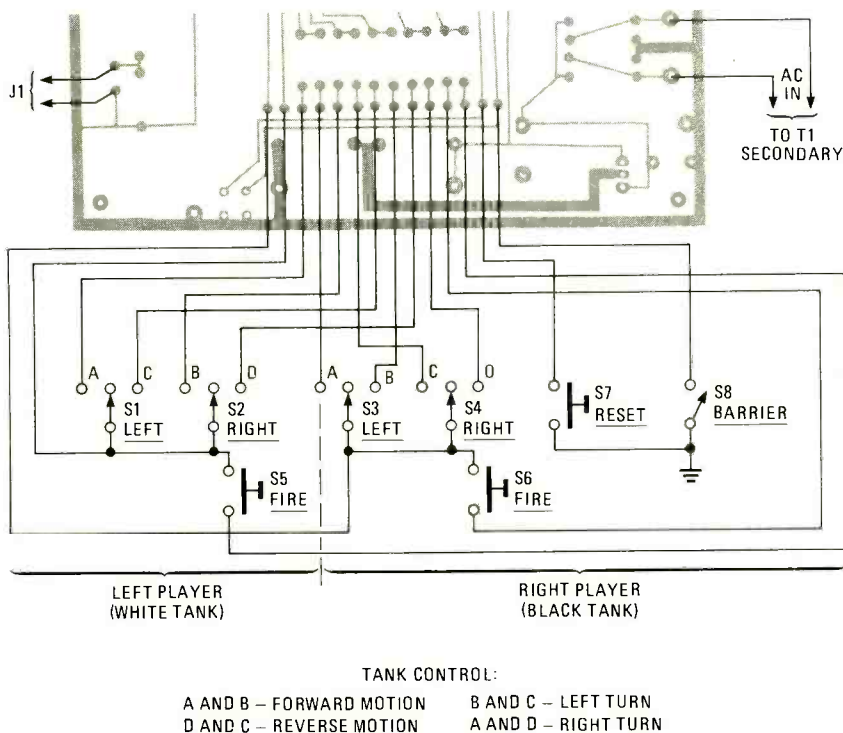

FIG. 6—HOW SWITCHES ARE CONNECTED to the game IC on the board. Lower section of the component side of board is shown for reference.

PARTS LIST

All resistors are 1/4 watt, 5%.

- R1—180 ohms
 - R2—510 ohms
 - R3—470 ohms
 - R4—1800 ohms
 - R5—1000 ohms
 - R6—270 ohms
 - R7, R16, R19, R20, R23, R28—10,000 ohms
 - R8—1600 ohms
 - R9—2400 ohms
 - R10—12 megohms
 - R11—220 ohms
 - R12—5000-ohm, PC-type potentiometer
 - R13—2.2 megohms
 - R14—2200 ohms
 - R15, R21, R26—20 megohms
 - R17, R22—3.9 megohms
 - R18—22,000 ohms
 - R24, R25—10 megohms
 - R27—30,000 ohms
 - R29—15 ohms
 - C1, C2—100 μ F, 50-volt electrolytic
 - C3—2.7- μ F tantalum
 - C4-C6, C13, C14—0.1- μ F disc
 - C7, C8—30-pF disc
 - C9, C10—0.01- μ F disc
 - C11, C12—0.22 μ F
 - C15, C16, C20—5 μ F
 - C17—0.47 μ F
 - C18—200 pF disc
 - C19—100-pF disc
 - C21—220- μ F, 15-volt electrolytic
 - D1-D10—1N4148 or similar
 - D11-D14—1N4005 or similar
 - Q1-Q3—2N3904 or similar
 - IC1—AY-3-8700-1 or AY-3-8710-1 LSI game
 - IC2, IC3—4001, CMOS quad NOR gates
 - IC4—78M05, 5-volt regulator
 - J1—miniature open-circuit jack
 - S1-S4—SPDT center-off, momentary-contact toggle switches
 - S5-S7—SPST normally open pushbutton switch
 - S8—SPST switch
 - S9—SPST toggle switch
 - T1—12VAC, 1A secondary transformer
 - XTAL—4.090900-MHz crystal
 - SPKR—8 ohms
 - MISC.—12 X 7 X 3-inch aluminum chassis, line cord, hook-up wire, four 1 1/2-inch stand-off busings.
- The following parts are available from Questar Engineering Company, McDonald Street, Mesa, AZ 85202: PC board, \$12.95; AY-3-8700-1 or AY-3-8710-1 (please specify), \$29.00; crystal, \$5.50; set of all switches, \$12.25. Kit of all parts, \$63.95.

selected, the tank cannot drive through barriers. If a tank gets trapped in a barrier, momentarily flip the barrier interaction switch to allow the tank to free itself. Also, sometimes the tanks may get locked together; the only way to separate them is to reset the game. In playing both the AY-3-8700-1 and AY-8710-1 games I very seldom have problems of the type outlined above. These special considerations are presented so that you know what to do in case a problem is encountered.

R-E

HOBBY CORNER

A look at some clever reader solutions to reader problems.

EARL "DOC" SAVAGE, K4SDS, HOBBY EDITOR

THE TIME HAS COME TO TRY TO CATCH UP on some of the more interesting mail that readers have been sending. I answer letters directly as much as possible, especially if an SASE is enclosed, but there just isn't time to answer all of them. I'd like now just to share some reader ideas with you.

A reader in Puerto Rico makes the point in his letter that he can find published circuits to do everything he has needed so far. These circuits can all be found in manufacturers' data sheets, application notes and various magazines and books. He then says that he would feel pretty silly sending in a circuit obtained from another source, and I agree with him.

Well, it seems to me that although this reader must have a tremendous collection of well-filed and indexed publications there is plenty yet to be discovered. There are many new ways to do old things and new applications for existing components (IC's, etc.).

For example, the lowly 555 has been around for several years now and I would like to have just 1/1000th of a penny for every word that has been written about it. I doubt (although I'm not absolutely sure) that there remains any undiscovered way to make the 555 function as a timer. Quite probably, they all have been discovered and discussed.

Yet, in spite of all that has been written, I am *sure* that many other applications for the 555 remain. Perhaps some are being discovered right now. There are ways to use the 555 that have not yet been dreamed of.

I agree that we should keep up with what is going on by buying all the magazines and books we can find or afford! After all, there is no point in "re-inventing the wheel" every time we begin a construction project. *Someone* is always finding new and better ways of doing things and we should be aware of them.

Recently, I received a letter describing a fantastic reader-built project. There was not a single new device in the project, but the way some of them were used—WOW! I immediately sent the letter to the editor of *Radio-Electronics*, and if things go as planned, that article may

appear in *Radio-Electronics*.

So, keep on reading, learning, experimenting and building. There is plenty to be discovered. Even if we don't find anything new, though, trying is more fun than anything else I can think of!

Rocket-launching circuit

A while back (July 1978) we discussed several problems on which readers had asked for help. Well, at least one of those problems hit a nerve. Apparently there are a number of model rocketry buffs or rocketeers among us.

A reader asked for a rocket-launching circuit, and it has been interesting to observe the different approaches that have been developed. Once again this proves that there are many approaches to solving a problem.

One of the best launching circuits was sent in by Tim Coffman (Route 2, Box 448, Liberty, MO 64068). I have given his full address because he wrote that he would be glad to correspond with other readers who are interested in model rocketry.

Unfortunately, there isn't enough space to go into Tim's system in detail. In brief, then, he uses eight IC's and two 7-segment digits to count down to 0, fire the igniter and, finally, count up until rocket touch-down to give the flight time. Three of those IC's are used to detect the 0 count, reverse the counters and start the firing. The timer is the ever-useful 555 operating at 1 Hz.

This rocket circuit is complete with appropriate safety switches and LED status indicators. The count can be placed on HOLD at any time, and the firing is done through an SCR rather than a relay. Altogether, it is a very straightforward circuit.

I must admit I am not a rocketeer. I have had a healthy respect for rockets ever since I saw someone's hand badly damaged by carelessly handled fuel. If you are just starting this hobby, be *very* careful to observe strict safety rules and precautions.

More rockets

A further note about model rockets: I received a letter and catalog from CNA,

Box 1252, Lewiston, ME 04240. This company specializes in rocketry electronics with small and large launching systems and other devices. Company president Alfred Celetti recommends that readers interested in model rockets and electronics write the National Association of Rocketry, Box 275, New Providence, NJ 07974.

Super-simple oscillator

A Canadian reader, Guy Isabel, sent in two useful circuits. One is an interesting timer with no moving parts—not even a pushbutton switch. The other is a neat oscillator.

Guy's super-simple oscillator uses four of the six gates in a 7404 hexadecimal inverter plus *one* additional part (see Fig. 1). The output frequency is determined by the value of the capacitor (which should *not* be an electrolytic). As capacitor C is changed from 300 μ F to 300 pF, the frequency changes from 1 Hz to 1 MHz.

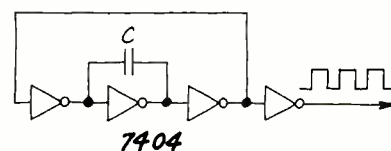

FIG. 1

This oscillator can be used to drive LED's, counters, transistor switches, relays and so on. It could be used as a signal source to test audio amplifiers and certain receivers. In many circuits, it could replace a 555. Used with a switch and several capacitors, it could provide selectable frequencies. And why not use a variable capacitor from an old broadcast radio to cover a range of frequencies?

In addition, Guy Isabel has offered to help those who need circuits for special applications. You can write him at 1725 East, Henri-Bourassa, Apt. 25, Montreal, P. Q. H2C 1J5, Canada.

Low-voltage detector

Hobby Corner received an interesting letter and circuit from Dave Corner of Chicago. Figure 2 is a diagram of Dave's low-voltage alarm circuit.

The values of R1, R2 and D1 are selected for the voltage applied. Using a 12-volt battery, R1 = 10K, R2 = 5.6K and D1 is a 5-volt Zener diode, or a string

of forward-biased silicon rectifiers equaling about 5 volts. Transistor Q1 is a general-purpose UJT (Unijunction Transistor), and Q2 is any small-signal or switching NPN transistor.

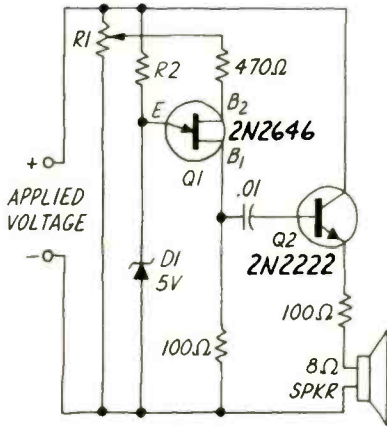

FIG. 2

When this detector is connected across the battery terminals, it draws little current and does not interfere with other devices powered by the battery. If the voltage drops below the trip voltage you have selected with the R1 setting, the speaker beeps a warning. The frequency of the beeps is determined by the amount of undervoltage.

If other voltages are being monitored, select R1 so that it draws only 1 mA or 2 mA (remember $E = IR$). Zener diode D1 is about one-half of the desired trip voltage, and R2 is selected to bias it at about 1 mA.

Thanks, Dave, for sharing this useful circuit with us.

Solder cream

Multicore Solders has a new line of solder cream that comes in tubes like toothpaste. This product doesn't even look like solder, but it is and does a beautiful job.

The type of solder useful for your projects is labeled "Ersin . . . for electrical soldering." All you do is squeeze a dab onto a joint and apply heat. For small joints that can't conduct the heat away so fast, the heat source can be a candle, match or cigarette lighter. On larger joints, you should use an iron or torch.

The rosin flux is incorporated in the cream along with the invisible solder. As the cream is heated, it changes to solder and then solidifies to make a good electrical and mechanical joint.

This solder cream is especially handy for use in places that are hard to reach with wire solder. For example, you can coat the end of a wire with cream, insert it into a pin like a phono plug or a PL-259, and then just heat the outside of the pin. It really simplifies the process.

I don't think solder cream will ever replace regular solderwire, but it can perform some jobs more conveniently.

Multicore also manufactures two other

types of solder cream, one an all-purpose variety that can be used for many kinds of metals, including stainless steel and silver. It can be used in the place of the acid-flux solderwire that cannot be applied on electrical joints.

The third solder cream is a lead-free cream composed of tin and silver. This cream can be used on stainless steel, silver and other metals; it is also nontoxic.

Solder cream is handy to have around. If you can't obtain it from a local dealer, write to Multicore Solders, Westbury, NY 11590. R-E

WE WANT YOUR PROJECT

As you have seen, **Radio-Electronics** regularly publishes construction articles covering all aspects of electronics. If you've just completed an interesting project, tell us about it. If we like it, we'll ask you to become one of our authors and prepare your project as an article. Even if you have never written for a magazine before, this is an opportunity to get your article published and to be paid for your efforts.

Send your proposals to Larry Steckler, Editor, **Radio-Electronics**, 200 Park Ave. South, New York, NY 10003.

THE BIG PLUS + Graphic Equalizer



LOADED with Quality Features!

- Stereo . . . Eleven Bands Per Channel •
- Extremely Low Noise & Distortion • LED Peak Indicators • Center Detent ("flat") sliders • Built-in "record" Switching •
- Line and Microphone Level Inputs/Outputs • Fully Guaranteed • Horizontal or Vertical Cabinets • Kit or Fully Assembled • Plus Much, Much More!

AARON-GAVIN INSTRUMENTS, INC.
17231 Corla Avenue send brochure
Tustin, California 92680

Yes! I've enclosed \$_____ RUSH me:
_____ assembled equalizers at \$189.95, p.p.d.
_____ unassembled equalizer kits at \$99.95, p.p.d.
cabinet Horizontal (flat) Vertical (up-right)
Visa & Master Charge orders accepted

Card No. _____
Exp. Date _____ Bank No. _____
Address _____
Name _____
City _____ State _____ Zip _____

California residents include 6% sales tax.
Dealer inquiries invited.

CIRCLE 73 ON FREE INFORMATION CARD

QUICK CHARGE IRON-QUICK CHANGE TIPS

ISO-TIP® Quick Charge Cordless Soldering Iron recharges in 3-4½ hours. Uses any of Wahl's 16 snap-in tips.

Low voltage, battery powered, ground free isolated tip design.

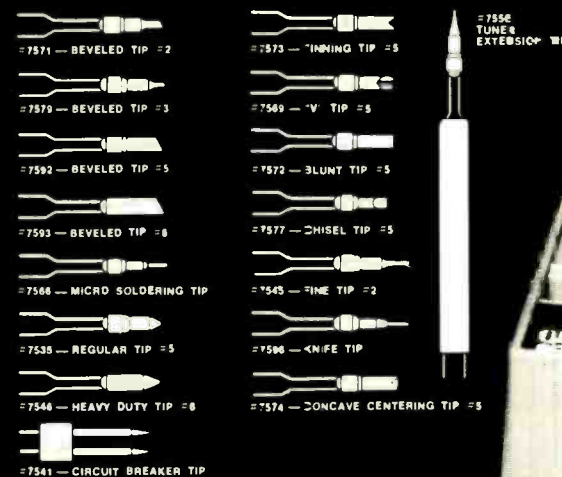

WAHL CLIPPER CORPORATION
ORIGINATORS OF PRACTICAL CORDLESS SOLDERING
Sterling, Illinois 61081 (8-5) 625-6525
"Manufacturing Excellence Since 1919"

CIRCLE 35 ON FREE INFORMATION CARD

COMPUTER CORNER

8085 *A look at the software required to control an eight channel analog signal monitor.*

C. TITUS, P. RONY, D. LARSEN, and J. TITUS*

IN A PREVIOUS COLUMN, WE DESCRIBED the needs of the 8085 control system and the use of the I/O ports and programmable timer to form an eight channel analog monitor. The necessary initialization of the I/O ports was also discussed. Now we will discuss the software that is

necessary for proper operation of the system. It is assumed that the control process is very simple, perhaps just sensing only upper and lower limits of the analog signals.

The programmable timer within the 8155 generates an interrupt every 10 ms.

```

RST75,  PUSHPSW      /SAVE REG A & FLAGS
        MVIA         /CLEAR INTERRUPT FLAG
        020
        SIM
        MVIA         /RE-ENABLE INTERRUPTS
        013
        SIM
        LDA          /GET # OF LOOPS REMAINING
        SEC
        0
        DCRA        /DECREMENT IT BY ONE
        STA         /SAVE IT
        SEC
        0
        JNZ         /IF NOT ZERO, DO ANOTHER LOOP
        NOTYET     /THROUGH THE INTERRUPT
        0
        MVIA         /YES, IT'S ZERO, SO RESET THE SECOND
        144        /COUNTER TO 100 (10 MSEC LOOPS)
        STA         /STORE IT
        SEC
        0
        LDA          /GET THE TIME
        BCDTIM
        0
        STC         /SET THE CARRY FLAG
        CMC         /COMPLEMENT IT TO CLEAR IT
        ADI         /ADD 239 = DECIMAL 99
        143
        DAA         /DECIMAL ADJUST IT FOR A SUBTRACTION OF ONE
        STA         /OF ONE, AND THEN STORE IT
        BCDTIM
        0
        JNZ         /IF THE RESULT IS NOT ZERO, LOOP THROUGH
        NOTYET     /AGAIN
        0

        /ADC SERVICE ROUTINE
        IN          /INPUT THE BCD DATA FROM THE SWITCHES
        201
        STA         /UPDATE THE BCD TIME
        BCDTIM
        0
        ADC,        NOP /THE ADC SERVICE STEPS GO HERE
        NOP
        NOP
        NOP
        NOTYET,    /ETC.
        POPPSW     /RESTORE REG A & FLAGS
        RET        /RETURN TO MAIN PROGRAM
    
```

FIG. 1

Since the basic unit of time in this system is a 1-second interval, 100 1-second interrupts must be counted before any action can occur. When the 1-second point has been reached, the program must check to see if it must perform some other action,

or continue timing for another 1-second interval. A read/write memory location, SEC, is set aside that will be used to count the 100, 10-ms interrupts. Another location will be required to contain the number of seconds that must be delayed between sampling. Since the thumb-wheel-switch data will be entered in binary-coded decimal (BCD) format, you have to decide whether it will be processed in binary or BCD format. We have chosen to process it in BCD format to eliminate a BCD-to-binary code conversion process.

A typical timer control subroutine is shown in Fig. 1. Note that there are steps in this subroutine that clear the RST 7.5 flag and then re-evaluate the RST 7.5 interrupt mask. The information stored in location SEC and BCDTIM has also been used.

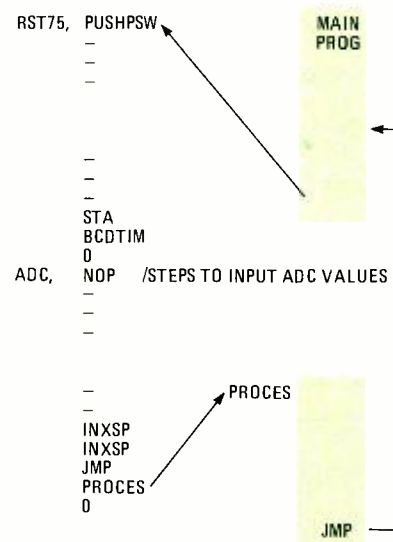

FIG. 2

In our example, it can take up to about 200 μ s to proceed through the steps shown, leaving 9800 μ s for the remaining program steps. If a slow A/D converter is used to acquire the eight samples, much of the 9800- μ s period would be gone, leaving little time in the interrupt-service subroutine before the next 10-ms interrupt occurs. If this happens, the interrupt-service subroutine is interrupted and the computer becomes interrupt-bound. Most A/D converters can perform conversions quickly so this will not be considered further.

We suggest that you acquire the analog

*This article is reprinted courtesy American Laboratories. Dr. Rony, Department of Chemical Engineering, and Mr. Larsen, Department of Chemistry, are with the Virginia Polytechnic Institute & State University. Both Mr. J. Titus and Dr. C. Titus are with Tychon, Inc.

data in the subroutine and then proceed to a data or control-processing section of the program that is *outside* of the interrupt-service subroutine. The control or processing of the program will be interrupted briefly every 10 ms, but it will have up to 1 second to process the old data. It has been assumed that the processing takes less than 1 second. The software example in Fig. 2 shows how the control processing software has been removed from the interrupt-service subroutine. There are other equally valid solutions to this problem. Remember, however, that when you do not intend to use a return address on the stack, you must increment the stack pointer twice to avoid loading the stack with useless information.

This application does not use the serial-in (SID) or serial-out (SOD) connections on the 8085. These connections could be used as a single line-control input and a single line-control output, respectively. They can also be used to serialize ASCII characters for output or to parallel the serial bit stream to reconstruct parallel data bytes. Thus, a software UART could be constructed very easily. **R-E**

Have regular medical check-ups.

American Heart Association
We're Fighting For Your Life

ANNUAL INDEX JANUARY—DECEMBER 1978

To present the maximum number of articles to our readers, we have not published the Annual Index as part of this issue. A 4-page brochure containing this index is available for those who need one. To get your free copy, send a *stamped self-addressed envelope (legal size)* to:

Radio-Electronics
Annual Index
45 East 17th Street
New York, NY 10003

Any requests postmarked on or before February 28 are free. After that date there is a 25¢ fee. Questions and comments about anything other than the Index that are included with your request cannot be handled. Send them separately to our Editorial Offices.

NOM CARD FOR 1802 *continued from page 48*

(\overline{EF}_2 , \overline{EF}_3 , \overline{EF}_4). The flip-flop is reset when the status/output register is read.

The only portion of the interface we have not discussed is the clock—a simple 400-kHz RC oscillator operating between +5 volts and -4 volts, and the hold/reset circuits. The reset circuit is a TTL-to-MOS voltage converter since the reset, hold and oscillator pins are non-TTL inputs. The reset must be held low for at least eight oscillator periods as part of its power-on sequence (8 oscillator periods

equals 20 μ s). Thus, when the system is powered-up as part of the initialization routine, the reset is set for a minimum of 20 μ s, during which time the input-ready flip-flop is clocked three times. The first two times it is set, write an 80_{HEX} to the input port to clear the flip-flop; this is necessary because the hold is set each time the output ready occurs. When the third signal occurs, the NOM interface is ready for its first instruction. If it is not needed at this time, store a 40_{HEX} in the input port. The hold circuit is formed by a TTL-to-MOS voltage converter driven by a 2-input OR gate.

continued next month



NEW

NLS LEADS AGAIN!!

MS-215 DUAL TRACE MINISCOPE



15MHz PORTABLE OSCILLOSCOPE

- 15 megahertz bandwidth.
- External and internal trigger.
- Time Base—0.1 microseconds to 0.5 Sec/div—21 settings.
- Battery or line operation.
- Automatic and line sync modes
- Power consumption less than 15 W.
- Vertical Gain—0.01 to 50 volts/div—12 settings.
- Weight is only 3 pounds.

**RECHARGEABLE
DUAL TRACE**

PORTABLE

2.7" H x 6.4" W x 7.5" D

AVAILABLE NOW

\$435

With Rechargeable Batteries & Charger Unit



**FREE
CASE**

DELUXE CARRYING CASE

A \$45 value, you get this deluxe carrying case free with the purchase of the MS215.

OFFER EXPIRES FEB. 28, 1979



212-687-2224

THE TEST EQUIPMENT SPECIALISTS

TOLL FREE HOT LINE
800-223-0474

54 West 45 Street, New York, N.Y. 10036

**ADVANCE
ELECTRONICS**

Trouble with the color and how to localize the problem.

JACK DARR, SERVICE EDITOR

THERE ARE REALLY ONLY THREE COLOR problems and they should be easy to analyze. These are: no color at all, the wrong color and the loss of color sync. These problems originate in three separate circuits—the bandpass amplifier, the 3.58-MHz reference oscillator and the color AFPC (Automatic Frequency and Phase Control) circuit. If you check a set and a perfect black-and-white picture appears, this clears everything else in the set!

A complete loss of color can be due to several causes. First, a loss of the color signal itself can be due to a dead 3.58-MHz oscillator, or to faults in the color-killer circuit. To find out which circuit is at fault, feed a color-bar signal into the set and scope the bandpass-amplifier output signal. This signal is normally present at the color control, but it will always appear at the input to the demodulators. If you see a normal “comb” pattern at the right amplitude, the bandpass-amplifier stage is working all right, as well as the killer circuit.

Check for the oscillator signal with a scope. This signal must be at the right amplitude. If the oscillator isn't working, there will be no color.

If you do not see the comb pattern at the bandpass-amplifier output, check all DC voltages, tubes/transistors and pay special attention to the bias on the second bandpass amplifier. This is where the killer bias is used. The DC voltage shown on the service schematic are for no-signal conditions, meaning no color.

The grid will be at a high negative voltage (for a tube circuit; cutoff polarity for a transistor). This voltage should drop to a much lower value when a color signal is fed in. Remember, this is just a plain IF amplifier circuit! If necessary, you can override the killer bias on the grid to check whether the color signal goes through. If so, check out the killer-bias circuitry. This may mean bad diodes, tubes, transistors, or just control misadjustment.

With reference to color alignment, the key word is *don't!* If you must perform alignment, do so only as a last resort and only after finding definite clues that it is needed. Use a sweep curve on your scope to check for misalignment. This will give

you a definite clue. However, you should remember that, unless it is very bad, misalignment does *not* cause a complete loss of color, nor will it ever cause a sudden dropout of color. In most cases, alignment is only needed because someone has tampered with the set. Check the scope pattern. If the comb is flat on top and the bars are clean and sharp, it is probably not necessary to align. (Hint—with older scopes, for a clearer pattern use a crystal-detector probe to trace the signals through the bandpass-amplifier stages.) With wideband scopes, use a low-capacitance probe.

If the color oscillator doesn't function at all, this causes a complete loss of color. Some Service Clinic readers write: “My color bars are bluish and greenish, but I can't get any reds!” In quite a few sets, this is because of a dead oscillator. The weak tints observed are because enough of the signal burst leaks through to make the demodulators try to work. The color burst phase is between blue and green. (By the way, this usually means that the demodulators are working!)

The 3.58-MHz signal is critical. A phase shift of only one-sixteenth of *one-cycle* causes blue to change to green, etc.! A working oscillator/AFPC circuit holds the frequency so steadily that this shift seldom occurs. For a network program, a frequency counter on this oscillator should read 3,579,545 Hz. (This frequency is generated by networks using atomic clocks, rubidium and caesium.)

A defective crystal changes the frequency. So far, I have not yet discovered a set that has a dead oscillator due to a bad crystal. If the crystal is just a little off-frequency, the oscillator tends to pull against the AFPC circuit control signal. This makes the color-sync extremely sensitive and prone to fall out with interruptions.

There are two types of oscillator circuits. One is a Pierce oscillator circuit. The crystal controls the frequency, which, in turn, is controlled by the signal burst through the AFPC circuit. Don't be afraid of the AFPC circuit—it basically resembles any horizontal AFC circuit! The oscillator frequency is controlled by a DC voltage developed across a diode pair. To adjust this, kill the AFPC circuit

so that the oscillator works independently. Now, adjust the reactance coil, etc., until the colors lock in momentarily. Taking the shunt off the AFPC circuit should lock the color in firmly. If the color falls out of sync, the AFPC circuit isn't operating.

There is one obscure *external* cause for color-sync problems. This is the horizontal oscillator automatic frequency control. In many older sets, this control held the picture in sync over a considerable range. However, at the ends of the control range, the *color* changed hue and fell out. This was due to the change in *phase* of the pulse from the flyback used to gate-out the burst signal. Changing the phase of this pulse far enough results in no signal burst or a very weak burst. Make sure that the horizontal-hold control is centered in its range.

The other type of color oscillator circuit is actually a burst amplifier. This circuit picks off the burst signal and feeds it to a sharp filter, usually a crystal. This causes the crystal to ring; this ring lasts long enough for the next burst signal to arrive. It therefore develops a continuous output that is actually the network signal burst itself. If the gating pulse is out of phase, the burst will not be strong enough to make the circuit work.

In circuits with a reactance-tube AFPC control, this control is actually a voltage-controlled oscillator (VCO). The AFPC diodes develop a small DC-control voltage by comparing the signal burst to the oscillator frequency, similar to horizontal AFC. In many sets, there should be zero voltage on the grid of the reactance tube with the oscillator locked on. (In some, this voltage is offset. Make sure to check the schematic voltage values.) Typical voltage values might range from +5 to -5.

If you run into one with tricky color sync, check to make sure that this voltage “crosses zero” to about the same voltages. This is actually just like any FM discriminator, which it is. Its output signal is an S-curve. If the crystal is just slightly off, you'll probably discover that the grid voltage is either a positive or a negative voltage, but it will not cross zero. It will come down to zero perhaps, and then return in the same polarity. Try a new crystal to see if you can obtain a zero crossing and lock in at 0 volt.

All TV set service data includes com-

plete instructions for making color-setup tests, alignment tests and so on. Follow these instructions to the letter. Watch out for deviations; some instructions are different. The tests are usually quite simple; in most, the only instrument you need is a DC voltmeter. Watch the screen to observe what's happening. Color troubles can be easy to troubleshoot if they are approached methodically and logically, one step at a time.

R-E

service questions

VERTICAL PROBLEM

David Day, of Flori-Day Electronics, Apalachicola, FL, sends these tips along. (He had two Zenith model 14B38Z chassis, both with automatic-gain control (AGC) problems. I suggested some possible cures, including replacing the VDR in the AGC circuit.)

"Here's some feedback for you! I changed the VDR's on both chassis. This didn't help, so I started on the first chassis. I checked all DC voltages around the AGC tube, and found that the voltage on pin 5 of the 8BA11 was only -4 instead of -11. You also suggested tracing the circuit and following it back to the

continued on page 82

For
faster
service

USE
ZIP
CODE

on
all
mail

Accuracy like a VTVM... Convenience like a VOM...

NEW BATTERY-OPERATED FET SOLID-STATE VOLT-OHMMETER #116

Easy-to-build KIT

\$44.78 =116K

Factory-Wired & Tested

\$60.05 =116W

Now you can get all the benefits of a VTVM (laboratory accuracy, stability and wide range) but with its drawbacks gone: no plugging into an AC outlet, no waiting for warm-up, no bulkiness. New Field Effect Transistor (FET) design makes possible low loading, instant-on battery-operation and small size. Excellent for both bench and field work.

Compare these valuable features:

- High impedance low loading: 11 meg-ohms input on DC, 1 megohm on AC • 500-times more sensitive than a standard 20,000 ohms-per-volt VOM • Wide-range versatility: 4 P-P AC voltage ranges: 0-3.3, 33, 330, 1200V; 4 RMS AC voltage ranges: 0-1.2, 12, 120, 1200V; 4 DC voltage ranges: 0-1.2, 12, 120, 1200V; 4 Resistance ranges: 0-1K, 0-100K, 0-10 meg., 0-1000 meg.; 4DB ranges. -24 to +56DB.

Sensitive easy-to-read 4½" 200 micro-amp meter. Zero center position available. Comprises FET transistor, 4 silicon transistors, 2 diodes. Meter and transistors protected against burnout. Etched panel for durability. High-impact bakelite case with handle useable as instrument stand. Kit has simplified step-by-step assembly instructions. Both kit and factory-wired versions shipped complete with batteries and test leads. 5¼"H x 6¾"W x 2¾"D. 3 lbs.

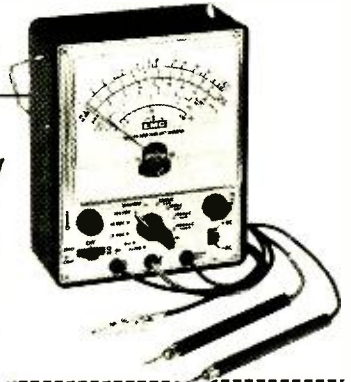

Send FREE catalog of complete EMC line and name of nearest distributor.

RE-12

Name _____

Address _____

City _____

State _____ Zip _____

EMC

ELECTRONIC MEASUREMENTS CORP.
625 Broadway, New York, N.Y. 10012



A Platt tool case won't fall apart at the seams because there are no seams.

Unlike other tool cases, the pockets on a Platt Pallet are molded without any seams, stitches or rivets to form a one-piece unit. It's practically indestructible.

The case itself has that same rugged construction. It comes in either tough, lightweight ABS Thermoplastic, rich looking expanded vinyl or a combination of both.

Platt also has rugged hardware. Like an aluminum rim for extra strength. Steel core handles. And tough brass locks.

Inside there are compartments for larger tools, parts boxes and testing equipment. And multiple lid pockets for paper and order books.

Besides having a tough case Platt has a tough 5-year guarantee on both the case and pallet.

platt

• Pat. No. 3,880,285

Cases for business and industry.

2301 S. Prairie Ave., Chicago, Ill. 60616 (312) 225-6670

CIRCLE 71 ON FREE INFORMATION CARD



Clever Kleps

Test probes designed by your needs — Push to seize, push to release (all Kleps spring loaded).

Kleps 10. Boathook clamp grips wires, lugs, terminals. Accepts banana plug or bare wire lead. 4¾" long. \$1.59
Kleps 20. Same, but 7" long. \$1.69
Kleps 30. Completely flexible. Forked-tongue gripper. Accepts banana plug or bare lead. 6" long. \$1.99
Kleps 40. Completely flexible. 3-segment automatic collet firmly grips wire ends, PC-board terminals, connector pins. Accepts banana plug or plain wire. 6¼" long. \$2.89
Kleps 1. Economy Kleps for light line work (not lab quality). Meshing claws. 4½" long. \$1.09
Prof 10. Versatile test prod. Solder connection. Molded phenolic. Doubles as scribing tool. "Bunch" pin fits banana jack. Phone tip. 5½" long. \$.99

All in red or black - specify. (Add 50¢ postage and handling). Write for complete catalog of - test probes, plugs, sockets, connectors, earphones, headsets, miniature components.



Available through your local distributor, or write to:
RYE INDUSTRIES INC.
 130 Spencer Place, Mamaroneck, N.Y. 10543
 In Canada: Rye Industries (Canada) Ltd.

CIRCLE 27 ON FREE INFORMATION CARD

HOBBYISTS! ENGINEERS! TECHNICIANS! STUDENTS!

Write and run machine language programs at home, display video graphics on your TV set and design microprocessor circuits—the very first night—even if you've never used a computer before!

ELF II featuring RCA COSMAC microprocessor/mini-COMPUTER \$995

ELF II by NETRONICS

As featured in POPULAR ELECTRONICS

Shown with optional 4k Memory Boards, GIANT BOARD™ & Kluge Board.

Stop reading about computers and get your hands on one! With ELF II and our new *Short Course* by Tom Pittman, you can master computers in no time at all! ELF II demonstrates all 91 commands an RCA 1802 can execute and the *Short Course* quickly teaches you how to use each of the 1802's capabilities.

ELF II's video output lets you display an alphanumeric readout or graphics on any TV screen or video monitor plus enjoy the latest video games, including an exciting new target/missile gun game that was specifically developed for ELF II.

But that's not all. Once you've mastered computer fundamentals, ELF II can give you POWER with add-ons that are among the most advanced found anywhere. No wonder IEEE chapters plus hundreds of universities and major corporations have chosen the ELF II to introduce their students and personnel to microprocessor computing!

Learn The Skill That May Soon Be Far More Important Than Your College Degree!

The ability to use a computer may soon be more important to your earning power than a college degree. Without a knowledge of computers, you are always at the mercy of others when it comes to solving highly complex business, engineering, industrial and scientific problems. People who understand computers can command MONEY and to get in on the action, you must learn computers. Otherwise you'll be left behind.

ELF II Is The F-A-S-T Way To Learn Computer Fundamentals!

Regardless of how minimal your computer background is now, you can learn to program a computer in almost no time at all. That's because Netronics has developed a special *Short Course on Microprocessor And Computer Programming* in non-technical language that leads you through every one of the RCA COSMAC 1802's capabilities so you'll understand everything ELF II can do... and how to get ELF II to do it!

All 91 commands that an 1802 can execute are explained to you, step-by-step. The text, written for Netronics by Tom Pittman, is a tremendous advance over every other programming book in print.

Keyed specifically to the ELF II, it's loaded with "hands on" illustrations. When you're finished, ELF II and the 1802 will no longer hold any mysteries to you.

In fact, not only will you be able to use a personal computer creatively, you'll also be able to read magazines such as BYTE, INTERFACE, AGE, POPULAR ELECTRONICS and PERSONAL COMPUTING and understand the articles.

If you work with large computers, ELF II and our *short Course* will help you to understand what makes them tick.

A Dynamite Package For Just \$99.95!

With ELF II, you learn to use machine language—the fundamental language of all computers. Higher level languages such

as FORTRAN and BASIC must be translated into machine language before a computer can understand them. With ELF II you build a solid foundation in computers so you'll really know what you're doing, no matter how complicated things get.

Video output also makes ELF II unique among computers selling for such a low price. Attached to your TV set, ELF II becomes a fabulous home entertainment center. It's capable of providing endless hours of fun for both adults and children of all ages! ELF II can create graphics, alphanumeric displays and fantastic video games.

No additional hardware is required to connect ELF II to your TV's video input. If you prefer to connect ELF II to your antenna terminals instead, simply use a low cost RF modulator (to order one, see coupon below).

ELF II's 5-card expansion bus (connectors not included) allows you to expand ELF II as your needs for power grows. If you're an engineer or hobbyist, you can also use ELF II as a counter, alarm, lock, thermostat, timer or telephone dialer, or for countless other applications.

ELF II Explodes Into A Giant!

Thanks to ongoing work by RCA and Netronics, ELF II add-ons are among the most advanced anywhere. Plug in the GIANT BOARD™ and you can record and play back programs, edit and debug programs, communicate with remote devices and make things happen in the outside world. Add Kluge Board to get ELF II to solve special problems such as operating a more complex alarm system or controlling a printing press. Add 4k RAM board and you can write longer programs, store more information and solve more sophisticated problems.

Expanded, ELF II is perfect for engineering, business, industrial, scientific and personal finance applications. No other small computer anywhere near ELF II's low price is backed by such an extensive research and development program.

The ELF-BUG™ Monitor is an extremely recent breakthrough that lets you debug programs with lightning speed because the key to debugging is to know what's inside the registers of the microprocessor and, instead of single stepping through your program, the ELF-BUG™ Monitor, utilizing break points, lets you display the entire contents of the registers on your TV screen at any point in your program. You find out immediately what's going on and can make any necessary changes. Programming is further simplified by displaying 24 bytes of RAM with full address, blinking cursor and auto scrolling. A must for serious programmers!

Netronics will soon be introducing the ELF II Color Graphics & Music System—more breakthroughs that ELF II owners will be the first to enjoy!

Now BASIC Makes Programming ELF II Even Easier! Like all computers, ELF II understands only "machine language"—the language computers use to talk to each other. But, to make life easier for you, we've developed an ELF II Tiny BASIC. It talks to ELF II in machine language for you so that you can program ELF II with simple words that can be typed out on a keyboard such as PRINT, RUN and LOAD.

"Ask Now What Your Computer Can Do... But What Can It Do For YOU!"

Don't be trapped into buying a dinosaur simply because you can afford it and it's big. ELF II is more useful and more fun than "big name" computers that cost a lot more money.

With ELF II, you learn to write and run your own programs. You're never reduced to being a mere keypunch operator, working blindly with someone else's predeveloped software.

No matter what your specialty is, owning a computer which you really know how to use is sure to make you a leader. ELF II is the fastest way there is to get into computers. Order from the coupon below!

SERVICE QUESTIONS

continued from page 81

21HB5 horizontal-output grid. When I did this, the bias on the 21HB5 was only -20 volts or so! (I found that I could clamp the pin 5 voltage to -11 and the picture and sound were good.) Why was the voltage so low? Was there leakage in the capacitor? When I checked, capacitor C65 was leaky. I replaced it and bingo! Button this one up.

The second chassis went white in a few minutes and then lost the horizontal drive completely. I followed same circuit; same problem, only heat-sensitive. I replaced C65; no luck. I replaced C66; no luck. Although the 21HB5 tube had been checked and showed good, I didn't change it because I didn't have a new one at the time. So I replaced the 21HB5. Hallelujah! Now the grid bias holds steady at -39 volts, which it should. It wouldn't do this before. So much for AGC problems (which aren't)!

(Congratulations on the persistence and perspicacity, Dave! We have run into quite a few oddball problems like this in horizontal-output tubes in the past few years. In general, it's a good idea to try a new tube and see if this clears the problem. The cause seems to be excessive grid emission (although this is only my opinion). In this case, the analysis became complex until we traced down the source of the negative voltage used to bias the AGC tube. This is a mildly unusual circuit, although quite workable if everything is in good shape.)

FUSE BLOWS VERY FAST

The main power-supply fuse blows very quickly in this Truetone model GEC-4316B. I've checked everything without result! I replaced a few parts, including the horizontal output transistor; no luck. It looks simple but isn't!—D. M., Brunswick, GA.

Here's my favorite remedy: Hook the set up to a variable voltage transformer (variac). Connect an AC ammeter across the empty fuse holder. (If you don't own an AC ammeter, hook up a 0.5-amp pilot light across the fuse holder.) Turn the line voltage up very slowly until you notice just a small current flow, or until the bulb lights up a little.

Check the DC power-supply voltages at a point where there should be voltage but it's missing. This solid-state power supply starts to conduct at a very low voltage, which allows you to get data without excessive smoke!

HEATER CIRCUIT OUT

Have I got problems in this Philco model 4C490! The high voltage is 28 kV, there's good sound, the dial lights work, but there's no raster because the picture tube heater is dead! The heater is not

continued on page 84

NOW AVAILABLE FOR ELF II—

- Tom Pittman's *Short Course On Microprocessor & Computer Programming* teaches you just about everything there is to know about ELF II or any RCA 1802 computer. Written in non-technical language, it's a learning breakthrough for engineers and laymen alike. \$5.00 postpaid!
- Deluxe metal cabinet with plexiglas dust cover for ELF II, \$29.95 plus \$2.50 p&h.
- ELF II connects to the video input of your TV set. If you prefer to use your antenna terminals, order RF Modulator, \$8.95 postpaid.
- GIANT BOARD™ kit with cassette I/O, RS 232-C/TTY I/O, 8-bit P I/O, decoders for 14 separate I/O instructions and a system monitor/editor, \$39.95 plus \$2 p&h.
- Kluge (Prototype) Board accepts up to 36 IC's, \$17.00 plus \$1 p&h.
- 4k Static RAM kit. Addressable to any 4k page to 64k. \$89.95 plus \$3 p&h.
- Gold plated 86-pin connectors (one required for each plug-in board), \$5.70 postpaid.
- Professional ASCII Keyboard kit with 128 ASCII upper/lower case set, 96 printable characters, onboard regulator, parity, logic selection and choice of 4 handshaking signals to mate with almost any computer. \$64.95 plus \$2 p&h.

SEND TODAY!

- Deluxe metal cabinet for ASCII Keyboard, \$19.95 plus \$2.50 p&h.
- ELF II Tiny BASIC on cassette tape. Commands include SAVE, LOAD, ±, ×, ÷, (,), 26 variables A-Z, LET, IF/THEN, INPUT, PRINT, GOTO, GO SUB, RETURN, END, REM, CLEAR, LIST, RUN, PLOT, PEEK, POKE. Comes fully documented and includes alphanumeric generator required to display alphanumeric characters directly on your TV screen without additional hardware. Also plays tick-tack-toe plus a drawing game that uses ELF II's hex keypad as a joystick. 4k memory required. \$14.95 postpaid.
- Tom Pittman's *Short Course on Tiny BASIC* for ELF II, \$5 postpaid.
- Expansion Power Supply (required when adding 4k RAM), \$34.95 plus \$2 p&h.
- ELF-BUG™ Deluxe System Monitor on cassette tape. Allows displaying the contents of all registers on your TV at any point in your program. Also displays 24 bytes of memory with full address, blinking cursor and auto scrolling. A must for the serious programmer! \$14.95 postpaid.

Coming Soon: A-D, D-A Converter, Light Pen, Controller Board, Color Graphics & Music System... and more!

Call or write for wired prices!

Netronics R&D Ltd., Dept. RE-12
333 Litchfield Road, Phone
New Milford, CT 06776 (203) 354-9375

Yes! I want to run programs at home and have enclosed: \$99.95 plus \$3 postage & handling for RCA COSMAC ELF II kit, \$4.95 for power supply (required), \$5 for RCA 1802 User's Manual, \$5 for *Short Course on Microprocessor & Computer Programming*.

I want mine wired and tested with power supply, RCA 1802 User's Manual and *Short Course* included for just \$149.95 plus \$3 p&h!

I am also enclosing payment (including postage & handling) for the items checked at the left.

Total Enclosed (Conn. res. add tax) \$ _____ Check here if you are enclosing Money Order or Cashier's Check to expedite shipment.
USE YOUR VISA Master Charge (interbank # _____)

Account # _____
Signature _____ Exp. Date _____
PHONE ORDERS ACCEPTED (203) 354-9375

Print Name _____
Address _____
City _____
State _____ Zip _____

DEALER INQUIRIES INVITED

CIRCLE 63 ON FREE INFORMATION CARD

Personal Computers & Microprocessing

Here are two inexpensive programmed learning courses designed to keep you up-to-date in digital electronics.

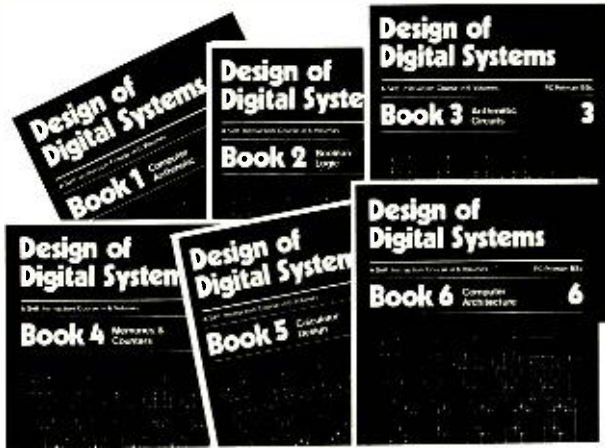

Design of Digital Systems - six volumes

The products of digital electronics technology will play an important role in your future. Calculators, digital watches and TV games are already commonplace. Now, microprocessors are generating a whole new range of products. Personal computers will be in widespread use very soon. Your TV, telephone and computer will combine to change your children's education, your job—your entire way of life.

WRITTEN BY EXPERTS

These courses were written by experts in electronics and learning systems so that you could teach yourself the theory and application of digital logic. Learning by self-instruction has the advantages of being faster and more thorough than classroom learning. You work at your own pace and respond by answering questions on each new piece of information before proceeding.

After completing these courses you will have broadened your career prospects as well as your understanding of the rapidly changing technological world around you.

The courses are designed as much for the professional engineer as for the amateur enthusiast. You'll learn about microprocessing as well as personal computing—not to mention all the other aspects of digital electronics design.

ADVANCED COURSE DESIGN OF DIGITAL SYSTEMS

Design of Digital Systems is written for the engineer and serious hobbyist who wants to learn more about digital electronics. Its six large-format volumes—each 11¼" x 8½"—are packed with information, diagrams and questions designed to lead you step by step through number systems and Boolean algebra to memories, counters and simple arithmetic circuits, and finally to a complete understanding of the design and operation of microprocessors and computers.

CONTENTS

The contents of Design of Digital Systems include:

Book 1: Octal, hexadecimal and binary number systems; representation of negative numbers; complementary systems; binary multiplication and division.

Book 2: OR and AND functions; logic gates; NOT, exclusive-OR, NAND, NOR and exclusive-NOR functions; multiple input gates; truth tables; DeMorgan's Laws; canonical forms; logic conventions; Karnaugh mapping; three-state and wired logic.

Book 3: Half adders and full adders; subtractors; serial and parallel adders; processors and arithmetic logic units (ALUs); multiplication and division systems.

Book 4: Flip-flops; shift registers; asynchronous counters; ring, Johnson and exclusive-OR feedback counter; random access memories (RAMs); read-only memories (ROMs).

Book 5: Structure of calculators; keyboard encoding; decoding display data; register systems; control unit; program ROM; address decoding; instruction sets; instruction decoding; control program structure.

Book 6: Central processing unit (CPU); memory organization; character representation; program storage; address modes; input/output systems; program interrupts; interrupt priorities; programming; assemblers; executive programs, operating systems, and time-sharing.

BASIC COURSE



Digital Computer Logic & Electronics

CONTENTS

Digital Computer Logic and Electronics is designed for the beginner. No mathematical knowledge other than simple arithmetic is assumed, though you should have an aptitude for logical thought. It consists of 4 volumes—each 11½" x 8½"—and serves as an introduction to the subject of digital electronics.

Contents include: Binary, octal and decimal number systems; conversion between number systems; AND, OR, NOR and NAND gates and inverters; Boolean algebra and truth tables; DeMorgan's Laws; design of logical circuits using NOR gates; R-S and J-K flip-flops; binary counters, shift registers and half-adders.

NO RISK GUARANTEE

There's absolutely no risk to you. If you're not completely satisfied with your courses, simply return them to GFN within 30 days. We'll send you a prompt, full refund, **Plus return postage.**

TAX DEDUCTIBLE

In most cases, the full cost of GFN's courses can be a tax deductible expense.

HOW TO ORDER

To order by credit card, call GFN's toll-free number — (800)331-1000; or send your check or money order (payable to GFN Industries, Inc.) to the address below.

Prices include overseas surface mail postage. **Air Mail:** additional costs (10 volumes); Caribbean \$10; Europe \$15; Africa, South America \$20; Australia, Asia \$25; or write for exact quote

Write for educational discounts, quantity discounts and dealer costs.

LOW PRICES - SAVE \$5

We ship promptly from stock. There are **no extras**—we pay all shipping costs; we even pay your sales tax where required. And if you order both courses, you save \$5. Order at no obligation today.

Design of Digital Systems \$19.95
- 6 volumes
Digital Computer Logic \$14.95
& Electronics - 4 volumes
Both courses - 10 volumes \$29.90

Also available at leading computer stores:

Computer Mart of New York, 118 Madison Ave., New York, NY
Erie Computer Co., 1253 West 8th St., Erie, PA.
Interactive Computers, 7646½ Dashwood, Houston, TX.
Interactive Computers, 16440 El Camino Real, Houston, TX
Interactive Computers, 217 W. San Francisco, Santa Fe, NM.
Readout Computer Stores, 6 Winspear Ave., Buffalo, NY
Imperial Computer Systems, Inc., 2105 23rd Ave., Rockford, IL
Home Computer Center, 6101 Yonge St., Willowdale, Ontario, Canada
and many others. Ask your dealer.



GFN Industries, Inc.
Suite 400-R
888 Seventh Ave.
New York
N.Y. 10019

Call TOLL-FREE (800) 331-1000
(orders only)

JUST \$495 GETS YOU THIS DUAL TRACE GOULD SCOPE PLUS TWO X10 PROBES.

You know that's a great price. Especially when you consider the outstanding performance you get with this Gould OS245A oscilloscope.

And you get clear, bright displays. 5mV/div. sensitivity and exceptionally versatile trigger performance. It's ideal for TV or general electronic service work; perfect for hobbyists and educational institutions. You can rely on Gould to live up to these specs:

- DC to 10 MHz; dual trace
- Trigger performance in excess of 15 MHz
- TV trigger facilitates solid synchronization with TV signals

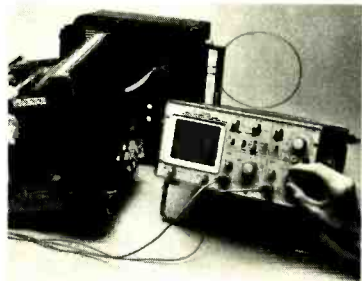

- Portable; weighs just 11 lbs.
 - Carries full two year warranty on all parts and labor excluding normal calibration, fuses and minor maintenance.
- Just one phone call gets you action.**

Don't miss out on

this bargain. Pick up the phone now and call us toll-free at 800-325-6400. (In Missouri call 800-342-6600). We'll rush you free literature and ordering information on the OS245A as well as other Gould oscilloscopes applicable to your needs. Gould Inc., Instrument Systems Division, 3631 Perkins Avenue, Cleveland, Ohio 44114.



CIRCLE 62 ON FREE INFORMATION CARD

SERVICE QUESTIONS

continued from page 82

open. Also, D101 was bad. I replaced it, but the new one lasts about 5 or 6 seconds and then shorts. Help!—D. W., Feeding Hills, MA.

The picture tube heater circuit in this set uses an instant-on transformer that places 5.0 volts on the tube heater. When you turn the switch on, the primary of this transformer is shorted out. In operation, the picture tube heater is fed from a winding on the flyback circuit. (This produces a 15,750-Hz pulse, at about 26 volts P-P, which is equal in heating effect to the normal 6 VAC 60-Hz pulse.)

If you used the substitute for D101 recommended in the parts list—RCA SK-3016—this is probably causing your trouble! The RCA SK-3016 is a "sine-wave diode," and the one you need must be a fast-recovery type. Try using SK-3175, SK-3515, etc. This applies to all sets using DC power supplies derived from flyback pulses.

R-E



HIGH BLOOD PRESSURE
Treat it...and live.

The National High Blood Pressure Education Program,
U.S. Department of Health, Education, and Welfare.

WANT TO CUT OUT A NEW CAREER IN LAND MOBILE SERVICE?

WE CAN HELP YOU SWITCH

... by providing professional HOME STUDY training for you and your technicians. MTI has been providing specialized training in land mobile servicing for 18 years. We would like to help you also. For more information, cut out this coupon.

NO SALESMAN WILL CALL!

Name _____

Address _____

City _____

State/Zip _____

ZZ3



Mobile Training Institute
Box 735, Camp Hill, PA 17011

CIRCLE 40 ON FREE INFORMATION CARD

THE ELECTRICAL TERMINAL & CONNECTOR SHOP™

Just about every bit of electrical hardware you'll ever need . . . over 1,000 pieces (that's 7 gross! over 84 dozen!) all organized & labeled in a heavy-duty, bin-cabinet!

You'll wonder how you ever did without it . . . truly one of the most important "tools" you could own!

FREE

A \$2.50-value, wall-size (17 1/2" x 24") Specifications Chart! Shows how to select the right terminal or connector . . . how to identify wire and stud sizes . . . and explains coding . . . and much, much more. Yours absolutely FREE!!

WORKSHOPS
ALL FOR JUST
\$29.95
plus \$3.90 shipping and handling

The hardware alone would cost around \$100 at retail prices! Price it out anywhere!!

25 MALE DISCONNECTS FULLY INSULATED 25 FEMALE DISCONNECTS FULLY INSULATED 35 MALE DISCONNECTS INSULATED



106 SPADE TERMINALS INSULATED 50 BUTT CONNECTORS 35 CLOSED END CONNECTORS 4 SPAD-SPICE CONNECTORS

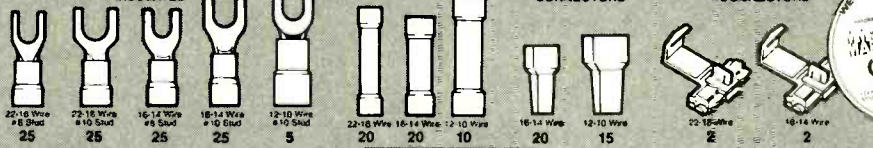

310 RING TERMINALS NON-INSULATED QUANTITIES IN BOLD TYPE 215 SPADE TERMINALS NON-INSULATED 3 ALLIGATOR CLIPS

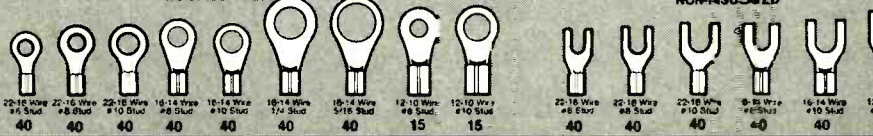

40 CABLE TIES 22-10 Wire Endless



LOOK AT ALL YOU GET! Every type, size and style of terminal and connector you'll probably ever need! Full size ranges!

- No more "making do" with just anything you have on hand!
- No more "drugstore quality" terminals and connectors!
- No more high prices!
- No more less-than-professional repair jobs!
- No more frustrating searches for the right piece of electrical hardware!
- No more time-consuming soldering!
- No more Saturday-morning trips to the hardware or electrical supply store!



To Order—24-hour Phone Service: Send check, money order, or company purchase order for full amount. Or charge it to any one of 5 major credit cards (see Order Coupon). Credit card buyers can also call our 24 hour, toll-free number: 800-247-2160 (in Iowa 1-800-362-2860).



UNCONDITIONAL 30-DAY GUARANTEE

Not Available in Retail Stores!

Mail to and make remittance payable to: 12243 D.R.I. Industries, Inc., Dept. RE-128 6864 Washington Avenue South, Eden Prairie, MN 55344

Indicate Order: Electrical Terminal & Connector Shop(s) @ \$29.95 plus \$3.90 shipping and handling each. Stanley Crimper(s) @ \$2.99 plus 75¢ shipping and handling each. (Limit: one per Shop purchased.)

Check (✓) Method of Payment: Check, money order, or company purchase order enclosed (MN residents add 4% sales tax). Charge it to: VISA/BankAmericard Master Charge American Express Diners Club Carte Blanche

CARD EXP. DATE _____
CARD NO _____
SIGNATURE X _____
NAME _____
ADDRESS _____
CITY _____ STATE _____ ZIP _____

© 1978 D.R.I. Industries, Inc. Eden Prairie, MN. "WORKSHOPS" and the "Electrical Terminal & Connector Shop" are trademarks of D.R.I. Industries, Inc. MAG-1
D.R.I. Industries, Inc., 6864 Washington Ave. So., Eden Prairie, MN 55344



PHILIPS

HICKOK



DORIC



Non-Linear Systems



C-Meter: MODEL 130 A precision, autoranging, capacitance meter

Autoranging
10 ranges are automatically selected from full scale values of 200 picofarads to 200,000 microfarads, with a maximum resolution of 0.1 picofarads.

Accurate
The C-meter achieves 0.1% (±1 count) up to 200 microfarads and 1% from 200 microfarads to 200,000 microfarads. It is accurate on all ranges at temperatures from 15° to 55°C (59° to 95°F).

DORIC \$325.

New Low Distortion Function Generator



MODEL 3010

- Generates sine, square and triangle waveforms
- Variable amplitude and fixed TTL square-wave outputs
- 0.1 Hz to 10 kHz in 10 ranges
- Push button range and function selection
- Typical sine wave distortion under 0.2% from 0.1 Hz to 100 kHz
- Variable DC offset for engineering applications
- VCO external input for sweep frequency tests

\$144.95

Regular price \$175.



MULTIFUNCTION COUNTERS

DISTINCTIVE PERFORMANCE FEATURES YOU CAN USE

The 1910A, 1911A And 1912A Family

Precise, rapid determination of frequency, period and period-average, coupled with totalize capability, represent superior versatility and performance in the Fluke 1910A, 1911A and 1912A multimeters. Here are the features and benefits that distinguish these hard working counters from all others in their price range.

Multifunction

The family does the work of counters costing much more. They measure frequencies to 10 MHz (1910A), 250 MHz (1911A), and 500 MHz (1912A) period of signal frequencies to 2 MHz.

Automatic Clean Dropout

The 1910A and 1912A CleanDrop input has a circuit which automatically monitors the input and gives you instant warning as the input level falls below the preset threshold of the trigger circuit. When the signal level returns to an acceptable level, the counter locks on for a correct reading. When you get a reading, you know it's right.

Sensitivity

A loss sensitivity of 15 mV, backed by Fluke's conservative design margin, guarantees you will get reliable, solid readings every time. In practice, a typical sensitivity of 10 mV will be experienced.

Autoreset

This automatic feature is activated every time you select a new range or function, which means you never have to wait for a second reading the first one in the new measurement sequence is always correct. Jobs of save time and reduce errors.

125 MHz 1910A \$395

250 MHz 1911A \$495

500 MHz 1912A \$620



SPECIFICATIONS

Input Characteristics

Model	Channel	Operating Range		Sensitivity
		Frequency	Period	
1910A	A	5 Hz 125 MHz	500 ns 0.25 to 10 2 MHz	15 mV rms, 5 Hz 25 mV rms, 100 MHz
		5 Hz 125 MHz	500 ns 0.25 to 10 2 MHz	15 mV rms, 5 Hz 25 mV rms, 100 MHz
1911A	A	5 Hz 125 MHz	500 ns 0.25 to 10 2 MHz	15 mV rms, 5 Hz 30 mV rms, 175 MHz
		50 MHz 250 MHz		15 mV rms, 50 MHz 25 mV rms, 175 MHz
1912A	A	5 Hz 125 MHz	500 ns 0.25 to 10 2 MHz	15 mV rms, 5 Hz 25 mV rms, 100 MHz
		50 MHz 500 MHz		25 mV rms, 50 MHz 50 mV rms, 500 MHz



DIGITAL MULTIMETERS

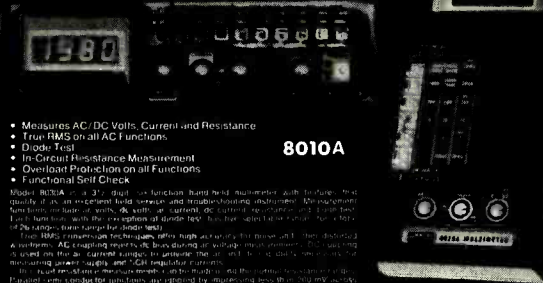

- Measures AC/DC Volts, Current and Resistance
- True-RMS on all AC Functions
- Diode Test
- In-Circuit Resistance Measurement
- Overload Protection on all Functions
- Functional Self Check

8010A

Model 8010A is a 3 1/2 digit, four function hand held multimeter with features that qualify it as an exceptional value source and trouble-free instrument. Measurement functions include AC/DC volts, AC current, DC current, resistance and diode test. Each function, with the exception of diode test, has four separate ranges for choice of 2% tolerance (see range for diode test).

The 8010A measures AC voltage, RMS, with accuracy of 1% or less. True RMS digital systems AC coupling input AC levels during AC voltage measurements. The coupling is used on the AC current ranges to guarantee the accuracy of the digital conversion of measuring current. Voltage and AC current currents.

The 8010A provides a maximum resolution of 0.1 microamps on the DC current range and 0.1 microamps on the AC current range. The 8010A is designed for maximum accuracy by engineering precision components, the industry standard.

SPECIFICATIONS

	DC Volt	AC Volt	DC Current	AC Current	Ohm	Diode Test
Range	0.2-100V	0.2-750V	0.2-100mA	0.2-10A	200-2000Ω	0.2-10V
Resolution	100 μV	100 μV	100 μA	100 μA	10 Ω	0.1
Accuracy	±0.1%	±0.5%	±0.5%	±1%	±2%	±0.2%

8010A \$239.

8020A

- 26 Ranges—5 Functions plus New Conduction Function for up to 10,000 Mill Leakage Measurements
- Extensive Overload and Transient Protection
- Rugged Construction—1 Year Warranty
- Hi/Low Power Ohms for In-circuit Resistance and Diode Testing
- 10 MHz AC/DC Input Impedance Doesn't Load Circuit
- 200 Hour 9V Battery Life—Low Battery Indicator
- Large LCD Readout—2000 Counts
- 1 Year Calibration Cycle—Only 3 Adjustments
- One Hand Operation
- Complete with Battery and Test Leads

The 8020A has been designed with the user in mind and features exclusive one-hand operation. For harsh service environments, the 8020A has a ruggedized case and extensive overcurrent protection backed up by a 1 year warranty. Long term stability (1 year calibration cycle) is excellent with only three cal adjustments. Up to 200 hours of continuous operation can be expected from a single 9V alkaline battery.

BASIC SPECIFICATIONS

	DC Volt	AC Volt	DC Current	AC Current	Ohm	Conductance
Range	0.2-100V	0.2-750V	0.002-2A	0.002-20A	200Ω-20MΩ	200 μS-2 mS
Resolution	100 μV	100 μV	1 μA	1 μA	0.01 Ω	0.1 μS
Accuracy	±0.25%	±0.75%	±0.75%	±1%	±1.5%	±0.3%

8020A \$169.



520 MHz Frequency Counter

MODEL 1850

- 500 to 520 MHz reading guaranteed—400 MHz typical
- Gate time from 10ms to 10 seconds
- Full period measurement capability
- 50 mV input sensitivity at 500kHz
- Operates from 115 or 230 VAC or 12 VDC
- Well protected input circuitry
- Temperature compensated crystal oscillator (TCXO)

\$379.95

Regular price \$450.

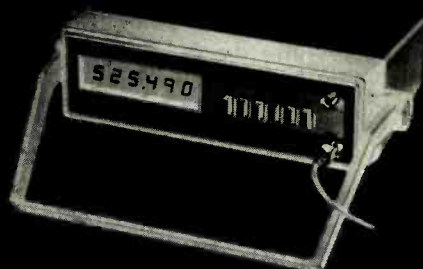

LCR-740 Transistorized LCR Bridge

- Highly accurate 3 digit readout.
- Measures Inductance (L), Capacitance (C) and Resistance (R), within ±0.5% accuracy.
- Range expandable—built-in 10% over range.
- Loss Factor scale (D).
- Battery, or AC adapter operation.

\$279.95

Regular price \$310.



LCG-395 SOLID STATE VIDEO COLOR SIGNAL SOURCE

- Provides staircase, window, convergence and white purity adjustments
- Multi-purpose applications for CATV, MATV, CCTV, VTR and NTSC testing
- Segment display information provides data details for every color check requirement
- Exclusive convergence check facility gives hztl and vert'l lines and dots within 80% safety margin
- 5-step staircase signal for checking modulation levels in 20% segments from 0 (black) to 100% (white)
- Window and noiseless white raster position
- 10 gated rainbows, plus 3 gated color bars, plus overall rainbow pattern
- Return trace blanking for vert'l hztl signals
- 2 switch selectable RF chan frequencies

\$199.95

\$299.95

Regular price

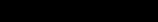
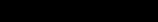
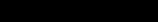
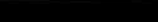
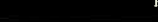
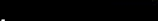
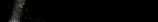
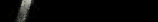
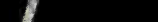

Simpson

TRIPLETT

BK PRECISION

VIZ formerly **NSA**

LEADER



DATA PRECISION

Dual-Trace 5" 30MHz Triggered Scope...

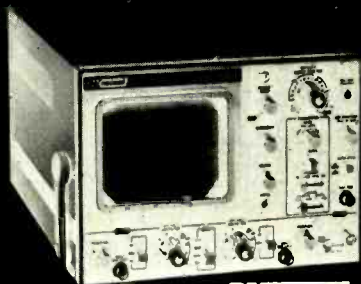

MODEL
1474

- Sweep time 11.2 uls or less
- Sweep of leading edge, rise permits
- Triggers on signals up to 50 MHz
- Selects vertical sensitivity
- Mode automatically shifts
- Includes CMOS and ALTERNATE
- Checks user digital logic circuitry, including ECL
- High accuracy ion position vertical
- Flat response with smooth roll-off
- PDA CRT with P21 phosphor
- Manual trigger and freeze-flare
- Maintains calibration accuracy from
- 100-130 VAC and 200-250 VAC
- 50 calibrated sweeps - 9.2 x 10 cm
- -8.5 cm

\$729.⁹⁵

BK PRECISION

Probes not included in price

LBO-520
30MHz, Fixed Delay

LEADER
Instruments Corp.



- Dual trace, 30MHz bandwidth
- 5mV/cm Vertical Sensitivity
- Fixed delay facilitates hi-speed readings of the leading edge of a pulse or pulse train
- Add subtract, alternate selection, chopped and front panel X-Y modes broaden areas of application
- TV sync and TV-H sync for both CH-1 & 2

\$849.⁹⁵

Regular price \$1,150.

Model 517
Dual-Trace
15 MHz
Triggered
Oscilloscope

HICKOK

\$589.⁹⁵

Regular price \$695.

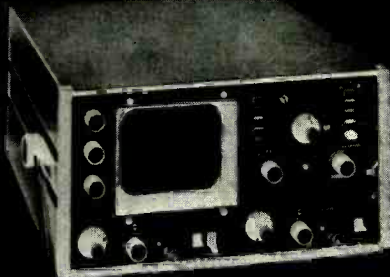

- 15 MHz response flat within 3dB for all signal levels. Excellent pulse response
- Minimizes overshoot and ringing
- Sensitive sensitivity useful for solid state work
- Footprint fitting to 27 MHz (30 MHz typical)
- X-Y operation for vector scope measurements
- Bright 5 cm x 10 cm display
- Auto mode triggering provides baseline for recurrent sweep operation
- CHOP or ALTERNATE mode automatically selected as sweep time is changed for speedy setup

- Algebraic sum and difference capability
- Differential input capability
- Digital logic circuit capability, including CMOS
- Analyze CB AM and SSB waveforms
- TV sync separator built-in
- Regulated power supply maintains amplifier gain with changes in line voltage from 105 to 125 volts

LBO-508
20MHz, Dual Trace

LEADER
Instruments Corp.



- Add subtract modes on CH-1 & CH-2 facilitates easy check-out for simultaneous pulses, signal levels, distortion & noise cancelling
- Front panel X-Y operation useful for phase shift measuring, sweep alignment, vector scope service
- 17.5 Sec rise time
- Automatic chop and alternate selection for low and high frequency checks
- Automatic trigger for CH-1 or 2 includes TV sync
- 10mV to 20V/cm Vertical Sensitivity; 11 steps
- 0.5µs/cm to 200MS/cm sweep speed; 14 steps; X5 magnification

\$614.⁹⁵

Regular price \$765.

SUPER SPECIALS

Shipping not included in prices Sale ends Dec. 31, 1978

New 15MHz portable 3" dual-trace scope

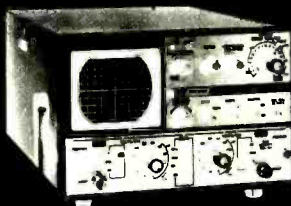

MODEL
1432

- 15MHz bandwidth with smooth roll-off; usable response extends beyond 30MHz
- 2mV/div. vert. at sensitivity
- Operates on 117VAC, 234 VAC, 12VDC or optional internal battery pack
- Fully regulated high and low-voltage supplies
- Fully automatic and subtraction of Channel 1 and 2 input signals
- Nine-step calibrated range range covers 6 microsecond to 3.3 seconds
- TTL Compatible 2-bit input
- Compact size; measures only 1.6 x 3.1 x 1.3
- Includes tie-in body 10-1 direct probes and accessory tape
- Built-in sync separator

BK PRECISION

\$629.⁹⁵

Regular price \$780.

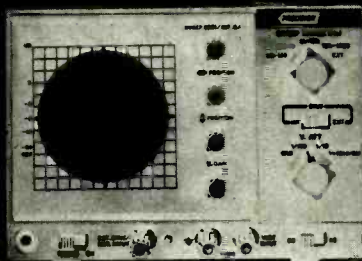

5MHz Solid State 3" Oscilloscope

MODEL
1403A

BK PRECISION

- 5 MHz with high sensitivity
- For protection level, schools, field service work, hobbyists
- CB modulation monitor
- Ultra-compact and lightweight; 600g approx
- Use the 100µs to release more expensive scopes from monitoring applications
- Vertical sensitivity of 10mV/division
- High brightness CRT and shock-proof globe

\$209.⁹⁵

Regular price \$250.

3-1/2 Digit DMM with .5% Accuracy



BK PRECISION

MODEL
2810

\$109.⁹⁵

Regular price \$130.

- 3 1/2 digit easy to read LED display
- 0.5% DC accuracy typical
- 60,000, 0.1% resolution
- 0.1µm range and control 0.1µm accuracy
- Adjustable high, low power, auto, and auto zeroing
- Compactly overlaid protective on all 25 ranges
- 100% overrange reading to 2000 counts full scale
- Protected against RF interference
- Completely portable

THE TEST EQUIPMENT SPECIALISTS

TOLL FREE HOT LINE
800-223-0474

54 West 45 Street, New York, N.Y. 10036 212-687-2224

ADVANCE ELECTRONICS

The Big, NEW HEATHKIT® Christmas Catalog is just off the press!

FR

Read about all the exciting new products you can give, or get, for real kitbuilding fun and satisfaction! We're the world's biggest and best source of quality money-saving electronic kits.

New

Computerized Weather Monitor

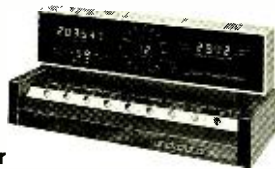

If you need weather information for ANY purpose, the ID-4001 is the way to get it! This microcomputer-based weather instrument digitally displays—time of day in 12 or 24-hour format; wind direction and magnitude; indoor and outdoor temperature; barometric pressure; even wind chill factor! What's more, the computer's memory stores the highest and lowest data for each function so you can recall it for easy and accurate record keeping. Chart recorder and computer outputs provide even more versatility!

Includes remote transmitter with windcups and weathervane that have been wind-tunnel tested and an outdoor temperature sensor using the latest infra-red technology.

New

Hand-Held 2-Meter Transceiver

Superb features, specifications and a great low price make the VF-2031 a terrific buy in a hand-held two-meter transceiver.



Features 8-channel simplex with ± 600 kHz offset using one crystal per channel, minimum 2 watts out, and 0.5 μ V sensitivity for 20 dB quieting. Includes built-in antenna, nickel-cadmium batteries and battery charger. An optional tone encoder and other accessories are also available. Units will be available in January, subject to FCC approval.

New

WH14 Line Printer for "Hard Copy" Computer Readout



Low-cost microprocessor-controlled line printer is designed to give you a convenient "hard copy" printout of your computer programming. It eliminates losing and recalling program lines after they have scrolled off a CRT, it also provides handy printed lists of address lines, lists or other program data for easy editing and manipulation. Prints the standard 96-character ASCII set (upper AND lower case) on a 5x7 dot matrix print head. Designed for use with Heathkit computers and others as well. Available fully assembled and tested only.

New

Digital Readout Car Clock with Trip Timer



Versatile clock/timer for any vehicle shows time in hours and minutes, has 24-hour timer that reads to nearest second. Bright, easy-to-read display, low-power circuit doesn't drain battery.



New
Battery-Operated Portable Timing Light

Operates on its own rechargeable batteries for safety, convenience and complete portability. Ideal for use on boats or other vehicles where battery may be inaccessible. Also features dual-range tachometer, rugged pistol grip, extra-bright xenon tube for easy-to-see timing flashes.

New

Low-Cost Dual-Trace Oscilloscope

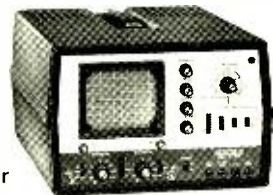

Low-priced dual-trace scope ideal for audio and TV servicing. Features outstanding sensitivity, extra-bright traces, selectable triggering, 7-position variable time base, DC to 5 MHz bandwidth.

HEATHKIT ELECTRONIC CENTERS* PROVIDE SALES AND SERVICE



*Units of Schlumberger Products Corporation.

Retail prices may be slightly higher.

Heath Company, Dept. 020-480
Benton Harbor, Michigan 49022

ARIZONA — Phoenix, 85017, 2727 W. Indian School Rd. 602-279-6247.

CALIFORNIA — Anaheim, 92805, 330 E. Ball Rd. 714-776-9420; El Cerrito, 94530, 6000 Potrero Ave. 415-236-8870; Los Angeles, 90007, 2309 S. Flower St. 213-749-0261; Pomona, 91767, 1555 N. Orange Grove Ave. 714-623-3543; Redwood City, 94063, 2001 Middlefield Rd. 415-365-8155; Sacramento, 95825, 1860 Fulton Ave. 916-486-1575; San Diego, (La Mesa, 92041), 8363 Center Dr. 714-461-0110; San Jose (Campbell, 95008), 2350 S. Bascom Ave. 408-377-8920; Woodland Hills, 91364, 22504 Ventura Blvd. 213-883-0531.

COLORADO — Denver, 80212, 5940 W. 38th Ave. 303-422-3408.

CONNECTICUT — Hartford (Avon, 06001), 395 W. Main St. (Rte. 44) 203-678-0323.

FLORIDA — Miami (Hialeah, 33012), 4705 W. 16th Ave. 305-823-2280; Tampa, 33614, 4019 West Hillsborough Ave. 813-886-2541.

GEORGIA — Atlanta, 30342, 5285 Roswell Rd. 404-252-4341.

ILLINOIS — Chicago, 60645, 3462-66 W. Devon Ave. 312-583-3920; Chicago (Downers Grove, 60515), 224 Ogden Ave. 312-852-1304.

INDIANA — Indianapolis, 46220, 2112 E. 62nd St. 317-257-4321.

KANSAS — Kansas City (Mission, 66202), 5960 Lamar Ave. 913-362-4486.

KENTUCKY — Louisville, 40243, 12401 Shelbyville Rd. 502-245-7811.

LOUISIANA — New Orleans (Kenner, 70062), 1900 Veterans Memorial Hwy. 504-722-6321.

MARYLAND — Baltimore, 21234, 13 E. Joppa Rd. 301-661-4446; Rockville, 20852, 5542 Nicholson Lane. 301-881-5420.

MASSACHUSETTS — Boston (Peabody, 01960), 242 Andover St. 617-531-9330; Boston (Wellesley, 02181), 165 Worcester Ave. (Rt. 9 just west of Rt. 128) 617-237-1510.

MICHIGAN — Detroit, 48219, 18645 W. Eight Mile Rd. 313-535-6480; E. Detroit, 48021, 18149 E. Eight Mile Rd. 313-772-0416.

MINNESOTA — Minneapolis (Hopkins, 55343), 101 Shady Oak Rd. 612-938-6371; St. Paul, 55106, 1645 White Bear Ave. 612-778-1211.

MISSOURI — St. Louis (Bridgeton) 63044, 3794 McKelvey Rd. 314-291-1850.

NEBRASKA — Omaha, 68134, 9207 Maple St. 402-391-2071.

NEW JERSEY — Fair Lawn, 07410, 35-07 Broadway (Rte. 4) 201-791-6935; Ocean, 07712, 1013 State Hwy. 35. 201-775-1231.

NEW YORK — Buffalo (Amherst, 14226), 3476 Sheridan Dr. 716-835-3090; Jericho, Long Island, 11753, 15 Jericho Turnpike. 516-334-8181; Rochester, 14623, 937 Jefferson

CIRCLE 100 ON FREE INFORMATION CARD

www.americanradiohistory.com

EE



Heathkit®

41 New Products for Christmas Giftgiving-1978

NO EXPERIENCE NECESSARY
 Thousands of people with no electronics experience whatsoever — people who have never handled a soldering iron before — have proved that you can build any Heathkit product you want — and enjoy every moment of it! Simple step-by-step manuals make it easy as 1-2-3.



New
Portable Room-Size Electronic Air Cleaner

An important addition to any household — it removes dust,

dirt and pollutants from any room in your house while cleaning and refreshing the air — and all for just pennies a day. It's especially important for insulated and tightly sealed houses where air can get "stale" after parties, smoking, etc. Features 3-way cleaning operation to remove both large and small particles and household odors. Variable speed control that lets you "quick-clean" a room, then lower the speed to maintain a fresh air level. Handsome Southern-Pecan vinyl finish cabinet blends nicely with any decor. Easy NO SOLDER kit assembly too.

Read about these and nearly 400 other fascinating and practical electronic kits you can build yourself for fun, for satisfaction and for savings. Mail coupon for your catalog today!

COAST-TO-COAST

- Rd. 716-244-5470; White Plains (North White Plains, 10603), 7 Reservoir Rd. 914-761-7690.
- OHIO — Cincinnati (Woodlawn, 45215), 10133 Springfield Pike. 513-771-8850; Cleveland, 44129, 5444 Pearl Rd. 216-292-7553; Columbus, 43229, 2500 Morse Rd. 614-475-7200; Toledo, 43615, 48 S. Byrne Rd. 419-537-1887.
- OKLAHOMA — Oklahoma City, 73112, 2727 Northwest Expressway. 405-848-7593.
- PENNSYLVANIA — Philadelphia, 19149, 6318 Roosevelt Blvd. 215-288-0180; Frazer (Chester Co.) 19355, 630 Lancaster Pike (Rt. 30) 215-647-5555; Pittsburgh, 15235, 3482 Wm. Penn Hwy. 412-824-3564.
- RHODE ISLAND — Providence (Warwick, 02886), 558 Greenwich Ave. 401-738-5150.
- TEXAS — Dallas, 75201, 2715 Ross Ave. 214-826-4053; Houston, 77027, 3705 Westheimer. 713-623-2090; San Antonio, 78216, 7111 Blanco Road. 512-341-8876.
- UTAH — Salt Lake City (Midvale, 84047), 58 East 7200 South. Opening Mid-November.
- VIRGINIA — Alexandria, 22303, 6201 Richmond Hwy. 703-765-5515; Norfolk (Virginia Beach, 23455), 1055 Independence Blvd. 804-460-0997.
- WASHINGTON — Seattle, 98109, 505 8th Ave., N. 206-682-2172.
- WISCONSIN — Milwaukee, 53216, 5215 W. Fond du Lac. 414-873-8250.

A Heathkit gift is a truly satisfying way to celebrate the holiday season. In addition to giving a fine piece of electronic equipment that will perform beautifully for years to come you also give the pride, satisfaction and sense of accomplishment that come with building it yourself.



HEATHKIT MAIL ORDER CATALOG 842
Heath and Heathkit are registered trademarks of Heath Company
 ©1978 Heath Company

SUPER HOLIDAY SPECIAL!
 FREE Remote Control worth \$89.95 with purchase of any 25" or 21" Heathkit Color TV! See pages 90-94.

See handy index on back cover.

This FREE Catalog coupon can also be redeemed at any of the Heathkit Electronic Centers* nationwide. (See list at left.)

HEATH	
Schlumberger	Heath Company, Dept. 020-430 Benton Harbor, Michigan 49C22
Please send me my FREE Heathkit Catalog. I am not on your mailing list.	
Name _____	
Address _____	
City _____	State _____
GX-359	Zip _____

CIRCLE 100 ON FREE INFORMATION CARD

ADVANCED Electronic Music

Products.... effects devices to computer controlled modular synthesizers. Select from experimenter's kits, step-by-step product kits or fully assembled professional equipment.



Free color catalog

FAA ELECTRONICS, INC.
1020 W. Wilshire Blvd. Oklahoma City, OK 73116

SEND FREE CATALOG TO:

name _____

address _____

city _____ state _____ zip _____

FAA ELECTRONICS, DEPT. R

1020 W. WILSHIRE BLVD., OKLAHOMA CITY, OK 73116

CIRCLE 32 ON FREE INFORMATION CARD

Put Professional Knowledge and a **COLLEGE DEGREE** in your Electronics Career through

HOME STUDY

Earn Your DEGREE

by correspondence, while continuing your present job. No commuting to class. Study at your own pace. Learn from complete and explicit lesson materials, with additional assistance from our home-study instructors. Advance as fast as you wish, but take all the time you need to master each topic. Profit from, and enjoy, the advantages of directed but self-paced home study.

The Grantham electronics degree program begins with basics, leads first to the A.S.E.T. degree, and then to the B.S.E.E. degree. Our free bulletin gives complete details of the program itself, the degrees awarded, the requirements for each degree, and how to enroll. Write for *Bulletin R-79*,

Grantham College of Engineering
2000 Stoner Avenue
P. O. Box 25992
Los Angeles, CA 90025

Worldwide Career Training thru Home Study
CIRCLE 12 ON FREE INFORMATION CARD

Designing Digital Circuits

Continued from page 66

entry in the group below it, seeing if the differences in parentheses are the same (though they may be in any order), and seeing if the difference of the first numbers is a power of two. Indicate the end of the check of each group by a horizontal line in the next column, to show a new group there.

We now have a list of cubes that cover the 1-output boxes, similar to the cover created in the Karnaugh map. However, using the Karnaugh map, one can visually inspect to obtain the largest cubes to cover each 1-labeled box. This is not the case using the Q-M method, so a "cover map" must be drawn. On this map, we draw vertically the decimal equivalents of the cubes that are left unchecked in Fig. 12, and draw horizontally the decimal equivalent of each input that is to produce a 1 (but not a don't-care) output (see Fig. 13). A check is now placed in each box of

	4	8	9	12	13	14
4,12	✓			✓		
12,14				✓		✓
8,9,12,13		✓	✓	✓	✓	

FIG. 13—COVER MAP is obtained by listing the decimal equivalents of the unchecked cubes from Fig. 12.

the table under the column that is covered by a given row, i.e., the row labeled 4,12 has a check in columns 4 and 12.

Now we look at each column to see which rows are needed. We see that the column labeled 4 has only one check, in row 4,12. Thus row 4,12 (i.e., the term corresponding to 1-cube 4,12, as in the Karnaugh map) is essential to obtain an output of 1 when 4 is input, so we place a check above the columns numbered 4 and 12 to indicate that these have been covered. Column 8 has only one check, indicating row 8,9,12,13 is essential. A check is placed by this row and above columns 8, 9, 12 and 13. The only uncovered column is 14, which can only be covered by row 12,14. That row and column 14 are checked. The map now appears as shown in Fig. 14.

	✓	✓	✓	✓	✓	✓
	4	8	9	12	13	14
✓	4,12	✓		✓		
✓	12,14			✓		✓
✓	8,9,12,13		✓	✓	✓	✓

FIG. 14—ESSENTIAL ROWS are determined and then confirmed by placing a check next to them.

All columns with only one check in them should be handled first in this manner. For the remaining unchecked columns with more than one table entry

check, choose the largest possible cubes to cover the most unchecked columns. In this manner, the function will be completely reduced. In any case, all columns must have a check above them when done, so that all output situations are covered. Any rows that do not have a check beside them are eliminated.

The remaining rows (those with a check to the left of them) then correspond to the inputs to each of the gates. To determine the inputs, the decimal numbers in the labels of each row are written in binary, and the input bits that do not change between the numbers are the inputs to the gate. For example, Fig. 15 illustrates that for row 8,9,12,13, bit a_1

	a_1	a_2	b_1	b_2
8	1	0	0	0
9	1	0	0	1
12	1	1	0	0
13	1	1	0	1

FIG. 15—TRUTH TABLE of final function is shown.

must always be on, and bit b_1 must always be off, while a_2 and b_2 may be either 0 or 1, to generate a 1-output for this term of the expression. Thus, the output is 1 if $a_1\bar{b}_1 = 1$. Similarly, row 4,12 indicates a 1-output if $a_2\bar{b}_1\bar{b}_2 = 1$, and row 12,14 indicates a 1 output if $a_1a_2\bar{b}_2 = 1$. Our final function is thus:

$$f = a_1\bar{b}_1 + a_2\bar{b}_1\bar{b}_2 + a_1a_2\bar{b}_2$$

This function is implemented as shown in Fig. 16.

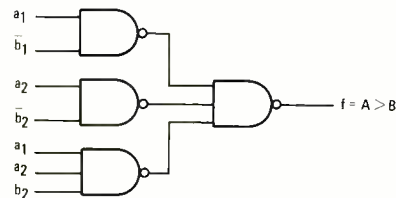

FIG. 16—LOGIC CIRCUIT implementation of truth table shown in Fig. 15.

Next month we will discuss multiple-output functions and sequential circuits along with cover maps and truth and state tables used in digital circuit design. **R-E**



"Don't let on you know—but actually it's just a simple project requiring the plugging of a few units into a prewired PC board."

SPEAKER CABLES
continued from page 62

patches, etc., because they deteriorate the quality of the audio signal. M & K claims its cable has an inductance that is 12 times lower than No. 12 zip cord and comparable resistance.

The Fulton cable uses silver-plated wire; the tips are finished off in spade lugs; 30-foot sections of No. 16 wire cost \$1.34-per-foot; and No. 12 cable costs \$2.60-per-foot.

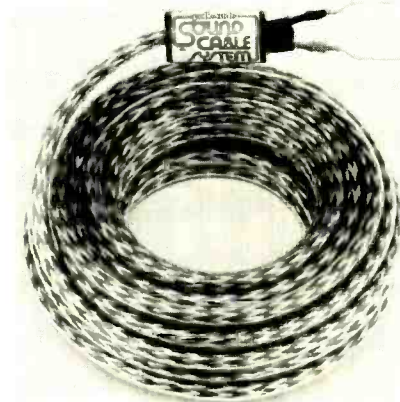

FIG. 6—POLK AUDIO SPEAKER CABLE consists of 144 strands of low-resistance wire braided into two sets of conductors at right angles to each other.

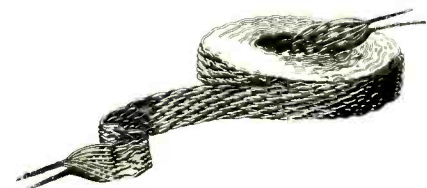

FIG. 7—AUDIO SOURCE's High Definition cable, with 10-ohm impedance, has 10 pairs of braided wire, connected in parallel and with special tips.

The Polk cable comes in a round version (see Fig. 6) at \$1.34-per-foot; in four different lengths, up to 50 feet; and is claimed to have a characteristic 9-ohm impedance. The Polk cable consists of 144 strands of separately insulated, low-resistance wire braided into two sets of conductors that constantly lie at right angles to each other to avoid inductance.

All the braided cables are arranged this way because it is claimed that this eliminates interference between the adjoining magnetic fields, thus minimizing self-inductance. In addition, the two polarities are brought as close as possible to each other to insure minimal and correct characteristic impedance.

The *Mogami* cable's stacked arrangement has an inner core of nonconductive material for spacing and extra strength; a final conductor layer has 60 strands of wire about equal to No. 11; a layer of insulation made of tough synthetic material; and another conductor layer wound

continued on page 102

How do you really use a multimeter?

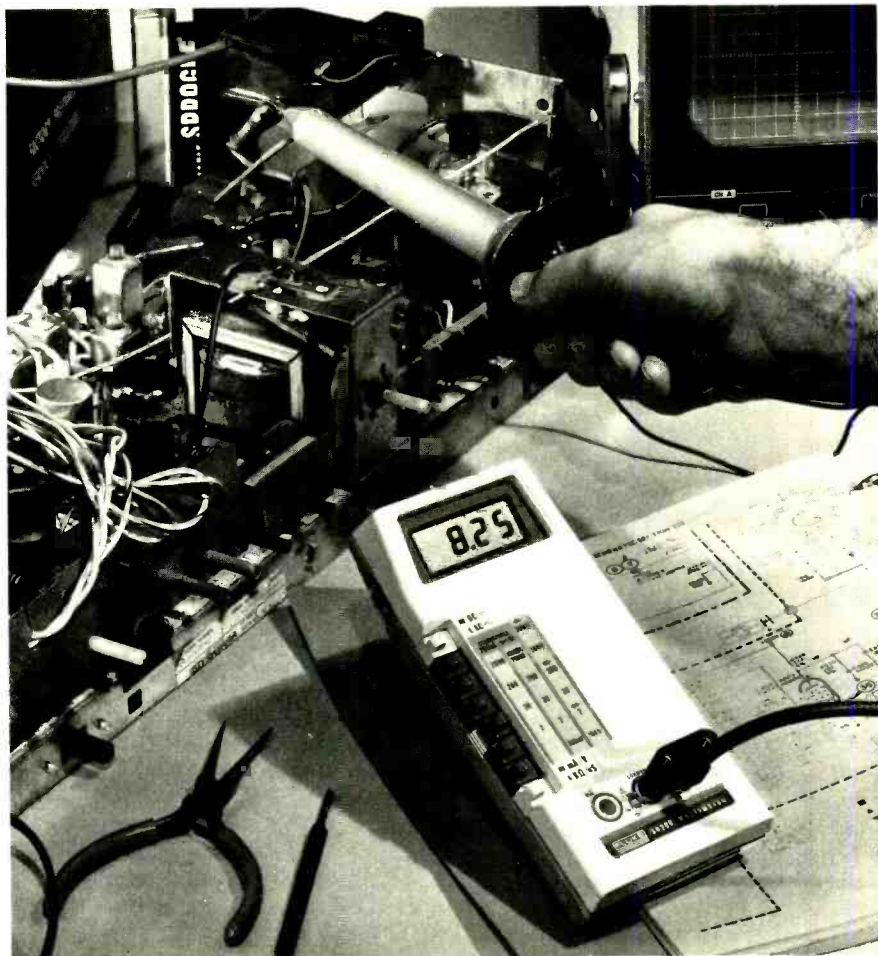

Usually at your bench, in the shop, shared with others. And, if it's a Fluke multimeter, you use it with confidence.

Now you can carry that same bench precision on the job. Introducing the new Fluke 8020A DMM for only \$169.

This rugged beauty packs more field-valuable features than any other DMM available, at any price. And that means field versatility when you need it most.

The 8020A has six resistance ranges, including a 20 megohm range for those special high-resistance TV components. Plus, you can measure focus dividers, pcb and capacitor leakage clear up to 10,000 megohms with the new conductance function. And conductance allows you to measure transistor beta—unique

with the 8020A.

Ever damaged your meter in the fly-back circuit? Rest easy. The 8020A is MOV-protected to 6000V against hidden spikes and transients.

Your 8020A comes with a full-year warranty, with worldwide service backup. Regardless of what happens to it, we'll fix it inexpensively and quickly, making the 8020A a truly cost-effective investment.

Call (800) 426-0361*, toll free. We'll tell you the location of the closest Fluke office or distributor for the best value in DMMs around.

Price U.S. only.

*Alaska, Hawaii and Washington residents — please call (206) 774-2481.

The DMM for Home Electronics Experts.

2507-7207



CIRCLE 79 ON FREE INFORMATION CARD

THE COUNTERS YOU REALLY WANT

MODEL 380



MODEL 385

AT AFFORDABLE PRICES.

A Model for every need.

MODEL 380. 1 Hz to 80 MHz, 10 ppm	\$209
MODEL 380X. 1 Hz to 80 MHz, 1ppm	\$269
MODEL 385. 1 Hz to 512 MHz, 10ppm	\$419
MODEL 385X. 1 Hz to 512 MHz, 1ppm	\$499

Perfect for communications, CB, audio, TV and digital work, servicing and laboratory applications.

All 4 field-proven models feature full 7-digit display with automatic decimal and full autoranging. Our exclusive SPEED READ mode provides fast update (5/sec) time for easy tuning and adjusting.

Handsome, rugged metal case with brushed aluminum panel including all-angle tilt stand. (Low cost rack mounting kits for standard 19" rack also available.) All models come packaged in a plastic carrying case that protects the unit in shipment and in use.

Why settle for less than the best. See these hard-working counters at your distributor now.

If you're outside of Ohio, call us toll free at 800-321-4664 for the name of your nearest Hickok distributor.

HICKOK

the value innovator

INSTRUMENTATION & CONTROLS DIVISION
THE HICKOK ELECTRICAL INSTRUMENT CO.
10514 Dupont Avenue • Cleveland, Ohio 44108
(216) 541-8060 • TWX: 810-421-8286

CIRCLE 55 ON FREE INFORMATION CARD

new products

More information on new products is available from manufacturers of items identified by a Free Information number. Free Information Card is inside back cover.

DIP SOCKET low-profile unassembled Molex sockets available in 14-pin and 16-pin versions. IC DIP sockets come in display card package containing four terminal carrier strips and four IC nests. When assembled, components form two complete DIP sockets whose terminals are made of 70/30 spring-tempered tin-plated brass. Assembly instructions are given on the back of the

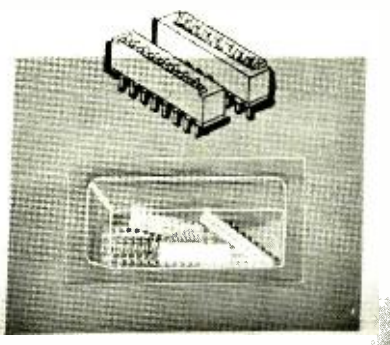

card. Socket assemblies are available from Waldom distributors. Prices: parts for two 14-pin sockets, 95¢; two 16-pin sockets, \$1.—Waldom Electronics, Inc., 4301 W. 69th St., Chicago, IL 60629.

CIRCLE 114 ON FREE INFORMATION CARD

MAGNETIC SCREWDRIVER, model 70035, has magnet built into the shank to hold interchangeable bits plus the screw. Confordome handle has a removable dome cap that keeps three extra bits

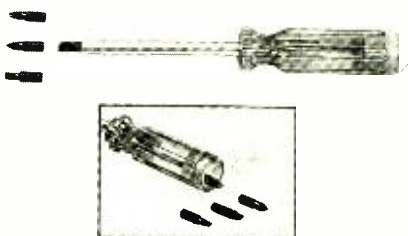

stored inside handle while fourth bit is being used. Comes with 1/16-in. and 1/32-in. slotted, No. 1 and No. 2 Phillips bits.—Vaco Products, 1510 Skokie Blvd., Northbrook, IL 60062.

CIRCLE 115 ON FREE INFORMATION CARD

WIRELESS REMOTE CONTROL, model GP-500, attaches to the antenna terminals of any black-and-white or color TV set. The unit's 10-channel capacity is tunable to either VHF or UHF, and each channel can be preset. A built-in RF preamplifier has a power gain of 30 dB (typical). Other specifications include: Maximum noise—90 dB (VHF) and 12 dB (UHF); IF rejection—40-dB minimum (VHF) and 60-dB minimum (UHF); minimum

image rejection—50 dB (VHF) and 40 dB (UHF); input impedance—75 ohms; tuner frequency bands—55.25 to 83.25 MHz, 175.25 to 211.25



MHz (VHF); 471.25 to 888.25 MHz (UHF). The model GP-500 components are encased in two-tone high-impact plastic; the receiver measures 6 X 10 1/4 X 3 1/4 inches; the transmitter measures 2 1/2 X 5 1/4 X 1 inch. Suggested list price: \$99.95.—GP Electronics, Ltd., Subsidiary of Gold Peak Industries, Ltd., Box 261, Middletown, NJ 07748.

CIRCLE 116 ON FREE INFORMATION CARD

SOLDER STRIP PACKAGE, *Emergency Solder*, is designed for on-the-spot repairs and requires only a match to melt the solder. Multiple cores of noncorrosive, nonconductive flux are contained in the strips. *Emergency Solder* can be used on any solderable metal (not suitable for aluminum). Package includes 36 inches of solder strip, and complete directions.—Multicore Solders, Westbury, NY 11590.

CIRCLE 117 ON FREE INFORMATION CARD

DUAL-TRACE 30-MHz OSCILLOSCOPE, model LBO-520, offers built-in 120-ns delay line. Among the unit's other features are a 5 mV-per-division vertical sensitivity; display modes include Channel 1, Channel 2, alternate, subtract, add and X-Y modes; continuously variable sweep speeds from 0.2 μs-per-centimeter to 0.5 second-per-centi-



meter; X 10 magnification. In addition, the model LBO-520 provides trace rotations; + and - polarity; an uncalibrated warning indicator lamp; and lever-type input switches. Priced at under \$1000, the instrument comes with contoured

handle that doubles as locking bale; probes and accessories are included.—**Leader Instruments Corp.**, 151 Dupont St., Plainview, NY 11803.

CIRCLE 128 ON FREE INFORMATION CARD

LOGIC MONITOR, model LM-2, is a self-powered unit that clips right onto IC under test; a series of 16 LED's at top of the clip follow IC pin pattern. A rotary switch selects the proper logic threshold



for monitoring RTL/DTL, TTL/HTL and CMOS circuits. A separate cable for CMOS circuits uses the circuit voltage to determine the logic level and operates up to a 30-kHz input frequency at 50% of duty cycle. The **model LM-2**, with self-contained 117 VAC 50- to 60-Hz power supply, is priced at \$129.95. A 220 VAC 50- to 60-Hz model is also available.—**Continental Specialties Corp.**, 70 Fulton Terrace, New Haven, CT 06509.

CIRCLE 129 ON FREE INFORMATION CARD

SCREWDRIVER SET, model 31802. Five-piece mechanic's screwdriver set comes packaged in heavy vinyl pouch. It contains one 1/4 X 4-inch blade (3/8 X 2 3/4-inch handle); 3/16 X 4-inch blade (1 X 3 3/4-inch handle); 1/4 X 4-inch blade (1 1/4 X 4 1/4-inch handle); 3/16 X 3-inch blade with No. 1 tip

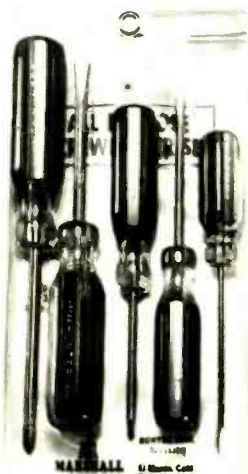

(1 X 3 3/4-inch handle); and 1/4 X 4-inch blade with No. 2 tip (1 1/4 X 4 1/4-inch handle). Screwdrivers are made of chrome vanadium steel, with cross-ground tips and easy-grip handles. Suggested resale price, \$7.63.—**Hunter Tools**, 9674 Telstar Ave., El Monte, CA 91731.

R-E

CIRCLE 130 ON FREE INFORMATION CARD



Give a Great Vise!

PanaVise ... a great gift idea. Everyone loves a PanaVise. It tilts, turns and rotates every which way to quickly and securely position electronic parts and PC boards exactly where wanted.

Sturdy all metal construction. Model 396 PanaVise shown. Available at your electronic distributors, boxed ready to go, along with a variety of other PanaVise interchangeable bases, holders and accessories.

PANA VISE® Write for **FREE** brochure and distributor list.

Dept. CE5, 2850 29th Street, Long Beach, CA 90806

CIRCLE 52 ON FREE INFORMATION CARD

\$UBSCRIBE AND \$AVE!



Get every excitement-packed issue of Radio-Electronics delivered to your door. And save money, too—up to \$9 off newsstand prices! Use the handy coupon and subscribe today!

Mail to: **Radio-Electronics**
SUBSCRIPTION DEPT., P.O. BOX 2520,
BOULDER, COLO. 80323 (please print)

Name		
Address		
City	State	Zip Code

Indicate the offer you prefer:
 1 Year—12 issues ONLY \$9.98 (You save \$2.02 off newsstand price.)
 2 Years—24 issues ONLY \$19.00 (Save More! \$5.00 off newsstand price.)
 3 Years—36 issues ONLY \$27.00 (Save Even More! Save \$9.00 off newsstand price.)

Payment enclosed Bill me
 Check here if this is a new subscription.
 Check here if you are extending or renewing your subscription.

Extra Shipping: Canada \$3.00 per year, all other countries \$5.00 per year. 40M8

Microprocessor Accessories.



Get the complete Bugworks® catalog and see E&L's complete line of micro-accessories and aids for versatile, professional

circuit design. All compatible with both E&L Microprocessor systems and many others: from Hex Keypads for E&L's Mini Micro-Designer® (MMD-1) and MMD-1 Student Stations, to breadboarding cards and aids for the Altair/Imjai and DEC systems. E&L has the products, instruments and educational materials to help you master the world of electronics. See them in your free copy of the complete Bugworks catalog.



E&L INSTRUMENTS, INC.
61 First Street, Derby, Conn. 06418
(203) 735-8774 Telex No. 96 3536

TM

CIRCLE 10 ON FREE INFORMATION CARD

3 Automotive instruments in 1

Today's most exciting automotive accessory, AUTOCOMP, is actually three complete instruments in one — each operated by electronic microprocessor control. AUTOCOMP mounts easily in or on your dash and provides large LED readouts of these functions by pushbutton control. With this valuable data at your fingertips, you can significantly reduce fuel bills by monitoring and improving your driving habits.

DIGITAL CLOCK

AUTOCOMP is a digital clock. Press the TIME button and the LED display reads the correct time (in hours and minutes). The clock may instead be used to display ELAPSED TIME.

MPG METER

AUTOCOMP is also a true MPG meter, utilizing a patented flowsensor and a speedsensor to compute instantaneous miles-per-gallon or average miles-per-gallon as you drive. Press the INST MPG button and read how many miles per gallon your vehicle is attaining at each moment. Press the AVE MPG button, and read the average miles per gallon the vehicle has attained since the last reset (up to 200 MPG).

TRIP COMPUTER

AUTOCOMP is a complete trip computer. Press the FUEL button and read the amount of fuel the vehicle has used since last reset (up to 1000 gallons). Press the DIST button and read the distance the vehicle has traveled since last reset (up to 1000 miles).

AUTOCOMP can be installed on most American and Japanese (special adapter is required at \$9.95) make autos and vans except those with fuel injection. It is supplied with all necessary components and hardware and illustrated instructions that make it easy to install. AUTOCOMP is covered by a 1 year Manufacturer's Limited Warranty.



\$99.95 FOR ORDERS ONLY
CALL TOLL FREE ANYTIME!
 PRICE 1-800-423-2355 Ext. 601
 REDUCED! In California 1-800-232-2175 Ext. 601
 For more information call 805-965-1015

SPACEKOM-AUTOCOMP
 212 E. Gutierrez Street
 Santa Barbara, CA 93101



Please send me _____ AUTOCOMP(s) at \$99.95 each.
 (California residents must add 6% sales tax.)

Car on which AUTOCOMP will be installed

Make	Model	Year
------	-------	------

Factory Cruise Control? Yes No
 Total enclosed (Cal. res. add tax) \$ _____

USE YOUR CHARGE CARD!
 (Postage and handling will be added.)
 BankAmericard (VISA)
 Master Charge (Interbank # _____)

Charge # _____ Exp. Date _____
 Signature _____
 PRINT NAME _____
 ADDRESS _____
 CITY _____
 STATE _____ ZIP _____

CIRCLE 67 ON FREE INFORMATION CARD

computer products

More information on new products is available from manufacturers of items identified by a Free Information number. Free Information Card is inside back cover.

Z80 COMPUTER BOARD, 90F/MPS, is a Z80-based, single-board device with resident floppy-disc controller that supports up to four 5 1/4-inch or 8-inch single-density floppy-disc drives. The basic board contains 4K bytes dynamic RAM (expandable to 64K bytes); six 2708/2716 EPROM sockets; 1K byte resident PROM monitor

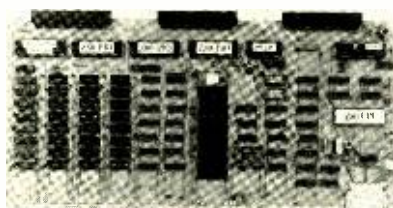

with static RAM scratch pad; PROM programmer; counter/timer; hardware UART with RS232C/TTY serial I/O; plus a programmable 8-bit parallel I/O port with two expansion sockets for additional PIO IC's. Prices: single unit, \$995; OEM discounts available.—**Quay Corp.**, Box 386, Freehold, NJ 07728.

CIRCLE 121 ON FREE INFORMATION CARD

COMPUTER PRINTOUT PICTURES are now available in a 23-picture set printed on 58 14 1/8 X 11-inch sheets. The set includes four pictures of Snoopy, five Christmas scenes, Abe Lincoln and others. Price: \$7.75.—**Data Analysis Systems**, Dept. F, Box 162, Franktown, CO 80116.

CIRCLE 122 ON FREE INFORMATION CARD

PROTOTYPE BOARD is a two-sided wire-wrap board that comes in kit form, complete with layout, instructions, 4 matching heat sinks plus hardware mounting, and 2 yards of AWG No. 18 wire. One side of the 10 X 5.5-inch board is fully S-100-bus compatible with 100 contacts spaced at 0.125-inch intervals. The board's other side has 50 contacts spaced at 0.156-inch intervals for the SS-50 bus but is only electrically compatible with the SS-50 bus. An SS-50 bus extender board is also available with a 22-slot maximum

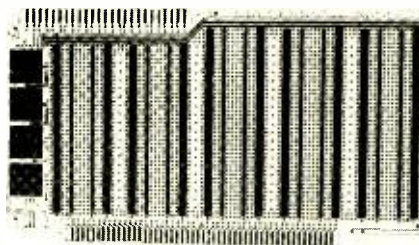

capability (no edge connectors are provided). The board accepts from 14- to 40-lead DIP packages, and additional space is provided for up to 26 or more resistors or transistors. The board also has provision for three-way keyed mounting, 2 card ejectors, filter capacitors for the voltage regula-

tors and transient suppressor capacitors at approximately 6-inch spacing. Prices: kit, \$29.95; SS-50 bus extender board, \$49.95; edge connectors available separately.—**AUM-Ideas**, Box 2582, Richardson, TX 75080.

CIRCLE 123 ON FREE INFORMATION CARD

COMPUTER SYSTEM, PeCos I, is a complete personal computing system that does not require hookup to any RF adapters, TV sets, audio cassettes, etc. It provides 24K ROM and 16K RAM; a 60-key keyboard with upper and lower case; a 9-inch CRT displaying 16 lines of 40 characters each with automatic scrolling and speed control; built-in dual cassette decks, each with 80K byte storage capability; 6502 microprocessor; power supply; and RS 232 port for connecting a printer. Software is implemented in PeCos, an English-like language derived from Rand JOSS; and includes full 9-digit floating point

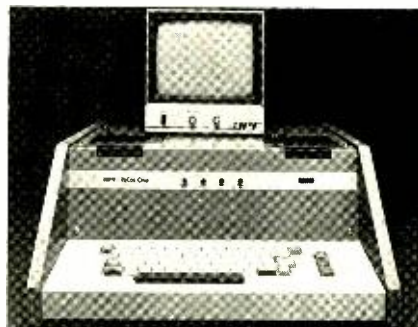

arithmetic computation. The unit measures 18 1/2 X 19 1/2 X 8 1/2 inches. Suggested retail price: \$1695.—**APF Electronics, Inc.**, 444 Madison Ave., New York, NY 10022.

CIRCLE 124 ON FREE INFORMATION CARD

GRAPHIC/TEXT VIDEO DISPLAY INTERFACE, Merlin, comes assembled and tested, or as a kit. It can be used to interface to any S-100 bus computer and provides 4K bytes of ROM, keyboard input port, plus text and graphic displays. The text display consists of 20 lines, 40 characters-per-line, suitable for BASIC and assembly programs. The medium-resolution bit-mapped

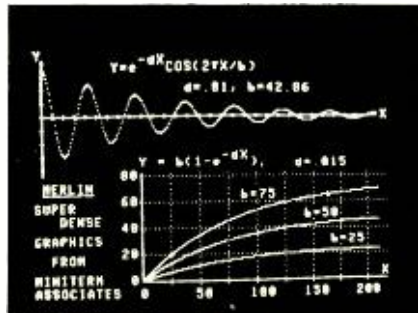

graphic display is 160H by 100V with expansion to 320H by 200V using super-dense graphic option.

The keyboard contains the following modes: edit function, scrolling, monitor, 25 cursor/edit functions, graphic subroutines and graphic drawing. The display address and display mode (text, graphic or "split screen") are software-programmable. Prices: assembled (with 4K ROM control and super-dense graphic option) \$499.95; kit (without ROM software) \$299.95.—MiniTerm Associates, Inc., Dundee Park, Andover, MA 01810.

CIRCLE 125 ON FREE INFORMATION CARD

PROGRAMMABLE TERMINAL SYSTEM, EXOR 68, is multifunctional—consists of basic display unit with 12-inch CRT, six keyboard options and a group of micromodule subassembly boards. The CRT display unit consists of video monitor that can display 128 ASCII characters in 24 lines (up to 1920 characters); switches select word length, baud rate, communications mode and modem



control. Other features include inverted cursor, scrolling and page/edit/protect display modes; remote or keyboard data entry capability; and optional motherboards. Basic display unit is available separately for end applications without keyboards. Keyboard options include Standard TTY/control key format plus 5 other variations. End-use micromodule options range from partial computers (memory, interface, etc.) to complete single-board assemblies; all are compatible with EXOR 68 system. Basic display unit with extended communications and display features plus keyboard and cable assembly sells for \$2600 (approx.) in single quantities.—Motorola Microsystems, 3102 N. 56th St., Phoenix, AZ 85018.

CIRCLE 126 ON FREE INFORMATION CARD

COMPUTER TERMINAL, model OE1000, comes as a kit or assembled, and interfaces to any computer having a 300-baud serial data output port. It offers the full duplex mode with either a 20-mA current loop or an RS 232 voltage swing. Displays 96 ASCII characters and 32 special characters in a 16-line by 64-character format.

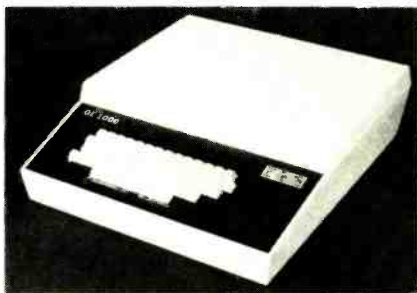

with either upper and lower case or TTY modes. Other features are full cursor control, automatic scroll, erase to end of line, erase to end of screen and clear screen. Prices: kit, \$275; assembled, \$350.—Otto Electronics, Box 3066, Princeton, NJ 08540.

CIRCLE 127 ON FREE INFORMATION CARD

FORDHAM BEST BUYS

HICKOK OSCILLOSCOPES

High Performance • American Made • Discount Prices!

30 MHz, Dual trace

11.7 MS risetime • Fixed delay for leading edge viewing of fast rise time signals • Stable pushbutton triggering to 50 MHz • High and Low pass filters • Bright, ultra sharp trace PDA CRT • Deluxe probe kits included • Full time 4X expansion and multitrace horizontal position control • Ideal for logic and pulse circuits, microprocessor applications.

SPECIFICATIONS:

VERTICAL

Ranges: 10mV/DIV in 11 calibrated steps plus variable control.
Accuracy: ± 4%
Frequency Response: DC to 30 MHz.
Risetime: 11.7ns
Overshoot: 4% or less.
Vertical Modes: Channel A only; Channel B only; Alternate A & B, Chopped A & B, Add (A + B)

TIME BASE

Sweep Rates: 2 SEC/DIV to 0.05 SEC/DIV in 24 calibrated steps plus variable control.
Accuracy: ± 4%. Except 7% slowest 3 speeds.

TRIGGERING

Modes: AC-HF, AC-LF
Sources: Line, Internal, External.
Slope: Positive and negative, continuously Variable level
Sensitivity: Internal, 1/2 division to 30 MHz

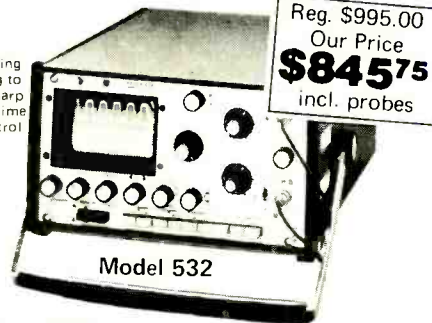

Reg. \$995.00
Our Price
\$845.75
incl. probes

Model 532

GENERAL

CRT: 4-inch flat faced round with viewing area of 6 x 10 divisions. P31 phosphor with 3.8 kV accelerating voltage.
Power Requirements: 105-125V, 50-400 Hz, 35 watts.

DIMENSIONS AND WEIGHT

6 7/8" h x 11 1/4" w x 17 3/4" d, 27 pounds

ACCESSORIES

Rack mounting kit RM-4 (P/N 100-138) also available.

Reg. \$695.00
Our Price
\$590.00
incl. probes



Model 517

15 MHz, Dual trace

24ns rise time • 15 MHz response for all signal levels • 5 mV sensitivity • Foolproof pushbutton triggering to 27 MHz • TV Sync separators for easy locking to complex video waveforms at any sweep speed • TIME/cm switch automatically selects line or frame sync as well as Chop or Alternate sweep in Dual mode • Perfect for VCR, TV, and audio service as well as digital and industrial work • CHA, CHB, Dual, Add, Subtract modes • TTL compatible intensity modulation (X-AXIS). Large 8cm x 10cm viewing area • Front-panel Vectorscope operation.

SPECIFICATIONS:

VERTICAL

Ranges: 10mV/cm to 50V/cm in 12 calibrated steps Variable control from 5mV/cm to 50V/cm.
Accuracy: ± 3%
Frequency Response: DC to 15 MHz.
Risetime: 24ns

TIME BASE

Sweep Rates: 0.2 SEC/cm to 0.5 μSEC/cm (0.1 μSEC/cm with X5 expander) in 18 calibrated steps. Variable control from 0.1 μSEC/cm to 1 SEC/cm.
Accuracy: ± 5%.

TRIGGERING

Slope: + & - Variable level control.
Sensitivity: 1 division (on CRT) to 27 MHz guaranteed.
TV Sync: Separator circuitry permits locking to TV video waveform. TV-H (Line) and TV-V (frame) sync automatically selected by TIME/CM switch.

EXTERNAL HORIZONTAL (X-AXIS):

Variable from 0.5V/cm to 50V/cm with X5 expander.
Frequency Response: DC to 1 MHz.

GENERAL

CRT: 5-inch flat faced round with viewing area of 8 cm x 10 cm.
Z-Axis: (Intensity Modulation) Rear panel connector for display blanking by 5V signal (TTL compatible).
Power: 105-125V, 50-400 Hz, 35 watts.

DIMENSIONS

14 5/8" w x 7" h x 17 1/2" d.

ACCESSORIES

Rack mounting kit RM-3 (P/N 100-205) also available.

15 MHz, Triggered Sweep

• Same specs and performance as Model 517 except single trace • 15 MHz frequency response • 5mV sensitivity • TV Sync separators built-in • Bright 8cm x 10cm display • Front Panel vectorscope operation • Lightweight, portable • Designed for industrial and consumer service applications as well as educational and laboratory purposes.



Model 515

Reg. \$495.00
Our Price
\$425.75
incl. probes



FREE

Immediate Delivery...
To Place Your Order

Call TOLL FREE (800) 645-9518

N.Y. State call (516) 752-0050

FORDHAM RADIO SUPPLY CO. INC.
855R Conklin St.
Farmingdale, N.Y. 11735

YOUR ONE STOP DISCOUNT CENTER

Send for new 1978 catalog of over 3,000 items. 164 pages of test equipment, CB tools, tubes, components and electronic supplies.

Mastercharge
BankAmericard
VISA and
C.O.D.'s accepted
ADD \$3.00 TO COVER
SHIPPING HANDLING &
INSURANCE N.Y. Res. add
approp. sales tax.

CIRCLE 77 ON FREE INFORMATION CARD

**MATHEMATICS
ELECTRONICS
ENGINEERING MATHEMATICS
ADVANCED MATHEMATICS
DIGITAL TECHNOLOGY**

These unusual courses are the result of many years of study and thought by the President of Indiana Home Study, who has *personally* lectured in the classroom to *thousands* of men, from all walks of life, on mathematics, and electrical and electronic engineering.

You will have to see the lessons to appreciate them!

WE ARE THIS SURE:—you order your lessons on a money-back guarantee.

In plain language, *if you aren't satisfied you don't pay*, and there are no strings attached.

Write today for more information and your outline of courses.

You have nothing to lose, and everything to gain!

**The INDIANA
HOME STUDY INSTITUTE**
EASTERN DIVISION
P.O. BOX 1189
PANAMA CITY, FLA 32401

CIRCLE 14 ON FREE INFORMATION CARD



NATCAM
catalog
Shopping center for small and precision tools

A fine selection of small tools, measuring instruments, hard-to-find items for shop, home and lab. Convenient one-stop shopping for technicians, engineers, craftsmen, hobbyists. Major credit cards accepted, satisfaction assured. Get your NATCAM catalog today.

National Camera, Inc.
2000 West Union Ave., Dept. GBF
Englewood CO 80110 USA

CIRCLE 19 ON FREE INFORMATION CARD

stereo products

More information on new products is available from manufacturers of items identified by a Free Information number. Free Information Card is inside back cover.

DIRECT-DRIVE TURNTABLE, model PS-TI, is a semiautomatic unit that features a linear-torque, brushless, slotless DC servomotor with ring-shaped magnet and fixed coil. The speed-monitoring system consists of a magnetic coating on outer rim of the platter, which is tracked by a magnetic head to detect speed variations. Other



features include a J-shaped tonearm (statically balanced to provide 7–9-Hz resonance), counterweight with stylus pressure gauge, antiskating device, safety clutch, reject button and illuminated strobe. Suggested list price: \$130.—**Sony Corp. of America**, 9 W. 57th St., New York, NY 10019.

CIRCLE 113 ON FREE INFORMATION CARD

AM/FM STEREO RECEIVER, model CR-3020, incorporates preamp containing peak-reading meters, coil-head amplifier, signal meter, LED display and two headphone jacks (with separate

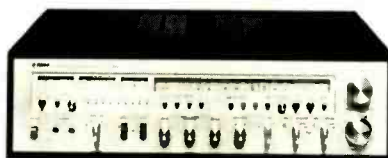

volume control). General specifications: continuous RMS power, 200 watts-per-channel (at 4 ohms, 0.05% THD); 20-Hz–20 kHz THD (phono 1 & 2 to record output), 0.003% at 5 volt output; input sensitivity (phono 1), 2 mV; frequency response (aux, tape 1 & 2 to speaker output) 5 Hz–100 kHz, -3 ± 2 dB; S/N ratio (phono 1 & 2) 96 dB (10-mV input).

FM section: usable sensitivity at 300 ohms, 11.2 dBf; 50-dB quieting (mono) 15.3 dBf, (stereo) 37.2 dBf; IHF distortion (stereo), 0.1% (local), 0.6% (DX). AM section: 1000-kHz selectivity, 45 dB (± 10 kHz), 35 dB (± 9 kHz).

The model CR-3020 comes in an ebony cabinet, measures $24\frac{1}{4} \times 7\frac{1}{2} \times 19\frac{1}{2}$ inches and weighs 81 lb, 8 oz. Price: \$1400.—**Yamaha International Corp.**, 6000 Orangethorpe Ave., Buena Park, CA 90622.

CIRCLE 112 ON FREE INFORMATION CARD

CEILING SPEAKERS, models DK5-F, RS69-F and RSQ8-F are made of acrylic plastic and feature cloth-roll suspension, 1½-lb magnet construction and an aluminum voice coil. The speakers are easily mounted and come with complete mounting instructions. The model DK5-F (shown) is a 5-inch two-way speaker with a 360° swivel tube for directional sound and a decorative grille; its specifications include a 48-Hz–20-kHz frequency response, 8-ohm impedance, 65-Hz resonant frequency and 25-watt power handling capability. The model RS69-F is a 6 × 9-inch two-



way recessed round speaker with a 35-Hz–19,500-Hz frequency response, 8-ohm impedance, 50-Hz resistant frequency and 40-watt power handling capability. The model RSQ8-F is an 8-inch two-way recessed square speaker with a white exterior and chrome grille. Its specifications are: a 28-Hz–21-kHz frequency response, 8-ohm impedance, 50-Hz resonant frequency and 45-watt power handling capability. List prices: model DK5-F, \$54.95; model RS69-F, \$64.95; model RSQ8-F, \$69.95.—**Rohn Electronics, Ltd.**, 5 Pearsall Ave., Glen Cove, NY 11542.

CIRCLE 111 ON FREE INFORMATION CARD

AM/FM TAPE CAR STEREO, 8-track model 873 and cassette model 633, both deliver 20 watts-per-channel RMS; the tuner sections feature FET frontends and PLL circuitry in the multiplex

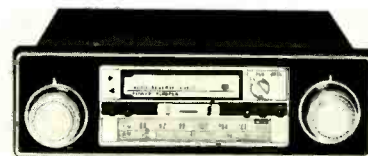

decoder, plus local/distance switch and FM muting. The model 873 player had indicator lights and a dial-in-door cartridge slot. The model 633 cassette player (shown) provides automatic reverse, pushbutton eject, locking rewind/fast forward switches, plus tape direction indicators.

Both units contain bass/treble, balance/fader, and volume/loudness controls. Suggested retail prices: model 873, \$209.95; the model 633, \$244.95.—J.I.L., Dept. P, 737 W. Artesia Blvd., Compton, CA 90220.

CIRCLE 106 ON FREE INFORMATION CARD

HI-FI CABLES/CONNECTORS, full line of stereo cables and connectors for all systems. Product line includes 2-pin DIN speaker, line plugs and sockets; 3- and 5-pin DIN plugs and sockets; leads with either RCA or DIN plugs and sockets in



different lengths and configurations; leads with combined RCA/DIN plugs or sockets; a head-phone extension cable; and an FM dipole antenna.—AudioSource, 1185 Chess Drive, Foster City, CA 94404.

CIRCLE 110 ON FREE INFORMATION CARD

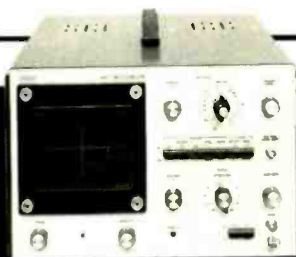

NEW EICO 480 TRIGGERED SWEEP SCOPE

100% Solid State • Includes 10:1 Probe

More Professional scope performance for your money! DC to 10 MHz bandwidth, AC and DC coupling, 11 position calibrated attenuator, 10 mV/cm sensitivity, push-button operation. Outstanding features: Built-in TV Sync Separator; Digitally controlled trigger circuits; reference baseline display; calibrated 21 step sweep speed; Fully regulated power supply; Custom Bezel for standard camera mounting. **Assembled \$449.95**

FREE '78 EICO CATALOG

Check reader service card or send 50¢ for first class mail. See your local EICO Dealer or call (516) 681-9300, 9:00 a.m.-5:00 p.m. EST. Major credit cards accepted.

EICO-108 New South Rd.
Hicksville, N.Y. 11801



CIRCLE 8 ON FREE INFORMATION CARD



You can build a better organ than you can buy!

A magnificent Schober Electronic Organ

What a marvelous way to put your special talents to work! With our Schober Electronic Organ Kits and your skill, you can build yourself some very special satisfaction, and a lifetime of great music!

Schober Organs are literally far superior to comparably-priced "ready-made" units. You could actually pay twice as much and get no better organ...and miss the fun of assembling it yourself. A PC board at a time, component by component, you'll assemble your own "king of instruments." And when you're done, you'll wish there was more to do. And there is! For then, Schober will help you learn to play, even if you've never played a note before!

Schober Organ Kits range from \$650 to \$2850, and you can purchase in sections to spread costs out...or have two-year time payments. Combine the incomparable quality of Schober components with your talent...and produce a far better organ than you can buy!

Thousands of others have, ever since 1955.

You can have all the details, without cost or obligation. Just send the coupon for the fascinating Schober color catalog (or enclose \$1 for a record that lets you hear as well as see Schober quality.) Why not clip it right now, before you forget?

The Schober Organ Corp., Dept. RE-181
43 West 61st Street, New York, N.Y. 10023

- Please send me Schober Organ Catalog.
 Enclosed please find \$1.00 for 12-inch L.P. record of Schober Organ music.

NAME _____

ADDRESS _____

CITY _____

STATE _____ ZIP _____

CIRCLE 66 ON FREE INFORMATION CARD

BYTE® The leading magazine in the personal computer field

BYTE is the magazine for the creative home computer experimenter. BYTE tells you everything you want to know about personal computers, including how to construct and program your own system.

Home computers are now practical and affordable. Low cost peripherals have resulted in more hardware and software, more applications than you could imagine. BYTE brings it all to you. Every issue filled with stimulating, timely articles by professionals, computer scientists and serious amateurs.

BYTE and BYTE logo are trademarks of BYTE Publications, Inc.



Fill in the coupon today. Read your first copy of BYTE; if it's everything you expected, honor our invoice. If it isn't, just write "CANCEL" across the invoice and mail back. You won't be billed, and the copy is yours.

Allow 6 to 8 weeks for processing.
BYTE Subscription Dept. 800-258-5485

BYTE Subscription Dept. • P.O. Box 590 • Martinsville, NJ 08836

PLEASE ENTER MY SUBSCRIPTION FOR

- One year \$15 (12 issues) Two years \$27 Three years \$39
 Check enclosed (entitles you to 13 issues for price of 12)*
 Bill Visa Bill Master Charge Bill me*

Card Number _____

Expiration Date _____

Signature _____

Name (please print) _____

Address _____

City _____

State/Country _____

Code _____

FOREIGN RATES (To expedite service, please remit in U.S. Funds)

- Canada or Mexico \$17.50 - One Year Two years \$32 Three years \$46.50
 Europe \$25 - One Year (Air delivered)
 All other countries except above \$25 - One year (surface delivery)

*North America only

Air delivery available on request.

7GB8

CIRCLE 80 ON FREE INFORMATION CARD

BEST IN NEW ELECTRONICS BOOKS!

Digital Interfacing With An Analog World	406 p., 277 il.	\$8.95
Illus. Dictionary of Microcomputer Terminology	322 p., 150 il.	\$7.95
How To Design/Build Your Own Custom TV Games	546 p.	\$9.95
The Complete Handbook of Robotics	364 p., 137 il.	\$7.95
24 Tested, Ready-To-Run Game Programs In BASIC	266 p.	\$5.95
Beginner's Guide to Computers/Microprocessors	308 p.	\$6.95
Direct Current Motors - Characteristics & Applications		\$14.95
303 Dynamic Electronic Circuits	308 p., 303 il.	\$6.95
How To Design, Build, Test Complete Speaker Systems	336 p.	\$6.95
Antenna Construction Handbook for Ham, CB & SWL	238 p.	\$5.95
First Class Commercial FCC License Study Guide	378 p.	\$7.95
Radar Detector Handy Manual	80 p., 48 il.	\$2.25
Jap Radio, Record, Tape Player Schem./Svcing. Manual #2		\$7.95
CBer's Handy Manual of Base Stations	96 p., 55 il.	\$2.50
The Handbook of Telephones & Accessories	432 p., 215 il.	\$9.95
Install Electronic in Cars, Boats, Planes, Trucks & RV's	384 p.	\$7.95
The BASIC Cookbook	140 p., 49 il.	\$4.95
How to Repair Video Games	270 p., 182 il.	\$7.95
Beginner's Gde.-Designing/Building Trans. Radios	140 p.	\$4.95
Towers' International FET Selector	140 p.	\$4.95
How to Design/Build Electronic Instrumentation	420 p.	\$9.95
How to Repair Movie & Slide Projectors	304 p., 270 il.	\$7.95
Understanding Sound, Video & Film Recording	140 p., 74 il.	\$5.95
Build-It Book of Solar Heating Projects	196 p., 111 il.	\$4.95
Hdbk. of Solar Flare Monitoring/Propag. Forecasting	196 p.	\$6.95
57 Practical Programs & Games in BASIC	210 p., 611 il.	\$7.95
Hearing Aid Handbook	432 p., 224 il.	\$8.95
CMDS Databook	280 p., 270 il.	\$6.95
Master OP-AMP Applications Handbook	476 p., 320 il.	\$9.95
Miniprocessors: From Calculators to Computers	196 p., 67 il.	\$5.95
Complete Hdbk. of Public Address Sound Systems	272 p.	\$7.95
Modern Transistor Radios	64 p., 112 il.	\$2.50
Microwave Oven Service & Repair	420 p., 210 il.	\$9.95
Solid-State Motor Controls	322 p., 182 il.	\$8.95
Master Handbook of Ham Radio Circuits	392 p., 301 il.	\$8.95
Towers' International Transistor Selector	200 p., 179 il.	\$6.95
Ham Radio Incentive Licensing Guide	154 p., 70 il.	\$4.95
Programming Microprocessors	280 p., 102 il.	\$6.95
The "Computer" Book - Build Super Calculators	322 p.	\$7.95
Master Transistor/IC Substitution Handbook	518 p., 165 il.	\$7.95
Home-Brew HF/VHF Antenna Handbook	210 p., 143 il.	\$5.95
CBer's Handy Manual of SSB	80 p., 42 il.	\$2.25
Beginner's Gde.-Making Electronic Gadgets	140 p., 113 il.	\$4.95
Modern Digital Communications	308 p., 122 il.	\$6.95
Microprocessor Progr.-Computer Hobbyists	378 p., 219 il.	\$8.95
Illus. Dict.-Broadcast/CAIV/Telecommunications	420 p.	\$8.95
Linear IC Applications Handbook	280 p., 183 il.	\$6.95
Build-It Book of Optoelectronic Projects	238 p., 175 il.	\$5.95
How to Use AF & RF Signal Generators	238 p., 162 il.	\$5.95
Model Railroad Electronics	308 p., 218 il.	\$5.95
The ABC Book of Hi-Fi/Audio Projects	182 p., 131 il.	\$4.95
Complete Hdbk. of Electrical/House Wiring	476 p., 197 il.	\$6.95
88 Practical Op Amp Circuits You Can Build	140 p., 120 il.	\$4.95
How to Build Metal/Treasure Locators	140 p., 60 il.	\$3.95

SEND NO MONEY! We'll invoice you on 10-DAY FREE TRIAL. Ship entire ad to order. 100% guaranteed or your money refunded.

TAB BOOKS DEPT. RE-128
BLUE RIDGE SUMMIT PA 17214

CIRCLE 28 ON FREE INFORMATION CARD

You Can Count On DAVIS!



NEW CTR-2A 500 MHz & 1 GHz COUNTERS

NOW WITH
PERIOD MEASUREMENT (Optional)
AND BUILT-IN PREAMP

- 8 Digit, 3" LED Display
- High Stability TCXO Time Base
- Built-in VHF-UHF Prescaler & Preamp
- Period 1us to 1 sec. (optional)
- TCXO Std. ± 2 ppm
- Input Diode Protected
- 12V-DC Operation (optional)
- Oven Crystal $\pm .5$ ppm (optional)
- Selectable Gate Times .1 sec. & 1 sec.

500 MHz kit CTR-2A-500K	\$249.95
500 MHz assembled CTR-2A-500A	349.95
1 GHz kit CTR-2A-1000K	399.95
1 GHz assembled CTR-2A-1000A	549.95

OPTIONS:

(02) Oven Crystal	\$49.95
(03) 43" LED	10.00
(04) 12 V-DC	10.00
(05) 10 sec. Time Base	10.00
(06) Period Option	15.00



DAVIS ELECTRONICS
636 Sheridan Drive
Tonawanda, NY 14150
716/874-5848



RADIO-ELECTRONICS

100

CIRCLE 47 ON FREE INFORMATION CARD

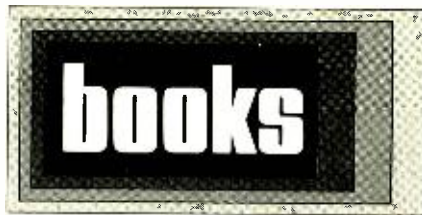

MICROCOMPUTER HANDBOOK, by Charles J. Sippl, Petrocelli/Charter, Div. Mason/Charter Publishers, Inc., 641 Lexington Ave., New York, NY 10022. 454 pp. 6 1/2 x 9 1/2 in. Hardcover \$19.95.

This book is designed to serve the needs of designers, students, hobbyists and all those who require a thorough understanding of low-cost microminiaturized computer systems. Systems engineers and developers who must integrate these computers into existing systems will also find this book a useful guide.

Early chapters deal with and contrast standard computers and minicomputers. Other chapters describe the various types of microcomputers and their capabilities, software, programs and many applications. All terminology is carefully defined, and photos and diagrams clarify the text.

THE DESIGN OF OPERATIONAL AMPLIFIER CIRCUITS, WITH EXPERIMENTS, by Howard M. Berlin. E&L Instruments, Inc., 61 First St., Derby, CT 06418. 266 pp. 6 x 9 in. Softcover \$8.50.

The beginning experimenter and hobbyist will find this latest in the *Bugbook* series useful in a home study program dealing with the design and operation of different types of op-amp circuits. Each chapter contains its own set of experiments on a wide spectrum of circuits, from linear amplifiers to single-supply units. Chapter 1 introduces the reader to the basics; other chapters deal with the fundamental circuits using bipolar and Norton-type op-amps; and Chapter 10 discusses the instrumentation amplifier used in augmenting low-level signals.

WORKSHOP IN SOLID STATE, Second Edition, by Harold E. Ennes. Howard W. Sams & Co., Inc., 4300 W. 62nd St., Indianapolis, IN 46268. 384 pp. 5 1/2 x 8 1/2 in. Softcover \$7.95.

The student and technician with previous training in electronics will find this book helpful in making the transition from vacuum-tube circuitry to solid-state devices. The material was originally developed to aid in training broadcast technicians, but the basic principles apply to other branches of electronics as well.

The text covers the fundamentals of solid-state devices, circuits for both linear and pulse applications, logic-circuit principles and testing and servicing information. Test questions follow most chapters, with answers in an appendix in the back of the book.

HOME-BREW HF/VHF ANTENNA HANDBOOK, by William Hood. TAB Books, Blue Ridge Summit, PA 17214. 210 pp. 5 x 8 1/4 in. Softcover, \$5.95; hardcover, \$8.95.

This how-to guide on building antennas contains complete down-to-earth instructions on designing, constructing, installing, selecting, buying and customizing any HF/VHF antenna, from a basic dipole to stacked-beam arrays. The first two chapters deal with essential antenna principles, formulas, systems and configurations. Also included are in-depth examinations of wave propagation, radiation characteristics, transmission lines, baluns, etc., plus instructions and schematics for constructing dummy antennas, SWR meters, impedance bridges, L- and Pi-networks, and many more. Contains four appendixes and an index.

R-E

FREE SWTP

CATALOG

Audio-Computers
Instruments
Kits & Assembled

COMPUTER
PRODUCTS
CATALOGUE



Southwest Technical Products Corporation
219 W. RHAPSODY
SAN ANTONIO, TEXAS 78216

CIRCLE 57 ON FREE INFORMATION CARD

Try this exciting new hobby!

Build your own electronic concert organ. It's easy. No technical knowledge required. Just follow the clearly pictured instructions of the famous Wersi do-it-yourself system. Choose from seven different models. Send \$2.00 (refundable) with coupon for colorful 104 page catalog.

WERSI



Wersi Electronics, Inc.
Dept. 42,
1720 Hempstead Road
Lancaster, PA 17601

Enclosed is \$2.00 for my copy of your 104 page catalog.

Name _____
Address _____
City _____ State _____ Zip _____

CIRCLE 29 ON FREE INFORMATION CARD

next month

JANUARY 1979

- Build An Audio Test Station
- How To Troubleshoot Communication Receivers
- Build An Arcade Quality Motorcycle Game
- All About Optical Fiberquides
- Simplifying The Wire-Wrap Jungle

PLUS

Lab Tested Hi-Fi Test Reports

Build A Compact 600 MHz Freq Counter

CET Test

Computer Corner

HOBBY COMPUTER POWER SUPPLIES

Continued from page 59

Keep it cool

While giant strides have been made in the miniaturization of electronic components, nobody has yet miniaturized the *joule* (i.e., watt-second). Heat causes many electrical component failures, and it is likely that series-pass transistors and regulators will fail if allowed to get too hot. Additionally, most such devices have a temperature coefficient that defines an output voltage change in percent-per-degree centigrade (%/°C).

At current levels up to about 5 amperes, ordinary heat-sinking and convection cooling will usually suffice, but at higher current levels it becomes increasingly necessary to use a blower or fan in addition to the heat sink.

In one configuration of my Z-80 system, I used a heat-sinked HEP S7000 in the circuit of Fig. 3 to provide 5 volts at 10 amperes. The heat sink was one of the large finned International Rectifier models sold in hobbyist outlets. This transistor got so hot after 20 minutes of operation at near full load that a first degree burn would reward anyone foolish enough to touch it! But a 50-cfm "whisper" fan reduced the temperature to the "barely hot" level in only a few minutes!

In short, it is good practice to always use forced-air cooling on power regulators and series-pass transistors operated at more than a few amperes of constant load current. Keeping the case temperature low will not only improve longevity, but will also prevent output voltage drift due to thermal changes. The rules for keeping a regulator and rectifier cool are:

1. Mount the IC regulator, series-pass element and rectifiers on heat sinks, not just on the chassis.
2. Use silicone/heat-transfer grease between all devices and their respective heat sinks.
3. Blow 40 to 105 cubic-feet-per-minute (cfm) of air across the heat-sink fins. Such fans or blowers can usually be obtained at low-cost surplus or somewhat higher cost at retail. The investment is well worth it—remember that bit about the silicon-to-carbon converter! R-E

INTERNATIONAL FM-2400CH

FREQUENCY METER FOR TESTING MOBILE TRANSMITTERS AND RECEIVERS

• Portable • Solid State • Rechargeable Batteries

The FM-2400CH provides an accurate frequency standard for testing and adjustment of mobile transmitters and receivers at predetermined frequencies.

The FM-2400CH with its extended range covers 25 to 1000 MHz.

The frequencies can be those of the radio frequency channels of operation and/or the intermediate frequencies of the receiver between 5 MHz and 40 MHz.

Frequency stability: $\pm .0005\%$ from $+50^\circ$ to $+104^\circ\text{F}$.

Frequency stability with built-in thermometer and temperature corrected charts: $\pm .00025\%$ from $+25^\circ$ to $+125^\circ$ (.000125% special 450 MHz crystals available).

- Tests Predetermined Frequencies 25 to 1000 MHz
- Extended Range Covers 950 MHz Band
- Pin Diode Attenuator for Full Range Coverage as Signal Generator
- Measures FM Deviation

FM-2400CH (meter only) Cat. No. 035320	\$595.00
RF crystals (with temperature correction)	24.90 ea.
RF crystals (less temperature correction)	18.90 ea.
IF crystals	catalog price

Write for catalog

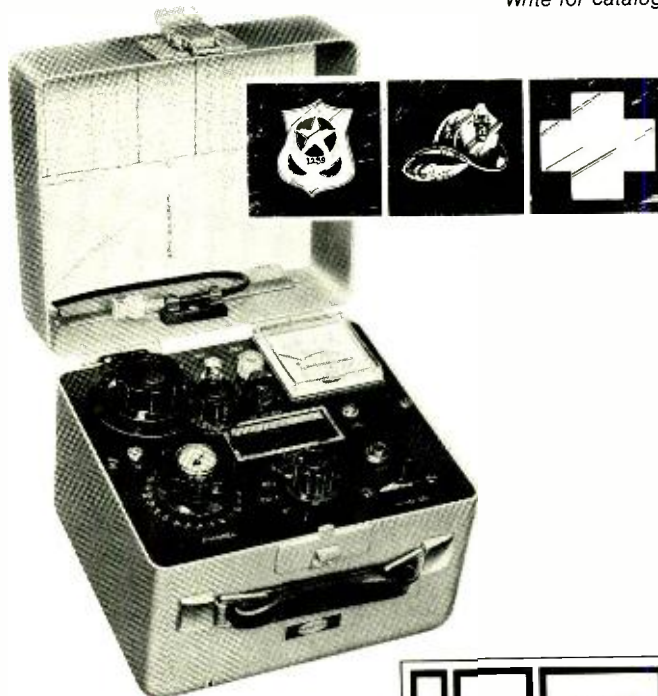

INTERNATIONAL CRYSTAL MFG. CO., INC.
10 North Lee / Oklahoma City, Okla. 73102

CIRCLE 73 ON FREE INFORMATION CARD

DECEMBER 1978

101

SPEAKER CABLES
continued from page 93

in the opposite direction. Both conductor layers are wound at a 45-degree angle, constantly crisscrossing each other.

The *High Definition* cable manufactured by Audio-Source (see Fig. 7) is the least expensive, costing 80 cents-per-foot, with a characteristic 10-ohm impedance; having 10 pairs of braided wire; and connected in parallel to reduce DC resistance and with specially finished tips.

It is impossible to predict accurately how certain speaker/wire/amplifier com-

binations will perform. Some amplifiers cannot handle capacitances greater than 6000 pF and shut down. Some amplifiers cannot handle *too little capacitance*, and shut down or produce a metallic or ringing sound. Dr. Maier, president of the Disc Washer Group, distributors of *Smog Lifters*, says: "Very fine amplifiers with highly balanced output stages, with complementary power supplies will sustain up to one microfarad just like certain amps will play 'into' and sound good on electrostatic speakers. Amps, which do not like electrostatic speakers, and which sound terrible on them, tend to be candidates for super cable problems."

Some high-powered amplifiers have had problems with too small a capacitance—1500 and 15,000 pF. Engineers say this can be avoided by inserting an inductor in the output circuit.

The *Smog Lifter* cables are claimed to have a lower capacitance (480 pF) than other super cables. Dr. Maier believes "the capacitance of the *Smog Lifters* allows most amps to be used, but we are including a disclaimer of consequential damage with our words of caution for the protection of everybody."

The problem is somewhat similar to using penicillin or any other drug—not all people respond the same way. There is a dynamic equation between speaker wire and amplifier. So here's a word of caution for any potential user: Not all people will hear the difference between a No. 16 wire and a No. 22 wire; nor may they hear the difference between the super cables and the best of conventional cord. You may discover that upgrading your cable doesn't actually make a difference. In my tests, which were not highly controlled blind listening tests, I discovered there was a difference—a cleaner percussive sounds and a tighter bass.

If you're looking for better sound from your audio system, try the super cables (or even just heavier wire) on a money-back basis; you may be pleasantly surprised with the results. R-E



\$24.50

ONLY AT DELTA

Burglar ALARM

MOTION DETECTOR

When there is a new development in electronics, it takes some time before that development is available to hobbyists and experimenters, especially at surplus prices. This time we have reversed the trend and announce a DELTA EXCLUSIVE, the DELTA MOTION DETECTOR. This device detects any motion or movement for a minimum distance of 6 ft. The secret is in the ultra-complex custom LSI chip, which combines the latest in linear & digital circuitry. The device is completely self-contained, in a case 6 x 3 1/2 x 2 1/2" and operates from four "AA" NiCad batteries. Nothing else is needed, for the device to perform its basic function, motion detection. When motion or movement is detected, a "whoop" alarm is sounded. The MOTION DETECTOR is designed to provide either an audible or silent alarm. The silent alarm is controlled by a timer, which delays the alarm up to 30 seconds. The silent alarm activates a relay, whose contacts are brought out to plug, and will activate ANY device, such as siren, horn, tape recorder, telephone-dialer, etc.

AMPEX TAPE We have acquired an inventory of AMPEX 1.0 mil recording tape. These tapes have been used one time by government weather stations, and then we set them. On standard 7" AMPEX reel. **5588R \$1.75 (4 for \$6)**

EDGE READING
1 MA MOVEMENT METERS

These meters were previously used in medical work. The meters listed below all have a scale dia. of 1" x 3/8". The meter depth is 1 1/2". All these meters have a removable plastic cover, so that you can remove the scale & replace it with a scale of your choice. The original price of these meters was \$29.50 each.

Each **\$4.95**
2 for \$9.

LEGEND:
Delta No. AB487R Systolic mm Hg...Scale: 0 to 300
AB488R Diastolic/MEAN mm Hg... 0 to 300
AB489R Rate...Scale: 0 to 300
AB488R RESP./min...Scale: 0 to 120
AB485R mm Hg...Scales: 0 to 300 0 to 25

50-0-50 MICRO AMP DC CENTER READING METER

COMPLETE with 3 scales (1) 0-100 mA volts (2) 0-100 MW (3) 60-120 dBm (4) 10 to 100 Gain. Meter has a plastic case with removable scale. Size: 4 1/2" x 3 1/2" x 2 1/2" d. #5422R

2 for \$25. **\$12.95 Each**

50 MICRO AMP DC DUAL SCALE

Input: Intermodulation or Log Volt RMS Scales: 0 to 1.0 (0 to 1). Meter has a taut band & is enclosed in a plastic case with a removable scale. Overall size: 4 1/2" x 3 1/2" x 2 1/2" d. #5502R

2 for \$17. **\$8.95 Each**

G-E HORIZON LINE TAUT BAND METER

GF Model 251 - 50 microamp movement, 2 Scales: 20 - 0 - 100 and 0 - 3 - 2 mtg. hole. Shielded movement. Distributor's price \$13.95. Our spectacular price less than 25%. Delta No. 5643R

2 for \$15. **\$7.95**

(COUNTER-LATCH-DECODER)

These devices cost \$11.71 each at the distributors. The ones we have are out of eqpt. but are 100% guaranteed. The 3 digits contain 2 TTL-307s & the 4 digit contains 4 TTL-307s. Delta provides data. The 4 digit in each case is a 1.

TIL 307

PRECISION CRYSTAL OSCILLATOR

Your computer is only as good as its clock. Delta has been fortunate in acquiring a lot of OVENAIRE, precision crystal oscillators. Model O8C-62-11A. Output freq. is 3.840 MHz. The frequency readily divides into many useable frequencies with the use of standard SN7490 series ICs. Among the many frequencies are 6.0 KHz, 60 KHz, 32 KHz, 20 KHz, 10 KHz, 6 KHz, 1 KHz, 600 Hz, 100 Hz, 60 Hz, 50 Hz, & many more. We provide data showing the freq. needed to get these frequencies. The oscillator is precise to 2 parts per million & is adjustable to even greater precision. Ideal for computers, freq. standards, clocks, etc. This oscillator is a current production item. & the next production run at the factory is \$134.50 (100 lot, \$150.00) so our price of \$14.95 each is a fantastic bargain! 1 1/2" x 2 1/2" PC mount. Voltages required are 5 VDC & 12 VDC. Output is TTL compatible. 5 VDC. #5592R

2 for \$28. **14.95** each

TEXAS INSTRUMENT 7-SEG. READOUT WITH LOGIC & data.

Texas Instrument TIL-307 is a 7-seg. readout, with all the logic necessary for counters built into the chip. This simplifies design & makes for small packages in instrumentation. Overall dimensions: 1 x 1 and the digit is .270. Device mounts in a 16-pin DIP socket, & all that is needed is the input signal.

\$10
#5614R
#5614R 3 1/2 Digit \$10.00 2 for \$19.
#5619R 4 1/2 Digit \$12.50 2 for \$24.

RCA NUMITRON 2 1/2 & 3 1/2 DIGIT ASSEMBLIES

These units consist of 2 1/2 & 3 1/2 digit assemblies of RCA Numitron 7-seg. incandescent readouts, plus a readout. Readouts lend themselves to use of many different color filters, so that almost any color is obtainable. Assemblies are out of eqpt & most contain several logic chips, & a trimpot for adjusting brightness. Many of the 2 1/2 digit chips contain three SN7475s & two SN7447s. The 3 1/2 digit assemblies may contain three SN7447s, two SN7475s and a SN7475.

2 for \$5. **\$3** 2 1/2 Digit
2 for \$8. **4.50** 3 1/2 Digit

RADIO-ELECTRONICS

When in our area, Northeastern Massachusetts or Southern New Hampshire, visit our new showroom, loaded with many desirable items that never get in the catalog or ads, due to a limited quantity.

Please enclose sufficient postage. Excess refunded.

DELTA ELECTRONIC HOBBIES
5151 BUFORD HWY, DORAVILLE, ATLANTA, GA.

ATLANTA, GEORGIA

TELEPHONE AREA 388-4705 617

FREE CATALOG

Send for new catalog 13-120 pages of computer & electronic bargains... the best in the world!

DELTA ELECTRONICS
P.O. BOX 2, DEPT. 12R
7 OAKLAND ST.,
AMESBURY, MASS.
01913

9 reasons why the real pros prefer Endeco desoldering irons

- Operates at 120v, 40w. Idles at 20w for longer tip life
- Flexible, burn resistant Neoprene cord set
- Cool, unbreakable polycarbonate handle
- Exclusive bracket insures alignment, prevents damage
- Safety light in handle tells when it's on
- Stainless steel construction
- Temperature control. Low, high or off.
- Eight tip sizes. Comes with .063 I.D.
- Converts to soldering iron with 1/4" shank type tip

See your distributor or write . . .

Enterprise Development Corp.
5127 E. 65th St. • Indianapolis IN 46220
PHONE (317) 251-1231

market center

CLASSIFIED COMMERCIAL RATE (for firms or individuals offering commercial products or services). **\$1.50 per word (no charge for zip code)** . . . minimum 15 words.

NONCOMMERCIAL RATE (for individuals who want to buy or sell personal items) **85¢ per word** . . . no minimum.

ONLY FIRST WORD AND NAME set in bold caps. Additional bold face (not available as all caps) at 10¢ per word. Payment must accompany all ads except those placed by accredited advertising agencies. 5% discount for 6 issues, 10% for 12 issues within one year, if paid in advance. All copy subject to publisher's approval. Advertisements using P.O. Box address will not be accepted until advertiser supplies publisher with permanent address and phone number. Copy to be in our hands on the 26th of the third month preceding the date of the issue (i.e., August issue closes May 26). When normal closing date falls on Saturday, Sunday or a holiday, issue closes on preceding working day.

FOR SALE

FREE catalog (anglais). IC's, semi's. **CORONET ELECTRONICS**, 649A Notre Dame W., Montreal, Que., Canada, H3C-1H8. US inquiries.

RADIO & TV tubes 36¢ each. One year guaranteed. Plus many unusual electronic bargains. Free catalog. **CORNELL**, 4217-E University, San Diego, Calif. 92105

BLITZ ZOINK ZATT: UNSCRAMBLE these fascinating police communications with our **CODE-BREAKER** and keep informed. Tunes all scramble frequencies, works with all scanners, and is factory built and guaranteed. \$34.95PP. **UNSCRAMBLER KIT**: Latest Technology, 2 1/2 X 2 1/2 X 1/2 -inch, complete instructions, only \$19.95PP. Thousands of satisfied customers. Catalog 50¢. Order from **KRYSTAL KITS**, BOX 445, BENTONVILLE, ARK. 72712. COO orders. 501-273-5340.



TUBES sale!!! Sylvania, G.E.—Brand-new receiving tubes, 70%–75% discount. Semiconductors—low, low prices. **UJI**, 18374 Oxnard St., Tarzana, CA 91356. Tel 213-996-4222

PRINTED CIRCUIT

Positive Acting Photo Resist; Carbide bits; Bubble etchers; Artwork; Epoxy Glass Boards.

Send stamp & address label for flyer
TRUMBULL

833 Balra Dr., El Cerrito, CA 94530

RECORDS-TAPES! Discounts to 73%; all labels; no purchase obligations; newsletter; discount dividend certificates; 100% guarantees. Free details. **DISCOUNT MUSIC CLUB**, 650 Main St., Dept. 3-1278, New Rochelle, NY 10801

NEW, adjustable, three-output, regulated power supply, plus 900 parts worth over \$400.00 in complete cartrivision television recorder electronics assembly. Documentation included. Perfect for **microprocessor** and all electronic applications. \$16.95 plus \$4.50 S&H. Master Charge, VISA. Free brochure. **MADISON ELECTRONICS**, 369, Madison, AL 35758. Satisfaction guaranteed. 205-837-6658, Res.

To run your own classified ad, put one word on each of the lines below and send this form along with your check for \$1.50 per word (minimum 15 words) to:

Radio-Electronics, 200 Park Avenue South, N.Y., N.Y. 10003

ORDER FORM

PLEASE INDICATE in which category of classified advertising you wish your ad to appear. For special headings, there is a surcharge of \$10.

() Plans/Kits () Business Opportunities () For Sale
() Education/Instruction () Wanted ()

Special Category: \$10

(PLEASE PRINT EACH WORD SEPARATELY, IN BLOCK LETTERS.)

1	2	3	4	5
6	7	8	9	10
11	12	13	14	15
16	17	18	19	20
21	22	23	24	25
26	27	28	29	30
31	32	33	34	35

Burglar - Fire - Smoke Alarm Catalog

• Billions of dollars lost annually due to lack of protective warning alarms.

FREE CATALOG Shows you how to protect your home, business and person. Wholesale prices. Do-it-yourself. Free engineering service.



Burdex Security Co.

Box 82802 RE-128 Lincoln, Ne. 68501

NAME brand test equipment. Up to 50% discount. Free catalog and price list. **SALEN ELECTRONICS**, P.O. Box 82, Skokie, IL 60076

LIGHT-triggered relay driver. 6VDC adjustable threshold. Completely assembled only \$3.00 302AT. **Sonic** switch turns on lamps, radio, tape, etc. Completely assembled, solid-state super buy only \$3.00 210AT. **3 transistor** audio preamp for mike, phono, tape, etc. Hi-Q-input, 8-45-ohm output. 9VDC completely assembled, only \$4.00 AT032. **ABT SYSTEMS**, P.O.B. 173, Schererville, IN 46375

SPEAKER INFORMATION KIT

Get 70 pages of speaker facts, specs, construction tips plus info on our raw speakers, crossovers and a line of 9 quality hi-fi speaker system kits. We'll send you our **full-color catalog**; plus **How to Hook Up Your System**, an exhaustive step-by-step treatise on hi-fi system installation; and our **Speaker Operating Manual**, chock full of facts on how to get the most from any speaker system. For Free. Even if you don't buy from us we want you to have the facts. That's how we got to be the world's largest manufacturer of speaker kits.

Send to:
Speakerlab, Dept. RE-J
735 N. Northlake
Seattle, WA 98103



TEST equipment catalog listing used Tektronix, HP and GR equipment at bargain prices. Price \$1.00 refundable with first order. **PTI**, Box 8699, White Bear Lake, MN 55110

CIRCUIT boards from camera-ready artwork. Quantity discounts. Free details. **CM CIRCUITS**, 22 Maple Avenue, Lackawanna, NY 14218

PICTURE TUBE MACHINE
We buy and sell **NEW** and **USED CRT** rebuilding machinery. **COMPLETE TRAINING**. Buy with **CONFIDENCE** from the **ORIGINAL MFG.**
For complete details send name, address, zip to:
LAKESIDE INDUSTRIES
4071 N. Elston Avenue
Chicago, Ill. 60618
Phone: 312-583-6565



B & K test equipment. Free catalog. Free shipping. Dinosaur discounts. **SPACETRON-DM**, 948 Prospect, Elmhurst, IL 60126

FREE KIT Catalog

STOP! Take a minute & let us send our latest kit catalog. If you like, send us the name & address of a friend who may also be interested and we'll include to you our booklet "How to build electronic thermometer" contains **TEST & EXPERIMENTER'S EQUIP.**

DAGE SCIENTIFIC INSTRUMENTS
BOX 1054R LIVERMORE CA 94550

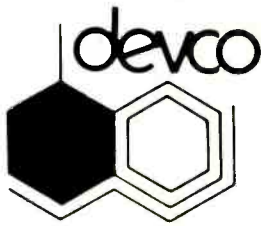

ATTENTION SERVICE DEALERS

• Buy Directly •

Top Line Solid State Replacements, Original Japanese Transistors and Integrated Circuits

PARTIAL 'JST' MONTHLY SPECIALS

Part Number	Your Cost	Part Number	Your Cost	Part Number	Your Cost
AN 214	2.25	2SC 799	2.95	2SD 292	2.50
AN 247	3.25	2SC 867	4.99	2SD 331	1.15
2SA 495	.50	2SC 1034	4.25	2SK 23A	.75
2SA 643	.50	2SC 1358	2.90	SG-609	3.75
2SC 710	.30	2SC 1383	.45	SID 30-15	1.45

Hurry while our supply lasts!

Send for our complete list of Japanese parts and prices

- Our Professional Replacement parts are top quality and replace over 130,000 industry types at a substantial savings to you over most other replacement lines.
- To order, just send us the ECG, SK, GE, or other part number and we will promptly ship you the premium PR direct replacement, plus a free PR replacement guide. Remember—these are first quality parts—no culls, no seconds! 2 year warranty on all parts.
- Orders over \$25.00 shipped free, under \$25 add \$1 UPS. C.O.D. orders are welcome. To approximate the cost of a replacement part order, deduct 40% from dealer cost of ECG or other types. All orders shipped within 24 hours.

Write or Call—Toll Free 800-526-4463

DEVCO P.O. Box 270, Garwood, NJ 07027 • (201) 688-0300

CIRCLE 37 ON FREE INFORMATION CARD

SOLID-state brownout protector for central air-conditioning systems. Simple 3-wire connection to existing 24V control transformer. \$14.95 ppus. S & S Electronics, Box 430260, Miami, FL 33143

YOUR PHONE CALLS ON TAPE

Record incoming and outgoing calls automatically with this all solid state unit connected to your telephone jack and tape recorder. Starts recording when phone is lifted. Stops when you hang up, making a permanent record. Easily installed. No extra monthly phone charges. FCC APPROVED 2-1/4 x 1-3/4 x 3/4



FCC APPROVED

AMAZING ELECTRONIC

MICRO MINI MIKE



Among world's smallest, solid state, self contained WIRELESS MIKE. Mercury Bat. turn Picks up most sounds and transmits without wires up to 300 ft. thru FM Radio. Tuneable. Use as mike, ampl., alarm & alert system, baby sitter, hot line, etc. (*Plus \$1.00 Pstg. & Hdg.) Money back guarantee. California residents add tax. Free data. Mail order. Visa, M/C, Cod's o.k. Quantity discount available. AMC Sales, Dept. 19, 9335 Lubec St., Box 928, Downey, Calif. 90241 Phone (213) 869-8519

\$18.95*
2-1/4 x 1-3/4 x 1/2

VIDEO recorder—instant playback of your favorite TV show, birthday party or any special event with accessory vidicon camera. Blank tape and pre-recorded movies available. Only \$235.00 or \$395.00 with 12" receiver/monitor. **MEDIA ASSOC.**, 616 National Ave., Mt. View, CA 94043. (415) 968-2444

NO-ETCH

Duplicate or make additions to, modifications of Any Etched Board. Ideal for point-to-point or wire wrap breadboards. Complete set of (3) tools IP6003 \$25.00 ppd. Write for free brochure, as covered in the July Radio-Electronics. A.F. Stahler Co., P.O. Box 354R, Cupertino, CA 95014—(408) 252-4219.



ELECTRONIC EQUIPMENT HOTLINE is a classified advertising newsletter for professional, industrial, and surplus electronic equipment. Subscriptions \$6/year, ads 50¢/word. PO Box 4768, Dept RE, Panorama City, CA 91412

BULLET ELECTRONICS

P.O. BOX 19442R DALLAS, TEX. 75219
(214)823-3240

MC1351P FM-IF AMP AND DISCRIMINATOR

USED IN FM & TV SOUND CIRCUITS REQUIRES MINIMUM EXTERNAL COMPONENTS 14 PIN DIP DIRECT REPLACEMENT FOR HEPC 6060, ECG 748 and MANY OTHERS. HOUSE # WITH SPECS **50¢**

LM3900 QUAD NORTON AMP

WE BOUGHT A LARGE QUANTITY OF THESE HOUSE NUMBERED PARTS THAT ALLOWS US TO SELL THEM AT A LOW, LOW **39¢**

MINI GRANDFATHER CLOCK KIT

Complete Electronics!
• Chimes the hour (ie: 3 times for 3 o'clock)
• Unique "swinging" LED pendulum.
• Tick-tock sound matches pendulum swing.
• Large 4 digit 5" LED readout
• All CMOS construction
• Complete electronics including transformer & speaker; drilled and plated PC boards measure 4.5" x 6.5"
• Beautiful solid walnut
Custom case for above kit. Over 9% off!
39.95
Reviewed in April 1978 RADIO ELECTRONICS

MK-05 MINI MOBILE CLOCK

The smallest and best priced mobile clock kit on the market. Designed to be a mobile clock from the ground up. There has been no compromise on quality.
FEATURES:
• Quartz crystal timebase
• Toroid & zener noise & overvoltage protection
• Magnified 15" 5 digit LED readout
• Complete with orientable 24 hr alarm
• 9-14 VDC @ 40 to 50 ma
• Readouts can be suppressed
• EASY QUICK ASSEMBLY
• All components required included (you supply the speaker)
• Top quality drilled and plated PC boards
Clock board: 2.3" x 2"
Readout board: 2.3" x 7.5"
12.95

MJ900 - MJ1000

COMPLIMENTARY PNP, NPN DARLINGTON POWER TRANSISTORS, 8 AMPS WE SUPPLY A SCHEMATIC TO BUILD A HIGH POWER (35W) LOW DISTORTION AUDIO AMP WITH ONLY ONE ADDITIONAL TRANSISTOR AND A DOZEN INEXPENSIVE COMPONENTS! TO 3 CASE STYLE BUY A PAIR FOR **\$3.00!**

POWER SUPPLY METERS

Quality 3 1/2" meters for the P-514 D-15VDC & O-25A. Matched set, individually packaged. NOT SURPLUS! **12.95/set**

POWER SUPPLY KIT PS-14

• Better than 200MV load and line regulation
• Foldback Current Limiting
• Short Circuit Protected
• Thermal Shutdown
• Adjustable Current Limiting
• Less than 1% ripple
• 15 amps, 11.5 to 14.5 V
• All parts supplied including heavy duty transformer.
• Quality plated fiberglass PC board.
Less Cost meters & leads UPS SHIPPING PAID!
42.95

REVIEWED IN 7/78 73 MAG
15A CONT. 20A INT. **42.95**

ALL COMPONENTS 100% GUARANTEED

- CA3011 WIDEBAND IF AMP w/specs **50¢**
- 2N2569 NPN EPOXY 1W **6/1.00**
- 741 OP AMP 8 PIN DIP **5/1.00**
- 723 VOLTAGE REG 14 PIN DIP **5/1.00**
- MP68530 NPN HOUSE # **8/1.00**
- 725 OP AMP LOW NOISE-HOUSE # **8/1.00**
- 7815 15V 1A REGULATOR HOUSE # **8/1.00**
- LM3407-12 12V 1A VOLT REG w/specs **8/1.00**
- 7CA430 QUAD OSCILLATOR 1/8ppcs **8/1.00**
- 2N4343 P CHANNEL J FET **4/1.00**
- 2N6111 PNP MED PWR 40W TO-220 **3/1.00**
- 2N6026 PROGRAMMABLE UNIJUNCTION w/specs **5/1.00**
- TRIAC 200V 6A UNMARKED **3/1.00**

FND510 69¢

COMMON ANODE READOUT "W" CHARACTER **LIMIT 24 PER CUSTOMER!**

CAPACITORS

SMALL SIZE!
2200 MFD @ 16 VDC RADIAL **3/1.00**

UNIVERSAL SOUND EFFECTS BOARD

HAVE YOU EVER WISHED YOU COULD DUPLICATE THE SOUND OF A STEAM TRAIN OR A PHASOR GUN? HOW ABOUT GUNSHOTS, WHISTLES, SIRENS, BARKING DOGS AND OTHER SOUND EFFECTS? NOW YOU CAN WITH OUR PROGRAMMABLE SOUND EFFECTS KIT. IT USES THE NEW 28 PIN T.I. SOUND SYNTHESIZER CHIP, SN76477 AND SUPPORT CIRCUITRY. 5 TO 12VDC IS REQUIRED TO GIVE APPROX. 1/4 WATT OF AUDIO OUTPUT. WE PROVIDE THE P.C. BOARD, PARTS AND INSTRUCTIONS ALONG WITH A CHART TO PROGRAM SOME COMMON SOUNDS. USE YOUR IMAGINATION TO CREATE ORIGINAL SOUND EFFECTS. ORDER: SE-01 **14.95 (Less Spgr.) 3/39.95**

FANTASTIC SOUND EFFECTS CHIP

AVAILABLE ONLY FROM BULLET!
THIS 28 PIN MARVEL CONTAINS A LOW FREQUENCY OSCILLATOR, VCO NOISE OSCILLATOR, ONE SHOT, MIKER AND ENVELOPE CONTROL WITH 8 PAGE MANUAL 5 to 9VDC **3.95**

OVERVOLTAGE PROTECTION KIT 6.95

Provides cheap insurance for your expensive equipment. Trip voltage is adjustable from 3 to 30 volts. Overvoltage instantly fires a 25A SCR and shorts the output to protect equipment. Should be used on units that are fused. Directly compatible with the PS-12 and PS-14. All electronics supplied. Drilled and plated PC board. (Order OVP-1)

MK-03A CLOCK/TIMER KIT

Features 24 hour Zulu time and up to 24 hours of elapsed time on the same set of six digit LED readouts. Totally independent operation of both functions. Clock has presettable alarm with 10 minute snooze. Timer has reset, hold, and count functions. Full noise and overvoltage protection. 24 hour only. Readouts has timer feature or they can be turned off without disturbing the clock or timer. Timebase included (.01% accuracy). Because of the many options and mounting considerations the case and switches are not included. Switches are standard types. Will fit inside standard aircraft instrument case.
9-14VDC **28.95**

CAPACITORS

- 022 @ 100VDC Mylar 8/1.00
- .22 @ 50VDC Mylar 8/1.00
- 1.5mfd @ 400VDC Mylar 4/1.00
- 47mfd @ 35V Tant Axial 6/1.00
- 2.2mfd @ 35V Tant Axial 5/1.00
- 22mfd @ 20V Dip Tant 4/1.00
- 33mfd @ 10V Dip Tant 4/1.00
- 220mfd @ 25V Alum. Axial 7/1.00
- 500mfd @ 25V Alum. Axial 5/1.00

HOUSE # PNP POWER

TO-3 IDENTICAL TO 2N3790
150 WATTS
90 VCEO
10 AMPS **1.00**

IL-1 OPTO ISOLATORS

BY LITRONIX 8 PIN DIP STANDARD PINOUT LED-TRANSISTOR COMBINATION. **50¢** WHILE THEY LAST!

ULTRASONIC SENDER RECEIVER KIT US-02

TOTAL SECURITY! Completely invisible ultrasonic (23KHz) sound beam works like a photoelectric beam but is unaffected by light, heat or noise. Sensitive. Transmitter and Receiver can be used from 6 inches to 25 feet. A solid object breaking the beam causes an output to glow that will sink up to 150 MA. Use to Drive a Relay, TRIAC, etc. Complete electronics are provided. Works on 12VDC (unregulated) and draws less than 100 MA. Use 1 for burglar alarms, object counters, automatic door openers, automatic door bells, electronic rat trap! and more. COMPLETE KIT LESS CASES **21.50**

- * NO C.O.D.'S
- * SEND CHECK M/D OR CHARGE CARD NO.
- * PHONE ORDERS ACCEPTED ON VISA AND MASTERCARD ONLY
- * ADD 5% FOR SHIPPING
- * TX. RES. ADD 5% STATE SALES TAX
- * ORDERS OF \$50 & OVER TAKE 10% DISCOUNT
- * FOREIGN ORDERS ADD 10%
- * 10% AIRMAIL U.S. FUNDS ONLY

AMERICA'S LARGEST SUPPLIER

of ORIGINAL Japanese Semi-Conductors
for CB, TV and Stereo Repair

We carry only genuine replacement parts

TYPE	25-UP	10-24	1-9	TYPE	25-UP	10-24	1-9	TYPE	25-UP	10-24	1-9	TYPE	25-UP	10-24	1-9
2SA 102	.20	.27	.30	2SC 696	1.00	1.20	1.30	2SD 234	.60	.70	.80	TA 7205P	1.60	1.80	2.00
2SA 234	.45	.53	.59	2SC 710	.20	.27	.30	2SD 235	.60	.70	.80	TA 7310P	1.30	1.45	1.60
2SA 473	.45	.53	.59	2SC 711	.20	.27	.30	2SD 261	.35	.40	.45	TBA 810SH	1.90	2.10	2.40
2SA 484	1.50	1.75	1.95	2SC 730	3.00	3.20	3.40	2SD 287	2.50	2.70	2.90	TC 5080P	5.00	5.20	5.80
2SA 495	.30	.35	.40	2SC 732	.20	.27	.30	2SD 313	.60	.70	.80	TC 5081P	3.00	3.20	3.40
2SA 497	1.00	1.20	1.30	2SC 735	.20	.27	.30	2SD 315	.60	.70	.80	TC 5082P	3.40	3.55	3.90
2SA 509	.30	.35	.40	2SC 756	1.50	1.80	2.00	2SD 325	.60	.70	.80	UHC 002	4.20	4.40	4.90
2SA 561	.30	.35	.40	2SC 756A	1.50	1.80	2.00	2SD 427	1.80	2.00	2.25	UHC 004	4.20	4.40	4.90
2SA 562	.30	.35	.40	2SC 781	1.90	2.10	2.40	2SD 525	.90	1.10	1.20	UHC 005	4.20	4.40	4.90
2SA 564A	.20	.27	.30	2SC 784	.30	.35	.40	2SD 526	.60	.70	.80	UPC 20C	2.10	2.50	2.80
2SA 634	.40	.45	.50	2SC 799	2.00	2.20	2.50	FET				UPC 563	1.90	2.10	2.40
2SA 643	.30	.40	.45	2SC 828	.20	.27	.30					25K 19BL	.45	.55	.60
2SA 673	.35	.40	.45	2SC 839	.30	.35	.40	25K 23	.70	.80	.90	UPC 576	1.90	2.10	2.40
2SA 678	.35	.40	.45	2SC 867	3.20	3.40	3.70	25K 30	.40	.45	.50	UPC 592HZ	.70	.80	.90
2SA 682	.80	.90	1.00	2SC 867A	3.20	3.40	3.70	25K 33	.60	.70	.80	UPC 1001	1.90	2.10	2.40
2SA 683	.30	.35	.40	2SC 897	2.00	2.20	2.50	25K 55	.60	.70	.80	UPC 1008C	4.20	4.40	4.90
2SA 684	.35	.40	.45	2SC 930	.20	.27	.30	35K 39	.90	1.10	1.20	UPC 1020H	1.90	2.10	2.40
2SA 695	.40	.53	.59	2SC 945	.20	.27	.30	35K 40	.90	1.10	1.20	UPC 1025H	1.90	2.10	2.40
2SA 699A	.50	.64	.70	2SC 983	.50	.64	.70	35K 41	1.30	1.45	1.60	UPC 1154	2.00	2.20	2.50
2SA 706	.85	1.00	1.10	2SC 959	1.10	1.20	1.30	35K 45	1.30	1.45	1.60	UPC 1155	2.00	2.20	2.50
2SA 719	.30	.35	.40	2SC 1000BL	.35	.40	.45	35K 48	3.40	3.55	3.90	UPC 1156	1.90	2.10	2.40
2SA 720	.30	.35	.40	2SC 1014	.50	.64	.70	35K 49	1.30	1.45	1.60	UPC 1430S	3.00	3.20	3.40
2SA 733	.20	.27	.30	2SC 1018	.60	.70	.80	IC				UPD 861	8.00	8.40	9.50
2SA 747	4.20	4.40	4.90	2SC 1030C	1.80	2.10	2.40					AN 214Q	1.30	1.70	1.90
2SA 818	.70	.81	.90	2SC 1061	.70	.80	.90	AN 239	4.20	4.40	4.90	UPD 858	6.00	6.30	7.00
2SA 841	.20	.27	.30	2SC 1079	3.40	3.55	3.90	AN 247	2.50	2.70	3.00	PLL 01A	3.00	4.20	4.60
2SB				2SC 1096	.45	.55	.60	AN 274	1.50	1.75	1.95	PLL 02A	5.00	5.30	5.90
				2SC 1098	.50	.64	.70	AN 313	3.00	3.20	3.40	PLL 03A	7.60	8.00	8.80
2SB 22	.30	.35	.40	2SC 1111	2.10	2.50	2.80	AN 315	1.80	2.00	2.25	DIODES			
2SB 54	.20	.27	.30	2SC 1124	.80	.90	1.00	BA 511A	1.80	2.00	2.25				
2SB 75	.35	.40	.45	2SC 1172B	3.20	3.60	3.95	BA 521	1.90	2.10	2.40	1S 332	.35	.40	.45
2SB 175	.20	.27	.30	2SC 1173	.50	.55	.60	HA 1151	1.50	1.75	1.95	1S 953	.16	.18	.20
2SB 186	.20	.27	.30	2SC 1226	.50	.55	.60	HA 1156	1.60	1.80	2.00	1S 1007	.35	.40	.45
2SB 324	.30	.35	.40	2SC 1226A	.50	.55	.60	HA 1306W	2.00	2.20	2.50	1S 1209	.35	.40	.45
2SB 337	.70	.80	.90	2SC 1239	2.20	2.70	2.90	HA 1322	2.50	2.70	3.00	1S 1211	.35	.40	.45
2SB 405	.30	.35	.40	2SC 1306	1.30	1.45	1.60	HA 1339	2.50	2.70	3.00	1S 1555	.20	.22	.25
2SB 407	.80	.90	1.00	2SC 1307	1.90	2.10	2.40	HA 1339A	2.50	2.70	3.00	1S 1588	.20	.22	.25
2SB 434	.80	.90	1.00	2SC 1318	.35	.40	.45	HA 1366	2.50	2.70	2.90	1S 1885	.16	.18	.20
2SB 435	.90	1.10	1.20	2SC 1383	.30	.35	.40	HA 1366W	2.50	2.70	2.90	1S 2076	.20	.22	.25
2SB 463	.90	1.10	1.20	2SC 1384	.35	.40	.45	HA 1366WR	2.50	2.70	2.90	1S 2093	.35	.40	.45
2SB 473	.80	.90	1.00	2SC 1419	.60	.70	.80	LA 4031P	1.80	2.00	2.25	1S 2473	.16	.18	.20
2SB 474	.70	.80	.90	2SC 1675	.20	.27	.30	LA 4032P	1.80	2.00	2.25	1N 34	.12	.13	.15
2SB 492	.60	.70	.80	2SC 1678	1.10	1.25	1.40	LA 4400	1.90	2.10	2.40	1N 60	.12	.13	.15
2SB 507	.80	.90	1.00	2SC 1728	.70	.80	.90	LA 4400Y	2.00	2.20	2.50	10D 1	.30	.35	.40
2SB 528D	.70	.80	.90	2SC 1730	.45	.53	.59	LA 4420	2.00	2.20	2.50	10D 10	.45	.55	.60
2SB 595	1.10	1.40	1.50	2SC 1760	.70	.80	.90	M51513L	2.00	2.20	2.50	V06B	.30	.35	.40
2SB 596	1.10	1.40	1.50	2SC 1816	1.50	1.75	1.95	STK 011	3.80	4.00	4.40	ZENERS			
2SC				2SC 1856	.50	.64	.70	STK 013	7.60	8.00	8.80				
				2SC 1908	.30	.35	.40	2SC 1909	1.80	2.00	2.25	STK 015	4.20	4.40	4.90
2SC 281	.30	.35	.40	2SC 1945	4.50	5.00	5.60	STK 435	4.50	5.00	5.60	WZ 090	.20	.22	.25
2SC 372	.20	.27	.30	2SC 1957	.60	.70	.80	TA 7045M	2.00	2.20	2.50	WZ 120	.20	.22	.25
2SC 373	.20	.27	.30	2SC 1970	2.10	2.50	2.80	TA 7060P	.70	.80	.90	WZ 192	.20	.22	.25
2SC 380	.20	.27	.30	2SC 1978	5.40	6.00	6.60	TA 7061P	.90	1.10	1.20	MISC.			
2SC 394	.20	.27	.30	2SC 2028	.50	.64	.70	TA 7062P	1.10	1.25	1.40				
2SC 394	.20	.27	.30	2SC 2029	1.50	1.80	2.00	TA 7089P	2.00	2.20	2.50	78L05	.90	1.00	1.10
2SC 458	.20	.27	.30	2SC 2076	.50	.64	.70	TA 7202P	2.50	2.70	2.90	MPS U31	1.50	1.70	1.90
2SC 495	.45	.55	.60	2SC 2091	.90	1.10	1.20	TA 7203P	2.50	2.70	2.90				
2SC 509	.35	.40	.45	2SC 2092	1.80	2.00	2.25	TA 7204P	2.00	2.20	2.50				
2SC 515A	.80	.90	1.00	2SC 2166	1.40	1.60	1.80								
2SC 517	2.50	2.70	3.00	2SD											
2SC 535	.30	.35	.40	2SD 72	.50	.64	.70								
2SC 634A	.35	.40	.45												

Minimum order \$5.00. Add \$1.00 postage and handling. Ask for our complete price list when ordering. Overseas buyers. Manufacturers. Distributors or Dealer orders welcome. All parts are guaranteed against factory defects for one year. C.O.D. orders are welcome. 48-hour delivery.

ORDER TOLL FREE

Telex: 21-4732



EAST
Nationwide 800-543-1607
Ohio 800-582-1630
Mon-Fri 10:00 to 7:00 - Saturday 10:00 to 5:00
P.O. Box 40325 • Cincinnati, Ohio 45240

WEST
Nationwide 800-543-1642
California (Call Collect) 213-533-1221
Mon-Fri 9:00 to 5:00 • Sat 9:00 to 3:00
P.O. Box 3375 • Torrance California 90510

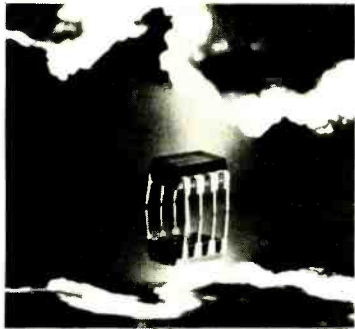

THE NEW HOBBY WORLD CATALOG

Your source for factory prime, professional quality equipment. Computers, add-on boards, IC's, sockets, resistors, supplies, tools, test equipment,

books, and more. Shop your buy list at Hobby World. You'll find what you want, and at a solid savings. For example, look at this month's specials:

THE NEW ELENCO 3 1/2 DIGIT SOLID STATE MULTIMETER

The ultimate in performance: measures resistance to .01 ohms, voltage to 100 micro-volts, current to one micro-amp. Assembled and tested, with 2-Year warranty. Lists at \$99.95. **HOBBY WORLD PRICE ONLY \$74.95!**

16K MEMORY ADD-ON FOR APPLE OR TRS-80

HOBBY WORLD PRICE IS ONLY \$98.00 (specify when ordering)

WAHL ISO-TIP CORDLESS SOLDERING IRON

Includes ni-cad batteries and wall plug transformer. Lists at \$19.95. **BUT HOBBY WORLD HAS IT FOR \$14.95!**

SEND ME A FREE CATALOG!

Name _____

Address _____

City _____

State _____

Hobby World
19355 Business Center Dr #6
Northridge CA 91324

TELEPHONE ORDERS
Inside Cal 213 886 9200
Outside Cal 800 423 5387

RE-DEC

CIRCLE 59 ON FREE INFORMATION CARD

STAMP collectors. Fine sets of no-gum unused Canadian postage stamps. More than \$2 face value only \$1 US funds plus SASE. Quantities limited. G. STECKLER, 24 Straw La., Hicksville, NY 11801

BREATHE BETTER AIR WITH AMAZING NEGATIVE ION GENERATOR KITS AND ASSEMBLED UNITS

Scientists have long known that negative ions can be beneficial to man's health. These tiny but potent atmospheric particles abound in nature. Now, through the magic of science, you can duplicate this delightful phenomenon in the privacy and convenience of your own home or office.

Room/Portable Units
Ion Testers
Accessories

DEALERS
WANTED

GOLDEN ENTERPRISES
P.O. Box 1282-RE
Glendale, Arizona 85311

(Please send \$1.00 for fascinating details)

PLANS & KITS

LINEAR AMPLIFIER: Ham only 2-30 MHz, 100 watt, solid-state. **FREQUENCY COUNTER:** 300 MHz, miniportable/mobile, memory! **VOX-COMPRESSOR:** Splatter-free modulation booster. Construction plans \$3.00 each. All \$7.50! Many others, catalog with order. **PANAXIS PRODUCTIONS**, Box 130-F12, Paradise, CA 95969

AMAZING ELECTRONIC PROJECTS and PRODUCTS:

Lasers Super Powered, Burning, Cutting, Rifle, Pistol, Pocket. See in Dark—Shotgun Directional Mike—Unscramblers—Giant Tesla—Stunwand—TV Disrupter—Energy Producing, Surveillance, Detection, Electrifying, Ultrasonic, CB, Auto and Mech. Devices, Hundreds More—All New Plus INFO UNLTD PARTS SERVICE. Catalog \$1. Information Unlimited, Dept. R8 Box 716 Amherst, N.H. 03031.

SCANNER users—build many useful accessories. Free kit catalog. **CAPRI ELECTRONICS**, Route 1R, Canon, GA 30520

CONSTRUCTION plans; over 100. From TV to telephone, from broadcasting to computers. Catalog air mailed \$1.00; includes year's subscription to Electronic Newsletter. **DON BRITTON ENTERPRISES**, PO Box G, Waikiki, HI 96815

AUTOMATICALLY records phone calls onto cassette recorder. Plans \$5.00. **CASCO**, Box 947, Roswell, GA 30077

New Tone Electronics

Quality components at fair prices

HIGH FIDELITY SPEAKERS

8-INCH COAXIAL

Combines a high quality 8" woofer and a tweeter into a pre-phased sound reproducer. Built-in cross-over network. Excellent choice for a low cost Hi-Fi system for autos, vans, or in your home. Frequency response is a smooth 80-15000 Hz. 8-ohm VC, 10 oz. ceramic ring magnet. 25W rating. **NT577 \$13.99 plus 40 cents postage**

10-INCH WOOFER

The speaker for your "big sound" system. Frequency response is 20-4000 Hz; 8-ohm aluminum VC, powerful 20 oz. ceramic ring magnet and a rubberized accordion-edge suspension for excellent compliance. Handles 50W max. Use with the NT576 for a super system. **NT578 \$17.99 plus 40 cents postage**

50W DOME TWEETER

Here is the super tweeter. A rugged 10 cm (4") dome tweeter which handles 50W max. Frequency response is 4000-20000 Hz. 8 ohm VC, 8-oz. ceramic magnet. Your system can have a brilliance you never imagined. **NT576 \$6.99**

Resistors Standard values, ±5%, first quality. Packed 5 of one value.
¼W 5 for \$1.25 ½W 5 for \$3.30

Capacitor Special 3600 mF, 40Vdc Sprague "Powerlytic" \$1.89

Relay SPDT, 12Vdc; 5A contacts **NT565 \$1.79**

Sound Activated Switch Complete, ready to use. Built-in microphone's output triggers a Triac which acts as a switch. Measures only 1" x 3" Requires 3-6Vdc.

NT527 \$1.29

And, the largest inventory of domestic and Japanese transistors and ICs in the United States.

ALL PARTS GUARANTEED
WRITE FOR FREE CATALOG



Minimum Order \$5. Add \$1.50 Postage and Handling. Canada add \$2.00. N.J. Residents add 5% Sales Tax.

New Tone Electronics
PO BOX 1738
Bloomfield, N.J. 07003

CIRCLE 44 ON FREE INFORMATION CARD

www.americanradiohistory.com



Digital Auto Security System

3-Way Protection For Your Entire Car or Van

- Proximity Triggered Theft Protection - for valuables, CB or Ham equipment.
- Voltage Triggered Entry Protection - for doors and trunk.
- Mechanically Triggered Entry Protection - for under-hood parts.
- Activated by Personal 4-Digit Code.
- Uses Your Auto Horn As An Alarm, Or Add A Siren.

Forget about anything you may have heard about other anti-theft systems. The OCULAR 2®, total security system, adds a new dimension to automobile security — **Proximity Detection**. Even if the would-be thief could enter your car without triggering the voltage sensing circuit (not likely) — just approaching the protected area will sound your alarm instantly. **He does not have to touch anything!** Attention is the one thing the "rip-off" artist doesn't want.

And, there's more protection. Raising the hood sounds the alarm. Any change in voltage (dome or trunk light on, starting the car) sounds the alarm. If the cable connecting the units in the passenger compartment is cut, the OCULAR 2 turns itself on and sounds the alarm.

Your personal 4-digit code activates and deactivates the whole system. Just enter your code through the attractive push-button "Code Lok" keyboard when you leave your car and the system is activated. When you return, there's enough time to enter your code to deactivate the system before the alarm sounds.

Installation is easy and requires only simple hand tools. Complete with all hardware, instructions and your personal code. For 12-volt, negative-ground electrical systems only.

Sorry, but at this price, we must limit each order to only two systems per customer.

Was \$49.95, now **Ocular 2 \$19.95**

Radio Shack: No. 1 Parts Place

Low Prices and New Items Everyday!

Top-quality devices, fully functional, carefully inspected. Guaranteed to meet all specifications, both electrically and mechanically. All are made by well-known American manufacturers, and all have to pass manufacturer's quality control procedures. These are not rejects, not fallouts, not seconds. In fact, there are none better on the market! Always count on Radio Shack for the finest quality electronic parts!

Linear ICs

By National Semiconductor and Motorola — first quality

Type	Cat. No.	ONLY
301CN	276-017	49¢
324N	276-1711	1.49
339N	276-1712	1.49
386CN	276-1731	99¢
555CN	276-1723	79¢
556CN	276-1728	1.39
565CN	276-1724	1.89
567CN	276-1721	1.99
723CN	276-1740	69¢
741CN	276-007	49¢
741H	276-010	49¢
390N	276-1713	99¢
390N	276-1705	99¢
4558CN	276-038	79¢
75491	276-1701	99¢
75492	276-1702	99¢
7805	276-1770	1.29
7812	276-1771	1.29
7815	276-1772	1.29

Hand-Held 6-Digit Frequency Counter

- Counts from 100 Hz to 45 MHz
- kHz and MHz Decimals

99⁹⁵

A high quality "pocket" counter with accuracy of 3ppm at 25°C or less than 30 Hz at 10 MHz! Overload-protected 1-meg input. Sensitivity, 30 mV up to 30 MHz. Lead-zero blanking. Just 3x4 1/2". With mini-rod antenna, leads, case, instructions. Requires 9V alkaline battery. 22-351 99.95



Wire Wrapping Accessories

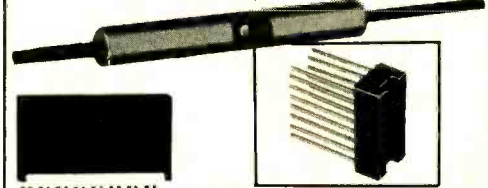

IC Socket Wrapping Tool. Strips and wraps 30-gauge wire. 276-1570 6.95
 14-Pin Wire Wrapping Sockets. 276-1993 2/1.29
 16-Pin Wire Wrapping Sockets. 276-1994 2/1.39
 DIP Header, 16 pins. 276-1980 1.29
 30' Red 30-ga. Kynar Wire. 278-501 1.99
 50' White 30-ga. Kynar Wire. 278-502 1.99
 50' Blue 30-ga. Kynar Wire. 278-503 1.99

Computer Chip



8-Bit Data Bus, 16-Bit Address Bus

8080A Microprocessor. 100% prime CPU handles up to 65K bytes memory. 276-2510. 12.95

NEW IC Breadboard Sockets



Modular boards snap together and feature standard 0.3" center. Accepts 22 through 30-gauge solid hookup wire.

- Ⓐ 550 connections in 2 bus strips of 40 tie points each with 47 rows of 5 connected tie points. 2 1/2"x6". 276-174 9.95
- Ⓑ 270 connections in 2 bus strips of 40 tie points each with 23 rows of 5 connected tie points. 2 1/2"x3 1/2". 276-175 5.95
- Ⓒ Mini-Socket. 22 rows of 5 tie points each, plus 2 bus strips with 10 connections each. 2 1/2"x1 1/2". 276-176 3.95

Solar Cells

Electricity from Light

4cm x 2cm Silicon Cell

2 1/4" Dia. Silicon Cell



SALE

Silicon type cell converts light to electrical power, delivering up to 100 mA at 0.5V. Use several in series-parallel for higher voltage or current. 276-120 Reg. 2.99 Sale 2.29

Highly efficient! Delivers up to 400 mA at 0.5V. Ideal for solar power projects, battery charging and operating electronic equipment. 276-121 5.99

RAM Memory IC



Under 450 nS Access Time

2102 1K Static RAM. Low power version. 16-pin DIP. Buy 8 and save! 276-2501 2.49 Ea. or 8/14.95

TTL and CMOS Logic ICs



Full-Spec Devices Direct from Motorola and National Semiconductor

Type	Cat. No.	ONLY
7400	276-1801	35¢
7402	276-1811	39¢
7404	276-1802	35¢
7406	276-1821	49¢
7410	276-1807	39¢
7413	276-1815	79¢
7420	276-1809	39¢
7427	276-1839	49¢
7432	276-1824	49¢
7441	276-1804	99¢
7447	276-1805	99¢
7448	276-1816	99¢
7451	276-1825	39¢
7473	276-1803	49¢
7474	276-1818	49¢
7475	276-1806	79¢
7476	276-1813	59¢
7485	276-1826	1.19
7486	276-1827	49¢
7490	276-1808	79¢
7492	276-1819	69¢
74123	276-1817	99¢
74145	276-1828	1.19
74150	276-1829	1.39
74154	276-1834	1.29
74192	276-1831	1.19
74193	276-1820	1.19
74194	276-1832	1.19
74196	276-1833	1.29
4001	276-2401	49¢
4011	276-2411	49¢
4013	276-2413	99¢
4017	276-2417	1.49
4020	276-2420	1.49
4027	276-2427	89¢
4049	276-2449	89¢
4050	276-2450	89¢
4511	276-2447	1.89
4518	276-2430	1.49

Low-Cost Power Transformers



- Primaries Designed to Operate from 120VAC, 60 Hz
- Solder Lugs for Easy Wiring or PC Board Mounting

Volts	Current	Cat. No.	Each	Volts	Current	Cat. No.	Each
6.3	1.2A	273-050	2.49	6.3 CT	3A	273-1510	3.99
6.3	300 mA	273-1384	1.99	12.6 CT	3A	273-1511	4.69
12	300 mA	273-1385	1.99	25.2 CT	2A	273-1512	4.99
24	300 mA	273-1386	2.49	12	5A	273-1513	8.95
24	1.2A	273-1480	2.99	18 CT*	4A	273-1514	8.95
12.6 CT	1.2A	273-1505	2.89	18 CT*	2A	273-1515	4.99

*Ideal for 5V (using CT) or 12V solid-state regulators

NEW 3-Amp 4PDT Relay



With Clear Protective Cover

Switch up to four different circuits! Contacts rated 3 amps at 125VAC. 12VDC coil. 160 ohms resistance. Solder terminals. Just 1 3/8"x1 1/2"x1 1/8". 275-214 4.99

Radio Shack Reference Books



Digital Integrated Circuits. Complete specs. AC test circuits, waveforms. 62-1370 3.95
 Voltage Regulator Handbook. 62-1371 2.95
 Linear Integrated Circuits. Covers op-amps, voltage regulators, more. 62-1372 3.95
 Linear Applications. Fully indexed and cross-referenced. 62-1373 2.95
 Linear Applications, Vol. 2. The latest data sheets, applications. 62-1374 Reg. 2.95 Sale 1.95

CMOS Integrated Circuits. Covers 74C series. CD4000 with data specs. 62-1375 Reg. 3.95 Sale 2.29
 Memory Data Book. 62-1376 Reg. 3.95 Sale 2.29
 Intel® 8080/8085 Programming Manual. Uses Intel's assembly language. 62-1377 3.95
 Intel Memory Design Handbook. Companion to Data Catalog, below. 62-1378 3.95
 Intel Data Catalog. 928 pages of complete specs on most Intel standard devices. 62-1379 4.95

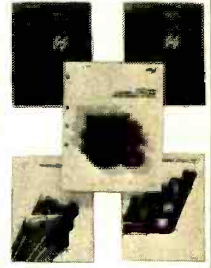

Paddle Switches



Rated 6 Amps at 125VAC

Mounts in 3/4" round hole — no need to cut square opening. SPST Black. 275-641 1.89
 SPDT Red. 275-642 1.89
 DPDT Black. 275-643 2.19

Lighted DPDT Pushbutton Switch



NEW

Push-on/push-off switch rated 4A at 12VDC. Button glows red in "on" position. Mounts in 9/16" hole. U.L. listed. 275-675 4.89

8-Rocker DIP Switch

Standard .100x.300" DIP

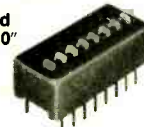

Designed for easy change of preset logic states in digital circuits. Fits 16-pin IC socket or mounts on PC board. 275-1301 1.99

Epoxy-Glass Plug-In PC Boards



For 22-pin connectors. 4 1/2"x4 1/10" grid. 3 styles available. Standard. 276-155 4.49
 Digital. 276-156 4.49
 Op-Amp. 276-157 4.49
 22-Pin Dual Connector. 276-1551 2.99

WHY WAIT FOR MAIL ORDER DELIVERY?
 IN STOCK NOW AT OUR STORE NEAR YOU!

Prices may vary at individual stores and dealers

Radio Shack®

A DIVISION OF TANDY CORPORATION • FORT WORTH, TEXAS 76102
 OVER 7000 LOCATIONS IN NINE COUNTRIES

CATCH-A-PULSE II LOGIC PROBE

10 Nsec SPEED AT 4 to 15V LEVELS



Compatible with DTL, TTL, CMOS, MOS, and Microprocessors using a 4 to 15V power supply. Thresholds automatically programmed. Automatic resetting memory. No adjustment required. Visual indication of logic levels, using LEDs to show high, low, bad level or open circuit logic and pulses. Highly sophisticated, shirt pocket portable (protective tip cap and removable coil cord). Eliminates need for heavy test equipment. A definite savings in time and money for engineer and technician.

- 10 Nsec pulse response
- Open circuit detection
- Replaceable tip & cord
- High input impedance
- Pulse stretching
- Multi-family

SPECIAL PAK-II \$51.95

Includes a standard coiled cord, coiled cord with micro hooks, adapter for using CATCH-A-PULSE on logic families whose power supply is 15V to 25V. Shipping add \$2.00 per probe.

ONLY \$44.95

AV ELECTRONICS
Box 19299, San Diego CA 92119
(714) 447-1770

CIRCLE 6 ON FREE INFORMATION CARD

AMPLIFIER kits: Low TIM, Class A, BI-FET circuitry. Free 60-page manual. **MOONLIGHTER ELECTRONICS**, 117 Inverness, San Francisco, CA 94132

HOBBYIST give your project the professional look. Printed circuit boards from your sketch or artwork. Affordable prices. Also fun kit projects. Rush free details. **DANOCINHS**, Westland, MI 48185

3 DIGIT LED voltmeter kit \$19.60 complete. S.A.S.E. brings specifications,—schematic. **ALPHA-SUPERKIT**, Box 21105-A, Woodhaven, NY 11421

EDUCATION & INSTRUCTION

GRANTHAM's FCC License Study Guide—377 pages, 1465 questions with answers/discussions—covering third, second, first radiotelephone examinations. \$13.45 postpaid. **GSE PUBLICATIONS**, 2000 Stoner, Los Angeles, CA 90025

LOUDSPEAKER repair—complete how-to. 26 illustrations. \$2: **REPAIR**, 2860 Park St., Hono., HI 96817

F.C.C. EXAM MANUAL
PASS FCC EXAMS! Memorize, study—Tests—Answers for FCC 1st and 2nd class Radiotelephone licenses. Newly revised multiple choice questions and diagrams cover all areas tested in FCC exams, plus Self-Study Ability Test. \$9.95 postpaid. Money-back guarantee.

Tests—Answers for FCC First and Second Class Commercial License

COMMAND PRODUCTIONS P.O. BOX 26348 E
RADIO ENGINEERING DIV. SAN FRANCISCO, CAL 94126

TELEPHONE bugged? Don't be Watergated! Countermeasures brochure \$1.00. **NEGEY LABORATORIES**, Box 547-RE, Pennsboro, WV 26415

UNIVERSITY degrees by mail! Bachelors, Masters, Ph.D's . . . Free revealing details. **COUNSELLING**, Box 317-RE12, Tustin, CA 92680

YOUR SCOPE OR COUNTER/TIMER CAN INSTANTLY MAKE PRECISE CAPACITANCE MEASUREMENTS WITH THE



The C-PROBE is a precision test instrument using the latest CMOS IC technology to transform a capacitor's value into something your scope or counter/timer already understands . . . DIGITAL PULSES. The C-PROBE replaces the usual probe and causes a direct readout of a capacitor's value from 1 pF to over 10,000 Mfd. on the scope or C/T.

LEVER TERMINAL + BNC OUTPUT
1" SPACED TEST STRIP
FOR Cx INPUT TTL & CMOS COMPATIBLE

RANGES: 1-10,000pF, .01-10,000Mfd., Resolution .1pF & .0001Mfd.

TEN TURN TRIMMERS ASSURE EXACT pF & Mfd SETTINGS AND ZERO CONTROL FOR STRAY CAPACITANCE

ACTUAL COUNTER/TIMER & SCOPE DISPLAYS W/C PROBE

10 MHZ or BETTER C/T 1 MHZ or BETTER SCOPE

SHIPPED WITHIN 10 DAYS OF ORDER/ FULLY CALIBRATED & WITH 100 HOUR, EASILY REPLACEABLE BATTERY

Box 3751
Thousand Oaks, CA 91359
805/495-7673

INTERNATIONAL INSTRUMENTATION, INC.
(dealer enquiries welcome)

C-PROBES @ \$49.95 Each
CALIBRATION CAPACITORS
pF RANGE @ \$1.14 Each
Mfd RANGE @ \$1.49 Each
SHIPPING & HANDLING
USA \$2.00; EUROPE \$4.50
CA 6% SALES TAX

JUMBO LED READOUT ARRAY



By Bowmar. .5 in. character common cathode. Designed for use with multiplexed clock chips 4 digits in 1 pack!

\$1.95 LIMITED STOCK

COMPUTER PARTS

Z-80	—	\$19.95
Z-80A	—	\$24.95
8080A	—	\$6.95
8212	—	\$2.25

NATIONAL SEMICONDUCTOR JUMBO CLOCK MODULE

MA1008A BRAND NEW!

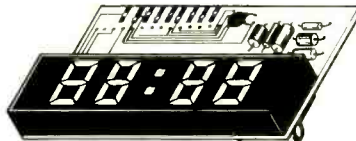

\$6.95

2 FOR \$13

(AC XFMR \$1.95)

- FEATURES**
- FOUR JUMBO 1/2 INCH LED DISPLAYS
 - 12 HR REAL TIME FORMAT
 - 24 HR ALARM SIGNAL OUTPUT
 - 50 OR 60 HZ OPERATION
 - LED BRIGHTNESS CONTROL
 - POWER FAILURE INDICATOR
 - SLEEP & SNOOZE TIMERS
 - DIRECT LED DRIVE (LOW RF!)
 - COMES WITH FULL DATA

ASSEMBLED! NOT A KIT!

ZULU VERSION!
We have a limited number of the 24 HR Real time version of this module in stock.
#MA1008D — \$9.95

PERFECT FOR USE WITH A TIMEBASE.

COMPARE AT UP TO TWICE OUR PRICE!

MANUFACTURER'S CLOSEOUT!

16K DYNAMIC RAM CHIP

16K X 1 Bits. 16 Pin Package. Same as Mostek 4116-4. 250 NS access. 410 NS cycle time. Our best price yet for this state of the art RAM. 32K and 64K RAM boards using this chip are readily available. These are new, fully guaranteed devices by a major mfg.

\$14.95 each

VERY LIMITED STOCK!

8 FOR \$89.95

EXPERIMENTER'S CRYSTAL



262 144KHZ. This frequency is 2 to the 18th power. Easily divided down to any power of 2, and even to 1Hz. New by CTS-Knight. A \$5 value!

\$1.25 each

SALE!

1N4148 DIODES

High speed switching diodes. Silicon. Same as 1N914. Brand New. Full Leads. Prime!

100 FOR \$2 1000 FOR \$17.50

FAIRCHILD JUMBO READOUTS
.5 inch Char. High Efficiency! FND-503-Common Cathode FND-510-Common Anode
YOUR CHOICE 69¢
10 FOR \$5.75

DISC CAPACITORS
.1 MFD 16V. P.C. leads. Most popular value! By Sprague.

20 for \$1.00

Full Wave Bridge
4 Amp 200 PIV
69¢ea. 10/5.75

MALLORY POWER SUPPLY CAPACITOR
1500 MFD 16 WVDC
3/\$1.00 10/\$2.95
FACTORY FRESH! SMALL SIZE

RECTIFIER SALE!

1N4006. Prime
New by ITT.
1 AMP. 800 PIV.
15 FOR \$1

FET SALE!
2N4304. Brand New N Channel. Junction Fet BVGD0-30V IDSS-15 MA Typ. 1500 uMHOS. TO-18 Plastic Case. Mfg. by Teledyne.
6 FOR \$1

Motorola PNP Power!
2N4905 TO-3 case 90W. VCEO-60. HFE-100 max at 2.5A Good mate for the 2N3055 PRIME!
75¢ ea. 4/\$2.50

COMPUTER CAPACITOR
By GE 36,000 MFD 15W VDC. Small Size. 4 1/4 x 1 1/4 Inches.
SUPER DEAL! \$2.95 Each
3 FOR \$8

RCA MICRO-POWER OP AMP.
#CA3078T Metal Can. Most OPAMPS require .15V to operate. But the CA3078 is designed to operate from .75 V to .6V! Perfect for battery use. Standby power as low as 700 nW! High Gain. 92 DB typical. Open Loop Gain. Requires only one capacitor for compensation. See RCA Linear Data Book for more details. Similar to National LM112. Originally cost about \$2 each.
75¢ EACH 3 FOR \$2

Digital Research Corporation
(OF TEXAS)
P. O. BOX 401247B GARLAND, TEXAS 75040 • (214) 271-2461

TERMS: Add 30¢ postage. We pay balance. Orders under \$15 add 75¢ handling. No C.O.D. We accept Visa, MasterCard, and American Express cards. Tex. Res. add 5% Tax. Foreign orders (except Canada) add 20% P & H. 90 Day Money Back Guarantee on all items.

CIRCLE 54 ON FREE INFORMATION CARD

ADVANCED COMPUTER PRODUCTS

THE FIRST TO OFFER PRIME PRODUCTS TO THE HOBBYIST AT FAIR PRICES NOW LOWERS PRICES EVEN FURTHER!

1. Proven Quality Factory tested products only, no re-tests or fallouts. Guaranteed money back. We stand behind our products.
2. Same Day Shipment All prepaid orders with cashiers check, money order or charge card will be shipped same day as received.

\$100 PRODUCTS

LOGOS 18K STATIC RAM

- ★ Low Power
- ★ Selectable Memory Protect
- ★ Totally Buffered
- ★ Battery Back-up
- ★ Address on 1K boundary



ASSEMBLED KIT
 250ns. 199.95 250ns. 149.95
 450ns. 179.95 450ns. 129.95

Bare PC Board w/Data \$21.95

Now over 1 year successful field experience
 "Special Offer" Buy (4) 8K 450ns. Kits \$117.00 ea.

EXIDY SORCERER
 Complete expandable Z-80 based computer.
 w/8K \$8.95 (4-5 weeks) w/32K \$13.95 stock
 w/16K \$11.50 stock w/32K \$13.95 stock
 S-100 Expansion module \$299.00

SPECIAL KEYBOARD BUY WHILE THEY LAST
 "Clare Pender 63 Key ASCII w/26 Pin & 34 Pin Output Conn." \$54.95

IMS STATIC RAM BOARDS
 ★ Memory Mapping ★ Low Power
 ★ Phantom ★ 250 ns. or 450 ns.
 Only available assembled & tested

8K Static	\$209.00	\$189.00
16K Static	\$449.00	\$399.00
32K Static	\$869.00	\$819.00

EXPANDORAM MEMORY KITS
 ★ Bank Selectable ★ Uses 4115 or 4116 200 ns.
 ★ Write Protect ★ Power 8VDC, ±16VDC
 ★ Phantom ★ Lowest Cost/Bit

Expando 32 Kit (4115) Expando 64 Kit (4116)

8K	\$149.95	16K	\$245.95
16K	\$239.95	32K	\$469.95
24K	\$325.00	48K	\$675.00
32K	\$400.00	64K	\$869.95

PARATRONICS LOGIC ANALYZER KIT
 MODEL 100A \$219.95
 (analyzes any type of digital system)

Trigger Expander Model 10 \$229.00
 Baseplate 9.95
 Model 10 Manual 4.95
 Model 150 Bus Grabber Kit 369.00

DC HAYES DATA COMMUNICATIONS ADAPTER
 ★ Telephone/TWAX ★ S-100 compatible
 ★ Bell 103 req. ★ Originate & answer mode
 Assembled & Tested \$279.95

DATABOOKS & MANUALS

NSC TTL Data	\$ 3.95	AMI MOS/LSI Data	3.95	Mot Vol 4 Mcd Data	3.95
NSC Linear Data	4.95	GI MOS/LSI Data	4.95	Mot Vol 5 CMOS Data	3.95
NSC Linear AP/Note II	3.95	Osborne Intro to Micro Vol 0	8.50	Mot Vol 6 Linear Data	3.95
NSC CMOS Data	2.95	Osborne Intro to Micro Vol 1	8.50	Mot Vol 7 Schottky TTL	2.95
NSC Audio Data	3.95	Osborne Intro to Micro Vol 2	115.00	Mot MPU Applications	25.00
NSC Memory Data	3.95	Osborne 8080 Programming	8.50	Mot MPU Ref Manual	8.50
NSC MOS/LSI Data	2.95	Osborne 6800 Programming	8.50	Mot Power Data	2.95
NSC Memory Data	3.95	Osborne Z80 Programming	8.50	Mot Rectifier Data	2.95
NSC Reg. I/O Data	3.95	TI Power Sem's Data	7.50	Mot Switching Tran	2.95
NSC Power Transistors	2.95	TI TTL Data	6.95	Mot Zeners	2.95
Inter Databook	3.95	TI Transistors & Diodes	8.50	Basic Software SRI Vol I or II	24.95
Inter MCS85 Manual	7.50	TI Memory Data	3.95	Basic Software SRI Vol III	39.95
Inter MCS80 Manual	7.50	TI Op/eletronics	3.95	Basic Software SRI Vol IV or V	39.95
AMI 8080 Handbook	4.95	TI Linear Data	3.95	Basic Software SRI Vol VI	49.95
AMI Linear Data	4.95	TI Bipolar Memory	3.95	Basic Software SRI Vol VII	39.95
AMI Schottky Data	4.95	TI Interface Data	4.95	1978 IC Master	47.50
		Motorola Sem. Data 1, 2, 3	9.95		

6800 DESIGNER BOARDS MODULES PORT BOARDS
 ★ Motorola Compatible Modules*

MEK 6800 D2 Kit \$235.00
 9600 6800 MPU Module 495.00
 9601 16 slot Mother Bd 175.00
 9602 16 slot Card Cage 75.00
 9603 8 slot Mother Bd 99.00
 9604 System Power Supply 250.00
 9610 Prototype Board 36.00
 9615 4KEprom Module 250.00
 9620 16 port parallel I/O 375.00
 9626 8K Static RAM 295.00
 9626K 8K Static RAM Kit 225.00
 9630 Extender Card 60.00
 9640 Multiple Tuner Prog. 395.00
 9650 8 port Duplex Asyn. I/O 385.00
 Mot 43/86 Connectors w/w or s/t 5.95
 AMI EVK 99' 6800 sub Kit 99.00
 AMI EVK 200 Kit 249.95
 AMI EVK 300 Assembled 275.00

Z-80/Z-80A CPU BOARD

★ On board 2708 ★ 2708 included (450ns.)
 ★ Power on jump ★ completely socketed

Assembled and tested \$185.00
 Kit \$ 34.95

Bare PC Board \$ 34.95
 For 4MHz Speed Add \$15.00

MICRODESIGN MR-16 2716 EPROM BOARD

(MR-8 Also Available at same price)

- ★ Individual Prom Address
- ★ Uses Low cost 16K TI EPROMS
- ★ Optional 1K RAM ★ Phantom-control

Assembled and Tested 174.95
 Kit 99.50

HI PLOT LOW COST DIGITAL PLOTTER

★ RS 232 NEW
 ★ Plot Size 7" x 10" List: \$1085.00
 ★ Digitizer Avail. Soon OUR
 ★ High Resolution PRICE \$999.00
 ★ 2.4"/sec Plot Speed

BYTE USER 8K EPROM BOARD

★ Power on Jump ★ Reset Jump

Assembled & Tested 94.95
 Kit 64.95

Bare PC Board 21.95

Special Offer: Buy 4 kits only \$59.95 each
 NOTE: 2708-6 only \$5.95

TARBELL FLOPPY INTERFACE

★ S100 Compatible ★ Uses CPM
 ★ Jumper Selectable ★ Persci Shugart eq.

Assembled and tested \$269.95
 Kit \$179.95

Bare PC Board \$ 39.95

NOTE: For CPM Add \$70.00
 Documentation Add \$20.00

★ Cassette I/O Kit only \$115.00

TRS 80 16K-UPGRADE KIT

★ 16K with Jumpers & Instructions
 for either Level I or Level II \$119.95
 ★ 16K for Apple II Upgrade \$117.95

PET TO S-100 ADAPTER

Allows Pet to be interfaced to popular S-100 Bus.

Kit \$189.95
 Assembled \$269.95

For Low Cost 8 Slot Bus to expand your Pet only \$149.95 Kit

FLOPPY DISK I/O

1771 01 & MiniFloppy 27.95
 2001 32 Floppy 49.95
 1781 Dual Floppy 39.95
 1791 Dual Floppy 99.00

CHARACTER GEN

RO3251-3001 (SV) Upper 9.50
 RO3251-3005 (SV) Lower 11.95
 RO3251-3003 (SV) Lower 11.95
 MCM571 10.75
 MCM572 14.95
 MCM573 10.75
 MCM575 10.75

KEYBOARD ENCODERS

AVS-2376 13.75
 2072 32 Key Floppy 29.95
 1781 Dual Floppy 39.95
 1791 Dual Floppy 99.00

UARTS/USRTS

AY51013 (SV) 12V 3.95
 AY51014A (1612-14V) 6.95
 AY51014B (1612-14V) 6.95
 TMS 6011 (6V) 12V 5.50
 IM6402 9.95
 IM6403 9.95
 2350 USRT 9.95
 1671 B Asyns 24.95

SALE TRI 474B 8.95

BAUD RATE GEN

MC14411 11.25
 AT07 14.95
 WD1941 9.95

TV CHIPS

MM5320 TV Sync 7.95
 LM1838 Prescaler 9.95
 LM1838 Modulator 3.95
 CW350 Saw Function 1.50
 MM5212 Color TV Game 24.95
 MM51704 Codec 3.75
 AY3850-U TV Game 5.95
 AY3850-U Color TV Game 24.95
 AME851-1 Color Converter 8.95
 AY3790-U Tank Chip 29.95
 8000 Modulator with Audio 89.95

A/D CONVERTERS

8700 8 bit Binary 13.50
 8701 10 bit Binary 22.00
 8702 12 bit Binary 38.25
 8703 8 bit TS 13.50
 8705 12 bit IS 42.95
 9400 Volt to Freq Conv 7.25
 8750 3 1/2 Dgt BCD 13.95
 8753 Multiplication 3.95
 1408L6 6 bit 1.95
 1408L8 8 bit 5.95
 DAC01 AY 5.95

TV INTERFACES

Pave-Vener 8.50
 TV1 Video Interface 8.95
 Pikes & Trout TV Mod Kit 20.00
 Microwriter 35.00
 MR Modulator 35.00

EVK Kluge Board 95.00
 EVK 16K Byte Ram Board 75.00
 EVK 6 Slot Motherboard 35.00
 EVK Extender Board 45.00
 EVK Solid Frame Chassis 129.00
 EVK Connectors 6.50
 AMI 6800 Proto Rom 30.00
 AMI 6800 Micro Assembler Rom 30.00
 6800 Tiny Basic Paper Tape 20.00
 6800 Tiny Basic Eprom 125.00

PCG PROGRAMMABLE CHARACTER GENERATOR
 The hottest version of STARWARS available from Objective Design.
 S-100 Compatible 2MHz Kit with object code (on labels or cuts) \$169.95

UV "Eprom" Eraser
 Model UV-11E \$84.95
 Note: 4 Eprom's at a time
 Backed by 45 years UV experience
 Model S-52T \$219.95
 Professional Industrial Model

SUPPORT DEVICES

AM9511 Arith Processor	\$195.00
AM9512 DMA Controller	71.95
AM9519 Universal Interrupt	24.95
3881 Z80 PIO	10.45
3882 Z80 DMA	14.95
3882 Z80 CTC	10.45
3882 Z80 I/O	14.95
8212 8 bit I/O Decoder	2.50
8214 Priority Int	6.95
8218 Bus Driver	2.50
8224 4 I/O Driver	9.75
8228 Sys Control	3.95
8238 Sys Comp	6.95
8251 Prog I/O	11.50
8251 Int Timer	19.50
8255 Prog I/O	11.50
8257 Prog DMA	19.50
8259 Serial Adapter	9.95
8273 CRT Controller	74.95
8279 Prog Keyboard	19.95
8810 I/O 8 x 8 RAM	7.75
6820 PIA	7.20
6821 PIA	7.25
6823 Priority Int	11.95
6834-1 512 x 8 Eprom	12.95
6850 ACIA	7.20
6852 Serial Adapter	9.95
6845 HD4850S CRT Cont	39.95
6880 Modem	14.50
6882 Modulator	14.50
6871A 1.0MHz OSC	25.95
6873	8.25
2380 USRT	9.95
6880 Bus Driver	2.39
1821 SCD 1K RAM	65.00
1822 SCD 256 x 4 RAM	16.95
1824 CD 32 x 8 RAM	9.95
1826 CD 8 bit I/O	10.50
1856 CD I/O	8.95
1857 CD I/O	8.95
6520 PIA	7.50
6522 Mult	9.95
6530-002	15.50
6530-001	15.50
6530-005	15.50
6532 CD 16 Prog Store	14.95
3853 F8 Memory I/O	14.95

MICROPROCESSORS

Z-80	\$119.00
280A	25.95
F-8 (3850i)	18.95
2650	24.95
1801B02	19.95
8080A	9.95
8080A 4MHz	19.95
8085	21.95
8008	2.50
8008-1	2.50
2901	21.95
2901A	29.95
TMS 9900L	69.95
CP1600	39.95
6502	13.95
IM6100	29.95
6800	18.95
6802P	29.95
8605	17.50

SOCKETS

8 Pin WW 32	8 Pin SW 17
14 Pin WW 37	14 Pin SW 20
16 Pin WW 38	16 Pin SW 22
18 Pin WW 60	18 Pin SW 31
20 Pin WW 90	20 Pin SW 34
22 Pin WW 93	22 Pin SW 35
24 Pin WW 97	24 Pin SW 41
28 Pin WW 115	28 Pin SW 49
40 Pin WW 149	40 Pin SW 63

CONNECTORS

6 Pin Single S/E	1.49
15/30 Dual S/E	1.95
16/36 Dual S/E	2.35
22/44 Dual S/E	2.95
40/80 WW	4.95
43/85 Dual WW/S/T	5.95
50/100 IMSAI WW	4.75
50/100 IMSAI S/T	4.75
50/100 IMSAI WW/S/T	4.75
MSAI Card Guides	4/1.00

CTS DIPSWITCHES

CTS206-4 \$1.75	CTS208-8 \$1.95
CTS208-6 \$1.75	CTS209-8 \$1.95
CTS206-6 \$1.75	CTS209-10 \$1.95
CTS207-7 \$1.75	

LIVERMORE BASIC

ON 6SK ROM
 TMS1200 (Board/ROM)
 OUR PRICE only \$95.00

NAKED PC BOARD SALE

Z-80 CPU (Ithaca) \$34.95
 8080A CPU \$44.95
 8K Static RAM (Ithaca) 21.95
 16K Static RAM (2114) 29.95
 32K Static RAM (2114) 39.95
 1204 (Ithaca) 39.95
 Cassette I/O (Tarbell) 21.95
 8K Eprom (2708) 29.95
 1702 Eprom Board 30.00
 2708/2716 Eprom (Ithaca) 34.95
 2708/2716 Eprom (WMC) 30.00
 Realtime Clock 34.95
 ACP Proto Bd (3M Conn) 27.95
 Vector 8800 Proto Board 19.95
 Vector 8803 11 slot MB 29.95
 ACP Extender w/Conn 15.95
 Video Interface (SSM) 27.95
 Parallel Interface (SSM) 27.95
 13 Slot Mother Board (WMC) 32.95
 8 Slot Mother Board (WMC) 29.95
 8 Slot Mother (expandable) 34.95

ATTENTION KIM USERS

1484 Expansion to S-100 125.00
 1484 Expansion to S-100 125.00
 1484 Expansion to S-100 125.00
 1484 Expansion to S-100 125.00
 1484 Expansion to S-100 125.00
 1484 Expansion to S-100 125.00
 1484 Expansion to S-100 125.00
 1484 Expansion to S-100 125.00
 1484 Expansion to S-100 125.00
 1484 Expansion to S-100 125.00

ATTENTION PET USERS

8000 expansion to S-100 109.00
 8000 expansion to S-100 109.00
 8000 expansion to S-100 109.00
 8000 expansion to S-100 109.00
 8000 expansion to S-100 109.00
 8000 expansion to S-100 109.00
 8000 expansion to S-100 109.00
 8000 expansion to S-100 109.00
 8000 expansion to S-100 109.00
 8000 expansion to S-100 109.00

ATTENTION TRS-80 USERS

2040 Memory Board/WMC 79.95

ATTENTION APPLE II USERS

Apple II 16K \$1045.00
 Apple II 32K 1045.00
 Apple II 64K 1045.00
 Apple II 128K 1045.00
 Apple II 256K 1045.00
 Apple II 512K 1045.00
 Apple II 1024K 1045.00
 Apple II 2048K 1045.00
 Apple II 4096K 1045.00
 Apple II 8192K 1045.00
 Apple II 16384K 1045.00
 Apple II 32768K 1045.00
 Apple II 65536K 1045.00
 Apple II 131072K 1045.00
 Apple II 262144K 1045.00
 Apple II 524288K 1045.00
 Apple II 1048576K 1045.00
 Apple II 2097152K 1045.00
 Apple II 4194304K 1045.00
 Apple II 8388608K 1045.00
 Apple II 16777216K 1045.00
 Apple II 33554432K 1045.00
 Apple II 67108864K 1045.00
 Apple II 134217728K 1045.00
 Apple II 268435456K 1045.00
 Apple II 536870912K 1045.00
 Apple II 1073741824K 1045.00
 Apple II 2147483648K 1045.00
 Apple II 4294967296K 1045.00
 Apple II 8589934592K 1045.00
 Apple II 17179869184K 1045.00
 Apple II 34359738368K 1045.00
 Apple II 68719476736K 1045.00
 Apple II 137438953472K 1045.00
 Apple II 274877906944K 1045.00
 Apple II 549755813888K 1045.00
 Apple II 1099511627776K 1045.00
 Apple II 2199023255552K 1045.00
 Apple II 4398046511104K 1045.00
 Apple II 8796093022208K 1045.00
 Apple II 17592186044416K 1045.00
 Apple II 35184372088832K 1045.00
 Apple II 70368744177664K 1045.00
 Apple II 140737488355328K 1045.00
 Apple II 281474976710656K 1045.00
 Apple II 562949953421312K 1045.00
 Apple II 1125899906842624K 1045.00
 Apple II 2251799813685248K 1045.00
 Apple II 4503599627370496K 1045.00
 Apple II 9007199254740992K 1045.00
 Apple II 18014398509481984K 1045.00
 Apple II 36028797018963968K 1045.00
 Apple II 72057594037927936K 1045.00
 Apple II 144115188075855872K 1045.00
 Apple II 28

'LYTIC SPECTACULAR!

PRICES SLASHED! THIS AD ONLY! Can type 'lytics in all the popular sizes including single, double, & triple section. Wow! Fresh, small size, pop US mfrs.

STOCK NO.	SECTION 1	SECTION 2	SECTION 3	EA.
C-3236	600/360V	--PHOTOFASH--	--	.59
C-1760	2000/24V	--	--	.49
C-2175	2500/30V	--	--	.59
C-2260	6000/50V	--COMPUTER GRADE--	--	2.49
C-1620	20/200V	20/200V	--	.25
C-2316	1500/75V	1500/70V	--	.89
C-2320	2500/30V	2000/25V	--	.79
C-2400	8/250V	8/250V	50/250V	.25
C-2705	1000/35V	1500/25V	1000/25V	.79
C-2333	2000/75V	3000/25V	1000/25V	.89
C-3135	2500/30V	2000/25V	2000/20V	.89

K-4150 KIT

5 or 10MHz, TTL, MOS or CMOS compatible!

Specify frequency!

PRECISION OSCILLATOR

±0.002% -10 to +60°C

Precision hermetic Xtal 5 to 12V Operation

Choice of 5 or 10MHz Frequency trimmer

Use with TTL.CMOS

\$1.95

OR WRITE FOR PRODUCTION QUOTES.

Add \$3 for assembled & tested unit

KIT INCLUDES ALL PARTS, PC BOARD, INSTRUCTIONS. ONLY 3 CONNECTIONS-- +VCC, GROUND, OUTPUT. SIZE 1.2" x 1.5". FAN OUT 10 TTL LOADS. ASSEMBLED UNITS ARE FACTORY CALIBRATED. CALL FOR PRODUCTION QUOTES.

BUSINESS OPPORTUNITIES

MECHANICALLY inclined individuals desiring ownership of Small Electronics Manufacturing Business—without investment. Write: **BUSINESSES**, 92-R, Brighton 11th, Brooklyn, NY 11235

HIGHLY PROFITABLE ONE-MAN ELECTRONIC FACTORY

Investment unnecessary, knowledge not required, sales handled by professionals. Ideal home business. Write today for facts! **Postcard will do. Barta-RE-L, Box 248, Walnut Creek, CA 94597.**

SAVE!

AXIAL 'LYTICS at the lowest prices anywhere! Small size, long leads, fresh stock. Stock up while they last!

STOCK NO.	MFD	DCWV	EA.
C-1405	450	15	.25
C-1450	450	25	.27
C-1435	500	30	.29
C-1445	500	60	.39
C-1460	1000	15	.39
C-2314	1000	50	.59
C-1500	1500	30	.49
C-1040	1600	10	.39
C-2114	2000	20	.49
C-3200	3200	20	.59

RHYTHM GENERATOR ROM IC

\$1.89 PRE-PROGRAMMED MEMORY HAS MANY RHYTHM PATTERNS STORED THAT ARE "WALKED OUT" WITH A COUNTER. CHANGE PATTERNS BY CHANGING ADDRESS. 24 PIN DIP SUPPLIED W/DATA. GREAT FUN TO PLAY WITH! D-6304

.001 Hz TO 1 MHz, SINE, SQUARE AND TRIANGLE OUT

\$3.95 8038 SUPER-FUNCTION GENERATOR

12 PAGE DATA SHEET \$1.00

TTL, CMOS, or MOS outputs.

Multi-Frequency Oscillator!

±0.001% +15 to +35°C

8 Independent outputs: 4MHz, 2MHz, 1MHz, 500 kHz, 250 kHz, etc.

Use any or all!

\$1.95

5 to 12V operation

Assembled - Add \$3

KIT INCLUDES ALL PARTS, SOCKETTED IC'S PC BOARD, INSTRUCTIONS. SIZE 1.5" x 2.5". ALL THE POP FREQUENCIES IN ONE UNIT!!

CABLE FM station. No experience required, excellent spare-time income, others operate for you. Details free. **BROADCASTING**, Box 130-F12, Paradise, CA 95969

MECHANICALLY INCLINED INDIVIDUALS —WANTED—

Assemble electronic devices in your home. Get started in spare time. Experience, Knowledge or Investment Not Necessary. Expect big profits: \$300 - \$600/Wk. Possible. Write for free literature telling how.

TRIACS & SCR'S 6AMP 200V

YOUR CHOICE

59¢.. 10/55

TO-220 "POWER TAB" CASE, HIGH GATE SENSITIVITY. FAMOUS MFRS. LOSS IS YOUR GAIN

T-2006 6A 200V TRIAC .59

S-2006 6A 200V SCR .59

JFET INPUT 741

59¢

PIN-FOR-PIN WITH A 741 OP AMP, BUT WITH AN INPUT Z OF 5 x 10¹¹ OHMS!! TYPE LF 13741 BY NATIONAL.

"OUR FIFTH YEAR"

DIAMONDBACK ELECTRONICS COMPANY

PO BOX 194 SPRING VALLEY, IL 61362

FREE CATALOG

ALL MERCHANDISE 100% GUARANTEED

MINIMUM ORDER \$5

ILL RESIDENTS ADD 5% SALES TAX

PLEASE INCLUDE SUFFICIENT POSTAGE

PHONE ORDERS 815/664-5151

ELECTRONIC DEVELOPMENT LAB

Box 1535R, Pinellas Park, FL 33565

GOVERNMENT SURPLUS

JEeps — \$59.30! — **Cars** — \$33.50! — 450,000 items! Government surplus — most comprehensive directory available tells how, where to buy — your area — \$2.00 — **moneyback guarantee** — **GOVERNMENT INFORMATION SERVICES**, Department VA—12, Box 99249, San Francisco, CA 94109

CIRCLE 61 ON FREE INFORMATION CARD

NEW-TONE ELECTRONICS INTERNATIONAL

Specializing in Japanese Semiconductors, with THE LARGEST INVENTORY AND LOWEST PRICES ANYWHERE

AND YOU CAN ORDER TOLL FREE 800-631-1250

Check the prices in this partial list. Dealers - send for our complete volume discount price list.

INTEGRATED CIRCUITS

AN115	2.25
AN228	4.65
AN272	3.90
AN313	4.85
AN321	2.25
AN326	3.30
AN362	2.70
AN366	2.49
AN606	4.50
AN612	2.70
BA001	1.50
BA102	1.50
BA505	6.30
BA612	2.40
BA1310	2.34
HA1125	2.10
HA1329	2.45
HA1366W	3.30
HA1366WR	3.30
HA1388	3.35
HA1406	1.20
LA1222	1.59
LA1365	2.25
LA1368	3.42
LA3101	3.75
LA4220	2.55
LA4300	2.70
LD3000	2.25
LD3080	2.70
LD3110A	3.75
LD3150	1.95
MS109P	3.30
MS112Y	6.70
MS118L	2.50
MS130P	3.12
MS135P	3.40
MS142P	5.70
MS340P	1.55
MS930P	.85
MS935P	1.20
MS946P	.85
MS953P	2.55
MS962P	.85

INTEGRATED CIRCUITS

MS1202	1.55
MS3216P	1.80
MS3273P	1.60
MS8473P	7.90
MB3710	2.95
MB8719	7.70
MN3006	5.90
MN3007	19.95
NPC5107	14.95
PL103A	14.95
SG264A	7.80
SG609	4.50
SG629-3	3.40
SG6523	17.50
SI010	6.90
SI020	13.95
SI030	19.00
SI050	27.80
SM5104	8.90
SM5107C	11.95
STK013	11.25
STK014	11.85
STK041	17.40
STK075	8.22
STK143	6.75
TA7092P	6.50
TA7117P	3.60
TA7206P	3.06
TA7214P	5.15
TA7217AP	3.30
TA7222P	3.50
TA7521M	3.55
TA7607P	9.90
TA7609P	4.80
TB8A10AS	3.30
TB8A10DS	3.30
TB8A10S	5.70
TB8A10SH	3.30
TB8A20	2.10
TDA1190Z	6.50
TDA2002	4.60
UPC141C	2.50
UPC572C	4.10

INTEGRATED CIRCUITS

UPC574	1.20
UPC583C	3.30
UPC1028	1.80
UPC1031H	2.98
UPC1032H	1.35

TRANSISTORS

2SC1429	1.49
2SC1452	1.40
2SC1474	96
2SC1548	79
2SC1583	68
2SC1622	49
2SC1630	3.60
2SC1681	39
2SC1682	39
2SC1761	1.58
2SC1762	4.85
2SC1775	.54
2SC1778	.62
2SC1787	.82
2SC1811	1.29
2SC1844	54
2SC1885	79
2SC1906	48
2SC1923	39
2SC1940	64
2SC1945	6.75
2SC1951	1.59
2SC1959	39
2SC1963	3.30
2SC1981	2.60
2SC1982	3.30
2SC2009	.85
2SC2021	.65
2SC2072	3.95
2SC2120	4.5
2SC2212	1.65
2SC2213	1.45
2SC2214	2.95
2SD388	3.65
2SD477	1.65
2SD528	3.30
2SK58	4.45
2SK97	4.85
2SK107	1.15
2SK120	4.90
2SK121	1.20
2SK125	1.75
2SK130A	3.90

INTEGRATED CIRCUITS

AN214	2.75
AN217	1.70
AN239	6.50
AN241	2.10
AN247	4.10
AN315	2.80
BA511A	2.65
BA521	2.75
CX101G	6.20
HA1306W	3.50
HA1339A	3.75
LA1366	3.60
LA4051P	2.70
LA4400	3.10
LD3141	1.80
MS115P	4.90
MS1513L	3.90
MN3001	19.50
MN3002	11.70
MN3003	11.70
PLD1A	8.60
PLD2A	8.40
PLD2A-G	8.40
STK011	5.80
STK015	6.15
STK032	13.80
STK046	.85
STK056	10.90
STK415	8.10
STK439	10.10
TA7045M	2.80
TA7060P	1.05
TA7063P	1.10
TA7074P	2.90
TA7089P	2.75
TA7092P	5.45
TA7120P	1.05
TA7153P	6.75
TA7201P	3.15
TA7203P	3.60
TA7204P	3.20
TA7205P	2.60
TA7310P	2.95

INTEGRATED CIRCUITS

UHC005	5.60
UHC005	5.60
UHC006	6.40
UPC20C	3.65
UPC555H	1.80
UPC563H2	3.65
UPC566H	1.15
UPC575C2	2.35
UPC592H2	1.05
UPC1001H2	3.40
UPC1008C	5.75
UPC1020M	3.05
UPC1025H	2.85
UPC1152H	3.25
UPC1156H	2.80
UPD857C	9.99
UPD858C	7.20

TRANSISTORS

2SB175	39
2SB324	55
2SB337	63
2SB370	1.25
2SB405	45
2SB407	1.20
2SB435	1.25
2SB463	1.40
2SB474	85
2SB492	85
2SC372	35
2SC373	35
2SC380	35
2SC387A	45
2SC394	39
2SC458	45
2SC460	45
2SC481	1.45
2SC482	1.35
2SC495	79
2SC509	45
2SC517	3.25
2SC535	45
2SC627	1.35
2SC634A	4.25
2SC710	37
2SC730	45
2SC732	3.95
2SC735	35
2SC756A	2.40
2SC778	3.35
2SC781	2.50
2SC784	45
2SC799	2.65
2SC828	30
2SC839	43
2SC867A	3.95
2SC930	35
2SC945	35
2SC1014	83
2SC1018	85

TRANSISTORS

2SC1034	5.45
2SC1061	1.00
2SC1079	3.95
2SC1096	75
2SC1166	40
2SC1172	4.80
2SC1173	70
2SC1226A	70
2SC1237	2.15
2SC1239	3.15
2SC1306	2.45
2SC1307	3.85
2SC1383	45
2SC1384	55
2SC1675	40
2SC1678	1.90
2SC1728	1.00
2SC1760	1.05
2SC1909	2.75
2SC1957	95
2SC1973	55
2SC2028	74
2SC2029	3.35
2SC2091	2.40
2SC2092	3.10
2SC2098	3.40
2SD72	78
2SD92	1.75
2SD180	2.35
2SD218	3.45
2SD234	80
2SD235	80
2SD261	.49
2SD313	90
2SD315	1.05
2SD325	85
2SD330	89
2SK19	68
2SK33	85
2SK55	89
2SK22	1.80
3SK40	1.90
3SK45	2.10

N.J. Residents add 5% Sales Tax. We pay postage for prepaid orders of \$50.00 or more, under \$50.00, add \$1.00. Canada \$1.50.

COD's WELCOME Hours - Daily 9 AM - 7 PM E.S.T., Sat 9 AM - 5 PM ALL PARTS GUARANTEED AGAINST FACTORY DEFECTS

n-te INTERNATIONAL

NEW-TONE ELECTRONICS INTERNATIONAL P.O. Box 1739, Bloomfield, N.J. 07003 New Jersey Phone: 201/748-5089

CIRCLE 43 ON FREE INFORMATION CARD

SAVE

COMPUTER INTERFACES & PERIPHERALS

SAVE

For free catalog including parts lists and schematics, send a self-addressed stamped envelope.

APPLE II SERIAL I/O INTERFACE *

Part no. 2
Baud rate is continuously adjustable from 0 to 30,000 • Plugs into any peripheral connector • Low current drain RS-232 input and output • On board switch selectable 5 to 8 data bits, 1 or 2 stop bits, and parity or no parity either odd or even • Jumper selectable address • SOFTWARE • Input and Output routine from monitor or BASIC to teletype or other serial printer.
• Program for using an Apple II for a video or an intelligent terminal. Also can output in correspondence code to interface with some selectrics. Board only — \$15.00, with parts — \$42.00; assembled and tested — \$62.00.



T.V. TYPEWRITER

Part no. 106
• Stand alone TVT
• 32 char/line, 16 lines, modifications for 64 char/line included • Parallel ASCII (TTL) input • Video output • 1K on board memory • Output for computer controlled cursor • Auto scroll • Non-destructive cursor • Cursor inputs: up, down, left, right, home, EOL, EOS • Scroll up, down • Requires +5 volts at 1.5 amps, and -12 volts at 30 mA • All 7400, TTL chips • Char. gen. 2513 • Upper case only • Board only \$39.00; with parts \$145.00

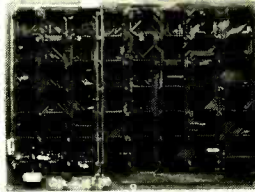

8K STATIC RAM

Part no. 300
• 8K Altair bus memory • Uses 2102 Static memory chips • Memory protect • Gold contacts • Wait states • On board regulator • S-100 bus compatible • Vector input option • TRI state buffered • Board only \$22.50; with parts \$160.00

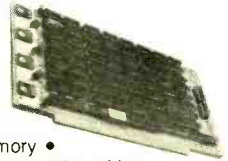

MODEM *

Part no. 109
• Type 103 • Full or half duplex • Works up to 300 baud • Originate or Answer • No coils, only low cost components • TTL input and output-serial • Connect 8 ohm speaker and crystal mic. directly to board • Uses XR FSK demodulator • Requires +5 volts • Board \$7.60; with parts \$27.50



TIDMA *

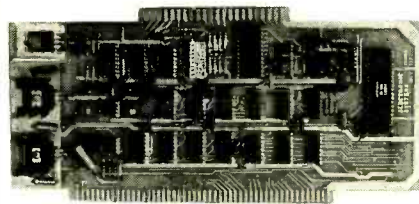

Part no. 112
• Tape Interface Direct Memory Access • Record and play programs without bootstrap loader (no prom) has FSK encoder/decoder for direct connections to low cost recorder at 1200 baud rate, and direct connections for inputs and outputs to a digital recorder at any baud rate. • S-100 bus compatible • Board only \$35.00; with parts \$110.00

RF MODULATOR *

Part no. 107
• Converts video to AM modulated RF, Channels 2 or 3. So powerful almost no tuning is required. On board regulated power supply makes this extremely stable. Rated very highly in Doctor Dobbs' Journal. Recommended by Apple. • Power required is 12 volts AC C.T., or +5 volts DC • Board \$7.60; with parts \$13.50



DC POWER SUPPLY *

Part no. 6085
• Board supplies a regulated +5 volts at 3 amps, +12, -12, and -5 volts at 1 amp. • Power required is 8 volts AC at 3 amps, and 24 volts AC C.T. at 1.5 amps • Board only \$12.50; with parts excluding transformers \$42.50



RS 232/TTY *

Part no. 600
• Converts RS-232 to 20mA current loop, and 20mA current loop to RS-232 • Two separate circuits • Requires +12 and -12 volts • Board only \$4.50, with parts \$7.00



TAPE INTERFACE *

Part no. 111
• Play and record Kansas City Standard tapes • Converts a low cost tape recorder to a digital recorder • Works up to 1200 baud • Digital in and out are TTL-serial • Output of board connects to mic. in of recorder • Earphone of recorder connects to input on board • No coils • Requires +5 volts, low power drain • Board \$7.60; with parts \$27.50



UART & BAUD RATE GENERATOR *

Part no. 101
• Converts serial to parallel and parallel to serial • Low cost on board baud rate generator • Baud rates: 110, 150, 300, 600, 1200, and 2400 • Low power drain +5 volts and -12 volts required • TTL compatible • All characters contain a start bit, 5 to 8 data bits, 1 or 2 stop bits, and either odd or even parity • All connections go to a 44 pin gold plated edge connector • Board only \$12.00; with parts \$35.00 with connector add \$3.00

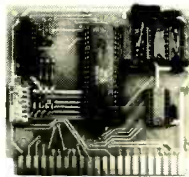

RS 232/TTL *

Part no. 232
• Converts TTL to RS-232, and converts RS-232 to TTL • Two separate circuits • Requires -12 and +12 volts • All connections go to a 10 pin gold plated edge connector • Board only \$4.50; with parts \$7.00 with connector add \$2.00

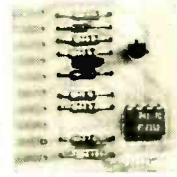

ELECTRONIC SYSTEMS

Dept. RE-9 P.O. Box 21638, San Jose, CA. USA 95151

To Order:

Mention part number and description. For parts kits add "A" to part number. In USA, shipping paid for orders accompanied by check, money order, or Master Charge, BankAmericard, or VISA number, expiration date and signature. Shipping charges added to C.O.D. orders. California residents add 6.5% for tax. Outside USA add 10% for air mail postage, no C.O.D.'s. Checks and money orders must be payable in US dollars. Parts kits include sockets for all ICs, components, and circuit board. Documentation is included with all products. All items are in stock, and will be shipped the day order is received via first class mail. Prices are in US dollars. No open accounts. To eliminate tariff in Canada boxes are marked "Computer Parts." Dealer inquiries invited. 24 Hour Order Line: (408) 226-4064



* Circuits designed by John Bell

FIRST QUALITY CARBON RESISTOR KITS 1/4W

Each kit contains all the EIA designated 10% values from 2.2 ohms to 8.2 megohms. Your cost: Only \$.02 per resistor.



KIT A
1,000 Pcs. 19⁹⁵ ppd.
Includes FREE 9-drawer box (\$5.00 value)



KIT B
500 Pcs. 9⁹⁵ ppd.
Includes FREE compartmentalized box (\$2.00 value)

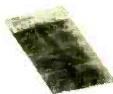

KIT C
250 Pcs. 4⁹⁵ ppd.
in Poly Bag

MANY OTHER KITS
Aluminum Electrolytic, Tantalum and Ceramic Capacitor Kits. Semiconductor Kits, too. Lamps also.

We have over 2,000 quality Receiving Tubes. Many hard-to-get types. All at 75% off list.

ORIGINAL JAPANESE SEMICONDUCTORS
Full range available to fill just about any requirement.

Call (516) 752-0060 or send for complete catalog



TO ORDER:
Send check or Money Order—
N.Y. residents add appropriate tax.

STEVEN PRODUCTS
P.O. BOX 698, MELVILLE, N.Y. 11746

MULTI-TESTER

IT TESTS
TRANSISTORS AND LED's
AS WELL!!

YX-360TR

TRANSISTOR TESTER
20K OHMS/VOLT

SPECIFICATIONS

DCV 0.0 1.0 5.2 5 10 50 250 1000 (20k Ω /V) : 3%, 25k (w/MV probe)
DCA 0.50uA 0.2 5 25mA 0.0 25A (100mV & 250mV) : 3%
ACV 0.10 50 250 1000 (8k Ω /V) : 4%
Freq. 30Hz to 30kHz
I: -1, -10, -1k, -10k (max. 20M)
Batt. 1.5V x 2 & 9V x 1
dB -10 to +62
ICEO 0.150uA 0.15 150mA -5%
hFE 0.1000 : 3% (w/connector)
150-100-57 420gr



\$28.50

THE MOST POPULAR MM5314 CLOCK KIT

Features:

- * 12/24 Hours Display
- * 50/60 Hz Input
- * 6 Digits Bright Orange Readouts

Kit includes plastic case, MM 5314 I.C. One set transistor drivers, P.C. Board, gas discharge displays, all other electronic parts and transformer. Catalog no. DC-8SP

SPECIAL PRICE
\$16.95 PER KIT



9 STEPS LED LEVEL INDICATOR KIT



for most stereo amplifiers
This new project works as a pair of VU meter to indicate the output level of your amplifier from -20dB to +3dB. Kit includes all LED, transistors, electronic components, P.C. Board and instructions.

Easy to build and fun to see,
ONLY \$12.50 EA.

60W + 60W

STEREO

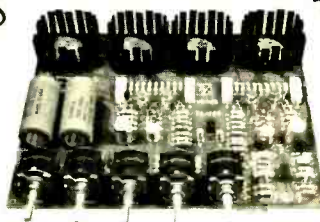

AMPLIFIER

COMPLETED UNIT—NOT A KIT!

OCL pre amp. & power stereo amp. with bass, middle, treble 3-way tone control. Fully assembled and tested, ready to work. Total harmonic distortion less than 0.5% at full power. Output maximum is 60 watts per channel at 8 Ω . Power supply is 24 - 36V AC or DC. Complete unit

only \$49.50 ea.
Power transformer \$ 8.50 ea.

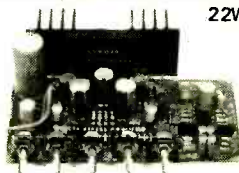

POWER TRANSFORMER \$6.50 EACH

22W + 22W STEREO HYBRID AMPLIFIER KIT

It Works in 12V D.C. As Well!! Kit includes 1 PC SANYO STK-024 stereo power amp. IC LM 1458 as pre amp, all other electronic parts, PC Board, all control pots and special heat sink for hybrid. Power transformer not included. It produces ultra hi-fi output up to 44 watts (22 watts per channel) yet gives out less than 0.1% total harmonic distortion between 100Mz and 10KHz.

\$32.50 PER KIT

SANYO HYBRID

Audio power amplifiers I.C.
Max. hi-fi output power, minimum ext. components needed.



15 Watts	STK-28	\$ 8.50
23 Watts	STK-054	\$13.50
30 Watts	STK-056	\$17.50
50 Watts	STK-050	\$26.50
10W + 10W (stereo)	STK-040	\$14.50
15W + 15W (stereo)	STK-041	\$25.50
20W + 20W (stereo)	STK-043	\$31.50

*data sheet comes with purchase

COMPUTER GRADE CAPACITORS



All capacitors are Brand New
U.S. made in standard size

9000MFD	50V	\$3.25 EA.
11000MFD	35V	\$3.20 EA.
14500MFD	40V	\$3.40 EA.
23000MFD	20V	\$3.00 EA.
58000MFD	20V	\$3.20 EA.
100,000MFD	6V	\$2.50 EA.

ULTRA-SONIC REMOTE CONTROL SWITCH KIT



Kit includes the transmitter, the receiver, ultra sonic transducers, P.L.L. I.C., all other electronic parts and P.C. Boards. Ideal for control TV, light, fan or garage door. Case not included.

\$18.50 PER KIT

DIP SWITCHES



(On-Off Contacts)	
4 positions	\$1.50
5 positions	\$1.60
6 positions	\$1.70
7 positions	\$1.70
8 positions	\$1.80
10 positions	\$2.00

ELECTRONIC WHEEL OF FORTUNE KIT!

With 10 numbers split into black and white on dial. The LED turns when you hit the play switch, then it slows down and stops on one number. It sounds like a motor inside, but there is none. Lots of fun and easy to build. Kit comes with nice looking case, all electronic parts, P.C. Board and LEDs. Battery not included.



\$12.50

SUPER 15 WATT AUDIO AMP KIT



ONLY \$23.50 each

Uses STK-015 Hybrid Power Amp

Kit includes: STK-015 Hybrid IC, power supply with power transformer, front Amp with tone control, all electronic parts as well as PC Board. Less than 0.5% harmonic distortion at full power 1/2dB response from 20-100,000 Hz. This amplifier has QUASI-Complimentary class B output. Output max is watt (10 watt RMS) at 4Ω.

63 KEYS ASC 11 DECORDED COMPLETE KEYBOARD by Honeywell

with dual color key tops, uses TMS 5000 decoder LSI. (schematic data included)



SPECIAL \$56.50 NOT A KIT!

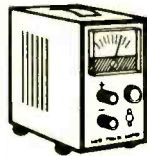

PROFESSIONAL CASE

for our 0-30V Power Supply. It is a nice looking metal cast case with giant 4" volt/amp meter; output blinding post and fuse holder, on/off switch and line cord!

ONLY \$21.50 EA.

CASE 030

MANY SOUND DECISIONS!

Solid state sound indicator operating voltage 6V DC 30μA. Small size approx. 1 1/2" x 1 1/2".

Model EB2116 (Continuous)
Model EB2126 (Slow Pulse)
Model EB2136 (Fast Pulse)



\$3.60 EACH

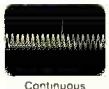

Continuous



Slow pulse

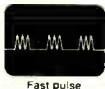

Fast pulse

1Watt AUDIO AMP

All parts are pre assembled on a mini PC Board
Supply Voltage 6-9V D.C.
SPECIAL PRICE \$1.95 ea.



"FISHER" 30 WATT STEREO AMP

MAIN AMP (15W X 2)

Kit includes 2 pcs. Fisher PA 301 Hybrid IC all electronic parts with PC Board, Power supply ± 16V DC (not included). Power band with (KF 1% ± 3dB). Voltage gain 33dB. 20Hz - 20KHz.

Super Buy Only \$18.50



5W AUDIO AMP KIT

2 LM 380 with Volume Control
Power Supply 6-18V DC
only \$5.00 ea.



TIMER KIT

Time Controlled from 1-100sec. Ideal to be used as timer delay unit for burglar alarm, photo service, and other purposes. Max. loading 110V, 2 AMP. Supply voltage 12-18V DC.
\$11.50 each



FT-40 ELECTRONIC IC TIMER

ELECTRONIC ALARM SIREN

COMPLETE UNIT
Ideal for use as an Alarm Unit or hookup to your car back up to make a reverse indicator.
Light Output up to 130dB
Voltage Supply 6-12V
\$7.50



AU-999

SOUND ACTIVATED SWITCH

All parts completed on a PC Board
SCR will turn on relay, buzzer or trigger other circuit for 2-10 sec. (adjustable).
Ideal for use as door alarm, sound controlled toys and many other projects.
Supply voltage 4-5V-9V D.C.
\$1.75 ea./2 for \$3.00



LINEAR SLIDE POT 500KΩ SINGLE Metal Case 3" Long 2 FOR \$1.20



DIGITAL ELECTRONIC LOCK KIT

for auto ignition, entry door, burglar alarm, etc.
\$6.50 ea. 4 Digits Programmable to CMOS I.C. Any Combination IN CIRCUIT



400R RELAY AND KEY PAD NOT INCLUDED

BATTERY POWERED FLUORESCENT LANTERN

FEATURES

- * Circuitry: designed for operation by high efficient, high power silicon transistor which enable illumination maintain in a standard level even the battery supply drops to a certain low voltage.
- * 9" 6W cool/daylight miniature fluorescent tube.
- * 6 X 1.5V UM-1 (size D) dry cell battery.
- * Easy sliding door for changing batteries.
- * Stainless reflector with wide angle increasing illumination of the lantern.



\$9.60 EACH MODEL 888 R



POWER SUPPLY KIT

0-30V D.C. REGULATED
Uses UA723 and ZN3055 Power TR output can be adjusted from 0-30V, 2 AMP. Complete with PC board and all electronic parts.

0-30 POWER SUPPLY \$10.50 each

Transformer for Power Supply, 2 AMP 24V x 2 \$6.50
30V DC Panel Meter \$4.20

12V DC MINI RELAY

P.C. Board Solder Type

2AMP Contact SPDT \$1.30 EA
5AMP Contact DPDT \$1.75 EA
5AMP Contact 4PDT \$2.20 EA



ELECTRONIC SWITCH KIT

CONDENSER TYPE

Touch On Touch Off uses 7431 IC and 12V relay \$5.50 each

AUTO ALARM KIT



The Crimefighter Auto Alarm is an electronic, self-controlled auto protection system, normally mounted within the glove box of an automobile. Two minutes after turning off the ignition, the alarm automatically turns itself "on". When auto is re-entered, the horn will sound after a 10-45 second entry delay. The automobile owner, by inserting the ignition key, will activate the alarm. Once activated, the alarm will sound for two minutes before automatically turning off. The alarm then resets and is ready to again protect the vehicle from unwanted entry.

FEATURES: Simple Installation: 5 wires. Automatically turns on when auto is parked. Adjustable entry time. Extended exit time to allow for unshut exit from vehicle. Numerous applications include protection of boats, campers, trailers, motorcycles, trucks. Cannot be deactivated by not wiring an auto. Cannot be turned off without ignition key. Negative ground only.

ONLY \$14.00 PER KIT



4 DIGITS ALARM CLOCK

COMPLETE UNIT NOT A KIT

- 0.5" RED LED READ OUT
- 24 HRS. ALARM SET
- 10 MINS. SNOOZE SET
- AM/PM ALARM INDICATORS
- SECOND DISPLAY SWITCH
- AUTOMATIC BRIGHTNESS CONTROL
- COMPACT AND HANDSOME PACKING
- 110V AC 60HZ INPUT

\$17.50 EACH



2 1/2" ROUND SPEAKER

8Ω 0.25W for most sound projects
SPECIAL 3 for \$2.00



I.C. TEST CLIPS

Same as the E-Z clips With 20" Long Leads In Black and Red Colors \$2.75 per pair



FM WIRELESS MIC KIT

This new model FM wireless MIC kit uses 3 high freq. transistors, works in the FM range (88-108 MHz). It transmits the sound wave fidelity clearly over long distances (up to 250 ft.). Kit comes with all electronic parts, P.C. Board and mini microphone!

\$6.95 EACH KIT



Sub-Mini Size Condenser Microphone \$2.50 each FET Transistor Built-in

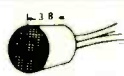

WE FOUND THE CASE FOR THE FM MIC!
Small nice looking aluminum case size like a pack of cigarettes. It is an intercom. Audio amp inside with a mic jack, a mini toggle sw on top, can be used for many projects. We give you the circuit data as well.
VERY SPECIAL PRICE 2 for \$4.99

FLUORESCENT LIGHT DRIVER KIT

12V DC POWERED

Lights up 8-15 Watt Fluorescent Light Tubes Ideal for camper, outdoor Auto or Boat



Kit includes high voltage coil, power transistor, heat sink, all other electronic parts and PC Board, light tube not included!
ONLY \$5.50 PER KIT



12V D.C. AUTO DIGITAL CLOCK

Complete Unit Not a Kit!

0.4" blue color 4 digits display. Turn off readouts when car is not running. X'ial controlled time base for time accuracy. Special designed case for easy mounting on top of your dashboard. Ideal for car, boat and campers.
SALE!
ONLY \$28.00 ea. \$24.50



AA SIZE NI CD BATTERY

6 in a pack 11.2V X 61500 MA/HR \$4.80 PER PACK



BRAND NEW EVEREADY CH15 AA size NI-CD 500 MA/HR. 4 for \$5.50
Only limited quantity available



Sub Mini Size PANEL METER 500 UA ONLY \$1.20 ea



PANEL METER (D.C. Type) size 60MM X 66MM White Face Type \$5.50 ea.
0-50 UA 0-30V
0-1MA 0-50V
0-5MA 0-100V
0-100MA



TRANSFORMERS

ALL 117 VOLT INPUT

30V 4AMP \$7.50 EA.
36V CT 3AMP \$6.50 EA.
48V CT 3AMP \$6.50 EA.
24V CT 3AMP \$6.50 EA.
24V CT 0.8AMP \$1.80 EA.
12V CT 0.8AMP \$1.80 EA.
12V CT 120MA \$1.25 EA.



AC POWER SUPPLY

Wall Type Transformer

12V AC Output 200MA \$2.75 EA.
16V CT AC Output 100MA \$2.10 EA.
6V DC Output 120MA \$1.90 EA.
12V DC Output 100MA \$1.90 EA.



WIDE ANGLE PANEL METER

1 1/2" x 1/2" IMA Full Scale (scale marks 0-100) \$1.50 each



HOUR INDICATOR

This unit is 1 5/8" long operating voltage 4V D.C. will tell you how many hours your circuit or machine has been in service up to 100 hours.
Limited Quantity ONLY \$1.75 ea.



HEAVY DUTY CLIP LEADS

10 pairs - 5 colors Alligator clips on a 22" long lead. Ideal for any testing.
\$1.85/pack

MINI-SIZED I.C. AM RADIO

Size smaller than a box of matches! Receives all AM stations Batteries and ear phone included

Only \$8.50



MINI-MINI TOGGLE SWITCH

Half size of submini toggle switch rated 3 amp 125V AC contact 1-9 10-99 MS 344 SPDT 1.00 0.90 MS 245 DPDT 1.20 1.10 LARGE QUANTITY AVAILABLE FOR OEM



SUBMINIATURE TOGGLE SWITCHES

SPDT On/Off \$1.30 ea
DPDT On/Off \$1.50 ea
3PDT On/Off \$1.75 ea
Mini size Rocker Type (Also available at the same price)



MINI SIZE REED RELAY

Approx. 1" square SPST Normal Open Contact rated 1AMP Coil 6-12V DC All brand new by AMF 3 for \$2.00



PUSH-BUTTON SWITCH

N/Open Contact Color: Red, White, Blue, Green, Black 4/\$1.00 N/Close also Available 50 ea. LARGE QTY. AVAILABLE



SOLID STATE ELECTRONIC BUZZER

Mini size 1" x 1/2" x 1/4" Supply voltage 1.5V 12V Ideal for Alarm or Tone Indicator \$1.50 each

MINIMUM ORDER \$10.00. California residents add 6% sales tax and 10% shipping. Out of state add 15% of total purchase for shipping charges, out of USA and Overseas add 25% of total purchase. 12/78 SEND CHECK OR MONEY ORDER TO.



FORMULA INTERNATIONAL INC.

12603 GRENSHAW BOULEVARD • HAWTHORNE, CALIFORNIA 90250

For more information please call (213) 973-1921, (213) 679-5162

STORE HOURS 10-7 Monday - Saturday

SEND \$1.00 FOR DETAILED CATALOG



Jameco Kits

Regulated Power Supply



- Uses LM 309K
- Heat sink provided
- P.C. board construction
- Provides a solid 1 amp @ 5V
- Includes components, hardware and instructions
- Sizes: 3-1/2" x 5" x 2" high

JE200 \$14.95

Function Generator Kit



- Provides 3 basic waveforms: sine, triangle & square wave
- Frequency range from 1 Hz to 100K Hz
- Output amplitude from 0-volts to over 6 volts (peak to peak)
- Uses a 12V supply or a ±6V split supply
- Includes chip, P.C. board, components and instructions.

JE2206B \$19.95

Digital Stopwatch Kit

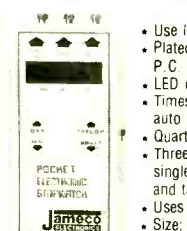

- Use Intersil 7205 Chip
- Plated thru double-sided P.C. Board
- LED display (red)
- Times to 59 min. 59.59 sec. with auto reset
- Quartz crystal controlled
- Three stopwatches in one: single event, split (cumulative) and taylor (sequential timing)
- Uses 3 penlite batteries
- Size: 4.5" x 2.15" x .90"

JE900 \$39.95

4-Digit Clock Kit

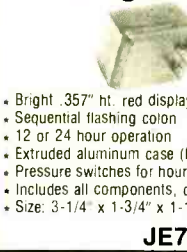

- Bright .357" ht. red display
- Sequential flashing colon
- 12 or 24 hour operation
- Extruded aluminum case (black)
- Pressure switches for hours, minutes and hold modes
- Includes all components, case and wall transformer
- Size: 3-1/4" x 1-3/4" x 1-1/4"

JE730 \$14.95

6-Digit Clock Kit

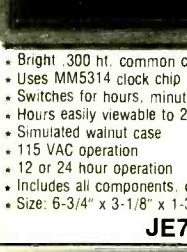

- Bright .300 ht. common cathode display
- Uses MM5314 clock chip
- Switches for hours, minutes and hold functions
- Hours easily viewable to 20 feet
- Simulated walnut case
- 115 VAC operation
- 12 or 24 hour operation
- Includes all components, case and wall transformer
- Size: 6-3/4" x 3-1/8" x 1-3/4"

JE701 \$19.95

Jumbo 6-Digit Clock Kit

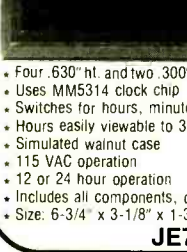

- Four .630" ht. and two .300" ht. common anode displays
- Uses MM5314 clock chip
- Switches for hours, minutes and hold functions
- Hours easily viewable to 30 feet
- Simulated walnut case
- 115 VAC operation
- 12 or 24 hour operation
- Includes all components, case and wall transformer
- Size: 6-3/4" x 3-1/8" x 1-3/4"

JE747 \$29.95

MICROPROCESSOR COMPONENTS

8080A/8080A SUPPORT DEVICES		MICROPROCESSOR MANUALS	
8080A CPU	\$ 9.95	M-280 User Manual	\$7.50
8214 8-Bit Input/Output	2.25	M-280P/802 User Manual	7.50
8216 Priority Interrupt Control	5.95	M-2650 User Manual	5.00
8216 Bi-Directional Bus Driver	3.49		
8224 Clock Generator/Driver	3.95		
8226 Bus Driver	3.49		
8228 System Controller/Bus Driver	5.95		
8238 System Controller	3.95		
8251 Prog. Comm. 1/0 (USART)	14.95		
8253 Prog. Interval Timer	14.95		
8255 Prog. Prio. 1/0 (PP)	19.95		
8257 Prog. DMA Control	19.95		
8259 Prog. Interrupt Control	19.95		
6800-6800 SUPPORT DEVICES		ROM'S	
MC6800 MPU	\$14.95	2513(2140) Character Generator (upper case)	\$9.95
MC6800CP MPU with Clock and Ram	24.95	2513(2021) Character Generator (lower case)	9.95
MC6801 (RAM) 128K8 Static Ram	5.95	2516 Character Generator	10.95
MC6821 Periph. Inter. Adapt. (MC6820)	7.49	MMS230N 2048-Bit Read Only Memory	1.95
MC6828 Priority Interrupt Controller	12.95		
MC6830L 1024X8 Bit ROM (MC68A30-B)	14.95		
MC6850 Asynchronous Comm. Adapter	7.95		
MC6852 Synchronous Serial Data Adapt.	9.95		
MC6860 0-600 bps Digital MODEM	12.95		
MC6862 2400 bps Modulator	14.95		
MC6880A Quad 3-State Bus Trans. (MC68126)	2.25		
MICROPROCESSOR CHIPS - MISCELLANEOUS		RAM'S	
Z8017801 CPU	\$19.95	1101 256K11 Dynamic	\$1.49
Z801780-1 CPU	24.95	1103 1024X1 Static	1.95
COP1802 CPU	19.95	2101(8101) 256K4 Static	3.75
2650 MPU	19.95	2102 1024X1 Static	1.95
8005 8-Bit MPU w/clock RAM 1/0 lines	19.95	2102 1024X1 Static	1.95
P8085 CPU	19.95	2114-3 1024X4 Static 300ns low power	11.95
TMS9901U 16-Bit MPU w/hardware multiply & divide	49.95	2114-3 1024X4 Static 450ns	9.95
		2114-3 1024X4 Static 450ns low power	10.95
		2114-3 1024X4 Static 300ns	10.95
		2114-3 1024X4 Static 300ns low power	11.95
		2114-3 1024X4 Static	7.95
		2114-3 1024X4 Static 450ns	14.95
		2114-3 1024X4 Static 450ns low power	10.95
		2114-3 1024X4 Static 300ns	10.95
		2114-3 1024X4 Static 300ns low power	11.95
		2114-3 1024X4 Static	7.95
		2114-3 1024X4 Static 450ns	14.95
		2114-3 1024X4 Static 450ns low power	10.95
		2114-3 1024X4 Static 300ns	10.95
		2114-3 1024X4 Static 300ns low power	11.95
		2114-3 1024X4 Static	7.95
		2114-3 1024X4 Static 450ns	14.95
		2114-3 1024X4 Static 450ns low power	10.95
		2114-3 1024X4 Static 300ns	10.95
		2114-3 1024X4 Static 300ns low power	11.95
		2114-3 1024X4 Static	7.95
		2114-3 1024X4 Static 450ns	14.95
		2114-3 1024X4 Static 450ns low power	10.95
		2114-3 1024X4 Static 300ns	10.95
		2114-3 1024X4 Static 300ns low power	11.95
		2114-3 1024X4 Static	7.95
		2114-3 1024X4 Static 450ns	14.95
		2114-3 1024X4 Static 450ns low power	10.95
		2114-3 1024X4 Static 300ns	10.95
		2114-3 1024X4 Static 300ns low power	11.95
		2114-3 1024X4 Static	7.95
		2114-3 1024X4 Static 450ns	14.95
		2114-3 1024X4 Static 450ns low power	10.95
		2114-3 1024X4 Static 300ns	10.95
		2114-3 1024X4 Static 300ns low power	11.95
		2114-3 1024X4 Static	7.95
		2114-3 1024X4 Static 450ns	14.95
		2114-3 1024X4 Static 450ns low power	10.95
		2114-3 1024X4 Static 300ns	10.95
		2114-3 1024X4 Static 300ns low power	11.95
		2114-3 1024X4 Static	7.95
		2114-3 1024X4 Static 450ns	14.95
		2114-3 1024X4 Static 450ns low power	10.95
		2114-3 1024X4 Static 300ns	10.95
		2114-3 1024X4 Static 300ns low power	11.95
		2114-3 1024X4 Static	7.95
		2114-3 1024X4 Static 450ns	14.95
		2114-3 1024X4 Static 450ns low power	10.95
		2114-3 1024X4 Static 300ns	10.95
		2114-3 1024X4 Static 300ns low power	11.95
		2114-3 1024X4 Static	7.95
		2114-3 1024X4 Static 450ns	14.95
		2114-3 1024X4 Static 450ns low power	10.95
		2114-3 1024X4 Static 300ns	10.95
		2114-3 1024X4 Static 300ns low power	11.95
		2114-3 1024X4 Static	7.95
		2114-3 1024X4 Static 450ns	14.95
		2114-3 1024X4 Static 450ns low power	10.95
		2114-3 1024X4 Static 300ns	10.95
		2114-3 1024X4 Static 300ns low power	11.95
		2114-3 1024X4 Static	7.95
		2114-3 1024X4 Static 450ns	14.95
		2114-3 1024X4 Static 450ns low power	10.95
		2114-3 1024X4 Static 300ns	10.95
		2114-3 1024X4 Static 300ns low power	11.95
		2114-3 1024X4 Static	7.95
		2114-3 1024X4 Static 450ns	14.95
		2114-3 1024X4 Static 450ns low power	10.95
		2114-3 1024X4 Static 300ns	10.95
		2114-3 1024X4 Static 300ns low power	11.95
		2114-3 1024X4 Static	7.95
		2114-3 1024X4 Static 450ns	14.95
		2114-3 1024X4 Static 450ns low power	10.95
		2114-3 1024X4 Static 300ns	10.95
		2114-3 1024X4 Static 300ns low power	11.95
		2114-3 1024X4 Static	7.95
		2114-3 1024X4 Static 450ns	14.95
		2114-3 1024X4 Static 450ns low power	10.95
		2114-3 1024X4 Static 300ns	10.95
		2114-3 1024X4 Static 300ns low power	11.95
		2114-3 1024X4 Static	7.95
		2114-3 1024X4 Static 450ns	14.95
		2114-3 1024X4 Static 450ns low power	10.95
		2114-3 1024X4 Static 300ns	10.95
		2114-3 1024X4 Static 300ns low power	11.95
		2114-3 1024X4 Static	7.95
		2114-3 1024X4 Static 450ns	14.95
		2114-3 1024X4 Static 450ns low power	10.95
		2114-3 1024X4 Static 300ns	10.95
		2114-3 1024X4 Static 300ns low power	11.95
		2114-3 1024X4 Static	7.95
		2114-3 1024X4 Static 450ns	14.95
		2114-3 1024X4 Static 450ns low power	10.95
		2114-3 1024X4 Static 300ns	10.95
		2114-3 1024X4 Static 300ns low power	11.95
		2114-3 1024X4 Static	7.95
		2114-3 1024X4 Static 450ns	14.95
		2114-3 1024X4 Static 450ns low power	10.95
		2114-3 1024X4 Static 300ns	10.95
		2114-3 1024X4 Static 300ns low power	11.95
		2114-3 1024X4 Static	7.95
		2114-3 1024X4 Static 450ns	14.95
		2114-3 1024X4 Static 450ns low power	10.95
		2114-3 1024X4 Static 300ns	10.95
		2114-3 1024X4 Static 300ns low power	11.95
		2114-3 1024X4 Static	7.95
		2114-3 1024X4 Static 450ns	14.95
		2114-3 1024X4 Static 450ns low power	10.95
		2114-3 1024X4 Static 300ns	10.95
		2114-3 1024X4 Static 300ns low power	11.95
		2114-3 1024X4 Static	7.95
		2114-3 1024X4 Static 450ns	14.95
		2114-3 1024X4 Static 450ns low power	10.95
		2114-3 1024X4 Static 300ns	10.95
		2114-3 1024X4 Static 300ns low power	11.95
		2114-3 1024X4 Static	7.95
		2114-3 1024X4 Static 450ns	14.95
		2114-3 1024X4 Static 450ns low power	10.95
		2114-3 1024X4 Static 300ns	10.95
		2114-3 1024X4 Static 300ns low power	11.95
		2114-3 1024X4 Static	7.95
		2114-3 1024X4 Static 450ns	14.95
		2114-3 1024X4 Static 450ns low power	10.95
		2114-3 1024X4 Static 300ns	10.95
		2114-3 1024X4 Static 300ns low power	11.95
		2114-3 1024X4 Static	7.95
		2114-3 1024X4 Static 450ns	14.95
		2114-3 1024X4 Static 450ns low power	10.95
		2114-3 1024X4 Static 300ns	10.95
		2114-3 1024X4 Static 300ns low power	11.95
		2114-3 1024X4 Static	7.95
		2114-3 1024X4 Static 450ns	14.95
		2114-3 1024X4 Static 450ns low power	10.95
		2114-3 1024X4 Static 300ns	10.95
		2114-3 1024X4 Static 300ns low power	11.95
		2114-3 1024X4 Static	7.95
		2114-3 1024X4 Static 450ns	14.95
		2114-3 1024X4 Static 450ns low power	10.95
		2114-3 1024X4 Static 300ns	10.95
		2114-3 1024X4 Static 300ns low power	11.95
		2114-3 1024X4 Static	7.95
		2114-3 1024X4 Static 450ns	14.95
		2114-3 1024X4 Static 450ns low power	10.95
		2114-3 1024X4 Static 300ns	10.95
		2114-3 1024X4 Static 300ns low power	11.95
		2114-3 1024X4 Static	7.95
		2114-3 1024X4 Static 450ns	14.95
		2114-3 1024X4 Static 450ns low power	10.95
		2114-3 1024X4 Static 300ns	10.95
		2114-3 1024X4 Static 300ns low power	11.95
		2114-3 1024X4 Static	7.95
		2114-3 1024X4 Static 450ns	14.95
		2114-3 1024X4 Static 450ns low power	10.95
		2114-3 1024X4 Static 300ns	10.95
		2114-3 1024X4 Static 300ns low power	11.95
		2114-3 1024X4 Static	7.95
		2114-3 1024X4 Static 450ns	14.95
		2114-3 1024X4 Static 450ns low power	10.95
		2114-3 1024X4 Static 300ns	10.95
		2114-3 1024X4 Static 300ns low power	11.95
		2114-3 1024X4 Static	7.95
		2114-3 1024X4 Static 450ns	14.95
		2114-3 1024X4 Static 450ns low power	10.95
		2114-3 1024X4 Static 300ns	10.95
		2114-3 1024X4 Static	

7400 TTL			
SN7400N	16	SN7470N	29
SN7401N	18	SN7471N	35
SN7402N	18	SN7472N	35
SN7403N	18	SN7473N	35
SN7404N	18	SN7474N	35
SN7405N	20	SN7475N	50
SN7406N	29	SN7476N	59
SN7407N	29	SN7477N	59
SN7408N	29	SN7478N	59
SN7409N	29	SN7479N	59
SN7410N	18	SN7480N	1.75
SN7411N	25	SN7481N	4.5
SN7412N	25	SN7482N	4.5
SN7413N	40	SN7483N	43
SN7414N	70	SN7484N	59
SN7415N	25	SN7485N	65
SN7420N	20	SN7486N	65
SN7421N	29	SN7487N	3.00
SN7422N	39	SN7488N	3.00
SN7423N	25	SN7489N	3.5
SN7424N	29	SN7490N	3.5
SN7425N	29	SN7491N	3.5
SN7426N	29	SN7492N	3.5
SN7427N	25	SN7493N	3.5
SN7428N	39	SN7494N	3.5
SN7429N	39	SN7495N	3.5
SN7430N	25	SN7496N	3.5
SN7431N	25	SN7497N	3.5
SN7432N	25	SN7498N	3.5
SN7433N	25	SN7499N	3.5
SN7434N	25	SN7500N	3.5
SN7435N	25	SN7501N	3.5
SN7436N	25	SN7502N	3.5
SN7437N	25	SN7503N	3.5
SN7438N	25	SN7504N	3.5
SN7439N	25	SN7505N	3.5
SN7440N	20	SN7506N	3.5
SN7441N	89	SN7507N	3.5
SN7442N	46	SN7508N	3.5
SN7443N	75	SN7509N	3.5
SN7444N	75	SN7510N	3.5
SN7445N	75	SN7511N	3.5
SN7446N	75	SN7512N	3.5
SN7447N	59	SN7513N	3.5
SN7448N	59	SN7514N	3.5
SN7449N	59	SN7515N	3.5
SN7450N	20	SN7516N	3.5
SN7451N	20	SN7517N	3.5
SN7452N	20	SN7518N	3.5
SN7453N	20	SN7519N	3.5
SN7454N	20	SN7520N	3.5
SN7455N	20	SN7521N	3.5
SN7456N	20	SN7522N	3.5
SN7457N	20	SN7523N	3.5
SN7458N	20	SN7524N	3.5
SN7459N	20	SN7525N	3.5

20% Discount 100 pcs combined order 25% - 1000 pcs combined order

C/MOS			
CD4000	23	CD4070	55
CD4001	23	CD4071	23
CD4002	23	CD4072	49
CD4003	11	CD4073	39
CD4004	25	CD4074	39
CD4005	25	CD4075	39
CD4006	25	CD4076	39
CD4007	25	CD4077	39
CD4008	25	CD4078	39
CD4009	25	CD4079	39
CD4010	25	CD4080	39
CD4011	23	CD4081	1.25
CD4012	23	CD4082	1.25
CD4013	39	CD4083	1.25
CD4014	1.39	CD4084	1.25
CD4015	1.19	CD4085	1.25
CD4016	1.19	CD4086	1.25
CD4017	1.19	CD4087	1.25
CD4018	1.19	CD4088	1.25
CD4019	1.19	CD4089	1.25
CD4020	1.19	CD4090	1.25
CD4021	1.19	CD4091	1.25
CD4022	1.19	CD4092	1.25
CD4023	23	CD4093	1.25
CD4024	23	CD4094	1.25
CD4025	23	CD4095	1.25
CD4026	2.25	CD4096	1.25
CD4027	69	CD4097	45

74C00			
74C00	39	74C163	2.49
74C01	39	74C164	2.49
74C02	39	74C165	2.49
74C03	39	74C166	2.49
74C04	39	74C167	2.49
74C05	39	74C168	2.49
74C06	39	74C169	2.49
74C07	39	74C170	2.49
74C08	39	74C171	2.49
74C09	39	74C172	2.49
74C10	39	74C173	2.49
74C11	39	74C174	2.49
74C12	39	74C175	2.49
74C13	39	74C176	2.49
74C14	39	74C177	2.49
74C15	39	74C178	2.49
74C16	39	74C179	2.49
74C17	39	74C180	2.49
74C18	39	74C181	2.49
74C19	39	74C182	2.49
74C20	39	74C183	2.49
74C21	39	74C184	2.49
74C22	39	74C185	2.49
74C23	39	74C186	2.49
74C24	39	74C187	2.49
74C25	39	74C188	2.49
74C26	39	74C189	2.49
74C27	39	74C190	2.49
74C28	39	74C191	2.49
74C29	39	74C192	2.49
74C30	39	74C193	2.49
74C31	39	74C194	2.49
74C32	39	74C195	2.49
74C33	39	74C196	2.49
74C34	39	74C197	2.49
74C35	39	74C198	2.49
74C36	39	74C199	2.49
74C37	39	74C200	2.49
74C38	39	74C201	2.49
74C39	39	74C202	2.49
74C40	39	74C203	2.49
74C41	39	74C204	2.49
74C42	39	74C205	2.49
74C43	39	74C206	2.49
74C44	39	74C207	2.49
74C45	39	74C208	2.49
74C46	39	74C209	2.49
74C47	39	74C210	2.49
74C48	39	74C211	2.49
74C49	39	74C212	2.49
74C50	39	74C213	2.49

LINEAR			
LM106H	99	LM710N	79
LM300H	99	LM711N	39
LM300CN/H	35	LM723N	1.00
LM302H	75	LM733H	1.19
LM304H	1.00	LM741N	35
LM305H	60	LM741AN	39
LM307CN/H	35	LM742N	39
LM308CN/H	1.00	LM743N	39
LM309CN/H	1.10	LM744N	39
LM310CN	1.25	LM745N	2.05
LM311CN	1.25	LM746N	1.00
LM312H	1.95	LM747N	1.95
LM317A	6.50	LM748N	1.75
LM318CN/H	1.50	LM749N	1.75
LM319N	1.50	LM750N	1.75
LM320N	1.35	LM751N	1.75
LM320N-5	1.35	LM752N	1.75
LM320N-12	1.35	LM753N	1.75
LM320N-18	1.35	LM754N	1.75
LM320N-24	1.35	LM755N	1.75
LM320N-30	1.35	LM756N	1.75
LM320N-36	1.35	LM757N	1.75
LM320N-42	1.35	LM758N	1.75
LM320N-48	1.35	LM759N	1.75
LM320N-54	1.35	LM760N	1.75
LM320N-60	1.35	LM761N	1.75
LM320N-66	1.35	LM762N	1.75
LM320N-72	1.35	LM763N	1.75
LM320N-78	1.35	LM764N	1.75
LM320N-84	1.35	LM765N	1.75
LM320N-90	1.35	LM766N	1.75
LM320N-96	1.35	LM767N	1.75
LM320N-102	1.35	LM768N	1.75
LM320N-108	1.35	LM769N	1.75
LM320N-114	1.35	LM770N	1.75
LM320N-120	1.35	LM771N	1.75
LM320N-126	1.35	LM772N	1.75
LM320N-132	1.35	LM773N	1.75
LM320N-138	1.35	LM774N	1.75
LM320N-144	1.35	LM775N	1.75
LM320N-150	1.35	LM776N	1.75
LM320N-156	1.35	LM777N	1.75
LM320N-162	1.35	LM778N	1.75
LM320N-168	1.35	LM779N	1.75
LM320N-174	1.35	LM780N	1.75
LM320N-180	1.35	LM781N	1.75
LM320N-186	1.35	LM782N	1.75
LM320N-192	1.35	LM783N	1.75
LM320N-198	1.35	LM784N	1.75
LM320N-204	1.35	LM785N	1.75
LM320N-210	1.35	LM786N	1.75
LM320N-216	1.35	LM787N	1.75
LM320N-222	1.35	LM788N	1.75
LM320N-228	1.35	LM789N	1.75
LM320N-234	1.35	LM790N	1.75
LM320N-240	1.35	LM791N	1.75
LM320N-246	1.35	LM792N	1.75
LM320N-252	1.35	LM793N	1.75
LM320N-258	1.35	LM794N	1.75
LM320N-264	1.35	LM795N	1.75
LM320N-270	1.35	LM796N	1.75
LM320N-276	1.35	LM797N	1.75
LM320N-282	1.35	LM798N	1.75
LM320N-288	1.35	LM799N	1.75
LM320N-294	1.35	LM800N	1.75
LM320N-300	1.35	LM801N	1.75
LM320N-306	1.35	LM802N	1.75
LM320N-312	1.35	LM803N	1.75
LM320N-318	1.35	LM804N	1.75
LM320N-324	1.35	LM805N	1.75
LM320N-330	1.35	LM806N	1.75
LM320N-336	1.35	LM807N	1.75
LM320N-342	1.35	LM808N	1.75
LM320N-348	1.35	LM809N	1.75
LM320N-354	1.35	LM810N	1.75
LM320N-360	1.35	LM811N	1.75
LM320N-366	1.35	LM812N	1.75
LM320N-372	1.35	LM813N	1.75
LM320N-378	1.35	LM814N	1.75
LM320N-384	1.35	LM815N	1.75
LM320N-390	1.35	LM816N	1.75
LM320N-396	1.35	LM817N	1.75
LM320N-402	1.35	LM818N	1.75
LM320N-408	1.35	LM819N	1.75
LM320N-414	1.35	LM820N	1.75
LM320N-420	1.35	LM821N	1.75
LM320N-426	1.35	LM822N	1.75
LM320N-432	1.35	LM823N	1.75
LM320N-438	1.35	LM824N	1.75
LM320N-444	1.35	LM825N	1.75
LM320N-450	1.35	LM826N	1.75
LM320N-456	1.35	LM827N	1.75
LM320N-462	1.35	LM828N	1.75
LM320N-468	1.35	LM829N	1.75
LM320N-474	1.35	LM830N	1.75
LM320N-480	1.35	LM831N	1.75
LM320N-486	1.35	LM832N	1.75
LM320N-492	1.35	LM833N	1.75
LM320N-498	1.35	LM834N	1.75
LM320N-504	1.35	LM835N	1.75
LM320N-510	1.35	LM836N	1.75
LM320N-516	1.35	LM837N	1.75
LM320N-522	1.35	LM838N	1.75
LM320N-528	1.35	LM839N	1.75
LM320N-534	1.35	LM840N	1.75
LM320N-540	1.35	LM841N	1.75
LM320N-546	1.35	LM842N	1.75
LM320N-552	1.35	LM843N	1.75
LM320N-558	1.35	LM844N	1.75
LM320N-564	1.35	LM845N	1.75
LM320N-570	1.35	LM846N	1.75
LM320N-576	1.35	LM847N	1.75
LM320N-582	1.35	LM848N	1.75
LM320N-588	1.35	LM849N	1.75
LM320N-594	1.35	LM850N	1.75
LM320N-600	1.35	LM851N	1.75
LM320N-606	1.35	LM852N	1.75
LM320N-612	1.35	LM853N	1.75
LM320N-618	1.35	LM854N	1.75
LM320N-624	1.35	LM855N	1.75
LM320N-630	1.35	LM856N	1.75
LM320N-636	1.35	LM857N	1.75
LM320N-642	1.35	LM858N	1.75
LM320N-648	1.35	LM859N	1.75
LM320N-654	1.35	LM860N	1.75
LM320N-660	1.35	LM861N	1.75
LM320N-666	1.35	LM862N	1.75
LM320N-672	1.35	LM863N	1.75
LM320N-678	1.35	LM864N	1.75
LM320N-684	1.35	LM865N	1.75
LM320N-690	1.35	LM866N	1.75
LM320N-696	1.35	LM867N	1.75
LM320N-702	1.35	LM868N	1.75
LM320N-708	1.35	LM869N	1.75
LM320N-714	1.35	LM870N	1.75
LM320N-720	1.35	LM871N	1.75
LM320N-726	1.35	LM872N	1.75
LM320N-732	1.35	LM873N	1.75
LM320N-738	1.35		

TRS-80 MEMORY EXPANSION: \$159!

Our Conversion Kit contains all parts (and detailed instructions) necessary to upgrade a TRS-80 main-frame from 4K to 16K, or populate the Memory Expansion Module. Also works with APPLEs. Only \$159 (3 kits/\$450) . . . and we back up our parts with a 1 year warranty.

MP1003 CLOCK MODULE: \$16.50

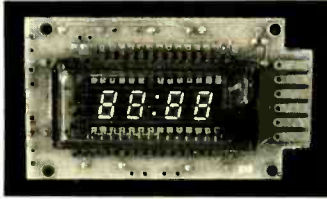

Add 3 time-setting switches, 12V DC, and you're up and running. Crystal-controlled timebase makes this unit ideal for car, van, boat, other mobile applications. Large (0.3") blue-green fluorescent readouts are visible under conditions where LEDs would wash out. Includes special options for car applications (for example, turning on headlights dims display slightly for night viewing). Whether you need a clock for yourself or want to present someone with a fine gift, this is an excellent choice. With applications data. 3/\$46.

12V 8A POWER SUPPLY \$44.50

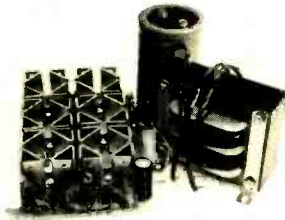

Handles 12A with 50% duty cycle. Ideal for powering mobile equipment (CB rigs, portable TVs, transceivers, etc.) in the home; can also power bunches of floppy disc drives. Crowbar overvoltage protection, foldback current limiting, adjustable output 11-14V, custom heavy-duty transformer, RF suppression, and easy assembly (all parts except xfrmr/filter caps/diodes mount on circuit board). Does not include case. With full assembly instructions.

**play with wire?
request our flyer!**

Our flyer is full of parts, music kits, computer kits, enclosures, specialty tools, capacitors, resistors . . . 40 pages of bargains in all. It's free: send us your name and address, we'll take care of the rest.

TERMS: Cal res add tax. Allow 5% shipping, (more for power supply), excess refunded. COD OK with street address for UPS delivery. VISA*/Mastercharge® call 24 hr. order desk at (415) 562-0636. Thank you for your business.

GODBOUT

BILL GODBOUT ELECTRONICS
BOX 2355, OAKLAND AIRPORT, CA 94614

CIRCLE 49 ON FREE INFORMATION CARD

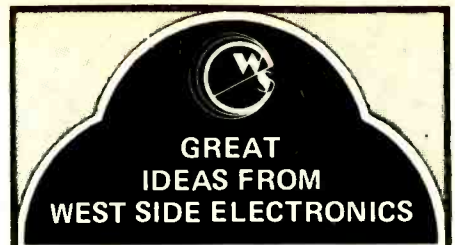

GREAT IDEAS FROM WEST SIDE ELECTRONICS

17 Digit, 10 Function Digital Clock Kit

The Ultimate Electronic Timepiece. 17 digits continuously read out the time, date, alarm setting, and timer. 12/24 HR. AC/DC. crystal timebase. 3 mode timer, status LEDs, snooze, and more. Now with DIGISE™ thumbwheel preset option (see below). Featured in Radio-Electronics (Aug/Sept 1977)
MT1-C kit, less case \$129.95

Pink Noise Generator Kit \$13.95

NOW IMPROVED!! with 5% tolerance components. Allows proper set-up of graphic equalizer in a stereo system to achieve acoustically flat response. Uses latest MDS IC. See Jan. '78 Radio-Electronics.
PNG-2C Partial kit \$13.95
PNG-2K Complete kit with case \$19.95
PNG-2W Assembled and tested \$27.95

WRITE FOR DETAILS

DIGISE™ Thumbwheel preset for MT1. Simply dial in alarm setting, timer, etc. and DIGISE™ does the rest. Also adds second ALARM feature. Will work with other 7001 based clocks.
APPLE II OWNERS: Real Time Clock plugs directly into any I/O slot. Crystal oscillator and AC supply (with battery backup) keeps clock running at all times.

★ ★ SPECIAL ★ ★ 16K MEMORY EXPANSION KIT \$130.00

Includes 8 MK4116 RAMs and instructions for Apple and TRS-80. Upgrade NOW at this LOW PRICE

WEST SIDE ELECTRONICS
P.O. Box 636, Chatsworth, CA 91311
We pay all shipping in Continental U.S.A.
Others add 10%, California residents add 6% tax.

CIRCLE 69 ON FREE INFORMATION CARD

Everything you ever want to know about Personal Computers . . .

\$1.00

Postage Paid in U.S.

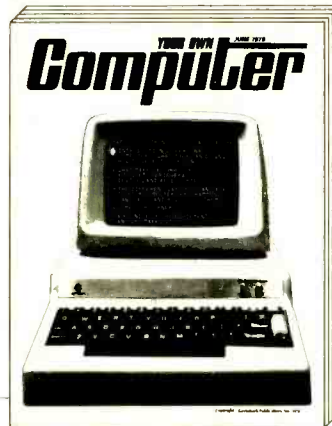

Here it is—everything you need to know about the state of the art, just as it appeared in the big, colorful special section of the June, 1978 RADIO-ELECTRONICS—“Your Own Computer.”

This complete, colorful, 32-page reprint of that first-in-the-field special feature tells you *everything* you want to know, including: An Introduction to Personal Computers—what they can do and how to select your own; What Makes a Computer System—peripheral devices and accessories; The Different Ways You Can Talk To Your Computer—programming languages and how to use them; a special edition of Computer Corner; and, A Roundup of the Equipment, the most complete Who-Makes-It Computer Manufacturer Listing you can find!

We've reprinted this giant special section of RADIO-ELECTRONICS for your convenience. Every serious experimenter and technician will want this vital information at home *and* in the office, lab or workshop, where you can refer to it when you need it. At this very special low, low price of just \$1.00, you can afford to have your own copy of “Your Own Computer” everywhere you go—and give some to friends, too.

Don't delay. We're ordering a big reprint of this very popular feature section, but we're expecting a big demand, too. For your convenience, use the coupon below to order your own reprints of the single most authoritative, most colorful, most comprehensive report on today's Personal Computers.

Please send me _____ copies @ \$1.00, Total \$_____ of your 32-page reprint of RADIO-ELECTRONICS' "Your Own Computer" special report. My check or money order is enclosed. New York State residents must include State Sales Tax. CANADA—Add 50¢ postage. ALL OTHER COUNTRIES—Add \$1.00 postage.

Ms. Nancy Estrada
17 Slate Lane, Central Islip, New York 11722

Name _____
Address _____
City _____ State _____ Zip _____

Visit our new retail location!

Visit our new retail location!

NLS

1c SALE

LM3A 3 dig 1% DC \$134.00
LM3.5A 3 1/2 dig .5% DC \$158.50
LM40A 4 dig .1% DC \$209.00
LM4A 4 dig .03% DC \$250.00

- Rechargeable batteries and charger included
- Measures DC Volts, AC Volts, Ohms and Current
- Automatic polarity, decimal and overload indication
- Rechargeable batteries and charger
- Measures DC Volts, AC Volts, Ohms and Current
- Automatic polarity, decimal and overload indication
- No zero adjustment and no full-scale ohms adjust
- Battery-operated — NiCad batteries; also AC line operation.
- Large LED display for easy reading without interpolation
- Size: 1.9" H x 2.7" W x 4" D
- Parts & labor guaranteed 1 year
- Tilt stand option \$ 3.50
- Leather case \$20.00

Purchase any of the LM series Meters and buy the LEATHER CASE for 1C

NLS

\$318.

MS-15 MINISCOPE
 With Rechargeable Batteries & Charger Unit

- 15 megahertz bandwidth.
- External and internal trigger.
- Time base — 1 microsec. to 0.5 Sec/div - 21 settings ± 3%
- Battery or line operation.
- Automatic & line sync modes
- Power consumption < 15 watts
- Vertical Gain — 01 to 50 V/div; 12 settings ± 3%
- Viewing area 1 1/2" x 1 3/8"
- Case size 2 7/8" H x 4 1/4" W x 7 5/8" D, 3 pounds
- Parts & Labor guaranteed 1 year
- 10 to 10-meg probe
- Leather carrying case

PROBE 1c
 PROBE 1c with the purchase of SCOPE and the MENTION of this MAGAZINE

\$27.
\$45.

MS-215 Dual Trace Version of MS-15 \$435.

3 LEVEL GOLD WIRE WRAP SOCKETS

Sockets purchased in multiples of 50 per type may be combined for best price.

	1-24	25-49	50-99	100-249	250-999	1K-5K
18 pin*	41	38	.35	.31	.27	.23
8 pin*	39	38	.36	.32	.29	.27
16 pin*	43	42	.39	.35	.32	.30
18 pin	63	58	.54	.47	.42	.36
20 pin	80	75	.70	.63	.58	.53
22 pin*	90	85	.80	.70	.61	.57
24 pin	90	84	.78	.68	.63	.58
28 pin	1.10	1.00	.90	.84	.76	.71
40 pin	1.50	1.40	1.30	1.20	1.04	.89

All sockets are GOLD 3 level closed entry. End and side stackable. 2 level. Solder Tail, Low Profile, Tin Sockets and Dip Plugs available. CALL FOR QUOTATION

SALE S-100 BUS EDGE CONNECTORS SALE

\$100-MWG 50/100 Cont. 125 ctrs. 3 LEVEL WIRE WRAP .025 sq posts on 250 spaced rows. GOLD plated
 1-4 5-9 10-24
 \$4.00 \$3.75 \$3.50

\$100-STG 50/100 Cont. 125 ctrs. DIP SOLDER TAIL on 250 spaced rows for VECTOR and MASI motherboards. GOLD plated
 1-4 5-9 10-24
 \$4.00 \$3.75 \$3.50

R81G 50/100 Cont. 125 ctrs. DIP SOLDER TAIL on 140 spaced rows for ALTAIR motherboards. GOLD plated
 \$5.00

R681-3 50/100 Cont. 125 ctrs. PIERCED SOLDER EYELET tails. GOLD
 \$7.35

Other Popular Edge Connectors

R644-G 22/44 Cont. 156 ctrs. PIERCED SOLDER EYELET tails. GOLD plated
 1-4 5-9 10-24
 \$3.00 \$2.75 \$2.50

R644-3 22/44 Cont. 156 ctrs. WIRE WRAP tails. GOLD
 \$4.71

ATTN: OEM'S and Dealers, many other connectors available call or quotation.

LIQUID CRYSTAL DIGITAL CLOCK-CALENDAR

- For Auto, Home, Office
- Small in size (2x2 1/2x1 1/2)
- Push button for seconds release for date.
- Clocks mount anywhere with either 3M double-sided tape or VELCRO, included.
- 2 MODELS AVAILABLE
- LCD-101, portable model runs on self-contained batteries for better than a year.
- LCD-102, runs on 12 Volt system and is back-lighted.
- LCD-101 or LCD-102 your choice

\$34.95.. • Clear desk stand for **\$2.00**

8803 MOTHER BOARD FOR \$100 BUS MICRO-COMPUTERS

- All-includes 12 16pin capacitors for x-5 -x12
- 12 buses and 100 lead mounting sockets
- Working side shown. Component side bare epoxy glass with white markings for component locations
- 610 epoxy glass board with 2 ounce copper solder plated and .038 ounce for holes for leads
- Solder mask with solder windows on critical circuits to avoid accidental short circuits
- Mounts 11 receptacles with 100 contacts (2 rows) on 125 centers with 250 low-spacing. Vector part number R681-2, or mounts 10 receptacles plus interconnectors to smaller mother board for expansion
- Includes etched circuits and instructions for option of active pull-up or floating terminations
- Large buses - 5V and GND (10 AMP) - 12V or 16V (7 AMP). Current ratings are per MIL-STD-275 with IPC rise
- Fits in Vector rack enclosures
- Fits in M561-8000 microcomputer as expand board

Price: \$29.50

Vector Plugboards

8800V
 Universal microcomputer/processor plugboard. Use with S-100 bus. Complete with heat sink & hardware 5 3/4" x 10 1/2" x 1 1/8"

1-4	5-9	10-24
\$19.95	\$17.95	\$15.96

8801-1
 Same as 8800V except plain, less power buses & heat sink

1-4	5-9	10-24
\$14.95	\$13.46	\$11.96

3677 9.6" x 4.5"
\$10.90

3682-2 6.5" x 4.5"
\$9.81

3677-2 6.5" x 4.5"
\$9.74

3662 6.5" x 4.5"
\$7.65

3662-2 9.6" x 4.5"
\$11.45

Gen. Purpose D.I.P. Boards with Bus Pattern for Solder or Wire Wrap
 Epoxy Glass 1/16" 44 pin con spaced 156

3690-12 CARD EXTENDER
 Card Extender has 100 contacts-50 per side on 125 centers-Attached connector is compatible with S-100 Bus Systems \$25.00
3690 6.5" 22/44 pin-158 ctrs. Extenders \$12.00

1/16 Vector BOARD
 .042 dia holes on 0.1 spacing for IC's

Phenolic

PART NO	SIZE	1-9	10-19
64P44XXXP	4.5x6.5"	\$1.49	1.34
169P44XXXP	4.5x17"	\$3.51	3.16

Epoxy Glass

PART NO	SIZE	1-70	1-89
64P44	4.5x6.5"	\$1.70	1.53
64P44	4.5x8.5"	\$2.10	1.89
169P44	4.5x17"	\$4.30	3.87
169P84	8.5x17"	\$7.65	6.89

ELITE

Wraps insulated wire on .025 square posts
FOUR TIMES FASTER
 than regular manual-wrap post tools

P180
 with two 100' spools of 28 ga wire
\$24.50

P180-AT
 Includes charger, wire
\$75.00

NO PRE-STRIPPING*
NO PRE-CUTTING*
SPOOL-FED WIRE*

*The spooled wire passes through the tool past a slitting edge next to the wrap post. A narrow longitudinal cut is made in the insulation where it presses the square post corner. The bare copper is defined by the sharp edge (1/16" dia x 28 contacts)

*Insulation is cut while wrapped but not before forming post. *Cut length out of the tool

SLIT-WRAP WIRE
 NO. 28 GAGE INSULATED WIRE, 100' SPOOLS
 W28 2 Pg 3 Green W28 2 Pg 3 Clear W28 2 Pg 3 Red W28 2 Pg 3 Blue

2708 8K 450 ns EPROM

FACTORY PRIME \$ 9.00 EA.

25 + Call For Price

14 & 16 PIN GOLD 3 LEVEL WIRE WRAP SOCKETS

14 - G3 100 for **\$30.00**
 16-G3 100 for **\$30.00**
 50 of each for **\$32.00**

Sockets are End & Side stackable, closed entry

PC BOARD HOLDER 315
 PRICE: \$16.95

315-S same as 315 but with 14" bar to accommodate "S100" boards
 PRICE: \$17.95

HORIZONTAL JAW VISE HEAD 304
 PRICE: \$12.95

STANDARD VISE HEAD 303
 PRICE: \$12.95

STANDARD VISE BASE 300
 PRICE: \$11.95

VACUUM BASE 380
 PRICE: \$16.95

WIDE OPENING VISE HEAD 366
 PRICE: \$12.95

PANAVISE TILTS, TURNS, AND ROTATES TO ANY POSITION. IT HOLDS YOUR WORK EXACTLY WHERE YOU WANT IT.

PANAVISE

Perfectly balanced, fluorescent lighting with precision magnifier lens. For prof. techn. & hobbyist. Has die cast protective shade. Inst. start 3 diopter lens 42" reach

LEDU MG 10A List \$72. SPECIAL \$49.95

with T-9 fluorescent lamp (included)
 colors: Gray or Black
 Chrome or Silver
 2 1/2 lbs. approx

SC-5 With Rechargeable Batteries & Charger Unit \$ 98

FM-7 With Rechargeable Batteries & Charger Unit \$215

Features include: • By using the new NLS SC-5 Prescaler, the range of the FM-7 Frequency Meter, which is 10 Hz to 60 MHz, may be extended to 512 MHz (the upper VHF & UHF frequency bands). • The FM-7 utilizes an LED readout, providing 7 digit resolution. • The FM-7 can be calibrated to an accuracy of 0.00001%. • The SC-5 is accurate to one part per million. • Each unit has 30 millivolts sensitivity, is battery powered and has a charger unit included. • Dimensions of each are 1 9/16" H x 2 1/2" W x 3 1/8" D. • The units may be obtained separately or as a "Frequency Duo." • Parts & Labor guaranteed 1 year
 Tilt stand option
 Leather case

Vector WRAP POST
 for .042 dia. holes (all boards on this page)

T-44 pkg 100	\$ 2.28
T-44 pkg 1000	\$14.00
A-13 hand installing tool	\$ 2.80

PRIORITY ONE ELECTRONICS

16723R Roscoe Blvd. Sepulveda, CA 91343

Terms: VISA, MC, BAC, check, Money Order, C.O.D., U.S. Funds Only. CA residents add 6% sales tax. Minimum order \$10.00. Orders less than \$75.00 include 10% shipping and handling, excess refunded. Just in case please include your phone no.

phone orders welcome (213) 893-8202

OEM and Institutional inquiries invited.

MA1003 CAR CLOCK
 Price Breakthrough! \$17.50

Bright Green Fluorescent Display Crystal Time Base Assembled, just add switches and 12 VDC.

SPECIAL
 14CS2 100 for \$14.95
 16CS2 100 for \$16.95
 14 pin CS2 10 for \$2.25
 16 pin CS2 8 for \$2.25

These low cost DIP sockets will accept both standard width plugs and chips. For use with chips, the sockets offer a low profile height of only .125" above the board. These sockets are end stackable.

24 PIN DIP PLUGS WITH COVERS

3 / \$1.00
40 / \$10.00

DIGI-KEY CORPORATION

TOLL FREE 800-346-5144

Quality Electronic Components

MINN., AK., HI. RESIDENTS 218-681-6674

IC'S • RESISTORS • TRANSISTORS • CAPACITORS • DIODES • I.C. SOCKETS & PINS • SWITCHES
CLOCK MODULES • OPTOELECTRONICS • BREADBOARDING & TESTING DEVICES • DRAFTING SUPPLIES
DATA BOOKS • HEAT SINKS • WIRE • TOOLS ... AND MORE ... WRITE FOR FREE CATALOG ...

INTEGRATED CIRCUITS

7400	7410	7420	7430	7440	7450	7460	7470	7480	7490
7400	7410	7420	7430	7440	7450	7460	7470	7480	7490
7401	7411	7421	7431	7441	7451	7461	7471	7481	7491
7402	7412	7422	7432	7442	7452	7462	7472	7482	7492
7403	7413	7423	7433	7443	7453	7463	7473	7483	7493
7404	7414	7424	7434	7444	7454	7464	7474	7484	7494
7405	7415	7425	7435	7445	7455	7465	7475	7485	7495
7406	7416	7426	7436	7446	7456	7466	7476	7486	7496
7407	7417	7427	7437	7447	7457	7467	7477	7487	7497
7408	7418	7428	7438	7448	7458	7468	7478	7488	7498
7409	7419	7429	7439	7449	7459	7469	7479	7489	7499
7410	7420	7430	7440	7450	7460	7470	7480	7490	
7411	7421	7431	7441	7451	7461	7471	7481	7491	
7412	7422	7432	7442	7452	7462	7472	7482	7492	
7413	7423	7433	7443	7453	7463	7473	7483	7493	
7414	7424	7434	7444	7454	7464	7474	7484	7494	
7415	7425	7435	7445	7455	7465	7475	7485	7495	
7416	7426	7436	7446	7456	7466	7476	7486	7496	
7417	7427	7437	7447	7457	7467	7477	7487	7497	
7418	7428	7438	7448	7458	7468	7478	7488	7498	
7419	7429	7439	7449	7459	7469	7479	7489	7499	
7420	7430	7440	7450	7460	7470	7480	7490		
7421	7431	7441	7451	7461	7471	7481	7491		
7422	7432	7442	7452	7462	7472	7482	7492		
7423	7433	7443	7453	7463	7473	7483	7493		
7424	7434	7444	7454	7464	7474	7484	7494		
7425	7435	7445	7455	7465	7475	7485	7495		
7426	7436	7446	7456	7466	7476	7486	7496		
7427	7437	7447	7457	7467	7477	7487	7497		
7428	7438	7448	7458	7468	7478	7488	7498		
7429	7439	7449	7459	7469	7479	7489	7499		
7430	7440	7450	7460	7470	7480	7490			
7431	7441	7451	7461	7471	7481	7491			
7432	7442	7452	7462	7472	7482	7492			
7433	7443	7453	7463	7473	7483	7493			
7434	7444	7454	7464	7474	7484	7494			
7435	7445	7455	7465	7475	7485	7495			
7436	7446	7456	7466	7476	7486	7496			
7437	7447	7457	7467	7477	7487	7497			
7438	7448	7458	7468	7478	7488	7498			
7439	7449	7459	7469	7479	7489	7499			
7440	7450	7460	7470	7480	7490				
7441	7451	7461	7471	7481	7491				
7442	7452	7462	7472	7482	7492				
7443	7453	7463	7473	7483	7493				
7444	7454	7464	7474	7484	7494				
7445	7455	7465	7475	7485	7495				
7446	7456	7466	7476	7486	7496				
7447	7457	7467	7477	7487	7497				
7448	7458	7468	7478	7488	7498				
7449	7459	7469	7479	7489	7499				
7450	7460	7470	7480	7490					
7451	7461	7471	7481	7491					
7452	7462	7472	7482	7492					
7453	7463	7473	7483	7493					
7454	7464	7474	7484	7494					
7455	7465	7475	7485	7495					
7456	7466	7476	7486	7496					
7457	7467	7477	7487	7497					
7458	7468	7478	7488	7498					
7459	7469	7479	7489	7499					
7460	7470	7480	7490						
7461	7471	7481	7491						
7462	7472	7482	7492						
7463	7473	7483	7493						
7464	7474	7484	7494						
7465	7475	7485	7495						
7466	7476	7486	7496						
7467	7477	7487	7497						
7468	7478	7488	7498						
7469	7479	7489	7499						
7470	7480	7490							
7471	7481	7491							
7472	7482	7492							
7473	7483	7493							
7474	7484	7494							
7475	7485	7495							
7476	7486	7496							
7477	7487	7497							
7478	7488	7498							
7479	7489	7499							
7480	7490								
7481									
7482									
7483									
7484									
7485									
7486									
7487									
7488									
7489									
7490									
7491									
7492									
7493									
7494									
7495									
7496									
7497									
7498									
7499									

NEW!
DIGI-KEY
only \$2.90

Part No. 5001K

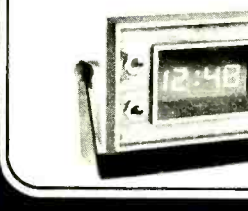

ELECTROLYTIC CAPACITORS

VALUE	100	1000	10000	100000	1000000
47.5V	12	103	833	17	10
1.50V	12	103	833	17	10
3.30V	12	103	833	17	10
4.70V	12	103	833	17	10
10.00V	12	103	833	17	10
15.00V	12	103	833	17	10
20.00V	12	103	833	17	10
25.00V	12	103	833	17	10
30.00V	12	103	833	17	10
35.00V	12	103	833	17	10
40.00V	12	103	833	17	10
45.00V	12	103	833	17	10
50.00V	12	103	833	17	10
55.00V	12	103	833	17	10
60.00V	12	103	833	17	10
65.00V	12	103	833	17	10
70.00V	12	103	833	17	10
75.00V	12	103	833	17	10
80.00V	12	103	833	17	10
85.00V	12	103	833	17	10
90.00V	12	103	833	17	10
95.00V	12	103	833	17	10
100.00V	12	103	833	17	10
105.00V	12	103	833	17	10
110.00V	12	103	833	17	10
115.00V	12	103	833	17	10
120.00V	12	103	833	17	10
125.00V	12	103	833	17	10
130.00V	12	103	833	17	10
135.00V	12	103	833	17	10
140.00V	12	103	833	17	10
145.00V	12	103	833	17	10
150.00V	12	103	833	17	10
155.00V	12	103	833	17	10
160.00V	12	103	833	17	10
165.00V	12	103	833	17	10
170.00V	12	103	833	17	10
175.00V	12	103	833	17	10
180.00V	12	103	833	17	10
185.00V	12	103	833	17	10
190.00V	12	103	833	17	10
195.00V	12	103	833	17	10
200.00V	12	103	833	17	10
205.00V	12	103	833	17	10
210.00V	12	103	833	17	10
215.00V	12	103	833	17	10
220.00V	12	103	833	17	10
225.00V	12	103	833	17	10
230.00V	12	103	833	17	10
235.00V	12	103	833	17	10
240.00V	12	103	833	17	10
245.00V	12	103	833	17	10
250.00V	12	103	8		

Rockwell AIM 65

The Head-Start in Computers

AIM 65 Technical Overview

THERMAL PRINTER

Most desired feature on low-cost microcomputer systems

- Wide 20-column printout
- Versatile 5 x 7 dot matrix format
- Complete 64-character ASCII alphanumeric format
- Fast 120 lines per minute
- Quiet thermal operation
- Proven reliability

FULL-SIZE ALPHANUMERIC KEYBOARD

Provides compatibility with system terminals

- Standard 54 key, terminal-style layout
- 26 alphabetic characters
- 10 numeric characters
- 22 special characters
- 9 control functions
- 3 user-defined functions

TRUE ALPHANUMERIC DISPLAY

Provides legible and lengthy display

- 20 characters wide
- 16-segment characters
- High contrast monolithic characters
- Complete 64-character ASCII alphanumeric format

PROVEN R6500 MICROCOMPUTER SYSTEM DEVICES

Reliable, high performance NMOS technology

- R6502 Central Processing Unit (CPU), operating at 1 MHz. Has 65K address capability, 13 addressing modes and true index capability. Simple, but powerful 56 instructions.
- Read/Write Memory, using R2114 Static RAM devices. Available in 1K byte and 4K byte versions
- 8K Monitor Program Memory, using R2332 Static ROM devices. Has sockets to accept additional 2332 ROM or 2532 PROM devices, to expand on-board Program Memory up to 20K bytes
- R6532 RAM-Input/Output-Timer (RIOT) combination device. Multipurpose circuit for AIM 65 Monitor functions.
- Two R6522 Versatile Interface Adapter (VIA) devices, which support AIM 65 and user functions. Each VIA has two parallel and one serial 8-bit, bidirectional I/O ports, two 2-bit peripheral handshake control lines and two fully-programmable 16-bit interval timer/event counters.

BUILT-IN EXPANSION CAPABILITY

- 44-Pin Application Connector for peripheral add-ons
- 44-Pin Expansion Connector has full system bus
- Both connectors are KIM-1 compatible

TTY AND AUDIO CASSETTE INTERFACES

- Standard interface to low-cost peripherals
- 20 ma. current loop TTY interface
- Interface for two audio cassette recorders
- Two audio cassette formats: ASCII KIM-1 compatible and binary, blocked file assembler compatible

ROM-RESIDENT ADVANCED INTERACTIVE MONITOR

Advanced features found only on larger systems

- Monitor-generated prompts
- Single keystroke commands
- Address independent data entry
- Debug aids
- Error messages
- Option and user interface linkage

ADVANCED INTERFACE MONITOR COMMANDS

Major Function Entry

- (RESET Button)—Enter and initialize Monitor
- ESC—Re-enter Monitor
- E —Enter and initialize Text Editor
- T —Re-enter Text Editor
- N —Enter Assembler
- 5 —Enter and initialize BASIC Interpreter
- 6 —Re-enter BASIC Interpreter

Instruction Entry and Disassembly

- I —Enter mnemonic instruction entry mode
- K —Disassemble memory

Display/Alter Registers and Memory

- * —Alter Program Counter to (address)
- A —Alter Accumulator to (byte)
- X —Alter X Register to (byte)
- Y —Alter Y Register to (byte)
- P —Alter Processor Status to (byte)
- S —Alter Stack Pointer to (byte)
- R —Display all registers
- M —Displays four memory locations, starting at (address)
- (SPACE)—Display next four memory locations
- / —Alter current memory location

Manipulate Breakpoints

- # —Clear all breakpoints
- 4 —Toggle breakpoint enable on/off
- B —Set one to four breakpoint addresses
- ? —Display breakpoint addresses

Control Instruction/Trace

- G —Execute user's program
- Z —Toggle instruction trace mode on/off
- V —Toggle register trace mode on/off
- H —Trace Program Counter history

Control Peripheral Devices

- L —Load object code into memory from peripheral I/O device
- D —Dump object code to peripheral I/O device

- 1 —Toggle Tape 1 control on/off
- 2 —Toggle Tape 2 control on/off
- 3 —Verify tape checksum
- CTRL PRINT—Toggle Printer on/off
- LF —Line Feed
- PRINT—Print Display contents

Call User-Defined Functions

- F1 —Call User Function 1
- F2 —Call User Function 2
- F3 —Call User Function 3

Text Editor Commands

- R —Read lines into text buffer from peripheral I/O device
- I —Insert line into text buffer from Keyboard
- J —Delete current line of text
- (SPACE)—Display current line of text
- L —List lines of text to peripheral I/O device
- U —Move up one line
- D —Move down one line
- T —Go to top line of text
- B —Go to bottom line of text
- F —Find character string
- C —Change character string
- Q —Quit Text Editor, return to Monitor

LOW COST PLUG-IN ROM OPTIONS

- 4K Assembler — symbolic, two-pass
- 8K BASIC Interpreter

POWER SUPPLY SPECIFICATIONS

- 5 VDC + 5% regulated @ 2.0 amps (max)
- +24 VDC + 15% unregulated @ 2.5 amps (peak), 0.5 amps (average)

- AIM 65 (1K) \$375.00 (*\$15.00)
- AIM 65 (4K) \$450.00 (*\$15.00)
- Assembler ROM — Add \$85.00
- BASIC Interpreter — Add \$100.00
- Power Supply — Add \$45.00
- *Shipping and handling charge
- Calif. residents add 6% sales tax.

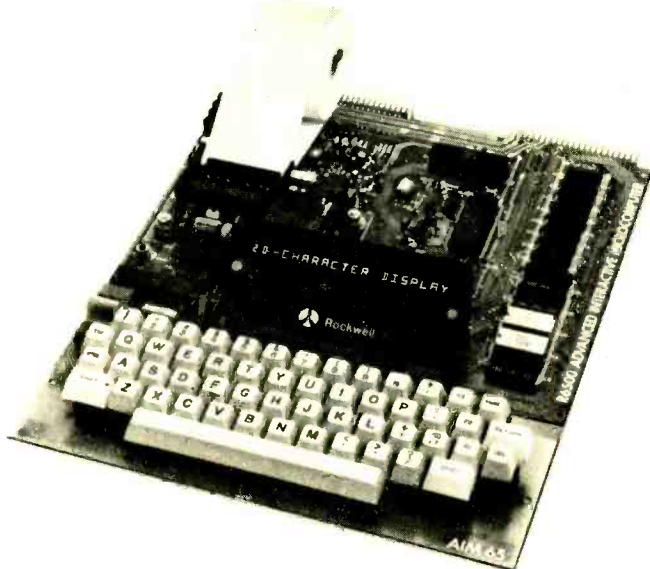

Rockwell's AIM 65 Advanced Interactive Microcomputer can get you into the exciting world of microcomputers a lot easier and at a lower cost than you may have thought possible. And you'll be working with the 6500 family, the advanced state-of-the-art NMOS system that's an ever-increasing favorite for new commercial and hobbyist applications.

As a learning aid, AIM 65 gives you an assembled, versatile microcomputer system with a full-size keyboard, 20-character display and, uniquely, a thermal printer. An on-board Advanced Interactive Monitor program provides extensive control and program development functions. And our AIM 65 User's Manual will help you along each step of the way.

You'll master fundamentals rapidly. Then you'll appreciate the fact that unlike the computer "toys" on the market, AIM 65 offers flexibility and expandability you would expect to find in a sophisticated microcomputer development system.

THERMAL PRINTER GIVES YOU HARD COPY — FAST AND QUIET.

AIM 65's 20-column Thermal Printer prints on low-cost, thermal roll paper at a fast 120 lines per minute. It produces all of the standard 64 ASCII characters with a crisp-printing five-by-seven dot matrix. AIM 65's on-board printer is a unique feature for a low-cost computer.

EXTENDED ALPHANUMERIC DISPLAY IS BUILT FOR UNDERSTANDING, NOT DECIPHERING.

AIM 65 comes with a 20-character true Alphanumeric Display. Information is displayed with bright, magnified 16-segment font monolithic characters. It's both unambiguous and easily readable.

FULL-SIZE KEYBOARD IS DESIGNED FOR HUMANS, NOT ELVES.

AIM 65's terminal-style keyboard frees you from the hassles of fumbling around with a tiny calculator-type keypad. And its 54 keys provide 70 different alphabetic, numeric, control and special functions.

ON-BOARD ADVANCED INTERACTIVE MONITOR GETS YOUR PROGRAMS UP AND RUNNING.

The ROM-resident AIM 65 Advanced Interactive Monitor Program provides a comprehensive set of easy-to-use, single-keystroke commands for debugging your programs, and offers features normally available only in larger, expensive microcomputer development systems. And with the AIM 65 Monitor, there's no guesswork involved; the Monitor gives a self-explanatory prompt when it needs information and will generate a meaningful error message if an error has occurred.

The AIM 65 Monitor includes commands to

- Enter and edit programs directly — no "opcode" memorization
- List programs on Printer or TTY
- Display/alter registers and memory
- Set breakpoints, trace and debug program execution
- Control the Thermal Printer
- Transfer information to/from attached Cassette Recorders or TTY
- Execute programs in on-board or external RAM, ROM or PROM memory
- Interface the optional AIM 65 Assembler and BASIC Interpreter

AIM 65'S ADVANCED R6500 NMOS ARCHITECTURE.

The R6502 Central Processing Unit is the heart of the AIM 65. It provides demonstrated speed and simplicity, plus 65K addressability and the power of a 56-command, minicomputer-like instruction set.

The R6532 RAM-Input/Output-Timer (RIOT) combination device is used by the AIM 65 Monitor for scratchpad memory and Keyboard operations.

Two R6522 Versatile Interface Adapter (VIA) devices are provided. One device supports AIM 65's Thermal Printer and the TTY and Cassette Interfaces, the other supports two user-dedicated 8-line I/O ports, plus an 8-bit serial I/O port and access to two 16-bit interval timer/event counters, on the module's Application Connector.

AIM 65 comes with two R2332 4K Read Only Memory (ROM) devices installed. These hold the Advanced Interface Monitor program. Spare sockets allow the user to expand on-board ROM up to 20K bytes. These sockets will accept user programs on R2332 ROMs or compatible PROMs, or can be used to install the optional AIM 65 Assembler and BASIC Interpreter ROM devices.

On-Board Read/Write RAM memory is available in 1K-byte and 4K-byte configurations.

AIM 65 HAS EXPANSION BUILT IN.

And to allow AIM 65 to grow the way you want it to, we've provided an Application Connector and an Expansion Connector. The Application Connector permits you to plug on a TTY (20 ma. current loop) and one or two standard audio cassette recorders. It also has the pinouts for the VIA's General-Purpose I/O ports. The Expansion Connector extends AIM 65's system bus — address, data and control — out to additional memory, or anything else you might attach.

And, BASIC high-level language programming is a built-in option.

MONEY BACK GUARANTEE
If you are not convinced that the AIM 65 is the best of its kind on the market, we will refund your money immediately.

TRINICO INTERNATIONAL

2795-L West Lincoln Ave.
Anaheim, CA 92801
(714) 821-0234

Store Hours 10 - 7, Mon. - Sat.

VISA

MASTERCARD

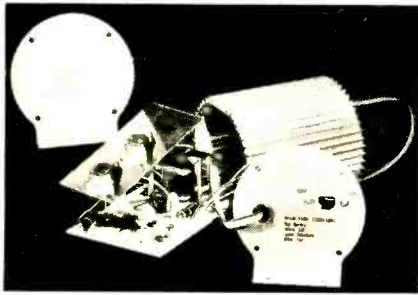

FROM KIT TO CAR IN 80 MINUTES!

Electronic ignition is "in." Update your car with the TOPS in power, efficiency and reliability — the TIGER SST capacitive discharge ignition (CD).

The TIGER delivers everything other CD's promise — and more: quicker starting, more power, more gas mileage, tune-ups eliminated, lifetime plugs and points, reduced repairs and pollution.

The TIGER can be built and installed in your car in 80 minutes. The TIGER is unique!

The TIGER comes with a switch for TIGER or standard ignition for 12V negative ground only.

Simpli-Kit \$21.95
POST PAID U.S.A.

WE ACCEPT:

Mastercharge or BankAmericard.
Send check or money order with order to:

Tri-Star Corporation

DEPT. FF, P.O. Box 1727
Grand Junction, Colorado 81501

CIRCLE 41 ON FREE INFORMATION CARD

TAPE RECORDER!

5 TRACK, 4 CASSETTE,
EASILY MODIFIED TO PLAY ONE
RECORD ANOTHER, ALL CON-
TROL SIGNALS ON EDGE CONNE-
CTORS! 2000FT 1/4" TAPE/CASS-
ETTE, PRINTED CIRCUIT MOTORS
& TACH GEN; BALL BEARINGS, TOP
QUALITY MFG! REQUIRES 12VOLT 5AMP DC;
DATA BOOK & 1 CASSETTE FURNISHED; WT 85
LBS SHIP'D COD. BOOK \$25, CASSETTE \$25.

\$169.00

STEPPING MOTOR

15°/STEP, 28VOLT, LEAD
SCREW SHAFT PRECISION BALL
BEARING, 5 LEAD WINDING, \$4.95
WITH FOLLOWER & GUIDE \$9.50
SHAFT 3/10 DIA 5/16 LG 4" WORKING,
MOTOR 1/16" DIA 2 1/2 1/16" LONG

NEW CATALOG! PLEASE
SEND SELF ADDRESSED STAMPED
ENVELOPE FOR FREE COPY NOW!

DC MOTORS

SMALL SIZE 1/8" DIA
27/16" LG, SHAFT 1/8"
DIA 1/2" LG, PM FIELD, BALL BEARING, 28VOLT
REMOVED FROM EQUIP. \$6.00 EACH
HI TORQUE 3/16" DIA 3/4" LG SHAFT, PM FIELD
W/MU-METAL SHIELD, B.B., 28VOLT, EA. \$7.50
MOTOR & TACH GENERATOR, SET \$11.00
TACH GENERATOR 1" DIA 1 3/4" LG, SHAFT 1/8"
DIA 3/8" LONG, PM FIELD, WIRE LEADS, \$5.00
ADD \$3.00 POSTAGE -BALANCE REFUNDED

CIRCUIT BOARD

WIRE WRAP, GOLD, 8-16PIN
32-14PIN, 8-26 PIN .025 SQ,
MALE RIBBON CONNECTORS,
YOU STRIP, EACH \$10.00

NEW KLUGE BOARDS!

EPOXY-GLASS,
2 SIDE COPPER, 1/16" X 7 1/2" X 10 1/2" DRILLED
FOR 7-16PIN, 28-14PIN, 1-24PIN, & 4-28PIN
SOCKETS, MANY THRU HOLES, EACH \$5.00
NO.2 SAME EXCEPT HAS 13-16PIN, & 36-14PIN
PATTERNS, YOU ETCH. \$7.50 MIN ORDER \$10.00

J&E ELECTRONICS SALES
PO BOX 4504, FT.WORTH, TX. 76106

CIRCLE 17 ON FREE INFORMATION CARD

YEAR-END SPECIALS

they won't last long at these low prices!"

DC/DC CONVERTER: Outputs ±15VDC @ 100 mA, for 15VDC input. Ultra hi isolation. .05% reg'n. Only 2" sq by .375" thick. An extremely unusual bargain! **\$19.00**

SYNTHESIZER (MUSICI) VCO: Sawtooth & trigger outs. +10 vP-P. 10-10kHz out. 1 volt per octave response (exponential), linear input. Needs ±15 VDC. **\$26.50**

ANALOG DELAY IC: Identical to SAD 1024A. Produces real time audio delay w/ data. **\$17.95**

ARTICLES & SYNTHESIZER LITERATURE: "TECH NOTES", our own R&D newsletter. Featuring articles on building Active Filters, Audio Freq. Shapers, VCO's, VCF's, Flangers, Synthesizers, & other Audio/Electronic Devices. Tech Notes Subscription/12 issues **\$19.50**

DUAL SEC. PWR. TRANSFORMERS: 115/230V 50/60Hz Primary, output 2x 19V @ 1 amp. Hi quality. **\$4.25**

5 VOLT 50 WATT ZENER: TO-3 pkg., 10 amp capability. **\$4.95**

UNUSUAL IC: 14 pin DIP, generates pseudo random music sequence. A synthesizer on-a-chip! Clear plastic pkg, also, senses motion VISUALLY. A unique buy! **\$7.95**

STATE VARIABLE FILTER IC: Hybrid, identical to the AF 100 ICJ. 4 on-board op amps. 10K/100K. Hi-pass, Band-pass, & Notch. **\$9.95**

POWER TRANSISTORS: 30ES TO-3, 49¢ ea. 1 3772 TO-3, more power. **79¢**

2N6487/2N6490 TO-220, Complimentary pair. **99¢**

EXAR 2209: Current Controlled oscillator minidip. w/ data. **\$3.50**

4.000 MHZ CRYSTAL: .005 tolerance. **\$2.49**

2 WATT STEREO DIP IC: Improved version ULN 2277-LM377. **\$1.49**

1101 STATIC RAM: 256 x 1, 1 pin. 99¢ **MOSTEK MK2002P** Char. Gen. **\$2.96**

MINIATURE ELECT. TROL RELAYS: 500 ohm, 12 VDC SPDT, 8VDC SPST. **Both 99¢ ea.**

HI CURRENT DIODE: 5m to 1N1186, 35 amps @ 200V/mm. **\$1.19**

HI SLEW RATE OP AMP: NE531 minidip. By Signetics & Raytheon. **\$9.95**

RECTANGULAR CERMET TRIMMERS: Standard, multi turn, 10K & 100K. **Both 59¢ ea. 215.00**

REGULATORS: 7815-15VDC @ 1 amp. **99¢**

LAMBDA LAS: 12 VDC @ 3 amps. **\$3.49**

POWER ZENERS: TO-3 5V @ 50 watt: **\$3.95** 24V @ 50 watt: **\$1.95**

COMPUTER GRADE ELECTROLYTIC: 40,000 MFD @ 25 VDC. 40 V surge only **\$3.50**

DUAL 15 VOLT REGULATOR IC: Outputs ±15 VDC @ over 50 mA, more with pass Xistors. Balanced, tracking outputs with 5% reg'n or better. w/ data. **\$4.25**

MINIDIP SOCKET: Solid nylon w/machined gold plated pins. 8-pin, made by Augat. **\$1.00**

1 uF, 50 VDC CAPACITORS: Mylar construction, PC leads. **12¢/1.00**

OP AMP SPECIALS

CA 3140 minidip **65¢ ea.** CA3401 quad dip **49¢ ea.**

LM 709 minidip **12¢ ea.** TL 084 quad bifet **\$1.19**

LM 741 minidip **18¢ ea.** SG 1435T TO-99, Hi V. **\$9.95**

LM 733 dip **35¢ ea.** SG 307 W/LM 307 minidip. **19¢ ea.**

We have many unusual and unique bargains in our CATALOG FLYER. Send a stamp or 25¢ for postage for a FREE COPY and get on our MAILING LIST.

CFR Associates, Inc.
Newton, N.H. 03858
603/382-5179

- Minimum order \$10.00
- Add \$2.00 for shipping
- MC, VISA, & C.O.D. accepted
- Phone orders are welcome
- SATISFACTION GUARANTEED

CIRCLE 64 ON FREE INFORMATION CARD

FORDHAM BEST BUYS

BK PRECISION 3 1/2-Digit Portable DMM

- Overhead Protected • Battery or AC operation • 3" high LED Display • Auto Zeroing
- Model 2800
- \$85**

TEICO 3 1/2 Digit DMM

- Flashing Over Range Indicator • Auto Polarity • Overload Protected
- Model 270 wired Reg. \$80.00
- Kit \$65.00**

Weller Xcelite

Service Master Attache Style Tool Kit **\$39.95**

Tool Cases **\$239.50**

Roll Kit **\$13.95**

WAHL NEW ISO-TIP "Quick Charge"

2 units **\$27.95** 3 or more **\$26.95**

- Model 7500 Cordless Soldering Iron **\$17.95**
- Model 5800 Thermal Spot Circuit Tester **\$22.50**

NLS 15 MHz Mini Oscilloscope

Model MS 15

Reg. \$318.00 **\$270.30**

- Battery or line operation
- Automatic and line sync modes
- Power consumption less than 15 W

NOW AVAILABLE

Dual Trace Version Model MS 215 Reg. \$435.00 **\$385.00**

RCA Color Generator

Model WR 508

Reg. \$89.50 **\$59.95**

LEADER Instrument Corp

20 MHz Dual Trace

Model L80-508

- Add, subtract modes on CH 1 & CH 2
- Front panel X Y operation
- 17.5 nSec rise time

Reg. \$769.95 **\$654.50** with accessories

BK PRECISION SUPER SPECIAL

New 30MHz Portable Frequency Counter

- 30MHz reading guaranteed, 50MHz typical • Full 6-digit display with range switch allows 8-digit accuracy • 1Hz resolution—even at 30MHz and beyond • Ideal for field service and MRO applications

Model 1827 Reg. \$120.00 **\$59.95**

BSR Record Changer Accessories

Model BSR 129 **\$24.95**

Logic Probe

Model LP-1

- Compact circuit powered
- Multi-family compatibility DTL TTL HTL CMOS
- Detects pulses as short as 50 nSec.

\$40.00 complete

Econo-Lamp

Colors: Red, yellow, blue, black, oyster, white U.L. listed

Model XL 334A **\$14.95**

HICKOK Function Generator

Model 270 Reg. \$199.00 **\$169.15**

Logic Monitor

Model LM-1

- Automatically displays static and dynamic logic
- Works with DTL, HTL, TTL and CMOS
- 16 LED display
- Circuit powered design

\$67.50 complete

Transistor Tester

Model 100

9-volt battery included **\$22.00**

- Movable base pin conforms to TO 5, TO 18 and small "in-line" leads
- Tests transistors in or out of circuit • Operates on contact
- Clear speaker tone, no visual observations to make

Magnifier LAMP

Model MG 10A **\$42.50**

700 Series

Precision ground and polished magnification lens. Uses 22W T 9 Cooltube fluorescent

LEADER Instrument Corp

Transistor Checker

Model LTC-906 Reg. \$159.95 **\$136.00**

SENCORE UHF Prescaler

Model PR-47

- Extends counter range to 600 MHz
- FCC accurate with FC 45

Reg. \$125.00 **\$79.95**

BK PRECISION 15MHz Portable 3" Dual Trace Scope

Model 1432P Reg. \$780.00 **\$663.00** with probes

VOM Multimeters

20K ohm/v **\$17.95** with mirrored scale.

1K ohm/v **\$9.95**

FREE 1978 Catalog

Call TOLL FREE (800) 645-9518

For N.Y. State call (516) 752-0050

Before you buy test equipment any make or model check our prices

MasterCharge • Bank Americard • C.O.D. • Check • Money Order

Add \$3.00 for shipping and insurance

C.U.D. • Extra New York State residents add appropriate sales tax

FORDHAM
855 Conklin St. Farmingdale, N.Y. 11735

CIRCLE 65 ON FREE INFORMATION CARD

INTERNATIONAL ELECTRONICS UNLIMITED

YEAR END CLEARANCE

TTL PACKAGE
dual-in-line IC's
tested functional & marked
5 each of the following
7400 7430 7453 74151
7401 7432 7454 74153
7402 7437 7460 74164
7403 7438 7474 74165
7404 7439 7476
7406 7440 7483 74175
7410 7441 7485 74177
7416 7442 7493 74180
7423 7445 7495 74182
7425 7446 7496 74189
7426 7448 74181 74195
7427 7450 74145

LOW POWER TTL PACKAGE
\$15.00
dual-in-line package
tested functional & marked
10 each of the following
74100 74106 74151 74178
74102 74110 74172 74186
74103 74120 74173 74193
74104 74142 74174 74195

HEAT SINK
for TO-220 package
aluminum, PC mt tabs
\$5/1.00 100/\$15.00



LINEAR CIRCUITS

LM300H .49	LM340T (78XX) 1.19	LM566CN 1.19	ULN2208 .89
LM301CN .20	5.6, 8.12, 15, 18, 24 1.19	LM567CN 1.19	ULN2209 .89
LM302H .80	LM370 2.93	LM567H 1.49	CA3046 1.19
LM305H .45	LM372N .65	LM703CN .39	CA3081H 1.97
LM307CN .20	LM376CN .25	LM709N .25	CA3082 1.45
LM307H .30	LM377N .95	LM709H .29	LM3900N .35
LM308H .39	LM380N .79	LM710N .59	LM7524 .79
LM309H 1.05	LM380-8CN .59	LM711N .35	LM7525 .79
LM309K 1.05	LM381N 1.75	LM723H .55	LM7535 .45
LM310CN 1.07	LM382N 1.75	LM723M .52	803380 4.59
LM311CN .40	LM385K .25	LM733H .65	75450AN .35
LM311H .50	LM386CN .49	LM739N .59	75451CN .25
LM319N 1.13	LM387CN .49	LM741CN(8) .25	75452CN .25
LM320K .15	NE531V 1.90	LM741CN(14) .32	75453CN(351) .25
LM320T (79XX) 1.29	NE540L 1.90	LM741CH .35	75454CN .35
5.12, 15 1.19	NE540A 1.09	LM747H .79	75491N .65
LM322N .69	NE550A .75	LM748CN .25	75492N .75
LM324N .95	LM555CN .39	LM1310N 2.25	XR220T 1.49
LM339N .69	NE556A .85	LM1414N .60	XR256T 1.49
LM340K .69	LM561N 2.95	LM1456CN 1.29	XR4136 1.49
5.6, 8.12, 15, 18, 24 1.29	LM565N .59	LM1458CN .59	XR4202 .69
	LM565H 1.39	LM1496N .89	XR4212 .69
	LM565H 1.39	LM1800N 1.75	XR4739 .69

LINEAR IC PACKAGE
\$26.50
5 each of the following
301 mDIP op amp 380 DIP dual amp
302 705 V follower 565 DIP PLL
307 mDIP op amp 723 DIP V reg
308 705 op amp 733 705 vid amp
311 mDIP V comp 739 DIP dual op amp
322 DIP prec timer 741 mDIP op amp
339 DIP quad comp 748 mDIP op amp
340T 6Volt reg 3900 DIP quad amp
340T 15Volt reg 75453 mDIP op drv
376 mDIP V reg 75491 seg driver

LED DISPLAY SPECIALS
DL702 .30" red CC LHDP .59
HP3400 .8" red CA LHDP .99
HP3405 .8" red CC LHDP .99
HP7651 .43" red CA RHPD .69
HP7653 .43" red CC RHPD .69

TRANSISTOR PACKAGE \$12.95
5 each of following
2N1132A PNP Gen. purpose trans. TO-39
2N2218A NPN Low power trans. TO-5
2N2219A NPN Low power trans. TO-5
EM2222 NPN Low power trans. TO-18
2N2369 NPN Low power trans. TO-18
2N2904 PNP Low power trans. TO-5
2N3271 NPN Low power trans. TO-18
2N3565 NPN Low power trans. R-110
2N4304 PNP Low power trans. R-110
SCA .500V Power trans TO-5

14 PIN IC SOCKETS
T1 low profile solder tail
10/\$1.65 100/\$15.00

LINEAR IC PACKAGE \$15.00
tested functional & marked
5 each of the following
301 mDIP op amp 565 DIP PLL
307 mDIP op amp 739 DIP dual op amp
311 mDIP V comp 748 mDIP op amp
340T 6V reg 1414 DIP dual comp
376 mDIP volt reg 3900 DIP quad amp

CAPACITOR PACKAGE \$3.95
polyester radial .10
10 each of following values
.0047u/100V .022u/100V
.015u/100V .033u/100V
.018u/100V .047u/200V

**IC'S 10% OFF ON \$25.00
15% OFF ON \$50.00**

TANTALUM CAPACITORS
20 solid dipped
1-10 11-
22u/35V .25 .20 10u/16V .35 .30
33u/35V .25 .20 10u/20V .38 .33
1u/35V .25 .20 15u/6.3V .38 .33
2.2u/20V .28 .23 22u/20V .45 .40
2.2u/35V .30 .25 22u/16V .45 .40
3.3u/35V .35 .30 33u/10V .55 .50
4.7u/16V .25 .20 47u/6V .55 .50
6.8u/16V .30 .25 67u/20V .65 .55
6.8u/16V .30 .25 56u/6V .75 .65
6.8u/50V .35 .30 100u/20V 1.45
cylindrical (axial)
1-10 11-
68u/15V .20 .15
15u/25V .40 .35

TRIMPOT PACKAGE \$11.95
miniature cermet
single turn, Mecco 8014
2 each of following values
500 ohm, 1K, 2K, 5K, 10K,
20K, 50K, 100K, 500K, 1M

CAPACITOR PACKAGE \$7.95
electrolytic - axial
5 each of the following
.1uF/200V 22uF/50V
1uF/16V 100uF/10V
2.2uF/25V 150uF/25V
5uF/25V 220uF/25V
10uF/50V 500uF/30V
shipping & handling
US, Canada & Mexico \$1.00
Other countries \$2.50

TTL - 7400

7491 .64	7400 .10	7441 .75	74163 .75
7492 .39	7401 .35	7442 .35	74164 .65
7493 .29	7402 .14	7443 .45	74165 .75
7494 .59	7403 .12	7444 .60	74166 .95
7495 .59	7404 .14	7445 .50	74170 1.50
7496 .49	7405 .17	7446 .55	74173 1.25
74100 .89	7406 .15	7447 .65	74174 1.05
74105 .18	7407 .15	7448 .60	74175 .65
74107 .25	7408 .18	7450 .15	74176 .70
74121 .29	7409 .15	7451 .15	74177 .70
74123 .32	7410 .10	7453 .13	74180 .40
74125 .45	7411 .19	7454 .10	74181 1.95
74126 .40	7413 .10	7460 .10	74182 .70
74132 .60	7414 .55	7466 .20	74195 1.85
74141 .70	7415 .22	7465 .20	74190 .95
74145 .70	7416 .14	7470 .27	74191 .85
74150 .89	7417 .20	7472 .30	74192 .50
74151 .50	7420 .14	7473 .29	74193 .50
74153 .50	7423 .28	7474 .18	74194 .85
74154 .95	7425 .32	7475 .42	74195 .50
74155 .55	7426 .15	7476 .29	74196 .80
74156 .40	7427 .20	7480 .17	74197 .75
74157 .45	7430 .17	7483 .58	74198 1.40
74158 .55	7432 .15	7485 .75	74199 1.25
74160 .65	7437 .15	7486 .27	74200 3.25
74161 .60	7438 .15	7489 1.25	74279 .65
74162 .95	7440 .13	7490 .35	

CERAMIC DISC CAPACITORS - 50V
1pf 22pf 56pf 102pf 270pf 820pf .022uf
5pf 27pf 68pf 150pf 390pf .001uf .030uf
7pf 33pf 82pf 180pf 470pf .0047uf .050uf
10pf 47pf 100pf 220pf 600pf .01uf .1uf

DISCRETE LED'S
MEI Infra-red emitter .17" radial 5/51
MY108 clear red lite .17" radial 6/51
MVS0 clear red lite .09" axial 15/51
NSL100 red .19" radial 10/51
Submin. red .125" (RL209) 10/51
Submin. green .125" 8/51
Submin. clear red lite .125" 8/51
Submin. white red lite .125" 10/51
white red lite .160" (RL203) 10/51
Jumbo red .200" 10/51
Jumbo green .200" 7/51
Jumbo yellow .200" 7/51
Jumbo clear .200" 10/51
Jumbo red .200" current reg. 10/51

BUMPONS
white vinyl pads
peel & stick
.53" sq. X .23" high
12/\$1.00 100/\$5.00

CERAMIC CAPACITOR ASSORTMENT - 50V
1pf 33pf 82pf 270pf 820pf .022uf
5pf 47pf 100pf 270pf .001uf .030uf
10pf 56pf 150pf 470pf .0047uf .050uf
22pf 68pf 180pf .001uf .1uf
10ea of above values \$11.95
Supplied in steel cabinet with clear styrene drawers \$19.95
Cabinet shipping chrg. US & Can. \$2.00
(UK & Canada) \$2.00

ELEKTOR MAGAZINE SPECIAL \$4.00
1 each of back issue \$1 shipping
No. 25, 26, 29, 30, & 31 & handling
Includes articles on:
ELEKTOR music synthesizer
Surround sound
Stereo encoder
Active loudspeaker crossover filters
Levitating
Microprocessors
Logarithmic dark room timer
TV pattern generator
Kirlian photography
Bi rhythm program & calendar
Infra red stereo transmitter
Ioniser
Magnetiser
Video bio feedback

ELECTRONIC BUZZER
Miniature, Solid State
6V 15ma (4-9V oper.) \$1.29 ea.
12V 15ma (8-20V oper.) \$1.29 ea.

IC SOCKETS
Low Profile Solder Tail Wire Wrap
8 pin \$1.16 24 pin \$3.36 8 pin .45
14 pin \$1.28 28 pin .44 14 pin .49
16 pin .21 40 pin .61 16 pin .55
18 pin .28

TANTALUM CAPACITOR KIT
solid dipped, 12 values, 5 each
.1uF/35V 2.2/35 10/25 33/10
.33/35 4.7/16 15/20 47/25
1/35 6.8/16 22/16 56/6
capacitors only \$14.95

METAL FILM RESISTORS Rohm
± 1%, 1/4w, ± 50 PPM/OC
Standard Decade Values 10.5 - 464K
Qty. Ea. Min 10/value Min 100/value
1-99 \$1.20 \$1.15
100-999 .20 \$9.00/100
1000- .10 \$8.00/100

REGULATED POWER SUPPLY
Plus & minus
5V
12V
15V
Uses 3 LM340T and 3 LM320T regulators, 115V/29V CT transformer plus PC board capacitors & diodes. All parts, schematic, instructions PS-29.....\$12.95 + \$1.00 Shpping.

BEZELS - with red filters
140-2 cut-out 1.125" x 2.375"
max .062" panel thickness \$1.75
140-4 cut-out 1.160" x 4.375"
max .125" panel thickness \$2.75

SUMMER CIRCUITS
ELEKTOR 78
Double issue containing more than 100 circuits - such as high-perf. disc pre-amp, Audio control ampli., LED level indicator, Car amplifier, Bipe speedometer, A/D converter and many more.
with order \$3.00
mag only 4.25

METAL FILM RESISTORS Rohm
Carbon Film Resistors ± 5% 1/4w, 1/2w
15 ea. of 12 values:
100, 220, 470, 1K, 1.5K, 3.3K
4.7K, 6.8K, 10K, 33K, 100K, 1M.
\$5.45

PRECISION RESISTOR PACKAGE Rohm
Metal film, 1%, 1/4w, 500ppm
240 resistors, 4 ea. from 10.5 to 464K
Supplied in steel cabinet with clear styrene drawers \$27.95
Cabinet shipping chrg. US & Can. \$2.00

SIGNAL DIODES Silicon, 400mw 25/51 200/55

PRECISION RESISTOR PACKAGE
Metal Film ± 1% 1/4 watt
Starter Kit - 2ea. 60 values
120 Resistors 10.5 ohm - 464K \$14.95
Supplied in 15 Drawer 60 Comp. Cabinet - \$26.50 + \$2.00 Sh.

PRECISION RESISTOR PACKAGE
Metal Film ± 1% 1/4 watt
Starter Kit - 2ea. 60 values
120 Resistors 10.5 ohm - 464K \$14.95
Supplied in 15 Drawer 60 Comp. Cabinet - \$26.50 + \$2.00 Sh.

IC BREADBOARD
Silver plated copper circuits holds 5 - 16 pin DIP IC's and interconnection holes. \$1.00

LED DISPLAY
DL10A 27" Red CA LHD .79
MAN66 60" Red CA LHD 1.19
DL33B 2 Dig. 17" Red CC .29
DL33B 3 Dig. 17" Red CC .49
NSN33 3 Dig. 17" Red CC .39
MAN72 30" Red CA LHD .59
MAN74 30" Red CC RHD .59
NSN74R 30" Red CC RHD .59
MAN82 30" Yellow CA LHD .69
DL702 30" Red CC LHD .69
HP7651 5" Red CA RHD .79
HP7653 5" Red CC RHD .79
HP3400 8" Red CA LHD 1.25
HP3405 8" Red CC LHD 1.25
MAN3620 30" Orange CA LHD .79
MAN3630 30" +1 Orange CA RHD .49
MAN4610 40" Orange CC RHD .59
HP5082 5 dig. 11" mag. Red CC RHD .49
HP5082 4 dig. 11" mag. Red CC RHD .39
HP5082 5 dig. 11" mag. Red CC CD .49

PRECISION RESISTOR PACKAGE
Metal Film ± 1% 1/4 watt
Starter Kit - 2ea. 60 values
120 Resistors 10.5 ohm - 464K \$14.95
Supplied in 15 Drawer 60 Comp. Cabinet - \$26.50 + \$2.00 Sh.

UNIVERSAL BREADBOARD
Silver plated copper circuits fits any IC and related components. 2 triple rows of 27 holes for DIP. 3-3/16"x5-1/16" \$1.00

PRECISION RESISTOR PACKAGE
Metal Film ± 1% 1/4 watt
Starter Kit - 2ea. 60 values
120 Resistors 10.5 ohm - 464K \$14.95
Supplied in 15 Drawer 60 Comp. Cabinet - \$26.50 + \$2.00 Sh.

TRIMPOT - Single Turn
SINGLE TURN, 1/4" dia., 150' height
Mecco/Electra Series 8014 (ET14)
3w = 100ppm/°C ± 20%
available sizes
500 Ohm, 2k, 10k, 20k, 50k, 100k, 500k, 1M

VECTOR BOARD - Phenolic
169P44-062 (.1" spacing, .42" dia.)
4-1/4" x 4-1/2" x .0625" ... \$1.15 ea.

UNIVERSAL BREADBOARD
Silver plated copper circuits fits any IC and related components. 2 triple rows of 27 holes for DIP. 3-3/16"x5-1/16" \$1.00

VECTOR BOARD - Phenolic
169P44-062 (.1" spacing, .42" dia.)
4-1/4" x 4-1/2" x .0625" ... \$1.15 ea.

COMPLETE SATISFACTION GUARANTEED. SHIPMENT TO US AND CANADA PREPAID UNLESS INDICATED OTHERWISE. OTHER COUNTRIES ADD 10% - EXCESS REFUNDED. ORDERS SHIPPED IN 3 WORKING DAYS FROM RECEIPT. MINIMUM ORDER \$10.00 CALIFORNIA RESIDENTS ADD SALES TAX. MINIMUM COD OR CHARGE ORDER \$15.00

INTERNATIONAL ELECTRONICS UNLIMITED
VILLAGE SQUARE, P.O. BOX 449, CARMEL VALLEY, CA 93924 USA
TELEPHONE 408 659-3171



Same day shipment. First line parts only. Factory tested. Guaranteed money back. Quality IC's and other components at factory prices.

INTEGRATED CIRCUITS

7400TL	1.10	CD4511	94	8212	2.90
7400N	1.17	LM340T-24	1.10	8214	8.20
7402N	4.50	CD4516	1.10	8216	2.90
7404N	1.15	CD4518	1.02	8224	2.90
7409N	4.50	CD4520	1.00	8228	3.35
7410N	5.00	CD4527	1.51	8251	8.50
74140N	1.00	CD4528	7.79	8253	10.00
7415N	1.60	CD4553	5.75	8255	9.25
7420N	1.70	CD4566	2.25	8257	18.50
7422N	1.60	CD4568	4.50	8259	18.50
7430N	2.80	CD4585	1.10	CDP1802CD	19.50
7442N	50	CD40192	3.00	CDP1802D	25.00
7445N	69	LM723H-N	28	CDP1861	14.95
7447N	87	74C00	33	6802	9.35
7448N	69	LM7101H	35	74C04	28
7450N	17	LM741N	25	74C10	28
7474N	82	74C14	2.10	8502	12.50
7475N	49	LM748N	35	74C20	28
7485N	88	LM1303N	82	74C30	1.98
7490N	2.00	LM1304	1.10	74C48	2.20
7490N	43	LM1305	1.27	74C74	1.40
7492N	43	LM1307	2.00	74C76	1.40
7493N	43	LM1310	2.75	74C80	1.15
7495N	69	LM1458	47	74C93	1.40
74100N	90	LM1800	1.75	74C154	3.00
74107N	72	LM1812	7.50	74C160	1.44
74121N	34	LM1889	3.00	74C175	1.35
74120N	59	LM2111	1.75	74C192	1.85
74128N	39	LM2902	1.50	74C221	2.00
74155N	99	LM3900N	60	74C305	3.00
74150N	99	LM3905	1.75	74C306	5.50
74150N	69	LM3909N	61	74C314	1.35
74154N	1.00	MC1488V	5.00	74C322	7.50
74157N	69	NE540L	2.89	74C323	5.50
74161N	87	NE550N	7.50	74C325	6.35
74165N	87	NE555V	43	74C326	6.95
74165N	87	NE556A	7.9	74C327	6.95
74175N	90	NE566V	1.50	INTERFACE	
74175N	90	NE566V	1.20	8095	65
74192N	87	NE610	5.00	8096	65
74193N	85	NE571B	5.00	8097	65
74193N	1.65	8098	65	8098	65
74288N	1.65	78L08	60	8198	6.50
74365N	66	78L05	70	8110	4.50
74365N	66	78L05	70	8110	4.50
74367N	66	75L08	1.75	8120	3.75
				8123	3.10
				8124	3.50
				8125	3.50
				8126	3.50
				8127	3.50
				8128	3.50
				8129	3.50
				8130	3.50
				8131	3.50
				8132	3.50
				8133	3.50
				8134	3.50
				8135	3.50
				8136	3.50
				8137	3.50
				8138	3.50
				8139	3.50
				8140	3.50
				8141	3.50
				8142	3.50
				8143	3.50
				8144	3.50
				8145	3.50
				8146	3.50
				8147	3.50
				8148	3.50
				8149	3.50
				8150	3.50
				8151	3.50
				8152	3.50
				8153	3.50
				8154	3.50
				8155	3.50
				8156	3.50
				8157	3.50
				8158	3.50
				8159	3.50
				8160	3.50
				8161	3.50
				8162	3.50
				8163	3.50
				8164	3.50
				8165	3.50
				8166	3.50
				8167	3.50
				8168	3.50
				8169	3.50
				8170	3.50
				8171	3.50
				8172	3.50
				8173	3.50
				8174	3.50
				8175	3.50
				8176	3.50
				8177	3.50
				8178	3.50
				8179	3.50
				8180	3.50
				8181	3.50
				8182	3.50
				8183	3.50
				8184	3.50
				8185	3.50
				8186	3.50
				8187	3.50
				8188	3.50
				8189	3.50
				8190	3.50
				8191	3.50
				8192	3.50
				8193	3.50
				8194	3.50
				8195	3.50
				8196	3.50
				8197	3.50
				8198	3.50
				8199	3.50
				8200	3.50
				8201	3.50
				8202	3.50
				8203	3.50
				8204	3.50
				8205	3.50
				8206	3.50
				8207	3.50
				8208	3.50
				8209	3.50
				8210	3.50
				8211	3.50
				8212	3.50
				8213	3.50
				8214	3.50
				8215	3.50
				8216	3.50
				8217	3.50
				8218	3.50
				8219	3.50
				8220	3.50
				8221	3.50
				8222	3.50
				8223	3.50
				8224	3.50
				8225	3.50
				8226	3.50
				8227	3.50
				8228	3.50
				8229	3.50
				8230	3.50
				8231	3.50
				8232	3.50
				8233	3.50
				8234	3.50
				8235	3.50
				8236	3.50
				8237	3.50
				8238	3.50
				8239	3.50
				8240	3.50
				8241	3.50
				8242	3.50
				8243	3.50
				8244	3.50
				8245	3.50
				8246	3.50
				8247	3.50
				8248	3.50
				8249	3.50
				8250	3.50
				8251	3.50
				8252	3.50
				8253	3.50
				8254	3.50
				8255	3.50
				8256	3.50
				8257	3.50
				8258	3.50
				8259	3.50
				8260	3.50
				8261	3.50
				8262	3.50
				8263	3.50
				8264	3.50
				8265	3.50
				8266	3.50
				8267	3.50
				8268	3.50
				8269	3.50
				8270	3.50
				8271	3.50
				8272	3.50
				8273	3.50
				8274	3.50
				8275	3.50
				8276	3.50
				8277	3.50
				8278	3.50
				8279	3.50
				8280	3.50
				8281	3.50
				8282	3.50
				8283	3.50
				8284	3.50
				8285	3.50
				8286	3.50
				8287	3.50
				8288	3.50
				8289	3.50
				8290	3.50
				8291	3.50
				8292	3.50
				8293	3.50
				8294	3.50
				8295	3.50
				8296	3.50
				8297	3.50
				8298	3.50
				8299	3.50
				8300	3.50

ELECTRONICS

CLOCK MODULES Complete alarm clocks ready to hook up with transformer and switches. Very compact with 50' and 8 1/2" digits.
MAX100A C or E 50' 8.95
MAX100B C or E 8 1/2" 11.95
102P3 Transformer 2.25
102P2 Transformer 2.25
Special transformer and six switches when purchased w/module 2.95
MAX100 car module 3" 19.95
green floor display 15.95

RESISTORS 1/2 watt 5%
 10 per type .03 1000 per type .012
 15 per type .025 350 piece pack
 100 per type .015 5 per type 6.75

KEYBOARDS
56 key ASCII keyboard kit \$62.50
Full assembly \$125.00
53 key ASCII keyboard kit \$55.00
Fully assembled \$65.00 Endlosure 14.95

LED'S
Red T018 15
Green, Orange, Yellow T018 .20
Jumbo Red .20
16 pin package Yellow Jumbo .25
Chipset LED Mounting Clips \$8

KITS • KITS • KITS

Perforated Boards **NOT INCLUDED** w/100 Series

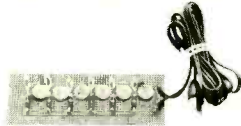

103 MINI-WINK NEON FLASHER. Random flash pattern. Interesting displays. 6 neon lamps. AC operated.

- 103 \$3.00
- 103A (103 w/PCB) 4.65
- 103B (103 w/PCB,CASE) 6.90



110 ELECTRONIC WHOOPER SIREN. Powerful wailing sound. Dual oscillator circuit. Use with any alarm circuit. Battery not included.

- 110 \$4.95
- 110A (110 w/PCB) 6.50
- 110B (110 w/PCB,CASE) 9.60



117 TUNABLE ELECTRONIC ORGAN. Tunable 7-note scale. Play sing-a-long favorites. Battery not included.

- 117 \$7.55
- 117A (117 w/PCB) 9.50
- 117B (117 w/PCB,CASE) 12.60



120 SIREN/CODE OSCILLATOR. Loud, piercing alarm. Practice Morse code. Battery not included.

- 120 \$4.20
- 120A (120 w/PCB) 5.55
- 120B (120 w/PCB,CASE) 8.65



104 VARIABLE STROBE LIGHT. Great for parties and photography. Variable flash rate. AC operated.

- 104 \$10.60
- 104A (104 w/PCB) 14.85
- 104B (104 w/PCB,CASE) 20.35



126 PROGRAMMABLE DOORBELL. Adjustable rate and pitch for 15 musical notes. Play favorite tunes. 6 IC's. Uses existing transformer and switch.

- 126 \$16.95
- 126A (126 w/PCB) 23.70
- 126B (126 w/PCB,CASE) 29.20

502 POWER SUPPLY. Switch from 6 to 9V DC. 100mA output. Filtered. Manual. Stepdown transformer. Insulated test clips.



\$6.95 Complete

540 BINARY CLOCK. Handcraft tomorrow's timepiece today. Watch constantly changing patterns of LED's as they display Binary Time. This unique clock project enhances the learning of Digital Logic and the Binary Coding System, as well as offering a beautifully styled conversation piece.

10 TTL INTEGRATED CIRCUITS • VOLTAGE REGULATOR • MANUAL TEACHES BINARY SYSTEM • FAST, SLOW AND HOLD CONTROLS • 115VAC 50 or 60Hz.



\$39.95 Complete

523 STROBE LITE. Create flashing light effects. Ideal for creating kaleidoscope effects for photography. Long life flash tube. PCB. Manual. Variable flash control. On-off switch. Silicon diodes. 117VAC 50-60 Hz.



\$22.95 Complete

536 8-TRANSISTOR AM RADIO. Experience jewel-like clarity in sound. The best superheterodyne kit circuit available. SEPARATE LOCAL OSCILLATOR for high sensitivity and excellent selectivity. Unique IF Transformer mounting system. Manual. 9V battery required (not included).



\$16.45 Complete

504 TRANSISTOR AMPLIFIER. 4 Transistors. Push-Pull output. Variable volume control. Requires one 9V battery (not included). PCB. Manual. 3 transformer stages for maximum gain. Power output 360mW. Can be operated with any 3.2 - 8 ohm speaker.



\$6.95 Complete

510 FIVE TUBE RADIO. Rediscover TUBES. This fun antique circuit offers high selectivity and sensitivity. 2 IF Transformers. Hi-Q Ferrite antenna. Manual. Superheterodyne circuit. Large PM speaker. For 110-120 VAC or DC.



\$34.95 Complete

401 TACHOMETER. Know exactly when to shift. This fabulous Tach, with a range from 0-8 grand, will mount anywhere — dash, steering column, boat, motorcycle frame, etc. 250° wide sweep scale. Reading accuracy within 2% of full scale. PCB. Manual. Illuminated dial. For all cylinder engines.



\$27.95 Complete

Perforated Boards **NOT INCLUDED** w/100 Series



124 WARBLING SIREN. Two-tone oscillating siren. Loud and penetrating. 2 IC's. For automobile or other 12 volt systems.

- 124 \$5.65
- 124A (124 w/PCB) 7.10
- 124B (124 w/PCB,CASE) 10.20



105 FISH CALLER. Clicking sound imitates distressed fish. Adjustable speed. Battery not included.

- 105 \$3.15
- 105A (105 w/PCB) 4.30
- 105B (105 w/PCB,CASE) 5.80



107 COLOR ORGAN CONTROL — 3 CHANNEL. Over 200W per channel. Separate sensitivity control. Hi-mid-to frequency response. AC operated.

- 107 \$9.20
- 107A (107 w/PCB) 11.85
- 107B (107 w/PCB,CASE) 14.95



118 TV SCRAMBLER. Tunable to all VHF stations. 30 foot range. Battery not included.

- 118 \$1.95
- 118A (118 w/PCB) 2.90
- 118B (118 w/PCB,CASE) 4.40



122 COMPUTER SOUND EFFECTS GENERATOR. Produces weird, spacey sounds. 4 IC's. Control tone, rate and blip or glide. Battery not included.

- 122 \$14.95
- 122A (122 w/PCB) 19.40
- 122B (122 w/PCB,CASE) 22.75

We accept:

VISA,



MASTER CHARGE CALL NOW TOLL FREE
BANKAMERICARD, 800-824-5136

IN CALIFORNIA CALL 800-852-7631
 ASK FOR OPERATOR 318

DO NOT SEND CASH • NO COD • ORDER BY PHONE OR MAIL

MINIMUM ORDER \$10.00. CALIF. RESIDENTS
 ADD 6% SALES TAX.

WE PAY POSTAGE AND HANDLING
 IN U.S.A. OVERSEAS COUNTRIES:

ADD 15% OF TOTAL FOR POSTAGE.

SEND CHECK OR
 MONEY ORDER TO:

Graymark International, Inc.

1751 McGaw Avenue Dept. 12 Irvine, CA 92714 (714) 540-5480

ELECTRONIC SUPERMARKET

Terms: Add postage. No C.O.D.'s. Phone Orders BA MC AE: (617) 532-2323.
P.O. Box 619 DEPT. R-12 Lynnfield, Massachusetts 01940

CLOSEOUT!

ORIGINAL PRICE \$189.00

MOTION DETECTOR

This alarm sensor has up to 50' range & fills the protected area with an energy screen that cannot be seen, felt or heard. Triggers your alarm whenever burglar moves through detect or field. Mounts on ceiling, wall, desk, shelf etc. Optional delay mode, auto-reset. Operates on 12.5 VDC. A close-out that originally sold for \$189.00 3 Lbs. Qty. Ltd. 8D30336 **\$49.88**

ALSO AVAILABLE:

Power Supply Kit 8D0472 \$3.88
Connector Kit 8D0504 \$1.50



REMOTE CONTROL SYSTEM

CLOSEOUT!

ORIGINAL PRICE \$63.50

This handy control was part of an Admiral remote control package for color TV. The original functions were On-Off, Volume, VHF-UHF, and Channel Select. Receiver contains 3 relays and one four position stepping relay. Also includes a complete data pkg. Control section operates on 115 VAC. Good for toys, garage door openers, TV, stereo systems or any of those STAR TREK innovations you would like to make on your own. (Energize or de-energize your alarm system remotely.)

Range 30' Transmitter requires AA cell (not included). Qty. Ltd.
Sh. Wt. 1 Lb. 8C30372 **\$25.00**
3 for \$69.88 8C30372 \$69.88/3

PIEZO-ELECTRIC TWEETERS

*3 1/2" Super Horn \$7.88 Ea. \$14.88 Pr.
*2X5" Horn Tweeter \$17.88/Pr.
*2X6" Horn Tweeter \$23.88/Pr.

SEND FOR FREE CATALOG!
CIRCLE FREE INFO. CARD

Visit our Retail Stores 119 Foster St., Peabody, Mass. 01960 or our NEAREST STORE THE TOWN DEPT. INC., next to WOODCO, 777 Willow St., Manchester, New Hampshire.

TOUCH SWITCH ALARM SYSTEM

New package system. A super close-out item. Protects your valuables. CB's stereo equipment, test equipment, etc. List Price \$22.88
Sh. Wt. 1 Lb. 8M10474 \$7.88
3 for \$22.88 8M10474 \$22.88/3

RACK CABINETS EQUIPTC

Size: 24"x24"x68 1/2" with rails on front & back for mounting equipment on 19" centers. No doors or sides - list price \$185.00 - NEW SURPLUS! Your cost only \$50.00 each. Qty. Ltd. Frt. collect. 80B2049 **\$50.00**

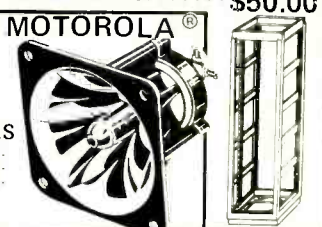

INTEGRATED ELECTRONICS

540 Weddell Drive, #4, Sunnyvale, CA 94086 (408)734-8470

CMOS	74C08	.55	7427	.35	74161	1.00	8973	2.95	8334	4.00	
	74C10	.25	7430	.15	74163	1.30	8974	2.95	8553	6.50	
4000	.15	74C14	1.75	7432	.30	74164	1.45	8976	2.95	8556	3.25
4001	.20	74C20	.26	7437	.44	74165	1.35	75107	3.25	8599	3.25
4002	.20	74C30	.26	7440	.18	74166	1.20	75450	1.00		
4007	.20	74C32	.30	7442	.100	74173	1.70	75451	.80		
4010	.36	74C42	1.40	7445	.70	74175	1.05	75452	.80		
4011	.20	74C48	2.75	7446	.70	74177	.90	75453	.80	LINEAR	
4012	.20	74C73	1.25	7448	.70	74182	.95	75491	1.25	301N	.35
4013	.35	74C74	.75	7450	.25	74191	1.20	75492	1.40	307N	.35
4014	.80	74C86	1.00	7451	.25	74192	1.45	75494	1.50	308H	1.00
4015	.80	74C90	1.10	7454	.22	74193	1.35			309K	1.25
4016	.35	74C93	1.25	7453	.25	74195	1.00			318H	1.50
4017	.92	74C151	2.75	7460	.35	74196	1.10	8212	3.50	320H-5	.88
4018	.92	74C154	3.00	7472	.40	74197	1.10	8214	8.50	320T-5	1.25
4019	.20	74C157	2.10	7473	.40	74199	2.25	8216	3.75	320T-12	1.25
4020	1.00	74C160	1.40	7474	.40	74367	.90	8224	4.75	324N	1.75
4022	.83	74C162	1.70	7475	.55			8228	9.90	340T-5	1.25
4023	.21	74C164	1.70	7476	.45	0025	3.50	8251	11.50	340T-12	1.25
4024	.75	74C165	1.75	7483	1.05	0026	1.75	8255	10.50	340T-15	1.25
4025	.20	74C174	1.50	7485	1.10	0027	1.75	2513	9.50	340T-24	1.25
4027	.34	74C902	.85	7486	.43	8640	1.25	2516	9.50	387N	1.25
4028	.79	74C904	.85	7489	2.00	8641	2.75	1013	6.50	388N	1.15
4029	1.00	74C905	3.00	7492	.75	8806	3.00			555N	.35
4030	.70	74C914	1.95	7493	.65	8819	1.25	8000	TTL	556N	.85
4035	.95			7496	.85	8820	5.00	8120	3.25	558N	2.80
4040	1.00			7499	.78	8830	5.00	8131	1.75	561N	5.00
4041	1.00	7400	.16	74121	.25	8833	2.45	8092	.95	566N	1.70
4042	.70	7401	.17	74122	.49	8835	2.45	8094	.60	567N	1.65
4044	.60	7403	.17	74123	.65	8836	1.25	8095	.80	709N	.30
4049	.35	7404	.19	74126	.65	8837	2.45	8096	.90	741H	.25
4051	1.10	7406	.40	74132	1.25	8838	2.45	8098	.90	3035	2.40
4056	.70	7407	.40	74141	1.15	8859	1.50	8121	2.25	340I	1.25
4068	.40	7409	.25	74145	1.10	8865	4.90	8136	3.25	74LSxx *	
4069	.40	7410	.18	74148	1.20	8866	1.50	8220	3.25	74LS00	.25
4075	.20	7413	.78	74150	.90	8867	1.85	8231	2.25	through	
4082	.23	7414	.68	74153	1.10	8869	1.75	8242	1.75	74LS670	3.95
74C00	.25	7417	.38	74154	1.25	8879	2.25	8250	1.75		
74C02	.45	7420	.18	74155	.75	8880	2.75	8260	2.25		
74C04	.32	7421	.35	74157	1.00	8884	2.45	8281	1.00		

* For more 74LSxx, refer to our ad in the June issue of this magazine.

SPECIAL DISCOUNT

OEM EDUCATORS AND SCHOOLS

For a low quote, send a list of your needs and, if possible, desired prices. No quantity is too small.

Minimum order \$5.00 US currency. Check or money order only. Add 5% to cover shipping and handling charges. Calif. residents add 6% sales tax. Santa Clara County residents add 6.5% sales tax.

CIRCLE 58 ON FREE INFORMATION CARD

CIRCLE 51 ON FREE INFORMATION CARD

CB LOCKMOUNT



Reg. 13.98
4.99
AU-540

- Anti-Theft Protections
- For CB or Monitors
- SO-239 Antenna Jack
- For 6-12 VDC

Gallium Phosphide LED's



LOW AS **59c**

- 2Volt 10mA •Shpg. wt 1lb
- PL-233, Large Red 59c
- PL-235, Large Green 89c
- PL-237, Large Yellow 89c
- PL-249, Large Orange 89c
- PL-274, Large Clear 89c

HOBBY MOTORS

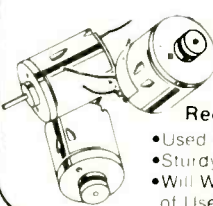

Pkg. of 5 **49c**
Reg. 59c MO-333

- Used in Most Slot Cars
- Sturdy Construction
- Will Withstand Many Hours of Use

2 Station INTERCOM SYSTEM

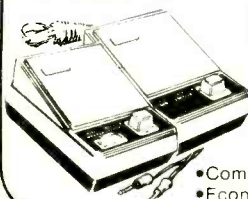

Reg. 9.99
6.99
AM-252

- Complete
- Economical To Operate

RECORDER MIKE



Reg. 1.99
1.49
MK-093

- A Perfect Replacement For Most Portable Cassette Recorders
- Fits Easily in Hand - NOT Bulky

TV-FM Wall Plates



Reg. 1.49
88c
AA-051

- Mounts In Standard Wall Box
- For Flat TV Lead-in
- Includes Plug
- Shpg. wt 1lb

COMPACT TRUMPET



Reg. 6.99
4.99
SS-453

- Mounts Under Hood or In/On Truck Cab

Olson electronics
FREE!

Dept. LK 260 S. Forge St. Akron, Ohio 44327

NAME				
ADDRESS				
CITY				
STATE		ZIP		
Qty	Stk #	Description	Price Ea.	Total
Tax				
Postage				
Total				

Please send me a free subscription to Olson Value Packed Catalog.

STUDENTS & TEACHERS		FREE SOCKETS WITH PURCHASE OF ANY OF THESE I.C.'s.		8080 SYSTEM		CPU's cont.		PROG. LOGIC ARRAYS		S 100 MOTHER BOARD	
WITH YOUR ORDER SEND PROOF OF YOUR STATUS AND RECEIVE 5% OF YOUR PRESENT ORDER AS A CREDIT CERTIFICATE YOU CAN USE ON YOUR NEXT ORDER				8080A 5.95	8008 8.95	82S100 11.95	S 100 32K STATIC MEMORY BOARD			8 Slot Kit 69 00	
CHRISTMAS SPECIAL OF 5% OFF EFFECTIVE ON ALL ORDERS MAILED BEFORE DECEMBER 25, 1978.				8212 3.75	8035 19.95	82S101 11.95	ALL BURNED IN AND TESTED			650ns 599 00	
THE FIRST MEMORY SPECIAL YOU WON'T FORGET				8214 8.95			ultra low power			450ns 735 00	
2102-2 650ns 8/9 ⁹⁵	32/37 ⁰⁰	64/71 ⁰⁰	128/135 ⁰⁰	8216 3.50			KEYPAD — 16 key x-y matrixed			200ns 875 00	
2102-4 450ns 8/10 ⁹⁵	32/41 ⁰⁰	64/78 ⁰⁰	128/145 ⁰⁰	8224 4.80	7489 2.95		KEYPAD — 20 key x-y matrixed				
2114D 450ns 8/79 ⁰⁰	16/149 ⁰⁰	32/274 ⁰⁰	64/499 ⁰⁰	8226 4.75	3101 3.95		WIRE WRAP POSTS				
				8228 7.25	8225 2.95		2 level 100/3 95				
				8238 8.25	2101-1 2.95		4 level 100/4 95				
				8251 9.45	2101-2 3.25		TAPE READER — 12 level — includes both IR sources and pickups			29 00	
				8253 21.50	2101A 3.25		MAKE YOUR OWN PAPER TAPE READER				
				8255 10.75	2102-2 1.50		1/10" SPACED PHOTO TRANSISTORS			10/9 50	
				8257 20.50	2102L1 1.95		REED RELAY — TTL compatible			1 89	
				8259 20.50	82S10 4.95		SOLID STATE RELAY — micro reed actuated for total isolation			3 95	
							CRYSTAL FILTERS — 455 Kc miniature single section 1 95			dual section 2 95	
							PRECISION THERMISTORS				
							YS1 BEAD — 1% 5000 OHM			2 95	
							GLASS BEAD — 1% 15000 OHM			2 95	
							GLASS BEAD — 1% 200 OHM			2 95	
							CYLINDRICAL 01% POWER THERMISTOR — positive temperature coefficient 20-2500 OHM			2 95	
							D/A CONVERTER — NE5008 (8 bit)			7 95	
							D/A CONVERTER — DAC 01 SH (6 bit)			6 95	
							PHOTO DIODE — super fast 0.5ns			3 95	
							IR DETECTOR — super sensitive			4 95	
							READ OUTS — MULTI DIGIT				
							LCD 3-1/2 dig. 4" 4 95			3 1/2 dig 3" 1 95	
							LED 17" 3 dig 1 25			6 dig 3 95 — 8 dig 4 95	
							PHOTO DEVICES — DIODES, XSTR's, DARLINGTONS				
							2N5771 - 1.25 FPT100A 79			MDI 1 95	
							H-38 3.25 MRD-250 1 95			LASCR 1 95	
							HIGH VOLTAGE TRANSISTORS				
							2SC1358 100W 1400V 5A			TO 3 7 95	
							BUY69B 110W 800V 10A			TO 3 5 95	
							W905 100W 500V 5A			Plastic 4 95	
							362 4 20W 500V 1A			Plastic 2 25	
							338-7 20W 350V 1A			Plastic 1 50	
							HIGH VOLTAGE DIODES				
							UNMARKED 1500V at 1 AMP			10/1 99	
							EG 250 2500V at 35 AMP			9 95	
							HV60EL 6000V at 25 ma			1 95	
							SUBMINIATURE 20,000V at 100 ma			2 95	
							CARBIDE DRILL BITS AND ROUTER BITS for P C board work — MIXED SIZES				
							OUR MIX — DRILLS 10/12 95 100/95 00				
							OUR MIX — ROUTERS 10/15 95 100/125 00				

RADIO SHACK® TRS-80™ COMPUTER SERVICE AND MODIFICATION

BE FIRST TO TURN YOUR TRS-80 INTO A SUPER MACHINE

1. Keyboard and Video Mod
ADD RAM FOR LOWER CASE CHARACTERS AND CLEAN UP HORIZONTAL SMEAR (SEND YOUR TRS-80 MICROCOMPUTER ONLY)
PARTS AND LABOR \$59⁰⁰

4. Clock Mod
INCREASE YOUR PROCESSING SPEED BY 30%. WITH THIS OPTION YOU CAN SWITCH-SELECT BETWEEN THE FASTER 2.66MHZ CLOCK RATE AND 1.77MHZ.
INSTALLATION, PARTS AND LABOR \$49⁰⁰

SPECIALS!! DO MORE THAN ONE MOD AND SAVE
MODS 1, 2, 3, 4 AND 5 \$449⁰⁰
MODS 1 AND 2 \$234⁰⁰
MODS 2 AND 3 \$243⁰⁰
16K MEMORY, PARTS AND INSTALLATION DATA \$159⁰⁰

ALL WORK GUARANTEED UNCONDITIONALLY FOR 1 YEAR

TERMS FOR TRS-80 WORK: WE ACCEPT ONLY TRS-80 MICROCOMPUTERS! SHIP YOUR TRS-80 MICROCOMPUTER TO US, INSURED AND SUITABLY PACKAGED AND WE WILL RETURN SAME FREIGHT COLLECT. ALL FACTORY SEALS MUST BE INTACT. ANY UNIT WHOSE SEALS HAVE BEEN TAMPHERED WITH WILL BE SHIPPED BACK IMMEDIATELY. MODS 1, 2, 4 AND 5 SEND TRS-80 MICROCOMPUTER ONLY. MOD 3 SEND YOUR TRS-80 MICROCOMPUTER AND LEVEL 2. MOD 6 SEND TRS-80 AND EXPANSION INTERFACE. **NORMAL TURN AROUND TIME IS UNDER 10 DAYS WITH CERTIFIED FUNDS**

2. Install 16K Memory
JUST SEND US YOUR TRS-80 MICROCOMPUTER AND WE DO THE REST
16K OF MEMORY AND LABOR \$189⁰⁰

5. Serial Printer Interface Mod
OPERATE CRYSTAL CONTROLLED TTY WITH LEVEL 1 OR 2. WE INSTALL SWITCH SELECTABLE BAUD RATES OF 75, 110, 137.5, 150, 300, 600, 1200, 2400, 4800, 9600 OR EXTERNAL EIA RS232 AND CURRENT LOOP OUTPUT.
PARTS AND LABOR \$119⁰⁰

SEND TRS-80 KEYBOARD ONLY!!
RETURN SHIPPING:
FROM ENGLAND ADD \$30.00 FOR AIR. \$9.50 SURFACE MAIL
FROM JAPAN ADD \$35.00 FOR AIR. \$8.50 SURFACE MAIL

3. Level 2 plus 1 Mod
WE INSTALL YOUR LEVEL 2 SO YOU KEEP LEVEL 1 AND CAN USE IT BY JUST FLIPPING A SWITCH. (SEND LEVEL 2 WITH YOUR TRS-80)
\$69⁰⁰

6. Mini Floppy Mod
YOU PROVIDE EXPANSION INTERFACE AND WE'LL INSTALL A PERTEC F D 200 MINI FLOPPY.
PARTS AND LABOR (PERTEC F D 200 MINI FLOPPY INCLUDED) FOR ONLY \$425⁰⁰

REPAIR—WE WILL REPAIR ANY ORIGINAL TRS-80 MICROCOMPUTER OR ONE OF OUR MODIFICATIONS.
ALL PARTS AND LABOR \$69⁰⁰

NOTE: THIS IS AN INDEPENDENT SERVICE EFFORT NOT AFFILIATED WITH RADIO SHACK® OR TANDY CORPORATION

F. REICHERT SALES

DROP INTO ONE OF OUR LOCATIONS

<p>1110 E. GARVEY AVE. W. COVINA, CA 91790 (213) 967-3846</p> <ul style="list-style-type: none"> • \$20 MINIMUM ORDER • FREE UPS DELIVERY ON U.S. ORDERS ONLY—OR BY SURFACE MAIL IF SPECIFIED. • MONEY BACK GUARANTEE (MOS & LED DEVICES EXCLUDED) • UNDER 8 HOUR PROCESSING ON MONEY ORDERS & CASHIER'S CHECK. 	<p>LOS ANGELES (213) 967-4611</p> <p>LMN ELECTRONICS 1042 E. GARVEY AVE WEST COVINA, CA</p> <ul style="list-style-type: none"> • SORRY! NO COD'S, PO'S OR CREDIT CARDS • CALIF. RES. ADD 6% SALES TAX • CANADA, PUERTO RICO & U.S. POSSESSIONS ADD U.S. \$3.50. ALL OTHERS ADD U.S. \$7.00. • U.S. FUNDS ONLY. 	<p>PORTLAND (503) 646-4044</p> <p>WIZARD OF PARTS 8225 S.W. CIRRIUS DR. BEAVERTON, OREGON</p> <p>DENVER (303) 573-5214</p> <p>ELECTRONIC LOLLIPOP 5643 N. BROADWAY, DENVER (125 & 58th AVE)</p>
---	--	---

ALL ITEMS SUBJECT TO PRIOR SALE PRICES SUBJECT TO CHANGE WITHOUT NOTICE

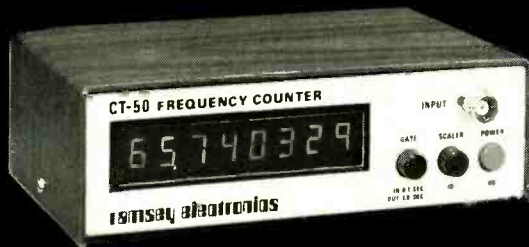

FREQUENCY COUNTER KIT

Outstanding Performance

Incredible Price

\$89⁹⁵

CT-50

The CT-50 is a versatile and precision frequency counter which will measure frequencies to 60 mHz and up to 600 mHz with the CT-600 option. Large Scale Integration, CMOS circuitry and solid state display technology have enabled this counter to match performance found in units selling for over three times as much. Low power consumption (typically 300-400 ma) makes the CT-50 ideal for portable battery operation. Features of the CT-50 include: large 8 digit LED display, RF shielded all metal case, easy pushbutton operation, automatic decimal point, fully socketed IC chips and input protection to 50 volts to insure against accidental burnout or overload. And, the best feature of all is the easy assembly. Clear, step-by-step instructions guide you to a finished unit you can rely on.

Order your today!

CT-50, 60 mHz counter kit
 CT-50WT, 60 mHz counter, wired and tested
 CT-600, 600 mHz scaler option, add

\$89.95
159.95
29.95

CB-1, Color TV calibrator-stabilize
 DP-1, DC probe, general purpose probe
 HP-1, High impedance probe, non-loadier

\$14.95
12.95
15.95

SPECIFICATIONS:

Frequency range: 6 Hz to 65 mHz, 600 mHz with CT-600
 Resolution: 10 Hz @ 0.1 sec gate, 1 Hz @ 1 sec gate
 Readout: 8 digit, 0.4" high LED, direct readout in mHz
 Accuracy: adjustable to 0.5 ppm
 Stability: 2.0 ppm over 10° to 40° C, temperature compensated
 Input: BNC, 1 megohm/20 pF direct, 50 ohm with CT-600
 Overload: 50VAC maximum, all modes
 Sensitivity: less than 25 mv to 65 mHz, 50-150 mv to 600 mHz
 Power: 110 VAC 5 Watts or 12 VDC @ 400 ma
 Size: 6" x 4" x 2", high quality aluminum case, 2 lbs
 ICS: 13 units, all socketed

CAR CLOCK



The UN-KIT, only 5 solder connections

Here's a super looking, rugged and accurate auto clock, which is a snap to build and install. Clock movement is completely assembled—you only solder 3 wires and 2 switches. Takes about 15 minutes! Display is bright green with automatic brightness control photocell—assures you of a highly readable display day or night. Comes in a satin finish anodized aluminum case which can be attached 5 different ways using 2 sided tape. Choice of silver, black or gold case (specify)
 DC-3 kit, 12 hour format **\$22.95**
 DC-3 wired and tested **\$29.95**
 110V AC adapter **\$5.95**

Under dash car clock



12, 24 hour clock in a beautiful plastic case features 6 jumbo RED LEDs, high accuracy (1 min. mo.) easy 3 wire hookup, display blanks with ignition, and super instructions. Optional: dimmer automatically adjusts display to ambient light level
 DC-11 clock with mtg. bracket **\$27.95**
 DM-1 dimmer adapter **2.50**

PRESCALER



Extend the range of your counter to 600 mHz. Works with any counter. Includes 2 transistor pre-amp to give super sens. typically 20 mv at 150 mHz. Specify +10 or +100 ratio
 PS-1B, 600 mHz pre-scaler **\$59.95**
 PS-1BK, 600 mHz pre-scaler kit **49.95**

OP-AMP SPECIAL

741 mini dip **12/\$2.00**
 B1-FET, mini dip, 741 type **10/\$2.00**

VIDEO TERMINAL

A completely self-contained, stand alone video terminal card. Requires only an ASCII keyboard and TV set to become a complete terminal unit. Two units available, common features are: single 5V supply, XTAL controlled sync and baud rates (to 9600), complete computer and keyboard control of cursor, Parity error control and display. Accepts and generates serial ASCII plus parallel keyboard input. The 3216 is 32 char. by 16 lines, 2 pages with memory dump feature. The 6416 is 64 char. by 16 lines, with scrolling, upper and lower case (optional) and has RS-232 and 20ma loop interfaces on board. Kits include sockets and complete documentation.
 RE 3216, terminal card **\$149.95**
 RE 6416, terminal card **189.95**
 Lower Case option, 6416 only **13.95**
 Power Supply Kit **14.95**
 Video/RF Modulator, VD-1 **6.95**
 Assembled, tested units, add **60.00**

CALENDAR ALARM CLOCK

The clock that's got it all: 6-5" LEDs, 12, 24 hour, snooze, 24 hour alarm, 4 year calendar, battery backup, and lots more. The super 7001 chip is used. Size: 5x4x2 inches. Complete kit, less case (not available) **\$34.95**
 DC-9

30 Watt 2 mtr PWR AMP

Simple Class C power amp features 8 times power gain: 1 W in for 8 out, 2 in for 15 out, 4 W in for 30 out. Max. output of 35 W, incredible value, complete with all parts, less case and T-R relay.
 PA-1, 30 W pwr amp kit **\$22.95**
 TR-1, RF sensed T-R relay kit **6.95**

FM MINI MIKE KIT



A super high performance FM wireless mike kit! Transmits a stable signal up to 300 yards with exceptional audio quality by means of its built in electret mike. Kit includes case, mike, on-off switch, antenna, battery and super instructions. This is the finest unit available.

FM-3 kit **\$12.95**
 FM-3 wired and tested **16.95**

CLOCK KITS



our Best Seller
 your Best Deal

Try your hand at building the finest looking clock on the market. Its satin finish anodized aluminum case looks great anywhere, while six 4" LED digits provide a highly readable display. This is a complete kit, no extras needed, and it only takes 1-2 hours to assemble. Your choice of case colors: silver, gold, bronze, black, blue (specify)
 Clock kit, 12, 24 hour, DC-5 **\$22.95**
 DC-10 **27.95**
 Alarm clock, 12 hour only, DC-8 **24.95**
 12V DC car clock, DC-7 **27.95**
 For wired and tested clocks add \$10.00 to kit price

Ramsey's famous MINI-KITS

FM WIRELESS MIKE KIT
 Transmits up to 300' to any FM broadcast radio, uses any type of mike. Runs on 3 to 9V. Type FM-2 has added sensitive mike preamp stage.
 FM-1 kit **\$2.95** FM-2 kit **\$4.95**

VIDEO MODULATOR KIT
 Converts any TV to video monitor. Super stable, tunable over ch. 4-6. Runs on 5-15V, accepts std. video signal. Best unit on the market!
 Complete kit, VD-1 **\$6.95**

SUPER SLEUTH
 A super sensitive amplifier which will pick up a pin drop at 15 feet! Great for monitoring baby's room or as general purpose amplifier. Full 2 W rms output, runs on 6 to 15 volts, uses 8-45 ohm speaker.
 Complete kit, BN-9 **\$5.95**

COLOR ORGAN/MUSIC LIGHTS
 See music come alive! 3 different lights flicker with music. One light for lows, one for the mid-range and one for the highs. Each channel individually adjustable, and drives up to 300W. Great for parties, band music, nite clubs and more.
 Complete kit, ML-1 **\$7.95**

STONE DECODER
 A complete tone decoder on a single PC board. Features: 400-5000 Hz adjustable range via 20 turn pot, voltage regulation 567 IC. Useful for touch-tone decoding, tone burst detection, FSK, etc. Can also be used as a stable tone encoder. Runs on 5 to 12 volts.
 Complete kit, TD-1 **\$5.95**

POWER SUPPLY KIT
 Complete triple regulated power supply provides variable 5 to 18 volts at 200 ma and +5V at 1 Amp. Excellent load regulation, good filtering and small size. Less transformers, requires 6.3V @ 1 A and 24 VCT.
 Complete kit, PS-3LT **\$6.95**

LED BLINKY KIT
 A great attention getter which alternately flashes 2 jumbo LEDs. Use for name badges, buttons, warning panel lights, anything! Runs on 3 to 15 volts.
 Complete kit, BL-1 **\$2.95**

WHISPER LIGHT KIT
 An interesting kit, small mike picks up sounds and converts them to light. The louder the sound, the brighter the light. Completely self-contained, includes mike, runs on 110VAC, controls up to 300 watts.
 Complete kit, WL-1 **\$6.95**

SIREN KIT
 Produces upward and downward wail characteristic of a police siren. 5W peak audio output, runs on 3-15 volts, uses 3-4.5 ohm speaker.
 Complete kit, SM-3 **\$2.95**

Hard to find PARTS

LINEAR ICs	REGULATORS	TTL ICs
301 \$.35	78MG \$1.25	74500 35
324 1.50	723 50	7447 65
380 1.25	309K 85	7475 50
380-8 75	7805 85	7490 50
555 45	78L05 25	74196TI 1.35
556 85	7905 1.25	SPECIAL ICs
566 1.15	7812 85	11C90 13.50
567 1.25	7912 1.25	10116 1.25
1458 50	7815 85	4511 2.00
3900 50		5314 2.95
CMOS ICs		5375AB 2.95
40-1 20		7001 6.50
40-3 35		4059 + N 9.00
4046 1.85		7208 17.95
4049 40		LEDs
4518 1.25		Jumbo red 8/1.00
5369 1.75		Jumbo green 6/1.00
		Jumbo yellow 6/1.00
TRANSISTORS		8 pin 8/1.00
2N3904 type 10/1.00		Micro red 8/1.00
2N3906 type 10/1.00		BiPolar .75
NPN 30W Pwr 3/1.00		FERRITE BEADS
PNP 30W Pwr 3/1.00		Jumbo red 15/1.00
2N3055 .60		With info, specs 15/1.00
UJT 2N2646 type 3/2.00		6 hole balun 5/1.00
FET MPF102 type 3/2.00		
UF-F 2N5179 type 3/2.00		
MRF-238 RF 11.95		
SOCKETS		
8 pin 10/2.00		
14 pin 10/2.00		
16 pin 10/2.00		
24 pin 4/2.00		
28 pin 4/2.00		
40 pin 3/2.00		

ramsey electronics
 BOX 4072, ROCHESTER, N.Y. 14610

PHONE ORDERS CALL
 (716) 271-6487



TERMS: Satisfaction guaranteed or money refunded. COD, add \$1.50. Minimum order, \$6.00. Orders under \$10.00, add \$7.50. Add 5% for postage, insurance, handling. Overseas, add 15%. NY residents, add 7% tax.

CIRCLE 45 ON FREE INFORMATION CARD

www.americanradiohistory.com

DECEMBER 1978

127



- Solar cell panels, used, OK condition
- 20 cell panel, 2" cells 6 volt 1/2 amp \$ 75.00
 - 36 cell panel, 12 volt 1/3 amp 100.00
 - 24 cell panel, 8 volt .45 amp 85.00
 - 10 half cell panel, 5 volt 1/4 amp 50.00
 - 5 cell panel, 2.5 volt 1/2 amp 40.00
 - Single 3.5 inch cell, 1 amp, .45 volt 8.50
 - Solar power kit, 3.5 inch cell, motor, propellor... \$ 10.25
 - ULTRASONIC room alarm, intrusion detection with full data for hookup 40.00

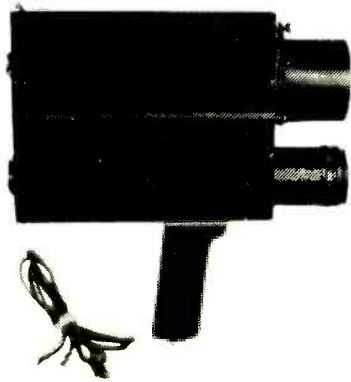

SEE IN THE DARK
 IR viewer complete ready to operate. Guaranteed by the manufacturer. Portable, runs on lantern battery. New, seen in total darkness. No shipments to Calif. Comes complete with built in IR source and adjustable focus lens.
SPL-21 \$199.00

All items FOB Lynn, Mass. Send for free 64 page catalog jam packed with goodies.

Meshna Inc., PO Box 62, E. Lynn, Mass. 01904

CIRCLE 39 ON FREE INFORMATION CARD

WIRE WRAP

— PRECUT WIRE —
Why buy wire on rolls?

PRECUT & STRIPPED WIRE IS:

- Fast - No more cutting & stripping by hand
- Reliable - Good, clean, uniform strip
- Economical - Cheaper than using bulk wire

PRECUT WIRE BULK WIRE

100 lbs of #3 at \$1.06 24.14 50 ft roll at \$1.99 4c/ft
 100 lbs of #6 at \$1.06 24.14 100 ft roll at \$2.95 3c/ft
 Wire color at \$6.95 2 x 2c/ft

* 30 Kynar stripped 1" on each end. Lengths are overall. Colors: Red Blue Green Yellow Black Orange White. Wire packaged in plastic bags. Add 25¢ length for tubes.

	100	500	1000	5000
2 in	78	2.40	4.30K	3.89 K
3 in	82	2.60	4.71 K	4.22 K
3 in	86	2.80	5.12 K	4.55 K
4 in	90	3.00	5.52 K	4.88 K
4 in	94	3.21	5.93 K	5.21 K
5 in	98	3.42	6.34 K	5.52 K
5 in	102	3.65	6.75 K	5.86 K
6 in	106	3.85	7.16 K	6.19 K
6 in	115	4.05	7.57 K	6.52 K
7 in	120	4.25	7.98 K	6.85 K
7 in	126	4.45	8.39 K	7.18 K
8 in	129	4.65	8.80 K	7.53 K
8 in	132	4.85	9.21 K	7.84 K
9 in	136	5.05	9.62 K	8.17 K
9 in	140	5.25	10.03 K	8.50 K
10 in	145	5.51	10.44 K	8.83 K
Additional	10	41	82 K	66 K

WIRE WRAP SOCKETS

1-9 10-24 25-99 100-249 250-999 1K-5K

	1-9	10-24	25-99	100-249	250-999	1K-5K
18 pin	35	33	31	29	25	23
14 pin	35	33	31	29	28	27
16 pin	37	35	33	31	30	29
18 pin	60	55	45	43	40	37
20 pin	84	78	71	63	59	54
22 pin	90	85	82	78	70	60
24 pin	91	84	78	68	64	59
28 pin	95	89	84	80	76	74
40 pin	150	140	130	120	105	90

Gold 3-Level Closed End Sockets End & Side Stackable All prices include gold 2-Level Sockets Available

WIRE WRAP TOOLS



\$34.95

HOBBY WRAP MODEL BW 630

With FREE Wire Kit #1 (\$6.95 Value)

Batteries & Charger \$11.00
 WSU 30 Hand Wrap-Unwrap Strip Tool 6.25
 WSU 30M for Modified Wrap 7.25
 BT 30 Extra Bit 2.95

INTERCONNECT CABLES

Ribbon cable connectors for connecting boards to front panels or board to board

	SINGLE ENDED			DOUBLE ENDED		
	14 pin	16 pin	24 pin	14 pin	16 pin	24 pin
6	1.24	1.34	2.05	2.24	2.45	3.37
12	1.33	1.44	2.24	2.33	2.55	3.32
24	1.52	1.65	2.63	2.52	2.78	4.31
36	1.91	2.06	3.40	2.91	3.17	5.08

WIRE KITS

#1	\$6.95	#2	\$19.95
250 3 100 4	250 2 250 4	250 6	250 6
3 100 5	3 200 3	3 250 5	100 6
100 4 100 6	500 3 100 5	100 7	100 7
	500 4	1 250 ft roll bulk	

Choose One Color Assortment \$ 1.00

PAGE DIGITAL ELECTRONICS

135 E. Chestnut St #5
 Monrovia, California 91016
 (213) 357-5005

ORDERING INFORMATION

- Orders under \$25 and COD \$, add \$2
- All others shipped Ppd in U.S. via UPS
- For Blue Label (Air) or 1st Class, add \$1
- We accept Visa & MasterCard
- Most orders shipped same day

DEALER INQUIRIES INVITED

CIRCLE 22 ON FREE INFORMATION CARD

UNIVERSAL 4Kx8 MEMORY BOARD KIT

\$69.95
 32 2102-1 fully buffered, 16 address lines, on board decoding for any of 64 pages, standard 44 pin bus, may be used with F-8 & KIM

EXPANDABLE F8 CPU BOARD KIT

\$99.00
 featuring Fairbug PSU 1K-of static ram, RS 232 interface, documentation, 64 BYTE register

C/MOS (DIODE CLAMPED)

4001	18	4019	37	4049	35	74C73	65
4002	18	4020	80	4050	35	74C74	45
4006	95	4021	80	4053	110	74C83	115
4007	18	4022	90	4055	125	74C88	40
4009	37	4023	18	4056	70	74C93	75
4010	37	4024	75	4071	18	74C151	140
4011	18	4025	18	4016	97	74C160	105
4012	18	4027	37	4020	22	74C174	105
4013	29	4028	80	74C00	70	74C181	105
4014	75	4029	95	74C02	22	74C175	105
4015	75	4030	33	74C04	24	74C919	120
4016	29	4035	97	74C08	22	74C901	48
4017	90	4042	65	74C10	27	74C902	48
4018	90	4046	135	74C12	85	74C914	120

PRINTED CIRCUIT BOARD

4 1/2" x 7" SINGLE SIDED EPOXY BOARD 1.16" Thick 5/32" Thick \$5/2.60
7 WATT LD-65 LASER DIODE 1R \$8.95

2N 3820 P FET	\$ 45
2N 5457 N FET	\$ 45
2N2646 UJT	\$ 45
ER 900 TRIGGER DIODES 4	\$1.00
2N 6028 PROG UJT	\$ 65

MINIATURE MULTI-TURN TRIM POTS 100, 1K, 2K, 5K, 10K, 20K, 50K, 100K, 200K, 500K, 1Meg, 5.75 each \$2.00

CHARGED COUPLE DEVICES

CCD 201C 100x100 Image Sensor \$95.00
 CCD 202C 100x100 Image Sensor \$145.00
VERIPAX PC BOARD \$4.00
 This board is a 1/16" single sided paper epoxy board, 4 1/2" x 6 1/2" DRILLED and ETCHED which will hold up to 21 single 14 pin IC's or 8, 16 or LSI DIP IC's with buses for power supply connector.

SP 10 PHOTO TRANS \$ 50
 RED, YELLOW, GREEN or AMBER
 LARGE LED'S 2" 6/\$1.00
 TTL 118 OPTO-ISOLATOR \$ 75
 MOLEX PINS 100/\$1.00 1000/\$8.00

1 WATT ZENERS 3.3, 4.7, 5.6, 9, 110, 12, 15, 18, or 22V \$6.00
 MCG860 MODEM CHIP \$9.95
 MCM 6571A 7 x 9 character gen \$10.75

Silicon Power Rectifiers

PRV	1A	3A	12A	50A	125A	240A
100	06	14	30	80	3.70	5.00
200	07	20	35	1.15	4.25	6.50
400	09	25	50	1.40	6.50	9.50
600	11	30	70	1.80	8.50	12.50
800	15	35	90	2.30	10.50	16.50
1000	20	45	110	2.70	12.50	20.00

SAD 1024 a REDICOM 1024 stage analog "Bucket Brigade" shift register \$18.95
 IN 4148 IN914 15 \$1.00

RS232 CONNECTORS DB 25P male \$2.25
 DB 25S female \$2.95
 HOODS \$1.00

REGULATORS 309K \$.95 340K 12,15 723 \$.50 or 24V \$.95
 LM 376 \$.60 340T 5, 6, 8, 12 320T 12, 15 15, 18 or 24V \$.95
 or 24V \$1.25 78 MG \$1.35 79 MG \$1.35

TRANSISTOR SPECIALS

2N6233 NPN SWITCHING POWER \$ 1.95
 MRF-8004 a CB RF Transistor NPN \$ 7.75
 2N3772 NPN Si TO 3 \$ 1.00
 2N1546 PNP Ge TO 3 \$.75
 2N4005 PNP Si TO 18 \$ 1.00
 2N6066 NPN Si TO 3 Diaphan \$ 1.70
 2N5806 PNP Si TO 92 \$ 4.50
 2N3137 NPN Si RF \$ 5.55
 2N3919 NPN Si TO 3 RF \$ 1.50
 2N1420 NPN Si TO 5 \$ 3.00
 2N3767 NPN Si TO 66 \$ 5.70
 2N2272 NPN Si TO 18 \$ 5.10
 2N3055 NPN Si TO 3 \$ 5.50
 2N3004 NPN Si TO 92 \$ 6.15
 2N3906 PNP Si TO 92 \$ 6.15
 2N5296 NPN Si TO 220 \$ 5.50
 2N6109 PNP Si TO 220 \$ 5.55
 2N3748 PNP Si TO 5 \$ 5.10
 MPS4 13 NPN Si \$ 4/5 1.00

TTL IC SERIES

7400	-13	7445	-65	74151	-61
7401	-13	7446	-68	74153	-61
7402	-13	7447	-58	74154	-94
7403	-13	7448	-68	74155	-58
7404	-13	7450	-15	74157	-55
7405	-15	7472	-25	74162	-79
7406	-13	7473	-28	74163	-55
7407	-20	7474	-28	74164	-85
7408	-18	7475	-45	74165	-95
7409	-18	7476	-30	74170	-168
7410	-13	7480	-31	74173	-120
7411	-18	7483	-65	74174	-95
7412	-13	7486	-28	74175	-65
7413	-36	7489	-1.25	74177	-75
7414	-60	7491	-67	74180	-65
7416	-22	7491	-55	74181	-1.90
7417	-25	7492	-43	74190	-1.00
7420	-13	7493	-43	74191	-1.00
7425	-25	7494	-67	74192	-79
7426	-22	7495	-65	74193	-79
7427	-19	7496	-65	74194	-80
7430	-13	74107	-68	74195	-50
7432	-21	74121	-29	74196	-86
7437	-21	74122	-38	74279	-55
7438	-21	74123	-45	74367	-50
7440	-13	74125	-40	75225	1.50
7441	-70	74126	-40	75491	-1.50
7442	-37	74150	-94	75492	-50

DATA CASSETTES 1/2 HR \$.95

22/44 Pin Solder Tail 156" Conn \$1.95

MM 5387AA new clock chip which will directly drive LED'S 1/2 Hz 1r. Supply & alarm \$5.95

NO. 30 WIRE WRAP WIRE SINGLE STRAND 100' \$1.40

ALCO MINIATURE TOGGLE SWITCHES
 MTA 106 SPDT \$.95
 MTA 206 DPDT \$ 1.70
 MTA 206 P-DPDT CENTER OFF \$ 1.85
 MSD 206 P-DPDT CENTER OFF \$ 1.85
 LEVER SWITCH

Full Wave Bridges

PRV	2A	6A	25A
100	.75	1.25	2.00
400	.95	1.50	3.00
600	1.20	1.75	4.00

DIP SOCKETS

8 PIN 17 24 PIN 35
14 PIN 20 28 PIN 40
16 PIN 22 40 PIN 60
18 PIN 25

SANKEN AUDIO POWER AMPS

\$ 1010 G 10 WATTS \$ 7.80
 \$ 1020 G 20 WATTS \$ 15.70
 \$ 1050 G 50 WATTS \$ 28.50

TANTALUM CAPACITORS

22UF 35V \$1.00	6.8UF 35V 4 \$1.00
47UF 35V \$1.00	10UF 10V \$.25
68UF 35V \$1.00	22UF 25V \$.40
1UF 35V \$.50	15UF 35V 3 \$1.00
2.2UF 20V \$1.00	30UF 6V \$51.00
3.3UF 20V \$1.00	47UF 20V \$.35
4.7UF 15V \$51.00	68UF 15V \$.50
	100UF 10V \$.40

74LS SERIES

74LS00	18	74LS137	75
74LS02	19	74LS139	75
74LS03	21	74LS151	75
74LS04	21	74LS152	75
74LS06	21	74LS153	58
74LS08	21	74LS154	62
74LS09	21	74LS155	62
74LS10	20	74LS157	56
74LS11	20	74LS158	75

Active Electronic Sales Corp.

1978 IC MASTER

Complete integrated circuit data selector. New 1978 edition (2200 pages) is twice as big as last year. Master guide to the latest IC's including microprocessors and consumer circuits.



Free quarterly updates

~~\$24.95~~ **\$19.95**

Tremendous Opportunity. Subject to Prior Sale, Lowest Price Ever Offered Anywhere.

TTL LOW POWER SCHOTTKY PLASTIC DUAL-IN-LINE I.C.

Part No.	Price	Part No.	Price	Part No.	Price	Part No.	Price	Part No.	Price	Part No.	Price
74LS00	15	74LS47	89	74LS123	79	74LS170	125	74LS258	75	74LS368	55
74LS01	15	74LS48	89	74LS124	99	74LS173	95	74LS259	145	74LS373	175
74LS02	15	74LS49	89	74LS125	59	74LS174	69	74LS260	29	74LS374	175
74LS03	15	74LS51	19	74LS126	59	74LS175	69	74LS261	185	74LS375	65
74LS04	19	74LS54	19	74LS132	79	74LS181	250	74LS266	39	74LS377	150
74LS05	19	74LS55	19	74LS133	29	74LS183	350	74LS273	165	74LS378	125
74LS08	19	74LS63	150	74LS136	39	74LS190	89	74LS275	450	74LS379	135
74LS09	19	74LS73	29	74LS138	64	74LS191	89	74LS279	59	74LS386	49
74LS10	15	74LS74	35	74LS139	64	74LS192	95	74LS280	175	74LS390	150
74LS11	19	74LS75	49	74LS145	99	74LS193	95	74LS283	85	74LS393	125
74LS12	19	74LS76	39	74LS147	195	74LS194	75	74LS290	85	74LS395	150
74LS13	35	74LS78	39	74LS148	99	74LS195	66	74LS293	110	74LS396	170
74LS14	59	74LS83	79	74LS151	59	74LS196	109	74LS295	125	74LS398	265
74LS15	19	74LS85	99	74LS153	59	74LS197	109	74LS298	125	74LS399	150
74LS20	15	74LS86	35	74LS155	99	74LS221	125	74LS299	295	74LS424	450
74LS21	19	74LS90	59	74LS156	80	74LS240	195	74LS324	125	74LS445	125
74LS22	19	74LS91	99	74LS157	59	74LS241	195	74LS325	255	74LS447	125
74LS26	25	74LS92	59	74LS158	69	74LS242	195	74LS326	255	74LS490	195
74LS27	21	74LS93	49	74LS160	84	74LS243	195	74LS327	255	74LS668	90
74LS28	21	74LS95	70	74LS161	84	74LS244	195	74LS347	125	74LS669	90
74LS30	15	74LS96	99	74LS162	84	74LS245	195	74LS348	175	74LS670	200
74LS32	25	74LS107	39	74LS163	84	74LS247	125	74LS352	135		
74LS33	27	74LS109	32	74LS164	89	74LS248	125	74LS353	135		
74LS37	23	74LS112	32	74LS165	125	74LS249	125	74LS362	700		
74LS38	23	74LS113	39	74LS166	145	74LS251	85	74LS365	55		
74LS40	19	74LS114	39	74LS168	150	74LS253	85	74LS366	55		
74LS42	54	74LS122	50	74LS169	150	74LS257	60	74LS367	55		

Dual In-line Sockets

Finest Quality Sockets Available Anywhere

- PLUGGABLE SOCKET FOR IC PACKAGES WITH LEADS
- HIGH RELIABILITY GAS TIGHT JOINT
- FULLY QUALIFIED TO MIL-S-874
- COMPACT LOW PROFILE DESIGN
- NO WICKING WHEN SOLDERED TO PC BOARD
- FLAMMABILITY RATING UL 94V-0

Stock level	Contacts	Price
14000	8 PIN	.11
345000	14 PIN	.13
156000	16 PIN	.15
33000	18 PIN	.19
18000	22 PIN	.27
84000	24 PIN	.28
25000	28 PIN	.36
46000	40 PIN	.48

All new major manufacturer production material offered. Largest variety of device types available anywhere.

LINEAR I.C.'S

LM324N	49	Quad Op Amp
LM339N	49	Quad Comparator
LM555N - 8	29	Timer
LM556N - 14	59	Dual Timer
LM723CN	34	Voltage Regulator
LM723CH	39	Voltage Regulator
LM741CH	37	Op Amp
LM741CN - 8	24	Op Amp
LM1458N - 8	39	Dual Op Amp

MOS Static RAM'S

Stock level	Part No.	Price
41400	2114 4K (1K x 4) 450NS	7.50
59500	2102LFPC 1K 350NS (Low Power)	1.19

MICROPROCESSOR CHIPS

Stock level	Part No.	Price
21600	8080A	5.95 5.50
2700	6800	8.95 7.95

MOS Dynamic RAM'S

Stock level	Part No.	Price
21110	4K 4060 300NS	3.95
27550	16K 416-3 200NS	11.95
18650	16K 416-5 300NS	8.95

INTERFACE SUPPORT CIRCUITS

Stock level	Part No.	Price
1250	8212	1.98
1800	8214	4.95 3.95
11200	8216	1.98
1700	8224	2.75
2800	8226	1.98
1500	8228	4.75
1000	8238	4.75
4900	8251	5.95 4.95
500	8253	14.95
5200	8255	5.95
1100	8257	9.95
300	8259	14.95

GENERAL INSTRUMENT 1 Amp Rectifiers (Epoxy)

Stock level	Part No.	Price	Stock level	Part No.	Price
1.7 Million	1N4001	50V 029	29000	W02M	200V 28
9 Million	1N4002	100V 039	57000	W04M	400V 32
5 Million	1N4003	200V 045	390000	W06M	600V 34
5.7 Million	1N4004	400V 039	80000	W08M	800V 39
1.6 Million	1N4005	600V 055	7000	W10M	1000V 60
8 Million	1N4006	800V 065			
1.8 Million	1N4007	1000V 07			

1.5 AMP Single Phase Silicon Bridge Rectifiers

SWITCHING DIODES

Part No.	Price
1N914 (100V 4NS)	.027
1N4148 (100V 4NS)	.027



Z80-CPU	14.95	Z80-SIO/0	59.00
Z80A-CPU	24.95	Z80A-SIO/0	68.00
Z80-PIO	7.95	(common TX & RX clocks with DTRB)	
Z80A-PIO	11.95		
Z80-CTC	7.95	Z80-SIO/1	59.00
Z80A-CTC	11.95	Z80A-SIO/1	68.00
Z80-DMA	46.00	(separate TX & RX clocks without DTRB)	

UART'S

Stock level	Part No.	Price
29000	AY5-1013A	4.95
9200	AY3-1015	5.95

1K CMOS RAM

Stock level	Part No.	Price
4400	5101 450NS (Low Power)	4.95

P.O. BOX 1035 FRAMINGHAM, MASSACHUSETTS 01701



Active Electronic Sales Corp.

Over-the-counter sales.

12 Mercer Rd., Natick, Mass. 01760

Behind Zayres on Rte. 9

Telephone Orders & Enquires (617) 879-0077

IN CANADA 3 LOCATIONS

5651 FERRIER ST.
MONTREAL, QUEBEC
H4P 2K5
Tel: (514) 735-6425

4800 DUFFERIN ST.
DOWNSVIEW, ONTARIO
M3H 5S9
Tel: (416) 661-1115

BAXTER CENTRE
1050 BAXTER ROAD
OTTAWA, ONTARIO
K2C 3P2
Tel: (613) 820-9471

*MINIMUM ORDER \$10.00 • ADD \$2.00 TO COVER POSTAGE & HANDLING • Canadian customers add 30% for exchange and handling. All federal and provincial taxes extra.

Foreign customers please remit payment on an international bank draft or international postal money order in American dollars.



ADVERTISING INDEX

RADIO-ELECTRONICS does not assume any responsibility for errors that may appear in the index below.

Free Information Number Page

42	Active Electronics	129
—	Advance Electronics	22,79,86,87
3	Advanced Computer Products	109
—	A M C Sales	104
2	American Antenna	Cov. 4
70	A P Products, Inc.	17
6	A V R Electronics	108
5	Audio-Technica	25
—	Karel Barta	110
60	B & K Precision Dynascan Co.	34
—	Bullet Electronics	104
—	Burdex Security Co.	103
80	Byte	99
64	C F R Associates	120
—	Chaney	130
—	CIE-Cleveland Institute of Electronics	28-31
—	Command Productions	108
7	Continental Specialities	Cov. 3
74	The Cooper Group Electronics Division	27
—	CREI-Div. of McGraw-Hill Continuing Education	70-73
—	Dage Scientific Instruments	103
47	Davis Electronics	100
46	Delta Electronics	102
37	Devco	104
61	Diamondback Electronics	110
48	Digi-Key	118
—	DRC	108
—	DRI Industries	85
10	E & L Instruments	95
8	E I C O	99
18	Electronics & Control Engineer's Book Club McGraw-Hill Book Division	18-21
—	Electronic Development Lab	110
—	E M C-Electronics Measurements	81
58	Electronic Supermarket	124
—	Electronic Systems	111
9	Enterprise Development Lab	102
—	Exar	69
79	Fluke	93
77,65	Fordham Radio Supply	97,120
11	Formula International	112,113
—	Fuji - Svea	105
78	Gavin Instruments	77
—	G F N	83
49	Godfoot Electronics	116
—	Golden Enterprises	106
62	Gould	84
12	Grantham College of Engineering	92
—	Graymark	123
34	G. T. E.-Sylvania-Consumer Renewal	2
100	Heath	88-91
55	Hickok Electrical Instruments	94
59	Hobby World	106
14	Indiana Home Study	98
—	Information Unlimited	106
51	Integrated Electronics	124
73	International Crystal Mfg. Co.	101
31	International Electronics	121
54	Int'l Instrumentation Inc.	108
17	J & E Electronics	120
16	James Electronics	114,115
—	Krystal Kits	103
—	Lakeside Industries	103
39	Meshna	128
40	M T I-Motorola Training Institute	84

19	National Camera Supply	98
—	National Radio Institute-NRI	8-11
—	National Technical Schools	23
63	Netronics	82
44,43	New-Tone Electronics International	106,110
36	Ohio Scientific	1
20	O.K. Machine & Tool	26
—	Olson	124
21	Optoelectronics	15
22	Page Digital Electronics	128
32	P A I A	92
15	Jim-Pak	13
52	Panavise	95
56	PTS Electronics	5
—	Personal Computers	116
71	Platt Luggage	81
38	Poly Paks	125
23	Priority 1 Electronics	117
53	Quest	122
—	Radio Shack	107
45	Ramsey Electronics	127
72	F. Reichert Sales	126
—	R C A	32-33
27	Rye Industries	81
—	Sabtrons	7
66	Schober Organ	99
24	Solid State Sales	128
57	Southwest Technical Products	100
67	Spacecom	96
—	Speakerlab	103
—	A. F. Stahler Co.	104
33	Steven Products	112
28	Tab Books	100
26	Trinco International	119
41	Tri-Star	120
—	Trumbull	103
68	Vector	24
—	Vero Electronics	Cov. 2
75	Viz. Mfg.	16
35	Wahl Clipper	77
29	Wersi Electronics	100
69	West Side Electronics	116

MOVING?

Don't miss a single copy of **Radio-Electronics**. Give us: Six weeks' notice

Your old address and zip code

Your new address and zip code

ATTACH LABEL HERE

name (please print)

address

city state zip code

Mail to: Radio-Electronics
SUBSCRIPTION DEPT., P.O. BOX 2520,
BOULDER, COLO. 80322



NATIONAL EMERGENCY ALARM REPEATER

UNIQUE DEVICE MADE FOR THE U.S. GOVERNMENT TO WARN OF NUCLEAR ATTACK. IT WAS TO BE PLUGGED INTO THE WALL OUTLET AND WAS TO SOUND OFF WHEN THE POWER COMPANY SWITCHED FROM 60 CYCLE TO 50 CYCLES. CONTAINS RELAY, TIMER/NOISE GENERATOR, RESISTORS, CAPACITORS, DIODE, REED SWITCH AND 50 CYCLE VIBRATING REED ALL IN AN ATTRACTIVE BLACK AND SILVER CASE, APPROX. SIZE 3.7" x 3.2" x 2.4". AN EXPERIMENTOR'S DELIGHT! BRAND NEW IN BOXES. C22706 **\$3.95**

GE FAST CHARGE Nicad Pack

CONTAINS 3 SERIES CONNECTED AA SIZE CELLS EACH RATED 1.2V AT 500MAH. CAN BE CUT APART OR USED AS A PACK. RECHARGE THESE IN AS LITTLE AS 3 HOURS! BRAND NEW. C23351 **\$2.95**

BISTABLE RELAY



\$2.00

SLA-1

7 SEGMENT COMMON ANODE READOUT CHARACTER HEIGHT .334". PRIME SEALED PKG. 4 for **\$2.00**

150 Watt Seconds STROBE TUBE



C23443 **\$3.95**

PHOTOFLUOR CAPS

350 mf 330V **100**
720 mf 360V **150**
1600 mf 360V **\$2.25**

CALCULATOR BOARDS

WITH DISPLAY LESS KEYBOARD AND CASE (AS IS) **\$1.50**



CARRYING CASE



C22864 **89¢**

STROBE TUBE & REFLECTOR ASSEMBLY

Small metal reflector w/ 70 bulb. Shows strobe tube. Requires 200VAC. min for 4 seconds. 3/4" x 1 1/2" long. Extra part tube. Made for Hi-Voltage Amp. (see spec. 11, W x 1/8" H x 1" D)

\$2.25 ea C22874

NONFLUOR PROJECTION LENSES

5" f/3.5 C23370 **\$3.95**

2" ROUND Speaker



C23068 **99¢**

V.O.X.

So it state Voice Operated Switch. Complete and assembled. With schematic. C21623 **99¢**

CRYSTAL Oscillator 14.04 Mhz

IC CLOCK OSC. #101 C23269 **\$1.98**

MINIATURE 1 MF, 350V CAPACITOR

SMALL SIZE MILITARY LONG LEADS **10 for \$1**

LED PANEL MOUNTING HITS



12 for \$1 C22707

Hex Nuts

Standard size hex nuts for pots, lenses **30 for \$1**

C22791

Strobe Light Kit



COMPLETE WORKSHEET includes 18" x 18" Kit includes lens and PC board and instructions. Do press on 11" VAC. **\$7.50**

Electronic Warning Flasher Kit

This battery operated device continuously emits a burst of intense light. Great safety device for bicycle riders, skiers, hikers, boaters & campers. Comes complete w/ all electronic parts, quality glass-optic PC board & easy to understand instruction. Uses high-output, custom flash tube which flashes 2 times per second when batteries are operating continuously for 12 hours on 2 alkaline batteries. You need only to replace the batteries and, if C23207 **\$8.95**

STROBE TUBE ASST.

Brand new factory prime strobe tubes. Assortment of 5 strobe tubes w/ 500VAC. **\$3.00**

C23280

MINIATURE REFLECTOR

Appx size 1.7/16" L x 7/8" W x 3/4" D **\$1.00**

C23227

AMAZING EARADIO

THIS IS PROBABLY THE WORLD'S SMALLEST RADIO. IT WEIGHS ONLY 1/2 OUNCE AND IS WORN BEHIND THE EAR. CONTAINS AN IC AND SEVERAL DISCRETE DEVICES TO GIVE AN EQUIVALENT OF 12 TRANSISTORS. THE RADIO HAS A I.R.F. DESIGN OPERATING FROM 1 STANDARD SIZE 1.5V HEARING AID BATTERY (INCLUDED). IT PROVIDES GOOD VOLUME TO EARPHONE ON SEVERAL STATIONS IN METROPOLITAN AREAS. DOESN'T REQUIRE ANY ANTENNA, GROUND OR OTHER ADDITIONAL WIRES - FULLY SELF CONTAINED & TUNABLE. SIZE: 1 1/8" x 1 1/4" x 3/8" **\$5.95**

510V BATTERY



EVEREADY NO. 497 1000-CRAB - 25 YEAR WARRANTY PROVIDES 510V AND 80V. THESE ARE NEW 1.5 IN. THE 16 20 24 30 36 42 48 54 60 66 72 78 84 90 96 102 108 114 120 126 132 138 144 150 156 162 168 174 180 186 192 198 204 210 216 222 228 234 240 246 252 258 264 270 276 282 288 294 300 306 312 318 324 330 336 342 348 354 360 366 372 378 384 390 396 402 408 414 420 426 432 438 444 450 456 462 468 474 480 486 492 498 504 510 516 522 528 534 540 546 552 558 564 570 576 582 588 594 600 606 612 618 624 630 636 642 648 654 660 666 672 678 684 690 696 702 708 714 720 726 732 738 744 750 756 762 768 774 780 786 792 798 804 810 816 822 828 834 840 846 852 858 864 870 876 882 888 894 900 906 912 918 924 930 936 942 948 954 960 966 972 978 984 990 996 1000

\$9.99 C23458

WATER THIN COPPER CLAD GLASS EPOXY BOARD

C23454 **\$04**

The new, green epoxy board is made with 100% copper. Can be used in place of FR-4. Can be used in place of FR-4. Can be used in place of FR-4. Can be used in place of FR-4.

SOLID CARBIDE PC DRILL BITS

.03" #1 C21626 **\$1.50**

ULTRA MINIATURE ADJUSTABLE CAPACITOR

3.5 - 11 PF **3 for \$1.49**

100M PHOTOFLUOR KIT

SIMPLE TO ASSEMBLE KIT INCLUDES PRE-ASSEMBLED CIRCUIT BOARD, CAPACITOR, FLASH TUBE, REFLECTOR, SWITCH AND HOOKUP DIAGRAM, LESS CASE, BATTERY HOLDER AND BATTERIES (OPERATES ON 2 AA CELLS). GUIDE #28 AT ASA 25. C23435 **\$2.95**

14" STROBE /SHUTTER CORD



\$1



CHANNEY electronics

P.O. BOX 27038, DENVER, CO. 80227 Ph: 303-781-5750

Minimum order \$5.00
Please include \$1 for postage
Visa, MC and COD accepted.
Phone orders are welcome.

RADIO-ELECTRONICS

130

www.americanradiohistory.com

Spend less. Test more.

Faster, easier and more economical digital testing. That's what CSC's Logic Probes are all about. And that's what engineers, technicians and hobbyists need, to deal with the increased use and complexity of digital circuits.

Unlike oscilloscopes, meters and other conventional test equipment, CSC probes are *logic-state oriented*: Just touch the probe to a circuit node and *instantly* read logic state, detect level transitions, check duty cycles. And store high-speed, low-rep-rate events that even fast scopes miss.

By accurately detecting the state of individual logic elements without removing ICs or cutting copper paths, CSC's circuit-powered,



multi-family Logic Probes locate over 95% of circuit problems in minutes instead of hours. And they're easy to use. Simply connect two clip leads across the power supply, touch the probe tip to a node and watch the LEDs.

LP-1 LOGIC PROBE. \$44.95*

LP-1 has a minimum detectable pulse width of 50 nanoseconds and maximum input frequency of 10 MHz. This 100 K ohm probe is an inexpensive workhorse for any shop, lab or field service tool kit. It detects high-speed pulse trains or one-shot events and stores pulse or level transitions, replacing separate level detectors, pulse detectors, pulse stretchers and pulse memory devices. All, for less than the price of a DVM.

LP-2 LOGIC PROBE. \$24.95*

LP-2 performs the same basic functions as the LP-1, but for slower-speed circuits and

without pulse memory capability. Handling a minimum pulse width of 300 nanoseconds, this 300 K ohm probe is the economical way to test



circuits up to 1.5 MHz. It detects pulse trains or single-shot events in TTL, DTL, HTL and CMOS circuits, replacing separate pulse detectors, pulse stretchers and node state analyzers.

LP-3 LOGIC PROBE. \$69.95*

Our LP-3 has all the features of the LP-1 plus extra high speed. It captures pulses as narrow as 10 nanoseconds, and monitors pulse trains to over 50 MHz. Giving you the essential capabilities of a high-quality memory scope at *about 1/100th the cost*. LP-3 captures one-shot or low-rep-rate events all-but-impossible to detect any other way. All without the weight, bulk, inconvenience and power consumption of conventional methods.



Use CSC's highly versatile logic probes for testing, debugging or servicing any type of digital circuit. They give you a lot of information about IC circuit conditions... and help you do more in less time. For less money.

NEED MORE INFORMATION? CALL

203-624-3103 to order, or for the name of your local distributor. Prices slightly higher outside U.S.A.

© 1978, Continental Specialties Corporation. Prices, specifications, subject to change without notice.

* Manufacturer's suggested retail.

Corporate Headquarters:
Continental Specialties Corporation
70 Fulton Terr., Box 1942, New Haven, CT 06509
351 California St., San Francisco, CA 94104
(415) 421-8872, TWX 910-372-7992

CONTINENTAL SPECIALTIES CORPORATION

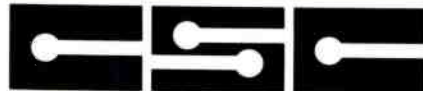

Europe, Africa, Mid-East: CSC UK LTD.
Shire Hill Industrial Estate, Units 1 and 2
Saffron Walden, Essex CB 11 3AQ
Telephone Number: SAFFRON WALDEN 21682
TLX 817477

CIRCLE 7 ON FREE INFORMATION CARD

www.americanradiohistory.com

New, K40 Magnamount: Grips like a grapple, actually improves transmission.



We double guarantee it.*

Exclusive Octopole Construction.



That's eight magnets set in eight different directions to give you a magnetic seal so complete and powerful, your antenna would stay up there if you could squeeze between two semis passing each other at 180 miles an hour. That's magnetic octopower.

* GUARANTEE I

Placed on the roof of a vehicle; properly tuned, the K40 Magnamount is guaranteed to transmit a further distance than a standard K40 without the Magnamount or you will receive a prompt and full refund from your K40 dealer who installed and tuned the Magnamount K40 for you.

* GUARANTEE II

Materials and workmanship are guaranteed for a full 12 months. Any part that fails to perform satisfactorily will be replaced absolutely free.

Exclusive K40 Flux Harmonics for Greater Transmission.

The magnetic radiation pattern was designed to match the K40 antenna radiation for greater distance than the standard K40. See our guarantee.

The facts: Physics and Physical.

1. Magnamount is a bigger, stronger magnet—in fact it's 8 bigger, stronger, magnets.
2. It doesn't just hold the K40 antenna, it helps it transmit further.
3. Remember the law of reciprocity. The antenna that transmits better, receives better.
4. It provides a flatter, lower SWR because the Magnamount is capacitance grounded.
5. It puts your $\frac{5}{8}$ wave K40 antenna securely in place in the most advantageous place to work against a ground plane—high and free from obstruction. That's square in the middle, right up on top.

\$15.95 buys it.

(SUGGESTED RETAIL)

K40 Magnamount.

American Antenna 1945 South Street Elgin, Illinois 60120

This professional CB equipment available only through Registered K40 Dealers!

CIRCLE 2 ON FREE INFORMATION CARD

www.americanradiohistory.com