

Radio-Electronics

BIOFEEDBACK TRAINING TECHNIQUE

75c ■ FEB. 1976

Radio-^{IND}Electronics

THE MAGAZINE FOR NEW IDEAS IN ELECTRONICS

BUILD ONE OF THESE

- ★ Biofeedback Thermometer
- ★ 555 IC Timer Circuits
- ★ Pocket Data Terminal
- ★ Calculator-Stopwatch

SOLID-STATE ELECTRONICS

- ★ New Computer Columns
- ★ State Of Solid State

TELEVISION

- ★ Step-By-Step Troubleshooting Charts
- ★ Probes For Your Test Gear
- ★ Jack Darr's Service Clinic

STEREO-HIGH-FIDELITY

- ★ Inside The New Tuner Standards
- ★ Two R-E Lab Test Reports

PLUS

- ★ Equipment Reports
- ★ Reader Problems & Solutions
- ★ Looking Ahead



GERNSBACK
PUBLICATION

You've Got Us Where You Want Us

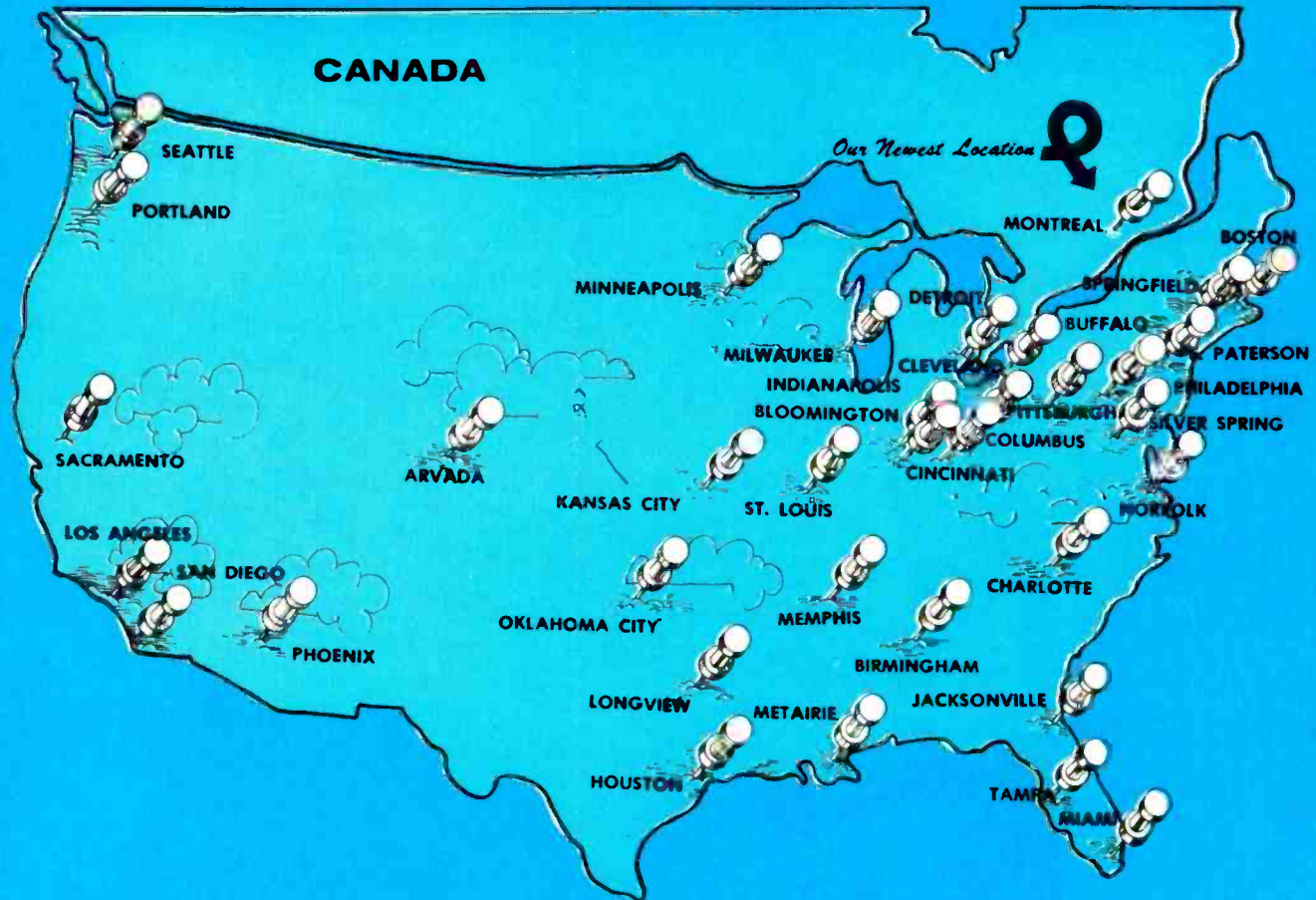

Even though we're the world's largest tuner repair service, recommended by more TV manufacturers than any other company, we think small. Really! We could put the whole thing under one roof. Instead, we have 36 small service centers across the country, staffed by more than 200 professional technicians. Why? Service for one thing . . . same-day

service. Bring us a tuner . . . any tuner . . . at 8 a.m. and it's repaired and tested by 4 p.m. Then there's quality . . . original parts, and once repaired, it's good as new. Oh sure, being the world's largest is something we're proud of. But we also like the fact that with 36 service locations, we can be small enough to give every tuner repair job a personal as well as a professional touch.



ELECTRONICS, INC.

PRECISION TUNER SERVICE

Consult the white pages of your telephone directory for the address and telephone number of the PTS center nearest you.

Circle 1 on reader service card

Lowest Price in the World!

In January of 1975, MITS stunned the computer world with the announcement of the *Altair 8800* Computer that sells for \$439 in kit form.

Today MITS is announcing the Altair 680.

The *Altair 680*, built around the revolutionary new 6800 microprocessor chip, is the lowest priced complete computer on the market. **It is now being offered at the special, low price of \$345!**

The *Altair 680* comes with power supply, front panel control board, and CPU board inclosed in an 11" wide x 11" deep x 4 11/16" case. In addition to the 6800 processor, the CPU board contains the following:

1. 1024 words of memory (RAM 2102 type 1024 x 1-bit chips).
2. Built-in Interface that can be configured for RS232 or 20 mA Teletype loop or 60 mA Teletype.
3. Provisions for 1024 words of ROM or PROM.

The *Altair 680* can be programmed from the front panel switches or it can be connected to a computer terminal (RS232) or a Teletype such as an ASR-33 or surplus five-level Baudott Teletype (under \$100).

The *Altair 680* can be utilized for many home, commercial or industrial applications or it can be used as a development system for *Altair 680* CPU boards. With a cycle time of 4 microseconds, 16-bit addressing, and the capability of directly addressing 65,000 words of memory and a virtually unlimited number of I/O devices, the *Altair 680* is a very versatile computer!

Altair 680 Software

Software for the *Altair 680* includes a monitor on PROM, assembler, debug, and editor. This software will be available to *Altair 680* owners at a nominal cost.

Future software development will be influenced by customer demand. MITS will sponsor lucrative software contests to encourage the rapid growth of the *Altair 680* software library. Programs in this library will be made available to all *Altair 680* owners at the cost of printing and mailing.

Altair Users Group

All *Altair 680* purchasers will receive a free one year membership to the Altair Users Group. This group is the largest of its kind in the world and includes thousands of *Altair 8800* and *680* users.

Members of the Altair Users Group are kept abreast of Altair developments through the monthly publication, **Computer Notes**.

Altair 680 Documentation

The *Altair 680* kit comes with complete documentation including assembly manual, assembly hints manual, operation manual, and theory manual. Assembled units come with operation and theory manuals. Turnkey model and CPU boards also include documentation.

NOTE: A complete set of Altair 680 manuals in a 3-ring Altair binder is now available for \$14.50 (regularly \$25). Offer expires January 30, 1976.

Delivery

Personal checks take 2-3 weeks to process while money orders and credit card purchases can be processed in 1-3 days. Delivery should be 30-60 days but this can vary according to order backlog. All orders are handled on a first come, first served basis.

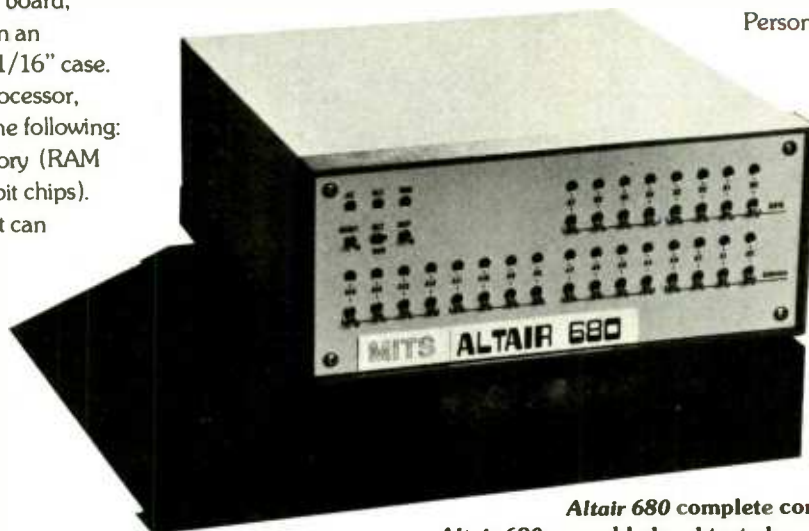

Altair 680 Prices

<i>Altair 680</i> complete computer kit.....	\$345
<i>Altair 680</i> assembled and tested.....	\$420
<i>Altair 680T</i> turnkey model (complete <i>Altair 680</i> except front panel control board) Kit Only.....	\$280
<i>Altair 680</i> CPU board (including pc board, 6800 microprocessor chip, 1024 word memory, 3 way interface and all remaining components except power supply) ..	\$195
<i>Altair 680</i> CPU board assembled and tested.....	\$275
Option IC socket kit (contains 40 IC sockets, CPU, memory and PROM sockets come with 680 kit).....	\$ 29
Option cooling fan (required when expanding 680 internally).....	\$ 22
Option cooling fan installed.....	\$ 26
PROM kit (256 x 8-bit ultraviolet, erasable 1702 devices) \$	25
Connectors (Two sets of 25-pin connectors. Required when interfacing 680 to external devices).....	\$ 22

Prices, delivery and specifications subject to change.

MITS

"Creative Electronics"

MITS/6328 Linn N.E., Albuquerque, NM 87108 505/262-1951

MAIL THIS COUPON TODAY!

- Enclosed is check for \$_____
- BankAmericard # _____ or Master Charge # _____
- Altair 680 Kit Assembled Altair 680T Altair 680CPU
- Socket Kit Fan PROM kit Documentation Special
- Please send literature

NAME _____

ADDRESS _____

CITY _____ STATE & ZIP _____

MITS/6328 Linn N.E., Albuquerque, NM 87108 505/262-1951

Circle 2 on reader service card

The new Sansui



The Sansui 9090

Powerhouse.

Power, features and performance. That's what the new Sansui 9090 and 8080 stereo receivers are all about.

Listen to what the new Sansui 9090 at under \$750.00* has to offer: • A whopping 110 watts minimum RMS power per channel with both channels driven into 8 ohms over the 20 to 20,000 Hz range with no more than 0.2% total harmonic distortion. • Twin power meters to monitor the output for each channel • Advanced PLL IC Multiplex Demodulator for improved channel separation, eliminating distortion and reducing detuning noise • Twin signal meters for easy, accurate tuning • 7-position tape play switch for total creative versatility in dubbing and monitoring • and many other exciting features. Cabinet finished in walnut veneer.

All in all the Sansui 9090 represents what is probably the most advanced receiver available today. Watt for watt, feature for feature, dollar for dollar, an almost unbelievable value.

Also available is the Sansui 8080 at under \$650.00* with 80 watts of continuous RMS power under the same conditions with almost all the same features. Cabinet in simulated walnut grain.



Sansui 9090

Sansui 8080

Try, and then buy, one of the new Sansui receivers at your favorite Sansui franchised dealer today. You will be glad you did. For years to come.

*The value shown is for informational purposes only. The actual resale price will be set by the Individual Sansui dealer at his option.

SANSUI ELECTRONICS CORP.
Woodside, NY 11377 • Gardena, California 90247
SANSUI ELECTRIC CO., LTD., Tokyo, Japan
SANSUI AUDIO EUROPE S.A., Antwerp, Belgium
In Canada: Electronic Distributors



Circle 3 on reader service card

Radio-Electronics®

THE MAGAZINE FOR NEW IDEAS IN ELECTRONICS

Electronics publishers since 1908

FEBRUARY 1976 Vol. 47 No. 2

BUILD ONE OF THESE

- 33 **Electronic Thermometer With Biofeedback Output**
It not only measures temperature accurately, it helps you train your mind to control your body. **by Mitch Waite**
- 40 **555 IC Timer Circuits**
Part I: A look at the 555 and circuits you can build around it. **by Robert F. Scott**
- 57 **Calculator-Stopwatch**
Part II: Final instructions on assembling this valuable unit. **by Tim Tyler**
- 60 **Pocket Data Terminal**
Part II: Automatic dialing add on you can build. **by Charlie Edwards**

GENERAL ELECTRONICS

- 4 **Looking Ahead**
Sneak preview of tomorrow's news. **by David Lachenbruch**
- 14 **Komputer Korner**
Elements in a computer. **by Tim Barry**
- 22 **State Of Solid State**
New IC's and applications prepared by our Semiconductor Editor. **by Karl Savon**

STEREO AUDIO HI-FI

- 43 **New FM Tuner Standards**
There are new rules for checking FM tuner performance. Our Hi-Fi Editor reports on the new standards. **by Len Feldman**
- 52 **R-E Lab Tests Sansui 9090**
Stereo. AM/FM receiver gets a going over. **by Len Feldman**
- 55 **R-E Lab Tests Yamaha TC-800 GL**
Portable cassette recorder comes up looking great. **by Len Feldman**

TELEVISION AND TEST GEAR

- 20 **Equipment Report**
Jerrold L-200 Levelite.
- 20 **Equipment Report**
Sencore DVM-32.
- 30 **Equipment Report**
Hickok 440 Curve Tracer.
- 50 **All About Probes**
Part II: More ways to use these vital accessories. **by Charles Gilmore**
- 62 **Step-By-Step Troubleshooting Charts**
Video sweep modulation can help speed servicing. **by Stan Prentiss**
- 69 **Service Clinic**
Bits and pieces. **by Jack Darr**
- 100 **Reader Questions**
R-E's Service Editor solves reader problems.

DEPARTMENTS

- | | |
|-------------------------------|--------------------------------|
| 116 Advertising Index | 87 New Literature |
| 12 Advertising Offices | 84 New Products |
| 18 Letters | 98 Next Month |
| 6 New & Timely | 119 Reader Service Card |

ON THE COVER

That's a very special sort of electronic thermometer . . . it does much more than just tell you the temperature. It also makes it possible for you to do some biofeedback training in a direct effort to control your own body's temperature. Try it yourself. The story starts on page 33.

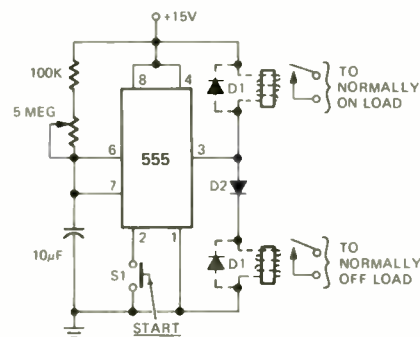

TIMER CIRCUIT APPLICATIONS are easy to use when there's a 555 IC around. Look into a flock of circuits this issue.

... turn to page 40

Radio-Electronics, Published monthly by Gernsback Publications, Inc., 200 Park Avenue South, New York, NY 10003. Phone: 212-777-6400. Second-class postage paid at New York, NY and additional mailing offices. One-year subscription rate: U.S.A., U.S. possessions and Canada, \$8.75. Pan-American countries, \$10.25. Other countries, \$10.75. Single copies 75c. © 1976 by Gernsback Publications, Inc. All rights reserved. Printed in U.S.A.

Subscription Service: Mail all subscription orders, changes, correspondence and Postmaster Notices of undelivered copies (Form 3579) to Radio-Electronics Subscription Service, Boulder, CO 80302.

A stamped self-addressed envelope must accompany all submitted manuscripts and/or artwork or photographs if their return is desired should they be rejected. We disclaim any responsibility for the loss or damage of manuscripts and/or artwork or photographs while in our possession or otherwise.

As a service to readers, Radio-Electronics publishes available plans or information relating to newsworthy products, techniques and scientific and technological developments. Because of possible variances in the quality and condition of materials and workmanship used by readers, Radio-Electronics disclaims any responsibility for the safe and proper functioning of reader-built projects based upon or from plans or information published in this magazine.

looking ahead

Safety recalls

Almost every week, small numbers of consumer electronic products are recalled for inspection or modification under government safety regulations. Here are the latest ones, illustrating one typical month's recalls: Admiral is calling back some 500 color sets made since 1973 to inspect for linecord damage that may have been incurred during manufacture. Electra Co. says it plans to modify about 70,000 Bearcat scanning monitors that may have faulty wall plugs. Ford is replacing some 450 color sets leased to Florida hotels because of possible overheating of circuit boards as a result of salt air and humidity. Wells-Gardner is inspecting 136 color sets for the possibility of shock hazard resulting from a pinched wire. Bowmar has recalled 168 microwave ovens for possible excessive radiation.

New TV standards?

Three prominent television engineers have independently urged government and the TV industry to start seriously thinking about an overhaul of color TV standards to prepare for a new kind of viewing based on large picture-on-the-wall flat-screen electroluminescent devices. All three proposals have centered on wide-screen high-resolution pictures with about 1,000 scanning lines.

The idea was first publicly proposed by consultant Raymond Wilmotte in his report commissioned by the FCC, "Technological Boundaries of Television" (R-E, Sept. 1975). K. Blair Benson, vice president of Goldmark Communications Corp., an official of the Society of Motion Pictures and Television Engineers and a former CBS vice president, told a recent Communications Bar Association meeting that current TV standards have been outmoded and called for

the immediate establishment of a technical standards committee to update them. "The impending availability of special programming via satellites for distribution over closed-circuit cable TV will result in a greater need for high-resolution standards," he said, adding that an orderly introduction of new standards would be feasible by means of simultaneous dual-standard transmissions, to serve both old and new type sets.

Donald G. Fink, executive consultant to the IEEE and a member of the National Television System Committee which formulated the current color standards, also thinks the time is coming for a change. He told a recent IEEE luncheon that a 1,000-line television system using a widescreen aspect ratio would be the equivalent of a 35-mm motion picture. Using present transmission systems, he said, this would require four times the bandwidth of the current TV channel, but new techniques of bandwidth compression could easily reduce this to double the present channel width, or 12 MHz. While phasing out the 525-line system, he suggested that the new 12-MHz channels be assigned to the underpopulated UHF band. At the same time, he pointed out, cable systems have vast numbers of unused channels that could be used for a new system. Until original programming is developed, Dr. Fink said, existing widescreen feature films would provide a ready-made programming staple for the new service.

MagTape scratched

RCA, deeply immersed in developing its SelectaVision VideoDisc system, has discontinued work on its MagTape home videocassette system, first shown in 1972. The company said it will devote its financial and technical resources to the videodisc system and its TV lines. An RCA spokesman said the retail

price of the MagTape deck "would have exceeded the range necessary to make it a viable consumer product." In addition, the market potential of the system would be "relatively small" compared to RCA's principal market for television receivers and the potential for videodisc players. Following in-home tests of the MagTape system in 1974, RCA decided that its one-hour-per-cassette playing time wasn't long enough and developed a second-generation model with two-hour recording and playing time. The only videocassette system specifically designed for the home being marketed in the United States is Sony's Betamax, which is now in retail stores in several major metropolitan areas.

Direct phone coupling

Widespread proliferation of telephone answering devices, automatic dialers, loudspeakers and other phone gadgets is expected to result in a new FCC ruling that permits their direct connection to telephone lines without the use of a special AT&T-approved interconnection protective module. Effective April 1, manufacturers of the devices will merely be required to prove to the FCC that they won't cause any harm to the telephone network. Most such gadgets are currently being produced with built-in protective modules, and the rule change could result in quick price declines of as much as \$30 or even \$50, and further reductions as a result of an expanded market and increased competition. Not affected by the new rules are telephone instruments and switchboards.

VTR of the month

Virtually every month, a new "standard" home videoplayer is introduced, always incompatible with all of the other

standard systems that preceded it. This month we bring you a new home videocassette standard, introduced in Japan by Matsushita (Panasonic) under the name National Home Video. A deck with an all-channel tuner feeds into the color set's antenna terminals. The magnetic tape, encased in a two-reel cartridge, moves at 3.42 ips. The cartridge, measuring $6 \times 2 \times 8\frac{1}{2}$ inches, contains $\frac{1}{2}$ -inch tape and will store an hour's programming and costs about \$18.25. The deck itself lists at around \$766 in Japan and is being marketed there on a test basis. Matsushita says it doesn't plan to introduce the unit in this country. The only videocassette system now being promoted for home use in the United States is Sony's Betamax. But don't worry, there'll be more coming along—at least more "proposed" standard systems. Some, like Sony's and Matsushita's, may actually go into production.

Audio rule change

Heeding complaints of amplifier manufacturers, the Federal Trade Commission has changed one part of its audio power measurement rules that many of them said was impractical. In the FTC-prescribed procedures for measuring RMS power, frequency response and bandwidth, the rules stated that amplifiers must be warmed up for one hour at one-third maximum power before tests are made. The only problem was that many amplifiers overheat and shut off within 20 minutes when operated under such conditions—and this made the actual tests impossible to perform. The Commission finally relented and issued an "interpretation:" Warmup time is still an hour, but it needn't be continuous. Amplifiers may be allowed to go through as many off-on cycles as necessary to accumulate an hour of "on" time.

by DAVID LACHENBRUCH
CONTRIBUTING EDITOR

The new Mallory CA3 Intrusion Alarm.

Reliable.



(And inconspicuous.)

This area-and-perimeter device creates and transmits an ultrasonic wavelength field for detection up to a distance of 20 feet. And because of its modern design and walnut-grain finish, the CA3 is attractive and inconspicuous enough to pass as a radio or stereo tuner.

Virtually any movement by an intruder (or a break in the perimeter circuit) activates the built-in horn and the remote outlet for two minutes. An automatic

reset handles the possibility of a new or renewed intrusion. And special CA3 circuitry guards against false alarms from line transients and insects. A variety of companion indoor or outdoor accessory devices is available.

The Mallory CA3 Ultrasonic Intrusion Alarm. From the manufacturer of the most complete line of do-it-yourself security products. Another sound reason to see your Mallory distributor today.



MALLORY DISTRIBUTOR PRODUCTS COMPANY

a division of P. R. MALLORY & CO. INC.

Box 1284, Indianapolis, Indiana 46206; Telephone: 317-856-3731

Batteries • Capacitors • Controls • Security Products • DURATAPE® • Resistors • Semiconductors • SONALERT® • Switches • Timing Devices and Motors

DURACELL® DURATAPE® and SONALERT® are registered trademarks of P. R. Mallory & Co. Inc.

Circle 4 on reader service card

Illinois housewife and Manila radio operator win Gernsback awards

The fifth first-prize winner in the 1975-76 Hugo Gernsback Scholarship Awards is Maxine Sanderson, Morton, IL. The award is a \$150 check given annually to the most deserving student in each of eight leading home study electronics schools.

Maxine Sanderson, married and with two sons, taught elementary school for 17 years. Though she lists electronics as one of her hobbies (the other is needlework), she had no formal training in elec-



MAXINE SANDERSON

tronics until she enrolled with the National Technical Schools of Los Angeles in March 1975. She is taking the Master Course in Electronic Communications. When she finishes the course, she hopes to open an electronic business.

Winner of the second prize, a WV-529A service VOM donated each month by RCA



ROGELIO M. MONDALA

to the contest runner-up, is Rogelio M. Mondala, at present a radio operator on a merchant ship. A graduate of Manilas'

Mapua Institute of Technology with a BS in electrical engineering, he was later a Senior Airways Communicator with the Philippine CAA. He is taking the National Technology Schools Master Course in TV and radio servicing. Like Mrs. Sanderson, he expects to open an electronics shop in the Philippines when he retires from his present job. Another of his reasons for increasing his knowledge of electronics is that with a training in the subject he will have a hobby that will last him through life and help him avoid the boredom that some of his friends have found after their active years.

New generation microprocessors to run our homes for us?

In less than 10 years, a new type of small, inexpensive computer may be monitoring the heating and cooling of your home, helping to plan the meals, turning lights on and off, and even answering the phone. So say the scientists at Sperry Univac, of Blue Bell, PA.

The new fourth-generation microprocessors, they say, should cost no more than a major appliance like a refrigerator, and would be small enough to fit in a desk drawer. Far more flexible than today's "automatic" equipment, they will be programmed to consider a wide range of factors and meet a variety of conditions. For instance, in replacing the thermostat in the house heating system, the microprocessor would take outdoor as well as indoor temperatures into account, and the rate at which they are rising or falling. Thus it would turn on the furnace if a sudden outside drop occurs, or turn off the furnace on a spring morning when the outside temperature is rising rapidly.

If you leave home on vacation, the computer can be programmed to turn lights on and off at certain hours, giving the house the appearance of being lived in, and even to answer the phone with an automatic recording.

In handling domestic duties, the computer would balance all the household accounts without agony to the homemaker, and could even analyze a proposed menu for dietary content and cost.

30 kilowatts of RF power beamed one mile by radio

Scientists of the Jet Propulsion Laboratory, Goldstone CA, report sending more than 30 kilowatts of power through space for one mile at a frequency of 2.388 terahertz (2,388 megahertz). A 450-kilowatt klystron in an 85-foot parabolic antenna is used for transmission.

At the receiving end, the transmission is picked up by 17 flat receiver panels.

These contain some 4,590 tuned dipoles and special rectifier equipment that converts the RF to DC with an 82% efficiency.

The received power is then used to light a bank of 300-watt lamps, which besides dissipating the power, serve by their brightness to help the transmitter engineers to guide the beam.

The rectifier antennas were designed by William C. Brown of Raytheon, a pioneer in radio power transmission who in 1964 kept a small helicopter flying by radio power 60 feet above ground for 10 hours. The power beamed to the helicopter was between 200 and 250 watts.

The possibility of radio power transmission has been discussed for many years, but in the past little has been attempted or accomplished. Before the 1964 experiment, the only significant success in transmitting power was Nikola Tesla's classic achievement at Colorado Springs in 1899. Tesla lit a bank of 200 lamps at a distance of 26 miles from a transmitter, which was a radio-frequency transformer (Tesla coil) operating at about 12 million volts and 50 or 100 kilohertz. Such voltages were not again duplicated until a year or two ago, and then only by apparatus designed to duplicate almost exactly that used by Tesla.



FOR THE SECOND SUCCESSIVE YEAR, the National Alliance of Television and Electronic Service Associations (NATESA) has awarded Larry Steckler, CET and Editor of this magazine, its Award for Cooperation. Mr. Steckler, shown above, is also active in NETSDA (National Electronic and Television Service Dealers Association) and is President of IS CET (International Society of Certified Electronic Technicians).

(Continued on page 12)

SBE Formula D

The state-of-the-art in fifty states

Stated simply, the SBE Formula D transceiver is in a class by itself.

It's the one full-feature CB radio with frequency synthesis and digital logic. It covers all 23 channels with a single crystal. Phase-lock-loop circuitry holds each channel right "on target." Audio comes through clean and crisp. And there's plenty of power for the built-in PA system.

And that's just the beginning.

Formula D is designed to give you superb sensitivity and signal-to-noise ratio to master weak signal reception. Plus such exceptional features as audio tone control, local/distance switch (to prevent overload from strong signals), delta tune, automatic noise limiter, back-lighted monitor meter, and dynamic microphone with coil cord.

For the perfect ending to the story, see and hear Formula D for yourself. You'll love the way it all comes out.



Better Communications through Creative Technology

For information write: SBE Inc., 220 Airport Blvd., Watsonville, CA 95076

Circle 5 on reader service card

Prepare for a high-paying career in Complete Communications

Including equipment installation,
and maintenance...in actual practice



Get 2-way radio training with this solid-state 500-channel digitally synthesized VHF transceiver and power supply!



Your communications/CB training will be up-to-the-minute when you experiment with this solid-state transceiver. Mount it in your car or use it with your AC power supply as a base station. You get "hands-on" experience that puts your course theory into practice the practical way.

The field of communications is bursting out all over. In Citizens Band alone, estimates predict a growth in equipment sales from \$514 million in 1973 to \$1.2 billion dollars in 1982! That means a lot of openings in service and maintenance jobs. NRI can train you at home to fill one of those openings . . . including your FCC license and solid-state 2-way radio service.

NRI's Complete Communications Course will qualify you for a First Class Commercial License within 6 months after graduation or you get your money back! It covers AM and FM transmission systems, teletype, radar principles, marine electronics, mobile communications, and aircraft electronics.

You will learn to service and adjust communications equipment . . . using your own 500 channel VHF transceiver and AC power supply for hands-on experience as well as your own personal use.

With NRI's training program, you can learn this important skill easily, at home in your spare time. You get 10 training kits, including an

Antenna Applications Lab, CMOS frequency counter and optical digital transmission systems. You'll learn from bite-size lessons, progressing at your own speed to your FCC license and then into the communications field of your choice.



Only NRI offers you five TV/Audio Servicing Courses



NRI can train you at home to service TV equipment and audio systems. You can choose from 5 courses, starting with a

48-lesson basic course, up to a Master Color TV/Audio Course, complete with 25" diagonal solid state color TV and a 4-speaker SQ® Quadraphonic Audio System. NRI gives you both TV and Audio servicing for less than you'd pay for either course at the next leading home study school!

All courses are available with low down payment and convenient monthly payments. All courses provide professional tools and "Power-On" equipment along with NRI kits engineered for training. With the Master Course, for instance, you build your own 5" wide-band triggered sweep solid state oscilloscope, digital color TV pattern generator, CMOS digital frequency counter, and NRI "Discovery" electronics lab.



* Trademark of CBS, Inc.

NRI's complete computer electronics course gives you real digital training

Digital electronics is the career area of the future . . . and the best way to learn is with NRI's Complete Computer Electronics Course. NRI's programmable digital computer goes far beyond any "logic trainer" in preparing you to become a computer or digital technician. With the IC's in its new Memory Kit, you get the only home training in machine language programming . . . experience essential to trouble shooting digital computers. And the NRI programmable computer is just one of ten kits you receive, including a TVOM and NRI's exclusive "Discovery" Lab. It's the quickest and best way to learn digital logic and computer operation.

You pay less for NRI training and you get more for your money

NRI employs no salesmen, pays no commissions. We pass the savings on to you in reduced tuitions and extras in the way of professional equipment, testing instruments, etc. You can pay more, but you can't get better training.

More than one million students in 62 years have learned at home the NRI way.

Mail the insert card and discover for yourself why NRI is the recognized leader in home training. No salesman will call. Do it today and get started on that new career.



APPROVED FOR CAREER TRAINING UNDER GI BILL
Check box on card for details.

MAIL THE INSERT CARD FOR YOUR FREE NRI CATALOG No salesman will call



NRI SCHOOLS
McGraw-Hill Continuing Education Center
3939 Wisconsin Avenue,
Washington, D.C. 20016

Hugo Gernsback (1884-1967) founder
M. Harvey Gernsback
 editor-in-chief and publisher
Larry Steckler, CET, editor
Robert F. Scott, W2PWG, CET,
 technical editor
Arthur Kleiman, associate editor
Jack Darr, CET service editor
Leonard Feldman
 contributing high-fidelity editor
David Lachenbruch, contributing editor
Karl Savon, semiconductor editor
Vincent P. Cicenja, production manager
Donna L. Glass, production assistant
Harriet I. Matysko, circulation director
Sheila Werthing, circulation assistant
Arline R. Bailey, advertising coordinator

Cover photo by Walter Herstatt

Cover design by Louis G. Rubsamen

Radio Electronics is a member of the *Institute of High Fidelity* and is indexed in *Applied Science & Technology Index* and *Readers Guide to Periodical Literature*.



Radio-Electronics is published by Gernsback Publications, Inc. 200 Park Ave. S. New York, NY 10003 (212) 777-6400

President: M. Harvey Gernsback

Secretary: Bertina Baer

ADVERTISING SALES

EAST

Stanley Levitan, Sales Manager
 Radio-Electronics
 200 Park Ave. South
 New York, NY 10003
 (212) 777-6400

MIDWEST/Texas/Arkansas/Okla.

Ralph Bergen
 Jim Reilly
 The Ralph Bergen Co.
 6319 N. Central Ave.
 Chicago, IL 60646
 (312) 792-3646

PACIFIC COAST Mountain States/SOUTHEAST

Jay Eisenberg
 J.E. Publishers Representative Co.,
 8732 Sunset Blvd.,
 4th Floor,
 Los Angeles, CA 90069
 (213) 659-3810
 Sales Mart Building
 1485 Bayshore Blvd., Box 140
 San Francisco, CA 94124
 (415) 467-0125

New element for touch controls eliminates former problems

Touch or proximity controls are becoming increasingly popular, especially on elevators and TV receivers. A touching or approaching finger changes the capacitance or conductivity of a sensor to generate the actuating signal. Such switches are sensitive and rugged, but have disadvantages that bar them from numbers of

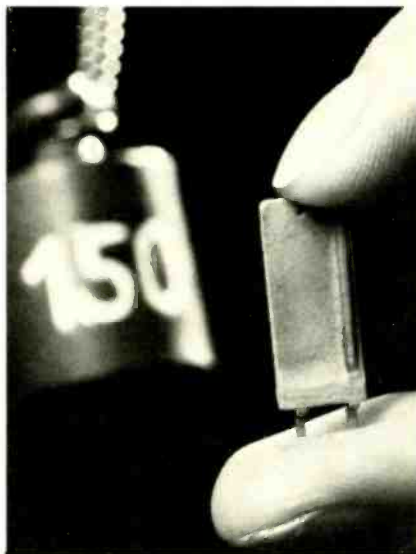

PIEZOCERAMIC TRANSDUCER is the core of Siemens new pushbutton element. The transducer, shown above, produces approx. 0.8 volts when subjected to a pressure of 150 grams.

industrial and domestic uses. They are affected by moisture, and vibrations at certain amplitudes and frequencies can set them off. Moreover, they can sometimes be falsely actuated by accidental touching or approach of a hand.

Siemens has now developed a sensor element, working on the piezoelectric principle, designed to overcome these difficulties. The sensor responds to a light touch (approximately 150 grams) to produce a voltage of about 0.8. The deformation is less than one two-thousandth of a millimeter. The transducer is in the form of a thin foil whose top edge can be subjected to mechanical force. Its slender shape greatly increases the piezoelectric energy for a given pressure.

Since the actuating area is part of a practically rigid and hermetically sealed surface, the sensor is not affected by moisture or dirt, and can be used on such devices as washing machines and kitchen ranges, as well as other devices exposed to unfavorable environmental conditions. Its insensitivity to vibration

opens up another field in industrial controls, as does its invulnerability to accidental triggering.

G-E's new YC TV color chassis rated 91.78% by NESDA jury

A serviceability rating of 91.78% was awarded to the G-E YC modular color TV chassis by a panel of five National Electronic Service Dealers Association (NESDA) members. The rating is based on a comprehensive checklist of key items in making the diagnosis and repair of a TV receiver easy and rapid.

Participating in the serviceability review were Dean Mock, CET, chairman of the NESDA serviceability committee, Mock's TV, Elkhart, IN; Dick Glass, CET, executive vice president of NESDA, Indianapolis, IN; Lew Edwards, CET, Color Tech TV, Trenton, NJ; Jesse Leach, CET, Lee's TV, Linthicum, MD, and John McPherson, CET, Mac's Electronics, Yorktown, VA.

Panel member Dick Glass reported that the same G-E 19-inch color chassis had received the highest score of nine color receivers tested during NESDA's national convention in Winston-Salem last August. The set, introduced last June, is built around a swing-away concept that allows immediate access to the seven modular subassemblies. These subassemblies contain approximately 90% of the set's components. The modules are interchangeable with those of the YA chassis used in G-E's 13 and 17-inch sets.



CHECKING OUT G-E's NEW YC CHASSIS are, left to right: Jesse Leach, CET, Lee's TV, Linthicum, MD; Lew Edwards, CET, Color Tech TV, Trenton, NJ; Dean Mock, Mock's TV, Elkhart, IN, and Dick Glass, executive vice president of NESDA.

Introductory offer to new members of the ELECTRONICS AND CONTROL ENGINEERS' BOOK CLUB

any one
of these great
professional books
for only **\$1.00**
values up
to \$42.50

Special \$1.00 bonus book comes to you
with your first club selection



649/170
**OPERATIONAL
AMPLIFIERS**
by G. E. Tobey,
J. G. Graeme,
and
L. O. Huelsman
Pub. price, \$18.95
Club price, \$11.50



238/901
**APPLICATIONS
OF OPERATIONAL
AMPLIFIERS**
by J. G. Graeme
Pub. price, \$16.00
Club price, \$10.50



287/597
**MANUAL OF
ACTIVE FILTER
DESIGN**
by J. L. Hilburn
and
D. E. Johnson
Pub. price, \$14.50
Club price, \$10.50

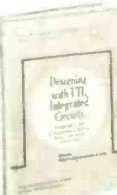

637/458
**DESIGNING WITH
TTL INTEGRATED
CIRCUITS**
by Texas
Instruments, Inc.
Pub. price, \$24.00
Club price, \$13.50



491/364
**THE DESIGN OF
DIGITAL
SYSTEMS**
by
J. B. Peatman
Pub. price, \$18.50
Club price, \$12.95



423/156
**INTEGRATED
ELECTRONICS**
by J. Millman
and C. Halkias
Pub. price, \$19.50
Club price, \$13.95



772/142
**HANDBOOK OF
APPLIED
MATHEMATICS**
by C. E. Pearson
Pub. price, \$37.50
Club price, \$27.50



209/804
**ELECTRONIC
ENGINEERS'
HANDBOOK**
by D. G. Fink
Pub. price, \$42.50
Club price, \$32.50



404/437
**SOURCEBOOK
OF ELECTRONIC
CIRCUITS**
by J. Markus
Pub. price, \$23.50
Club price, \$17.50



100/810
**MOS/LSI DESIGN
AND
APPLICATION**
by W. N. Carr
and J. P. Mize
Pub. price, \$22.00
Club price, \$13.50



404/445
**ELECTRONIC
CIRCUITS
MANUAL**
by J. Markus
Pub. price, \$24.75
Club price, \$15.75



209/731
**STANDARD
HANDBOOK FOR
ELECTRICAL
ENGINEERS,
10/e**
by D. G. Fink
and
J. M. Carroll
Pub. price, \$38.50
Club price, \$28.50



353/387
**MINICOMPUTERS
FOR ENGINEERS
AND SCIENTISTS**
by G. A. Korn
Pub. price, \$21.50
Club price, \$13.95



287/341
**STANDARD
HANDBOOK FOR
ENGINEERING
CALCULATIONS**
by T. G. Hicks
Pub. price, \$19.50
Club price, \$14.25

save time and money by joining the ELECTRONICS AND CONTROL ENGINEERS' BOOK CLUB



Here is a professional book club designed to meet your on-the-job engineering needs by providing practical books in your field on a regular basis at below publisher prices. If you're missing out on important technical literature—if today's high cost of reading curbs the growth of your library—here's the solution to your problem.

The Electronics and Control Engineers' Book Club was organized for you, to provide an economical reading program that cannot fail to be of value. Administered by the McGraw-Hill Book Company, all books are chosen by qualified editors and consultants. Their understanding of the standards and values of the literature in your field guarantees the appropriateness of the selections.

How the club operates: Every month you receive free of charge *The Electronics and Control Engineers' Book Club Bulletin*. This announces and describes the Club's featured book of the month as well as alternate selections available at special members' prices. If you want to examine the Club's feature of the month, you do nothing. If you prefer one of the alternate selections—or if you want no book at all—you notify the Club by returning the card enclosed with each Bulletin.

As a Club member, you agree only to the purchase of four books (including your first selection) over a two-year period. Considering the many books published annually, there will surely be at least four you would want to own anyway. By joining the Club, you save both money and the trouble of searching for the best books.

MAIL THIS COUPON TODAY

ELECTRONICS AND CONTROL ENGINEERS' BOOK CLUB
P.O. Box 582, Princeton Road, Hightstown, New Jersey 08520

Please enroll me as a member of the Electronics and Control Engineers' Book Club and send me the two books indicated below. I am to receive the bonus book for just \$1, and my first selection at the special Club price. Actual postage, plus 25¢ handling charge will be added (sales tax, also, if applicable). These books are to be shipped on approval, and I may return them both without cost or further obligation. If I decide to keep the books, I agree to purchase as few as four books (including this first selection) during the next two years at special Club prices (guaranteed 15% discount, often more).

Write Code # of \$1.00
bonus book
selection here

Write Code # of
first
selection here

NAME _____

ADDRESS _____

CITY _____

STATE _____ ZIP _____

All prices subject to change without notice. E33288

Circle 6 on reader service card

ARROW AUTOMATIC STAPLE GUNS

CUT WIRE & CABLE INSTALLATION COSTS

... without cutting into insulation!

SAFE! Grooved Guide positions wire for proper staple development! Grooved Driving Blade stops staple at right depth of penetration to prevent cutting into wire or cable insulation!

No. T-18—Fits wires up to 3/16" in diameter.



BELL, TELEPHONE, THERMOSTAT, INTERCOM, BURGLAR ALARM and other low voltage wiring.

Uses T-18 staples with 3/16" round crown in 3/8" and 7/16" leg lengths.

No. T-25—Fits wires up to 1/4" in diameter.

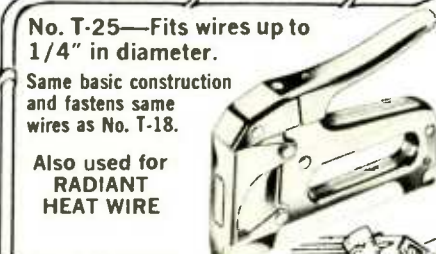

Same basic construction and fastens same wires as No. T-18.

Also used for **RADIANT HEAT WIRE**

Uses T-25 staples with 1/4" round crown in 9/32", 3/8", 7/16" and 9/16" leg lengths.

NEW! Intermediate No. T-37—Fits wires and cables up to 5/16" in diameter.



Same basic construction as Nos. T-18 & T-25.

Also used for **CATV and DRIVE RINGS** in stringing wires.

Uses T-37 staples with 5/16" round crown in 3/8", 1/2" and 9/16" leg lengths.

No. T-75—Fits wires and cables up to 1/2" in diameter.



RADIANT HEAT CABLE, UF CABLE, WIRE CONDUIT COPPER TUBING or any non-metallic sheathed cable.

Also used as **DRIVE RINGS** in stringing wires.

Uses T-75 staples with 1/2" flat crown in 9/16", 5/8" and 7/8" leg lengths.

ARROW FASTENER COMPANY INC.
271 Mayhill Street, Saddle Brook, N. J. 07663

KOMPUTER KORNER

The first in a series of columns that will illustrate the essential principles of computers.

by TIM BARRY

THE MICROPROCESSOR IS THE HOTTEST device in electronics today. If you doubt this you need only examine any of the current electronics trade magazines. "Microprocessor" has become the "buzz word" of 1975, and you will find it at the base of designs from TV games to home computers. Yet in spite of the features of all of this available hardware, few engineers and even fewer hobbyists are in a position to make effective use of these devices. The reason for this is that most users today lack even a rudimentary background in programming techniques and the design of hardware/software systems. As more and more standard microcomputers become available, the user emphasis will shift from design to being able to use software to get the most out of a given hardware design.

The columns in this series will illustrate the principles that are essential to all types of computer systems, but we will approach them from the hobbyist rather than the industrial point of view. We will discuss

and software. If there is sufficient interest, we will talk about what to look for in a hobbyist computer. This field is new, so we will want to hear what you want to talk about.

The need to be constantly aware of microcomputers as a hardware/software system is absolutely essential, since unlike most other hardware, a microprocessor and all the peripheral hardware in the world will not accomplish anything unless provided with the programs to tell it what to do. Similarly, a program that is not matched to the available hardware is just a useless abstraction. What we will aim for is to help you get maximum use from any system you can afford. The first several columns in this series will be a mini-course in how to program. If we all have a common level of general programming experience it will make later application-oriented columns easier to understand.

To present these concepts in a realistic manner which can actually be used on existing hardware, all programming in

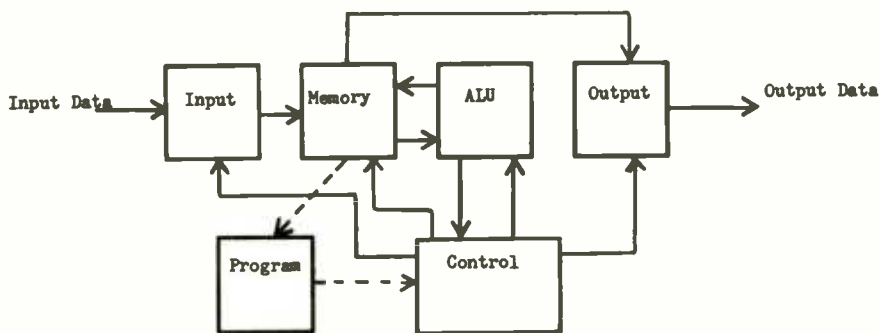

Fig. 1

control, I/O (Input/Output), arithmetic, subroutines, and all the other elements that are combined together to form programs. We will discuss how programs interact with the hardware to form systems and we will look at ways to implement useful features in both hardware

*Computers of all types are generally divided into two broad groups: digital and analog. Digital computers recognize only two data levels, conveniently represented in binary as "1's" and "0's". Analog computers, on the other hand, deal with continuously-variable data levels. While much of the discussion to follow applies to both digital and analog computers, this basic difference in data representation makes the hardware and software required to implement the two types of computers markedly different. The design of analog computer systems is a complete subject in its own right, and a parallel treatment of digital and analog computation would only detract from both. The microprocessor is part of a digital computer, and henceforth the analog world will be considered as something we convert digital data to or from, never lingering longer than absolutely necessary to perform the conversion.

this series will be demonstrated using the 8080-type microprocessor. The primary reason for this choice is that for the non-industrial user, the 8080 is presently the most available second-generation microprocessor. It is available from several sources in both component and finished computer form and support from the various manufacturers is good. Also, the instruction set and architecture of the 8080 are general enough so that the techniques and examples presented here should prove applicable to other microcomputers and minicomputers. The 8080, its instruction set, and other basic information required to program systems using it will be the subject of the second column in this series.

Since this is the first in a series of columns on microprocessor systems, it would be illustrative if we devoted some time to a brief presentation on the basics of computers, software, and the microprocessor itself.

Elements of computers

All digital computers*, from the \$9.95 pocket calculator to the largest computer (continued on page 16)

change tips... change temperatures



Weller[®] CONTROLLED OUTPUT SOLDERING STATION

...has interchangeable brains in the form of a ferromagnetic sensor mounted in the tip that controls iron temperature through unique "closed-loop" circuit. Change tips...change temperatures. A Weller exclusive! It's that simple. 600, 700, or 800° F...your choice. Switching tips is always easy because Weller's exclusive triple-plated construction prevents oxidation and "freezing"...assures quick interchangeability. And nobody offers as many tip options. Over 50 combinations of configuration, reach, and temperature, one just right for optimum soldering action and maximum tip life on any job.

UL-listed and OSHA-compliant, Weller's Model WTCP-L has its own built-in transformer...24 volt output for operator safety. Non-sinking holder supports and shields the comfort-grip, pencil iron when not in use. Grounded tip guards against static-discharge damage to sensitive workpiece circuitry. Base contains handy, tip-cleaning sponge and receptacle plus off/on switch and red indicator light. And non-burnable silicone power cord prevents annoying self-damage.

Weller's WTCP-L Station has all the functional features you need for today's sophisticated soldering...at the most attractive price. No fancy extras that only add to cost. Also available as WTCP-2 for low-temperature service. See it...*get it*...at your local distributor. Ask, too, about DS-100 de-soldering units. Or request technical information.

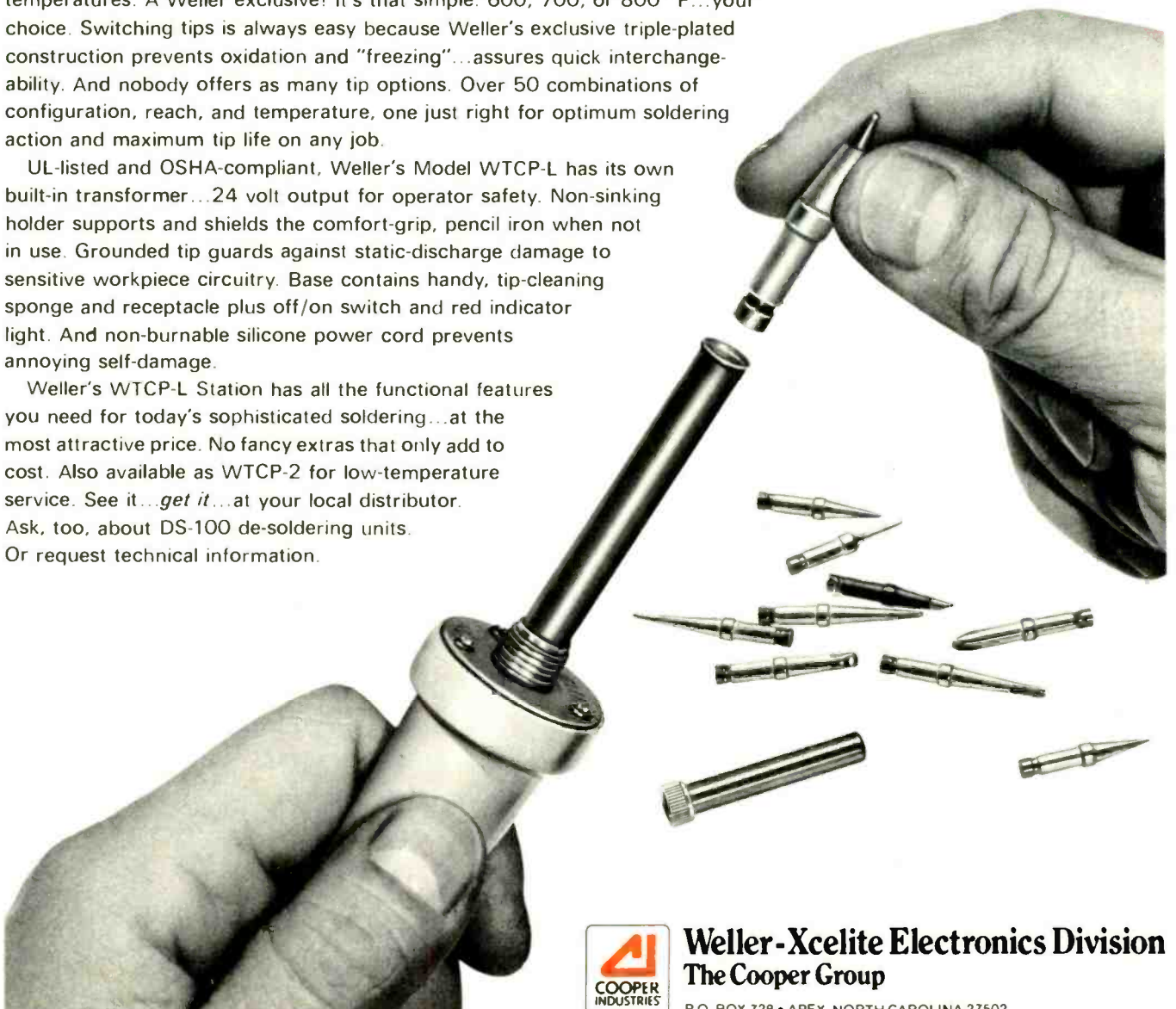

Weller-Xcelite Electronics Division
The Cooper Group

P.O. BOX 728 • APEX, NORTH CAROLINA 27502

Circle 8 on reader service card

DELUXE DIGITAL COLOR CONVERGENCE GENERATOR

NOW AT A PRICE EVERYONE CAN AFFORD

- ROCK SOLID PATTERNS
- ALL IC COUNTDOWN CIRCUITS
- QUARTZ CRYSTAL OSCILLATORS
- 2 FULL YEARS' WARRANTY

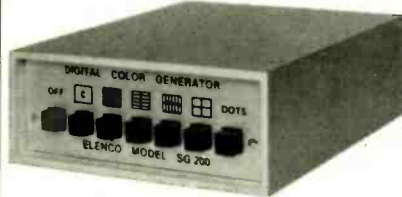

MODEL SG-200 \$99⁹⁵

10 Patterns: Full & Gated Rainbow, 4 Crosshatch, 4 Dot, Die Casted 1/8" Aluminum Case.

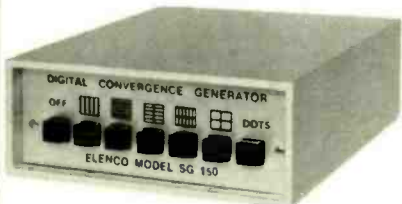

MODEL SG-150 \$75⁹⁵

10 Patterns: B&W Bars, White Field, 4 Crosshatch, 4 Dot.



MODEL SG-100
ONLY \$59⁹⁵

2 Patterns: 20 x 16 Crosshatch, 320 Dots, weight only 17 oz.

FULL 15 DAYS MONEY BACK GUARANTEE

See Your Distributor or Write:

ELENCO ELECTRONICS INC.
8744 W. North Ter., Niles, Ill. 60648

312-564-0919 MODEL SG-_____

- My check or money order enclosed.
- COD—Add \$2.50 mailing & handling.

NAME _____

ADDRESS _____

CITY _____ STATE _____ ZIP _____

DISTRIBUTORS' INQUIRIES INVITED

Circle 9 on reader service card

KOMPUTER KORNER

(continued from page 14)

networks, perform one basic function: they transform data from one form to another using precisely defined procedures. This basic definition immediately makes clear the two divisions of a computer system: hardware and software. Transformations of data are performed by hardware under the control of procedures defined by software. Any computer can now be divided into six blocks which accomplish these basic functions: input, memory, arithmetic logic unit (ALU),

MEMORY: Memory devices are used to store input data, programs, intermediate results, and output data. These devices are generally subdivided into serial-access devices such as disks, drums, and tapes and random access devices such as read only memory (ROM) and read/write memory (RAM). (The terms RAM and ROM as they are commonly used can lead to confusion. ROM stands for Read Only Memory, while RAM stands for Random Access Memory. One refers to the storage characteristics of the memory (read only) and the other refers to the way data in the memory is accessed (random access).)

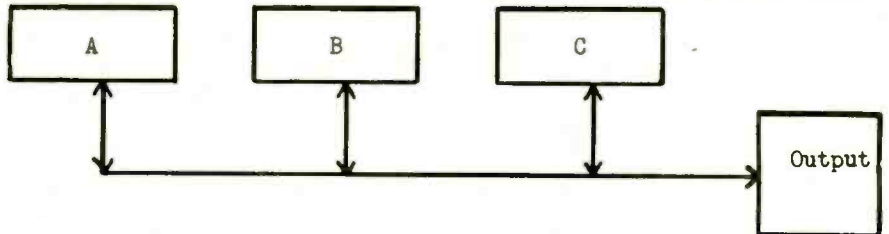

Code	Operation
01	Transfer A to B
02	" A to C
03	" A to Output
04	" B to A
05	" B to C
06	" B to Output
07	" C to A
08	" C to B
09	" C to Output

Architecture A

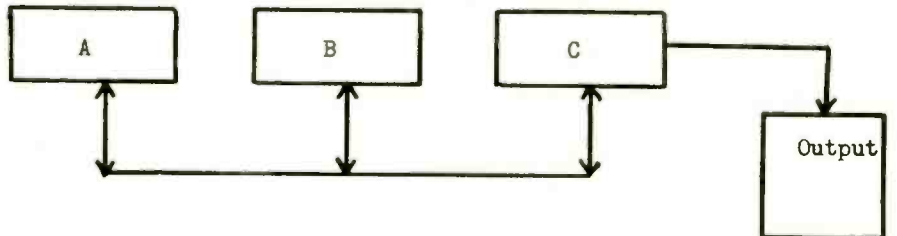

Code	Operation
01	Transfer A to B
02	" A to C
03	" B to A
04	" B to C
05	" C to A
06	" C to B
07	" C to Output

Architecture B

Fig. 2

control, output, and program. Graphically, this scheme is shown in Fig. 1.

Briefly, the functions of these blocks are as follows:

INPUT: Input devices are used to collect data for processing. These devices can be as simple as toggle switches or as complex as high-speed card readers. Examples would include keyboards, paper tape readers, and various types of magnetic tape units.

Most ROMs are also RAMs. To avoid any confusion on this basis the term RAM, if used, will refer to read/write memory. Generally, memory will be referred to as either read-only or read/write, with the implication being that both are semiconductor memories with random access organization.)

ARITHMETIC/LOGIC UNIT: This is the portion of the computer which actually

(continued on page 88)

NEW FROM JERROLD!

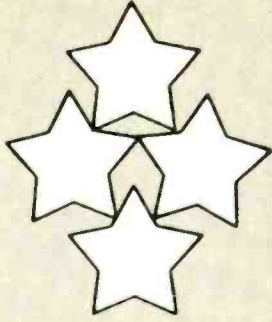

Levelite[®]

PATENTED

**EVERY TV-MATV
TECHNICIAN
NEEDS ONE!**



INSTANT GO, NO-GO TV SIGNAL INDICATOR

Levelite is not just a new product, it's a completely new type of test instrument . . . so different it has been granted a U.S. patent. About the size of a pocket calculator, it makes instant go, no-go tests for TV signals at antennas, preamplifiers, downlead, splitters and MATV outlets.

Just plug Levelite into an outlet, press the button and watch the green light. If the green light glows, you have TV signals. If not, there is insufficient signal.

Levelite is invaluable for troubleshooting TV and MATV signals. A handy range switch enables you to set the threshold signal level to -6 dBmV for weak signals or $+6$ dBmV for strong signals. The kit comes complete with adaptors for most types of 75-ohm and 300 ohm connectors, plus a padded holster-type carrying case that clips to any belt. Powered by 9-volt transistor battery (not supplied). One hand operation.

Ask your Jerrold distributor for a demonstration of the remarkable new Levelite.



**CHECKING
ANTENNA
SIGNALS**

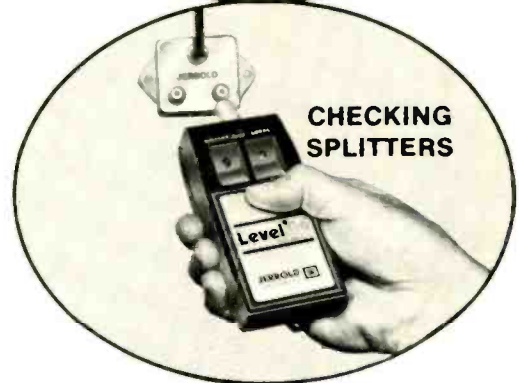

**CHECKING
SPLITTERS**

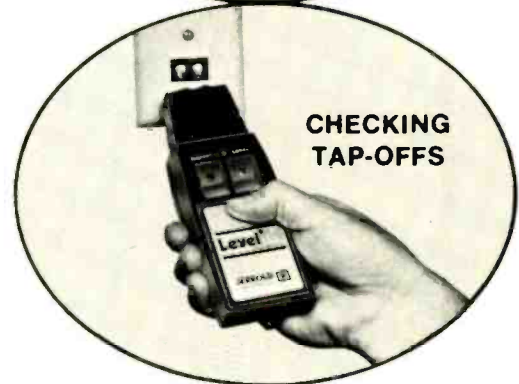

**CHECKING
TAP-OFFS**

JERROLD 
a GENERAL INSTRUMENT company

Distributor Sales Division

HEADQUARTERS & EASTERN OFFICE 200 Witmer Rd., Horsham, Penna: 19044. (215) 674-4800
SOUTHERN OFFICE 1 Perimeter Place, Suite 101, Atlanta, Georgia 30339, (404) 432-3102
WESTERN OFFICE 1255 Veterans Blvd., Redwood City, Calif. 94063, (415) 365-5050
MIDWESTERN OFFICE 1334 Atlantic Street, North Kansas City, Mo. 64116, (816) 474-0450

Circle 10 on reader service card

letters

R-E HELPED DO THIS?

Last July 4, an art group called Ant Farm drove a customized dream car through a pyre of flaming televisions (see photo). For safety, the people inside were shielded by an opaque Fiberglas cocoon. A monitor inside and a portable TV camera in the tall tail-fin put the driver's eye 2 meters above the road, and a video tape-recorder recorded the signal from the trunk. Two projects from the pages of **Radio-Electronics** made this video installation more useful.

I built P. J. Bunge's digital tachometer (R-E, April 1973) but had to trigger and reset the latch from the leading and falling edges of a 74121 because I could not get his design to work. A photocell counts spots painted on the rear tire for the speed. Numitron readouts inform the driver and the BCD data is passed to Don Lancaster's "Put The Time On Your TV Screen" (R-E, Sept. 1974). This allows the data to appear with the road image on the monitor and lets the video tape-recorder operate as a flight recorder.

I built a NASA-style down counter that

divides the vertical TV fields to get 1 Hz. We used 74192's that reverse count when they detect 00 (start), change the decoded minus sign on the screen (101101) to plus (101011). The device then counts up, recording elapsed impact time in seconds.

The monitor was made from an old Sony TV900U that was stripped of its RF, IF, and sound components to make room for more circuitry inside the case. The derelict AGC winding on the flyback provided horizontal trigger pulses, but also fed a rectifier and filter to provide -12 volts to run the character generator. The whole system—VTR, camera, monitor, and data—ran off a single 12-volt supply. My thanks to your authors for information and inspiration.

CURTIS SCHREIER
San Francisco, CA

COLOR TV CAMERA

The article by Gary Davis on building a color TV camera for about \$400 published in July, August and September 1975 issues has encouraged me to try a

similar project. This is an alternate approach that eliminated the need to build the video circuitry and, in view of a recent bankruptcy sale of black-and-white TV cameras, should cost about the same. These cameras weigh 2.7 lbs, are solid-state, use an Eumig Viennon lens, are new and cost \$125 each.

For purposes of a quick preliminary test, I have synchronized two cameras, Scotch-taped the Plexiglas filters in place, and run their video outputs to a color TV monitor connecting the blue and green guns together through a capacitor as suggested in Gary's article. I placed the cameras side-by-side and registered the returns from a color chart. The colors obtained, although not studio quality, were good enough to encourage me to proceed with the registration of the two cameras through the cube prism beamsplitter.

The parts list is included in the event some of your readers would like to try this approach.

Two TV cameras with service manual, sync instructions and 14-ft. cables at \$125 each.	\$250.00	Automation Systems 124 Lundy Lane Palo Alto, CA 94306
One 18-VDC, 15-watt power supply for the two cameras.	\$ 39.00*	Automation Systems
One 1/8-inch thick by 2-inch square red filter, Plexiglas #2423.	\$ 1.00	Corth Plastics 532 Howland St. Redwood City, CA 94063
Two 1/8-inch thick by 2-inch square green filters, Plexiglas #2414.	\$ 2.00	Corth Plastics
One beam-splitter cube-prism, 40-mm, stock #41211.	\$ 20.50	Edmund Scientific Co. Edscorp Building Barrington, NJ 08007

Total: \$312.50

*The power supply can be built at a savings from information supplied with the cameras.

NICHOLAS A. PIANKA
Mountain View, CA



Henry tried to fix it himself

TeleMatic MJ-195 MASTER TEST RIG FOR TUBE AND SOLID STATE SERVICING



\$149.95
less 19" picture tube

- 30 KV CAPACITY
- METAL CABINET
- SPEAKER BUILT IN

- HIGH VOLTAGE METER
- STATIC CONVERGENCE
- FRONT PANEL CONNECTIONS

TeleMatic

2245 Pitkin Ave., Brooklyn, N.Y. 11207

FREE! Adaptor Quick Reference Chart

Circle 11 on reader service card

Sleeper!

The Realistic® STA-90 Will Change Your Ideas About Who's #1 in Hi-Fi Features, Value and Style!

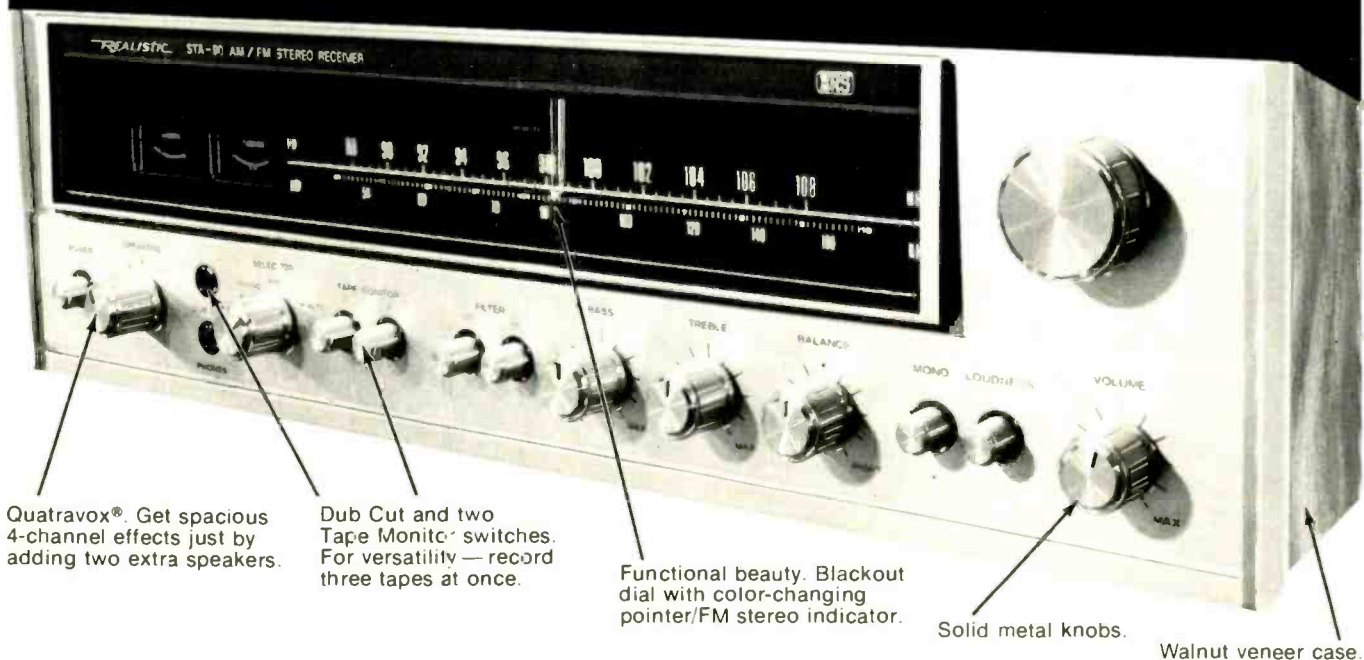

Quatravox®. Get spacious 4-channel effects just by adding two extra speakers.

Dub Cut and two Tape Monitor switches. For versatility — record three tapes at once.

Functional beauty. Blackout dial with color-changing pointer/FM stereo indicator.

Solid metal knobs.

Walnut veneer case.

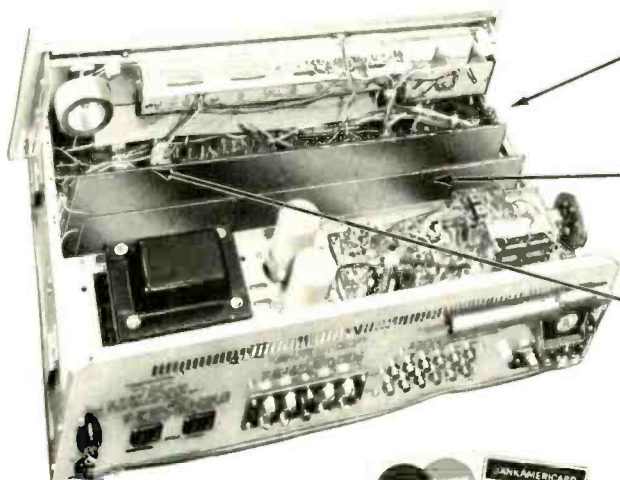

Dual-Gate MOSFET FM. Gets weak stations and still resists overload. Superior to FET designs.

Phase-locked loop FM stereo demodulator. For wider channel separation, almost zero distortion.

Direct-coupled amplifiers for powerful bass even at 20 Hz. 44 watts per channel, minimum RMS at 8 ohms from 20-20,000 Hz, with no more than 0.5% total harmonic distortion.

Amplifier Specs

Power Bandwidth: 17-35,000 Hz
 Response: 20-20,000 Hz ± 2 dB
 IM Distortion: 0.3% at 30W
 Phono Overload: 150 mV
 Hum and Noise (dB):
 Phono 1, -60
 Aux 1, -75

FM Tuner Specs

Sensitivity: 2.0 μ V IHF
 S/N Ratio: 65 dB
 Separation: 35 dB at 1 kHz
 Total Harm. Dist.: 0.8%
 Capture Ratio: 2 dB
 Selectivity: 60 dB



Only 359.95 at participating stores and dealers. Prices may vary at individual stores. U.L. listed. Ask for 31-2063. See what a Sleeper looks like — today!

SOLD ONLY WHERE YOU SEE THIS SIGN:

Radio Shack®

A TANDY CORPORATION COMPANY
 OVER 4000 STORES • 50 STATES • 8 COUNTRIES

FREE 164-Page Catalog Write to Radio Shack, P.O. Box 1052, Dept. 666, Ft. Worth, TX 76101

Circle 12 on reader service card

equipment reports

Jerrold L-200 "Levelite" Signal Indicator



Circle 47 on reader service card

TEST EQUIPMENT THAT DOES ONLY ONE thing, but does that one thing quickly and accurately, is very useful. The Jerrold model L-200 "Levelite" TV Signal Indicator is just such an instrument. There are two switches, and two LED's, one red and one green. That's it. It checks TV antennas, preamps, converters, twin-lead, coaxial cable, and any of the active devices in CATV/MATV systems.

What it does is indicate the presence of a high-band VHF signal. It lights the green LED when the signal is present. It looks simple, but it isn't inside. It has a selective amplifier that responds to only VHF high-band TV signals. (The idea of this is to reduce possible interference from FM radio stations that would give false readings.) Practically all systems have at least one high-band station. So, the Levelite will give you instant indications of the *presence* of a signal. This answers the question "Set or cable?" instantly. It is not a field-strength meter. However, it is calibrated. It has a LOCAL-DISTANT switch. In the LOCAL position, any signal with a minimum level of +6 dBmV (2,000 μ V) will light the green LED brightly. In the DISTANT position, only -6 dBmV (500 μ V) will light it.

It can be used with any kind of TV signal distribution system, from a simple antenna up to the larger MATV or CATV systems. Input adapters allow it to be used on 300 ohm or 75 ohm inputs. All of the adapters are quick push-on types.

This kind of instrument is ideal for quick location of faults in a MATV system. You start at the splitter or directional coupler of the dead leg and work your way back, checking each distribution tap until you find a signal indication. When you see this, the last one you passed is the bad one!

It can also be used for quick adjustment of signal levels by hooking it up to the tap and setting the attenuator until the green light barely glows with the switch in the LOCAL position. This shows that there is about +6 dBmV of signal here. Keep on doing this as you go down the line. If the

signal level on long runs drops off too much, you can go to the DISTANT switch position, which is still enough signal to make a pretty good picture.

The L-200 instrument with all of its adapters are in a padded soft case with a belt-hook and safety strap. They also put a loop on the bottom of the case for attaching a lanyard. Handy for using it if you must do any climbing.

The instrument is powered by one 9-volt transistor battery. If the red LED won't light or if both the red and green LED's light *without* a signal input, the battery is low. **R-E**

Sencore DVM-32 Digital Multimeter



Circle 48 on reader service card

A VOM HAS THE ADVANTAGE OF PORTABILITY while the VTVM has the advantage of high sensitivity. The self-contained digital multimeter has both, plus the inherent accuracy of digital circuitry. The latest entry in this field is Sencore's new DVM-32. It has all of the necessary ranges for any kind of electronics servicing, including color TV. Its 15-megohm input impedance gives it high sensitivity.

The DVM-32 is powered by internal batteries. It can be powered by an AC adapter for bench use and rechargeable Ni-Cad batteries can also be used with the same AC adapter unit. It's built in a tough Cyclac plastic case. The case, plus the fact that there is no delicate meter movement makes it rugged for field work.

Digital circuitry requires very little current. Despite the complexity of the circuitry, this instrument draws only 15 mA with the display unlit, and 100 mA at full display-brightness. Incidentally, the DVM-32 uses a Sencore patented circuit called Bright Display. The LED's are easily visible even under conditions of high ambient-lighting.

Another unique feature is the Auto-Display. This feature is controlled by a front-panel switch labelled AUTO. With the AUTO switch in the ON position, the display is blanked out and the unit draws only 15 mA. When a reading of over "010" is applied to the probes, the display lights. This

can be used on all ranges except resistance.

The DVM-32's resistance ranges have the handy HIGH-POWER and LOW-POWER ohms feature, for checking solid-state circuits. Either one can be used for regular resistance readings. The probe has a built-in isolation resistor of 200K ohms. This can be switched out for ohms readings, or when not needed by the type of voltage reading to be taken. This provides a handy quick check, too. Just switch the resistor in, set to the 2000K range on ohms, and short the probe tips. If you read 200 on the display, the instrument is working. By the way, the test probe is thin and has only a very small, sharp tip exposed. It's long enough to reach down into those jungles of parts, wires and stuff that we often run into, without shorting things.

The display has automatic decimal point placement. All scales are based on "2", which means a full-scale reading of "1.999". If you go over this, the display changes to "1.000" with the "1" blinking. Polarity indication is also automatic; you'll see a bright + or - sign at the left to tell you which is which. This doesn't work on AC or ohms, of course. It will light up on DC current; reading depends on how the leads are connected.

There is also a front-panel ZERO ADJUST control. Set this by switching to a DC voltage range, shorting the probes and adjusting for a "000" display. An internal zero-adjust can be used if the front panel control won't bring the display to zero.

To check the condition of the batteries, either the NiCad or standard dry cells, switch to the 20 volt DC range and touch the probe tip to the AC adapter jack in the back panel. A reading of more than 4.8 volts means that the batteries are still OK.

The DC voltage ranges cover from 1.999 volts to 1,999 volts in four ranges. The AC voltage ranges are from 1.999 volts to 1,000 volts RMS. The AC and DC current ranges are from 1.999 milliampere to 1,999 mA (1.999 Amps). The accuracy on DC voltages is 0.5%, on AC voltage 1.5%.

The resistance ranges have an accuracy of 1%. Digital ohmmeters have an inherent advantage over conventional meter movements. There is no crowding at the high end of the scale; they're linear. This means that you can read a resistance of say 12 ohms on the 0-2000 ohm range, with accuracy.

All ranges are well-protected by fuses, overload diodes, etc. Even the ohms ranges will withstand an application of 1,000 volts on all ranges! If the worst does happen, you'll find spare fuses for each size, thoughtfully stowed in little sockets just inside the battery cover!

Transistor and diode test data is provided in the instruction book. On HIGH POWER ohms, 2K range, a good silicon
(continued on page 30)

LIVE IN THE WORLD OF TOMORROW... TODAY!

And our FREE 164 PAGE CATALOG is packed with exciting and unusual values in electronic, hobby and science items — plus 4,500 finds for fun, study or profit... for every member of the family.

A BETTER LIFE STARTS HERE

4 1/4" ASTRONOMICAL TELESCOPE

See moon craters, rings of Saturn, double stars. New equatorial mount. f/10, 1/4 wave mirror (Pyrex®). Gives theoretical limit of resolution. Rack & pinion focusing. Aluminum tube, 6X finder, 1" F.L. 45X Kellner achromatic eyepiece and Barlow lens to double & triple power up to 135X. Free Star Chart plus 2 Books. Stock No. 85,105EH... (Shipping Wt. 42 lbs).



- 4 1/4" WITH CLOCK DRIVE #85,107EH \$159.50 FOB
- 6" REFLECTOR TELESCOPE (48X to 360X) #85,187EH \$249.50 FOB
- 6" WITH CLOCK DRIVE #85,086EH \$285.00 FOB
- 3" DELUXE REFLECTOR (30 to 90X) #80,162EH \$ 89.95 Ppd.
- STANDARD 3" REFLECTOR #85,240EH \$ 59.95 Ppd.

SOLAR POWERED WATCH: \$199.95

Fantastic new digital watch powered by the sun with quartz accuracy—for less than \$200! Bright LED display for 3-sec. reading of hr., mins., secs. at press of button; press again for self-correcting (till leap yr.) calendar to flash mo., date. 9 silicon solar cells charge 2 sub-mini batteries (guaranteed for minimum 3-yr. life) to power quartz control oscillator. Accuracy to within 1 min. a yr.—no moving parts in mechanism. Gold-plated case & band. Stock No. 1675EH..... \$199.95 Ppd.



ELECTRONIC DIGITAL RAIN GAUGE

... never needs emptying, measures rain up to 100-ft. away by tenths of an inch up to 999.9" and empties itself. Accumulate total rainfall count for hour, day, week, etc. Push reset button on indoor counter to start new counting period (no need to empty or check hermetically sealed outdoor collector which you easily mount on fence, roof, deck, etc. w/2 ordinary screws). Includes 30-ft. of waterproof wire, runs on 1-yr.-life 9v trans. battery, not incl. Stock No. 72,165 EH..... \$44.95 Ppd.



50-150-300 POWER MICROSCOPE

Amazing Value—3 Achromatic Objective Lenses on Revolving Turret! Color-corrected, cemented achromatic lenses in objectives give far superior results to single lenses usually found in this microscope price range. Results are worth the difference! Fine rack and pinion focusing. Imported! Stock No. 70,008 EH..... \$45.00 Ppd.



MOUNTED 500 POWER OBJECTIVE: Threaded achromatic lenses, 3mm F.L. Stock No. 30,197 EH..... \$9.75 Ppd.

WHEN YOU COME TO PHILADELPHIA BE SURE TO SEE
FREE BICENTENNIAL LIGHT SHOW
 IN BARRINGTON, N.J. ONLY 10 MINUTES AWAY AT
EDMUND FACTORY STORE

LOW COST 7X INFRA-RED VIEWER



For Infra-red crime detection surveillance, security system alignment, I.R. Detection, laser checking, nite wildlife study, any work req. I.R. detection & conv. to visible spectrum. Self cont. scope w/everything incl. I.R. light source. 6v or 12v power. 6032 I.R. converter tube, f/4.5 objective lens, adjust. triplet eyepiece. Focuses from 10' to infinity.

- No. 1659 EH (11x14 1/4 x 3")..... \$285.00 Ppd.
- WITHOUT LIGHT SOURCE**
- No. 1663 EH..... \$225.00 Ppd.

LEARN HOW TO RELAX BETTER!



New inexpensive biofeedback monitoring device helps you learn tension reduction techniques w/o electrode headbands, messy creams. Designed by clinical psychologists working in the stress reduction field, this handsome Executive Galvanic Skin Response

Meter features solid-state electronics for great sensitivity, compactness, dependability. Walnut & gold-plated brass case. Uses 9v batt. (incl). Learn to take a 10-minute "vacation" at your desk! (2 1/2 x 4 x 1 1/4")..... \$55.00 Ppd.

GIANT MAGNET, LITTLE PRICE!



"Fish" with this powerful 1 lb. ceramic magnet. Lifts over 150 pounds, only costs \$9.95. Tie a line to its stainless steel handle, drop it overboard and your first treasure haul (anchors, tackle, ferrous metal valuables?) can pay

more than its cost. 4 ceramic magnets, in series, between 4 steel plates; develops fascinating strength. Great for "fishing," for scrap metal and tool recovery, too! No. 42,318 EH (1x1 1/4 x 4 3/4")..... \$9.95 Ppd.

NEW! COMPLETE "KIRLIAN" LAB

Self-contained! Super sensitive! Variable energy controls! All the most wanted electrophotography features in one compact unit to take B & W, color pix, without camera or lens. Terrific value! Includes: classic ringed oscillator circuit; glass covered electrode w/ optimum dielectric isolation (sensitivity/safety); timing adjust. to assure quality pix; more! AC & 12v DC.

- No. 72,106 EH (8x10x4")..... \$145.00 Ppd.
- PRO MODEL: No. 72,053 EH..... \$399.00 Ppd.
- "STARTER'S" KIT: No. 71,938 EH..... \$ 49.95 Ppd.

MAKE, SELL CUSTOM PHOTO MUGS



Personalize 10-oz. thermal no-sweat plastic mugs with photos, names, trademarks in minutes—sell them for \$3 (3X your cost)! Easy 5-step method with included deluxe mug press takes 1 minute for professional looking break-resistant mug. Basic kit makes 36 finished, insulated mugs.

- No. 85,255EH (SHPG. WT. 34 LB.)..... \$149.95 FOB
- 125 ADDITIONAL 10-OZ. MUGS (& INSERTS)
- No. 85,257EH (SHPG. WT. 40 LB.)..... \$133.50 FOB
- 108 12-OZ. TUMBLERS (& INSERTS)
- No. 85,258EH (SHPG. WT. 13-LB.)..... \$115.50 FOB



MAIL COUPON FOR GIANT FREE CATALOG!

172 PAGES • MORE THAN 4500 UNUSUAL BARGAINS

Completely new 1976 edition. New items, categories, illustrations. Dozens of electrical and electromagnetic parts, accessories. Enormous selection of Astronomical Telescopes. Unique lighting and ecological items. Microscopes, Binoculars, Magnifiers, Magnets, Lenses, Prisms. Hard-to-get surplus bargains. Ingenious scientific tools. 1000's of components.

EDMUND SCIENTIFIC CO.
 300 Edscorp Building, Barrington, N.J. 08007
 Please rush Free Giant Catalog "EH".

Name _____
 Address _____
 City _____ State _____ Zip _____



COMPLETE AND MAIL WITH CHECK, M. O. OR CHARGE NO.
EDMUND SCIENTIFIC CO. 300 Edscorp Building, Barrington, N.J. 08007

How Many Stock No.	Description	Price Each	Total
<input type="checkbox"/>	PLEASE SEND GIANT FREE CATALOG "EH"		
<input type="checkbox"/>	Charge my BankAmericard *		
<input type="checkbox"/>	Charge my Master Charge *		
Interbank No. _____		Add Service and Handling Charge \$1.00	
My Card No. Is _____		I enclose <input type="checkbox"/> check <input type="checkbox"/> money order for TOTAL \$ _____	
Card Expiration Date _____		Signature _____	

30-DAY MONEY-BACK GUARANTEE. You must be satisfied or return any purchase in 30 days for full refund. *\$15.00 minimum

Name _____
 Address _____
 City _____ State _____ Zip _____

Circle 13 on reader service card

THE CURVE TRACER THAT WON'T COLLECT DUST.



The Hickok Model 440 semiconductor curve tracer is all purpose and convenient to use. It's the ideal instrument for testing, evaluating, classifying and matching all types of transistors, FET's and diodes. You'll get stable, full range dynamic displays that you can accurately scale right from the screen.

- Pull-out card for easy, fast set-up and operation.
- Set-up marks for rapid set-up of 80% of tests.
- Unique INSTA-BETA display takes the guesswork out of transistor and FET parameter measurement.
- In-or-out of circuit testing.
- A full range professional tracer at a price you can afford.

The Model 440 is the most modern, versatile tracer available. See it at your Hickok distributor or send for our technical bulletin.

\$179⁰⁰

HICKOK

the value innovator

INSTRUMENTATION & CONTROLS DIVISION
THE HICKOK ELECTRICAL INSTRUMENT CO.
10514 Oupont Avenue • Cleveland, Ohio 44108
(216) 541-8060 • TWX: 810-421-8286

Circle 14 on reader service card

State of SOLID STATE

Low-leakage monolithic FET's, an erasable PROM, and two 16-dB CATV amplifier modules round-out this month's column

by **KARL SAVON**
SEMICONDUCTOR EDITOR

NATIONAL SEMICONDUCTOR HAS INTRODUCED monolithic N-channel junction dual FET's—the 2N5902 series—that have leakage currents 100 times lower than the competition. Prices are 20 to 30 percent lower. Leakage is a vital parameter in medical and control instrumentation. With input voltages up to 30, the leakage is under 0.1 picoampere. The device has a diode-isolated substrate. Common-mode rejection of the differential pair is better than 120 dB typical. The 2N5902 line has eight devices matched to 5 mV and 5 μ V-per- $^{\circ}$ C drift.

National has added five MSI circuits to their 4000 series CMOS line for a total count of 41. They are the CD4018 Presettable Divide-by-N Counter, the CD4029 Presettable UP/DOWN

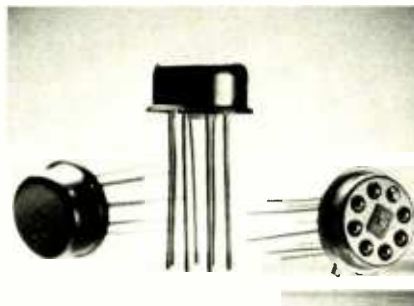

ONE PICOAMPERE LEAKAGE CURRENT makes these transistors especially valuable for medical uses, where leakage currents can be dangerous. The 1 picoamp figure for these National 2N5902 types is 100 times lower than that of available similar devices.

Counter, the CD4031 64-stage Static Shift Register, the CD4043 Quad Tri-State NOR R/S Latch, and the CD4044 Quad Tri-State NAND R/S Latch.

In the memory department the 1024-bit industry standard MM2101 entered volume production. Organization of the memory is in 256 4-bit words. Also the 2048-bit erasable PROM MM1702A is offered as a direct replacement for the Intel 1702A. It has 256 8-bit words, a useful format for

computer peripherals, data terminals, communication systems, and microprocessors. The MM1702A is non-volatile and compatible with bipolar logic. Factory programmed with logical zeros in every memory cell, ones can be entered with a 48-volt pulse. Exposure to 253.7-nanometer short-wave ultra-violet light through the package's transparent quartz lid resets all cells to zero. Prototype development is the 1702A's forte because errors in the program are quickly corrected on the spot. For production quantities, the (not yet available) companion MM1302 ROM gives an economical product.

Single-IC watch

A 32.768 kHz crystal is the time base for a single-IC watch from Texas Instruments. I²L (Integrated Injection Logic) technology is used. Bipolar transistors are operated in their inverted mode by reversing the function of their emitters and collectors. Nearly 1,000 components are packed onto the IC. I²L competes against contemporary CMOS watch circuits which require two separate drive circuits and other discrete components and interconnections.



NEW SINGLE-CHIP WATCH FROM TI.

Available in four case styles, the watches are labeled TI-101, 102, 103 and 104, with suggested retail prices from \$95 to \$175. Two 1.5-volt silver-oxide batteries power the watch for one year.

Five functions, a floating decimal,
(continued on page 24)

The Black Watch kit

At \$29.95, it's

★**practical**—easily built by anyone in an evening's straightforward assembly.

★**complete**—right down to strap and batteries.

★**guaranteed.** A correctly-assembled watch is guaranteed for a year. It works as soon as you put the batteries in. On a built watch we guarantee an accuracy within a second a day—but building it yourself you may be able to adjust the trimmer to achieve an accuracy within a second a week.



The Black Watch by Sinclair is unique. Controlled by a quartz crystal . . . powered by two hearing aid batteries . . . it's also styled in the cool prestige Sinclair fashion: no knobs, no buttons, no flash . . . just touch the front of the case to show hours and minutes and minutes and seconds in bright red LEDs.

The Black Watch kit is unique, too. It's rational—Sinclair have reduced the separate components to just four.

It's simple—anybody who can use a soldering iron can assemble a Black Watch without difficulty. From opening the kit to wearing the watch is a couple of hours' work.

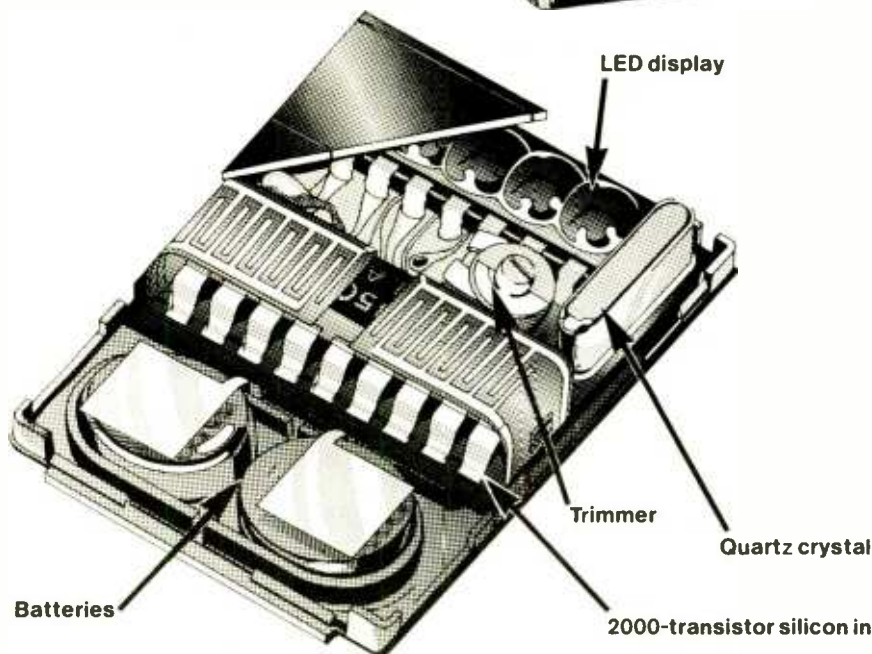

Complete kit \$29.95!

The kit contains

1. printed circuit board
2. unique Sinclair-designed IC
3. encapsulated quartz crystal
4. trimmer
5. capacitor
6. LED display
7. 2-part case with window in position
8. batteries
9. battery-clip
10. black strap (black stainless-steel bracelet optional extra—see order form)
11. full instructions for building and use.

All you provide is a fine soldering iron and a pair of cutters.

Take advantage of this no-risks, money-back offer today!

The Sinclair Black Watch is fully guaranteed. Return your kit within 10 days and we'll refund your money without question.

sinclair

SINCLAIR RADIONICS

375 Park Avenue
New York, N.Y. 10022
Tel. 212-688-6623

Please send me _____ Sinclair Black Watch kit(s) at \$29.95 (Plus \$2.50 per unit, shipping and handling). Stainless steel band \$4.00.

Enclosed is my check for _____

Name _____

Address _____

Mail to: Sinclair Radionics Inc., 375 Park Ave., New York, N.Y. 10022
N.Y. Residents add sales tax.

STATE OF SOLID STATE

(continued from page 22)

an 8-digit LED display, and an automatic constant are features of the model TI-1250 calculator. Add, subtract, recall, and clear are special memory functions included in the \$24.95 instrument. It is powered from a 9-volt battery or an optional adaptor, the AC-9180. For information on the new number cruncher write to Texas Instruments Inc., P.O. Box 22013, M/S 358, Dallas, TX 75222.

Motorola releases

Motorola's HEP semiconductor line

has been expanded with a new HEP-MRO program. The plan is to stock distributors with off-the-shelf replacement types for 80 percent of the industry's requirements. Newly introduced state-of-the-art types will be supported, along with data sheets, application notes and cross-references.

Two 16-dB CATV amplifier modules are new from Motorola. One is designed to drive the other in the 40 to 315 MHz range. The MHW570 pre-amp has a 7.5-dB noise figure at 300 MHz. The MHW572 has -57 dB 30-channel cross-modulation, -70 dB intermodulation, and 80 dB typical triple beat specs. Input and output impe-

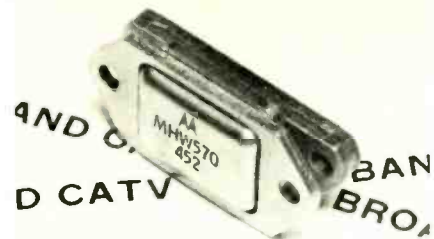

MOTOROLA's MHW570 16-dB CABLE pre-amp has a 7.5-dB noise figure at 300 MHz.

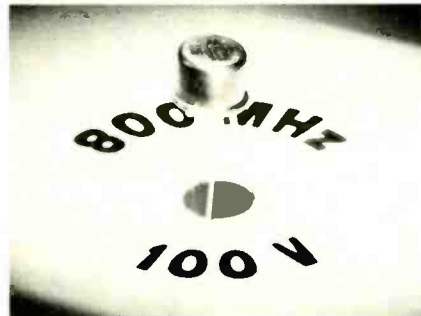

MRF531 SWITCHING TRANSISTOR has a collector-emitter breakdown voltage of 100, three times that of similar earlier types.

dances are 75 ohms and operation is from a 24-volt supply.

A BV_{CEO} rating of 100 volts, three times what has been available, is the collector-emitter breakdown of the MRF531. The high speed non-saturated switches can be designed into instrumentation and CRT drivers with large high-voltage swing requirements. Non-saturated switching times are in the low nanosecond range.

RCA expands COS/MOS series

RCA plans to improve specifications of the CD4000A and B series, including an increase in the maximum operating voltage to 20 volts in the B type. Some of the CMOS competition have tried to gain a competitive edge by offering spec advantages with their types.

An additional noise margin spec of 1 volt has been added for the CD4000A series; this type of rating being more familiar to TTL designers. Leakage current will be guaranteed to 1 micro-amp, and 100 percent testing will guarantee quiescent current at 15 volts. Previously, testing was done only to 10 volts.

In the first half of 1976 all A types will also be available as B's. The two lines will be maintained parallel.

Over 100 types have been price-reduced 15 to 40 percent, due to production efficiencies. The entire 15-volt A series has been cut by an average 30 percent and the 20-volt B series is priced 15 percent lower. RCA says that system designers should now find it less expensive to use RCA's COS/MOS rather than TTL. Included in this comparison is the use of smaller power supplies.

(turn to p. 72)

Free Stapler



When you stock up now on Perma Power Color-Brites... the serviceman's staple.

For a limited time, you can save \$4.65 on a four-pack of Perma Power Model C-511 Color-Brites. And the stapler is our gift!

Perma Power Color-Brites are among the staples of your business. Model C-511 fits most color tubes. Easy to use, it plugs right in, instantly restores faded color, contrast and sharpness to the older color television picture tube, extending useful life a full year or more! And your customer will remember you happily when replacement time comes.

Check your stock of Perma Power Color-Brite, while you can buy this serviceman's staple at savings of \$1.16 per britener. Hurry, supplies are limited, so see your distributor today.

Perma Power Color-Brite

A PRODUCT OF
Chamberlain

Chamberlain Manufacturing Corporation
Perma Power Division
5740 North Tripp Avenue, Chicago, Illinois 60646
Telephone (312) 539-7171

Circle 16 on reader service card

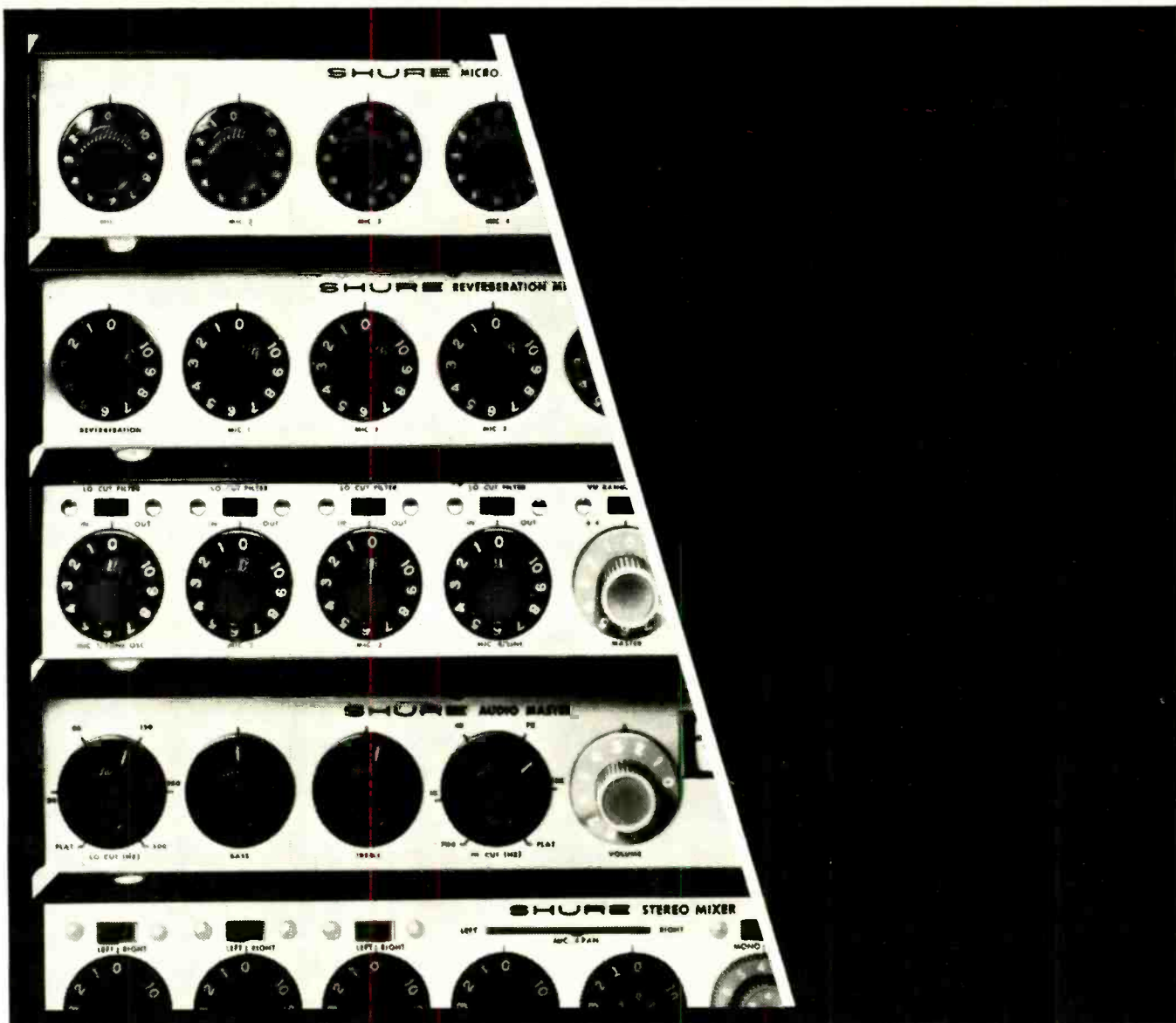

Panel full of miracles.



Shure mixers, audio level controllers, and feedback controllers are all designed to deliver more audio control, more features, and more performance dollar for dollar than any other components with similar audio features. Their compact size and modular "stackable" design mean they can be easily combined in various configurations in even the smallest spaces. And they're versatile—their input-output flexibility equips them for an extremely wide range of audio applications, giving you control you never thought possible without bulky, expensive installations. You can easily put together a system that's exactly right for your precise needs without putting extra dollars into built-in features you really don't need. For the details on our entire line of miracle workers, write:

Shure Brothers Inc.
 222 Hartrey Ave., Evanston, IL 60204
 In Canada: A. C. Simmonds & Sons Limited



Manufacturers of high fidelity components, microphones, sound systems and related circuitry.

Circle 17 on reader service card

Why live with

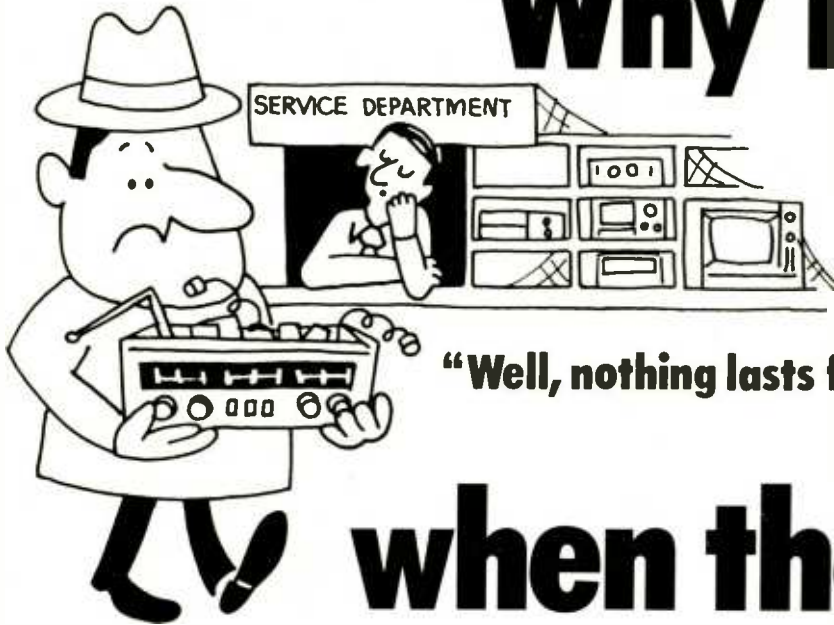

"Well, nothing lasts forever..." *

when the cure is

* How often have you heard that sighed remark? Or maybe even said it yourself...and been willing to accept the fact that you've been a victim of poor design or shabby component quality...or accepted mediocrity because you've been told that "it happens to everybody."

Well, it doesn't happen to

everybody. And it especially doesn't have to happen to you. Because now you can have a hand in deciding how much care goes into the assembly of over 400 electronic kit products.

Order your free Heathkit Catalog today and learn how you can assemble everything from hi-fi components to test equipment to color TV's to automotive accessories to much,

much more. And since you build it yourself, you can service it yourself...even if you've never built a kit before.

You'll learn how the famous Heathkit assembly manuals help you do it yourself...and that's your best hedge against someone else's built-in obsolescence. Don't be satisfied with less than the best.

See these exciting new Heathkit Products



Laboratory breadboard



4-band QRP transceiver

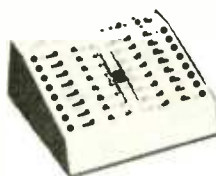

Digital IC Tester



Matching stereo preamp & equalizer



10 MHz dual-trace 'scope

...and over 400 other do-it-yourself kits in this big,

- Test & service equipment ● Color TV ● Stereo & 4-Channel
- Automotive tune-up gear & accessories ● Digital time, weather and date monitors

built-in obsolescence

in this book?...and it's FREE!

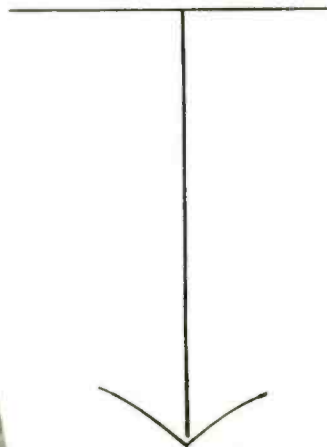

Send this coupon for your free Heathkit Catalog

new Heathkit Catalog.

- Amateur radio & shortwave
- Marine & fishing equipment
- R/C modeling gear
- Home security systems
- Educational programs

Heath Company, Dept. 20-14 Benton Harbor, Michigan 49022		HEATH Schlumberger
Please send my free Heathkit Catalog.		
Name _____		
Address _____		
City _____	State _____	Zip _____
CL-588		

Circle 100 on reader service card

ALLISON 'OPTO-ELECTRIC' The BEST...the ULTIMATE of ALL Ignition Systems!



Never wears out or needs any Maintenance!



★ Gives you Maximum HP
with continuous PEAK PERFORMANCE
that you can actually FEEL!

★ The Allison OPTO-ELECTRIC System eliminates the Points and Condenser, replacing them with an OPTO-ELECTRONIC TRIGGER, using a Light-Emitting Diode and Photo Transistor. The System operates on a beam of Light. As there are NO moving parts in rubbing contact, Friction-wear is completely eliminated. Timing adjustments are PERMANENT.

● Gives 40-Times more Timing accuracy than ANY system using "Mechanical Breaker-Points" UNLIMITED RPM!
● "Electronically-Controlled" DWELL automatically supplies HIGHEST Performance at both Low and High speeds. Spark strength does not fall off at high RPM POSITIVE SPARK helps eliminate "Misfire" for faster acceleration and improved Engine Performance. Sparkplugs LAST 3 to 10-Times LONGER.

● Easier Starting under any condition! Smoother running... (NO TIMING FLUCTUATION as with Magnetic Impulse Units)
All SOLID STATE Components UNAFFECTED By Temperature, Moisture, or Vibration! Only Highest grade materials used Guarantees you Solid, Dependable Performance!

● PERFECT TIMING INCREASES Engine Efficiency and Gas Mileage SAVES Precious Fuel! Allison gives you MAXIMUM Engine Efficiency 100% of the Time and that's the name of the game for the BEST in GAS MILEAGE AND ECONOMY

★ Perfect Timing and Dwell never change.

● Pays for itself! Eliminates ignition Tune-Ups forever!
"INFINITE LIFE" Once installed Never needs replacing!

★ PROVEN RELIABILITY!
Each Unit Tested to 15,000 RPM.
● Road and Race Proven.
(Opto-Electric Systems won at INDY Two years in a row!)

ALLISON Fits ALL the U.S. made & Foreign Cars!

"EASIEST-TO-INSTALL" UNIT ON THE MARKET.
(Not necessary to dismantle Distributor as with other systems)

ORDER with CONFIDENCE.
SATISFACTION GUARANTEED
★
10-YEAR FACTORY WARRANTY!
(Free Repair or Replacement)

Only \$49.95
COMPLETE.

that's EVERYTHING
including
Postage & Insurance

ORDER FACTORY DIRECT...and SAVE!

★ Send Check or M/D. (Calif. Res. add Tax)
State Make, Year, Engine Size. (4, 6, or 8-Cylinder).

● You may use your MASTER CHARGE or BANKAMERICARD.
Send us (1) Your Number, (2) Interbank No. (3) Exp. Date

★ M/C or B/A Card Holders. ORDER by TOLL FREE PHONE:
(800) 423-6525, Ext. 9. (When in Continental U.S.A.)
And YOUR ORDER will be SHIPPED IMMEDIATELY.

★ Before buying any other Type ignition system...
Send Postcard for our FREE BROCHURE.

★ If you have already installed a C-D ignition system,
Modernize and Increase its Efficiency...
CONVERT YOUR "C-D" UNIT TO BREAKERLESS!
Opto-Electric "TRIGGER UNIT"...Only \$34.95

● Our BEST Salesmen are the users of our ALLISON System!

America's Oldest and Largest Mfg. of
Opto-Electronic Ignition Systems.



ALLISON
AUTOMOTIVE COMPANY
1267-L, East EDNA PL., COVINA, CAL. 91722

Circle 18 on reader service card

EQUIPMENT REPORTS

(continued from page 20)

diode should read over ".800." Normally, this will be somewhere between "1.000" and "1.600." This is the forward reading. Reversing the probes and switching to the 2000K range should show infinity (over-range and blinking display) unless the junction is leaky or shorted. Germanium diodes will show some reading in reverse direction; however, if they read over-range on the 20K range, they're probably good.

The DVM-32 is a very compact unit. The handle can be used as a rest to raise the front of the instrument up to the best position for testing. The bright display makes it easy to read. Despite the compact size, the control knobs are easy to use and panel markings are very plain. An LED pilot light is placed under the display, to let you know that power is on with the display the Auto-Display feature operating. The extra-high DC voltage range of 2,000 volts makes it very useful for color TV work, where it is necessary to read boost-boost voltages up to 1200 volts. A very handy little instrument! **R-E**

Hickok Model 440 Curve Tracer



Circle 49 on reader service card

BACK IN THE GOOD OLD DAYS, A CURVE tracer was a very complex laboratory instrument used only for research work. Now it has come down out of the ivory towers and onto the service bench. This instrument will speed up any kind of solid-state device testing. The results are easy to read, and it doesn't take long to learn how.

If a transistor produces a "family" of curves with a curve tracer, the chances are that it is good. The curve tracer will give you instant and valid identification of transistor types. Leakage, breakdown voltage and many other things can be read with no trouble. Opens and shorts can be detected instantly.

Hickok's latest entry into this field is their model 440 Semiconductor Curve Tracer. It's a compact instrument and extremely versatile. All you need is a scope. With a calibrated DC coupled scope, the patterns will look "just like the book". However, you can use a narrow-band scope with it and get usable results.

The setup procedure shows you how to adjust the scope for both vertical and horizontal calibration. You adjust the scope so

that 5 dots appear on the CRT; this means 1 volt/division, both ways. The 440 has switching to adjust the scope sensitivity. You can measure .05, 1.0, 2, 5 and 10 mA/div vertically (collector current) and 1, 5 and 10 volts/div horizontally (base current) With a calibrated scope, you simply set vertical for 0.1 volt/div and horizontal to 1.0 volts/cm and away you go. I tried it on an ancient narrow-band scope and obtained very good recognizable patterns. The patterns did have a tendency to loop at the top, but otherwise fine.

The model 440 will check bipolar transistors, FET's of any type, all kinds of diodes including detectors, rectifiers, tunnel diode and Zeners. Also, diacs, triacs, UJT's, SCR's, and you name it. There are dual sockets for small transistors, plus two sets of jacks for test-leads. The test leads can be used for testing larger transistors such as TO-3, TO-66, and so on. A selector switch lets you cross-check instantly between any two transistors. This is fine for checking "matched pairs, and for making up your own from stock. (You should see some of the curves on "matched pairs" in some of the cheaper brands! Whoo.) One cute, and very useful trick, is checking dual-diodes such as the horizontal AFC diode units for matching. This is one that can really give you a headache!)

If you suspect that any transistor is either intermittent, thermal, etc., just set it up on the curve tracer and heat or cool it. This will tell you. I have a pet transistor that works perfectly at room temperature. Raise or lower its temperature just a very few degrees and out it goes! After many other tests had failed to show this up in the set, I caught it with a curve tracer!

If you want to make really accurate tests, the 440 will do it. Used with a good DC coupled scope, it will quickly and accurately read AC or DC beta, breakdown voltage (without damaging the transistor) saturation voltage, cutoff current (I_{cbo}), leakage current (I_{cbo}), and even the output admittance (h_{oe}) if you want any h-parameters! Temperature effects can be checked on any of these parameters. This makes the instrument very well suited for not only lab work but school use as well. Just for icing on the cake, you can also display a family of curves for a vacuum tube, too! All you need to do is supply heater voltage to it. You can do this with a simple adapter in your tube tester; two wires and a socket.

A special test is provided on the model 440. This is called "Insta-Beta". You set up the tester to display a family of curves. Then, turn the DISPLAY switch from NORMAL to INSTA-BETA and you get a graph display of a single slanting line. This shows the collector current (vertical) vs. the base current (horizontal). Since the scope has been calibrated by the curve-tracer, you can read the beta "instantly" by counting divisions. For the DC beta, which is I_c/I_b , if you see a vertical deflection of 5 MA and a horizontal deflection of .03 MA, the beta works out as 167. To get the AC beta, the formula is $\Delta I_c/\Delta I_b$. Draw a line, real or imaginary, on the graticule and count the horizontal divisions (I_b) needed to cause a certain number of vertical divisions of deflection (I_c) and there you are. You can read either of these with the full fam-

(continued on page 103)

THE SOLDERING IRON VS. THE PROTO-BOARD.[®] (IT'S NO CONTEST.)



The Soldering Iron

If you're still designing and testing breadboard circuits the conventional way, you're doing a lot of extra work, and getting a lot of grief in return. You've got to think as much about manual labor as you do about the circuit. Maybe even more.

Every time you add a component, there are 2 or more connections to make...over a dozen with most IC's, while watching out for overheating components and cold solder joints. And that's only half the problem.

The other half is when you want to change components or connections. Even with good desoldering equipment, you can still have a hassle on your hands. (Ever try to desolder a temperature-sensitive 14-pin DIP on a component-filled board?)

Solder. Desolder. Resolder.
Desolder: Now there's a better way...

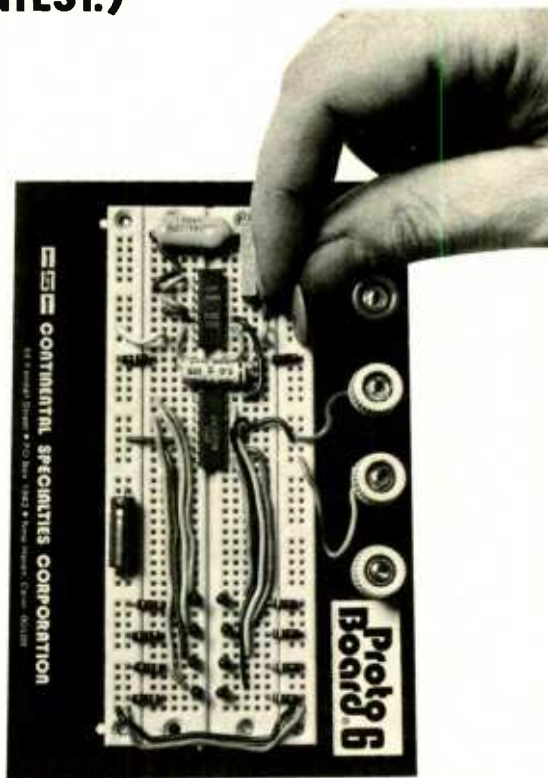

The Proto-Board

With the CSC Proto-Board breadboarding system, connecting components is as simple as pushing a lead into a hole. Rugged 5-point contacts insure low-resistance connections, and where jumpers are needed, components are interconnected with standard #22 AWG solid wire.

That's all there is to it.

You can choose Proto-Boards with anywhere from 630 to 3060 solderless tie-points.

Proto-Boards with or without regulated power supplies. Even assemble your own, with the same solderless QT sockets and Bus Strips,* for smaller (or larger) capacity. However you do it, you'll save time...money...aggravation...on every circuit.

CONTINENTAL SPECIALTIES CORPORATION



For more information, see your CSC dealer or distributor...or contact us for our catalog and distributor list.

Continental Specialties Corp., 44 Kendall Street, Box 1942, New Haven, CT 06509 • 203-624-3103 TWX: 710-465-1227
West Coast Office: Box 7809, San Francisco, CA 94119 • 415-421-8872 TWX: 910-372-7992
Canada: Len Finkler Ltd., 25 Toro Rd., Downsview, Ontario • 416-630-9103

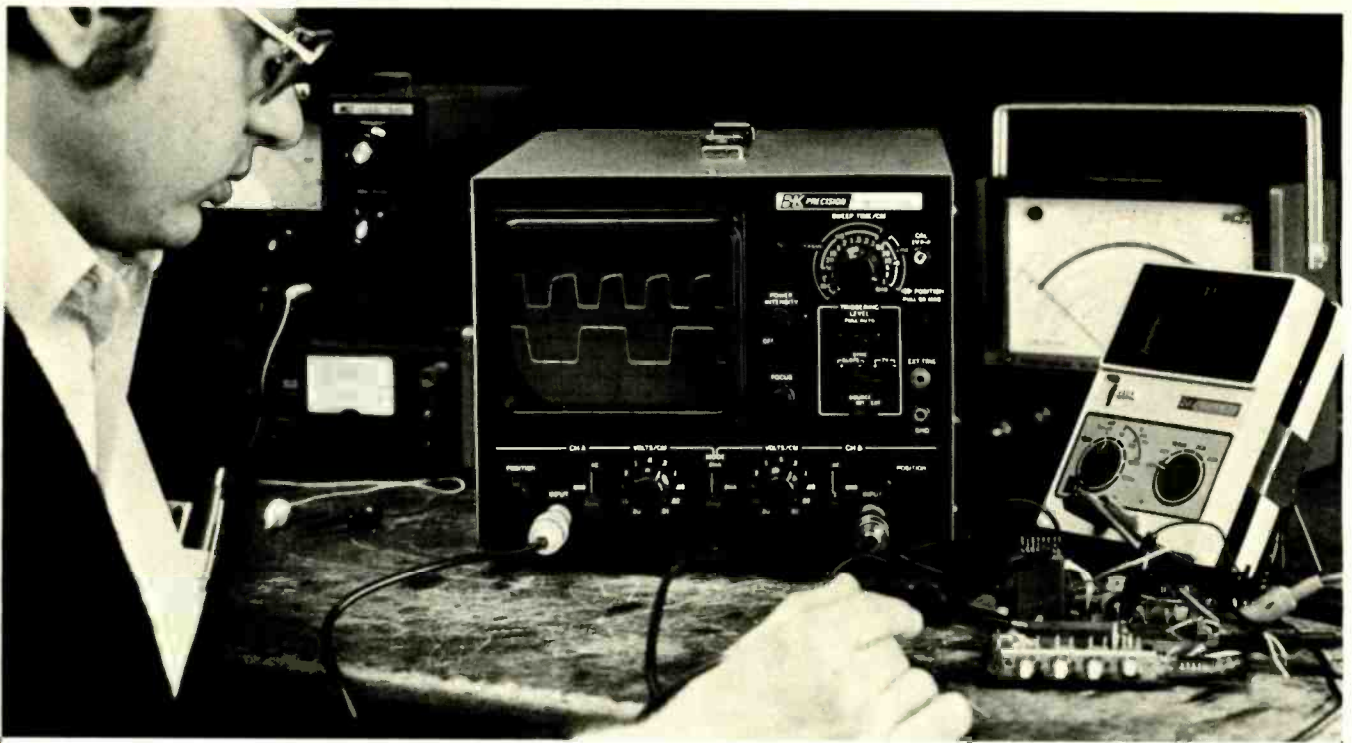

Remember when a good dual trace scope cost less than \$500? It does again.

Model 1471 Dual Trace Oscilloscope \$495

As the B&K-Precision Model 1471 rolls back the economic calendar, it significantly advances performance capabilities of 10MHz oscilloscopes. Model 1471 shares many of the performance and convenience features of our higher priced scopes, benefiting from Dynascan's position as a leading supplier of medium bandpass scopes.

Deflection factor is 0.01V/cm to 20V/cm in 11 ranges. Model 1471 has 18 calibrated sweeps—1 μ SEC/cm to .5SEC/cm and sweep to 200n-SEC/cm with 5x magnification. Regulation maintains calibration accuracy from 105 to 130VAC. Rise time is 35nSEC. Automatic triggering is obtained on waveforms with as little as 1cm deflection. Dual trace display mode automatically shifts between CHOP and ALTERNATE as sweep time is changed, speeding set-up.

Front panel X-Y operation uses matched vertical amplifiers, preserving full calibration accuracy for both amplitude and phase. The intensity modulation input (Z axis) is compatible with TTL, permitting use in character display systems, and for time or frequency markers. Bright blue P31 phosphor makes any waveform easy to see. Circuit board with plug connectors permit easy user maintenance. BNC connectors. Operates on 117/230-VAC 50/60Hz.

- 10 MHz Bandwidth—useable to 15 MHz
- Mode automatically shifts between CHOP and ALTERNATE as you change sweep time
- Bright blue P31 phosphor
- 18 calibrated sweeps—1 μ SEC/cm to .5SEC/cm
- Sweep to 200nSEC/cm with 5X magnification
- Maintains calibration accuracy over 105-130VAC range
- Front panel X-Y operation using matched vertical amps
- Input grounding switches
- TV sync separators
- Check most digital logic circuitry including CMOS
- Character display applications using TTL Z-axis intensity modulation
- BNC connectors

In-Stock Free Trial

Model 1471, or any B&K-Precision oscilloscope, can be obtained from your local distributor—or call Dynascan. You'll find the scope you need in stock today. Write for detailed specifications.

B&K PRECISION

PRODUCTS OF DYNASCAN

1801 W. Belle Plaine • Chicago, Illinois 60613

Build this biofeedback thermometer and learn how to control your body temperature and gain from the benefit of the relaxation and pain reduction that comes with it.

by MITCHELL WAITE
and LARRY BROWN

STAYING WARM IS SOMETHING THAT CONCERNS everyone. The most natural way to keep warm is to wear lots of clothes and build fires. But what if, rather than fighting the cold, you learn to adapt to it? Animals adapt by regulating their body temperatures until the minimum possible amount of body heat is radiated. People are now learning to regulate their body temperatures in yet another application of biofeedback—a painless technique that demands neither sacrifice nor discomfort.

Using sensitive electronic temperature sensors, scientists and biofeedback researchers are showing that people can learn to “turn off” many types of ailments by following a simple learning routine.

One group of reports explains that the old saying of “cold hands means cold heart” may in fact have much truth to it. Individuals have actually been taught to increase the temperature in their hands by ten degrees! This temperature change resulted in improved circulation and helped reduce the pain of migraine headaches. (**Warning:** *This feedback thermometer is intended for experimentation and entertainment only. It is not to be used as a substitute for professional clinical therapy. Persons with any tension-related illness should consult a physician. The device is not to be considered a home remedy for any illness.—Ed.*)

How do you take advantage of this? The electronic temperature sensor described in this article monitors body temperature. Through mental concentration, you attempt to vary your body temperature. Eventually you obtain some minor control. With additional practice, the control will increase somewhat. Once control is mastered, only occasional retraining is necessary. This technique of learning to control body temperature is called temperature biofeedback.

Another intriguing application of temperature biofeedback is teaching people how to relax. The stabilization of body temperature seems to have a calming effect on the entire nervous system. The highest success rate has been in the treatment of psychosomatic illnesses. The requirements on biofeedback devices are critical to this technique. Because the actual temperature changes are quite small, the temperature monitor must have a high degree of amplification along with stable response.



Build A BIOFEEDBACK Thermometer

The Biofeedback Thermometer described in this article covers from 60° to 110° Fahrenheit while maintaining an accuracy of $\pm 2\%$. The circuit is especially designed for biofeedback training and can detect temperature variations of as little as .05 degree Fahrenheit. A large 4½-inch front-panel meter is calibrated in °F. The meter displays the absolute body tempera-

ture with a resolution of 1 degree-per-division.

The Biofeedback Thermometer can also be used in an expanded-scale mode. In this mode, the meter has a resolution of 1/20 degree-per-division but only covers a 2.5° F range ($\pm 1.25^\circ\text{F}$). A front panel NULL control is used to center the meter when the thermometer is in this mode.

SPECIFICATIONS

Temperature Span:

Metered, $\pm 2\%$
Rear panel jack, $\pm 2\%$
Rear panel, 10%

60–100° F (15–45° C)
15–45° C (60–115° F)
0–90° C (32–194° F)

Resolution:

Normal range (60–110° F)
Expanded (2.5° F)

1° F/division
1/20° F/division

Rear-Panel Voltage Sensitivity:

100 mV/°C

Battery Life:

Two Neda 910 or Eveready 276 @ 2 hours/day 715 hours

VCO Range:

Linear from 12 clicks/minute (one every five seconds) to a 100-Hz tone. Increasing temperature causes decreasing frequency.

Response Time:

Less than one second for a 1-degree change in temperature.

Both modes are used with the front-panel meter for "eyes-open" monitoring. For eyes-closed monitoring, the output of a voltage-controlled oscillator (VCO) is modulated by the temperature variations. The VCO audio signal drops from a steady tone to a slow click as body temperature increases. The VCO output is used with headphones.

A jack on the rear panel allows the thermometer to measure temperature in degrees centigrade and over a wider range than is possible with the front-panel meter. This jack provides a linear 100 mV-per-degree-centigrade voltage over a range of 0°C to 90°C with an accuracy of ±10%. Within a narrower range (15°C to 44°C), the accuracy is within ±2%. Any 0 to 10-volt full-scale voltmeter connected to the jack on the rear panel will provide a direct

PARTS LIST

All resistors are ¼-watt, 5%, unless noted.

- R1, R4, R34—1000 ohms
- R2—3300 ohms
- R3—2000 ohm, ½-watt, horizontal-mount trimmer
- R5, R6—62,000 ohms
- R7—470,000 ohms
- R8—158,000 ohms, 1%
- R9—100,000-ohm Uni-Curve® thermistor
- R10, R12, R16—47,000 ohms
- R11—1 megohm
- R13—360 ohms
- R14, R30—5000 ohm, linear taper, potentiometer
- R15—1600 ohms
- R17—129,000 ohms
- R18, R25—100,000 ohm, ½-watt, horizontal-mount trimmer
- R19, R28—20,000 ohms
- R20, R26—27,000 ohms
- R21—200,000 ohms
- R22—51 ohms
- R23—5600 ohms
- R24, R29, R32—4700 ohms
- R27—10,000 ohms
- R31—2700 ohms
- R33—470 ohms
- C1, C2—0.1-μF, 100V, 10%, Mylar
- C3—0.47-μF, 100V, 10%, Mylar
- C4—10-μF, 25V, electrolytic
- IC1—Quad 741 op-amp (Raytheon RC4136DB)
- Q1—2N3565 transistor
- D1—5.6 volt, 200 mW, Zener diode (1N752 or equal)
- M1—100-μA, 4½-inch meter*
- S1—S4—SPDT slide switch, PC mount
- S5—DPDT slide switch, PC mount
- J1, J2—¼-inch phone jack
- Misc.—8-ohm headphones, battery snaps, shielded 2-conductor cable, hardware, etc.

The following parts are available from Cal Kit, PO Box 877, Sebastopol, CA 95472:

- #FT-1. Drilled and solder-plated PC board, \$8.50.
- #FT-2. 100,000-ohm Uni-Curve® thermistor, \$14.50.
- #FT-3. Complete kit including drilled and screened cabinet, PC board, thermistor probe, meter, and all components except headphones, \$99.00.
- #FT-4. RC4136 quad op-amp, \$4.00.

*Following parts are available from Mouser Corp., 11511 Woodside Ave., Lakeside, CA 92040:

- 100-μA, 4½-inch meter—order stock no. 39LK417—\$10.90.
- Meter illumination kit—order stock no. 39LK900—\$1.50.

FEEDBACK THERMOMETER BLOCK DIAGRAM

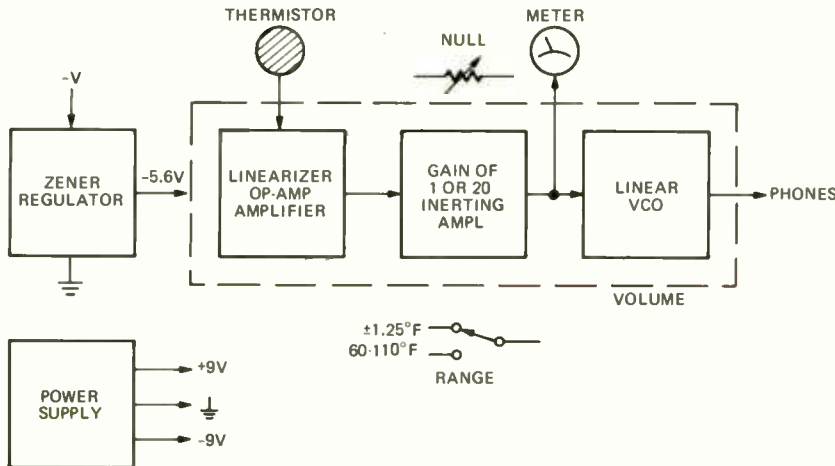

FIG. 1—BIOFEEDBACK THERMOMETER consists of a linearizer, inverting amplifier and a linear VCO.

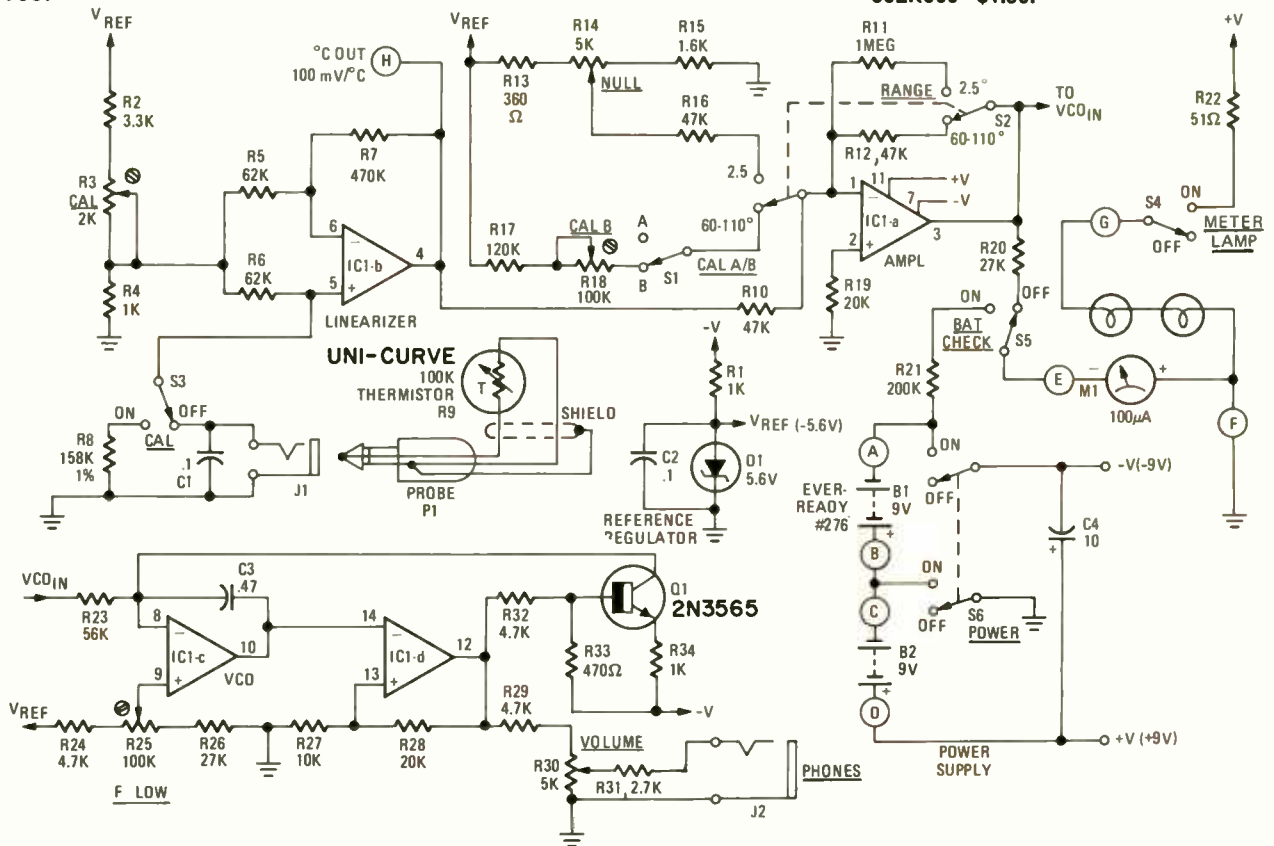

FIG. 2—CIRCUIT is built around a single IC.

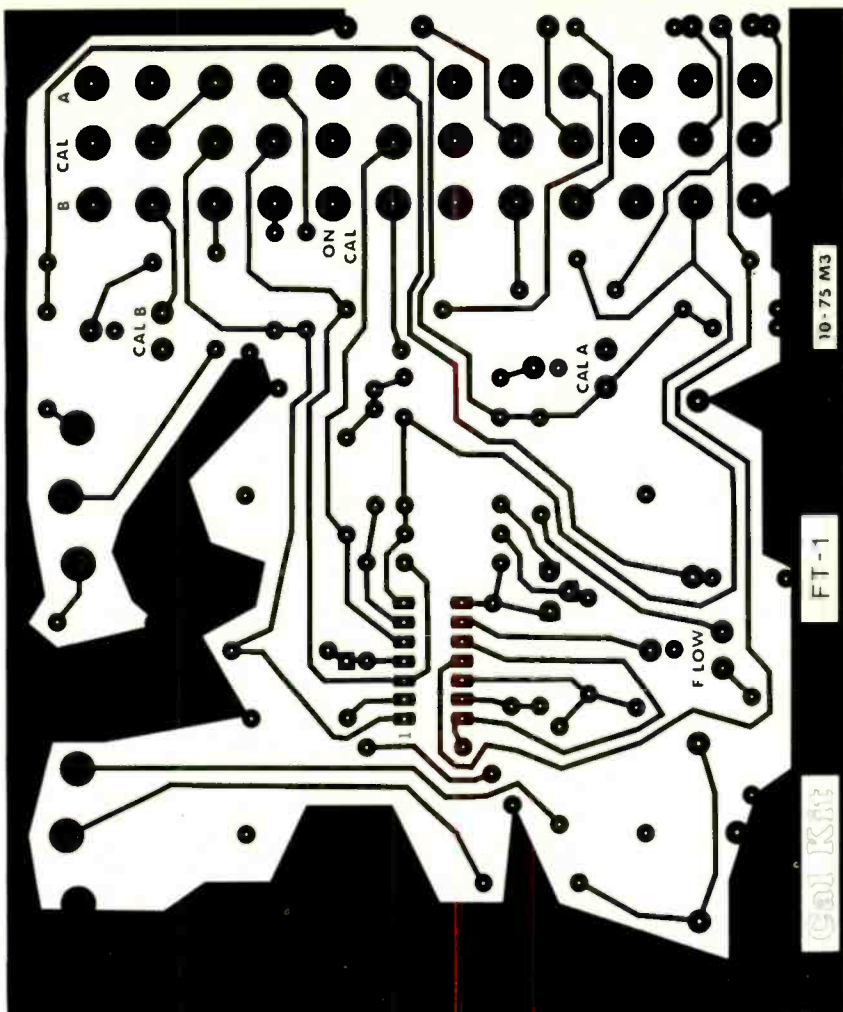

FIG. 3—FOIL PATTERN shown full-size.

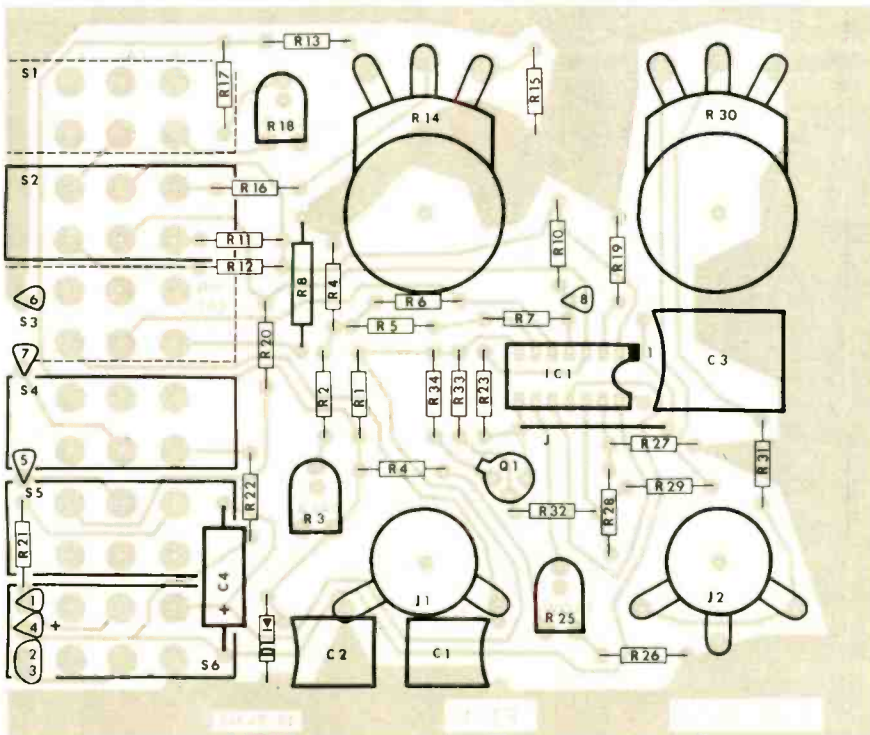

FIG. 4—COMPONENT PLACEMENT diagram.

readout of temperature in degrees centigrade. For example, a reading of 2.5 volts is equal to 25°C, 5 volts equal 50°C, and so on.

About the circuit

The Biofeedback Thermometer circuitry consists of a linearizer/amplifier, a second switchable amplifier with a gain of 1 or 20, and a linear audio voltage-controlled oscillator (see Fig. 1). All these circuits are contained in a single-quad op-amp integrated circuit (IC1). A low-cost thermistor plugs into the linearizer circuit and produces a voltage proportional to the temperature of the thermistor probe. The second amplifier drives the meter and VCO and amplifies the signal for the expanded-scale mode.

The linearizer circuit is used to convert the exponential resistance changes from the thermistor to linear voltage changes for the VCO and meter. Without the linearizer circuit, a non-linear voltage would be sensed, and the meter and VCO would have a highly asymmetrical response. The linearizer circuit can be made from a single op-amp and is quite a useful general-purpose circuit.

From the linearizer circuit the signal passes to an inverting amplifier with two possible gain settings, 1 or 20. In both cases, the amplifier inverts the thermistor signal. This results in an inverted frequency-temperature relationship in the VCO—as the temperature at the probe increases, the frequency of the VCO decreases. The gain-of-one stage also has a trimmer that cancels any offset errors in the op-amp and zeros the meter.

In the gain-of-20 setting, the additional amplification enables the thermometer to resolve down to 1/20 degree. When in this setting, the meter covers a range of 2.5°F (±1.25°F) and a front-panel NULL control is used to adjust the offset to the op-amp. This allows nulling the meter as the absolute temperature changes.

The output of the switchable gain amplifier drives a 100-μA meter and a VCO. The VCO is the classical two op-amp one-transistor type and produces both sawtooth and pulse outputs. Two 9-volt batteries form a hefty supply for the circuit.

How it works

The thermistor (R9) used in this circuit is a special interchangeable low-cost miniature type. This tiny device has a well-controlled accuracy of ±0.2 degree centigrade over a 0- to 70-degree range. Its small size allows it to respond to temperature changes rapidly. Different replacement thermistors of the same type can be placed in the circuit and no calibration is required.

The resistance of the thermistor increases as the temperature decreases. This changing resistance is coupled to the non-inverting input of IC1-b (see Fig. 2). Switch S3 connects a 1% resistor in place of the thermistor for calibration. The linearizer circuit (IC1-b) is also fed a constant voltage reference of -5.6 volts. The linearizer works on the principle that if the sensor response is truly exponential (follows the equation Ae^{-bT}), then there is a certain range (of bT) for which the circuit produces a linear voltage response. The re-

(continued on page 96)

When you're exploring technology... books



a fascinating new alone are not enough.

If you're like most men, deep down inside there's still a bit of the boy who loved to go exploring... and who'd love to go again. Well, now you can.

Only this time you'll explore the expanding world of electronics... a world more fascinating than any you ever dreamed of as a boy.

Learn by exploring... Bell & Howell Schools offers an exciting way for you to gain new occupational skills in electronics.

Everybody enjoys learning something new, but why learn it the old way? Classes to go to. Lectures to sit through. And only a bunch of books to keep you interested.

Bell & Howell Schools' adventure in learning is a far cry from all that.

You can probe into electronics and learn exciting new occupational skills right in your own home, in your spare time. On whatever days and whatever hours you choose. So there's no need to give up your present job and paycheck just because you want to learn something new.

What's more, when you're exploring a field as fascinating as electronics, reading about it is just not enough. That's why throughout this program you'll get lots of "hands on" experience with some of today's latest electronic training tools.

You'll be stimulated for hours on end as you build, experiment and learn while using the latest ideas and techniques in this fascinating field.

As part of the program you'll actually learn to build and work with your own electronics laboratory. Using it to put many of today's most dynamic electronic discoveries to the test... including electronic miniaturization.

Among the things you'll discover is how the development of tiny integrated circuits has made possible an electronic calculator small enough to fit into a shirt pocket! And a wristwatch that flashes the time with the push of a button.

You'll investigate the concept of "logic circuits." An idea that has been with us for centuries but only in recent years put to use as the "brain" behind all the new digital consumer appliances we see today.

But more important than anything else is the new occupational skills you'll develop in electronics troubleshooting. While no assurance of income opportunities can be offered, you'll develop skills that could lead you in exciting new directions. Use your training:

1. To seek out a job in the electronics industry.
2. To upgrade your current job.
3. As a foundation for advanced programs in electronics.

You build and perform many exciting experiments with Bell & Howell's Electro-Lab[®], an exclusive electronics training system.

Using our successful step-by-step method,

you'll build:

1. A design console, for setting up and examining circuits.
2. A digital multimeter for measuring voltage, resistance and current (it displays its findings in big, clear numbers like a digital clock).
3. A solid-state "triggered sweep" oscilloscope—similar in principle to the kind used in hospital operating rooms to monitor heartbeats. You'll use it to monitor the "heartbeats" of tiny integrated circuits. The "triggered sweep" feature locks in signals for easier observation.

Step-by-step you'll build and experiment with Bell & Howell's new generation color TV—investigating digital features you've probably never seen before!

This 25" diagonal color TV has digital features that are likely to appear on all TV's of the future. As you build it you'll probe into the technology behind all-electronic tuning. And into the digital circuitry of channel numbers that appear right on the screen! You'll also build in a remarkable on-the-screen digital clock, that flashes the time in hours, minutes and seconds. Your new skills will enable you to program a special automatic channel selector to skip over "dead" channels and go directly to the channels of your choice.

You'll also gain a better understanding of the exceptional color clarity of the Black Matrix picture tube, as well as a working knowledge of "state of the art" integrated circuitry and the 100% solid-state chassis.

After building and experimenting with this TV, you'll be equipped with the skills that could put you ahead of the field in electronics know-how.

We try to give more personal attention than other learn-at-home programs.

1. Toll-free phone-in assistance. Should you ever run into a rough spot during the program, we'll be there to help. While many schools make you mail in your questions, we have a toll-free line for questions that can't wait.
2. In-person "help sessions." These are held in 50 major cities at various times throughout the year where you can talk shop with your instructors and fellow students.

No electronics background needed.

What you really need is the thing you've never lost. A boy's love for exploring. Now you can go again, only this time learning new occupational skills all along the way.

Mail the postage-paid card today for more details!

Taken for vocational purposes, this program is approved by the state approval agency for Veterans' Benefits.

If card has been removed, write:

An Electronics Home Study School
DEVRY INSTITUTE OF TECHNOLOGY
ONE OF THE

BELL & HOWELL SCHOOLS
4141 Belmont Chicago Illinois 60641

Simulated TV test pattern.

"Electro-Lab[®]" is a registered trademark of the Bell & Howell Company



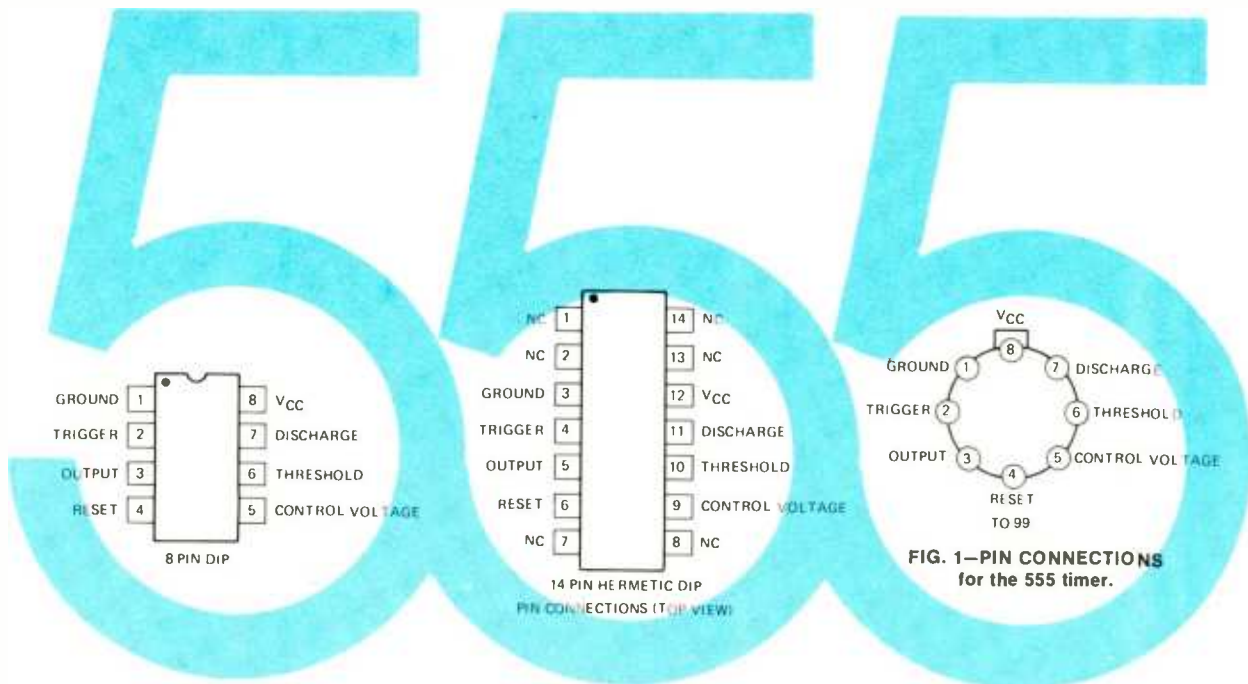

FIG. 1—PIN CONNECTIONS for the 555 timer.

TIMER IC APPLICATIONS

This series of articles will describe the operation of the 555 and present various applications including automotive, photographic and test equipment, among others.

FOR SEVERAL YEARS, IT APPEARED THAT THE 709 op-amp would remain unsurpassed as the most useful and versatile integrated circuit; especially for electronics hobbyists. Now, it looks like that honor may have passed to the 555 family of timers.

Basically, the 555 timer is a highly stable integrated circuit capable of functioning as an accurate time-delay generator and as a free-running multivibrator. When used as an oscillator, the frequency and duty cycle are accurately controlled by two external resistors and a capacitor. This device originated with Signetics and is now available from such manufacturers as Exar, Motorola, National, RCA, Raytheon, Teledyne and Texas Instruments. The typical data sheet for this device lists the following features:

- Timing from microseconds to hours
- Monostable and astable operation
- Adjustable duty cycle
- Output compatible with CMOS, DTL and TTL (when used with a 5-volt supply)
- High-current output can sink or source 200 mA
- Trigger and reset inputs are logic compatible
- Output can be operated normally off

Applications listed include:

- Precision timing
- Time-delay generation
- Sequential timing
- Pulse generation
- Pulse shaping

by **ROBERT F. SCOTT**
TECHNICAL EDITOR

- Pulse-position modulation
- Pulse-width modulation
- Clock generation
- Missing-pulse detection
- Appliance timing
- Frequency division
- Voltage-to-frequency conversion
- Linear sweep generation

We will examine the make-up and operation of the 555 family and then we will see how the various features and applications can be developed into practical circuits you can use in the home, car, lab and service bench.

The 555 is available in 8- and 14-pin DIP packages and in a circular TO-99 metal can with eight leads. The base connections are shown in Fig. 1. The device is available from most makers in at least two grades. The precision type generally maintains its essential characteristics over a range of -55°C to $+125^{\circ}\text{C}$ while the general-purpose type operates reliably only over a range of 0°C to 70°C . Type numbers for the precision (the precision types are listed first): SE555/NE555 (Intersil and Signetics), RM555/RC555 (Raytheon), MC1555/MC14555 (Motorola), LM555/LM555C (National), SN52555/SN72555 (Texas Instruments) and CA555/CA555C (RCA).

(Many of the manufacturers listed also offer the 556 which is basically two 555's

in a single package. Most dual timers have "556" in the type number. An exception is the D555—for dual 555—made by Teledyne. There are several quad timers available. Both dual and quad types may have specific limitations that do not apply to the 555. More about this later.

How the 555 operates

A functional block diagram of the 555 as a monostable timer is shown in Fig. 2 and the equivalent schematic of the IC is shown in Fig. 3. Timing is determined by external components R_T and C_T . The IC timer consists of a flip-flop, a high-current output stage, discharge and reset transistors and two comparators. (A comparator is an op-amp that compares an input voltage to a reference voltage and indicates whether the input is higher or lower than the reference potential. When the input swings slightly above the reference value, the op-amp's output swings into saturation. At the instant that the input drops below the reference level, the op-amp's output swings into reverse saturation. The output changes state when the input rises above or drops below the reference voltage level by only a few hundred microvolts.)

The reference voltages for the two comparators inside the 555 are developed across a voltage divider consisting of three 5K resistors. The threshold comparator is referenced at $\frac{2}{3} V_{CC}$ and the trigger comparator is referenced at $\frac{1}{3} V_{CC}$. The two comparators control the flip-flop, which, in turn, controls the state of the output. When the timer is in the

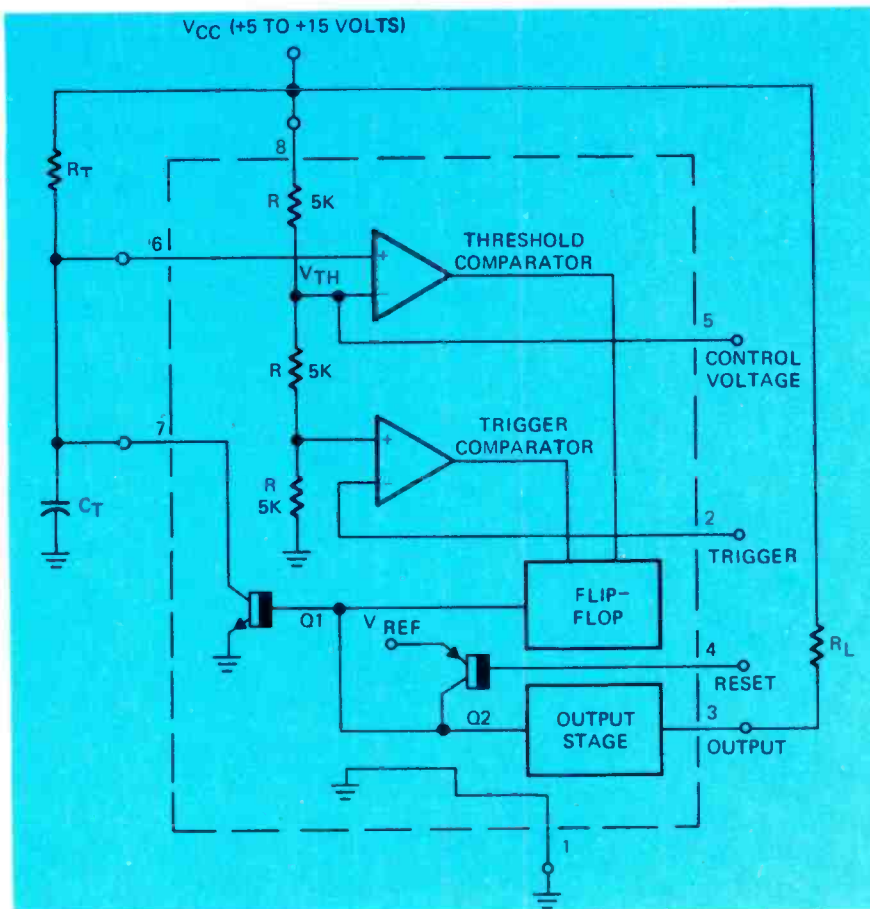

FIG. 2—FUNCTIONAL block diagram.

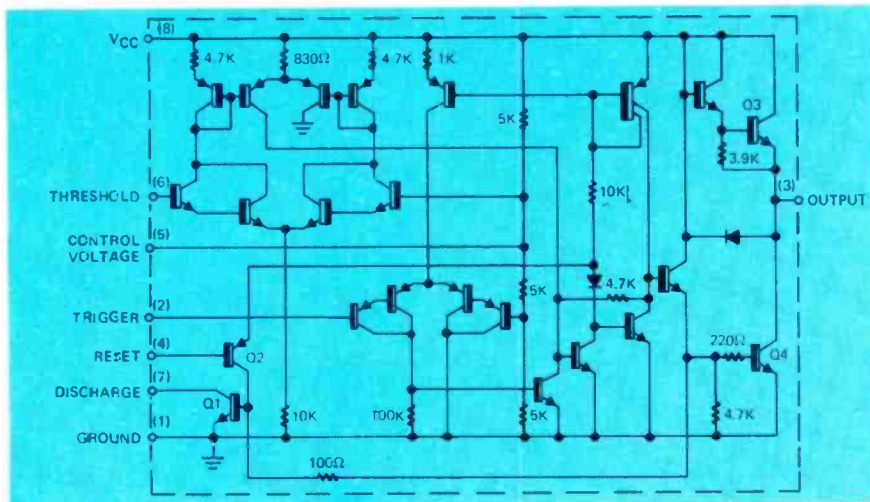

FIG. 3—555 TIMER schematic diagram.

quiescent state, internal transistor Q1 is conducting so it represents a short circuit across timing capacitor C_T . The level of the output terminal is low.

In most practical circuits, the voltage on pin 2 is held above the trigger point by a resistor connected to V_{cc} . When a negative-going trigger pulse on pin 2 causes the potential at this point to fall below $\frac{1}{3} V_{cc}$, the trigger comparator switches the flip-flop, cutting off Q1 and forcing the output level high to a value slightly below V_{cc} .

Capacitor C_T now starts to charge and the voltage across it rises exponentially until it reaches $\frac{2}{3} V_{cc}$. At this point the threshold comparator resets the flip-flop and the output returns to its low state—

just slightly above ground. Transistor Q1 is turned on, discharging C_T so that it is ready for the next timing period. Once triggered, the circuit cannot respond to additional triggering until the timed interval has elapsed.

Figure 4 shows the waveforms associated with the 555 when operated as a monostable timer. The delay period—the time that the output is high—in seconds is $1.1R_T C_T$, where R is in ohms and C is in farads. Figure 5 shows how delays running from 10 microseconds to 10 seconds can be obtained by selecting appropriate values of C_T and R_T in the range of .001 to 100 F and 1K to 10 megohms. In practice, R_T should not exceed 20 megohms. When you use an electrolytic ca-

pacitor for C_T , select a unit for low leakage. The time delay may have to be adjusted by varying the value of R_T to compensate for the very wide tolerance of electrolytics.

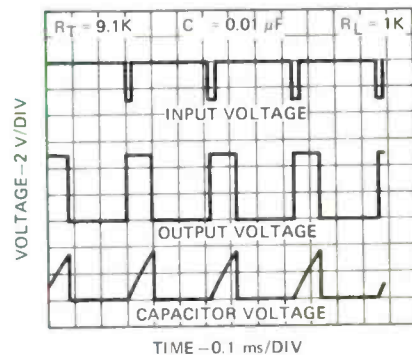

FIG. 4—555 TIMER WAVEFORMS when it is operated as a monostable.

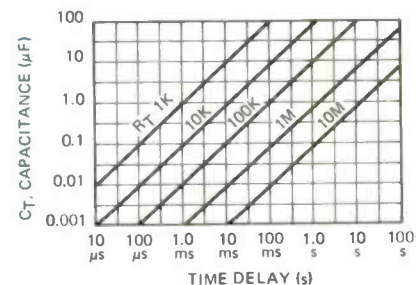

FIG. 5—DELAY TIMES for different values of capacitors and resistors.

Note that the 555, unlike most RC timers, provides a timed interval that is virtually independent of supply voltage V_{cc} . This is because the charge rate of C_T and the reference voltage to the threshold comparator are both directly proportional to the supply voltage. Operating voltage can range from 4.5 volts to a maximum of 18 volts for premium timers and 16 volts for general-purpose types.

Feeding the load

We have seen how the timed interval or delay is obtained. Now let's see how we can use it. A look at the output circuit (Q3 and Q4 in Fig. 3) shows it to be a quasi-complementary transformerless arrangement similar to many audio output stages. Furthermore, we know that in this type of circuit, one side of the load goes to the emitter-collector junction of the output transistors and the other side of the load can be connected to either V_{cc} or to ground. The same applies to the load connected to the 555. Output pulses developed across load R_L can be obtained directly from pin 3.

When the load is connected to V_{cc} , a considerable amount of current flows through the load into terminal 3 when the output is low. Similarly, when the output is high, the current through the load is quite small. Conditions are reversed when the load is returned to ground. In this case, output current through the load is maximum when the output potential is high and minimum when the output is low. The maximum current at terminal 3 is 200 mA when it is used as a current source or a current sink.

Driving a relay

A relay can be substituted for R_L in applications where the delay or timed interval is longer than 0.1 second. The relay should be a DC type with a coil operating at about V_{cc} , and not drawing more than 200 mA. Figure 6 shows a

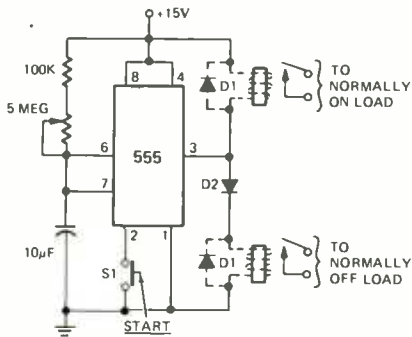

FIG. 6—RELAY TIMER showing two optional connections.

simple manual timer with the two optional connections for the relay. With the R/C values shown, the timing range is approximately 1 second to 1 minute.

You must be careful when connecting an inductive load such as a relay to the output of the 555 or any other solid-state device. When the current through an inductive load is interrupted, the collapsing magnetic field generates a high reverse emf (transient voltage) that can damage the device. The solution to this problem is to connect a diode (D1) across the relay coil so it conducts and absorbs the transient. Note that the diode must be connected so it is reverse biased in normal operation.

Diode D2 must be inserted in series with the relay coil when it is connected between the output terminal and ground. Otherwise, a negative voltage equal to one diode-junction drop will appear at pin 3 and cause the timer to latch up.

Triggering

We stated earlier that in most practical circuits, the trigger terminal is generally returned to V_{cc} through a resistor of about 22K. However, the simplest method of triggering a 555 is to momentarily ground the terminal. This is OK as long as the ground is removed before the end of the timed interval. Thus, if the device is used in a photo-timer application, as in Fig. 6, tapping pushbutton

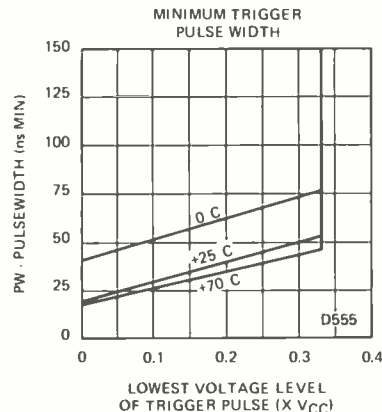

FIG. 7—TRIGGER PULSE WIDTH requirement varies with temperature and V_{cc} .

S1 is sufficient to trigger the circuit and start the timer.

In many applications, the 555 must be triggered by a pulse. The amplitude and minimum pulse width required for triggering are dependent on temperature and supply voltage. Generally, the current required for triggering is about 0.5 μ A for a period of 0.1 μ s. Triggering-voltage ranges from 1.67 volts when V_{cc} is 5 volts to 5 volts when V_{cc} is 15 volts. Figure 7 shows how trigger pulse width is related to temperature and V_{cc} .

The triggering circuit is quite sensitive and can be activated by simply touching the terminal with a finger or bringing your hand close to a length of wire fast-

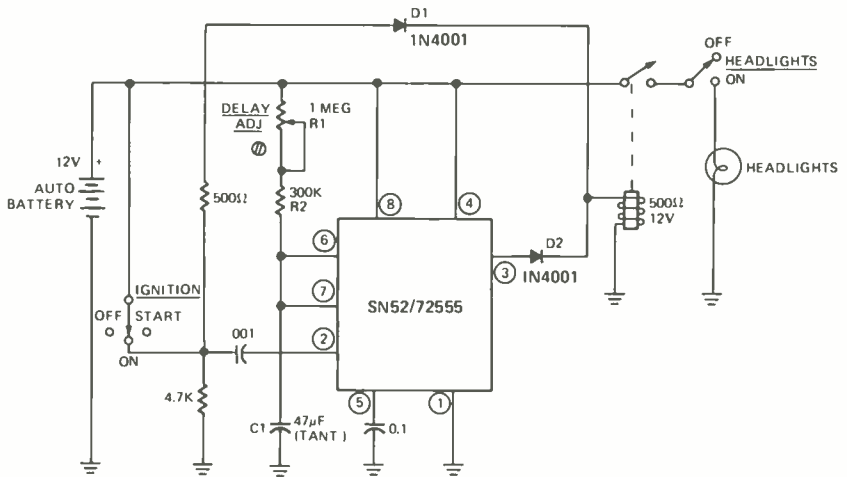

FIG. 8—AUTOMATIC HEADLIGHT turn-off circuit.

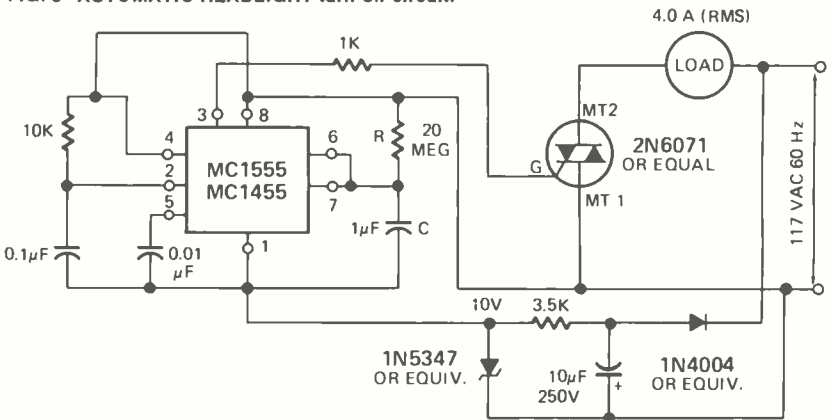

FIG. 9—555 TIMER used in a solid-state time-delay relay circuit.

ened to pin 2. Thus, we have the makings of a crude capacitance relay.

Resetting

Once a timed cycle has been initiated by a negative-going pulse on pin 2, the circuit is immune to further triggering until the cycle has been completed. However, the timed cycle can be interrupted by grounding the reset terminal (pin 4) or applying a negative-going reset pulse to it. The reset pulse causes timing capacitor C1 to be discharged and the output to return to its quiescent low state. Reset voltage is typically 0.7 volt and reset current is 0.1 mA. When the reset terminal is not being used, it should be connected to V_{cc} .

The control terminal

The $\frac{2}{3} V_{cc}$ point on the internal vol-

tage divider is brought out to pin 5—the control terminal. The timing cycle can be modified by applying a DC control voltage to pin 5. This permits manual or electronic remote control of the timed interval.

The control terminal is seldom used when the timer is operated in the monostable mode and should be grounded through a 0.01- μ F capacitor to prevent the timed interval from being affected by pickup of a stray AC or RF signal.

When the timer is operated as an oscillator in the astable mode, the generated signal can be frequency modulated or pulse-width modulated by applying a variable DC control voltage to pin 5. We'll

have more on this in the next part of this series.

Gadgets you can build

There is still quite a bit of practical technical information you will need to design your own circuits and to take full advantages of the potential of the 555-family. We hope to complete the technicalities in the next issue and get down to practical circuits you can use. In the meantime, here are a couple of circuits for you to try:

Automatic headlight turn-off—anyone who has stumbled around in a dark garage after leaving his car for the night will appreciate this automatic headlight shut-off switch (Fig. 8.) that was described in a Texas Instruments application note. It is to be installed in the car
(continued on page 102)

New FM Tuner Standards

New standards have been adopted by the Institute of High Fidelity for specifying tuner performance. Here are some of the more important changes.

by **LEN FELDMAN**
CONTRIBUTING HI-FI EDITOR

MORE THAN A YEAR AGO, WE DISCUSSED the desirability of expressing tuner sensitivity figures and input signal strengths in terms of power, rather than voltage (See "Femtowatt—Here It Comes," Len Feldman, *Radio-Electronics*, April 1974). We pointed out then that in addition to this basic change in specifying signal strength, many new measurements would be required to properly define tuner performance in the 1970's. After all, the previously used Institute of High Fidelity Standards were issued way back in 1958, fully three years before stereo FM broadcasting began in this country. Thus in theory at least, a manufacturer did not have to tell you anything about how his tuner or receiver performed in the stereo mode, even though most present day listening to FM (at least by high-fidelity enthusiasts) is done in stereo and not in mono. It will come as no surprise to readers to learn that most performance numbers come out poorer when measured in stereo compared with mono, and so most manufacturers refrained from supplying stereo specifications except in such cases where the specifications came out looking reasonably good.

Well, all that is over now. Not only has the IHF adopted new tuner measurement standards, but two other important industry organizations (the Institute of Electrical and Electronic Engineers and the Electronic Industries Association) have expended a great deal of effort in creating the new, industry-wide standards for FM tuner measurement. The new standard, in fact, bears two identifying numbers. It is IEEE Standard 185-1975 as far

as that organization is concerned and will be identified as IHF-T-200, 1975 for Institute of High Fidelity reference purposes. The new standards were issued officially on May 19, 1975 and member manufacturers have been urged to begin using them as soon as possible, allowing a maximum transition period of one year from date of adoption. This article will cover some of the more important changes and new measurements that must be listed in order for a manufacturer to conform to and reference IHF standards. Those interested in having a copy of the complete standard in published form can obtain one by writing either to the IHF, at 489 Fifth Avenue, New York, NY 10017, or to the IEEE at 345 East 47th Street, New York, NY. Copies of the 35-page document cost \$6.00 each.

Unchanged measurements

Several basic monophonic measurements remain essentially unchanged. For example, usable sensitivity (old IHF sensitivity) will still be measured as the signal strength required to produce a program level that is 30 dB greater in amplitude than the combined value of noise and distortion. The published specification will be listed in dBf, instead of in microvolts. A nomograph for converting microvolts to dBf for different antenna input impedances was supplied with the earlier referenced article that appeared in *Radio-Electronics* and will not be repeated here. Suffice it to say that for a 300-ohm input impedance, a power reference of 10 dBf for usable sensitivity would correspond to an "old" sensitivity figure of about 1.7 microvolts.

(0 dBf equals 10^{-15} watts of power which, for a 300-ohm input corresponds to about 1.1 microvolts of "open circuit" voltage).

Signal-to-noise ratio, previously measured with an input signal voltage of 1000 microvolts, will now be measured at 65 dBf, but the published signal-to-noise ratio will be in dB as before. Distortion will also be quoted based upon input signals of 65 dBf, as a percentage figure. Capture ratio, alternate-channel selectivity, image rejection, IF rejection and spurious-response rejection ratios remain essentially unchanged, except that the input signal strength reference used in measuring these specifications has been translated to a convenient dBf reference instead of microvolts. Frequency response measurements remain unchanged, as does AM suppression ratio measurements, which will now be measured at an input signal strength of 45 dBf (almost exactly the same—100 microvolts when referenced to a 300 ohm input).

New monaural measurements

Even before discussing the many new stereo specifications which will have to be measured and listed according to the new standards, we should mention at least two newly devised mono measurements that are extremely important in defining the quality and performance of an FM tuner or receiver. The first of these is the 50 dB quieting sensitivity specification. This will tell the consumer how much signal power is needed at the antenna to deliver an audio program that has a 50 dB signal-to-noise ratio. A signal-

to-noise ratio of 50 dB is considered to be an acceptable figure for high fidelity applications and, while two receivers or tuners may have *usable* sensitivities in the region of 10 or 11 dBf (1.7 to 2.0 microvolts across 300 ohms), they may differ widely in their ability to further reduce noise to the -50 dB level with increasing signal strength. This idea is illustrated in the

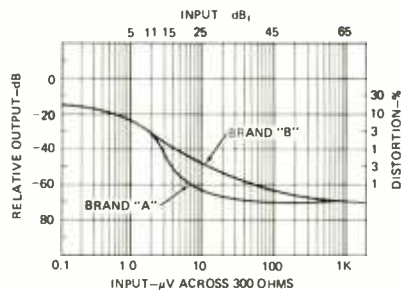

FIG. 1—USABLE SENSITIVITY of 11 dBf (2.0 μ V) is achieved by both tuners, yet brand A model reaches 50 dB quieting at lower input levels, making it clearly superior.

graphs shown in Fig. 1. While both the "brand A" tuner and the "brand B" tuner have usable sensitivities of 11 dBf (2.0 microvolts across 300 ohms), the "brand A" tuner achieves 50 dB of quieting with only 15 dBf of power applied while the "brand B" tuner requires a power input of 25 dBf to achieve the same degree of quieting.

Since the 50 dB quieting measurement involves only a measurement of residual noise (not noise plus distortion as was true in the case of usable sensitivity), another new publishable specification is the distortion at the 50 dB quieting input signal strength. All now be reported for three frequencies: 1000 Hz, 100 Hz and 6 kHz, since these low and high frequencies will often come through with greater THD than is the case for 1000 Hz. The high-frequency test point of 6 kHz was chosen simply because harmonics of higher frequencies would lie outside the FM audio passband, which only

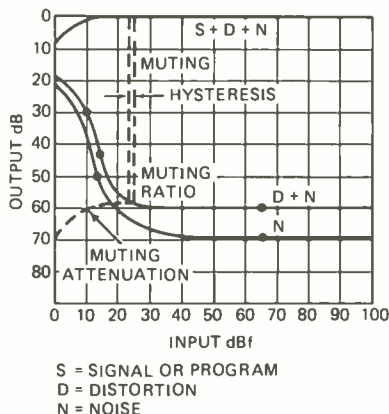

FIG. 2—MANY PERFORMANCE characteristics can be picked off a graph such as this. Similar graphs can be presented for stereo performance.

extends to 15 kHz. For example, the second harmonic of 7.5 kHz would already be at the end of the FM audio passband.

Because signal input strength will now be represented in dBf instead of microvolts, graphs normally used to show quieting and distortion characteristics of an FM tuner circuit will now have equally spaced divisions along the horizontal axis, as shown in Fig. 2. At least a dozen operating characteristics can be picked off of a graph such as the one shown. In addition to usable sensitivity, 50 dB quieting, S/N and THD (at 50 dB quieting and at 65 dBf), the curve also shows the muting threshold level (muting between station tuning is now almost a universally included feature on better tuners and receivers), muting hysteresis (difference in input levels required to defeat muting as signal strength increases compared to muting threshold with decreasing signal strength), muting ratio (reduction of output when muting occurs, expressed in dB) and muting attenuation (reduction in output at zero input signal, expressed in dB).

Another monophonic measurement that has been incorporated into the new standard is adjacent-channel selectivity. Previously, selectivity measurements involved an evaluation of the interfering effects of signals that were 400 kHz (two channel-widths) removed from the desired signal. The reasoning was that in any given area, it was not likely to encounter interfering signals closer in frequency than that because of the way in which the FCC assigns FM frequencies to broadcasters in a given geographical area. Improvement of tuner sensitivity over the years has actually served to defeat that argument. In the New York area,

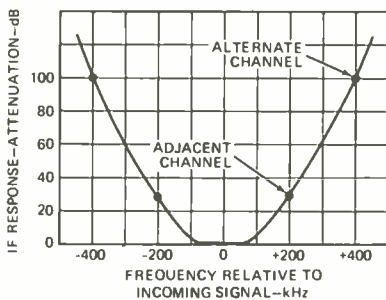

FIG. 3—NEW ADJACENT CHANNEL selectivity figures will be much lower (in dB) than the familiar alternate channel selectivity numbers now in use.

for example, using a good tuner connected to a directional antenna, it is usual to pick up well over fifty signals on the FM dial—which means that some of them must be only 200 kHz removed from each other. Figure 3 illustrates why adjacent selectivity figures are apt to be much poorer in absolute dB values compared with alternate

channel bandwidth, but publication of this value (likely to run between 20 and 35 dB or so) will help consumers to evaluate the differences between a very carefully and elaborately designed IF section with steep sloping attenuation characteristics to either side of desired center frequency and more typically designed IF stages which have a more gradual attenuation slope. Depending upon the user's location, a poor figure of adjacent channel rejection may or may not be too important, but at least the information will now be presented.

New stereo measurements

The chief failing of the previously used measurement standards was their lack of definitive measurements regarding stereo performance of an FM tuner or receiver. In the new standards, all of the specifications so far discussed which would yield different performance numbers when input signals contain stereo modulation must be remeasured and published in addition to

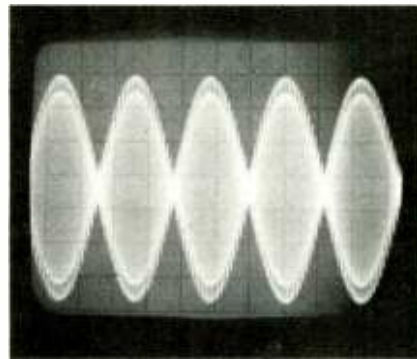

FIG. 4—L-R SIGNAL will be used as the standard modulation signal for stereo measurements.

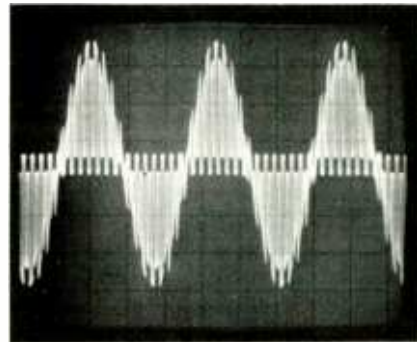

FIG. 5—LEFT-ONLY SIGNAL previously used as the modulation signal for stereo measurements.

monaural specifications. To make the measurements even more stringent, the modulation used for standard measurements will now be an L-R (left minus right) modulation signal, as shown in the oscilloscope photo of Fig. 4, instead of a left only signal, as shown in Fig. 5. A left-only or right-only signal really contains main carrier modulation as well as sub-carrier modulation. but as most readers know, the chief contribu-

tor to added noise and distortion when listening to stereo FM is the presence of sub-carrier modulation, which consists of the upper and lower sidebands of an AM-modulated suppressed 38-kHz carrier. By using an L-R signal as standard modulation in making stereo performance measurements we are, in effect, testing under worst case conditions.

Usable sensitivity, 50 dB quieting sensitivity, signal-to-noise ratio, frequency response, distortion at 50 dB quieting, distortion at 65 dB and IM distortion measurements will all have to be quoted for stereo operation, just as they were published for monaural operation. In the case of the harmonic distortion measurements, percentages will have to be quoted for the three standard audio frequencies, 100 Hz, 1 kHz and 6 kHz. Muting threshold, or stereo switching threshold, in dB is another specification that will have to be listed. Some tuners and receivers have this threshold set so high that it is not possible to receive weak signals in stereo since the set automatically switches to monaural operation in the presence of such weak signals and a consumer has a right to know the signal strength required to receive stereo, however noisy that reception may be.

Stereo separation is one specification that most manufacturers have proudly listed on their specification sheets ever since stereo FM broadcasting began. Generally, figures have been given only for 400 Hz or 1000 Hz audio frequencies since best separation usually occurs at these mid-frequencies. Under the new standards, a manufacturer will have to quote separation, in dB, for at least three frequencies: 100 Hz, 1 kHz and 10 kHz. Optionally, a manufacturer may supply a graph of separation

versus frequency similar to that shown in Fig. 6.

Additional specifications having to do with stereo FM performance that will be listed by manufacturers include subcarrier product rejection (the at-

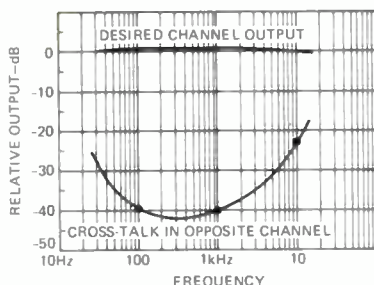

FIG. 6—STEREO SEPARATION at the three frequencies must be given if a manufacturer prefers not to provide a graph.

tenuation of all subcarrier components such as 19 kHz, 38 kHz and harmonics of either frequency) at the tuner or receiver outputs, expressed in dB. Tape recording enthusiasts have long been aware of the damaging effects that can be caused by the presence of inordinately high amounts of these high frequencies. Nonlinearities in tape recording preamplifiers can cause audible beats to develop in the recording that are the result of difference frequencies between the sub-carrier product outputs of the tuner and the locally generated tape bias oscillator frequency.

Finally, manufacturers will have to publish a specification regarding the SCA rejection ratio, expressed in dB. SCA sub-carriers are still used by many FM stations to transmit private, point-to-point subscriber services such as background music and other special services. A second subcarrier having a frequency of 67 kHz is frequency modulated with these audio services, but the

presence of the 67 kHz FM subcarrier can create audible interference when listening to stereo FM programs on poorly designed sets. This last specification will be quoted in dB, and a good measurement figure would be one in excess of 60 dB.

Transition to the new standards

No one (with the possible exception of the buying public) can force manufacturers to begin using the new standards. The IHF has suggested to its members that the transition be a gradual one, completed in about one year. It has also been suggested that the new dBf values used to denote signal strengths be accompanied, parenthetically, by older microvolt figures so that the buying public can get used to the new terminology.

In our own test reports covering tuners and receiver products, we propose to do just that and will, in future, list microvolts as well as dBf for all applicable measurements. Our test reports anticipated the need for distortion measurements at more than one frequency and separation measurements at multiple frequencies, so no major changes will be required in these areas. As manufacturers begin to supply data regarding some of the other new parameters we will include these newer measurements in our test reports as well.

Many years of effort have gone into the creation of these new tuner standards and the three organizations responsible for their creation feel that adherence to the new measurement standards on the part of honest manufacturers can only lead to a better informed buying public and, thereby, to the design and production of better performing FM equipment. **R-E**

COLOR SYNC PROBLEM

The color sync is poor in this Curtis-Mathes CMC-40. When I ground the burst and try to adjust the reactance coil, I can't make the rainbows "cross over"; they come up to a fairly steady pattern and then start back the same way. Do you think this is a bad crystal?—G.O., Hatfield, AR.

This is possible. However, try this first. Tune up the oscillator plate coil and then retune the reactance coil. In some cases, if the plate coil is badly detuned, this won't let the reactance coil cross-over as it ought to. Sounds as if this has been diddled with. If you get this part straightened out, put the scope on either the red or blue grid and tune up the bandpass and color takeoff coil for best amplitude and waveform.

MORE WRONG COLOR

"Tell W. H. of Porter's Lake, NS (R-E, Sept. 1975, page 69) that an open diode in the full-wave bridge rectifier will also cause this kind of regaussing problem! The degauss current comes from the initial charging surge. With an open diode, this is lower than normal and it won't degauss properly. This can also remagnetize the tube." Thanks to Jim Knoble, Fairmont, WV for this.

INTERMITTENT CONVERGENCE

The convergence in this Curtis-Mathes CMC-40 is intermittent. I can set it up very nicely, but after about 30 minutes it goes away out. Everything seems to be OK as far as input pulses are concerned. Any ideas?—L.R., Ft. Smith, AR.

There is one thing that could be causing this. Try heating up the clamp diode unit on the convergence board. From the time-constant, this sounds like a thermal problem. Alternate, cool it off after the trouble shows up. RCA SK-3110 is exact replacement for this unit.

BEAMS HITTING WRONG COLORS

I wrote you about a problem of the beams hitting the wrong colors in a CTC-16XL RCA. I checked out the things you recommended. Then, I found the cause; there was a bad solder joint on the + output of the bridge rectifier! This cured the trouble, but I don't know why! Do you?—R.D., Benton, KY.

Educated (?) guess: you had one diode in the bridge open. As you said, this didn't have too much effect on the B+ voltage. However, this will increase the ripple quite a bit, and this was probably upsetting the degaussing coil action. It can also affect the purity and convergence. **R-E**

You may not know how good you are. But ETI will show you how good you can be.

Perhaps you've heard about all the activity going on in the world of electronics. And maybe you've wondered if it wouldn't pay *you* to get into this exciting field.

Now is your chance to prove just how good you can be in any one of a number of well-paying jobs in electronics. The

Electronics Technical Institute can train you at home, in your spare time. And faster than you dare hope.

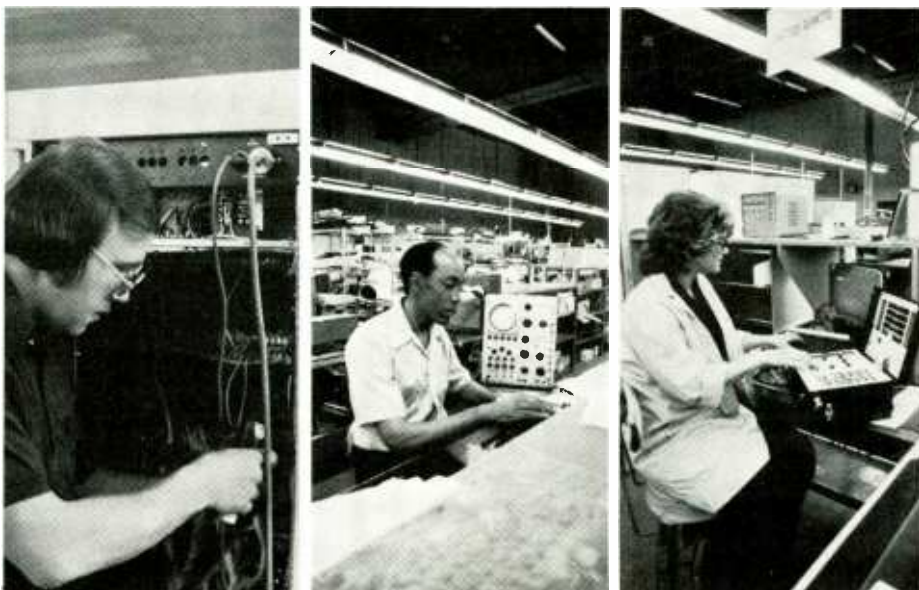

Take your choice. Whether your choice is TV and radio servicing, an FCC-licensed job, computers, solid-state specialties, electronics drafting, or any one of a number of good jobs in electronics, ETI can help you make it through solid, thorough training.

You can start from the beginning. Even if you know nothing about electronics, you can start your career with Fundamentals of Electronics, a course which features ETI's special, exclusive, simplified system of teaching called *Autotext*. It's also been called one of the most efficient methods of home study ever developed. You learn fast, learn well and keep what you learn. What's more you'll *enjoy* learning.

Your ETI instructor—an all-pro. Working with you will be your personally assigned ETI instructor, a professional in both home study and electronics. Licensed by the State of New Jersey, he knows how to move you ahead quickly. His friendly but straight-from-the-shoulder comments and suggestions at the end of

each assignment will help you take on the next one with enthusiasm and confidence.

ETI—a leader in home study. Working *for* you is the reputation of a school—ETI—that began as the Marconi Institute back in 1909. Employers and professional people respect the work of ETI, because they know its instruction is thorough, complete, and up-to-the-minute in every respect. And thousands of graduates now working in electronics attest to the same thing.

Hands-on training and experience. It is not all study when you take an ETI course. In many phases of your training, you use specially developed Project Kits for vital, hands-on experience. You learn by doing, from the very beginning to the completion of



the basic units. As you learn, you build confidence in your ability to get the job done and done well.

Check it all out.

If what we've said seems too good to be true, we'd like you to make us prove it. And you can do that very easily—with absolutely no obligation

on your part—by mailing the coupon or card today. We'll send you all the facts—all the proof you need—in a free, fully illustrated, 48-page Career Book. No salesman will call.

We do believe you owe **it** to yourself to learn all you can about the many opportunities awaiting you in electronics. The new ETI Career Book will give you the facts you need to decide on a future in electronics, and how you can attain your goal through one of ETI's 18 different courses and programs.

Now it's up to you to take the first step toward an exciting job in electronics.



And that first step is easy. Simply complete the card or coupon and mail today for your free 48-page ETI Career Book.

Electronics Technical Institute

Division of Technical Home Study Schools

Electronics Technical Institute • Dept. 2-479-026
Little Falls, New Jersey 07424

Send my free Career Book!

Tell me how I can get ahead in Electronics through ETI. I've checked the fields of special interest to me.

- | | | |
|---|---|---|
| <input type="checkbox"/> TV/Audio Servicing | <input type="checkbox"/> Computers | <input type="checkbox"/> Business and Engineering |
| <input type="checkbox"/> Black & White | <input type="checkbox"/> Digital Electronics | <input type="checkbox"/> Electronics Fundamentals |
| <input type="checkbox"/> Color | <input type="checkbox"/> Computer Technology | <input type="checkbox"/> Electronics Drafting |
| <input type="checkbox"/> Solid State | <input type="checkbox"/> Computer Programming | <input type="checkbox"/> Industrial Electronics |
| <input type="checkbox"/> CATV | <input type="checkbox"/> Communications | <input type="checkbox"/> Advanced Electronics |
| <input type="checkbox"/> Closed Circuit | <input type="checkbox"/> FCC License | <input type="checkbox"/> Industrial Instrumentation |
| <input type="checkbox"/> Video Recorders | <input type="checkbox"/> Aircraft | <input type="checkbox"/> Electronics Technology |
| <input type="checkbox"/> Radio | <input type="checkbox"/> Marine | <input type="checkbox"/> Medical Electronics |
| <input type="checkbox"/> Hi-Fi Stereo | <input type="checkbox"/> Mobile Two-Way | |
| | <input type="checkbox"/> Microwave | |

Check here for Veteran information.

Name _____ (please print)

Address _____

City _____ State _____ Zip _____

Circle 21 on reader service card

ALL ABOUT PROBES

Part II

Test leads, transmission lines, connectors and probes are as much a part of a measurement system as the test equipment itself. This month we will discuss the different types of connectors.

by CHARLES GILMORE*

Review of the hardware used with probes and cables is important because although much of this hardware is common and therefore familiar to most users, there is an equally great amount of hardware that has been expensive for many years. This hardware has been mostly used in the research laboratory and not on the bench of the home experimenter or the service shop.

Connectors

The days of the banana jack and plug being the only connectors used with an instrument are gone. Shown in Fig. 9 are a



FIG. 9—SOME OF THE low-frequency test cables and connectors in common usage today.

number of connectors used with DC and low-frequency AC test instruments today.

The simple banana-type connector is still the most commonly used for high-level DC and low-frequency AC instruments. Such items as voltmeters, low-frequency generators and a few oscilloscopes use this connector. The banana plugs come in two sizes, regular ($\frac{3}{4}$ inch) and miniature ($\frac{1}{2}$ inch), designated by the spacings given to dual connectors. Banana plugs are usually given a rating of 10 to 15 amperes DC carrying capacity. Both sizes come in the stackable and non-stackable configuration. For test leads, the stackable are especially handy.

The dual banana plug has two connectors spaced on $\frac{3}{4}$ inch centers, still the most common distance. Dual banana plugs are most commonly used in connecting shielded cables to banana jacks. Most instruments have a set of banana jacks mounted on $\frac{3}{4}$ inch spacings to accept such a dual plug. Often the dual plug will have a rib on one side so the shield or ground lead may be easily identified.

*Manager Design Engineering, Heath Co., Benton Harbor, Mich.

Connections for the banana plug come in two forms—the simple banana jack and the five-way binding post. The simple banana jack has a capacitance of 2-to 5-pF to the metal panel. The five-way binding post has a similar capacitance to the panel upon which it is mounted, and will also accept wire, spade lugs, tip jacks, or alligator clips. The five-way binding post offers the additional advantage of making a very low resistance connection when the screw cap is tightened onto a wire, tip plug or spade lug. Five-way binding posts come in both regular and miniature sizes. Standard center-to-center spacing is still $\frac{3}{4}$ inch for the regular binding posts and $\frac{1}{2}$ inch for the miniature.

Some voltmeters use a much smaller connector than the banana jack, called the tip jack. In the tip connector, the jack is a solid metal part, whereas the banana jack consists of four spring leaves which are bowed to make a firm connection in a round hole. Connection is made by spring elements in the jack with a tip connector. Tip jacks are rated at similar currents and capacitances to the banana jack.

Banana jacks and plugs, five-way binding posts, and tip jacks and plugs should not be used for measurements exceeding the 1500 to 2000 volt range for DC and line-frequency measurements. Special high-voltage connectors exist for such work and overcome the hazardous conditions presented when tip or banana jacks are used at these potentials. Measurements on signals such as the 15,750-Hz signals from TV high-voltage systems should not be made using these connectors for interconnections.

Color coding for the binding post caps as well as for test leads and other plug and jack covers is not standardized to any great extent. However, black is usually

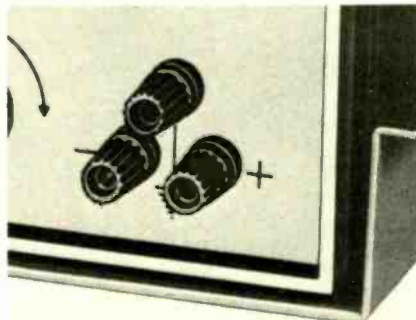

FIG. 10—TYPICAL OUTPUT TERMINALS using five-way binding posts with a $\frac{3}{4}$ -inch center-to-center spacing.

used for the common, negative, ground or low input terminal, and red is used for the high or positive input terminal. Green is frequently used for the chassis ground terminal.

A triangular mounting configuration is often used for binding posts or jacks when the instrument is floating, that is, the low or common terminal is not connected to chassis ground (see Fig. 10). A standard shorting link may be used to connect between $\frac{3}{4}$ inch or $\frac{1}{2}$ inch spaced binding posts, such as the low common to ground. A short length of wire is also satisfactory.

Connections made with dissimilar metals can generate low voltages. For this reason, many of the five-way binding posts are made of high quality metals when they are to be used on instruments capable of measuring or supplying small potentials. Some low-cost jacks and binding posts are made of aluminium. Mating aluminium plugs will generally not be found and are not desirable. Aluminium jacks should be avoided when low-millivolt measurements are being made.

Shielded cables and terminated transmission lines should be interconnected with other equipment by coaxial connectors, although the shielded cable is often terminated in the dual banana plug. Two types of coaxial connectors predominate. The most common is the BNC connector. This small connector, which readily connects and disconnects with a simple twist, is a natural for RG-58 sized cables. Until fairly recently, this connector has not been popular with the experimenter or the service technician as it has been expensive and very difficult to assemble at the end of a cable.

Recent simplifications in the design of the BNC connector have reduced the cost and made field assembly and repair quite practical. The BNC connector is close to 50 ohms in characteristic impedance and the common connector is good to 300 MHz or higher. Special BNC connectors may be obtained which can be used into the GHz region. BNC connectors are rated to 500 VDC and 1500 VAC (RMS). Most new oscilloscopes, RF generators, function generators, frequency counters, pulse generators, etc., use BNC connectors. Most adaptors, attenuators, terminators, etc., are available at their lowest cost with BNC connectors.

The old UHF connectors (SO-239 jack and PL-259 plug) are still found on some instruments. The disadvantages of the UHF connector lie in its size, the many

turns of the screw cap for disconnect or connect, and that it shows some reflections when installed in a 50-ohm line. UHF connectors have similar voltage ratings to those of the BNC type and are not recommended for use above 300 MHz. The UHF connector will fit larger coaxial cables, up to the size of RG-8, that BNCs will not. This connector has been quite popular in the high-power and VHF communications equipment field. It is wise to have a few BNC to VHF adaptors available, especially if communication equipment is frequently worked on.

Occasionally when dealing with UHF and higher frequencies, it is necessary to connect to the larger cables such as RG-8 and a better connector than either the BNC or UHF is required. The type N is often used in such instances. The type N connector comes in both 50- and 75-ohm models and is noted for its extremely low reflections. Type N connectors are difficult to assemble properly and command a high price. Frequently BNC to N adaptors are used; however, such adaptors are not completely reflection free and should be kept out of exacting situations.

The type F connector is used in the 75-ohm television RF transmission line service. This connector makes use of the solid center conductor of the coaxial cable for the center conductor of the male connector. The main advantage of the type F connector is its low cost. Only instruments



FIG. 11—COMMON COAXIAL CONNECTORS. The BNC type (left), the UHF type (middle), and the type N (right).

Ballpoint pen talks to computers

Brainchild of Dr. Hewitt D. Crane of Stanford Research Institute, a ballpoint pen translates handprinted data into



Type	Impedance ohms	Capacitance-per-foot (pF)	Voltage rating	Center conductor
RG-58/U	53.5	28.5	1900	#20 Solid
RG-58A/U	50	29.5	1900	#21 Stranded
RG-58C/U	50	29.5	1900	#21 Stranded
RG-59/U	73	21.0	2300	#22 Solid
RG-59A/U	75	20.5	2300	#23 Stranded
RG-59B/U	75	20.5	2300	#23 Stranded
RG-62/U	93	13.5	750	#22 Solid
RG-62A/U	93	13.5	750	#22 Solid

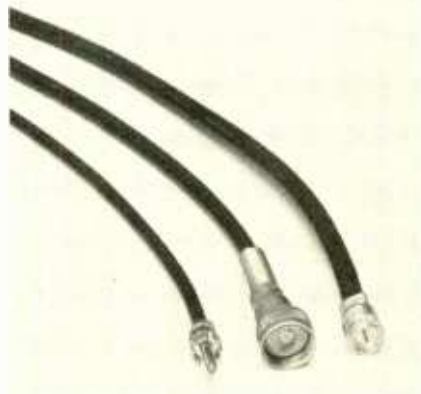

FIG. 12—COMMON SHIELDED CABLE CONNECTORS. The phono connector (left), the single button microphone connector (middle), and the type F connector (right).

specifically designed for television RF use are found with the type F connector.

Three other coaxial connectors are occasionally found, usually on shielded cables rather than transmission lines. The single button microphone connector was chosen for a few instruments (it can usually be neatly replaced by a BNC jack, in the same hole) and at this time has little to commend it. Although never really popular due to its inexpensive construction, the phonoplug and jack make a rea-

sonably good connection for small coaxial cables. The phono connector has been used with reasonable success to 500 MHz, and has voltage ratings that will permit use to a hundred volts. The two- or three-conductor phone plug is sometimes found in audio oriented equipment and it is also used as a test lead connector on some VTVM's. Figures 11 and 12 show a few of these connectors.

Coaxial cables

Three different coaxial cables are in common use for interconnections in instrumentation systems. These are RG-58 (the most common), a 50-ohm cable; RG-59, a 75-ohm cable most frequently found in television systems; and RG-62, a 93-ohm cable of much lower capacitance per unit length than the other two. The essential characteristics of these three cables are listed in Table I.

Although the majority of coaxial cable usage for instrumentation work is done with the three previously mentioned coaxial cables, there are applications utilizing other cables. Specialized applications include low-cost microphone cable, where neither capacitance nor characteristic impedance are important; two center conductors inside a shield, where differential measurements are to be made; and double shielded coaxial cables, where the 80 dB shielding of a single braid is not sufficient and the 120 dB shielding of a double braid is required. (continued next month)

computer language. The pen can transmit 16 characters—10 digits and 6 control signals—in a system called Alphabec-70 Entrz. It may replace many of the keyboard data entry devices now used. Normally wired to a computer, its output can be recorded, in remote locations, for later transmission to a data processing center. Several versions of the system are possible, in one laboratory setup, the pen is hooked to an audio unit that translates the characters into spoken English, which is played back over a loudspeaker.

NESDA elects officers, sets 1976 convention

Leroy Ragsdale, Modern Electronics, Fort Smith, AR, was elected President of the Executive Council of the National Electronic Service Dealers Association for the 1975-76 fiscal year. Election was at the Annual Convention at Winston-Salem, NC.

Everett Pershing, Pershing Radio and TV, Burbank, CA, was named Sr. Vice President. John McPherson, CET,

Mac's Electronics, Yorktown, VA, was elected Secretary, and John Kelly, CET, Sage and Sand TV, Litchfield Park, AZ, Treasurer.

Regional Vice Presidents are; by districts:

- 1: Norman Smith, CET, Hartford, CN;
- 2: Warren Baker, CET, Albany, NY;
- 3: W. H. Harrison, Norfolk, VA;
- 4: Hershall Lawhorn, CET, Perry, GA;
- 5: David Garwacki, CET, Toledo, OH;
- 6: Kurt Wertheim, San Antonio, TX;
- 7: Jack Hopson, CET, Omaha, NB;
- 8: Paul Dontje, CET, Wheatridge, CO;
- 9: West Correll, Tustin, CA;
- 10: Bob Villont, CET, Tacoma, WA.

Elected officers of the International Society of Certified Electronic Technicians (ISCET) are: Larry Steckler, CET, Chairman; Ron Palluth, CET, Vice-Chairman; Frank Grabiec, CET, Secretary, and George Sopocko, CET, Treasurer.

The next annual convention will be held at the Hotel Palacio del Rio, San Antonio, TX, August 13 to 17, 1976.

Radio-Electronics

Tests Sansui Model 9090

by **LEN FELDMAN**
CONTRIBUTING HI-FI EDITOR

THE SANSUI MODEL 9090, SHOWN IN FIG. 1, is the most powerful integrated AM/FM stereo receiver ever tested by R-E and, in its design approach, comes closest to providing the kinds of control and convenience features normally found only in separate preamplifier/power amplifier/tuner components. As an example, consider the two power meters located just beneath the dial scales in the large, blacked-out dial area of the receiver (detail view shown in Fig. 2). These meters are calibrated all the way from 0.5 watts to 200 watts, based upon 8-ohm speaker loads, and are the first such meters we have ever seen on an all-in-one receiver. Such power indicators are normally found only on high-powered basic amplifiers.

Triple tone controls (bass, treble, and mid-range), associated with tone defeat lever switches as well as selectable turn-over points (1.5 kHz and 3 kHz for the treble; 300 Hz and 150 Hz for the bass) are also provided and are characteristically found on better separate preamplifier control units, but only rarely on complete receivers. Other major controls along the lower section of the gold and black front panel include a speaker selector switch, dual headphone jacks, dual concen-

tric master volume and balance controls, loudness and mono/stereo lever switches, a rotary tape selector (with provisions for monitoring or copying from and to as many as two decks, a microphone level control associated with a mic input jack for mic mixing and a 5-position program selector switch.

In addition to a linearly calibrated, well illuminated FM dial scale, an AM dial scale and a reference logging scale, the large blacked out area of the panel has a pair of tuning meters (sensitivity/multipath and center-of-channel) to the left of the scales and a massive flywheel-coupled tuning knob at the right. Flanking the centrally located power meters are a series of 8 pushbuttons. The first is a power on/off switch that, when depressed, causes an adjacent red light to flash for a few seconds

until voltages have been stabilized, following which the light magically changes to green and audio signals are connected to the speakers. (This is another feature normally found only on expensive, high powered basic amps). A cluster of three more pushbuttons take care of low-cut and high-cut filter activation and 20-dB audio muting (useful when answering the phone or a doorbell, since preferred master volume setting can be left unaltered). The four pushbuttons to the right of the power meters handle signal meter selection (signal-strength or multipath), an MPX noise-cancelling circuit, FM muting on/off and the connection of an external Dolby noise-reduction adaptor (actually an additional tape monitoring circuit, if you choose to use it as such).

The center of the rear panel is occupied by large heat sinks with triple sets of SPEAKER terminals to one side (Fig. 3) that



1



2



3



4

SUMMARY OF MANUFACTURER'S PUBLISHED SPECIFICATIONS:

FM TUNER SECTION:

IHF Sensitivity: 1.7 μ V. **50-dB Quieting Sensitivity:** (Mono): 3.0 μ V. **Signal-to-Noise Ratio:** (Mono): 70dB. **Selectivity:** (Alternate Channel): 85 dB. **Capture Ratio:** Better than 1.5 dB. **Image Rejection:** 75 dB. **IF Rejection:** 100 dB. **Spurious Response Rejection:** 90 dB. **Total Harmonic Distortion:** (Mono): 0.2%; (Stereo) 0.3%. **Stereo Separation:** 40 dB @ 1 kHz. **Frequency Response:** 30 Hz to 15 kHz, +0.5, -2.0 dB.

AM TUNER SECTION:

Sensitivity: 50 dB/meter (internal antenna). **Selectivity:** 50 dB. **Image Rejection:** 80 dB/meter. **IF Rejection:** 80 dB/meter.

POWER AMPLIFIER SECTION:

Rated Power Output: 110 watts-per-channel, 8-ohm load, from 20 Hz to 20,000 Hz, both channels driven. **Rated Harmonic Distortion:** 0.2% at all power levels up to rated power output. **IM Distortion:** 0.2% at or below rated power output. **Frequency Response:** (Overall, from AUX inputs): 10 Hz to 30 kHz, ± 1 dB. **Damping Factor:** 10 (at 8 ohms).

PREAMPLIFIER SECTION:

Phono Frequency Response: RIAA ± 0.5 dB. **Input Sensitivity:** (Phono): 2.5 mV; (Aux. & Tape): 100 mV. **Phono Overload:** Greater than 200 mV for 0.2% THD. **Hum and Noise:** (Phono): 70 dB; (Aux. and Tape): 80 dB. **Tone Control Range:** (Bass): ± 10 dB @ 50 Hz; (Mid-Range): ± 5 dB @ 1.5 kHz. (Treble): ± 10 dB at 10 kHz. **Tone Control Turnover:** (Bass): 150 Hz & 300 Hz. (Treble): 1.5 kHz & 3 kHz. **Low Filter:** -10 dB @ 50 Hz; **High Filter:** -10 dB @ 10 kHz.

GENERAL SPECIFICATIONS:

Power Consumption: 750 watts maximum. **Dimensions:** 21-5/16" wide by 7-3/16" high by 15-11/16" deep. **Weight:** 51.4 lbs.

are well isolated from the low-level inputs, the tape-out, antenna (75-ohm, 300-ohm and external AM) and the preamp-out/main-in terminals on the opposite end of the rear panel (Fig. 4). AC convenience outlets (one switched, the other unswitched) and a line fuse are located near

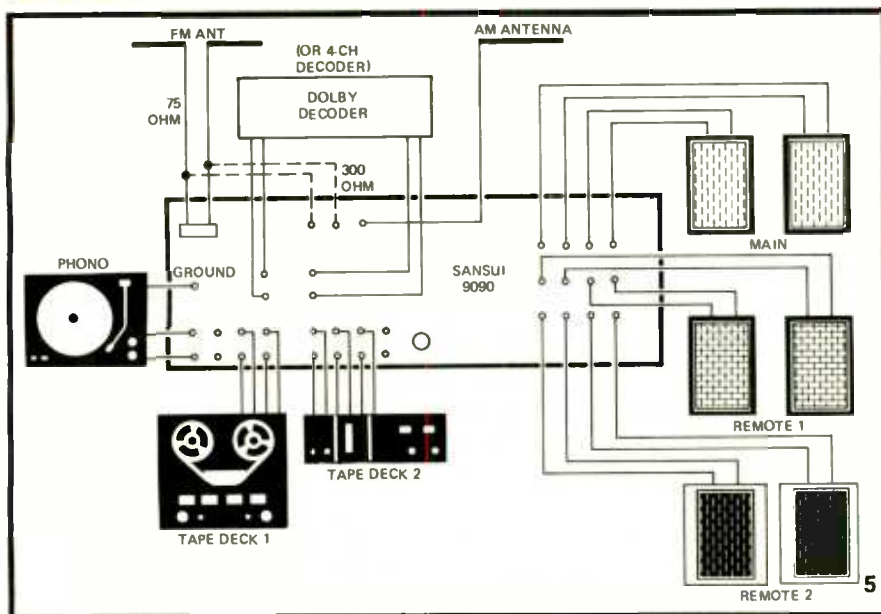

the speaker terminal area while a chassis ground terminal and a pivotable AM ferrite-bar antenna are located near the input terminals. A DIN socket parallels the TAPE 2 input and output jacks.

Figure 5 shows the variety of components that can be connected to and used with the Sansui 9090 receiver. One possible area of confusion, not adequately explained in the instruction manual (which is printed in three languages) has to do with Dolby FM reception. While one of the switch positions of the main selector switch is labelled DOLBY FM ADAPTOR, selecting this mode of operation simply changes the FM deemphasis characteristics from 75 microseconds to 25 microseconds. There is NO Dolby decoding circuitry included as part of the receiver's circuitry, hence the need for a separate Dolby accessory (as shown in Fig. 5) if the user wishes to receive properly decoded FM Dolby broadcasts. When such a decoder is added, the DOLBY NR/4-CHANNEL push-button must be depressed so that the external adaptor is connected to the receiver's circuitry.

Figure 6 is an inside view of the well laid out chassis of the Model 9090. The sealed front-end includes a 4-section tuning capacitor and a dual-gate MOS-FET is used as an RF amplifier. Three discrete IF stages are tuned by multi-element ceramic filters and are followed by three limiter stages. The conventional ratio detector circuit feeds a phase-lock-loop IC stereo multiplex decoder that requires no coil or capacitor alignment and a 2-stage L-C filter is used to reduce sub-carrier

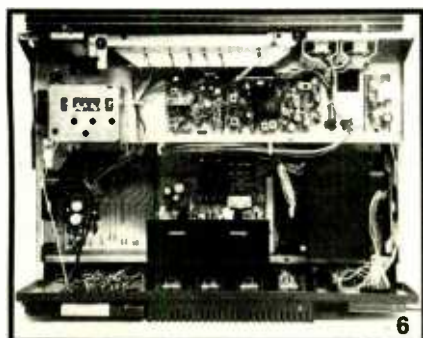

output products. The unique noise canceling circuit, when activated, senses noise present in the received audio signal and is automatically disengaged under strong-signal stereo receiving conditions.

The AM section uses a single IC circuit, preceded by a transistor RF stage. IF selectivity is controlled by a dual-resonator ceramic filter.

Power amplifier sections are fully direct-coupled and powered from a dual-polarity supply. Relay-activated protection circuits prevent speaker damage, amplifier overload and also eliminate turn-on transients thanks to a built-in time delay. The phono equalizer section uses a three-stage IC that is operated at 40 volts DC for improved overload capability. Tone controls are of the familiar negative-feedback Baxandall type and the rotary controls themselves are equipped with well defined click-stop positions that permit easy resettability. Some fourteen major module assemblies are used in the construction of the Sansui 9090, and total semi-conductor count is 51 bipolar transistors, 35 diodes, 1 FET, 10 IC's, 1 LED and 4 Zener diodes.

FM performance measurements

Table I summarizes the FM laboratory measurements made on our sample unit and will serve to compare measured results with published claims. Figures shown in parentheses are the new dBf values that depict signal strengths in terms of power (rather than voltage) referred to 1 Femto-

TABLE I
RADIO-ELECTRONICS PRODUCT TEST REPORT

Manufacturer: **Sansui**

Model: **9090**

FM PERFORMANCE MEASUREMENTS

SENSITIVITY, NOISE AND FREEDOM FROM INTERFERENCE

	R-E Measurement	R-E Evaluation
IHF sensitivity, Mono: (μ V) (dBf)	1.8 (10.5)	Very good
Sensitivity, Stereo (μ V)	7.0 (22.3)	Good
50 dB quieting signal, Mono (μ V)	2.3 (12.6)	Excellent
50 dB quieting signal, Stereo (μ V)	32.0 (35.3)	Average
Maximum S/N ratio, Mono (dB)	70	Very good
Maximum S/N ratio, Stereo (dB)	66	Very good
Capture ratio (dB)	1.2	Excellent
AM suppression (dB)	55.0	Very good
Image rejection (dB)	78.0	Excellent
IF rejection (dB)	100+	Superb
Spurious rejection (dB)	95	Excellent
Alternate channel selectivity (dB)	88	Excellent

FIDELITY AND DISTORTION MEASUREMENTS

	R-E Measurement	R-E Evaluation
Frequency response, 50 Hz to 15 kHz (\pm dB)	+0.2, -2.3	Fair
Harmonic distortion, 1kHz, Mono (%)	0.13	Excellent
Harmonic distortion, 1 kHz, Stereo (%)	0.30	Very good
Harmonic distortion, 100 Hz, Mono (%)	0.15	Excellent
Harmonic distortion, 100 Hz, Stereo (%)	0.45	Good
Harmonic distortion, 6 kHz, Mono (%)	0.125	Excellent
Harmonic distortion, 6 kHz, Stereo (%)	0.40	Very good
Distortion at 50 dB quieting, Mono (%)	0.60	Very good
Distortion at 50 dB quieting, Stereo (%)	0.70	Excellent

STEREO PERFORMANCE MEASUREMENTS

	R-E Measurement	R-E Evaluation
Stereo threshold (μ V) (dBf)	7.0 (22.3)	Good
Separation, 1 kHz (dB)	38	Good
Separation, 100 Hz (dB)	33	Very good
Separation, 10 kHz (dB)	29	Good

MISCELLANEOUS MEASUREMENTS

	R-E Measurement	R-E Evaluation
Muting threshold (μ V)	12	Fair
Dial calibration accuracy (\pm kHz @ MHz)	100 @ 108	Excellent

EVALUATION OF CONTROLS, DESIGN, CONSTRUCTION

	R-E Evaluation
Control layout	Excellent
Ease of tuning	Excellent
Accuracy of meters or other tuning aids	Excellent
Usefulness of other controls	Very good
Construction and internal layout	Excellent
Ease of servicing	Good
Evaluation of extra features, if any	Excellent

OVERALL FM PERFORMANCE RATING

Very good

watt (1×10^{-15} watts equals 0 dBf). With the exception of IHF usable sensitivity and stereo separation, all published claims were either met or exceeded, and distortion figures were particularly outstanding in mono and good to very good in stereo, rivalling those obtained with better quality separate tuners.

The deviation of sensitivity from that claimed was nominal, and within the accuracy of the test equipment used. As for the somewhat diminished stereo separation, we found that a slight touch up of the internal separation control (a single potentiometer) brought the figures above rated specs. We are, however, reporting our measured results as obtained prior to this readjustment since most consumers would have no way of touching up this control.

Amplifier and preamplifier measurements

Table II summarizes our measurements taken on the power amplifier and preamplifier-control sections of the Sansui 9090 receiver. The amplifier is most conservatively rated, as evidenced by the 143 watts-per-channel we were able to measure at rated (0.2%) total harmonic distortion at mid-frequencies. Even at the more difficult 20 Hz and 20 kHz frequency extremes, the available power output into 8-ohm loads at 0.2% THD was 132 and 138 watts, respectively. At the rated output (110-watts), THD measured only 0.065% while IM distortion was a bit higher (but well below claims), measuring 0.167%.

We examined the spectral content of the distortion products at the rated output power using a spectrum analyzer sweeping from 20 Hz to 20 kHz. Results are shown in Fig. 7. The high-amplitude peak repre-

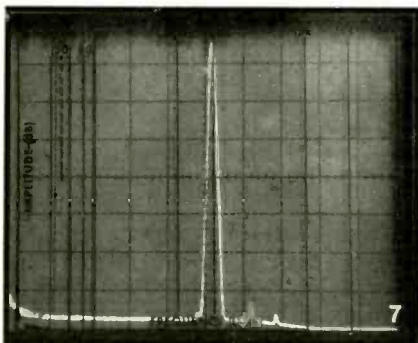

sents the fundamental 1 kHz test signal, while the two tiny signals to the right represent second and third harmonic distortion. Each major division (measured vertically) on the scope face represents 10 dB, so the contribution of second harmonic distortion is some 72 dB below full output (approximately 0.025%) while the contribution of the third harmonic is about 74 dB down (approximately .02%). Any higher order harmonics are so far down as to be non observable on the 80 dB dynamic range of the spectrum analyzer.

The analyzer was also used to plot the tone control characteristics of the 9090 receiver, with sequential sweeps stored on the scope face to show range of bass and treble control action in each of the selected turnover points. The difference in tone control action obtained when selecting different turnover points is shown in

TABLE II RADIO-ELECTRONICS PRODUCT TEST REPORT		
Manufacturer: Sansui		Model: 9090
AMPLIFIER PERFORMANCE MEASUREMENTS		
	R-E Measurement	R-E Evaluation
POWER OUTPUT CAPABILITY		
RMS power/channel, 8-ohms, 1 kHz (watts)	143	Excellent
RMS power/channel, 8-ohms, 20 Hz (watts)	132	Superb
RMS power/channel, 8-ohms, 20 kHz (watts)	138	Excellent
RMS power/channel, 4-ohms, 1 kHz (watts)	N/A	---
RMS power/channel, 4-ohms, 20 Hz (watts)	N/A	---
RMS power/channel, 4-ohms, 20 kHz (watts)	N/A	---
Frequency limits for rated output (Hz-kHz)	16-24	Excellent
DISTORTION MEASUREMENTS		
Harmonic distortion at rated output, 1 kHz (%)	0.065	Excellent
Intermodulation distortion, rated output (%)	0.167	Good
Harmonic distortion at 1 watt output, 1 kHz (%)	0.065	Excellent
Intermodulation distortion at 1 watt output (%)	0.080	Very good
DAMPING FACTOR, AT 8 OHMS		
	14	Good
PHONO PREAMPLIFIER MEASUREMENTS		
Frequency response (RIAA \pm ___ dB)	0.5	Very good
Maximum input before overload (mV)	260	Excellent
Hum/noise referred to full output (dB) (at rated input sensitivity)	69	Excellent
HIGH LEVEL INPUT MEASUREMENTS		
Frequency response (Hz-kHz, \pm ___ dB)	20-25, 1	Very good
Hum/noise referred to full output (dB)	81	Excellent
Residual hum/noise (min. volume) (dB)	95	Excellent
TONAL COMPENSATION MEASUREMENTS		
Action of bass and treble controls	see Fig. 8	Very good
Action of secondary tone controls	see Fig. 9	Excellent
Action of low frequency filter(s)	see Fig. 9	Very good
Action of high frequency filter(s)	see Fig. 9	Very good
COMPONENT MATCHING MEASUREMENTS		
Input sensitivity, phono 1/phono 2 (mV)	2.5/	
Input sensitivity, auxiliary input(s) (mV)	100.0	
Input sensitivity, tape (input(s) (mV)	100.0	
Output level, tape output(s) (mV)	100.0	
Output level, headphone jack(s) (V or mW)	N/A	
EVALUATION OF CONTROLS, CONSTRUCTION AND DESIGN		
Adequacy of program source and monitor switching		Very good
Adequacy of input facilities		Fair (see text)
Arrangement of controls (panel layout)		Excellent
Action of controls and switches		Excellent
Design and construction		Excellent
Ease of servicing		Good
OVERALL AMPLIFIER PERFORMANCE RATING		
		Excellent

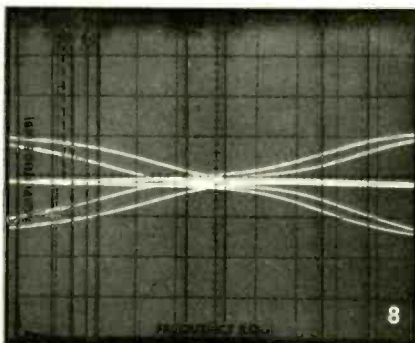
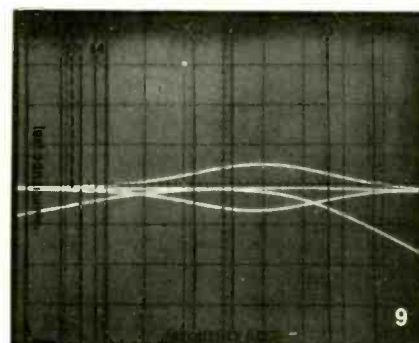

Fig. 8. Action of the MID-RANGE (or presence) control was photographed along with the action of the high and low cut filters and results are shown in Fig. 9. The spectrum analyzer was further used to plot the action of the loudness control that, in the case of the Sansui 9090, emphasizes both bass and treble frequencies as volume control settings are progressively lowered (see Fig. 10).

Overload distortion of the preamplifier-equalizer stages occurred with an input signal of 260 millivolts, well above the



200-mV claimed. This high overload capability accounts, in part, for the excellent reproduction we heard when playing a variety of recorded discs in our listening tests. Measured response in phono was within 0.5 dB of the required RIAA playback characteristic, as claimed.

Listening and use tests

Controls on the 9090 are smooth acting and reliable. Obviously, even with two sets of speakers connected (only two sets out of a possible three are selectable for simul-

TABLE III
RADIO-ELECTRONICS PRODUCT TEST REPORT

Manufacturer: Sansui

Model: 9090

OVERALL PRODUCT ANALYSIS

Retail price	\$750.00
Price category	High
Price/performance ratio	Excellent
Styling and appearance	Excellent
Sound quality	Excellent
Mechanical performance	Very good

Comments: The gap between separates components (amplifier, tuner, preamplifier) and all-in-one integrated receivers has, in our opinion, been further narrowed with the introduction of this high-powered receiver by Sansui. The tremendous power output capability of the 9090 is immediately apparent when listening to good program material such as uncompressed tape recordings, carefully produced disc recordings and a few FM signals in our area that manage to put out a clean signal. Few, if any, of the popular low-efficiency speaker systems would require more power than is available from this unit in any home listening situation.

But power alone is not what makes the Sansui so outstanding. Front panel control flexibility rivals that found on all but the most sophisticated preamplifiers and the presence of those power meters (a feature hitherto reserved for the very costly and highest powered separate basic amplifiers) will appeal to the audio enthusiast who wants every possible visual indicator available while listening to music. While Sansui stopped short of providing such niceties as dual pairs of phono inputs and input level controls (which would have rendered the loudness control more effective), such additions might have pushed the retail price of this receiver beyond its very attractive present levels. In the short period since its introduction, this top-of-the-line receiver has been well accepted by consumers and comments from local dealers indicate that it has stood up well to date, insofar as trouble-free performance is concerned. The people at Sansui advise that first production runs have been completely sold out and the company is doing all it can to keep up with demands for the unit.

taneous listening), there was plenty of power available and, more importantly, that power was clean and undistorted. Surprisingly, we had expected the somewhat low damping factor (10 claimed, 14 measured) to affect the quality of the sound we heard, but in the case of at least three types of speakers used in our listen-

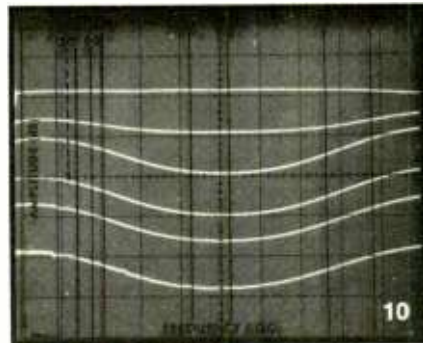

ing tests, we were unable to detect any degradation in sound ascribable to this characteristic. In our opinion, the Sansui 9090 offers an alternative to the audio buff who wants high-powered separates but can't afford them or doesn't have the space for them. At its \$750.00 suggested retail price, the Sansui 9090 is a good buy for the power and feature-hungry audiophile. **R-E**

Yamaha Model TC-800GL

ONE OF THE MOST UNUSUAL LOOKING cassette decks we have come across is Yamaha's new model TC-800GL AC/DC operated stereo recorder shown in Fig. 1. Yamaha has described it as "wedge shaped" and we cannot think of a more apt term. In order to stand this unit on a table top or shelf and not have it tip over, a support bracket swings out from under the unit, as shown in Fig. 2, disclosing instructions for battery installation. This deck can be operated either from a 120 VAC power source or from nine "C" size batteries that will provide up to two hours of continuous running. The LINE INPUT and OUTPUT jacks, a combination RECORD/PLAY (DIN) socket and a place for connecting the separately supplied AC line cord are also



located on the underside of the unit, as shown in Fig. 2. Left and right MICROPHONE INPUTS, HEADPHONE JACK and a socket for connection of any 12-VOLT DC supply (as might be obtained via the cigarette lighter socket in automobiles) for yet

a third method of powering the TC-800GL deck are located on the left side panel of the unit shown in Fig. 3.

The organization and layout of the front panel itself, are a model of human engineering and compact design. Seven "piano key" buttons are located beneath the cassette compartment at the left take care of all transport motions (FAST REWIND, FAST FORWARD, STOP, PLAY/RECORD and PAUSE) as well as ejection of the cassette and switching of the electronics into the record mode. As with most cassette decks, it is necessary to press PLAY and RECORD simul-



MANUFACTURER'S PUBLISHED SPECIFICATIONS:

MECHANICAL SPECIFICATIONS:

Wow and Flutter: Less than 0.06% WRMS. Speed deviation: Less than 1.0%. Pitch Control: $\pm 3\%$. Fast Forward or Rewind Time: (C-60), Less than 80 seconds.

ELECTRONIC SPECIFICATIONS:

Frequency Response: (Low Noise Tape): 30-13,000 Hz; (CrO₂ or FeCr): 30-15,000 Hz. S/N Ratio (at 0 VU): Over 50 dB; (with Dolby on): 58 dB. Harmonic Distortion: Less than 2.5% (1 kHz, 0 VU). Channel Separation: Over 30 dB. Input sensitivity: (Line): 50 mV; (Mic): 0.5 mV, 10K ohms. Line Output Level: 0.4 volts (at 0 VU). Headphone Output Level: 1 mV into 8 ohms; 3 mV into 150 ohms. Bias Frequency: 85 kHz.

GENERAL SPECIFICATIONS:

Power Consumption: (AC) 16 watts; (DC) 7 watts. Dimensions: 12 $\frac{1}{4}$ " wide \times 3 $\frac{3}{4}$ " high \times 12 $\frac{1}{4}$ " deep. Weight: 11 lbs. (less batteries). Suggested Retail Price: \$390.00.

**TABLE I
RADIO-ELECTRONICS PRODUCT TEST REPORT**

Manufacturer: Yamaha

Model TC-800GL

CASSETTE TAPE DECK MEASUREMENTS

FREQUENCY RESPONSE MEASUREMENTS	R-E Measurements		R-E Evaluation
Frequency response, standard tape (Hz-kHz ±dB)	30-13.5, -3		Good
Frequency response, CrO ₂ tape (Hz-kHz ±dB)	40-15.0, -3		Very good
Frequency response, other (see text) (Hz-kHz ±dB)	N/A		-
DISTORTION MEASUREMENTS (RECORD/PLAY)			
Harmonic distortion @ -10 VU (1 kHz) (%)	1.5%		See text
Harmonic distortion @ -3 VU (1 kHz) (%)	1.3%		Good
Harmonic distortion @ 0 VU (1 kHz) (%)	1.2%		Excellent
Harmonic distortion @ +3 VU (1 kHz) (%)	1.3%		Excellent
SIGNAL-TO-NOISE RATIO MEASUREMENTS			
	Weighted	Unweighted	
Standard tape, "Dolby" off (dB)	56	52	Very good
Standard tape, "Dolby" on (dB)	64	60	Very good
CrO ₂ tape, Dolby off (dB)	59	54	Very good
CrO ₂ tape, Dolby on (dB)	67	62	Very good
MECHANICAL PERFORMANCE MEASUREMENTS			
Wow-and-flutter (% WRMS) (weighted/unweighted)	0.04/0.09		Superb
Fast wind and rewind time, C-60 (seconds)	50		Excellent
COMPONENT MATCHING CHARACTERISTICS			
Microphone input sensitivity (mV)	0.5		
Line input sensitivity (mV)	41.0		
Line output level (mV)	430.0		
Phone output level (mV)	1 mW/8 ohms		
Bias frequency (kHz)	85		
TRANSPORT MECHANISM EVALUATION			
Action of transport controls			Very good
Absence of mechanical noise			Fair
Tape head accessibility			Good
Construction and internal layout			Very good
Evaluation of extra features, if any			Excellent
CONTROL EVALUATION			
Level indicator(s)			Excellent
Level control action			Fair (See Text)
Adequacy of controls			Excellent
Evaluation of extra controls			Very good
OVERALL TAPE DECK PERFORMANCE RATING			Good to Very Good

taneously to get into the record mode—a protective feature that prevents accidental erasure of previously recorded cassettes. This feature does not prevent a user from "cueing up" the machine, since the PAUSE button can be used to prevent the start of actual recording before all levels have been properly set.

The right half of the front panel contains all the necessary input and output controls, meters and other special features. The LEVEL meters are calibrated from -40 dB to +6 dB and are illuminated when AC power is applied, but only illuminated momentarily by means of a pushbutton switch when batteries are used to preserve their life. Just below the -2 and +3 readings on each meter are two indicator lights, one green and the other red, that provide peak indications that the VU meters would be too slow to register. The right-channel LEVEL meter also has a calibration mark for checking battery condition when a separate BATTERY CHECK pushbutton is depressed. A three-digit tape counter together with a RESET button are located beneath the left-channel LEVEL meter. The next row of buttons in this

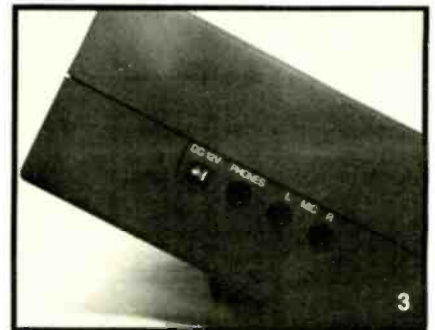

tiered or terraced front-panel layout includes five pushbuttons for activation of the rewind MEMORY feature, the peak LIMITER circuits (useful when recording from microphone sources), DOLBY noise reduction circuitry, bias an equalization for the new Ferri-Chrome tapes and a POWER on/off switch. There are no bias or equalization switches for regular or CrO₂ tape, since the new CrO₂ tapes have an extra indentation in their packaging to which the deck responds automatically. The slide-type PITCH control (speed of tape transport is variable ±3% during playback only), left and right PLAYBACK level controls, left and right MICROPHONE level controls and left and right LINE input controls all operate horizontally, with increase in level accomplished by sliding the controls from right to left. The sliders are serrated on their surfaces so that only a light finger-touch is required to move them smoothly to desired settings.

Possible components that may be used with the deck during recording are shown separately in the hook-up diagram of Fig. 4. No schematic diagram of the TC-800GL is supplied with the unit and we are therefore not in a position to comment on circuitry other than to the degree that our test measurements were able to prove or disprove performance claims made by the manufacturer.

(continued on page 90)

**TABLE II
RADIO-ELECTRONICS PRODUCT TEST REPORT**

Manufacturer Yamaha

Model TC-800GL

OVERALL PRODUCT ANALYSIS

Retail Price	\$390.00
Price Category	Medium
Price/Performance Ratio	Very good
Styling and Appearance	Excellent
Sound Quality	Good
Mechanical Performance	Very good

Comments: One cannot help but admire the striking design of this unusual cassette deck, which does not resemble any tape deck that has come before it. Its sloped panel provides perfect visibility of controls and, for all its features and slide controls, the deck does not look overly cluttered. Functionally, we wish that all the sliders would have worked so as to increase levels when moved from left to right (instead of the other way round) and it took us some time (and cost us several recording errors during testing) to get used to this "backwards" operation of the controls, but that is purely personal conditioning.

The fact that this unit operates from batteries or a 12-volt automobile supply makes it one of the few high quality stereo cassette decks that can be used in the field as well as at home—and that in itself is quite an accomplishment. Usually, one is faced with the choice of an inexpensive, low-fidelity "portable" cassette unit if remote recording is to be done. Performance, in general, was good though we have measured somewhat better frequency response in AC-only units selling for about the same price. No doubt the customer must expect to pay something for the battery operation feature.

Mechanical operation of the transport, though a bit noisy in our sample, was otherwise smooth with fast forward and rewind time faster than on most competitive units. The Yamaha TC-800GL provides ample proof that a good performing high fidelity component (or any home entertainment product, for that matter) can be styled to attract the eye, and internally designed to please the discerning ear.

BUILD THIS

ELECTRONIC STOPWATCH

PART II

Add elapsed time measurement feature to basic calculator circuit.

by TOMMY N. TYLER

THE FIRST PART OF THIS ARTICLE (November, 1975 issue) described the basic operation of the calculator circuitry.

This second and concluding part presents the foil pattern, construction and operation of the stopwatch.

Stopwatch operation

Figure 5 shows the complete schematic of the stopwatch circuit. For good temperature stability and accuracy throughout the allowable battery voltage range of 6.5 to 9 volts, a 555 integrated circuit timer is used for the 100 Hz oscillator. Inverters IC4-c and IC4-d form a flip-flop that alternately switches the reset (pin 4) of the 555 timer from low to high in response to successive closures of S1, turning the oscillator on and off. The flip-flop offers immunity to contact bounce and ignores contact resistance even as high as 1K ohms.

The operation of the "+," "C," and "1" keys of the calculator are simulated by AND gates IC5-b, IC5-c and IC5-d, respectively. Closing RESET switch S2 causes the output of inverter IC4-e to go high, and after a slight delay from the R7-C2 time constant, IC5-b is enabled to clear the display. When the RESET switch is released, IC5-b is disabled immediately while the input to IC5-a and IC4-f rises slowly due to the R6-C4 time constant. This provides a slight delay following the CLEAR operation, to satisfy debounce requirements. When the voltage on capacitor C4 reaches the threshold of IC5-a, its output goes high and enables IC5-d to enter a "1" into the calculator. Almost simultaneously, the output of inverter IC4-f goes low, and after a few milliseconds delay from R8-C3, IC5-a and IC5-d are disabled.

Switch S2 is also connected through diode D3 to the start/stop flip-flop so

that the timer will be automatically switched off if the RESET switch is pushed while it is running. The delay provided by R7-C2 before application of the clear signal is to satisfy the debounce requirements in case the timer output line (pin 3) happens to be high at the moment S2 was closed. Diode D4 eliminates any delay in removal of the clear signal. If the stopwatch is operated at 50 Hz, the input to IC5-d is taken from the digit-3 output instead of the digit-2 output, so that a "2" is entered instead of a "1."

Resistor R12 and capacitor C7 filters the noise on the +9V supply so that it does not cause jitter in the oscillator. The component values for R9, R10, R11, and C6 shown in Figure 5 are for 100 Hz operation. For 50 Hz operation either double the value of C6, or increase the values of R9, R10, and R11 to 120K, 22K, and 50K, respectively. The stability of the oscillator will be almost entirely dependent upon the quality of these four components. For outdoor operation under widely varying temperature conditions use metal film resistors for R9 and R10, a Cermet pot for R11, and a Mylar the 50 Hz version.

If you choose to build just the stopwatch and omit the keyboard, tie unused input K2 to ground. The MM5736 calculator chip is capable of directly driving only the small, low current LED displays that require 1 mA or less average current per segment. Most of the .080-in. to .125-in. high common-cathode digital displays fall into this category, particularly the ones that have integral magnifying lenses. Each segment output pulse is current limited in the chip to about 6 mA. Since each digit is lighted only 1/6 of the time due to the multiplexing, the average current per segment is about 1 mA. The total

current consumption with all six digits displaying "8s" is therefore about 40 to 50 mA. When you consider that the calculator chip itself only draws about 5 mA, it's easy to see where all the power goes and why battery life is so dependent on how the calculator is used. In fact, for timing long intervals or for preserving reading over extended periods of time, you might even want to add a display blanking switch which removes the +9V supply from the digit driver.

If you use individual digits, such as the MAN-3 for your display, connect a suitable resistor from the +9V bus to the decimal point of the third digit. For multidigit arrays that have decimal points for all positions tied together on a common bus, a different technique is required to light only the digit-3 decimal point. Connect the decimal bus to the digit-3 output. This will enable the anodes of all decimal points during digit-3 time, but only the one in position 3 will have its cathode enabled at the same time by the digit driver.

Construction

The unit pictured was made from a Commodore Minuteman-6 calculator, which is the easiest to use because the "works" can be removed from the case with the keyboard and display intact. Remove the 3-position battery switch from the old case and carefully pry the display window loose from the aluminum top cover where it is cemented at each end. Using the top cover as a template, scribe the keyboard and display openings onto the chassis box and cut these out using a nibbler, jeweler's saw, file, or whatever method you favor for making chassis cutouts. Also cut a rectangular hole for the slide switch.



Cement the window into its opening, taking care not to get cement or scratches on the polished surfaces. Next, cement the keyboard into position very carefully with a blob of epoxy at each corner. Try not to overlap the circuit board on the back of the keyboard with epoxy so that it can be taken out later for servicing if necessary by removing the seven screws. Above all, do not let epoxy get into the key holes. Finally, cement the slide switch to the chassis box, again making sure the epoxy doesn't interfere with

the operation of the switch.

All of the added stopwatch components can be placed on a 2-in. x 3-in. printed-circuit board Vector board. Figure 6 is a full-size layout of the board, and Figure 7 shows component placement and external connections. Resistors and diodes are mounted on end to conserve space. Jumpers on the board are No. 22 bus wire. Use very small gauge stranded hookup wire for the interconnections between the stopwatch board and the calculator board. All of these connections are made at

the calculator board by laying the tinned ends of the wires against the pad at the appropriate IC pins or other suitable points, and heating the solder just enough to hold them in place. Cut away a small section of the foil pattern on the calculator board between pin 1 of the calculator chip (IC1) and pin 8 of the digit driver (IC2) as indicated by the dotted line in schematic, Fig. 5.

Operation and calibration

The circuit is designed so that the stopwatch oscillator is always off when

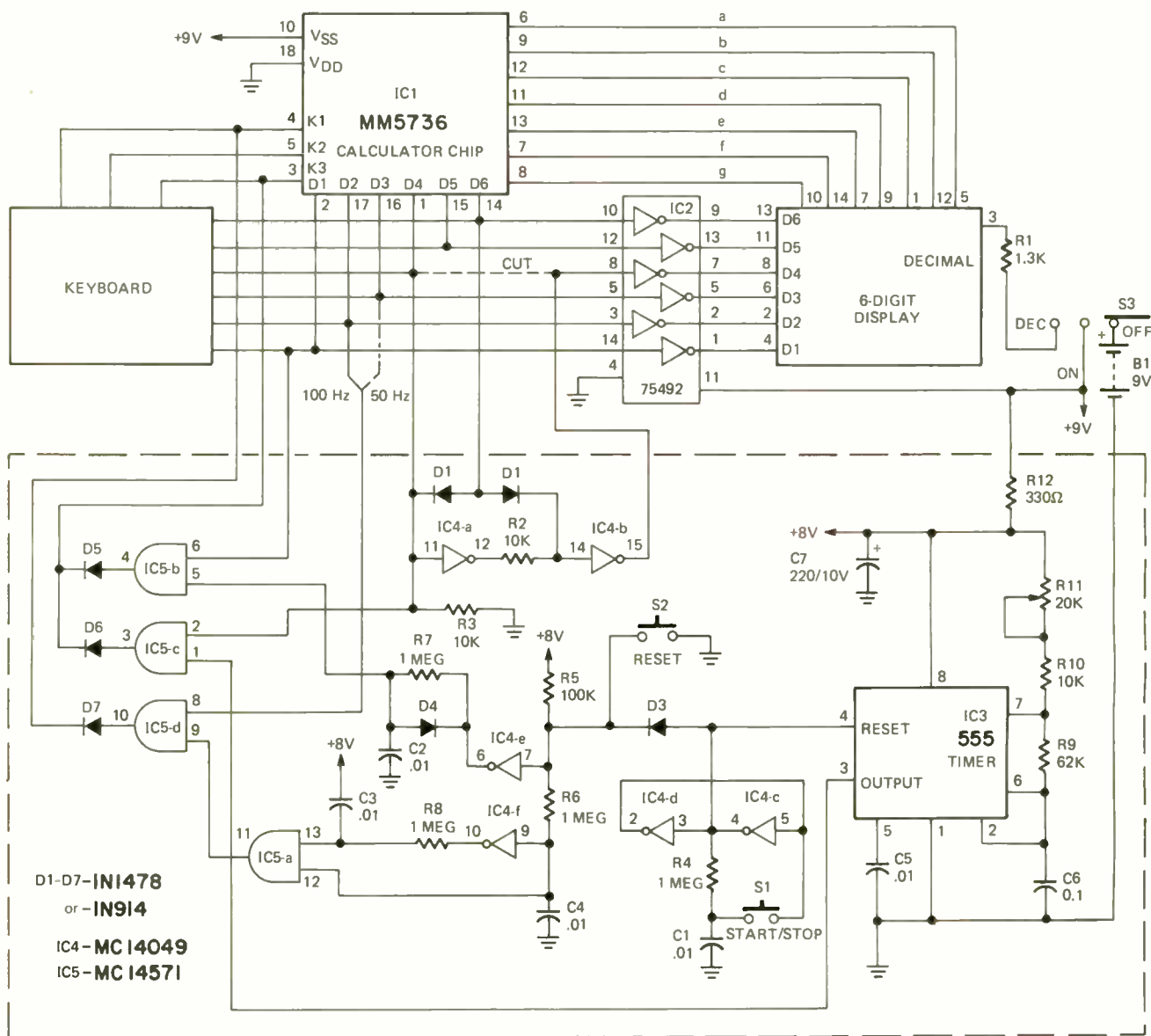

FIG. 5—STOPWATCH CIRCUITRY is shown within the dotted lines. Calculator circuit appears outside dotted lines.

Note: If a calculator is not purchased, the following additional parts will be required.

- IC1—MM5736 calculator chip
- IC2—DM75492 digit driver
- B1—9V transistor radio battery
- Battery connector
- S3—Slide switch, SPDT, miniature (Calectro Cat. No. E2-104, or equal.)
- R1—1,300 ohms, 1/4 W, 10%
- Display—6-digit LED, National Semiconductor, type NSN66A, dual NSN33 or NSN98A (or equal.)

- R2, R3, R10—10,000 ohms, 1/4 W, 5%
- R4, R6, R7, R8—1 megohm, 1/4 W, 10%
- R5—100,000 ohms, 1/4 W, 10%
- R9—62,000 ohms, 1/4 W, 5%
- R12—330 ohms, 1/4 W, 10%
- R11—20K Trimpot, 20-turn (Amphenol type 3805P-203, or equal.)
- C1, C2, C3, C4, C5—0.01 μ F disc ceramic
- C6—0.1 μ F Mylar
- C7—220 μ F/10V electrolytic

- D1-D7—1N4748 or 1N914, diode
- IC3—LM555 Timer
- IC4—MC14049 CMOS Hex Inverter
- IC5—MC14571 CMOS Quad 2-Input AND
- S1, S2—Pushbutton switch, SPST-NO, momentary contact (Radio Shack Cat. No. 275-1547 or equal.)
- Chassis Box—4 1/8-in. x 2 1/8-in. x 1 1/8-in. (Calectro Cat. No. J4-744)

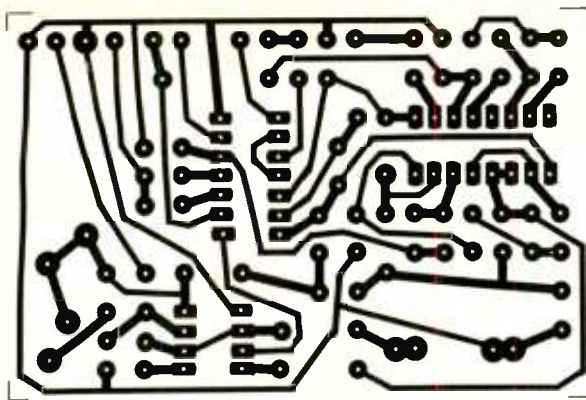

FIG. 6—FOIL PATTERN for stopwatch circuitry is shown full size.

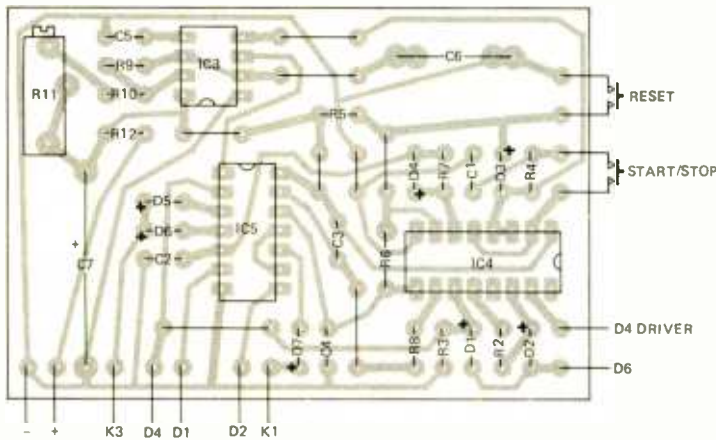

FIG. 7—COMPONENT PLACEMENT of stopwatch circuit board. Connections are made to calculator board.

the calculator is first turned on. The calculator should be cleared twice to ensure that all registers are reset to zero. The first CLEAR operation affects only the display register; the second CLEAR affects all other registers. You can also clear the calculator by pushing the RESET switch twice. When this switch is held down the display will read "0." When it is released the display will read "1." Pressing the start/stop switch once starts the stopwatch, and pressing it again stops it. The stopwatch can be restarted without resetting if desired. Pressing the RESET switch while the stopwatch is running will immediately stop the counter and reset the display to "1." The calculator can be used in the normal manner any time the stopwatch is not running.

The easiest way to calibrate the oscillator is with a precision frequency counter attached to pin 3 of IC3. If you don't have access to that kind of equipment, you can calibrate the unit pretty accurately by trial-and-error fashion using a line-operated wall clock with a sweep second hand. While watching the clock, start and stop the stopwatch at known intervals and adjust R11 to speed up or slow down the oscillator as necessary. Use short intervals at first, say 10 or 20 seconds, increasing the interval as accuracy progresses. The longer the interval, the less will be the error caused by your

reaction time in pushing the start/stop switch. With a little patience you should be able to time a period of 10 minutes on the clock with less than 1/2 second error on the stopwatch. This corresponds to an accuracy of better than 0.1%.

Troubleshooting

The MM5736 chip was designed for battery operation where the DC source is switched. If you decide to do preliminary testing with a bench power supply to save on batteries, make sure the voltage on the V_{cc} pin rises abruptly, since a slow ramp will not always initialize the calculator chip properly.

If you run out of adjustment of oscillator frequency (R11) it probably means R9 and C6 are both at one end of their allowable tolerance. Reduce R10 to about 4.7K if the oscillator can't be adjusted fast enough. Increase it to about 15K if it can't be adjusted slow enough.

A missing digit-4 (fourth from right) indicates a problem in the stopwatch circuitry since the drive pulse for this digit passes through inverters IC4-a and IC4-b. Another point to keep in mind is that when any key is pressed, the calculator will not do anything further until that key is released for the required debounce time. If the calculator seems "hung up" with the display lighted and will not respond to any key

switches, check to see if the output of IC5-b, IC5-c or IC5-d is staying high.

If the calculator operates properly, the RESET switch clears and enters a "1," the output of the oscillator appears at IC5-c, and yet the stopwatch doesn't count, it may be that the debounce requirements are preventing the calculator from cycling as fast as the 100-Hz oscillator. Test for this by starting and stopping the unit about a half dozen times to see if the display reading increases by 1 each time it is started. Another way to check is to temporarily shunt capacitor C6 with additional capacitance to slow down the oscillator and see if the stopwatch starts counting. Make sure the waveform on the digit-4 line has the characteristic double pulse shape shown in Fig. 4, which indicates the speedup circuit is working. The oscillator circuit has been designed to provide about a 40% duty cycle on, 60% off. This is about as close to the ideal square wave as we can get and still have a practical range of adjustment of frequency. To meet the debounce requirements discussed previously, at least four pairs of the double pulses on digit-4 line must occur within the shortest (40%) portion of the oscillator waveform. Verify this on a scope by comparing the waveform at pin 1 of IC5-c and pin 1 of the calculator chip. If you cannot obtain a 100-Hz waveform with the required four scan cycles minimum in both the ON and OFF portions of the signal, you will have to try another calculator chip or revert to the 50-Hz version.

R-E

HORIZONTAL AND COLOR PROBLEMS

This Wards Airline 12448A has a horizontal sync problem, and no color. Do you have any ideas on it?—J.O., Deming, WA.

I've got one very good idea! Find out what's the matter with the horizontal sync first, and fix that. When you do, you may find out that your color problem is fixed too. This applies to any color set. If the horizontal pulses are out of phase, this can literally kill the color by upsetting the numerous gated stages.

UNLISTED TRANSISTOR

I need a horizontal driver transistor for an old Motorola 19P1. I can't find a reference on it, and the parts man says that they don't make this any more. Do you know of a substitute?—C.B., Youngstown, OH.

You could use a TO-5 transistor jammed into that heat sink. However, I would rather try mounting a TO-3 socket on the chassis. You've got room. Then you could use something like an RCA SK-3034; this one has plenty of safety factor to hold the load. (Reader says: "I did, and it worked.")

Build This Pocket Data Terminal

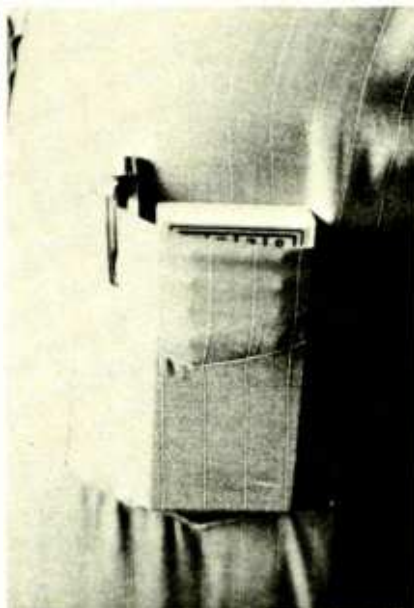

PART II

Use it to access a computer with a sound input, and with the optional plug-in memory, it can automatically dial a 7-digit telephone number.

LAST MONTH WE DESCRIBED THE POCKET Data Terminal in detail, with block diagram, complete schematic and parts list. This month will show how to construct and program it, and will also give a little information on the advantages of the *Touch-Tone** system of signalling.

Construction

The Pocket Data Terminal is built on three double-sided glass epoxy PC boards with plated-through holes. Board 1, the Main Frame and Keyboard, is etched with the number 789 in the upper center on the component side. It measures 1.95 x 3.15 inches. Board 2 is the Auto-Dial option board and is etched with a 788 in the upper center on the component side. It measures 1.9 x 2 inches. Board 3 is the Memory Board and is etched with 787 in the upper center of the solder side. This board measures 1.9 x 2 inches and is programmable with diodes to remember any 7-digit telephone number. All PC boards plug together with pins and sockets; no soldering or de-soldering is required to assemble or disassemble the three boards.

Because the keyboard contacts are etched into the Main Frame PC board and because of the unit's compactness, it is recommended that the unit be built using only PC boards. As was pointed out last month, the construction of double-sided plated-through holes is beyond the capabilities of most home constructors. A set of PC boards (as well as a complete set of parts) is available from Executive Devices, 740 South Locan Avenue, Fresno, CA 93727. The PC boards with drilled and plated-through holes are available for \$5.95 each. Order PC boards 788, 789, 790. See Parts List last month for information on ordering complete kits or parts or assembled units.

Caution: The *Touch-Tone** Generating Chip (ICI) is MOS and is likely to be zapped by static electricity if not left in its protective conductive black foam holder

*Trademark of American Telephone and Telegraph Co.

by CHARLES EDWARDS

until ready to be installed in the PC board. To be doubly safe, before removing the IC4 from the conductive foam, cut a 1 inch square of kitchen-type aluminum foil and form it over the top of the IC so that all 16 leads touch the aluminum foil. Wrap it around the body of the IC to hold in place. Pull the IC out of the protective foam and, holding the IC through the foil, insert it into the PC board. Leave the foil on the IC until after all soldering on the PC board is finished. The above MOS IC should be the last component put on the PC board; all other components should have been inserted and soldered before IC1 is installed. Besides keeping all leads shorted together so a static charge won't ruin an expensive IC, the aluminum foil also helps protect the IC from the heat of soldering by acting as a heat sink.

Refer to the component layout (January, 1976 issue) for parts locations. Observe diode and electrolytic capacitor polarities. Also double-check to make sure the IC's are installed with the end notch in the correct direction before soldering. The numbers and letters in circles and on large pads in the component layout are PC board interconnect pin numbers.

Adding the Auto-Dial option requires that the interconnect pins be added to the Main Frame board; follow these steps to assure proper alignment of pins and sockets.

1. Insert and solder into place all components and jumper wires on the Auto-Dial board.
2. Hold Auto-Dial board with component side facing up. Insert 11 each mini-jacks from component side (with the open end of the jack visible from the component side of the board) into holes 1, 2, 3, 4, 5, 6, 7, 8, 9, 11, 13. (Don't solder yet!)
3. Insert the *long* end (end farthest from the swaged shoulder on pin) of a long pin in each of the sockets. Be sure it is fully seated.

4. Place Main Frame PC Board (component side down) over Auto-Dial board (component side up); guide the pins through matching holes in Main Frame board. Be sure boards are 0.250 inch apart all the way around, measured from the face of the component side of one to the face of the component side of the other. Insert temporary spacers made from small washers or wood blocks to keep boards parallel while soldering is done.
5. Solder (using a very small amount of solder) pins on solder side only of Main Frame board. Cut off pins even with surface of PC board on solder side of board. This keeps the pins from interfering with the operation of the keyboard.
6. Flip assembly over and solder sockets from solder side of Auto-Dial board.
7. Boards now may be un-plugged and re-mated, but be careful to keep the boards as parallel as possible while plugging and unplugging, to keep from bending the pins or sockets.

Follow a similar procedure to assure correct alignment of pins and sockets between Auto-Dial board and Memory board:

1. With Auto-Dial board laying on table with component side down, insert 15 each sockets from solder side (with open end of socket facing solder side of board) into holes 1', 2', 3', 4', 5', 6', 7', 8', A, B, B, D, E, F, G. (Don't solder yet!)
2. Insert the short end (.050 from end of pin to shoulder) of the short pins supplied with the Memory board into each of the sockets.
3. Overlay a Memory board (with programming diodes already in place) with *diode side down* over Auto-Dial Board and guide pins through

matching holes in Memory board. Be sure the boards are a maximum of 0.125-inch apart, measured from the face of solder side of the Auto-Dial Board to the face of the diode side of the Memory board. Insert temporary 0.125-inch thick spacers between the boards as above if necessary to make them parallel until after soldering is done.

4. Solder pins on solder side of Memory board and cut off pins flush with top of solder.
5. Flip assembly over and solder sockets on component side of Auto-Dial board.

Rather than using a PROM (Programmable Read Only Memory) which is more expensive and requires a special programming unit, the Pocket Data Terminal Auto-Dial Memory card can be programmed with 14 each low-cost silicon diodes. Almost any diode will work including 1N914 or 1N4148 silicon diodes, advertised in the back of R-E at from 4¢ to 7¢ each, or 1N270 germanium diodes. Using diodes with a higher than specified forward conducting voltage drop will result in a lower volume from the speaker, while using the more expensive (12¢ to 15¢) 1N270 germanium diodes will result in a higher speaker volume. Under normal conditions, silicon diodes have been found to provide a sufficient volume level out of the speaker to work into a telephone handset microphone or two-way radio microphone, providing the speaker



PRESSING THE LEFT BUTTON on the Pocket Data Terminal starts it into Auto-Dial operation—pressing the right button boosts the output volume level. Hold both buttons down until the sequence is complete.

hole in the back of the Pocket Data Terminal is centered on and makes contact with the handset's microphone.

Programming a number

The Pocket Data Terminal generates, with its crystal-controlled LSI integrated circuit, all the eight *Touch-Tone* frequencies used by the telephone company. These are used, two at a time, to identify which one of the 16 buttons (four more than on a standard *Touch-Tone* telephone) is being pressed. See Table 1.

Memory boards programmed for a phone number are shown (see January, 1976 issue). Each digit generated by the Auto-Dial unit requires two diodes (one for each tone). To dial the number 1, for

TABLE 1—Touch-Tone* Frequencies

Button	Frequencies (Hertz)
1	697 (L1) + 1209 (H1)
2	697 (L1) + 1336 (H2)
3	697 (L1) + 1477 (H3)
4	770 (L2) + 1209 (H1)
5	770 (L2) + 1336 (H2)
6	770 (L2) + 1477 (H3)
7	852 (L3) + 1209 (H1)
8	852 (L3) + 1336 (H2)
9	852 (L3) + 1477 (H3)
0	941 (L4) + 1336 (H2)
.	941 (L4) + 1209 (H1)
#	941 (L4) + 1477 (H3)
A	697 (L1) + 1633 (H4)
B	770 (L2) + 1633 (H4)
C	852 (L3) + 1633 (H4)
D	941 (L4) + 1633 (H4)

*Trademark of American Telephone and Telegraph Co.

example, requires 697 Hertz (L1) and 1209 Hertz (H1). In the first diagram, diodes connect the vertical conductor 1 with the horizontal conductors (on the other side



USING THE POCKET DATA TERMINAL with a telephone. Be sure the nickel-plated grommet on the rear of the unit is centered over and touches the microphone of the phone (or two-way radio). The gain of the system receiving the signal determines whether the volume boost (right top button) should be used.

of the board) L1 and H1. Dialing a 7 requires L3 and H1, and it can be seen that the last (seventh) vertical conductor is connected to those frequencies. Thus the number 123-4567 will be dialed. The second component layout produces an output that is not a telephone number, but might be used in a control or other operation.

To change numbers in Memory simply move the diodes around to a new configuration, or order several more spare Memory board kits, available for \$6.95 from Executive Devices, 740 South Locan Avenue, Fresno, California 93727. The Memory board kit (Part MEM-700K) includes a double-sided epoxy-glass Memory PC board with plated-through holes, 15 diodes (2 each required for a 7-digit telephone number) plus a spare diode and 10 each

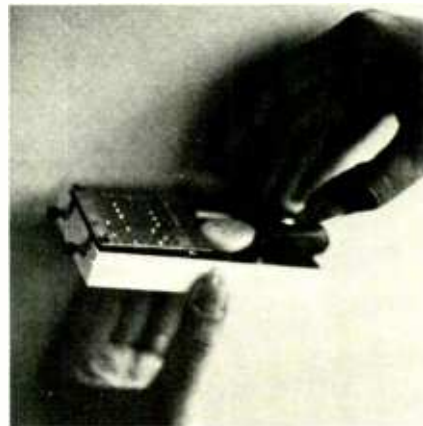

BATTERY CHANGE PROCEDURE. Grasp the unit about one-third the way down. Pull halves apart, keeping them as parallel as possible when separating. Lift battery up and out at connector end, as shown above.

mini-pins, used to plug the Memory board into the sockets on the Auto-Dial board. By having several spare Memory boards on hand, the telephone number may be conveniently changed.

The two systems

Touch-Tone was developed by Bell Labs as a replacement for dialing with rotary dial pulses. A rotary telephone dial puts out a series of pulses (two pulses for a 2; eight pulses for an 8, etc.). The telephone number 999-9999 thus takes much longer to dial than 111-1111. To dial 999-9999 requires 63 digital pulses; 111-1111 requires only 7. Each dial pulse is 100 milliseconds long with a 650 ms pause between digits. To dial the shortest possible 7-digit telephone number would take 4,600 ms or 4.6 seconds.

With *Touch-Tone* signalling it takes the same time to send a 1, a 9 or any other number. Each digit is made by a combination of two tones, as shown in the Table. Both tones must be present for a minimum of 40 ms and there must be a 4-ms (minimum) pause between digits. Thus the minimum time required to send any 7-digit number is 480 ms, or just under 0.5 second, over 20 times as fast as it takes to send the fastest phone number by the old rotary dial.

R-E

Step-By-Step TV Troubleshooters Guide

Video Sweep Modulation is a powerful troubleshooting technique that can be used to localize various troubles in the entire receiver, even the audio circuits.

by STAN PRENTISS

VIDEO SWEEP MODULATION (VSM) IS simply the output from a 60-Hz service-type sweep generator whose sweep begins at theoretical 0 and extends to 5 MHz or more. It can be defined as the IF picture carrier being modulated by the video sweep—thus VSM. This signal can be injected into the tuner and is usually detected by the receiver or the oscilloscope probe. (See Fig. 1). The bandwidth of the signal is usually no more than 5 MHz (following the video detector) because of the video IF and trap limitations. Once rectified, half of the sweep envelope is rejected; therefore the somewhat oval appearance of Fig. 1-b you'll see duplicated shortly in actual photographs. Various sweep instruments generate this narrow-band signal in several ways.

VSM is certainly not new. RCA has marketed a sweep generator-modulator rig for some time with absorption markers that will pass signals through receiver antenna terminals and produce waveforms similar to those shown in Fig. 1. The difference here, however, is that we'll use a one-resistor modified Sencore SM152 sweep generator with crystal-controlled birdie

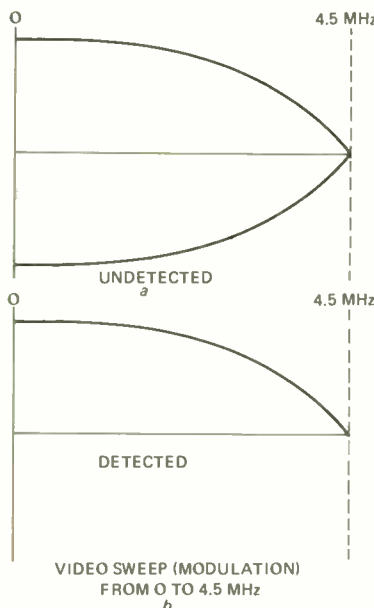

FIG. 1—VSM SIGNAL shown detected in b, and undetected in a.

bypass markers—for which the manufacturer gives adequate modification instructions in his instrument manual—but where we have combined a sweep variable resistor and cutoff switch so the generator can be returned to its normal mode of operation and usual sweep width of 300 kHz to 15 MHz simply by flipping the switch. This method also saves special instrument calibration.

There are strong indications that VSM—as vectorscopes in chroma alignment—can be a very powerful tool in troubleshooting solid-state television receivers, especially those with integrated circuits. Also, like an ordinary 200 MHz sinewave generator applied to the TV tuner permitting dial readout of television interfering frequencies (TVI), a calibrated VSM with adequate markers should be of inestimable use throughout the entire receiver. Using the modified Sencore SM152, only the preset chroma functions is operational since the sweep mode is automatically restricted and the crystal-controlled markers (and possibly even variable external markers, if you wish) are easily observed on the response curve. The block diagram in Fig. 2 shows both equipment hookup and the circuits affected.

VSM detection

With sweep-restricted signals going into the IF via the mixer test point and outputs from the sweep gen-

erator being introduced into the scope through its Y1, Y2 amplifiers (in the Y-Y mode), output signals such as shown in the waveforms of Fig. 3

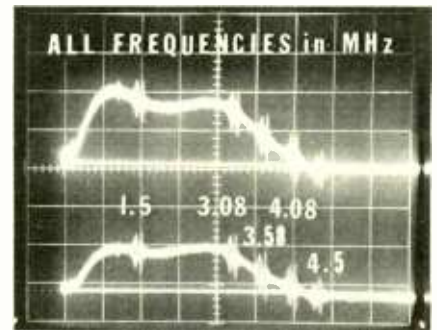

FIG. 3—VSM IF waveforms with AGC (lower trace) and without AGC (upper trace).

should be detected anywhere in the video IF and regular video amplifiers. These waveforms should be detected in the chroma amplifiers too, but with a somewhat different shape and position due to the 3.08-4.08 MHz pass-band and the 3.08-4.08 and 3.58 MHz chroma sideband and subcarrier references.

As you can see, there are two traces apparent in Fig. 3. The top trace is a completely uncompensated input into the tuner-mixer terminals, with the output taken through an isolation resistor following the video detector—actually at the emitter of the 1st video amplifier. The lower trace has forward

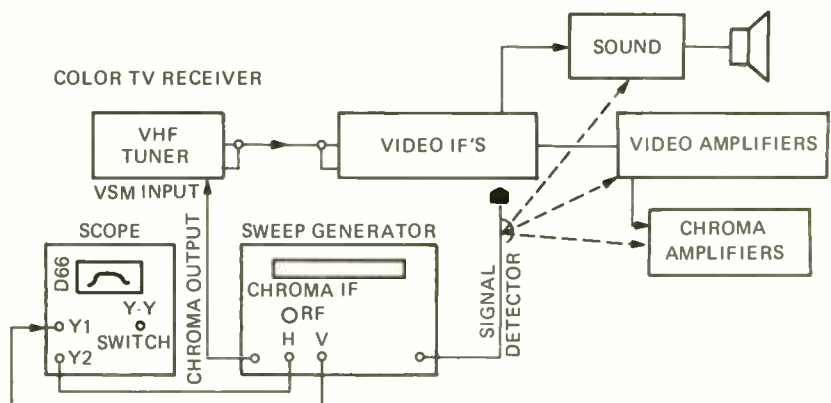

FIG. 2—VSM SETUP for a typical color TV receiver.

AGC compensation for the 1st and 2nd video IF stages. Here the AGC flattens the trace and makes it appear a little more symmetrical, but otherwise there are no real differences. Observe that the sweep does not begin precisely at 0, but probably about 250 kHz because of our modified variable sweep-width switch and resistor which, of course, is now engaged. And just to make the whole thing seem truly real, the IF response curve of the color receiver is shown in Fig. 4, without disturbing a



FIG 4—NORMAL IF response of color receiver.

single thing but changing the sweep band of the generator to the 10 to 50 MHz range and popping in the usual 41.25, 42.17, 44.25, 45.75, and 47.25 MHz trap and video-chroma markers. So the process, as you can see, is very much established and we suspect that it is remarkably useful because there are no adjustments necessary for video, audio, or chroma once the 0 to 5 MHz sweep is injected into the tuner. The downward VSM waveform slope, of course, is simply the combined falloff response of both sweep and bandpass of the television receiver.

Luminance amplifiers

Let's move on down the line of luminance amplifiers—and don't worry about the DC potentials since the SM152 has a 0.27- μ F capacitor in its

input, so DC is readily blocked. At the contrast control and video amplifier output, the same type of VSM waveforms again appear in Fig. 5 as they did in Fig. 3. However, both the slope

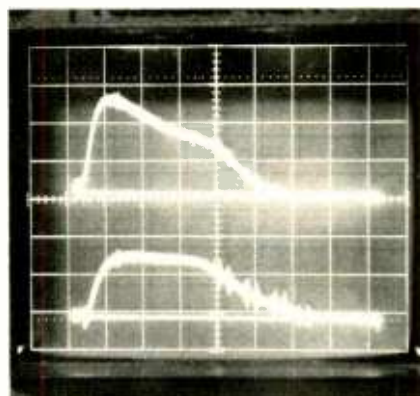

FIG 5—VSM RESPONSE of video amplifier is shown without AGC (upper trace) and with AGC (lower trace) applied.

and amplitude of the upper trace has increased considerably, and all markers are much smaller. But with a little AGC (lower trace), waveform symmetry at a reduced amplitude can once more be obtained, and the markers (at their fixed amplitudes) are, therefore, relatively larger than in the upper trace. (Generator marker-amplitude here is maximum.) The frequencies are the same as in Fig. 3.

VSM is also good for looking at audio circuits, too, but not always the very low level ones. For instance, an IC detector isn't capable of delivering a large amplitude signal. But the audio output collector is another matter entirely, and most of the amplified discriminator "S" curve is readily apparent in Fig. 6. Does need a bit of tuning, though, doesn't it? And tuning by VSM is readily accepted and accurate, too. But you must be careful not to saturate the S-curve—it's sensitive. So audio sections of receivers accept this interesting technique also, and offer yet another

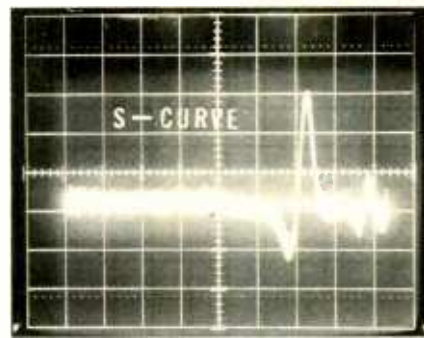

FIG 6—S-CURVE of audio detector that is slightly de-tuned.

means of evaluating and adjusting circuits that have been usually difficult before.

Chroma amplifiers

The chroma circuits in this hybrid receiver we will be looking at are part of a Sylvania D18 chassis. In the past, we've had great good fortune in vectorscope alignments with a color-bar generator and oscilloscope. In fact, the very chroma system we're investigating now was aligned previously with this vectorscope method.

Figure 7 shows the results of the previous alignment taken from the collector of the 1st bandpass amplifier. The 3.08 MHz chroma sideband is on the left slope of the waveform, the 3.58 MHz subcarrier at center, the 4.08

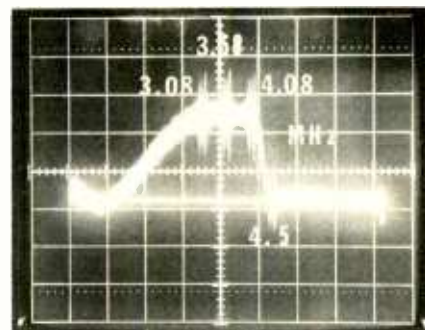
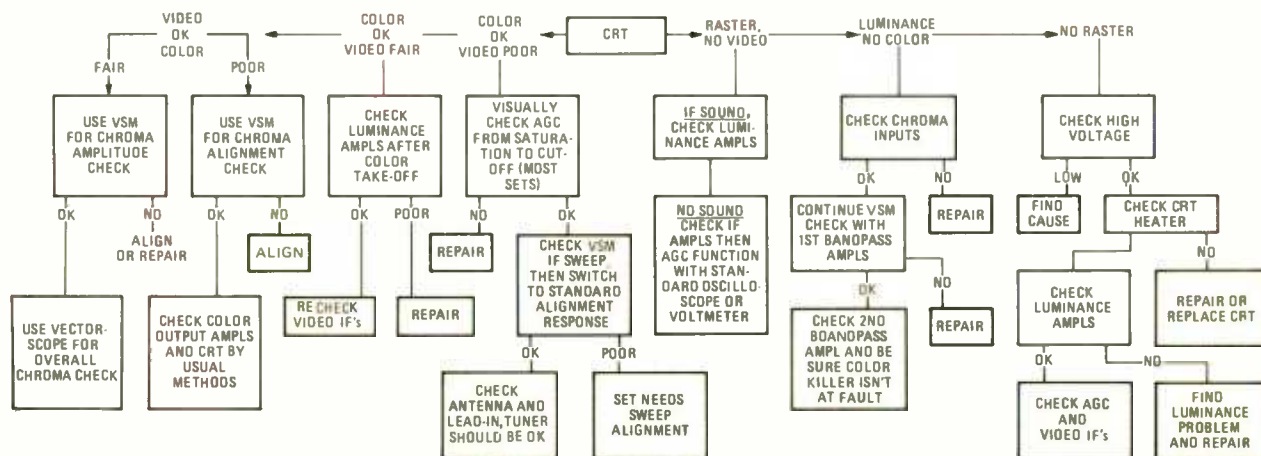

FIG 7—IDEAL VSM CHROMA response at collector of 1st bandpass amplifier.

TROUBLESHOOTING CHART (VSM)



NOTE: IN SOME RESPECTS, THESE ARE ORDINARY CHECKOUT PROCEDURES, BUT WITH VSM INCLUDED, QUALITY AND QUANTITY CHECKOUTS ARE SUCCESSFULLY COMBINED.

If you can't go to college for your career in electronics -read this!

CREI brings college-level training to you with eight educational advantages, including special arrangements for engineering degrees

The best way to qualify for top positions and top pay in electronics is obviously with college-level training. The person with such training usually steps more quickly into an engineering level position and is paid considerably more than the average technician who has been on the job several years.

A regular college engineering program, however, means several years of full-time resident training—and it often means waiting several years before *you can even start your career*. This, of course, is difficult if you must work full time to support yourself and your family.

If your career in electronics is limited without college-level training, take a look at the advantages a CREI home study program can offer you.

1. Convenient Training

CREI brings the college to you. Through the convenience of home study, you receive exactly the same level of training you will find in any college or university offering programs in electronic engineering technology. With CREI, however, you can “go to college” whenever you have spare time at home or on the job.

2. Specialized Programs

With CREI, you enjoy the advantage of *specialized* training. That is, your program will include only those courses directly applicable to your career in electronics. We omit such courses as English, social studies and other subjects, which are usually required in resident schools. Therefore, with CREI, you move ahead faster to the more interesting and useful part of your training.

3. Practical Engineering

CREI programs give you a *practical engineering* knowledge of electronics. That is, each part of your training is planned for your “use on the job.” By using your training, you reinforce the learning process. And by demonstrating your increased knowledge to your employer, you may qualify for faster career advancement.

4. Engineering Degrees

CREI offers you a number of special arrangements for earning engineering degrees at recognized colleges and universities. You can earn college credit while you are taking your CREI program or apply later, whatever is best for your career plans.

Career Training at Home

5. Unique Laboratory

Only CREI offers you the unique Electronic Design Laboratory Program. This complete college laboratory makes learning advanced electronics easier and it gives you extensive practical experience in many areas of engineering, including design of electronic circuits. No other school offers this unique program. It is a better "Lab" than we have found in many colleges. And the professional equipment included in the program becomes yours to keep and use throughout your professional career.

6. Wide Program Choice

CREI gives you a choice of specialization in 14 areas of electronics. You can select exactly the area of electronics best for your career field. You can specialize in such areas as computer electronics, communications engineering, microwave, CATV, television (broadcast) engineering and many other areas of modern electronics.

7. Prepared by Experts

Experts in industry and technical organizations of government develop CREI programs. Each part of your training is developed by a recognized expert in that area of electronics. That means you get the most up-to-date and practical instruction for your career.

8. Industry Recognition

That CREI training is recognized by industry and government is evident from the fact CREI provides training to advanced technical personnel in over 1,700 technical organizations. Many subsidize the training of their employees with CREI. If there is any question about the advantages of CREI training for you, ask your employer or any engineer to evaluate the outline of a CREI program for you.

Other Advantages

Of course, there are many other advantages to CREI training. For example, throughout your training, CREI's staff gives you personal instruction for each step of your program. And in many industrial areas, both in the U. S. and abroad, CREI Field Service Representatives provide a number of important personal services for your training and your career.

FREE Book

There isn't room here to give you all of the facts about career opportunities in advanced electronics and how CREI prepares you for them. So we invite you to send for our free catalog (if you are qualified). This fully illustrated, 80 page catalog describes in detail the programs, equipment and services of CREI.

Qualifications

You may be eligible to take a CREI college-level program in electronics if you are a high school graduate (or the true equivalent) and have previous training or experience in electronics. Program arrangements are available depending upon whether you have extensive or minimum experience in electronics.

Send for this **FREE Book** describing your opportunities and CREI college-level programs in electronics



Mail card or write describing qualifications to

CREI CAPITOL
RADIO
ENGINEERING
INSTITUTE

McGraw-Hill Continuing Education Center
3939 Wisconsin Avenue Northwest
Washington, D.C. 20016

Accredited Member National Home Study Council

GI Bill

CREI programs are approved for training of veterans and servicemen under the G.I. Bill.



FEBRUARY 1976

MHz upper sideband is precisely on the right lip, and the 4.5 MHz inter-carrier sound marker is down, where it should be, in the right trough. By now, if there are any doubters, this should prove a bushel! In all honesty, we have often seen this particular response drawn, but never photographed, and it's quite exciting to know that advanced techniques and good equipment will do all that's theorized.

A similar waveshape can also be seen at the output of the 2nd bandpass amplifier but, for some reason, it is quite sensitive to tilt. Of course, the sweep generator's detector probe continues in use until the actual color information is detected and amplified by either the RGB-Y color difference or RGB (luminance added) amplifiers.

And that is really all there is to the

shape of our VSM techniques at the moment. As different sweep generators and other receivers are investigated, there will be additional reports. But, for the moment, here's where the matter must rest. Perhaps some of our readers have used similar techniques and have interesting thoughts. We're always open to worthwhile ideas and suggestions.

Future prospects

With familiarity in the VSM technique, it may be possible to very accurately align at least the chroma sections of any and all color receivers in a very short period with no AGC adjustments since low to upper passband signals are already being generated. Sync, of course, simply flywheels and there are no AGC coincidence pulses for hori-

zontal keying. Should you desire this type of sync signal input, you'll need a color-bar generator or one of the analyzer types of equipment that are specifically designed to produce composite waveforms, including sync.

Naturally, signals through the tuner, video IF's etc., set up the entire receiver operating parameters and, with a little practice, it should not be difficult to find problem areas with little more effort than lifting the sweep generator's signal detector and moving it from one test point to another. In this way, signal gain as well as circuit or module performance can be checked dynamically and qualitatively throughout most of the entire receiver. This will especially be helpful in present and future IC sets where many new schematics are showing little more than block diagrams. **R-E**

Hickok Model 334 Digital Multimeter



Circle 31 on reader service card

THE DIGITAL MULTIMETER IS PROBABLY THE fastest-growing item in test equipment. We can't say "digital voltmeter" any more, for the new ones are truly multimeters. The Hickok model 334 DMM (Digital MultiMeter) is a good example. It will read AC or DC voltages up to 1200 volts. (When measuring AC voltage, the maximum RMS voltage is 1,000 volts. The peak voltage of this will then be within the safe limits of the instrument.) The lowest range for both AC and DC voltage is 0-200 millivolts. This gives you the ability to make direct readings in cases where you need a 50-millivolt input signal to a solid-state amplifier, and so on. This is a high-impedance input, 10 megohms when measuring DC voltage, for minimum circuit loading.

Resistance can be read in six ranges, with the lowest being 0-200 ohms and the highest 0-20 megohms. The accuracy is $\pm 0.5\%$ of the reading. On the 0-200 ohm range, with a reading of 100 ohms, the measurement would be within ± 0.5 ohm.

The model 334 will read DC current from a low of 0-200 microamps up to 2.0 amps, at a maximum resolution of 0.1 microamp. In addition to this, it will read AC current on the same ranges. The AC current reading is a feature that was often wanted on other instruments. It can be very handy for a lot of tests. Because of the very high sensitivity of the instrument, voltage drop across the meter when measuring current is only 200 mV on all ranges except the 2.0-A range where it is 300 mV.

The display is a 7-segment fluorescent type with plenty of brightness; it glows a bright green, making it easy to read. If the input goes over range for a given setting, the display blinks on and off. The decimal point is automatically positioned within the display to give instant readability.

Each range is basically a "2". So, on the 0-2 volt range, the maximum reading would be "1.999" with the decimal point placed to the right of the left-hand digit. On the 0-20 volt range, the maximum reading would be "19.99" volts, and so on up to the highest range. If the input goes higher than the maximum for any range, the top and bottom segments of the left-hand digit blink on and off.

The polarity of any DC voltage is indicated. If you see no polarity indicator, the voltage is assumed to be +. If it's negative, a - sign lights up to the left of the display. The polarity indicator is turned off for AC voltages, current and resistance readings.

One thing I like about this instrument is that they have provided a ZERO adjust control on the front panel. Early models didn't have one. Actually it may not be too necessary, but it does give us a control that can be set to start out with a zero reading. To adjust this, you set the FUNCTION switch to DC volts, short the test prods and then adjust the ZERO adjust control until you see a "000" reading with the - sign blinking on and off. If the zero setting ever changes when switching ranges, an internal zero control is provided. This control is conveniently located on the back panel. Full details of this adjustment are given in the manual.

Speaking of the manual, it is very plainly written and gives full details of operation. There are also a couple of really handy tricks that can be done. My favorite is the measurement of very minute leakages. You can use the model 334 to check capacitor leakage, or the reverse leakage of a transistor.

It's very simple to measure leakage. Connect the component to a source of DC voltage within its safe limits (working voltage of capacitor, reverse voltage of transistor, etc.). Then connect the model 334, set on a low DC volts range, between

the open end of the component and common. Set the range switch so that the instrument doesn't overrange. What you're doing is measuring the voltage drop across the 10-megohm impedance of the meter itself. To get the exact value of the leakage, you divide the voltage reading in volts by 10 megohms. For example, if the DC voltage source was 50 volts and the measurement was 100 mV., the leakage current would be $I_L = 100 \text{ mV}/10 \text{ megohms} = 10 \text{ nanoamperes}$. $1 \text{ nanoamp} = 1 \times 10^{-9} \text{ A}$.

To find the exact leakage resistance of the component, divide the supply voltage in volts minus the measured voltage in volts by the measured voltage in volts and multiply by 10 megohms. With the 50 volt supply and a reading of 0.5 volt, the calculation should come out to 990 megohms. Incidentally, this last trick could be used to check the value of something like the resistor in a high-voltage probe, or similar unit. Very few of us have ohmmeters that'll read up to 1,000 megohms.

There are also tables provided for checking transistor junctions of both Ge and Si types. The tables provide the actual reading that you should measure. Since I believe that more service technicians use ohmmeters for transistor checking than any other instrument, this is a very useful thing.

The model 334 is a compact little instrument, very easy to use on the bench. A tilt-handle can set the display at whatever angle needed to get the best visibility. Controls are placed to make it easy to adjust, and the panel markings are easy to read!

R-E

**National
Safety
Council**

**If you don't like
thinking about safety,
think where you'd be
without it.**

R-E's Service Clinic

Bits and pieces

The small components cause most of the troubles

by JACK DARR
SERVICE EDITOR

"HOW DO I FIND THEE? LET ME COUNT the ways—". With this dreadful paraphrase of a beautiful poem, let us look into the ways of finding some of the bad bits and pieces that cause troubles in electronics. That is, the small parts: resistors, capacitors and so on. Someone once said that most of the troubles in electronics are caused by bad resistors or capacitors, and that they're all simple things—AFTER you find 'em. (That's a correct quote, because I'm the one that said it.)

Resistors

Resistors can go bad in several ways. For one, they can burn up. We have two possible causes for this. The most common one is an overload of current due to a short in a capacitor, tube or transistor that is fed through the resistor. They can also break down internally, start heating, and burn themselves up. This happens mainly to carbon resistors though the film types aren't immune.

For a quick check you can replace the resistor, turn the set on, and quickly read the voltage on the load end. If this voltage is very low and the resistor is heating, turn the set off. You've got a short in the load. If the voltage is normal, then the resistor self-destructed internally. That is, unless the short in the load was *intermittent*. (Someone's always taking the joy out of life.) Cooking the set for several hours will help. In tube sets, jar the tube. In transistor sets, heat the transistor. A lot of intermittent transistors are thermal.

Drift

Carbon resistors are subject to drift

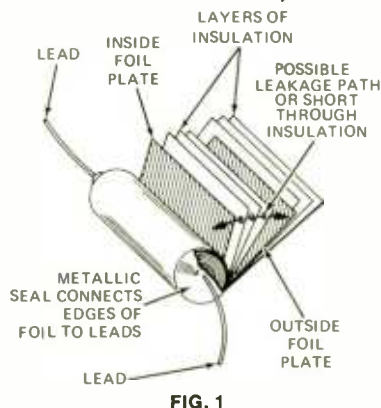

FIG. 1

(their values change). This is especially true in the cheaper types. When you have odd symptoms in circuits using several high-value resistors, suspect each one of them. (I have no confidence in any resistor larger than 470K). Applying heat will often cause the drift to show up. You can take the resistor out and hook the ohmmeter across it, and then warm it up to make sure.

Capacitors

Capacitors can cause some dandy problems. There are only two kinds of defects possible in paper capacitors and their plastic counterparts—the rolled type. These can not *change* in capacitance because of the way they're built (see Fig. 1). The faults will be leakage through the insulation, or a dead short. An ohmmeter or voltmeter will catch this very quickly.

The ceramic disc types can produce some weird problems. These show up mainly in the cheaper import types, so be on the alert. In one case with a kit color TV set with some questionable parts, I had a bad sync problem. Scoping the path from the sync separator to the sweep oscillators revealed

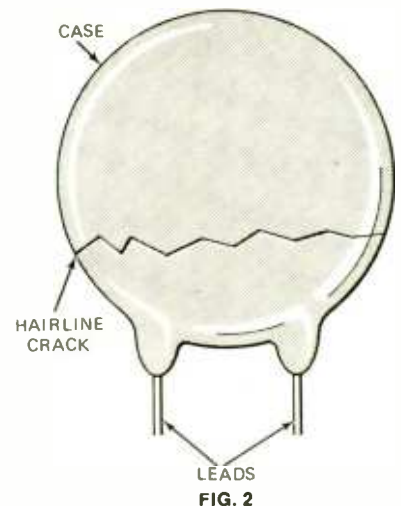

an excessive drop in the sync signal where it went through a coupling capacitor. After checking for possible leakage on the load-end, I bridged another capacitor of the same size across the original. This cured the sync problem. Taking the original capacitor out, I measured its capacitance. Though it

This column is for your service problems—TV, radio, audio or general and industrial electronics. We answer all questions individually by mail, free of charge and the more interesting ones will be printed here.

If you're really stuck, write us. We'll do our best to help you. Don't forget to enclose a stamped, self-addressed envelope. If return postage is not included, we cannot process your question. Write: Service Editor, Radio-Electronics, 200 Park Ave. South, N.Y. 10003.

You can study FM two-way radio at home!



MTI offers the only training for professional FM two-way radio available. Qualified technicians are employed in government, industry, and public service. But training is your key.

You could cut out a career as a two-way radio technician by cutting out this coupon. We'll send you information on how you can learn more about this specialized field, at home, for only \$345.

I am interested in learning more about professional FM two-way radio. Please send me a free Course Outline.

Name _____
Address _____
City/State/Zip _____



formerly

**MOTOROLA TRAINING
INSTITUTE**

College Hill, Summerdale, Pennsylvania 17093

P

3

Circle 22 on reader service card

was plainly marked .001 μ F, it read somewhere below .0001 μ F.

A careful examination showed a tiny crack across the case. Evidently this had also cracked the ceramic disc, reducing the capacitance to a small fraction of the normal value. Figure 2 shows this. Later, in the same set I found quite a few capacitors like this; some were used as bypasses and others as couplers. Since that time, I have run into the same kind of thing in other TV sets.

The best way to troubleshoot this problem is with the scope. For coupling capacitors, measure the input signal vs. the output signal. There should be practically no voltage drop across any coupling capacitor. To check bypass capacitors, use the same test. Scope the point which is bypassed. If you see *any* signal at this point, the bypass isn't doing its job. This kind of problem causes weird symptoms like the half-blue, half-gold screen on a color TV. A bad bypass in the plate circuit of the bandpass amplifier did it. In audio circuits, check emitter bypasses. If you see a good-sized signal on the emitter despite the obvious presence of a good-sized bypass capacitor, look out. The emitter signal causes a severe degeneration and loss of gain.

Electrolytics

Electrolytic capacitors can cause some real dandies. This is especially true of the filter capacitors in the DC power supply. A "dry electrolytic" is not dry at all; it's moist. If it does dry up due to old age or a leaky seal, the capacitance drops rapidly. When this happens, your DC power supply no longer has zero impedance to ground. There will be a *feedback path* through the power supply. This can couple every stage in the set to all of the

others. Some of the symptoms caused have to be seen to be believed.

The raster shown in Fig. 3 is familiar. This is the typical double hum-bar pattern; a low or open input filter capacitor caused this. But how about the scope pattern shown in Fig. 4? I'll give you a clue; the scope is set to a 30-Hz sweep rate. The symptom in the TV set was absolutely no vertical sync at all, although horizontal sync was perfect. The composite sync waveform on the sync-separator plate looked good; correct P-P amplitude and all. However, killing the vertical oscillator and scoping the sync input showed no sync whatsoever.

After some time, I found the DC power supply and scoped very sharp spikes at 60 Hz. I then bridged a new capacitor across the original and the spikes disappeared and at the same time the vertical sync reappeared! Evidently this sharp spike, originating in the vertical output stage, was getting into the sync-separator plate supply in just exactly the right phase and polarity to neatly punch-out the vertical sync only! (Honest Confession is Good Department: rechecking the composite sync waveform with the bad capacitor showed that there really *wasn't* any vertical sync in this waveform! I'd looked at it too quickly!)

Another oddball symptom in a transistor stereo was a hash noise in one channel. The scope showed a clean signal on one side of a tiny low-voltage electrolytic coupling capacitor but not on the output. Unsoldering this capacitor and replacing it cleared up the hash. Putting the original back, no hash! Evidently the noise had been due to a bad connection inside the original capacitor, that had been cleared up by the unsoldering.

Intermittents

This brings up the bane of every technician's life—the intermittent. In older sets, the filter capacitors were notorious for being intermittent. This was due to a bad connection on the tabs used to connect to the foils. Apparently they would oxidize, open up and go bad. When a sharp transient hit the circuit, this would re-weld the tab and the capacitor was good again. This often happened when bridging new capacitors across suspected ones.

There is a way to avoid this. With the power off, clip the sub capacitor across the suspected one. Now turn the power on. The capacitor substitution boxes have a resistor in series with the capacitors. This lets the substitution unit charge up slowly and avoids the transient. For the test, this resistor is shorted out by the switch.

Before leaving electrolytics, let us say this. If you see any kind of screw-

(continued on page 100)

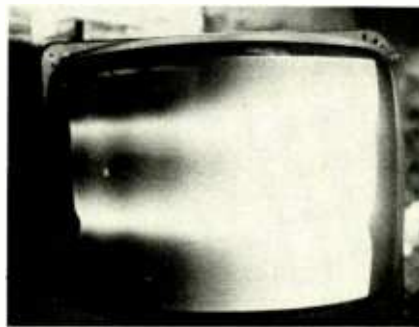

FIG. 3

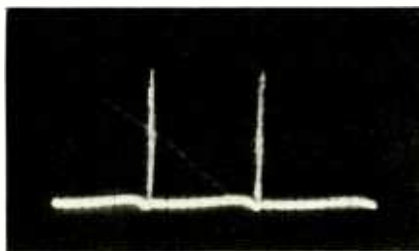
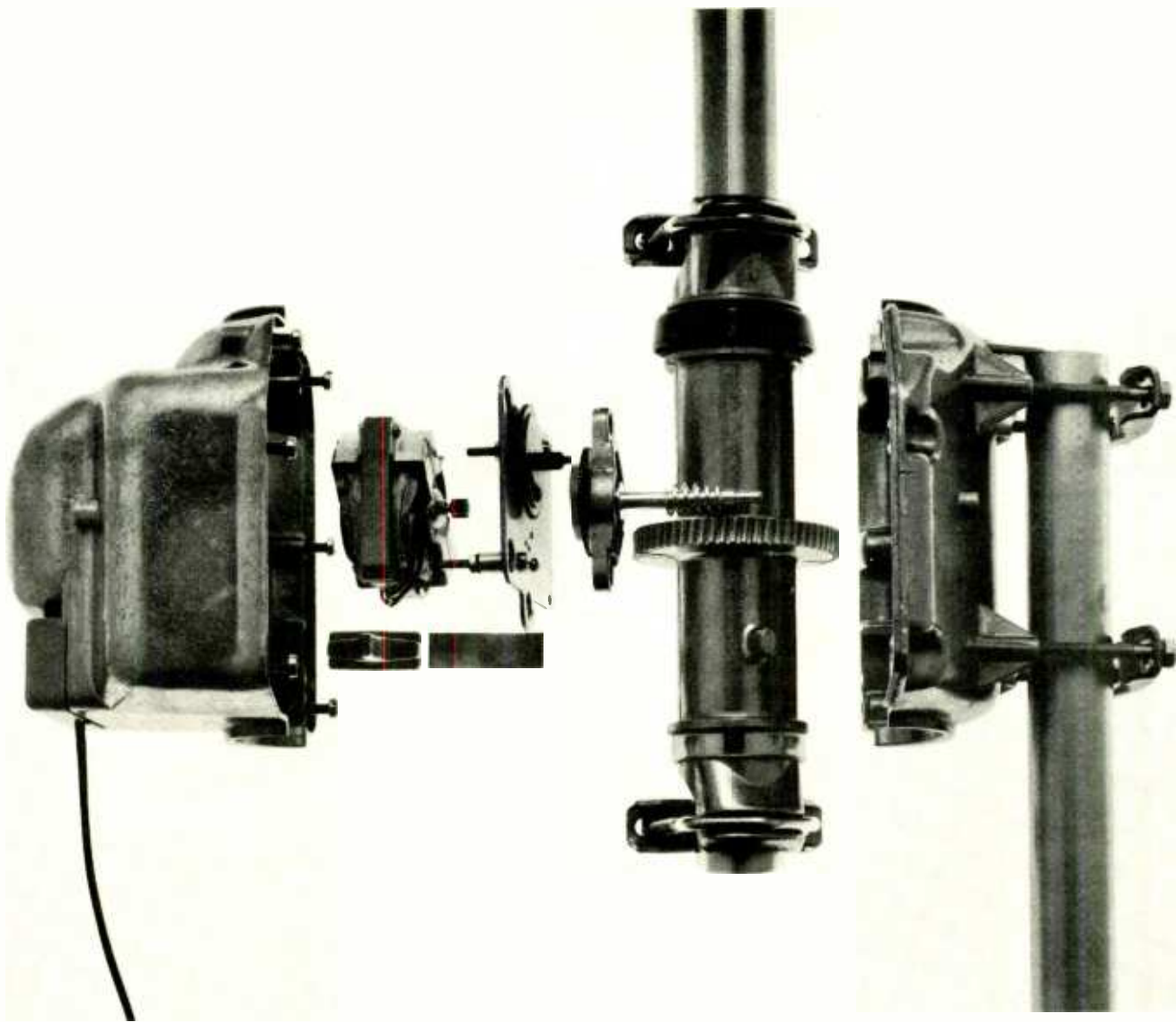

FIG. 4



“RCA warrants this product against defects in materials and workmanship for a period of two years from date of purchase...”

RCA's Selecta-Channel Automatic Rotator carries the only 2-year warranty from a major company.

The Drive Unit for model 10W606 (shown above) features an easily removable high-tensile aluminum alloy housing. Inside, a powerful high efficiency motor. Permanently lubricated oversize stainless steel bearings — no external thrust bearings are required. Quick-connect pressure terminals. A new mast mounting that won't snag lead-in wires. Premounted hardware, and a reinforced shaft.



The Control Unit is an attractive chrome-trimmed beige, with cushioned base. The transparent “direct select” control knob has a moving direction indicator light showing the antenna's exact position. And, it's quiet: no click-clack sound.

For more information on the 10W606 or the deluxe Automatic Rotator 10W707, call your RCA Distributor. Or contact RCA Distributor and Special Products Division, Building 206-2, Cherry Hill Offices, Camden, New Jersey 08101.

**RCA
Rotators**

RCA power darlington

With 5 amps of current flowing through the RCA1B07 or RCA1B08, the DC beta ranges between 1000 and 15,000. This is the compound beta of two Darlington connected transistors. At the same 5 amp current, the saturation voltage is 2 volts.

Contained in a simple power transistor case are the two devices, a reverse-poled protection diode and two biasing resistors across the base-to-emitter junctions.

Schematics are shown for two ampli-

fiers to drive 4- and 8-ohm speakers using 58- or 64-volt split power-supplies. The diagram in Fig. 2 shows the parts for an 8-ohm amplifier with the values for 4-ohm operation in parentheses.

Rated total harmonic-distortion of the amplifier is 0.5%, but a glance at the distortion plot (Fig. 3) shows that this is somewhat conservative. Locating the 0.5% point on the data sheet distortion curve finds it well up on the sharply increasing portion of the curve, at 50 watts. Between 0.1 and 40 watts at 1 kHz, the curve shows THD below or equal to 0.04%. The total harmonic-distortion is constant between 10 Hz

and 3 kHz, then rises, doubling at about 15 kHz, and tripling at 30 kHz. High-frequency distortion is less important than mid-band distortion since the higher harmonics are beyond the hearing spectrum. Besides, at 30 kHz it's still only 0.1%. The IHF power bandwidth is 5 Hz to 50 kHz at the rated 0.5% distortion.

Fairly conservative amplifier design starts with the audio input capacitively coupled to one base on an NPN differential input pair. DC feedback through a 15K resistor to the opposite input base keeps the output voltage at 0 volts where it is referenced to ground by the base resistor of Q1. The AC gain must be higher than the unity DC gain to be productive and partial signal bypassing at Q2's base is the way it's done. The AC gain is 15,000/560 or 26.8 times. The output is 17.9 volts RMS across 8 ohms (40-watts) so the input for full output is 17.9/26.8 or 670 millivolts. The data sheet says the input selectivity for full output is 700 millivolts, so I guess I made the calculation right!

A pair of RCA1A16 PNP's, a second diff-amp has its bases tied to the NPN collectors, adding to the open-loop gain. The more open-loop gain with the same amount of distortion, the lower the resulting distortion with feedback is going to be. Single-ended drive to the output circuit is fed from the collector of Q3 with Q4's collector grounded.

Crossover distortion of the output stage is controlled by separating the bases of the two Darlington output devices by an active circuit. Q5 uses a 1K pot and a 1K resistor to adjust the output idling current. The transistor is a negative feedback DC amplifier with its collector-to-emitter voltage regulated by the gain-determining resistance ratio and its base-emitter voltage.

Protection of the output Darlington's is accomplished by Q7 and Q8. They sense the voltage across the two 0.39-ohm current-sensing resistors. High currents in the upper or lower output transistors turn on the corresponding protection device loading down the input to limit the current. Forward biasing the base to collector junctions of the protection transistors is prevented by D7 and D8.

Many protection circuits have the following problem. The current-limiting value is a fixed number determined by the value of the sensing resistor. Dividing the turn-on V_{be} of the protection device by the value of the current sensing resistor gives the limiting current. The problem is that as the output voltage approaches ground potential, there is a larger voltage drop across the conducting output transistor. Sustained currents just under or at the limiting value can destroy the transistor because

(continued on page 78)

EDLIE'S
BARGAIN
BONANZA
ONLY
HIGHEST QUALITY
PRODUCTS



SURPLUS TUBES

All guaranteed for 1 full year.

Acquired from U.S. Defense depots or removed from equipment (new and used). These are laboratory tested and guaranteed for one full year. Most are of such standard makers as RCA, GE, etc.

3A3	6AU6	6EB8	12AL5
3AF4	6AV6	6EJ7	12AL11
3BN6	6AV11	6EM7	12AT7
3DG4	6AX4	6ER5	12AU7
3KT6	6AX5	6EY6	12AV6
3Q4	6AY3	6GF7	12BE6
4BC5	6AY11	6GH8	12BH7
4BN6	6BA6	6GN8	12C8
4BU8	6BG6	6GU7	17J28
4BZ7	6BJ8	6K6	18FW6
4CY5	6BQ6	6K11	21K06
5V6	6BZ6	6LB6	25L6
5Y3	6CB6	6SN7	35EH5
6AF4	6CG7	6T8	35Z5
6AG5	6CM7	6V6	36AM3
6AG7	6DE4	6W4	50A5
6AL5	6DR7	6X4	50L6
6AQ7	6DW4	10EW7	
6AT6	6E8	12AE7	

THIS MONTH'S SPECIALS!

- 74515 Schottky 3 inp pos AND. O.C. 45¢
- 739 Dual lo-noise pre-amp 85¢
- N8815A Dual 4 inp. NOR 2 for \$1.00
- (K018) 4 LSD's in mini-DIP \$2.00

TTL			
<input type="checkbox"/> 7400	16¢	<input type="checkbox"/> 7446	80¢
<input type="checkbox"/> 7401	18¢	<input type="checkbox"/> 7447	80¢
<input type="checkbox"/> 7402	23¢	<input type="checkbox"/> 7448	80¢
<input type="checkbox"/> 7403	23¢	<input type="checkbox"/> 7473	49¢
<input type="checkbox"/> 7404	23¢	<input type="checkbox"/> 7474	49¢
<input type="checkbox"/> 7405	23¢	<input type="checkbox"/> 7475	85¢
<input type="checkbox"/> 7406	23¢	<input type="checkbox"/> 7476	53¢
<input type="checkbox"/> 7410	23¢	<input type="checkbox"/> 7490	79¢
<input type="checkbox"/> 7411	27¢	<input type="checkbox"/> 7492	79¢
<input type="checkbox"/> 7413	40¢	<input type="checkbox"/> 7493	69¢
<input type="checkbox"/> 7420	23¢	<input type="checkbox"/> 7495	79¢
<input type="checkbox"/> 7430	23¢	<input type="checkbox"/> 74121	57¢
<input type="checkbox"/> 7440	30¢	<input type="checkbox"/> 74122	57¢
<input type="checkbox"/> 7442	\$1.12	<input type="checkbox"/> 74123	67¢

- LINEARS**
- LM309K 5v Ia reg. \$1.15
- 555 Timer 75¢
- 566 Function gen. \$1.75
- 567 Tone decoder \$1.95
- 741 comp. op amp 39¢
- 2102 1024 bit RAM \$4.95
- 8038 volt cont osc \$4.25

- CLOCK CHIPS WITH DATA**
- (MM5314) 6 dig clock \$4.95
- CT 7001 Alarm & Date \$5.95

- LED'S**
- (K223) 10 Asst LEDs \$1.00
- (K242) 5 Jumbo Green LEDs \$1.00
- (K242) 5 Med Yellow LEDs \$1.00
- (K001) 5 Jumbo Red LEDs \$1.00
- (K011) 5 Med Red LEDs \$1.00
- (K012) 5 Mini Red LEDs \$1.00
- (K293) DL707 (equiv.) 7 seg red LED, .3" char, comm anode \$1.00
- (K007) DL747 7 seg red LED, .6" char, comm anode \$1.95
- (K013) MAN 5 (equiv.) 7 seg green LED, .27 char, comm anode \$1.49
- (K014) MAN 8 (equiv.) 7 seg yellow LED, .27 char, comm anode \$1.49

- IC BREADBOARDS & TERMINALS**
- Boards have .042 holes. Made of 1/16" polyester glass.
- (KB663) 3"x4" 94¢
- (KB664) 3"x6" \$1.29
- (KB665) 4"x6" \$1.65
- (KB666) 4"x8" \$2.12

- Push-in terminals
- (KP6601-20) pkg 20/90¢
- (KP6601-100) pkg 100/\$2.89
- Push-in flanged pins
- (KB6602-20) pkg 20/90¢
- (KB6602-100) pkg 100/\$2.89
- Push-in flea clips
- (KB6603-20) pkg 20/90¢
- (KB6603-100) pkg 100/\$2.89
- (K008) 14 pin DIP sockets 3 for \$1.00

- (K1104) IC REMOVAL AND INSERTION TOOL \$4.95
- "Pul-n-sertic" extracts and inserts ICs without damage.
- (K271) IN4148 High Speed switching diode. Full leads. 12 for \$1.00

- (K015) TOP QUALITY RECORING TAPE. Made by Scotch, Soundcraft, or Ampex. On 10 1/2" reels, 1/4" x 3600'. \$1.99 ea. 2 for \$1.75 ea. 10 for \$1.50 each.
- (K017) COPPER CLAD BOARDS! Copper on one side, 1/16" thick. Excellent quality for either production or experimental work. B) 4"x16 1/8" 99¢ ea. 3/\$2.69 D) 8"x16 1/8" \$1.19 ea. 3/\$2.99 E) 6 1/2"x17 1/2" \$1.19 ea. 3/\$2.99
- (K134) 8 ROTARY SWITCHES. Some multiple gang. \$1.00
- (K128) 13 MINIATURE ELECTROLYTIC CAPACITORS \$1.00. Axial & upright, popular values.
- (K144) TRANSISTOR REPAIR KIT \$1.19. Various parts used to repair transistorized devices.
- (K336) TO-3 TRANSISTOR SOCKETS 12 for \$1.00
- (K298) 1 WATT ZENERS 60¢ available in 5V 9.1V, 12V, 20V.
- (K164) 4 ROLLS OF WIRE \$1.00. Approx. 25 ft. per roll, 20-28ga.
- (K140) TAPE RECORDER SPARE PARTS KIT \$2.95. Parts for repairing most tape recorders: capacitors, meter, pilot lamp, jacks, and MUCH MORE.
- (K167) 10 MINIATURE POTENTIOMETERS \$1.00
- (K182) 2 MISC. METERS \$1.00. Miniature.
- (K156) 60 DISC CAPACITORS \$1.00. Asst. from .0001 to .1, most 600v, Z5U, NPO, N750, etc.

- (K147) 4 lb. GRAB BAG SPECIAL \$1.00. Full of exotic and exciting electronics parts.

- (K155) TUBE BONANZA! \$1.00. 20 asst. popular tubes, untested.

- (K142) 50 PRECISION RESISTORS \$1.00. All 1%, 1/2w and 1w, low and high ohmages.

- (K150) 15 HI-FI KNOBS \$1.00. Every one superb! Purchased from Harmon, Kardon, Fisher, etc.

- (K102) CALCULATOR KEYBOARD \$2.95. Wild Rover C-1380. Can be used with CT5001. 4 function, clear, clear entry and constant. 7 cm x 9 cm.

- (K175) 70 1/2w CARBON RESISTORS \$1.00. Asst. values. Some 5%.

- (K154) 150 CUT LEAD RESISTORS \$1.00. Carbon, all leads long enough for soldering.

- (K149) 20 POLYSTYRENE TOP GRADE CAPACITORS \$1.00
- (K132) 20 DUAL POTS \$1.00

MONEY BACK GUARANTEE
Terms: Minimum order \$4.00. Include postage. Either full payment with order or 20% deposit, balance C.O.D.

WRITE FOR FREE 1976 VALUE PACKED CATALOG
Listing thousands of components, tubes, transistors, IC's, kits, test equipment.

BONUS FREE CAPACITOR KIT
With Every \$5 Purchase

EDLIE ELECTRONICS, INC., 2700-K HEMPSTEAD TPKE., LEVITTOWN, N.Y. 11756

Circle 23 on reader service card

RADIO-ELECTRONICS



ANNOUNCING the TEKTRONIX T900 Oscilloscopes

from \$695
probes included and more...

Here's important news for engineers, technicians and educators who want the quality, reliability and support associated with TEKTRONIX Oscilloscopes - all at a moderate price. T900* Oscilloscopes are an entirely new line designed for cost savings without sacrifice of basic performance.

This New Line Includes:

- T921—Dc to 15 MHz; single-trace, mono time-base \$ 695**
- T922—Dc to 15 MHz; dual-trace, mono time-base \$ 850**
- T932—Dc to 35 MHz; dual-trace, mono time-base \$1050**
- T935—Dc to 35 MHz; dual-trace, dual time-base with delayed sweep \$1250**
- T912—(Storage model) Dc to 10 MHz, dual-trace mono time-base .. \$1195**

Easy to Use

T900 Oscilloscopes are simple to use. All have a large, bright (8 x 10 cm) crt, beam finder, single knob trigger control, delay line to enable viewing of waveform leading edge, automatic selection of tv line or frame display and functionally color-coded control panels. Convenience is also enhanced by a full complement of accessories including 10X probes (included in price), optional scope stand, camera, rain jacket and more... T900 Oscilloscopes are easy to handle and fit into small spaces. They weigh only 15-18 lbs. and measure only 7" x 10" x 19".

Tektronix Support

T900 Oscilloscopes are warranted against defective materials and workmanship for one year. There are over 37 service centers and 50

field offices across the U.S. Whenever you need help in the selection, operation, application or servicing of T900 Oscilloscopes your local field engineer is available to help you... no extra charge... just extra value.

For a copy of the new T900 Brochure (includes complete specifications), or ordering information write to Tektronix, Inc., P.O. Box 500, Beaverton, Oregon 97077. For immediate information call your local

Tektronix field engineer or Tektronix, Inc. (503) 644-0161 extension T900.

*Available presently in U.S.A. only.
**U.S.A. price FOB Beaverton, Oregon.



TEKTRONIX®

committed to
technical excellence

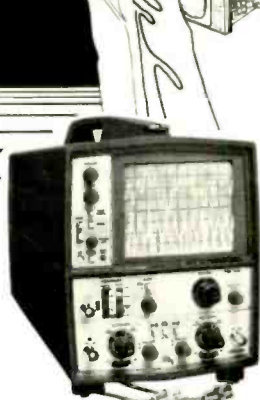

T912



T921

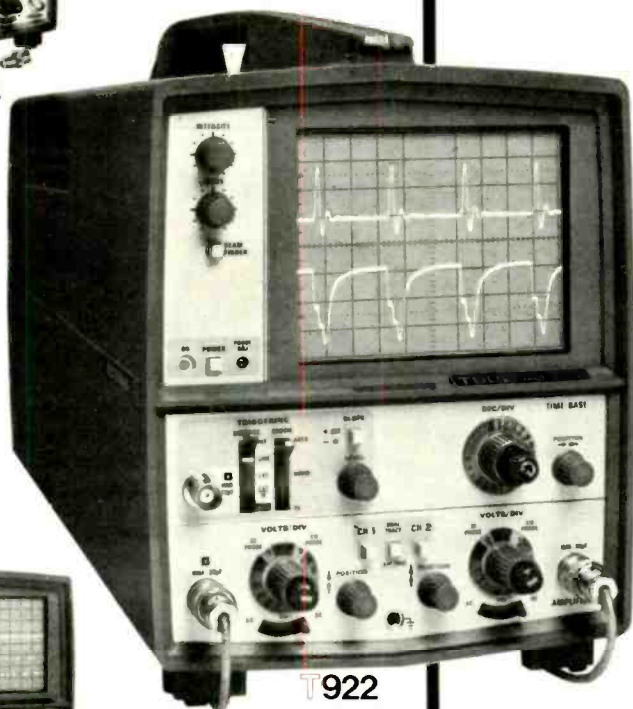

T922



T935



T932

Circle 24 on reader service card

Circle 32 on reader service card for demonstration

Learning with CIE is



Electronics no picnic.

**It takes work.
And a few
sacrifices.
But
it's worth it!**

The minute you start your CIE course you'll see why CIE is different than other home-study schools.

Because as a CIE student you'll get the kind of electronics training that prepares you for a career, not just a job. We'll give you a meaningful, well-rounded foundation in electronics theory and practice. And with our special Auto-Programmed® Lessons, we'll make sure you grasp the key theories and methods of modern Electronics. No "fun and games" frills. No time-wasting, superficial lesson material. No "snap" exams.

We'll challenge your thinking.

We have to. Because after you graduate, employers will expect you to really know how to analyze and troubleshoot virtually all kinds of electronics equipment. Some employers of electronics personnel have told us that our graduates have what it takes.

That's why we're so thorough. We've got a 40-year reputation to uphold and we're going to keep it by giving our students the best *independent home-study* training we can.

Sure, some of our weaker students drop out. (Learning Electronics with CIE is no free ride.) But you can bet on this... the ones who do make it are ready! Ready to go out and make it in the rewarding world of Electronics. And that's the reason you want to learn, isn't it?

You can have attractive job opportunities

There have already been many exciting developments and breakthroughs in

Electronics and some people might assume there will be no new frontiers... no new worlds to conquer. Not so.

Electronics is still growing. In nearly every one of the new and exciting fields of the Seventies you'll find electronics skills and knowledge in demand. Computers and data processing. Air traffic control. Medical technology. Pollution control. Broadcasting and communications.

Importance of an FCC License

If you want to work in commercial broadcasting... television or AM or FM broadcasting... as a broadcast engineer, federal law requires you to have a First Class Radiotelephone License. Or if you plan to operate or to maintain mobile two-way communications systems, microwave relay stations or radar and signaling devices, a Second Class FCC License is required.

But even if you aren't planning a career which involves radio transmission of any kind, an FCC "ticket" is valuable to have as Government certification of certain technical skills. It's a job credential recognized by some employers as evidence that you know your stuff.

A good way to prepare for your FCC License exam is to take one of the CIE career courses which include FCC License preparation. We are confident you can successfully earn your license, if you're willing to put forth an effort,

because the vast majority of CIE students have. In fact, based on continuing surveys, close to 9 out of 10 CIE graduates have passed their FCC exams!

So if you are serious about getting ahead in Electronics... if you are willing to put in the extra work... get in touch with us.

We have many *career* courses for you to select from. If you already have some electronics training, you may want to skip our beginner-level courses and enroll in an intermediate program. Or, if you're really hot, there's a tough, college-level course called "Electronics Engineering" that can make you even better.

Send today for FREE school catalog

Send today for our FREE school catalog and complete package of *independent home-study* career information. For your convenience, we will try to have a representative call to assist in course selection. Mail reply card or coupon to CIE... or write: Cleveland Institute of Electronics, Inc., 1776 East 17th Street, Cleveland, Ohio 44114.

Do it TODAY.

G.I. Bill Benefits

All CIE career courses are approved for educational benefits under the G.I. Bill. If you are a Veteran or in service now, check box for G.I. Bill information.

CIE Cleveland Institute of Electronics, Inc.

1776 East 17th Street, Cleveland, Ohio 44114
Accredited Member National Home Study Council

Yes, I want your FREE school catalog and career information package today.

I am especially interested in:

- | | | |
|--|--|-------|
| <input type="checkbox"/> Electronics Technology | <input type="checkbox"/> Industrial Electronics | RE-64 |
| <input type="checkbox"/> FCC License Preparation | <input type="checkbox"/> Electronics Engineering | |
| <input type="checkbox"/> Color TV Maintenance | <input type="checkbox"/> Other _____ | |
| <input type="checkbox"/> Mobile Communications | | |

Print Name _____

Address _____

Apt. _____

City _____

State _____

Zip _____

Age _____

Check box for G.I. Bill information. Veteran On Active Duty

Circle 25 on reader service card

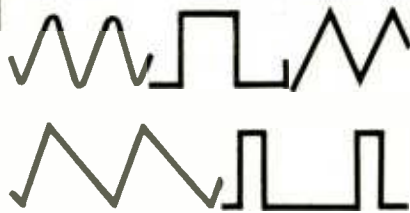

0.1 Hz. to 100 KHz.



For only \$39.95

Our new FG-2 Function Generator kit gives you all five of the most useful waveforms for design and testing at one fourth the cost of previous similar instruments. Thanks to improved IC's the FG-2 now features amplitude stability of ± 1 db over any range, Sine wave distortion of less than 1% from 20 Hz. to 20,000 Hz. and an output of 4.0 Volts peak-to-peak with adjustable offset. The offset selector lets you put the positive peak, negative peak, or the center of the waveform on DC ground. The DC coupled circuit keeps the waveforms in exactly the same position no matter what the level control setting.

Gray impact plastic case 5 1/4 x 6 1/2 x 2 1/2. 115 Volts 60 cycle power supply included.

FG-2 Function Generator Kit shipping weight 3.0 lbs.....\$39.95 PPD

GET OUR
**NEW 1976
CATALOG**

listing this and other unique kits

"FREE"

by simply circling our number on the reader service card.



SOUTHWEST TECHNICAL PRODUCTS CORPORATION

DEPT. RE

219 W. Rhapsody
San Antonio, Texas 78216

Circle 26 on reader service card

STATE OF SOLID STATE

(continued from page 72)

of overheating or second breakdown because of the excessive voltage-current power dissipation product.

The RCA design uses D9 and D10 to dynamically change the current limiting value as the output voltage swings. As the output voltage rises for example, D9 conducts and provides a path to

Q8876. Characteristics for all the transistors in the 40-watt amplifiers are listed in addition to those for the 1B07 and 1B08.

Sprague Darlington arrays

Speaking of Darlington's, the Semiconductor Division of Sprague Electric has released three transistor arrays. They can be used to drive solenoids, relays and lamps.

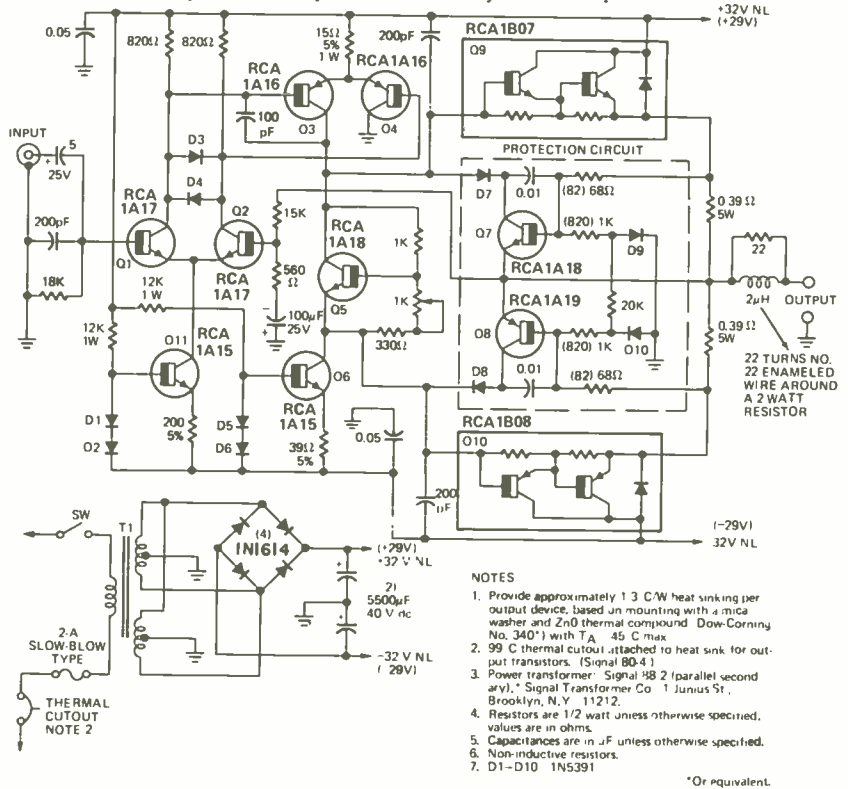

FIG. 2—RCA POWER DARLINGTON transistors are used in the output stage of this 40-watt amplifier.

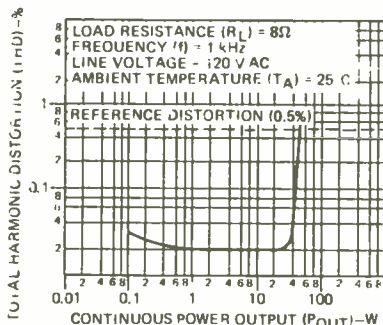

FIG. 3—TYPICAL DISTORTION plot for 40-watt amplifier using 64-volt supply.

ground, robbing current away from the base of Q7. The current limiting effect increases as the output voltage increases. Under these conditions, the load demand is the highest and the collector to emitter voltage lowest and everything is changing the right way. Near ground, the limit current is lowest where the most protection and the least normal current drive is needed.

Commercial data bulletin, File No. 791, is available from RCA Solid State Division, Box 3200, Somerville, NJ

Seven Darlington pairs with minimum betas of 1000 are in 16 pin DIP plastic packages with a total package dissipation limit of 2 watts. Inrush currents of 500 mA make the arrays ideal for driving tungsten filament lamps with their low resistance when cold. Steady loads of 500 mA from 50-volt sources are accommodated.

The ULN-2001A is a general-purpose unit which can be driven by DTL, TTL, PMOS, or CMOS circuitry. A 7-volt Zener and 10.5K resistor in series with the inputs of the ULN-2002A limits the input current when driven from 14 to 25 volt PMOS devices. And the ULN-2003A has a 2.7K series base resistor for direct-drive from 5-volt TTL or CMOS.

Sections can be paralleled to increase the output current ratings beyond the 500 mA individual values. All the inputs are neatly lined up on one side of the package and the outputs are directly opposite.

Bulletin 29304 gives the details from the Technical Literature Service, (continued on page 80)

WHO'S AFRAID OF 35Kv?

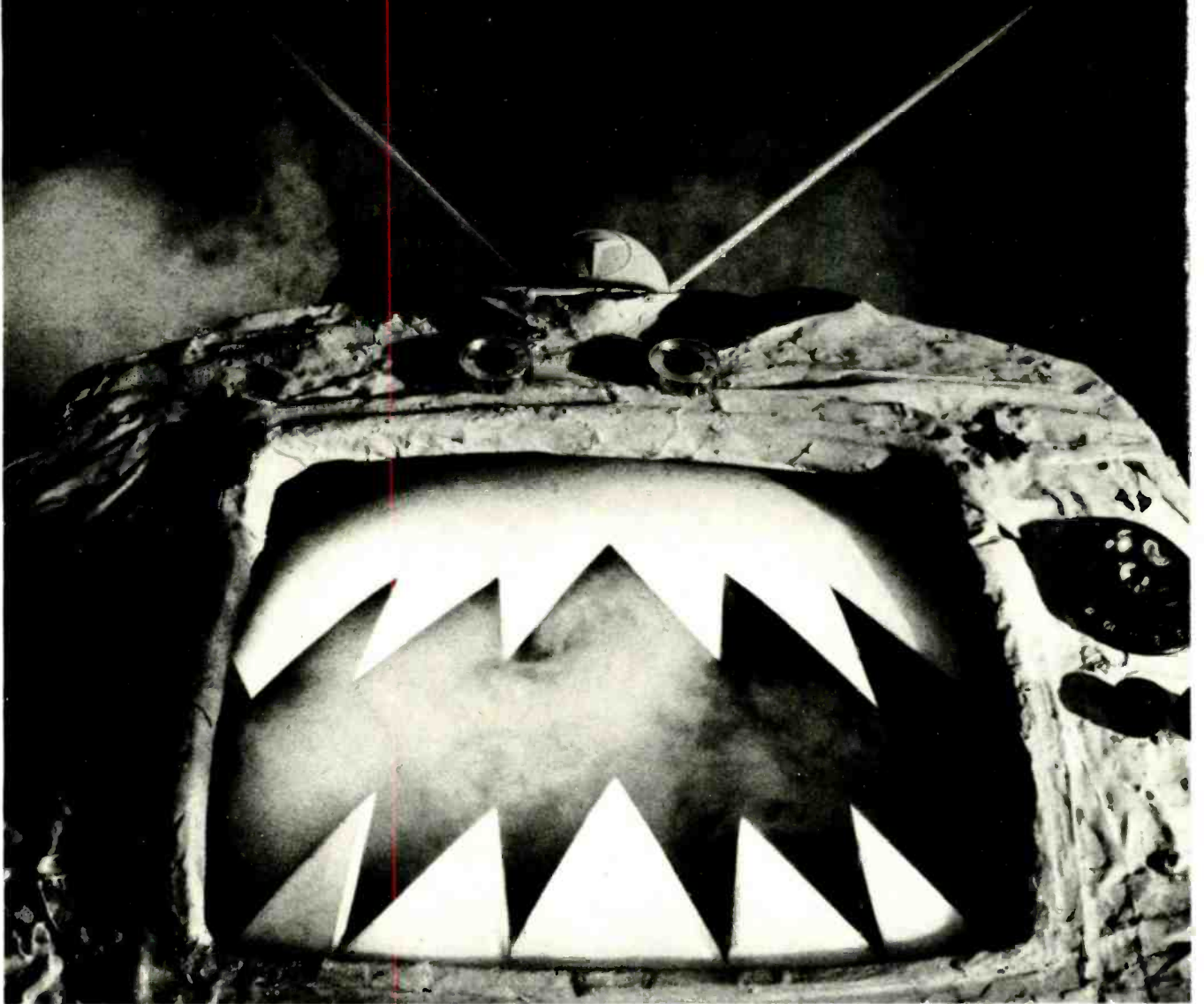

Now you can test new 35Kv chassis with your 22Kv test jig.

Introducing the CK2000 regulator.

It protects your test jig's picture tube against arcing.

It connects quickly to practically any jig without modification.

Secret of the CK2000 is a special varistor that takes any anode voltage from



22 to 35Kv and converts it to 22Kv for your test jig. Voltages below 22Kv simply don't activate the varistor.

Best of all, our CK2000 costs only about a quarter as much as many new test jigs.

Who's afraid of 35Kv? With our new CK2000 regulator, there's probably not a TV set in the world that can scare you.

See your Sylvania distributor.

We're helping you make it.

GTE SYLVANIA

Circle 27 on reader service card

Polaris

40 KV DUAL RANGE Probe

MEASURES
VOLTAGE
AND
CURRENT

FOR
TODAY
AND
TOMORROW

MODEL
#651

Only
\$29⁹⁵

SPECIFICATIONS

Range One:
40,000 Volts D.C.
Range Two: 0-400 MA, D.C.
Accuracy: $\pm 2\%$ Full Scale
Meter Movement: 50 μ A

Polaris DC POWER SUPPLY 0-25 VOLTS 250 MA TEST & SERVICE SOLID STATE EQUIPMENT

MODEL
TPS 225

Only
\$29⁹⁵

- Operates on 105/125 V.A.C.
- Adjustable Voltage Output
- Meter Measures Voltage & Current
- Extremely Low Ripple



Polaris COBRA CURVE TRACER

RAPID TRANSISTOR & DIODE TESTER

MODEL CT 751

Only
\$22⁹⁵

- In & Out of Circuit Testing
- Gain-Junction-Leakage Test
- In Circuit Test Leads
- Checks Diodes for Function & Polarity



Polaris New York

2862 Fulton St., Bklyn, N.Y. 11207

Please send me information on

Probe Power Supply Curve Tracer

Name _____

Street _____

City _____ State _____ Zip _____

My supplier is _____

SOLD THROUGH DISTRIBUTORS ONLY

STATE OF SOLID STATE

(continued from page 78)

Sprague Electric Co., 81 Marshall Street, North Adams, MA 01247.

ER201M analog function array

The circuit possibilities for the ER-201M are numerous, but probably the most interesting application for our readers is the scope chopper. With a single circuit and a handful of resistors plus one timing capacitor, the adapter is complete. A dual-channel oscilloscope chopper needs an electronic one-out-of-two multiplexor and a chopping-oscillator drive source. Figure 4 is the

volts. Again when passing through the comparison threshold point, the output switches state quickly.

Comparator 2 is the clock inverter. The samplers have inverted control-enable functions. When the control inputs are high, the output is effectively disconnected and the switch open. Lowering the voltage on the input lines to $-V_{cc}$ turns on the switch and the output follows the input within the 30-milivolt maximum offset of the sampler. The non-inverting input of comparator 2 is at ground potential because of the R6-R7 divider. The negative input is fed from the output of comparator 1.

Each comparator's output feeds one

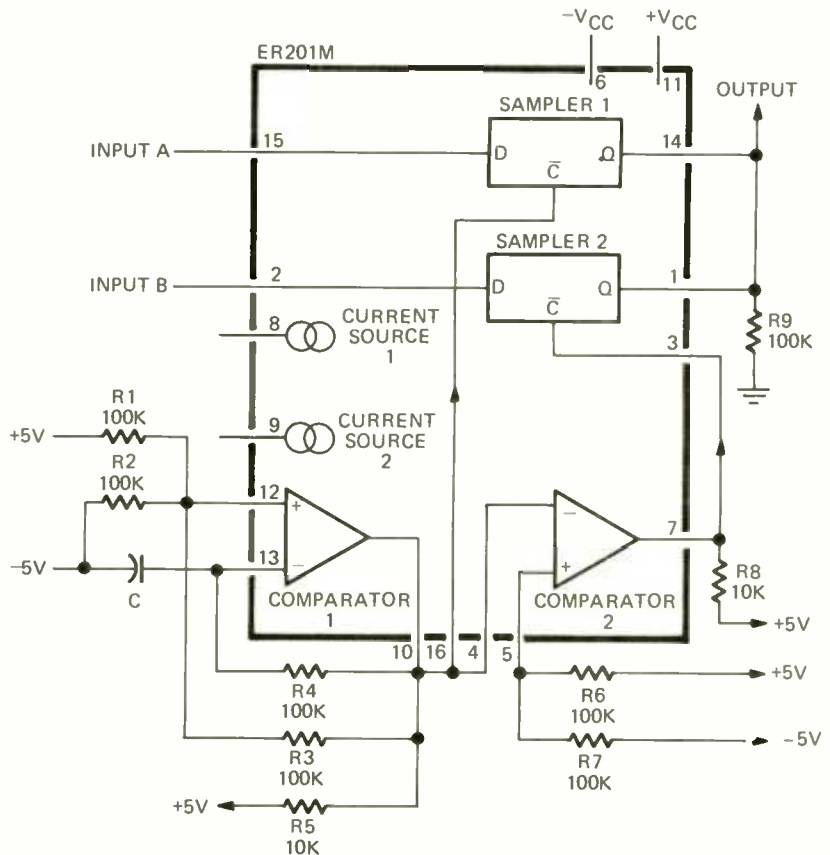

FIG. 4—DUAL TRACE OSCILLOSCOPE adapter using ERG's analog function array.

ERG dual-trace adapter with a 50-kHz chopping frequency.

Comparator-1 is connected as an RC oscillator with both negative and positive feedback. Choosing as a starting point the state where the comparator-1 output is switched off, there is a path through R3 raising the voltage on pin 12 above its zero-volt R1-R2 biasing level to about 1.3 volts. Capacitor C charges through R4 towards 5 volts; this is the negative feedback path. As the voltage on pin 13 passes through the raised reference voltage on pin 12, the comparator switches quickly because of the positive feedback through R3. The output (pin 10) is pulled down to -5 volts. The situation is now symmetrically reversed lowering the voltage on pin 12 below zero to about -1.3 volts and C discharges towards -5

of the complemented enable inputs of the samplers. Because of their 180 phase relation, the control inputs alternately turn on as one samples its input for a half cycle and then the other. Sampler outputs are paralleled and terminated by R9, and the switched signal feeds the vertical channel of the oscilloscope.

At higher input-levels, attenuation should be provided in front of the adapter to prevent overloading. A good place to insert the sampler is in or after the oscilloscope preamplifier where the level is controlled to a narrow signal level range by the scope gain controls. Insertion here also assures that the weaker signals are amplified before entering the chopper for small DC error and minimized noise contribution by

(continued on page 88)

5 WAYS TO STOP WASTING TIME IN ELECTRONICS.

1. Stop wasting your time soldering. Save hours of soldering, desoldering, re-soldering with QT sockets and bus strips. Connect and disconnect resistors, capacitors, transistors, IC's etc., literally as fast as you can push in—or pull out—a lead. Make instant interconnections with short lengths of wire. And interlock sockets and bus strips for infinite expandability on bench, chassis, plug-in cards, etc. At \$2.00-12.50*, you'll wonder how you've done without them!

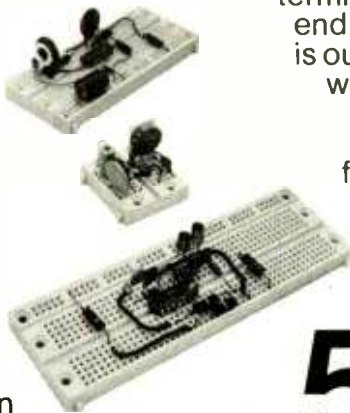

popular solderless breadboarding system... our Proto-Board® line. For just \$15.95*, you can have our PB-6 Proto-Board kit. Takes about 10 minutes to assemble, and gives you 630 solderless QT terminals. On the other end of the spectrum is our giant PB-104, with 3,060 solderless terminals for \$79.95*, or only 2.6¢ apiece! You can choose from a variety of models, with or without regulated power supplies.

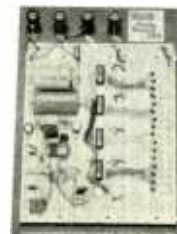

2. Stop wasting your time designing circuits. Design Mate™ 1 will help, by providing you with QT hookup versatility (see above), a continuously-variable 5-15V, 600mA 1%-regulated supply, and a voltmeter to monitor supply or circuit. Plug it in, turn it on and start designing more by soldering less. At \$49.95*, you can afford to.



3. Stop wasting your time testing. On DIP IC's, finding the lead you want—and making sure you don't short others—can be as delicate as surgery. Until you discover our handy Proto-Clip™... the instant, short-proof way to test IC's up to 24 pins. Available without cable or with cable, they're the most economical and foolproof IC test aids on the market.

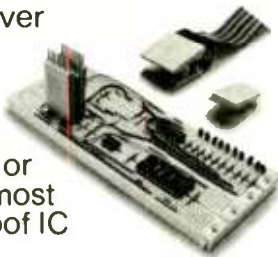

5. Stop wasting your time testing. You can own the test gear you need at economical prices. Our Design Mate 2, for instance, gives you a 3-waveform function generator—sine, square and triangle—from 1 Hz to 100 kHz... for just \$64.95*. Design Mate 3 R/C bridge provides 5%-accurate measurements of unknown resistors and capacitors from 10 ohms to 10 meg and 10 pF to 1 uF, with built-in LED null indication. Price is a "micro" \$54.95*. And as you're reading this, we're busy adding new low-priced, high-quality Design Mates.



Stop wasting your time reading. Send for the complete CSC catalog and distributor list... and start making more of your time in electronics.

*Manufacturer's recommended retail.



44 Kendall Street, Box 1942
New Haven, CT 06509 • 203-624-3103 TWX: 710-465-1227
West Coast office Box 7809, San Francisco, CA
94119 • 415-421-8872 TWX 910-372-7992
Canada Len Finkler Ltd., Ontario

If you've ever said...

"There must be a better

Send for a free Career Booklet that could start you on the road to success in a rewarding new career.

It happens to all of us, sooner or later. No matter what kind of job we have.

One day, it suddenly strikes home that we're going to have to work for a living, the rest of our lives. And most of us are horrified at the thought of forever being locked into the jobs we now hold.

"Surely," we tell ourselves, "there must be a way to get more satisfaction out of working. Surely, there must be a way to find a job that's more rewarding."

"Surely," in other words, "there must be a better way to earn a living!"

If you, too, have been thinking these same thoughts, you'll find one of our free Career Booklets very helpful at this time. We invite you to send for one.

Your free booklet will describe the opportunities for higher income and greater job security you might expect in one of the career fields listed on our coupon. It will also explain why ICS can pre-



way to earn a living..”

pare you for this new career field...right in your own home...in your spare time...regardless of your education or past experience.

Of course, no school — not even ICS — can guarantee you a better job. But ICS *can* give you the first-rate training you need — especially if you're interested in one of the growing careers where ICS concentrates its training. Like Electrician. Engineer. Auto Mechanic. TV Repairman. Air Conditioning Serviceman.

Along with your Career Booklet, you'll also receive a free Demonstration Lesson.

Please bear in mind that ICS has a long and distinguished record of success. In fact, since 1890, millions of men and women around the world have turned to ICS for career training.

More than 70 of America's largest 100 corporations (including Gulf Oil, Bethlehem Steel, 3M, Westinghouse, and International Paper) use ICS training for their own employees.

Earn a degree without going to college

And the ICS Center for Degree Studies is authorized by the Pennsylvania Department of Education to grant the Associate in Specialized Business degree in Accounting and Business Management, and the Associate in Specialized Technology degree in Civil, Mechanical, Electrical, and Chemical Engineering Technologies.

These degree programs are not mere stepping-stones to higher education nor are they primarily intended for transfer toward more advanced degrees. They are practical, career-oriented programs designed to help you reach your objectives without further academic training.

If you already have some college education, you may be able to receive advanced standing toward your degree. With a degree from ICS, you'll be able to apply with pride for jobs that call for career training.

An Ideal Way to Learn

Whether you choose a degree program or a non-degree program, as an ICS student you study at home, on your own schedule. You waste no time

traveling to and from class. And you never have to miss a paycheck.

But you're never alone. Skilled instructors are ready to help you.

If you ever have doubts or problems or just want to talk to an instructor, you can call ICS from anywhere in the continental United States and Canada using our toll-free Dial-a-Question® service.

No one can promise success, but if you *want* more — more money, more security, more day-to-day satisfaction and more future — our free Career Booklet and free Demonstration Lesson can help you get started in the right direction. Just check the box next to the field that interests you most and mail the coupon today. There's no obligation.

Remember, it's your life. You might as well make the most of it.

© 1975 Intext. Inc.

FOR A FREE CAREER BOOKLET & DEMO LESSON,
CHECK BELOW.

<input type="checkbox"/> Electrician	<input type="checkbox"/> Automotive Mechanics
<input type="checkbox"/> Engineering	<input type="checkbox"/> Business Management
<input type="checkbox"/> Accounting	<input type="checkbox"/> Civil Engineering
<input type="checkbox"/> Drafting	<input type="checkbox"/> Interior Decorating
<input type="checkbox"/> Electronics Technician	<input type="checkbox"/> Construction Electrician
<input type="checkbox"/> TV Service & Repair	<input type="checkbox"/> Appliance Service & Repair
<input type="checkbox"/> Surveying & Mapping	<input type="checkbox"/> Income Tax
<input type="checkbox"/> Diesel Mechanic	<input type="checkbox"/> Motel/Restaurant Mgt.
<input type="checkbox"/> Air Conditioning & Refrigeration	<input type="checkbox"/> Mechanical Engineering
	<input type="checkbox"/> High School

EARN A DEGREE WITHOUT GOING TO COLLEGE

Business Programs:	Engineering Technologies:
<input type="checkbox"/> Accounting	<input type="checkbox"/> Civil
<input type="checkbox"/> Business Management	<input type="checkbox"/> Mechanical
	<input type="checkbox"/> Electrical
	<input type="checkbox"/> Chemical

The ICS Center for Degree Studies is authorized by the Pennsylvania Department of Education to offer career programs at home leading to Associate in Specialized Business and Associate in Specialized Technology degrees. For more information, check the field of your choice above.

Name _____ Age _____

Address _____

City _____

State _____ Zip _____

Phone _____

XA921N

ICS
INTERNATIONAL CORRESPONDENCE SCHOOLS
SCRANTON, PA 18515

VETERANS: TAKEN FOR CAREER PURPOSES. ICS PROGRAMS QUALIFY FOR VA BENEFITS. CANADIAN RESIDENTS USE SCRANTON, PA ADDRESS FOR SERVICE FROM ICS CANADIAN, LTD IN HAWAII 931 UNIVERSITY AVE., HONOLULU, HAWAII 96814

new products

More information on new products is available from the manufacturers of items identified by a Reader Service number. Use the Reader Service Card inside the back cover.

FET MULTIMETER, model 370, has capacitance measurement capability as well as full VTVM ranges and functions. It is a versatile solid-state bench instrument with full volts, current and ohms measurement capability plus six ranges of capacitance from 500 pF to 10,000 μ F. Input impedance on AC and DC voltage measurements is 10 megohms on all ranges.

Pushbutton selection of ranges and functions in the *model 370* speeds measurements and avoids switching through unwanted steps. True auto-polarity with indication eliminates lead reversing or switching on DC



voltage measurements and requires no zero-centered scale. All functions and ranges are protected against overload.

With a frequency response from 20 Hz to 50 kHz, the *model 370* is ideal for measuring voltages in AC amplifiers. DC voltage measurements in RF circuits are facilitated by a built-in isolating resistor that requires no third lead or probe switch, and HI/LO OHMS ranges allow in-circuit resistance measurements in solid-state circuits as well as conventional front-to-back ratio tests. A built-in op-amp supply eliminates the cost and nuisance of batteries for ohms tests.

The large 5½-inch mirrored-scale meter has seven easy-to-read, color-coded scales: two for volts and milliamps; one each for ohms, capacitance, and dB; and two for peak-to-peak volts. \$175.00—Hickok Electrical Instrument Company, Instrumentation & Controls Division, 10514 Dupont Ave., Cleveland, OH 44108.

Circle 33 on reader service card

SPEAKER SYSTEM, the *Gale GS401*, is a four-speaker, three-way bookshelf system recommended for use with high-powered amplifiers. It should be driven by an amplifier rated for at least 40 watts per channel. Power handling capacity is well in excess of 100 watts integrated program material. The speaker is said to be capable of producing high acoustic levels with exceptionally low harmonic and intermodulation distortion.

Measurements using methods suggested by the British Standards Institute show a frequency response of 55–20,000 Hz \pm 3 dB in an anechoic chamber. In a typical room

environment, frequency response is 35–25,000 \pm 5 dB. Usable bass response extends down to 30 Hz, and the speaker's wide dispersion ensures a stable stereo image that is unaffected by changes in listening positions.

The speakers include a pair of acoustically coupled 8" woofers, mounted in a damped sealed enclosure, a 4" sealed mid-range and

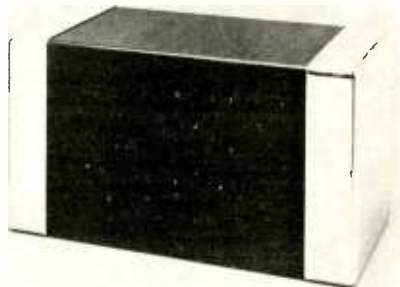

a ¾" dome tweeter. Controls are provided for adjustment of the midrange and treble balance.

The crossover network design minimizes both amplitude and phase distortion, especially at the crossover points, while maintaining a smooth impedance curve. All inductors are aircored and are wound with heavy gauge copper wire to minimize transient and harmonic distortion at high power levels. The critical capacitors are metallized paper. Further, a military-grade glass epoxy printed-circuit board is used for long-term reliability.

The cabinet is constructed from three-layer, extremely high-density chipboard with six internal bracing struts. This construction is intended to render it acoustically inert.

The system is available in two cabinet designs: Model *GS401A* has a matte black and chrome exterior and is priced at \$425; model *GS401B* is finished in a hand-rubbed walnut veneer, and is priced at \$385. Dimensions for both are 13 x 23¾ x 10¾ in.

The speaker is guaranteed for seven years against defects in materials and workmanship.—Roth/Sindell, Suite 102, 540 Kelton Ave., Los Angeles, CA 90024.

Circle 34 on reader service card

DIGITAL MULTIMETER, model 464, is a low-profile 3½-digit instrument with extra-large 0.43" LED readout. Housed in an attractive, high-impact, shock-resistant molded case, the instrument features: full pushbutton operation—ranges and functions; low-profile, modern case design; unique, tilt-and-view, adjustable handle; 0.2% VDC reading accuracy; bi-polar operation and automatic zero; and built-in rechargeable battery circuit in one version.

Simpson offers the new multimeter in two models, *464A* and *464D*. The *A* version, priced at only \$210.00, operates at line voltages of 120/240 VAC, 50-400 Hz. The *464D*,

(complete with internal battery-charging circuit), price \$235., permits line-free battery operation in the field for up to 8 hours in addition to full AC line operation without



batteries. Batteries required are four NiCad "D" size rechargeable cells.

This complete DMM measures all popular electrical parameters in 28 ranges; six DC and AC current ranges to 10 amperes, six resistance ranges to 20 megohms and five AC and DC voltage ranges to 1000 volts. A wide variety of accessories expands the utilization capabilities of the *model 464*. These include RF and high voltage probes, AC *Amp-Clamp* adapter and custom carrying case.—Simpson Electric Co., 853 Dundee Ave., Elgin, IL 60120.

Circle 35 on reader service card

RECORD CLEANING DEVICE, Groov-Kleen, consists of a chrome and steel armature that utilizes a sable tracking brush to lift dust and dirt out of record grooves. Then a removable velvet roller collects any residue before it reaches the stylus, reducing wear. And a



separate brush is enclosed to clean the roller. *Groov-Kleen* has height and balance adjustments so that it can be used with any record player or system without causing speed variation. A self adhesive seal anchors the unit to the turntable firmly and permanently.

Individually packaged in a PVC tuckbox with a vacuum-formed molded insert.—BIB Hi Fi Accessories, 155 Michael Drive, Syoset, NY 11791.

Circle 36 on reader service card

UNIVERSAL COLOR TV TEST JIG, 10J106, is a new RCA test instrument which facilitates the servicing of over 8600 different color television receivers. The unit enables service technicians to remove the chassis section of a faulty TV receiver for diagnosis and repair without the need for transporting the entire set to the service shop. It has its own picture tube, adjustable deflection components and speaker which connect to

the chassis of the receiver being repaired in place of its own. When it is adjusted to match the electrical characteristics specified for the chassis under test, the resulting picture is identical to the one which would be obtained in the home while the TV receiver was intact.

The model 10J106 TV test jig has specially designed built-in transformers with a switching system to permit the testing of almost all television receivers. Yoke impedances for virtually every TV set on the market are matched by simply turning two switches.

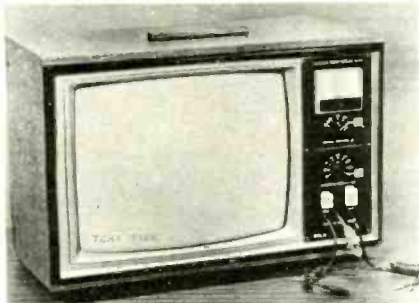

Simple pin-to-pin adapters are available to match the different connectors used by various manufacturers.

The 10J106 has a built-in high-voltage meter calibrated up to 35 kV with an accuracy of $\pm 2\%$. Also there is a built-in high-voltage lead, a ground lead, an audio cable and 16-ohm monitor speaker. It comes complete with extension cables and adapters needed for almost all RCA color chassis manufactured within the past ten years.

The unit is fully enclosed in a light-weight, sturdy cabinet with carrying handle. The test jig has a built-in magnetic tube shield, that reduces the effects of external magnetic fields.

Furnished with the 10J106 test jig is a complete cross-reference handbook which explains use of the instrument with almost all television receivers sold by the leading TV manufacturers. \$339.95.—RCA Distributors and Special Products Div., Bldg. 206-2, Cherry Hill Offices, Camden, NJ 08101.

Circle 37 on reader service card

OSCILLOSCOPE AND ADAPTER, LBO-310 HAM and LA-31, respectively, for communications make IF circuit waveform observations along with SSB and AM trans-



mitter signal monitoring. The new 3" scope, which has a vertical sensitivity of 20 mV p-p/div and a vertical bandwidth of DC to 4 MHz will also indicate tuned condition for RTTY operation as well as facilitate SSB signal observation through the use of an internal, two-tone generator. The LBO-310 HAM, in combination with the LA-31 adapter will also provide continuous monitoring of RF output to 500 watts.

Maximum input to the vertical amplifier is 600 volts. DC + AC peak-to-peak at a 1 meg-

**Some stores
sell test
equipment
at discount
prices.**

**At Fordham
we discount
their discount
prices.**

B&K, EICO, RCA, SENCORE
FLUKE, HICKOK, LEADER
and SIMPSON

Complete line of tubes,
tools and electronic supplies

**FREE CATALOG
FORDHAM**

RADIO SUPPLY CO., INC.

558 Morris Ave., Bronx, N.Y. 10451
Tel: (212) 585-0330

Circle 30 on reader service card

You don't have to buy a new car to get an electronic ignition.

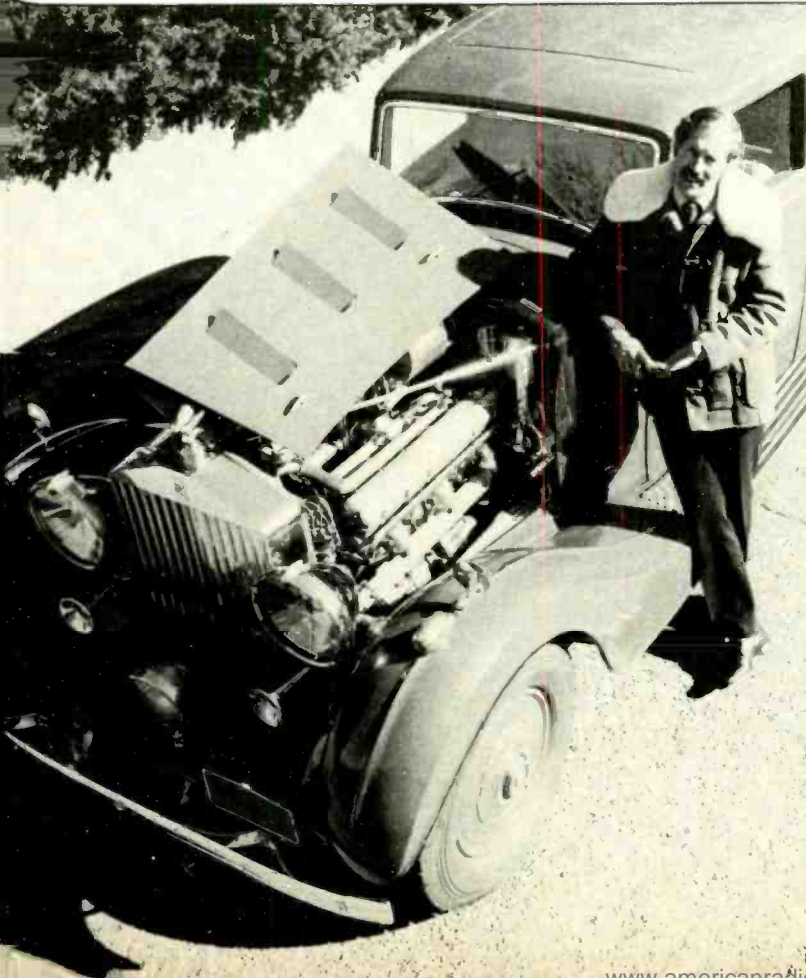

Let's face it. After 37 years, even a Phantom III can use a lift. That's why I put a Delta Mark Ten B Capacitive Discharge Ignition on my Phantom . . . to give her a spark I'd pit against any '75 model car. I went to Delta because they aren't Johnny-come-latelys. Delta's been making electronic ignition systems for over a decade.

Whatever kind of car you drive, you can give it the same great Delta performance I gave mine.

- Mark Ten B Capacitive Discharge Ignition Systems are manufactured by Delta Products, Inc., a company with a conscience, and with a proven record of reliability both in product and in customer relations.
- The Mark Ten B really does save money by eliminating the need for 2 out of 3 tune-ups. Figure it out for yourself. The first tune-up or two saved pays for the unit, the rest is money in your pocket. No bunk!
- Because the Mark Ten B keeps your car in better tune, you actually can save on expensive gasoline.
- With a Mark Ten B, spark plugs stay clean and last longer . . . fouling is virtually eliminated.



I want to know more about Mark Ten B CDI's. Send me complete no-nonsense information on how they can improve the performance of my car.

Name _____
Address _____
City _____ State _____ Zip _____

DELTA PRODUCTS, INC.
P.O. Box 1147, Dept. RE, Grand Junction, Colo. 81501
303-242-9000

Mark Ten B, assembled	\$64.95 ppd	Standard Mark Ten, assembled	\$49.95 ppd
Mark Ten B, kit	\$49.95 ppd	Deltakit®	\$34.95 ppd

Circle 61 on reader service card

FREE EICO CATALOG

346 Ways To Save On Instruments, Burglar Alarms, Automotive & Hobby Electronics!

The more you know about electronics, the more you'll appreciate EICO. We have a wide range of products for you to choose from, each designed to provide you with the most pleasure and quality performance for your money. The fact that more than 3 million EICO products are in use attests to their quality and performance.

"Build-it-Yourself" and save up to 50% with our famous electronic kits.

For latest EICO Catalog on Test Instruments, Automotive and Hobby Electronics, Eicocraft Project kits, Burglar-Fire Alarm Systems and name of nearest EICO Distributor, check reader service card or send 50¢ for fast first class mail service.

EICO—283 Malta Street,
Brooklyn, N.Y. 11207

Leadership in creative electronics
since 1945.



Circle 62 on reader service card

ohm impedance. Transmitter monitoring is from 1.8 to 54 MHz at power levels from 2 to 500 watts with a deflection sensitivity of 1 watt per division into 50- or 75-ohm impe-



dances. The LBO-31C HAM is priced at \$269.95. The LA-31 adapter which makes it possible to monitor the output waveform and power of both SSB and AM transmissions sells for \$22.95.—Leader Instruments Corp., 151 Dupont St., Plainview, Li. NY 11803.

Circle 38 on reader service card

FLEXIBLE-SHAFT POWER TOOL, model 232 Moto-Flex Tool, has a lightweight and slim handpiece that permits the user to perform hundreds of intricate operations in hard-to-reach areas. It can grind, drill, polish, buff, carve, sand, sharpen, deburr and engrave with speed and precision on metals, wood, glass, stone and plastics. The handpiece has ball bearings and measures 5 3/8" long by 23/32" in diameter and is knurled for positive

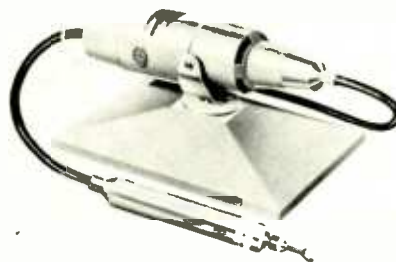

grip. It contains a 1/8" collet that accommodates all of Dremel's 1/8" diameter accessories. Other optional collet sizes are also available (3/32", 1/16" and 1/32").

It is powered by a 25,000 RPM, 1/15th horsepower, 1.0 amp., 115 VAC motor and comes complete with 34" long vinyl covered flexible shaft with ball bearing handpiece and a 360° swivel base for bench use and a handy hanger bracket for overhead mounting. Suggested retail price is \$59.95.

Also available are two solid-state speed controls that can regulate the motor speed from 0 to full RPM. The no. 217 is foot operated and has a retail price of \$21.95. The no. 219 is manually operated and has a retail price of \$19.95. Both units enable the user to control the motor speed to match the material and accessory being used—Dremel Manufacturing Division of Emerson Electric Co., Dept. PR., 4915 21st Street, Racine, WI 53406.

Circle 39 on reader service card

LOW-COST CURVE TRACER, EC-101 econo-trace displays a semiconductors characteristic curve on any oscilloscope with an external horizontal input. Simple to operate—test an unknown transistor in seconds—just connect three leads to scope, select polarity and base drive. Size the display with the scope vertical gain, and you have it—the actual operating characteristic of the device.

Then read subtle characteristics that would be very difficult (if not impossible) to derive from a meter-tester: leakage, noise, saturation voltage, linearity, matching, breakdown, and beta vs. collector current. Removes the doubt about transistor servicing; a shorted,

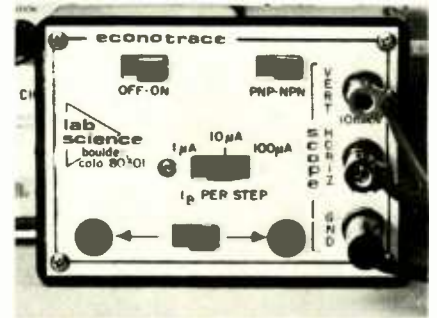

open, or high-leakage device shows up immediately.

The econo-trace operates from a single 9-volt battery (included) which lasts for over a year under normal use. Calibrated base drive, vertical and horizontal outputs make exact measurements possible. Current limiting and low-voltage circuits protect the device so that it is virtually impossible to harm it. 2 7/8" x 4 x 1 1/4"; 2 lbs; \$39.50.—Lab Science, Box 1972, Boulder, CO 80302.

Circle 40 on reader service card

SOLDERLESS BREADBOARDS. A new series of plug-in breadboards created to facilitate prototype design, experimentation, and testing of circuitry without the need for hard-wiring. The new boards accommodate 14- or 16-pin DIP's and other packages, and are made in various sizes to accept from one up to as many as 50 integrated circuits.

Principal feature of the new boards is that they employ plug-in socket pins instead of the

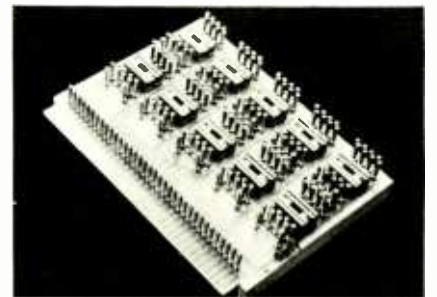

usual wire-wrappable or solderable connections. Thus, reliable yet temporary circuit interconnections can be quickly made and quickly changed during the course of design or test. A full range of accessories for these boards is also available. These include plug-in jumpers of various lengths, contact adapters to provide through connections when stacking boards, and self-mounting contact assemblies (individual connecting points which are easily field-installed in 0.055" diameter holes). Prices range from \$6.00 to \$4.80 per IC position.—Garry Manufacturing Co., 1010 Jersey Avenue, New Brunswick, NJ 08902.

Circle 41 on reader service card

DYNAMIC RANGE EXPANDER, model RG-1 can be added to any stereo high-fidelity component system to recover the musical dynamic range that is usually compressed or restricted in recordings, tapes and FM broadcasts.

It is designed to enhance transients, add overall dynamic range and downward expand soft passages. This reversal of the recording process results in a close approximation of the dynamics of the original program. The model RG-1 restores dynamic range by reducing the level of soft musical passages and

increasing the loudness level of the louder passages. As an added benefit, the downward expansion reduces noise components—tape hiss, record surface noise and background FM noise.

The model RG-1 is a single-ended device—no previous encoding or processing of program material is required. Since all program sources are not compressed by an equal amount, the RG-1 is equipped with a selector switch that enables the user to choose the degree of expansion best suited to the program material. The combination upward and



downward expansion feature can be switched off for instant comparison, or when live, un-compressed program material is played.

It is easily connected to any hi-fi component system via the tape-out and tape-monitor jacks; tape monitoring functions are duplicated on the rear panel of the unit to preserve that important interconnection facility.

In addition to the expansion range switch, the RG-1 is equipped with an input set control that matches the unit to the components with which it is used. Twin meters show the user the amount (in dB) of expansion being applied. It is supplied in its own cabinet, measures 13 3/4" x 5 3/4" x 12 1/2" deep. The suggested retail price is \$175.00—U.S. Pioneer Electronics Corp., 75 Oxford Dr., Moonachie, NJ 07074.

Circle 42 on reader service card

new lit

All booklets, catalogs, charts, data sheets and other literature listed here with a Reader Service number are free. Use the Reader Service Card inside the back cover.

COMPONENTS CATALOG. 88-page catalog contains a myriad of electronic components. The components described are high-quality surplus items of large companies.

Items include a complete TV remote control system, programmable counter, electronic organ components, keyboards, capacitors, switches, resistors, readout devices, semiconductors, transformers, relays, and much more—Delta Electronics, P. O. Box 1, Lynn, MA 01903.

Circle 43 on reader service card

AUDIO ACCESSORIES CATALOG. A 20-page listing of Pro Sound audio accessories, including a broad range of guitar plugs, microphone connectors, cable, cable assemblies, tools, equipment and services. All Switchcraft audio accessories are available through the Pro Sound Catalog, as well as high-quality Hypalon cable. Custom cable assembly, cable marking, bulk cable and cutting to

order are a few of the additional services described. Products are available in bubble-pak or bulk.—Pro Sound, P.O. Box 91798, Los Angeles, CA 90009.

Circle 44 on reader service card

POCKET CALCULATOR BUYER'S GUIDE. 32-page brochure describes and gives specifications for the company's full line of pre-programmed and programmable pocket calculators for science, engineering, business, finance and education. The brochure, No. 5952-6062D, also includes a complete listing of pocket calculator accessories, support literature and prerecorded programs, as well as a description of the HP-65 Users' Library of calculator programs.—Hewlett-Packard Company, Inquiries Manager, 1501 Page Mill Road, Palo Alto, CA 94304.

Circle 45 on reader service card

COMPUTER NOTES, the Altair Users Group newspaper, keeps its readers informed of new developments in the Altair computer line. The monthly tabloid provides helpful hints in the form of articles written by MITS engineers and software specialists, though items of a more general nature are included as well.

Through the monthly software contest, members of the Altair Users Group are encouraged to submit programs to the Altair software library. Prizes for the best programs are awarded. Those who submit software for the competition but don't win a prize are entitled to a free printout of any two software programs from the Altair library upon acceptance of their programs by MITS software experts. Other features include "Boo Boo's", a column of printing errors and newly discovered flaws in Altair equipment. Subscriptions are available at a cost of \$10 per year.—MITS, 6328 Linn N. E., Albuquerque, NM 87108.

Circle 46 on reader service card

Test Equip. Special Discount Prices

BK **TECO**

Leader

SENCORE

- TRANSISTOR RADIO
asst type good, bad, broken,
as-is, pullack 1.50
- TAPE RECORDER
assorted types good, bad
broken, as-is, pullack 4.00
- 200 ASST. 1/2 W RESISTORS
Top Brands, Short Leads,
Excellent Selection 1.00
- 75-ASST. 1/2 WATT RESISTORS
stand, choice ohmmages, some in 5% 1.00
- 100-ASST. 1/2 WATT RESISTORS
stand, choice ohmmages, some in 5% 1.00
- 70-ASST. WATT RESISTORS
stand, choice ohmmages, some in 5% 1.00
- 35-ASST. 2 WATT RESISTORS
stand, choice ohmmages, some in 5% 1.00
- 30-PRECISION RESISTORS
asst. list price \$50 less 98% 1.00
- 20-ASSORTED WIREWOUND
RESISTORS, 1/2, 10, 20 watt
best types and sizes 1.00
- 250-ASST. SOLDERING LUGS
best types and sizes 1.00
- 250-ASST. WOOD SCREWS
finest popular selection 1.00
- 250-Asst Self Tapping SCREWS
#8, #8, etc. 1.00
- 100-ASST. #32 SCREWS
and 100-6/32 HEX NUTS 1.00
- 100-ASST. #32 SCREWS
and 100-8/32 HEX NUTS 1.00
- 100-ASST. 2.56 SCREWS
and 100-2.56 HEX NUTS 1.00
- 100-ASST. 4.40 SCREWS
and 100-4.40 HEX NUTS 1.00
- 100-ASST. 5.40 SCREWS
and 100-5.40 HEX NUTS 1.00
- 500-ASSORTED RIVETS
most useful selected sizes 1.00
- 100-ASST RUBBER BUMPERS
for cabinet bottoms—other uses 1.00
- 100-Asst RUBBER GRDMMETS
best sizes 1.00
- 1-KENWOOD TWEETER
Special Buy—1" Round 4.79

IMMEDIATE DELIVERY . . . Scientific light packing for safe delivery at minimum cost.
HANDY WAY TO ORDER . . . Send check or money order, add extra for shipping. Lists of new offers will be returned in your order.
Please specify order on shipping overpayment desired: CHECK POSTAGE STAMPS MERCHANDISE (our choice) with advantage to customer

MARKET SCOOP COLUMN

- 4-ASSTD. PHILCO SWITCHES
—PUSH —PUSH TYPE #T2-
3-1, & Sig. Sw. With knobs steel
type 2.59
- POWER TRANSFORMER
(PT 18)—110V Pri.—11V Sec.
Use in many transistor
Power supplies 2.29
- COMPLETE CONVERGENCE
ASSY.—Incl. Yoke Board &
Plug Conn. Adaptable
to most 40" sets 3.95
- COLOR DELAY LINE—1 set
in most color sets 1.69
- Silicon NPN HV TRANSISTOR
10"V—SK-3021—Hep-40 1.00
- 10"V—SK-1025—Hep-211 1.00
- Transistor Specials—Your Choice
SK3006 SK3014 SK3020 1.00
- SK-122 SK3021 1.00
- Transistor Specials—Your Choice
SK3009 SK3023 SK3040 1.98
- TACHOMETER 2 1/2" Sq. Panel
Meter 1 VDC coil scale 3 Ohm
coil res. Lemo #8000 R.P.M. 2.00
- CASSETTE type dynamic Mike
with universal plug—200 ohms
VU "PANEL METER 2.99
- 20" GREY SPEAKER WIRE
Conl. mini zip, 100 uses 2.00
- WAIL-CORDLESS SOLDER
IRON complete with auto-
charger Fast Heating Compact
1 Audio Output TRANSFORM
Sub-min for Trans Radios 1.79
- 5-1.F. Coil TRANSFORMERS
106-ke for Transistor Radios 1.00
- UNIVERSAL SPEAKER
Top quality Special Buy EA 1.59
- UNIVERSAL SPEAKER
Large Magnet—Top quality 4.95
- UNIVERSAL SPEAKER—
Large Magnet—Special Buy 2.89
- UNIVERSAL TWEETER
1/2" Magnet 1.29
- 2 1/2" K" SPEAKER
Special Buy 10 for \$5 EA 69
- Large magnet . . . Special HV
4"x6" "QUAM" 18 OHM SPK.
(10 for \$15.00) 1.79
- 8" — HEAVY DUTY 10 OZ.
SPEAKER Ceramic Type—4 Ohm 4.50
- 1-6"x9" Heavy Duty 10 oz. Speaker
Ceramic Type—8 Ohm 4.90
- ELECTROLYTIC CON. 2.00
- DENISERS. 100/80/20 MFD—
300 Volts 2.00
- Top Brand Silicon RECT.
1 amp., 1000 PIV 1.00
- RCA 110° FLYBACK TRANS-
FORMER. For BK. & Wht. sets
—BKV—For all types TV's, line
schem. 3 FOL 1000 3.95
- 110° TV DEFECTION YOKE 4.95
- for all types TV's. Incl. schemath
- "COMBINATION SPECIAL"
RCA 110° FLYBACK plus
110° DEFECTION YOKE 6.95
- 90° FLYBACK TRANSFORMER
for all type TV's (Blk & Wht) 2.95
- 70° FLYBACK TRANSFORMER
for all type TV's (Blk & Wht) 2.00
- 70° TV DEFECTION YOKE 2.00
- for all type TV's (Blk & Wht.)
OLYMPIC & SHARP FLY-
BACK Part #FT-12 Equip.
Stator #110 104— 2.00
- THORLAB #115 130
"COIL" YOKE For all
Rectangular 12 to 27"
"OUR" CRT'S 7.95
- 70 COLORE YOKE 5.95
- For all round color CRT'S
DELMONICO NIVICO COLOR
FLYBACK Part #A20411-B 7.95
- WESTINGHOUSE FM TUNER
#475-01510 1 Transistor 3.99
- WESTINGHOUSE FM TUNER
(1212) Tube 1.00
- UHF TUNER—Transistor Type
Used in all TV sets 2.95
- G.E. UHF TUNER—TRANSIS-
TOR TYPE Model #NA1 3.95
- ADMIRAL TV TUNER
Model #01393-1 (HA55-11J8)
#7A 120-1 4087-11A7 Tubes 7.95
- G.E.—TV TUNER (2GK5 11J8)
Model #EP 86x11 7.95
- PHILCO UHF VHF TUNER
Transistor 9.95
- G.E. ANTENNA 1.00
- General replacement for any set
UNIVERSAL TV Antenna Black of
set mounting . . . 5 section rods 2.99
- BLUE LATERAL Magnet Assy.
Replacement for most color TV's
5-10K—2 WATT BIAS POTS
Used in most color sets 1.00
- COLOR CONVERGENCE ASSY.
Universal type—good for most sets 2.49
- 3 SPEAKER—7 WAY SELECTOR
SWITCH Wall Mount 1.00
- 7 TUBE AM-FM STEREO
AMPLIFIER CHASSIS. Com-
pletely assembled—AS 18 needs
slight adjustments 1.95
- 10-MINI ELECTROLYTIC Cond 1.00
- For Transistor & miniature work
- HIGH VOLTAGE POWER
TRANSISTOR Equip. HEP 707
List price \$16.00 2.29
- 75-ASSORTED TRANSISTORS
106 factory scoop—sold as is 1.00
- 9 VOLT MOTORS 1.00
- Excellent for hobbyist
- ELECTROLYTIC COND
100 mfd.—25V 1.00
- 1 VARGO STEREO CAR-
TRIDGE Model TV18 with holder 2.95
- ELECTROLYTIC CONDENS-
ERS 50 100 50 VFB)—150V 1.00
- ELECTROLYTIC COND
200 20V—mfd.—350V 1.00
- ELECTROLYTIC COND
100 mfd.—100V 50 mfd.—75V 1.00
- ELECTROLYTIC COND
100 mfd.—500V 10 mfd.—400V 1.00
- MINI PILOT BULBS With
Leads—6.3V 30MA (5000 Hrs.) 1.00
- MINI PILOT BULBS With
Leads—6.3V 350MA (5000 Hrs.) 1.00
- TEST PRODD WIRE
EXCELLENT QUALITY red & black
—COLOR POWER 6.95
- TRANSFORMER
—Colorburst Quartz-Crystal
For most color TV sets 700 15 KC 1.89
- ASST GLOBAR VARISTOR
Popular replacements for
most "01011 TV 1.00
- JHF or VHF Matching Trans.
Simple Fool-proof installation 1.00
- COLOR TV RECTIFIER—1-1/2"
8 pin metal tube sets—5000 hrs. 1.00
- TV ALIGNMENT TOOLS 1.00
- Most useful assortment #1 1.49
- TV ALIGNMENT TOOLS 1.49
- For Color TV #2 1.00
- TOOLS Most popular type—
TV TWIN LEAD-IN 2.79
- 500 Ohm 500"—\$7.10"—\$1.50, 50"
CO-AX CABLE RG59 (Black) 2.69
- 250"—\$10, 100"—\$4.50, 50"
—DUAL DIODE—MOST
POPULAR TYPES (Common
cathodes in Series connected) 2.50
- DIPPED MYLAR CAP. 1.00
- 01—600V 1.00
- 03—600V 1.00
- 15-DIPPED MYLAR CAP. 1.00
- 033—100V 1.00
- 15-DIPPED MYLAR CAP. 1.00
- 047—100V 1.00
- 15-Molded Tubular Capacitors
076—100V 1.00
- 15-DIPPED MYLAR Condensers 1.00
- 0039 400V

Minimum Order \$5.00

BROOKS RADIO & TV CORP., 529 Columbus Ave., New York, N.Y. 10024 TELEPHONE 212-874 5600

Circle 63 on reader service card

MATHEMATICS ELECTRONICS ADVANCED MATHEMATICS

These unusual courses are the result of many years of study and thought by the President of Indiana Home Study, who has *personally* lectured in the classroom to *thousands* of men, from all walks of life, on mathematics, and electrical and electronic engineering.

You will have to see the lessons to appreciate them!

NOW you can master mathematics and electronics and actually *enjoy* doing it!

WE ARE THIS SURE: you sign no contracts—you order your lessons on a money-back guarantee.

In plain language, *if you aren't satisfied you don't pay*, and there are no strings attached.

Write today for more information and your outline of courses.

You have nothing to lose, and everything to gain!

**The INDIANA
HOME STUDY INSTITUTE**
P.O. BOX 1077
ROCKFORD, IL 61105

Circle 64 on reader service card

FREE catalog
over **2000**
unique tools,
handy kits,
precision
instruments,
technical
supplies.



Our 23rd year of service to the World's finest craftsmen and technicians.

A carefully selected and tested assortment of unique, hard-to-find tools, clever gadgets, precision instruments, bargain kits. One-stop shopping for the technician, craftsman, hobbyist, lab specialist, production supervisor. Many tools and measuring instruments available nowhere else. One of the most unusual and complete tool catalogs anywhere. Get your copy of the NC FLASHER today.

National Camera 2000 West Union Ave., Dept. GBA
Englewood, Colorado, 80110
Phone (303) 789-1893

Circle 65 on reader service card

STATE OF SOLID STATE

(continued from page 80)

the added device.

The value of capacitor C was not given for the circuit but a quick frequency calculation seems to take the

form of $f = \frac{1}{2RC} \ln 2$. The fractional logarithm ($\ln 2 = .693$) term accounts for the fact that the oscillator frequency is lowered because the capacitor voltage is exponential and not linear. Exponential charging waveforms are the rule when capacitors are charged through resistors from fixed voltages. The value of C calculates to about 69 pF.

The current sources are not used in this application. Constant current into a capacitor generates an increasing ramp voltage at a uniform rate. Linear sawtooth or triangle generators are designed around this principle. They can be found on the ERG data sheet available from Electronics Research Group, 22 Mill Street, Arlington, MA 02174.

KOMPUTER KORNER

(continued from page 16)

performs the data translations. It consists of registers and arithmetic/logic hardware which can be controlled and tested by the control unit.

CONTROL: The control unit is a logic network which sequentially decodes the program being executed into sequences of signals which control the computer's operation.

OUTPUT: Output devices transmit the processed data from the computer to the outside world. Output devices would include printers, CRT displays, paper tape punches, and magnetic tape devices.

PROGRAM: The program is the means by which the user defines the procedures which he wants the computer system to perform.

The dotted lines linking memory, program, and control are to show that the program controlling the computer is often stored in the same memory as the data being operated on. Indeed, it is possible for a program to treat itself as data and modify its function. Unintentional use of this feature can result in some spectacular program failures and a good deal of debugging time. A microprocessor combines the control and arithmetic/logic portions of the computer on a single integrated circuit. There is some confusion as to the use of the terms "microprocessor" and "microcomputer," so we will adhere to the following definitions: A microprocessor is the integrated circuit which is used to perform the control and arithmetic/logic functions in a microcomputer. A microcomputer is a system consisting of a microprocessor, memory, and I/O interfacing. The 8080, 6800, and F-8 are examples of microprocessors while the Altair 8800, Logical Services Servant-8, and the Intel Intellec 8 Mod 80™ are microcomputers. Generally we will be talking about programming microcomputers,

since the microprocessor itself requires considerable support hardware to be made into a useful system.

The way a specific computer implements these general computer features is known as the computer's architecture. This includes the computer's register resources, its memory organization, input/output structure, interrupt structure, arithmetic and logic functions, and the data paths by which data transfers and operations using these features are performed. There are many types of computer architecture, and comparisons between machines is a difficult task, even for experienced computer scientists. A detailed discussion of architecture is not appropriate to these columns, although we will discuss the 8080 architecture in some detail in the next article.

As computer users, the most important thing to recognize about architecture is that it has a direct effect on the ease with which you will be able to use the computer. This is because the architecture of the computer determines the functions that you will be able to perform directly with it. The functions that can be performed directly by the computer comprise its instruction set or its machine language. Machine language is simply a pattern of "1's" and "0's" in memory which the control unit decodes to determine the functions to be performed by the computer.

Ultimately all programs result in sequences of machine language codes which are translated and executed by the processor. Thus programming in machine language allows you direct access to all the features provided by the computer's architecture. Now while it is true that cunning programming can overcome the deficiencies of a bad architecture, a good architecture can make your life a lot easier. Consider the two simple register architectures and partial machine languages shown in Fig. 2. If it is desired to move the contents of register A to the output device, a single machine instruction, 03 (move A to Output), would suffice for architecture A. This is because all three registers and the output device are connected directly to the same data path. With architecture B it is not so simple. The three registers can all be freely interchanged, but only the C register can communicate with the output device. Thus two commands are now required to perform the transfer:

02 (move A to C)

09 (move C to Output)

Now if C happened to contain something we needed to save, we would have to add two more instructions to save and restore C (in B, for example).

08 (move B to C)

02 (move A to C)

09 (move C to Output)

04 (move B to C)

Thus, this one simple change in the data paths connecting the registers caused a significant change in the programming required to do output operations. Other small architectural changes can have comparably large effects on ease of computer operations.

There is no generally accepted "best" architecture, so all computers will exhibit characteristics that the designers felt were most important for their application. The

architecture of all computers is affected by many compromises which affect speed, I/O, memory size and access, and functions provided. This is even more true of the single-chip microprocessor. Process constraints forced extreme architectural compromises on the earlier microprocessors. More recent processors (8080, M-6800, F-8, etc.) have fewer compromises, but they still exhibit more compromises than computers composed of SSI/MSI devices. The most important thing to remember about architecture is that it is something you have to live with, since it is not possible to alter the internal workings of a microprocessor. Understanding the architecture of the processor you have chosen enables you to use programming to compensate for most of the deficiencies and take advantages of the strengths to gain maximum effective use from your own system. **R-E**

KOMPUTER KORNER 2

by JOHN TITUS, DAVID LARSEN,
and PETER RONY*

*This article is reprinted courtesy American Laboratories.

THIS MONTH WE WILL DISCUSS WHAT A MICRO-processor is and how it fits into the general scheme of the controllers and computers that exist today. In the book entitled *Introduction to the Basic Computer*, by D. Eadie, the term data processor is defined as "a digital device that processes data. It may be a computer, but in a larger sense it may gather, distribute, digest, analyze, and perform other organization or smoothing operations on data. These operations, then, are not necessarily computational. Data processor is a more inclusive term than computer."¹

A microprocessor is a single integrated circuit that contains at least 75% of the power of a computer. It usually cannot do anything without the aid of additional IC's and memory and therefore can be distinguished from a microcomputer.

A microcomputer is a full operational system based upon a microprocessor chip that contains memory, latches, counters, input/output devices, buffers, and a power supply in addition to the microprocessor chip. A microcomputer may be a 'black box' with only a single switch: OPERATE/RESET. The 8080 microprocessor chip, for example, is a 40-pin LSI chip (see Fig. 1). A typical system based upon

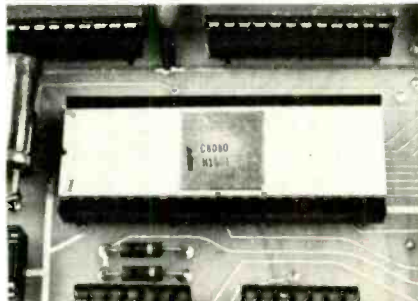

Fig. 1

this chip is shown in Fig. 2 with the 8080 chip located on the CPU board on the left.

A microcomputer has all of the minimum requirements of a computer. For example:

(continued on page 91)

LEADER LBO-506 your lowest priced DUAL TRACE AUTOMATIC 5" SCOPE

SYNCS TO
35 MHz

COMPLETE PRICE
\$569.⁹⁵

**Automatic Trigger!
Automatic Horizontal sweep!
Automatic Vertical input!**

Automatic operation is the key and error-free accuracy your bonus. With this unique 5" dual chan/dual trace scope you can test b & w. color. audio or CB circuits. The advanced design lets you read between ranges in any position as easily as you can with analog VTVM's or VOM's. Features high reliability PC board construction: a high intensity CRT with excellent contrast; and special attenuator networks for proper pulse shape and stability. Important plus features are: Automatic X-Y, separate or simult. sweep mode display for ch 1 & 2... alternate, chopped, auto or norm trigger, including pre-set TV-V and TV-H comp.; direct RF signal input to 100 MHz; and x5 sweep mag. to 100nanosec. The LBO-506 not only performs every test with accuracy and minimal chance for error, it also checks delay lines and stereo amplification... checks for proper color burst phase and fly-back pulse arrival... and, you'll use it for any and all measurements to test color circuitry stage by stage. Whatever your need, the LBO-506 offers high accuracy and economical operation.



with all accessories...
worth \$45 and more!

Here are important features:

- Automatic Horizontal sweep; Automatic Vertical Input gain & Automatic trigger.
- Compact, lightweight with low power consumption.
- DC to 10MHz Bandwidth; Sync's to 35MHz.
- 10mVp-p/cm to 20 Vp-p/cm Vert. sensitivity in 11 calibrated steps.
- Separate or simultaneous Sweep Mode Display of Ch. 1 & 2—alternate, chopped, automatic trigger.
- Monolithic dual FET's provide undetectable DC trace drift.
- Dual, in-line package 'DIP' transistor arrays for accurate vertical input amplification.
- Direct input for RF signals up to 100MHz.
- Sweep Range 0.5µS/cm to 0.25/cm, 18 steps calibrated.
- X5 Sweep mag — 100ns/cm max. speed.
- X-Y display, less than 3° phase shift.
- Vectorscope display for color phase adjustments.
- Ideal for industry, education, service and maintenance.
- Complete with these accessories: 2 Direct Lo/Cap Probes; 2 Terminal Adapters; & 3 Leads w/Banana Plugs & Alligator Clips. Write for catalog.

**LEADER
Instruments Corp.**

"Put Us To The Test"

151 Dupont Street, Plainfield, N.Y. 11803 516-822-9300
In Canada: Omnifonix Ltd. Montreal, Quebec

Circle 66 on reader service card



You can build a better organ than you can buy!

A magnificent Schober Electronic Organ

What a marvelous way to put your special talents to work! With our Schober Electronic Organ Kits and your skill, you can build yourself some very special satisfaction, and a lifetime of great music!

Schober Organs are literally far superior to comparably-priced "ready-made" units. You could actually pay twice as much and get no better organ...and miss the fun of assembling it yourself. A PC board at a time, component by component, you'll assemble your own "king of instruments." And when you're done, you'll wish there was more to do. And there is! For then, Schober will help you learn to play, even if you've never played a note before!

Schober Organ Kits range from \$650 to \$2850, and you can purchase in sections to spread costs out...or have two-year time payments. Combine the incomparable quality of Schober components with your talent...and produce a far better organ than you can buy!

Thousands of others have, ever since 1955.

You can have all the details, without cost or obligation. Just send the coupon for the fascinating Schober color catalog (or enclose \$1 for a record that lets you hear as well as see Schober quality.) Why not clip it right now, before you forget?

The Schober Organ Corp., Dept. RE-147
43 West 61st Street, New York, N.Y. 10023

- Please send me Schober Organ Catalog.
- Enclosed please find \$1.00 for 12-inch L.P. record of Schober Organ music.

NAME _____
ADDRESS _____
CITY _____ STATE _____ ZIP _____

Circle 67 on reader service card

R-E LAB TEST REPORTS

(continued from page 50)

Lab measurements

A summary of our test results is listed in Table I. The frequency response of the deck using Maxell UD C-60 cassettes (one of the many brands of tape recommended in the instruction manual supplied with the machine) is shown in Fig. 5. Roll-off (-3 dB) occurs at 13,500 Hz using this tape and recording at a -20 dB level as registered on the deck's LEVEL meters. The reference plot at 0-dB record level is merely shown to indicate the degree of tape saturation at high frequencies at this high level. This serves to assess the "head-room" capability of this deck to some degree. A similar graph of record/play re-

sponse using TDK KR-C60 CrO₂ tape is shown in Fig. 6, and in this case response extends to 15,000 Hz for a -3dB roll-off.

A comparison of other measured results with the manufacturer's published specifications shows that the unit meets its specifications and in many instances exceeds them by a wide margin.

Use tests

We used the Yamaha TC-800GL deck for about a week in our lab and recorded a variety of program material with it in order to familiarize ourselves with its controls and all of its features. The Dolby calibration (not accessible to the consumer) was found to be quite accurate as factory adjusted and provided the usual 10 dB or so of noise reduction above frequencies of 5 kHz. We were able to increase recording level to +7.5 dB (off-scale as far as the meters were concerned and well beyond the point where the "red light" indicators became illuminated) be-

fore reaching 3% total harmonic distortion and our signal-to-noise readings as listed in Table I are based upon that high recording-level. Wow-and-flutter was about the best we have measured for a cassette deck to date, all the more surprising since during our use tests we did hear a bit of mechanical noise which was cyclical (once per reel-revolution) and might have been expected to contribute to the rather unusually low wow-and-flutter readings we measured.

The one disconcerting feature of the machine is the right-to-left arrangement of the slide-level controls, about which we comment in greater detail in our summary comments found in Table II. If you can overcome your conditioned reflexes with regard to this arrangement (as we did eventually), you will find the Yamaha TC-800GL cassette deck to be more than just an example of imaginative industrial design. It is a good high-fidelity performer as well.

R-E

BETTER THAN A THIRD HAND!



PANA VISE TILTS, TURNS, AND ROTATES TO ANY POSITION. IT HOLDS YOUR WORK EXACTLY WHERE YOU WANT IT.

PanaVise has great strength yet is gentle enough to firmly hold delicate objects.

Quite possibly the finest new tool you will buy this year, PanaVise is built to exacting professional standards. We guarantee it!

Illustrated is the Electronics Vise Model 396. Three other bases and a wide variety of heads are available. All interchangeable! Buy a basic unit, then add on to create your system.

Available through your dealer. Write for a free catalog.

PANA VISE Dept. 22E
10107 Adella Ave., South Gate, CA 90280
In Canada: 25 Toro Rd., Downsview, Ont. M3J 2A6

 A Division of Colbert Industries

Circle 68 on reader service card

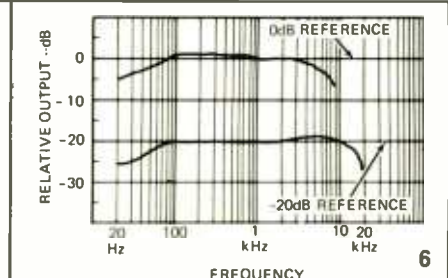
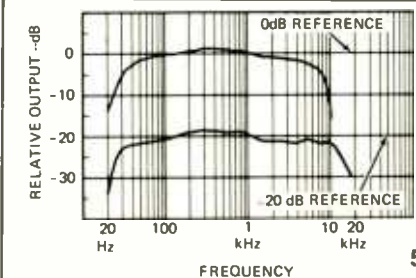
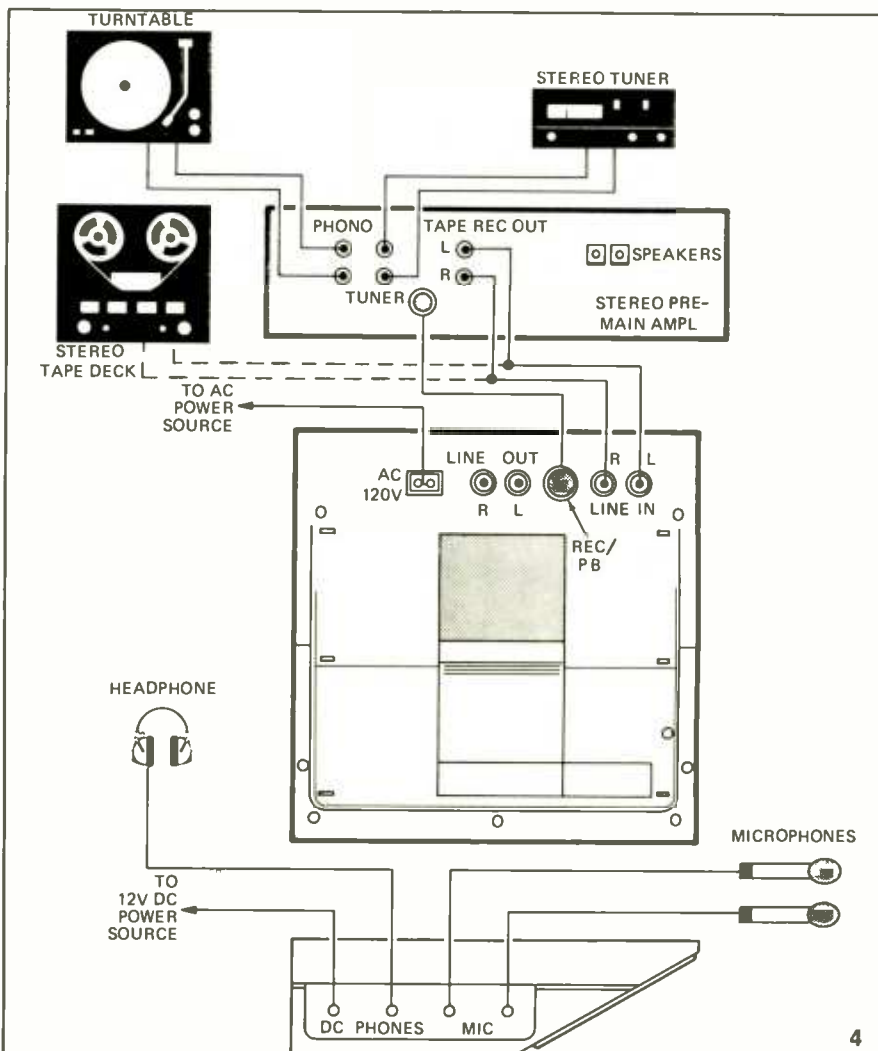

KOMPUTER KORNER

(continued from page 89)

- It can input and output data, which is usually in the form of digital electronic signals. Common I/O devices include teletypes, CRT displays, paper tape readers, floppy disks, magnetic tapes, cassette tapes, laboratory instruments, and process control devices.
- It contains an arithmetic/logic element (ALU) that can perform arithmetic and/or logic operations such as add, subtract, compare, rotate left, rotate right, AND, OR, negation, and exclusive OR.
- It contains a minimum amount of "fast" memory such as RAM, ROM, PROM, or core, but usually not cards or paper tape, in which data and program instructions are stored. The data and instructions are stored as 4-bit, 8-bit, 12-bit, or 16-bit words.

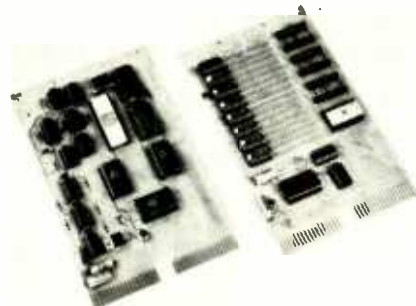

Fig. 2

- It is programmable. The data and program instructions can be arranged in any sequence desired, in contrast to the programmable calculator, in which the precise manner that a keyboard function is executed cannot be changed by the operator.
- It is fast, with an ability to execute a simple instruction in ten microseconds or less. All existing microcomputers are digital and TTL compatible.

There is some misunderstanding concerning the role of current microprocessors and microcomputers relative to other types of computers. There is a great temptation to order a modest microcomputer system and then to surround it with \$5000 worth of I/O devices such as floppy disks and line printers.

Microprocessor and microcomputer applications fall between relay logic and discrete random logic (gates and flip-flops) on one hand and inexpensive minicomputers such as the PDP-8A and the LSI-11 on the other. Microcomputers fabricated from microprocessor chips are not as sophisticated as some of the popular minicomputers and cannot easily perform certain types of data processing problems. They are simply not set up at this moment to run FORTRAN, COBOL, or other high-level languages. Those microcomputers that can, in principle, handle high-level languages still suffer in comparison with minicomputers supplied by Digital Equipment Corporation, Hewlett-Packard, Data General, Varian, and other manufacturers in the amount of high-level software available. If you desire to solve tomorrow's problem, you can consider the purchase of a microcomputer system and develop your own high-level software. If you desire to solve today's problem, pay particular attention to software support. Your time is valuable. Software costs can easily equal and exceed the total hardware costs of your data acquisition system if you are not careful.

For the moment, then, it would be more appropriate to call systems constructed from microprocessor chips *microcontrollers* or *logic processors*. They can sequence events in response to decisions upon input data.

(continued on page 99)



endeco soldering & desoldering equipment



SOLDERING IRONS

Pencil style. Safety light. Two heats — 20w and 40w. 6 tips. Unbreakable handle. 2 and 3 wire neoprene cords



DESOLDERING IRONS

Pencil style. Safety light. Some operate at 40w, idle at 20w. 8 tip sizes. 2 and 3 wire neoprene cords.



SOLDERING & DESOLDERING KITS

Everything needed to solder or desolder or both. All in a handy lifetime metal box with hasp.

See your distributor or write

Enterprise Development Corp.
5127 E. 65th St. • Indianapolis IN 46220
PHONE (317) 251-1231

Circle 69 on reader service card

free

BA 1976 catalog



the world's most complete catalog of everything in electronics

since 1927

76

burstein - applebee

244 PAGE RADIO, TV & ELECTRONICS CATALOG

Your buying guide for Everything in Electronics ... Stereo, Hi-Fi, TV's, Radios, Tape Recorders, CB, Kits, Tools, Books and Electronic Parts.

**WRITE FOR YOUR
FREE COPY NOW!**

burstein - applebee

DEPT. RE-2 3199 MERCIER ST.
KANSAS CITY, MO. 64111

NAME _____

ADDRESS _____

CITY _____

STATE _____ ZIP _____

TeleMatic FOCUS VOLTAGE SUPPLY

Service The New Low Focus Voltage TV's On Any Test Rig



FVS 3950

- Easy Installation
- Safety Light
- Adjustable Voltage

The TeleMatic Focus Voltage Supply Model FVS 3950 is indispensable for servicing many of today's TV's that incorporate low voltage focus systems. These TV's require this external voltage source to properly focus the Test Rig picture. The Focus Voltage Supply has a control for adjusting the voltage according to chassis requirements. A safety light indicates that the unit is properly hooked up, to insure the high voltage contact is secure.

Circle 70 on reader service card

The better the training the better you'll

Send for
FREE
illustrated
career
guide

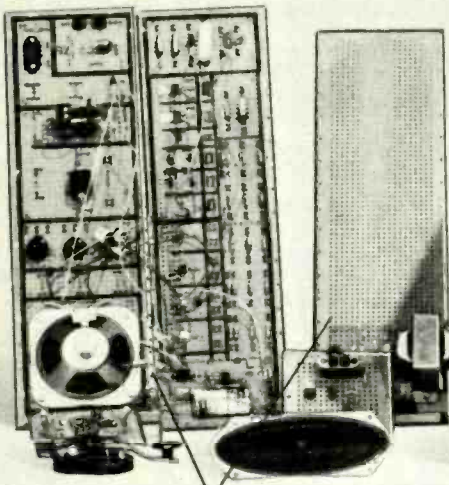
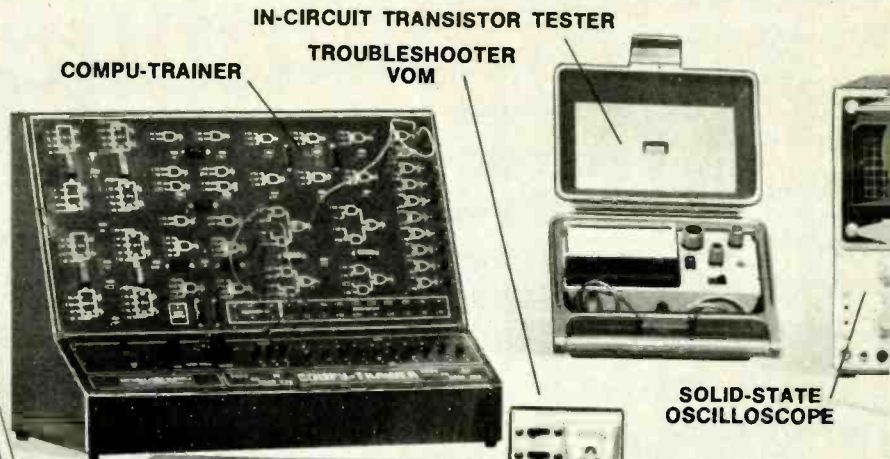
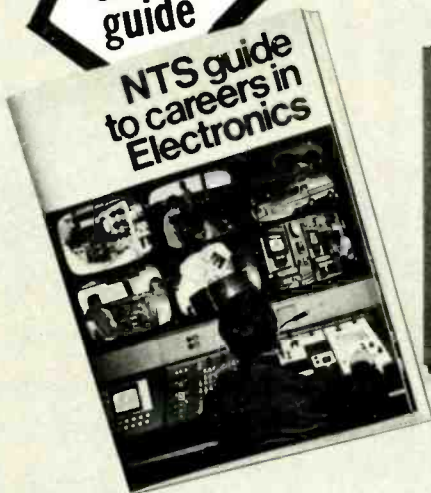

As an NTS student you'll acquire the know-how that comes with first-hand training on NTS professional equipment. **Equipment you'll build and keep.** Our courses include equipment like the **NTS/Heath Digital GR-2000 Solid State color TV** with first-ever features like silent varactor diode tuning; digital channel selection, (with optional digital clock), and big 315 sq. in. ultra-rectangular screen.

Also pictured above are other units — 5" solid state oscilloscope, vector monitor scope, solid-state stereo AM-FM receiver with twin speakers, digital multi-meter, and more. It's the kind of better equipment that gets you better equipped for the electronics industry.

This electronic gear is not only designed for training; it's field-type — like you'll meet on the job, or when you're making service calls. And with NTS easy-to-read, profusely illustrated lessons you learn the theory behind these tools of the trade.

Choose from 12 NTS courses covering a wide range of fields in electronics, each complete with equipment, lessons, and manuals to make your training more practical and interesting.

Compare our training; compare our lower tuition. We employ no salesmen, pay no commissions. You receive all home-study information by mail only. All Kits, lessons, and experiments are described in full color. Most liberal refund policy and cancella-

and the equipment be equipped.

COMPARE OUR
KITS AND LESSONS.
COMPARE OUR
TUITION.



tion privileges spelled out. Make your own comparisons, your own decision. Mail card today, or clip coupon if card is missing.

NO OBLIGATION. NO SALESMAN WILL CALL

APPROVED FOR VETERAN TRAINING

Get facts on new 2-year extension

NATIONAL TECHNICAL SCHOOLS

TECHNICAL-TRADE TRAINING SINCE 1905
Resident and Home-Study Schools
4000 So. Figueroa St., Los Angeles, Calif. 90037

NATIONAL TECHNICAL SCHOOLS
4000 South Figueroa St., Los Angeles, Calif. 90037 Dept. 206-026
Please send FREE Color Catalog and Sample Lesson.
NO OBLIGATION. NO SALESMAN WILL CALL.

<input type="checkbox"/> Color TV Servicing	<input type="checkbox"/> Electronics Technology
<input type="checkbox"/> B & W TV and Radio Servicing	<input type="checkbox"/> Computer Electronics
<input type="checkbox"/> Electronic Communications	<input type="checkbox"/> Basic Electronics
<input type="checkbox"/> FCC License Course	<input type="checkbox"/> Audio Electronics Servicing

NAME _____ AGE _____
ADDRESS _____ APT # _____
CITY _____ STATE _____

Please fill in Zip Code for fast service _____
 Check if interested in G.I. Bill Information.
 Check if interested ONLY in classroom training in Los Angeles.

the bright one

new phosphor picture tube
with twice the brightness

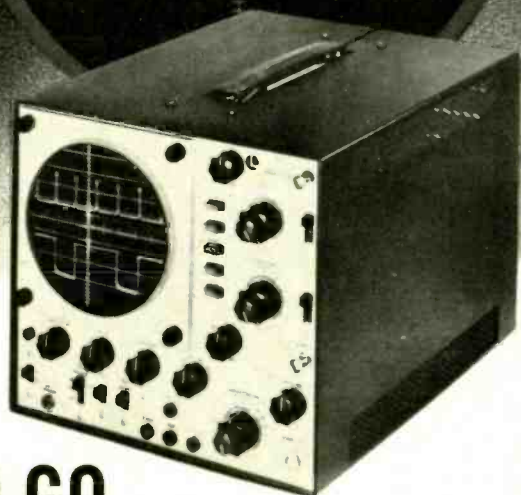

TO-60 automatic dual-trace triggered-sweep oscilloscope

P-31 phosphor CRT has double the brightness for bright displays even in high speed dual-trace modes. Bandwidth: DC to 15 mhz. Unique features for the industry's greatest value are: • Automatic Triggering • Automatic Astigmatism • Automatic Horizontal Sweep • Automatic Horiz/Vert. TV Triggering provides positive display on composite video signals. Vertical sensitivity: .01 volts/cm to 20 volts/cm in 1-2-5 step sequence. Horizontal Sweep Speeds: .2 sec/cm to .5 μ sec/cm in 1-2-5 step sequence. Has 5X magnifier at all sweep speeds. External Horiz. Amp. Bandwidth: DC to .5 mhz; Sensitivity: .5 volts/cm. Calibrated Test Signal: 1 volt P-P square wave. Power: 105-125 volts, 60 cycles, 65 watts

Model TO-60 Less Probes. Net \$489.50

TO-55 automatic single-trace triggered sweep oscilloscope. Features same as TO-60 except Vert. Bandwidth is DC to 10 mhz.

Model TO-55 Less Probes. Net \$379.50

For the "bright one," see your distributor, or write:



LECTROTECH, INC.

5810 N. Western Avenue, Chicago, Illinois 60659
Area (312) 769-6262

Circle 71 on reader service card

BIOFEEDBACK THERMOMETER

(continued from page 35)

sponse depends on the input and feedback resistors. Trimmers R3 is used to adjust the gain of the linearizer to approximately five for calibration.

The output of the linearizer is coupled to IC1-a, the inverting op-amp. In normal operation, the signal is inverted and applied to meter M1 through resistor R20. The negative terminal of M1 receives the active signal, while the positive terminal is grounded. As the output of IC1-a becomes more negative, the meter reads up-scale. In the gain-of-20 setting of the op-amp, a larger feedback resistor (R11) is used along with a different offset network. The network allows varying the offset so the voltage coming out of this stage can be adjusted for a center reading on the meter.

The output of the linearizer is also coupled to the VCO. The VCO circuit consists of an integrator (IC1-c) and a comparator (IC1-d). Transistor Q1 is used to reset the oscillator once every cycle by discharging the timing capacitor C3 through R34. C3 charges through R23. The ratio of R23 to R34 is about 56 to 1, which results in a fairly narrow output pulse. Trimmer R25 subtracts a current from C3, allowing the VCO low-frequency point to be adjusted.

A Zener diode regulator (D1) provides -5.6-volt reference voltage. Capacitor C2 removes any noise in the reference voltage. The battery condition is checked by a circuit that uses S5 to disconnect the meter from the amplifier and to reconnect it through Resistor R21 to the negative terminal of the battery. With the POWER switch off, current flows from the negative terminal of B1, through R21, the meter, ground, then to the positive terminal of battery B2 and finally back to B1. A mark on the meter shows

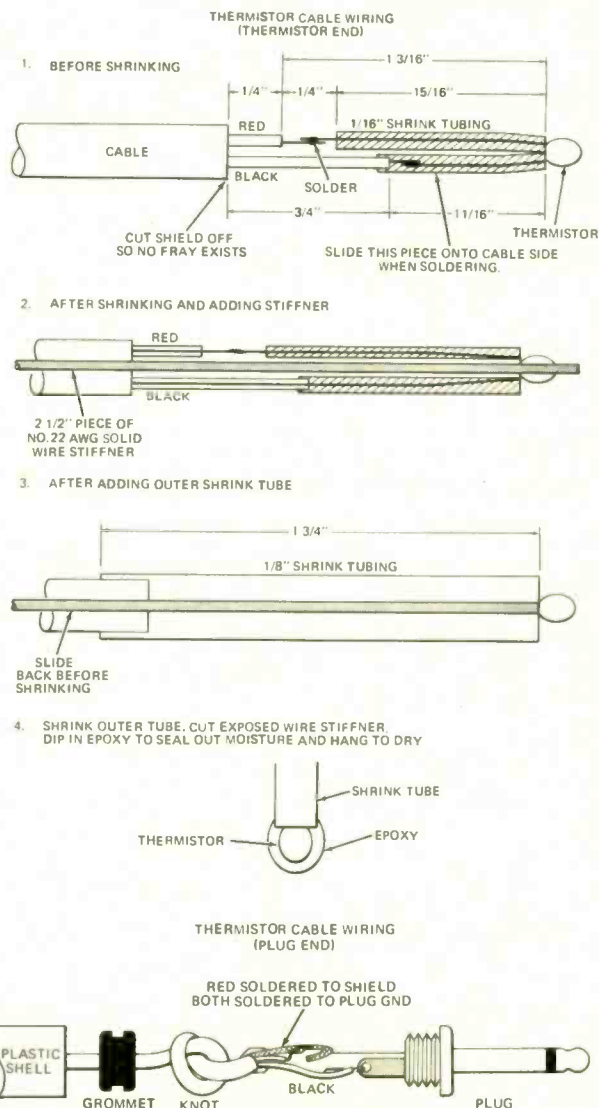

FIG. 5—CONSTRUCTION OF THERMISTOR PROBE. The steps for constructing the thermistor-end and the plug-end of the cable.

when the batteries have reached the point where the Zener stops regulating.

Switch S4 is used to turn on the two small incandescent lamps used for meter illumination. R22 limits the current to these lamps to under 50-mA.

Resistor R8 is a 1% resistor that allows calibrating the circuit to a known standard. Its value, 158,000 ohms, is the same as that of the thermistor at 25 degrees centigrade. Capacitor C1 bypasses any 60-Hz signal on the thermistor probe and C4 decouples the circuit from instability in the op-amps.

Construction

The easiest way to build the Biofeedback Thermometer is to use printed circuit board. The foil pattern of the PC board is shown in Fig. 3 and the component placement diagram is shown in Fig. 4. The board is designed to accept plug-in switches and pots; this reduces construction time. (A pre-drilled solder-plated board is available from the supplier indicated in the parts list.)

The actual wiring is not complex and almost any technique will suffice. Start by installing and soldering all the resistors, capacitors, and semiconductors. Next install and solder the one jumper, followed by the slide switches, potentiometers and jacks. When you install the potentiometers, bend their lugs down so they touch the pads on the board and then solder them. Solder the two large 9-volt battery clips, and wire in the meter, illumination lamps and rear panel jack.

Construct the probe using the drawings (Fig. 5) as a guide. Heat-shrink tubing works well in sealing the thermistor from the outside world and insulating its leads. Use a shielded cable with the shield grounded at the chassis side and floating at the thermistor side (the cable should be twin-conductor). The plug of the cable should be strain-relieved with a knot and grommet.

Check-out and calibration

Attach the two 9-volt batteries using the large battery clips. Plug in the thermistor probe. Set the RANGE switch to 60 to 110 degrees, METER LAMP to OFF, BAT. CHECK to OFF, and S3 (the calibration on/off switch) to ON. Switch S1 (the CAL A/B switch) to CAL B. Zero the meter by adjusting the CAL B trimmer (R18). Now switch S1 to CAL A and adjust the CAL A trimmer (R3) until the meter reads exactly 88 degrees or 56 microamps if a 100-microamp scale is used). Switch back and forth between CAL A and CAL B until no improvement can be made in the adjustments. The accuracy of the gains should be within 2%. Set switch S3 to OFF and S1 back to CAL B. Hold the probe in your hand. The meter should start moving up-scale and settle around body surface temperature, 85 to 90 degrees.

Next adjust the FLOW trimmer (R25) so that when the meter is registering about 85 degrees, the VCO produces a slow click. The circuit is designed so that, according to the setting of R25, the frequency can be either increasing or decreasing as temperature increases. However, the decreasing direction will give better results for biofeedback. Adjust R25 for the lowest possible click at the desired temperature.

R-E

CHECK THOSE PIX-TUBE VOLTAGES!

In September, 1975, I asked you for help in finding a no-raster problem in a Philco 3CY80. You suggested checking the DC voltages on the picture tube. The problem turned out to be a 15¢ resistor! 330K, in series with the +290 volt supply to the three picture tube screen controls. It was completely open. Thanks for the help!—W.L., Cincinnati, OH.

REPLACEMENT TRANSISTORS

Can you tell me what transistors will replace types D325E and B511E in a Dokorder stereo amplifier?—P.R., Barbados.

I can give you an educated (?) guess. This is an import, and not listed in Sams. In many Far Eastern countries, they use JEIA transistor numbering, "2SC—". In quite a few cases, the first two digits left off!

Here's the guess: for a 2SD325E, RCA SK-3054. For 2SB511E, SK-3084. Actually I'd rather use an SK-3083 for the last one since it has a high collector-breakdown voltage, matching the voltage of the SK-3054. Both substitute transistors have the same cases as the originals.

Put Professional Knowledge and a COLLEGE DEGREE in your Electronics Career through HOME STUDY

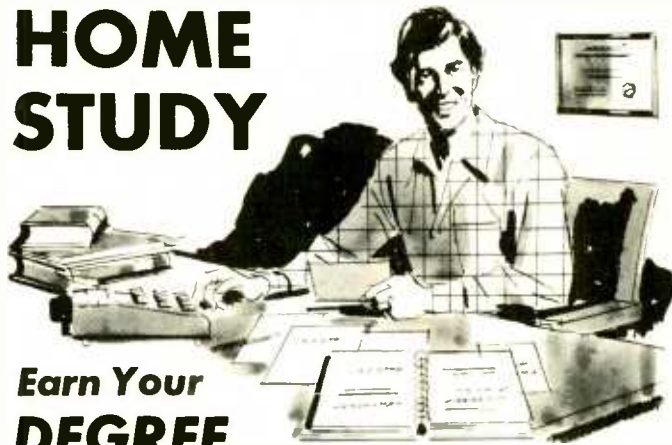

Earn Your DEGREE

by correspondence, while continuing your present job. No commuting to class. Study at your own pace. Learn from complete and explicit lesson materials, with additional assistance from our home study instructors. Advance as fast as you wish, but take all the time you need to master each topic. Profit from, and enjoy, the advantages of independent study.

The Grantham correspondence degree program in electronics is comprehensive. It begins with basics, written in very simple language, and continues through the B.S.E.E. degree level. Throughout the entire program, heavy emphasis is placed on clear explanations written in great detail, progressing from the simple to the complex, in easy steps.

Our free bulletin gives complete details on the curriculum, the degrees awarded, the requirements for each degree, and how to enroll.

GRANTHAM SCHOOL OF ENGINEERING

2000 Stoner Ave., Los Angeles CA 90025

● Telephone (213) 477-1901 ●

Worldwide Career Training thru Home Study

Mail the coupon below for free bulletin.

Grantham School of Engineering RE 2-76
2000 Stoner Ave., Los Angeles, CA 90025

I have been in electronics for _____ years. Please mail me your free bulletin which gives details concerning your electronics degree programs.

Name _____ Age _____

Address _____

City _____ State _____ Zip _____

Circle 72 on reader service card

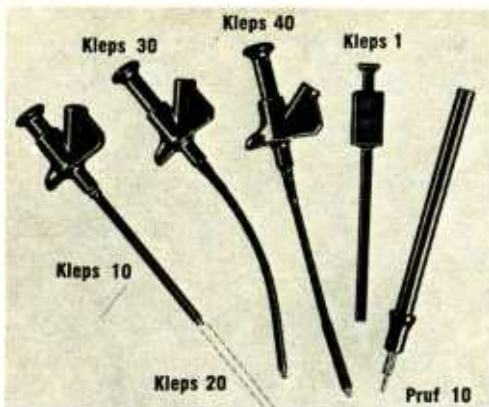

Clever Kleps

Test probes designed by your needs—Push to seize, push to release (all Kleps spring loaded).

Kleps 10. Boathook clamp grips wires, lugs, terminals. Accepts banana plug or bare wire lead. 4¾" long. \$1.39
Kleps 20. Same, but 7" long. \$1.49
Kleps 30. Completely flexible. Forked-tongue gripper. Accepts banana plug or bare lead. 6" long. \$1.79
Kleps 40. Completely flexible. 3-segment automatic collet firmly grips wire ends, PC-board terminals, connector pins. Accepts banana plug or plain wire. 6¼" long. \$2.59
Kleps 1. Economy Kleps for light line work (not lab quality). Meshing claws. 4½" long. \$.99
Pruf 10. Versatile test prod. Solder connection. Molded phenolic. Doubles as scribing tool. "Bunch" pin fits banana jack. Phone tip. 5½" long. \$.89
 All in red or black - specify. (Add 50¢ postage and handling).
 Write for complete catalog of - test probes, plugs, sockets, connectors, earphones, headsets, miniature components.

Available through your local distributor, or write to:



RYE INDUSTRIES INC.

127 Spencer Place, Mamaroneck, N.Y. 10543
 In Canada: Rye Industries (Canada) Ltd.

Circle 73 on reader service card



next month

MARCH 1976

■ Why 4-Channel Went Wrong

Herb Friedman ticks off the reasons why 4-channel hasn't become the roaring success we all looked to. And then he tells what is still to come that may make it one.

■ How To Buy A Record Changer

Know what's important when making that selection. You'll have to live with the changer you buy for quite some time, so shop wisely now.

■ New Kind Of Music System

Modulus from Heath is a fantastic new hi-fi system that you build from a kit. R-E Lab tells you everything you want to know about this receiver and amplifier system.

■ Cutting Audio Test Time

It's easy when you know how. Len Feldman tells some of his secrets to faster hi-fi service. You can learn how to speed your shop procedures and more dollars.

■ Build An Electronic Fuse

Need instant power cutoff in case of emergency? Here's an automatic circuit that cuts off in less than 10 microseconds. Build one for your bench.

■ More 555 IC Applications

Another group of fascinating 555 IC circuit for the experimenter. You'll want to try them all.

PLUS

State-Of-Solid-State
 Service Clinic
 Equipment Reports

A Blow for Microprocessor Independence. Bugbook III:

for only \$14.95



Bugbooks are dedicated to the proposition that all men should be electronically independent and creative . . . that you should be able to conceive and execute your own circuit designs.

Bugbook III focuses on microprocessor system design, using an 8080 based system for microcomputer interfacing. Typical subjects: microcomputer programming and I/O; breadboarding the Micro-Designer™; clock cycles and timing loops; and more.

All practical. All clear. In 592 pages, with a glossary of 200 microcomputer terms. And, most important of all, 60 self-teaching experiments designed to make you independent and creative.

Strike a blow for independence — your independence. Bugbook III is available now for \$14.95 from the people who are revolutionizing the way digital electronics is learned. Send your check or money order today.



E&I INSTRUMENTS, INC.

61 First Street, Derby, Conn. 06418
 Telephone (203) 735-8774

Circle 74 on reader service card

KOMPUTER KORNER

(continued from page 91)

Figure 3 depicts where microcomputer applications fit today. As the price of individual microprocessor chips drops to \$10 to \$30 per

WHERE MICRO COMPUTERS FIT

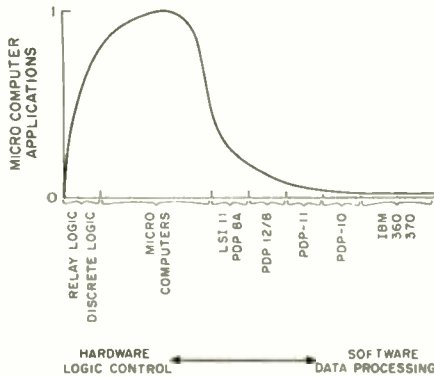

Fig. 3

chip, it will be clear that the dominant application will be as sophisticated control elements in instruments and machines of all types. **R-E**

References

1. Eadie, D., *Introduction to the Basic Computer*, Prentice-Hall, Inc., Englewood Cliffs, New Jersey, 1968.
2. Riley, W. B., "Computers," *Electronics* 47 (21), 71 (1974).

**LOOK FOR
THE
MARCH
ISSUE OF
RADIO-
ELECTRONICS
AT YOUR
NEWSDEALER
FEB. 19**



INTERNATIONAL FM 2400CH

**FREQUENCY METER
for testing
mobile
transmitters
and receivers**



- Tests Predetermined Frequencies 25 to 1000 MHz
- Extended Range Covers 950 MHz Band
- Pin Diode Attenuator for Full Range Coverage as Signal Generator
- Measures FM Deviation

The FM-2400CH provides an accurate frequency standard for testing and adjustment of mobile transmitters and receivers at predetermined frequencies.

The FM-2400CH with its extended range covers 25 to 1000 MHz. The frequencies can be those of the radio frequency channels of operation and/or the intermediate frequencies of the receiver between 5 MHz and 40 MHz.

Frequency Stability: $\pm .0005\%$ from $+50^\circ$ to $+104^\circ\text{F}$.

Frequency stability with built-in thermometer and temperature corrected charts: $\pm .00025\%$ from $+25^\circ$ to $+125^\circ$ (.000125% special 450 MHz crystals available).

Self-contained in small portable case. Complete solid state circuitry. Rechargeable batteries.

- FM-2400CH (meter only) \$595.00
- RF crystals (with temperature correction) ... 24.00 ea.
- RF crystals (less temperature correction) 18.00 ea.
- IF crystals catalog price

In a hurry? try these high-performance
A·C·E
All-Circuit Evaluators

All solderless plug-in tie-points

7 models for fast building and testing of circuits

Photo shows ACE 227

On all models simply plug in your components and interconnect with 22-ga. solid wire. All models accept all DIP's, TO-5's and discretes with leads to .032" dia. Multiple buses easily linked for power and ground distribution, reset & clock lines, shift command, etc. 5-way binding posts.

obsoletes ordinary breadboards

Four rubber feet included.
Gold-anodized aluminum bases
Non-corrosive nickel-silver terminals.

Order No.	ACE Model No.	Tie Points	DIP Capacity	No. Buses	No. Posts	Board Size (inches)	Price Each
9223333	200-K (kit)	728	8 (18's)	2	2	4-9/16 x 5-9/16	\$18.95
9223332	208 (assem.)	872	8 (18's)	8	2	4-9/16 x 5-9/16	28.95
9223334	201-K (kit)	1032	12 (14's)	2	2	4-9/16 x 7	24.95
9223331	212 (assem.)	1224	12 (14's)	8	2	4-9/16 x 7	34.95
9223326	218 (assem.)	1760	18 (14's)	10	2	6-1/2 x 7-1/8	46.95
9223325	227 (assem.)	2712	27 (14's)	28	4	8 x 9-1/4	59.95
9223324	236 (assem.)	3648	36 (14's)	36	4	10-1/4 x 9-1/4	79.95

SEND ORDERS TO: **A P PRODUCTS INCORPORATED**
Box 110-R, Painesville, OH 44077

A P PRODUCTS INC.		QTY	PART NO.	\$ EACH	\$ TOTAL
Box 110-R, Painesville, OH 44077					
BankAmericard & Master Charge cards honored					
ACCOUNT NUMBER					
TERMS: NET 30 DAYS					
GOOD THRU					
SIGNATURE					
PRINT NAME					
ADDRESS					
CITY STATE ZIP					

DEALER INQUIRIES INVITED

Merchandise Total
Sales Tax (OH & CA)
Shipping (see below)
TOTAL ENCLOSED

SHIPPING HANDLING
Up to \$15.00 \$1.00
\$15.01 to \$25.00 1.50
25.01 to \$50.00 2.00
50.01 to \$100.00 2.50
100.01 to \$500.00 3.00

ORDERS SUBJECT TO ACCEPTANCE AT FACTORY

Company P.O.'s F.O.B. Painesville



International Crystal Manufacturing Company, Inc.
10 North Lee, Oklahoma City, Oklahoma 73102

Circle 106 on Reader Service Card

Circle 75 on reader service card

FROM THE COMPANY THAT DELIVERS
COMES THE BIGGEST SURPRISE OF THE CENTURY.

ASSEMBLED COMPUTER

Graphics and Cassette I/O

\$860.00

... A GRAPHICS CONTROLLER FOR USE WITH YOUR TV. MOTOROLA 6800 MICROPROCESSOR BASED COMPUTER HOUSED IN AN ATTRACTIVE DESKTOP TERMINAL. AND MUCH. MUCH MORE.

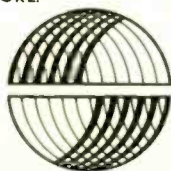

SPHERE CORPORATION

791 South 500 West Dept. 122 (801) 292-8466
Bountiful, Utah 84010

WRITE TODAY FOR THE FULL MICRO-SPHERE PACKAGE.

Circle 76 on reader service card



the audio amateur ?

Old George Frederic would today doubtless compose a Royal Fire and Water Works salute to the prowess of Audio Amateur magazine readers who design, build and customize their transmission lines and electrostatic speakers, 900 w. electrostatic amps, mixers, pre-amps and more.

Free prospectus on joining the jolly group of subscribers.

**the Audio
Amateur**

Box 176R
Peterborough, N. H.
03458

Craig Stark of STEREO REVIEW says:
"Top quality, only U.S. publication devoted to the serious audiophile constructor."

Name
Street
City State
Zip

Circle 77 on reader service card

For
faster
service

USE
ZIP
CODE

on
all
mail

SERVICE CLINIC

(continued from page 70)

ball symptom and most especially if you have *multiple* symptoms, suspect the electrolytics in the DC power supply. This is the one thing that's common to all stages. The scope is the fastest and most accurate way to check it out. If you can see any signal at all with vertical gain at maximum, the capacitor is bad.

Resistors can be intermittent, too. This is mostly due to a break in the carbon element inside the case. Wirewounds and carbons can also have intermittent contact to the leads. These can often be caught by wiggling the leads. One of the soldering-aid tools with a slotted end is ideal for doing this.

Paper capacitors can also be intermittent from loose connections to the ends of the foils. The later molded-case types are a lot better in this respect; the tough plastic case protects this connection from damage. Even the ceramic capacitors aren't always innocent; check to see if the case is cracked around the leads.

Thermals

A lot of intermittents are thermal. Heating causes expansion of parts, leads, etc, which is often enough to make a bad connection pull apart and open. We have several ways of checking this. You can cool suspected parts with coolant spray, or heat them up. Something like the Wahl *Thermal-Spot* model 5800, is fine. This has a plastic nozzle so that you can blow hot air on only one part at a time. Hair-driers can also be used though they're somewhat of a shotgun effect—they heat up quite a bit of territory. The tip of a soldering iron is also useful. Good parts will not be affected by this, but a bad one will show up. This can be used where a transistor is suspected.

So, check up on the bits and pieces and you'll catch a lot of the more common troubles. **R-E**

reader questions

REGULATOR TROUBLE PLUS

The low-voltage regulator in this Philco 3CR41 is acting up. I get only 7 volts from the +207V source. I get +22.5V from the rectifier, but only +17.5V on the collector of Q200, and very little on the output. Is there an easy way to check this?—R.B., Toledo, OH.

Not too easy, but it works. There are two things that cause this kind of trouble; weak supply and overload of current. The +20-volt supply is supposed to provide only 130 mA. Note that you are getting a 5.5 volt drop across a 9-ohm resistor (see diagram). This indicates something like 600 mA drain!

Try shedding loads. Disconnect the circuits fed from the +20-volt supply and see if it comes back to normal. If it doesn't, look for an open input filter capacitor. Once this is working, reconnect the loads one at a time till you find

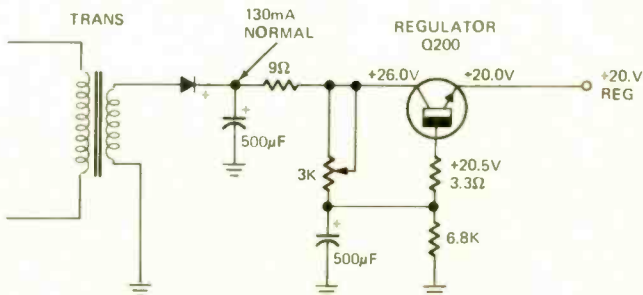

out which one is taking all that current.

(Feedback: reader says that he found a bad socket on Q200, the regulator transistor. Also, the tuner was taking entirely too much current. This turned out to be due to a little choke coil wound on a 1K resistor in the UHF tuner. It had slipped off and was grounding the +20-volt supply. Centering this on the resistor and cementing it cleared up the rest of the problems!)

PIECRUST

There is a piecrust or gear-tooth effect on images in this CTC-49XA RCA. The effect varies with brightness changes. This is the second one of these with this problem that I've seen. No one else seems to know anything about it. Can you help?—S.G., Franklin, NC.

Hope so! Check that 1K resistor connected across CR2 (Sams) which is the bias-clamp diode; CR402, RCA. If this is open, it may cause this symptom. Check around this area for possible loose solder joints, too.

(Miracles do happen. Reader reports that 1K resistor was open, and that there was also a bad solder joint on the primary (pin 2) of T403, the input reactor, which is connected directly to this diode. Another symptom, not mentioned before, was a singing in T403. Both cleared up.)

HIGH-VOLTAGE PROBLEM

We've burned some midnight oil on this one! It's a Zenith 14Y33. As long as we leave the plate cap off the 2AS2 high-voltage rectifier, fine. Lots of arc, boost normal, etc. The 2AS2 heater is lit, too. If we put the plate cap back on the 2AS2, away goes everything, and no high voltage! Hope there's a clue in here somewhere!—E.S., W. Palm Beach, FL.

There sure is! This is telling us that the high-voltage supply is in good shape right up to the high-voltage rectifier plate. However, you *must* have some kind of a weird leakage somewhere in or around the high-voltage rectifier socket, wiring to tube, etc.

Try this. Get one of the solid-state "stick" high-voltage rectifiers; RCA SK-3108, etc. (This will go to 20 kV.) Now plug the plate cap lead on one end of it and connect the other to the ultor button of the picture tube. (Watch the polarity, of course.) Light the fire and see what happens. You may even decide to leave it in, if it works. Not hard to mount. (Field Feedback: It worked.)

SUB FOR 1N916 DIODES

I'm having problems finding the 1N916 diodes needed in the LCD Clock article in the R-E August 1975 issue. Is there a good substitute?—S.R., Rapid River, MI.

Yep. The 1N916 is a silicon switching diode. Replacements: RCA SK-3100, GE-300, Motorola HEP-R0602 (new numbering), Sylvania ECG-177. Any of these ought to do nicely.

WHAT IS 19A3 TUBE?

I have a strange question. What is a 19A3 tube? I've got a Star-Lite radio with one burned out. It has two 12BA6's plus a 13BE6, 12AV6, 17EW8 and a 35C5 beside the dead one. This is an AM/FM set. Do you know of a substitute?—J.T., Canton, OH.

This particular chassis isn't listed in Sams Photofacts. However, I did run one down that has all of the *other* tubes in it. You have a tube for all functions of an AM/FM radio except the rectifier. So the 19A3 ought to be a rectifier. (The one I found had a silicon diode.) No substitute listed. Use a silicon diode to get your B+ voltage and add a series resistor to take up the 19 volts for the heater. Something like 135 ohms since this is a 150 mA heater string. Sneaky trick; replace the 35C5 with a 50C5 and you'll only need a 5-volt drop!

R-E

The Money Generator



A BETTER APPROACH TO TV ANALYZING

Pat. Pend.

The ATC-10 is different from other color bar pattern generators. It's like a portable test lab with the versatility to perform the most commonly used functions of an analyst and a substitute tuner. It's a time saver for both in-home and on-the-bench servicing. That's why we've nicknamed it the MONEY GENERATOR. Since it takes more than a few words to describe the ATC-10's many unique features, we'd like to send you our big 4 page illustrated brochure.

This brochure tells you about the ATC-10's unique patterns which include RED RASTER, 3.58 MONITOR, GRAY QUAD, and HATCHDOTS. It also describes some unusual test capabilities such as: • A full range of crystal controlled RF, IF, and video injection signals • Receiver sensitivity and dynamic range checks using the calibrated RF output control • Fast accurate purity and 3.58 oscillator checks with no need to disable guns or short test point(s) • Extra clear oscilloscope and vector patterns • In-home receiver bandpass checks at 60 Hz, 1.78 MHz, and 3.56 MHz • Complete convergence series using a single composite pattern • (all of these and many more for only \$299.95.)

The brochure is free, but, if you'd like still more information on the operation of the ATC-10, you can obtain a copy of the 2 volume (home-shop) owner's manual. Just include \$1.00 for postage and handling. Act now and evaluate for yourself the many ways the ATC-10 can be a real MONEY GENERATOR for you.

Mail Request To:
AMERICAN TECHNOLOGY CORP.
225 Main, Dept. 2C, Canon City, CO. 81212

Name _____
Address _____
City _____
State _____ Zip _____

Circle 78 on reader service card

Accuracy like a VTVM... Convenience like a VOM...

NEW BATTERY-OPERATED FET SOLID-STATE VOLT-OHMMETER #116

Easy-to-build KIT

\$36.90 =116K

Factory-Wired & Tested

\$49.49 =116W

Now you can get all the benefits of a VTVM (laboratory accuracy, stability and wide range) but with its drawbacks gone: no plugging into an AC outlet, no waiting for warm-up, no bulkiness. New Field Effect Transistor (FET) design makes possible low loading, instant-on battery-operation and small size. Excellent for both bench and field work.

Compare these valuable features:

- High impedance low loading: 11 meg-ohms input or DC, 1 megohm on AC
- 500-times more sensitive than a standard 20,000 ohms-per-volt VOM
- Wide-range versatility: 4 P-P AC voltage ranges: 0-3.3, 33, 330, 1200V; 4 RMS AC voltage ranges: 0-1.2, 12, 120, 1200V; 4 DC voltage ranges: 0-1.2, 12, 120, 1200V; 4 Resistance ranges: 0-1K, 0-100K, 0-10 meg., 0-1000 meg.; 4dB ranges: -24 to +56dB.

Sensitive easy-to-read 4½" 200 micro-amp meter. Zero center position available. Comprises FET transistor, 4 silicon transistors, 2 diodes. Meter and transistors protected against burnout. Etched panel for durability. High-impact bakelite case with handle useable as instrument stand. Kit has simplified step-by-step assembly instructions. Both kit and factory-wired versions shipped complete with batteries and test leads. 5¼"H x 6¾"W x 2⅞"D. 3 lbs.



Send FREE catalog of complete EMC line and name of nearest distributor. RE-2

Name _____
Address _____
City _____
State _____ Zip _____

EMC

ELECTRONIC MEASUREMENTS CORP.
625 Broadway, New York, N.Y. 10012

Circle 79 on reader service card

FEBRUARY 1976

FREE burglar — fire alarm catalog



over 500 systems, detectors, controls, sounders, tools, locks, supplies

TO PROTECT HOMES, BUSINESSES, INDUSTRY

Huge selection of hard-to-find security equipment from stock. 96 fact-filled pages loaded with 100's of highest quality professional alarm products, technical notes, diagrams.

ONE-STOP SUPERMARKET SELECTION INCLUDES:

ultrasonics, radar, infrared, undercarpet mats, magnetic contacts, smoke & heat detectors; Controls; Alarms: bells, sirens, phone dialers, lights, guard panels. Large selection of tools, relays, wire, holdup alarms, books. Fills need for industry, alarm cos., businesses, homes, institutions. Order your copy today.



mountain west alarm
4215 n. 16th st.
phoenix, az. 85016
(602) 263-8831

Circle 80 on reader service card

LISTEN TO Spectacular 4-Channel Sound!

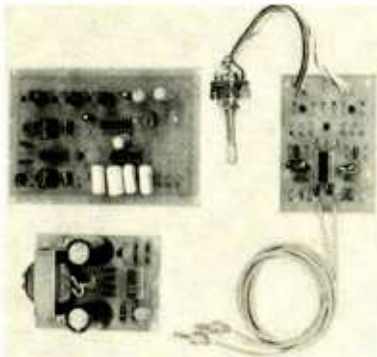

VISTA "SQ" DECODER/SYNTHESIZER

Exclusive CBS Licensed Kit

4 IC's for Super Fidelity and Maximum Channel Separation • Full Logic, Wave-matching with Variable Blend and 2-Position Stereo Synthesizer • Our Synthesizer Offers Surround or Concert Hall Realism from Stereo Sources by Synthesizing a 4-Channel Matrixed Signal that is Decoded by the "SQ" Full Logic Circuitry • This Unit is Complete with Power Supply, Case and Knobs. **SQ-4 \$84.95**

Shipping in USA \$2.00 NY State add Tax

PHOTOLUME CORPORATION

118 East 28th STREET, New York, N.Y. 10016

Circle 81 on reader service card

555 IC APPLICATIONS

(continued from page 42)

and used to automatically turn off the headlights a predetermined period after the ignition is switched off.

When the ignition is first switched on, battery voltage is fed to the relay coil through the 500-ohm resistor and diode D1. Switching off the ignition generates a negative-going pulse on pin 2 that triggers the timer. The output of the IC goes high to energize the relay and keep the headlights on long enough for you to leave the garage. With the values shown for R1, R2 and C1, the delay is adjustable from 10 seconds to 1 minute.

Timer with solid-state load control—(Fig. 9, from Motorola data sheet) uses a 555 timer to trigger a triac operating as a solid-state relay controlling a 4-ampere, 117-volt AC load. The 20-megohm resistor and 1- μ F capacitor provide a 22-second delay in the application of power to the load.

A circuit of this type can be used in applications where two or more operations must be performed in a timed sequence. It might be used to delay the application of power to a fuel pump or gas valve in an industrial or domestic heating system until an exhaust fan has been running long enough to purge unburnt fuel. Or, perhaps it can be used to start the blower of an air conditioner before the compressor. Can you think of any applications for such a circuit?

R-E

Illegal Citizens band operator sentenced to year in jail

Ronald Eugene Evans, San Bernadino, CA, was fined \$2,000 and sentenced to a year in prison by Judge Manuel Real of the U.S. District Court for the Central District of California last September, for operating a Citizens band transmitter without a proper license.

The conviction was the result of a month-long investigation by the FCC, responding to numerous complaints of television interference received from San Bernadino TV users. Besides operating without a license, Evans was found to be operating with an 800-watt linear amplifier, which put out 200 times as much power as is permitted.

Los Alamos judge has electronic as well as legal savvy

California physicist Paul VanderMaat answered a speeding charge with the defense that the ionized air that precedes a thunderstorm can affect a radar speed unit. He had been clocked—incorrectly, he said—by a police radar at 33 miles per hour in a 25-mile zone.

The judge, Raymond E. Hunter, agreed that ionization or static electricity accompanying an electric storm could result in a false radar reading, stating:

"Only in Los Alamos could a defendant use a principle of advanced physics and have a judge understand what he's talking about."

Hunter, who serves only part time as a Municipal Court judge, is, like VanderMaat, a theoretical physicist at Los Alamos Scientific Laboratory.



12 REASONS YOUR CAR NEEDS TIGER CDI

Instant starting in any weather - Eliminates tune-ups - Increases gas mileage - Increases horsepower 15% - Improves acceleration and performance - Spark plugs last up to 70,000 miles - Reduces engine maintenance expense - Amplifies spark plug voltage to 45,000 volts - Maintains spark plug voltage to 10,000 RPM - Reduces exhaust emissions - Dual ignition switch - An Unconditional LIFETIME GUARANTEE - Installs in 10 minutes on any car with 12 volt negative ground - No rewiring - Most powerful, efficient and reliable Solid State Ignition made.

SATISFACTION GUARANTEED or money back

TIGER 500 assembled \$53.95

TIGER SST assembled \$42.95

Post Paid in U.S.A.

Send check or money order with order to:

Tri-Star Corporation

P. O. Box 1727 B
Grand Junction, Colorado 81501

DEALER INQUIRIES INVITED

Circle 82 on reader service card

WHAT CREATURE CAN:

- Make outer space sounds for rock musicians?
- Demonstrate principles of music & acoustics for educators?
- Create sound effects for theatre companies?
- Provide rhythmic pulses and tones for modern dance groups?
- Be one of the neatest toys in the world for an audiophile?

PAIA'S GNOME,



of course!

The 1st Micro-Synthesizer...
under \$50 in kit form.

FOR DETAILS AND PHOTOGRAPHS OF THE GNOME, AS WELL AS DOZENS OF OTHER KITS FEATURING INNOVATION RATHER THAN IMITATION, WRITE TO US FOR A

FREE CATALOG

PAIA Electronics, Dept. 1-R
Box 14359, Oklahoma City, OK 73114

Circle 107 on reader service card

market center

CLASSIFIED COMMERCIAL RATE (for firms or individuals offering commercial products or services). **\$1.40 per word** . . . minimum 15 words.

NONCOMMERCIAL RATE (for individuals who want to buy or sell personal items) **85¢ per word** . . . no minimum.

ONLY FIRST WORD AND NAME set in bold caps. Additional bold face (not available as all caps) at 10¢ per word. Payment must accompany all ads except those placed by accredited advertising agencies. 10% discount on 12 consecutive insertions, if paid in advance. All copy subject to publisher's approval. Advertisements using P.O. Box address will not be accepted until advertiser supplies publisher with permanent address and phone number. Copy to be in our hands on the 26th of the third month preceding the date of the issue (i.e. August issue closes May 26). When normal closing date falls on Saturday, Sunday or a holiday, issue closes on preceding working day.

BUSINESS OPPORTUNITIES

HIGHLY PROFITABLE ONE-MAN ELECTRONIC FACTORY

Investment unnecessary, knowledge not required, sales handled by professionals. Ideal home business. Write today for facts! Postcard will do. Barta- BB Box 248, Walnut Creek, CA 94597.

ROYALTIES paid for electronic plans, details, forms, \$1.00. **CIRCUIT SOURCE**, Box 370633 Miami, FL 33137

OWN YOUR OWN PICTURE TUBE REBUILDING BUSINESS
With Lakeside Industries re-building equipment you can rebuild any picture tube!
For complete details send name, address zip code to
LAKESIDE INDUSTRIES
3529 W Fullerton Ave
Chicago, Ill 60647
Phone 312-342-3399

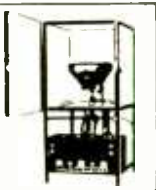

EDUCATION & INSTRUCTION

MANUALS for Govt. surplus radios, test sets, scopes. List 50¢ (coin). **BOOKS**, 7218 Roanne Drive, Washington, DC 20021

SEMICONDUCTOR and parts literature, J. & J. **ELECTRONICS**, Box 1437R, Winnipeg, Manitoba, Canada, U.S. Inquiries Invited.

F.C.C. EXAM MANUAL
PASS FCC EXAMS! Memorize, study—Test-Answers for FCC 1st and 2nd class Radio-telephone licenses. Newly revised multiple choice questions and diagrams cover all areas tested in FCC exams, plus Self-Study Ability Test. \$9.95 postpaid. Money-back guarantee.

Tests-Answers for FCC First and Second Class Commercial License

COMMAND PRODUCTIONS P.O. BOX 76348 E
RADIO ENGINEERING DIV. SAN FRANCISCO, CAL. 94126

TELEPHONE bugged? Don't be Watergated! Countermeasures brochure \$1.00. **NEGEYE LABORATORIES**, Box 547-RE, Pennsboro, WV 26415

ELECTRONICS DESIGN NEWSLETTER

- ★ Logic Design Techniques
- ★ Digital & Linear Design Theory & Procedures
- ★ Construction Projects

Subscription \$6 Sample Copy \$1

VALLEY WEST Box 2119-L Sunnyvale, CA 94087

FREE educational electronics catalog. Home study courses. Write to: **EDUKITS WORKSHOP**, Dept. 276G, Hewlett, NY 11557

COMPUTER hobbyists! Learn how to program. Complete self-taught programming course. Details \$1.00. **CREATIVE COMPUTER**, Box 52, Palo Alto, CA 94302.

RADIO opportunities: Pass FCC examinations, find jobs, start your own broadcast station. **Free literature.** **WILSON**, Box 5516-FB, Walnut Creek, CA 94596

FCC License Study Guide. New, 377 pages. Includes 1465 FCC-type questions, with answers and discussions, covering third, second, and first class radiotelephone exams. \$8.95 postpaid. **GSE PUBLICATIONS**, 2000 Stoner Ave., Los Angeles, CA 90025

FOR SALE

HARD-TO-GET repair supplies for police radar. **ELECTRONIC SPECIALISTS, INC.**, Box 122-RE, Natick, MA 01760

CASSETTES

Plain white cassette labels. **Norelco** cassette cleaners, famous brand cassettes. Send for open reel and cassette discount catalog.

Cassette Labels	1-9	10-99	100	1000	10M
		.02	.015	.01	.006
Norelco Cassette Cleaner	.65	.60	.55	.50	.45
10" Metal, NAB, Used Reel	1.00	1.00	.90	.80	.75
10" Fiberglass used 3/8" Hole	.50	.50	.40	.35	.30
Scotch Cassette SC90HE	2.72	2.55	2.44		COBALT
*Buy 2, SC90HE, get 1 free.					

Plus Postage by Weight and Zone. Minimum Order \$5.00

OPEN REEL STEREO TAPE BUYERS!

At last! An open reel catalog, including titles, songs, etc. of 95 long play, 2-3 hour albums by American Airlines or Ampex 4 track stereo tapes. Send \$1.00—and we will also mail you a 140-page Harrison stereo tape guide—so you'll get both for \$1.00—and this \$1.00 is refundable on your first \$10.00 purchase of open reel stereo tapes at our 30% discount.

We've Got the "Spirit" The Prices And The Address To Prove It

Saxitone's Bicentennial Tape Shoppe
1776 Columbia Rd., N.W., Wash. D.C. 20009



CARBON film resistors—1/4W, 5% 10—4.7 megohms for 3 1/2¢ each. Fifty per value \$0.85. Discounts available. Free samples/specifications. Other quality components. \$1.00 postage. **COMPONENTS CENTER**, Box 134R, New York, NY 10038

NEW ELECTRONIC SURPLUS COMPONENTS

— SAME DAY SHIPMENT —
Call 617-261-1100
AMERICAN USED COMPUTER CORP.
P.O. Box 68
Kenmore Station, Boston, Mass. 02215
member **COMPUTER DEALERS ASSOCIATION**

FREE catalog. Ultrasonic devices, LED'S, transistors, IC's, keyboards, digital thermometers, unique components. **CHANEY'S**, Box 15431, Lakewood, CO 80215

BURGLAR alarm dialing unit automatically calls police. \$29.95. Free literature. **S&S SYSTEMS**, 5619-G St. John, Kansas City, MO 64123

EQUIPMENT REPORTS

(continued from page 30)

ily of curves, too, but a single line is much less confusing.

The human-engineering on the model 440's panel is good. All controls are located so that they're easy to use, and very plainly marked. The correct patterns are even printed on the panel alongside the controls that affect them. Scope connections are at the very top, out of the way. The dual transistor sockets/jacks are at the bottom, with the selector switch between them. Setup controls are in the middle. The final touch is a plastic card that slips into a pocket underneath the instrument. Printed on this is a complete setup procedure in case you forget how to run it. The correct patterns are also printed on this card. The card cannot be pulled all the way out and lost, it locks in.

This is a very easy instrument to use and one that should be a definite asset to any technician who works with solid-state devices, as who doesn't any more? **R-E**

PIONEERS OF RADIO

Dr. Mahlon Loomis—first to demonstrate electrical communication through space.

by **FRED SHUNAMAN**

IN OCTOBER, 1866 A WASHINGTON dentist, Dr. Mahlon Loomis, flew two kites from Blue Ridge mountain peaks about 18 miles apart. Each had a 15-inch square of wire mesh on its underside and a 600-foot wire to ground "in a wet spot." Inserting a telegraph key in one wire and a galvanometer in the other, he was able to deflect the galvanometer in the circuit 18 miles away by keying his "aerial wire." Working back and forth with an assistant on a time schedule, "signalling continued for nearly three hours, when the circuit became inoperative as the upper electric body moved away," Loomis said.

For in Loomis's day, science had "proved" that there was a large ocean of positive electricity above the earth, (the earth was considered negative) separated from it by the insulating layer of air. Loomis expected, by suddenly connecting and disconnecting those two opposite charges, to set up "shocks and pulsations" in that sea—perturbations that would spread out like waves and affect the flow of electricity at any other aerial penetrating the "ocean." In modern terms, he envisioned an electric field in which waves could be set up that would affect other conductors in the field.

Loomis was able to interest financiers
(continued on page 112)

RECORDS-TAPES! Discounts to 73%; all labels; no purchase obligations; newsletter; discount dividend certificates; 100% guarantees. Free details. **DISCOUNT MUSIC CLUB**, 650 Main St., Dept. 3-36, New Rochelle, NY 10801

BARGAINS! on IC's, readouts, switches, more. Send stamp. **C. F. ENTERPRISES**, 8905 Holly, Kansas City, MO 64114

COMPLETE inventory of parts and equipment of small electronics shop. For more information call or write. **NORRIS TV**, 918-835-0998, 4317 N. Mingo Rd., Box 77, Tulsa, OK 74116

DESCRAMBLERS: Several professional models that work with all scanners. Tone encoders/decoders. Scanmate, AAPP, radar detectors, Big Ears, alarms, books, kits, parts. Catalog 25 cents: **KRYSTAL KITS**, Box 445, Bentonville, AR 72712

SURPRISE! Build inexpensively, the most unusual test instruments, futuristic gadgets using numerical readouts! Catalogue free! **GBS**, Box 100B, Greenbank, WV 24944

Govt. SURPLUS ELECTRONIC EQUIPMENT CATALOG

New ITEMS . . . New BARGAINS! **FREE UPON REQUEST!**

If you haven't received our new Catalog, write for free copy today. Address: Dept. RE

FAIR RADIO SALES
1016 E. EUREKA • Box 1105 • LIMA, OHIO • 45602

JAPANESE transistors. All transistors original factory made. Free catalog. **WEST PACIFIC ELECTRONICS**, P. O. Box 25837, W. Los Angeles, CA 90025

RADIO & TV tubes 36¢ each. One year guaranteed. Plus many unusual electronic bargains. Free catalog. **CORNELL**, 4217-E University, San Diego, CA 92105

TV-GAMES, with scoring, sound, and lots more. 5 game plan set—\$5.00. Big 12 game plan set—\$12.00. Full description and specs—\$1.00. **ADVANCED ELECTRONICS**, P.O. Box 1128, Cupertino, CA 95014

PRINTED CIRCUIT MATTE FILM; ARTWORK TAPE; 1X DIP AND DOUGHNUT RUB-OFF TRANSFERS; CARBIDE BITS
TRUMBULL
833 BALRA DR., EL CERRITO, CA. 94530

CANADIAN discount and factory clearouts catalog. Top brand stereo equipment, calculators, test gear, CB & communications, telephones. Factory dumps—government surplus. Amazing bargains. Unusual items. Rush \$1. **ETCO-RE**, 521 5th Ave., NYC, 10017

FOR SALE • MINIS — DEC • DG
CAI • CASC • HP • HIS • IBM
INT • LOCK • MICRO • SEL
TEMPO • UNIVAC • VARIAN • XLO
• PRINTERS • PAPER TAPE
• CARD READERS
• MAGNETIC TAPE
SAME DAY SHIPMENT

617-261-1100

AMERICAN USED COMPUTER CORP.
P.O. Box 68
Kenmore Station, Boston, Mass. 02215
member **COMPUTER DEALERS ASSOCIATION**

S. D. SALES CO.

P.O. BOX 28810 DALLAS, TEXAS 75228

6 Digit Digital Clock Kit

We wanted our word to mean something to you. When we first introduced our clock we used such words as "impossible", "unbelievable bargain", "prime quality", and "unconditional money back guarantee." We anticipated selling several hundred kits. Your response to our clock has been fantastic. Now several thousand kits later, we hear such comments as "outstanding value", "exceptional service", "I can't believe it", etc. One enthusiastic customer even wrote saying it was "the best thing since bottled beer."

Here's What The Kit Includes:

- 1 - MM5314 National Clock Chlp with socket
- 6 - Common Cathode Led Readouts (.25 in. char.)
- 13 - NPN and PNP Driver Transistors
- 2 - Push Button Switches for time set
- 1 - Switch for Time Hold
- 1 - Filter Cap
- 4 - IN4001 Rectifiers
- 1 - IN914 Diode
- 2 - .01 Disc. Caps
- 9 - Carbon Resistors

\$9⁹⁵ (KIT)
WITH SPECS.
*Transformer POSTPAID
\$1.50
P.C. BOARD FOR ABOVE
\$3.00 each

INTEL 1702A 2K ERASEABLE PROM'S \$6.95

We tell it like it is. We could have said these were factory new, but here is the straight scoop. We bought a load of new computer gear that contained a quantity of 1702A's in sockets. We carefully removed the parts, verified their quality, and are offering them on one heck of a deal. First come, first served. Satisfaction guaranteed.

PROFESSIONAL QUALITY STEREO HEADPHONES

Here is the kind of super deal that S. D. is famous for. Treat your ears to a super sound at a super price. Soft padded ear cushions, lightweight, fully adjustable headband, long coiled cord, wide response. **\$6 Post Paid - NEW IN ORIGINAL FACTORY BOXES**

INSTRUMENT KNOBS

Black with brushed aluminum insert. Medium size, very attractive style. **SPECIAL 5 FOR \$1**

2102 1K RAM's - 8 FOR \$12.95

New units by National. We bought a load on a super deal, hence this fantastic price. Units tested for 500NS Speed.

DUAL 741 (5558)

Another S.D. "SPECIAL" — 2 — 741V in one MINI DIP Package. These units were bought from Xerox Corporation on another of our super buys. They are house numbered, but guaranteed prime. They feature: No frequency compensation required. Short circuit protection. Low power consumption. No latch-up. **S.D. SPECIAL INTRODUCTORY PRICE**

4/\$1.00

We do not sell junk. Money back guarantee on every item. WE PAY POSTAGE. Orders under \$10 add 75c handling. No C.O.D. Texas Res. add 5% tax.

S. D. SALES CO.
P.O. BOX 28810
DALLAS, TEXAS 75228

S.(ide) D.(eals)

No Repairs or Refrets here — You Want Quality You have it with this popular 0.3" L.E.D. by Hewlett Packard Fits Standard I.C. Socket. Right hand Dip.
5002-7740 — Common Cathode \$1.25
6 for \$6.00

H.P. ISSBACKI

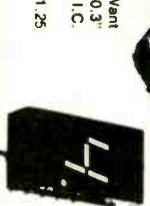

FAIRCHILD LED READOUTS - 99¢
FND-70: Common cathode. Right hand decimal point. .25 inch character. Prime new units. Perfect for clocks, frequency counters, etc. 99¢ 10 For \$9

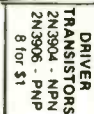

DRIVER TRANSISTORS
2N3304 - NPN
2N3306 - PNP
8 for \$1

FET'S BY TEXAS INSTRUMENTS
#TIS-75 but with an internal house number. TO-92 plastic case. N Channel. Junction type FET.
SPECIAL 5 FOR \$1

A big .50 inch easy to read character. Now available in either common anode or common cathode. Take your pick. Super low current drain, only 5 MA per segment typical.
FND - 510 Common Anode
FND - 503 Common Cathode
YOUR CHOICE \$2 ea.

FAIRCHILD BIG LED READOUTS

DO YOU NEED A LARGE COMMON ANODE READOUT AT A FANTASTIC PRICE!
S. D. presents the MAW-64 by Monsanto - .40 inch character. All LED construction - not reflective bar type, fits 14 pin DIP. Brand new and factory prime. Left D.P.
\$1.50 ea. 6 for \$7.50

ORDERS OVER \$15

CHOOSE \$1
FREE MERCH.

LM324 • QUAD 741 OP AMP - 99¢
NE555 - Timers 2/\$1.00
709CH - OP AMPS - \$1.00
GE SCR C10681 4 AMP 200PIV. Sensi-tive Gate. 59¢

NEW • UNEQUALLED • VALUE
MINATURE SOLID STATE

VIDEO CAMERA KIT

A UNIQUE CAMERA KIT
FEATURING A . . . 100 X 100 BIT
SELF SCANNING CHARGED
COUPLED DEVICE

INCLUDES THE FOLLOWING
UNIQUE FEATURES . . .
FOUND IN FAR MORE
EXPENSIVE CAMERAS
IF AVAILABLE

- LOW VOLTAGE SUPPLY (OR BATTERIES) + 5 AND ± 15 VOLTS
- SENSITIVE TO INFRARED AS WELL AS VISIBLE LIGHT
- MAY BE USED FOR IR SURVEILLANCE WITH AN IR LIGHT SOURCE
- EXCELLENT FOR STANDARD SURVEILLANCE WORK BECAUSE OF ITS LIGHT WEIGHT AND SMALL SIZE
- ALL COMPONENTS MOUNTED ON TWO PARALLEL 3" X 5" SINGLE SIDED BOARDS TOTAL WEIGHT UNDER 2 LBS
- MAY BE WIRED BY PERSON WITH SOME TECHNICAL EXPERIENCE IN 4-6 HRS

MAY BE USED WITH AMATEUR RADIO FOR VIDEO

USED FOR CHARACTER RECOGNITION FOR COMPUTERS WITH EXTERNAL CIRCUITS

MAY BE USED IN A VACUUM, UNDER WATER, HIGH ALTITUDE, AND IN MAGNETIC ENVIRONMENT BECAUSE THERE IS NO HIGH VOLTAGE OR MAGNETIC DEFLECTION

WE SUPPLY ALL SEMICONDUCTORS, BOARDS, DATA SHEETS, DIAGRAMS, RESISTORS AND CAPACITORS

SORRY, WE DO NOT SUPPLY THE CASE, BATTERIES (FOR SUPPLY) OR THE LENSE

SUPER UNBELIEVABLE

\$225⁰⁰

ONLY

(OPTIONAL)

ADD \$2.00 POSTAGE AND HANDLING, PLUS \$6.00 FOR ALL IC SOCKETS



SOLID STATE SALES

P.O. BOX 74
SOMERVILLE, MASS. 02143
TEL. (617) 547-7053

COMPLETE CLOCK KITS



MODEL MM

Only \$22.50

Kit Includes: MM5314 clock chip, 6 green readouts, PC board, transistors, resistors, resistors, diodes, capacitors, transformer and case.



MODEL CT ALARM with MONTH and TIME

Only \$28.50

Plastic case add \$7.00.

Kit Includes: CT7001 clock chip, 6 Fairchild FND503 0.5" Led, 75491, 95492 drivers, transistors, resistors, capacitors, switches, speaker, PC boards and transformer.



MODEL OC ALARM CLOCK

Only \$28.50

Kit Includes: TI Alarm clock chip, LD8132 0.5" Green readouts, PC board with all electronic parts, speakers, transformer and specially designed case.

LED LAMPS

Red Color	.15 ea	\$12.00 per 100
Green Color	.20 ea	16.00 per 100
Orange Color	.20 ea	16.00 per 100
Yellow Color	.20 ea	16.00 per 100
Clear Color	.20 ea	16.00 per 100
Opto-Isolator Mini Dip	10	for \$3.00

WALL TYPE TRANSFORMERS



12V AC 300 MA output Wall Type Adapter (Designed for Clock to limited Space) 2.25 ea



12V-0-12V- or 24V 1 Amp output 2.25 ea

0-0.8V-12V 300MA output (For our fluorescent tubes) 2.50 ea

18V 1amp output 2.50 ea

0-3V-12V-24V 500MA output (for CT 7001 Drive LD 8132 Readouts) 2.50 ea

0-15V-160V 150MA output (for Gas discharge Readouts) 1.00 ea

CLOCK CHIPS

MM5311 28 Pin BCD & 7seg. 6 digits MUX	3.80
MM5313 28 Pin 1 pps BCD & 7 seg 6 digits	3.80
MM5314 24 Pin 7 seg 6 digits MUX	3.50
MM5315 28 Pin BCD & 7 seg Stopwatch	4.00
MM 5316 40 Pin Alarm AM/PM Direct Drive FND 500 Led	4.50
CT 7001 28 Pin Alarm Date AM/PM Stopwatch	6.50

FLUORESCENT READOUTS

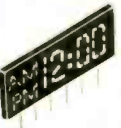

NEC LD 8132 0.5" Com. Anode 4 digits Multiplex with A/M display, Green color, Supply voltage 24 volt. (used in our CT 7001 PC board) 13.50

ROCKWELL A4001 I.C.

ELECTRONIC SLIDE RULE SCIENTIFIC CALCULATOR KIT !!

Kit Includes: Rockwell A4001 IC
HP 9 Digit LED Readouts
Complete Keyboard with Case
PC Board with all Electronic Parts
Instructions and Batteries



SPECIFICATION

- * 9-digit HP Red Led Displays
- * 8 digits capacity for data entry or results
- * (10⁻⁸ ~ 10⁸)
- * Full floating point
- * Dome keyboard for excellent response and preventing double entry input

BASIC FUNCTION

- * Algebraic mode operation
- * Constant operations
- * Repeat Operations
- * Chain operations
- * Change sign operation
- * Display and Y-register exchangeable
- * One accumulating memory
- * Display and memory exchangeable

SPECIAL FUNCTION

- * Trigonometric functions (sin, cos, tan)
- * Inverse trigonometric functions (sin⁻¹, cos⁻¹, tan⁻¹)
- * Radian or degree selectable
- * π constant
- * Logarithms (ln, log)
- * Anti-logarithms (e^x)
- * Power functions (y^x)
- * Reciprocal (1/x)
- * Square root (\sqrt{x})
- * Display recall

ONLY \$28.⁵⁰

Dimension: 32.5mm(H) x 77mm(W) 145mm (L)
1 9/32 in (H) x 3 1/32 in (W) x 5 23/32 in (L)

LINEAR I.C.

LM 309K	5V 1A Regulator	1.00
LM 340T	Pos. 1A V. Regulator (5V, 6V, 12V, 15V.)	1.00
LM 380	2W Audio Amp	.80
LM 381	Lo Noise Pre Amp	1.00
LM 555	Timer Mini Dip	.55
LM 556	Dual 555 Timer	.85
LM 565	Phase Locked Loop	1.50
LM 567	Tone Decoder	1.50
UA 709	Operational Amp	.20
UA 741	Comp Op Amp	.25
LM 747	Dual 741 Op Amp	.55
LM 1458	Dual Comp Op Amp	.55
LM 3900	Quad Op Amp	.50
DM 8864	9 Digit Led Driver	1.40
75492	HEX MOX to Led Digit Drivers	.60
75491	Quad Seg. Drivers	.60

TTL I.C.S.

PART NO	PRICE	PART NO	PRICE	PART NO	PRICE
7400	\$.16	7453	\$.15	74148	\$1.80
7401	.16	7454	.15	74150	1.00
7402	.14	7460	.15	74151	.80
7403	.16	7470	.30	74152	1.40
7404	.20	7472	.30	74153	1.00
7405	.20	7473	.37	74154	1.40
7406	.35	7474	.30	74155	1.00
7407	.35	7475	.55	74156	1.10
7408	.22	7476	.30	74157	1.00
7409	.22	7480	.59	74158	1.20
7410	.16	7481	1.18	74160	1.30
7411	.28	7482	.89	74161	1.20
7412	.33	7483	.60	74162	1.40
7413	.55	7484	3.00	74163	1.40
7414	1.23	7485	1.00	74164	1.30
7416	.25	7486	.30	74165	1.50
7417	.30	7489	2.00	74166	1.30
7420	.15	7490	.60	74170	2.50
7421	.33	7491	.90	74173	1.50
7422	.50	7492	.50	74174	1.60
7423	.47	7493	.55	74175	1.60
7426	.22	7495	.75	74177	.80
7427	.31	7496	1.40	74180	.73
7428	.50	74100	1.00	74181	3.00
7430	.18	74104	.65	74182	.70
7432	.22	74105	.60	74184	2.00
7433	.60	74107	.28	74185	2.00
7437	.30	74109	.90	74188	4.80
7438	.30	74110	.72	74190	1.20
7439	.28	74114	.93	74191	1.20
7440	.15	74118	1.52	74192	1.30
7441	.85	74121	.42	74193	1.20
7442	.50	74122	.45	74194	1.40
7443	.95	74123	.65	74195	1.00
7444	1.05	74125	.50	74196	1.00
7445	.80	74126	.50	74197	1.00
7446	.80	74128	.90	74198	2.00
7447	.70	74132	1.00	74199	2.10
7448	.75	74136	.95	74200	5.60
7450	.15	74141	1.20	8284	1.20
7451	.15	74145	.60	8243	1.00
		74147	2.40	8281	.80

MEMORIES

MM 2102-1



1024 Bit Static Ram Memories 500ms.
1-9 pcs. \$2.20 ea 10-49 pcs. \$2.00 ea
50 pcs. up \$1.80 ea
Erasable Prom (MM1702A) \$13.50 ea
CPU Special (8080A) \$39.50 ea

LED READOUTS



DL 727 0.5" Common Anode Double Digit Led \$2.80
DL 747 0.6" Common Anode Red 2.50
DL 707 0.3" Common Anode Red 1.30
Fairchild FND 503 0.5" Common Cathode 1.60
Fairchild FND 70 0.25" Common Cathode.60

COMPUTER KEYBOARDS



Standard Teletype Keyboards with gold plated contact switches. All switches are independent and allow you to connect into any form of output. **Only \$22.50**

POWER HYBRID CIRCUITS By RCA (HC2500)

High power output: up to 100W (rms)
High output current: 7 A (peak)
Stability with resistive or reactive loads
Single or split power supply
(30 to 75V. single, +15 to +37.5, split)
Only \$8.75 Ea.

MINIMUM ORDER \$10.00. Add \$1.00 to cover postage and handling. California residents add 6% sales tax.
SEND CHECK OR MONEY ORDER TO:

FORMULA INTERNATIONAL INC.

12603 CRENSHAW BOULEVARD • HAWTHORNE, CALIFORNIA 90250

For more information please call (213) 879-5162
BUSINESS HOURS 10-7 Monday - Saturday

Circle 88 on reader service card

GIANT SOPHISTICATED BOARDS

R9224

Brand new boards, over-run from a maker of large computers. The value of the parts is typically over \$200 per board! We supply data for most of the parts.

R9224....Contains 7 SIGMA 12v DC reed relays, SPST, NO contacts. Also 6 RCA 40669 SCRs, a heat sink, 2 250 mfd, 25v electrolytics, 7 1 mfd, 50v elec., bridge rectifier, diodes, etc. 9 1/4" x 10 1/2", 1 lb.
STOCK NO. R9224 \$4.95 ea, 2/9.00

R9227....Has 6 MONSANTO opto-isolators (6 pin mini-DIPs), plus 1 other opto coupler! Loaded with other parts: 56 ICs, 2 741 op amps, 2 bridge rectifiers, 5 SCRs, 2 trimmers, 9 power transistors, and much more. 6" x 14 1/2", 3 lbs.
STOCK NO. R9227 \$15.95 ea, 2/30.00

R9225....Contains 79 ICs! Also LM-301 op amp, 12 GE C106 SCRs, 2 ea. 2N4401 & 2N4403 complementary pairs, and many resistors, caps, and diodes.. 7" x 18 1/2", 3 lbs.
STOCK NO. R9225 \$13.95 ea, 2/26.00

R9233....Has 4 LM-301 op-amps, 4 TO-5 linear circuits, and 37 ICs. Also 4 P&B 12v reed relays (2 latching), an LM-309 with heat sink, 50K trimpot, 9 2N5061 SCRs, 2 C106 SCRs, etc. 7" x 18 1/2", 3 lbs.
STOCK NO. R9233 \$12.95 ea, 2/25.00

TRANSFORMER with dual 4.3v @ 1 amp secondaries, center tapped. By combining windings, 4.3v @ 2 amps CT, 6.4v @ 1 amp, or 8.6v @ 1 amp CT is possible. Ideal for making a 5v power supply. 1 1/2 lbs.
STOCK NO. R9896 \$3.00 ea, 2/5.00

MINIMUM ORDER \$5.00. Include sufficient postage, excess refunded. Send for new 88 page Catalog 15, bigger than ever.



BANKAMERICARD and MASTERCHARGE now accepted; minimum charge \$15.00. Please include all numbers. Phone orders accepted.



DELTA ELECTRONICS CO.

**BOX 1, LYNN, MASSACHUSETTS 01903
Phone (617) 388-4705**

Circle 89 on reader service card

For
faster
service

USE
ZIP
CODE

on
all
mail

You'll never know
how much good
you can do
until you do it.

You can help people.
In fact, there's a crying need for you. Your talents. Your training. Your concerns. They can make you priceless as a volunteer in your community.
There are probably several local organizations hard at work doing things you'd be proud to be part of. We'll put you in touch with them. Join one. Or, if you see the need, start a new one.

If you can spare even a few hours a week, call the Voluntary Action Center in your town. Or write: "Volunteer," Washington, D.C. 20013.

It'll do you good to see how much good you can do.

Volunteer.

The National Center for Voluntary Action

A Public Service of This Magazine & The Advertising Council



CB SPECIALS--R.F. DRIVERS--R.F. POWER OUTPUTS--FETS

2SC481 1.85	2SC767 15.75	2SC866 5.85	2SC1449-1 1.60	40081 1.50
2SC482 1.75	2SC773 .85	2SC1013 1.50	2SC1475 1.50	40082 3.00
2SC495 1.10	2SC774 1.75	2SC1014 1.50	2SC1678 5.50	2SC608 7.90
2SC502 3.75	2SC775 2.75	2SC1017 1.50	2SC1679 4.75	SK3046 2.15
2SC517 4.75	2SC776 3.00	2SC1018 1.50	2SC1728 2.15	SK3047 3.75
2SC614 3.80	2SC777 4.75	2SC1173 1.25	2SC1760 2.15	SJ2095 3.50
2SC615 3.90	2SC778 3.25	2SC1226A 1.25	2SC1816 5.50	SK3048 3.25
2SC616 4.15	2SC797 2.50	2SC1237 4.50	2SC1908 .70	SK3054 1.25
2SC617 4.25	2SC798 3.10	2SC1239 3.50	2SC1957 1.50	
2SC699 4.75	2SC781 3.00	2SC1243 1.50	2SF8 3.00	2SK19 1.75
2SC710 .70	2SC789 1.00	2SC1306 4.75	HEP-S 3001 3.25	2SK30 1.00
2SC711 .70	2SC796 3.15	2SC1306-1 4.90	2SD235 1.20	2SK33 1.20
2SC735 .70	2SC799 4.25	2SC1307 5.75	MRF8004 3.00	
2SC756 3.00	2SC802 3.75	2SC1307-1 6.00	4004 3.00	3SK40 2.75
2SC765 9.50	2SC803 4.00	2SC1377 5.50	4005 3.00	3SK45 2.75
2SC766 10.15	2SC839 .85	2SC1449 1.30	40080 1.25	3SK49 2.75

JAPANESE TRANSISTORS

2SA52 .60	2SB187 .60	2SC458 .70	2SC815 .75	2SC1569 1.25
2SA316 .75	2SB235 1.75	2SC460 .70	2SC828 .75	2SC1756 1.25
2SA473 .75	2SB303 .65	2SC478 .80	2SC829 .75	
2SA483 1.95	2SB324 1.00	2SC491 2.50	2SC830 1.60	2SD30 .95
2SA489 .70	2SB337 2.10	2SC497 1.60	2SC839 .85	2SD45 2.00
2SA490 .80	2SB367 1.60	2SC515 .80	2SC945 .65	2SD65 .75
2SA505 .70	2SB370 .65	2SC535 .75	2SC1010 .80	2SD68 .90
2SA564 .50	2SB405 .85	2SC536 .65	2SC1012 .80	2SD72 1.00
2SA628 .65	2SB407 1.65	2SC537 .70	2SC1051 2.50	2SD88 1.50
2SA643 .85	2SB415 .85	2SC563 2.50	2SC1061 1.65	2SD151 2.25
2SA647 .25	2SB461 1.25	2SC605 1.00	2SC1079 3.75	2SD170 2.00
2SA673 .85	2SB463 1.65	2SC620 .80	2SC1096 1.20	2SD180 2.75
2SA679 3.75	2SB471 1.75	2SC627 1.75	2SC1098 1.15	2SD201 1.95
2SA682 .85	2SB474 1.50	2SC642 3.50	2SC1115 2.75	2SD218 4.75
2SA699 1.30	2SB476 1.25	2SC643 3.75	2SC1166 .70	2SD300 2.50
2SA699A 1.75	2SB481 2.10	2SC644 4.00	2SC1170 4.00	2SD313 1.10
2SA705 .55	2SB492 1.25	2SC681 2.50	2SC1172B 4.25	2SD315 .75
2SA815 .85	2SB495 .95	2SC684 2.10	2SC1209 .55	2SD318 .95
2SA816 .85	2SB507 .90	2SC687 2.50	2SC1213 .75	2SD341 .95
	2SB511 .70	2SC696 2.35	2SC1226 1.25	2SD350 3.25
2SB22 .65		2SC712 .70	2SC1243 1.50	2SD352 .80
2SB54 .70	2SC206 1.00	2SC713 .70	2SC1293 .85	2SD380 5.70
2SB56 .70	2SC240 1.10	2SC732 .70	2SC1308 4.75	2SD389 .90
2SB77 .70	2SC261 .65	2SC733 .70	2SC1347 .80	2SD390 .75
2SB128 2.25	2SC291 .65	2SC739 .70	2SC1383 .75	2SD437 5.50
2SB135 .95	2SC320 2.00	2SC715 1.75	2SC1409 1.25	
2SB152 4.50	2SC352 .75	2SC762 1.90	2SC1410 1.25	
2SB173 .55	2SC353 .75	2SC783 1.00	2SC1447 1.25	
2SB175 .55	2SC371 .70	2SC784 .70	2SC1448 1.25	
2SB178 1.00	2SC372 .70	2SC785 1.00	2SC1507 1.25	
2SB186 .60	2SC394 .70	2SC793 2.50	2SC1509 1.25	

POWER-TRANSISTORS HIGH-VOLT. TV. TYPE

BU204 1300V 3.90	BU207 1300V 5.40	2SC1172B 1100V 4.25
BU205 1500V 4.70	BU208 1500V 6.25	2SC1308 1100V 4.95
BU206 1700V 5.90	2SC1170 1100V 4.00	2SC1325 1100V 4.95

OEM SPECIALS

1N270 .10	2N960 .55	2N2219A .30	2N2913 .75	2N3740 1.00	2N4401 .20
1N914 .10	2N962 .40	2N2221 .25	2N2914 1.20	2N3771 1.75	2N4402 .20
	2N967 .50	2N2221A .30	2N2916A 3.65	2N3772 1.90	2N4403 .20
2N173 1.75	2N1136 1.35	2N2222 .25	2N3019 .50	2N3773 3.00	2N4409 .20
2N178 .90	2N1142 2.25	2N2222A .30	2N3053 .30	2N3819 .32	2N4410 .75
2N327A 1.15	2N1302 .25	2N2270 .40	2N3054 .70	2N3823 .70	2N4416 .75
2N334 1.20	2N1305 .25	2N2322 1.00	2N3055 .75	2N3856 .20	2N4441 .85
2N336 .90	2N1377 .30	2N2323 1.00	2N3057 1.00	2N3866 .85	2N4442 .90
2N338A 1.05	2N1420 .20	2N2324 1.35	2N3247 3.40	2N3903 .20	2N4443 1.20
2N398B .90	2N1483 .95	2N2325 2.00	2N3250 .50	2N3904 .20	2N4852 .55
2N404 .30	2N1540 .90	2N2326 2.85	2N3375 6.50	2N3905 .20	2N5061 .30
2N443 1.75	2N1543 2.70	2N2327 3.80	2N3393 .20	2N3906 .25	2N5064 .50
2N456 1.10	2N1544 .80	2N2328 4.20	2N3394 .17	2N3925 3.75	2N5130 .20
2N501A 3.00	2N1549 1.25	2N2329 4.75	2N3414 .17	2N3954 3.50	2N5133 .15
2N508A 4.45	2N1551 2.50	2N2368 .25	2N3415 .18	2N3954A 3.75	2N5138 .15
2N555 .45	2N1552 3.25	2N2369 .25	2N3416 .19	2N3955 2.45	2N5198 3.75
2N652A .85	2N1554 1.25	2N2484 .32	2N3417 .20	2N3957 1.25	2N5294 .50
2N677C 6.00	2N1557 1.15	2N2712 .18	2N3442 1.85	2N3958 1.20	2N5296 .50
2N706 .25	2N1560 2.80	2N2894 .40	2N3553 1.50	2N4037 .60	2N5306 .20
2N706B .40	2N1605 .35	2N2903 3.30	2N3563 .20	2N4093 .85	2N5354 .20
2N711 .50	2N1613 .30	2N2904 .25	2N3565 .20	2N4124 .20	2N5369 .20
2N711B .60	2N1711 .30	2N2904A .30	2N3638 .20	2N4126 .20	2N5400 .40
2N718 .25	2N1907 4.10	2N2905 .25	2N3642 .20	2N4141 .20	2N5401 .50
2N718A .30	2N2060 1.85	2N2905A .30	2N3643 .15	2N4142 .20	2N5457 .35
2N720A .50	2N2102 .40	2N2906 .25	2N3645 .15	2N4143 .20	2N5458 .30
2N918 .35	2N2218 .25	2N2906A .30	2N3646 .14	2N4220A .45	C103y .25
2N930 .25	2N2218A .30	2N2907 .25	2N3730 1.50	2N4234 .95	C103d .40
2N956 .30	2N2219 .25	2N2907A .30	2N3731 2.75	2N4400 .20	C106b1 .50
					C106di .75

SILICON UNIUNCTIONS INTEGRATED CIRC. RECTIFIERS

2N2646 .50	2N4871 .50	UA703C .40	10 100
2N2647 .60	2N4891 .50	709C OP. AMP. .25	IN4001 .60 5.00
2N6027 .50	2N4892 .50	741C OP. AMP. .25	IN4002 .70 6.00
2N6028 .70	2N4893 .50	7400 .15	IN4003 .80 7.00
D5E37 .25	2N4894 .50	7404n .18	IN4004 .90 8.00
2N2160 .65	MU10 .40	7430n .19	IN4005 1.00 9.00
2N4870 .50		74L00J .35	IN4006 1.10 10.00
		74h55n .35	IN4007 1.20 11.00



New-Tone Electronics
P.O. Box 1738 A
Bloomfield, N.J. 07003
Phone: (201) 762-9020

ALL PARTS GUARANTEED AND TESTED ON PREMISES.

N.J. residents add 5% sales tax. Minimum order \$5.00. All orders add \$1.00 postage. Dealers write or phone for discount prices.

Circle 90 on reader service card

RADIO-ELECTRONICS

Electronic Parts & Accessories
ORDER TODAY! Send to Olson Electronics, 260 S. Forge St., Akron, Ohio 44327. Allow for postage, C.O.D. 20% Deposit. Ohio Residents Add 4% Sales Tax.

500-ft Hookup Wire Kit	WW-579	1.69
3-6V DC Mini Hobby Motor, Kit/5	MO-333	.55
3-6V DC Ass'd Hobby Motor, Kit/4	MO-334	.79
3-6V DC Ass'd Hobby Motor, Kit/4	MO-335	.99
1 Amp 200 PIV Diode, Kit/50	DI-051	.69
IM4148 Switch Diode, Kit/10	XM-382	.59
1/4 - 1/2 - 1 Watt Resistors 1 lb. Kit	RS-239	.99
PNP Audio Transistors Kit/10	TR-445	.39
NPN Audio Transistors Kit/10	TR-444	.39
C-60 Cassettes Kit/3	TA-879	.99
8 Tr. 40-Min. Blank, Each	TA-854	.89
8 Tr. 80-Min. Blank, Each	TA-855	.99
IM4001 1A, 50 PIV Diode, Kit/5	DI-028	.39
IM4002 1A, 100 PIV Diode, Kit/5	DI-029	.39
IM4003 1A, 200 PIV Diode, Kit/5	DI-030	.39
IM4004 1A, 400 PIV Diode, Kit/5	DI-031	.39
SCR Assortment, Untested, Kit/25	TR-446	.99
7A. Per. Trans. NPN like SK3054, Each		1.00
1A, 50 PIV Epoxy Diodes, Kit/50		1.20
5 Volt 1 Amp Regulator, Each		1.00
6.2 Volt Zener Diode, HEP 103		1.00
650KV Color TV Rectifier		3 for 1.95
Colorburst Quartz Crystals		2 for 1.89
10 Ass'd. Diodes IN34-IN48-IN60-IN64 Etc.		1.00

SILICON POWER RECTIFIERS				
PRV	1 Amp.	3 Amp.	12 Amp.	50 Amp.
100	.06	.14	.30	.60
200	.07	.20	.38	1.15
400	.09	.25	.50	1.40
600	.11	.30	.70	1.80
800	.15	.35	.90	2.30
1000	.20	.45	1.10	2.75

TRIACS			
PRV	1 Amp.	10 Amp.	25 Amp.
100	.40	.70	1.30
200	.70	1.10	1.75
400	1.10	1.60	2.80
600	1.70	2.30	3.00

SCRs			
PRV	1.5 Amp.	6 Amp.	35 Amp.
100	.40	.50	1.20
200	.60	.70	1.50
400	1.00	1.20	2.20
600			3.00

LM 703 CN Linear OP Amp	.45
LM 709 H Linear OP Amp	.29
LM 709 N Linear OP Amp	.29
LM 710 N Linear OP Amp	.75
LM 711 N Linear OP Amp	.75
LM 723 N Linear OP Amp	.55
LM 723 H Linear OP Amp	.55
Mini Numeric Hex 170V DC, XM-107	.80
3 1/2 Digit Liquid Crystal Display, XM-371	6.00
Fairchild 914 Type IC, Kit/2, TR-297	.60
Fairchild 717 Type IC, TR-294	.30
200 Bit Shift Register, Kit/5, TR-295	.50
Fairchild 909 Type IC, RE-131	.60
6-12 Amp Stud Rectifiers, Pkg. of 3, TR-443	.60
Low Voltage Electrolytics, Pkg. of 50, CD-407	.70
DSBR Numeric Indicator Tube, XM-338	1.20

DUAL IN-LINE IC'S

Made in U.S. These IC's are guaranteed against defects. With diagram. Shpg. wt. 1/4 lb.

LOW AS 29c

Type 7400 Quad 2-Input Pos. NAND Gate. High speed, diode-clamped inputs. 29c

TR-431, Type 7402 Quad 2-Input Pos. NOR Gate. Low-noise propagation delay. 12 ns. 29c

TR-432, Type 7404 Hex Inverter. Low noise, low power dissipation. 79c

TR-433, Type 7410 Triple 3-Input Pos. NAND Gate. Low output impedance. diode-clamped inputs. 29c

TR-434, Type 7447 BCD to 7-Seg. ment Decoder/Driver. With common anode displays. 59c

TR-435, Type 7473 Dual J-K Master/Slave Flip-Flop. 39c

TR-436, Type 7474 Dual D-Type Edge Triggered Flip-Flop. 39c

TR-437, Type 7475 4-Bit Latch. Temp. stores binary coded info. 79c

TR-437, Type 7490 Decade Counter. Binary coded decimal counter with symmetrical divide. 79c

TR-439, Type 7475 4-Bit Latch. Temp. stores binary coded info. 79c

LED'S 2V 10mA

Large Dome Type

Gallium phosphide source emits bright red light. Long life. — high quality. Shipping wt. 1/4 lb.

59c

Pkg. of 5

PL-333

5 amp. Mercury switch S.P.D.T.	SW-586	.49
5 amp. Mercury switch S.P.S.T.	SW-750	.44
Auto long toggle switch	SW-539	1.19
10 A. snap action switch S.P.S.T.	SW-454	.39
Center-off toggle switch D.P.D.T.	SW-154	Pkg. 2 2.49
3 Button push switch	SW-460	.24
Thermostatic switch 50-600 N.O.	SW-636	.39
Unimax 15A. switch S.P.S.T.	SW-752	.49
SA. toggle S.P.S.T. N.O.	SW-409	.69
Phone type lever switch 4 — S.P.S.T.	SW-431	.82
Read switch w-magnet S.P.S.T.	SW-632	Pkg 10 1.29
JA. see-saw switch D.P.D.T.	SW-409	.69
Unimax 20A. S.P.D.T. switch	SW-579	.29
1M RPM timing motor 120 V.A.C.	MO-277	.49
1/15 RPM timing motor 120 V.A.C.	MO-310	.39
1/25 RPM timing motor 120V.A.C.	MO-315	.39
1/15 RPM timing motor 240V.A.C.	MO-317	.39
1/30 RPM timing motor 120V.A.C.	MO-359	.49
2500 ohm output transformer	TT-092	.84
5 volt 1/2 A. filament transformer	TF-045	.44
6 volt 1/2 A. filament transformer	TF-047	.44
12 volt 2 A. filament transformer	TF-050	.47
6 volt 1/2 A. & 12 volt 1/2 A transformer	TF-068	.54
455 kHz IF transformer	TT-290	2.79
24 volt 1A. power transformer	LL-083	Pr. 1.04
455 kHz IF transformer	KN-030	.49
4 pc. knob set 1/8 in. shaft	KN-057	.26
0-1 Mc panel meter 1 1/2" mfg. hole	ME-182	.74
0-200 U.A. edge panel meter 1 1/4" x 1 1/2"	ME-205	.74
0-150 U.A. panel meter 1 1/4" x 1 1/4"	ME-204	.74
100-0-100 U.A. 1 x 1 1/4" meter	ME-203	.74
Neon panel lamp 117V. AC	PL-159	Pkg. 2 1.09
Mini neon panel lamp 117V. AC	PL-157	Pkg. 2 .78
1 Red-1 Yellow neon lamp 117V. AC	PL-148	Pkg. 3 1.29
6 volt panel lamps 1 Red — 1 Green	PL-085	Pkg. 2 .79
NE-2 neon lamps	PL-153	Pkg 10 .74
3000 ohm resistors	RS-242	Pkg. 5 .59
Assorted volume controls	VC-276	Pkg. 12 .59
1/4 watt resistor kit 10 to 2M. ohm	RR-093	Pkg. 50 1.69
12K ohm gto-bar resistors	RS-241	Pkg. 2 .39
500K ohm slide volume control	RR-091	1.00
Mini relay 117V. DC B.P.D.T.	SW-573	1.29
Plug-in 50V. AC relay B.P.D.T.	SW-585	1.69
Plug-in 117V. AC relay 4.P.D.T.	SW-543	1.69
Mini 117V. AC relay S.P.D.T.	SW-561	.89
117 volt AC solenoid	SC-966	Pkg. 5 .84
Mini electrolytic 5 mfd. 10 volts	CC-967	Pkg. 5 .59
Mini electrolytic 10 mfd. 25 volts	CC-968	Pkg. 5 .59
Mini electrolytic 30 mfd. 25 volts	CC-969	Pkg. 5 .79
Mini electrolytic 50 mfd. 25 volts	CC-970	Pkg. 5 .83
Mini electrolytic 100 mfd. 10 volts	CC-234	Pkg. 5 .39
500 Pf. poly cap 125V.	CC-235	Pkg. 5 .39
1000 Pf. poly cap 125V.	CC-216	Pkg. 3 .59
100 mfd. 50 volt electrolytic	CC-224	Pkg. 3 .29
80-50 mfd. 150 volt tub. electrolytic	CC-001	1.10
Ass'd mini electrolytics 3-16 volt		

Pushbutton AM Car Radio AU-534 Reg. \$12

4 Digit Mechanical Counter XM-367 Reg. \$4

Adapt radio to any van, truck, car, motor home, etc. Manual tuning control. Complete with knobs 12 VDC negative ground Dash opening size 3 1/4" W x 1 1/4" H. Overall 7 1/4" x 7 1/4" W x 6 1/2" H.

Four-digit mechanical counter has ratchet mechanism that counts to 10 with each counterclockwise rotation of the shaft. It is not resettable. Shpg. wt. 1/4 lb.

TV CARTS

XM-374 Reg. \$4

XM-375 Reg. \$4

Automatic Antenna Rotor AA-876 Reg. \$7.20

For Warm Climates Only
 No backlash or overtravel. Silent operation. Solid-state dependability. Not for use in temperatures below 32°F. or for continuous duty. 117 VAC. Shpg. wt. 9 lbs.

12 VDC Pencil Tip Soldering Iron TL-793 Reg. \$2.78

Ideal for Solid-State
 Easy to use. 12 volt soldering iron is for delicate soldering work. Tip temperature reaches 250°F. Iron is 9" long. Shpg. wt. 1/4 lb.

Handsomely styled, easy to assemble carts are ruggedly constructed of metal with a wood vinyl trim. Each cart is equipped with four 3" roll-free casters for convenient mobility of your portable television set. Choose between a Contemporary and a Traditional style. Buy now and take advantage of the low prices! Shpg. wt. 4 lbs.

Free

Next 7 Issues of Olson Catalog

CB Catalog with Dealer Prices

Rembrandt PERSONAL ALARMS

EXPERIMENTORS CAN MODIFY TO PROTECT HOME, CAR, POOL almost anything

Choose Between Standard, Heavy-Duty or Professional Model Alarms

Alarms have immediate pushbutton alarm with piercing police-like siren to summon help. Carry over shoulder or attach to belt. Solid-state alarms operate on standard 9V batteries in black, featherette carrying case. Wt. 2 lbs.

XM-482 Reg. 1995 \$7

XM-483 Reg. 2995 \$9

XM-484 Reg. 3995 \$11



\$120

Reg. \$150

Olson Stereo/Discrete 2/4 Channel Receiver

Model RA-632

Universal Matrix Decoder Circuitry

Model RA-632. True discrete and matrixed 4 channel sound — synthesizes regular stereo sources for 4-channel effect when four speakers are used. Tape monitor input to add 4-channel discrete disc demodulator. Features FET FM tuner, FM Muting Circuit, dual concentric bass and treble controls adjust front and rear channels. With 360° joystick balance control. Attractively styled. 117 VAC, 18 1/2" x 4 1/2" x 12". Shpg. wt. 20 lbs.



Olson CB-409

23-Channel Mobile Citizens Band Transceiver

Includes Trunk Mount Antenna

Has local/distance and PACB switch, 'ON AIR' light and channel indicator, push-to-talk microphone and also features S/R/F meter, squelch and volume control plus jacks for antenna, external and PA speaker and mike connector. 0.5V/4 for 10 dB S+N/N 12 VDC. neg. grd. Shpg. wt. 3 1/2 lbs.

Reg. \$104

Sep. Price \$159



CB DEALER DISTRIBUTOR WANTED

Olson Electronics has just opened the new Distributor-Dealer CB Division. If you are interested in participating in this area of consumer electronics we invite you to contact us, using your formal business letterhead stationary, or stop at any Olson Electronic store for a free copy of the Olson Dealer-Distributor Catalog and Price Lists.

Magnavox Stereophones PH-330 Reg. \$2.88

For Use in Auto or Home

Compact, lightweight, comfortable headpieces with adjustable earpieces with vinyl cushions. 8 ohms. 8-ft cord, std. 1/4 stereo plug. 1 lb.

5 lb. Surprise Kit XM-196 Reg. \$1.29

Surprise kit contains 5 pounds of resistors, capacitors — the most wanted and needed parts and hardware for the kit-maker and hobbyist. 5 lbs.

CASTERS XM-111 Reg. \$1.69

Package of 4

Top quality, universal casters make almost anything conveniently rollable. Casters have a 1 1/4" mounting hole 1 1/2" diameter. Shpg. wt. 2 lbs.

Desk Type Lock & Key XM-478 Reg. \$1.59

Rugged Construction

A popular type lock and key commonly used on drawers, desks, tool boxes and more! Styles may vary slightly. Comes without mounting hardware. Shpg. wt. 1/4 lb.



Olson Electronics Dept LG 260 S. Forge St., Akron, Ohio 44327

Name _____

Address _____

City _____ State _____

Zip _____

7400N TTL

SN7400*	13	SN7415N	27	SN74151N	1.25
SN7401N	16	SN74153N	27	SN74153N	1.35
SN7402N	21	SN7454A	41	SN74155A	1.25
SN7403N	16	SN7459A	25	SN74155N	1.21
SN7404*	16	SN7460N	22	SN74156N	1.30
SN7405A	24	SN7470N	45	SN74157N	1.30
SN7406A	45	SN7472N	39	SN74158N	1.35
SN7407N	45	SN7473N	37	SN74161N	1.45
SN7408A	25	SN7474N*	32	SN74163A	1.35
SN7409A	25	SN7475N*	59	SN74164A	1.65
SN7410N	16	SN7476N*	32	SN74165A	1.65
SN7411N	30	SN7480N	50	SN74166A	1.70
SN7412N	42	SN7482N	1.75	SN74167N	3.00
SN7413N	85	SN7483N	1.15	SN74170N	5.00
SN7414N	70	SN7485N	1.12	SN74172N	18.00
SN7416A	43	SN7486A	45	SN74173N	1.50
SN7417N	43	SN7488A	3.50	SN74174A	1.95
SN7418N	25	SN7489A	3.00	SN74175A	1.95
SN7420N	21	SN7490N*	49	SN74176N	90
SN7421N	39	SN7491N	1.20	SN74177N	3.50
SN7423N	37	SN7492N	82	SN74180N	1.05
SN7425N	43	SN7493A*	57	SN74181N	3.55
SN7426N	31	SN7494N	91	SN74182N	95
SN7427N	31	SN7495N	91	SN74183A	2.30
SN7429N	42	SN7496A	91	SN74185N	2.20
SN7430N	26	SN74100N*	1.00	SN74187N	6.00
SN7432N	47	SN74107N	49	SN74189A	1.50
SN7433N	47	SN74121N*	45	SN74191N	1.50
SN7434N	40	SN74122N	49	SN74192N*	1.19
SN7439N	25	SN74123N	70	SN74193N*	99
SN7440N	21	SN74125N	60	SN74194N	1.45
SN7441N	1.10	SN74126N	81	SN74195N	1.00
SN7442N	1.00	SN74127N	2.00	SN74195N	3.25
SN7443N	1.05	SN74141N	1.15	SN74197N	1.00
SN7444N	1.10	SN74142N*	4.00	SN74198N	2.25
SN7445N	1.10	SN74143N	4.50	SN74199N	2.25
SN7446N	1.15	SN74144N	4.50	SN74200N	7.00
SN7447N*	79	SN74145N	1.15	SN74201N	1.25
SN7448N	99	SN74148N	2.50	SN74284N	6.00
SN7450N	26	SN74150N	1.10	SN74285A	6.00

MANY OTHERS AVAILABLE ON REQUEST
20% Discount for 100 Combined 7400's

CD4000	25	CMOS	74C10N	65
CD4001	25		74C20N	65
CD4002	25		74C30N	65
CD4006	2.50		74C42N	2.15
CD4007	25		74C73N	1.50
CD4009	59		CD4042	1.90
CD4010	59		CD4044	1.50
CD4011	25		CD4046	2.50
CD4012	25		CD4047	2.25
CD4013	47		CD4049	73
CD4016	56		CD4050	79
CD4017	1.36		CD4051	2.98
CD4019	55		CD4052	2.98
CD4020	1.49		CD4060	3.25
CD4022	1.25		CD4066	1.75
CD4023	25		CD4069	45
CD4024	1.50		CD4071	45
CD4025	2.00		CD4072	45
CD4027	69		74C00N	39
CD4028	1.65		74C02N	75
CD4029	2.90		74C04N	75

LM100H	15.00	LM1310N	2.95
LM109H	2.50	LM1351N	1.65
LM117H	3.75	LM1418N	65
LM1212H	7.00	LM1496N	95
LM300H	80	LM1496N	95
LM300H*	31.00	LM3000N	1.05
LM301H*	31.00	LM3081N	1.79
LM302H	75	LM3081N	1.79
LM3084H	1.00	NE501A	8.00
LM3085H	95	NE510A	6.00
LM3097H	1.00	NE531H	3.00
LM3098H	1.00	NE536H	6.00
LM3099H	1.00	NE540H	6.00
LM3099N	1.10	NE550N	7.00
LM3099S	1.25	NE553	2.50
LM3100H	1.15	NE555V	45
LM3111H	90	NE565H	1.25
LM3111N	90	NE568N	1.25
LM3118N	1.50	NE5660N*	1.85
LM3191N	1.30	NE567H	1.25
LM3192N	1.30	NE567V	1.50
LM3200K-5	1.35	LM7030N	45
LM3200K-5.2	1.35	LM7099N	29
LM3200K-12	1.35	LM7099N	29
LM3200K-15	1.35	LM7111N	39
LM3200K-5 10.50		LM7233N	55
LM324N	1.80	LM7233N	55
LM339N	1.90	LM7233N	55
LM340K-5	1.95	LM7339N	1.00
LM340K-12	1.95	LM7339N	1.00
LM340K-15	1.95	LM7412H*	31.00
LM340K-24	1.95	LM7412N*	31.00
LM3401-5	1.75	LM7414N	39
LM3401-6	1.75	LM7417N	79
LM3401-12	1.75	LM7474N	79
LM3401-15	1.75	LM7481N	39
LM3401-24	1.75	LM7481N	39
LM350N	1.00	LM1303N	80
LM351CN	65	LM1305N	1.19
LM370N	1.15	LM1305N	1.40
LM370N	1.15	LM1307N	85

KITS EXAR IC'S

XR 2706KA SPECIAL \$17.95
Includes: interfacing, function generator IC, PC board and assembly instructions manual.

XR 2706KB SPECIAL \$27.95
Same as XR 2706KA, plus includes external components for PC board.

TIMERS WAVEFORM GENERATORS

XR 5552CP	\$ 69	XR 205	\$3.70
XR 320P	1.55	XR 2706CP	3.70
XR 556CP	1.85	XR 2707CP	3.70
XR 7556CP	3.70		
XR 2740CP	3.25		

PHASE LOCKED LOOPS

XR 210	5.20	XR 1310P	8.40
XR 215	6.60	XR 1800P	3.85
XR 567CP	1.95		
XR 7567CP	2.99		

DATA HANDBOOKS

7400	Pin-out & Description of 5400/7400 IC'S	\$2.95
CMOS	Pin-out & Description of 4000 Series IC'S	\$2.95
LINEAR	Pin-out & Functional Description	\$2.95
	ALL THREE HANDBOOKS	\$6.95

JAMES FEBRUARY SPECIALS

Astrisk Denotes Items On Special For This Month

Special Requested Items

RC4194	Dual Track V reg	\$ 5.95	NR197	\$ 3.00	MC6007 \$10.95	MC4044	4.50	
RC4195	15V Track Reg	3.25	402AP	2.25	8261	3.95	LM3909	2.25
F3668	Diode	3.55	2513	11.00	8267	2.75	MM5320	19.95
LD10111	DVM Chip Set	28.00	2513	7.00	8288	1.15	74279	90
CA3130	Super CMOS Op Amp	1.49	2524	3.50	8826	3.00	4072AE	45
MC140817	A/D	9.95	2525	6.00	8880	1.35	451AE	2.50
F3341	FHD	8.95	2927	5.00	7497	5.00	4136	2.50

WE'LL BE HAPPY TO QUOTE ON YOUR SPECIAL PARTS...

XCITON OPTO ELECTRONICS R - RED LITRONIX DISCRETE LEDES G - GREEN MONSANTO Y - YELLOW O - ORANGE

.125" dia.		.185" dia.		.190" dia.	
XC209R	5/81	XC526R	5/81	XC111R	5/81
XC209G	4/81	XC526G	4/81	XC111G	4/81
XC209Y	4/81	XC526Y	4/81	XC111Y	4/81
XC209O	4/81	XC526O	4/81	XC111O	4/81

.200" dia.		.200" dia.		.085" dia.	
XC22R	5/81	XC556R	5/81	0B5	.085" dia Micro
XC22G	4/81	XC556G	4/81	red led	6/81
XC22Y	4/81	XC556Y	4/81		
XC22O	4/81	XC556O	4/81		

DISPLAY LEDES

FND70	DL707	MAN2	MAN3	MAN7	DL747	DL338		
TYPE	POLARITY	HT	TYPE	POLARITY	HT	TYPE	POLARITY	HT
MAN 1	COMMON ANODE	270 \$1.95	MAN 74	COMMON CATHODE	300 \$1.50			
MAN 2	5 x 7 DOT MATRIX	300 3.95	DL707	COMMON ANODE*	300 \$1.50			
MAN 3	COMMON CATHODE	125 .39	DL747	COMMON ANODE*	600 1.95			
MAN 4	COMMON CATHODE	187 2.50	DL750	COMMON CATHODE	600 2.49			
MAN 7	COMMON ANODE	300 1.50	DL338	COMMON CATHODE	110 1.95			
MAN 7G	COMMON ANODE-GREEN	300 2.50	PND70	COMMON CATHODE	250 5.00			
MAN 7Y	COMMON ANODE-YELLOW	300 2.50	PND303	COMMON CATHODE	500 1.75			
MAN 7Z	COMMON ANODE	300 1.50	PND507	COMMON ANODE	500 1.75			

IC SOLDERTAIL — LOW PROFILE (TIN) SOCKETS

8 pin	1-24	25-49	50-100	1-24	25-49	50-100	
14 pin	5.17	16	15	24 pin	\$ 38	37	36
16 pin	20	19	18	28 pin	1.39	1.26	1.15
18 pin	22	21	20	36 pin	.60	.59	.58
22 pin	29	28	27	40 pin	.63	.62	.61

14 pin	\$ 27	25	24	28 pin	5.99	90	.81
16 pin	30	27	25	36 pin	1.39	1.26	1.15
18 pin	35	32	30	40 pin	1.59	1.45	1.30
24 pin	49	45	42				

8 pin	\$ 30	27	24	24 pin	\$ 1.70	.63	.57
14 pin	30	27	24	28 pin	1.40	1.25	1.10
16 pin	38	35	32	36 pin	1.75	1.40	1.26
				40 pin	1.75	1.59	1.45

50 PCS. RESISTOR ASSORTMENTS \$1.75 PER ASS'T.

ASS'T. 1	5 ea.	10 OHM	12 OHM	15 OHM	18 OHM	22 OHM	25 OHM	50 OHM	1/4 WATT 5% = 50 PCS.
ASS'T. 2	5 ea.	180 OHM	220 OHM	270 OHM	330 OHM	390 OHM	470 OHM	560 OHM	1/4 WATT 5% = 50 PCS.
ASS'T. 3	5 ea.	1.2K	1.5K	1.8K	2.2K	2.7K	3.3K	3.9K	1/4 WATT 5% = 50 PCS.
ASS'T. 4	5 ea.	22K	27K	33K	39K	47K	56K	68K	1/4 WATT 5% = 50 PCS.
ASS'T. 5	5 ea.	56K	68K	82K	100K	120K	150K	180K	1/4 WATT 5% = 50 PCS.
ASS'T. 6	5 ea.	390K	470K	560K	680K	820K	1M	1.2M	1/4 WATT 5% = 50 PCS.
ASS'T. 7	5 ea.	2.7M	3.3M	3.9M	4.7M	5.6M			1/4 WATT 5% = 50 PCS.

ALL OTHER RESISTORS FROM 2 1/2 OHMS 5.6M AVAILABLE IN MULTIPLES OF 5 ea

14 PCS. POTENTIOMETER ASSORTMENTS
ASS'T. A 2 ea. 10 OHM 20 OHM 50 OHM 100 OHM 200 OHM 500 OHM
ASS'T. B 2 ea. 1K 7.5K 10K 20K 50K
ASS'T. E 2 ea. 50K 100K 200K 500K 1M 2M
\$9.95 Per Ass't.

Each assortment contains 18 pcs of 10 turn pots. All parts are available in large and quantities. \$99 ea.

PRIME INTEGRATED CIRCUIT ASSORTMENTS

ASS'T. E	5 ea.	SN7100	880	7401	7403	7404	7405	7406	7407	7408	7409	7410	7411	7412	7413	7414	7415	7416	7417	7418	7419	7420	7421	7422	7423	7424	7425	7426	7427	7428	7429	7430	7431	7432	7433	7434	7435	7436	7437	7438	7439	7440	7441	7442	7443	7444	7445	7446	7447	7448	7449	7450	7451	7452	7453	7454	7455	7456	7457	7458	7459	7460	7461	7462	7463	7464	7465	7466	7467	7468	7469	7470	7471	7472	7473	7474	7475	7476	7477	7478	7479	7480	7481	7482	7483	7484	7485	7486	7487	7488	7489	7490	7491	7492	7493	7494	7495	7496	7497	7498	7499	7500	7501	7502	7503	7504	7505	7506	7507	7508	7509	7510	7511	7512	7513	7514	7515	7516	7517	7518	7519	7520	7521	7522	7523	7524	7525	7526	7527	7528	7529	7530	7531	7532	7533	7534	7535	7536	7537	7538	7539	7540	7541	7542	7543	7544	7545	7546	7547	7548	7549	7550	7551	7552	75
----------	-------	--------	-----	------	------	------	------	------	------	------	------	------	------	------	------	------	------	------	------	------	------	------	------	------	------	------	------	------	------	------	------	------	------	------	------	------	------	------	------	------	------	------	------	------	------	------	------	------	------	------	------	------	------	------	------	------	------	------	------	------	------	------	------	------	------	------	------	------	------	------	------	------	------	------	------	------	------	------	------	------	------	------	------	------	------	------	------	------	------	------	------	------	------	------	------	------	------	------	------	------	------	------	------	------	------	------	------	------	------	------	------	------	------	------	------	------	------	------	------	------	------	------	------	------	------	------	------	------	------	------	------	------	------	------	------	------	------	------	------	------	------	------	------	------	------	------	------	------	------	------	------	------	------	------	----

CRYSTALS

Part #	Frequency	Case Style	Price
CY1A	1 000 MHz	HC231U	\$4.95
CY7A	2 000 MHz	HC231U	\$4.95
CY7A	4 000 MHz	HC181U	\$4.95
CY7A	5 000 MHz	HC181U	\$4.95
CY12A	10 000 MHz	HC181U	\$4.95
CY19A	18 000 MHz	HC181U	\$4.95
CY22A	20 000 MHz	HC181U	\$4.95
CY30B	32 000 MHz	HC181U	\$4.95

— AVAILABLE IN THESE FREQUENCIES ONLY —

CLOCK CASES



Nicely styled, small, complete with red three digit use in such applications as desk clocks, car clocks, alarm clocks, instrument cases.
DIMENSIONS: W-4, L-4 1/2, H-2
\$5.95

MULTIPURPOSE KEYBOARDS



MULTIPURPOSE KEYBOARDS
75 Keys — Touch Tone
This schematic version calculator or other system of which any type of keyboard there is an optional addition. This unit may be used as a calculator unit.
\$2.95



This unit was originally intended for calculator type applications but can be applied to a variety of other types of which any type of keyboard there is an optional addition. This unit may be used as a calculator unit.
\$2.49

CALCULATOR CHIPS AND DRIVERS

MM5725	8 DIGIT 4 FUNCTION	\$1.98
DM75491	SEGMENT DRIVER	.79
MM5736	6 DIGIT 4 FUNCTION	1.95
DM75492	DRIVER FOR 5736	.89
MM5738	8 DIGIT 5 FUNCTION	2.95
DM8964	DRIVER TYPE 1	2.00
DM8865	DRIVER TYPE 2	1.00

CLOCK CHIPS

MM5311	6 DIGIT WBCD	\$4.95
MM5312	4 DIGIT WBCD	4.95
MM5313	6 DIGIT WBCD	4.95
MM5314	6 DIGIT CLOCK	3.95
MM5316	ALARM CLOCK	4.95
CT7001	CALCLOCK CHIP	5.95

DIGITAL WATCH READOUT

FOR USE WITH WATCHES, DVMS, COUNTERS, ETC.
\$1.95



HP-5082-7300

HP 5082-7300
3" Dm Matrix type numeric readouts with decoder-driver latch built on the chip. Only 8 pins (BCD in, OP, Latch, +5v, ground).
HP 5082 7300 **\$1.95**



HP 5082 7304

HP 5082 7304
1 version of 7300 **4.95**

1 1/2" x 1 1/2" XFEMERS

These were designed for clock type applications. 110 Vac primary @ 60 Hz. Secondaries: 8-10 Vac @ 30 mA-50 mA. 50 Vac @ 30 mA-50 mA. E-10 for miniature power supplies & gas discharge displays.
SPECIAL \$7.99



1/16 VECTOR BOARD

Part No.	Length	Width	Price		
PHENOLIC	64P44 02XXXP	4.50	6.50	1.72	1.54
EPORY	169P44 02XXXP	4.50	17.00	3.69	3.32
GLASS	84P44 062	4.50	6.50	2.07	1.86
	84P44 062	4.50	8.50	2.56	2.31
	169P44 062	4.50	17.00	5.04	4.53
	169P44 062	8.50	17.00	9.23	8.26
EPORY GLASS	169P44 082C1	4.50	17.00	8.60	6.12

VECTOR WRITING PENCIL

Vector Writing Pencil (P73) consists of a hand held (feather-weight) (under one ounce) tool which is used to guide and wrap insulated wire. Fed off a set of standard-replaceable bobbin, onto component leads or terminals installed on pre-punched "P" Pattern Vectorboard. Connections between the wrapped wire and component leads, pads or terminals are made by soldering. Complete with 250 FT of red wire. **\$9.50 ea.**

REPLACEMENT WIRE — BOBBINS FOR WIRING PENCIL

W36-3-A-Pkg. 3	(Green)	\$2.40
W36-3-B-Pkg. 3	(Red)	\$2.40
W36-3-C-Pkg. 3	(Clear)	\$2.40
W36-3-D-Pkg. 3	(Blue)	\$2.40

9V BATTERY CLIP
STANDARD CLIP FOR USE WITH 9V TRANSISTOR BATTERIES WITH 4" LEADS **9/99**

TERMINAL STRIPS
THREE TERMINAL STRIPS, WITH CENTER TERMINAL USED FOR MOUNTING **15/\$1.00**

AMP TERMINAL PINS
TERMINAL PINS FOR MOUNTING COMPONENTS ALSO PERFECT FOR USE WITH BOARD CONNECTORS AND SUBASSEMBLIES **\$1.00/100 PCS.**

MICROPROCESSOR COMPONENTS

8080A \$39.95

8080 AND 8088 SUPPORT COMPONENTS
8224 CLOCK GENERATOR USED TO GENERATE TWO PHASE BUS AND CONTROL SIGNALS FOR MEMORY **\$12.95**
74LS138 DECODER PERFECT FOR DECODING THE THREE 8088 STATE LINES INTO 8 USEABLE LINES FOR ADDRESS LATCHING **\$3.95**

8228 SYSTEM CONTROLLER GENERATES A SYSTEM DATA BUS AND CONTROL SIGNALS FOR MEMORY \$21.25

	CPU'S	RAM'S	STATIC	DYNAMIC	
8008	8 BIT CPU	159.95	1101	256K1	\$2.25
8080	SUPER 8008	39.95	1103	1024X1	6.95
4040	4 BIT 8080	39.95	2101	256K1	6.95
	SR'S		2102	1024X1	2.95
2904	1024 DYNAMIC	59.00	2107	4096X1	18.95
2518	HEX 32 BIT	7.00	2111	256K4	7.95
2519	HEX 40 BIT	4.00	7010	1024X1	29.95
2524	512 DYNAMIC	3.50	7489	16K4	2.49
2525	1024 DYNAMIC	6.00	8101	256K4	7.95
2527	DUAL 256 BIT	3.95	8111	256K4	7.95
2529	DUAL 512 BIT	4.00	8599	16K4	3.49
2532	QUAD 80 BIT	3.95	9102	1024X1	2.95
2533	1024 STATIC	7.95	74200	1024X1	6.95
3341	FIPO	6.95	93410	75681	1.75
74LS670	16K4 REG	3.95	5262	2048X1	2.95
AV-5-1013	20K BAOD	\$6.95	1702A	2048	15.95
	ROM'S		5203	2048	14.95
2513	CHAR. GEN	11.00	8223	32K8	3.00
7488	RANDOM BITS	3.50	745287	1024	7.95

JOLT 159.95

ACCESSORIES

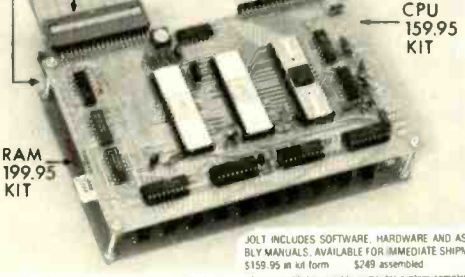

RAM 199.95 KIT

CPU 159.95 KIT

The JOLT system consists of a set of modular microcomputer boards which can be used singly or tied together to produce any desired microcomputer system configuration. The minimum system is one CPU board, which alone constitutes a viable computer system complete with central processor, I/O, interrupts, timer, read-write memory, and a complete software debug monitor at read-only memory.

JOLT SYSTEM DESCRIPTION
JOLT RAM Card — Fully static 4,096 bytes of RAM with 1 microsecond access time and on-board decoding. Hardware and assembly manuals included. AVAILABLE FOR IMMEDIATE SHIPMENT. \$199.95 kit. \$285 assembled.
JOLT Power Supply — Operates at +5, +12 and -10 voltages. Supports JOLT CPU, 4k bytes of RAM and JOLT I/O card — or, CPU and 8 I/O cards. Manuals included. AVAILABLE FOR IMMEDIATE SHIPMENT. \$99.95 kit. \$145 assembled.
JOLT Assembly Bag — Contains enough hardware to connect one JOLT card to another. Such necessary items as flat cable, connectors, cord spacers, hardware, etc. AVAILABLE FOR IMMEDIATE SHIPMENT. \$39.95.

JOLT I/O Card (Peripheral Interface Adapter) — 2 PIA/LSI chips, 32 I/O lines, four interrupt lines, on-board decoding and standard TTL drive. Fully programmable. Manuals included. AVAILABLE FOR IMMEDIATE SHIPMENT. \$95.50 kit. \$140 assembled.
JOLT Universal Card — Same size (4 1/2" x 7"), same form, factor as other JOLT cards. Completely blank, drilled to accept 14, 16, 24 or 40 pin sockets. Used for additional user memory or I/O control panels, TV interfaces, keyboards, LEDs, or other interface logic. AVAILABLE FOR IMMEDIATE SHIPMENT. \$24.95
JOLT +5V Booster Option — Fits onto JOLT Power Supply card. Supports CPU, 16k bytes of RAM — or, CPU and 8k bytes RAM and I/O cards — or, CPU and 4k bytes RAM and 16 I/O cards. Manuals included. AVAILABLE FOR IMMEDIATE SHIPMENT. \$24.95

64 KEY BOARD
These are high quality keyboards, which were originally made by Digital Equipment Corporation. Each keyboard has 64 keys, which are brought out on unconnected pins. They utilize magnetic reed type switches, and are new in appearance. **\$29.95**
HD0165 Keyboard Encoder ROM **\$7.95**

AWG	COLOR	25 FT. MIN.	50 FT.	100 FT.	1000 FT.
30 AWG	WHITE	\$2.10	\$2.75	\$3.50	\$24.00
30 AWG	YELLOW	2.10	2.75	3.50	24.00
30 AWG	RED	2.10	2.75	3.50	24.00
30 AWG	GREEN	2.10	2.75	3.50	24.00
30 AWG	BLUE	2.10	2.75	3.50	24.00
30 AWG	BLACK	2.10	2.75	3.50	24.00

Conductors	1-99/ft	10-24/ft	25-99/ft	100R
10	39	29	25	23
20	59	49	45	43
30	79	69	65	62
40	99	89	85	80
50	119	109	105	100

6' 2 CONDUCTOR POWER CORDS 125V @ 5A

NUMBER	LENGTH	AWG	0.05	RATING	COLOR	PRICE
17236	6	18(41X34)	265	1250W	BLACK	Special 99 ea
17237	6	18(41X35)	253	10A-125V	GREY	1.25
17238	8	18(41X34)	265	1250W	BLACK	Special 99 ea
17239	8	18(41X34)	253	1250W	GREY	1.30
17000	4	18(41X34)	253	10A-125V	BLACK	59

Satisfaction Guaranteed. \$5.00 Min. Order. U.S. Funds. California Residents — Add 6% Sales Tax. Write for FREE 1976 Catalog — Data Sheets .25¢ each

GAMES

P.O. BOX 822, BELMONT, CA. 94002
PHONE ORDERS — (415) 592-8097

JE SERIES KITS

JE801 DVM



The JE801 is a three and one-half digit, auto polarity digital voltmeter. In a kit form. It features several options not available in any commercial digital voltmeter. Its low cost is perhaps the most important feature which is achieved by offering it in a kit form. A kit allows the unit to be used by small OEM's where cost effectiveness is an important factor, and by the hobbyist who has to be concerned with cost. The unit also features no pot or regulators, allowing it to be operated off a single plus and minus fifteen volt, unregulated power supply. The unit has a small size of three inches width, three and three quarters of an inch length, and one and a quarter inch height.

\$39.95 Per Kit printed circuit board

JE803 PROBE



The Logic Probe is a unit which is for the most part indispensable in trouble shooting logic families. TTL, DTL, RTL, CMOS. It derives the power & needs to operate directly off of the circuit under test, drawing a scant 10 mA max. It uses a MAN7 readout to indicate any of the following states by these symbols: (H) — 1 (LOW) — 0 (PULSE) — P. The Probe can detect high frequency pulses to 45 MHz. It can't be used at MOS levels or circuit damage will result.

\$7.95 Per Kit SPECIAL printed circuit board

JE700 CLOCK



The JE700 is a low cost digital clock, but is a very high quality unit. The unit features a simulated walnut case with dimensions of 6" x 2 1/2" x 1 1/2". It utilizes a MAN72 high brightness readout, and the MMS314 clock chip.

12 or 24 Hour
115 VAC — \$19.95 per kit.



JOYSTICK
These joysticks feature four 100K potentiometers, that vary resistance proportional to the angle of the stick. Sturdy metal construction with plastics components only at the movable joint. Perfect for electronic games and instrumentation.
\$9.95 ea

ELECTRONIC ROULETTE



Complete kit with all components case and transformer.
\$29.95 Per Kit
115 VAC

ELECTRONIC CRAPS



Complete kit with all components case and transformer.
\$19.95 Per Kit



CONTINENTAL SPECIALTIES \$15.95

PROTO BOARD 6
The PB-6 lets the user test and build circuits without soldering of patch cords, all interconnections between components are made with common #22 AWG hook-up wire. This quality breadboarding kit includes 630 component tie points at less than 2.5¢ each. It measures 6" long by 4" wide. Designed specially to Breadboard Microprocessor Circuits. **\$15.95**

PROTO BOARD 100
A low cost, big 100 IC capacity breadboard kit with all the quality all OT sockets and the best of the Proto Board series complete down to the last nut, bolt and screw. Includes 2 01-355 Sockets, 1 01-358 Bus Strip, 2 5-way binding posts, 1 rubber feet, screws, nuts, bolts, and easy assembly instructions. **\$19.95**

Bring IC leads from pc board for fast signal tracing and trouble-shooting. Inject signals. Wire unused circuits into boards. Scope Probes and test leads lock onto Dynagrip inset (see circle) for hands off testing. Plastic construction eliminates springs, pivots. Non-corrosive nickel silver contacts for simultaneous low resistance connections.
PC-14, 14 pin Proto Dip. \$4.50 ea.
PC-18, 18 pin Proto Dip. \$4.75 ea.
PC-24, 24 pin Proto Dips. \$8.50 ea.

F.C.C. exam manual, newly revised 1976. Manual includes multiple-choice, questions and diagrams. Covers all areas tested in FCC exam plus reference material, which includes over 400 questions. \$10.95 postpaid. **ELECTRONIC COMMUNICATION SCHOOLS**, Box 622, Troy, MI 48084

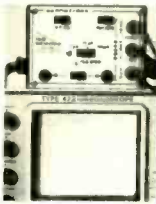

Lab Science
EQUIP YOUR LAB OR SHOP WITH A GENUINE QUALITY SEMICONDUCTOR CURVE TRACER. MEASURES BETA, LEAKAGE, BVCEO, NOISE, MATCH PAIRS, ETC. USES LATEST CMOS CIRCUITRY. COMPLETE WITH BATTERY. COMPARES WITH TRACERS SELLING FOR \$150.00 OR MORE AND EASIER TO OPERATE. SEND CHECK FOR \$99 PLUS \$10 FOR POSTAGE & HANDLING. COLD RES. ADD 31% SALES TAX. MONEY BACK GUARANTEE.
PO BOX 1972 BOULDER, COLO. 80302

TEKTRONIX and **Hewlett-Packard** oscilloscopes and test equipment. Free information. **AMERICAN CALIBRATION SERVICES**, Box 8104, Athens, GA 30601

COMPUTER accessories, kits, surplus, semi-conductors-DIP TTL FF ten for \$1.26, telecommunications, catalog \$0.50. **E/S LAB**, Box 738B, College Park, MD 20740

FREE catalog, IC's, Semi's. **CORONET ELECTRONICS**, 649A Notre Dame W., Montreal, Que. Canada, H3C-1H8. US Inquiries.

BASIC telephone wiring. Unique report gives complete details. \$3.50 postpaid. **QUEENS VILLAGE TELEPHONE SUPPLY**, Box 29002-Z, Queens Village, NY 11429

WANTED: Hard core technicians, engineers, experimenters, as our customers. Military and industrial components. Free catalog. Canadian inquiries welcome. **BRAND X SURPLUS**, Box 444, Baker, OR 97814

COMPUTER accessories—Real world interface kits—speed, sound, temperature, more. **Games**—Startrek, Blackjack, Football, Centerfold Pictures, Math, Business, Engineering, Position programs, more. Send \$1 for samples catalog. **SRI**, PO Drawer C, Marcy, NY 13403

PLANS & KITS

CONVERT any television to sensitive, big-screen oscilloscope. Only minor changes required. No electronic experience necessary. Illustrated plans \$2.00. **SANDERS**, Dept A-25, Box 92102, Houston, TX 77010

BUILD YOUR OWN TV CAMERA

Ideal for home & business



THE ECONOMIC ANSWER TO HOME MONITORING OF NURSERIES, ENTRANCES, DRIVEWAYS, BUSINESS AND INDUSTRIAL SURVEILLANCE. TV AMATEUR TV PLUS HUNDREDS OF OTHER APPLICATIONS. MODEL AT-1A SERIES D - KIT FORM \$185. ASSEMBLED \$215. SOLID-STATE. WORKS ON ANY TV SET. OPTIONAL SOUND KIT \$28.95. PHONE OR WRITE for catalog. Dial 402-987-3771
BOX 453-RE, **ATV Research** DAKOTA CITY, NE 68731

MILLI the C-MOS probe converts your voltmeter into FET input millivoltmeter. Complete kit only \$11.95. Free information. **DAGE SCIENTIFIC INSTRUMENTS**, Box 1054, Livermore, CA 94550

BUILD that electronic organ you always wanted at a price you can afford. Third edition of "Organ Builder's Guide", pictured product kit line, circuits, block diagrams, design rationale using IC divider and independent generators with diode keying. \$3.00 Postpaid. Also, free brochure on keyboards. **DEVTRONIX ORGAN PRODUCTS**, Dept. B, 5872 Amapola Drive, San Jose, CA 95129

AMAZING ELECTRONIC PROJECTS AND PRODUCTS:

Lasers Super Powered, Burning, Cutting, Rifle, Pistol, Pocket. See in Dark—Shotgun Directional Mike—Unscramblers—Giant Tesla—Stunwand—TV Disrupter—Energy Producing, Surveillance, Detection, Electrifying, Ultrasonic, CB, Auto and Mech. Devices, Hundreds More—All NEW PLUS INFO UNLTD PARTS SERVICE. Catalog \$1. Information Unlimited, Box 626, Lord Jeffery Court, Amherst, N.H. 03031.

WANTED

QUICK cash for electronic equipment, components, unused tubes. Send list now! **BARRY**, 512 Broadway, New York, NY 10012, 212 Walker 5-7000

GOV'T SURPLUS Electronic "Super-Buys"

Nationally Known-World Famous SURPLUS CENTER offers finest, Government Surplus electronic units and components at a fraction of their original acquisition cost.



STANDARD DIAL TELEPHONE
• (ITEM #715) - Std. commercial telephone. Same as used throughout U.S.A. Like new condition. Polished block. Use as extension phone or connect several phones together for local intercom system. Full instructions furnished. Wt. 9 lbs.
Original Cost \$24.50
\$7.39



STEP-BY-STEP TELEPHONE SWITCH
• (ITEM #738) - Amazing selector switch makes great experimental item. When used with 2-wire telephone dial it will select any number from 0 to 100. Make private phone or intercom system. Turn on remote lights, motors, etc. Complete with contact bank. 13" x 6" x 5" (16 lbs.)
\$7.81 Cost Over \$90.00



SPECIAL SALE Correspondence Course in ELECTRICAL ENGINEERING
• (ITEM #700) - Telephone Dial For use with #738 switch **\$1.38**
• (ITEM #9-101) - Technical training of low cost Lincoln Engineering School suspended its Correspondence Courses because of rising costs. Limited number of Electrical Engineering courses (without examination grading service) available. Course consists of 15 lesson books with associated exams and standard answers. Home Experimental Lab Bench book included FREE!



BUILD ELECTRIC CARTS WITH UNIQUE MOTORIZED DRIVE WHEEL
• (ITEM #5-936) - Permanent magnet field motor drives wheel through gear box for high torque. Operates on 6 or 12-volt storage battery. Reversible. 65 to 125 RPM. Swivels for steering. 4 1/2" diam. rubber tire wheel.
\$9.98

ALL ITEMS F.O.B. LINCOLN, NEBR.
Write For Catalogs Order Direct From Ad.
SURPLUS CENTER
DEPT. RE - 026 LINCOLN, NE. 68501

INTEL 8080 CPU	\$62.50
8008 8 BIT MICRO PROCESSOR	
ING CHIP (with Data Book)	\$19.00
2102-2 1024 BT RAM	\$ 2.95
5202A UV PROM	\$12.50
MM5203 UV PROM	\$12.50
1702A UV PROM	\$13.95
5204-4K PROM	\$24.95
MINIATURE TRIM POTS 100, 500	
5K, 10K, 25K, 50K, 100K, 200K	
\$.75 ea.	3/\$2.00
MULTI-TURN TRIM POTS Similar to	
Bourns 3010 style, 1/2" x 3/8" x	
1 1/4" .50, 100, 2000, 10,000 ohms	
\$1.50 ea.	3/\$4.00
LIGHT ACTIVATED SCR'S	
TO-18, 200V 1A	\$1.75
PRINTED CIRCUIT BOARD	
4 1/2" x 6" single sided epoxy	
board, 1/8" thick, unetched	
\$.50 ea.	5/\$2.20
VECTOR BOARD 1" SPACING	
4.5" x 6.5" SHEET	\$1.50
4 WATT IR LASER DIODE	\$7.95
2N 5460 P FET	\$.45
2N 5457 N FET	\$.45
2N 4891 UJT	\$.45
TIS 43 UJT	\$.35
ER 900 TRIGGER DIODES 4/\$1.00	
2N 6028 PROG. UJT	\$.65

VERIPAX PC BOARD
This board is a 1/4" single sided paper epoxy board, 4 1/2" x 6 1/2", DRILLED and ETCHED which will hold up to 21 single 14 pin IC's or 8, 16 or LSI DIP IC's with buses for power supply connector. **\$5.25**

MV 5691 YELLOW-GREEN	
BIPOLAR LEO	\$1.25
MT-2 PHOTO TRANS	\$.60
RED, YELLOW, GREEN OR	
AMBER LARGE LED'S	ea. \$.20
14 PIN DIP SOCKETS	\$.35
16 PIN DIP SOCKETS	\$.38
MOLEX PINS	100/\$1.00
	1000/\$8.00
8 PIN MINI DIP SOCKETS	\$.30
10 PIN TO-5 TEFLON	
PC SOCKETS	\$.60
10 WATT ZENERS 3.9, 4.7,	
12, 18, OR 22V	ea. \$.75
1 WATT ZENERS 4.7, 5.6, 10,	
12, 15, 18 OR 22V	ea. \$.25

Silicon Power Rectifiers				
PRV 1A	3A	12A	50A	125A
100 .06	.14	.30	.80	
200 .07	.20	.35	1.15	4.25
400 .09	.25	.50	1.40	6.50
600 .11	.30	.70	1.80	8.50
800 .15	.35	.90	2.30	10.50
1000 .20	.45	1.10	2.76	12.50

REGULATED MODULAR POWER SUPPLIES	
+ -15VDC AT 100ma	
115VAC INPUT	\$24.95
5VDC AT 1A, 115VAC INPUT	\$24.95
12V .5A	\$24.95
IN 4148 (IN914)	15/\$1.00
1103, 1024 bit RAM	\$2.75
NEC 6003 2048 bit RAM	\$6.00
1101 256 bit RAM	\$2.30
7489 RAM	\$2.30
7 POLE 1 THROW TO-5 MINIATURE ROTARY SWITCH	
5-30V LDW CURRENT	\$1.15
H. P. Common Cathode 7740	
space .3" Red Display	ea. \$1.50

TRANSISTOR SPECIALS	
2N3585 NPN Si TO-66	\$.95
2N3772 NPN Si TO-3	\$1.80
2N4901 PNP Si TO-3	\$.85
2N1546 PNP GE TO-3	\$.95
2N5086 PNP Si TO-92 4/\$1.00	
2N4898 PNP TO-66	\$.60
2N404 PNP GE TO-5 5/\$1.00	
2N3919 NPN Si TO-3 RF	\$1.50
MPSA13 NPN Si TO-92 3/\$1.00	
2N3767 NPN Si TO-66	\$.70
2N2222 NPN Si TO-18 5/\$1.00	
2N3055 NPN Si TO-3	\$.80
2N3904 NPN Si TO-92 5/\$1.00	
2N3906 PNP Si TO-92 5/\$1.00	
2N5296 NPN Si TO-220	\$.50
2N6109 PNP Si TO-220	\$.55
2N3866 NPN Si TO-5	\$.75
2N3638 NPN Si TO-5 5/\$1.00	
2N6517 NPN TO-92 Si 3/\$1.00	

CAPACITORS	
35V AT 47 uF TANT 5/\$1.00	
35V AT 68 uF TANT 5/\$1.00	
25V 33 uF TANT	\$.40
35V AT 6.8 uF TANT 3/\$1.00	
20V AT 150 uF TANT	\$.40
6V 30 uF TANT	5/\$1.00
200V 4.7 uF ELECT	\$.30

CD201 100X100 CHARGED COUPLE DEVICES	\$145.00
FPA 711-7 LEVEL Diode Array Optical Tape Readers	\$5.95

MM1402-3.20	MM5057-4.00
MM1403-3.20	MM5058-4.95
MM1404-2.50	MM5060-4.95
MM5013-7.75	MM5061-4.30
MM5016-3.50	MM5555-6.25
MM5017-4.75	MM5556-6.25
MM5055-4.00	MM5210-1.95
MM5056-4.00	MM5260-2.95

TTL IC SERIES	
74L00-.26	7476-.35
7400-.14	7480-.48
7401-.15	7483-.75
7402-.15	7485-1.05
7403-.15	7486-.34
7404-.18	7490-.49
7405-.18	7491-.79
7406-.35	7492-.49
7407-.33	7493-.49
7408-.18	7495-.74
7409-.15	7496-.79
7410-.15	74107-.34
7411-.25	74121-.38
7412-.30	74123-.74
7413-.45	74125-.54
7414-1.45	74126-.54
7416-.33	74150-.92
7417-.33	74151-.69
7420-.15	74153-.79
7425-.27	74154-1.05
7426-.24	74155-1.05
7427-.27	74157-.75
7430-.15	74161-.95
7432-.24	74163-.95
7437-.29	74164-1.10
7438-.29	74165-1.10
7440-.15	74171-1.35
7441-.95	74175-.95
7442-.50	74177-.75
7445-.79	74181-2.30
7446-.87	74192-1.10
7447-.87	74193-1.10
7448-.85	74194-1.15
7472-.28	74195-.74
7473-.34	74196-.95
7474-.35	75324-1.75
7475-.49	75491-1.10

ALCO MINIATURE TOGGLE SWITCHES	
MTA 106 SPDT	\$1.20
MTA 206 DPDT	\$1.70

C/MOS (DIODE CLAMPED)		
74C02-.26	4013-.45	4026-1.90
74C10-.30	4015-1.24	4027-.55
74C157-1.75	4016-.50	4028-.95
4001-.24	4017-1.15	4030-.49
4002-.24	4018-1.24	4035-1.50
4006-1.35	4019-.50	4042-.75
4007-.24	4022-1.24	4046-2.75
4009-.50	4023-.24	4047-3.50
4010-.50	4024-.95	4050-.49
4011-.24	4025-.24	4055-1.95
4012-.24		

CT7001 ALARM CLOCK CHIP	\$6.50
00-33-A 3 OIG. LED ARRAY READOUT	\$1.35
MAN-1 READOUT	\$1.75
MAN-3 READOUT	\$1.00
MAN-4 READOUT	\$1.30
MAN-7 READOUT	\$1.25
DL 747	\$3.50
Full Wave Bridges	
PRV 2A 6A 25A	
200 .95 1.25 2.00	
400 1.15 1.50 3.00	
600 1.35 1.75 4.00	

CD 110 LINEAR 256 XI BIT SELF SCANNING CHARGED COUPLED DEVISE	\$125.00
SANKEN AUDIO POWER AMPS	
Si 1010 G 10 WATTS	\$ 6.90
Si 1020 G 20 WATTS	\$13.95
Si 1050 G 50 WATTS	\$24.95

LINEAR CIRCUITS	
LM 309K 5V 1A REGULATOR	\$1.20
723 -40 +40V REGULATOR	\$.54
301/748-Hi Per. Op. Amp.	\$.28
320T 5, 12, 15, OR 24V	
NEGATIVE REG.	
741A OR 741C OP. AMP.	\$.31
709C OPER. AMP.	\$.25
307 OP AMP	\$.25
CA 3047 HI PERF. OP AMP	\$.95
CA 3088 FM IF SYSTEM	\$3.25
340T-5, 8, 12, 15, 18, 24V	
POS. REG. TO-220	\$1.20
101 OPER. AMP. HI PERFORMANCE.	\$.75
LM 308 Oper. Amp., Low Power	\$1.05
747-DUAL 741	\$.65
556-DUAL TIMER	\$.95
537-PRECISION OP. AMP.	\$2.60
540-70W POWER DRIVER	\$2.50
LM 3900-QUAD OP. AMP.	\$.49
LM 324-QUAD 741	\$1.50
560-PHASE LOCK LOOP	\$2.50
561-PHASE LOCK LOOP	\$2.50
566-FUNCTION GEN.	\$1.75
567-TONE DECODER	\$1.75
LM 1301N FM STEREO DEMOD.	\$2.75
8038 IC VOLTAGE CONT. OSC.	\$3.90
LM370-AGC SQUELCH AMP.	\$1.15
555-2 μs-2 HR. TIMER	\$.53
553 QUAD TIMER	\$3.50
FCD 810 OPTO-ISOLATOR	\$.80
1458 DUAL OP. AMP.	\$.65
LM 380-2W AUDIO AMP.	\$.95
LM 377-2W Stereo Audio Amp.	\$2.50
LM 381-STEREO PREAMP	\$1.15
LM 382-DUAL AUDIO PREAMP	\$1.15
LM 311-HI PER. COMPARTOR	\$.95
LM 319-Dual Hi Speed Comp.	\$1.10
LM 339-QUAD COMPARTOR	\$1.25

TRIACS	
PRV 1A 10A 25A 1.5A 6A 35A	
100 .40 7.0 1.30 .40 50 1.20	
200 7.0 1.10 1.75 .60 70 1.60	
400 1.10 1.60 2.60 1.00 1.20 2.20	
600 1.70 2.30 3.60 1.50 3.00	
SCR'S	
Send 20c for our catalog featuring Transistors and Rectifiers	
145 Hampshire St., Cambridge, Mass.	

Terms: FOB Cambridge, Mass. Send Check or Money Order. Include Postage. Minimum Order \$5.00. COD's \$20.00.



SOUTH STATE SALES
P.O. BOX 740
SOMERVILLE, MASS. 02143
TEL. 617 547-4005

WE SHIP OVER 95% OF OUR ORDERS THE DAY WE RECEIVE THEM

Poly Pak's

SALE



EXCLUSIVE 'BARREL'

THE BIGGEST INFLATION-FIGHTING VALUE EVER! TEST 'EM YOURSELF 'N SAVE!

Every kit carries money back guarantee.

BUY 'EM FROM THE "BARREL"

<p>BARREL KIT #1 SN7400 DIP IC'S 75 for \$1.98</p> <p>Marked 14 and/or with 16 pin dips, may include meters, registers, flip flops, counters. Who knows! GUARANTEED SATISFACTION! Cat. No. 2415 Untested.</p>	<p>BARREL KIT #2 LINEAR OP AMPS DIP'S 75 for \$1.98</p> <p>Un- tested May include 709's, 741's, 703's, 560 series, 555 in-cludes marked and un-cluded. Cat. No. 2418 Untested.</p>	<p>BARREL KIT #3 1N4148/914 SWITCHING DIODES 100 for \$1.98</p> <p>You never saw this before. Imagine famous switching diodes at these prices! Cat. No. 2418 Untested.</p>	<p>BARREL KIT #4 "4000" RECTIFIERS 100 for \$1.98</p> <p>These are the famous micro miniature rectifiers of the 1N4000 series. May include 25, 30, 100, 200, 400, 600, 800 and 1000 volts. Cat. 2417 Untested.</p>	<p>BARREL KIT #5 SCRS, TRIACS, QUADRACS 40 for \$1.98</p> <p>All the famous plastic power tab type. Raw factory stock! All the 10 amp types. Cat. No. 2419 Untested.</p>	<p>BARREL KIT #7 VOLVME CONTROL BONANZA! 40 for \$1.98</p> <p>100% good Single, dual, variety of values, styles, big ones, small ones. Cat. No. 2421</p>	<p>BARREL KIT #8 SUBMINIATURE IF TRANSFORMERS 60 for \$1.98</p> <p>100% good. Amazing. Includes 455ke, osc. antenna, who knows? From manufacturer radio manufacturers. No. 2422</p>	
<p>BARREL KIT #10 ROMS-REGISTERS 50 for \$1.98</p> <p>Un- tested 28 to 40 pin devices, marked. Internal factory numbers. etc. No. 2424</p>	<p>BARREL KIT #11 POWER TAB TRANSISTORS 40 for \$1.98</p> <p>NPN, plastic TO220 type. Assorted 2N numbers. Cat. No. 2425 Untested.</p>	<p>BARREL KIT #12 POWER TAB TRANSISTORS 40 for \$1.98</p> <p>PNP, plastic TO220 type. Assorted 2N numbers. Cat. No. 2426 Untested.</p>	<p>BARREL KIT #13 RESISTOR NETWORKS 40 for \$1.98</p> <p>Un- tested. By Corning Glass, in 14-pin dip paks. Cat. No. 2427</p>	<p>BARREL KIT #14 PRECISION RESISTORS 200 for \$1.98</p> <p>100% good Marked and unmarked 1/4, 1/2, 2 watts. No. 2428</p>	<p>BARREL KIT #15 MOSFET TRANSISTORS 60 for \$1.98</p> <p>All 4 leaders TO-18 case, includes UHF transistors too! Cat. 2429 Untested.</p>	<p>BARREL KIT #16 DISC CAPACITORS 200 for \$1.98</p> <p>Marked and unmarked. Red case type ass't. values. Cat. No. 2430 100% good.</p>	
<p>BARREL KIT #17 LINEAR & 7400 OIPI Un- tested 100 for \$1.98</p> <p>Marked and unmarked. Internal numbers of raw factory stock. No. 2431</p>	<p>BARREL KIT #18 ZENER-RECTIFIER MIX 100 for \$1.98</p> <p>Subminiature, DOT's, includes ass't. zeners and rectifiers. It's mixed at the factory, we cannot separate. Untested. Cat. 2432</p>	<p>BARREL KIT #19 DIPPEO MYLARS 60 for \$1.98</p> <p>Finest capacitors made, shiny finish. Imagine factory dumping 'em in barrels. Cat. No. 2597 100% good.</p>	<p>BARREL KIT #20 LONG LEAD DISCS 100 for \$1.98</p> <p>Factory distributor stock "action" sale. Prime, marked only. Long leads. Cat. No. 2598 100% good.</p>	<p>BARREL KIT #23 "RTL" IC'S 75 for \$1.98</p> <p>100% good. All in TO-5 cases, brand new. May include 90N, 911, 912, 913, etc. Cat. 2601</p>	<p>BARREL KIT #24 HIGH VOLTAGE RECTIFIERS 60 for \$1.98</p> <p>Un- tested. Up to 12,000 volts, 1 mill. epoxy, axial leads. Cat. No. 2602</p>	<p>BARREL KIT #25 METAL CAN TRANSISTORS 100 for \$1.98</p> <p>Un- tested. Includes TO-5, TO-18, etc., assorted 2N numbers, unmarked etc. Cat. No. 2603</p>	
<p>BARREL KIT #26 PLASTIC TRANSISTORS 100 for \$1.98</p> <p>Un- tested. Type TO-92 (TO-18), all manufacturers, variety of 2N 2's. Cat. No. 2604</p>	<p>BARREL KIT #27 PERFORMED DISCS 100 for \$1.98</p> <p>Hi-Fi infra's shelf inventory but he dumped 'em in barrels. Performed, for PC use. Mixed values too! Cat. No. 2605 100% good.</p>	<p>BARREL KIT #28 CERAMIC CAPACITORS 200 for \$1.98</p> <p>Not only do the barrels contain doghouses, but factory dumped, Eric Central, lab, molded types too! Cat. No. 2606 100% good.</p>	<p>BARREL KIT #29 VITAMIN Q CAPS 100 for \$1.98</p> <p>100% good. Every type of oil-impregnated caps, some worth \$2. But the "ole barrel" sale gives you the bargain-off-estimates. Cat. No. 2607</p>	<p>BARREL KIT #30 PREFORMED RESISTORS 200 for \$1.98</p> <p>We got barrels of 1/4 and 1/2 watt for pc use. You'll get even amount. 100, 1/2, 100 1/2 watters. Cat. No. 2608 100% good.</p>	<p>BARREL KIT #31 METALLIC RESISTORS 100 for \$1.98</p> <p>Made mostly by Corning, the finest resistor made. Mostly 1/2 watters, 1% to 5% tol. & a barrel of values 100% good. No. 2609</p>	<p>BARREL KIT #32 TRANSISTORS WITH A HOLE IN IT 50 for \$1.98</p> <p>Un- tested. Can't name factory but we bought barrels of 25 watters with hole in mid. die, PNP's and NPN's.</p>	
<p>BARREL KIT #34 TUBE SOCKETS 100 for \$1.98</p> <p>Good ole tube sockets, still in demand! Barrels and barrels: 4's, 5's, 7's, 8's, 9's, even computer types. Cat. No. 2612 100% good.</p>	<p>BARREL KIT #35 NEON LAMPS 40 for \$1.98</p> <p>100% good. Famous NE-2's. All prime, but factory made millions and barreled 'em. Your advantage. Cat. 2613</p>	<p>BARREL KIT #36 GERMANIUM DIODES 200 for \$1.98</p> <p>Famous maker, popular item. Never grows old. But this is the way the RE-TESTERS buy 'em from the factories. Untested. Cat. 2614</p>	<p>BARREL KIT #37 1 AMP "BULLET" RECTIFIERS 100 for \$1.98</p> <p>Famous style, ass't. volt-ages, silicon, axial includes all types of voltages to 1kV. Untested. Cat. No. 2615</p>	<p>BARREL KIT #38 2 AMP RECTIFIERS 75 for \$1.98</p> <p>Un- tested. "CYLINDER" type, silicon. Mallory. Includes all volt-ages up to 1kV. Axial leads. Cat. No. 2616</p>	<p>BARREL KIT #39 2N3055 HOBBY TRANSISTORS 15 for \$1.98</p> <p>100% good. From factory to you, these fallouts of the famous 2N3055. We have 10 barrels. Cat. No. 2617</p>	<p>BARREL KIT #40 PNP HIGH-POWER TRANSISTORS 20 for \$1.98</p> <p>Popular germanium TO-3 case units, now available at "good ole barrel" prices. Cat. No. 2618 100% good.</p>	
<p>BARREL KIT #41 TO-66 SCRS 30 for \$1.98</p> <p>Un- tested. IMAGINE! These popular TO-66 case (mini TO-3), etc., made up as barrel kit. Values to 600 volts. Silicon. Cat. No. 2619</p>	<p>BARREL KIT #42 100 IFT "GLASS 4000 RECTIFIERS 100 for \$1.98</p> <p>Un- tested. Just in! 1N4000 silicon rectifiers in epoxy, now in glass encased at barrel prices 50 to 1000V too! Cat. No. 2620</p>	<p>BARREL KIT #44 BILATERAL "POWER" SWITCHES 100 for \$1.98</p> <p>The "TOP HAT" of dimmer circuits. Acts like an acv. Includes many 200 PRV units. Cat. No. 2622</p>	<p>BARREL KIT #46 G.E. 3.5 WATT AMPLIFIERS 25 for \$1.98</p> <p>Hobby type, factory fallouts, we purchased them in barrels. These are unknowns. No. 2624 Untested.</p>	<p>BARREL KIT #49 QUAD'S QUAD'S! 50 for \$1.98</p> <p>LM 3900 Un- tested. 4 mirror op amps in one package. Why the factory barreled these we don't know. Cat. No. 2627</p>	<p>BARREL KIT #50 SIGNAL SILICON DIODES 200 for \$1.98</p> <p>Includes many, many types of switching, signal silicon types, all axial leads. Some may be zeners. Cat. No. 2628 Untested.</p>	<p>BARREL KIT #51 HOBBY OPTO COUPLERS 30 for \$1.98</p> <p>We got 1,000's unknown both the sensor or transmitter may be good, or both. WE DON'T KNOW! We don't know the type, 1500V isolation. No. 2629 Untested.</p>	
<p>BARREL KIT #52 DISCS! 500 for \$1.98</p> <p>No. 2630 100% good. The bargain of a lifetime! First time ever offered by Poly Paks for the economy-minded bargain hunters.</p>	<p>BARREL KIT #53 JUMBO RESISTOR PAK 100-pc. \$1.98</p> <p>No. 2721 Assortment metal films, precision, carbons, metal oxide powers, from 1/8 watt to 100 watts. Color coded & 100% good. Worth \$10.</p>	<p>BARREL KIT #54 9 DIGIT READOUTS 10 for \$1.98</p> <p>Un- tested. Bargain of a lifetime! All we got was barrel — the "bilador dielit" types. Multiplexed. Cat. No. 2722</p>	<p>BARREL KIT #55 3 DIGIT READOUTS 15 for \$1.98</p> <p>Un- tested. National cleaned its warehouse — now we have barrels of NSN-33 type. Untested. Cat. No. 2723</p>	<p>BARREL KIT #57 HI-POWER RECTIFIERS 15 for \$1.98</p> <p>50-Amp studs: 6, 12, 21, 48V, 100% material. Factory rectifier "line" rejects. Cat. No. 2725 100% good.</p>	<p>BARREL KIT #58 SLIDE SWITCHES 30 for \$1.98</p> <p>All shapes, sizes, ass't. dpdit, momentaries, etc. Tremendous shop-pak for 100's of switching projects. Cat. No. 2726 100% good.</p>	<p>BARREL KIT #59 POWER TRANSISTORS 40 for \$1.98</p> <p>15 watt Bendix B-5000 outlet transistors, num. all good, purchased from a pre-ster, have millions of 100% good. Cat. No. 2727</p>	
<p>BARREL KIT #60 DTL'S IC'S 75 for \$1.98</p> <p>Un- tested. This is prime barrel material. Who wants DTL's? 930, 936, 946's. Your gain is our loss. They're marked 100%. Cat. No. 2728</p>	<p>BARREL KIT #61 POLYSTYRENE CAPS 100 for \$1.98</p> <p>Un- tested. Finest caps made. As a gamble we bought 10 barrels from factory, mixed values; all good. Cat. No. 2729</p>	<p>BARREL KIT #62 MIXED IC'S 100 for \$1.98</p> <p>Un- tested. All shapes: 7400 Series, 8000, 9000, ROMS, RTL's, DTL's, linears of all kinds. What a mix! Have fun — Cat. No. 2730 Untested.</p>	<p>BARREL KIT #64 6-DIGIT ARRAYS 20 for \$1.98</p> <p>Un- tested. Here's a bargain! This is a National "dump" initiation is stopped here. Cat. No. 2732 Untested.</p>	<p>BARREL KIT #65 MIXED READOUTS 30 for \$1.98</p> <p>Un- tested. Factory returns — such numbers as MAN-4's, MAN-7's, MAN-3's, 11 barrels & no time to separate. We got Cat. No. 2733 Untested.</p>	<p>BARREL KIT #67 2-WATT AMPLIFIERS 50 for \$1.98</p> <p>Un- tested. Buy from the barrel 'n save! LM-380 types in dip paks. Are they good? We don't know. Buy from the barrel 'n save! Millions. Cat. No. 2734</p>	<p>BARREL KIT #68 2 WATTS 100 for \$1.98</p> <p>100% good. Nobody seems to want 'em! So many suppliers don't count, but throw 'em in the barrel. It's a J! gold mine. All marked. Cat. No. 2735</p>	
<p>BARREL KIT #71 CAPACITOR SPECIAL 100 pcs. \$1.98</p> <p>Un- tested. Emptied stockrooms into barrels of mylars, poly's, mica's, muled's, plastic's, ceramic's, disc's, etc. Nifty 100% good. Cat. 2738</p>	<p>BARREL KIT #72 TERMINALS, RECEPTACLES 150 for \$1.98</p> <p>100% good Maker of these dumped in to barrels. Color coded & 6 strips & receptacles. What a buy! Cat. No. 2739</p>	<p>BARREL KIT #73 TRANSISTOR ELECTROS 50 for \$1.98</p> <p>Un- tested. It "bugs" us why the factories dump 'em in barrels. We don't wish to separate wide ass't voltages & values up to 300 mf. No. 2747</p>	<p>BARREL KIT #75 400MW ZENERS 100 for \$1.98</p> <p>Un- tested. Factory out of biz! Amazing offer: 5, 10, 12 to 15V. You test, hermetically sealed glass pak. Double plug. Cat. No. 2740 Untested.</p>	<p>BARREL KIT #76 1-WATT ZENERS 100 for \$1.98</p> <p>Un- tested. Factory same as 400-mw's. Never-to-see-again offer, 6, 8, 10, 12, 15V, under glass. Double plug. Cat. No. 2741</p>	<p>BARREL KIT #77 "BROWN" BODY TRANSISTORS 40 for \$1.98</p> <p>Un- tested. G-E B-40 series, has hi-voltage, Darlington's, hi-current, npn's. Factory line discontinued. Power tabs. Cat. No. 2742 Untested.</p>	<p>BARREL KIT #78 "RED" BODY TRANSISTORS 40 for \$1.98</p> <p>Un- tested. D-12 series. You test — go into your own biz! High current, hi-V, NPN. Get length of leads. May include 4, 6, 8, 12, 15, 18, 24 volts. Power tab. No. 2635</p>	
<p>BARREL KIT #79 DARLINGTON POWER TABS 25 for \$1.98</p> <p>Un- tested. Brown body, power tab Darlington's are mixed, raw factory stock. Who's pay more? Cat. No. 2744</p>	<p>BARREL KIT #80 HOBBY CAPS 200 for \$1.98</p> <p>Un- tested. Precision line stopped. Barrels of mylars, oila, tubulars, but unmarked with all kinds of sizes. All good; you test. Cat. No. 2745</p>	<p>BARREL KIT #81 SUBMINI RESISTORS 100 for \$1.98</p> <p>Un- tested. 100% good. PC upright type, color coded, 1/8 watt. Ass't. values. Come to us in a barrel. Cat. No. 2746</p>	<p>BARREL KIT #82 8000 SERIES IC'S 50 for \$1.98</p> <p>Un- tested. By National. From factory to you. Assortment of popular series, factory fallouts, overruns. Untested. Cat. No. 2634</p>	<p>BARREL KIT #83 LM-340T Un- tested VOLTAGE REGULATORS 15 for \$1.98</p> <p>Un- tested. Factory rejected them for length of leads. May include 4, 6, 8, 12, 15, 18, 24 volts. Power tab. No. 2635</p>	<p>BARREL KIT #84 UN- tested "THE CLAW": 5V 15 mil. LED hobby or experimental use, for understanding the working of "mini" or calculator readouts. A segment may be missing. No. 2679</p>	<p>BARREL KIT #86 HOBBY LEDS 40 for \$1.98</p> <p>Un- tested. Wow! A Litronics dump of all kinds of mixed discrete LEDs, shapes, colors, good, poor, etc. Cat. 2859</p>	<p>BARREL KIT #87 NATIONAL IC BONANZA 100 for \$1.98</p> <p>Un- tested. Factory dumps into barrels. Types 8000, 7400 series, DTL's, ROM's, registers, clock & calc. chips, linears, etc. Cat. No. 2860 Untested.</p>

Terms: Add postage Rated: net 30
Phone: Wakefield, Mass. (617) 245-3829
Retail: 16-18 Del Carmine St., Wakefield,
(off Water Street) C.O.D.'s MAY BE PHONED

POLY PAKS
P.O. BOX 942R-2,
LYNNFIELD, MASS. 01940

MINIMUM ORDER — \$4.00

20c CATALOG on Fiber Optics, 'IC's', Semi's, Parts

Circle 95 on reader service card

PIONEERS OF RADIO

(continued from page 103)

in his invention, but his first backers were wiped out in the "Black Friday" financial crash of 1869. A second supporter, Austin G. Day of New York, was forced to withdraw after the Great Panic of 1873. Meanwhile, on July 30, 1873, Loomis received the first patent ever granted (129,971) for wireless (radio) telegraphy.

After his two failures to get his invention off the ground, Loomis' image waned in the eyes of investors, and his further attempts to obtain capital failed. His pocketbook, his

health, and finally his domestic relations suffered from his single-minded efforts to promote his invention. He left his family in Washington and retreated to his brother's home in West Virginia, where he died October 13, 1886.

Dr. Loomis has three claims to fame: He was the first person to conceive, propose and demonstrate electrical communication through space. He was the first to conceive an electrical field (he called it an ocean) that could be disturbed to produce intelligence-carrying waves. And he was the first to develop the antenna or aerial as a means of transmitting and receiving.

QUALITY ELECTRONIC COMPONENTS

SAME DAY SERVICE

NEW DISCOUNT SCHEDULE SAVES YOU EVEN MORE!

8080A \$49.95 **2102 \$2.65**

MICROPROCESSOR **1024 Bit Random Access Memory**
 0-70°C 480 ns Clock Period **500 ns Typical, 1000 ns Max Access Time**

INTEGRATED CIRCUITS — TTL, CMOS, LINEAR & MOS

7400	.21	7473	.30	74174	.98	4001	.23	4073	.23
7401	.21	7474	.30	74175	.93	4002	.23	4075	.23
7402	.21	7475	.49	74176	.79	4006	1.23	4081	.23
7403	.21	7476	.32	74177	.79	4007	.23	4082	.23
7404	.21	7480	.60	74184	.70	4028	.79	4097	.79
7405	.21	7482	.70	74181	2.15	4009	.44	4510	1.14
7406	.25	7483	.70	74182	.79	4010	.44	4511	1.05
7407	.25	7485	.89	74184	2.10	4011	.23	4514	2.90
7408	.21	7486	.28	74185	2.19	4012	.23	4515	2.90
7409	.21	7489	2.19	74188	3.50	4013	.40	4516	1.23
7410	.21	7490	.44	74189	3.50	4014	.96	4518	1.14
7411	.21	7491	.70	74190	1.23	4015	.96	4520	1.14
7412	.21	7492	.44	74191	1.23	4016	.40	4527	1.68
7413	.25	7493	.44	74192	.88	4017	1.05	4528	.88
7414	.89	7494	.70	74193	.88	4018	1.05	4585	1.23
7415	.25	7495	.70	74194	.88	4019	.73	LM309K	.88
7417	.25	7496	.70	74195	.88	4020	1.14	LM324N	1.28
7420	.21	74100	1.28	74196	.88	4021	1.14	LM340T-5	1.25
7421	.25	74101	.30	74197	.88	4022	.23	LM340T-6	1.25
7423	.35	74109	.33	74198	.49	4023	.23	LM340T-8	1.25
7425	.35	74121	.35	74199	1.49	4024	.23	LM340T-12	1.25
7426	.25	74122	.44	74201	1.09	4025	.23	LM340T-15	1.25
7427	.35	74123	.44	74202	.88	4027	1.68	LM340T-18	1.25
7428	.28	74125	.40	74365	.67	4027	.40	LM340T-24	1.25
7430	.21	74126	.40	74366	.67	4028	.89	LM3900N	.88
7432	.25	74132	.70	74367	.67	4029	1.14	NE536T	3.24
7433	.30	74141	.88	74368	.67	4030	.23	NE540L	2.04
7437	.25	74145	.70	75150	1.31	4033	1.51	NE555A	.88
7438	.25	74147	1.63	75450	.88	4034	3.50	NE560B	3.83
7440	.21	74148	.30	75451	.88	4035	1.14	NE561B	3.83
7441	.88	74150	1.16	75452	.61	4040	1.14	NE562B	3.83
7442	.53	74151	.70	75453	.61	4041	.79	NE565A	1.25
7443	.63	74153	.65	75454	.61	4042	.79	NE565B	1.25
7444	.63	74154	1.02	75491	.81	4043	.79	NE567V	1.36
7445	.70	74155	.70	75492	.84	4044	.70	uA709CV	.44
7446	.70	74156	.70	75493	1.09	4046	1.86	uA710CA	.44
7447	.70	74157	.70	75494	1.19	4048	.40	uA711CA	.44
7448	.70	74160	.88	8093	.40	4050	.40	uA723CA	.60
7450	.21	74161	.88	8094	.40	4051	1.26	uA741CV	.44
7453	.21	74162	.88	8095	.67	4052	1.26	uA747CA	.70
7454	.21	74163	.88	8096	.67	4053	.79	uA748CV	.49
7460	.21	74164	.96	8097	.67	4060	1.58	MC148CV	.53
7470	.30	74166	1.26	8098	.67	4066	.79	MC1458V	.53
7472	.30	74170	2.64	8252S	2.19	4071	.23	2102	2.65
		74173	1.42	4000	.23	4072	.23	8080A	49.95

AP SUPER STRIP II—Universal Breadboarding

Element with 840 Solderless Plug-in Tie-Points

\$17.00

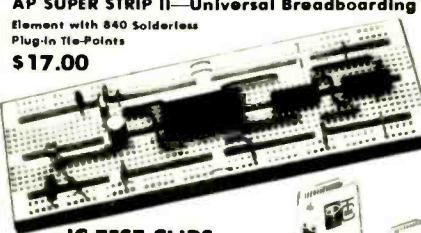

IC TEST CLIPS

14 pin TC-14 \$4.50 24 pin TC-24 \$13.85
 16 pin TC-16 \$4.75

We carry AP's Patch Cards, Terminal Strips, Distribution Strips and ACE's tool

BISHOP GRAPHICS Printed Circuit Drafting

Aids are now available from Dig-Key

ROCKWELL CALCULATORS

We stock a complete line from \$16.88 through \$99.95.



- 4-pin, low-profile DIP
- Leads on standard .10" (2.54 mm) grid
- 1 Amp at 40°C (I_{OL})

DIB DUAL IN-LINE BRIDGE

An integrated bridge rectifier in a miniature dual in-line package



CMOS DATABOOK \$1.50

Specifications and pin-outs for 80 different 4000 series parts

REED RELAYS

1.5 AMP SPST N.O.M. Contacts

4.8V Coil	\$1.70	\$125/C
6.0V Coil	\$1.70	\$125/C
12V Coil	\$1.70	\$125/C
24V Coil	\$1.70	\$125/C

1/4 WATT 5% CARBON FILM RESISTORS

5¢ each in multiples of 5 per value \$1.70/100 of same value, 10¢ when 1.0 meg

RESISTOR ASSORTMENTS

5¢ off 10% 1/4 W. Vol. from 2.2 to 22 meg (125 pcs) \$12.00
 5¢ off 10% 1/4 W. Vol. from 10 to 5.6 meg (120 pcs) \$12.00

SILICON DIODES

1N4148	.40/10	3.50/C	1N4004	.70/10	5.95/C
1N4001	.54/10	5.50/C	1N4005	.82/10	7.05/C
1N4002	.66/10	5.60/C	1N4006	.90/10	7.75/C
1N4003	.68/10	5.80/C	1N4007	.90/10	8.60/C

VOLUME DISCOUNT SCHEDULE

Merchandise Total	Discount	Merchandise Total	Discount
\$ 0.00 - 9.99	NET	\$ 100.00 - 500.99	LESS 15%
\$ 10.00 - 24.99	LESS 5%	\$ 500.00 - 999.99	LESS 20%
\$ 25.00 - 99.99	LESS 10%	\$ 1000.00 & up	LESS 25%

— Then Add the Standard Charge Below

STANDARD SHIPPING/HANDLING CHARGE

If your merchandise total after discount is between:

0-4.99	add \$2.00	50.00-99.99	add \$0.25
5-9.99	add \$0.75	100.00 & up	No Charge
10-19.99	add \$0.50		

Includes shipping & insurance to USA & Canada

LED DISPLAYS

Your Choice of RED, GREEN or YELLOW

Part No.	Color	Case	Part No.	Color	Case
XAN72	RED	C.A.	XAN672	RED	C.A.
XAN52	GREEN	C.A.	XAN652	GREEN	C.A.
XAN62	YELLOW	C.A.	XAN642	YELLOW	C.A.
XAN74	RED	C.C.	XAN684	RED	C.C.
XAN54	GREEN	C.C.	XAN654	GREEN	C.C.
XAN64	YELLOW	C.C.	XAN684	YELLOW	C.C.

SILICON TRANSISTORS

MPS918, MPS930, MPS2222A, MPS2369A, MPS2712, MPS2907A, MPS3392, MPS3393, MPS3394, MPS3395, MPS3563, MPS3565, MPS3638, MPS3638A, MPS3640, MPS3641, MPS3643, MPS3645, MPS3646, 2N3904, 2N3906, 2N4124, 2N4126, 2N4401, 2N4403, 2N4410, PNP888, 2N5087, PNP599, PNP5129, PNP5133, PNP5134, PNP5137, PNP5138, PNP5139, 2N5210, PNP5964 - 16¢, \$1.55/10, \$13.60/100 of same part no.

MPF102 .36 \$20.00/C 2N5457 .48 \$41.00/C 2N5413 .28 \$24.00/C 2N3055 .99 \$85.00/C

ELECTROLYTIC CAPACITORS

Radial Lead	Axial Lead	Axial Lead
2uf/50v .08 .65/10	1uf/50v .11 .90/10	47uf/25v .17 1.30/10
2.2uf/50v .08 .65/10	2.2uf/50v .12 .90/10	100uf/16v .17 1.30/10
3.3uf/50v .08 .65/10	3.3uf/25v .12 .90/10	100uf/25v .20 1.55/10
4.7uf/25v .08 .65/10	3.3uf/50v .12 .90/10	220uf/50v .29 2.30/10
4.7uf/50v .08 .70/10	4.7uf/25v .11 .90/10	220uf/10v .29 2.30/10
10uf/25v .08 .65/10	4.7uf/35v .12 .95/10	220uf/25v .29 2.35/10
10uf/50v .10 .75/10	10uf/15v .11 .90/10	330uf/16v .29 2.35/10
22uf/25v .09 .70/10	10uf/25v .12 1.00/10	330uf/25v .32 2.55/10
22uf/50v .12 1.00/10	10uf/50v .14 1.15/10	470uf/16v .32 2.55/10
100uf/6.3v .09 .75/10	22uf/15v .12 1.00/10	470uf/25v .37 3.00/10
100uf/15v .11 .85/10	22uf/25v .13 1.05/10	1000uf/16v .39 3.15/10
100uf/25v .13 1.10/10	33uf/15v .12 1.00/10	1000uf/25v .46 4.50/10
	33uf/25v .14 1.15/10	2200uf/16v .62 4.95/10
	47uf/16v .14 1.15/10	

DISC CAPS

1/2 WATT ZENER DIODES

100pf/500v .04 .36/10	1M52268 3.3v .15 \$11/C	1N52268 7.5v .15 \$11/C
220pf/500v .04 .36/10	1M52278 3.6v .15 \$11/C	1N52268 8.2v .15 \$11/C
470pf/500v .04 .36/10	1M52288 3.9v .15 \$11/C	1N52268 9.1v .15 \$11/C
1000pf/500v .04 .37/10	1M52298 4.3v .15 \$11/C	1N52268 10.0v .15 \$11/C
2200pf/500v .04 .37/10	1M52308 4.7v .15 \$11/C	1N52268 11.0v .15 \$11/C
4700pf/500v .04 .37/10	1M52318 5.1v .15 \$11/C	1N52268 12.0v .15 \$11/C
.01uf/500v .06 .50/10	1M52328 5.6v .15 \$11/C	1N52268 13.0v .15 \$11/C
.01uf/500v .06 .50/10	1M52338 6.0v .15 \$11/C	1N52268 14.0v .15 \$11/C
.01uf/500v .06 .50/10	1M52348 6.2v .15 \$11/C	1N52268 15.0v .15 \$11/C
.01uf/500v .06 .50/10	1M52358 6.8v .15 \$11/C	

RADIO-ELECTRONICS

OPTICALLY COUPLED ISOLATOR

Gallium Arsenide diode light source optically coupled to silicon NPN photo transistor. Mini dip package.
 #SOC \$1.00 6/\$5.00

3 OCTAVE KEYBOARD \$12.50

Suitable for tone oscillator board top musical devices.

POWER SUPPLY KIT

Puts out 24-12-6 volt DC 2 amps. Includes xfmr, line cord, filter, silicon bridge.
 #PK-2B \$9.00

B & L HELIUM NEON GAS LASER

Fully assembled, runs on 115 volts AC. Less Laser tube \$15.00

POWER AMP TRANSFORMER \$9.00

115 volts input, output of 96 VCT 2 amps. \$9.00 each 3/\$25

1N1131 Sil. Signal Diode	0.3 amp.	
1500 PIV		2/\$1.00
2N2222 (HEP 555)		8/\$1.00
1103A 1024 bit RAM	\$2.50 each	5/\$10
MC 1440G Sense Amp		2/\$1.00

Please add shipping cost on above.
 FREE catalog

Meshna SURPLUS ELECTRONIC MATERIAL

P.O. Box 62
 19 ALLERTON STREET
 E. LYNN MASS. 01904

Circle 97 on reader service card

2 in 1

5 x 4 1/2" Display counter module 4 x 5 inches
 4 digit 7 seg LED All other modules 3 x 5 inches



FREQUENCY COUNTER & MULTIMETER MODULES

\$79.95 FREQUENCY COUNTER - MULTIMETER

MODULES

- (1) DECADE COUNTER MODULE \$24.95
- (2) TIME BASE DIVIDER CHAIN MODULE 19.95
- (3) 1MHz crystal controlled oscillator & decade divider. 1MHz, 100kHz, 10kHz, 1kHz, 100Hz, 10Hz outputs. Accuracy better than .001%. Module contains dual JK Flip Flop for stopwatch time application.
- (4) FREQUENCY COUNTER GATE MODULE 14.95
- (5) Schmitt trigger input requires 1V. Frequency basic 30MHz. Has 1 stop schmitt prescaler extending freq. range to 100MHz.
- (6) DIGITAL MULTIMETER MODULE 24.95
- (5a) 150u - 1000uF digital multimeter specs for range and label.
- (a) DVM module (DC volt & current)
- (b) AC converter, OHM module (AC volt & current, OHM)
- (5) CAPACITANCE COUNTER 19.95
- 100uF to 1000uF, 1% typically. Require Freq. counter system, 101
- (6) FUNCTION GENERATOR 19.95
- 1Hz to 1MHz. Simultaneous sine, square, triangle wave. Adjustable duty cycle. Less than 1% Distortion 0.1% linearity. Can be modulated.

SYSTEMS

(A) FREQUENCY COUNTER - DIGITAL MULTIMETER \$79.95

(Also stopwatch, timer, crystal calibrator)
 Consists of module (1), (2), (3), (4a), and (4b).
 4 Digit Frequency Counter, 30MHz range basic with one schmitt prescaler extending range to 100MHz. Schmitt trigger input requires 1V. Frequency basic 30MHz.
 Digital Multimeter, 1 1/2 MEG OHM input impedance on all ranges. 100% coverage, i.e., 0-1.999 on 0-1.000V range.
 AC & DC voltage range: 0-1.000V, 10.00V, 100.0V, 1000V.
 AC & DC current range: 0-1.000mA, 10.00mA, 100.0mA, 1000mA.
 OHMS range: 0-1000HM, 1K, 10K, 100K, 1MEG.
 All attenuating & shunt networks of precision resistors.
 Accuracy: ± 3 count ± 1% (extended display version available add 6.95)
 (B) FREQUENCY COUNTER - STOPWATCH \$49.95
 (C) STOPWATCH-TIMER-TIME BASE 14 digit
 Consists of module (1) and (2). Time range from 10us to 9999 seconds.
 116.85 mini two input gate Start & Stop.
 (D) POWER SUPPLY \$24.95
 2 1/2V at 500ma and 5V at 1.0amp. (Use for more than 4 digits.)
 18.95
 2 1/2V at 500ma and 5V at 1.5amp. (Use for more than 4 digits.)
 22.95

(Systems do not include hardware such as TTL switches, etc.)
 Add \$1.50 Postage & Handling - Power Supply \$1.80 additional
 ALL MODULES ASSEMBLED AND TESTED
 Please allow 3 weeks for shipping & delivery.
 SEND CHECK OR MONEY ORDER TO

LIN CORPORATION

17313 Denker Avenue
 Gardena, California 90247
 (213) 532-8537

Circle 98 on reader service card

			MATSUO TANTALUM CAPACITORS				
			MFD	WVDC	1-9	10 up	50 up
FEBRUARY SPECIALS			.1	35	30	25	20
			.15	35	30	25	20
			.22	35	30	25	20
			.33	35	30	25	20
			.47	35	30	25	20
			.68	35	30	25	20
			1.0	35	30	25	20
			1.5	35	30	25	20
			2.2	20	30	25	20
			3.3	35	38	30	24
			4.7	35	40	32	26
			6.8	35	40	32	26
			10.0	16	38	30	24
			15.0	35	40	32	26
			22.0	16	40	32	26
35.0	20	95	64	56			
50.0	20	1.40	1.05	90			
68.0	16	1.40	1.05	90			

XR-2206KA SPECIAL \$16.95
Includes monolithic function generator IC, PC board, and assembly instruction manual.
XR-2206KB SPECIAL \$26.95
Same as XR-2206KA above and includes external components for PC board.

		1-9	10 up
COM2502		\$13.20	\$10.60
COM2502P	Universal	8.00	6.85
COM2017	asynchronous	13.20	10.60
COM2017P	timing resistor array	8.00	6.85
COM2502M	transmitter	25.00	20.00
COM2017H		25.00	20.00
COM2601	Univ. sync. rec./trans.	30.00	24.00
COM5016	Dual baud rate gen. prog. div	12.00	9.60
XR-2376-S1	Keyboard encoder ROM	20.00	17.50
XR-3600-S1	10-channel multioctet	20.00	17.50
NMX5010	12-digit print. cal. spl. chip	12.00	9.60
CAL 1032	MOS/LSI circuit	60.00	52.00

PULSE GENERATOR



Interdesig. 1101: 0.1Hz-2MHz.
0.5V Output, var. width, line or battery operation. **\$158.00**

High Quality CARBON FILM RESISTORS

$\frac{1}{4}$ Watt 5%

\$1.69 per 100

Only in multiples of 100 per value

• 150 different values in stock from 10 ohm to 10 megohms

PLESSEY RADIO COMMUNICATIONS CIRCUITS

SL610C RF amplifier	4.07	SL621C AGC generator	6.15	SL624C Multimode det. AF amp.	5.70	SL648C Square law device	7.55
SL611C RF amplifier	4.07	SL622C AF amp/VOGAD	15.21	SL630C AF amplifier	3.85	SL650B Mod./phase loc. loop	10.85
SL612C IF amplifier	4.07	SL623C SSB demod.		SL640C Dbl. bal. modulator	7.55	SL650C 3rd./phase loc. loop	6.53
SL613C Limiting amp/det.	8.66	SL623C AM det./AGC amp/SSB demod.	11.19	SL641C Receiver mixer	7.55	SL651B Mod./phase loc. loop	12.05
SL620C VOGAD	6.15					SL651C Mod./phase loc. loop	7.55

EXAR ICs

XR-100K XR-chip cust. IC des. kit	\$80.00	XR-856CP Dual timing circuit	1.82	XR-2207P VCO	6.72
XR-8101 NPN trans. array, sm. sig.	3.50	XR-857M Tone decoder	12.96	XR-2207CN VCO	4.80
XR-8102 PNP array	3.50	XR-857CN Tone decoder	1.84	XR-2207CV VCO	3.84
XR-C101 NPN array, sm. sig.	3.50	XR-1310P Stereo demod.	3.20	XR-2208M Op. multiplier	8.88
XR-C102 PNP array, lat. & subs.	3.50	XR-1310EP Stereo demod.	3.20	XR-2208P Op. multiplier	7.92
XR-C103 NPN array, pwr. schottky	3.50	XR-1468CN 215V tracking VR	3.84	XR-2208CN Op. multiplier	5.60
XR-C104 Waveform gen. IC	25.00	XR-1468CP 215V tracking VR	2.54	XR-2208CP Op. multiplier	5.20
XR-C105 Offused & pinch res. array	3.50	XR-1488M Quad line driver	5.76	XR-2240CN Prog. timer/ctr.	12.24
XR-C106 Bal. mod. & NPN/PNP cur. source	3.50	XR-1488AN Quad line rec.	4.80	XR-2240M Prog. timer/ctr.	19.52
XR-5200 Multi-function IC	28.00	XR-1489AP 215V track. VR	4.32	XR-2240CN Prog. timer/ctr.	8.80
XR-205 Waveform gen. IC	8.40	XR-1868M 215V track. VR	14.32	XR-2240P Prog. timer/ctr.	7.20
XR-206K Waveform gen. kit	25.00	XR-1800P Stereo decoder	7.20	XR-2240CP Prog. timer/ctr.	4.80
XR-210 FSK mod. demod.	5.20	XR-2206M Monolithic funct. gen.	11.20	XR-2556M Dual 555 timer	10.56
XR-210M FSK mod. demod.	10.40	XR-2206P Monolithic funct. gen.	10.24	XR-2556CN Dual 555 timer	3.52
XR-215 Gen. purpose PLL	6.56	XR-2206CP Monolithic funct. gen.	6.56	XR-2567M Dual 567 tone decoder	16.94
XR-220 Timing resistor array	2.00	XR-2207M VCO	15.44	XR-2567CN Dual 567 tone decoder	7.90
XR-855CP Timing circuit	1.07	XR-2207N VCO	7.76	XR-2567CP Dual 567 tone decoder	5.18
XR-856M Dual timing circuit	10.56				
XR-856CN Dual timing circuit	2.88				

SPDT MINIATURE TOGGLE SWITCH

115V 1050 5A RATING \$.95

PREMIUM QUALITY TRANSISTORS

2N125	1.40	2N1136	1.40	2N2221	.24	2N2907	.19	2N3986	2.90	2N4870	.60	2N5249	.30	2N5777	.50
2N173	2.15	2N1137A	1.90	2N2221A	.26	2N2907A	.26	2N3987	1.45	2N4878	3.85	2N5249A	.31	2N5778	.54
2N293	.60	2N1143	1.90	2N2222	.24	2N2911	21.00	2N3988	1.45	2N4894	.95	2N5254	.75	2N5779	.80
2N321	.60	2N1168	.55	2N2222A	.26	2N2913	.89	2N3989	1.09	2N4898	1.10	2N5295	.60	2N5780	.85
2N324	.80	2N1204	1.40	2N2259	1.10	2N2925	.20	2N3970	1.20	2N4901	2.70	2N5296	.95	2N5810	.34
2N336	1.00	2N1302	.30	2N2270	.40	2N2926	.14	2N3971	1.00	2N4902	3.00	2N5298	1.00	2N5811	.38
2N338A	1.25	2N1303	.80	2N2289	3.60	2N2947	14.40	2N3972	1.39	2N4903	3.99	2N5305	.26	2N5812	.36
2N389	9.00	2N1305	.35	2N2290	5.90	2N2949	8.50	2N3973	1.04	2N4904	2.90	2N5306A	.40	2N5813	.42
2N396A	1.20	2N1307	.80	2N2297	.95	2N2950	6.40	2N4032	1.90	2N4905	4.10	2N5307	.40	2N5815	.36
2N397	1.20	2N1309	.80	2N2323	1.90	2N2958	1.90	2N4037	.70	2N4906	4.30	2N5308	.44	2N5816	.38
2N398B	1.00	2N1377	1.40	2N2326	3.30	2N2969	30.90	2N3398	.25	2N4918	1.30	2N5309	.36	2N5817	.38
2N404	.30	2N1408	.60	2N2396	8.80	2N3019	.50	2N3414	.20	2N4922	1.00	2N5310	.40	2N5818	.40
2N404A	.65	2N1420	.50	2N3022	17.90	2N3415	.20	2N3645	.16	2N4958	.25	2N5311	.44	2N5819	.42
2N417	.85	2N1485	2.60	2N3259	15.90	2N3053	.34	2N3646	.16	2N4959	1.00	2N5312	.70	2N5820	.40
2N443	1.15	2N1521	4.80	2N3268	.29	2N3054	.80	2N3647	.22	2N4960	.25	2N5314	1.10	2N5822	.60
2N486	1.30	2N1523	6.00	2N3269	.22	2N3055	.94	2N3648	1.60	2N4985	1.90	2N5323	.66	2N5822	.66
2N491	6.10	2N1537	.35	2N3290	2.95	2N3060	2.95	2N3649	.98	2N4986	.95	2N5354	.30	2N5823	.66
2N506A	.40	2N1540	1.05	2N2440	3.45	2N3066A	1.19	2N3441	1.70	2N4987	.65	2N5355	.35	2N5824	.24
2N511A	3.50	2N1543	3.40	2N2455	7.40	2N3107	.78	2N3442	2.15	2N4988	.95	2N5356	.40	2N5825	.26
2N512B	2.90	2N1549	1.30	2N2468	1.00	2N3117	1.50	2N3445	4.90	2N4989	1.40	2N5366	.40	2N5826	.28
2N525	.90	2N1549	1.30	2N2475	.55	2N3130	4.90	2N3467	1.45	2N4990	.75	2N5367	.42	2N5827	.32
2N526	.90	2N1551	3.90	2N2476	.79	2N3202	15.90	2N3468	1.58	2N4991	.75	2N5368	.24	2N5828	.38
2N527	.90	2N1552	3.90	2N2483	.28	2N3209	.89	2N3478	2.00	2N4993	1.60	2N5370	.26	2N5800	.60
2N555	.50	2N1684	1.90	2N2484	.25	2N3227	2.30	2N3501	6.40	2N4994	.25	2N5371	.22	2N5801	.52
2N586	1.00	2N1687	1.70	2N2492	4.00	2N3239	2.90	2N3506	7.40	2N4995	.25	2N5372	.26	2N5802	.54
2N594	1.50	2N1560	3.20	2N2518	5.90	2N3241	3.80	2N3507	3.90	2N4996	3.75	2N5375	.25	2N5804	.54
2N630	4.00	2N1613	4.00	2N2526	4.40	2N3250	.49	2N3545	2.90	2N4997	3.90	2N5380	.60	2N5810	.62
2N652	.40	2N1671	2.00	2N2527	5.40	2N3307	8.50	2N3563	1.80	2N5006	.50	2N5381	.56	2N5811	.64
2N652A	.40	2N1671B	2.10	2N2538	2.40	2N3308	6.50	2N3563	.18	2N5068	.45	2N5382	.50	2N5814	.66
2N657A	.40	2N1693	14.90	2N2600	7.00	2N3309	7.10	2N3564	.14	2N5069	.80	2N5383	.56	2N5815	.68
2N677C	5.50	2N1711	.40	2N2605	.49	2N3323	1.15	2N3565	1.58	2N5089	1.80	2N5385	2.90	2N5820	.60
2N683	2.70	2N1715	.70	2N2606A	.58	2N3324	.80	2N3567	.19	2N5090	2.40	2N5387	2.80	2N5822	.64
2N697	.25	2N1720	4.90	2N2606	3.50	2N3325	.70	2N3569	.19	2N5091	.22	2N5406	31.90	2N5828	.66
2N697A	.50	2N1893	.36	2N2647	1.30	2N3368	.80	2N3570	2.50	2N5127	.16	2N5409	.25	2N5829	.64
2N699	.66	2N1898	1.00	2N2648	3.80	2N3378	5.60	2N3571	2.10	2N5130	.20	2N5418	.30	2N5899	1.90
2N700	3.00	2N1907	4.90	2N2658	6.90	2N3390	4.00	2N3572	6.50	2N5131	.20	2N5419	.34	2N6101	.95
2N705	.60	2N1921	2.90	2N2708	.25	2N3391	.41	2N3584	1.80	2N5132	.17	2N5420	.30	2N6103	.98
2N706	.20	2N1924	1.25	2N2712	.30	2N3391A	.20	2N3614	1.10	2N5134	.18	2N5447	.26	2N6109	2.30
2N706B	.40	2N1934	9.30	2N2713	.14	2N3392	.20	2N3616	1.24	2N5135	.16	2N5448	.27	2N6111	2.60
2N711	.35	2N1990	.75	2N2714	.40	2N3393	.20	2N3617	2.40	2N5136	.17	2N5450	.24	2N6114	4.50
2N711B	.60	2N2060	2.05	2N2715	.18	2N3394	.22	2N3634	7.90	2N5154	7.05	2N5451	.24	2N6115	2.10
2N718	.28	2N2080	.40	2N2716	.18	2N3395	.24	2N3638	.18	2N5155	3.20	2N5453	5.35	2N6218	8.00
2N718B	.40	2N2081A	2.60	2N2718	94.00	2N3396	.25	2N3640	.19	2N5157	9.85	2N5457	.40	2N6219	.59
2N720A	.60	2N2100	2.90	2N2802	9.70	2N3397	.28	2N3642	.19	2N5158	1.25	2N5458	.40	2N6220	.68
2N744	.35	2N2102	.45	2N2833	3.90					2N5159	.17	2N5459	1.40	2N6221	.52
2N829	2.90	2N2143	1.60	2N2850	112.6										



POTTER BRUMFIELD

Type KHP Relay
4 PDT 3A Contacts

24 VDC (550 coil) \$1.50 Ea.
120 VAC (10.5 MA coil) \$1.75 Ea.

CMOS

CD4000	\$.29	CD4016	\$.69
CD4001	.29	CD4019	.69
CD4002	.29	CD4023	.29
CD4008	1.98	CD4024	1.50
CD4009	.59	CD4025	.34
CD4010	.59	CD4030	.65
CD4011	.29	74C20	.65
CD4012	.29	74C42	2.00
CD4013	.69	74C157	2.50
CD4015	1.98	74C195	2.00

RCA 2010

Mumitron Digital Display Tube
Incandescent 5-volt 7-segment
with .6" high numeral visible
from 30 ft., standard 9-pin
base (solderable), and left
hand decimal point.
EACH \$5.00 5 FOR \$20.00

Numeric Display 1/4" Single Digit GaAsP LED



SUPER SPECIAL \$ 59
TEN for \$4.95

COMMON CATHODE WITH RH DECIMAL
ACTUAL SIZE
Compact - 10 digits in 3" panel width
Highly legible - bright red 'X' character easily read
within 10 feet over a wide viewing angle (180°)
Low power - 125 mW per digit at typical brightness

2102-2 MOS 1024 BIT MEMORY (DIP)

FULLY DECODED STATIC RANDOM ACCESS MEMORY
DIRECTLY TTL COMPATIBLE INPUTS AND OUTPUT
SINGLE 5V SUPPLY - NO CLOCKS OR REFRESH
\$3.99 EA. 10 FOR \$27.95

NEW!



FULL WAVE BRIDGE RECTIFIERS
25 AMP 500 PIV
EACH \$2.00 10 FOR \$16.50

CD-2 COUNTER KIT

Unit includes board, 7490, 7475, quad
latch, 7447 seven-segment driver, and
RCA DR2010.



COMPLETE KIT \$10.95
FULLY ASSEMBLED \$15.00
Boards can be supplied separately at
\$2.50 per digit.

NPN TO3 POWER TRANSISTORS

410 (RCA) 200V - 10A
2N3772 70V - 30A (MAX)
Each \$1.75 10 for \$15.00



2N3055: PD-115M: VCE-60V;
HFE-50: FT-30K.
Each \$.90 10 for \$6.95

TRANSISTOR

2N3904 - HEP236
T092 PLASTIC - NPN
300 MW - 60V - 8100-300
NEW - FAIRCHILD - MARKED
EACH \$.15 10 FOR \$1.00



25K Trimmer

PRINTED CIRCUIT BOARD
TYPE
EACH \$.20 10 FOR \$1.50



All IC's are new and fully tested.
Leads are plated with gold or solder.
Due to increased costs, orders under
\$7.00 add \$1.00 postate and handling.
Residents of California add sales tax.
Orders are shipped within 2 workdays.
kits are shipped within 10 days. \$10
minimum order on C.O.D.'s.

Phone: (916) 334-2161 Mail orders to: P.O. Box 41778
TAX: Sacramento, CA 95841
910-367-3521

BABYLON ELECTRONICS

MONEY BACK GUARANTEE ON ALL GOODS!
SEND FOR FREE FLYER LISTING 100's OF
MONEY-SAVING BARGAINS!

Specials

DIP TRIMMER



-12 turn trim pots
which plug into
a DIP socket
-5K and 200K
-1/2" x 1/2" x 1/2"
-4 leads spaced
.3" x .2"

Each \$ 6.65 10 for \$4.95

MEMORY CHIPS



8223 PROM
8 BIT-32 WORD
MEMORY
\$3.00 EACH 10 FOR \$29.00
WE PROGRAM FOR \$5.00 EACH

82S129 SIGNETIC
1024 BIT-256/4
FIELD PROGRAMMABLE
(WE WILL NOT PROGRAM)
EACH \$5.00 8 FOR \$34.95

1772 - 2748 BIT PROM
2K - ULTRA VIOLET
LIGHT ERASABLE
STATIC UNITS.
EACH \$9.95

TERMS: Add 50c to orders under \$10. Cal + tax. Sorry, no COD.

BANKAMER CARD[®] MASTERCARD[®] call (415) 357-7007

BILL GODBOUT ELECTRONICS BOX 2355 OAKLAND AIRPORT CA 94614

Wire Pencil... \$9.50

FROM VECTOR. Slashes time of point-to-point wiring; eliminates cutting to length, stripping, and crimping! 36 ga. wire has special insulation that melts when heated. With 1 red, 1 green bobbin of wire. +1 lb sh.

& BOBBINS

OK, all you wire pencil fanatics, we've got replacement wire. GREEN, RED, BLUE, CLEAR. specify 3/\$2.40

5370 ALARM CLOCK IC \$4.50

The 2nd generation clock IC: MULTIPLEXED digits make it much easier to use than the 5316. Colon drive, hours & minutes, snooze, alarm out, & much more.

BY CRAIG ANDERTON. This fully illustrated book has a section on practical electronics, then tells how to build 19 projects. \$6.95 + 1 lb shpg.

"ELECTRONIC PROJECTS FOR MUSICIANS"

Shortproof source of power for mobile stuff or bench supply. Kit less case and hardware \$22.50 + 7 lb shp.

2102 \$1.95

The memory workhorse: guaranteed under 750 NS. Quantity discounts available.

CLM6000 \$3.50

FROM CLAIREX: This opto-isolator consists of an LED and photoresistor in a miniature, light tight package. Low distortion, fast response; use for many projects.

CIRCLE NUMBER BELOW FOR FLYER: NO PLOT, BUT STILL GOOD READING!
Circle 102 on reader service card

INTRODUCING VDM-1 Video Display Module

The VDM-1 is an ultra high-speed intelligent display on a single printed circuit card. The new card generates 16, 64 character lines of Alpha-numeric data in upper and lower case characters from a 1K Byte memory.

The VDM-1 configuration allows you to build a power terminal, with a standard video output into your Altair Processor. Price: \$160.00

SPECIAL FREE OFFER! Scientific Notation Software Package with Formatted Output

With the purchase of (1) VDM-1 and (1) 4KRA Memory: Just \$299.00 (Offer expires 2-1-76)

The floating point math package features 12 decimal digits with exponents from +127 to -127; handles assigned and unassigned numbers. With it is a 5 function calculator package; + - X ÷ & sq. root. It includes 3 storage and 3 operating memories and will handle chain and column calculations.

Write for more details on these and other 8800 plug in compatible modules.

Processor Technology
2465 Fourth Street
Berkeley, Ca. 94710

5% OFF ON ORDERS OVER \$50.00
10% OFF ON ORDERS OVER \$100.00
15% OFF ON ORDERS OVER \$250.00

TTL

7400	\$.14	7451	.17	74154	1.25
7401	.16	7453	.17	74155	1.07
7402	.15	7454	.17	74156	1.07
7403	.16	7460	.17	74157	.99
7404	.19	7464	.35	74158	1.79
7405	.19	7465	.35	74160	1.39
7406	.35	7470	.30	74161	1.25
7407	.35	7472	.30	74162	1.49
7408	.35	7473	.35	74163	1.39
7409	.18	7474	.35	74164	1.59
7410	.19	7475	.57	74165	1.59
7411	.16	7476	.39	74166	1.49
7412	.25	7483	.79	74170	2.30
7413	.55	7485	1.10	74173	1.49
7416	.35	7486	.40	74174	1.62
7417	.35	7489	2.48	74175	1.39
7420	.16	7490	.59	74176	.89
7422	.26	7491	.97	74177	.84
7423	.29	7492	.71	74180	.90
7425	.27	7493	.60	74181	2.98
7426	.26	7494	.94	74182	.79
7427	.29	7495	.79	74184	2.29
7430	.20	7496	.74	74185	2.29
7432	.23	74100	1.30	74187	5.95
7437	.35	74105	.44	74190	1.35
7438	.35	74107	.40	74191	1.35
7440	.17	74121	.42	74192	1.25
7441	.98	74122	.45	74193	1.19
7442	.77	74123	.85	74194	1.25
7443	.87	74125	.54	74195	.89
7444	.87	74126	.63	74196	1.25
7445	.89	74141	1.04	74197	.89
7446	.93	74145	1.04	74198	1.79
7447	.99	74150	.97	74199	1.79
7448	1.04	74151	.79	74200	5.90
7450	.17	74153	.99		

LOW POWER TTL

74100	\$.25	74151	\$.29	75190	\$1.49
74102	.25	74155	.33	74191	1.45
74103	.25	74171	.25	74193	1.69
74104	.25	74172	.39	74195	1.69
74106	.25	74171	.49	74198	2.79
74110	.25	74174	.49	74164	2.79
74120	.33	74178	.79	74165	2.79
74130	.33	74185	1.25		
74142	1.49	74186	.69		

HIGH SPEED TTL

74100	\$.25	74121	\$.25	74155	\$.25
74101	.25	74122	.25	74160	.25
74104	.25	74110	.25	74161	.25
74108	.25	74140	.25	74162	.25
74110	.25	74150	.25	74172	.39
74111	.25	74152	.25	74174	.39
74120	.25	74151	.25	74176	.49

8000 SERIES

8091	\$.53	8214	\$1.49	8811	\$.59
8092	.53	8220	1.49	8812	.89
8095	1.25	8230	2.19	8822	2.19
8121	.80	8520	1.16	8830	2.19
8123	1.43	8551	1.39	8831	2.19
8130	1.97	8552	2.19	8836	.25
8200	2.33	8554	2.19	8880	1.19
8210	2.79	8810	.69	8263	5.79
				8267	2.59

9000 SERIES

9002	\$.35	9304	\$.79	9601	\$.89
9301	1.03	9312	.79	9602	.79

CMOS

4000A	\$.26	4017A	1.19	4066A	.89
4001A	.25	4020A	1.49	4068A	.44
4002A	.25	4021A	1.39	4069A	.44
4006A	1.35	4022A	1.10	4071A	.26
4007A	.26	4021A	.25	4072A	.35
4008A	1.79	4024A	.89	4073A	.39
4009A	.57	4025A	.25	4075A	.39
4010A	.54	4027A	.59	4078A	.39
4011A	.29	4028A	.98	4081A	.26
4012A	.25	4030A	.44	4082A	.35
4013A	.45	4035A	1.27	4528A	1.60
4014A	1.49	4042A	1.47	4585A	2.10
4015A	1.49	4049A	.59		

74C00	\$.22	74C74	\$1.04	74C162	\$2.93
74C02	.26	74C76	1.34	74C163	2.66
74C04	.44	74C107	1.13	74C164	2.66
74C08	.68	74C151	2.61	74C173	2.61
74C10	.35	74C154	1.15	74C195	2.66
74C20	.35	74C157	1.76	80C95	1.35
74C42	1.61	74C160	2.48	80C97	1.13
74C73	1.04	74C161	2.93		

ALARM CLOCK CHIP

MM5375AA 4-6 digit, 12 hour, 60Hz snooze alarm, brightness control capability, alarm tone output 24 pin DIP \$4.95

8038 FUNCTION GENERATOR

Voltage controlled oscillator — sine, square, triangular output. 16 pin DIP with data \$3.95

7001 CLOCK CHIP

4-6 digit, 12-24 hr. alarm, timer and date circuits — with data \$6.95

DVM CHIP 4 1/2 DIGIT

MM5330 — P channel device provides all logic for 4 1/2 digit volt meter. 16 pin DIP with data \$14.95

MEMORIES

1702A	14.95
2102	2.95
2102-1	3.25
2102-2	3.25
F93410	
256 bit RAM	2.19

FEBRUARY SPECIALS

POCKET CALCULATOR

5 function plus constant — addressable memory with individual recall — 8 digit display plus overflow — battery saver — uses standard or rechargeable batteries — all necessary parts in ready to assemble form — instructions included.



Kit with AC adaptor included \$14.95
Set of Alkaline batteries (disposable) \$2.50

UNIVERSAL BOARD

Silver plated copper circuit board 3-3/16" x 5-1/16". 2 rows of 27 holes for DIP IC's — space for transistors, resistors & capacitors. Versatile and simple for bread-boarding IC circuitry \$1.50 ea. 50 pcs. 1.00 ea.

AFTER CHRISTMAS SPECIAL

PULTRON V.I.P. QUARTZ REGULATED LED WATCH

MEN'S 5 function—hours, minutes, month, day and seconds. Latest slim-line design (prox. 1/2" thick) four year calendar—requires setting only on February 29th. One year warranty against all defects in material and workmanship. Built-in phototransistor adjusts intensity of display. Gold tone—with adjustable mesh strap.



\$79.50

\$.50 Shipping & Handling

USUAL DISCOUNT APPLIES

LINEARS

308	mDIP	.69
310	mDIP	.89
319	DIP	.92
3201-5v	TO-220	1.39
3201-12v	TO-220	1.39

TTL'S

7441	.75	7448	.79
7442	.59	7483	.65
7443	.69	7485	.79
7445	.69	7496	.59
7446	.75	74123	.69

ALARM CLOCK KIT

4 Large Digits + AM-PM. Complete kit includes TMS 3834 chip — green fluorescent panel with 5" digits — PC board — alarm speaker — all necessary components — case — schematic and instructions. Shipped UPS or Parcel Post \$31.95



Data sheets on request. With order add \$.30 for items less than \$1.00 ea.

NEW ITEM—EXCLUSIVE WITH IEU RESISTOR ASSORTMENTS

Supplied with convenient storage unit designed for experimenters, technicians and schools. Replacements available at low cost by mail from IEU.

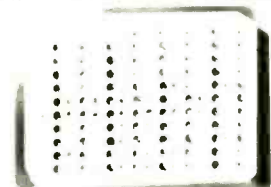

USUAL DISCOUNT APPLIES

RS 10-25 \$99.50

AN ASSORTMENT OF 2725 RESISTORS 170 VALUES FROM .51 OHMS TO 5.6M OHMS QUANTITIES DETERMINED BY TYPICAL USAGE 1/2 WATT 5% CARBON FILM

RS 11-25 \$114.50

AN ASSORTMENT OF 4000 RESISTORS 100 EACH OF 40 STANDARD VALUES 1 OHM TO 3.3M OHM 1/2 WATT 5% CARBON FILM

RS 11-50 \$69.50

AN ASSORTMENT OF 2000 RESISTORS 50 EACH OF 40 STANDARD VALUES 1 OHM TO 3.3M OHMS 1/2 WATT 5% CARBON FILM

-\$1.00 SHIPPING & HANDLING — SHIPPED UPS OR PARCEL POST

LED's

MV108	Red TO 18 Axial leads	\$.22
MV50	Jumbo Vis. Red (Red Dome)	.18
MV5020	Jumbo Vis. Red (Clear Dome)	.22
ME4	Infra red diff. dome	.54
MAN1	Red 7 seg. .270"	2.19
MAN2	Red alpha num. .32"	4.39
MAN4	Red 7 seg. .190"	1.95
MAN5	Green 7 seg. .270"	3.45
MAN6	.6" high solid seg.	4.25
MAN7	Red 7 seg. .270"	1.19
MAN3	Red 7 seg. .127"	.29
MAN8	Yellow 7 seg. .270"	3.45
MAN66	.6" high spaced seg.	3.75
MCT2	Opto-iso transistor	.61

MEMORIES

1101	256 bit RAM MOS	\$ 1.50
1103	1024 bit RAM MOS	3.95
1702A	2048 bit static PROM UV eras.	17.95
2102-2	1024 bit static RAM	4.25
5203	2048 bit UV eras. PROM	17.95
5260	1024 bit RAM	2.49
5261	1024 bit RAM	2.69
5262	2048 bit RAM	5.95
7489	64 bit ROM TTL	2.48
8223	Programmable ROM	3.69
74200	256 bit RAM tri-state	5.90

CALCULATOR & CLCK CHIPS

5001	12 DIG 4 funct fls dec	\$2.49
5002	Same as 5001 exc btry power	2.79
5005	12 DIG 4 funct w/mem	2.99
MM5725	8 DIG 4 funct chain & dec	1.98
MM5736	18 pin 6 DIG 4 funct	4.45
MM5738	8 DIG 5 funct K & mem	5.35
MM5739	9 DIG 4 funct (btry sur)	5.35
MM5311	28 pin BCD 6 dig mux	4.45
MM5312	24 pin 1 pps BCD 4 dig mux	3.95
MM5313	28 pin 1 pps BCD 6 dig mux	4.45
MM5314	24 pin 6 dig mux	4.45
MM5316	40 pin alarm 4 dig	5.39

MULTIPLE DISPLAYS

NSN33	3 digit .12" red led 12 pin fits IC sht.	\$1.79
HP45082	5 digit .11 led magn. lens com. cath	3.49
7405	4 digit .11 LED magn. lens comm. cath.	3.25
FNA37	9 digit 7 seg led RH dec. cir. magn. lens	4.95
SP-425-09	9 digit .25" neon direct interface with MOS/LSI, 180 VDC, 7 seg.	1.79

SHIFT REGISTERS

MM5013	1024 bit accum. dynamic mDIP	\$1.75
MM5016	500/512 bit dynamic mDIP	1.59
SLS-4025	QUAD 25 bit	1.29

DTL

930	\$.15	937	.15	949	.15
932	.15	944	.15	962	.15
936	.15	946	.15	963	.15

Satisfaction guaranteed. Shipment will be made via first class mail in U.S., Canada and Mexico within 5 days from receipt of order. Add \$.50 to cover shipping and handling for orders under \$25.00. Minimum order \$5.00. California residents add sales tax.

INTERNATIONAL ELECTRONICS UNLIMITED
P.O. BOX 1708/ MONTEREY, CA. 93940 USA
PHONE (408) 659-3171

TAR SMELL

I replaced the power transformer in a Zenith portable, and the owner complains of a "hot tar" smell after the set has been on for about an hour. I've checked input power, and it's right on the button. I've run the set for 24 hours and it doesn't burn up. He said someone told him to put chloroform tablets on the transformer and it would go away. Have you ever heard of that?—J.W., Margate, NJ.

Nope. From your tests, the transformer must be OK. The smell could be from a little tar left after the first one burned up. This is a "trigger" smell to all electronics men. A power transformer in one of my old scopes burnt out while I was gone, four or five years ago, and I'll swear that I can still smell it once in a while!

The "chloroform tablets" is a new one on me. I've tried spraying things, and none of them did anything. If anyone has any proven ideas, let me know.

TUNER DRIFT

I have a problem with tuner drift in this Motorola TS-921. On manual, the color fades out. I get a sync buzz and sound bars, and then it goes to an adjacent channel! Flipping the AFT on, everything goes back to normal. The set plays fine on a tuner-subber. Changing the tuner didn't help. I'm lost.—J.H., San Luis Obispo, CA.

No wonder! This is pretty weird. Since a new tuner didn't clear it up, you must have something on the chassis that's causing it. A good prospect for this would be the 5-volt reference source. When you switch AFT to off, this is supposed to clamp the varactor in the tuner on-frequency. If this source is *changing*, you could get exactly the kind of drift you have. It would cause the tuner to change channels, etc. Check this. You can use a bias-box and clamp it to 5 volts, and see what this does.

(Field feedback; it did! That was it).

Independent News Company, Inc. is pleased to announce a Retail Display Plan available to all retailers interested in earning a display allowance on Radio-Electronics magazine and who purchase the magazines from suppliers other than Independent News Co., Inc., or the publisher.

To obtain details and a copy of the formal contract please write to Director, Retail Sales Division, Independent News Co., Inc., 75 Rockefeller Plaza, New York, N.Y. 10019. Under the display plan in consideration of your acceptance and fulfillment of the terms of formal contract to be sent to you upon your request you will receive a display allowance of 10% of the cover price per copy sold by you. This plan will become effective with all issues of Radio-Electronics delivered to you subsequent to the date your written acceptance of the formal Independent News Co., Inc. Retail Agreement is received and accepted by our Company.

ADVERTISING INDEX

RADIO-ELECTRONICS does not assume any responsibility for errors that may appear in the index below.

READER SERVICE CARD NO.	PAGE
18	Allison Automotive Co. 30
78	American Technology Corp. 101
106	AP Products 99
7	Arrow Fastener 14
77	Audio Amateur 100
20	B & K, Division of Dynascan Corp. 32
	Bell & Howell Schools 36-39
63	Brooks Radio & TV Corp. 87
	Burstein-Applebee 91
86	Castle Electronics, Inc. Cov. IV
25	CIE, Cleveland Institute of Technology 74-77
19,29	Continental Specialties Corp. 31,81
	CREI, Division of McGraw-Hill Continuing Education Center 64-67
61	Delta Products 85
74	E & L Instruments, Inc. 98
23	Edlie Electronics 72
13,84	Edmund Scientific 21,118
62	EICO, Electronic Instrument Inc. 86
9	Elenco 16
21	Electronics Technical Institute, Division of Technical Home Study Schools 46-49
79	EMC, Electronics Measurement Corp. 101
69	Enterprise Development Corp. 91
30	Fordham Radio Supply Corp. 85
72	Grantham School of Electronics 97
27	GTE Sylvania Electronic Components 79
100	Heath Co. 26-29
14	Hickok Electrical Instrument Co. 22
	ICS, International Correspondence Schools 82,83
64	Indiana Home Study Institute .. 88
75	International Crystal Mfg. Co. . 99
10	Jerrold Electronics Co. 17
66	Leader Instruments Corp. 89
71	Lectrotech, Inc. 96
4	Mallory Distributor Products .. 5
6	McGraw-Hill Book Co. 13
2	MTS, Micro-Instrumentation Telemetry Systems, Inc. 1
22	MTI, Motorola Training Institute 70
80	Mountain West Alarm Supply Co. 102
65	National Camera Co. 88
	National Technical Schools .. 92-95
	NRI, Division of McGraw-Hill Continuing Education Center. 8-11
68	Panavise Division of Colbert Industries 90
16	Perma Power 24
81	Photolume Corp. 102
1	PTS Electronics Inc. Cov. II
12	Radio Shack 19
	RCA Distributor and Special Products: Accessories 71
73	Rye Industries 98
3	Sansui Electronics Corp. 2
5	SBE 7
67	Schober Organ Corp. 89

READER SERVICE CARD NO.	PAGE
17	Shure Brothers Inc. 25
15	Sinclair Radionics Inc. 23
76	Sphere Corp. 100
26	Southwest Technical Products .. 78
24	Tektronix, Inc. 32
11,28,70	Telematic 18,80,91
82	Tri-Star Corp. 102
8	Weller-Xcelite Electronics Div. . 15
85	Winegard Cov. III

MARKET CENTER

	American Used Computer Corp. 103,104
95,105	Ancrona Corp. 113,117
	ATV Research 110
101	Babylon Electronics 114
	Karel Barta 103
	Command Productions 103
89	Delta Electronics 106
89	Digi-Key 106
	Fair Radio Sales 104
88	Formula International Inc. 105
102	Bill Godbout Electronics International 114
	Information Unlimited Inc. 110
92,93	James Electronics 108,109
	Lab Science 110
	Lakeside Industries 103
98	Stanley Lin 112
97	Meshna Electronics, John Jr. ... 112
90	New-Tone Electronics 106
91	Olson Electronics 107
95	Polypaks 111
103	Processor Technology Corp. 114
	Saxitone Tape Sales 103
87	SD Sales 104
	Solid State Sales 104,110
94	Surplus Center 110
83	Teletronics Company of America 106
	Trumbell 104
	Valley West 103

MOVING?

Don't miss a single copy of **Radio-Electronics**. Give us:

Six weeks' notice

Your old address and zip code

Your new address and zip code

ATTACH LABEL HERE

name (please print)
 address
 city state zip code

Mail to: Radio-Electronics
 SUBSCRIPTION DEPT., BOULDER, COLO.
 80302

CONTINENTAL SPECIALTIES



PROTO BOARDS

Build & test circuits as fast as you think!

- PB100 10 IC cap breadboard kit, 4.5 x 6.0 x 1.35" \$19.95
- PB101 10 IC-DIP cap, 5-way post, 940 x 1.35" \$29.95
- PB102 12 14-DIP cap, like PB101 with 1,240 tie points, 7.0 x 4.5" \$39.95
- PB103 24 14-DIP cap, 4 5-way posts, 2,250 tie points, 6.0 x 9.0" \$59.95
- PB104 32 14-DIP cap, 3060 solderless tie points, 8.0 x 9.76" \$79.95

LOGIC MONITOR

Simultaneously displays static and dynamic logic states of DTL, TTL, HTL or CMOS DIP ICs. Pocket size. \$84.95.

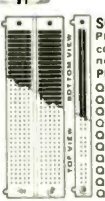

SOCKETS & BUS STRIPS

Plug in, wire, test, modify or expand without patch cords or solder. Snap together to form breadboard needed.

PN/Description	L. Hole-to-Hole Term's	Price
QT595 Socket	6.5" 6.2"	118 \$12.50
QT598 Bus	6.5" 6.2"	20 2.50
QT413 Socket	6.5" 6.2"	94 10.00
QT47B Bus	5.3" 5.0"	16 2.25
QT355 Socket	4.1" 3.8"	70 8.50
QT358 Bus	4.1" 3.8"	12 2.00
QT415 Socket	1.8" 1.5"	36 4.75
QT125 Socket	1.8" 1.5"	24 3.75
QT85 Socket	1.4" 1.1"	16 3.25
QT75 Socket	1.3" 1.0"	14 3.00

7400N TTL

7400N .12	7442N .58	7497N 5.00	74164N 1.10
7401N .16	7443N .74	74100N 1.00	74165N 1.10
7402N .14	7444N .73	74104N 1.20	74166N 1.28
7403N .16	7445N .75	74105N .50	74170N 1.29
7404N .19	7446N .75	74107N .33	74171N 1.29
7405N .19	7447N .72	74109N .74	74174N 1.14
7406N .29	7448N .80	74110N .72	74175N .98
7407N .29	7450N 1.14	74111N 1.20	74176N 1.25
7408N .18	7451N .14	74112N 1.20	74177N 1.40
7409N .20	7453N .14	74121N .36	74178N 1.42
7410N .18	7454N .14	74122N .38	74179N 3.60
7411N .26	7459N .20	74123N .71	74180N .75
7412N .33	7460N .14	74125N .46	74184N 2.39
7413N .44	7470N .66	74126N .53	74189N 1.87
7414N 1.05	7472N .26	74128N .84	74189N 1.84
7416N .28	7473N .37	74132N 1.10	74185N 2.20
7417N .33	7474N .32	74136N .95	74188N 4.75
7418N .30	7475N .14	74137N 1.20	74190N 1.17
7420N .13	7476N .32	74145N .89	74191N 1.17
7421N .33	7480N .59	74147N 2.40	74192N 1.08
7422N .50	7481N 1.30	74148N 2.00	74193N 1.02
7423N .49	7482N .89	74150N 1.00	74194N 1.05
7425N .23	7483N .66	74151N .80	74195N .74
7426N .22	7484N .30	74152N 1.40	74196N .99
7427N .25	7485N .90	74153N .79	74197N .76
7428N .33	7486N .34	74154N 1.40	74198N 1.51
7430N .20	7489N .21	74155N 1.50	74199N 1.50
7432N .24	7490N .48	74156N .78	74200N 5.60
7433N .36	7491N .78	74157N .69	74221N 1.50
7437N .29	7492N .49	74158N 1.52	74251N 1.40
7438N .29	7493N .49	74160N .98	74278N 2.45
7439N .38	7494N .72	74161N .36	74279N .94
7440N .16	7495N .80	74162N .99	74293N 1.00
7441N .83	7496N .67	74163N .99	74298N 1.98

HIGH SPEED TTL

74H00N .33	74H20N .33	74H52N .36	74H73N .80
74H01N .26	74H21N .33	74H53N .36	74H74N .80
74H04N .33	74H22N .33	74H54N .36	74H76N .75
74H05N .33	74H30N .33	74H55N .36	74H102N .75
74H06N .40	74H40N .40	74H56N .36	74H103N .90
74H10N .33	74H50N .36	74H71N .75	74H106N .95
74H11N .33	74H51N .36	74H72N .75	

LOW POWER TTL

74L00N .24	74L10N .24	74L51N .34	74L90N 1.62
74L02N .24	74L20N .33	74L73N .48	74L93N 1.74
74L03N .39	74L24N 1.40	74L74N .90	74L95N 1.62
74L04N .33			

74LS

74LS00 .42	74LS27 .47	74LS112 .65	74LS170 5.80
74LS01 .58	74LS30 .42	74LS113 .92	74LS174 2.25
74LS02 .42	74LS32 .47	74LS114 .92	74LS175 2.42
74LS03 .50	74LS38 .53	74LS138 1.94	74LS181 7.00
74LS04 .47	74LS51 .50	74LS139 2.06	74LS194 4.40
74LS08 .42	74LS64 .72	74LS141 .92	74LS195A 2.40
74LS09 .58	74LS65 .58	74LS153 1.92	74LS196 2.76
74LS10 .42	74LS73 .65	74LS157 1.68	74LS251 2.06
74LS11 .42	74LS74 .65	74LS158 1.68	74LS252 2.42
74LS15 .58	74LS76 .92	74LS160 3.06	74LS257 2.06
74LS20 .42	74LS79 .92	74LS161 3.06	74LS258 2.06
74LS21 .58	74LS107 .92	74LS162 3.06	74LS260 .58
74LS22 .58	74LS109 .92	74LS163 2.90	

SCHOTTKY TTL

74S00 .44	74S32 .80	74S113 1.50	74S174 3.30
74S01 .76	74S40 .65	74S114 1.20	74S175 2.90
74S02 .60	74S50 .76	74S133 .80	74S181 6.00
74S03 .75	74S61 .80	74S138 2.20	74S189 4.40
74S04 .55	74S60 .80	74S139 2.20	74S194 3.30
74S05 .76	74S64 .80	74S140 .80	74S196 3.30
74S08 .80	74S65 .80	74S151 2.20	74S251 2.20
74S09 .76	74S74 .90	74S153 3.40	74S253 2.40
74S10 .85	74S75 1.15	74S157 2.40	74S257 2.40
74S11 .65	74S78 1.16	74S158 2.00	74S258 2.40
74S15 .76	74S85 6.10	74S160 3.90	74S260 1.20
74S20 .65	74S86 2.50	74S161 4.70	74S280 5.70
74S21 .76	74S112 1.00	74S172 6.00	74S289 4.00
74S30 .80			

9300 SERIES

9300PC \$1.00	9318PC 1.20	9366PC 1.75	93118 3.50
9301PC 1.20	9321PC 1.20	93100 1.50	93121 1.50
9304PC 1.50	9322PC 1.30	93101 1.60	93122 1.80
9306PC 1.60	9324PC 2.00	93108 3.20	93124 2.80
9309PC 2.50	9328PC 2.50	93109 1.80	93128 3.70
9309PC 6.90	9334PC 2.95	93110 2.80	93134 4.00
9310PC 1.50	9338PC 3.30	93111 4.20	93138 4.20
9311PC 2.20	9340PC 5.00	93112 1.80	93140 6.50
9312PC 1.20	9341PC 4.10	93114 1.70	93141 6.50
9314PC 1.20	9342PC 1.15	93115 2.20	93142 6.50
9316PC 1.50	9360PC 1.75	93118 3.50	93166 2.70

AUDIO AMPS

TYPE	V	W	Ω	PRICE
LM352	6-15	1.15	8	1.60
TAA611812	6-15	1.15	8	1.60
TAA621A12	6-27	1.40	8	2.00
TAA641B11	6-18	2.20	4	3.00
TBA800	5-30	2.0	4	3.00
TBA810AS	4-20	2.50	4	3.00
TBA820	3-16	0.75	4	1.70
TCA830	5-20	2.00	4	2.20
TCA940	6-24	6.50	8	4.40



H=TO-5	N=DIP	M=MINI-DIP	D=CER-DIP	K=TO-3
LM105H 3.90	LM311H 1.20	LM710CH .90		
LM108H 4.90	LM311D .90	LM710CN .90		
LM114H 3.00	LM311M 1.75	LM711CH .90		
LM300H 1.20	LM312N 1.50	LM711CN .90		
LM301A 1.50	LM312M 3.50	LM715C 4.60		
LM301AM .80	LM318A 2.40	LM725C 6.00		
LM301AN 1.10	LM324A 1.90	LM723CN .65		
LM301M .95	LM331M 2.40	LM725C 5.00		
LM302H 1.40	LM332A 2.60	LM725C 5.00		
LM304H 1.20	LM320-5K 2.90	LM733C 1.40		
LM305H .85	LM320-5T 2.50	LM733CN 1.30		
LM305M 1.05	LM320-5T 2.50	LM733CN 1.30		
LM305N 1.00	LM340-5K 2.60	LM741C 1.25		
LM306N .95	LM340-6K 2.60	LM741CN .39		
LM307H .60	LM340-8K 2.60	LM747C 75		
LM307M 1.80	LM340-12K 2.60	LM747CN .90		
LM308H .85	LM340-15K 2.60	LM748CN .55		
LM308M 2.25	LM340-24K 2.60	LM777C 2.15		
LM308H 1.50	LM555C 70	LM777CN 2.10		
LM309H 1.75	LM555CT 50	LM3046CN .95		
LM309K 1.50	LM567CM 1.70	LM3054CN 1.50		
LM310H 1.50	LM567CM 1.70	SG4501T 2.40		
LM310M 1.80	LM709CH .75	SG4501N 2.40		
	LM709CN .75	LM5000K 7.50		

C-MOS

P/N	1-9	10up	P/N	1-9	10up	P/N	1-9	10up
4000AE 22 .21	4027AE .50	4047AE .60	4070AE .60	4071AE .22	4072AE .40	4072AE .40	4073AE .33	4075AE .50
4001AE 23 .22	4028AE .54	4048AE .38	4076AE .12	4077AE .70	4078AE .50	4078AE .50	4079AE .50	4081AE .22
4002AE 23 .22	4029AE .54	4049AE .38	4082AE .22	4083AE .22	4084AE .22	4085AE .22	4086AE .22	4087AE .22
4004AE 4.00	4030AE .38	4051AE .19	4088AE .22	4089AE .22	4090AE .22	4091AE .22	4092AE .22	4093AE .22
4006AE 1.16	4032AE .38	4053AE .19	4094AE .22	4095AE .22	4096AE .22	4097AE .22	4098AE .22	4099AE .22
4007AE 22 .21	4033AE .38	4054AE .19	4099AE .22	4100AE .22	4101AE .22	4102AE .22	4103AE .22	4104AE .22
4008AE 1.79	4034AE .38	4055AE .19	4105AE .22	4106AE .22	4107AE .22	4108AE .22	4109AE .22	4110AE .22
4009AE 6.00	4035AE .38	4056AE .19	4111AE .22	4112AE .22	4113AE .22	4114AE .22	4115AE .22	4116AE .22
4011AE 24 .23	4036AE .38	4057AE .19	4117AE .22	4118AE .22	4119AE .22	4120AE .22	4121AE .22	4122AE .22
4012AE 21 .20	4037AE .38	4058AE .19	4123AE .22	4124AE .22	4125AE .22	4126AE .22	4127AE .22	4128AE .22
4013AE 38 .37	4038AE .38	4059AE .19	4129AE .22	4130AE .22	4131AE .22	4132AE .22	4133AE .22	4134AE .22
4014AE 24 .23	4039AE .38	4060AE .19	4135AE .22	4136AE .22	4137AE .22	4138AE .22	4139AE .22	4140AE .22
4015AE 1.24	4040AE .38	4061AE .19	4141AE .22	4142AE .22	4143AE .22	4144AE .22	4145AE .22	4146AE .22
4016AE .46	4041AE .38	4062AE .19	4147AE .22	4148AE .22	4149AE .22	4150AE .22	4151AE .22	4152AE .22
4017AE 1.01	4042AE .38	4063AE .19	4153AE .22	4154AE .22	4155AE .22	4156AE .22	4157AE .22	4158AE .22
4018AE 24 .23	4043AE .38	4064AE .19	4159AE .22	4160AE .22	4161AE .22	4162AE .22	4163AE .22	4164AE .22
4019AE .49	4044AE .38	4065AE .19	4165AE .22	4166AE .22	4167AE .22	4168AE .22	4169AE .22	4170AE .22
4020AE 1.24	4045AE .38	4066AE .19	4171AE .22	4172AE .22	4173AE .22	4174AE .22	4175AE .22	4176AE .22
4021AE 1.24	4046AE .38	4067AE .19	4177AE .22	4178AE .22	4179AE .22	4180AE .22	4181AE .22	4182AE .22
4022AE .94	4047AE .38	4068AE .19	4183AE .22	4184AE .22	4185AE .22	4186AE .22	4187AE .22	4188AE .22
4023AE 23 .22	4048AE .38	4069AE .19	4189AE .22	4190AE .22	4191AE .22	4192AE .22	4193AE .22	4194AE .22
4024AE .75	4049AE .38	4070AE .19	4195AE .22	4196AE .22	4197AE .22	4198AE .22	4199AE .22	4200AE .22
4025AE .23	4050AE .38	4071AE .19	4201AE .22	4202AE .22	4203AE .22	4204AE .22	4205AE .22	4206AE .22
4026AE 1.90	4051AE .38	4072AE .19	4207AE .22	4208AE .22	4209AE .22	4210AE .22	4211AE .22	4212AE .22

PREMIUM QUALITY COMPONENTS

We've been buying and selling top quality components for nearly ten years. Our annual volume exceeds \$3 million. We handle only original parts, from the world's leading manufacturers and our customers include some of the largest and most quality-conscious companies. Now you can take advantage of our component buying skills and power and select from a broad range of advanced circuits.



LIVE IN THE WORLD OF TOMORROW... TODAY!

And our FREE 164 PAGE CATALOG is packed with exciting and unusual values in electronic, hobby and science items — plus 4,500 finds for fun, study or profit... for every member of the family.

A BETTER LIFE STARTS HERE

SUPER POWER FOR ANY AM RADIO

New antenna assist turns a tiny transistor into a tiger, has pulled in stations 1000* miles away! Just set beside radio (no wires, clips, grounding) and fine-tune Select-A-Tenna's dial to same frequency—"gangbusters"! Great for clearing weak signals in radio depressed areas, off-coast islands, crowded frequency stations. Solid state—uses no electricity, batts., tubes.



Stock No. 72,095 EH \$15.95 Ppd.
Ultra Select-A-Tenna No. 72,147 EH \$22.95 Ppd.
(*Over 1000 Mi.)

SEE MUSIC IN PULSATING COLOR

New 3-Channel Color Organ adds to music listening pleasure, lets you modulate 3 independent strings of colored lamps with intensity of your music to create an audio "light show." They flash, vary in brightness related to music's rhythm, pitch, volume—pulsating lighting performance to music! Fully assembled & priced half that of others, the Edmund Sound To Light Control is a terrific value. Plug in, turn on!



No. 42,309 EH (ASSEMBLED) \$17.95 Ppd.
No. 42,336 EH (UNASSEMBLED) \$13.95 Ppd.

AN ALPHA MONITOR FOR \$34.95?

Yes, because you built it! Use your ability to tune in your brainwaves, an aid to relaxation, concentration. Kit incl. everything you need (except 9v trans. batt.) to own a portable self-cont. BIOFEEDBACK unit for a pittance: steth. earphones, electrode headband, solid-state circuitry; 5 microvolt sensitivity, more! Compl. assembly instructions & op. manual. With basic electronics knowledge, you can do it!



No. 61,069 EH (KIT) \$34.95 Ppd.
No. 71,809 EH (FULLY ASSEMBLED) \$55.00 Ppd.

FLYWHEEL GENERATED FLASHLIGHT

Never needs batteries! Lights the way free by using flywheel energy. Each time you squeeze handle the alternator generator spins, flywheel disengages from the clutch, and your flashlight lights for about 2 seconds. By continuous squeezing (generating a soft hum), the light stays bright. Energy-saving 6-oz. flashlight pays for itself many times over. And demonstrates flywheel generator principle. Never buy flashlight batteries again!

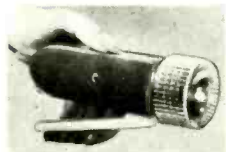

No. 61,086 EH (2x5 1/2") \$14.95 Ppd.

MAIL COUPON FOR GIANT FREE CATALOG!

172 PAGES • MORE THAN 4500 UNUSUAL BARGAINS

Completely new 1976 edition. New items, categories, illustrations. Dozens of electrical and electromagnetic parts, accessories. Enormous selection of Astronomical Telescopes. Unique lighting and ecological items. Microscopes, Binoculars, Magnifiers, Magnets, Lenses, Prisms. Hard-to-get surplus bargains. Ingenious scientific tools. 1000's of components.

EDMUND SCIENTIFIC CO.
300 Edscorp Building, Barrington, N.J. 08007
Please rush Free Giant Catalog "EH".

Name _____
Address _____
City _____ State _____ Zip _____



COMPLETE AND MAIL WITH CHECK, M. O. OR CHARGE NO.

EDMUND SCIENTIFIC CO. 300 Edscorp Building, Barrington, N.J. 08007

How Many Stock No. Description Price Each Total

PLEASE SEND GIANT FREE CATALOG "EH"

Charge my BankAmericard *

Charge my Master Charge *

Interbank No. _____

My Card No. Is _____

Card Expiration Date _____

30-DAY MONEY-BACK GUARANTEE.

You must be satisfied or return any purchase in 30 days for full refund. *\$15.00 minimum

BankAmericard master charge I enclose check money order for TOTAL \$ _____

Signature _____

Name _____

Address _____

City _____ State _____ Zip _____

Add Handling Charge \$1.00

DELUXE "ON" TIME MONITOR MEASURES & RECORDS %
No. 1652 EH \$299.95 Ppd.



KNOW YOUR ALPHA FROM THETA!

For greater relaxation, concentration, listen to your Alpha-Theta brainwaves. Ultra-sensitive electrode headband slips on/off in seconds—eliminates need for messy creams, etc. Atch'd to amplifier, filters brainwaves, signals beep for ea. Alpha or Theta wave passed. Monitoring button simulates Alpha sound; audio & visual (L.E.D.) feedback. Reliable, easy-to-use unit—comparable to costlier models. Completely safe. Comprehensive instruction booklet.

No. 1635 EH (8x3x4"; 24 oz.) \$149.50 Ppd.

LOW COST "STARTER" UNIT

No. 71,809 EH \$ 55.00 Ppd.



PLUG IN 200,000 CANDLEPOWER!

Powerful 12v emergency light projects big straight beam visible for 2 miles. Plugs into car's cigarette lighter; only 3 1/2 lbs. Great for motorists, outdoorsmen, emergency crews, security men, campers. Super bright 200,000 candle-

power G.E. aircraft landing light in a rugged weatherproof steel housing with baked enamel finish, steel lens grate, polished chrome-plated reflector, on/off switch. 15 ft. extension cord; 6 1/4 dia. x 11 1/2". Keep it handy!

Stock No. 72,093 EH \$22.95 Ppd.



"SEE" & HEAR YOUR HEARTBEAT!

Compact bioelectrical cardiac monitor lets you "see" and "hear" your heartbeat electronically. Completely safe. It detects contraction of the heart muscle and amplifies the signal, triggering a flashing light and beeping read-

out. Easy to use, ideal for science projects, animals' heart analysis, other biofeedback studies. Great party fun—show how heartbeat fluctuates with emotions (love, fear, etc.). Incl. 2 9v batts, lab experiment manual, instrs.

No. 72,102 EH (5x2x4") \$59.95 Ppd.



WORLD'S SMALLEST ELECTRONIC CALCULATOR \$19.95

Does Everything Big Ones Do Small but mighty! 8-digit, 4-function electronic calculator does everything big ones do—even has automatic % key... for only \$19.95. Take it anywhere. Fits in your pocket—2/3 size of cigarette pack 3 1/2 oz. dynamo features floating decimal, constant key, lead zero depression, more! Includes plug-in rechargeable Ni-Cad battery pack. 2x3 1/2x9/16" with plenty of room for most fingers. Another Edmund first with advanced technology.

Stock No. 1945EH \$19.95 Ppd.

TO: JOE RIDGE
WINEGARD SALES MANAGER

FIRST REPORTS FROM FIELD REALLY FANTASTIC!
INSTALLERS SAY WE HAVE A REAL WINNER IN
CHROMSTAR--MORE POWERFUL PERFORMANCE, ESPECIALLY
UHF--STRONGEST ANTENNA EVER BUILT--EASIER
INSTALLATION. ACCEPTANCE AND DEMAND HIGH AND
GROWING . . . KEEP 'EM COMING!

DISTRIBUTORS PLEASED WITH DEALER REACTION, AND
HAPPY WITH NEW, COMPACT CARTON SIZES. SET
OWNERS GETTING CLEARER PICTURES, BETTER COLOR
FROM ALL STATIONS IN RANGE. AM SENDING YOU
ACTUAL DEALER STATEMENTS.

LEO RIDDLE
DISTRICT MANAGER



Dealers Everywhere Welcome CHROMSTAR™ First New TV Antennas In Years.

Response has been totally enthusiastic because of the many far-ahead features built into Chromstar models!

- New Standard of Excellence In Construction and Performance.
- Anodized and Ruggedized for Weather Protection, Long Life.
- New Tri-Linear UHF Director System Increases Gain Up To 30%
- Models To Solve Every Reception Problem.

GET ALL THE FACTS FROM YOUR WINEGARD DISTRIBUTOR.
FREE SPEC CHARTS ON ALL MODELS. CASH IN WITH
CHROMSTAR SALES AND INSTALLATIONS!

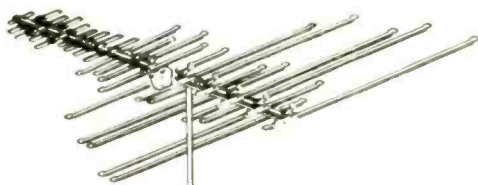

CH-7080
VHF-UHF-FM

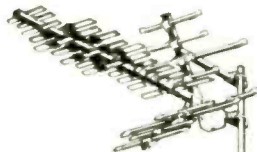

CH-9085
UHF only

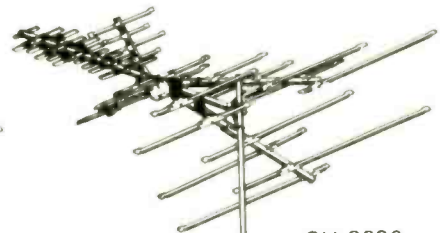

CH-8096
VHF-UHF-FM



WINEGARD®
C O M P A N Y

3000 Kirkwood • Burlington, Iowa 52601

TV ANTENNAS MORE PEOPLE LOOK UP TO.

Circle 85 on reader service card

You enjoyed the **TIMESAVING** advantages of the previous models of the Castle Subber[®] analyst . . . **NOW** you will want to move up to this superior, redesigned model . . . our best yet!

SUBBER[®]

Mark IV-CUV

**UHF-VHF tuner
and i-f analyst**

net \$64.95



If you haven't joined the ranks of thousands of professional technicians using this **TIMESAVING** instrument . . . **NOW** is your opportunity to own the latest model boasting these improved features:

- **TUNES ALL VHF & UHF CHANNELS.** Use where prime signals are on either VHF or UHF . . . or both.
- **ELECTRONIC FINE TUNING.** Smooth, exact tuning ensures precise setting for ease in testing color receivers.
- **DUAL 40MHz IF OUTPUT JACKS.** Select Hi or Lo impedance output for best coupling match to circuit being substituted . . . tube or transistor.
- **BATTERY CONDITION INDICATOR.** IC comparator driven LED shows when inbuilt 9v transistor batteries require replacement. Battery & 120-vac line powered.

The Mark IV-CUV tunes all 82 VHF & UHF channels for substitution tests of the tuners and entire i-f system of any 40MHz TV receiver. Permits signal injection after the agc controlled stages for the high speed agc system analyzing procedure invented by Castle . . . the first practical method for analyzing agc system defects without confusion.

Mark IV-C

The Mark IV-C tunes all 12 VHF channels for substitution injection tests of the VHF tuner, UHF tuner and entire i-f system of any 40MHz TV receiver.

- **ELECTRONIC FINE TUNING.** Battery & 120-vac line powered.
- **DUAL 40MHz IF OUTPUT JACKS.**
- **BATTERY CONDITION INDICATOR.**

net \$54.95



Made in USA.



See your stocking distributor . . . or write for more details and complete specifications.

CASTLE ELECTRONICS, INC.

5715 N. Western Ave., Chicago, Illinois 60645 Phone: (312) 728-1800
Circle 86 on reader service card