

60c ■ DEC. 1972

Radio-Electronics®

FOR MEN WITH IDEAS IN ELECTRONICS

BUILD A "ZERO DISTORTION" STEREO PREAMP

ELECTRONIC CALCULATORS
From Fingers to LED's

OPERATIONAL AMPLIFIERS
10 Audio Circuits

DIGITAL IC BREADBOARD
Build It Yourself

THE TRANSISTOR
It's 25 Years Old



PLUS

Jack Darr's Service Clinic
Using A Color-Bar Generator
Step-By-Step TV Troubleshooting
Lou Garner's State of Solid-State

A
GERNSBACK
PUBLICATION

Pioneering again.....Castle presents a sensational NEW Timesaver for the Professional TV Service Technician..... Speed Testing by signal substitution. A new, simplified approach to signal circuit analyzing.....

TV TUNER SUBBER™



Transistorized Test Unit substitutes the tuner in defective TV Receiver to prove whether original tuner is good or bad. Performs tests normally made using elaborate and expensive signal generating equipment and oscilloscopes . . . but much more simply, with easily understood results. Tests that are, in fact, so simple that they can be made right in the home, in most cases without removing the tuner or chassis from cabinet.

Use with any 40MHz receiver . . . black and white or color . . . tube or transistor.

Completely self contained and battery operated; Mk. II, all solid state, improved version of original "subber." Uses L.E.D. indicator, has higher gain with wide range control affording more than 40db of gain reduction. Use on the bench or in the home . . . anywhere.

Substitutes the VHF tuner and tests the UHF tuner. Provides signal to simplify testing of tuner, i.f. system and AGC system. Comes complete with extension cables and instructions.

Unsolicited praise bestowed this revolutionary device includes:

" . . . works good. I know it will save hours in my TV Service . . . you are to be commended . . ."

" . . . in one month . . . TV Tuner Subber . . . already paid for itself — twice! Thanks much!"

" . . . received only Ch. 5, and not good. Used the new Castle TV Tuner Subber and got all channels . . . original tuner removed for service!"

TV TUNER SUBBER MK. II net \$31.95

Contact your distributor.

Include \$1.50 shipping and handling on prepaid mail orders: we will ship C.O.D.



CASTLE TV TUNER SERVICE, INC.

5715 N. Western Ave., Chicago, Illinois 60645 • Phone: (312) — 561-6354

Circle 1 on reader service card

Earn Your Electronics DEGREE by studying at home.

Grantham School of Engineering specializes in teaching electronics and supporting subjects, mainly by correspondence. The School is authorized under the laws of the State of California to grant academic degrees, and is approved under the G.I. Bill.

The A. S. E. T. Degree is offered in four "correspondence semesters" plus a two-week residential seminar. Then, the B. S. E. E. Degree is obtainable through further residential training in engineering subjects and transfer credits in the humanities. For complete information, write for our free **BULLETIN R-73.**

GRANTHAM School of Engineering

1505 N. Western Avenue
Hollywood, CA 90027

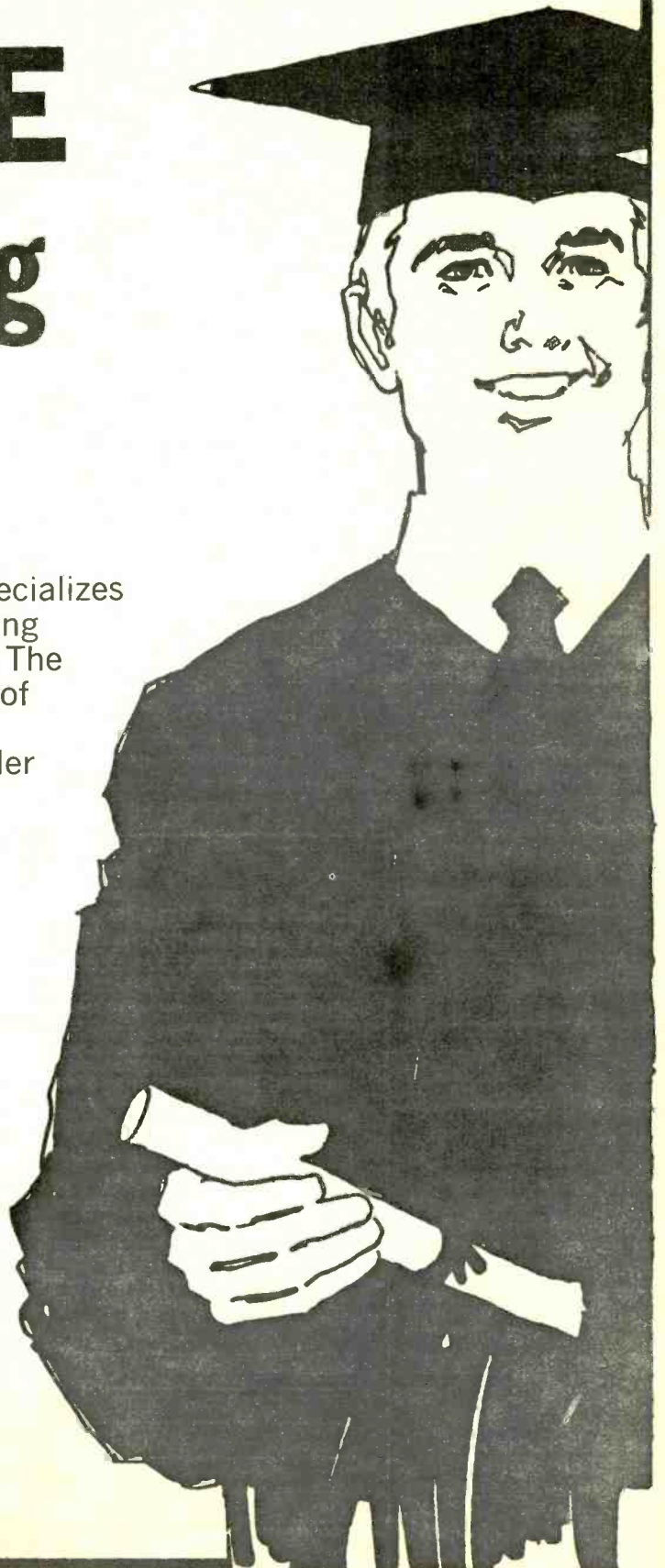

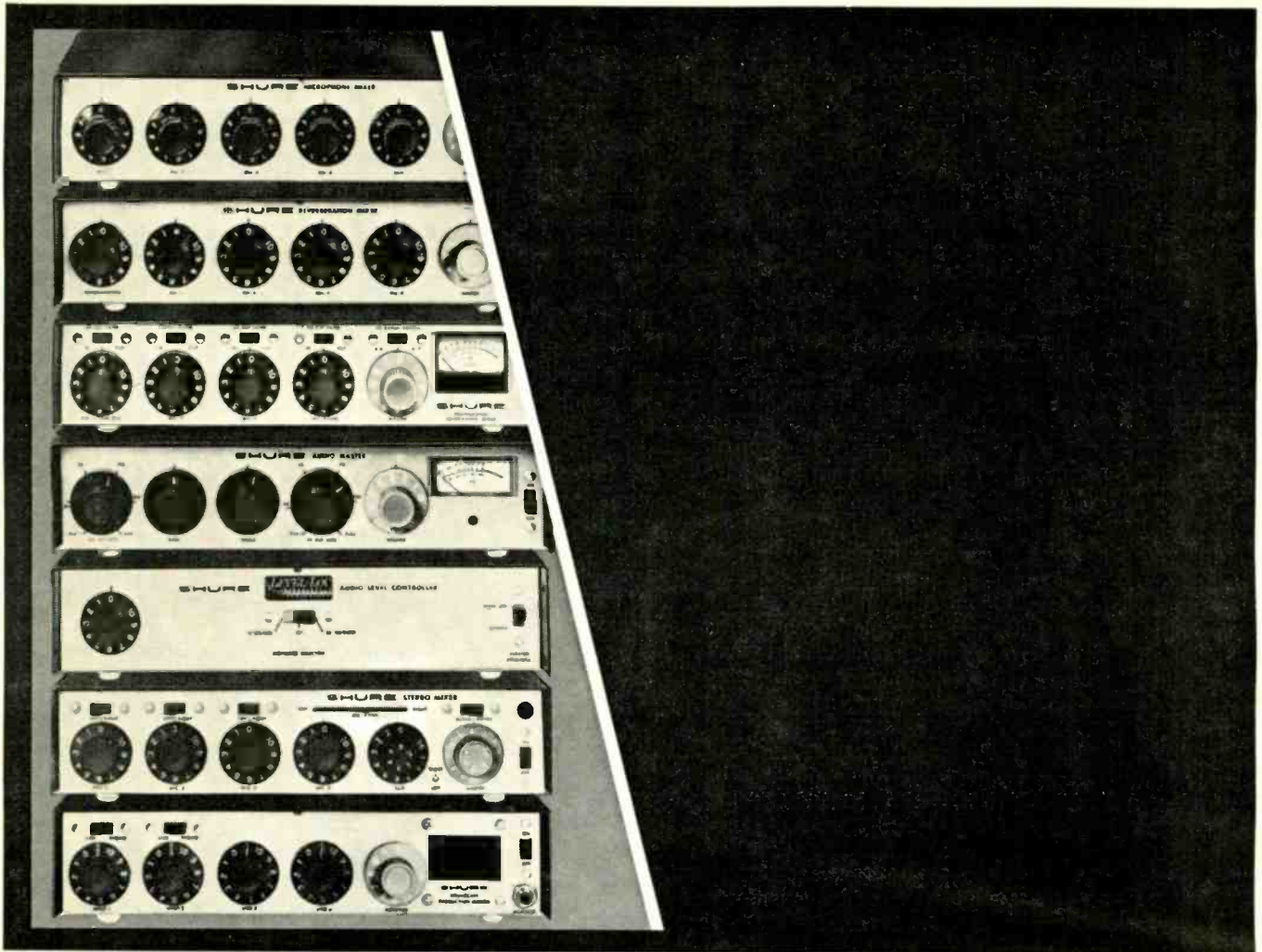

The Magnificent Seven



We've been hearing unsolicited rave reviews from soundmen across the country concerning our seven ingeniously versatile problem-solving audio control components (1) *M68 Microphone Mixer*, vanguard of the low-cost, high-performance portable mixers; (2) *M68-RM Mixer*, with built-in reverb for vocalists and special effects; (3) *M67 Mixer*, the trail-blazing low-cost professional mixer; (4) *M63 Audio Control Center*, that gives you variable response shaping; (5) *M62V Level-Loc*, the audio level controller that automatically limits output level; (6) *M688 Stereo Mixer*, made to order for stereo recording and audio-visual work; and finally, (7) *M675 Broadcast Production Master*, that teams up with our M67 to give a complete broadcast production console (with cuing) for under \$325. Write for the new Shure Circuitry catalog that shows them all:

Shure Brothers Inc.
222 Hartrey Ave., Evanston, Ill. 60204



Circle 3 on reader service card

Radio-Electronics

FOR MEN WITH IDEAS IN ELECTRONICS

December 1972

SPECIAL FEATURES

- 35 **Now The Transistor Is 25**
December 23 marks the 25th anniversary of the transistor. Here's a look at its short, exciting history. *by Fred Shunaman*
- 51 **All About Electronic Calculators**
From fingers to abacus to electronics—see how they evolved. *by Forrest M. Mims*

AUDIO HI-FI STEREO

- 32 **Equipment Report**
Beta 3 amplified car-radio antenna
- 50 **Agc For Automatic Recording Level**
- 58 **Audio Applications of the Op-Amp**
10 circuits for the experimenter. *by B. R. Rogen*

BUILD ONE OF THESE

- 39 **"Zero Distortion" Stereo Preamp**
A top quality 2-channel preamp with push-button tone controls. Build it, you'll like it. *by Gary Kay*
- 44 **Build An IC Breadboard**
This unit has a built-in power supply, clock generator, and pulser switches to speed circuit development. *by Jack Cazes*
- 94 **Digital Grinchwal Test Equipment**
Final details for building the mainframe. *by Don Lancaster*

TELEVISION

- 48 **Step-By-Step Troubleshooters Guide**
Inside the active power filter. *by Art Margolis*
- 55 **Using Color-Bar Generators**
The lowdown on how to use a color-bar signal effectively. *by Forest Belt & Estille Dobson*
- 68 **TV Service Clinic**
An unexpected problem. *by Jack Darr*
- 69 **Reader Questions**
R-E's Service Editor solves reader problems

GENERAL ELECTRONICS

- 4 **Looking Ahead**
Tomorrow's news today. *by David Lachenbruch*
- 6 **Guest Editorial**
The world of radio-TV. *by E. Aisberg*
- 61 **State Of Solid State**
Holiday shopping hints, electronic siren, device/product news. *by Louis E. Garner*
- 76 **R-E's Christmas Shoppers Guide**
- 88 **Annual Index**
Index of all articles published in 1972
- 98 **Appliance Clinic**
Overseas power converters. *by Jack Darr*

DEPARTMENTS

- | | |
|----------------------------|--------------------------------|
| 86 Circuits | 78 New Products |
| 24 Letters | 83 Next Month |
| 12 New & Timely | 109 Reader Service Card |
| 84 New Books | 87 Technotes |
| 82 New Literature | 100 Try This |

SEASON'S GREETINGS

The editors and staff of *Radio-Electronics* extend best wishes for the holiday season.

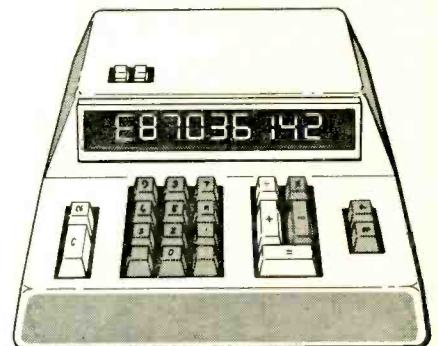

CALCULATORS ARE BIG NEWS. See how they evolved from counting on your fingers (the first "digital" computer) to the modern electronic marvels we are using today.

.....see page 51

Hugo Gernsback (1884-1967)
founder

M. Harvey Gernsback, editor-in-chief and publisher

Larry Steckler, editor, CET

Robert F. Scott, W2PWG technical editor, CET

Jack Darr, service editor

Louis E. Garner, Jr., semiconductor editor

I. Queen, editorial associate

Matthew Mandl, contributing editor

David Lachenbruch, contributing editor

James A. Gupton, Jr., photographic electronics

Vincent P. Cicenia, production manager

Nancy Gipson, production assistant

H. Matysko, circulation

Cover photograph by Walter Herstatt

Cover design by Marius Trinqu

Radio-Electronics is indexed in **Applied Science & Technology Index** and **Readers Guide to Periodical Literature**.

Radio-Electronics, December 1972, Vol. 43, No. 12. Published monthly by Gernsback Publications, Inc., 200 Park Avenue South, New York City 10003. Second-class postage paid at New York, N. Y., and additional mailing office. One-year subscription rate: U.S.A., U.S. possessions and Canada, \$7. Pan-American countries, \$8. Other countries, \$8.50. Single copies 60¢. ©1972 by Gernsback Publications, Inc. All rights reserved. Printed in U.S.A.

Subscription Service: Mail all subscription orders, changes, correspondence and Postmaster Notices of undelivered copies (Form 3579) to Radio-Electronics Subscription Service, Boulder, Colo. 80302



looking ahead

Cable pay TV

Pay TV, which never succeeded over the air, appears to have much better chance via cable, and several tests of special-programming-for-a-fee are under way now or will start shortly. The standard argument against over-the-air pay TV was that it took programming away from free TV by blacking out a channel to non-payers. Proponents of cable pay TV say wired systems add rather than subtract, since they simply introduce new channels—mostly in the "mid-band" between Channels 6 and 7—for the new subscription services.

Home tests of at least eight different pay-TV systems in as many as 25 or 30 communities could be in progress within the next few months. The home pay-TV tests will literally be coast-to-coast, from Atlanta to San Diego. Some will involve signals scrambled for security, while others will merely use special converters without scrambling. Two systems will be tested simultaneously in 10 cities each. One, backed by Columbia Pictures, requires the CATV subscriber to call a special number on the telephone to get reception of the day's feature film. The other, developed by Warner Brothers' cable-TV subsidiary, provides a special channel for recent feature films at a monthly subscription fee of \$4-\$8, in addition to the regular CATV fee. Pay-TV subscribers are provided special converters for the mid-band pay channel.

Two of the systems involve a form of ticket. One requires a magnetically encoded ticket to be purchased in advance and inserted in a set-top receptacle to activate the circuit which unscrambles the picture. Another uses punched cards to activate a

decoder permitting the viewer to see films, sports events and other special programs for a week.

Experiments with various methods of providing secure pay-as-you-see programming is widespread. It's unlikely that a single, standard system will emerge in the near future, since there's no particular need for one—CATV being closed-circuit hookups, generally one to a community. In all cases, the cable company provides the converter and/or decoder, so the consumer only pays for the programming—either on a per-program or a monthly basis.

Another video LP

Hot on the grooves of our report last month that RCA had developed a relatively low-cost color videodisc capable of playing 20 minutes per side, another system has emerged which promises 45 minutes of playing time on each side. This is enough playing time to provide a feature movie on one or two 12-inch discs.

The new system was developed by the European electronics giant, Philips of the Netherlands. Called VLP (for Video Long Play), the system is based on optical encoding. A unique feature is that, theoretically at least, neither the disc nor the pickup device is susceptible to any wear—since they don't touch each other. In place of grooves, the VLP disc has a series of oblong microscopic pits. Variations in the length of the pits and their distance from one another provides brightness, color, sync and sound. A low-powered (one-milliwatt) helium neon laser scans the disc from the bottom as it revolves at 1,500 rpm. The U.S. version will revolve at 1,800 rpm, to provide one full revolution of the disc

for each television frame. A feature of the system is its ability to freeze any single frame as a still picture, to play backwards, in slow or fast motion.

The master disc is cut by a laser, and vinyl pressings are made in a manner similar to the manufacture of audio recordings. After pressing, a highly reflective microscopically thin aluminum coating is applied. Officials of Philips hope that the system will be on the market in 1974, with a price of about \$625 quoted for the player, designed to be attached to the antenna terminals of any television receiver. The quality of the picture produced by the system is excellent, those who have seen it agree. The equipment is expected to be marketed in the United States by the North American Philips Co. (Norelco), and possibly by other manufacturers.

Color politics

Color television is still a sensitive political issue in many countries. Back in 1966 and earlier, most of the world chose up sides among the American NTSC color system, the German PAL system and the French SECAM. Although the decisions were couched in weighty engineering terms, they tended to be dominated, in actuality, by political considerations. The American bloc—including Japan, Mexico and the Philippines—had already selected NTSC. Canada chose NTSC because its citizens were receiving color from across the U.S. border. Most of Western Europe picked PAL. The French bloc—including France's former colonies in Africa, after many engineering studies, decided SECAM was the only way to go. This was at a time when France and the Communist countries were

chummy, so the Soviet Union and other Eastern European countries conducted scientific tests which confirmed that SECAM had strong engineering advantages. Mainland China indicated her preference for SECAM, too.

Suddenly, a little repetition of the color TV war has erupted. One battle is being fought in Venezuela, where the U.S. State and Commerce Departments are fighting mightily for NTSC—to the point of helping to sponsor elaborate on-the-air demonstrations. Brazil has already chosen the PAL system, but there is a strong feeling that Venezuela will influence the Spanish-speaking South America.

Meanwhile, Italy has become another battleground. It was long assumed that it would follow most of Europe in selecting the PAL system—but with increasingly close relations between Italy and France, Italy is now engaged in test broadcasting of the SECAM and PAL systems.

The next arena could be mainland China, where communications experts had their first exposure to the NTSC color system during President Nixon's visit. They apparently were impressed with it, because they are reported to be talking with various Japanese companies about the possibility of establishing color TV receiver plants there. As her relations with the Soviet Union have cooled, so has China's enthusiasm for the SECAM system.

But what about the Soviet Union? Color broadcasting there is in the SECAM system, but Russia's alliance with France has weakened, and some experts now predict the emergence of a fourth color system, invented in the Soviet Union.

by DAVID LACHENBRUCH
CONTRIBUTING EDITOR

There must be an easier way...

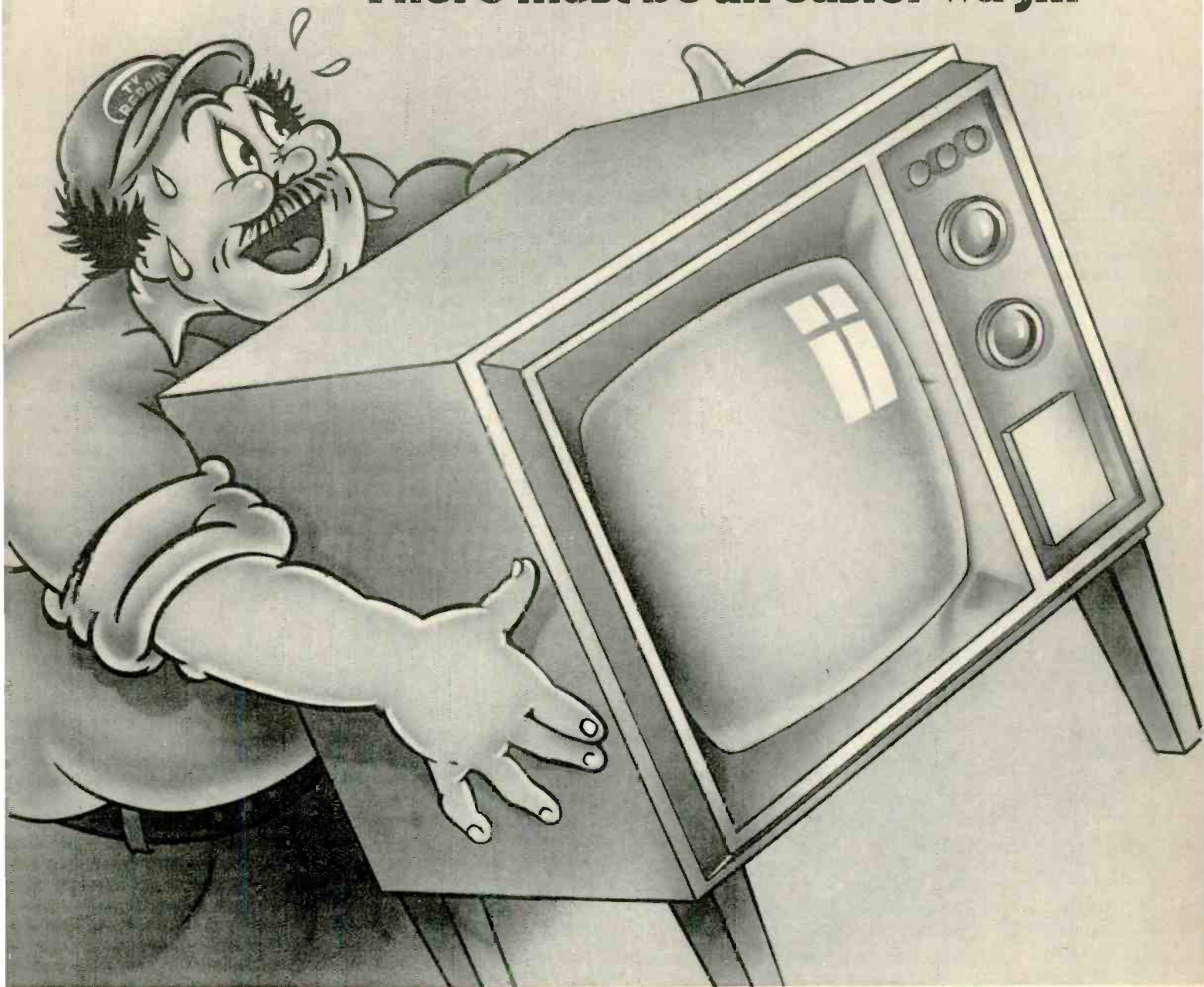

There is: Sylvania's Chek-A-Color test jig.

TV servicemen were never meant to be movingmen.

But, that was before antique, modern and French Provincial units that included hi-fi, tape decks and record players were built around a large-screen color TV set.

Getting those units to the shop can be a big job.

That's why we developed our two Chek-A-Color test jig units. One, our full-house model, gives everything you need to test a chassis. The other is a basic unit that practically lets you design your own test jig.

All you have to take back to the shop is the electronic guts of the TV monsters.

Regardless of the size of the original picture, Chek-A-Color lets you see it on a benchtop 14-inch



(diagonal) screen. It adapts to both high and low focus voltage sets and a full line of adapters lets you test over 5,000 different models.

A front-panel switch controls a yoke programming system that gives you a range of impedances and/or deflection voltages to closely match both tube and solid-state systems.

For actual testing, a convenient meter lets you measure anode voltage and a speaker lets you check sound performance.

Since Chek-A-Color handles tube, hybrid and solid-state chassis, there won't be many complete cabinets to lug.

With a Chek-A-Color test jig all you have to take is the chassis. Get the picture? Sylvania Electronic Components,

100 First Avenue, Waltham, Mass. 02154

GTE SYLVANIA

guest editorial

the world of radio-tv

Radio was born a little more than three-quarters of a century ago. It was in May, 1895 that Alexander Popoff made what was possibly the first public demonstration of wireless telegraph equipment, which he did by combining the electromagnetic wave transmitter devised by Heinrich Hertz and the coherer, developed through experiments made by Branley in 1890.

Broadcasting started—in the principal countries of the world—a half century ago. Though its beginnings date back to before the second World War, regular television transmissions began about a quarter century ago.

Even though the development of radio and TV has been comparatively recent, those who have benefited from it have been numerous indeed. Today humanity has about a billion broadcast receivers and more than 160 million television sets. And each of these serves several persons—usually a whole family. Which is to say a prodigious number of people listen to the radio or view TV.

Technology has progressed very rapidly in this area. The receivers of sounds and images have been perfected in all points: sensitivity, sound and picture quality, and selectivity. No other technique has benefited from such impressive progress (no small part of which is due to the fundamental revolution initiated by the invention of the transistor in 1947).

If we admire the rapid evolution of our technique, we are also profoundly moved in noting what an influence it has exercised on the life of humanity. No invention has so affected the evolution of the world as has radio and television!

During the second World War, the populations of occupied countries were kept abreast of the true course of events by listening to the broadcasts from the free countries, and thereby their morale was sustained.

The Resistance profited notably by radiophone communications. We can state that with all the more certainty, as at the time we were able to erect, at Annecy, a shortwave transmitter for the courageous Resistance groups assembled in the mountains near Lake Geneva.

In our days, radio and television reach all the people of the world. Because of the reflection of short waves from the Heaviside layer and—more recently—the action of artificial satellites receiving and retransmitting signals, sounds and images can be transmitted to any part of the earth.

Thus the Olympic Games, played in Japan and Germany, were viewed directly—and even in color—in all countries. Several hundreds of millions viewed the same scenes at the same time.

And radio communication is not limited by the dimensions of our planet. When the people of Earth went walking on the Moon, we viewed them direct over the 240,000 miles that separated us.

This enormous distance is far from being the limit of our communications range. In the near future we will be able to see the surfaces of other planets of the solar system on our television screens. And in the more distant future, our descendants will be able to view other stars of our galaxy and their planets. The term "direct view" or "live" will cease to have meaning, for the waves will spend months or years traversing the distance that separates their transmitters from the Earth.

* * *

The liaison that our technique makes possible between all peoples must eventually have as its happy result the unification of humanity.

Certainly, for a better understanding between the inhabitants of different countries, it will be useful to employ that international auxiliary language, Esperanto. Easy to learn because its grammar consists of 16 simple rules; because by using a rational system of prefixes and suffixes one can form a large number of words from a small number of roots, that language, created in 1887 by Dr. Zameshof, should be taught simultaneously in all the schools of the world.

The use of Esperanto in relations with the people of other countries would also preserve better the quality of the national languages.

But—even in its present state—the liaison that radio and television has already established between the peoples of our planet has already brought them closer together. Knowing each other better, they will have a greater feeling of solidarity.

We hope therefore that, thanks to the worldwide expansion of our technique, there may be no more war, that a spirit of cooperation may develop between the various countries and that humanity may be able to carry out the precept of Jesus Christ: "Love one another!"

—E. Aisberg*

*See page 82 for a word about our guest editorialist.



8 Sams Books to update and broaden your Electronics Skills

Three are newly revised editions . . . 5 are brand new this fall . . . all will be valuable additions to your library.

ABC'S OF LASERS AND MASERS (3rd Edition)

By Allan Lytel and Lawrence Buckmaster
The completely updated explanation and review of the development and applications of lasers and masers in measurements, communications, medical surgery, and industrial usages; 128 pages; 5½" x 8½"; softbound.
No. 20863 \$3.50

99 WAYS TO IMPROVE YOUR SHORTWAVE LISTENING (NEW)

By Len Buckwalter
A valuable source of information for both hobbyist and experienced technician. Includes: antennas and installation, receiver improvements, accessories, interference sources, troubleshooting tips, listening techniques. 144 pages; 5½" x 8½"; softbound.
No. 20911 \$3.95

101 QUESTIONS AND ANSWERS ABOUT AM, FM, & SSB (NEW)

By Leo G. Sands
Easy-to-understand information about the three basic modulation techniques and the various types of transmission. Describes best uses, technical aspects and limitations of each in a Q&A format. 96 pages; 5½" x 8½"; softbound.
No. 20919 \$3.95

1-2-3-4 SERVICING STEREO AMPS (NEW)

By Forest H. Belt
Details the "divide and conquer" method of troubleshooting and servicing stereo equipment and shows how to apply the method for best results. Many illustrations and schematics in this clear, easy-to-read manual. 240 pages; 5½" x 8½"; softbound.
No. 20912 \$4.95

NORTH AMERICAN RADIO-TV STATION GUIDE (8th Edition)

by Vane A. Jones
Lists nearly 10,000 a-m, fm and television stations in the U.S., Canada, Mexico, and the West Indies. Includes: power (day and night), antenna height, and time sharing. Arranged by geographical location, frequency (or channel), and call letters. 160 pages; 5½" x 8½"; softbound.
No. 20915 \$3.95

ABC'S OF INDUSTRIAL ELECTRONICS (NEW)

By J. A. Wilson
Covers the circuits and applications of electronics used in manufacturing, together with all types of electronics systems that are not designed for home entertainment. Tells and shows how electronics have improved on old-time methods of machine and process controls. 86 pages; 5½" x 8½"; softbound.
No. 20913 \$3.95

FM MULTIPLEXING FOR STEREO (3rd Edition)

By Leonard Feldman
Analyzes the fm stereo signal; gives requirements for fm stereo receiver; covers multiplex decoder circuit variety and servicing, stereo indicator lights and automatic stereo switching; test equipment and alignment procedures. 176 pages; 5½" x 8½"; softbound.
No. 20910 \$4.95

MARINE SINGLE SIDEBAND (NEW, NOT SHOWN)

By Donald M. Stoner and Pierre B. Goral
Fills a void in published literature on the subject of Marine Single Sideband, the method by which all marine electronic voice communications must soon be carried out. Covers all facets of Single Sideband in marine communications. 192 pages; 5½" x 8½"; softbound.
No. 24029 \$5.95

 **HOWARD W. SAMS & CO., INC.**
4300 West 52nd Street, Indianapolis, Indiana 46268

Order from your Electronics Parts Distributor, or mail to Howard W. Sams & Co., Inc.

Send books checked at right. \$_____ enclosed.
Please include sales tax where applicable.
Canadian prices slightly higher.

20863 20915
 20911 20913
 20919 20910
 Send Free 1972 Sams Book Catalog. 20912 24029

Name _____
Address _____
City _____ State _____ Zip _____

RE122

NRI "hands-on" training in Television, Communications, Electronics and Computers can give you as much as 2 years of on-the-job experience.

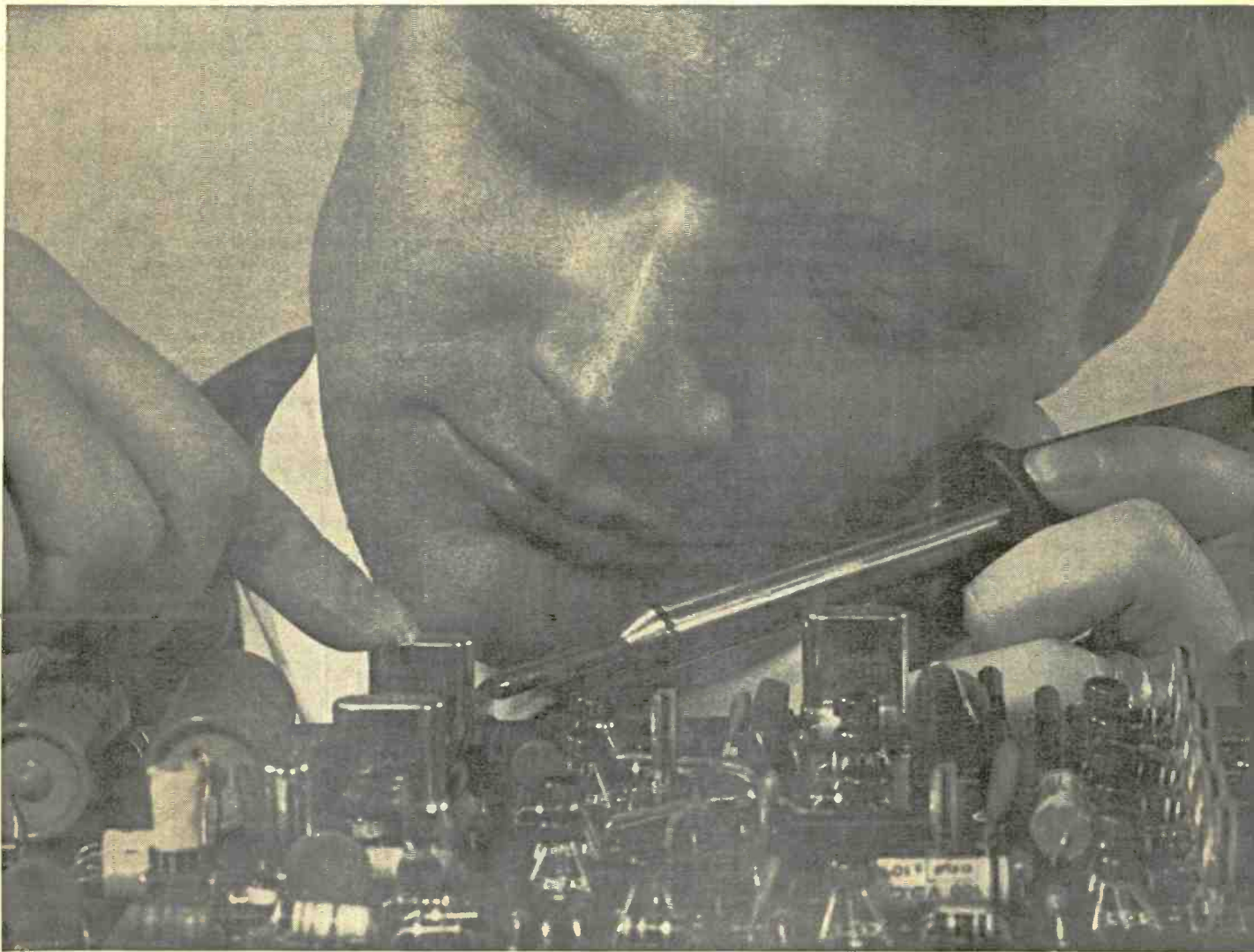

EARN YOUR FCC LICENSE – OR YOUR MONEY BACK

NRI Communications training programs will qualify you for a First Class Commercial Radiotelephone License issued by the FCC. If you fail to pass the FCC examinations for this license after successfully completing an NRI Communications course we will, on request, refund in full the tuition you have paid. This agreement is valid for the period of your active student membership and for six months after completion of your training. No school offers a more liberal FCC License agreement.

Experience is still your best teacher

...here's how you get it with unique NRI training at home

Ask any teacher, job counselor, engineer, technician or prospective employer about the need for practical application of theory in Electronics. He'll tell you Electronics is as much a "hands-on" profession as dentistry or chemistry. That's how you learn at home with NRI. You prove the theory you read in "bite-size" texts, by actual experimentation with the type of solid-state, transistor and tube circuits you'll find on the job today — *not* hardware or hobby kits. You introduce circuit defects, analyze results, discover quickly the kind of trouble-shooting and design techniques that will make you employable in Electronics.

Train with the leader — NRI

NRI lab equipment is designed from chassis up for effective, fascinating training — not for entertainment. The fact that end results are usable, quality products is a bonus. In Communications, for example, you build and analyze, stage by stage, your own 25-watt phone/cw transmitter. It's suitable for use on the 80-meter amateur band, if you have an interest in ham radio. In TV-Radio Servicing your practical training gives you your choice of monochrome or color TV sets. All training equipment is included in the low tuition — you pay nothing extra. Discover for yourself the ease, excitement and *value* of NRI training. Mail postage-free card today for new NRI Catalog . . . or use the coupon below. No obligation. No salesman will call on you. NATIONAL RADIO INSTITUTE, Washington, D.C. 20016.

APPROVED UNDER NEW GI BILL

If you have served since January 31, 1955, or are in service now, check GI line on postage-free card or in coupon.

MAIL THIS COUPON IF CARD IS GONE



NATIONAL RADIO INSTITUTE 3-122
Washington, D.C. 20016

Please send me your new NRI Catalog. I understand no salesman will call and there is no obligation.

Name _____ Age _____

Address _____

City _____ State _____ Zip _____

Check for facts on new GI Bill

ACCREDITED MEMBER NATIONAL HOME STUDY COUNCIL



NRI Achievement Kit is educator-acclaimed and the original "starter" kit in home study training. Imitated but never duplicated, this kit is designed and personalized for you and your training objective. It has one purpose — to get you started quickly and easily.



"Bite-Size" Texts average an easily-digested 40 pages of well-illustrated, scientifically prepared subject matter in the course of your choice. Questions in each book are carefully hand-graded and returned to you with helpful instructional notes. You get unlimited personal help from the day you enroll.

Designed-For-Learning Equipment

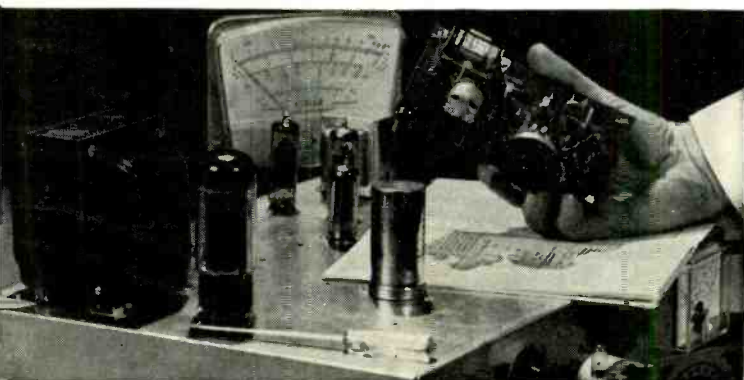

Like this phone-cw transmitter (Kit #7 in the Communications course) is engineered from chassis up to demonstrate principles you must know. NRI does not use modified hobby kits for training, but the finest parts money can buy, professionally and educationally applied.

new & timely

Electronic goggles "blink" for flashes of bright light

Electronic safety goggle lenses that switch from transparent to practically opaque (0.01% transmission) in less than 50 microseconds have been developed by researchers at Sandia Laboratories (New Mexico).

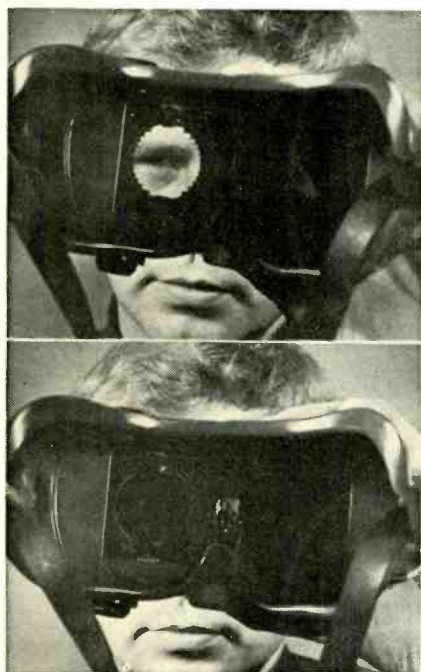

THE FLASHPROOF GOGGLES. Above, full "on." Below, completely opaque (one lens in top photo is shadowed by inventor's hand.)

Designed primarily to protect workers from flashblindness due to nuclear flashes, the goggles are equally useful in industrial jobs like arc welding. The lenses may also be used to protect sensitive light detectors (image intensifiers, vidicon tubes, etc.), as an optical shutter for high-speed photography or an optical switch or light gate. (Had the moon television camera that was put out of action by being pointed at the sun been protected by one of these lenses, it would not have been damaged.)

The variable-density lens is a sandwich—two polarizers oriented at 90° to each other, with a ceramic layer of lanthanum-modified lead zirconate-lead titanate (PLZT) between them. Transparent electrodes of sputtered copper or gold, 2 mils wide and 40 mils apart, are supplied with 90 volts (maximum) from a 5.5-volt battery in a pocket-size power pack. Current is a fraction of a microampere.

The power supply is controlled by an array of five photodiodes—pointed in different directions—mounted above the nosepiece of the goggles. The light threshold, at which the glasses start to darken, can be adjusted by changing the resistors in the circuit. In the "on" state the goggles are more transparent than ordinary sunglasses, with a light transmission of 21% (U.S. Air Force sunglasses transmit 15%). Transmission may be set at any level between this 21% and complete opacity with a simple resistance control.

New York technician reports absolutely new TV trouble

The TV-radio technician has become familiar with the set that can't be turned off, as well as the TV that "makes the room cold when it's turned on," but the type of trouble recently reported by Belin Radio and Television of New York City has apparently never before been noted in the literature.

According to Mel Ressler, proprietor, a woman whose set had just been repaired called back hysterically: "I can't turn it off!" Mel suspected a shorted switch and advised her to pull the plug. Then he says, the lady called back a few minutes later, really hysterical this time: "Everything is off but the dial. It's still lit! And I can't get it to go out!"

"This," thought Mel, "I've gotta see!" So he went over. "And," he says, "she took me to the set. There was this light inside, all right. The guy had left his flashlight in there and left it on with the light shining through the numbers."

Computer improves quality of man-made crystal

Automatic control of the growth process and diameter of crystals grown for communications systems improves the quality of the crystal and reduces the cost of producing it, Bell Laboratories scientists report. Crystals are grown by pulling a crystal "seed" slowly out of melted crystal material. The time required—in the case of the crystals grown in this experiment—is 20 to 30 hours.

If the crystal is pulled too rapidly it becomes skinny—if too slowly, its diameter increases. To keep defects to a minimum, the diameter of the crystal must be kept as near uniform as possible. This previously required that a skilled technician watch over the crystal throughout the whole 20 to 30 hours.

In the automatic method a digital scale takes a continuous series of measurements of the weight of the molten material. The computer uses these to calculate the crystal's rate of growth, and feeds back information that lowers or raises the temperature of the melt, according to whether the crystal is growing too fast or too slow. Thus not only does constant human surveillance become unnecessary, but the crystal is more uniform than even a skilled technician could make it.

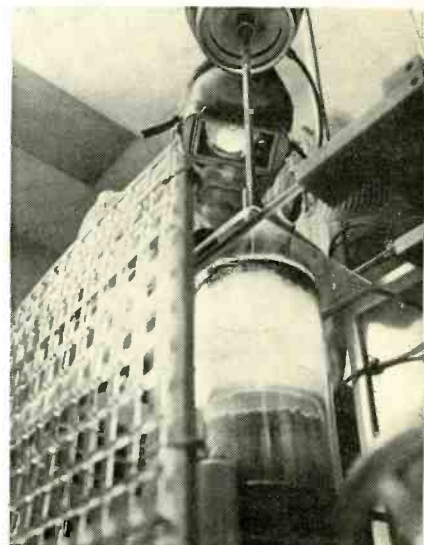

AUTOMATIC CRYSTAL GROWER about to go into action. The rod with which the crystal is "pulled" can be seen clearly. The wearer of the goggles is Ralph C. Joseph of the Materials Development Dept., Bell Labs, Allentown, Pa.

The new system has been used to grow crystals of gadolinium gallium garnet, a substrate material for the magnetic "bubbles" developed by Bell with the prospect of using them in automatic switching systems and computers. Similar control systems will probably be used for growing other types of communications crystals.

Radio warning beacons to prevent auto accidents?

The French Ministry of Transport is experimenting with a new technique for cutting down the number of automobile accidents that occurs regularly in dangerous places, those "black spots" that pile up large totals of damage and fatalities. [In some foreign countries, roadside signs bearing a large black circle (black

(continued on page 14)

TRIGGERED SWEEP

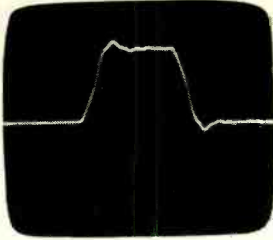

250-nanosecond (¼-microsecond) pulse demonstrates trace expansion and rise time capability of the new RCA WO-535A in Triggered Sweep Mode.

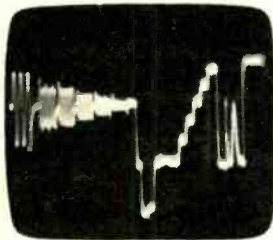

Typical TV VITS pattern on the new RCA WO-535A in Triggered Sweep Mode.

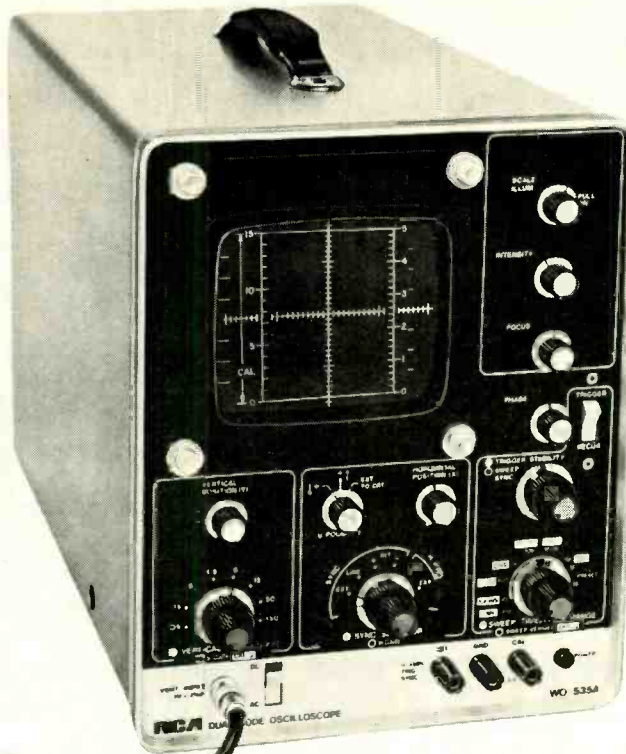

RECURRENT SWEEP

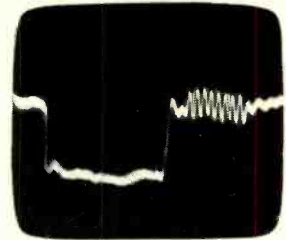

Expanded video signal on the new RCA WO-535A in Recurrent Sweep Mode shows the horizontal sync pulse and 3.58 MHz color-burst signal.

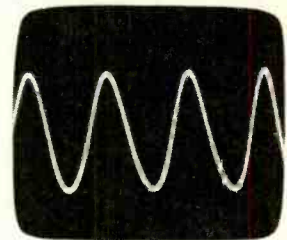

3.58 MHz sine-wave as shown on new RCA WO-535A in Recurrent Sweep Mode.

Now...a 5-inch triggered/recurrent sweep oscilloscope for only \$329*

It's the all solid-state RCA WO-535A featuring one-step calibration for simplified voltage measurements and usable frequency response to 10 MHz.

In the Triggered Sweep Mode, you can lock in waveforms and patterns that cannot be viewed easily using recurrent sweep. Triggered sweep with wide, variable trace expansion permits you to view small segments of complex waveforms, such as vertical-interval test signals (VITS). In the Recurrent Sweep Mode, you get all the ad-

vantages of a conventional continuous-sweep oscilloscope.

There are many other features of the WO-535A you'll like — and your RCA Distributor will be glad to supply complete information about this general-purpose oscilloscope that provides high performance in such applications as radio and TV servicing, industrial maintenance, troubleshooting, and general waveform analysis.

Also ask your RCA Distributor for the full story on the RCA WO-505A,

priced at \$299*, and the RCA WO-33A, priced at \$180*. Or write RCA Test Equipment Headquarters, Harrison, N.J. 07029.

*Optional Distributor Resale Price, complete with direct/low capacitance shielded probe and cable.

RCA|Electronic Components|Harrison, N.J. 07029.

RCA

INTERNATIONAL SALES OFFICES: ARGENTINA—Casilla de Correo 4400, Buenos Aires/BRAZIL—Caixa Postal 8460, São Paulo/CANADA—21001 No. Service Rd. Ste. Anne de Belle-vue, B10 Quebec/ENGLAND—Sunbury-on-Thames, Middlesex/HONG KONG—P.O. Box 112/MEXICO—Apartado 17-570, Mexico 17, D.F./SWITZERLAND—2-4 rue du Lièvre, 1227 Geneva.

Circle 5 on reader service card

DECEMBER 1972 • RADIO-ELECTRONICS 13

FREE

send now for the *all new*

Olson

1973 CATALOG



Your Savings Guide to Everything in Electronics

Here's your NEW and complete annual buying guide to:

- Everything in audio & hi-fi
- Tape recorders & accessories
- Radios & phonos of all kinds
- New build-your-own kits
- Auto electronics & accessories
- Citizens Band two-way radios
- VHF & UHF police/fire monitors
- Amateur & shortwave radio
- Electronic security equipment
- TV-FM antennas • Test gear
- Books, parts bargains, tubes, transistors, wire, more!

NOW! Send for the only catalog with a wide selection of **THE BEST OF THE FAMOUS BRANDS**

OLSON EXCLUSIVES!

See special products & values sold only by Olson including our all-new TELEDYNE stereo line.

Many full-color pages!

Olson Electronics

Olson Electronics Dept. LA

260 S. Forge St., Akron, Ohio 44327

Send FREE 1973 Olson catalog

Name _____ Apt. _____

Address _____

City _____

State _____ Zip _____

Name _____ Apt. _____

Address _____

City _____

State _____ Zip _____

Circle 6 on reader service card

new & timely

(continued from page 12)

spot) are used to mark locations where vehicular accidents occur regularly, resulting in death and property damage.]

The Ministry is installing small transmitters in a number of these "black spots" and placing receivers tuned to the transmitters in a number of cars. As the car approaches a "black spot" the driver hears a bleep-bleep that warns him of present dangers.

If the technique seems effective, the Ministry may move to have all French motor cars equipped with inexpensive receivers permanently tuned to the beacon frequency.

According to a spokesman for the Ministry of Transport: "It has been proved that accident warning signs are not very effective, but we feel that a sudden unexpected sound inside the car might persuade drivers to be cautious."



TWENTY SEVEN FEET LONG, WEIGHING 1,500 pounds, this Hughes Aircraft Co. radar antenna is being installed in the radome assembly of a Boeing 707-320 aircraft. It is intended for use in the Air Force Alrborne Warning and Control System (AWACS). Boeing is also testing a competing radar by Westinghouse, and will recommend one of them to the Air Force.

Electron device detects human cancerous cells

The principle of nuclear magnetic resonance used in magnetometers may be useful in detecting cancer, says Dr. Raymond Damadian, Brooklyn physician-biophysicist. In a nuclear-resonance device (RADIO-ELECTRONICS, April, 1960, page 38) hydrogen atoms are aligned with an external magnetic field. The magnetic field is suddenly cut off and the atoms drop back to random align-

ment or alignment with the earth's magnetic field, giving off electromagnetic energy (radio signals) as they do so.

Dr. Damadian has discovered that it is possible to distinguish between the signals given off by atoms in cancerous tissue and those from atoms in healthy tissue. Up to the present his researches have been confined to small tumors, but he hopes within the next couple of years to construct a cancer-detecting nuclear magnetic resonance device large enough to enclose the entire human body.

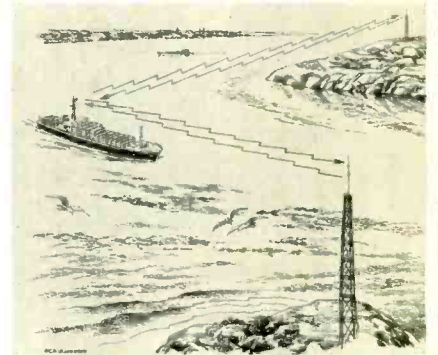

A NEW NAVIGATION AID has been proposed by RCA for the U.S. Coast Guard's River and Harbor Aid to Navigation System. It is based on a transponding technique. Shore stations with transponders reply to signals transmitted by interrogators aboard ship. Thus the ships will be able to identify the stations and calculate their distance from them. A ship, if also equipped with anti-collision radar, could enter a harbor in densest fog. The system would be near ideal for ferries, which could operate in any weather.

Cool conductors increase carrying capacity 7-fold

A 40-foot section of aluminum underground power cable—chilled to -320°F (77°K)—has stood up for several days under voltages comparable to those now handled by commercial oil-filled underground power cables. Voltages up to 435,000 were applied to it. At the low temperature of the tests, conductor resistance is greatly reduced and fantastic currents can be carried. The test was carried out in the General Electric Research and Development Center, Schenectady, NY, in a project designed to find means of carrying larger amounts of power from the outskirts of a city to its center.

The success of the tests indicates to General Electric engineers that such cryogenic (low-temperature) cables could carry more than 3,500 megavolt-amperes

(continued on page 16)

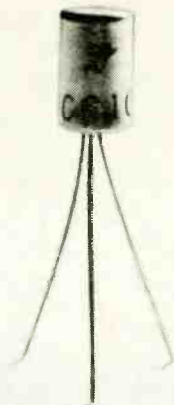

Our ECG 102A transistor replaces...

To Be Replaced	ECG Replacement	To Be Replaced	ECG Replacement
HB333	102A	MA393E	102A
HB354	102A	MA393G	102A
HB355	102A	MA393R	102A
HB356	102A	MA815	102A
HB375	102A	MA881	102A
HB375C		MA882	102A
HB377	102A	MA883	102A
HB377B	102A	MA884	102A
HB377C	102A	MA886	102A
HB156	102A	MA886	102A
HB156C		MA887	102A
HB171	102A	MA888	102A
HB172	102A	MA889	102A
HB175	102A	MA890	102A
HB176	102A	MA891	102A
HB178		MA892	102A
HB186	102A	MA893	102A
HB187	102A	MA894	102A
HB263	102A	MA895	102A
HB270	102A	MA896	102A

and hundreds more.

The 102A is only one big part of our very small line.

Just 124 Sylvania ECG semiconductor parts will replace over 41,000 manufacturer's part numbers and JEDEC types.

Our new ECG semiconductor replacement guide makes it easy for you to find out exactly which one of ours is the one you need.

With our guide and our 124 replacements, you can service practically any solid-state entertainment product on the market.

No more lugging sets back to the shop because you couldn't carry all the parts you needed.

With Sylvania's 124 semiconductors you can handle almost all of your repair jobs right in your customer's home.

Stock up on Sylvania ECG semiconductors now.

It's just another small thing from GTE Sylvania that can take a big load off your back.

Sylvania Electronic Components,
Waltham, Mass. 02154

GTE SYLVANIA

Reduce Car Maintenance Increase Engine Performance.

Put a Mark Ten Capacitive Discharge Ignition (CDI) System On Your Car.

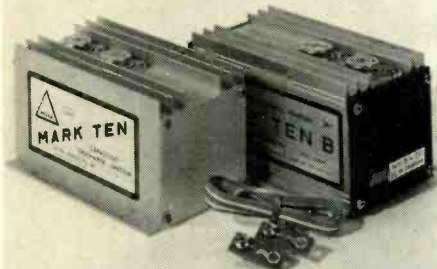

Even Detroit finally recognizes that electronic ignition systems dramatically increase engine performance. Chrysler is now putting them on their new models. The Mark Ten CDI, the original electronic ignition system, has been giving increased performance with lower maintenance to hundreds of thousands of satisfied customers for over eight years. Install a Mark Ten CDI on your car, boat or truck and eliminate 3 out of 4 tune-ups. Increase gasoline mileage up to 20%. Enjoy improved engine performance. Or put a Mark Ten B on your car. It was especially designed for engines with smog control devices. By reducing combustion contaminants, the Mark Ten B restores power losses caused by these devices. Equipped with a convenient switch for instant return to standard ignition, the Mark Ten B is applicable to ANY 12 volt negative ground engine. Both systems install in 10 minutes with no rewiring. Order a Mark Ten or Mark Ten B CDI today.

Mark Ten (Assembled) \$44.95 ppd.
Mark Ten (DeltaKit) \$29.95 ppd.

(Kit available in 12 volt only positive or negative ground.)

Mark Ten B \$59.95 ppd.
(12 volt negative ground only)

Superior Products at Sensible Prices
Mfg. in U.S.A.



Dept. RE
DELTA PRODUCTS, INC.

P.O. Box 1147 / Grand Junction, Colo. 81501
(303) 242-9000

Please send me free literature.

Enclosed is \$ _____ Ship ppd. Ship C.O.D.

Please send:

___ Mark Ten B @ \$59.95 ppd.

___ Standard Mark Ten (Assembled)
@ \$44.95 ppd.

___ 6 Volt: Neg. Ground Only

___ 12 Volt: Specify

___ Positive Ground ___ Negative Ground

___ Standard Mark Ten (DeltaKit®) @
\$29.95 ppd.

(12 Volt Positive Or Negative Ground Only)

Car Year _____ Make _____

Name _____

Address _____

City/State _____ Zip _____

new & timely

(continued from page 14)

(MVA). By contrast, a 500 MVA rating would be considered high for present metropolitan-area cables.

The cable was insulated by a winding of paper about 1 inch thick. Liquid nitro-



CHECKING THE COOL CABLE after several days of testing. In a commercial three-phase system, three conductors would be used instead of the single conductor employed in the tests.

gen was used as the coolant, and the whole enclosed in a steel pipe 20 inches in diameter.

The engineers look forward to some years of further research and development before the system is ready for regular use.



MOBILE DIGITAL RADIO TERMINAL is mounted in a patrol car of the Kansas City, Mo., Police Department. It can transmit messages in 1.5 seconds and receive its computer answer in about 5 seconds, as well as display broadcasts from the police control. The unit is a Kustom MCT-10, made by Kustom Electronics, Chanute, Kan. R-E

Radio-Electronics is published by Gernsback Publications, Inc. 200 Park Ave. S. New York, N.Y. 10003 (212) 777-6400
President: M. Harvey Gernsback
Secretary: Bertina Baer

ADVERTISING SALES

EAST

Stanley Levitan, Eastern Sales Mgr.
Radio-Electronics
200 Park Ave. South
New York, N.Y. 10003
(212) 777-6400

MIDWEST/Texas/Arkansas/Okla.

Ralph Bergen
The Ralph Bergen Co.
6319 N. Central Ave.
Chicago, Ill. 60646
(312) 792-3646

PACIFIC COAST/Mountain States

Jay Eisenberg
J.E. Publishers Representative Co.,
8560 Sunset Blvd.,
Suite 601,
Los Angeles, Calif. 90069
(213) 659-3810
420 Market St.,
San Francisco, Calif. 94111
(415) 981-4527

SOUTHEAST

E. Lucian Neff Associates
25 Castle Harbor Isle,
Fort Lauderdale, Florida 33308
(305) 566-5656

MOVING?

Don't miss a single copy of **Radio-Electronics**. Give us:

Six weeks' notice

Your old address and zip code

Your new address and zip code

ATTACH
LABEL
HERE

name (please print)

address

city state zip code

Mail to: Radio-Electronics
SUBSCRIPTION DEPT., BOULDER, COLO.
80302

Circle 7 on reader service card

A NEW STANDARD!... THE 7400 SCIENTIFIC & ENGINEERING CALCULATOR

THE MOST POWERFUL SCIENTIFIC CALCULATOR FOR UNDER \$500.00

The price of the 7400 is low enough to make a desk top computer available to almost anyone.

SIGNIFICANT FEATURES NOT FOUND IN MOST COMPETITIVE MACHINES

- ▣ DYNAMIC RANGE: 10⁻⁹⁹ to 10⁹⁹
- ▣ DATA STORAGE: 2 Auxiliary Storage Registers plus up to 7 push-up Stack Registers.
- ▣ Roll up and roll down keys for complete control of operational stack
- ▣ Interfacing provisions for printer and programmer
- ▣ Correct X (Allows the operator to correct one digit, without re-entering the whole problem)
- ▣ Polar to Rectangular conversion and Rectangular to Polar conversion

DISPLAY: Either full floating or scientific notation, 14 large, easy-to-read digits.

SIZE: 8½" x 12" x 3½"

WEIGHT: 4 lbs.

7400A 3 Registers

Kit \$299.95

Assembled \$379.95

7400B 5 Registers

Kit \$319.95

Assembled \$399.95

7400C 7 Registers

Kit \$339.95

Assembled \$419.95

PRICES INCLUDE CARRYING CASE

MITS will repair any 7400 for a fee of \$25.00 for a 5-year period after the normal 1-year warranty has expired.

Use Your BankAmericard or Master Charge

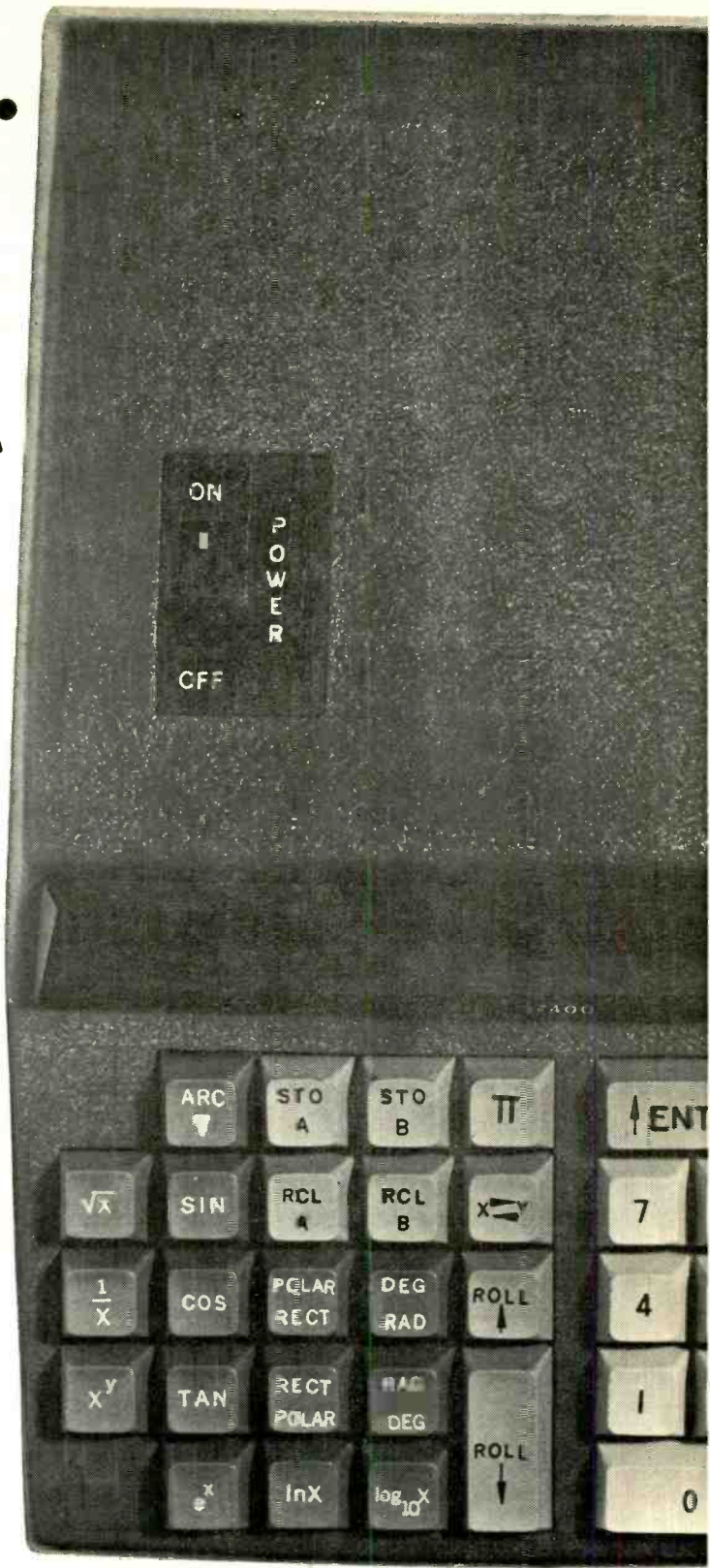

MITS
 WRITE OR MAIL COUPON FOR
 ADDITIONAL INFORMATION:
**Micro Instrumentation &
 Telemetry Systems, Inc.**
 5404 Coal Ave., S.E., Albuquerque, New Mexico 87108
 505/266-2330

Kit
 Assembled

ENCLOSED IS CHECK FOR MODEL # _____

AMOUNT OF CHECK (Include \$5.00 for Postage & Handling) \$ _____

I am interested in additional information.

NAME _____

ADDRESS _____

CITY _____

STATE _____ ZIP _____

R 12-2

Circle 8 on reader service card

RCA Institutes Home Training may be
your best investment
for a rewarding
career in electronics

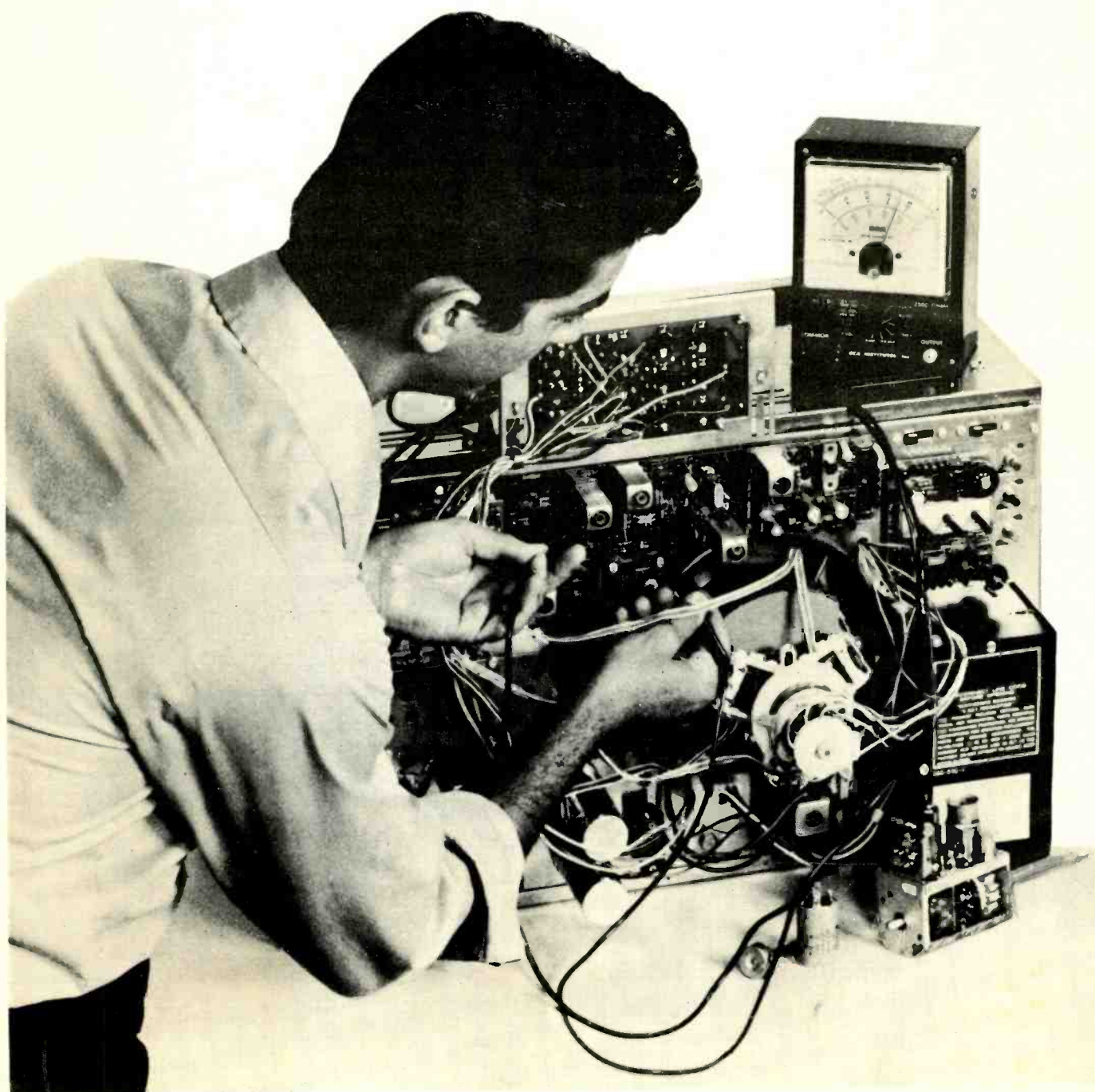

1 LEADER IN ELECTRONICS TRAINING

For over half a century, RCA Institutes, Inc., a subsidiary of RCA, has been a leader in resident school technical training in electronics. For many years, it has offered home study training in electronics.

2 RCA AUTOTEXT TEACHES ELECTRONICS RAPIDLY, EASILY

Beginner or refresher, AUTOTEXT, RCA Institutes' own method of programmed Home Training will help you learn electronics rapidly, easily.

3 WIDE CHOICE OF CAREER PROGRAMS

Start today preparing for an electronics career. On the attached card is a list of "Career Programs," each of which starts with the amazing AUTOTEXT method of programmed instruction. Look the list over, pick the one best suited to you and check it off on the card.

4 SPECIALIZED ADVANCED TRAINING

For those already working in electronics or with previous training, RCA Institutes offers advanced courses. You can start on a higher level without wasting time on work you already know.

5 PERSONAL SUPERVISION THROUGHOUT

All during your program of home study, your exams are reviewed and your questions are answered by RCA Institutes instructors who become per-

sonally involved in your efforts and help you over any "rough spots" that may develop.

6 HANDS-ON TRAINING

To give practical application to your studies, a variety of valuable kits are included in many programs. In RCA's Master TV/Radio Servicing Program, you will actually build and keep an all solid-state black and white TV set, and a color TV set. You also construct an oscilloscope which is yours to keep and use on the job.

7 FCC LICENSE TRAINING - MONEY BACK AGREEMENT

Take RCA's Communications Career Program - or enter with advanced standing and prepare immediately for your 1st, 2nd, or 3rd class FCC Radio Telephone License examinations. RCA Institutes money-back agreement assures you of your money back if you take, and fail to pass, the FCC examination taken within 6 months after completing the course.

8 CONVENIENT PAYMENT PLANS

You get a selection of tuition plans. And, we are an eligible institution under the Federally Insured Student Loan Program.

9 RCA INSTITUTES IS FULLY ACCREDITED

RCA Institutes is licensed by N.Y. State and is accredited by the Accrediting Commission of the National Home Study Council. Its courses of study, faculty and instructional facili-

ties are approved by the State Education Department. In addition, all RCA Institutes courses and programs require the approval of the RCA Institutes Board of Technical Advisers who represent various technical, research and educational activities of RCA Corporation.

Approved by N.Y. State Education Dept. for the training of veterans.

SEND ATTACHED POSTAGE PAID CARD TODAY! FREE DESCRIPTIVE BOOK YOURS WITHOUT OBLIGATION!

If reply card is detached, send this coupon

RCA INSTITUTES, INC.
DEPT. 758-212-0
320 W. 31 ST.
NEW YORK, N.Y. 10001

Please send me FREE illustrated career catalog. I understand that I am under no obligation.

Name _____

Address _____

City _____

State _____ Zip _____

Age _____

Veterans: Check here

RCA

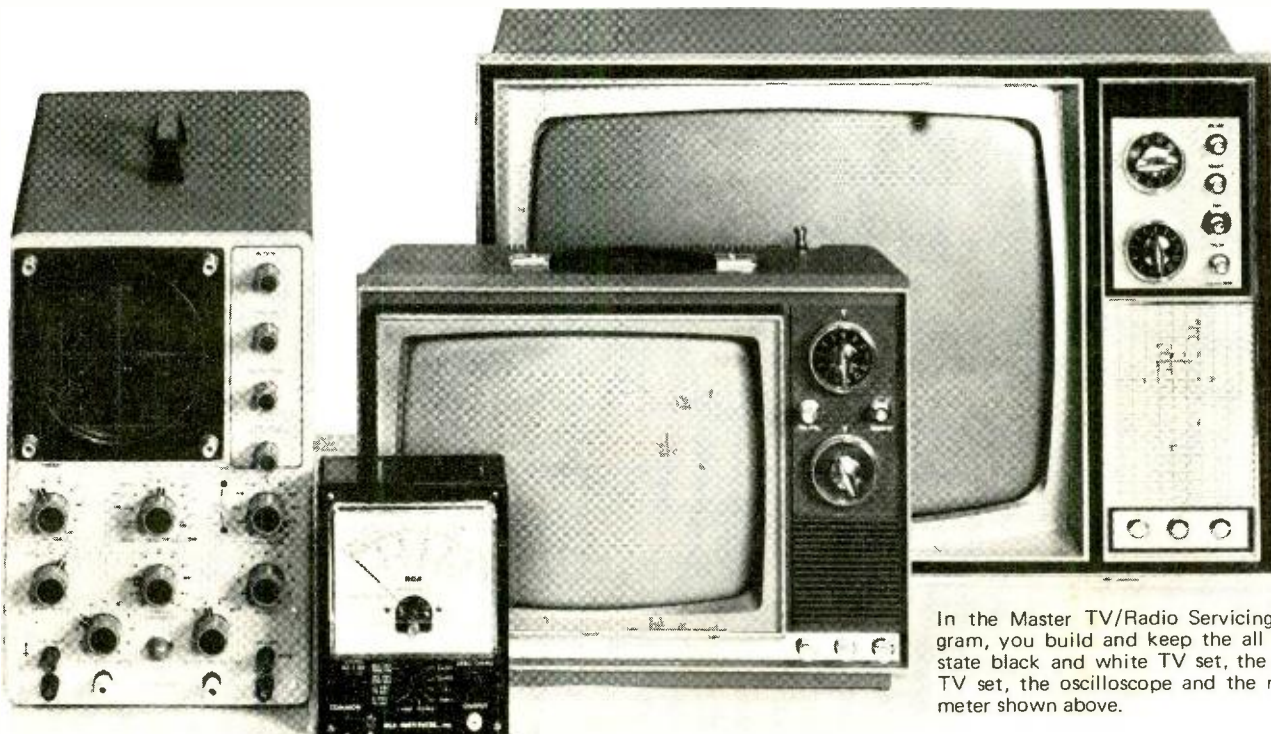

In the Master TV/Radio Servicing Program, you build and keep the all solid-state black and white TV set, the color TV set, the oscilloscope and the multi-meter shown above.

You don't have to get a college in electronics.

Next to a willingness to work, nothing will improve your chances of success in electronics more than a college-level education. But family obligations and the demands of your job may make it very difficult for you to attend classes. That doesn't mean you have to forget about getting ahead. CREI makes it possible for you to get the college-level education you need without going back to school.

Learn at home

At your own pace, your own schedule . . . without giving up your present job. CREI lessons are written to be clearly understood without the presence of a teacher. Your problems are anticipated. Your instructors will work with you in a very personal manner and give you all the individual attention you need. Many men learn far more readily through home study than they ever did in the classroom.

Not for beginners

CREI programs are written for men familiar with basic electronics, but who want to

get the advanced, specialized knowledge they must have to move up to engineering-level positions and engineering-level pay. All CREI training material is developed with the help of top engineers and scientists from private industry and government laboratories. Each of these men is an expert in his field of electronics. He knows exactly what level of specialized knowledge a man needs to work successfully in that particular field today. This is your assurance that what you learn from your CREI study can be applied on the job.

You can have confidence in CREI

Since 1927, CREI has helped tens of thousands of men move ahead in every phase of the electronics industry. You'll find CREI graduates and students in key jobs wherever up-to-date knowledge of electronics is demanded. Leading companies recognize the quality of CREI education. Many pay all or part of CREI tuition for their employees.

CREI education is up-to-date education

CREI courses are continually being revised. New developments are included as quickly as they occur. Right

now, CREI students are getting the latest information on cable TV, LSI chips, microminiaturization, lasers and masers, telemetry systems, servomechanisms and data links. If it's new in electronics, CREI—and you—will know about it.



Send for free book with complete information on CREI programs

Use postpaid card—no stamp needed. If card is detached use coupon or write: CREI, Dept. E 1412C, 3939 Wisconsin Ave., N.W., Washington, D.C. 20016

CREI

Founded 1927
Accredited Member of
the National
Home Study Council

to go to college -level education

Capital Radio Engineering Institute

This certifies that
Robert Dewey, Jr.
has satisfactorily completed the Course of Study in
Electronic Engineering Technology

Majoring in
Computers

Diploma

and upon the recommendation of the Board of Directors is granted this
In Testimony Whereof, we have affixed our signatures

B. A. Costello

CREI, A Division of the McGraw-Hill Continuing Education Company

Dept. E 1412 C, 3939 Wisconsin Ave, N.W.,
Washington, D.C. 20016

Please send me free book with full information about
CREI Programs.

Name _____ Age _____

Address _____

City _____ State _____ Zip _____

Employed by _____

Type of Present Work _____

I am interested in: Computers Electronic Engineering
Technology Nuclear Engineering Technology
 Industrial Electronics Electronics Systems
Engineering Television Engineering Non-Technical
Course in Computer Programming New! Cable TV

APPROVED FOR TRAINING UNDER NEW GI BILL



Whatever your tape handling needs...

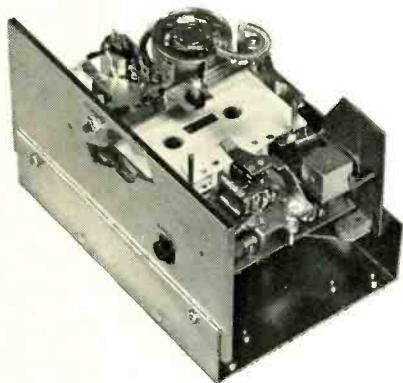

cassette...



cartridge...



reel to reel...

Telex has an answer. Professional magnetic tape handling equipment, designed for heavy duty commercial and industrial use. Available with a wide choice of configurations, options and associated electronics. Write for free information.

PRODUCTS OF SOUND RESEARCH
TELEX[®]
COMMUNICATIONS DIVISION

9600 ALDRICH AVENUE SOUTH
MINNEAPOLIS, MINNESOTA 55420

CANADA: DOUBLE DIAMOND ELECTRONICS, LTD., Ontario
EUROPE: ROYAL SOUND COMPANY, INC., 409 North Main St., Freeport, N.Y. 11520 U.S.A.
INTL.: TELEX EXPORT DEPT., 9600 Aldrich Ave. So., Minneapolis, MN. 55420 U.S.A.

Circle 12 on reader service card
32 RADIO-ELECTRONICS • DECEMBER 1972

Beta 3 Amplified car antenna

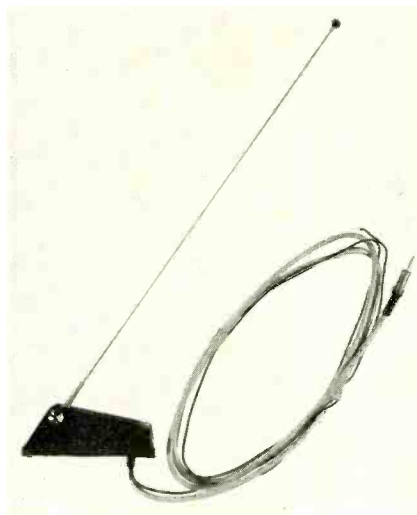

Circle 20 on reader service card

IN THE MAY 1972 ISSUE WE FEATURED AN article describing car radio combination antenna-preamplifier systems. When optimally designed there can be an improvement in receiver performance because of an increase in the signal to noise ratio at the receiver's antenna terminals. The advantage is not due to negating the effect of cable loss and thermal noise pickup as in analogous television preamp systems, but is due to a reduction in the influence of ignition interference on the antenna lead-in wire. In many situations where signal strength is generally good this improvement may not be significant. However, the principle may still prove attractive if a physically smaller antenna is desired. Preamplifier gain compensates for the lower induced voltage and S/N is maintained. One of the models described in the May issue is disguised as a side view mirror.

Hans Kolbe and Co. produce the Beta 3 Electronic Antenna which is designed for operation on both the AM and FM bands. A short 15 inch whip extends with an adjustable angle from the amplifier base. An optional extension cable permits the antenna to be mounted virtually anywhere on the vehicle. The 6 or 12 volt supply is connected with a single wire, ground return being made through the car body. We measured a current drain of 10 mA at 12 volts. The amplifier gain drops off by about 1 dB at the lower supply voltage.

The preamplifier is built on two miniature printed circuit boards which together contain some 3 transistors and 25 other components. The two boards apparently split the AM and FM functions and are electrically coupled at input and output. Impedance and gain were carefully measured across the two bands and the results graphed and explained below.

AM measurements

Figure 1 shows both input and output impedance falling with increasing

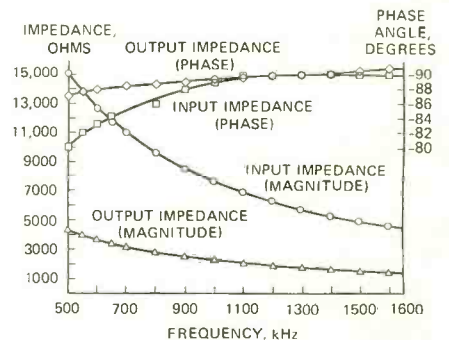

Figure 1

frequency. Both impedances are essentially reactive as indicated by the nearly -90 degree phase angle of the impedances. In fact these curves suggest that the input and output impedances can be closely approximated by 22 and 80-pF capacitors respectively. Since the auto antenna is electrically much shorter than a wavelength on the AM band it

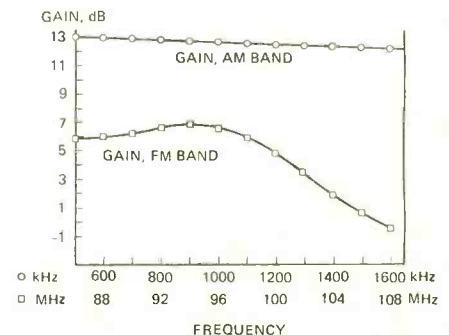

Figure 2

can be accurately represented by a 30-pF capacitor driven by the induced voltage on the antenna. The car radio conventionally sees this capacitance shunted with the lead-in cable capaci-

equipment report

tance resulting in a source impedance on the order of 100 pF. The rf input circuitry is tuned to be inductive for maximum power transfer from the antenna at midband. The 80-pF capacitance includes the lead-in cable attached to the preamp and can be tuned for good match by the radio's antenna trimmer. The gain measurements plotted in Fig. 2 are flat across the band at about 12.5 dB. Measured open-circuit with a low-impedance signal source this figure must be corrected by about 6 dB due to input matching losses. So before entering the antenna cable the signal from the whip is amplified by a net 6 dB or 4 times in power.

FM measurements

Considerable variations in both impedance and gain were measured across the FM band. Figure 3 plots the magnitude and phase of the FM impedances. Midband input impedance is 330 ohms

at 60 degrees. This impedance nearly doubles near the high end of the band. The impedance of a car antenna varies depending on antenna location and the ground plane effect of the car body, but will be in the neighborhood of 300

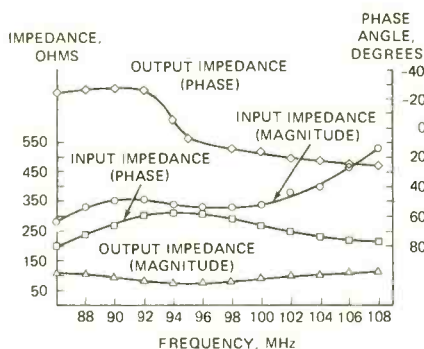

Figure 3

ohms at a small angle with a 0.4 wavelength whip. The match at mid-

band to the Beta 3 is fairly good. As the frequency increases the antenna looks longer and its radiation resistance lowers. A poorer match therefore exists at the high end of the band. Unfortunately this measurement coincides with a gain drop off as shown in Fig. 2. The output impedance looks almost purely resistive midband at 75 ohms and 15 degrees rising slightly above 100 ohms at both band edges. The weak point of this amplified antenna system is seen to be the high end of the FM band where the signal to noise will be degraded. **R-E**

COLOR TV ISSUE

Next month is our 10th Annual Color TV Issue. It's literally packed with information on all phases of color television. You won't want to miss a single article. Look for it on the newsstand.

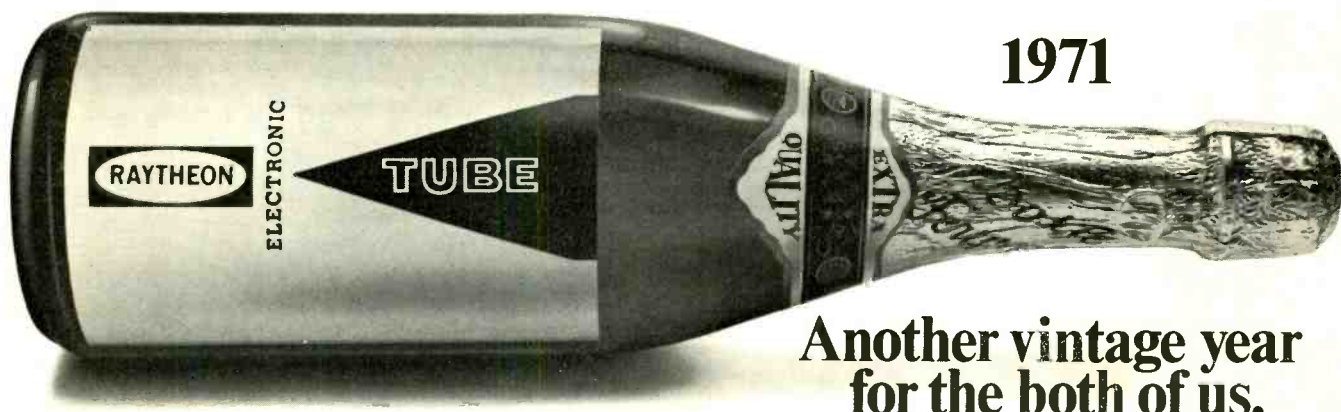

1971

Another vintage year for the both of us.

1971 was a very good year. And 1972 already tastes even better. The truth is every year's a vintage year for you, the independent serviceman, and Raytheon, the largest independent tube supplier in the business. Last year, while a lot of other suppliers were running behind, even dropping out of the race, the two of us had another great year. We've come a long way together.

And like a good wine, we keep getting better.

That's because Raytheon works so well with you.

And never works without you. That's the kind of thing that makes for a very good year for both of us. Year after year.

Circle 13 on reader service card

There's Only One Thing That's Cheap About These Stereo Hi-Fi Systems... THE RADIO SHACK PRICE!

When shopping for low-cost hi-fi you've got to make every dollar count. Otherwise you might find yourself with a diluted "system" that just doesn't measure up to genuine hi-fi standards. The value-priced systems shown here, based on our own Realistic "SA" and "TM" series amplifiers and tuners, are Radio Shack's insurance against "non-hi-fi" components whose only resemblance to the real thing is their shape. Hear what we mean at your nearby Radio Shack — 1600 stores in all 50 states!



Realistic SA-175C Amplifier. Mini-sized but big on performance. Magnetic or ceramic phono input, tape inputs and outputs, ITL/OTL solid-state "even power" circuit, phone jack. 24 watts, ± 1 dB, walnut case. Only 14 x 10 x 7"

64.50

Realistic TM-175B AM/FM Tuner. You'll love it alongside the SA-175C. Effortless vernier tuning. 5-microvolt sensitivity really pulls 'em in. Tuning meter for FM and AM. Excellent 25 dB separation. Stereo indicator light. Same size. case. as SA-175C.

69.95



Complete FM/AM/Phono 24-Watt Stereo System. SA-175C and TM-175B at left, plus pair of MC-500 two-way speaker systems and LAB-12A changer with magnetic cartridge. Savings of \$19.45!

224.95



Realistic SA-100C Amplifier. Value sensation of '73! Solid-state FET design for extremely clean sound. Rated 10 watts. Has ceramic phono and tuner inputs; wide-range tone, volume and balance controls; phone jack. Stylish walnut-grain wood case. 9 x 6½ x 3"

39.95

Realistic TM-100 AM/FM Tuner. Perfect stereo mate for our SA-100 amplifier. Has stereo indicator light, line-cord FM antenna, terminals for external FM antenna. 25 dB separation for exciting stereo. Five-microvolt sensitivity. Same case as SA-100C.

44.95



Complete FM/AM/Phono 10-Watt Stereo System. Features SA-100C and TM-100 at left, plus pair of Solo-4 reflex-type bookshelf speakers and "Modulaire" changer. System savings of \$9.90!

144.95



FREE 1973 CATALOG
See What's REALLY New in Electronics! Stereo, Communications, Hobby, Parts, Kits, Antennas, Tools, Much More. At Your Nearby Store or Write.

Radio Shack

and ALLIED RADIO STORES

A TANDY CORPORATION COMPANY

P. O. Box 1052, Fort Worth, Texas 76107

Circle 14 on reader service card

DATE Dec 24 1947
CASE No. 3P139-7

We obtained the following A. C. values at 1000 cycles

$$E_g = .016 \text{ R.M.S. volts} \quad E_p = 1.5 \text{ R.M.S. volts}$$

$$P_g = \frac{6.25 \times 10^{-7}}{5.4 \times 10^{-7}} \text{ watts} \quad P_p = 2.25 \times 10^{-5}$$

Voltage gain 100 Power gain 40

Current loss $\frac{1}{2.5}$

This unit was then connected in the following circuit.



This circuit was actually spoken for by us by exhibiting the noise in and out a distinct gain in speech level could be heard and seen on the scope presentation with no noticeable change in ~~power~~ quality. By ~~at 1000 cycles~~ at 1000 cycles at 1000 cycles

THE TRANSISTOR DID NOT QUITE SPRING on a startled world like a bolt from the blue. It was discovered (on December 23, 1947) by a team of Bell Laboratories scientists—Shockley, Bardeen and Brattain—who were engaged in a project to find just some such thing. Shockley had already worked out in theory and sketched a semiconductor device that might amplify, and it was while testing and modifying that device (which surfaced some years afterward as a field-effect transistor) that the point-contact transistor (Fig. 1) was born.

But "coming events cast their shadows before," and there had been hints of amplification in semiconductor devices in the past. Earliest was possibly the "oscillating crystal" of zincite announced in 1924 by Lossev. It was described in U.S. magazines*, but apparently nobody but Lossev could make it work. Since the effect of impurities in a crystal structure was then unknown, nobody realized that Lossev succeeded because he happened to have a particular sample of zincite, and the "oscillating crystal" was passed over and forgotten.

In 1930, Dr. Julius Lilienfeld actually patented a solid-state amplifier (U.S. Patent 1,745,175) based on a semiconductor. Though probably his own experimental amplifier worked, Dr. Lilienfeld's invention was never "reduced to practice," probably also due to the general ignorance of the action of semiconductors and impurities.

(turn page)

THE TRANSISTOR—25 YEARS OLD

... it was determined that the gain was about 100. Various pictures were taken of which some show the point-contact transistor. H. P. Moore, J. Bardeen, G. H. Pearson, W. Shockley, H. Fletcher, R. Brown. Mrs. W. D. Moore assisted in setting up the circuit and the demonstration occurred on the afternoon of Dec 23, 1947.

Revised handwritten notes at bottom right: "Revised handwritten by G.H. Pearson on 12/23/47 H.P. Moore on 12/23/47"

On the left are the original lab notebook pages outlining the discovery of the transistor. From such humble beginnings we now have devices that threaten the continued need for vacuum tubes. Here's a short 25-year history of how it happened

by FRED SHUNAMAN

*Radio News, September, 1924.

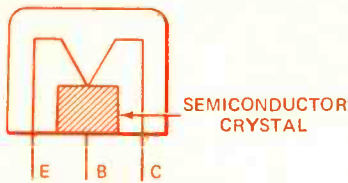

FIG. 1—A POINT CONTACT TRANSISTOR.

Only about a year before the actual invention of the transistor, Hugo Gernsback described in one of his April Fool stories, a remarkable "crystal amplifier" which he called the Crystron. As Fig. 2 shows, this was a forecast of the FET (field-effect transistor).

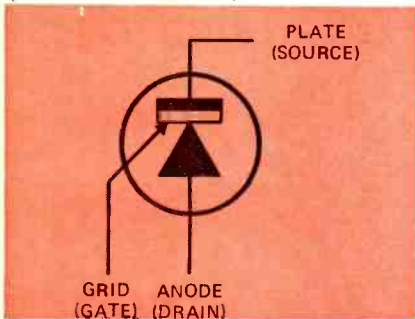

FIG. 2—THE CRYSTRON, the imaginary crystal amplifier dreamed up by Hugo Gernsback.

In an editorial in the May 1928 issue of *Radio-News* Hugo Gernsback had speculated, "Then, too, there is always the chance that a totally new discovery will come along that, in itself, will obliterate the vacuum tube in one way or another; and it is even within the bounds of possibility that there will be invented some new device that will require so little power that a small dry-cell battery will operate it for a considerable length of time. This, in turn, would again make the radio set independent of the lighting current and make it more transportable. But all these things are yet in the future." (Perhaps he knew!—*Editor*)

The first transistors

Less than a year after the transistor was invented, Western Electric put a few on the market for experimental purposes. These first crude devices (sold at \$15 each) fell far short of what scientists predicted for the transistor. They were short-lived for the most part, though it had been suggested that their life might be indefinitely long. They were noisy. Their characteristics often varied with time. Gain was far below what was said to be theoretically possible. The frequency range was limited, and for a time it seemed that the transistor would be entirely an audio device.

And no two transistors were alike! A tube manufacturer could tool up to make a run of, say, 6L6's, and be reasonably sure of the output. The early way to make transistors was to make a run, test the units, and decide what to call them as a result of the tests. Ray-

theon, for example, put out a CK-series. Those that most closely approximated what the design engineers had in mind were called CK721's and were sold commercially. Those that fell short or varied too widely from the specs, but seemed still usable, were called CK722's and sold to the hobby market. And those that were least noisy became CK227's and were dedicated to hi-fi audio use.

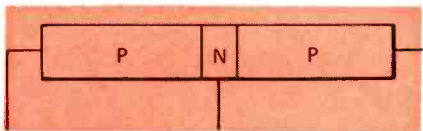

FIG. 3—THE JUNCTION TRANSISTOR overcame many earlier problems and disadvantages.

But improvement came fast. The junction transistor (invented by Shockley) was more reliable than the point-contact type. The emitter and collector of this transistor, instead of being fine wires contacting the base, became part of the same crystal, making a perfect contact with the base from each side (Fig. 3).

Zone refining

Shortly afterward—about 1954—control of impurities in the crystal made a great leap forward. W. G. Pfann, of Bell Labs, discovered that if a rod of crystal material (invariably germanium at that time) was melted, and then part of it solidified, it tended to leave any impurities in the melted portion, concentrating them in the last bit of metal to harden. Using a process he called zone refining, he melted a portion of a germanium rod by putting an inductive

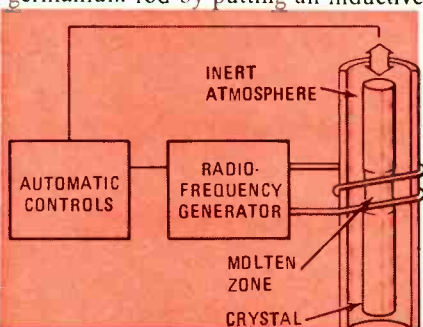

FIG. 4—ZONE REFINING, an important step ahead in the development of the transistor.

heating coil around it, then by moving the coil (or the crystal) gradually moved the melted portion down the rod, melting new material ahead and allowing the rod to solidify behind (Fig. 4). Since the impurities tended to remain in the melt, it was possible to "sweep" them down the rod, leaving behind material of hitherto-unheard-of purity.

The same theory was applied in making junction transistors. Using a melt that contained both n and p-type impurities, it was found that if the crystal was grown slowly, there was a ten-

dency to take up the n-type impurities in the growing crystal, making it an n-type. Now, if the process were speeded up, the p-type impurities that had collected just below the crystal would be swept up into it, creating a p-type zone. By alternately speeding up and slowing down the growth, sections of the right width for bases could be grown in the crystal. All that was necessary was to saw it up into pieces of the right length, with the base in the center.

This type of junction transistor was considered an improvement on the point-contact transistor, but had weaknesses. Control of impurities was inexact. Frequency range was limited. Methods were found to overcome these weaknesses, and the grown-junction transistor faded into the background. It never became obsolete, however, and a few types are still on the market.

The next step was the alloy transistor. A thin slab of material, destined to be the base, was etched from both sides

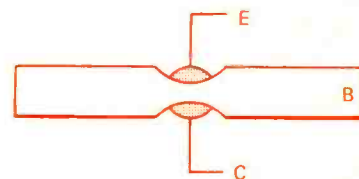

FIG. 5—THE ALLOY TRANSISTOR increased reliability, raised frequency limits.

until it became very thin. The collector and emitter "buttons" were then alloyed into the base, as shown in Fig. 5. For the first time, transistors that would operate at frequencies in the megahertz region were produced. In Philco's famous "surface-barrier" transistors, a thin stream of etching fluid was directed on opposite sides of the strip, making a sort of pit on each side. When the partition between the two pits became thin enough, the composition of the fluid was changed to one containing a saturated solution of indium, which was "plated" on the base material.

A great step forward

The next step in the development of better and faster transistors was *diffusion*. Instead of alloying material with the desired impurities onto the substrate, the impurities were introduced directly into it by exposing it to a gas containing the desired impurities. This is done in an oven at high temperatures. The impurities penetrate the surface of the substrate material, and may change it from p to n or vice versa. The concentration and depth of penetration can be controlled by diffusion better than by any method developed before it.

Diffusion brought with it another important technical advance, the *masking* technique. To control the boundaries of the diffused area, an insulating layer of silicon dioxide (quartz,

roughly) is laid down over the surface of the crystal. This is covered with a *photoresist*, a layer that resists etching acids if exposed to light. A *mask* with the desired pattern is placed over the surface and light projected onto it, to activate the photoresist. The unexposed areas are then etched away, making "windows" to the surface below, into which impurities can be diffused over sharply bounded areas.

Masking, incidentally, not only led to more varieties of transistors, but to other devices, the ultimate of which is our present large-scale integrated circuitry. A large number of maskings, etchings and diffusions are used to make an integrated circuit.

Diffusion also led to *drift* transistor, in which the base material is heavily doped near the emitter, and gradually more lightly doped as the collector is approached. The resultant electric field across the base speeds up carrier flow, and the possibility of doping the area near the emitter heavily and that near collector more lightly reduces capacitive charging time, again increasing the upper frequency limit.

The mesa transistor

The base area may now be diffused into the collector material. Early transistors of this type had a diffused gold stripe contacting the base as a non-rectifying (ohmic) contact. A diffused aluminum stripe, forming a rectifying contact, became the emitter. The area around the base was etched away to reduce collector-base capacitance. (Fig. 6), leaving the region sitting on top of

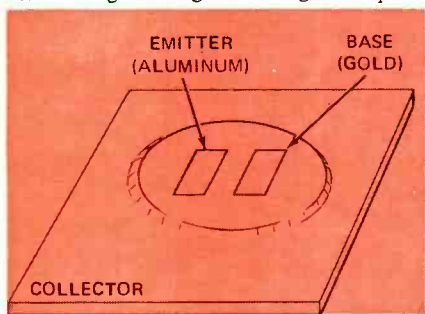

FIG. 6—THE MESA, a diffused transistor.

the collector in a way that caused it to be called a *mesa* transistor.

The next step was to diffuse the emitter as well as the base into the crystal. Once the base was laid down, the emitter was diffused into it. A standard formation was a ring-shaped base around a smaller center emitter, with the collector as the substrate. Note in Fig. 7 that the base not only surrounds the emitter, but extends under it, forming a base region between the emitter above and the collector below. This *planar* transistor, which appeared in the early '60's, reached an upper frequency limit above 800 MHz by 1964.

The *epitaxial* transistor (Greek: epi

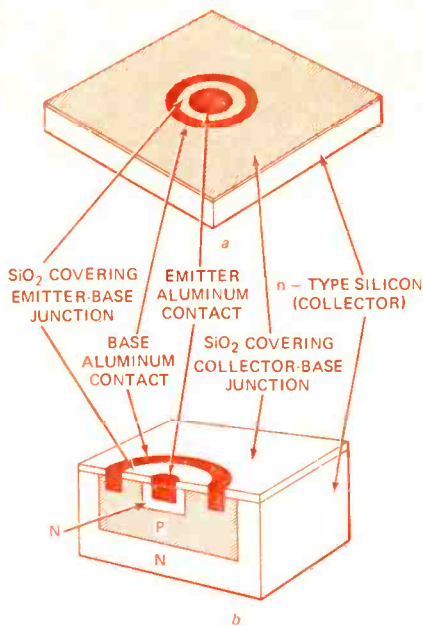

FIG. 7—THE PLANAR TRANSISTOR was an early use of silicon as a transistor material.

= upon; taxis = arrangement, structure) was next. Like the ordinary diffused type, this transistor is made in a heated chamber. Base atoms are deposited on the collector material atom by atom, in such a way that the added material continues the original crystal structure. This reduces the resistance. In some transistors, a thin epitaxial collector layer is grown on top of the original collector, the epitaxial layer being more lightly doped than the rest of the collector material. The base is then grown on the epitaxial collector layer. Transistors made this way have a higher breakdown voltage.

New approaches

Note that about this time we find the base taking shapes other than that of the "dot" or "button" used to describe emitter and collector and base areas up to that time. The reason for irregular shapes is that it is desirable to have the boundary between the two regions (the junction) as large as possible in comparison to the total area of the section. In late designs, this approach

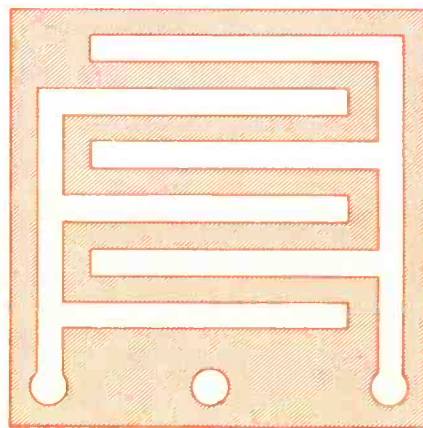

FIG. 8—INTERDIGITAL TRANSISTOR.

has been carried out to the point where the emitter and base regions look like the teeth of two combs pushed together (Fig. 8). The engineers call this *interdigitation* (fingers between each other).

This technique has become important in both increasing the frequency limits and greatly increasing the power handling capacity of the transistor. In some high-power transistors, emitters are counted by the hundreds. They are bonded together with aluminum strips, which overlay the rows of emitter buttons (giving the unit its name of *overlay transistor*). In microwave transistors, the width of the "digits" and the spacing between them has been reduced to a thousandth of an inch or so.

Another kind of transistor

Experiments with field-effect transistors had been underway, and began to bear fruit in the early 1960's. The FET is actually older than the ordinary transistor. Lilienfeld's device was a kind of FET, as well as Gernsback's imaginary Crystron, and also the device designed on paper by Shockley that set engineers on the trail of the first transistor in 1947.

The first FET's were junction types, the earliest being the Tecnetron, invented in France. It was a cylindrical device of n-type semiconductor (Fig. 9-a). It resembled a resistor, which in fact

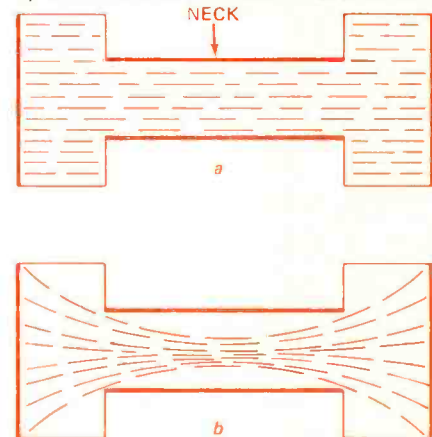

FIG. 9—THE TECNETRON, an early field effect transistor, was of the junction type.

it was. A ring or "neck" of indium around the center was the control element. With no voltage on the neck, the unit had a certain resistance. If now the neck were given a negative bias, its electrons would drive away the electrons immediately below it (Fig. 9-b) creating a *depletion region* and reducing the current through the cylinder, the conductive area of which had now been reduced. With enough negative bias, the field, or depletion region, could extend to the center of the material, *pinching off* the current entirely.

The modern metal-oxide-semiconductor FET has largely superseded the earlier junction (J-FET) type. It consists

of channels of either n or p material, with a control element placed above, and insulated from, the channels. (Fig. 10). Charges applied to this gate can produce a depletion effect like that of

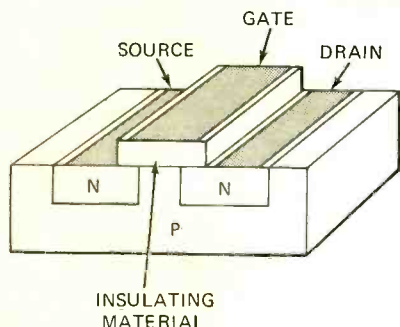

FIG. 10—MOSFET, the metal oxide semiconductor field effect transistor, has a high input impedance, like a vacuum tube. This leads to its use in rf amplifiers at high frequencies.

the Tectron. This is a depletion-type FET. In an enhancement type, the process is opposite. If the channels are n-type, a positive voltage applied to the gate attracts electrons into the p-type area beneath it, changing the p-area in effect into an n-region. The resistance between the channels is decreased and current flows. If the channels are p-type, the region beneath the gate is of n-type material, and the gate is forward-biased by a negative voltage. Metal-oxide-semiconductor (MOS) FET's are often used in complementary circuits, an n-p-n and a p-n-p in parallel to produce a push-pull output.

Silicon enters the field

Up to about 1960, germanium transistors dominated, despite the fact that there are dozens of materials that can be classed as semiconductors. A silicon transistor was announced in the late '50's. Its gain was low and it was expensive to manufacture, but it had a breakdown voltage of 300, much higher than that of germanium devices. Within the next half-dozen years or so the silicon transistor became more important than its germanium opposite number, and today silicon transistors with an upper frequency limit of over 4 gigahertz at low power levels and a power dissipation of more than 300 watts are in common use. Larger transistors have been built for specialized purposes. Silicon n-p-n transistors with a current rating of 250 amperes have been produced, as well as units with a breakdown rating of 1500 volts.

Transistors and near-transistors

Several variants fall just outside the definition of transistor, though very close to it in function. One of these is even called the "unijunction transistor," though its other name, double-based diode, would seem more exact. In its simplest form, it is a rod of semiconduc-

tor material, which acts as a resistor when a voltage is placed across the ends. An emitter is placed part-way down the rod, and when forward-biased, injects electrons or "holes" into it, lowering the original resistance. Thus the emitter controls the current much as the charge on the neck of a Tectron controls the current through it.

The silicon controlled rectifier is usually compared to two transistors hooked up in a feedback circuit. Other variants include the hook and the intrinsic-layer transistors, which follow transistor principles, though they have more elements than the conventional transistor. Still others are the spacistor and trinistor.

Transistors of the future

The optical transistor is a true transistor that is activated by light instead of current or voltage on its control element. It and its transmitting counterpart, the light-emitting diode, form the base of a whole new division of the art, *opto-electronics*. Applications of the optical transistor include detection of infrared and visible light transmissions, spectroscopy, surveillance in space and a host of others.

But probably the most important transistors of today (and of the future) are the tiny ones imbedded in integrated circuits. Made by masking and diffusion, as previously described, they are replacing discrete components in all branches of the industry. As an example, a complete integrated circuit chroma system for color TV receivers is now available in the form of three dual in-line IC's (Fig. 11). One of them is

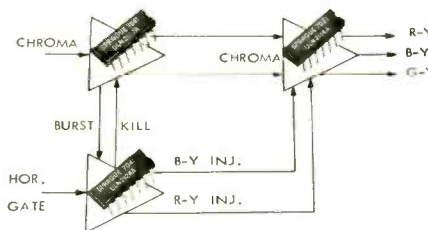
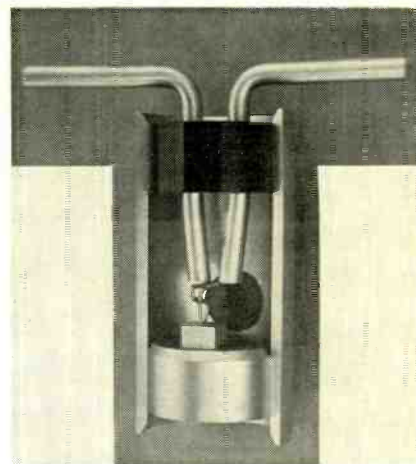

FIG. 11—THREE TINY UNITS make up the whole color section of a television receiver.

the chroma amplifier, supplying a burst signal to the second IC, the combined oscillator, acc and apc circuits and the color killer, which returns a signal to the color amplifier. The third unit is a balanced product detector and matrix that receives the chroma signal and outputs the R - Y, B - Y, G - Y signals to the picture tube. And this is just the first step in integration of common electronic circuitry. Not only may we expect to see all the color circuitry in a TV receiver in one integrated circuit—we will probably see other circuits combined with it, the limits of integration being controlled only by economic, not electronic factors. In that direction lies the future of the transistor. R-E

early transistors



ONE OF THE EARLIEST TRANSISTORS, this point-contact type was mounted in a case like that of the diodes in use at the period.

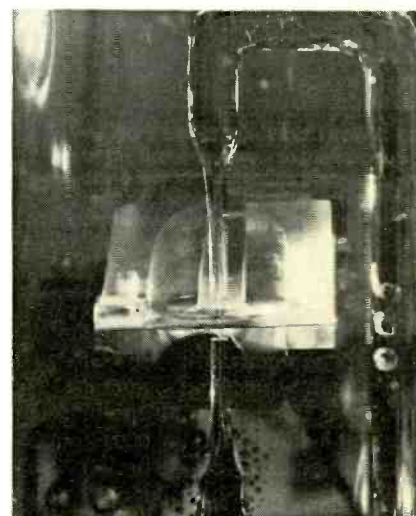

AN ALLOY TRANSISTOR in the making. A thin stream of etching fluid is directed at each side of the base material, wearing it thin. Then "bumps" of indium are alloyed into each side.

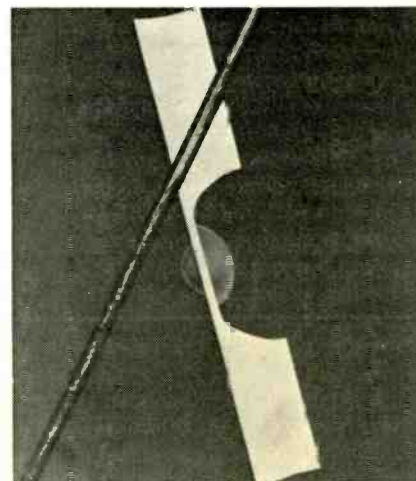

BASE OF THIS ALLOY TRANSISTOR is thinner than the human hair in front of it. The "bumps" are emitter and transistor buttons.

INTERESTED IN BUILDING A HIGH-quality stereo preamplifier for a price well under the cost of commercial units having comparable features? It's not just an ordinary preamp, but an attractive, easy to build unit based on state-of-the-art circuit design techniques that deliver noticeable advantages over conventional preamps.

Most preamps use a series of capacitor-coupled class-A amplifier stages using local feedback for equalization and to control the gain of the individual stages. The distortion and frequency response characteristics of this type of construction are not the best, and some designers are using operational amplifier integrated circuits. The operational amplifier technique works very well (see article on page

68) with the added bonus of low noise.

Each channel of this preamp uses two of these gain modules, which plug on to mother boards. In addition, all of the pushbutton switches as well as all of the input and output connectors are soldered directly to the circuit boards, reducing wiring to a minimum.

Functionally, the preamp has an internal power supply, pushbutton BASS and TREBLE switches, external BALANCE control, internal LEVEL controls on the TAPE, TUNER, AUX, and TAPE MONITOR inputs and the TAPE and PREAMP outputs. Switches are provided for POWER-OFF, TAPE MONITOR-NORMAL, LOUDNESS-VOLUME, and MONAURAL-STEREO modes. The power

is provided by an emitter follower to reduce loading on Q1 while Q5 acts as a class-A amplifier operating into active load current source Q6, for maximum gain and improved linearity. The closed loop gain of the circuit is set, as on other operational amplifier circuits, by the use of feedback. One of the feedback resistors, R13 is already provided on the board. Capacitor C3 in series with R13 decreases the gain to unity at dc no matter what the ac gain has been chosen to be. The other feedback component(s) X_{cb} , is inserted between points C and B. The ratio $X_{cb} + R13/R13$ sets the ac gain of the amplifier. If X_{cb} is composed of reactive components the gain can be made to vary as a function of frequency to provide equalization or tone control.

BUILD A "ZERO DISTORTION" STEREO PREAMP

by GARY KAY

Stereo preamp has push-button tone controls; printed-circuit board construction and performance specifications that are almost too good to be true

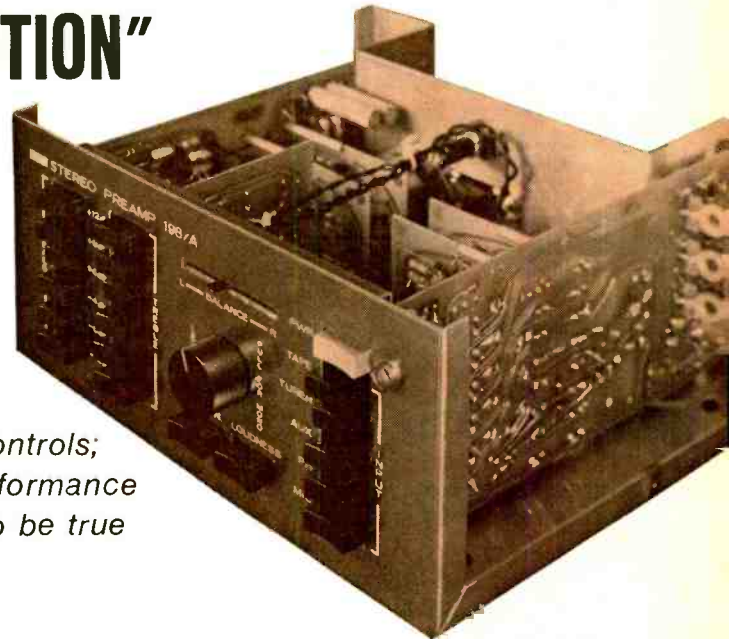

58 of this issue). The idea is to use feedback on an active device with a very high open-loop gain. The feedback controls the closed-loop gain, and greatly enhances the distortion, noise and frequency response characteristics of the device. Unfortunately, inexpensive IC's are inherently noisy and although the feedback helps, the noise is still at a level that makes it undesirable for use in high-quality audio equipment. The key to this preamp's operation is a unique gain module recently described in a British periodical ("Audio Preamplifier using Operational Amplifier Techniques" by Daniel Meyer, *Wireless World* magazine, July 1972). This gain module is actually a high-gain amplifier built using operational amplifier techniques but constructed from discrete components. It provides all of the advantages of high open-loop gain de-

switch controls power for the preamp as well as for two ac receptacles on the rear panel. All input-output jacks are the RCA-phono type and are orientated so the unit can be nearly flush mounted against the back panel of a bookshelf if desired.

How it works

The amplifier module circuitry was designed for high gain, minimum distortion, low noise, and maximum power supply isolation among other things. Transistors Q1 and Q2 (Fig. 1) form a differential pair with a current source feeding the emitters. This provides good power-supply isolation and operates the transistors in their optimum low-noise region. Active load current source Q3 provides power supply isolation and is a high-impedance load for transistor Q1, thus insuring high gain. Transistor Q4 operates as

The overall circuit operation can best be understood from the block diagram, Fig. 2 and the schematic in Fig. 3. Amplifier module 1 boosts the audio level from either a magnetic phono cartridge, mike, or high-level input to a level compatible with the input of the second amplifier module. The input-selector-pushbutton-switch channels the desired input into the amplifier module 1 and simultaneously connects the appropriate feedback network to provide equalization. All high-level inputs are fed into the amplifier through a 1-megohm resistor and trimmer resistor. This guarantees a minimum input impedance of 1 megohm and enables the user to set each individual level control for a uniform audio level whenever changing inputs. The output of amplifier module 1 then passes through a balance control, tape monitor switch and a

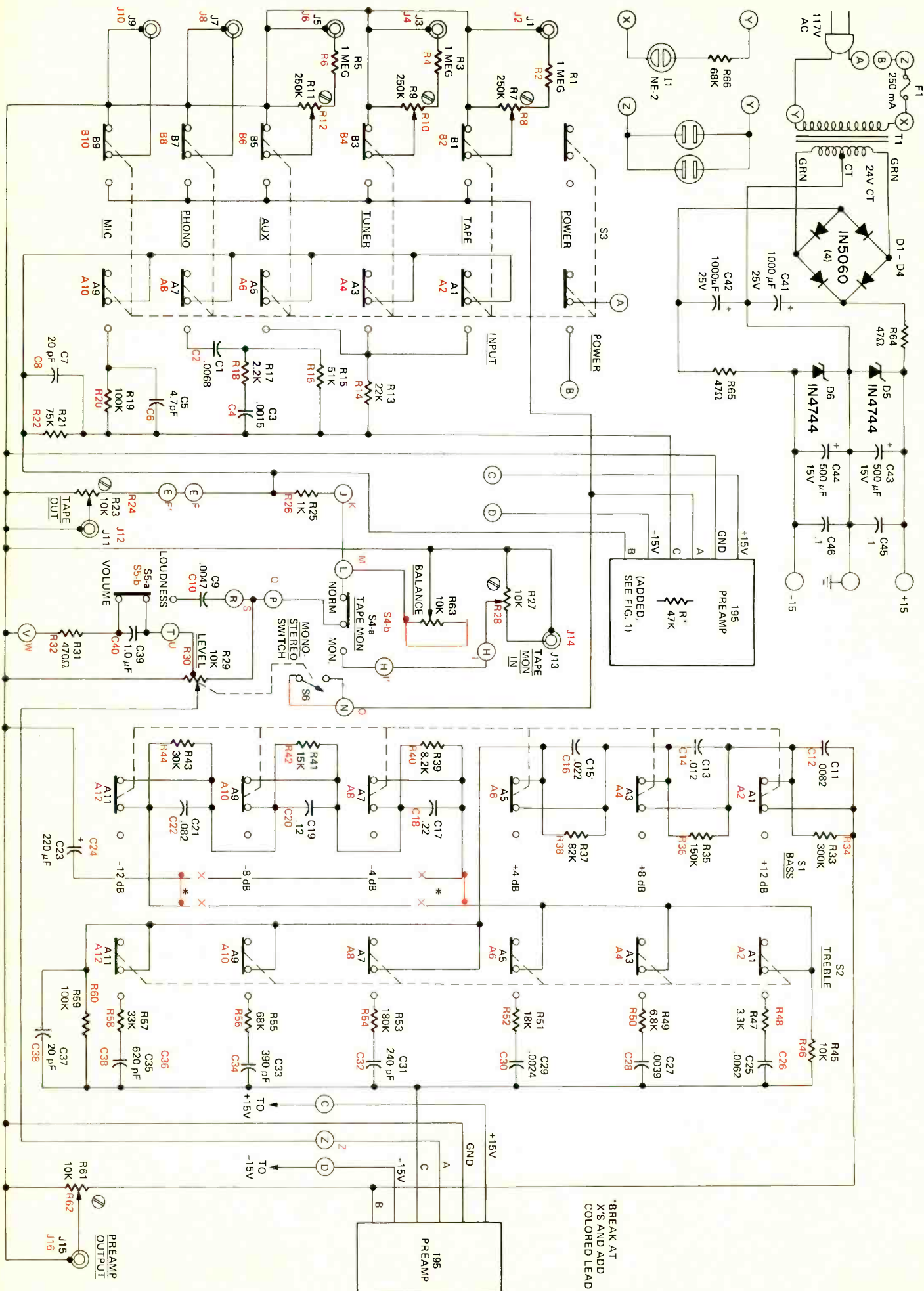

PARTS LIST

- R1 thru R6—1 megohm ¼-W 10%
 R7 thru R12—250,000-ohm trimmer
 R13, R14—22,000-ohm ½-W 5%
 R15, R16—51,000-ohm ½-W 5%
 R17, R18—2,200-ohm ½-W 5%
 R19, R20, R59, R60—100,000-ohm ½-W 5%
 R21, R22—750,000-ohm ½-W 5%
 R23, R24, R27, R28, R61, R62—10,000-ohm trimmer
 R25, R26—1,000-ohm ½-W 10%
 R29, R30—10,000-ohm audio taper pot with 5,000-ohm tap with pull switch
 R31, R32—470-ohm, ½-W 10%
 R33, R34—300,000-ohm ½-W 5%
 R35, R36—150,000-ohm ½-W 5%
 R37, R38—82,000-ohm ½-W 5%
 R39, R40—8,200-ohm ½-W 5%
 R41, R42—15,000-ohm ½-W 5%
 R43, R44—30,000-ohm ½-W 5%
 R45, R46—10,000-ohm ½-W 5%
 R47, R48—3,300-ohm ½-W 5%
 R49, R50—6,800-ohm ½-W 5%
 R51, R52—18,000-ohm ½-W 5%
 R53, R54—180,000-ohm ½-W 5%
 R55, R56—68,000-ohm ½-W 5%
 R57, R58—33,000-ohm ½-W 5%
 R63—10,000-ohm linear taper slide pot
 R64, R65—47-ohm ½-W 10%
 R66—68,000-ohm ½-W 10%
 R*, R*—47,000-ohm ¼-W 10%
 C1, C2—.0068-µF polystyrene
 C3, C4—.0015-µF polystyrene
 C5, C6—4.7-pF disc
 C7, C8, C37, C38—20-pF disc
 C9, C10—.0047-µF polystyrene
 C11, C12—.0082-µF polystyrene
 C13, C14—0.012-µF metalized polycarbonate
 C15, C16—0.022-µF metalized polycarbonate
 C17, C18—0.22-µF metalized polycarbonate
 C19, C20—0.12-µF metalized polycarbonate
 C21, C22—0.082-µF metalized polycarbonate
 C23, C24—220-µF @ 6.3V electrolytic
 C25, C26—.0062-µF polystyrene
 C27, C28—.0039-µF polystyrene
 C29, C30—.0024-µF polystyrene
 C31, C32—240-pF polystyrene
 C33, C34—390-pF polystyrene
 C35, C36—620-pF polystyrene
 C39, C40—1-µF 15 volt electrolytic
 C41, C42—1000-µF 25 Vdc electrolytic
 C43, C44—500-µF 15 Vdc electrolytic
 C45, C46—0.1-µF
 D1 thru D4—1N5060 silicon diode or equal
 D5, D6—15-V 1-W Zener diode, Motorola 1N4744 or equal
 *S3—5-station dpdt tandem plus 1 station push-to-lock pushbutton switch
 *S1, S2—6-station dpdt pushbutton switch
 *S4, S5—dpdt pushbutton switch
 S6—spst pull switch mounted on the rear of level control
 F1—¼-amp fuse
 T1—24-volt 80 mA ct transformer 117 Vac primary
 LM1—neon lamp NE-2

*S1 thru S5 are being custom made for Southwest Technical and no substitutes are available.

Parts List No. 195 Preamp Module

- Q1, Q2, Q6, Q7—2N5210 Motorola
 Q3, Q4, Q5—2N5087 Motorola
 D1—4.7-V 400mw Zener diode Motorola MZ-70-4.7 or equal
 D2, D3—1N914 diode or equal
 C1—4.7-µF tantalum electrolytic
 C2—5-pF disc
 C3—33-µF @ 6-V electrolytic
 R1, R3, R9, R10, R11, R13—1000-ohm ½-W 10%
 R2—47,000-ohm ½-W 10%
 R4, R5—22,000-ohm ½-W 10%
 R6—15,000-ohm ½-W 10%
 R7—8200-ohm ½-W 10%
 R8—10,000-ohm ½-W 10%
 R12—4700-ohm ½-W 10%

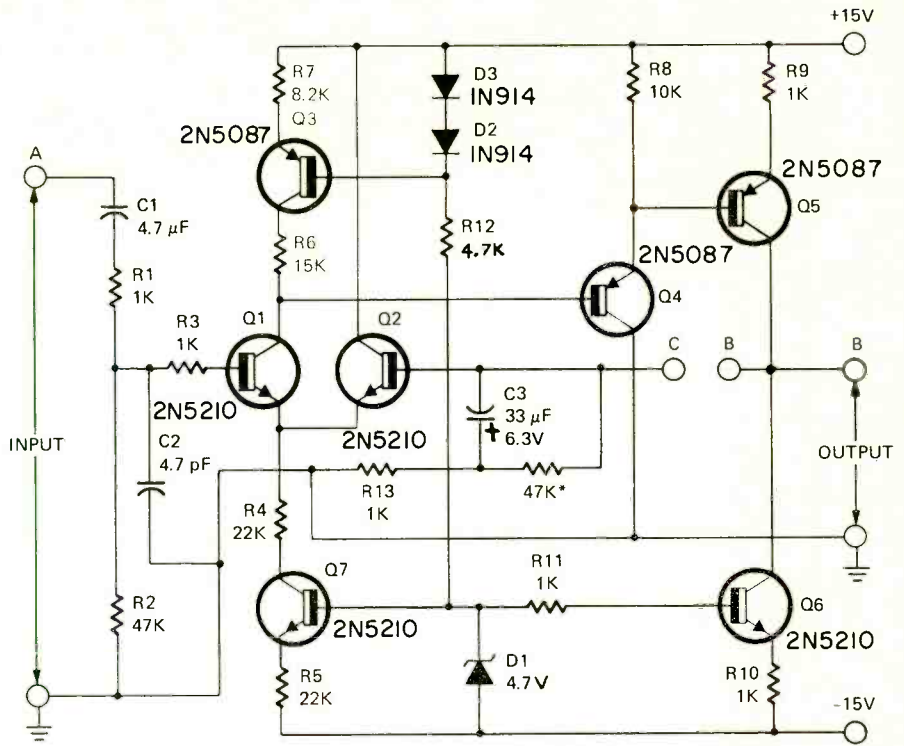

* USED ONLY ON INPUT MODULES

FIG. 1—AMPLIFIER MODULE CIRCUITRY. Four of these modules are needed; two for each channel. Note that pre 47,000-ohm resistor is used only in the input modules; it is not needed in the output modules.

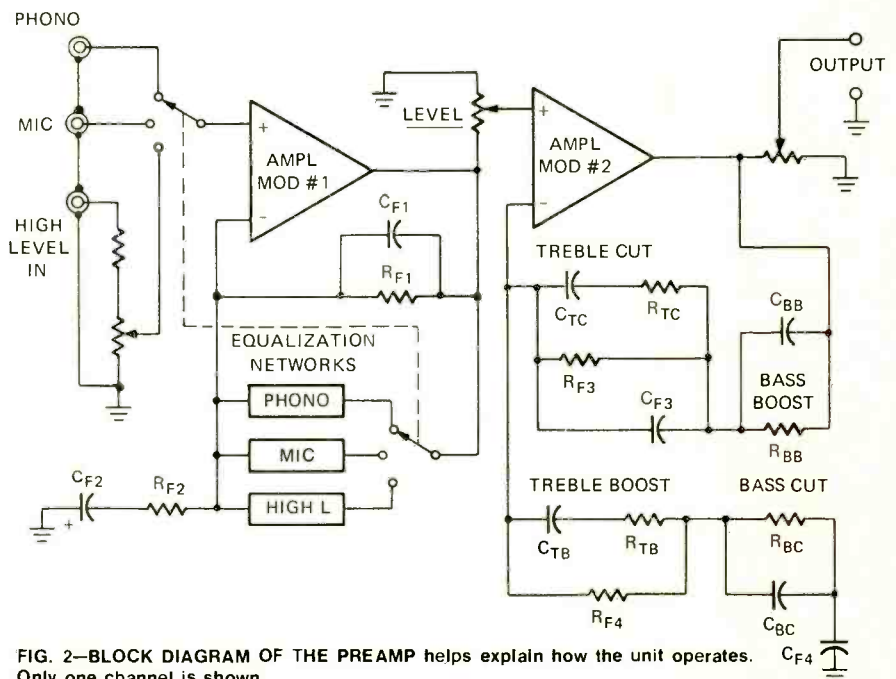

FIG. 2—BLOCK DIAGRAM OF THE PREAMP helps explain how the unit operates. Only one channel is shown.

level control. The LEVEL control normally operates as a volume control unless the LOUDNESS switch is depressed. The loudness circuit introduces a slight bass and treble boost on the lower end of the level control which is contoured to compensate for the low- and high-frequency deficiencies of the human ear at low sound pressure levels.

The output of the level control is then fed into amplifier module 2 which provides more gain and also introduces the desired bass and treble

compensation. By switching different resistor-capacitor combinations into the feedback loop, the gain of amplifier module 2 is made vary with frequency thus providing a convenient means of introducing bass and treble boost or cut. Tonal increments are 4 dB with a maximum boost and cut of +12 dB and -12 dB respectively. A complete tone control response curve is shown in Fig. 3. Operating the unit with all switches out will provide flat response making the unit ideal for situations where no boost or cut can be

SPECIFICATIONS

Sensitivity:	Phono—2.0 mV at 1-kHz for 1.0 V rms out Mic—1.0-mV for 1.0-V rms out Aux, Tape, Tuner—200-mV for 1.0-V rms out maximum sensitivity—adjustable for less
Frequency Response:	Down 3 dB at 5 Hz and 80 kHz
Total Harmonic Distortion:	At 1.5 V rms out, less than 0.02% on all inputs
Max Input:	70 mV (phono)
Hum and Noise:	65dB below one volt on phono 75dB below 1V on all other inputs
Input Impedance:	Phono—47,000 ohms Mic—47,000 ohms Aux, Tape, Tuner—1 megohm
Output Impedance:	10,000 ohms or less
Power Required:	117 Vac, 0.5 A
Dimensions:	10" W x 5" H x 10" D

The right and left channels are identical electrically. Codes, terminal markings and wiring shown in solid black are for the left channel. Codes shown in color are for the right channel. Constructors using the PC board patterns supplied will note minor differences in the right- and left-channel signal paths through the tone controls. In the left channel, the signal goes from the arm of the +4 dB TREBLE switch to the arm of the -12 dB BASS switch. In the right-channel wiring, the signal from the arm of the +4 dB switch goes to the normally closed terminal on the -4 dB BASS switch. These and other wiring differences between the two channels are indicated by "X" break points and colored circuit lines. For example BALANCE control R63 is connected between terminal L in the left channel and terminal M in the right channel. Similarly, S6 is connected between terminals N and O.

tolerated such as in professional audio work.

The output level control is provided at the output of amplifier module 2 to allow the user to set the maximum output level of the preamp to match the maximum input requirements of the power amplifier with which the preamp is being used.

Construction tips

The prototype was built using 0.050" aluminum for the three main chassis panels and subpanels. The cover is from a vinyl covered piece of wood with an aluminum foil shield cemented to the inside. The front panel of the unit is made from a piece of 0.025" plated brushed steel which was lettered and cemented to the aluminum panel.

There are eight circuit boards in the unit. Four for the preamp switching circuitry, the other four are identical and are the gain modules.

Assemble all eight boards making sure to orientate all diodes, transistors, and electrolytic capacitors correctly. All trimmer resistors on the boards as well as resistor R66 and lamp LMI are attached and soldered from the foil side of the board. Insert jumper wires on the boards where indicated by a solid line connecting pads printed on the component side of the board. On two of the four high-gain amplifier boards omit the jumper connecting pad C to ground. On the other two boards attach and solder a 47,000 ohm 1/4-watt 10% resistor across electrolytic capacitor C3. The two boards without the jumpers are used on the left side of the unit when viewed from the front while those with the resistor added are used on the right side. All chassis members are held together by 6-32 hardware while the circuit boards with the pushbutton switches are se-

cured with 4-40 hardware.

All chassis hardware should be orientated and attached as shown in the photos. All wiring is No. 24 or No. 26. The only exceptions are the wires going to the power switch terminals A and B. These should be No. 18. The two pairs of wires running to the LEVEL control should be shielded cable, and the wires connected to the terminals of the ac receptacles, should also be No. 18. Use twisted pairs where shown in the photos and route the twisted pairs along the top plane of the chassis. All other wires are routed along the lower chassis surface.

Using the preamp

Insert the four gain modules into the mounting slides and orient the boards so the component sides are toward the front of the chassis. Set all trimmer resistors so the tab on the knurl of the controls is about halfway between its two end points. Set all tone control switches so the response is flat and be sure LOUDNESS and TAPE MONITOR switches are not depressed. Press the LEVEL control switch in so the unit operates in a stereo mode and set the control in the fully counterclockwise position. Set the BALANCE control to its midway position and depress the PHONO input selector. Attach the patch cords of your turntable to the phono inputs of the preamp. Plug in the line cord and depress the power switch. Using a vom or scope, check the dc voltage level at the preamp output on both the left and right channels. This voltage should be well under 0.1 volt dc. If it is not, unplug the unit and recheck all construction steps. If this measurement is correct, put a record on the turntable and monitor the ac voltage. As the LEVEL control is advanced the meter should show a fluctuating reading of around 0.25 volts rms. If you are using a

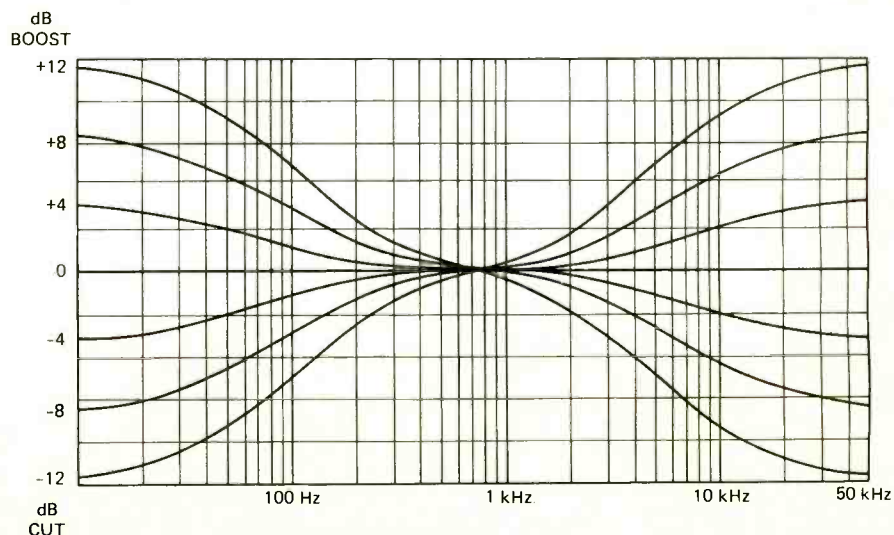
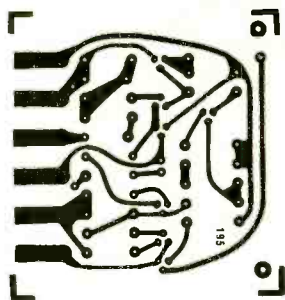
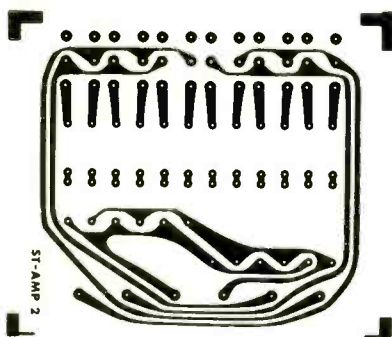

FIG. 3—COMPLETE TONE-CONTROL RESPONSE CURVE. There is one curve for each tone-control push-button selector position.



CIRCUIT BOARD B. Four are needed.



CIRCUIT BOARD C. One is required.

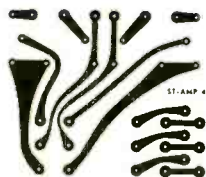

CIRCUIT BOARD D.

All boards shown one-half actual size.



CIRCUIT BOARD A.

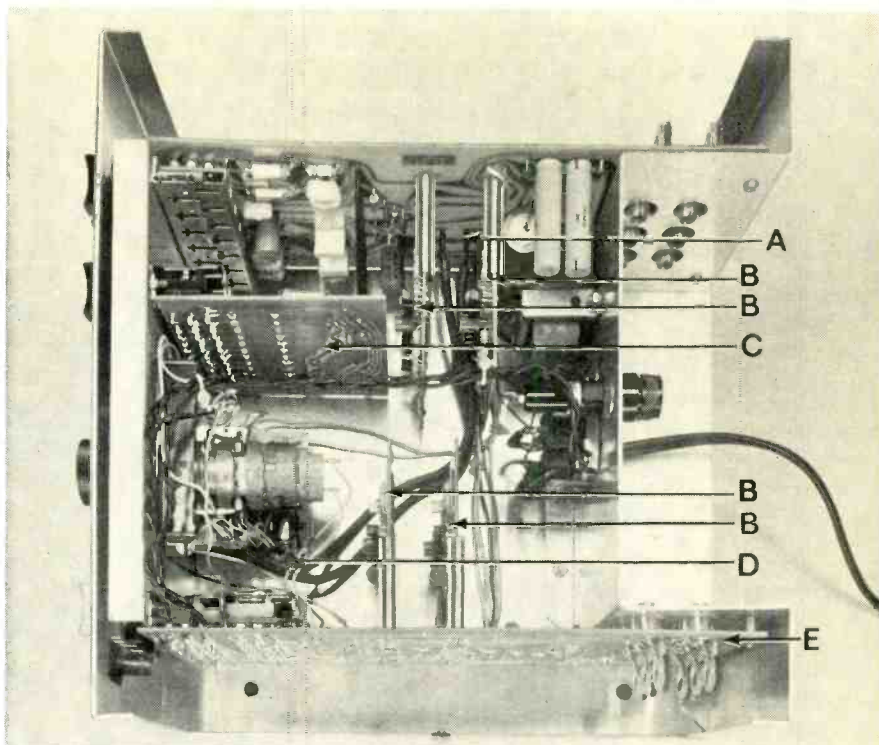

INTERIOR PHOTO OF FINISHED PREAMPLIFIER. Each circuit board is identified by letter. These letters match the circuit boards shown on this page. All circuit board patterns are shown exactly half size.

The following parts for this preamp are available from Southwest Technical Products Corp., 219 W. Rhapsody, San Antonio Texas 78216. Complete set of 9 printed-circuits, drilled, with socket clips. No. 198-cb \$17.50
 Set of 9 circuit boards, socket clips, 3 pushbutton switches, and volume control (dual control with push-pull switch). No. 198-SW \$34.50
 Complete kit of all parts including cabinet and front panel. No. 198-k \$69.50

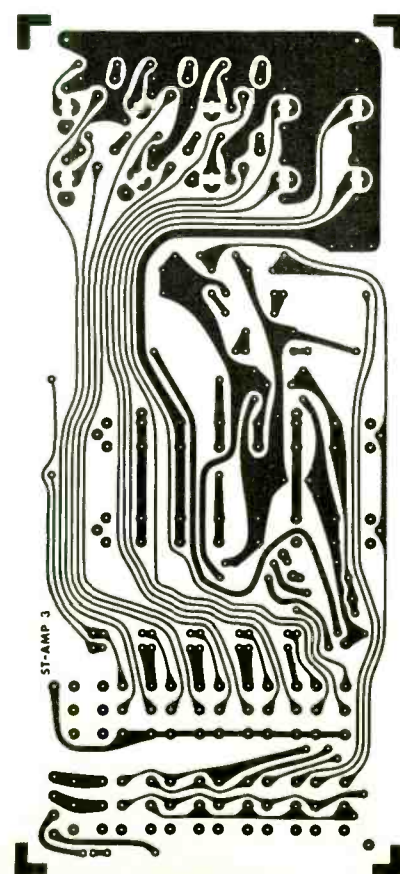

CIRCUIT BOARD E.

scope, you should see a normal audio trace. If everything still looks OK, remove power, and connect the output of the preamp to the input of your power amplifier. Turn the LEVEL control down near low volume, apply power, set the trimmer resistors to give the desired amount of preamp gain. Connect all other input devices to the preamp and set the appropriate input level controls to give the desired amount of gain. After setting all trimmer resistors, secure the cover. The only precautions to be noted are to 1.) Be careful of 117-volt power wires when adjusting the trimmer resistors 2.) Do not repeatedly turn the unit off and on 3.) Keep the unit away from components generating strong magnetic fields such as power transformers, line cords, etc. **R-E**

Space limitations did not permit us to include, in this issue, some additional photographs of the assembled tuner. We also omitted parts placement diagrams that show where to position the various component parts on the printed-circuit boards. All of this information will be presented in the January 1973 issue. The information presented here will permit you to get started.

DIGITAL IC BREADBOARD

Build It Yourself

For fast breadboarding of digital IC circuits you need more than just a breadboard. You also need a power supply; a clock generator; and some logic switches. Here's a single unit that has it all

by JACK CAZES

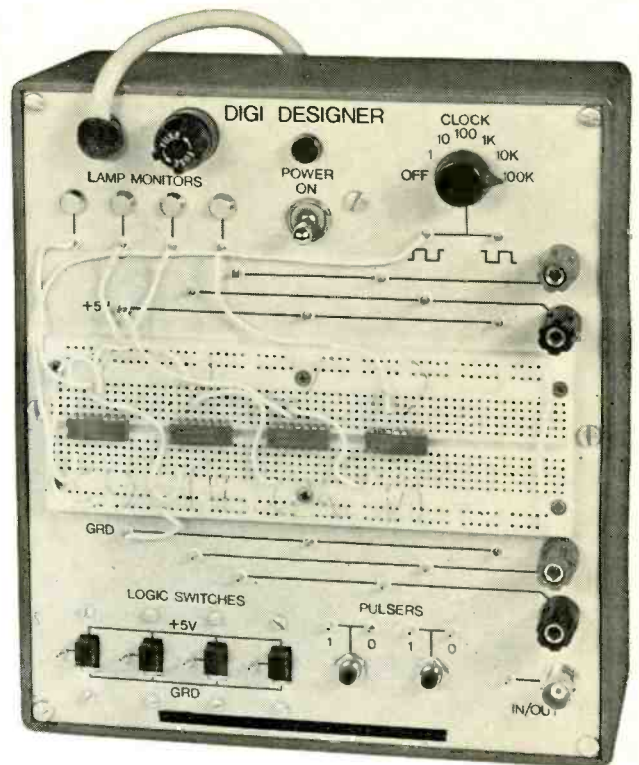

HOW OFTEN HAVE YOU BREADBOARDED AN IDEA AND WISHED you had a fast, solderless way to do it so you could spend more time testing your circuit than wiring it? Have you ever ruined heat-sensitive components such as transistors and IC's because of repeated soldering and unsoldering? Do your breadboarding attempts sometimes end up as a cumbersome maze of boxes—experimental circuit in one box, power supply in another, logic indicators in still another?

The DIGI-DESIGNER incorporates many circuits that the serious digital hobbyist uses to design relatively complex digital circuits, all in a single, compact unit, and . . . it uses two unique new breadboarding components that enable you to make solderless connections by simply pushing wires into holes. Connections to and from circuits *within* the Digi-Designer are made by inserting the stripped ends of pieces of No. 22 solid wire into small holes in the tops of *bredding pins*; these are miniature, feedthrough, Teflon-insulated terminals that serve as low-resistance solderless connecting points.

Integrated circuits, transistors, capacitors, resistors, etc., plug into solderless terminals of a unique breadboarding socket. It has 128 sets of five electrically connected terminals each, at the center; and 8 sets of 25 electrically connected terminals each along each edge. The terminals in the center are spaced 0.1-inch apart to accommodate the pins of a DIP (Dual Inline Package) integrated circuit. When an IC is plugged into the breadwing socket, four connections can be made to each of its pins without soldering or additional jumpers. The groups of terminals at the edges of the socket are handy where numerous connections must be made to common circuit points, such as ground, V_{cc} , and reset bus.

Circuits that are built into the DIGI-DESIGNER include

- A transistor-regulated 5-volt power supply, that can deliver up to several hundred milliamperes,
- A six-decade 1 Hz to 100 kHz digital clock generator, with complementary outputs,
- Two manual bounceless (digitally conditioned) pulsing buttons, also with complementary outputs,
- Four logic-level lamp monitors, each with its own Darlington transistor driver circuit, and,
- Four logic switches.

Building the Digi-Designer

Wiring and component layout are not critical, but should be kept neat to make debugging (if necessary) easy. The front-panel layout shown is a convenient arrangement that minimizes the number of crossed and tangled leads. Make the front panel first. This includes drilling, painting, and marking. Dry-transfer lettering is handy here. Next, install all front-panel mounted components; lamps, switches, breadwing pins and socket. Also install four insulated 5-way binding posts and a BNC connector along the right edge of the case. These were selected to mate with a variety of commonly used pieces of test equipment. It might be a good idea to check your own test gear and select connectors that match them.

Install breadwing pins by first slipping their insulators into No. 29 holes drilled in the front panel, and then pushing the metal posts through the insulators with the flat side of a heavy pair of pliers. Be sure to push the metal post straight in, with little or no lateral wobbling. Careful insertion results in even expansion of the insulator at the rear of the panel, with a solid fit.

Fasten the breadwing socket to the case with the six countersunk screws provided. No permanent electrical connections are made between the socket and the rest of the Digi-Designer. Be sure, when fastening the socket, that the self-stick insulating backing is between the socket and the case to prevent any of its metal terminals from shorting to the case.

The power supply, pulser button conditioning circuits, clock circuits, and the lamp driver circuits are all on printed circuit boards. The power supply and clock circuit are on one board, the pulser circuits are on another board, and the lamp driver circuits are on a third. Insert components in their respective locations on the boards according to the drawings. Be sure to use a temporary heat sink, such as a pair of long-nose pliers, when soldering transistor and IC leads to the copper foils on the boards, since they can be easily damaged by overheating. DIP sockets are not required, but are convenient for mounting the IC's.

Now connect all panel-mounted ground points together with a piece of bare wire. These include J10, J11, J12, one side of S5 thru S8, J26, J30, the outside of J28, and the com-

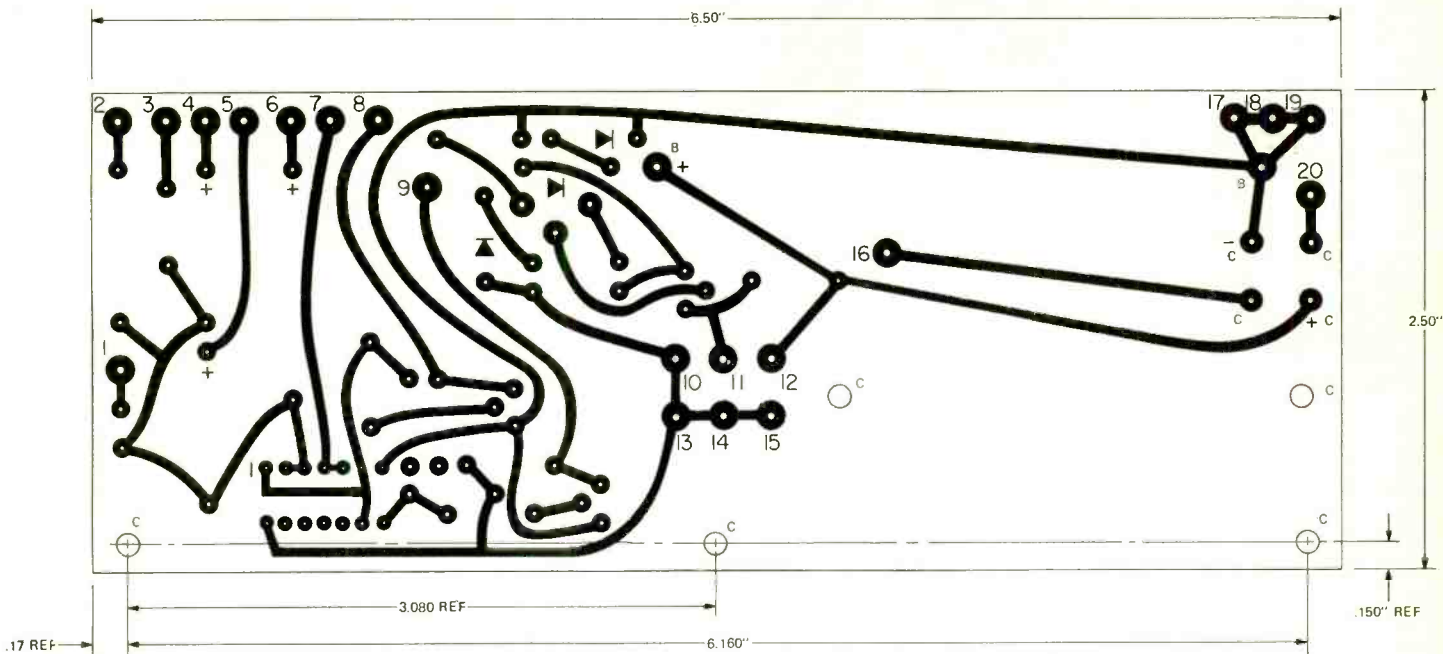

MAIN PRINTED CIRCUIT BOARD (above) is used for both the clock generator and power supply. **CLOCK-GENERATOR CIRCUIT** (right) is simple and easy to build. **POWER-SUPPLY CIRCUIT** (below) uses Zener-diode regulation.

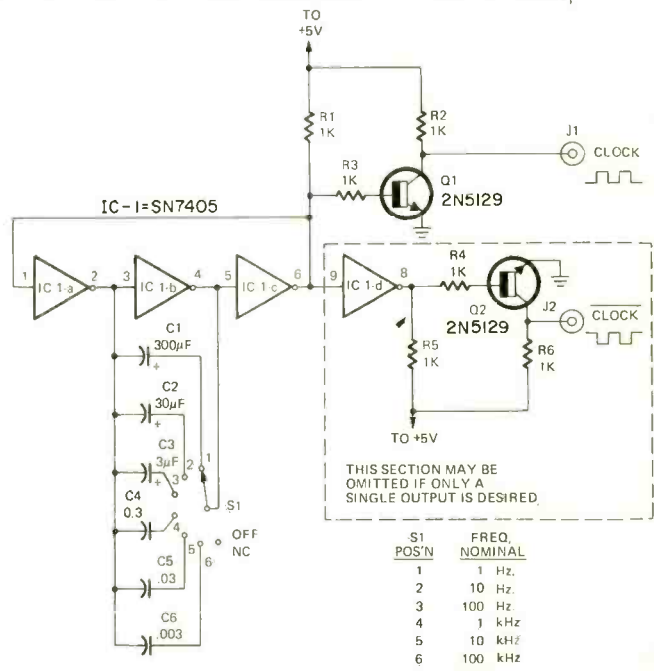
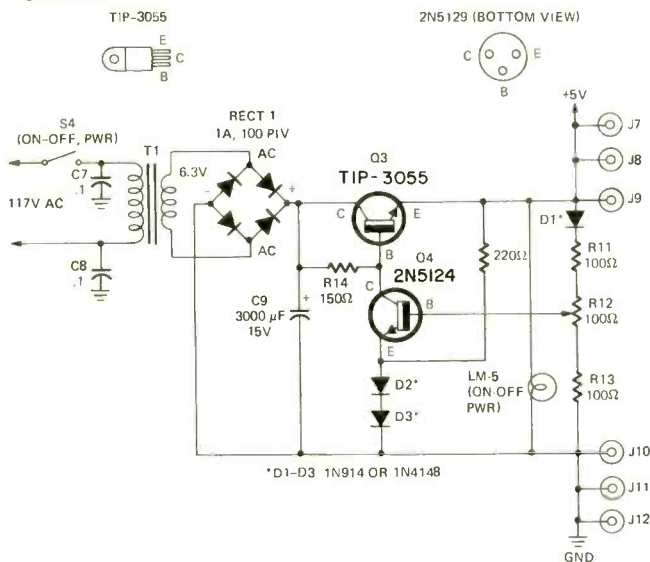

- All resistors 1/4 watt 10% unless noted**
 R1 thru R10—1000 ohms
 R11, R13—100 ohms
 R12—100 ohms, trimmer
 R14—150 ohms
 R15—220 ohms
 R16 thru R19—22,000 ohms
All capacitors 15V ceramic unless noted
 C1—300-µF electrolytic
 C2—30-µF electrolytic
 C3—3-µF electrolytic
 C4—0.3 µF
 C5—0.03 µF
 C6—0.003 µF
 C7, C8—0.1-µF 400V
 C9—3000-µF electrolytic

- Q1, Q2, Q4 thru Q12—2N5129
 Q3—TIP3055 or 2N3055
 IC1—SN7405
 IC2—SN7400
 D1, D2, D3—1N914 or 1N4148
 RECT—Full-wave bridge rectifier, 1 amp, 100 piv
 T1—117 Vac primary, 6.3V secondary, 1.2A
 (Stancor No. P6134 or equal)
 S1—single pole, 7-position, non-shorting selector switch
 S2, S3—spdt monetary pushbutton
 S4—spst toggle
 S5 thru S8—spdt toggle
 LM5 thru LM5—5V, 50mA lamps
 SOCKET—EL breadboarding socket SK-10
 J1 thru J29—EL breading pins

- J30, J31, J33, J34—Five-way binding posts
 J32—BNC panel connector
 Misc.—PC boards, DIP sockets, case, etc.
A complete kit of all parts needed to build the Digi-Designer, including a case, is available for \$49.95 including postage. An SK-10 socket and 29 breading pins are available for \$24.95, postpaid. E. L. Instruments, Inc., 61 First Street, Derby, Conn. 06418.
Kit DES-1, consisting of the IC's needed to perform the experiments described in this article (3-SN7400, 4-SN7490, and 1-SN74181 selected for the computer circuit described is available for \$17.95, postpaid, from Electronics Co., Inc., P.O. Box 278, Cranbury, N.J. 08512.

mon terminals of S2 and S3. Similarly, use a length of insulated wire to connect all panel-mounted 5-volt points together, including J7, J8, J9, and the other side of S5 thru S8. Also install the jumpers between the output connectors and their respective breading pins.

The power supply/clock board is mounted on the rear of the panel after making connections between it and other panel-mounted components. Mount the lamp driver board directly onto the lamp terminals with stiff connecting leads

that are sturdy enough to support it. Similarly, mount the pulser board onto the pulser switches. Next, tie all ground points together and all 5-volt points together on boards and other components. Finally, wire the transformer primary circuit and connect a line cord to it.

Set R12 for an output voltage of less than 5 volts at any convenient tie point (at J7, for instance). Plug IC1 and IC2 into their respective sockets, making certain that pin 1 of each IC is in socket position 1. Adjust R12 so that the output volt-

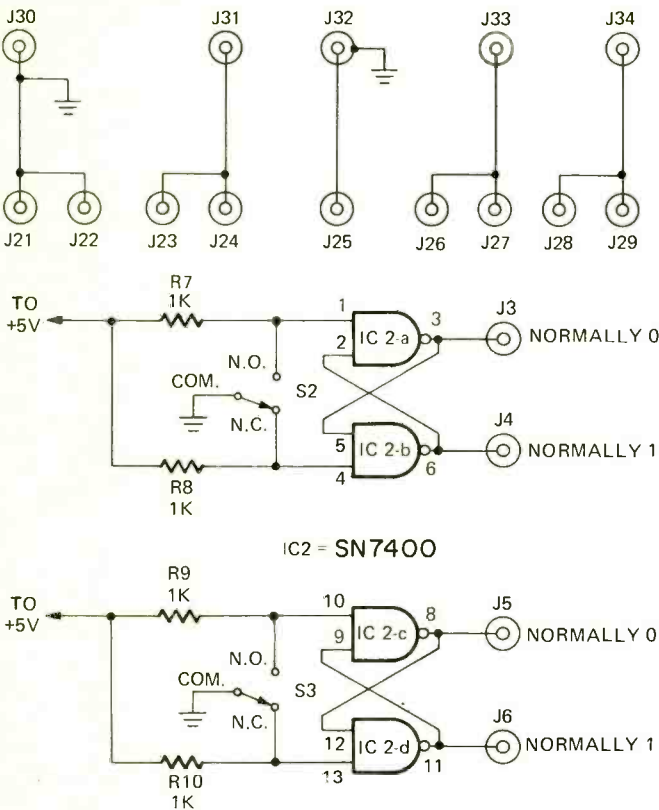
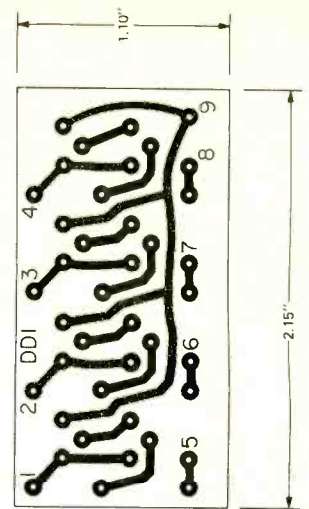
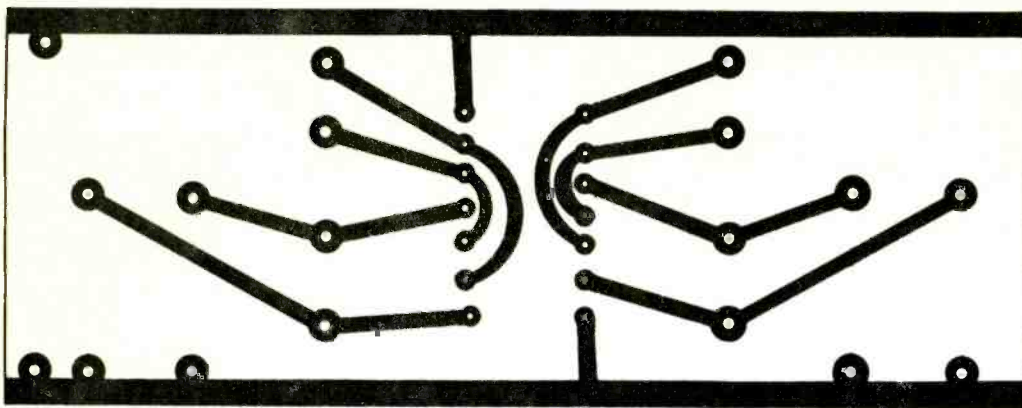

S2, S3 SPDT MOMENTARY PUSHBUTTON SWITCHES

age is exactly 5.0 volts.

Measure the voltage between each of the 5-volt pins (J7-J9) and ground (J10-J12) to see that 5-volts is present at each of these locations. Connect jumpers from each of the lamp-monitor pins to 5 volts. They should light. If they do not, and you're sure that all your wiring is correct, then check the lamps with an ohmmeter. Also, check or replace the driver transistors in those circuits that are inoperative, since it is easy to damage these by careless soldering. If all lamps are operating properly (off when grounded, and on when connected to 5 volts), they can now be used to check other circuits in the Digi-Designer. Connect jumpers from each of the logic switch common pins (J17 thru J20) to lamp monitors. With the switches in their grounded positions, all lamps should be off; in the 5-volt positions, lamps should be on.

Move the jumpers to connect the pulser button output pins (J3 thru J6) to the lamp monitors. A logic "1" output should turn on a lamp, whereas a logic "0" output should turn a lamp off. Now connect the complementary clock generator outputs (J1 and J2) to two of the lamp monitors. Set the clock selector switch (S1) to the 1 Hz position. The lamps should turn alternately on and off at a rate of about once per second. With the selector switch in the 10 Hz position, the on-off flashing should be barely discernible. Higher frequency set-

TWO CIRCUIT BOARDS used in the digital breadboard. The one at the top left is for the pulsers. The one at the top right is for the lamp-driver circuit.

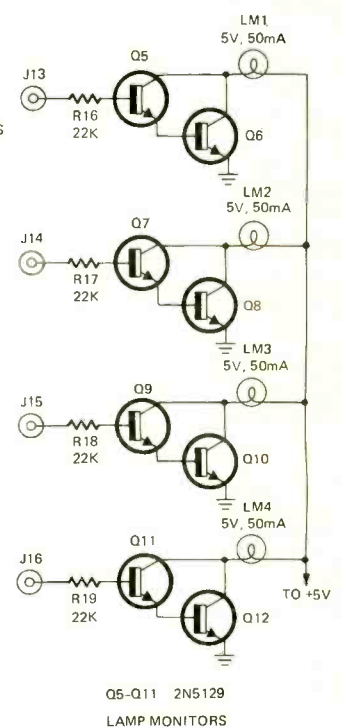
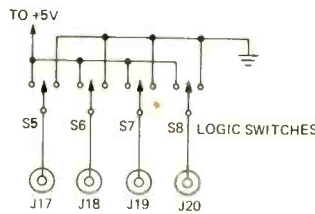

OUTPUT JACK connections (top left) for the Digi-Designer. PULSER SWITCH circuits are shown at the left.

tings should cause both lamps to appear to be on continuously, at about half-normal brilliance. If a scope or frequency counter is available, measure the actual frequencies and record them for future reference. The capacitor tolerances are generally so broad that actual frequencies obtained will probably be quite different from the nominal values. In my prototype, the following frequencies were measured:

NOMINAL SETTING	ACTUALLY MEASURED
1 Hz	1 Hz
10 Hz	12.5 Hz
100 Hz	122 Hz
1 kHz	1.4 kHz
10 kHz	13.6 kHz
100 kHz	143 kHz

Using the Digi-Designer

Let's look at a few examples of how to use the Digi-Designer to breadboard and operate digital circuits. Remember, all you have to do to make a connection is to push the stripped ends of wires, or the bare ends of component leads into the holes in the breadboard socket and breadboard pins. External pieces of equipment (scope, meter, power supplies, etc.) are plugged into a mating external connector, with breadboard pins serving as breadboarding tie points.

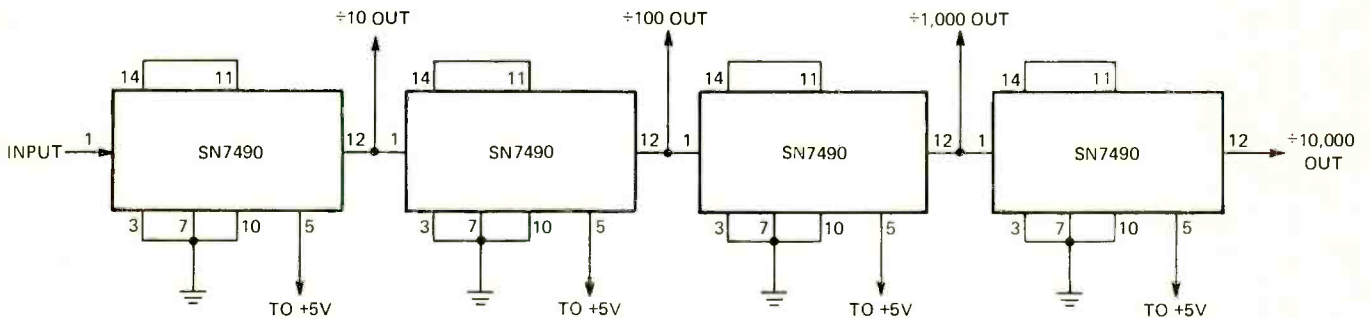
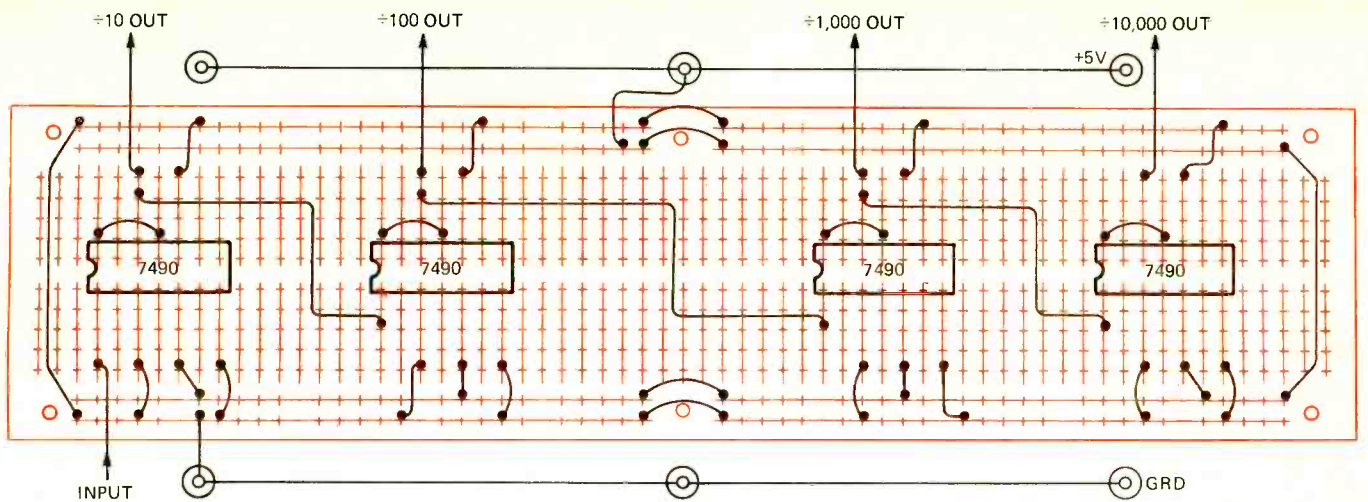

Four-Decade Scaler—Plug four SN7490 integrated circuits into the breadboard socket as shown above. Here, as in most cases, several 5-volt and ground connections are involved. It's convenient to set up long strips of tie points for this. It should take only a few minutes to hook up the scaler circuit shown in the schematic; one possible physical arrangement is shown. Connections to the input and the four outputs are determined by the end use to which the scaler will be ap-

plied. You might try connecting the input to the CLOCK or to the PULSER button, and the outputs to lamp monitors or to a scope to observe the various input/output relationships for the four scaler stages. Thus, we have built, in a few minutes, an extremely accurate frequency scaler for use in digital division applications, such as digital clocks, calculators, digital measuring instruments, etc. Additional decade stages can be included by moving the IC's closer together.

Digital Binary Adder Circuit—In many computers, addition and subtraction are the only functions performed. Multiplication, division, exponentiation; are carried out by multiple additions and/or subtractions. The binary adder described here represents the basic arithmetic building block of such a computer. In actual use, numbers consisting of more

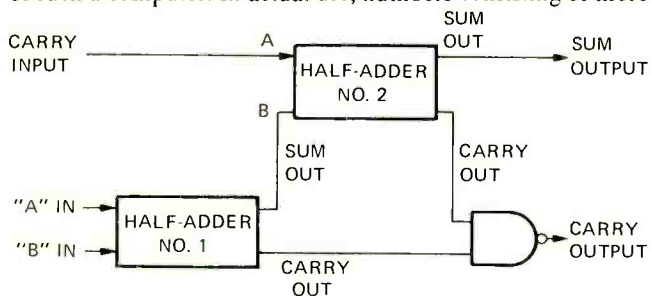

than a single bit (as is generally the case) are handled in either of two ways:

1. Have a *full adder* to handle each bit simultaneously.
2. Feed the bits, one at a time, to a single, high-speed full-adder.

Wire the half-adder as shown below and note the states of the SUM and CARRY outputs that result from various combinations of A and B inputs. Now, build two half-adders and connect them together as shown in the schematic, to form a single-bit full-adder. Again compare input/output relationships. This time, a CARRY INPUT is provided. This input accepts the CARRY OUTPUT from a previous stage.

I think that these examples have shown you how you can make use of your Digi-Designer to conveniently design, assemble, and test relatively complex digital circuits, even a small computer, without soldering . . . and in only a few minutes. **R-E**

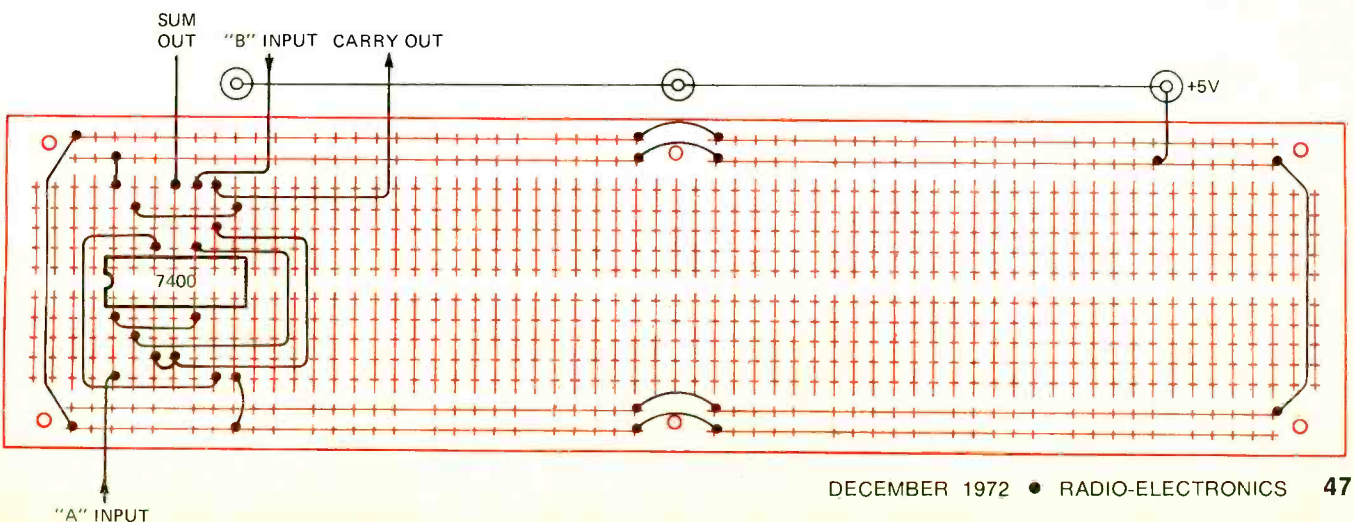

step-by-step

TV TROUBLE

Power supplies with state color TV. Here's

by ART MARGOLIS

IT IS BECOMING COMMON TO FIND transistors in the power supply in solid-state color TV sets. They are identified by such terms as active power filter, filter driver, voltage regulator, regulator driver, capacitance multiplier and error amplifier.

Component failure in this circuit makes the TV exhibit the old familiar "hum in the video." It is usually 120-Hz hum since most modern TV power supplies have full-wave rectifiers.

A typical circuit has the transistors somewhere between the rectifiers and the B-plus output, among the filter capacitors. They take the place of

the choke in a pi-type filter network. In a typical circuit, see schematic, a pair of pnp transistors are in parallel as series regulators (Q1 and Q2) with their collectors attached to the B-plus output. The emitters are both tied to the rectifier output, while the bases are tied to the collector of Q3, an npn transistor. The base of Q3 is attached through the arm of the pot to a voltage divider on the B-plus line.

Voltage regulation

When the TV is turned on, electrons flow from all the circuits into the B-plus source point (the junction of the three B-plus lines). At that junction

the electrons find two paths. One, a direct line through a 390-ohm resistor (R1) to the rectifiers. Two, through the forward-biased series regulator transistors (Q1 and Q2) from collector, to emitter and then on to the rectifiers.

The power supply has a bleeder resistance made up of potentiometer R3 and its two series resistors. The pot's arm permits a varying voltage to be picked off and fed to Q3's base as operating bias.

By varying the pot, electron flow from Q3's emitter to base is made heavier or lighter. This varies the bias on Q1 and Q2 and controls their col-

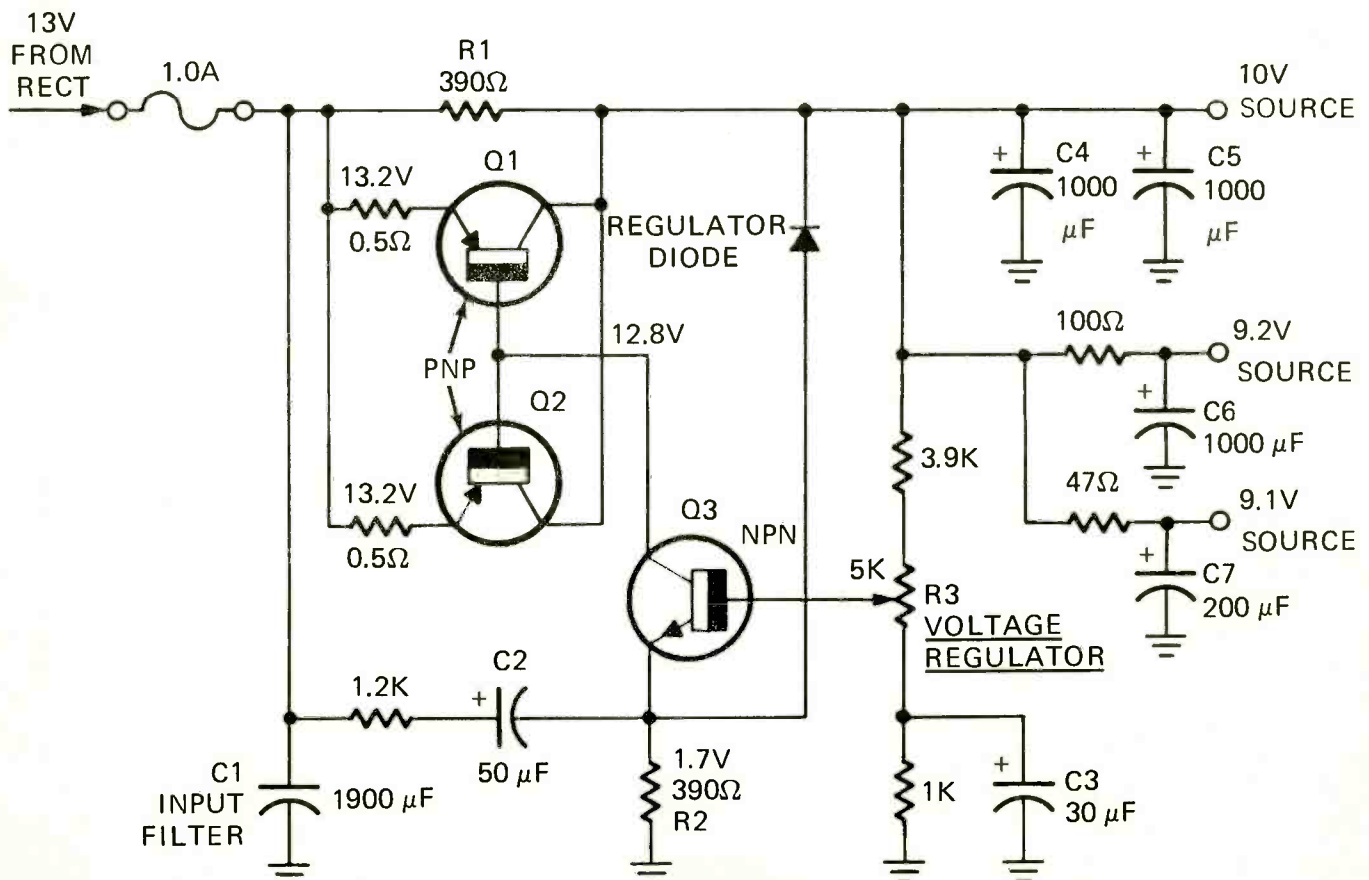

SOLID-STATE REGULATED POWER SUPPLIES are common in transistor color TV sets and in some high-power hi-fi equipment. This is a typical circuit arrangement. Some may have one high-current transistor in place of Q1 and Q2. In some circuits Q1 and Q2 are connected as emitter followers.

SHOOTER'S GUIDE

electronic regulation are common in solid-state how they work and how to troubleshoot 'em.

lector current. When they conduct heavily, their collector current causes a greater drop in the B-plus. If they have a light electron flow, the B-plus rises with the lower collector load. It is seen, the pot sets the TV's B-plus level.

Active Power Filter. In solid-state circuits with their attendant low-voltage, high-current levels, large capacitance filters and expensive chokes must be used to take out ripple. The transistors also augment the B-plus filters.

Solid-state color sets operate from low-voltage, high-current supplies that would normally require filter chokes

and very large amounts of filter capacitance to reduce residual ripple and interstage coupling to desired levels. In the interest of space and economy most sets have an *active* electronic filter that effectively *multiplies* the value of the filter capacitance in the circuit. For example, if a 30-volt B-plus source has a 250-mV ripple, it is possible to reduce the ripple at the output to 1 mV by using a capacitance multiplier with a factor of 250.

In the circuit shown, ripple and current pulses on the B-plus lines cause variations in the drop across R1 that appear as instantaneous variations in the V_{CE} of Q1 and Q2. Small

amounts of the ripple and pulse voltages are fed to Q3's base. After amplification and inversion by Q3, these voltages are applied to the bases Q1 and Q2 to provide degenerative action. Now, any change in the voltage input to the filter or current drain will produce an opposite change in the voltage across the load. Thus, R3 not only sets the B-plus level, but also controls the ripple and decoupling between the three B-plus lines.

Troubleshooting

The active filter circuit can blow the line fuse if it develops a dead short to ground. For instance, if the input filter C1 shorts. Or, B-plus can be missing or too low if R1 opens.

However, typical failure in the circuit causes hum bars or shrinking or both. Too much or too little B-plus is produced and ripple is serious. When these symptoms start, the best approach is to take a dc voltage reading at the B-plus source. The rectifier output is 13 volts. The source is supposed to regulate and filter the 13 to a ripple-free 10 volts.

If the source is higher than 10 volts and R3 cannot be adjusted to restore 10 volts, then all the components around and including the three transistors are suspect. When the transistors turn off and present no load to the rectifier output, the voltage rises toward the 13 volts and cannot be adjusted. If the regulator diode and R2 are both shorted the load might drag down the B-plus, but that possibility is not very probable. In general a higher than normal source B-plus indicates the transistor circuit.

When the source is lower than 10 volts and R3 adjustment will not bring it back up to 10 volts, the input and output filter capacitors are suspect.

Take a dc reading at the rectifier output. If it is low there too, then C1 is leaking badly. Should the normal 13 volts be present, then C4, C5, C6 or C7 may be shorter or leaky. The chart goes into greater detail.

R-E

COLOR TV SERVICING
ACTIVE POWER FILTER TROUBLESHOOTING CHART

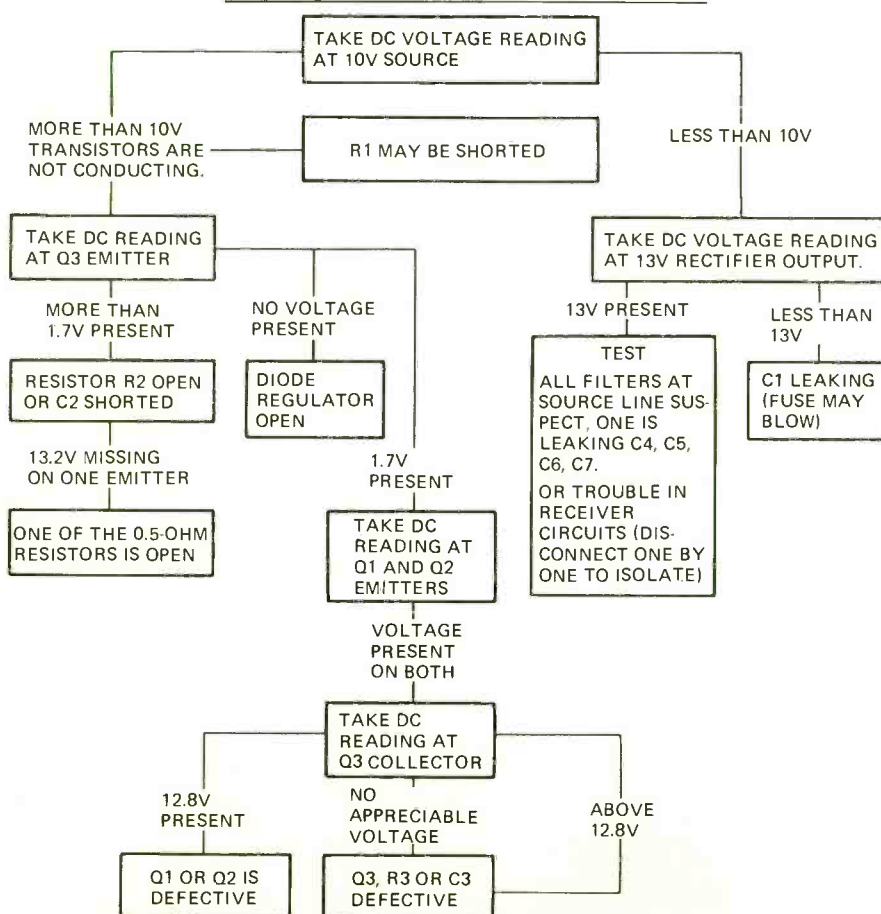

AGC for automatic recording level

Admiral recorder uses transistor's collector-emitter resistance as heart of its recording circuit.

The Admiral model STR901 cartridge tape recorders do not have recording-level meters because the recording level is automatically controlled by an agc system. The diagram shows the simplified circuit of one of the channels of the recorder.

A portion of the signal from the collector of the output transistor is tapped off and rectified by the agc rectifier. The resulting dc signal is fil-

tered by the 1000- μ F electrolytic. The AGC BALANCE control determines the amount of the dc voltage that is applied as a variable base bias to the agc controlled transistors. The varying base bias makes the controlled transistor act as a variable control that determines the amount of the signal that will be bypassed to ground through the transistor and the 12,000-ohm resistor.

During playback, the adjustable

volume or LEVEL controls are switched into the circuits. A portion of the output of each channel is tapped off and fed as negative feedback to the emitters of the third af amplifiers. The out-of-phase signal fed back determines the bias and gain of the third stage amplifier. **R-E**

RECORDING LEVEL is held relatively constant by this circuit. It eliminates the need for a manual input control when recording.

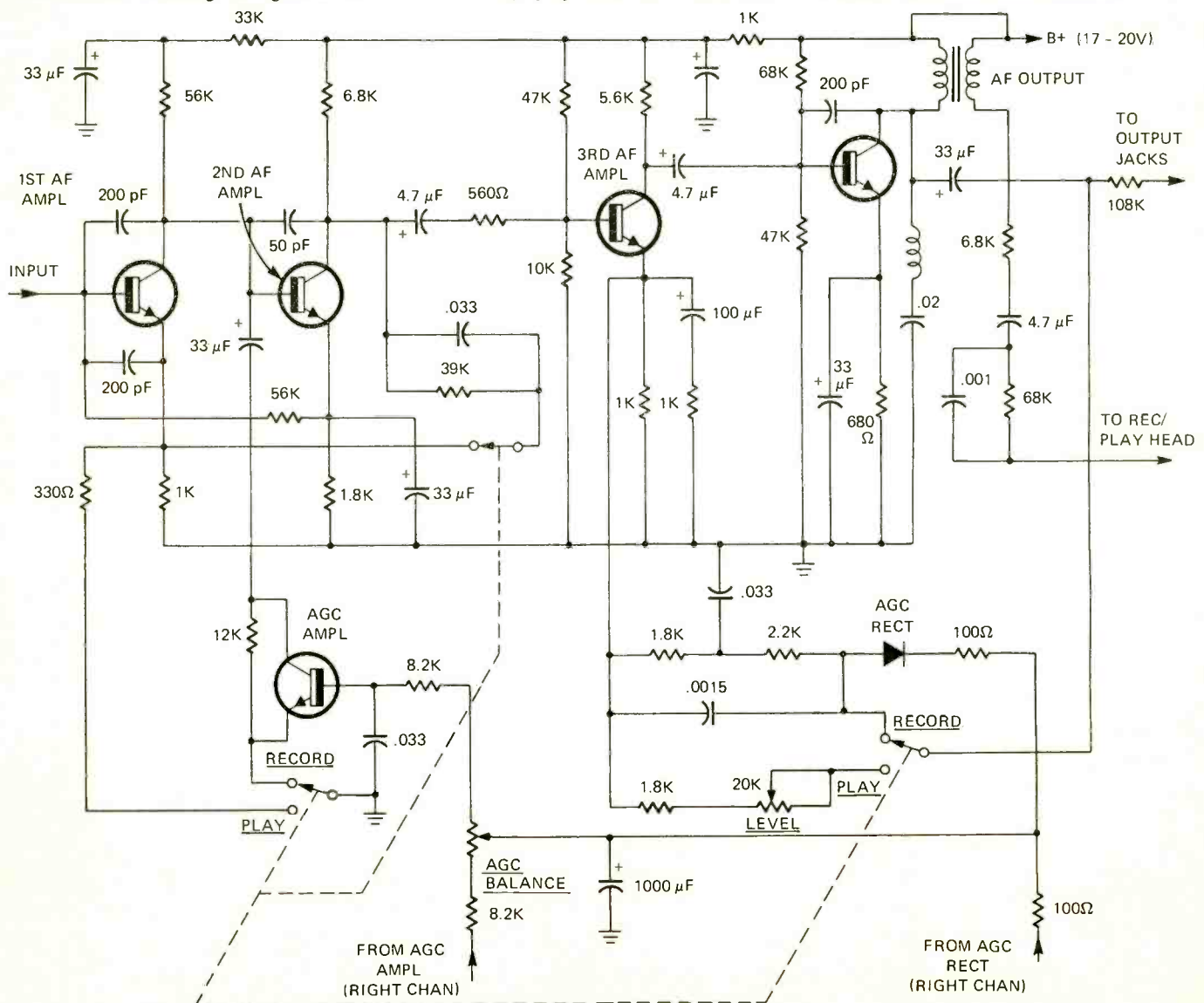

CALCULATORS

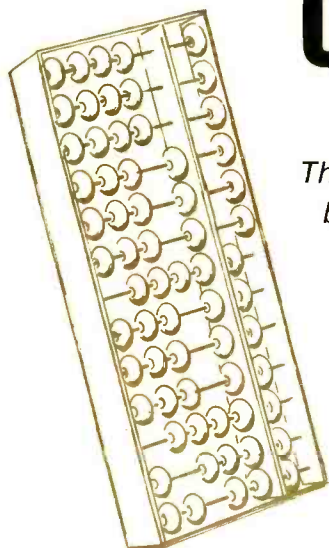

The first "digital" calculating was done by early man using his fingers. Then came the abacus and finally the electronic calculator

by FORREST MIMS

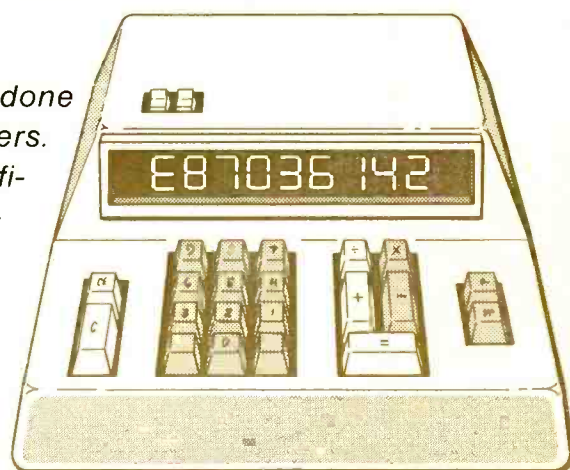

from the abacus to the electronic calculator

IT'S NO COINCIDENCE THAT FINGERS AND THE NUMBERS 0-9 are all referred to as digits because man's first counting machine was his two hands. Finger counting, which is actually primitive addition, is still used throughout the world. But even before recorded history man invented counting techniques which permitted the counting of sums greater than the total of his fingers. Notched bones, marked sticks, and knotted strings made possible more advanced counting, an absolute requirement for time keeping, bartering, and establishing formal commerce.

The earliest mechanical calculator was the abacus. It's believed that the abacus was in use in Egypt as early as 450 B.C., and a type of abacus may have been used in China as early as 600 B.C. The first abacuses consisted of small pebbles moved through grooves drawn in loose sand, and the machine began to bear some resemblance to its modern form when the counting stones were placed in grooves formed in a wood or metal tablet.

The modern abacus consists of a frame which supports a dozen or more parallel rods. Five to seven moveable beads or counters provide the counting mechanism and there is generally a central bar across the top center of the frame to separate one or two beads on each rod from the rest. The beads on top correspond to fives, while the counters below the dividing bar correspond to ones.

To place a number on an abacus, the frame is first cleared by moving all the one's beads *down* and the five's beads *up*. By assigning one rod to be the one's column and those to its left the ten's, hundred's, thousand's, and so forth, it's easy to "write" numbers on the machine by moving the beads toward the central dividing bar.

Arithmetic with an abacus is remarkably simple and efficient, and with practice one can soon gain speed in the ancient art of abacus manipulation. In a now famous competition held in 1946 between a Japanese abacus operator and an American equipped with a mechanical desk calculator, the abacus beat the calculator in four out of five areas of competition. The abacus was faster than the mechanical machine since the operator performs the arithmetic as new numbers are inserted into the machine. In the case of the desk calculator, the operator must activate a total mechanism before the final answer can be calculated, but the abacus provides a running total and the final answer is ready as soon as the last number has been inserted into the machine.

Abacuses are still in use throughout the Orient, the Soviet Union, and other parts of the world. Chinese style abacuses have two beads on the top side and five on the bottom, while the modern Japanese version, the *soroban*, has one bead on top and four below. The soroban is designed for speed and efficiency since elimination of the additional beads forces the operator to "carry" as soon as each column of digits exceeds nine.

The abacus can easily be used for addition and subtraction by a beginner and for multiplication and division after a little practice. But as more advanced mathematical operations were developed a need for more comprehensive calculating machines was created. The first significant step beyond the abacus was a gear driven adding machine invented by Blaise Pascal in 1642. The teen-aged genius designed and assembled a mechanical calculator capable of adding series of eight digit numbers. Another important seventeenth century invention was John Napier's device for calculating with logarithms, and still another was William Oughtred's invention of the slide rule.

The basic concept of Pascal's mechanical adder is found in modern mechanical adding machines, and slide rules are still an important tool of modern engineering. But no inventor foresaw the resolution of the modern calculator as clearly as Charles Babbage.

An outspoken English mathematician and philosopher, Babbage was obsessed with the idea of designing and constructing an advanced mechanical calculator which would perform the four basic arithmetic functions as well as advanced manipulations of these fundamental operations.

In 1822 Babbage succeeded in constructing the "Difference Engine" for the solution of polynomial equations ($x^2 + x + a = 0$). The machine's success convinced him that he could construct a more advanced calculator, the Analytical Engine, with a punched card input, a memory of 1,000 50-digit numbers and both visual and hard-copy output.

Unfortunately the machining state of the art in Babbage's time was not sufficiently advanced to permit all the required mechanical parts of his highly complex Analytical Engine to be constructed with the necessary degree of precision. The apparatus required hundreds of precision mechanical components. Though Babbage completed literally thousands of intricate engineering drawings detailing the machine's assembly and internal operation, a feat in itself, the precision tool-

ing required for fabricating the working parts was just not available.

Babbage spent the last 40 years of his life working on the Analytical Engine and died in 1841 without seeing his project completed. He did, however, make important contributions to the science of machining and designed the basic organization of a modern digital computer system. Indeed, some of the operations which would have been performed on Babbage's Analytical Engine bear an amazing resemblance to some of the basic FORTRAN statements used with many modern computers.

By the beginning of the twentieth century the basics of the two major classes of calculating machines had been discovered. The digital calculator, as represented by the abacus and other primitive counting systems, had reached its pinnacle with Babbage's Analytical Engine. And slide rules and Lord Kelvin's tide-prediction machine, an 1872 invention, represented the analog calculators. While both digital and



A FULLY PROGRAMMABLE ELECTRONIC CALCULATING SYSTEM, the Hewlett-Packard 9820A, with a built-in printer. This versatile machine represents the pinnacle in electronic desk calculators and offers many of the capabilities of a true minicomputer. The three keyboards to the right of the central arithmetic portion of the machine can be "user defined" by means of plug-in read-only memory modules.

analog calculators were designed to perform arithmetic, and even differential equations in the case of Kelvin's machine, their operation was fundamentally different.

Digital calculators utilize discrete quantities in making calculations, while analog calculators measure or approximate quantities. The differences between the two types of calculators gives each relative advantages and disadvantages. Digital machines, for example, are far more accurate than their analog counterparts and large-capacity digital devices can express answers accurate to one part in a trillion—or better. The accuracy of an analog device will rarely exceed 0.01%.

Analog calculators do have advantages, however, and they are well suited to modeling a complex physical problem and providing solutions to a variety of conditions. In aerodynamics, for example, analog calculators and computers are frequently used to simulate aircraft shapes. By simply turning potentiometers connected to simulate drag, velocity, air density, and other parameters, it's possible to conveniently select optimum aircraft configurations for particular flight requirements.

Getting back to the evolution of calculators, there were a number of important developments at the turn of the century which directly affected future prospects for both analog and digital calculating machines. One of the most important of these was the invention of electrically-read punched cards by Dr. Herman Hollerith. The Hollerith cards were first developed for use in the 1890 United States census and are direct predecessors of the modern IBM card.

The next big development in the field was the design in 1925 of a large analog computer by Dr. Vannevar Bush. An advanced version of the Bush machine was secretly used during World War II to calculate artillery firing tables. Also in

World War II a complex analog calculating system was used in the fire control system of B-29 bombers.

In 1944 interest in calculating machines suddenly shifted from analog devices back to digital techniques with the completion of the Mark I Automatic Sequence Controlled Calculator. Containing more than 3,000 relays, the Mark I could multiply two 23 digit numbers, its maximum capacity, in 4-½ seconds. The Mark I was conceived by Howard Aiken and built with the assistance of IBM. While designing the calculator, Aiken came upon some of Babbage's work and recognized its contribution to the principles of complex digital calculating machines. Aiken once remarked "If Babbage had lived 75 years later, I would have been out of a job."

The Mark I was followed by an even more significant calculating machine. In 1946 Drs. J. Presper Eckert and John Mauchly completed the ENIAC (Electronic Numerical Integrator and Calculator), a significant advance over the Mark I in that it used high-speed vacuum tubes instead of the much slower electro-mechanical relays. The new machine was a major scientific and engineering accomplishment, but it brought along some major problems as well. With 18,000 tubes, 11,000 switches and terminals and more than half a million solder connections, the ENIAC required two and a half years to assemble and more than 1,800 square feet of floor space. But the added complexity gave the ENIAC much faster speed than the Mark I. While the relay machine required a third of a second to add two numbers, the ENIAC could perform 5,000 additions in one second.

The ENIAC marked the beginnings of the computer age, and it was soon followed with high-capacity machines such as the EDSAC (Electronic Delay Storage Automatic Calculator), EDVAC (Electronic Discrete Variable Automatic Calculator) and SSEC (Selective Sequence Electronic Calculator). The EDSAC was unique in that it incorporated a *stored program* for the first time.

The stored program, a key to the success of modern digital calculators and computers, provides the internal instructions necessary for a calculator or computer to perform com-



THE MOST ADVANCED POCKET CALCULATOR made today—the Hewlett-Packard HP-35. This sophisticated electronic slide rule has trig functions, a memory, and can take square roots. It also handles logs and exponential terms. The HP-35 represents a major breakthrough in miniature electronic calculating machines.

plex operations with a minimum of outside instructions. A typical stored program, for example, will have the necessary instructions for determining trigonometric functions. The operator is then saved the laborious task of encoding the appropriate instructions each time he needs to refer to such a function. In a typical operation he merely instructs the machine to find the cosine (or tangent or sine) of a particular angle with a few code letters (usually "COS" in the case of cosine) and the machine's internal stored program automatically furnishes the detailed instructions required for the operation to the arithmetic section. Large digital computers frequently use magnetic tape for stored programs, while advanced electronic

desk calculators employ solid-state memories for the same purpose.

In 1951 Eckart and Mauchly completed work on the famous UNIVAC, the first modern digital computer. The original version of this machine was purchased by the United States Census Bureau and was used until 1963 when it was replaced by more modern equipment. The first UNIVAC is now on permanent exhibition along with several other pioneering calculating devices at the Smithsonian Institution in Washington, D.C.



THE CANON POCK-ETRONIX is the only portable electronic calculator with a paper tape printout. This novel machine incorporates Texas Instruments MOS LSI circuitry but is manufactured in Japan. Texas Instruments also manufactures the semiconductor thermal printout device. The paper tape can be replaced almost instantly by plugging in a new cassette.

During the 1950's the UNIVAC was followed by a series of advanced digital computers developed by the newly founded computer industry.

Though the transistor had been invented in 1948, most computers employed vacuum tubes. But in the late fifties and early sixties reliability of the machines was significantly enhanced when the switch to transistor operation was accomplished. In addition to improving reliability, transistors meant the once bulky computers could be squeezed into much tighter spaces. The size reductions were vital to military and civilian aerospace endeavors and for the first time it became possible for an aircraft or missile to carry along its own portable digital computer for inertial navigation and other important roles. These early avionics computers were primitive by today's standards, but they represented an enormous step forward at the time of their introduction.

The semiconductor developments which made possible compact digital computer systems led to speculation about the prospects for electronic desk calculators. Integrated circuits had been invented by Texas Instruments in the late 1950's, and major technology improvements by Fairchild a few years later made possible the formation of several dozen electronic components on a single silicon substrate. Since even the first IC's crammed tens of components into the space normally required for one and since the components were all connected together within the IC itself, for the first time it became feasible to consider designing electronic desk calculators. But the development which began a literal explosion of electronic desk calculators was the Large-Scale Integrated circuit (LSI). A product of metal-oxide semiconductor (MOS) technology, LSI made possible the compression of the hundreds or even thousands of transistors and other components required to perform the computer operations of arithmetic, memory, and control onto several semiconductor chips each about a tenth of an inch square. With the availability of calculator "chips" it became feasible to manufacture multiple-function electronic desk calculators that required less space than a telephone.

A size comparison between a modern LSI calculator and

the first vacuum-tube calculator, the ENIAC, is truly impressive. Where the ENIAC required an entire room to house its racks of 18,000 vacuum tubes, a miniature LSI calculator containing the equivalent of 30,000 transistors will easily slip into a shirt pocket.

Continued developments in LSI technology have dramatically improved electronic calculators. Now, for example, nearly all the electronics required for a basic four function calculator (+, -, ×, ÷) can be placed on a single LSI chip. The result is calculators no larger than a portable transistor radio. In addition to LSI, these new calculators employ such recent developments as light-emitting diode (LED) displays and thermal printers. The market is highly competitive and more than a dozen firms produce the miniature machines.

Most miniature calculators employ LED or liquid-crystal displays, but there is one unit which provides a paper tape printout. Dubbed the Pocketronix, the machine represents a joint development by Texas Instruments, Inc. in this country and Canon, Inc. of Japan. The Pocketronix employs three LSI chips and a unique semiconductor thermal printer manufactured by Texas Instruments. As operations are pressed onto the keyboard, the entries, function signs, and results are immediately printed onto the cassette-loaded paper tape.

Another impressive miniature calculator is the HP-35. Manufactured by Hewlett-Packard, a major producer of programmable scientific desk calculators, the HP-35 has memory capability and can provide trigonometric functions, logs, pi, and square roots at the touch of a single function key. Since the HP-35 literally fits in a shirt pocket, it represents the fulfillment of many science-fiction predictions.

Miniature calculators are popular with students and anyone else requiring math assistance on-the-go, but for desk operation machines about the size of a cigar box are standard. Dozens of different types from as many manufacturers are now available and the perspective purchaser can choose from units that include such added features as memory capability, printers (electronic and electromechanical), special functions, and novel keyboard manipulation shortcuts.



A LATE MODEL DESK CALCULATOR, the Friden EC1117 has memory capability. Low-cost machines like this are popular with businesses. Friden also manufactures printing calculators and all electronic cash registers.

Prices for miniature and desk calculators begin at just under \$100 and range up to several thousand dollars for a machine equipped with a printer and peripheral equipment. As with any other purchase, the buyer gets what he pays for and the cheaper machines do not necessarily represent the best bargain. Many of the low-cost machines require special keyboard manipulations to perform simple problems in addition and subtraction.

A possible solution for the prospective purchaser with a limited budget and soldering iron experience is one of the

new kit calculators. Micro Instrumentation and Telemetry Systems, Inc. has been selling kit desk calculators since 1971 and now offers a line of machines ranging from a miniature machine to full function scientific calculator. Heathkit brought out a kit calculator in 1972, and the May 1972 issue of **Radio-Electronics** featured a construction article on a kit pocket calculator manufactured by Alpha Research Corporation.

Kit calculators are not difficult to assemble. Besides saving money, assembly of a kit machine provides background for future troubleshooting and enhances the kit builders' knowledge of general calculator construction and operation.

The development of other specialized calculator chips, particularly memories, has further enhanced calculator performance and now several companies are marketing *scientific* calculators. These machines include the standard four arithmetic functions on their keyboards but supplement the basic capability with keys for the various trigonometric functions, pi, square and square root, e^x, logarithms, and other operations common to mathematics. In this way, the scientific calculator becomes an instant access book of mathematical tables as well as an easy operating calculating machine.

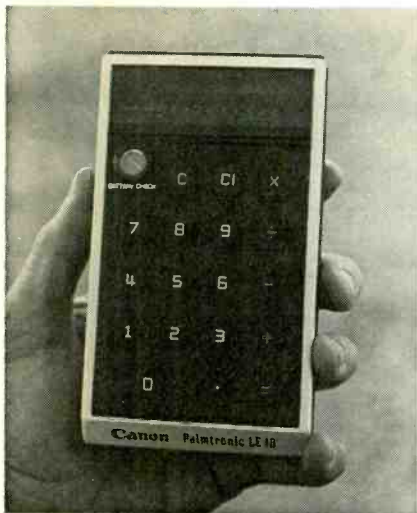

THE CANON PALMTRONIC LE-10 has an LED display and rechargeable batteries. To extend battery life, which is indicated by the built-in meter, the LED display turns off after about half a minute. Note that the machine incorporates separate keys for each function, a desirable feature not often found on miniature calculators.

The scientific calculator has the ability to perform complex operations as a result of the same kind of internally stored program used in large scale computers. Read only memory (ROM) chips store the microinstructions necessary to tell the calculator's arithmetic unit to calculate the desired mathematical function. Since the expanded capability of the scientific machines is in large part dependent on the capacity of the ROM, it's possible to further expand an existing machine by merely adding plug-in memory modules. Several manufacturers offer scientific calculators which are compatible with a variety of memory modules which let the operator literally custom-design his own keyboard in the time it takes to insert the module into the machine. A bank of unmarked keys is used to specify the operations and functions contained within the special ROM modules, and a snap-in label card notes the newly assigned function of each key. The calculator can be "redesigned" in the time it takes to exchange the ROM modules.

In what has become one of the fastest moving fields in

ARC-OVER IN BRIGHTNESS CONTROL

I'm getting arc-over in the brightness control of an Electrohome Viking TV, TCO-299R. I can't understand it. Shouldn't be any really high voltage around there.—E.B., Minden, Ont.

Right. There should be no more

than +135 volts on this control, and this won't arc to anything, unless it is very close indeed. There is one possibility: internal arcing in the pix-tube might cause it. Try tapping the neck carefully with a pencil eraser and watching for arcing inside the tube.

You might try adding an "arc-gap" to the pix-tube socket or wiring. Check

the pix-tube for internal shorts. If you find one, say between G1 and the focus or screen grid, try this: place the tube face down on a pad and rap the neck (carefully!). This will sometimes dislodge small particles which cause the short; they'll fall into the bell where they won't hurt anything. If this fails—new tube.

electronics technology in recent years, scientific calculators have led to the next logical development—the programmable calculator. With the operating ease of a calculator and the power of a small computer, programmable calculators fill an important gap between scientific calculators and minicomputers.

It's important to understand the difference between the programmable calculator and the minicomputer. In the important area of operational ease the calculator has the unquestioned lead. Programmable calculators with an algebraic



WANG SERIES 100 ELECTRONIC DESK CALCULATOR. Manufactured by the first company into the electronic desk calculator business, the machine includes scientific and statistical keys as well as interfacing for an optional printer. The display panel is on an axle and can be rotated for convenient viewing by the user.

keyboard can handle complex equations just as they are written on paper while a computer program must be written before the minicomputer will handle similar problems. Cost is another important area where the calculator comes out ahead. Programmable calculators can be purchased for about \$3,000, and \$10,000 will buy a fully expanded model with accessories such as additional memory, printer, plotter, and input devices. The price may seem high to the uninitiated, but the calculating power makes it a genuine bargain.

For those who cannot afford the price of a programmable machine but are eager to have one anyway, help is on the way in the form of a kit programming unit. MITS, Inc. plans to bring out a programmer kit which can be mated to its machines already on the market. The cost for a complete kit programming unit and calculator will be about a tenth of a corresponding assembled unit's cost. A MITS 7400 series scientific calculator and programmer will provide the technician, engineer, or experimenter with many of the capabilities of a minicomputer.

So there you have it. The primitive abacus, the 3,000 year old digital calculator still being used throughout the world, has finally been outclassed by electronics. In a development which would have been labeled as science fiction just 10 years ago, complete programmable calculating systems which fit on a standard desk top and multiple function machines which fit in a shirt pocket are available today.

R-E

USING THE COLOR-BAR GENERATOR

*Trying to service a color set without a color-bar signal
can be an exercise in futility*

by FOREST H. BELT and ESTILLE DOBSON

A VIDEO PATTERN OF DOTS, LINES, AND crosshatch is the standard for converging color sets. That kind of generator has been around since color first came out. For color-circuit work, NTSC color bars were added. Only later did the keyed-rainbow color pattern come into vogue in their place. Today, the keyed rainbow is by far the more popular.

You can track down many chroma faults with a station signal. But the job is difficult because levels of chroma change from scene to scene. A keyed rainbow signal produces a steady display of ten color bars. When you study the screen or trace with a scope, you know what to expect. That makes it easier to spot when something's wrong, and to analyze what the trouble is.

A keyed-rainbow generator

To make a rainbow on the color picture tube, a generator modulates an rf signal with an offset subcarrier at 3.563795 MHz. That's offset from the color subcarrier, 3.579545 MHz, by the horizontal line frequency. (A few modern instruments use other offset subcarrier and horizontal-line frequencies, but operation is essentially the same as with this popular version.)

The 3.56-MHz signal goes to the receiver demodulators. There it is compared with a 3.58-MHz reference signal. Their mixing creates a continuous change in demodulator output phase that totals exactly 360° across each horizontal line. The output shift produces one complete "rainbow" of colors during each line.

That makes a solid rainbow raster, *not* rainbow bars. So, the 3.56-MHz oscillator is shut off and keyed back on 12 times during each horizontal sweep. Those blank spaces interrupt the rainbow at 30° intervals, keeping it off for 15° each time. Off-time shows black on the TV screen, breaking the rainbow into bars.

Fig. 1-a shows the 12 bars that key the rainbow signal. Fig. 1-b shows the color-bar pattern on the color picture tube. The bar colors are labeled. Remember especially the positions of the red bar, third, at 90°; blue bar, sixth, at 180°; and green, tenth, at 300°.

Note that, of the twelve bars in the signal, only ten appear as color bars on the TV screen. This is because two of them fall during overscan. They are hidden at the sides of the screen. One is on the back porch of the horizontal sync pulse and acts as the color-sync reference burst; it triggers the 3.58-MHz color oscillator in the receiver.

For servicing, you need a way to find out if a set can hold color on weak signals. For this, some generators have a control for reducing color-signal level without lowering the rf output. You turn the color level down to check for poor color sync. Tune the station se-

lector off-channel and back several times. Color should lock in solid every time, without delay.

You can turn the generator's color level up higher than normal to force stability while you troubleshoot a set you know has poor color sync. This gives you a constant signal level to work with in color-sync or automatic color control circuits. Without this strong input, the color-sync signals may fluctuate and you can't get a steady voltage or scope waveform to measure. Too, you can check how well the acc (automatic chroma control) handles signal variations.

In the color stages

Suppose you suspect a color amplifier. Inject the keyed-rainbow signal, on its rf carrier, into the antenna terminals of the TV set. You can spot a dead chroma stage or loss of gain readily. Just scope the waveforms at the input and output of each color amplifier stage.

But the solution isn't always that simple. You can find an inoperative color amplifier but still not know whether the fault is there or in the color killer. Improper bias from the killer may be cutting the amplifier off.

There's a way to find out. Fig. 2 illustrates. Connect the negative lead of a variable bias supply to point Q, positive lead to ground. Set the bias knob to 6 or 8 volts. There should be no color in the bar pattern on the picture tube. Turn the bias knob down until you're applying only 0.5 volt of negative bias to the grid of the first color amplifier. That should bring out a good strong display of color in the bars.

If decreasing artificial cutoff bias lets the color amplifier work, the cause for it not working must lie in the natural bias-voltage source. Color-amplifier bias comes from the acc/killer system. So that's where to look for the defect.

Color bars tell you more. From

FIG. 1—KEYING GENERATOR'S OSCILLATOR on and off makes the bar signal at (a). Only ten bars show on the screen (b), two are lost in overscan.

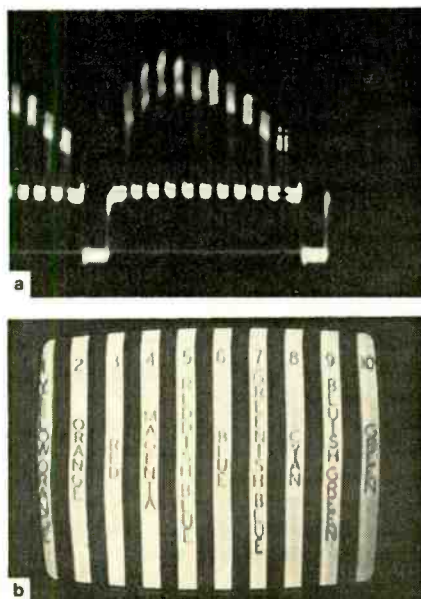

their appearance, you can see if tuned circuits need alignment. Poor frequency response or unwanted phase shift in the color amplifier shows up as color trailing the bars. Color smears over to the right of whatever video information it belongs with, as Fig. 3 shows.

About hue

The hue control permits the viewer to refine the color demodulation angle so colors come out accurate on the screen. This is necessary because the phase of chroma signals can vary among different television stations.

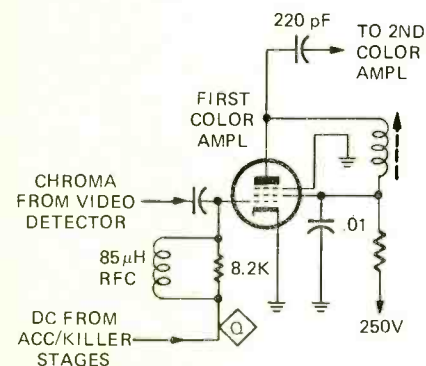

FIG. 2—USE VARIABLE DC SUPPLY to clamp the bias line of the color amplifier controlled by color killer. In this and similar Zeniths, bias goes to point Q.

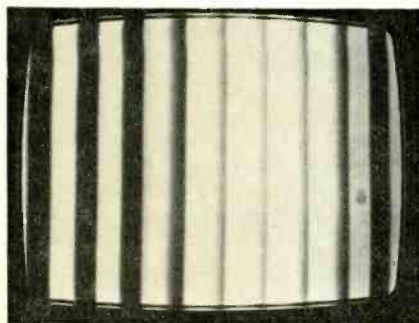

FIG. 3—THE SMEARS to the right of the bars are a result of color trailing video. This indicates a need for chroma alignment.

In some sets, controlling hue consists of manually altering the phase of the color reference burst before it reaches the color oscillator. In others, the control alters phase of the restored 3.58-MHz subcarrier itself. In occasional chassis, the control varies the phase of the chrominance sidebands before they are applied to the demodulators.

A keyed-rainbow generator has two uses here. One use: it can show if hues are about right when the hue control is at midposition. The bar colors should appear in the order labeled in Fig. 1-b. The red bar, remember, belongs at position 3.

Also, the generator lets you check whether the hue control shifts phase far enough for adequate hue range. Turning the hue knob back and forth moves

the whole rainbow pattern to right and left. Twisting the control from one stop to the other should move the red color from bar 2 to bar 4. That's the minimum for suitable viewing, and will handle the hue variations of most stations and programs.

If the color-bar positions are not correct, afpc (automatic frequency and phase) adjustment is in order. Put the hue control exactly in midrange. Adjust the burst-amplifier plate coil (or whatever other adjustment the manufacturer says) until the red bar is in the number-3 position. If other bars are then out of sequence, hunt the cause in the demodulator section.

Keep in mind that an older generator may be slightly "off." Make it a practice to recheck the hue range on color programs from several different stations. Refine the hue phase until the set produces good skin tones on as

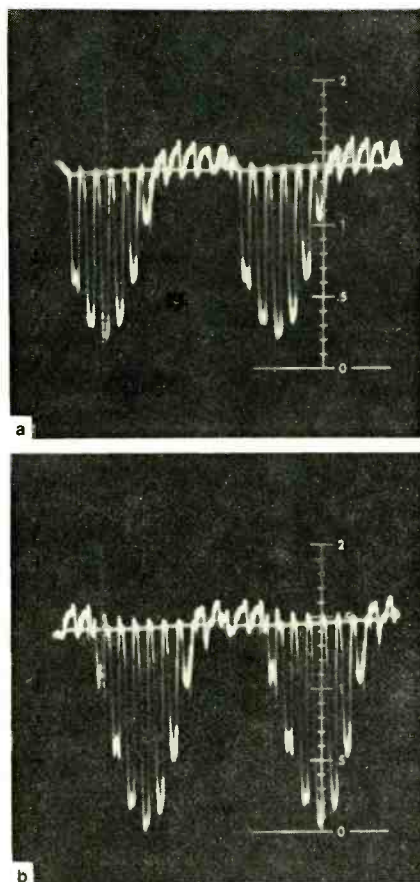

FIG. 4—SCOPE WAVEFORMS for color picture tube should have the third bar the most negative on the red grid (a) and the sixth bar the most negative on the blue grid (b).

many stations as possible with the hue knob near center.

3.58-MHz phasing

Many color sets operate with from 90° to 105° of phase difference between the two 3.58-MHz CW reference signals fed to the color demodulators. Phase shift between them is accomplished by feeding one signal through a coil or se-

ries of coils. Generally, the X or the R - Y demodulator gets the direct signal from the CW oscillator. The signal for the Z or the B - Y demodulator is shifted.

These two 3.58-MHz signals, separated by the phase shift, mix with chroma sidebands in the demodulators. One demodulator recovers R - Y. The phase of its CW signal forces that. The other recovers B - Y. The phase difference between the recovered color-difference signals must be accurate for the set, or hues won't be correct.

You can check the demodulator output phases by injecting a keyed-rainbow signal to the set. Attach a low-capacitance scope probe to the red grid of the picture tube. Adjust the hue control so the third bar goes furthest negative, downward from the waveform's zero reference line. Fig. 4-a shows how it should look on your scope.

Without changing the hue control, move the scope probe to the blue picture tube grid. Here, the sixth bar should be furthest negative (Fig. 4-b). If not, phase shift is wrong. The keyed-rainbow signal can be traced from the demodulators to find out why.

As an example, one RCA CTC28A chassis had all magenta color bars. Tracking was good on black-and-white, so the color difference amplifiers and the picture tube were apparently working OK. Presumably, one of the demodulators was not. New demodulator tubes didn't help.

The next step was to scope the red and blue picture-tube grids. Both grids had exactly the same waveforms, and that's not normal. The same thing was true at the R - Y and G - Y amplifiers, and at the outputs of the demodulators. The logical explanation was no phase shift between the two demodulators.

The circuit is shown in Fig. 5. Shorting phase-shift coil L703 with a clip lead made no change in the magenta bars. A new coil restored normal

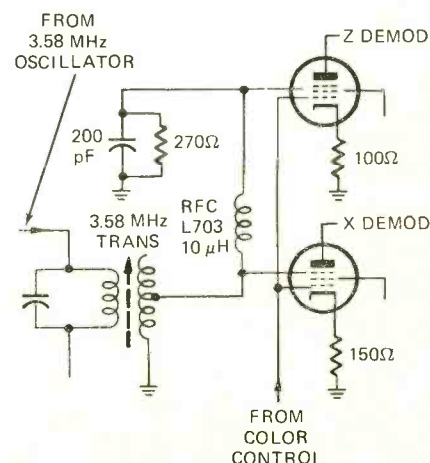

FIG. 5—COLOR DEMODULATORS are fed with a phase-shifted CW signal from the 3.58-MHz oscillator. Bad rf choke caused all-magenta bars on the receiver's screen.

colors for a satisfactory repair.

Integrated-circuit chroma demodulators, such as in recent Zenith chassis, may be checked by the same method. Connect the low-capacitance probe to the base of each video output transistor. You should find in the waveforms the phase difference described in Fig. 4.

Checking color lock

Color-sync problems can be diagnosed quickly with a keyed-rainbow generator. Lack of color sync makes color in the bars look like the stripes around a barber pole (Fig. 6-a). This is

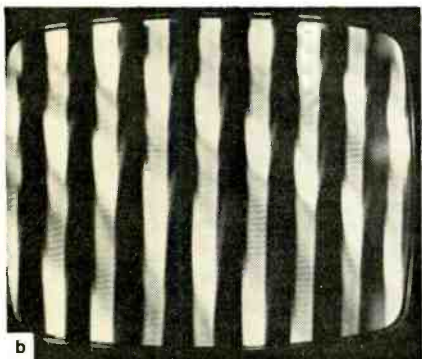
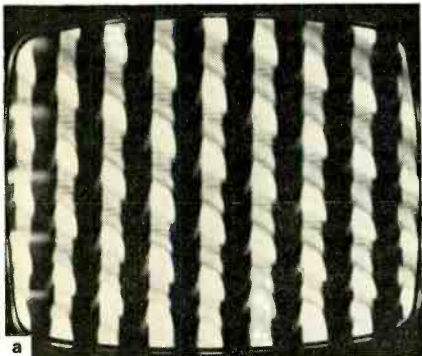

FIG. 6—BARBER-POLE EFFECT develops when color sync is lost. Colors are at angle to the upright bars. Frequency is away off in (a) and is almost right at (b).

because the phase difference between the set's own 3.58-MHz oscillator and the incoming offset subcarrier changes slower or faster than 360° per line. Many times, curing bad color sync only requires readjusting the set's color oscillator so it beats properly with the incoming color signal.

Connect the keyed-rainbow generator to the antenna terminals. Ground the grid circuit of the 3.58-MHz reactance control tube. Follow the manufacturer's instructions carefully for this procedure; it is easy to get misled. Adjust the oscillator plate coil until the colors stand still or float slowly "behind" the black bars. Try to make the color fill the bars from bottom to top and not in horizontal segments.

If you can't get zero beat, the barber-pole colors might continue to float rapidly through the bars. Look for a defective or off-value component in the

oscillator circuit itself.

One set (Fig. 7) still had that problem after a technician had tried aligning the coils. He disabled the reactance tube by grounding point A. Adjusting the reactance plate coil should stop barber pole. In this set, it only slowed the barber pole down to about three diagonal stripes of color (Fig. 6-b). Since the oscillator could be brought that close to zero beat, the technician suspected the resonant circuit itself. Substituting a new 10-pF capacitor across the reactance coil cured the fault. The old capacitor was open.

If you can lock color near zero by

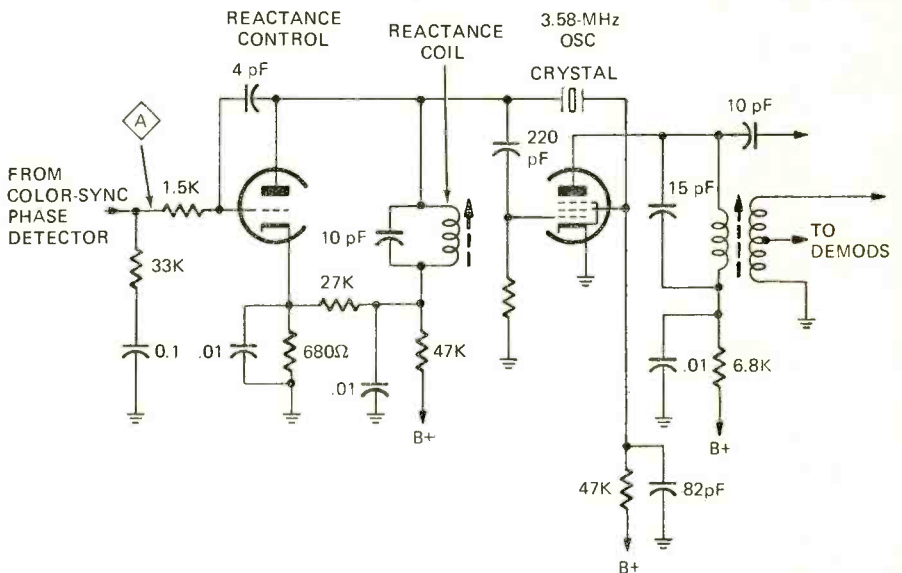

FIG. 7—COMMON COLOR-SYNC CIRCUIT uses reactance stage to lock CW oscillator on frequency. With point "A" grounded, reactance coil adjustment should pull frequency close to 3.58 MHz but leave it in a free-running state.

FIG. 8—PHASE DETECTOR compares signal from CW oscillator with incoming color sync. A phase difference causes diodes to develop an off-balance dc voltage to correct the oscillator through the reactance stage.

coil adjustment, then you know the 3.58-MHz oscillator operates in close phase relationship with the incoming signal. Look to the burst amplifier for defects. The color sync isn't locking the oscillator in solid.

On a similar set, the customer complained of rolling color in the picture. The technician brought the oscillator to zero beat OK, but when he removed the ground from point A the color fell out of sync again. That pointed to trouble in the color-sync phase detector (Fig. 8).

Checking there with a vtvm revealed a positive 50 volts at the cathode of CR705. The anode of CR706 had only 30 volts negative. These voltages should be alike but of opposing polarities.

None of the resistors had changed value. Reversing the diode connections switched the voltages, but left them unbalanced. That pointed to the diodes.

Replacing them with a new matched pair returned color sync to normal.

Color balance

The ratios between R - Y, B - Y, and G - Y signals are important. Most color hues in a scene are not primary colors but mixtures of all three. True colors (especially skin tones) demand a proper amplitude relationship among the three primary colors. Fig. 9 illustrates these relationships. With blue amplitude at 100%, red is about 85%, and green about 35%. Each varies with screen phosphors, but only slightly. You can connect up the rainbow generator

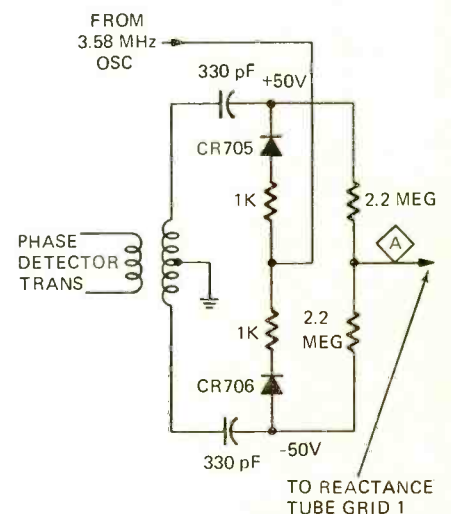

to produce the waveforms. Scope them at the grids of the picture tube.

Most service scopes measure peak-to-peak voltages. For an ordinary large-screen color tube, B - Y is around 140 volts p-p, R - Y about 120 volts p-p, and G - Y about 40 volts p-p.

Weak or missing blue, due perhaps to failure of the B - Y color-difference amplifier, leaves only red and green color bars on the screen. The left half is red, the right half is green. This might

(Continued on page 77)

OP-AMPS AT WORK

10 audio circuits

by B. R. ROGEN

WHEN THE OUTPUT OF AN OP AMP is directly proportional to the input, it is operating in a linear mode. And, we have learned in these past articles, that by selecting the feedback network judiciously, we can make the op amp do almost anything that we want it to. We are now going to apply some of our basic op amp know-how to various types of audio circuits, where the op amp can be used to make a low-component-count, almost noise-free, and better circuit than one of discrete semiconductor types.

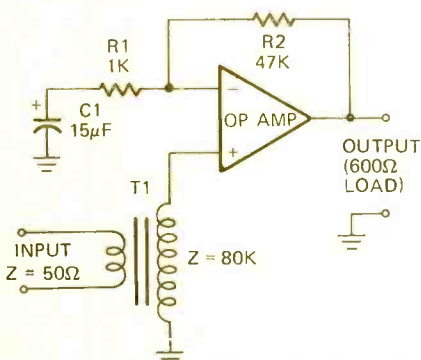

FIG. 1—THE BASIC LINEAR CIRCUIT, used here as a microphone-to-line preamplifier.

A basic linear amplifier such as that shown in Fig. 1 will make a good start. In this circuit, input transformer T1 steps up the voltage from the microphone by a factor of 40. This approach reduces the overall noise because the noise is the product of the transformer plus amplifier noise divided by the noise of the transformer. The amplifier overall gain is determined by $(R1R2)/(R1 + R2)$ remembering that capacitor C1 acts as an almost perfect audio bypass. In fact, the low-end 3-dB point is determined by R1 and C1 to produce a 10 Hz rolloff. The gain of the amplifier shown is approximately 1,000

(60 dB). The same circuit may be used as a variable-reluctance cartridge amplifier simply by connecting the cartridge between the non-inverting (plus) input of the op amp and ground. You can also connect a dynamic microphone in the same fashion.

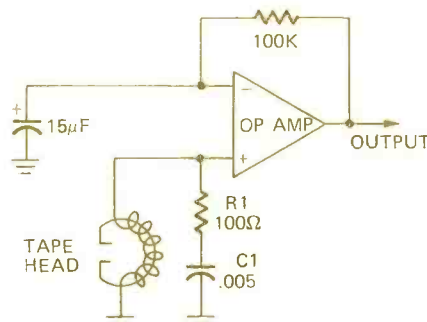

FIG. 2—A TAPE HEAD PREAMPLIFIER.

A low-noise high-quality tape-head preamplifier, appears in Fig. 2. Here the tape head is connected between the non-inverting input and ground. To remove any tendency for the tape head to self-oscillate, R1 and C1 (which do not affect the frequency response) have been added. To get the maximum gain from the op amp, the resistor at the inverting (-) input is removed, and the op amp operates at full gain.

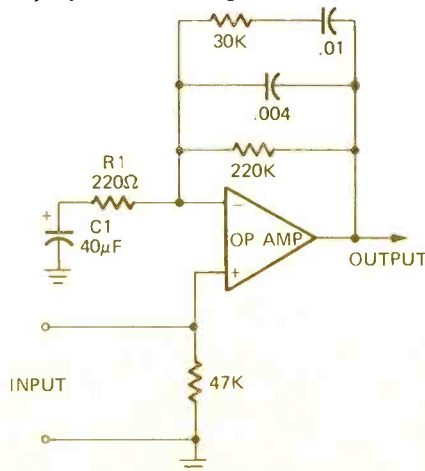

FIG. 3—RIAA DISC RECORD EQUALIZER.

An RIAA equalization preamplifier is shown in Fig. 3. The low-frequency break point is determined by R1 and C1 to produce a 6-dB per octave shelving off below 20 Hz. The feedback network around the op amp has a break frequency of 50 Hz going down at 6 dB per octave to about 2 kHz, where the circuit takes over and flattens out the curve until about 30 kHz where it once again shelves off at about 6 dB per octave. If you want a non-critical, yet good version, use a .005-μF capacitor in parallel with a 220,000-ohm resistor as the total feedback network.

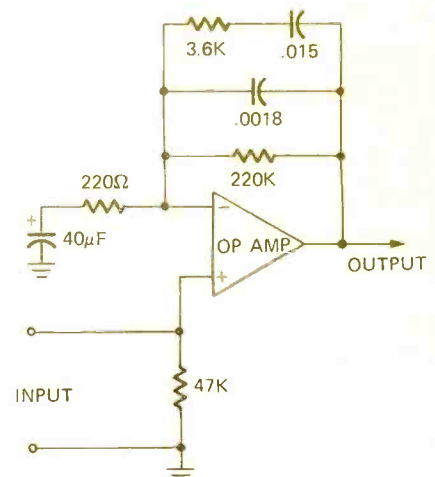

FIG. 4—NAB EQUALIZER, FOR TAPES.

The NAB tape equalizer in Fig. 4 is very similar to the RIAA equalizer except for the feedback network. In this case, the low-frequency break point is about 20 Hz, and the first upper break is at 50 Hz where the amplitude starts dropping at 6 dB per octave to 500 Hz.

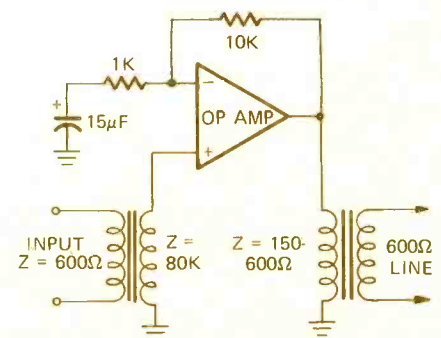
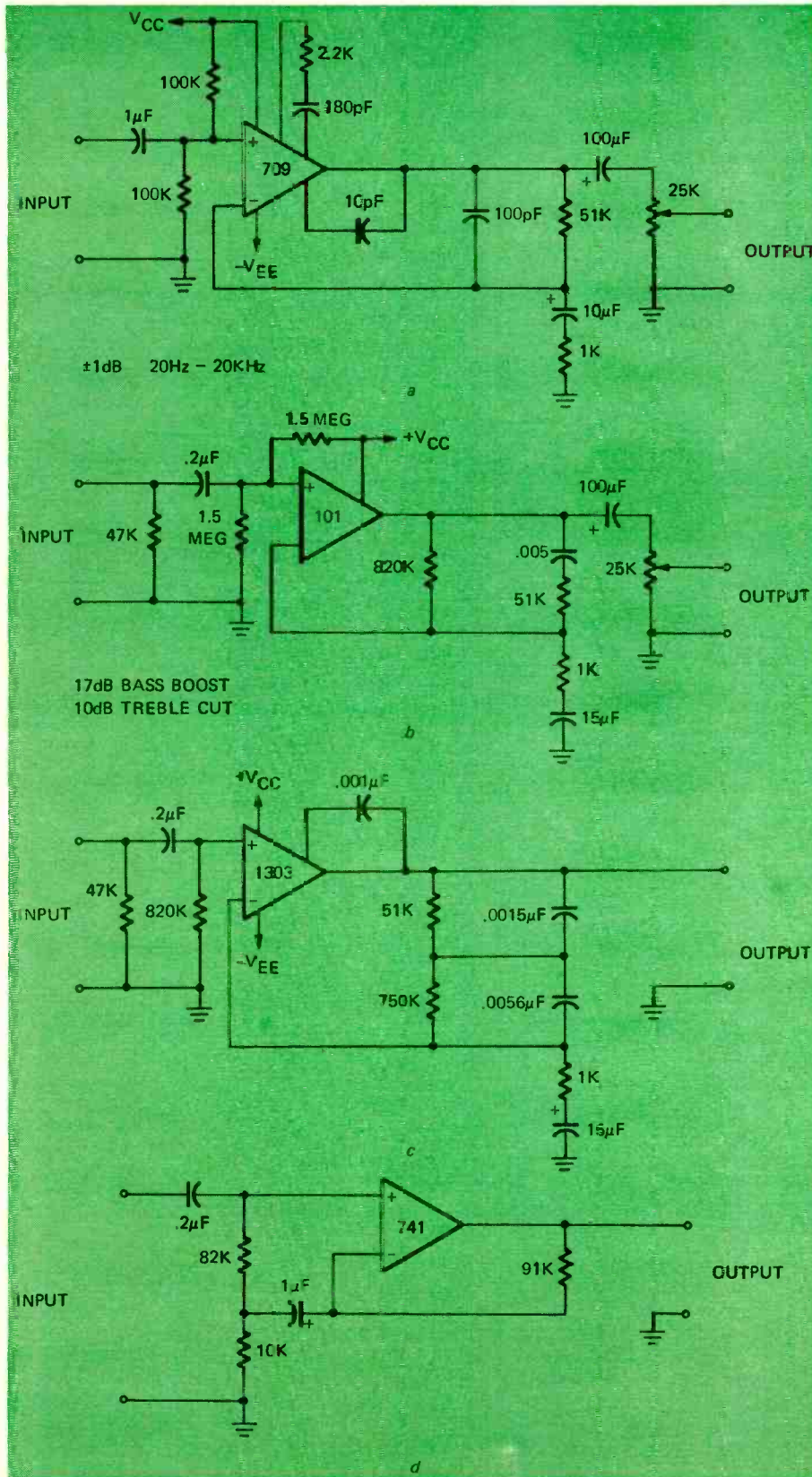

FIG. 5—LINE DRIVER (600-600 ohms).

There's a tape head preamp; an RIAA disc record equalizer; a line driver; a mike preamp; a crystal cartridge preamp; a unique tone-control circuit and five others



At this point the gain remains constant till 2 kHz, then drops at 6 dB per octave. Like the RIAA circuit, if you want a non-critical use, substitute a .002- μ F capacitor in parallel with a 220,000-ohm resistor as the total feedback network.

To drive an audio line of the standard 600-ohm), use the line driver in Fig. 5. The circuit should be familiar. If you want to increase the output level, make the primary of the output transformer about 150 ohms.

A group of audio op amp circuits appears in Fig. 6. In a is shown a microphone preamplifier with a flat response from 20 Hz to 20 kHz; b shows a tape head preamplifier having the required frequency tailoring; c illustrates a compensated magnetic cartridge pre-

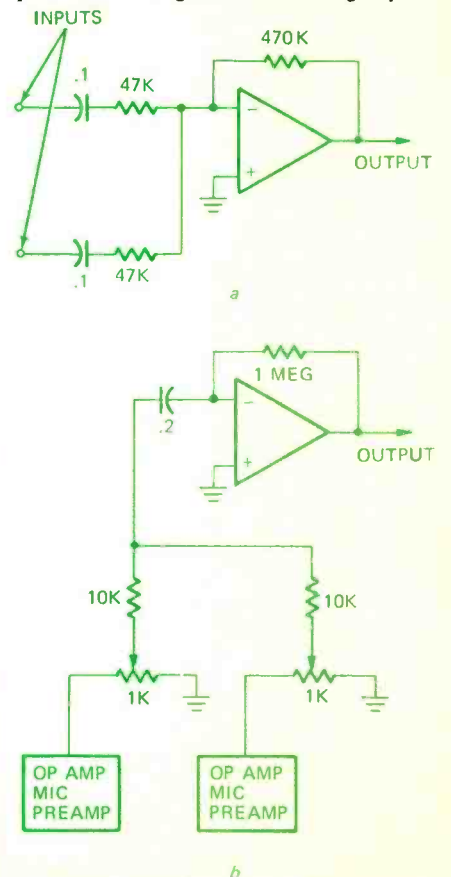

FIG. 7—(above) TWO AUDIO MIXING CIRCUITS. 7-a is a simple audio mixer; 7-b combines a number of the mike amplifiers of Fig. 1.

FIG. 6—(left) OP AMP AUDIO CIRCUITRY. a—mike preamp flat from 20 Hz to 20 kHz; b—an equalized tape head amplifier; c—a compensated magnetic cartridge preamp; d—a high-impedance preamplifier for use with a crystal cartridge.

amplifier, while **d** shows a high input impedance preamp for a crystal cartridge. Note that other than the 709 can be used in audio circuits.

To mix a bunch of audio signals, Fig. 7 shows a couple of approaches. In **a**, a number of inputs can be fed to a single op amp where they will all be combined. In **b**, a large number of op amp mike amplifiers (see elsewhere in this article) can be coupled to an op amp mixer or summer. The summer op amp can be operated with gain, unity gain, or less-than-1 gain, depending on the feedback resistor. The coupling capacitor removes any dc offset that might be present from any of the amplifier op amps.

Unique Tone Control, In the usual bass and treble controls found in audio systems, the maximum benefit is at the ends of the audio spectrum. When using either the bass or treble control, you have no control over just where in the spectrum you want the boost or cut. The

frequency of a 6-dB-per-octave slope in accordance with the name of the control. For example; as greater treble boost is brought in, with all other controls flat, the 6-dB-per-octave treble boost curve is brought down in frequency. In this way, you could start the treble boost at 5 kHz and have 12 dB boost at 20 kHz, or start at 500 Hz and get about 36 dB of boost at 20 kHz. You can then bring in the treble cut as desired, and where the two curves meet and pass over each other, the result is a flat curve which can be shifted up and down the spectrum as desired. The bass controls act the same way but at the low end of the spectrum. Because of the low input impedance of the cut filters, an emitter follower is used to drive the op amp. If you run a frequency response test, any slight "bumps" at the end of the spectrum can possibly be reduced by changing the value of the 270-ohm resistor of the filter coming from the

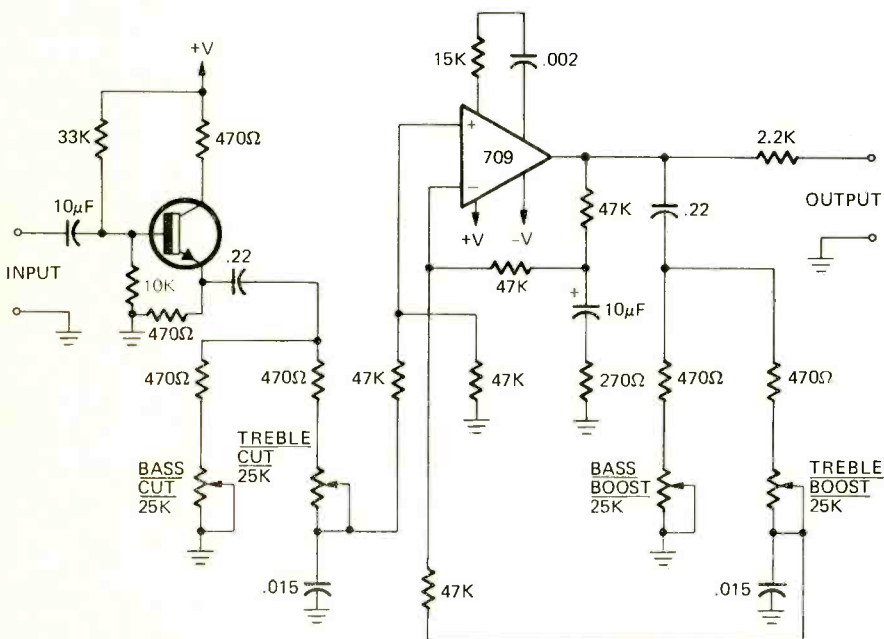

FIG. 8—UNIQUE TONE-CONTROL CIRCUIT gives you four separate tone controls for maximum versatility. Each tone control affects a different part of the response curve.

circuit shown in Fig. 8 is unique in that you can rig the bass and treble cut and boost controls so that you can not only control how much boost or cut, but pretty much call the turnover frequency. This is a form of graphic equalizer circuit and can be used (for example) to boost only the low frequencies below the point at which the speaker falls off. It also makes an excellent "presence" filter, or can be used to set up almost any type of frequency response curve you want without the ringing associated with a number of equalizers.

The circuit uses four filters, each having its own control with the cut filters positioned before the op amp, and the boost filters in the op amp feedback circuit. Each controls the 3-dB fre-

output of the op amp.

Once you get used to the idea of having *four* tone controls, you might find this circuit far more useful than any other tone control you have encountered in the past.

Such a circuit would be difficult to mechanize using discrete components, as the amplifier must deliver at least 36 dB of gain across the spectrum. **R-E**

MORE TO COME

We will be presenting three more articles on op-amp uses. One will cover biomedical circuits; the second will describe an assortment of active-filter circuits; and the third is a roundup of "oddball" op-amp uses. Don't miss them.

AUTO RADIO SPEAKER REPLACEMENT

Automobile speakers mounted face up either in the dash or the rear deck are particularly susceptible to deterioration. Temperature and moisture extremes are rough on these speakers, especially if the speaker has an oval-shaped cone, as most of them do.

What usually happens under these conditions is that the voice coil is pulled out of round by the oval speaker cone. Expansion and contraction produces unequal forces on the voice coil assembly as shown in the drawing. The solution, of course, is to use a round replacement speaker to keep physical distortion of the voice coil at a minimum.

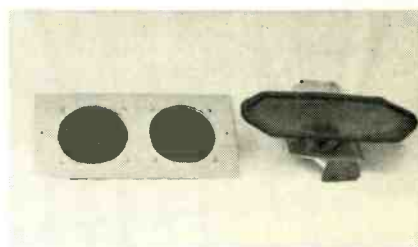

Better yet, use *two* round speakers to fill the speaker opening. You will have to make a speaker baffle out of cardboard or thin plywood as shown in the photo and in some cases exercise a little ingenuity in mounting the new speaker assembly, but the trouble-free service is well worth the effort.

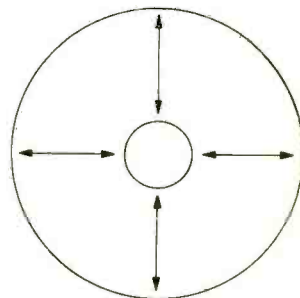

EQUAL FORCES

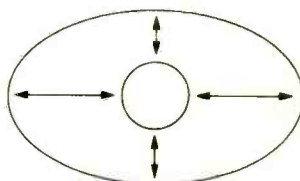

UNEQUAL FORCES

For a nominal load impedance of 3 or 4 ohms use two 8-ohm speakers in parallel. For a nominal load impedance of 6-8 ohms use two 3- or four-ohm speakers in series. The load impedance requirements are not critical. Two 4- or 5-inch speakers will serve as a replacement for the usual 5x7-inch speaker.—*F. J. Bauer* **R-E**

the state of

SOLID STATE

*Christmas shopping suggestions, circuits from readers, a dvm on a chip,
and device/product news of new IC's and semiconductors*

by LOU GARNER
SEMICONDUCTOR EDITOR

THE HOLIDAY SEASON BRINGS WITH IT the usually pleasant, but sometimes frustrating, chore of choosing gifts for one's relatives, friends, neighbors, business associates, and, if a student, school chums. Of course, when it comes to giving, some people stop at nothing, but if you'd like to do better than that, you might consider solid-state-operated products for your gift list. Using the catalogs issued by the larger electronics distributors as guides, it is possible to select gifts for almost everyone at virtually every price level.

For our purposes, we like to use the catalogs published by *Radio Shack* (2725 West 7th St., Fort Worth, Texas 76107); *Lafayette Radio Electronics* (111 Jericho Turnpike, Syosset, L. I., N.Y. 11791); *Olson Electronics* (260 S. Forge St., Akron, Ohio 44327); and the *Heath Company* (Benton Harbor, Mich. 49022).

Stuck for an "under \$5.00" gift? An AM transistor radio is almost always a good choice. All the catalogs offer receivers in this bracket. If you'd like to add a truly personal touch to your gift, however, you might assemble a reading or table lamp for that special someone using a solid-state lamp dimmer socket. This inexpensive (under \$5) device features a compact triac circuit and continuous control via a miniature potentiometer, and can be used either for new lamp construction (use an interesting wine bottle, varnished block of wood, or whatever strikes your fancy as a base) or for replacement of an old-fashioned switch type socket.

If your intended recipient is a sub-teen who's a budding scientist or engineer, you could select one of Radio Shack's *Science Fair* kits. Ranging in price from less than two dollars to \$24.95 for a 100-in-1 Electronic Project Kit featuring an integrated circuit, these kits are suitable for hobbyists into their

teens. Similar items are available from the other catalogs.

Perhaps you'd prefer something a little more difficult for the more sophisticated experimenter who would rather "roll his own" project, but still within a limited budget? Then you might consider one of the solid-state experimenter's modules. Offered at prices from as little as \$1.49 for a guitar amplifier, wireless code oscillator, or guitar tremolo module to as much \$5.00 for various shortwave and vhf converter modules, these encapsulated circuit elements are used with external accessories such as telegraph keys, batteries, loudspeakers, microphones, potentiometers, and switches to assemble complete functioning projects. The builder can exercise his imagination and skill in selecting a suitable housing and creating his final design.

If you can afford to spend up to twenty dollars for each gift, your choice widens considerably. An FM wireless microphone is a good "fun" gift at about \$20.00, or you might choose a portable solid-state cassette recorder in the same price range. A thoughtful family gift would be a Disaster Alarm Kit. This instrument can be a real life-saver. Featuring a gas-sensing semiconductor device, the Disaster Alarm will respond to isobutane, methane, or other ionized gases, even smoke, alerting the household with a loud buzzer alarm. If your intended recipient is interested in automobiles, or simply owns one, consider an Automobile Alarm System Kit (about \$15), an Automatic Windshield Wiper Delay Control Kit (about \$15) or a solid-state tachometer.

With the next bracket—gifts up to fifty dollars—you should be able to find something to please almost everyone, even the legendary person who "has everything." For the outdoorsman, you might choose a sensitive metal detector

(about \$35). Your hobbyist friends undoubtedly would appreciate a variable dc power supply capable of furnishing from 0 to 24 volts at currents of up to 1 ampere (about \$30).

We can't think of anyone who would refuse an all solid-state FM/AM/police/aircraft receiver (about \$50). If you're looking for a family gift, then you might take note of the rising crime rate and present your favorite family with a Security System (\$40 and up). Another good under fifty choice, which should be welcomed by travellers and stay-at-homes alike, would be an FM/AM travel clock radio.

Should your financial resources be large and your heart generous, your only considerations need be the interests and desires of your intended recipient—you might give a complete high-quality stereo system, for example, a solid-state color TV receiver, or even a video tape recording system. At a more modest level, however, our personal choice of gifts between, say, fifty and one hundred and fifty dollars would be either of two new state-of-the-art products . . . a compact cassette tape recorder or a pocket-sized portable electronic calculator. Either gift should be suitable for students, housewives, authors, storekeepers, engineers, technicians, salesmen, scientists, architects, accountants, or business or professional men and women—anyone, in fact, who may have occasion to make verbal notes and lists, to conduct interviews, or to perform mathematical calculations, whether totalling a grocery bill, determining income tax liability, figuring installment payments, or designing a machine, building, road, bridge, or electronic circuit.

Regardless of which gifts you choose, remember that your care in picking the item best suited to your re-

(continued on page 66)

How to become a “Non-Degree Engineer”

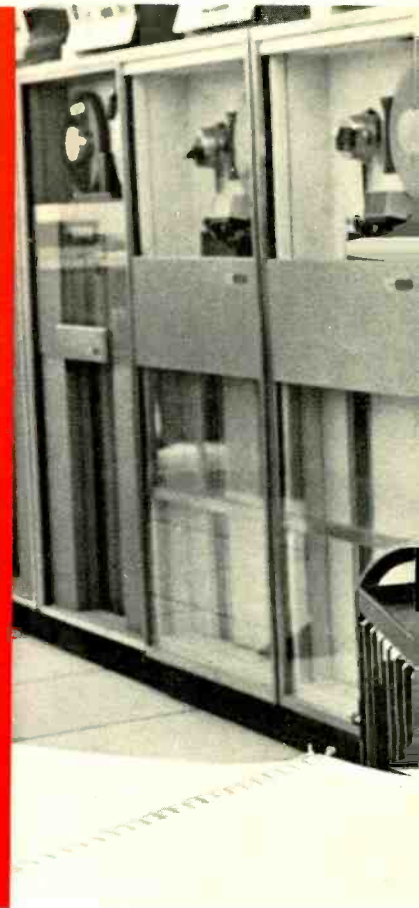

Exciting careers in the new industries of the Seventies are waiting for men with up-to-date electronics training. Thousands of engineering jobs are being filled by men without engineering degrees — provided they are thoroughly trained in basic electronic theory and modern application. The pay is good, the future is bright...and the training can now be acquired at home — in your spare time.

ELECTRONICS, The Science of the Seventies, has created a new breed of professional man — the “non-degree engineer.” Because industries depend on them to meet emergencies, move in and keep things running, they get top pay — and a title to match. At Xerox they’re called Technical Representatives. At IBM they’re Customer Engineers. In radio and TV, they’re the Broadcast Engineers.

But these men must know more than how to solder a connection, or test circuits or replace components. They need to know the fundamentals of Electronics and how to apply them.

How can you pick up this necessary knowledge? Many of today’s non-degree engineers earned their electronics diplomas at home from Cleveland Institute of Electronics.

7 Electronics Courses to Choose From

CIE is the largest home-study school in the U. S. specializing exclusively in Electronics. The seven CIE career courses provide solid preparation for nearly every career field in Electronics today.

The Electronics Technology with Laboratory Course teaches you fundamentals. With a 161-piece space-age laboratory, you apply the principles you learn by analyzing and troubleshooting electronics equipment.

If an FCC License is your goal, five of our courses prepare you to take the Government FCC License exam. For the man already working in Electronics, CIE offers a college-level Electronics Engineering Course.

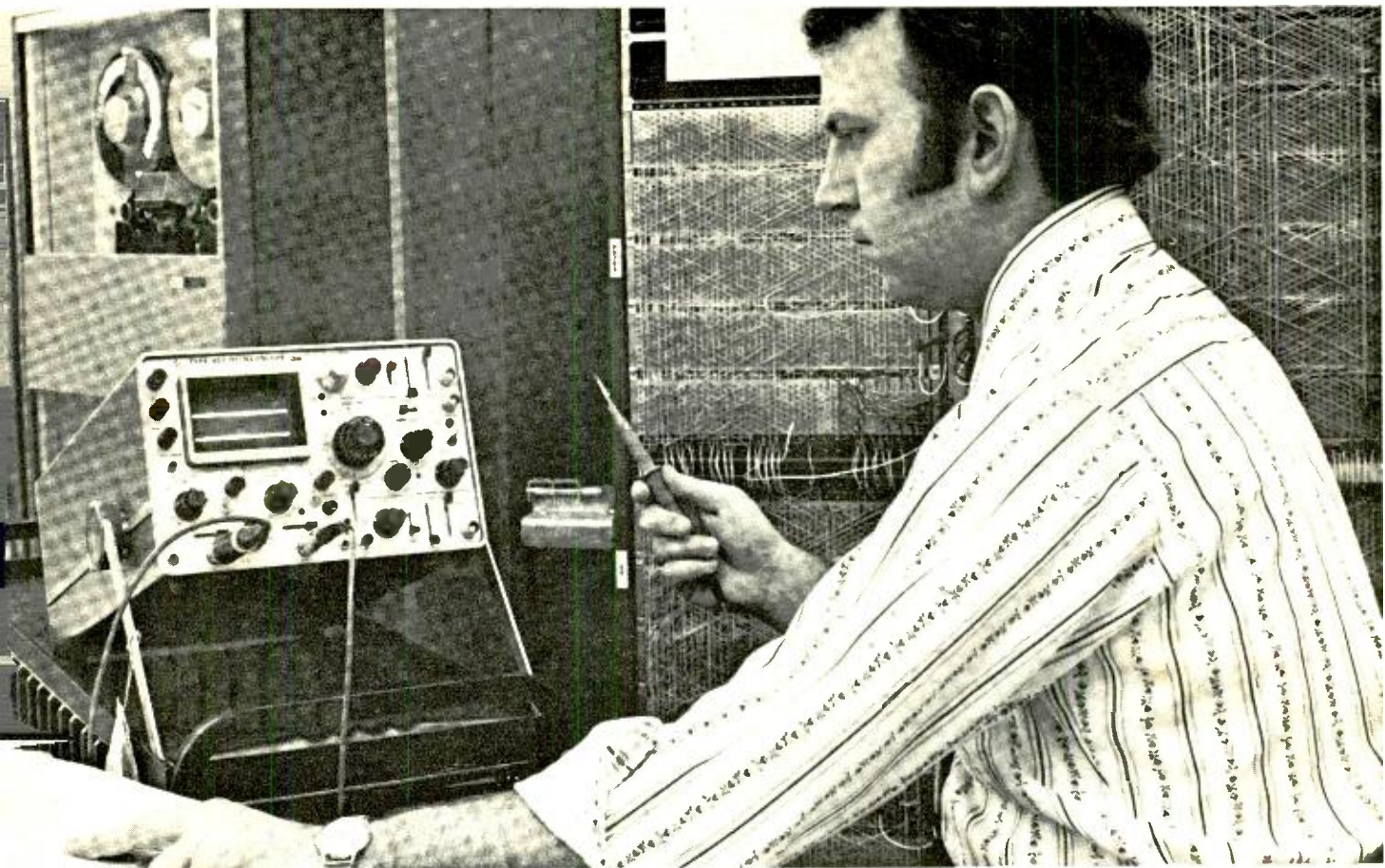

CIE Home-Study Method Works

Whatever CIE course you select, you can learn in your spare time while holding down your present job. Over the last 37 years, CIE has developed techniques that make learning at home effective even if you once had trouble studying. CIE's special Auto-Programmed® Lessons help you learn faster and easier than you'd believe possible.

The CIE Instruction Department gives immediate attention to the lesson examinations you send in. Your work is not only graded, it is analyzed. The corrected examination, complete with comments and suggestions, is mailed back to you the same day it is graded so that the lesson is still fresh in your mind.

If you have a special question, it will be referred to the most qualified instructor on the subject. You get the benefit, then, of the combined training and experience of the entire CIE Instruction Department.

Authorities feel that home study is the best way. *Popular Electronics* magazine says: "By its very nature, home study develops your ability to analyze and extract information as well as to strengthen your sense of responsibility and initiative."

Money-Back FCC License Warranty

CIE's home-study courses are so successful that, in a recent survey of 787 CIE graduates, better than 9 out of 10 CIE grads passed the FCC License exam. That's why we can offer our famous Money-Back Warranty: when you complete any CIE licensing course, you'll be able to pass your FCC exam or be entitled

to a full refund of all tuition paid. This warranty is valid during the completion time allowed for your course. You get your FCC License — or your money back!

Students who have good jobs in Electronics often comment on how much they learned from CIE. Says Joe Perry, Cambridge, Mass., Engineering Specialist at National Radio Co., "CIE training gave me the technology I needed to understand many of the electronic concepts I never dreamed I could learn. I'm already earning 30% to 40% more than I could have without my CIE training."

Richard Kihn, Anahuac, Texas, passed the Government exam for his 1st Class FCC License *before* finishing his CIE course. He landed a job as broadcast engineer at KFDM-TV in Beaumont, Texas. "I was able to work, complete my CIE course and get two raises. . . all in the first year of my new career in broadcasting."

FREE Book Can Help You

Thousands of men got started in Electronics by sending for our school catalog, "Succeed in Electronics." It tells of many non-degree engineering jobs and other electronics careers open to men with the proper training. And it tells which courses of study will best prepare you for the career you want.

Let us send you this interesting book FREE. Just fill out and mail the reply card. For your convenience, we will try to have a representative call. If card has been removed, mail coupon or write: Cleveland Institute of Electronics, Inc., 1776 E. 17th St., Cleveland, Ohio 44114.

APPROVED UNDER G.I. BILL

All CIE career courses are approved for educational benefits under the G.I. Bill. If you are a Veteran or in service now, check box for G.I. Bill information.

CIE
Cleveland Institute of Electronics, Inc.
 1776 East 17th Street
 Cleveland, Ohio 44114

Accredited Member National Home Study Council

Please send me your two FREE books:

1. Your school catalog, "Succeed in Electronics."
2. Your book on "How To Get A Commercial FCC License."

I am especially interested in:

- Electronics Technology
- Electronics Technology with Laboratory
- Broadcast Engineering
- First Class FCC License
- Electronic Communications
- Industrial Electronics
- Electronics Engineering

Name _____
(please print)

Address _____

City _____

State _____

Zip _____ Age _____

Veterans and Servicemen:
 Check here for G.I. Bill information.

RE-11

Circle 15 on reader service card

STATE OF SOLID STATE

(continued from page 61)

recipient's interests and desires is more important than the gift's cash value.

All prices quoted are from current catalogs. Mailing costs, local or state sales taxes, and optional accessories are extra.

Our readers respond

We've received letters from a number of readers expressing interest in the complementary amplifier/oscillator circuit described in our September column. Most of the letters described adaptations and modifications of the basic design for specialized applications. Two of the more interesting circuits are illustrated.

Joe DeRosa (365 Willow Ave., Long Branch, N.J. 07740) submitted the electronic siren circuit shown in Fig. 1.

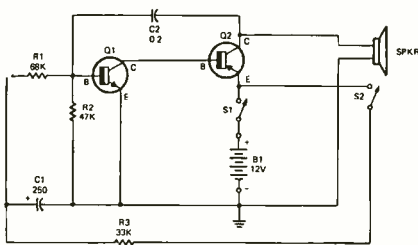

FIG. 1—SIMPLE SOLID STATE SIREN CIRCUIT suggested by reader Joe DeRosa.

He writes that he developed it as an inexpensive substitute for an electromechanical siren in an automotive burglar alarm system used in a friend's car. He assembled his model on perf-board and encapsulated it in epoxy for maximum protection.

Referring to the schematic, Joe's principal modification of the basic design is the addition of an RC circuit (R1-R2-R3-C1) to vary Q1's base bias in accordance with the changing instantaneous voltage of a charging capacitor, thus causing a corresponding change in the circuit's repetition rate (frequency) and simulating the changing pitch characteristic of a siren.

Joe used standard components in

his design. Q1 is a general purpose *nnp* small signal transistor, while Q2 is a *pnnp* power type. All resistors are half-watt units. C1 is a 250- μ F 15-volt electrolytic, C2 a 0.2- μ F low-voltage ceramic or Mylar capacitor. An 8-ohm PM loudspeaker is used. Spst switch S1 serves as the master power switch, while S2 is used to initiate siren operation. The power supply, B1, may be either a car's 12-volt battery or, for other applications, a power pack made up of eight series-wired flashlight cells or two 6-volt lantern batteries.

In a letter commenting on the amplifier version of the original complementary circuit, reader Reinhard Metz (9 S. 705 Barkdoll Rd., Naperville, Ill. 60540) has observed—correctly—that the basic design has low input impedance, poor temperature stability, and is intolerant of slight overloads, despite its extreme simplicity, high output impedance, and very high gain characteristics. These shortcomings can be overcome quite easily, however, albeit at some loss of gain, by providing stabilized base bias and adding inverse feedback. Reinhard suggests the modified circuit given in Fig. 2 for more critical applications, indicating he has used it a number of times as a line, tape, or tone control driver in audio systems.

In operation, divider R1-R2, in conjunction with tapped emitter resistor R4-R5, stabilizes Q1's base bias. Inverse feedback is provided by the unbypassed emitter resistor, while R3 serves to stabilize Q2's base bias. C1 and C2 serve simply as dc blocking capacitors.

For practical applications, Reinhard suggests type 2N3645 for Q1, type 2N6008 for Q2. The resistors are half-watt types and C1 and C2 25 to 50 volt dc power supply (B1) used, controlled by spst switch S1.

According to reader Reinhard, his tests, made with high-quality laboratory equipment, indicate that the specified circuit has a virtually flat frequency response to 500 kHz and a total harmonic distortion of less than 0.05%, while furnishing a voltage gain of approximately 10 and relatively high input impedance.

He recommends it for both preamp and line driver applications.

Device/product news

A new line of low-cost hybrid IC uhf/vhf broadband amplifiers has been introduced by the Amperex Electronic Corporation (Solid State & Active Devices Division, Slatersville, R.I. 02876). Designed for MATV/CATV systems, the devices are intended for use in antenna amplifiers and signal processors, but can be employed wherever a design calls for high gain and low distortion between 40 and 890 MHz. Four types are currently available. The ATF415 and ATF419 deliver 16 dB gain \pm 1 dB between 40 and 890 MHz, with a VSWR of 2.0 at the input and 1.8 at the output. Noise figure of the ATF415 is only 4 dB; output is 30 mV at -60 dB intermodulation distortion. The ATF419 has a rated noise figure of 6 dB, with an output of 60 mV at -60 dB intermodulation distortion. Type ATF417 is a high-gain device, furnishing 26 dB \pm 1 dB gain from 40 to 890 MHz; its noise figure is 4 dB; VSWR is 2.0 at the input and 1.8 at the output. Finally, the ATF414, illustrated in Fig. 3, offers an

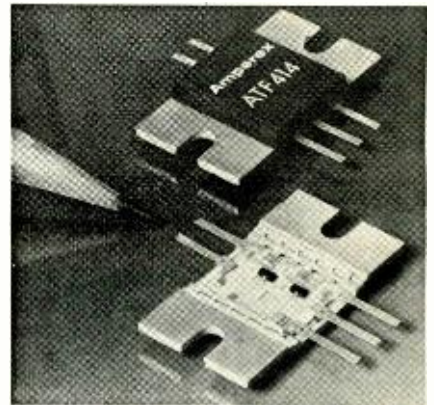

FIG. 3—NEW HYBRID IC UHF/VHF AMPLIFIERS introduced by Amperex for MATV/CATV applications.

extremely flat gain of 15 ± 0.5 dB over the same frequency range; its noise figure is 7 dB with a VSWR of 1.5 at both input and output. As shown, the ATF414 is packaged on a small metal heat sink, while the other three devices are offered in plastic encapsulations. All four devices are intended for operation on a standard 24-volt dc supply and have a rated operational temperature range from -25°C to 70°C.

DVM on a chip

A complete digital voltmeter on a single IC chip? Not quite, but almost. Fairchild's Semiconductor Components Group (464 Ellis St., Mountain View, CA 94040) is now producing a MOS IC that combines all the logic functions of a 4.5-decade DVM in a single array. Designated type A7R 3814 19X, the new device operates from dc to 600

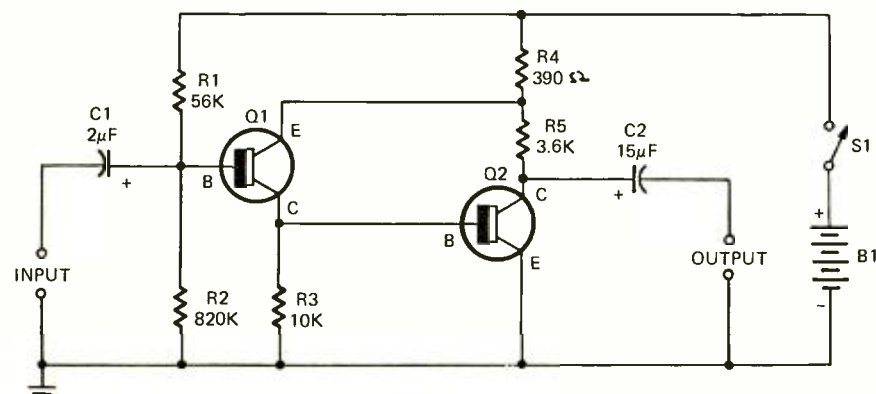

FIG. 2—STABILIZED COMPLEMENTARY AMPLIFIER circuit submitted by reader Reinhard Metz.

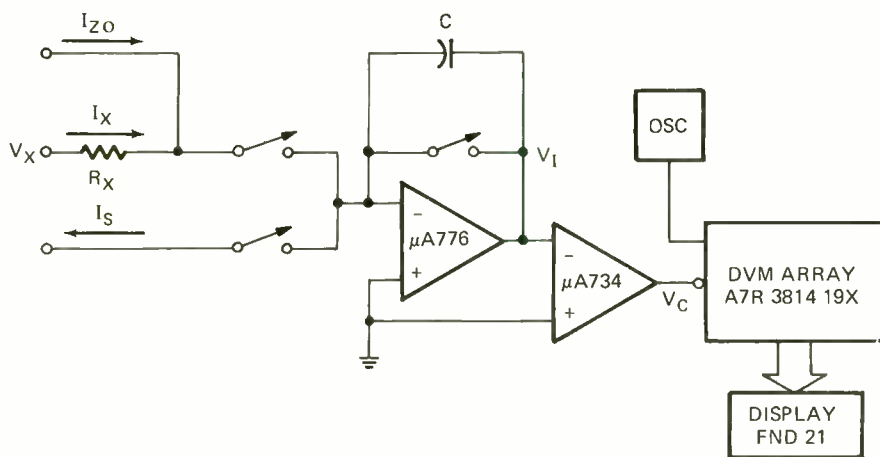

FIG. 4—SIMPLIFIED SCHEMATIC ILLUSTRATING use of Fairchild's 3814 DVM logic array in a digital voltmeter.

MHz and interfaces directly with TTL logic. All that's needed to assemble a DVM with the 3814 are a couple of amplifiers, an oscillator, a multiplex display module such as the FND 21, a few resistors and capacitors, a couple of switches, and a suitable dc power supply. A simplified schematic of a DVM using the 3814 is given in Fig. 4; more complete details are furnished in the Application Note and data sheets.

Special translation circuits are needed in any system composed of differing logic families, such as a computer and its peripheral equipment (see Fig. 5), to convert back and forth between

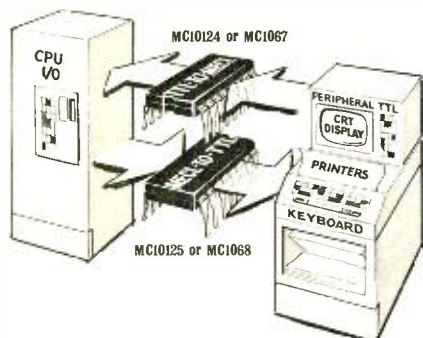

FIG. 5—AS SHOWN HERE, MOTOROLA'S NEW logic translator IC's can be used to interface between TTL and MECL systems.

differing voltage and current levels. Recognizing this, Motorola Semiconductor Products, Inc. (P.O. Box 20912, Phoenix, Ariz. 85036) has introduced a series of four new IC devices designed to serve as translators between TTL and MECL logic families. Types MC10124 and MC10125 are intended for interface between TTL and the MECL 10,000 Series systems, while types MC1067/1267 and MC1068/1268 are specified for corresponding applications between TTL and MECL II Series families. Types MC10124 and MC1067/1267 are designed as TTL in, MECL out translators; types MC10125 and MC1068/1268 are MECL in, TTL out translators. All four devices are supplied in 16-pin dual in-line packages.

More good news from RCA's Solid State Division (Route 202, Somerville, NJ 08876). Last month, you may recall, we announced joyfully that RCA had reduced prices on its entire line of commercial COS/MOS IC's. Our friends in Jersey have now topped themselves by announcing corresponding reductions in the prices of some 16 types of linear IC's, including such popular units as the CA3085 positive voltage regulator, CA3741CT high-gain operational amplifier, and CA3060E operational amplifier array.

Down south, the good guys at Texas Instruments, Inc. (P.O. Box 5012, M/S 308, Dallas, Tex. 75222) have introduced a number of new IC's, including two new TTL hex and quad Schmitt-trigger devices and a pair of TTL quad bus buffer gates. The Schmitt-trigger IC's are designed specifically for interface between unsuitable input waveforms and TTL inputs, while the quad bus buffer gates (Fig. 6) are in-

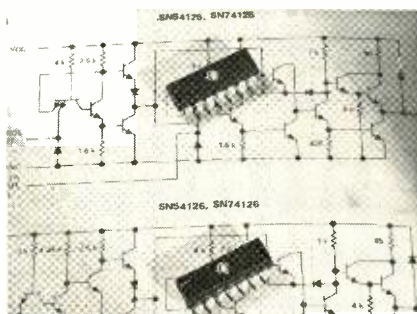

FIG. 6—NEW TTL QUAD BUS BUFFER GATE IC's recently introduced by Texas Instruments.

tended for interfacing directly with the data-bus in a bus-organized system. All four devices are supplied in standard 14-pin DIPs. The hex Schmitt trigger, designated type SN54/7414, features six interface circuits in a single package, each having a typical delay time of only 15 nanoseconds and a dissipation of but 25 mW. With similar delay times and dissipation ratings, the quad Schmitt trigger, type SN54/74132, provides four 2-input NAND interface circuits. The

quad bus buffer gates, types SN54/74125 and SN54/74126, feature tri-state outputs which can be enabled or disabled individually by separate control inputs; with the exception of this control, each circuit is simply a non-inverting data buffer for use between standard TTL outputs and a system bus. The output of the 125 is enabled when the control input is low, the 126 when its control is high; conversely, opposite logic levels disable the respective outputs.

That covers the solid state story for December—now you can relax and have fun—HAPPY HOLIDAYS!!! R-E

CHEVROLET 985159, 985315

This car radio developed an annoying intermittent after playing normally for about ten minutes—less on a hot day. It would suddenly get very loud and distorted. The first attempt at diagnosis was negative; the problem would not repeat on the bench, even with heat applied from a hair dryer.

Months later, as the problem occurred more and more frequently, the set was pulled into the shop again. This

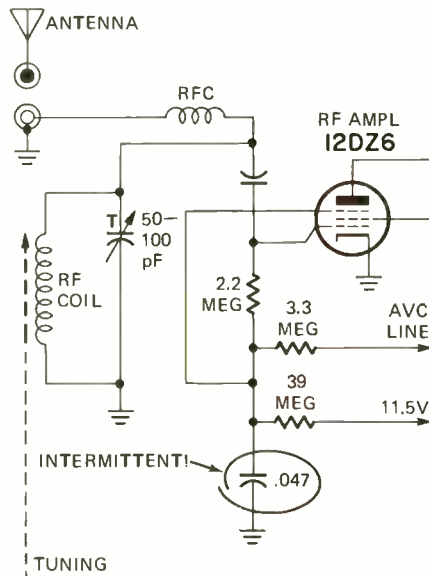

time, persistent testing with a voltmeter and futile replacement of a couple of resistors finally revealed an intermittent short in C3, the avc filter capacitor in the rf amplifier circuit. Replacement cured the problem.

The symptom of loud, distorted output was never duplicated on the bench because the short indoor antenna used did not provide as large a signal as the radio received in the car.—Donald R. Hicke R-E



R-E's Service Clinic

Troubleshooting problem—unexpected

Wattless current produces bugs in old troubleshooting kink

by JACK DARR
SERVICE EDITOR

QUITE A LONG TIME AGO, I "INVENTED" an emergency wattmeter. I used this in a couple of books, and many articles. It consists of a 1-ohm resistor with an ac voltmeter hooked across it. Connect this in the primary of the ac power supply and it will indicate 1 volt for each 1 ampere of current. Theoretically, this is an *Automatic Ohm's Law Calculator*.

If you know the current, you can easily figure the wattage by multiplying by the line voltage. I tried it out on my bench on several different kinds of equipment and found it worked very well. For a check, I compared the readings against my pet wattmeter fed through an isolation transformer. It checked very closely.

However, I got a letter a few weeks ago from a reader, giving me fits because my "wattmeter" didn't work. He had used it in another one of my pet tests, for shorts in power transformers. This consists of disconnecting all loads from the transformer, then plugging it into a wattmeter. If the transformer is good, you'll see only a very small reading, about 3 to 4 watts. This is the iron-loss of the transformer. If it has a shorted turn, you'll get a high reading, usually from 50 watts on up.

The irate reader claimed that he had tried this out on a large guitar-amplifier transformer, and it showed him a reading of 35 watts. So, he ordered a new transformer. Before installation, he checked this one, and it too showed him a 35-watt reading. (The problem turned out to be a leaky filter capacitor.) This is neither here nor there, in relation to this problem, of course.

So I rushed to the shop, got out a couple of old power transformers from the junkbox, and proceeded to run some tests. No-load current on the professional wattmeter showed the right answer. Practically no reading at all. Checking the same transformer on the resistor/voltmeter setup *did show a much higher reading!* On an old Philco TV power transformer with about 3 inches of iron, I got a reading

of 0.62 V. Figuring this out, it is the equivalent of 74.4 watts! Another power transformer showed a reading of 0.3 volts, or 36 watts.

Oh, oh! Something *is* wrong, but what? The answer finally dawned on me. The professional wattmeter is a dynamometer movement, or a "true wattmeter." It has two coils; a current coil and a voltage coil, plus a resistor. The resistor helps to correct for any reactance; so this type of instrument will read the actual power drawn, without regard for its power factor.

The resistor-voltmeter setup is apparently being upset by the fact that an *unloaded* transformer primary winding is acting as a more or less "pure inductance." So it causes a phase shift between voltage and current, and the resistor-voltmeter wattmeter is reading what someone called "wattless current." (Current out of phase with voltage.) This is causing the voltmeter to show a reading.

Further checks, and many, many tests in the past, show that a power transformer *under load* shows the same reading with either instrument. The loading of the primary brings the voltage and current back to an in-phase condition. Tests on pure resistive loads showed exactly the same readings on both meters. Incandescent lamps, soldering irons, heating elements, and so on: all matched.

So I came to the conclusion that this one test—the no-load transformer check, was the only one where the resistor-voltmeter setup was in error; or any test where the current through a pure inductance must be measured, of course. Actual testing seems to bear this out.

So, if you're using this test, with the resistor-voltmeter wattmeter, remember this. On an unloaded, *unshorted* power transformer primary, your reading will be high. Higher than it ought to be, that is. If the transformer *is* shorted, you'll be able to tell, very easily. You'll get a full-scale reading of several volts, or many, many watts, a definite indication of trouble. Just for luck, you might check

This column is for your service problems—TV, radio, audio or general and industrial electronics. We answer all questions individually by mail, free of charge, and the more interesting ones will be printed here.

If you're really stuck, write us. We'll do our best to help you. Don't forget to enclose a stamped, self-addressed envelope. Write: Service Editor, Radio-Electronics, 200 Park Ave. South, New York 10003.

a couple of new power transformers and see what the reading is. As an average, this will be dependent on the thickness of the iron core. On the old, heavy power transformers, you'll probably see readings of 40 to 60 watts or more, due to the greater iron-loss. On the typical power transformer, it'll run somewhere around 30-40 watts.

There's a double-check you can always make on a suspected power transformer. Just plug it in, and let it sit there for about 10 minutes. If it's shorted, it will get very hot. A good transformer will be barely above room temperature.

My sincere thanks to the alert Irate Reader who spotted this for me. Because I do have the built-in bench wattmeter, I had never tried this one test with the resistor-voltmeter setup. Never occurred to me. However, with my customary perfect 20-20 hindsight, now I can see the reason for it. R-E

reader questions

POOR HIGH-VOLTAGE REGULATION

I seem to have a high-voltage regulation problem in this Zenith 19CC19 color TV chassis. The raster blooms when the brightness control is turned, the high voltage fluctuates from about 16 kV to 27 kV at the same time, and everything is messed up in general. The HV ADJUST

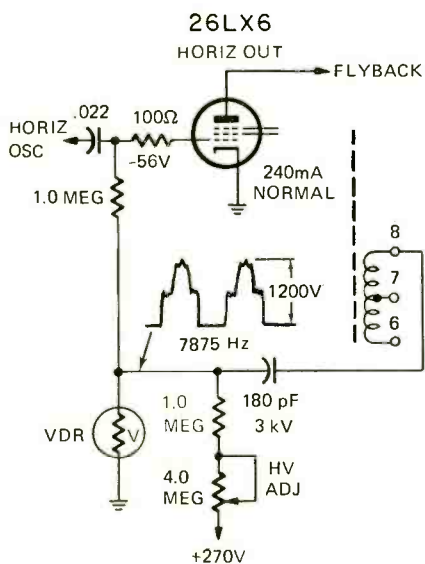

control has some effect, but the regulation is very bad. I don't see any high-voltage regulator in this one. —F.D., Ames, Okla.

There is no high-voltage regulator, of the type we're used to, in this circuit. They use a "rectified-pulse" system, that takes a 1200-volt pulse from the flyback, and feeds it to a network consisting of a VDR, with a "bucking-volt-

age from the +270 volt source (see diagram). This controls the grid bias, and so the conduction, of the horizontal output tube.

Check at the junction of the pulse-coupling capacitor, a 180-pF unit connected to No. 8 on the flyback, and the VDR. Be sure that the pulse is present, at the correct amplitude. (By the way, there's a typo in the factory service manual. This pulse is shown as waveform No. 54, at 500 volts peak-to-peak. It should be the same shape as waveforms 19 and 20, but at 1200 volts peak-to-peak.)

You could have one of two problems in this case. The 4.0-megohm high-

voltage adjustment control could be open, or the VDR could be open. Disconnect the control and check it. If the bucking voltage is not present from B+, which acts to clamp this bias voltage, you'll get wild fluctuations. To check the VDR, lift the ground end and connect a milliammeter in series. Vary voltage (HV ADJUST) and see if you get about 1.0 to 1.5 mA current; if so, OK.

VERY SLOW HEATER

I've a TV set with a set of really odd symptoms. Everything seems to be OK, but no high voltage. I went off and left it running with the high-voltage meter hooked up, and in about 15 minutes it

Leader

AUDIO TEST INSTRUMENTS

Now You Can Say Service... and Smile!



LV-77 FET MULTIMETER
Solid state dependability and stability plus high impedance—make this a fine general purpose meter. Has dual power supply—batteries and AC line. It's truly portable! $\pm 3\%$ full scale accuracy with easy to read, clearly marked face panel. \$109.95

LFM-30 TAPE SPEED/CHECKER
Checks tape dependability for speed and drift accuracy at 3KHz as well as 1, 2, 4, 5, 6, 7, 8 & 9KHz frequencies. 100MV to 10Vrms input level. $\pm 5\%$ end scale accuracy with -3% to $+3\%$ test range. Complete with carrying case. \$129.95

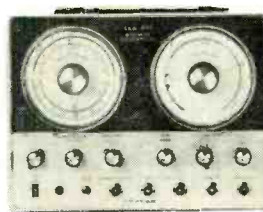

LSW-250 FM-TV SWEEP/MARKER GENERATOR
Use with any scope to test and service FM, TV and more. Has 2-260MHz freq. range, cont. adjustable, with calibrated markings for most often used bands. Marking method is post injection with external signal input provision. Highly stable and accurate. With accessories. \$309.95



LMV-89 2 CHAN. AC MILLIVOLT METER
Test stereo circuitry and 4-channel too—especially where differences exist in voltage at two separate points. $\pm 3\%$ full scale accuracy (1KHz); dB scale readings at 0dB=0.775V and 1V each. 2 chans., 100MV to 300V range in 12 steps. With separate pointers, individual switches, and amplifier systems. Both channels operate separately or together. \$229.95

Write for details. See your distributor.

The more you see... the more you believe... the more you save

Leader Instruments Corp. 37-27 Twenty-Seventh St. L.I.C., N.Y. 11101 (212) 729-7410

Circle 16 on reader service card

DECEMBER 1972 • RADIO-ELECTRONICS 69

started up. In about 2 hours it had gotten up to 5 kV. Later on, it came up a little faster.

Now, I can get a fair picture by running the ac line voltage up to 125 volts, but it still takes about 20 minutes to warm up.—L.F., Poughkeepsie, N.Y.

I'll tell you the exact truth; I haven't the faintest idea. However, you can get a good deal of information by reading the cathode current of the 6JE6. If it is very low at first, and gradually rises, this would indicate some problem in the dc voltages on the tube. A slow-heating damper tube could also do it, or an open (intermittent or thermal) boost capacitor.

This cathode current will be the key clue. Check it.

"FLICKER" IN CAR-TAPE PLAYER

I have a Panasonic 8-track auto tape player. Works fine in the car, but when I hooked it up to a home-made 12-volt dc power supply for use in the house, the pilot light flickers with the loudness of the music. It doesn't do this in the car.—F.V., San Francisco, Calif.

You've got a little voltage regulation problem. The flicker is due to voltage drop on loud passages in the music. In all Class-B transistor amplifiers, there is a great difference between the resting current (no signal) and full-volume current.

Your power supply will give you the right voltage under small load, but on loud passages the supply voltage is dropping, causing the flicker. Try using a bigger output filter capacitor; it may help. If not, you'll have to get a power supply with a greater current rating.

EMERGENCY REPAIR, OPEN CHOKE

A reader writes: I had no blue in the picture on my CTC-2 RCA. Check-

placement anywhere.

Looking at the schematic, I noted that this coil had a dc resistance of 11 ohms. Roughly figuring the reactance from this, I came out with about 12 ohms. Having nothing to lose, I put in a 10-ohm, 2-watt resistor in its place. Worked beautifully! Colors good, and everything lovely.

This might help out another technician in the same kind of jam. Leroy Brown, Baltimore, MD 21229

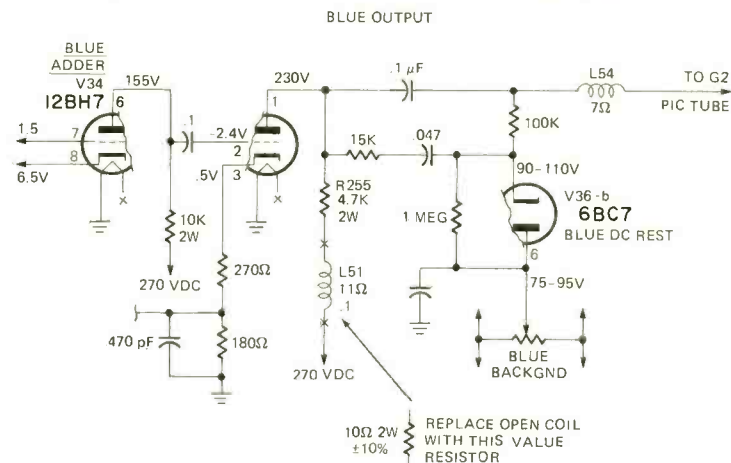

ing, I found that I had no plate voltage on the blue output tube. The choke, L51, was open. I tried to rewind it but it broke up on me. Couldn't find a re-

CIRCUIT BREAKERS TRIPPING

This has nothing to do with electronics, but I'm deeply confused! The two 50-ampere circuit breakers in the service entrance to my home trip at odd intervals. I called the power company the first time it happened, and they simply threw the breakers back on and everything was fine. I can't find anything that would cause this. It would take a big short somewhere to trip a 50-ampere breaker, wouldn't it? This could be dangerous.—R.A., Pine Bluffs, Ark.

Not a bad idea to be worried. However, it could have a simple explanation. Try this. Get a clamp-on ammeter from the power company or a friend. Open the entrance breaker box, and hook this around one of the hot wires. Don't hook it around two; it won't read.

Now have a helper go through the house and turn on as many heavy load appliances as possible; electric irons, air-conditioner, and so on. Watch the meter (the ammeter, that is). You may find that the "50-ampere" breaker will trip at about 25-30 amperes. When a breaker has been in service for a long time, it is possible for the contacts to corrode. This generates heat, and makes the breaker trip below its rated current.

CATHODE CURRENT

I have sound but no high-voltage on an Admiral portable, H1-1A. You're always saying "Check the horizontal output tube cathode current," but how do you do it on one of these? The cathode pin is part of the PC board-socket assembly.—P.F., Lone Pine, Calif.

With great difficulty. That is, if you

Pix-Mate™

the crt tester

you can afford to take along

only ... \$34.95

MODEL KP 710

A quality CRT tester with individual test for each gun.

- Compare guns for emission.
- Test for leakage and shorts.
- Legible 3 color scale.
- Compact, portable, rugged.
- Avoid recalls, check the CRT on every call.

WRITE US!

TeleMatic

2245 PITKIN AVE., BROOKLYN, N. Y. 11207

take along the time savers

- PIX-MATE • CRYM-MATE • GEN-MATE
- SOUND-MATE • TRACE-MATE

The Caddy-Mate Line.

Circle 17 on reader service card

try to unsolder the pin from the PC board. The only practical way, with this type of construction, is the tube-socket adapter with the cathode pin brought out; pin 8 in 33GY7's.

VIDEO-TAPE SYNC PROBLEMS

I have an odd horizontal problem. It shows up as an offsetting of parts of the picture, making vertical lines look jagged. It's intermittent, and often comes out when the station, changes cameras or programs. I can't do anything to the set that will make it show up. Seems to show up mostly on local programs. —W. L., Brooklyn, N.Y.

From the description, and the symptoms, this could be video-tape

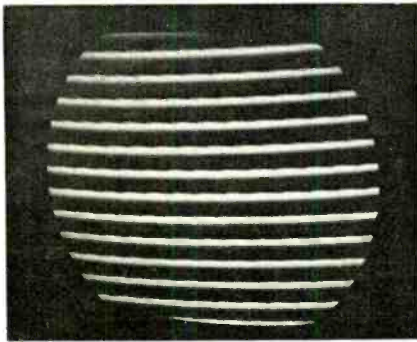

FIG. 1

trouble at the station. It is either a complete loss of horizontal sync, as in Fig. 1, or a partial loss as in Fig. 2. Notice that the "sawteeth" or bends here are about



FIG. 2

16 lines apart. One bad head on a standard video-tape recorder will do this.

In color tape programs, this usually shows up as orange streaks (still 16 lines apart) across solid-color backgrounds. In any case, it's not in the set.

NO BOOST

Help! I have no boost voltage on an Admiral 2G750 chassis. Only 230 volts instead of +540 as called for. I've been all over the place, and can't find out why. What do I do now?—A.J., Pawtucket, R.I.

Open the 38HK7 cathode (pin 8) and put a dc milliammeter in series to ground. If your cathode current is higher than normal (which is 150 mA) I'd suspect a small short in the horizontal yoke windings.

Now check. Disconnect the horizontal yoke coil (leave it on the tube) and clip on another yoke with about the same inductance—25 mH. Now fire it up and see if your boost and high voltage come back. If so, the original yoke is shorted.

If the cathode current is below normal, check the .022-mF boost capacitor; it will probably be open. This connects from terminal 2 on the flyback to B+; 170 volts.

NO HORIZONTAL SWEEP

I'm just getting started in color TV servicing. I've got a problem. I had arcing all around the flyback in an Emerson 835A. I replaced it. Now I have a bright

vertical line down the middle of the screen.—W.K., Hicksville, N.Y.

You go get your ohmmeter. We have an open horizontal yoke. You are getting high voltage, and vertical sweep, obviously. However, your horizontal yoke coil is open somewhere between the flyback and the yoke itself.

Pull the yoke plug, and take an ohmmeter reading between pin 1 and pin 6. This will tell you whether the yoke windings are open; should be about 10 ohms. From either 6 or 3 you should read 4700 ohms to pin 1; this resistor is inside the yoke cover.

If these readings are ok, then re-check the flyback connections! **R-E**

FREE



The World's Largest Consumer Electronics Catalog

The world's Foremost consumer electronics catalog is yours for the asking! Over 25,000 items . . . jam-packed with illustrations and descriptions of the very latest in Hi-Fi, CB, Tape recorders, Radios, Television, Electronic Parts, Technical Publications.

Everything in Electronics For Home, Business, Industry PLUS The Latest in 4-Channel Stereo!

LAFAYETTE 1973 CATALOG 730

Our 52nd Year

Stores From Coast-to-Coast

MAIL
THE
COUPON
TODAY

LAFAYETTE RADIO ELECTRONICS

P.O. Box 10, Dept. 17122
Syosset, L.I., N.Y. 11791

Send For Your Free Lafayette Catalog Today!

Send me the FREE LAFAYETTE Catalog 17122

Name _____

Address _____

City _____ State _____ Zip _____

Circle 18 on reader service card

Changes come fast in electronics.

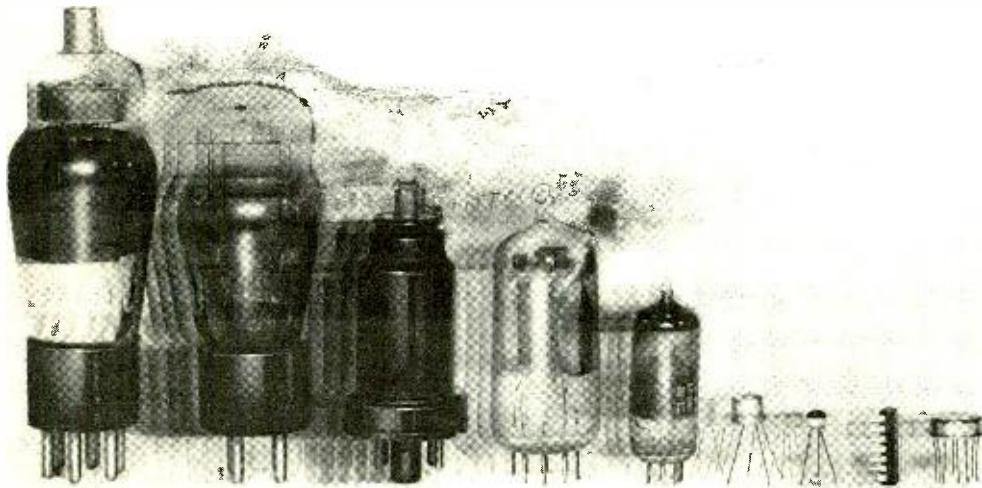

From
tube
to
LSI

Take a look at the race in circuit technology. In the 1960's the tubes made way for the transistors at the right. Today, transistors are surpassed by the large scale integrated circuit (LSI) at the far right. This circuit, less than a quarter inch square, replaces over 6000 transistors!

There's big money to be made by the men who stay ahead of this technology race. Put yourself

ahead with NTS Home Training! You get the latest, most advanced equipment (at no extra cost). More solid-state units, and more advanced technology. Plenty of training with integrated circuits, too! As an NTS graduate, you enter a world of electronics you're familiar with. You have a thorough working knowledge of solid-state circuitry. You're ready to tackle bigger jobs at higher pay!

NTS COLOR AND B & W TV SERVICING

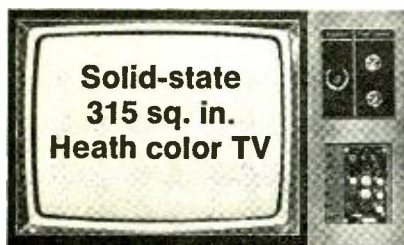

**Solid-state
315 sq. in.
Heath color TV**

Build and keep the largest, most advanced color TV made! Over-all solid-state design, ultra-rectangular screen, matrix picture tube, built-in self-servicing features, "Instant On," A.F.T., solid-state, 24-channel detent UHF/VHF power tuning, and much more! Also build and keep AM-SW Radio, Solid-State Radio, FET Volt-Ohmmeter, and Electronic Tube Tester. Learn trouble-shooting, hi-fi, stereo, multiplex systems, radio, color and B & W TV servicing.

Learn sophisticated solid-state circuitry as you build this B & W TV receiver. Lo-Silho "Superhet" Radio, FET Volt-Ohmmeter, Solid-State Radio, Electronic Tube Checker, and Signal Generator. TV

and all other equipment are yours to keep.

**Solid-state
B & W TV,
74 sq. in.
picture
(cabinet
included)**

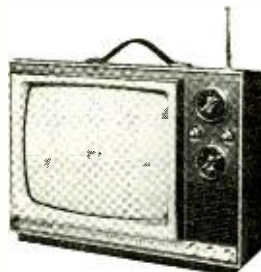

NTS ELECTRONICS & COMPUTER TECHNOLOGY

Build and keep this exclusive NTS Compu-Trainer. It teaches you the

**Solid-state
Compu-Trainer
14 integrated
circuits replace
198 transistors!**



same principles used in million-dollar systems. Contains 14 inte-

grated circuits! All Solid-State! You perform all wiring and patchcording. No shortcuts. No pre-wired circuit boards. Your training is complete! Also receive an FET Volt-Ohmmeter and a 5" wide-band Solid-State Oscilloscope.

NTS ELECTRONICS COMMUNICATIONS

Gain the prestige and earning power of owning an F.C.C. First Class Radio-Telephone License. Two comprehensive NTS courses cover the big opportunity field of transmitting and receiving.

You build and keep 14 kits, including this amateur phone 6-meter VHF Transceiver, NTS's exclusive 6-transistor Solid-State Radio, and a fully transistorized Volt-Ohmmeter. Also, learn 2-way radio, Citizens Band microwaves, and radar.

**5-watt AM
transmitter/
receiver**

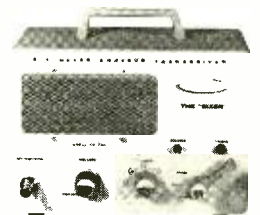

NTS Home Training puts you in the lead.

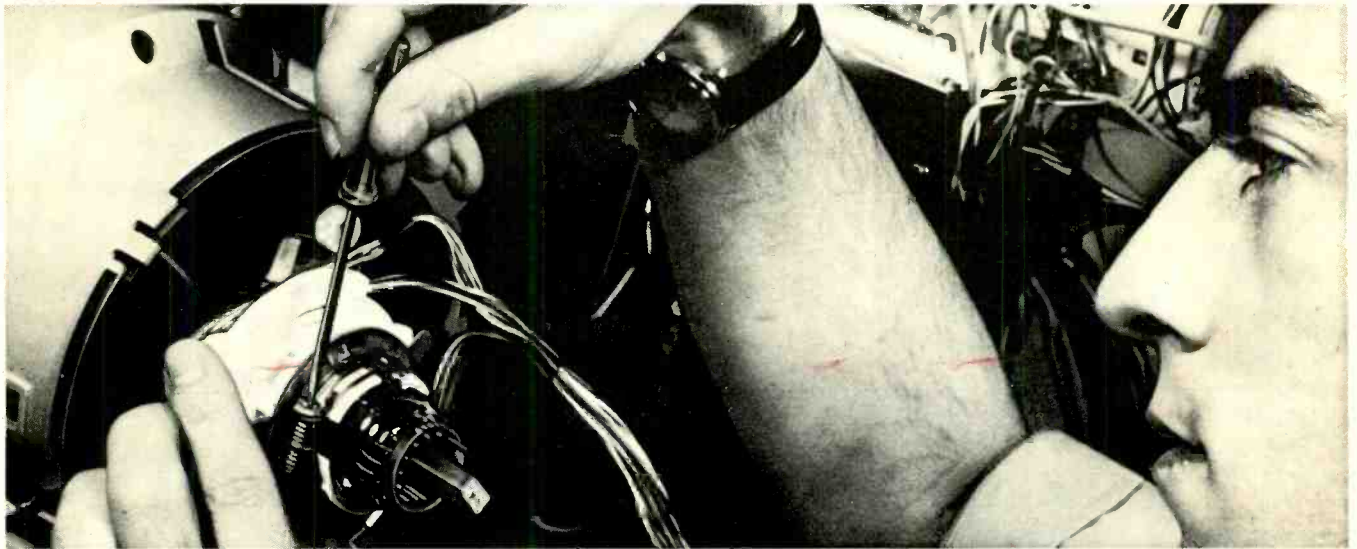

NTS INDUSTRIAL & AUTOMATION ELECTRONICS

Automation is the future of industry and you can play an important part! Learn industrial controls by training on the NTS Electro-Lab (a complete workshop). You also build and operate this 5" Solid-State oscilloscope. And you perform experiments that involve regulating motor speeds, temperature, pressure, liquid level, and much more. All equipment is yours to keep.



NTS AUDIO ELECTRONICS SERVICING

Learn basic sound theory—how it works in home radio, car tape

decks, stereo multiplex component systems, and more! Set up a spectacular music system. Learn about



Build and keep this famous Heath Stereo Receiver and Speakers.

sound distortion, amplification and control, loud-speaker baffles, problems of system installation, etc. Included is Volt-Ohmmeter, In-Circuit Transistor Tester, and Solid-State

Radio. Prepare yourself for great opportunities in the Home Entertainment Industry!

CLASSROOM TRAINING AT LOS ANGELES

You can take classroom training at Los Angeles in sunny Southern California. NTS occupies a city block with over a million dollars in technical facilities. Check box in coupon below.

NATIONAL TECHNICAL SCHOOLS

WORLD-WIDE TRAINING SINCE 1905
Resident & Home Study Schools
4000 S. Figueroa Street
Los Angeles, California 90037

APPROVED FOR VETERANS

Accredited Member: National Association of Trade and Technical Schools; National Home Study Council.

Big, Colorful NTS Guide to new opportunities in Electronics. Yours FREE!



NATIONAL TECHNICAL SCHOOLS
4000 S. Figueroa Street
Los Angeles, California 90037

Please rush me FREE Color NTS Electronics Guide & FREE lesson, plus information on course checked at right. No obligation. No salesman will call.

- MASTER COURSE IN COLOR TV SERVICING
- COLOR TV SERVICING (FOR ADVANCED TECHNICIANS)
- MASTER COURSE IN B&W TV & RADIO SERVICING
- MASTER COURSE IN ELECTRONIC COMMUNICATIONS
- PRACTICAL RADIO SERVICING
- FCC LICENSE COURSE
- MASTER COURSE IN ELECTRONICS TECHNOLOGY
- AUTOMATION & INDUSTRIAL ELECTRONICS
- COMPUTER ELECTRONICS
- BASIC ELECTRONICS
- AUDIO ELECTRONICS SERVICING

Dept. 206-122

NAME _____ AGE _____

ADDRESS _____

CITY _____

STATE _____ ZIP _____

- Check if interested in Veterans Training under new G.I. Bill.
- Check if interested ONLY in Classroom Training at Los Angeles

CHRISTMAS SHOPPERS GUIDE



ACCURATE TIME SOURCE. Try the portable Aries AR-720K chronometer kit. A precision quartz crystal is the reference for a 6-digit LED display. In a 2-1/4" housing, the AR-720K is powered by any 12-V battery. Low power drain and 12- or 24-hour readout make the unit ideal for any portable application. 24-V adapter optional. Aries AR-720K Quartz Chronometer Kit. \$59.50. Aries, Inc., Box 808, Peabody, Mass. 01960.



GO-ANYWHERE HELPMATE for after-holiday bills, the Aries pocket calculator kit. The 8-digit four function (+, -, ×, ÷) AR-420K, includes a constant register for multiple powers, reciprocals and conversions. Bright LED's display floating-point computations, made by a MOS/LSI chip. Powered by four penlight cells. Aries AR-420K Pocket Calculator Kit. \$75.00. Aries, Inc., Box 808, Peabody, Mass. 01960.



NEW UNIVERSAL DECODER accurately plays all 4-channel matrixes without switching. Extra separation-enhancement circuit to localize softest. Use with any pair of stereo amplifiers or receivers. Model EVX-44 \$99.95. Original EVX-4 Decoder \$59.95. Electro-Voice, Inc., Dept. RE-1, 619 Cecil St., Buchanan, Mich. 49107.

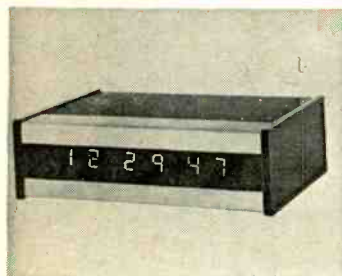

LOW-COST DIGITAL CLOCK kit. Reduced price for Christmas. Easy-reading 7-segment display tubes. Completely solid state. Printed circuit. Easy assembly. Accurate 60-Hz time reference. Push-button setting. Displays hours, minutes and seconds. Kit price: \$64.50. Case extra: Metal \$10, Walnut \$15. E. S. Enterprises, 506 Main St., El Segundo, Calif. 90245.



BUILD THIS HEATHKIT 6-digit electronic clock. Solid-state computer-logic accuracy, high-visibility readout tubes. Reads 12- or 24-hour time. Alarms automatically every 24 hours; has repeating 7-min. "snooze" switch. Easy 3 evening assembly. Kit GC-1005, 4 lbs., \$54.95. Heath Co., Dept. 20-12, Benton Harbor, Mich. 49022.

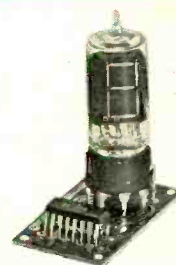

GO DIGITAL WITH RCA IC Project Kits like the KC4011 and KC4012. With them, you can build many interesting, functional projects such as a binary counter, photoelectric counter, dice game, 12- or 24-hour clock, and more. See the complete line-up of RCA Project Kits, Variety Packs and Kit Accessories at your RCA Distributor now. RCA/Electronic Components/Harrison, N. J. 07029.



COBALT ENERGIZED cassettes, RCA Red Seal, have low noise, high output, and extended frequency range characteristics resulting in superior performance over conventional low-noise tapes. Improved signal output, especially at higher frequencies, gives improved signal-to-noise ratio. Low friction virtually eliminates head wear. Ask for the name that means the finest recording quality.—RCA Red Seal. RCA/Electronic Components/Harrison, N. J. 07029.



"OPEN-AIRE" HEADPHONES have all the makings of a perfect gift: professional quality and reasonable price. New design principle combines unusually light (5 oz.) weight, wide (20-20,000 Hz) response . . . all the realism of stereo without cumbersome size and uncomfortable ear seals. Give a gift of privacy and perfect sound. Only \$33.95 from Sennheiser Electronic, 500 Fifth Ave., N.Y.C. 10036.



MECCA MODEL 1818, 8-track portable monaural tape cartridge player with high-sensitivity AM radio. New, compact design in black high-impact plastic, with brushed silver accents. Ac-dc (has built-in 117-V ac adapter). Separate tone-volume controls, radio and tape switch. \$31.95 ppd., with a free tape. Guaranteed for 90 days and warranted for two years. Supersonic Electronics Co., 192 Hooper St., Dept. C, Brooklyn, N. Y. 11211.

USING COLOR BAR GENERATOR

(continued from page 57)

be caused by an open coupling capacitor at the grid of the B - Y amplifier.

Sometimes color amplitude and phase difference appear correct according to waveforms on the picture-tube grids, but bar colors still are not right on the screen.

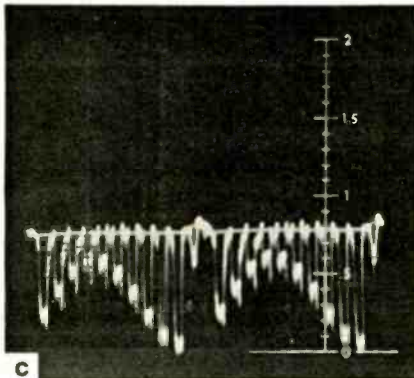
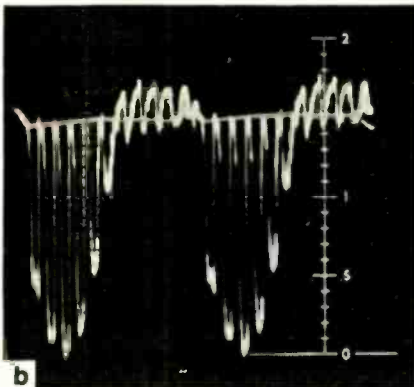
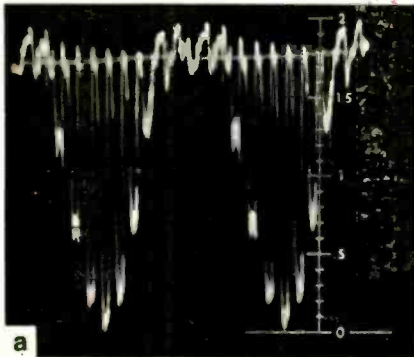
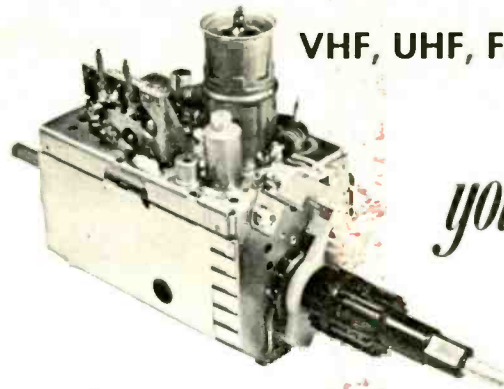

FIG. 9—COMPARATIVE AMPLITUDES of color-difference signals. Blue (a) at 100%, red (b) at 85% and green (c) at 35%.

In one such set, red was very weak. Gray-scale tracking was not as good as it should be. The technician connected his keyed-rainbow generator to the antenna terminals and scoped waveforms on the picture-tube grids. They showed exactly the amplitude and phase to reproduce proper color bars. He could only suspect the picture tube. A picture-tube tester confirmed his suspicion.

The keyed-rainbow generator does a large part of the work. You just supply the thinking. **R-E**

TV TUNER SERVICE



VHF, UHF, FM or IF-Subchassis. . .

. . . All Makes

you get...

Fast 8 hr. Service!

You owe it to yourself

to try P.T.S. We are the fastest growing, oldest and now the largest tuner service company in the world. Here is what you get.

1. Fastest Service—8 hr.—in and out the same day. Overnight transit to one of our six plants, for parts, tuners or IF-modules.
2. All tuners cleaned inside and out, repaired, realigned and air tested.
3. On IF-modules all stages checked, all traps set with high calibre test equipment.
4. Fine Quality! Your customers are satisfied and you are not bothered with returning your units for rework!
5. Lower Cost! Up to \$5.50 less than other tuner companies!
6. Friendly, helpful personalized service!

1 YEAR GUARANTEE



FIRST TO OFFER 365-DAY GUARANTEE!
 COLOR—BLACK & WHITE—TRANSISTOR TUNERS—
 ALL MAKES
 GUARANTEED COLOR ALIGNMENT—
 NO ADDITIONAL CHARGE

LIKE TO DO IT YOURSELF?

PTS makes all tuner parts available to you.

Send one dollar (redeemable) for our **TUNER REPLACEMENT GUIDE AND PARTS CATALOG**

- 60 pages of top information
- Blow-up of all tuners
- Largest exact tuner replacement guide
- Antenna Coil Replacement Guide
- Multi-fit Replacement Tuner Shaft Guide

We offer you finer, faster...



VHF-UHF-FM	\$ 9.95
UV-COMBO	\$16.95
IF-MODULE	\$12.50

Major Parts charged at Net Price

CUSTOMIZED REPLACEMENTS AVAILABLE FOR \$12.95 UP (NEW OR REBUILT)

For fastest service, send faulty unit with tubes, shields and all broken parts to:

PTS ELECTRONICS, INC.

HOME OFFICE—
 SOUTHEAST—
 WEST COAST—
 EAST—
 SOUTHWEST—
 MOUNTAIN—

P.O. Box 272—Bloomington, Ind. 47401
 P.O. Box 6771—Jacksonville, Fla. 32205
 P.O. Box 41354—Sacramento, Calif. 95841
 P.O. Box 3189—Springfield, Mass. 01103
 P.O. Box 7332—Longview, Tex. 75601
 P.O. Box 4145—Denver, Colo. 80204

Tel. 812/824-9331
 Tel. 904/389-9952
 Tel. 916/482-6220
 Tel. 413/734-2737
 Tel. 214/753-4334
 Tel. 303/244-2818

Circle 19 on reader service card

Your #1 enemy is the heart and blood vessel diseases



GIVE... so more will live HEART FUND



Contributed by the Publisher

new products

More information on new products is available from the manufacturers of items identified by a Reader Service number. Use the Reader Service Card inside the back cover.

STEREO AMPLIFIER, model LA-150, unit features built-in circuit to provide derived 4-channel sound from regular 2-channel stereo program sources. Power output is ± 1 dB, 125 watts IHF at 4 ohms; frequency response ± 1.5 dB, from 22-20,000 cycles; total harmonic distortion 1% or less at rated output, 0.05% at 1 watt. Power bandwidth, 13-35,000 Hz;



channel separation, 65 dB at 1 kHz. Includes tape monitor switch, low filter, high filter, loudness level A and level B and power on/off switches. Controls include bass, treble, volume, balance, mode selector, input function selector and speaker mode selector. \$149.95.—**Lafayette Radio Electronics**, 111 Jericho Turnpike, Syosset, L.I., N.Y. 11791.

Circle 31 on reader service card

LOW DISTORTION AMPLIFIER, model D-60, stereo power amplifier delivers 41 watts rms per channel into an 8-ohm load. Frequency response ± 0.1 dB from 20-20,000 Hz at 1 watt. Power bandwidth is ± 1 dB from 5-30,000 Hz at 30 watts. IM distortion less than 0.05% from 0.01 watt to 30 watts. Harmonic distortion



less than 0.05% at 30 watts from 20-20,000 Hz. Hum and noise 106dB below 30 watts per channel output. Separation, typically 106 dB at 1,000 Hz. Unit is protected against shorts, mismatching and open circuits. \$229.00. Walnut cabinet, \$29.00 additional.—**Crown International**, Box 1000, Elkhart, Ind. 46514.

Circle 32 on reader service card

STEREOPHONES, model PRO-B VI. Transparent housing reveals printed circuit crossover network and inner acoustic chamber. The heart of the unit is its woofer with controlled acoustic suspension and matched new ceramic tweeter. Has a 15-foot coil cord and a three-foot

straight section at the headphones with an attached clothing clip permitting coil cord pull to be absorbed at the belt or shirt



pocket. \$60.—**Superex Electronics Corp.**, 151 Ludlow St., Yonkers, N.Y. 10705

Circle 33 on reader service card

CB TRANSCEIVER, model 2376A, provides 23 channels of operation with crystal synthesizing technique and compensates for drift in crystal tolerances caused by temperature change. The transmitter provides 5 watts input power and a modulation boost circuit. The re-

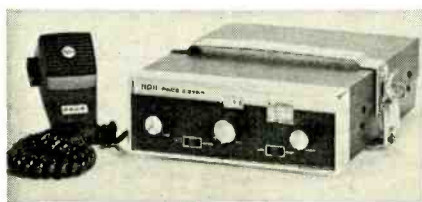

ceiver has a six-section tuned filter that provides noise limiting in addition to the regular series gate noise limitings circuitry. Additional features include an S meter and public address function. \$159.95.—**Pathcom Inc.**, P. O. Box 306, Harbor City, Calif. 90710.

Circle 34 on reader service card

ELECTRONIC IGNITION SYSTEM KIT, Tiger SST CD capacitive discharge unit. Using a transformer-inverter with capacitors, diodes, resistors and a SCR, the unit transforms 12-volt battery power to 400 volts input to the coil primary. The coil then produces up to 50,000 secondary volts to the spark plugs. The system reduces the 4-6 amperes at the points to only 0.5 amps. The high-intensity spark, three times normal, plus the fast rise time, 0.5 μ s compared to 80 μ s in a normal sys-

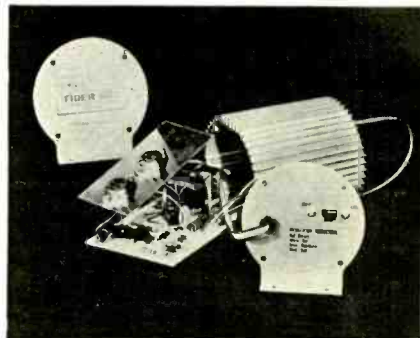

tem, helps keep the plugs clean. \$39.95 assembled; \$29.95 kit.—**Tri-Star Corp.**, P.O. Box 1946, Grand Junction, Colo. 81501.

Circle 35 on reader service card

PHOTOELECTRIC ALARM SYSTEM, No. 1318, has a range of up to 1000 feet. Uses a solid-state light source to send a pulse modulated invisible beam from the transmitter to the receiver. Transmitter and receiver are quite small, extending only 3 1/2"

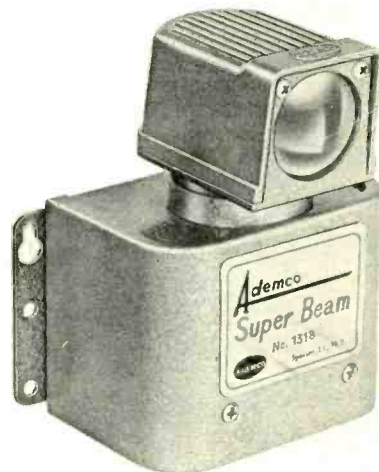

from the wall. No internal mirrors are used and a rechargeable battery with 24-hour standby capacity is built into the unit.—**Ademco, Alarm Device Manufacturing Co.**, Syosset, NY 11791.

Circle 36 on reader service card

AUTOMOBILE THEFT ALARM, model MDL-4, uses no external locks or inside



switches. Works in all 12 V negative-ground vehicles. Unit monitors current

drain in courtesy lamp circuit of vehicle. Opening the door starts the timer in the alarm. If the vehicle's ignition key is turned within the delay period, the alarm is turned off. If the ignition key is not turned on, the alarm sounds. When leaving the vehicle, turning off the ignition key starts another timer which allows about 30 seconds for the operator to leave the vehicle and shut the door. \$49.95.—**TM Electronic Enterprises, P. O. Box 10633, Pittsburgh, Penn. 15235.**

Circle 37 on reader service card

ULTRASONIC INTRUSION DETECTOR, model DS 501, transmits and receives back a characteristic pattern of inaudible sound waves. An intruder entering this sound pattern sets off the alarm. Pro-

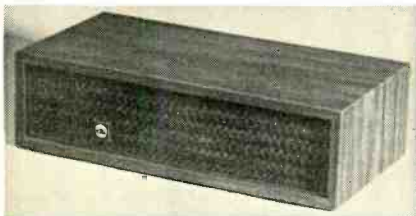

ducts an elliptically shaped area 25' long, 15' wide, 15' high.—**Detection Systems, Inc., 211 Byer Bldg., East Rochester, N.Y. 14445.**

Circle 38 on reader service card

SMOKE DETECTOR, No. 580, operates on the ionization principle. The unit detects fire at its earliest stage, before

smoke, heat and flame develop. Self-contained, battery powered unit requires no wiring. As battery voltage decreases

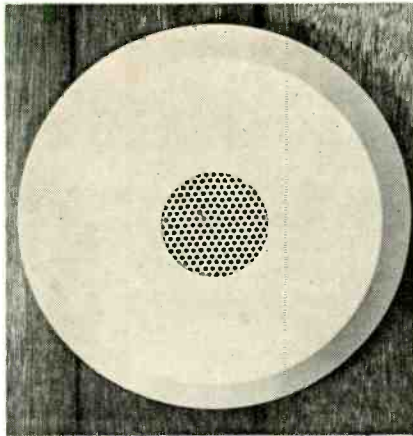

to a pre-set warning level, the alarm notifies the user that a new battery is required.—**Alarm Device Manufacturing Co., Syosset, N.Y.**

Circle 39 on reader service card

TELEPHONE ANSWERING SYSTEM, Ansafone 590. The system will answer an unattended telephone, play a message, record messages and permit remote interrogation of stored messages by telephone. To hear the stored messages, the user dials his office number, places a transistorized Dictacall next to the mouthpiece, presses a button and automatically hears his messages. Incoming

message capacity is 40 minutes with choice of voice activated or fixed time

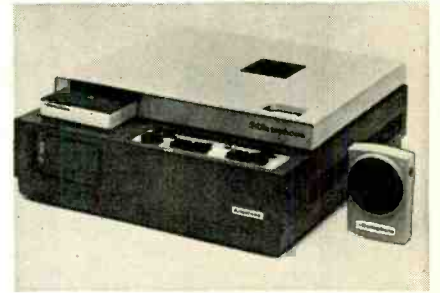

recording. \$695.00—**Dictaphone Corp., 120 Old Post Rd., Rye, N.Y. 10580.**

Circle 40 on reader service card

AUTOMATIC TELEPHONE DIALER, Hot liner, transmits up to six minutes of a cas-



INTERNATIONAL Frequency meter FM-2400CH



The **FM-2400CH** provides an accurate frequency standard for testing and adjustment of mobile transmitters and receivers at predetermined frequencies.

The **FM-2400CH** with its extended range covers 25 to 1000 MHz. The frequencies can be those of the radio frequency channels of operation and/or the intermediate frequencies of the receiver between 5 MHz and 40 MHz.

Frequency Stability: $\pm .0005\%$ from $+50^\circ$ to $+104^\circ\text{F}$.

Frequency stability with built-in thermometer and temperature corrected charts: $\pm .00025\%$ from $+25^\circ$ to $+125^\circ$ (.000125% special 450 MHz crystals available).

Self-contained in small portable case. Complete solid state circuitry. Rechargeable batteries.

WRITE FOR CATALOG!



- Tests Predetermined Frequencies 25 to 1000 MHz
- Extended Range Covers 950 MHz Band
- Pin Diode Attenuator for Full Range Coverage as Signal Generator
- Measures FM Deviation

FM-2400CH (meter only).....	\$595.00
RF crystals (with temperature correction)	24.00 ea.
RF crystals (less temperature correction)	18.00 ea.
IF crystals.....	catalog price



CRYSTAL MFG. CO., INC.
10 NO. LEE • OKLA. CITY, OKLA. 73102

Circle 61 on reader service card

CHRISTMAS SALE

RAYTHEON—G.E. TUBES

3BE6	\$.25 ea.
3EJ760 ea.
3HQ5	1.25 ea.
3KT685 ea.
4BU860 ea.
6AL560 ea.
6AU665 ea.
6BA1195 ea.
6BQ790 ea.
6SN775 ea.
12EK6-12DZ660 ea.
12GE595 ea.
35EH590 ea.
300 Asst'd Resist. 1&2 Watt	\$4.95
100 Mlca Cond. Asst'd	\$1.49
20 Asst'd Mallory Controls	\$2.49
25 Asst'd Cond. (Cans)	\$4.95
25 Asst'd Cond. (Axial)	\$4.95

DIODES—SEMI CONDUCTORS

HEP 170-2.5 Amp. 1000 PIV	25 for \$4.95
6500 PIV Focus Rect.	4 for \$2.00
13.5 KV Focus Rect.	5 for \$3.00
18.5 KV Focus Rect.	3 for \$2.49
Sel. Boost Rect.	5 for \$2.00
Crystal Diodes 1N34A	25 for \$2.00

CONDENSERS—AXIAL LEADS

25 mfd. 25 Volts	5 for \$1.00
50 mfd. 50 Volts	4 for \$1.00
50 mfd. 150 Volts	6 for \$1.49
100 mfd. 150 Volts	12 for \$1.98
1000 mfd. 50 Volts	6 for \$2.49
30 mfd. 450 Volts	6 for \$1.98

CONDENSERS—(CANS)

300 mfd. 150 Volts	3 for \$1.98
500 mfd. 200 Volts	2 for \$1.98
300 mfd. 200 Volts	4 for \$1.98

PHONO EQUIPMENT

Mono Tone Arms TO Cart	2 for \$2.19
Stereo Tone Arms TO Cart	2 for \$2.98
Equiv. Astatic 133 Boxed	\$3.19 ea.
Equiv. Astatic 142	\$2.79 ea.
Equiv. Astatic 13TX Boxed	\$2.98 ea.
Equiv. Sonotone 8T Boxed	\$2.98 ea.
Equiv. BSR5H Boxed	\$2.49 ea.
Equiv. Euphonics U-1 Boxed	\$2.49 ea.
Equiv. EV 275 Boxed	\$3.59 ea.
Equiv. EV 5015	\$3.59 ea.
RCA Phono Plugs	10 for \$1.00
Knife Switches DPDT	4 for \$1.00
4 Align. Tools Asst'd.	\$1.19

MINIMUM ORDER \$15.00

SEND FOR FREE CATALOG

TUBES UP TO 80% OFF

SEND CHECK OR
MONEY ORDER

TV TECH SPECIALS

P.O. BOX 603

Kings Park, L.I., New York 11754

sette tape recording of your message. Silently dials up to four different telephone numbers sequentially, then resets. Multi-circuit terminal block allows simple connections to your phone system, your primary alarm system and a secondary alarm system (optional). A standard four-prong phone jack is also available for plug-in installation. \$249.00—Teletronics, Inc., Box 4350, Hamden, Conn. 06514.

Circle 41 on reader service card

SHIRT POCKET CALCULATOR, Titan RBM, measuring 4" x 3" x 3/4". This pocket-size calculator adds, subtracts, multiplies, divides and makes chain calcu-



lations. The 10-ounce unit has LED readouts and will run four hours before charging the built-in rechargeable batteries is required.—Titan RBM, 12 W. First St., Havre, Mont. 59501.

Circle 42 on reader service card

DUAL TRACE SCOPE, model PM3110, offers simplified operators panel that has only four signal adjustment knobs. Level and stability controls for triggering as well as balance controls have been eliminated and replaced by automatic circuits. Triggering is fully automatic. Three selector switches control trigger source, trigger



polarity, and trigger mode. When TV triggering is selected, the unit automatically selects either line or frame sync pulses as trigger signals depending on the setting of the time base control. \$550.—Test & Measuring Instruments, Inc. 224 Duffy Ave., Hicksville, NY 11802.

Circle 43 on reader service card

FET VOM, model IM-104 a portable lab-grade unit that combines accuracy, versatility and convenience in an easily assembled kit. Fifty-three ranges on 4 scales include 9 dcV and acV ranges from 0.1 V to 1,000 V; six current ranges from 0.01 mA to 1,000 mA, both ac and dc; seven resistance ranges from 1 ohm to 100 megohms, conventional or low voltage modes; decibel ranges from -40 dB to +62 dB and dc null scale with better than 1 mV resolution. 4 1/2" taut-band meter is diode protected and built-

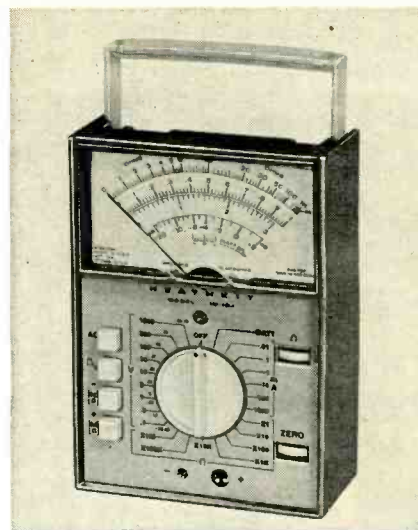

in circuitry shows the condition of the battery. \$79.95.—Heath Co., Benton Harbor, Mich. 49022.

Circle 100 on reader service card

DIGITAL MULTIMETER, model LDM-850, ac/dc unit measures voltage, current and resistance in 25 ranges. Has scale accuracy of 1% or better and provides 3 1/2 digit non-blinking display up to 1,999. Dual-slope operating mode. Maximum input voltage of 1,000 volts dc and 350 volts ac with 10-megohm input im-



pedance. Automatic polarity reversal and overrange lamp indication. Display has a hold and lock position and there is a segmented display lamp test position. \$299.50.—Leader Instruments Corp., 37-27 27th St., Long Island City, N.Y. 11101.

Circle 44 on reader service card

PORTABLE 8-TRACK CARTRIDGE RECORDER, model 410, includes AM/FM stereo radio, is complete with

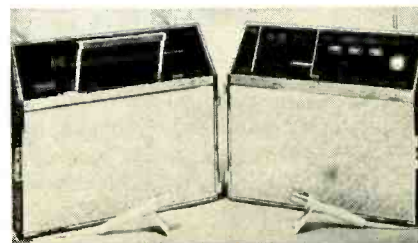

two dynamic microphones, stands, patch cords. Plays and records all standard 8-track cartridges. Records stereo live or

off the air with level meters and fast forward control. Features automatic and manual program switching, continuous play or automatic stop. Frequency response is 100-10,000 Hz with 8 watts total music power into 8 ohms. Flutter and wow 0.3% rms. Tape speed, 3 3/4 ips. Signal-to-noise ratio 45 dB. \$219.95.—**Toyo Radio Co. of America, Inc.**, 1842B West 169th St., Gardena, Calif. 90247.

Circle 45 on reader service card

EIGHT-TRACK HEAD CLEANER/DEMAGNETIZERS, model QM-280 and model QM-281. The new units are designed to remove accumulated dirt and oxide from magnetic heads in cartridge machines preventing spacing losses, damage to heads and protecting



pre-recorded tapes. Both cleaners also contain a demagnetizer to completely remove residual magnetism. The QM-280 is for use on 117 Vac. The QM-281, plugs into an automobile cigar lighter.—**Nortronics Co., Inc.**, 6140 Wayzata Blvd., Minneapolis, Minn. 55416.

Circle 46 on reader service card

COMPONENTS KIT, for servicing XL-100 RCA TV chassis. The new kit contains all the transistors, diodes, resistors and

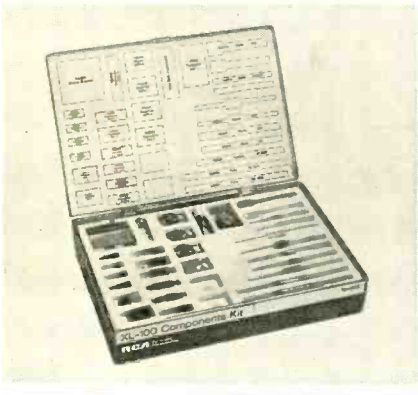

And just how will you feel if it turns out to be your wife who is going to miss her favorite soap opera because of you?

Unbeatable values from Supersonic! 8-track car players superbly engineered—all solid state!

FREE! 8-track tape of latest hits with every order. (Reg. \$6.00)

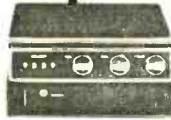

CONNECTS EASILY INTO YOUR CAR STEREO SPEAKERS

Model CXC-771 "Mecca" 18 watt car stereo mini 8-track cartridge player. Fits in any glove compartment. \$27.95

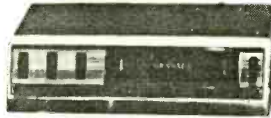

Model CXC-772 "Granada" 8-track player. Easy wheel-type volume, tone & balance control. Powerful 20 watt amplifier for great stereo music in your car. \$29.95



Model CXC-773 "Mecca" 8-track car player & FM multiplex radio. Fantastic 20 watt stereo sound. One touch changes FM to tape or multiplex to monaural, lighted dial, stereo light indicator. Sleek chrome & black styling. \$62.95

Model CXC-774 same as above with FM & AM — \$69.95

All units with automatic & manual lighted push button channel changer.

2 hi-quality speakers for all above units \$4.00. Easy installation instructions.

Supersonic Electronics Co.

192 Hooper St. Dept. B, Brooklyn, N.Y. 11211

Circle 63 on reader service card

Send check or money order. Add postage. All items fully guaranteed. Free catalog.

GIVE... so more HEART FUND



Contributed by the Publisher

Now...the most enjoyable do-it-yourself project of your life—a Schober Electronic Organ!

You'll never reap greater reward, more fun and proud accomplishment, more benefit for the whole family, than by assembling your own Schober Electronic Organ. You need no knowledge of electronics, woodwork or music. Schober's complete kits and crystal-clear instructions show you — whoever you are, whatever your skill (or lack of it) — how to turn the hundreds of quality parts into one of the world's most beautiful, most musical organs, worth up to twice the cost of the kit.

Five superb models with kit prices from \$500 to around \$2,000, each an authentic musical instrument actually superior to most you see in stores, easy for any musically minded adult to learn to play, yet completely satisfying for the accomplished professional. And there are accessories you can add any time after your organ is finished — lifelike big auditorium reverberation, automatic rhythm, presets, chimes, and more.

Join the thousands of Schober Organ builders — owners who live in every state of the Union. Often starting without technical or music skills, they have the time of their lives — first assembling, then learning to play the modern King of Instruments through our superlative instructions and playing courses.

Get the full story FREE by mailing the coupon TODAY for the big Schober color catalog, with all the fascinating details!

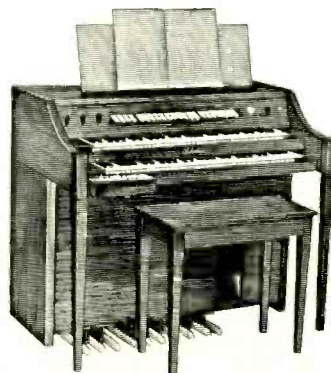

The Schober Organ Corp., Dept. RE-109
43 West 61st Street, New York, N. Y. 10023

Please send me Schober Organ Catalog.
 Enclosed please find \$1.00 for 12-inch L.P. record of Schober Organ music.

NAME _____
ADDRESS _____
CITY _____ STATE _____ ZIP _____

Circle 64 on reader service card

DECEMBER 1972 • RADIO-ELECTRONICS 81

one circuit breaker, 27 components in all. Selected by RCA Consumer Electronics as those most important for fast efficient service of the XL-100 chassis. A special parts location diagram and separate cross-reference chart speed the use of the kit.—**RCA, Parts & Accessories**, Deptford, N.J. 08096.

Circle 47 on reader service card

MATV-CATV PRODUCTS, line includes matching transformers, two and four-way

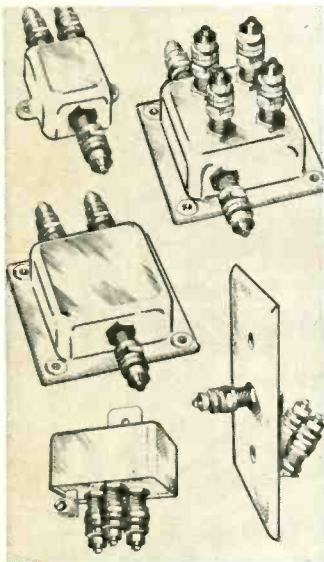

splitters, directional taps, multidirectional taps, directional wall plates and lightning

arrester blocks with and without splitters. Units are housed in cadmium steel covered with epoxy resin. Circuits are completely embedded in polyurethane foam and encased in epoxy resin.—**Workman Electronics Products, Inc.**, P. O. Box 3828, Sarasota, Fla. 33578.

Circle 48 on reader service card

TV CAMERA, model PB940R, offers 875-line resolution, available with a variety of Vidicons. 2:1 interlace programmed sync generator, crystal-controlled EIA sync option, remote control of beam, target, focus and automatic light control with

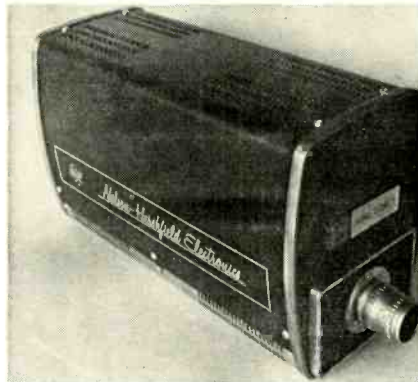

low-voltage remote power feed. Low light level operation is possible with silicon diode Vidicon.—**Nelson-Hershfield Electronics**, 1848 West Campbell Ave., Phoenix, Ariz. 85015.

Circle 49 on reader service card

new lit

All booklets, catalogs, charts, data sheets and other literature listed here with a Reader Service number are free. Use the Reader Service Card inside the back cover.

MAIL ORDER CATALOG, featuring audio components, Citizens-band equipment, radios and phonos, TV, kits and hobby items, antennas, tools and hardware, small parts, tubes and books. The catalog lists dozens of major names in electronics and includes some very new and unusual electronic items.—**Olson Electronics**, 260 S. Forge St., Akron, Ohio 44327.

Circle 50 on reader service card

OSCILLOSCOPES Catalog 5, 13 pages of complete specifications on this manufacturers full line of oscilloscopes. Includes a selectors' guide of points to look at when purchasing an oscilloscope. Three dual-trace scopes, four single-trace scopes and one dual-beam scope are detailed and illustrated.—**Tequipment**, P.O. Box 500, Beaverton, Ore. 97005.

Circle 51 on reader service card

SEMICONDUCTOR CATALOG, 92-page directory of transistors and integrated circuits made by Motorola, RCA, Fairchild, National and HEP. The catalog contains many device connection diagrams and also how-to-use circuits for IC's. Associated parts such as resistors and capacitors are also listed. A separate section contains complete equipment including CB gear, treasure finders and assorted test instruments.—**Circuit Specialists Co.**, Box 3047, Scottsdale, Ariz. 85257.

Circle 52 on reader service card

SCOPE ACCESSORIES CATALOG, 25-page two-color catalog of accessories available for the entire line of oscilloscopes manufactured by Philips and sold in the United States. Contains detailed applications and information as well as illustrations and descriptions of both passive and active scope probes, camera systems and related photographic equipment, scope carrying cases, battery packs, cables, plugs, adaptors, etc.—**Test & Measuring Instruments, Inc.**, 224 Duffy Ave., Hicksville, N.Y. 11802.

Circle 53 on reader service card

the tape that turned the cassette into a high-fidelity medium

TDK

Until TDK developed *gamma ferric oxide*, cassette recorders were fine for taping lectures, conferences, verbal memos and family fun—but not for serious high fidelity.

Today you can choose among high-quality stereo cassette decks.



TDK SUPER DYNAMIC (SD) TAPE



The new magnetic oxide used in TDK Super Dynamic tape distinctively differs from standard formulations in such important properties as coercive force, hysteresis-loop squareness, average particle length (only 0.4 micron!) and particle width/length ratio. These add up to meaningful performance differences: response capability from 30 to 20,000 Hz, drastically reduced background hiss, higher output level, decreased distortion and expanded dynamic range. In response alone, there's about 4 to 10 db more output in the region above 10,000 Hz—and this is immediately evident on any cassette recorder, including older types not designed for high performance. There's a difference in clarity and crispness you can hear.

Available in C30SD, C60SD, C90SD and C120SD lengths

TDK ELECTRONICS CORP.
LONG ISLAND CITY, NEW YORK 11103

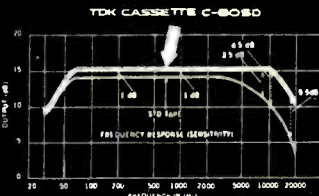

Circle 65 on reader service card

GUEST EDITORIAL

Eugene Aisberg, the author of this month's guest editorial on page 6, was for many years publisher and editor of the French Technical Journal *Toute l'Electronique*. He is also the author of about 20 texts on Radio, TV and Electronics including the famous "TV, It is a Cinch!" which ran as a serial for many months in *Radio-Electronics*, in the 1950's.

next month

JANUARY 1973

10TH ANNUAL COLOR TV ISSUE

It's crammed with informative articles on the latest developments in color television. There are articles on every important phase of color television in North America today

■ New Color Circuits

The '73 sets include some interesting innovations in circuits. Take this close-up R-E tour

■ ABC's Of Color Convergence

How to set up a color set as fast as possible with as little difficulty as possible

■ Color Controls

How they work: Instamatic, Auto Color, AFT, ACC and more. Take a look at what they will and won't do

■ Color TV Test Jigs

How to use them effectively to speed troubleshooting and avoid carrying color picture tubes

■ Color TV—Tomorrow

An expert in this field looks at what we might expect to be looking at in 1983.

PLUS
State Of Solid State
TV Service Clinic
Appliance Clinic

Introducing the expensive dual-trace scope that doesn't cost a lot.

The B&K Precision Model 1470.

The compact 5-inch solid-state 1470 is specially designed to meet 80% of all industrial scope applications.

It has DC to 10 MHz bandwidth with 10 mV/cm sensitivity. Sixteen triggered-sweep speeds range from 1 μ sec/cm to 0.2 sec/cm. Triggers on input signals as low as 5mV.

\$499⁹⁵

Sound good? Our prices become even more remarkable once you see our specs.

Call your B&K distributor. Or write Dynascan Corporation.

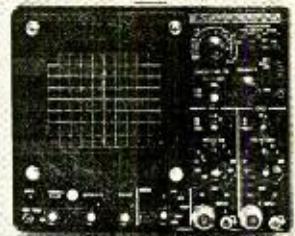

In stock at your parts distributor.

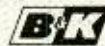

Product of
Dynascan Corporation
1801 West Belle Plaine Avenue, Chicago, Illinois 60613

Circle 66 on reader service card

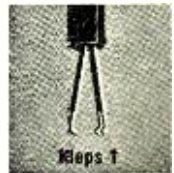
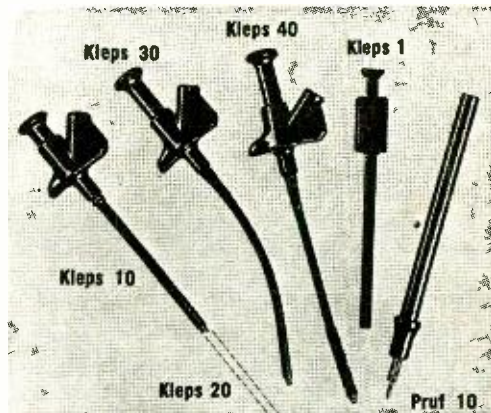

Clever Kleps

Test probes designed by your needs — Push to seize, push to release (all Kleps spring loaded).

Kleps 10. Boathook clamp grips wires, lugs, terminals. Accepts banana plug or bare wire lead. 4 $\frac{3}{4}$ " long. **\$1.19**

Kleps 20. Same, but 7" long. **\$1.39**

Kleps 30. Completely flexible. Forked-tongue gripper. Accepts banana plug or bare lead. 6" long. **\$1.47**

Kleps 40. Completely flexible. 3-segment automatic collet firmly grips wire ends, PC-board terminals, connector pins. Accepts banana plug or plain wire. 6 $\frac{1}{4}$ " long. **\$2.39**

Kleps 1. Economy Kleps for light line work (not lab quality). Meshing claws. 4 $\frac{1}{2}$ " long. **\$.99**

Pruf 10. Versatile test prod. Solder connection. Molded phenolic. Doubles as scribing tool. "Bunch" pin fits banana jack. Phone tip. 5 $\frac{1}{2}$ " long. **\$.79**

All in red or black — specify. For additional information, write for complete catalog of — test probes, plugs, sockets, connectors, earphones, headsets, miniature components.



Available through your local distributor, or write to:

RYE INDUSTRIES INC.
129 Spencer Place, Mamaroneck, N.Y. 10543

In Canada: Rye Industries (Canada) Ltd.

Circle 67 on reader service card

DECEMBER 1972 • RADIO-ELECTRONICS 83

new books

HOW TO BUILD PROXIMITY DETECTORS & METAL LOCATORS, by John Potter Shields. Howard W. Sams & Co., Inc., 4300 W. 62nd St., Indianapolis, IN. 46268. 8 1/2 x 5 1/2 in. 160 pp. Softcover, \$2.95

A complete text on proximity detectors and metal locators, including detailed instructions on how to build several different devices. While a number of practical circuits are described for building proximity detectors, metal locators and Theremins, the projects are broken down into two categories: Elementary and Advanced. The elementary circuits usually consist of one or two tubes or transistors. The circuits in the advanced category are more sophisticated and usually consist of two or more tubes or transistors. The final chapter discusses the Theremin, an electronic musical instrument that uses the beat-frequency, proximity-detector principle.

HANDBOOK OF PRACTICAL SOLID-STATE TROUBLESHOOTING, by John D. Lenk. Prentice-Hall, Inc., Englewood Cliffs, NJ 07632. 6 x 9 1/4 in. 310 pp. Hardcover edition, \$12.00.

This book is a straightforward, practical guide to pinpointing both circuit and component failures in today's solid-state and digital electronic equipment. The first chapter introduces fundamental troubleshooting theory and provides the framework for learning step-by-step servicing procedures. Coverage includes servicing and repair of basic solid-state circuits as well as specific equipment and systems. It also covers the use of test equipment and hand tools.

PRACTICAL ELECTRONIC SERVICING TECHNIQUES, by Larry Allen. TAB Books, Blue Ridge Summit, PA 17214. 5-3/4 x 8-3/4 in. 255 pp. Hardcover, \$7.95, Softcover, \$4.95.

Here's a text that tells how to sharpen electronics troubleshooting ability with the methods used by the "old pros". To condition the reader's thinking, the author begins Part I with an analysis of what troubleshooting really is and then he goes on to show the thinking of a tough-dog expert.

The remainder of Part I deals with logical approaches to time-constant circuits, tube circuits and an in-depth treatment of transistor circuits. In Part II, the author shows some actual treatment of real problems in audio gear, including automatic turntables and tape recorders. Part III hits transistorized circuits hard, showing valuable short-cuts to save time and methods of testing transistors in circuit. Part IV goes into the most troublesome parts of TV receivers, sweep systems and high voltage. Part V helps the reader get better acquainted with his test equipment. In this section is also a chapter devoted to efficient operation.

REPAIRING TRANSISTOR RADIOS, Revised Second Edition, by Sol Libes. Hayden Book Company, Inc., 116 West 14th Street, New York, N.Y. 10011. 6 x 9 in. 192 pp. Softcover, \$4.65.

This revised second edition is a practical, easy to use guide that clearly explains methods and procedures for troubleshooting and repairing the latest types of AM and FM transistor radios, including home, portable and auto radios. The book briefly explains the theory and structure of semiconductor elements, then covers transistor characteristics and types. Operation and servicing of all types of transistor circuits are discussed in-depth and accompanied by comprehensive troubleshooting charts for each receiver circuit.

AUTOMOTIVE TUNE-UP AND TEST EQUIPMENT, by Charles R. Cantonwine. Chilton Book Co., 100 East 42nd Street, New York, N.Y. 10017. 6 1/2 x 9 1/2 in. 350 pp. Hardcover, \$10.50.

Here's a book that explains and illustrates the principles of operation, adjustments and calibrating procedures for representative models of tune-up and test devices. The book covers the fundamentals and principles of operation of all electronic equipment likely to be encountered in the automotive service field. All circuits in this book have been traced from equipment serviced by the author and are up to date. The author has also devel-

SHOPPING POWER FOR YOUR DOLLAR

FREE \$1 BUY WITH EVERY 10 YOU ORDER Only applies to "\$1" Buys FREE GIFT WITH EVERY ORDER

SARKES TARZIAN TUNER
41mc



Latest Compact Model good for all 41 mc TV's.
BRAND NEW—

Best TUNER "SARKES TARZIAN" ever made—last word for stability, definition & smoothness of operation. An opportunity—to improve and bring your TV Receiver up-to-date.
\$7.95
COMPLETE with Tubes

- UHF TUNER — TRANSISTOR TYPE Used in all TV sets ... **\$3.95**
- STANDARD TUNER — TRANSISTOR (GUIDED GRID) 4 Channel closed circuit ... **\$1**
- PHILCO TV TUNERS Model — 76-13579-6 (5GJ7—3HQ5) ... **\$4.95**
- GE — TV TUNERS Model-ET 86X314 — (5LJ8-3GK5) ... **\$5.95**
- GE — STANDARD COIL TV TUNER Model EU-86XI (6HQ5—6GJ7) Model-ET 86X304 — (6LJ8—6HA5) ... **\$7.95**
- TV TUNERS VHF/UHF all new standard makes, including Tubes ... **\$7.95**
- ALL NEW TV TUNER Standard makes — less tubes ... **\$1**

- COLOR POWER TRANSFORMER — Good for most sets 26R150 List Price—\$36.78 ... **\$6.95**
- 4—50' HANKS HOOK-UP WIRE assorted colors ... **\$1**
- 100'—SPOOL SPEAKER WIRE 2 cond, mini zip, clear, 101 uses ... **\$1.50**
- 10 — ASST. RADIO & TV TUBES Every Tube a good number ... **\$1**
- 5 — I.F. COIL TRANSFORMERS 456-kc for Transistor Radios ... **\$1**
- 6" UNIVERSAL SPEAKER Top quality Special buy ... **\$1.29 Ea.**
- 12" UNIVERSAL SPEAKER Top Quality ... Large Magnet ... **\$4.89**
- 10" PHILCO SPEAKER Top Quality ... Large Magnet ... **\$2.99**
- 8" UNIVERSAL SPEAKER Large Magnet—Special Buy ... **\$2.99**
- 5" UNIVERSAL TWEETER 1 Oz. ... Magnet ... **\$1.29**
- UNIVERSAL 4" PM SPEAKER Top Quality ... **\$1**
- 2 1/2" x 4" SPEAKER Special Buy 10 For \$5— **69¢ Ea.**
- 3 1/2" — ROUND SPEAKER Special Buy ... **59¢**
- 4" X 6" "QUAM" 16 OHM SPEAKER Large magnet ... Special BUY (10 for \$15.00) ... **\$1.79**
- RONETTE STEREO CARTRIDGE latest dual sapphire flapper type ... **\$2**
- STEREO HEADPHONES Hi-Fi Quality ... Complete with stereo plug ... **\$5.95**
- UHF OR VHF MATCHING TRANSFORMER Simple Fool-proof installation ... **\$1**
- ALL AMERICAN TUBE KIT (12AV6-12BE6-12BA6-35W4-50C5) ... **\$2.99**

- 2 — COLORBURST QUARTZ-CRYSTAL For Most Color TV sets 3579.545 KC ... **\$1.89**
- 2 — ELECTROLYTIC CAPACITORS CD — 40/40 MFD — 450 Volts ... **\$1**
- SPECIAL TUBE BUY 4 — 18FY6 American made ... **\$1**
- 1—6" x 9" HEAVY DUTY 10 OZ. SPEAKER Ceramic Type ... 8 Ohm ... **\$3.69**
- 5 ASSTD. GLOBAL VARISTOR Popular replacements for most COLOR TV ... **\$1**
- 10 — SETS PHONO PLUGS & PIN JACKS RCA type ... **\$1**
- 5—PRINTED CIRCUIT IF TRANSFORMERS 4-Lug, 456 KC ... **\$1**
- 25 — 3900-OHM-7w RESISTOR 10% Corning glass ... **\$1**
- 20 — 47-600V CONDENSERS White Ceramic C.D.—American ... **\$1**
- 13 Pc. SCREWDRIVER & NUTDRIVER SET reg \$8.95 ... **\$5.95**
- CO-AX CABLE RG59U grey or black 250'—\$9 100'—\$3.69 50'— **\$2**
- 4 — TV ALIGNMENT TOOLS most useful assortment #1 ... **\$1**
- 4 — TV ALIGNMENT TOOLS For Color TV #2 ... **\$1.49**
- 6 — TV COLOR ALIGNMENT TOOLS Most popular type ... **\$2.79**
- 4 — 9 VOLT MOTORS Excellent for hobbyist ... **\$1**
- 200' — #24 SOLID PUSH BACK WIRE Yellow or Black excellent buy ... **\$1**
- UNIVERSAL TV ANTENNA Back of set mounting 5 section rods ... **\$1.98**

- TRANSISTOR RADIO *asst type* good, bad, broken, as-is, potluck ... **\$1.50**
- TAPE RECORDER—assorted types good, bad, broken, as-is, potluck ... **\$4**
- 300 — ASST. 1/2 W RESISTORS Top Brand, Short Leads, Excellent Selection ... **\$1**
- 100—ASST 1/4 WATT RESISTORS stand, choice ohmages, some in 5% ... **\$1**
- 100—ASST 1/2 WATT RESISTORS stand, choice ohmages, some in 5% ... **\$1**
- 70 — ASST 1 WATT RESISTORS stand, choice ohmages, some in 5% ... **\$1**
- 35 — ASST 2 WATT RESISTORS stand, choice ohmages, some in 5% ... **\$1**
- 50 — PRECISION RESISTORS asst. list-price \$50 less 98% ... **\$1**
- 20 — ASSORTED WIREWOUND RESISTORS, 5, 10, 20 watt ... **\$1**
- 10—ASSORTED SLIDE SWITCHES SPST, SPDT, DPDT, etc. ... **\$1**

KNOB SPECIAL

- 100 — ASSORTED RADIO KNOBS All standard types ... \$20 value ... **\$1**
- 50 — TV KNOBS — POPULAR TYPES Mostly Selector & Fine Tuning ... **\$1**
- 25 — VERTICAL LINEARITY KNOBS Long shank ... Front mount ... miniature assortment ... **\$1**
- 20 — VERTICAL LINEARITY KNOBS Slide mount ... Standard sizes ... **\$1**
- 25—KNURLED RADIO KNOBS Hard to get ... Best selection ... **\$1**
- 40 — DELUXE RADIO KNOBS Choice assortment ... Popular types ... **\$1**

ANY 6 KITS FOR \$5

IMMEDIATE DELIVERY . . . Scientific light packing for safe delivery at minimum cost.
HANDY WAY TO ORDER: Pencil mark or write amounts wanted in each box, place letter F in box for Free \$1 BUY. Enclose with check or money order, add extra for shipping. Tearsheets will be returned as packing slips in your order, plus lists of new offers.
Minimum Order \$3.00

Please specify refund on shipping overpayment desired: CHECK POSTAGE STAMPS MERCHANDISE (our choice) with advantage to customer

BROOKS RADIO & TV CORP., 487 Columbus Ave., New York, N. Y. 10024 212-874 5600 TELEPHONE

oped several pieces of special test equipment to service automotive engines. In this book are many original ideas not found anywhere else. A listing of sources of supply and brand names is provided and these are referred to in the text as appropriate.

199 TV TOUGH-DOG PROBLEMS SOLVED, by Art Margolls. TAB Books, Blue Ridge Summit, PA 17214. 5-3/4 x 8-3/4 in. 256 pp. Hardcover \$7.95, Softcover \$4.95.

Here is a massive collection of actual case-history solutions for both color and black-and-white sets, covering all popular makes from Admiral to Zenith. The book is organized so that solutions to particular problems can be located quickly and all solutions are drawn from practical experience; 199 toughies that required the best efforts of top technicians to solve. A cross reference of troubles by brand name and chassis is included. Contents include problems such as no high voltage, no raster, not enough high voltage, blooming, vertical oscillator and output troubles, wrong colors, no video, motorboating and more.

ARTIFICIAL INTELLIGENCE, by James R. Slagle. McGraw-Hill Book Company, 330 West 42nd Street, New York, N.Y. 10036. 6 1/4 x 9 1/2 in. 196 pp. Hardcover, \$9.65.

An integrated description of intelligent machines presented by this book, shows that machines can mimic the behavior or performance normally associated with human intelligence. Among the machines described are some that deduce answers to questions from given facts, play games, prove theorems and balance assembly lines.

CORRECTION

The price listed for the EICO Model FC-100 burglar alarm in their advertisement in the November issue was incorrect. The price in the ad was \$59.95. The correct price should have been \$69.95.

NEW EICO TR-410

Solid-State Triggered Sweep 10MHz Oscilloscope \$379.95

Never before has so much been built into a low cost solid state triggered sweep scope!



INCLUDES EXCLUSIVE DUAL PROBE

EICO introduces the first laboratory quality, high performance, wideband Triggered Sweep Oscilloscope, at a price you can afford!

Use as Vectorscope for Color TV Servicing ■ 3 calibration voltages (2, 5 and 10) ■ Quick connect BNC connector at Vertical Input ■ Front panel adjustable Horizontal and Vertical DC Balance Controls ■ Vertical and Horizontal selection of AC or DC modes of amplification ■ Sweep synchronized Gate Output ■ Flat faced CRT ■ Z Axis input ■ Rear panel astigmatism control ■ Edge lit calibrated screen ■ Operates on a standard 120 volt, a low 100 volt or a 220-230 volt line.

FREE 1973 EICO CATALOG

For name of nearest dealer and free catalog check re-order service card or send 25¢ for prompt first class mail service. EICO-283 Malta St., B'klyn, N.Y. 11207



Circle 68 on reader service card

SHANNON MYLAR RECORDING TAPE

2 1/2" - 225' .. \$.17	7" - 2400' \$1.79
3" - 225' .. .19	7" - 3600' 2.95
3" - 300' .. .27	CASSETTE C-6059
3 1/4" - 600' .. .58	CASSETTE C-90 1.00
5" - 600' .. .62	CASSETTE C-120 (TDK) 1.97
5" - 900' .. .80	2 1/2" TAPE REEL05
5" - 1200' .. .97	3" TAPE REEL06
5" - 1800' .. 1.49	3 1/4" TAPE REEL07
7" - 1200' .. .77	5" TAPE REEL14
7" - 1800' .. 1.12	7" TAPE REEL15

CANADIANS: Ordering is easy — we do the paperwork — try a small order

IBM COMPUTER SECTIONS

8 assorted Units we sell for \$1 are loaded with over 150 valuable parts.

Incl. — Transistors
Condensers, Resistors,
Heat Sinks,
Diodes, Etc.

8 for \$1
100 for \$10

WESTINGHOUSE ALL TRANSISTOR HOME/OFFICE MESSAGE CENTER

Leaves messages for other for replay . . . Built in speaker/microphone for talk-into convenience . . . Records up to 3 minutes of messages . . . Illuminated signal shows when a message is waiting. Control adjusts playback volume without affecting recording volume . . . Capstan Drive; BRAND NEW SOLD AS IS \$7.95

MARKET SCOOP COLUMN

- ASTATIC PICKUP MODEL 700-89T Contains 89T ceramic cartridge LIST PRICE \$17.00 ... \$2.95
- BLANK 8 TK CART. TAPE 64 Minutes \$1 80 Minutes \$1.39
- 70° COLOR TUBE BRIGHTNER \$3.95
- 90° COLOR TUBE BRIGHTNER \$4.95
- HEAVY DUTY COLOR FOCUS RECTIFIER 14,000 PIV @ 1 ma ... \$1
- STEREO TONE ARMS Most popular type—turn over cartridge ... \$2
- PENCIL TYPE SOLDERING IRON Lightweight 30 watt iron —UL Approved ... \$1.49
- 20 — DIPPED MYLAR CAPACITORS .01—600V ... \$1
- 20 — DIPPED MYLAR CAPACITORS .033—600V ... \$1
- 20 — DIPPED MYLAR CAPACITORS .0033—1000 V ... \$1
- 20 — DIPPED MYLAR CAPACITORS .047—400 V ... \$1
- 15 — MOLDED TUBULAR CAPACITORS .088—400 V ... \$1
- 20 — DIPPED MYLAR CONDENSERS .0039—400 V ... \$1
- 10 — SPRAGUE "ORANGE DROP" CAPACITORS .0056—2000 Volt ... \$1
- 1 — 20 FT. COILED GUITAR CABLE With plugs \$2.95
- 1—CASSETTE TYPE DYNAMIC MICROPHONE with universal plugs—200 Ohms ... \$2.49

- WESTINGHOUSE FM TUNER (12DT8 Tube) \$1.95
- WESTINGHOUSE FM TUNER #476-V-015D01 ... Transistor \$3.99
- 300 — ASSORTED HEX NUTS 2/56, 4/40, 5/40, 6/32, 8/32 .. \$1
- 250 — ASST. SOLDERING LUGS best types and sizes ... \$1
- 250 — ASST. WOOD SCREWS finest popular selection ... \$1
- 250 — ASST. SELF TAPPING SCREWS #8, #8, etc. \$1
- 150 — ASST. 6/32 SCREWS and 150 6/32 HEX NUTS ... \$1
- 150 — ASST. 8/32 SCREWS and 150—8/32 HEX NUTS ... \$1
- 150 — ASST. 2/56 SCREWS and 150—2/56 HEX NUTS ... \$1
- 150 — ASST. 4/40 SCREWS and 150—4/40 HEX NUTS ... \$1
- 150 — ASST. 5/40 SCREWS and 150—5/40 HEX NUTS ... \$1
- 500 — ASSORTED RIVETS most useful selected sizes ... \$1
- 300 — ASSORTED WASHERS most useful selected sizes ... \$1
- 100 — ASST. RUBBER BUMPERS for cabinet bottoms & other uses .. \$1
- 100—ASSORTED RUBBER GROMMETS best sizes ... \$1

RCA 110° FLYBACK TRANSFORMER

We scooped the Market Latest type — standard for all 110° TV's RCA's design of large Coil produces 18KV—assuring adequate width Incl Schematic Diagram application for any TV List price \$13.90

Your price ... \$3
10% off in lots of 3

- 110° TV DEFLECTION YOKE for all type TV's incl schematic \$3.95
- "COMBINATION SPECIAL" RCA 110° FLYBACK plus 110° DEFLECTION YOKE \$5.95
- 90° FLYBACK TRANSFORMER \$2.95 for all type TV's incl schematic
- 90° TV DEFLECTION YOKE \$2.95 for all type TV's incl schematic
- 70° FLYBACK TRANSFORMER \$2 for all type TV's incl schematic ..
- 70° TV DEFLECTION YOKE for all type TV's incl schematic .. \$2
- 2 — TV CIRCUIT BREAKERS \$1.19 Rated 4.2 TO 5.0 AMPS, etc. .
- 90° COLOR YOKE For all Rectangular 19 to 25" Color CRT's \$10.95
- RCA COLOR FLYBACK Part #113382 (Stancor #BO-601C) \$12.95

- COLOR-TV RECTIFIER — Used in most color sets— 6500 kv 3 for \$1.95
- 10 — STANDARD TRANSISTORS NPN & PNP 2N404, 2N411, etc. ... \$1
- 10—ASSORTED DIODE CRYSTALS 1N34, 1N48, 1N60, 1N64, etc. ... \$1
- 6 — TOP BRAND SILICON RECTIFIERS 1 amp, 1000 PIV \$1
- 5 — PNP TRANSISTOR general purpose, TO-5 case \$1
- 5 — NPN TRANSISTORS general purpose, TO-5 case \$1
- 50 — ASSORTED TRANSISTORS big factory scoop—sold as-is ... \$1
- TV TWIN LEAD-IN 300 ohm 500' — \$7 100'—\$1.50 50' — \$1
- 12—MINIATURE ELECTROLYTIC CONDENSERS For Transistor & miniature work ... \$1
- 6 — MINIATURE ELECTROLYTIC CAPACITORS 5 MFD—150 V ... \$1
- 3—ELECTROLYTIC CONDENSERS 100 mfd.—100 V, 50 mfd—75 V .. \$1
- 2—ELECTROLYTIC CONDENSERS C.D. 500 mfd—200 volts. \$1
- 2—ELECTROLYTIC CONDENSERS UNECAP ...2000/1000 Mfd ... 30 Volt ... \$1
- 2 — ELECTROLYTIC CONDENSERS ER5 80/50mfd-450V, 20mfd-250V, 150mfd-25V ... \$1
- 2 — ELECTROLYTIC CONDENSERS ER5 200/30/4 mfd — 350V ... \$1
- COLOR CONVERGENCE ASSEMBLY Universal type— \$2.49 good for most sets

Circle 69 on reader service card

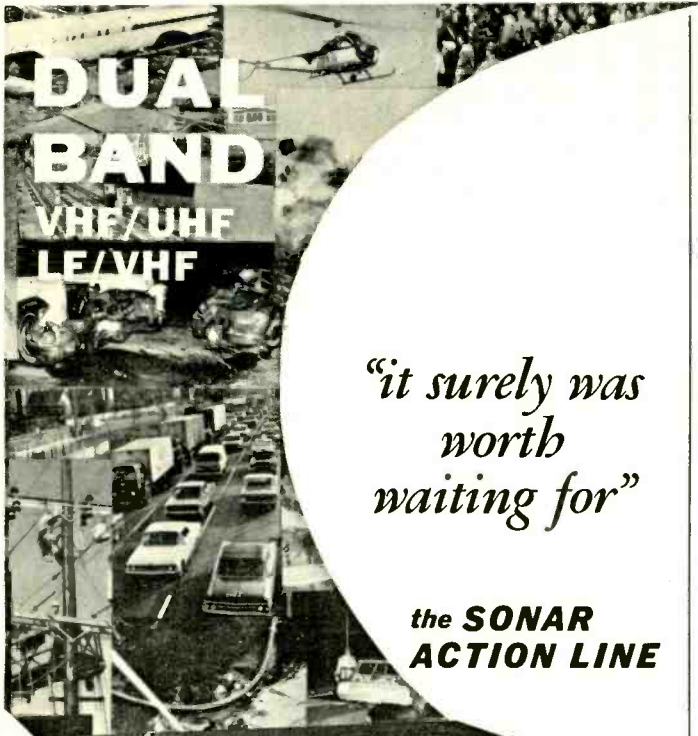

**DUAL
BAND
VHF/UHF
LF/VHF**

*"it surely was
worth
waiting for"*

**the SONAR
ACTION LINE**



SONAR-SCAN™

10 channel Dual Band FM monitor receivers

For those who seek a magnificent professional instrument with unusual flexibility, SONAR presents a new series of FM monitors with the most sophisticated and reliable circuitry ever conceived. It has power, more audio and more features than other monitors. Yes, it surely was worth waiting for.

- Dual band non-restrictive programming of channels allowing any combination of preselected channels
- Extra sensitivity to catch those weak signals
- Choice of VHF/UHF; LF/VHF; UHF
- Any channel may be switched out of scanning sequence
- A priority channel that will lock reception to the exclusion of all other signals
- Carrier delay to allow operator to hear mobile callbacks

This impressive array of engineering achievements are just some of the great features designed for complete flexibility whether it is used by police, fire dept. or any other law enforcement agency; and for business or industrial activity. SONAR fills the bill where constant communications is a necessity.



**FR-2526
VHF/UHF 18995**



**FR-2528
LF/VHF 18995**



**FR-2525
UHF only 17995**

Complete with antenna, AC and mobile power cables and mounting bracket, less crystals. Crystals \$5.00 each.

SONAR RADIO CORPORATION
73 Wortman Ave., Brooklyn, N.Y. 11207

Circle 70 on reader service card

circuits

TORNADO DETECTOR AND ALARM

The trick of using a TV set to detect the approach of a tornado has been described several times over the past few years (for example "Electronics Hunts Tornadoes", October, 1972, page 12). A TV is tuned to channel 13 and then the brightness control is turned down until the raster is just extinguished. The set is then switched to channel 2. A tornado within 10 to 20 miles causes the TV screen to light up.

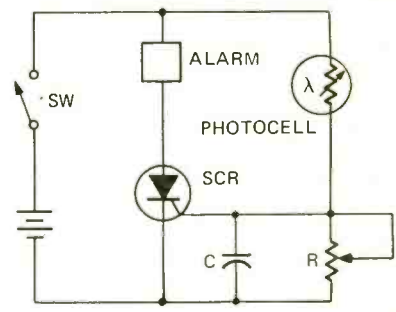

Electronic disturbances within the vacuum funnel of a tornado turn an energized but black TV screen white. The alarm (see diagram) consists of a photocell, a capacitor and resistor network to absorb transient voltage peaks and the affects of nearby lightning strokes, an SCR (rated for the alarm voltage and current), a battery and a switch. A suction cup holds the photocell against the picture tube. The alarm or alarms can be located away from the TV set as in a bedroom or barn.

MIKE MATCHING PREAMP

When a crystal microphone is fed into a 600-ohm input, the signal level output of the microphone is about 44 dB

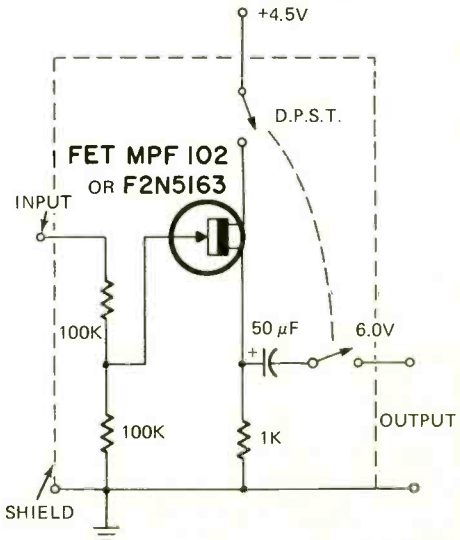

lower than the level available into a high input impedance. The simple matching amplifier shown here is for feeding the crystal microphone into a low-impedance input. For an adjustable gain control use a 200,000-ohm potentiometer in place of the fixed input voltage divider.—H.E. Goldstine R-E

technotes

CONVERGENCE AND PURITY PROBLEMS

Problems associated with screen purity and convergence frequently result from inadequate degaussing of *all* metal near the picture tube. Any magnetized metal near the tube can affect the landing points of the beams on the screen. For this reason, all metal—other than the permanent magnets purposely located close to the picture tube—must be completely demagnetized. Some sets have a metal back cover or a metal pix-tube neck cup attached to the back cover.

Frequently the back cover is not in place when the set is being degaussed. The back cover of the neck cup must be completely demagnetized to prevent it from affecting either convergence or purity. Be sure to degauss the metal portion of the back cover each time the set is degaussed.—*Magnavox Service News Letter*

G-E C2/L2 COLOR CHASSIS

In cases of no horizontal sync, check the horizontal feedback resistor (5R251). If it has overheated, replace this 1/2-watt resistor with a smooth-body type which has a better voltage

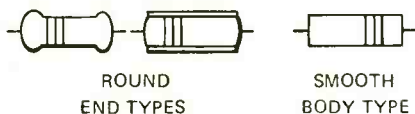

breakdown rating (Allen Bradley or IRC are preferred types). Don't use the round-end types (see illustrations) in this application.—*G-E Service Hints*

RCA CTC39 TUBE CHANGES

New tube types are used in the shunt regulator and horizontal output circuits in the CTC39 chassis used in "Q" line TV receivers. The chassis now has a 6EN4 in the shunt regulator circuit in place of the familiar 6BK4. The 6EN4 is designed especially to provide a margin of safety within the X-radiation standards established by H.E.W. **Do not** attempt to replace the 6EN4 with a 6BK4. The chassis is wired for a 6EN4 and will not accommodate the 6BK4. The 6EN4 can be used as a replacement for the 6BK4.

The 6ME6 horizontal output tube is also designed for limited X-radiation. Do not replace it with any other type. The 6ME6 can be used as a replacement for the 6LQ6.—*RCA Television Service Data*

SYLVANIA TV SERVICE NOTES

Vertical trouble—D05 chassis: C318, a .0056- μ F capacitor is a chronic trouble source in this chassis. Also check C320, the other .0056- μ F capacitor in the circuit for leakage or shorts.

Vertical jitter and rolling after warmup—D05, D06 and D011 chassis: Replace C310 with a 2-kV capacitor and relocate it under the circuit board away from the heat of the vertical oscillator and output tube.

Insufficient range; vertical linearity and height controls—D06 chassis: Try a new 6LU8 vertical tube. Check C322, .068 μ F. Check for open or leaky filter capacitor.

Insufficient width—D012 chassis: The 18,000-ohm, 1/2-watt resistor (R428) in the horizontal oscillator plate circuit has increased in value. Replace this resistor with a 1-watt unit to prevent future trouble.—*GTE Sylvania Service Notebook*

CALECTRO panel meters



A SIZE AND SHAPE
FOR EVERY NEED

LEVEL METER AND BATTERY CHECKER

Precision construction. Features D'Arsonval movement, jeweled bearings, and hand calibration.



MINIATURE EDGEWISE PANEL METERS

NEW
One Hole
Mount

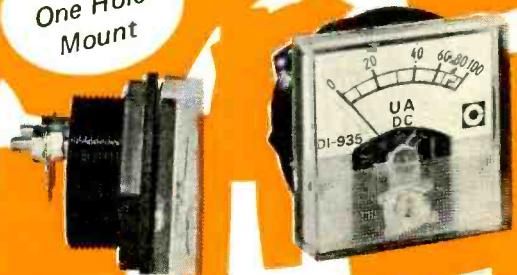

MINIATURE PANEL METERS

Full range of panel mini-meters featuring single hole mounting. Simply bore hole for movement and thats it. Thread nut onto back of meter. Meter in line — every time.

PRECISION PANEL METERS

Rugged construction — 2% accuracy. Hand calibrated and linear dial scales. D'Arsonval movement with jeweled bearings. Crystal clear plastic cover plate.



GC ELECTRONICS

DIVISION OF HYDROMETALS, INC.
ROCKFORD, ILLINOIS 61101 U.S.A.



Circle 71 on reader service card
DECEMBER 1972 • RADIO-ELECTRONICS

1972 ANNUAL INDEX

RADIO-ELECTRONICS January-December 1972 of Vol. 43

A		Counters, up-counting (Garner)†	Oct 68	Paging system, instant (Levin)	Jan 61
AC circuits nomogram (Quinn)	Feb 82	Curve tracer		IC's	
Add-on agc for PA system	Mar 42	Solid state, using (Horowitz)	Nov 62	Breadboard (Cazes)*	Dec 44
Alarms		Transistor (ER)	Jul 27	Digi-Mod-N frequency divider, R-E's (Cazes)*	Apr 42
Burglar		D			
Electronic watchdogs	Sep 33	Departments not indexed: New books, New literature,		Duo-trouble shooter—generator, tracer (Davidson)*	Sep 59
It's easy to install (Walters)	May 57	New and timely, New products, Noteworthy cir-		Experiments with op-amps (Rogen)	Jun 52
Multi-sensor (Lewart)* (Corres)	Apr 16	cuits, Tech notes; Try this one		4-channel preamp (Kaplan)* (Corres)	Jan 16
All about chromium dioxide tape (Andriesson)	Oct 36	Digi-Mod-N frequency divider, R-E's (Cazes)*	Apr 42	Function generator, \$40 (Lancaster)*	Sep 36; Oct 45
All about electronic calculators (Mims)	Dec 51	Digital		Key opens electronic door lock (Wicklund)*	Jun 41
All about electrolytics (Cunningham)	Feb 58, Mar 56	Circuits, bread-boarding (Cazes)	Jul 59	Logic demonstrator, R-E's (Lancaster)*	May 51
All about electrolysis (Cunningham)	Feb 58, Mar 56	Grinchwal test equipment, R-E's (Lancaster)*	Nov 33; Dec 94	New (Garner)†	Aug 24; Sep 52; Oct 68
Antennas		IC tester, R-E's (Cazes)*	May 33; Jun 55	Op-amp(s)	
Car radio, amplified (Johnson)	May 37	Multimeter (ER)	Sep 107	At work, using the 709 (Rogen)	Sep 44
MATV		Printing Computer, R-E's (Lancaster and Schoenfeld)*	Apr 50	Experiments (Rogen)	Jun 52
Cookbook (Shane)	Sep 62	Stopwatch, electronic (Rogen)*	Aug 39	Multimeter (Rogen)*	Jul 52
How it works (Wolf)	May 44	Superclock (Lancaster)*	Jul 54; Aug 60	Pocket calculator (Green)*	May 40
It's easy to install (Walters)	May 57	Diode uses (Franson)†	Mar 58	Potpourri (Jung)	Jan 68
TV booster testing, (CI)	Oct 69	Diodes isolate two power supply outputs (Laitinen)	Jan 97	Q-multiplier (Scott)†	Mar 55
Appliance clinic (Darr) (71) (Corres), Mar 16; Jan 22; Feb 24; Mar 22; Apr 22; May 24; June 24; Jul 22 (Corres) Sep 16; Aug 26; Sep 26; Oct 96; Nov 88; Dec 98		Displays, liquid crystal (Lancaster)	Feb 32; (Corres) May 16	Tester, R-E's digital (Cazes)*	May 33; Jun 55
Arc projector, zirconium (Pallatz)*	Aug 38	Dolby processing (Corres)	Feb 17; (Corres) May 16	Time-delay circuits	Oct 80
Audio		Drill, storing utility (Stillwell)	Jun 93	Indicator	
Omnisonics (Mann)	Apr 60	Duo-troubleshooter, IC—generator, tracer (Davidson)*	Sep 59	Garage-door (Boothroy)	Oct 58
Op-amps, audio applications of (Rogen)	Dec 58	E			
PA		Electrolytics, all about (Cunningham)	Feb 58; Mar 56	On-off, micropower (Scott)†	Nov 52
Add-on agc for system	Mar 42	Electronic		It's easy to install burglar alarms—MATV—PA intercoms (Walters)	May 57
It's easy to install (Walters)	May 57	Digital stopwatch (Rogen)*	Aug 39	K	
Paging-intercom system, instant (Levin)	Jan 61	Door lock, IC key opens (Wicklund)*	Jun 41	Kwik-Fix™ picture and waveform charts (Belt and Associates) Jan 57; Feb 43; Mar 39; May 61; Jul 41; Aug 51	
Preamplifier (ER)	Mar 92	Ignition facts and fallacies (Shane)	Apr 86	L	
Servicing—see Servicing audio; test instrument names		Photos	Sep 103	Laser	
Speaker		Snoopers, outfit (Cunningham)	Feb 25	Experiment	Feb 88
Setups for 4-channel listening	Jun 36	Watchdogs	Sep 33	Experiment with \$32 solid-state laser (Mims)*	Jun 44
System (ER)	Jun 92	Electronics outdoors—CB marine, stereo (Sands)	Jun 37	Liquid crystal displays (Lancaster)	Feb 32; (Corres) May 16
Stereo (see also Audio: stereo, 4-channel)		ESD (energy storage device) (Scott)†	Mar 53	Log taper from linear pots (Rotello)	Aug 41
Amplifier, how to design your own solid-state (Horowitz)	Apr 57; Sep 56	Experiment(s)		Logic demonstrator, RE's (Lancaster)*	May 51
Electronics outdoors (Sands)	Jun 37	Binary counting demonstrator (Gross)*	Feb 40	Low-ohms story (Cerveny)	Jul 76
Preamp, "zero distortion" (Kay)	Dec 39	Digital circuits, breadboarding (Cazes)	Jul 59	M	
Test tapes and test records, for better stereo use (Sutheim)	Jul 24	Laser	Feb 88	Magnet wire to replace hook-up wire (Plavcan)	Sep 55
Stereo, 4-channel (see also Audio: stereo)		\$32 solid-state (Mims)*	Jun 44	Makeshift ac wattmeter (Lennie)	May 53
Adapter roundup (Lawrence)	Mar 36	Op-amps (Rogen)	Jun 52	Marine electronics (Sands)†	Jun 37
Decoder, new universal (Shane)	Oct 33	F			
IC preamp (Kaplan)* (Corres)	Jan 16	Facts and fallacies of electronic ignition (Shane)	Apr 86	Matrix (Sansui) (Shane)	Jun 33
Matrix (Sansui) (Shane)	Jun 33	FET		MATV	
On a disc (CBS—Sony SQ matrix) (Petras), Mar 25; (Corres) June 16; (Corres) Sep 16		Designs, new (Garner)†	Sep 50	Cookbook (Shane)	Sep 62
On a disc (RCA—Panasonic—JVC discrete) (Lachenbruch) RCA 32; (Corres) Jun 16; (Corres) Sep 16; (Corres) Oct 16		VOM, micropower (ER)	Oct 44	How it works (Wolf)	Apr 44
Phones, R-E test report on (Friedman)	Oct 42	Fiber optics—now! (Doering)	Aug 33	It's easy to install (Walters)	May 57
Record review (R-E editorial staff)	Oct 59	Suppliers	Aug 72	Microammeter, op-amp dc (Rogen)†	Jun 54
Records: discrete vs. matrix	Mar 35	Field operations—technician's role (Farkas)	Jul 45	Millivoltmeter, op-amp ac (Rogen)†	Jun 54
Records, how they're made (Zide)	Oct 52	4-channel stereo—see Audio: stereo, 4-channel		More ways to use your tape recorder (Wels)	Feb 74
Speaker setups	Jun 36	Frequency divider, R-E's Digi-Mod-N (Cazes)*	Apr 42	Multimeter	
Switching systems (Butterfield)	Feb 77	Frequency meter (ER)	Jul 32; (ER) Nov 54	Digital (ER)	Sep 107
Cassette, tapes, R-E tests (Shane)	Mar 43	Frequency-time conversion	Jul 40; (Corr) Sep 16	Op-amp (Rogen)*	Jul 52
Cassettes for your car, Staar (Allen) (P)	Apr 37	Function generator (Garner)†	Aug 23	Multi-sensor alarm (Lewart) (Corres)	Apr 17
Chromium dioxide, all about (Andriesson)	Oct 36	Function generator, \$40 (Lancaster)*	Sep 36; Oct 45	N	
8-track car tape player repair (Carr)	Apr 54	G			
Noise, reduce (Friedman)	Oct 55	Game: Tic-tac-tronix (Lancaster)* (Corr)	Feb 22	New universal circuits for '72 (Scott)	Jan 42
Recorder, more ways to use your (Wels)	Feb 74	Garage door indicator (Boothroy)	Oct 58	New universal decoder for 4-channel matrix (Shane)	Oct 33
Turntable, automatic (ER) Mar 76; (ER) Oct 26		Generator(s)		Now the transistor is 25 (Shunaman)	Dec 35
Automatic tint controls for everyone (Maxwell)	Jan 53	Audio signal*	Feb 91	Numeric display, new (Garner)†	Sep 43
Automotive electronics		Color-bar generators, using (Belt and Dobson)	Dec 55	O	
Add on electronics for your car (Holder)	Apr 33	Color convergence, R-E's \$15 (Rogen)* Jan 50; (Corres) May 72; (Corr) Aug 22		Omnisonics (Mann)	Apr 60
Facts and fallacies of electronic ignition (Shane)	Apr 86	Combined square and triangle, Op-amp (Rogen)†	Jun 54	On-off indicator, micropower (Scott)†	Nov 52
8-track car tape player repair (Carr)	Apr 54	Dual-clock, solid-state (Lancaster)*	Feb 55	Op amp(s)	
Radio antennas, amplified (Johnson)	May 37	Duo-troubleshooter, IC (Davidson)*	Sep 59	At work, using the 709 (Rogen)	Sep 44
Staar cassettes for your car (Allen) (P)	Apr 37	Function (Garner)†	Aug 23	Audio applications (Rogen)	Dec 58
Tail light monitor for your car (Graf and Whalen)* (Corres)	Jan 16	Function, \$40 (Lancaster)*	Sep 36; Oct 45	Experiments with (Rogen)	Jun 52
VW computer checks your car (Holder)	Nov 37	Signal generator applications (Huffman)	Nov 55	Multimeter (Rogen)*	Jul 52
Windshield wiper pause control (Schultz)* (Corres)	Apr 16	Sine-wave, op-amp (Rogen)†	Jun 54	Oscillator, complementary (Garner)†	Sep 51
		Square-wave, op-amp (Rogen)†	Jun 53	Oscilloscope (scope) (ER)	Sep 104
		Sweep		Analysis of audio distortion (Middleton)	Feb 52
		Output low (CI)	Apr 69	Triggered dual-trace (ER)	Nov 52
		Unusual i.f. (Scott)†	Nov 52	Triggered sweep (ER)	Feb 51; (ER) Apr 32; (ER) Jun 26
		Ghosts due to mismatches (Shultz)	Sep 42	Outwit electronic snoopers (Cunningham)	Feb 25
		Grinchwal digital test equipment, R-E's (Lancaster)*	Nov 33; Dec 94	P	
		H			
		Ham-band receiver (ER)	May 26	PA	
		Hook-up wire, magnet wire to replace (Plavcan)	Sep 55	Add-on agc for system	Mar 42
		Hum bars, eliminating	Jan 70	It's easy to install (Walters)	May 57
		I			
		Incorrect use of semiconductors (Franson)	Mar 58	Paging-intercom system, instant (Levin)	Jan 61
		Intercoms		Photography	
		It's easy to install (Walters)	May 57	Electronic photos	Sep 103
				Printing computer, R-E's digital (Lancaster and Schoenfeld)*	Apr 50
				Zirconium arc projector (Pallatz)*	Aug 38
				Pots, log tapes from (Rotello)	Aug 41
				Power supply	
				Outputs, diodes isolate two (Laitinen)	Jan 97
				Versatile lab (Scott)†	Nov 53

Q		Dual-clock generator, solid-state (Lancaster)	Feb 55	Signal tracer (ER)	Dec 32
Q-multipliers (Scott)†	Mar 55	Duo-troubleshooter IC-generator, tracer (Davidson)*	Feb 59	Signal tracer—duo-troubleshooter, IC (Davidson)*	Sep 59
Quadraphonics—see Audio: stereo, 4-channel		Frequency meter (ER)	Jul 32; (ER) Nov 54	Silicon diodes, switching tricks with (Mandi)	May 54; (Corres) Aug 16; Oct 22
R		Function generator (Garner)†	Aug 23	Sine-wave generator, op-amp (Rogen)†	Jun 54
Radio		Function generator, \$40 (Lancaster)*	Sep 36; Oct 45	Solid state	
American Radio Hobbyists Association (Corres)		Grinchwal digital test equipment, R-E's (Lancaster)*	Nov 33; Dec 94	Curve tracer, using (Horowitz)	Nov 62
AM booster (McClellan)	Aug 22	IC tester, R-E's digital (Cazes)*	May 33; Jun 55	Dual-clock generator (Lancaster)*	Feb 55
Antique buffs (Corres)	Apr 25	Low-ohms story (Cerveny)	Jul 76	Laser, experiment with \$32 (Mims)*	Jun 44
Car antennas, amplified (Johnson)	Mar 17	Micrommeter, op-amp dc (Rogen)†	Jun 54	Relay, ratchet (Scott)†	Nov 53
CB		Millivoltmeter, op-amp ac (Rogen)†	Jun 54	State of (Garner)	Aug 23; Sep 50; Oct 62; Nov 59; Dec 60
Call light	Jun 59	Multimeter, digital (ER)	Sep 107	Stereo amplifier, how to design your own (Horowitz)	Mar 50; Apr 57; Sep 56
Electronics outdoors (Sands)†	Jun 37	Multimeter, op-amp (Rogen)*	Jul 52	Triodes and pentodes (Garner)†	Sep 51
Frequency meter (ER)	Jul 32	Power supply, versatile lab (Scott)	Nov 53	"Tubes" (CI)	Jul 62
ESD (energy storage device) (Scott)†	Mar 53	Scope (ER)	Sep 104	Setup for 4-channel stereo listening	Jun 36
FM		Scope power transformer replacement (CI)	Jul 69	System (ER)	Jun 92
Break through radio pollution (Cooper)* (Corres)	Feb 16	Scope, remote-control transmitter seen on (CI)	Oct 78	Spike suppressor, varistor (Garner)†	Oct 63
Dolby processing (Corres)	Feb 17; (Corres) May 16	Scope, sawtooth voltage from (CI)	Jan 99	Square-wave generator, op-amp (Rogen)†	Jun 53
Ham-band receiver (ER)	May 26	Scope, triggered dual trace (ER)	Nov 26	State of solid state (Garner)	Aug 23; Sep 50; Oct 62; Nov 59
Marine electronics outdoors (Sands)†	Jun 37	Scope, triggered sweep (ER)	Feb 51; (ER) Apr 32; (ER) Jun 26	Step-by-step TV troubleshooters' guide (Margolis)	Sep 53; Oct 60; Nov 50; Dec 48
Q-multipliers (Scott)†	Mar 55	Scope vertical deflection gone (CI)	Oct 78	Stereo—see Audio	
Relay, solid-state ratchet (Scott)†	Nov 53	Scope vertical positioning (CI)	Oct 72	Stopwatch, electronic digital (Rogen)*	Aug 39
Signal booster, broadband (Scott)†	Mar 53	Signal generator, audio*	Feb 91	Superclock—new digital timekeeper (Lancaster)*	Jul 54; Aug 60
Single-sideband made easy (Shunaman)	Jul 38	Signal squirter, bargain transistor (D'Airo)*	Aug 56	Sweep generator	
Technical topics (Scott)	Mar 53	Signal tracer (ER)	Dec 32	Output low (CI)	Apr 69
R-E editors now CET's	Nov 45	Sine-wave generator, op-amp (Rogen)†	Jun 54	Switch	
R-E tests cassette tapes (Shane)	Mar 43	Square-wave generator, op-amp (Rogen)†	Jun 53	Safety for bikes (Garbours)	Jun 40
Reduce tape noise (Friedman)	Oct 55	Sweep generator output low (CI)	Apr 69	Touch, sensitive (Tooker)*	Aug 54
Relay, solid-state ratchet (Scott)†	Nov 53	Sweep generator, unusual i.f. (Scott)†	Nov 52	Switching	
S		Tape-head test stick (Davidson)	May 43	Systems, audio (Butterfield)	Feb 77
Safety switch for bikes (Garbours)	Jun 40	Time savers (CI)	Jun 70	Tricks with silicon diodes (Mandi)	May 54; (Corres) Aug 16; (Corres) Oct 22
Scope—see Oscilloscope		Tube tester (ER)	Jan 26	Television—see also Servicing color TV	
SCR's, new (Garner)†	Sep 52	TV tuner-subber (Western)*	Apr 23; (Corr) May 22	Agc circuit, transistor TV's (CI)	May 70
Semiconductors—see also Solid state; names		Vectorscopes, how to use them (Middleton)	Nov 41	Age problems (CI)	Aug 69
Incorrect use of (Franson)	Mar 58	Vom, micropower FET (ER)	Oct 44	Band of ripples (CI)	Nov 81
Low power consumption (Garner)†	Nov 59	Vom, resistor burnt on imported (CI)	Jun 73	Blackout (CI)	Oct 73
Sensitive touch switch (Tooker)*	Aug 54	Vtm probes stay with meter (Legon)	May 69	Blooming (CI)	Jan 76
Service clinic (Darr)—see Servicing ("CI" indicates Clinic Item)		Vtm problem (CI)	Apr 63	Blur, floating (CI)	Nov 70
Servicing		Vtm, vom, tvm (Huffman)	Aug 42	Boost-boost rectifier arcing (CI)	Jan 74
Appliance clinic (Darr)		Wattmeter, makeshift ac (Lennie)	May 53	Boost-boost voltage out (CI)	Jan 77
Dec 71 (Corres), Mar 16; Jan 22; Feb 24; Mar 22; Apr 22; May 24; Jun 24; Jul 22; (Corres) Sep 16; Aug 26; Sep 26; Oct 96; Nov 88; Dec 98		Field operations—technician's role (Farkas)	Jul 45	Booster testing (CI)	Oct 69
Audio		Imagination aids troubleshooting (CI)	Nov 69	Cable TV (CATV) (CI)	Sep 69
Car 8-track tape player repair (Carr)	Apr 54	Television—see also Servicing color TV		Current low, raster full (CI)	Jul 63
Darlingtons, watch out for (CI)	Aug 69	Agc circuit, transistor TV's (CI)	May 70	Diagnosis puzzler, in sections (CI)	Aug 63
Hi-fi stereo repair scene (Maynard)	Oct 39	Age problems (CI)	Aug 69	Drive lines (CI)	Jan 74; (CI) Oct 73
Power transformer hot (CI)	Nov 78	Band of ripples (CI)	Nov 81	Factory goof (CI)	Jul 63
Scope analysis of audio distortion (Middleton)	Feb 52	Blackout (CI)	Oct 73	Focus rectifier burnout (CI)	Jan 75
Signal generator*	Feb 91	Blooming (CI)	Jan 76	Ghosts due to mismatches (Shultz)	Sep 42
Stereo amplifier current unbalanced in output (CI)	Sep 72	Blur, floating (CI)	Nov 70	Height loss (CI)	Aug 71
Stereo amplifier output transformer (CI)	Jul 71	Boost-boost rectifier arcing (CI)	Jan 74	High voltage low (CI)	Feb 63
Stereo amplifier rectifiers reversed (CI)	Aug 68	Boost-boost voltage out (CI)	Jan 77	High voltage out (CI)	Oct 72; (CI) Oct 79
Tape-head test stick (Davidson)	May 43	Booster testing (CI)	Oct 69	High-voltage problems (CI)	Jul 71
Tape player, orphan transistors in (CI)	Apr 63	Cable TV (CATV) (CI)	Sep 69	Horizontal driver transistor burnout (CI)	Apr 68
Tape recording distortion (CI)	Mar 69	Current low, raster full (CI)	Jul 63	Horizontal instability (CI)	Mar 68
Test tapes and records, for better stereo use (Suth-eim)	Jul 24	Diagnosis puzzler, in sections (CI)	Aug 63	Horizontal oscillator frequency problems (CI)	Nov 72
Ultrasonic oscillator substitute (CI)	Jun 71	Drive lines (CI)	Jan 74; (CI) Oct 73	Horizontal oscillator trouble (CI)	Sep 78
Cable television (CATV) (CI)	Sep 69	Factory goof (CI)	Jul 63	Horizontal output transistors (CI)	May 73; (CI) Nov 81
Color TV—see also Servicing television Bars, floating (CI)	Apr 63	Focus rectifier burnout (CI)	Jan 75	Horizontal shrinkage (CI)	Mar 68
Cable TV (CATV) (CI)	Sep 69	Ghosts due to mismatches (Shultz)	Sep 42	Horizontal sync poor (CI)	Nov 72
Cathode current rise slow (CI)	Jun 72	Height loss (CI)	Aug 71	Horizontal sync out (CI)	Jan 76
Color convergence generator, R-E's R15 (Rogen)*	Jan 50; (Corres) May 22; (Corr) Aug 22	High voltage low (CI)	Feb 63	Interference, transistor TV (Mandi)	Aug 58
Discolored picture (CI)	Oct 70	High voltage out (CI)	Oct 72; (CI) Oct 79	"Jig smear" in monitor (CI)	Aug 71
Dynamic convergence (CI)	Apr 62	High-voltage problems (CI)	Jul 71	Kwik-Fix™ picture and waveform charts (Belt and Associates)	May 61
Flare, intermittent; raster collapse (CI)	Nov 78	Horizontal driver transistor burnout (CI)	Apr 68	Oscillator squegging (CI)	Oct 72
Flashes, white (CI)	Nov 70	Horizontal instability (CI)	Mar 68	Picture roll (Davidson)	Feb 42
Focus "pulsing" (CI)	Jul 63	Horizontal oscillator frequency problems (CI)	Nov 72	Pix tube replacement (CI)	Jun 72
Focus rectifier flashover (CI)	May 73	Horizontal oscillator trouble (CI)	Sep 78	Raster grows (CI)	Jul 69
Horizontal hold vs. color burst (CI)	Sep 78	Horizontal output transistors (CI)	May 73; (CI) Nov 81	RF agc trouble (CI)	Jun 73
Horizontal ripple, top and bottom (CI)	Jul 68	Horizontal shrinkage (CI)	Mar 68	S-bending (CI)	Nov 78
Hum bar, mysterious (CI)	Jul 70	Horizontal sync poor (CI)	Nov 72	Scanning lines squeezed (CI)	Apr 69
HV rectifier failures (CI)	Jul 70	Horizontal sync out (CI)	Jan 76	Scopes, using (CI)	Feb 62
Interference, venetian blind (CI)	Jul 70	Interference, transistor TV (Mandi)	Aug 58	Shafts, reach inaccessible (Billos)	Aug 50
Keystone raster (CI)	Jul 69	"Jig smear" in monitor (CI)	Aug 71	Solid-state "tubes" (CI)	Jul 62
Kwik-Fix™ picture and waveform charts (Belt and Associates)	Jan 57; Feb 43; Mar 39; Jul 41; Aug 51	Kwik-Fix™ picture and waveform charts (Belt and Associates)	May 61	Speaker grille, shoe dye restores (Cabot)	Jul 53
Pix tube cracked (CI)	Mar 68	Oscillator squegging (CI)	Oct 72	Standards, US vs. UK (CI)	Jun 72
Problems? (CI)	Nov 72	Picture roll (Davidson)	Feb 42	Step-by-step troubleshooters guide (Margolis)	Sep 53; Oct 60; Nov 50
Purity problem (CI)	Jul 68	Pix tube replacement (CI)	Jun 72	Switching diodes for front ends (CI)	Jan 72
Raster ripple and rainbow bars (CI)	Feb 68	Raster grows (CI)	Jul 69	Switch replacement (CI)	Feb 68
Red bloom; no focus (CI)	Mar 63	RF agc trouble (CI)	Jun 73	Television Service Association code of ethics	May 96
Red faces (CI)	Oct 70	S-bending (CI)	Nov 78	Trap setting (CI)	Aug 71
Short, intermittent (CI)	Jan 77	Scanning lines squeezed (CI)	Apr 69	Triple trouble (CI)	Jan 74
Sync out (CI)	Apr 68; Sep 109	Scopes, using (CI)	Feb 62	Tuner-subber (Western)*	Apr 23
Transistor intermittent (CI)	Nov 80	Shafts, reach inaccessible (Billos)	Aug 50	(Corr) May 22	
Vertical blink (CI)	Nov 70	Solid-state "tubes" (CI)	Jul 62	Vertical deflection with tube out (CI)	Aug 70
Vertical foldover (Davidson)	Oct 100	Speaker grille, shoe dye restores (Cabot)	Jul 53	Vertical linearity (CI)	Jan 74; (CI) Nov 80
Volts high, current low (CI)	Aug 68	Standards, US vs. UK (CI)	Jun 72	Vertical problems (CI)	Nov 80
Diagnosis and methods thereof (CI)	Mar 62	Step-by-step troubleshooters guide (Margolis)	Sep 53; Oct 60; Nov 50	Vertical sweep out (CI)	Apr 68
Equipment		Switching diodes for front ends (CI)	Jan 72	Vertical white line (CI)	Oct 78
Color-bar generators, using (Belt and Dobson)	Dec 55	Switch replacement (CI)	Feb 68	Video low, smear bad (CI)	Sep 70
Color convergence generator, R-E's R15 (Rogen)*	Jan 50; (Corres) May 22; (Corr) Aug 22	Television Service Association code of ethics	May 96	Video smear (CI)	Jul 71
Combined square and triangle generator (Rogen)†	Jun 54	Trap setting (CI)	Aug 71	Time savers (CI)	Jun 70
Curve tracer, transistor (ER)	Jul 27	Triple trouble (CI)	Jan 74	Transistor testing is a cinch (Cunningham)	Feb 37
Curve tracer, transistor (Mulleit and (Caringella))	Jun 60	Tuner-subber (Western)*	Apr 23	Transistor training program (Garner)†	Sep 52
Curve tracer, using solid state (Horowitz)	Nov 62	(Corr) May 22		Signal generator applications (Huffman)	Nov 55
Drill, storing utility (Stillwell)	Jun 93	Vertical deflection with tube out (CI)	Aug 70	Audio*	Feb 91
T		Vertical linearity (CI)	Jan 74; (CI) Nov 80	Single-sideband made easy (Shunaman)	Jul 38
U		Vertical problems (CI)	Nov 80	Signal squirter, bargain transistor (D'Airo)*	Aug 56
V		Vertical sweep out (CI)	Apr 68		
W		Vertical white line (CI)	Oct 78		
Z		Video low, smear bad (CI)	Sep 70		
		Video smear (CI)	Jul 71		
		Time savers (CI)	Jun 70		
		Transistor testing is a cinch (Cunningham)	Feb 37		
		Transistor training program (Garner)†	Sep 52		
		Signal generator applications (Huffman)	Nov 55		
		Audio*	Feb 91		
		Single-sideband made easy (Shunaman)	Jul 38		
		Signal squirter, bargain transistor (D'Airo)*	Aug 56		
		Using a solid-state curve tracer (Horowitz)	Nov 62		
		Using color-bar generators (Belt and Dobson)	Dec 55		
		Varistor spike suppressor (Garner)†	Oct 63		
		Vectorscopes, how to use them (Middleton)	Nov 41		
		Vom			
		Low-ohms story (Cerveny)	Jul 76		
		Micropower FET (ER)	Oct 44		
		Resistor burnt on imported (CI)	Jun 73		
		Vtm, vom, tvm (Huffman)	Aug 42		
		Probes stay with meter (Legon)	May 69		
		Problem (CI)	Apr 63		
		Vtm, vom, tvm (Huffman)	Aug 42		
		VW computer checks your car (Holder)	Nov 37		
		Wattmeter, makeshift ac (Lennie)	May 53		
		Windshield wiper pause control (Schultz)* (Corres)	Apr 16		
		Zener uses (Franson)†	Mar 59		
		"Zero distortion" stereo preamp (Kay)	Dec 39		
		Zincium arc projector (Pallatz)*	Aug 38		

*Construction articles: † part of larger article, ER (Equipment Report), NC Noteworthy Circuits, Corr (correction), CI (Service Clinic); P (programmed), Corres (Correspondence)

3 WAYS TO BUILD YOURSELF A BIGGER, BRIGHTER FUTURE.

Which one's right for you?

1 Build, keep this Bell & Howell solid state 25-inch color TV

Home Entertainment Electronics Systems

Here's a field that's packed with opportunity! There's a growing demand for skilled technicians to build, install and service solid state color TV's... FM-AM radios... tape recorders... four-channel stereo systems... videotape recorders and more. Start preparing now. And build yourself a 25-inch color TV while you're at it. Mail the postage-free card for all the facts.

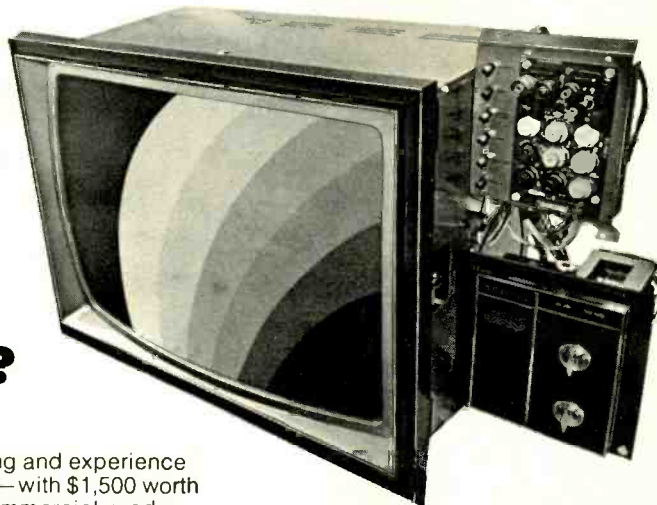

2 Use over \$1,500.00 worth of actual commercial-grade two-way radio electronic communications equipment right in your own home

Two-Way Radio Electronic Communications

There are almost two million commercial two-way radio systems in this country. And the FCC requires each to have its equipment checked and serviced regularly by a trained and licensed technician. Bell & Howell Schools offer you

the training and experience you need — with \$1,500 worth of real, commercial-grade equipment you use right in your own home. Get all the free facts you need. Mail postage-free card now.



3 Put the controls of an entire manufacturing plant at your fingertips

Electronic Operations Technology and Computer Controls

Automation is sweeping industry. And each of the roughly 90,000 computers in this country requires several highly-trained technicians to keep it working 24 hours a day! Get started on a lifetime career — one in which you can't be replaced by a machine. Mail the postage-free card now for free information. No obligation.



For free information about all three, detach and mail postage-free card today!

WHICHEVER PROGRAM YOU CHOOSE YOU BUILD AND KEEP THIS EXCITING ELECTRO LAB® ELECTRONICS LABORATORY-IN-THE-HOME!

Build it yourself and use it to perform hundreds of fascinating electronics experiments. Mail postage-free card for free facts now. No obligation.

Here's what you build and keep:

■ **Design Console** Use this to rapidly "breadboard" circuits without soldering. Equipped with built-in power supply ... test light ... speaker ... patented plug-in modular connectors.

■ **Oscilloscope** Portable 5-inch wide-band oscilloscope offers bright, sharp screen images ... calibrated for peak-to-peak voltage and time measurements ... 3-way jacks for leads, plugs, wires.

■ **Transistorized Meter** Combines most desired features of vacuum-tube voltmeter and quality multimeter. Registers current, voltage and resistance measurements on a large, easy-read dial. Features sensitive, 4-inch, jewel-bearing d'Arsonval meter movement.

Follow simple, step-by-step instructions

It doesn't matter if you've never had training in electronics before. You start with the basics. You take it one step at a time. You walk before you run. And you move ahead at your own pace.

Attend special "help sessions" if you like

If you run into a sticky problem or two, come in and see us. Meet an expert instructor in person. Talk over any rough spots with him — and with other students, too, if you wish.

Why you should know electronics

Everywhere you look, electronics is becoming a bigger and bigger part of the picture. The day may come when the man without electronics training will be severely handicapped in many industries.

Why you should get your training from Bell & Howell Schools

Each year, Bell & Howell Schools spends over \$200,000 improving programs and materials. Many thousands of people have used these programs as the foundation for new careers and businesses in electronics.



Consider these advantages . . .

Help Sessions We've scheduled "help sessions" every few Saturdays at the Bell & Howell Schools and in many other cities throughout the U.S. and Canada. Top instructors give you expert guidance and you meet other students, too.

Resident Study After you complete your program, you can transfer to any of the resident schools for more advanced study, if you wish.

Lifetime National Placement Assistance When you complete your course, we help you locate a position in the field of Electronics that fits your background and interests. Service is available any time after you graduate.

Veterans' Benefits We are approved by the state approval agency for Veterans' Benefits. Check the box for details.

Student Financial Aid We are an eligible institution under the Federally Insured Student Loan Program. Check the box for details.

**For free information about all three programs
and about the Electro Lab® you build and keep,
detach and mail postage-free card today!
or write**

330R

DeVRY INSTITUTE OF TECHNOLOGY
ONE OF THE
BELL & HOWELL SCHOOLS

4141 Belmont Avenue, Chicago, Illinois 60641



**Attention
Electronic
Technicians!**

**SCHOOLING
OF
EXCELLENCE
in ELECTRONICS
ENGINEERING**

If you have adequate schooling and experience at the technician level you may be able to qualify to enter our college-level Home Study Program in Electronics Engineering. The CIEE Program is OUTSTANDING, and up-to-date in every respect. CIEE is a forward-looking school, and Engineering is taught on the basis of application and understanding rather than on the basis of memorization. All lesson material and texts are thorough and easy-to-understand. Through this Highly Effective Home Study Program in Electronics Engineering you can raise your status and pay to the Engineering level. No residence classes required for those who qualify. If you are an electronics technician with above-average ambition, and not willing to settle for anything less than the best home study Engineering Schooling available anywhere, then you should write TODAY for our free revealing descriptive literature. There is no obligation, and no salesman will call on you.

COOK'S INSTITUTE
of Electronics Engineering
Raymond Road
P. O. Box 10634
Jackson, Miss. 39209
Established 1945
Formerly Cook's School of Electronics

Circle 72 on reader service card

**DISCOUNT
PRICES
TEST
EQUIPMENT**

B&K
**SENCORE
Leader**

**Shure and Electro-Voice
Microphones
I.E.C./Mullard
Tube Specials**

Catalog & Prices on Request

FORDHAM Radio Supply
Company, Inc.
265 E. 149 Street, Bronx, N.Y.
Tel: (212) 585-0330 **RCA**

DISTRIBUTORS OF ELECTRONIC SUPPLIES

94 Circle 73 on reader service card
RADIO-ELECTRONICS • DECEMBER 1972

by DON LANCASTER

HERE ARE THE FINAL DETAILS TELLING how to build the mainframe for your grinchwal digital test equipment mainframe. Plug-ins start in February.

Preliminary checkout

You'll need a previously tested and working counter module and your power supply for checkout. Hookup the circuit of Fig. 4-a and check out the counting unit for normal brightness, counting, and "hold-follow" operation. Next checkout the reset and lamp test modes. Finally, check the overflow lamp by resetting the counter and watching it light and stay lit on count number 10,000.

Now, go to the circuit for Fig. 4-b. Doublecheck the voltages on your PC board for IC1, making sure you have -12 volts only on pin 16, +6 only on pins 7 & 15, and ground only on pins 2, 3, 5, and 6. You can now solder IC1 in place using a small iron and fine solder. When you reapply power, the counter should promptly start running at a 100-Hz rate. If it doesn't, first make sure you are in the FOLLOW position, and then try several adjustments of the trimmer capacitor. In case of difficulty, the 1-MHz

BUILD GRINCHWAL

oscillator output may be monitored with an oscilloscope with a 10x probe directly on pin 10 of IC1.

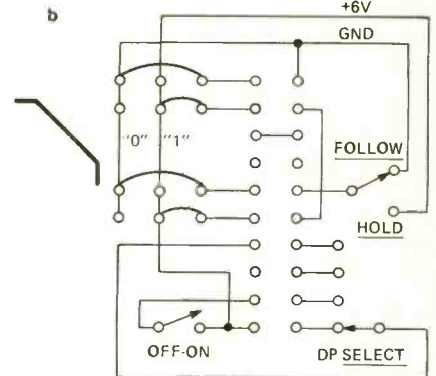
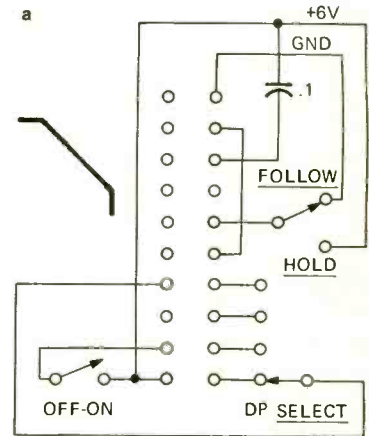

FIG. 4—WHEN UNIT IS ASSEMBLED test for proper operation with these two circuits.

When you switch off the +6-volt line, the -12-volt line is also switched off through "relay" Q2 and Q3. A connector PC pattern for the plug-in is shown in Fig. 5.

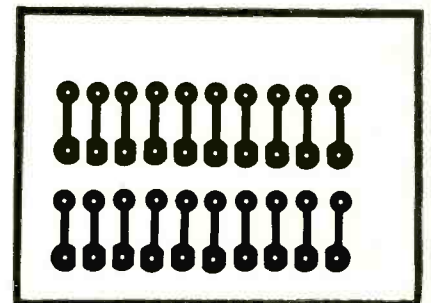

FIG. 5—CONNECTOR FOIL PATTERN. Each plug-in will use one of these connectors.

NOTE: The following are available from Southwest Technical Products, 219 West Rhapsody, San Antonio, Texas, 78216: PC Board, etched and drilled No. DGM-b, \$4.85 postpaid. Circuit board for readouts, No. DGR-b, \$3.85 postpaid. Kit of parts for readout, No. DR-C, \$34.50. Kit of parts for mainframe and timebase plug-in, including case and front panel, No. DM-C, \$26.75, less readouts and batteries, postpaid.

**NEW ENDECO
Desoldering
Kits**



MODEL
300-K
KIT
SHOWN

All you need to handle almost any desoldering and resoldering job!



Kit 300K includes the famous Endeco pencil desoldering iron Model 300, six different size tips (.038 to .090) for any job, tip cleaning tool, and metal stand for iron . . . all in a handy lifetime steel storage box. \$19.90 net. Model 300K-3 with a 3-wire cord \$20.90. Also a similar kit for military users. Kit 100K with large Endeco iron (Model 100A) is \$27.40, and 3-wire Kit 100AD-3 \$28.40.

SEE YOUR DISTRIBUTOR OR WRITE



**ENTERPRISE
DEVELOPMENT
CORPORATION**

5127 E. 65th • Indianapolis, Ind. 46220
Circle 74 on reader service card

DIGITAL TEST EQUIPMENT

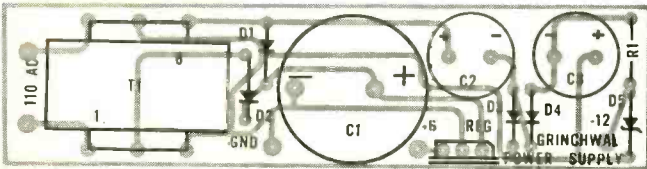
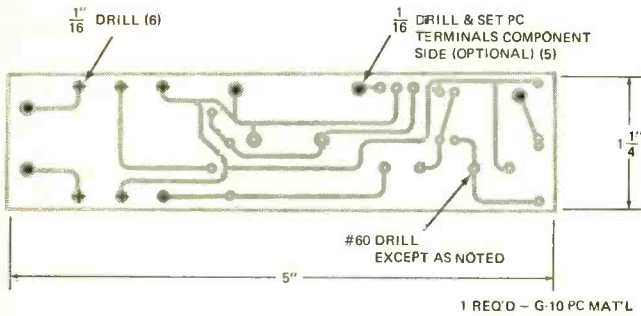
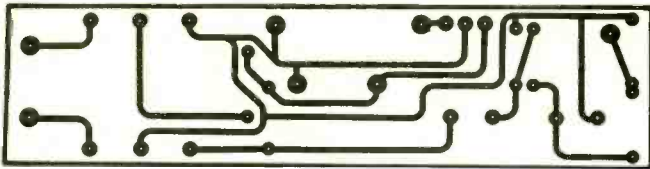

POWER SUPPLY CIRCUIT BOARD DETAILS. Three diagrams are shown. At the top is the foil pattern for the board. Next is the drilling guide. Last is a diagram showing parts placement on the circuit board.

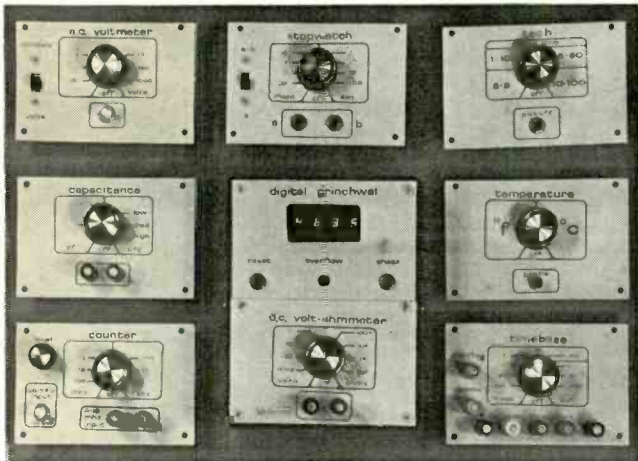

THESE ARE SOME OF THE PLUG-INS that go along with the Grinchwal digital Instrument. You'll want to have them all.

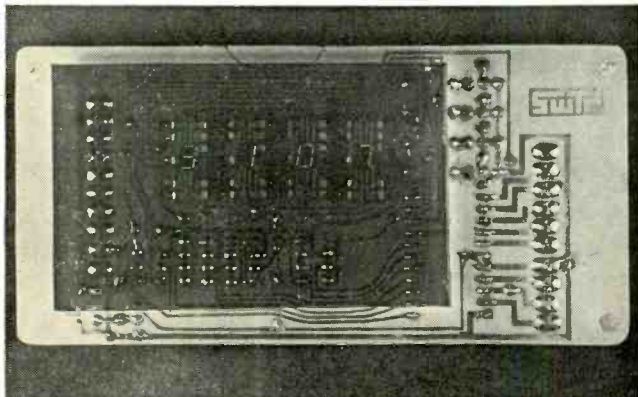

AN ASSEMBLED READOUT BOARD. The numerals are illuminated for this photo. Do not operate your unit out of its case.

(continued on page 96)

COMPUTER BOARD MONTH

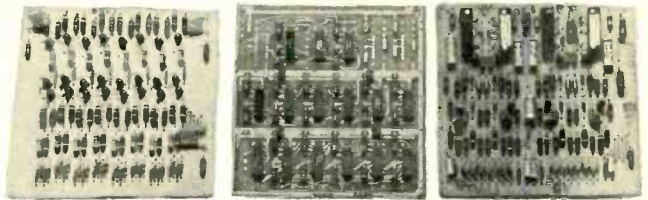

Three boards, one loaded with transistors, one loaded with integrated circuits, and one with from two to five trim pots, all with diodes, capacitors, and many other components. Each board 5 1/2" x 5 1/2". STOCK NO. J9380, 3 boards as above, \$2.00. 9 boards, \$5.00

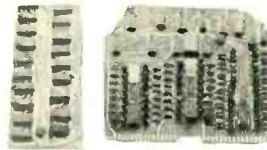

NEW FAIRCHILD TTL, DTL, MSI IC BOARDS

BRAND NEW computer boards, with 31 FAIRCHILD ICs, 32 MOTOROLA 2N4401, 32 FAIRCHILD 2N2369A, all marked, for a total catalog value of over \$108.00. Hex inverters, gates, flip flops, 2 One of ten decoders, a dual full adder (MSI). Six pulse transformers and many more components. An unusual set of two boards. Sockets available (2 per board). STOCK NO. J9421 2 Boards as above, \$6.50 2 sets \$12.00 STOCK NO. J9422, set of 4 sockets (edge connectors) \$1.00

AN OLD FAVORITE, "HONEYWELL BOARDS"

New lot of HONEYWELL boards, 4 1/2" x 12". Loaded with all kinds of components. STOCK NO. J9082 2 different boards, \$1.00, 12/5.00



Include sufficient postage, excess will be refunded. Send for new 48 page catalog loaded with other items. Minimum order \$3.00



DELTA ELECTRONICS CO.

BOX 1, LYNN, MASSACHUSETTS 01903
Phone (617) 388-4705

Circle 75 on reader service card

EIGHT INSTRUMENTS IN ONE

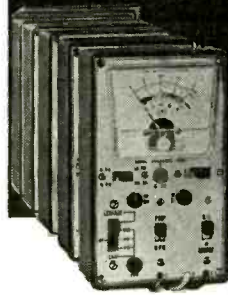

- Out-of-Circuit Transistor Analyzer
- Dynamic In-Circuit Transistor & Radio Tester
- Signal Generator
- Signal Tracer • Voltmeter
- Milliammeter
- Battery Tester
- Diode Checker

Transistor Analyzer Model 212

Factory Wired & Tested—\$23.50
Easy-to-Assemble Kit—\$15.50

YOU DON'T NEED A BENCH FULL OF EQUIPMENT TO TEST TRANSISTOR RADIOS! All the facilities you need to check the transistors themselves — and the radios or other circuits in which they are used — have been ingeniously engineered into the compact, 6-inch high case of the Model 212. It's the transistor radio troubleshooter with all the features found only in more expensive units. Find defective transistors and circuit troubles speedily with a single, streamlined instrument instead of an elaborate hook-up.

Features:
Checks all transistor types — high or low power. Checks DC current gain (beta) to 200 in 3 ranges. Checks leakage. Universal test socket accepts different base configurations. Identifies unknown transistors as NPN or PNP.

Dynamic test for all transistors as signal amplifiers (oscillator check), in or out of circuit. Develops test signal for AF, IF, or RF circuits. Signal traces all circuits. Checks condition of diodes. Measures battery or other transistor-circuit power-supply voltages on 12-volt scale. No external power source needed. Measures circuit drain or other DC currents to 80 milliamperes. Supplied with three external leads for in-circuit testing and a pair of test leads for measuring voltage and current. Comes complete with instruction manual and transistor listing.

EMC, 625 Broadway, New York 12, N. Y.

Send me FREE catalog of the complete value-packed EMC line, and name of local distributor.

NAME _____ RE-12

ADDRESS _____

CITY _____ ZONE _____ STATE _____

EMC

ELECTRONIC MEASUREMENTS CORP.
625 Broadway, New York, N. Y. 10012

SPECTACULAR!! PRICE WAR ON SURPLUS SEMICONDUCTORS

LINEAR DEVICES, OP AMPS, REGULATORS

- 709 High performance Op-Amp \$5.00
- 711 Dual Comparator \$5.00
- 723 Regulator \$1.25
- 741 Compensated Op-Amp \$5.00
- 558 Dual 741 \$1.00
- LM309 5 Volt 1 amp Regulator, TO-3 \$2.25

FAIRCHILD VOLTAGE REGULATOR



airchild UGH7805 5 Volt 1 amp voltage regulator. Perfect for logic supplies, very compact \$1.95

SPECIAL I.C.'S, PHASE LOCKED LOOPS

- NE560 Phase Locked Loop \$4.65
- NE561 Phase Locked Loop \$4.65
- NE562 Phase Locked Loop \$4.65
- NE565 Phase Locked Loop \$4.65
- NE566 Function Generator/Tone Encoder \$4.65
- NE567 PLL/Tone Decoder \$4.65
- NE595 Four Quadrant Multiplier \$3.75
- NE555 Timer, 2u Sec to 1 hour, Special \$1.25
- NE540 Power Driver, for 100w AB amp. \$2.25

MEMORIES, SHIFT REGISTERS, ROM'S

- 1101 256 Bit RAM, MOS \$4.00
- 1103 1024 Bit RAM, MOS \$8.75
- 7489 64 Bit RAM, TTL \$3.75
- 2513 Character Generator ROM \$14.75
- 1402 Shift Register \$4.00
- 1403 Shift Register \$4.00
- 1404 Shift Register \$4.00
- 8224 Programmable ROM \$14.75

Dear Customers,

We want to take this opportunity to thank you for your patronage. Your response, has in a few short years allowed us to grow to become one of the largest surplus dealers in the U.S., and because of our buying power, we are able to offer you "state of the art" components at prices the hobbyist can afford. Offering the latest technology though, has its pitfalls. Sometimes manufacturers, promising us the latest in LED's, MSI, or other advanced technology, have had problems getting their production lines going and have delayed shipment to us which resulted in a delay to you. We hope you will understand this at these times and accept our apologies.

In order to offer you still better service in the future, we have made some significant changes here at B & F. We have formed a joint venture with Aries Inc. to develop, manufacture and market kits only. (You will find their ad elsewhere in this magazine). The engineering staff represents some of the finest engineering talent in the United States, even if we say it ourselves. The division leaves us free to pursue the surplus business and to devote our full time to servicing your orders and finding new "buys".

We also have increased our staff and can now offer more service on information requests. Please keep them simple, however, as we can not do the engineering for you, but will do all within our power to provide you with complete data on everything we sell.

Thank you again, and we look forward to many more years of offering you the latest in electronics and electro-optical technology.

Very truly yours,

Franklin G. Fink
Peter E. Boniface

Franklin G. Fink
Peter E. Boniface
Partners - B & F Enterprises

HIGH POWER SCR'S



SCR's - invaluable for high power applications, motor speed controls, lighting circuits, welding controls, etc. Never before at this low price. Brand new packaged devices, complete with data sheet and 24 page consumer applications manual.

- 2N5062 Plastic 100V 1 amp \$3.35
- 2N5064 Plastic 200V 1 amp40
- 2N4169 100V/8 amp stud 1.45
- 2N4170 200V/8 amp stud 1.65
- 2N4172 400V/8 amp stud 1.95
- 2N3525 400V/3 amp press fit95
- 2N1772/C15A 100V/8 amp stud 1.75
- 2N1774/C15B 200V/8 amp stud 1.95
- 2N1777/C15D 400V/8 amp stud 2.50
- 2N1844/C20A 100V/12 amp stud 1.75
- 2N1846/C20B 200V/12 amp stud 1.95
- 2N5169 200V/20 amp stud 3.75
- 2N5170 500V/20 amp stud 4.75
- 2N5171 700V/20 amp stud 6.75
- 2N3896/C30A 100V/25 amp stud 2.95
- 2N3897/C30B 200V/25 amp stud 3.95
- 2N3899/C30E 500V/25 amp stud 4.95

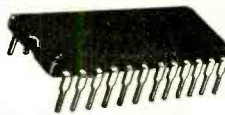

CALCULATOR CHIP SPECIAL

B and F has purchased a quantity of MOS large scale integration chips for calculators. We are not allowed to mention the manufacturers name, however, the specs should make them self-evident.

- Set "X" - Four 24 pin I.C.'s, BCD output, 16 digit, fixed automatic decimal point, possible memory expansion, constant \$29.00
- Set "Y" - Single 40 pin, 7 segment output, 12 digit, fixed automatic decimal, no constant \$15.00
- Set "Z" - Single 40 pin I.C., 7 segment output, 8 digit, floating point, constant \$19.50

7400 SERIES TTL SUMMER CLEARANCE MOST POPULAR I.C. SERIES MADE !!!!!

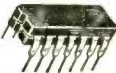

B and F maintains an inventory of over one million brand new, factory packaged integrated circuits, and is continually buying more from sources throughout the country. We intend to offer these at the lowest prices of any supplier, and to prove this point we have just cut our own normally fantastic low prices even lower. We will meet or better any 7400 series price. Data sheets are included with all items. On orders over \$20.00 we will include free, a TTL data book or Linear data book, totaling over 200 pages. Orders over \$100.00 will receive a 1000 page data file. An additional discount of 5% will be allowed for orders over \$250.00 and 10% for orders over \$1000.00.

- | | | |
|---------------|---------------|----------------|
| □ 7400 - .22 | □ 7451 - .22 | □ 74150 - 1.55 |
| □ 7401 - .22 | □ 7453 - .22 | □ 74151 - 1.13 |
| □ 7402 - .22 | □ 7454 - .22 | □ 74153 - 1.55 |
| □ 7403 - .22 | □ 7460 - .22 | □ 74154 - 2.30 |
| □ 7404 - .27 | □ 7470 - .40 | □ 74155 - 1.39 |
| □ 7405 - .27 | □ 7472 - .36 | □ 74156 - 1.39 |
| □ 7406 - .50 | □ 7473 - .48 | □ 74157 - 1.48 |
| □ 7407 - .50 | □ 7474 - .48 | □ 74158 - 1.48 |
| □ 7408 - .30 | □ 7475 - .76 | □ 74160 - 1.79 |
| □ 7409 - .30 | □ 7476 - .53 | □ 74161 - 1.79 |
| □ 7410 - .22 | □ 7480 - .72 | □ 74162 - 1.79 |
| □ 7411 - .27 | □ 7481 - 2.45 | □ 74163 - 1.79 |
| □ 7413 - .55 | □ 7482 - 2.45 | □ 74164 - 3.75 |
| □ 7416 - .50 | □ 7483 - 1.55 | □ 74165 - 3.75 |
| □ 7417 - .50 | □ 7485 - 2.45 | □ 74166 - 3.75 |
| □ 7420 - .22 | □ 7486 - .55 | □ 74167 - 4.75 |
| □ 7421 - .22 | □ 7489 - 4.00 | □ 74170 - 5.75 |
| □ 7426 - .32 | □ 7490 - .76 | □ 74180 - 1.13 |
| □ 7430 - .22 | □ 7491 - 1.35 | □ 74181 - 4.90 |
| □ 7437 - .53 | □ 7492 - .76 | □ 74182 - 1.13 |
| □ 7438 - .53 | □ 7493 - .76 | □ 74184 - 2.95 |
| □ 7440 - .22 | □ 7494 - 1.12 | □ 74185 - 2.95 |
| □ 7441 - 1.64 | □ 7495 - 1.12 | □ 74190 - 2.95 |
| □ 7442 - 1.21 | □ 7496 - 1.12 | □ 74191 - 2.45 |
| □ 7443 - 1.21 | 74100 - 1.44 | □ 74192 - 1.87 |
| □ 7444 - 1.21 | 74107 - .49 | □ 74193 - 1.87 |
| □ 7445 - 1.62 | 74121 - .53 | □ 74194 - 2.95 |
| □ 7446 - 1.17 | 74122 - .67 | □ 74195 - 1.95 |
| □ 7447 - 1.10 | 74123 - 1.06 | □ 74198 - 2.65 |
| □ 7448 - 1.37 | 74141 - 1.55 | □ 74199 - 2.65 |
| □ 7450 - .22 | 74145 - 1.33 | |

FLAT NYLON LACING TAPE

One pound tube of black lacing, about 1,000 yards, should last the average hobbyist several years. Usual price is \$10.50. At this price you can use it for all kinds of applications besides lacing. Test over 50 lbs.
□ Lacing Cord 1 lb. \$2.00

SANKEN HIGH POWER, HIGH PERFORMANCE HYBRID VOLTAGE REGULATORS

These hybrid regulators are easy to use, requiring no external components. Excellent for operational amplifier supplies, logic supplies and other high performance applications. All regulators have less than 50 millivolts ripple and better than 1% line and load regulation, some models far exceeding this specification.

- SI3120E 12 Volts, 1 Ampere \$2.25
- SI3150E 15 Volts, 1 Ampere \$2.25
- SI3240E 24 Volts, 1 Ampere \$2.25
- SI3050E 5 Volts, 1 Ampere \$2.25
- SI3554M 5 Volts, 3 Amperes \$7.00

SANKEN HYBRID AUDIO AMPLIFIER MODULES



We have made a fortunate purchase of Sanken Audio Amplifier Hybrid Modules. With these you can build your own audio amplifiers at less than the price of discrete components. Just add a power supply, and a chassis to act as a heat sink. Brand new units, in original boxes, guaranteed by B and F, Sanken and the Sanken U.S. distributor. Available in three sizes: - 10 watts RMS (20 watts music power), 25 watts RMS (50 watts M.P.) and 50 watts RMS (100 watts M.P.) per channel. 20 page manufacturers instruction book included. Sanken amplifiers have proved so simple and reliable, that they are being used for industrial applications, such as servo amplifiers and wide band laboratory amplifiers.

- SI1010Y 10 watt RMS amplifier, industrial grade \$4.75
- SI1025A 25 watt RMS amplifier, industrial grade \$14.75
- SI1050A 50 watt RMS amplifier, industrial grade \$22.50
- SI1025E 25 watt RMS amplifier, entertainment grade \$14.00
- SI1050E 50 watt RMS amplifier, entertainment grade \$21.00
- Transformer for stereo 10 watt amplifiers (2 lbs.) \$3.95
- Transformer for stereo 25 or 50 watt amplifiers (5 lbs.) \$5.95
- Set of (3) 2000 mfd 50V capacitors for 10 watt stereo. \$4.00
- Set of (3) 2200 mfd 75V capacitors for 25 or 50 watt amplifiers \$5.00
- 4 Amp Bridge Rectifier, suitable for all amplifiers \$2.00
- Complete kit for 100 watt RMS stereo amplifier (200 watt music) including two 50 watt Sanken hybrids, all parts, instructions, and nice 1/16" thick black anodized and punched chassis \$88.00
- Same for 50 watt RMS stereo amplifier, includes two 25 watt Sankens, etc. \$58.00
- Same for 20 watt RMS stereo, includes two 10 watt Sankens, etc. \$30.00

SGS TAA 621 AUDIO AMPLIFIER

□ I.C. audio amplifier in 14 pin DIP package, provides up to 4 watts power with proper heat sink, and 28 Volt supply. Can be used at 12 Volts with reduced output power. - \$1.95 6 for \$10.00



16 DIGIT POCKET CALCULATOR

COMPLETE WITH CARRYING CASE AC/DC TYPE

UNBELIEVABLE? A COMPLETE POCKET CALCULATOR FOR ONLY \$99.00

We are closing out some demonstrator Sanyo pocket calculators for only \$99.00. This is a complete unit with nickel cadmium battery. Has eight digit LED display, with sixteen digit capability. Fixed automatic decimal at 0, 2, or 4 places. Units are demonstrators, but are in original factory cartons with guarantee cards, instructions, etc. Carries full one year factory guarantee by Sanyo. Only 35 available so order now.

- Sanyo Pocket Calculator \$99.00
- AC Power Pack/Recharger \$19.00

ALL ITEMS WHERE WEIGHT NOT SPECIFIED

POSTAGE PAID IN THE U. S. A.

Phone in charges to (617) 531-5774 or (617) 532-2323. BankAmericard - Mastercharge. \$10.00 minimum. No C.O.D.'s please.



\$10.00 Minimum Charge



B. & F. ENTERPRISES

Phone (617) 532-2323
P.O. Box 44, Hathorne, Massachusetts 01937

3

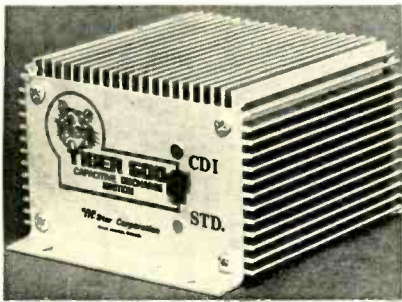

12 REASONS YOUR CAR NEEDS A TIGER 500

Instant starting in any weather - Eliminates tune-ups - Increases gas mileage - Increases horsepower 15% - Improves acceleration & performance - Spark plugs and points last up to 70,000 miles - Reduces engine maintenance expense - Amplifies spark plug voltage to 45,000 volts - Maintains spark plug voltage to 10,000 RPM - Reduces exhaust emissions - Dual ignition switch - Unconditional guarantee for original owner - Installs in 10 minutes on any car with 12 volt negative ground - No rewiring - Most powerful, efficient and reliable Solid State Ignition made.

SATISFACTION GUARANTEED
or money back.

Assembled \$49.95
Post Paid in U.S.A.

Send check or money order with order to:

Tri-Star Corporation

Dept. R, P. O. Box 1946
Grand Junction, Colorado 81501
DEALER INQUIRIES INVITED
Circle 79 on reader service card

FREE catalog



over
1000
unique tools,
handy kits,
precision
instruments,
technical
supplies.

Our 20th year of service to the World's
finest craftsmen and technicians.

National Camera
2000 West Union Ave. Dept. G88
Englewood, Colorado, 80110

Send a FREE copy of the nc Flasher

name

address

city

state

zip

National Camera
2000 West Union Ave. Dept. G88
Englewood, Colorado, 80110

Circle 80 on reader service card

98 RADIO-ELECTRONICS • DECEMBER 1972

appliance clinic

USE YOUR ELECTRICAL APPLIANCES WHEN ABROAD

by JACK DARR
SERVICE EDITOR

AMERICANS TRAVEL A LOT—PLEASURE, business, military, and so on. A lot of them like to take their home with them in the form of their electrical appliances—razors, clocks, record and tape players and most popular of all lately, hair dryers, styling combs, and the like. (Guys as well as gals, in this category!) This can lead to problems in most areas of the world. U.S. electrical things are built to work on a 115 to 120-volt 60-Hz power supply. Not so in a great many other countries.

The rest of the world uses a bewildering variety of power supply voltages and frequencies. Although dc power has been displaced by ac in this country, (at least in most places) you may still find it in use in homes of other countries; Spain, Sweden, Austria, Germany, Ireland, and so on. Only in the British Isles is there any semblance of a nation-wide standard. They use 230 volts, 50 Hz ac for residential power.

The undisputed champion for variety would probably be Italy. There, you'll find dc voltages at 110, 125, 150, 160, and 250; and ac supplies of 110, 115, 125, 135, 150, 220 and 260 volts, at either 42, 45 or 50 Hz. France runs them a close second, with 110, 120, 125 and 250 volts dc; and 110, 115, 120, 125, 200 and 230 volts ac at either 25 or 50 Hz. Other countries use similar voltages; all of Europe seems to use 50 Hz, as well as all of Asia and Africa. There are a few "60-Hz enclaves" here and there, such as Taiwan.

This poses problems for our travelers. How and where can they use their electrical appliances? The answer in some cases is "Forget it!" Units that have synchronous motors—clocks, tape-recorders, phonographs, will run slow on 50 Hz. More on this later. One helpful development in the clock and tape-recorder line is battery-powered clocks and tape-recorders, with dc motors.

Other units with "universal-wound" motors can be used on the right voltage. Many of these will even run on dc. Appliances with heating

elements, of course, don't care at all about the frequency, as long as the voltage is right.

This brings us to a question often received in the Clinic; "What can I do to make my — work overseas?" Within the limits mentioned, a great many of them can be used very well with a simple addition. Something to change the local line voltage to 115-120 volts ac. A simple auto-transformer can be used to step down the British 230-volt line (remember to say "mains" so they'll know what you mean.) The power rating of the auto-transformer depends on how much the appliance draws. Check the rating plate on yours to see what it needs.

Razors need only very small amounts of power; probably from 20 to 30 watts at a guess. Hair-dryers, however, have heating elements as well as fan-motors. The motor will draw perhaps 35 watts, but the heating element can take up to 1500 watts. So check it. If the wattage isn't given, just multiply the voltage rating by the amps, and this will be good enough. Recharger units for cordless appliances draw only minute amounts; 2 to 3 watts maximum. So, a very small autotransformer will take care of these very nicely.

I get a lot of inquiries about "making up a simple dropping resistor" for these. It would work, but frankly, I'm not too fond of it. A tapped dropping resistor could be "calibrated" to work with a single appliance, but if one of a different wattage were plugged into it, the voltage would be far off. Such a device would be impractical for high-drain units like hair-driers; your dropping resistor would get hotter than the drier.

So, the suitably-rated auto-transformer is probably the most practical solution for low-power units. It wouldn't be too big or too expensive. However, an autotransformer capable of handling a 1500-watt hair-drier would run about 50 pounds in weight! A 100-watt unit weighs only 7 pounds.

(continued on page 100)

ARIES

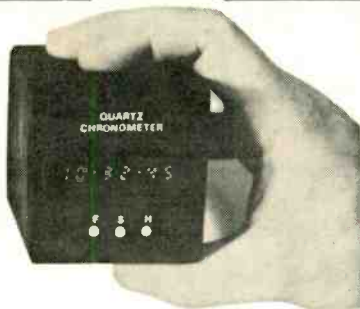

AIRCRAFT/AUTO/BOAT QUARTZ CRYSTAL CHRONOMETER

Revolutionary! was the reaction of our customers when they saw our latest kit. Measuring only 2-1/2" x 2-1/2" x 4", and accurate to 10 seconds a month, this chronometer promises to entirely replace mechanical clocks in cars, boats and airplanes.

Fits into a standard 2-1/4" instrument panel cutout. The displays are bright L.E.D. displays that should last a lifetime. Setting controls are recessed and operate from a pointed object such as a pencil point or paper clip, in order to keep non-authorized hands off. The clock should only have to be reset at very great intervals, or in the event of power loss (i.e. replacing battery in car). The clock is wired so that the timing circuits are always running, but the displays are only lit when the ignition is on, resulting in negligible power drain. The low price is only possible because of a new one chip MOS clock circuit, developed for quartz crystal wristwatches.

Operates from 10-14 Volts D.C. An accessory unit which mounts on the back adapts the unit to 20-28 volts for twin engine aircraft and larger boats using 24 Volts ignition. Know how disgusted you are with the usual car clock? Order this fine unit now for rallying, sports events, navigation, or just to have a fine chronometer that will give you a lifetime of superbly accurate time.

- Quartz Chronometer, Kit Form \$59.50
- Quartz Chronometer, Wired \$99.50
- 24 Volt Adapter \$10.00



DIGITAL CLOCK KIT WITH NIXIE DISPLAY

Because we have made an extremely good purchase of over 20,000 nixies, we can sell a complete digital clock kit for less than the usual cost of the display tubes alone. We provide a complete etched and thru-plated circuit board, all integrated circuits, complete power supply, display tubes, I.C. sockets and a nice front panel with polaroid visor. We have never seen anyone offer this kit for less than \$100.00 before. Includes BCD outputs for use as with timer option. May be wired for 12 or 24 hour display. Indicates hours, minutes and seconds.

- Clock Kit, complete less outside cover . . . \$57.50
- Aluminum blue or black anodized cover . . . \$4.50

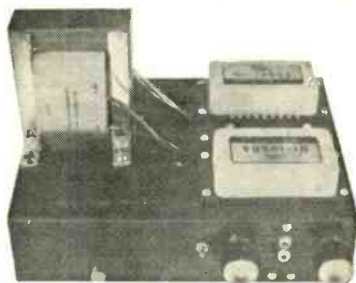

AUDIO AMPLIFIER KIT

This is not our prettiest kit, but it sure does perform. Hybrid Sanken audio modules make wiring easy. Output ratings are maximum continuous at 1000 Hz with a distortion less than 0.5% into a load of 8 ohms. Response is ± 0.5 db 20-20KHz @1 watt. Chassis supplied is heavy gauge anodized aluminum. Capacitors are all computer grade. Level controls on both inputs.

- 100 Watt (RMS) Stereo Kit \$88.00
- 50 Watt (RMS) Stereo Kit \$58.00
- 20 Watt (RMS) Stereo Kit \$30.00



50 MHz DIGITAL COUNTER LABORATORY SPECIFICATIONS AT A BUDGET PRICE!

We feel the most important thing about building a kit is saving money. There are a lot of other advantages of course . . . maintainability, use of standard parts, complete documentation, and the experience and fun of building it, but the overriding consideration is economy. This kit costs less than half that of the lowest priced competitive unit on the market.

The Aries 50 MHz counter is designed for years of maintenance free service. MSI integrated circuitry, cold cathode display tubes and conservatively rated transformers mean low temperature rise. All displays and I.C.'s are in sockets for easy maintainability. The master oscillator is a 1.0 MHz crystal in a custom designed cosmos oscillator circuit, having a stability of ± 3 PPM. Accuracy is 0.005% worst case, 0.0002% or better when adjusted to WWV with a communications receiver. A front panel selects a timing interval of 1.0 seconds, 0.1 seconds or 10 milliseconds. A variable monostable multivibrator holds the count on the front panel for a period of a fraction of a second to infinity. For use in the period mode, the 1.0 MHz oscillator is connected to the main counting chain and gated by the input signal.

Assembly time for the kit is approx. 10 hours. The semiconductor complement is (1) 7400, (1) 7408, (1) 7442, (10) 7490, (2) 74122, (6) 74141, (1) 74193, (1) 74196, (1) 74511, (1) CD 4007AE, (1) LM309, (6) Diodes, and (1) Transistor. If you always wanted a laboratory quality counter, but could never justify the price, here is your chance.

- 50 MHz Counter Kit, Complete with Crystal Time Base and Case - Postpaid in USA \$125.50



POCKET CALCULATOR

We expected a favorable reaction to our calculator, however, we were overwhelmed when we received orders for hundreds at a time. The reaction of our customers was that they felt this was the most advanced pocket calculator on the market, and priced so low, they could assemble and market it at a profit. The features that make this so exciting are:

- So compact it fits in a shirt pocket (3-13/16 x 4-5/8 x 1-1/4).
- Performs every function you would expect in a desk calculator, and then some, multiplies, divides, adds, subtracts and gives true credit balance. Includes constant and chain operation, full floating decimal, suppressed trailing zeroes, and automatic single entry squaring.
- Powered by self contained AA batteries with up to six hours operation (Nicad batteries with charger option, up to five hours per charge).
- Calculations performed by a single 40 pin LSI (large scale integration) chip. Displays are 8 digit LED's (light emitting diodes) and overflow and minus signs are also LED's.

As a student, engineer, salesman, accountant or anyone who would like fast accurate answers, this calculator fills the bill, and at a price that unquestionably makes this the lowest price high quality calculator available.

- Pocket Calculator Kit \$75.00
- Pocket Calculator Completed \$99.00
- NiCad Batteries & Charger \$17.50
- Batteries & Charger Completed \$25.00



16 DIGIT ELECTRONIC DESK TOP CALCULATOR KIT

Just one evening puts it together. Even if you have never assembled a kit before, our comprehensive step-by-step manual makes it easy. This calculator adds, subtracts, multiplies, divides - multiplies & divides by a constant. Has full 16 digit capacity with 8 decades of display and zero suppression. Entries and answers with greater than 8 digits can be displayed in their entirety in two alternate sections: the last eight digits and those digits exceeding eight. Negative results are correctly displayed, and an error symbol indicates an overflow beyond the 16 digit capability. Sequential operations can be performed using the answer to the previous operation as one of the entries for the next. The decimal point can be positioned following any of the eight least significant digits and will be carried automatically during subsequent operations. An additional good feature, concerning the beginner, is that all major components are in sockets, making troubleshooting easy. And if all else fails, (an unlikely occurrence) you can send it back to Aries and we will fix it for a maximum of \$10.00, no matter what is wrong, barring gross negligence.

- Kit - with Power Supply & Case \$99.00

Dear Customers;

Due to the tremendous demand for B & F Electronic kits a new company, ARIES/BF, has been formed. This move provides a complete, well staffed organization to deal with kits and only kits, thus offering faster delivery, better service, and most important of all, a continuing flow of new kits that will advance the "state of the art" in their fields.

The activities of the entire staff of ARIES/BF will be devoted full time to satisfying your needs and providing you with a large selection of interesting and up-to-the-minute kit devices for the home, the car, and the electronic shop.

Although ARIES is still at the mercy of vendors for their delivery in some cases, every effort is being made to develop sufficient inventory to be able to assure off-the-shelf delivery of all our kits.

Sincerely,

Arthur Pennell

Arthur Pennell
President, ARIES/BF

ARIES INC.
119 Foster Street, Peabody, Mass. 01960
(617) 532-0450



Please send:

Qty.	Description	Amount

Name _____

Address _____

City/State _____ Zip _____

Check Enclosed Master Charge BankAmericard

M.C. No. _____

B.A. No. _____

Expiration Date _____ Bank No. _____

Please call factory for quantity prices

Circle 81 on reader service card

ELECTRONIC TECHNICIANS!

Raise your professional standing and prepare for promotion! Win your diploma in

ENGINEERING MATHEMATICS

from the Indiana Home Study Institute

We are proud to announce two great new courses in Engineering Mathematics for the electronic industry.

These unusual courses are the result of many years of study and thought by the President of Indiana Home Study, who has personally lectured in the classroom to thousands of men, from all walks of life, on mathematics, and electrical and electronic engineering.

You will have to see the lessons to appreciate them!

NOW you can master engineering mathematics and actually enjoy doing it!

WE ARE THIS SURE: you sign no contracts—you order your lessons on a money-back guarantee.

In plain language, if you aren't satisfied you don't pay, and there are no strings attached.

Write today for more information and your outline of courses.

You have nothing to lose, and everything to gain!

The INDIANA HOME STUDY INSTITUTE

Dept. RE-12, P.O. Box 1189, Panama City, Fla. 32401

Circle 82 on reader service card

APPLIANCE CLINIC

(continued from page 98)

Frequency changers

It is, of course, possible to make frequency-changers. All you need is a power supply, an oscillator that will run at the desired frequency and a power amplifier. However, it would be shockingly un-economic. For very low-power units OK; but for high-power output, the output transistors alone would probably cost more than the price of a new appliance that would work on the "native" current. This says nothing at all about size, either. A 40-pound, \$250.00 converter running a \$19.95 electric razor would not make sense.

To sum up, it would be easiest to select cordless type appliances for your overseas journey, if possible. For the rest, check the power ratings on the plate. If they run up around 1000 watts you'll probably be better off leaving them at home. You can get power-adapters such as auto-transformers, in this country. One type is handled by the Franzus Co. Box 395, Shamokin Pa. 12872.

Of course, there are simple solutions. If time is your problem, just lift the phone and say "Bonjour, m'selle. Q'est-ce-que le temps du jour?" Of course, this won't work too well in England; there, the response would probably be "Coo! Wot did 'ee sye?" Of course, you could always listen for Big Ben.

One final cheerful note. By choosing your tour carefully, you can get along very well. The Society Islands in the South Pacific use good ol' 120-volt, 60-Hz power! Aloha. R-E

In East Europe

Their censored press keeps protesting But 31 million people keep listening to

RADIO FREE EUROPE

The In Sound from Outside

For information about East Europe and RFE, write:
**RADIO FREE EUROPE, Box 1972,
 Mt. Vernon, New York 10551**

try this

LOW-CAPACITANCE PARTS SUBSTITUTOR

This parts holder lets you try resistors and capacitors in a circuit without the loss of video or sound signals usually caused by hand capacitance. Cut

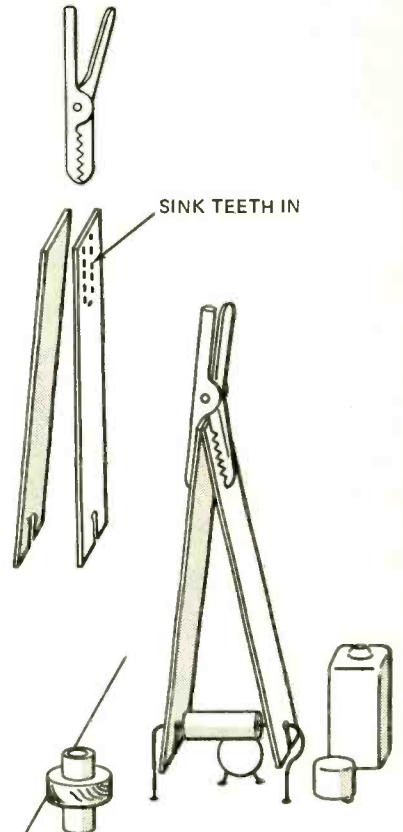

two strips of stiff plastic, then drill and slot their ends to take the part's lead wires. Clamp the strips in an alligator clip and heat both sides until the teeth sink in. When cool you have the tool.—Peter Legon R-E



THOUSANDS OF BARGAINS — TOP VALUES IN Electronic Parts

Transistors, Modules, Speakers, Stereo, HI-FI, Photo Cells and thousands of other Electronic Parts. Send for **FREE Catalog**



ELECTRONIC DISTRIBUTORS INC.
 Dept. TA-2, 4900 Elston
 Chicago, Ill. 60630

RUSH CATALOG

Name _____

Address _____

City _____ State _____ Zip Code _____

Circle 83 on reader service card

market center

TUBES

XENON STROBELIGHT FLASHTUBES FT106 50W \$2.50, 2/\$4.00, 10/\$16.00, 100/\$125.00. Plans 50¢. **MINDLIGHT**, P.O. Box 2846RE, Van Nuys, CA 91404

RECEIVING & INDUSTRIAL TUBES, TRANSISTORS, All Brands—Biggest Discounts. Technicians, Hobbyists, Experimenters—Request **FREE** Giant Catalog and **SAVE!** **ZALYTRON**, 469 Jericho Turnpike, Mineola, NY 11501

SAVE money on parts and transmitting-receiving tubes, foreign-domestic. Send 25¢ for Giant Catalog. Refunded first order. **UNITED RADIO COMPANY**, 56-R Ferry Street, Newark, NJ 07105

TUBES Receiving Factory Boxed, Low Prices, Free Price List. **TRANSELETRONIC INC.** 1306 40th Street, Brooklyn, N.Y. 11218. Telephone 212-633-2800.

TUBES-IEC 70% DISC. 5 FREE WITH EA. 50. SENCORE, EICO MALLORY, HEP, SHURE. ALSO CARTRIDGES, NEEDLES LOWEST PRICES. FULL GUARANTEE. M & K ELEC. DIST., 135-33 Northern BLVD., NYC 11354

RADIO and TV Tubes 36¢ each. One year guaranteed. Plus many unusual electronic bargains. Free Catalog. CORNELL 4217-E University, San Diego, CA 92105

WANTED

WANTED: VLF RADIO RECEIVER (very low frequency) Also want to contact **FIRM** that can build large **IONIZATION CHAMBER**. **EARL A. DILLON** P.O. Box 302, Three Rivers, TX 78071

QUICK CASH . . . for Electronic EQUIPMENT, COMPONENTS, unused TUBES. Send list now! **BARRY**, 512 Broadway, New York, NY 10012, 212 Walker 5-7000

CLASSIFIED COMMERCIAL RATE (for firms or individuals offering commercial products or services). \$1.00 per word . . . minimum 10 words.
NONCOMMERCIAL RATE (for individuals who want to buy or sell personal items) 70¢ per word . . . no minimum.
FIRST WORD and NAME set in bold caps at no extra charge. Additional bold face at 10¢ per word. Payment must accompany all ads except those placed by accredited advertising agencies. 10% discount on 12 consecutive insertions, if paid in advance. Misleading or objectionable ads not accepted. Copy for February issue must reach us before Dec. 1.

CLASSIFIED ADVERTISING ORDER FORM

1	2	3	4	5
6	7	8	9	10
11	12	13	14	15
16	17	18	19	20
21	22	23	24	25
26	27	28	29	30
31	32	33	34	35

No. of Words { @ .70 Non-Commercial Rates } = \$
 { @ \$1.00 Commercial Rate } = \$
 No. of Words in bold caps @ .10 = \$

Total Enclosed \$ \$

Insert _____ time(s)

Payment must accompany order unless placed through accredited advertising agency 28

Starting with _____ issue

NAME _____

ADDRESS _____

CITY _____ STATE _____ ZIP _____

SIGNATURE _____

MAIL TO: RADIO-ELECTRONICS, CLASSIFIED AD DEPT., 200 PARK AVE. SOUTH, NEW YORK, N.Y. 10003

U.S. GOV'T ELECTRONIC SURPLUS

• **Nationally Known - World Famous SURPLUS CENTER** offers finest, most expensive, Government Surplus electronic units and components at a fraction of their original acquisition cost.

23-Channel, 5-Watt, CB Base Station Transceiver



Limited Sale*

List Price \$149.95 Reg. Catalog \$109.90 **\$99.90**

• (ITEM #M13-891-RE) - Special savings on CB Base Station Transceiver ideal for Contractors, Construction Co.'s., Road Builders, etc. Full legal power (5-watts) gives you dependable radio contact with all your CB equipped vehicles in the field. Equipped with crystals for all 23 CB channels, none extra to buy! Latest design, solid state circuitry for trouble-free performance, long range, exceptional clarity.

• Operates on 110-VAC, equipped with complete controls, on-off-volume, illuminated channel selector, full variable squelch, transmit/modulate indicator light. Built-in 4" x 2 1/2" dynamic speaker. Dynamic microphone with coil cord furnished. Jacks provided for microphone, external speaker, external antenna. 11" x 7 1/2" x 4 1/2". (10 lbs.)

IBM COMPUTER POWER SUPPLY



• (ITEM #22-934) - Expensive, regulated unit. Fine for college labs, research co.'s, service shops, etc. Pure DC over a wide range of voltages. DC output voltages 6, 12, 48, etc. Wide range of AC voltages available.

• Finest transformers, filters, transistor load regulation system, independent of line voltage fluctuations. Contains five separate rectifier systems. Unit is furnished without small "regulating card" which can be easily made or can be bypassed. Data and circuit diagrams furnished. 30" x 12" x 10". (125 lbs.)

Cost Gov't Over \$500.00

\$24.95

ONCE-IN-A-LIFETIME SPECIAL

STANDARD DIAL TELEPHONE



• (ITEM #715) - Standard, commercial telephone - same as used throughout U.S.A. Attractive polished black, like new condition. Use as extension phone to private systems or connect several phones together for local intercom system. Full instructions are furnished. Wt. 9 lbs.

Original Cost \$24.50 **\$8.79**

STEP-BY-STEP TELEPHONE SWITCH



• (ITEM #738) - Amazing telephone selector switch. Great experimental item. When used with two-wire telephone dial will select any number from 0 to 100. Make intercom or private system. Use to turn on remote lights, start motors, etc. Complete with contact bank. 13" x 6" x 5". (16 lbs.) Cost Over \$80.00

\$8.95

• Telephone dial for use with above switch. Order as (Item #700) **\$1.97**

200 AMP., 50 VOLT, SILICON DIODE



• (ITEM #22-963) - A Four Star Buy! New, leading make. Heavy duty units excellent for use in 12 or 24-volt fast chargers, high current power supply systems, etc. 2 1/2" x 1 1/2" x 1 1/4". 3/16"-16 SAE mounting threads. (1 lb.)

List Over \$15.00

\$4.99

SPECIAL SALE

Correspondence Course In

ELECTRICAL ENGINEERING



\$8.79 Prepaid in U.S.A.
\$10.79 Outside U.S.A.

• (ITEM #A180) - Obtain technical training at low cost! Lincoln Engineering School has suspended its Correspondence Courses because of rising costs. A limited number of Electrical Engineering Courses are available, but without the examination ending service. The course consists of 15 lesson books, each with associated exams and standard answers. Book describing prize winning Home Experimental Laboratory Bench (furnished at no extra cost).

RUNNING TIME METER

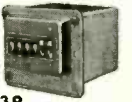

• (ITEM #2188) - Record number of operating hours of electric lights and electrical devices such as refrigerators, furnaces, etc. Records total hours, tenths and hundredths up to 9,999.99 hours. For 115-volt, 60-cycle. Size 4 1/2" x 3" x 2 1/2". Shipping weight 2 lbs.

\$4.39 Cost Over \$29.00

COMPUTER TRANSISTORS ON HEAT SINKS

IBM Computer Quality Units



• (#22-915) - Unit consists of two 150-watt power transistors, 2 pots., several diodes, capacitors, resistors, etc. on heavy-ribbed aluminum heat sink. Ideal for use as motor speed control. (4 lbs.)

Cost Gov't Over \$35.00 **\$4.91**



All Items F.O.B. Lincoln, Nebr.
 Order Direct From Ad. Money Back Guarantee.

SURPLUS CENTER

Dept. RE-122, Lincoln, Nebr. 68501

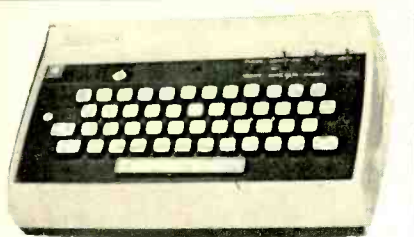

COMPUTER KEYBOARD W/ENCODER \$35

Another shipment just received. Alpha-numeric keyboard excellent condition. Once again we expect an early sellout. Price of \$35 includes prepaid shipment in the US and shipment made within 24 hours of receipt of order.

ALPHA-NUMERIC KEYBOARD WITH ASCII ENCODER \$55 ppd.

ALPHA-NUMERIC KEYBOARD NO ENCODER \$27 ppd.



TS 323 FREQ. METER

Similar to the familiar BC 221 except this one covers range of 20—450 mc. Accuracy .005% Used, guaranteed OK, less batteries, with schematic. TS-323 ship wgt 35 lbs. \$50.00

Please add postage for above items
Send 25¢ for Surplus Catalog . . .

JOHN MESHNA JR. ELECTRONICS
P.O. Box 62 E. Lynn, Mass. 01904

Circle 85 on reader service card

WANTED: Old radios, tubes—24, 47, 80's; pre 40's. M.E. SCOTT, M.D., Box 3608, Radford, VA 24141

PLANS AND KITS

NEW, YOU CAN DESIGN AND BUILD ANY CIRCUIT FOR JUST 45¢ (cents), ENGINEERS, TECHNICIANS, AMATEURS, FREE DETAILS, HOPE ELECTRONICS—CCR DEPT. PO BOX 181, BROOKLYN, NY 11210.

DIGITAL CLOCK KIT—\$59.95 postpaid, complete with **OILED WALNUT & BLACK ALUMINUM** case. Only 3½"x3½"x7". 6-digit **LARGE** 7-segment neon display. Excellent instruction manual. Factory wired model \$89.25 postpaid. **FREE** literature this and other digital kits. Mass-fer Charge, BankAmericard, and C.O.D.'s welcome. **HDE—HUNNICUTT DIGITAL ELECTRONICS**, Box 9793, Ft. Worth, TX 76107, (817) 731-1301.

WE SUPPLY KITS OF HIGH QUALITY SPACE AGE SEMICONDUCTORS WITH INSTRUCTIONS. You supply inexpensive external components. **ALL KITS ONLY \$2. EACH POSTPAID. DIGITAL KITS: LEARN ABOUT COMPUTER CIRCUITS. BINARY COUNTER KIT** (three integrated circuits, instructions); **LOGIC GATE KIT** (one integrated circuit, two light emitting diodes, two resistors, instructions); **MULTI GATE KIT** (two integrated circuits, one light emitting diode, one resistor, instructions); **LIGHT EMITTING DIODE EXPERIMENTERS KIT** (three LEDs, six resistors, instructions); **LINEAR KIT:** Experiment with operational amplifiers, build unusual wave generators (three integrated circuits, instructions). **SATISFACTION GUARANTEED. SUPERTRONICS, 29790 TOLAY CREEK, SONOMA, CA. 95476**

ADVERTISING INDEX

RADIO-ELECTRONICS does not assume responsibility for any errors which may appear in the index below.

READER SERVICE CARD NO. PAGE

81	Aries, Inc.	99
	Bell & Howell Schools	90-93
78	B.F. Enterprises	97
66	B & K, Division of Dynascan Corp.	83
69	Brooks Radio & TV Corp.	84-85
1	Castle TV Tuner Service, Inc.	Cover II
15	Cleveland Institute of Electronics	62-65
72	Cook's Institute of Electronics Engineering	94
	CREI, Division of the McGraw-Hill Continuing Education Co.	28-31
75	Delta Electronics	95
7	Delta Products, Inc.	16
84	Edmund Scientific Co.	108
83	Electronic Distributors, Inc.	100
68	EICO, Electronic Instrument Co.	85
	EMC, Electronic Measurements Corp.	95
9	Electro-Voice, Inc.	24
74	Enterprise Development Corp.	94
73	Fordham Radio Supply Co.	94
71	GC Electronics	87
2	Grantham School of Engineering	1
	GTE Sylvania Electronic Components	5
	GTE Sylvania Electronic Components	15
100	Heath Co.	22-23
82	Indiana Home Study Institute	100
61	International Crystal Mfg. Co.	79
76	Jensen Tools & Alloys	96
77	E.F. Johnson	96
18	Lafayette Electronics	71
16	Leader Instruments	69
8	Micro-Instrumentation Telemetry Systems, Inc.	17
80	National Camera Supply Co.	98
	National Radio Institute	8-11
	National Technical Schools	72-75
6	Olson Electronics	14
	Panasonic	Cover IV
19	PTS Electronics, Inc.	77
14	Radio Shack	34
13	Raytheon Co.	33
	RCA Institutes	18-21
11	RCA Sales Corp.	27
	RCA Electronic Components Semiconductor Division	Cover III
5	Test Equipment	13
	Robins Industries, Inc.	26
67	Rye Industries, Inc.	83
4	Sams & Co., Howard W.	7
64	Schober Organ	81
3	Shure Bros.	2
70	Sonar Radio	86
10	Sprague	25
63	Supersonic Electronics Co.	81
65	TDK Electronics	82
17	Telematic	70
12	Telex	32
79	Tri-star Corp.	98
62	TV Tech Aids	80

LM309K—5 volt regulator



This TO-3 device is a complete regulator on a chip. The 309 is virtually blowout proof, it is designed to shut itself off with overload of current drain or over temperature operation.

Input voltage (DC) can range from 10 to 30 volts and the output will be five volts (tolerance is worst case TTL requirement) at current of up to one ampere . . .

Each \$2.50

FIVE for \$10.00

FOLLOWING ITEMS IN LIMITED QUANTITY

75451 dual peripheral driver	
2 pin DIP	\$.75
NE565 phase lock loop TO-5	3.50
NE566 function generator 8 pin DIP	3.50
DIP	3.50
NE567 tone decoder 8 pin DIP	3.50

DIGITAL SPECIAL

Ten brand new (on carriers) dual-in-line JK flip-flops—LU321 with data sheet and two pages of application notes describing hookups for—divide by three through ten, and twelve. Also self correcting ring counter hookups, etc.

10 LU321 W/data \$4.00

LINEAR SPECIAL

Ten (10) Teledyne TO-5 741 operational amplifiers with a two-page sheet of application notes covering the basic circuits using op-amps.

\$65 each Op-amp package
10-741's, data sheet and application notes only \$5.00

COUNTER IC SPECIAL

Fairchild Dual In Line 958 decade counter and Fairchild 960 nixie* driver combination. These are new and fully guaranteed but are not marked.

combination (2 IC's)	\$1.75
ten sets (20 IC's)	\$15.00

*Trade Mark

LINEAR IC's (dual-in-line)

709 operational amplifier	\$.35
710 voltage comparator	\$.50
LM309K 5V-1A power supply module	2.50
LM100 positive voltage reg.	.80
747 dual 741 op amp DIP	1.00

All IC's are new and fully tested — leads are plated with gold or solder. Orders for \$5 or more will be shipped prepaid. Add 35¢ handling and postage for smaller orders. California residents add sales tax. IC orders are shipped within two workdays of receipt of order—kits are shipped within ten days of receipt of order. Money back guarantee on all goods sold.

TTL dual-in-line

7400, 7401, 7402, 7404, 7405, 7410, 7420, 7430, 7440, 7450, 7451, 7453	ea. \$2.2, 100, any mix, \$20.00
7741 BCD decoder driver	.90
7442 BCD decoder	.90
7447 7 Segment decoder driver	1.30
7473 dual JK flip-flop	.55
7474 dual type D FF	.40
7475 quad latch	1.15
7476 dual JK FF	.55

LED Red Emitting Lamp \$1.60

7480 gated full adder	.50
7483 4 bit full adder	1.15
7486 quad exclusive or gate	.65
7489 64 bit RAM	3.50
7490 decade counter	.90
7491 8 bit shift register	1.15
7492 divide by 12 counter	.90
7493 4 bit binary counter	.90
74154 one of 16 decoder	2.50
74181 Arithmetic Logic Unit	4.50
8261 fast carry for above	2.00
74192 up/down decade counter	2.25
74193 up/down binary counter	2.00
74195 univ. 4 bit SR	.90
8280 preset decade counter	1.15
8281 preset binary counter	1.15
8520 25 MC divide by "N"	
2 to 15	2.00
7495 4 bit SHIFT REGISTER	1.15
8590 8 bit shift register	2.00
8270 4 bit shift register	2.00
8570 8 bit SR, 80. shift register	2.50

40 PIN DIP Package

Add, subtract, multiply and divide.
12 digit display and calculate Chain Calculations.
True credit balance sign output.
Automatic overflow indication.
Fixed decimal point at 0, 2, 3, or 4.
Leading zero suppression.
Complete data supplied with chip.
Complete only \$12.95.
Data only \$1.00 refundable with purchase

3 Chip Calculator Set

Same features as 40 Pin Calculator chip above except—
8 digit display and calculate
Floating decimal point.
Complete with data \$8.95

CHRISTMAS SHOPPING GUIDE MARKET CENTER

86	ATV Research Corp.	103
	Babylon Electronics	102
	Command Productions	103
	Cornell Electronics	107
93	Digi-Key	107
89	Edwards Electronics	104
	Fair Radio Sales	104
90	G.F. Electronics	104
87	JTM Associates	103
	Lakeside Industries	104
85	Meshna Electronics, John Jr.	102
92	Polypaks	106-107
88	Solid State Sales	103
91	Southwest Technical Products	105
	Surplus Center	101
	Yeats Appliance Dolly Sales Co.	104

BABYLON ELECTRONICS

SEND FOR FREE FLYER



P.O. Box J
CARMICHAEL, CA. 95608
(916) 966-2111

Circle 86 on reader service card

CONVERT any television to sensitive big-screen oscilloscope. Only minor changes required. No electronic experience necessary. Illustrated plans \$2.00. **RELCO**—A25, Box 10563, Houston, TX

FREE catalog. Most unusual electronic kits available. Music accessories, Surf, Wind Synthesizers, Wind Chimes, many others. **PAIA ELECTRONICS**, Box B14359, Oklahoma City, OK 73114.

ELECTRONIC ORGAN KITS, KEYBOARDS for music synthesizers and organs. Independent and divider tone generators, diode keyer systems. I. C. circuitry. Many components. 25¢ for catalog. **DEVTRONIX ORGAN PRODUCTS**, Dept. B, 5872 Amapola Drive, San Jose, CA 95129

ROOM TONE EQUALIZER Ten knobs graphically compensate Hi-Fi to room, \$20.00 builds from scratch. Simple complete schematics \$1.00 **GREEN BANK SCIENTIFIC**, Box 100, Green Bank, WV 24944

TAPE & RECORDERS

RENT 4-track open reel tapes—all major labels—3,000 different—free brochure. **STEREO-PARTI**, 55 St. James Drive, Santa Rosa, CA 95401

FOR SALE

FREE catalog New Electronic Devices! World's Smallest Transmitter \$19.95! Telephone Answerer \$49.50! Telephone Recording Device \$19.95! "Bug" Detector \$59.50! Many more! **SONIC DEVICES**, 69-29R Queens Blvd., NY 11377.

"WINTER SALE" NEW GUARANTEED DIP IC'S

7400	7401	7402	7403	7404	
7405	7410	7420	7430	7408	EACH \$2.3
7440	7450	7453	7454	7460	

LOW POWER UNITS—WHY USE BIG EXPENSIVE POWER SUPPLIES? THESE IC'S USE ONLY ONE TENTH THE CURRENT

74L00	74L04	74L08		
74L10	74L20	74L30	74L51	EACH \$4.0

74L73	74L74			EACH \$9.0
-------	-------	--	--	------------

HOT PRICES!!

7441	7442	EA.	\$1.10	7475	EA.	\$7.75
7446	7447	EA.	1.10	7486	EA.	.55
7448	7483	EA.	1.40	7490	7493	EA. .75
7472	7474	EA.	.45	7495	7496	EA. 1.00
7473	7476	EA.	.50	74192	74193	EA. 1.80

SOPHISTICATED IC'S

DM 8200	4 Bit Magnitude Comparator	\$1.90
(Indicates Less-Than, More-Than, or Equal)		
DM 8281	Presetable 4 Bit Counter	1.30
DM 8520	Modulo N Divider-25 MC	1.90
DM 8570	8 Bit Serial-To-Par. Shift Reg.	1.90
DM 8590	8 Bit Par-To-Serial Shift Reg.	1.90
DM 86L70	Lo-Power Version of DM 8570	2.50
DM 8601	Retrig. Mono. Multivibrator	1.20
DM 8880	7 Segment Neon Decoder-Driver	2.50
SE 566	Function Generator—TO-5 Or Dip	3.25
SE 567	Tone Decoder—TO-5	3.25
SE 565	Phase Locked Loop	3.25

THE MONSANTO MAN-1 DISPLAY \$4.00
L.E.D.—7-SEGMENT—D.I.P.
NOT SOME "SIMILAR TO" OR "LIKE" COPY

LM 309K	5 Volt-1 amp Regulator—To-3 Package—Short-Circuit Protected	\$2.25
	Visible Light Emitting Diode	.60
LM 351	Dual Driver—Each Driver Has TTL 2-Input Nand Gate Control Of Output Transistor Rated Up To 30V..3A	1.90
LM 380	2 Watt Audio Amplifier	2.25

8223 FIELD PROGRAMABLE ROM
256 BIT WITH 32 8-BIT WORDS
ONLY \$8.00 ALSO—WE WILL PROGRAM FOR \$5.00 MORE—IF WANTED

All Shipments First Class Mail—Free To You
Missourians—Add 4% Sales Tax

JTM ASSOCIATES

P.O. Box 843 Manchester, Mo. 63011

Circle 87 on reader service card

THE GREATEST R&R ALBUM two years in compilation. Available only thru mail. All songs released in original master form. 19 songs inc Bopalena, House of Blue Lights, Strange Love etc. All songs are collectors items and stylistic landmarks in Rock and Roll. Send \$5.00 to **ALBUM** POB 1301, Studio City, CA 91604

LOGIC Probe with LED display \$20.00 postpaid U.S. Order from UTI POB 252 Waldwick, NJ 07463

BUILD A "SPACE-AGE" TV CAMERA!!

ONLY KNOWN SOLID-STATE CAMERA IN KIT FORM! Also available factory assembled. Ideal for experimenters, industry, education, etc. High quality performance backed by over seven years of lab and field testing. Fully Guaranteed. Completely self-contained. Connects to any TV set without modification. Easy-to-follow assembly manual. Model RT-1A, Series D complete with vidicon \$149.50 PP anywhere in U.S. & Canada (less vidicon tube \$116.95pp). Many other kits, parts and plans also available.

PHONE or WRITE for CATALOG...DIAL 402-987-3771

ATV Research DAKOTA CITY, NEBR. 68731

CANADIAN Surplus Catalog \$1.00. ETCO ELECTRONICS, 464B McGill, Montreal, Canada

TELEPHONE COUPLERS, Scramblers, Encoders, Decoders, Alarms, Sounders, Kits, Components. CATALOG 25, KRystal KITS, BOX 4232, LITTLE ROCK, AR 72204.

FREE CATALOG OF ELECTRONIC BARGAIN PARTS, SEND TO: KNESS ELECTRONICS 3236 N. ELSTON, CHICAGO, IL 60618

F.C.C. EXAM MANUAL

The Original Test-Answers exam manual that prepares you at home for FCC First and Second class licenses. Includes Updated multiple choice tests and key Schematic diagrams. PLUS *Self-Study Ability Test. -- Only: \$9.95 Postpaid

COMMAND PRODUCTIONS P.O. BOX 26348 - E
RADIO ENGINEERING DIVISION SAN FRANCISCO, CALIF. 94126

SCHOTTKY IC'S		TRANSISTOR SPECIALS	
74S00—.95	74S40—.95	2N965 PNP 6E TO-18 .15W 7V .1A 300MHZ 40Hte	5/\$1.00
74S03—.95	74S51—.95	2N1605 NPN 6E TO-5 .15W 24V .1A 14MHZ	125 5/\$1.00
74S04—1.05	74S73—1.95	2N2360 PNP 6E TO-33 .06W 20V .05A	980 32 \$5.0
74S05—1.00	74S74—1.75	2N5324 PNP 6E TO-3 60W 250V 10A	20 35 \$1.50
74S08—.95	74S108—1.95	2N1015D NPN SI TO-82 150W 200V 7.5A	.025 10 \$1.45
74S10—.95	74S112—2.25	2N2015 NPN SI TO-36 150W 50V 10A	.012 26 \$9.0
74S11—.95	74S153—2.25	2N3584 NPN SI TO-66 35W 250V 2A	10 100 \$1.50
74S20—.95	74S157—2.25	2N3055 NPN SI TO-3 115W 100V 15A	.01 50 \$1.00
74S22—.95		2N3772 NPN SI TO-3 150W 60V 30A	.2 30 \$1.25
		2N5296* NPN SI TO-220 36W 40V 4A	.8 60 \$5.0
		2N6109* PNP SI TO-220 36W 40V 4A	.8 60 \$5.5

*Match pair push pull amplifier

Analog Devices regulated power supplies have been designed to provide complementary power for Operational Amplifiers, Function Modules, A-D and D. A. Converters and Digital Logic. The supplies are completely self contained. Epoxy encapsulation provides properties close to a true hermetic seal.

Model	15-25	12-100	SE 12-60	Full Wave Bridges		
Output Voltage (VDC)	±15	±12	±12	PRV	2A	6A
Output Current (MA)	50	100	60	200	.90	1.20
Price	\$15.95	\$22.95	\$18.95	400	1.10	1.40
				600	1.25	1.60

NE 565 Phase lock loops \$3.25

7 segments 5V 8ma, 16 pin DIP display, 250,000 hr. lifetime \$3.25

2N3819 FET \$4.5
TIS43 UJT \$5.0

LSI CALCULATOR CHIP
A 40 pin DIP unit that adds, subtracts, multiplies and divides. Used in a 12 digit calculator 7 segment MOS levels. Data sheets included. \$12.95

ER900 TRIGGER DIODES. These bidirectional trigger diodes are one of the best and cheapest methods to trigger SCR's and triacs .4/\$1.00
FLY 100 Visible LED \$.65
GaAs IR LED \$.65
MRD 14B photo darlingtontons \$.65
3/4" reed switch 6/\$1.00
1N4886 25-40W Power varactor \$.95

TRIACS

PRV	1A	10A	15A	20A
100	.30	.60	.85	1.05
200	.65	.85	1.25	1.45
300	.75	1.10	1.45	1.65
400	.90	1.35	1.75	1.90
500	1.20	1.50	2.50	2.20

*Press fit

TANTULUM CAPACITORS
4.7 MFD at 20V 5/\$1.00
10 MFD at 20V 4/\$1.00
4.7 MFD at 100V \$.50
10 MFD at 100V \$.75
200 PRV 15A full wave rectifier \$.95

TTL IC SERIES

7400—.21	7474—.37
7401—.21	7475—.65
7402—.21	7476—.40
7404—.25	7480—.60
7410—.21	7481—1.10
7413—.50	7483—1.10
7416—.45	7486—.45
7420—.21	7490—.65
7430—.21	7492—.65
7440—.21	7493—.65
7441—1.00	7495—.90
7442—1.10	74107—.45
7445—1.40	74121—.49
7447—1.10	74145—1.20
7448—1.10	74154—1.75
7450—.21	74182—1.00
7460—.21	74192—1.60
7472—.30	74193—1.60
7473—.40	8570—1.50
	8590—1.50

14 Pin DIP sockets 3/\$1.00
16 Pin DIP sockets60

TEN TURN TRIM POTS
500ohm, 10K, 20K, 25K
50K \$.75 3/\$2.00

Silicon Power Rectifiers

PRV	1A	3A	12A	50A
100	.06	.09	.24	.90
200	.07	.12	.20	1.25
400	.09	.16	.35	1.50
600	.11	.20	.50	1.80
800	.15	.28	.70	2.30
1000	.20	.35	.90	2.75

NIXIE TUBES
Similar to Raytheon 8754 tubes, with socket & data sheet 1.85

DECADE COUNTER KIT
CONSISTING OF:
1—NIXIE TUBE and SOCKET
1—7490 1—7475 1—7441
Special priced at \$4.75

LINEAR CIRCUITS
LM309K 5V 1A regulator \$2.25
PA234 1W audio ampl. \$1.25
PA264—5 Watt regulator \$1.25
703-RF—IF amplifier \$.75
709C operational Amp \$.39
741 operational Amp \$.39
SE 501 Video Amp \$1.00
748 Adjust 741 \$.44
Dual 709 \$.75
723 Regulator \$.95
TVR 2002 high power 723 \$1.00

Silicon Control Rectifiers

PRV	6A	10A	20A	70A
50	.25	.32		
100	.30	.45	1.00	3.50
200	.50	.75	1.25	6.50
300	.60	.90	1.50	
400	.70	1.10	1.75	9.50
500	.80	1.25	2.00	
600	.90	1.40	2.25	11.00

Terms: FOB Cambridge, Mass.
Send check or Money Order. Include Postage. Average Wt. per package 1/2 lb. No. C.O.D.'s. Minimum Order \$3.00

Send for our fall catalog featuring Transistors and Rectifiers; 325 Elm St., Cambridge, Mass.

SOLID TATE SALES
Post Office Box 74D Somerville, Mass. 02143 Tel. (617) 547-4005

Circle 88 on reader service card

TREMENDOUS SAVINGS ON PC KITS!

Mod. 5	5V Power Supply	5.00
" 12AV	12V " "	5.20
" 15AV	15V " "	5.20
" 175	Nixie & IC Pwr Supply	8.00
" 13	Time Base Generator Crystal Controlled	12.00
" 7K	Decade Counter Kit With 8754-0-9 Without Latch	7.00
" 8K	Same as above With Latch	8.00
" 19K	Decade Resistor Box Kit—4 Decades 1 to 11,111Ω	14.95

Send For Free Flyer On Linears,
Readouts, Resistors & Other Bargains

DIODES

1N4148	100 for 3.00
1N4001	60 for 3.00
1N4004	40 for 3.00
1N4007	20 for 3.00
1N4729A	15 for 3.00
1N4734A	15 for 3.00

Min. order \$3.00. On orders less than \$10.00 enclose .50 for postage and handling. Send check or M.O. Send for our free flyer on many other bargains.

EDWARDS ELECTRONICS

The John Edwards Electronics Co.
P.O. Box 465, Glen Ellyn, Ill. 60137

Circle 89 on reader service card

EVERYTHING IN SEMICONDUCTORS
YOUR CHOICE FROM OVER 300 POPULAR
DEVICES. IF YOU DON'T SEE IT HERE, ASK
FOR IT.

PART #	MOTOROLA HEP REPL	DESCRIPTION	CASE STYLE	PRICE 1-.99
D3	103	Zener Diode 6.2V 1W 5%	DO-7	.70
D4	104	Zener Diode 9.1V 1W 5%	DO-7	.70
D5	105	Zener Diode 12V 1W 5%	DO-7	.70
D7	135	GE Diode 1N60 Subst.	DO-7	.18
D8	165	Sel Dual Diode Com. Cathode	8	.38
R2	153	Si Pwr Rect 200V 15A	DO-4	1.32
R7	159	Si Rect Ax lead 800V 2.5A	DO-41	.40
R9	161	Si Rect Ax lead 50V 3A	20	.66
R11	170	Si Rect Ax lead 1000V 2.5A	DO-15	.65
R47	100	B+ Boost Rectifier 300V	—	1.20
R49	—	6500 volt Focus Rectifier	30	.88
GT3	3	GE RF Tr PNP 250 MHz	TO-18	.77
GT6	281	GE Pwr Tr PNP 15A	TO-36	1.38
GT7	232	GE Pwr Tr PNP 7A	TO-3	1.65
GT8	233	GE Pwr Tr PNP 15A	TO-36	2.97
GT29	632	GE Audio Ampl. PNP	TO-5	1.10
GT36	639	GE Drift-Field PNP	TO-18	.89
GT38	641	GE RF Ampl. NPN	TO-5	.88
GT40	643	GE Audio Pwr Ampl. PNP	TO-66	1.15
ST2	51	Si RF Tr NPN 150 MHz	TO-5	.77
ST5	54	Si RF Tr NPN 30 MHz	TO-5	.66
ST6	55	Si RF Tr NPN 200 MHz	TO-92	.70
ST7	56	Si VHF Osc. NPN 750 MHz	TO-92	.88
ST11	249	Si Pwr Tr NPN 300V 10W	TO-66	1.20
ST14	243	Si Med Pwr Tr NPN 60V 3A	TO-5	1.10
ST17	246	Si Med Pwr Tr PNP 60V 3A	TO-220	1.32
ST18	247	Si Pwr Tr NPN 70V 10A	TO-3	1.70
ST20	310	Si Unijunction Tr 300mW	TO-92	.99
ST25	703	Si Audio Pwr Ampl. NPN	TO-66	1.76
ST28	704	Si Audio Pwr Ampl. NPN	TO-3	1.43
ST42	721	Si Audio Pwr Ampl. NPN 200 MHz	TO-92	1.50
ST69	3001	Si RF Pwr Tr NPN 65V 5W	TO-5	2.30
FET1	801	Fet Audio N Channel	TO-46	.99
FET2	802	Fet RF N Channel	TO-46	.99
FET3	803	Fet Audio RF P Channel	TO-46	2.10
TI5	320	Thyristor (SCR) 30V 800ma.	TO-18	.60
BR1	175	Phil Wave Bridge 50V 3A .750/.800Rd	60	

Terms: Add 25¢ for postage
Minimum Order 2 Dollars.
Send 10¢ for Complete catalog.

GF Electronics
P.O. Box 14
Greenwood, Mass. 01880

Circle 90 on reader service card

WALKIE TALKIE

RT-196/PRC-6 RECEIVER-TRANSMITTER—47 to 55.4 MHz. 43 channels. One (1) pre-set channel at a time. FM Voice, range approx. 1 mile depending on conditions; one crystal used for Rec. & Trans. 13 Tubes. Battery power req.: 1.5, 45 & 90 VDC. Mic. Phone and Antenna are included. Uses BA-270 Batt. which is not included. Size: 15 x 5 x 4 1/4". Wt.: 3 1/4 lbs. Price: Less Batt., Used: \$24.95

RT-70/GRC RECEIVER-TRANSMITTER—47 to 58.4 MHz. F.M. continuous tuning; also 2 pre-set chan., Voice, power output 500 MW. 18 Tubes, power req.: 90 VDC @ 80 MA. 6.3 @ 360 MA. 6.3 @ 180 MA. (See available accessories below) Size: 5 x 13 x 8". Wt.: 17 lbs. Price: Used \$22.95

AM-65/GRC AF AMPLIFIER—Three channel audio Freq. Amplifier used for interphone and radio monitoring of various types of GRC Rec.-Trans.; 7 Tubes, power req.: 135 VDC 35 MA. and 6. 12 or 24 VDC. (See below for accessories) Sizes: 4 1/4 x 13 x 7 1/4". Wt.: 15.5 lbs. Price: Used \$14.95

TECH MANUALS, including Schematics—For RT-196 or RT-70 — \$7.50 ea. Manual, with Schematic—For AM-65 — \$5.00 Schematics Only: \$1.00 ea.

H-33/RT HANDSET—Used with above units: Used: \$5.95—Unused: \$7.95

PP-281/GRC POWER SUPPLY—12 Volt, used with RT-70 & AM-65. This unit plugs inside the AM-65 and supplies the voltages for both units. Size: 4 1/2 x 6 x 3". Wt.: 6 lbs. Price: Used \$8.95

All prices are F.O.B., Lima, Ohio.—Dept. RE
SEND TODAY FOR OUR NEW CATALOG!

FAIR RADIO SALES
1016 E. EUREKA • Box 3105 • LIMA, OHIO 45802

YEATS APPLIANCE DOLLIES



- ★ STAIR-CLIMBING DOLLY
- ★ One Man Operation for light appliances
- ★ FREE illustrated brochure \$66.50

Yeats Appliance Dolly Sales Co.
1300 W. FOND DU LAC AVE.
MILWAUKEE, WIS. 53205

Adventure

EXPEDITION AROUND THE
WORLD. Remote places:
Galapagos, Pitcairn, Easter,
Tahiti, Fiji, etc. 180 Yacht.
Shipmates wanted. Share
expenses.

Write **YANKEE TRADER**,
P. O. Box 120, Dept. RW75,
Miami Beach, Florida 33139

REBUILD YOUR OWN PICTURE TUBES?

With Lakeside Industries precision equipment, you can rebuild any picture tube!

For complete details, send name, address, zip code to:

LAKESIDE INDUSTRIES
3520 W. Fullerton Ave.
Chicago, Ill. 60647
Phone: 312-342-3399



Technical Excellence in Electronics.

On our small, friendly campus the emphasis is on Living as well as Learning. Extra-curricular social activities, student clubs, a student operated radio station, student government, new dormitory and a full sports program help provide a world of your own in which to prepare for tomorrow. Associate Degree in Engineering Electronics. B.S. obtainable. G.I. approved.



VALPARAISO TECHNICAL INSTITUTE
Dept. C, Yellowstone Trail, Valparaiso, Indiana 46383

ELECTRONIC Ignition—Various Types. Information 10¢. **ANDERSON ENGINEERING**, Epsom, NH 03239

JAPANESE new products monthly! \$1.00. Refundable. **DEERE**, 10639 Riverside, North Hollywood, CA

TUBE TESTERS MERCURY MODEL 204 Write: **BOB GREBER**, 10144 Dunbarton Dr., El Paso, TX 79925

M.A.D. Music Associated's Detector for music-only programs now on FM. Use with any tuner. \$75.00. **Music Associated**, 65 Glenwood Road, Upper Montclair, NJ 07043. (201) 744-3387.

CB Two-Way radios—SBE's 23 Channel-mobile transceiver. All Crystals Supplied. Fully Warranted. \$99.95 check or M.O. (information on request). **CB RADIO EQUIPMENT**, P.O. Box 611, Fairfield, CT 06430.

PHOTOFASH: FT 106C, 800rF, trigger coil—\$12.50. Catalog. **TRANSPARK** Dept. R., Carlisle, MA 01741

FREE Catalog lists resistors, tubes, transistors, rectifiers, condensers, tools, tuners, etc. etc. **Hytron Hudson**, Dept. RE 2201 Bergentine Ave., Union City, NJ 07087.

PRINTED CIRCUITS in 24 HOURS from magazine page, magnetic marker layout, etc. Etch & trim \$3. Up. **BECO**, Box 686, Salem, VA 24153

15W RMS HYBRID AUDIO AMPLIFIER—Panasonic—Freq. response 20Hz–100KHz. 1/2% dist. Price \$6.50 PPD. **PACE ELECTRONIC PRODUCTS**, Box 161, Ontario Center, NY 14520

B & K, Sencor test equipment, discount prices. Free catalog and price sheet. **FORDHAM RADIO**, 265 East 149th Street, Bronx, NY 10451

STATEMENT OF OWNERSHIP, MANAGEMENT AND CIRCULATION (Act of August 12, 1970: Section 3685, Title 39, United States Code)

1. Title of publication: RADIO-ELECTRONICS
2. Date of filing: October 1, 1972
3. Frequency of Issue: Monthly
4. Location of known office of publication: 200 Park Avenue South, New York, New York 10003.
5. Location of the headquarters or general business offices of the publishers: Ferry Street, Concord, Merrimack County, New Hampshire 03301.
6. Names and addresses of publisher, editor and managing editor: Publisher and Editor-in-Chief, M. Harvey Gernsback, 200 Park Ave. South, New York, N.Y. 10003; Editor, Larry Steckler, 200 Park Avenue South, New York, N.Y. 10003.
7. Owner: Gernsback Publications, Inc., 200 Park Avenue South, New York, New York 10003; M. Harvey Gernsback, 200 Park Avenue South, New York, New York 10003; Mary H. Gernsback, M. Harvey Gernsback, Benjamin E. Winston as trustees under trust agreement dated September 30, 1965 c/o Benjamin E. Winston, Esquire, 2 W. 46th Street, New York, N.Y. 10036.
8. Known bondholders, mortgagees, and other security holders owning or holding 1 percent or more of total amount of bonds, mortgages or other securities: None.

9. For optional completion by publishers mailing at the regular rates (section 132.121 Postal Service Manual. In accordance with provisions of U.S.C. 3626, I hereby request permission to mail the publication named in item 1 at the reduced postage rates presently authorized by 39 U.S.C. 3626. (signed) H. Matysko, Circulation Manager.

10. For completion by nonprofit organizations authorized to mail at special rates: Does not apply in this case.

11. Extent and nature of circulation. Average number of copies each issue during preceding 12 months: (A) Total No. of copies printed (net press run): 205,802; (B) Paid circulation: (1) Sales through dealers and carriers, street vendors and counter sales: 44,176; (2) Mail subscriptions: 106,256; (C) Total Paid circulation: 150,432; (D) Free distribution by mail, carrier or other means: (1) Samples, complimentary, and other free copies: 1,409; (2) copies distributed to news agents, but not sold: 51,575; (E) Total distribution: 203,416; (F) Office use, left over, unaccounted, spoiled after printing: 2,386; (G) Total 205,802. Actual number of copies of single issue published nearest to filing date: (A) Total No. of copies printed (net press run): 205,614; (B) Paid Circulation: (1) Sales through dealers and carriers, street vendors and counter sales: 49,067; (2) Mail subscriptions: 108,282; (C) Total Paid circulation: 157,349; (D) Free distribution by mail, carrier or other means: (1) Samples, complimentary, and other free copies: 1,445; (2) Copies distributed to news agents, but not sold: 44,708; (E) Total distribution: 203,502; (F) Office use, left-over, unaccounted, spoiled after printing: 2,112; (G) Total 205,614.

I certify that the statements made by me above are correct and complete.
(Signed) H. Matysko, Circulation Manager

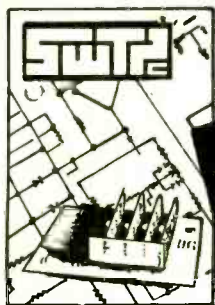

FREE

Southwest Technical Products Catalog of Unique Kits

Tired of the same old projects? Ready for something new and different? Your free Southwest Technical Products catalog describes almost 50 of our unique reasonable priced kits. Save up to 50% over the cost of comparable kits. Amplifiers, preamps, color organs, digital readout systems and more. Send for your free copy now.

Function Generator

**Sine-Square
Pulse-Triangle
and Ramp Waveforms
1.0 Hz to 1.0 MHz**



Ask anyone who has been able to afford one. A function generator is one of the handiest signal generators you can own. You get five different waveforms that may be used to test TV, radio, hi-fi, servo, digital logic and many other systems. Output level is 2.5 Volts P-P maximum at 70 Ohms source impedance. Choice of AC, or DC coupled output, with adjustable offset when DC coupled.

Plug together construction and three printed circuit boards make construction easy. 5¼ x 6¾ x 2½ impact plastic case. Get yours now at our special low introductory price.

Kit #FG-1. 3 lbs. \$39.95

NEW— Digital Tachometer

**400 to 9,990 RPM
4 Digit-LED Readout
Work with all 4, 6
or 8 cylinder engines**

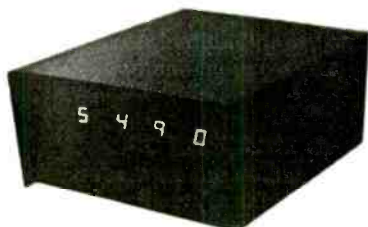

Something really different to add to your car. This beautiful little instrument reads out your engine RPM directly on a bright red light emitting diode display. Phase locked loop circuit makes possible a four digit readout that is accurate to ±2%.

Plug together construction simplifies construction. Only +12 Volts and distributor point connections required on the engine. 4½ x 2½ x 7 black vinyl covered metal case.

Kit # TACH-1 3.0 lbs \$79.50

Short Proof Power Supply

**0-32 Volts • 0-2 Amps
Dual Meters**



Continuous adjustment of voltage and current. Regulated low ripple output. Compare the voltage and current output with others at twice our low price.

Brushed gold front panel, black vinyl covered metal case. 9 x 7 x 3
Kit #143. 8 lbs. \$39.50

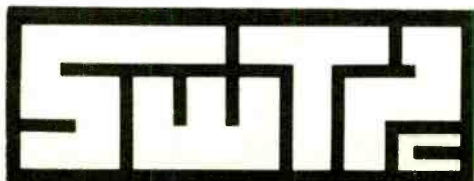

Universal Tiger MK II

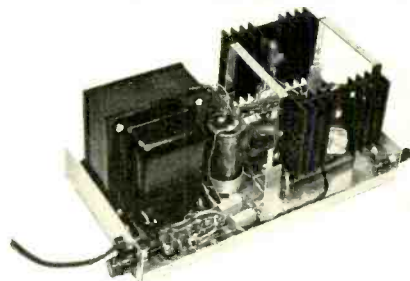

The latest version of our highly popular 80 Watt basic power amplifier is now available for those who want the best. Harmonic distortion is less than 0.1% up to full output and IM distortion less than 0.2% at the same level. Bandwidth is 5 to 200,000 Hz at the -1dB points.

Step-by-step assembly instructions and pictorial wiring diagrams make assembly of this kit very simple. Nothing but the best parts and our usual fibreglass circuit board are used in this kit.

Available only in independent single channel form to insure no power reduction with both channels driven and absolutely no crosstalk between channels in a stereo, or quad amplifier system.

Kit #175-A. 14 lbs. \$60.00
Special. Two of the above \$115.00

Two Great Color Organs for your Holiday Decorations PSYCHEDELIA I and now PSYCHEDELIA II

The best color organs available. Both of these unique color organ systems have four channel output. You can use up to 750 Watts of lamps per channel for a total of over 2.5 Kilowatts of light from each color organ circuit. Transformer isolated inputs can be safely driven from any sound system, or stereo system speaker connection.

Psychedelia I is a filter type color organ, using the "classical" filter and amplitude detector system to generate four channels. Op-amp active filters are used in our circuit along with our exclusive ramp triggering system to give fast proportional light response. Automatic level control allows the circuit to compensate for up to 40 dB variation in sound system level without any need to readjust the color organ sensitivity.

Psychedelia II is a digital color organ. This new and different approach to color organ design uses a sampling system and counting techniques to separate the sound input into four channels. This type system tends to produce a very active flashing type display which many prefer. It also is more random and does not follow the music in quite as obvious a way as a filter type color organ.

Kit QX-1 or QX-11 4 lbs. \$44.95
Both kits less display of any kind.
Bookshelf display semikit 26 lbs. \$26.50

Bank Americard and Master Charge Welcome
Send number and expiration date.
All Mail Orders—plus postage.

Southwest Technical Products Corporation
Dept. 12RE
219 W. Rhapsody, San Antonio, Texas 78216
Circle 91 on reader service card

WORLD FAMOUS SEMI-KON Dollar Stretchers

- 1-2N3055 npn, 100w 15A, TO-3, transistor \$1
- 2-2N3572 UHF, 1000mc, npn, TO-92, plastic transistor \$1
- 5-ER900 TRIGGER DIODES for SCRS & Triacs \$1
- 4-2.5 AMP 1000 PIV ITT, silicon epoxy rectifiers \$1
- 5-VARACTOR DIODES, 10pf, 20pf, 30pf, 40pf, 50pf \$1
- 2-FET'S 2N5450 N channel 500 umho TO-2 plastic \$1
- 1-90 WATT PNP, 15A, 2N2612, TO-3, silicon \$1
- 2-2N389 npn, silicon, 85 watts, Vce 80, square case \$1
- 3-2N1212 npn, silicon, 85 watts, Vce 60, stud case \$1
- 10-1N914 fast switch diodes, silicon 4 nanosecond \$1
- 10-2N404 germanium pnp, TO-5 chrome case \$1
- 2-6 AMP TRIAC 200 PIV, TO-5 \$1
- 40-G-E MICRO MINI RECTIFIERS, silicon, porcelain to 1 KV \$1
- 40-RECTIFIERS & ZENERS, 1W, & 1A. bullets, assorted volts \$1
- 30-WORLD'S SMALLEST RECT. & zeners, 1W, assorted volts \$1
- 1-FAIRCHILD 2n3919 80mc, 15W, npn, 10A, TO-66 \$1
- 5-2N3638 PNP, silicon, TO-5 plastic transistors \$1
- 5-2N3641 NPN, silicon, TO-5 plastic transistors \$1
- 4-2N4269 Nixie tube driver transistors 100V, npn \$1
- 2-FET'S 2N3085 N channel, 10,000 umho TO-18 transistors \$1
- 2-PUTS, prog. uni-transistors, similar to GE-D13T \$1
- 2-2N2950 P channel, 40W umho, TO-18 \$1
- 2-2N3819, Texas, N channel, 6500 umho, TO-18 \$1
- 6-TRIGGER DIODES, for SCRS only, axial leads \$1

ALPHA-NUMERIC 7-SEG. READOUTS

- MINI-7 1.75 x 1.7" .360 x .570" 1.5V AC/DC 42 mls \$1
- SLIM-7 1.8 x 0.375" .40 x .20" 1.5V AC/DC 42 mls \$1
- *Compatible to 7-segment driver IC's.
- MINI-7 All 3 have 0-9 numerals, decimals and letters. SLIM-7

- 3-2N2646 UNIJUNCTIONS, plastic transistors, Texas \$1
- 5-2N107, GE, most commonly used pnp, germanium \$1
- 3-3-AMP 1000 PIV epoxy bullet, silicon rectifiers \$1
- 50-SILICON, glass rectifiers, computer, axial leads \$1
- 50-GERMANIUM, glass rectifiers, signal, axial leads \$1
- 5-2N170, GE, RF, germanium, npn, transistors, TO-22 \$1
- 10-1-AMP 1000 PIV, epoxy, submini, silicon rectifiers \$1
- 30-500 MW ZENERS, axial 4, 6, 9, 10, 12V rectifiers \$1
- 4-2N3055, HOBBY, 40W umho, npn, transistors, TO-3 \$1
- 5-2N155, HOBBY, 10W pnp germanium transistors, TO-3 \$1
- 3-50 AMP SILICON RECTIFIERS, silicon, 6, 12, 24 volts \$1
- 5-2N1038, TEXAS, germanium pnp, 20 watts, TO-5, w/sink \$1
- 10-2N3054 hobby, npn, TO-66, silicon, 30W, 30mc \$1
- 10-SCRS, assorted voltages, TO-5, TO-18, TO-46 \$1
- 30-3-AMP RECTIFIERS, silicon, epoxy, assorted V, axial \$1
- 5-SN7441N, hobby, BCD-to-Nixie driver IC, DIP \$1
- 10-LINEAR AMPS, 709, 710, 711, 741, TO-5 \$1
- 10-709 LINEAR AMPS, 741 too, DIPs \$1
- 5-HOBBY MEMORY CELLS, SN7481, up to 16-cell, DIP \$1
- 10-709, 710, 711 LINEAR AMPS, brand name, flat pak \$1
- 2-2N5296 35-WATT PNP PLASTIC TRANSISTORS, for any 540 \$1
- 2-2N6109 40-WATT PNP PLASTIC TRANSISTORS, for any 640 \$1
- 10-RCA CA-3000 OP AMPS, TO-5 case \$1
- 3-723 VOLTAGE REGULATORS, TO-5 \$1
- 4-1000 HFE DARLINGTON transistors, TO-18 case \$1
- 2-2N5036 PNP, 100W trans, axial, 8 pin, 85 watts \$1
- 2-2N5296 HOBBY 35 watts, plastic power PNP \$1
- 2-2N2100 HOBBY 40 watts, plastic power PNP \$1

LED-PHOTO-SOLAR DOLLAR STRETCHERS

- 3-"LEDS", visible, micro-miniature, axial leads \$1
- 2-"LEDS", infrared, jumbo, TO-18 \$1
- 1-"LEDS", visible, jumbo, red, TO-18 \$1
- 1-"LED", invisible, parabolic reflector, RCA \$1
- 2-PHOTO TRANSISTORS, with darlington amp filter, lens \$1
- 2-PHOTO TRANSISTORS, with darlington amp, 2N5777, GE \$1
- 4-PHOTO CELLS, Clairex, pancake, 30K-70 ohms \$1
- 8-SOLAR CELLS, round, sq, rect., sun power circuits \$1
- 2-SILICON SENSORS, TEXAS, H-38 Matchatix, visible \$1

SUPER ECONOMY \$1 PARTS "DOLLAR STRETCHERS"

- 30-POWER RESISTORS, 3-to-25w, square, vitreous, ass't vals \$1
- 6-REED SWITCHES, 2" long, fastest mech, switch \$1
- 10-MICRO REED SWITCHES, 1" long, transistor work \$1
- 10-TRANSISTOR SOCKETS, for pnp-npn trans, powers too \$1
- 1-\$25, SURPRISE PAK, resistors, caps, transistors, etc. \$1
- 50-TERMINAL STRIPS, 1-to-8 acrow & tie lugs \$1
- 40-RADIO & KNOBS, ass't shapes, colors, styles \$1
- 30-SQUARE DISC CAPACITORS, ass't values \$1
- 75-PRE-FORMED DISCS, condensers, printed circuit \$1
- 10-PHONO PLUG-AND-JACK SETS, tuners, amps, doubles too \$1
- 10-KOAK LENSES, piano convex, concave, convex, mirror \$1
- 60-TUBE SOCKETS, receptacles, plugs, audio, etc. \$1
- 10-PRE-FORMED DISC CAPACITORS, ass't values \$1
- 30-OIPPEO SILVER MICAS, pop valves, silvers, too \$1
- 50-COILS & CHOKES, rf, ant, peaks, osc, parasitic \$1
- 10-IC SOCKET-ADAPTERS, TO-5, DIPs, flat, handy \$1
- 60-PRECISION RESISTORS, 1/8, 1/2, 1 & 2W, 1% ass't vals \$1
- 60-TUBULAR RESISTORS, 100, 500, 1K, 5K, 10K, 25K \$1
- 10-SUBMINIATURE IFS, 485 kcs, 1/4 square, transistor \$1
- 10-TUBULAR ELECTROLYTICS, to 100mf, for ac/dc sets, etc. \$1
- 15-NE-2 NEON BULBS, for 110vac, 100's of projects \$1
- 30-POLYSTYRENE CONDS, finest caps made, ass't values \$1
- 10-PANEL SWITCHES, 110vac, micro, rotary, thermal, slide, \$1
- 10-VOLUME CONTROLS, 100, 500, 1K, 5K, 10K, 25K, w/switch \$1
- 40-MICRO MINI RESISTORS, 1/4w, 100 ohm to 1meg, 5% \$1
- 30-MOLDED CONDENSERS, upright, & axial, to 1mf to 1KV \$1
- 50-ONE WATT RESISTORS, 1% & 5%, AB's too, 100 to 1 meg \$1
- 10-TRANSISTOR ELECTRO'S, 5mf to 300mf, upright too \$1
- 10-UPRIGHT TRANSISTOR ELECTRO'S 5mf to 300mf \$1
- 60-CERAMIC CONDENSERS, 100mf to .04, npo's, discs \$1
- 40-MICRO-MICRO-MINI CONDENSERS, to .05mf Cerafil \$1
- 5-IBM COMPUTER BOARDS, trans, caps, res, coils, etc. \$1
- 10-ELECTROLYTIC CONDS, FP's, & tubular, 2 & 3 sect. too \$1
- 5-TRIMMER POT 100, 500, 2K, 5K, 10K, 25K, 1/2w, snap-in \$1
- 60-HI-Q RESISTORS, carbon, 1/2, 1, 2W 5% \$1
- 10-OIL CAPACITORS, 100mf to .05, npo's, hi-Q, to 6KV \$1
- 50-MICA CAPACITORS, to .01, to 1KV, silvers too, ass't \$1
- 35-TWO WATERS, resistors, carbon, metal-film, 5% ass't \$1
- 30-MICRO POT 100, 500, 1K, 5K, 10K, 25K, 1/2w, snap-in \$1
- 400-PRINTED CIRCUIT PARTS, electro's, trans, etc. \$1
- 30-YELLOW PACKET MYLARS, assorted values & sizes \$1
- 10-POWER TRANSISTOR SOCKETS, for TO-3, ass't types \$1
- 3-MINIATURE MOTORS, shaft, 3-12vdc, high speed \$1
- 64-PLASTIC TRANSISTORS, TO-18, printed circuit \$1

- SN74500 Quad 2-input NAND gate \$.99
 - SN74501 SN74500 w/open collector \$.99
 - SN74503 Hex inverter \$.99
 - SN74504 Hex inverter (open coil) \$.99
 - SN74508 Quad 2 input AND gate \$.99
 - SN74509 Quad 2 input AND gate \$.99
 - SN74510 Triple 3 input NAND gate \$.99
 - SN74511 Triple input AND gate \$.99
 - SN74515, SN74511 w/open collector \$.99
 - SN74520 Dual 4 input NAND gate \$.99
 - SN74521 Dual 4 input AND gate \$.99
 - SN74522, SN74521 w/open collector \$.99
 - SN74540 Dual input buffer \$.99
 - SN74564 4 wide, 4-2-3-2 in AND/OR \$.99
 - SN74573 Dual J-K master slave flip flop \$.98
 - SN74574 Dual D edge trig. flip flop \$.98
 - SN745113, SN74874 with preset \$.98
- Buy 3 - Take 10% Discount

First Time Ever Offered At These Prices!

SCHOTTKY TTL IC'S

- * Flip flop toggle freq 75mhz to 125mhz
- * Switches 4 times faster than standard TTL's

The lowest price digital clock kit (with cabinet) as far as we can see in U.S.A. Scientific Devices' engineering dept. took extra patience in designing to give you the finest digital clock kit using the latest techniques in an easy-to-understand booklet. The cabinet-making section gives it the "interior decorating" touch so that it may fit into any room at home, shop or office. Walnut laminated tapered front cabinet, with gold-line front. Tapered legs for easy viewing. Large G.E. 7-segment fluorescent "blue-green" polaroid glow for the latest easy-viewing. FEATURES: 6 display tubes, completely etched and thru plated circuit board, all IC's. Includes BCD outputs for use with timer options, may be wired for 12 or 24 hour display. Indicates HOURS, MINUTES, SECONDS. 115 VAC 60 cy. Gift packed. Wt. 8 lbs. Buy 3 - Take 10% off

DIGITAL CLOCK KIT

By Scientific Devices

\$57.

WITH CASE

* Smaller & more compact

* 8" x 5 1/2" x 3" case



Largest Selection TTL IC's

"DIP" Packages Order by type number! Spec sheets on request "ONLY"

Type	Sale	SN7430	.21	SN7474	.39	SN74141	1.45
SN7400	\$2.21	SN7437	.50	SN7475	.71	SN74145	1.25
SN7401	.21	SN7438	.51	SN7476	.44	SN74150	1.25
SN7402	.21	SN7440	1.00	SN7480	.65	SN74151	1.13
SN7403	.21	SN7442	1.12	SN7481	1.10	SN74152	1.25
SN7404	.27	SN7443	1.21	SN7482	1.28	SN74154	1.95
SN7406	.45	SN7445	1.21	SN7483	1.25	SN74155	1.39
SN7407	.45	SN7446	1.17	SN7485	.85	SN74156	1.39
SN7408	.29	SN7447	1.10	SN7489	3.50	SN74157	1.25
SN7409	.29	SN7448	1.25	SN7491	.69	SN74158	1.10
SN7410	.25	SN7450	.21	SN7492	1.71	SN74160	1.79
SN7411	.25	SN7451	.21	SN7493	.71	SN74161	1.79
SN7413	.50	SN7453	.21	SN7494	1.10	SN74162	1.79
SN7416	.48	SN7454	.21	SN7495	1.10	SN74163	1.79
SN7417	.48	SN7456	.21	SN7496	1.10	SN74164	1.50
SN7420	.21	SN7470	.39	SN74107	.49	SN74181	4.10
SN7421	.21	SN7472	.32	SN74121	.67	SN74184	2.50
SN7426	.32	SN7473	.44	SN74122	.49	SN74185	2.50
				SN74123	.99	SN74189	1.75
						SN74193	1.75
						SN74198	1.19

Buy 100 - Take 20% * Factory Marked! Factory Guaranteed!

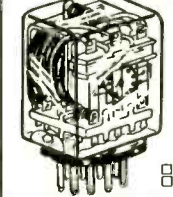

POTTER BRUMFIELD KAP RELAYS

Your choice 3 for \$7.50 **\$2.98**

- 115 VAC 3PDT \$2.98
- 12 VDC 3PDT 2.98

Excellent for "HAM" use as antenna switching, latching, transmit, receive, etc. and 100's of commercial or industrial uses. Includes plastic dust-cover with diagram and hookup info, 11-pin plug-in base. Contacts movable gold flashed silver, stationary overlay, with silver cadmium oxide movable. All contacts 10 amp 3PDT. Coil data: 115VAC 2250 ohms, 17.5 ma, 12 VDC 21 ohms 168 ohms. Size: 2 1/4" x 1 1/2" x 1 1/8". Wt. 4 ozs. Center pin missing. Comar Mfg. type equal too.

VU PANEL METERS

Only **\$1.95**

For measuring sounder noise levels. Essentially low range rectifier type voltmeter. Internal imp. 8900 ohms. Steady state reference 1 mw. For 600V line.



PHILCO-FORD DYNAMIC MIKE

\$1.98

Replacement for tape recorders, PA systems, audio amps. 200 ohms. 6-ft. cord and mini mike plug. 200-5000 Hz. Wt. 6 ozs. Fits in "palm of hand." 2 1/2" x 1 1/2" x 1/2". Impact plastic case.

NIXIE TUBE SALE \$2.50

Burroughs B7971, 0-to-9, A-to-Z, 2 1/2" high characters, 170V

EPOXY FULL WAVE SILICON BRIDGE RECTIFIERS

PIV	2 Amp	5 Amp	8 Amp
100	\$1.50	\$1.85	\$2.20
200	.79	.99	1.25
300	.95	1.25	1.50
400	1.19	1.50	1.75
500	1.35	1.75	2.00
600	1.59	1.95	2.25
1000	1.79	2.25	2.75

Code: 2 amp TO-5 case
8 Amp 1/2 x 1/2 x 3/16 sq

LOW PRICES ON 'TRIACS'

* Two SCRs in one case! * Most complete listing!

PRV	3 amp	6 amp	10 amp	15 amp	25 amp
50	\$2.22	\$3.35	\$4.45	\$6.65	\$8.85
100	.35	.52	.64	.85	1.05
200	.65	.72	.88	1.25	1.45
300	.79	.89	1.15	1.45	1.65
400	.92	1.15	1.35	1.85	1.95
500	1.25	1.39	1.55	2.55	2.25
600	1.50	1.69	1.95	2.65	2.85

3 & 6 amp TO-5, 10 amp TO-66, 15 & 25 amp stud.

STEREO PREAMP IC

Dual 739-739 8-transistors per channel. 500 in. imp. for phono-tape. 20-20,000 mc. DIP. Fairchild.

Choose Any **1.95**

3 for \$4.50

INTEGRATED CIRCUIT SOCKETS

Buy Any 3 - Take 10% Discount!

- 14-Pin, dual in line \$.50
- 16-Pin, dual in line \$.45
- TO-5, 8 or 10 pins \$.29

"How's Your MEMORIES For 1973?"

- 1101 256 BIT RAM MOS \$3.50
- 1103 1024 BIT RAM MOS \$7.95
- 7489 64 BIT RAM \$3.50
- 4000 BIT MEMORY PLANE, 18M \$4.95
- 8223 FIELD PROGRAMABLE ROM \$8.67

LED READOUTS

\$2.95 Buy 3 - Take 10%

This display is excellent for small portable electronics, such as OVM's, calculators, etc. Equivalent to Montano MAN 3A. Operates from 5 volts, 20 milliamperes, with 47 ohm dropping resistor.

NATIONAL VOLTAGE REGULATOR

LM-309K 5 volts, 1 amp TO-3 case. Internally set. Overload and short circuit proof. No external components. With spec sheets.

LM-370 AGC SQUELCH AMP

Self-contained AGC squelch system, with fast attack slow release. DC output shift is varied, differential inputs with large common mode input range. Outs. of several AMP may be directly summed in multi-channel systems 4.5V to 24V. TO-6

\$1.49

MAGIC "SOUND TRIGGER"

Unique Scientific Device, "hand clap" sensitizes crystal mike amplifier, triggers SCR. Needs only 3 to 6Vdc. Use as burglar alarm, intrusion device. Use with photo cell, triggers SCRs, relays, LED's. Even fiber optic light pipe may be used. With hand booklet.

\$1.98

LINEAR Op Amps

FACTORY GUARANTEED

Buy Any 3 MARKED - Take 10% Discount

Type	Description	Sale
531	Hi slew rate op-amp	\$2.50
532	Micro power 741 TO-5	2.50
533	Micro power 709	2.50
836	FET input op amp	3.95
537	Precision 741 TO-5	2.50
540	70W pwr driver amp	2.04
550	Precision 723 voltage reg.	1.17
555	Timer 2 uSeconds to 1-hour	1.19
558	Dual 741 (mini DIP)	3.25
560	Phase lock loops	3.25
565	Phase lock loops (A)	3.25
566	Function generator (Mini DIP)	3.25
567	Tone decoder (Mini DIP)	3.25
595	Four quadrant multiplier	3.10
702C	Hi-gain, OC amp, TO-5	1.00
703C	RF-IF, amp, 14 ch, TO-5	1.00
709C	Operational amp (A)	.39
710C	Differential amp (A)	.39
711C	Dual diff. comp (A)	.39
723C	Voltage regulator (A)	.95
741C	Frequency comp 709 (A)	.41
741CV	Frequency comp 709 (mini OIP)	.49
747C	Qual 741C, (A)	1.25
748C	Freq. adj. 741C (A)	.44
709-709	Qual 709C (OIP)	1.00
739-739	Dual stereo preamp	1.98
741-741	Qual 741C (A)	1.07

(A) TO-5 or DIP dual in line pak

Terms add postage, cod's 25%. Rated: net 30. Phone Orders: Wakefield, Mass. (0177) 245-3829. Retail: 211 Albion St., Wakefield, Mass. C.O.D.'S MAY BE PHONED IN

POLY PAKS

P.O. BOX 942R, LYNNFIELD, MASS. 01940

**EXCLUSIVE ECONOMY-PACKED
DOUBLE BONUS Sale**

BONUS #1
Free \$25
Add 25¢ for handling PAK

PLUS CHOOSE ANY ITEM \$1 OR LESS FREE

BOTH FREE WITH ANY \$10. ORDER

**PHILCO 11 TRANSISTOR
AM RADIO CHASSIS**



Use as:
● Mike amplifier
● Phone amplifier
● Tape amplifier
● Covers 555 Kcs to 1500 Kcs Broadcast band
● AC or DC

Only \$5.95

One of the most versatile AM Radio and multi-purpose amplifiers we have seen at Poly Paks famous "Economy" price. Measures only 4 1/2" x 3 7/8" x 2" high. With tuning capacitor, IF circuitry, loopstick, ant., volume control with switch, AC and phono-mike jacks. Separate switch for changing from AM radio to amplifier. Uses either 110V plug-in adapter (not with unit) and a 9-volt battery power. Exceptional sensitivity and power. Feeds into 16 ohm speaker. Complete with spec sheets, diagrams, and hookup ideas. **BUY 2 FOR STEREO**

**8 TRANSISTOR
AMPLIFIER CHASSIS**
Only \$3.95



Same as above, except no AM radio section. Completely wired! With built-in preamp, mike, phono and tape inputs. Color-coded wires with diagram and hookups. Works off 9VDC transistor battery. Excellent fidelity. Shpg. wt. 1-lb.

AC-DC CHARGER-CONVERTER — Only \$1.98

Converts above 11-and-8-transistor chassis from 9VDC to 110VAC. Easy to hook in. Use as "NICAD" battery charger too (with instructions). Size: 2" x 1 3/4" x 1 3/4". Shpg. wt. 1-lb.

5-IN. "HI-FI" PM SPEAKER — Only \$1.98

5-ounce ceramic, cylindrical magnet. Twin voice, coil, 4 and 8 ohms. Excellent for above radios and amplifiers. 50-16,000 cycles. Shpg. wt. 3 lbs.

BRAND NEW LOWEST PRICES

GENERAL \$2.95

ELECTRIC 3 FOR \$6.00

3-WATT AUDIO AMP

Delivers 3.5 watts continuous, 10 watts peak with heat sinks; micro-mini size: 3/4" x 1/2" x 1/2". 9 to 30V supply. High sensitivity, 8 to 18 ohms. For mono and stereo phonos, tape, FM, AM, TV, servo.



IT'S NEW! 12-DIGIT 3 for \$35

"CALCULATOR ON A CHIP"

Sorry, can't name U.S. maker! Type SD5001. Similar to Mostek 6012. Outperforms Texas 8-digit TMS-1802. Features: 40-pin DIP; not 5, not 3, but only single "calculator chip". 12-digit capacity; adds, subtracts, multiplies, divides, fixed point (0, 2, 3 or 4 decimal places), chain operations, leading zero blanking, 7-segment decoded display output, overflow lockout, and negative sign output. Drive incandescent, fluorescent, Nixies, and LED readouts, complete with instruction booklet.



**3.88 SOLID STATE
AM-FM TUNER**

FM 88-108mhz & AM 550-1600kcs. Sensitive 2 3/4" x 2 1/4" x 1 1/2" module. Can be used with 10.7mc & 455kcs IF strips & any hi-fi amp. P.C., wired. 4-gang variable supply voltage 9V. 6 mls. Varactor diode for AFC. Schematics.

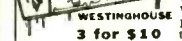

0.9 plus letters for SN7446 or SN7447. Snaps in 14-pin DIP socket. 3/4" x 3/8" x 3/8", characters: 1/4" x 3/4". 5V, 20-mils per sec. characters: 1/4" x 1/8". Famous MAN-1 type. Sockets .80 ea.

LED READOUTS
4.50
3 for \$12.

'PIK-A-PAK' FACTORY IC KITS

● Factory To You!
● With Diagrams!
● No Test!

- 24-709, 710, 711, 723, 741 asst. cases \$2.98
- 24-7400 Series, Dual in line, asst. 1.98
- 24-Linear & 7400 Series, asst. 1.98
- 10-709, 710, 711, 723, 741, TO-5 1.00

Type G, 1/2" dia. x 1 1/2" high. Mounts 1/4" hole, with shaft, linear, immersion-proof high freq.

- 75 2.0K 7.K 25.K 2 for \$1
- 100 2.5K 10.K 75.K
- 500 5.0K 20.K 100.K 5 Meg

We stock Locknut Bushing & Screwdriver types at same low prices.

ALLEN BRADLEY'S 'TRANSISTOR' POTS

- 75 250 1.0K 7.5K 25.K 100K Any
- 100 500 2.5K 10.0K 50.K 2 Meg
- 200 750 5.0K 20.0K 75.K 5 Meg \$1

Terms: add postage, cod's 25%. Rated: net 30. Phone Orders: Wakefield, Mass. (617) 245-3829. Retail: 211 Albion St., Wakefield, Mass. C.O.D.'S MAIL BE FURNISHED IN

POLY PAKS P.O. BOX 942R
Lynnfield, Mass. 01940



INVENTIONS & PATENTS

INVENTIONS Wanted Patented; Unpatented. GLOBAL MARKETING, 2420-AE 77th Ave., Oakland, CA 94605

BUSINESS OPPORTUNITIES

Start small, highly profitable electronic production in your basement. Investment, knowledge unnecessary. Postcard brings facts. Barta-REI Box 248, Walnut Creek, CA 94597.

ELECTRONICS ENGINEERING & INSTRUCTION

AVIATION ELECTRONICS TECHNICIAN—Prepare for exciting career in new field of "Avionics". Train at nation's largest aeronautical school. Indicate if eligible for G. I. Benefits. SPARTAN AIRSCHOOL, International Airport, MN, Tulsa, OK 74151

TV TUNER REPAIRS—Complete Course Details. 12 Repair Tricks. Many Plans. Two Lessons, all for \$1. Refundable. FRANK BOECK, Box 3236 (Enterprise), Redding, CA 96001



At Christmastime, children are especially dear to us. Your Christmas gift to The Salvation Army helps us to care for a child who has no parents of its own... or whose parents cannot provide the care needed.



SHORTCUTS To Success! Highly Effective, Profitable Short Courses. (75 Choices). Study At Home. Diploma Awarded. Our 27th Year. Free Literature. CIEE-E, Box 10634, Jackson, MS 39209.

HIGH SCHOOL DIPLOMA for adults. Earn State Diploma. Accepted by Civil Service, business, colleges. Low cost. No tedious study. Money-back guarantee. DETAILS: H-S PROGRAM, Suite 2507, 1221 Avenue of Americas, New York, NY 10020

PARTS! CORNELL TUBES!
FREE Send For FREE
CORNELL'S New Color Catalog
48 Pcs. New Items IN LOTS OF 100
33¢ per tube
36¢ per tube
ORDER FREE IF NOT SHIPPED IN 24 HOURS!
4215 E UNIVERSITY AVE. SAN DIEGO, CALIF. 92105

**IC PRICES SLASHED
FACTORY FIRSTS**

NATIONALLY KNOWN BRANDS SATISFACTION GUARANTEED

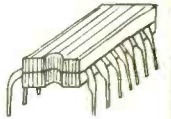

DIGITAL TTL	
7400N	22¢
7401N	22¢
7402N	22¢
7403N	22¢
7404N	24¢
7410N	22¢
7420N	22¢
7430N	22¢
7440N	22¢
7441N	\$1.20
7442N	\$1.15
7447N	\$1.02
7451N	22¢
7453N	22¢
7454N	22¢
7472N	35¢
7473N	46¢
7474N	42¢
7475N	72¢
7476N	50¢
7486N	52¢
7490N	72¢
7492N	72¢
7493N	72¢
7495N	\$1.05
74107N	47¢
74121N	51¢

"5% OFF TTL IC PRICES AT 100 PCS TTL ICs MIXED.

LINEAR INTEGRATED CIRCUITS

DIP or TO-5 709...38¢, 10/\$3.50, 710...38¢, 10/\$3.50, 741...40¢, 10/\$3.70, 748...43¢, 10/\$3.95 TO-5 only 723...90¢, 10/\$8.25, Dual 741 (558) TO-5 90¢, 10/\$8.25, Dual 741 (558) Mini-DIP 75¢, 10/\$6.75 LM 309K TO-3 \$2.25 5/\$10.00

GENERAL PURPOSE TRANSISTORS

2N5134 Si NPN or 2N5138 Si PNP...15¢ 8/\$1.00
2N3055 Si NPN Power\$1.00 10/\$9.50

1 AMP SILICON SUBMINIATURE RECTIFIERS

1N4001 50 PIV, 1N4002 100 PIV, 1N4004 400 PIV 1N4005 600 PIV.....10/\$1.00, 100/\$7.50
1N4007 1000 PIV 7/\$1.00, 100/\$9.95

SILICON SIGNAL DIODES

1N4148 (1N914 equiv.)20/\$1.00, 100/\$4.00

RTL INTEGRATED CIRCUITS

uL900, uL914 & uL923 Mix
5/\$1.00, 100/\$15.00

READOUT TUBES

5 Volt 7 Segment Readout Tube \$2.95, Counting and Display Kit (Readout Tube +7490+7475+7447) \$5.25, 3 Kits for \$15.00

1/2 WATT 10% RESISTORS

Pick Values 4¢ 25/75¢ 100/\$2.50 500/\$11.25

Free Catalog—Large Quantity Discounts—Orders Less Than \$10.00 Add 25¢—Others Postpaid

DIGI-KEY PRICE PACESETTER FOR QUALITY IC'S
BOX 126H THIEF RIVER FALLS, MN56701

Get the whole kit and caboodle from RCA

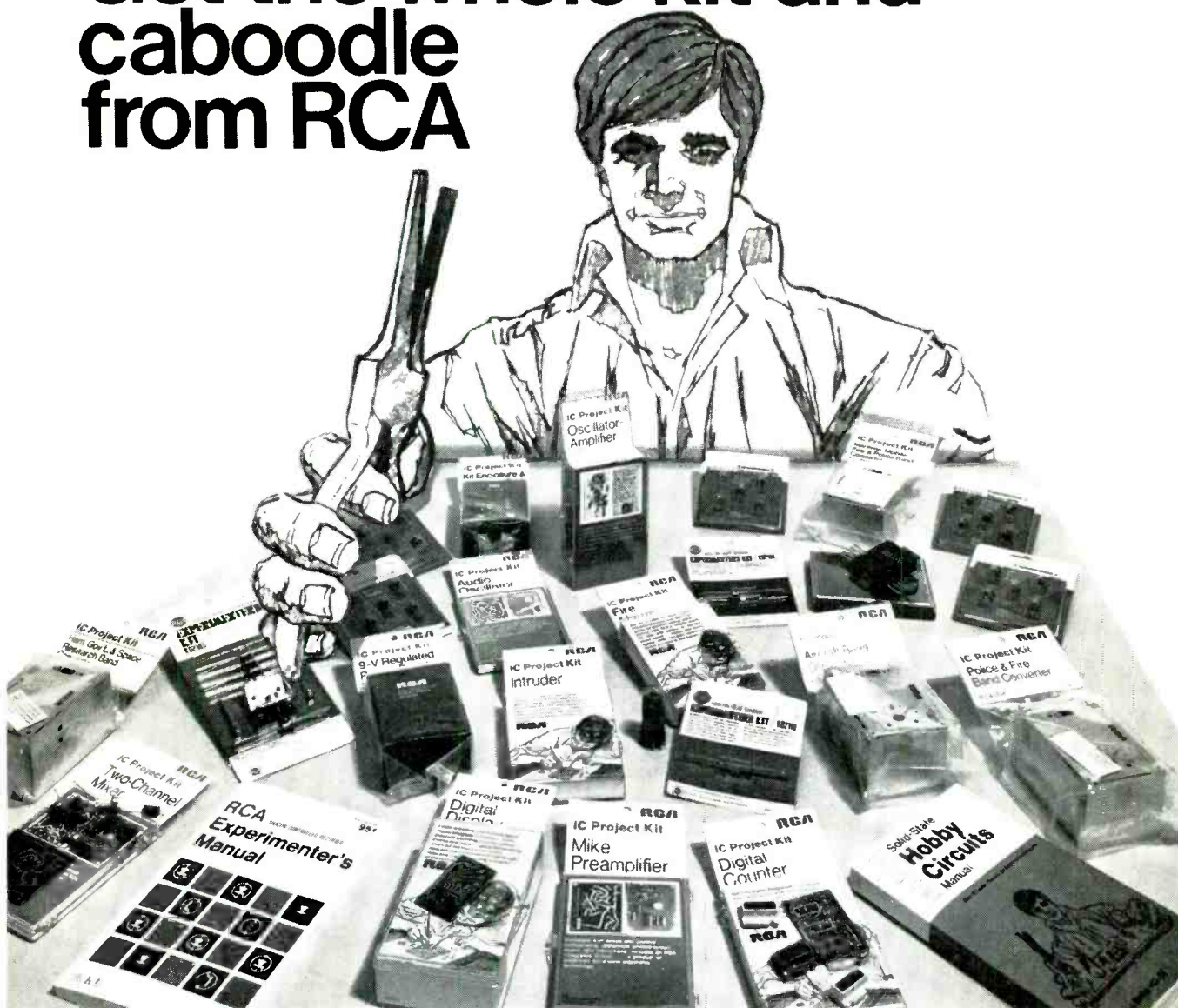

Now available from RCA . . . a wide variety of solid-state components in convenient kit form to build interesting and useful projects. Each one gives you the essentials for getting the most out of your project . . . in enjoyment, knowledge and performance.

And with RCA's popular hobby and experimenter's manuals, you can expand your solid-state experience. For example, the 368-page RCA Solid State Hobby Circuits Manual (HM-91) has over 60 interesting circuits you can build, and the 136-page RCA Silicon Controlled Rectifier Experimenter's Manual (KM-71) has 24 more! See your RCA Distributor to buy the RCA Kits and Manuals of your choice. RCA | Electronic Components | Harrison, N.J. 07029.

RCA Electronic Components

RCA IC Project Kits, Experimenter Kits, and Devices

Type	Description	Type	Description
KC4000	1 C. Microphone Pre-Amplifier Kit	KD2100	Silicon Control Rectifier Assembly
KC4001	1 C. Two-Channel Mixer Kit	KD2105	SCR Experimenter Kit
KC4002	1 C. Audio Oscillator Kit	KD2106	Add on Light Sensor Kit
KC4003	1 C. Power Amplifier and Oscillator Kit	KD2110	Add on Heat Sensor Kit
KC4004	1 C. Regulated Power Supply Kit	KD2117	1 C. Experimenter Package Basic Kit Contains 2-KD2114, 1 KD2115, 2-KD2116
KC4005	1 C. Intruder Alarm Kit	KD2118	NPN Silicon Variety Pack (5 Units)
KC4006	1 C. Fire Alarm Kit	KD2120	PNP Silicon Variety Pack (5 Units)
KC4007A	1 C. Converter Kit: 118-136MHz Aircraft Band	KD2123	PNP Germanium Variety Pack (5 Units)
KC4008A	1 C. Converter Kit: 134-150MHz Ham, Government, Space Research Band	KD2124	NPN Germanium Variety Pack (5 Units)
KC4009A	1 C. Converter Kit: 148-164MHz Maritime Mobile, Police, Fire Band	KD2131	70-Watt 1C Power Module
KC4010A	1 C. Converter Kit: 160-174MHz Police, Fire Band	3N1280P	MOS/FET Device in Display (Blister) Pack
KC4011	Digital/Readout 1C Kit	40214DP	1B Amp 1/4 in. Stud Silicon Rectifier Device in Display (Blister) Pack
KC4012	Digital/Counter 1C Kit		
KC4500	Kit Enclosure for use with KC4000, KC4001, KC4002, includes Input & Output Jacks, On/Off Switch and Hardware		

Your next receiver should have 3 things missing.

The input transformer. The output transformer. And the output capacitor. Because when you cut those three things out of a receiver, you cut down on a fourth thing. Distortion. We do it with a system called direct coupling. And Panasonic puts it in all its FM/AM/FM Stereo Receivers.

With this system the amplifier circuit is coupled directly to the speaker terminals. To improve transient response and damping. So there's less than 0.8% harmonic distortion. To help you hear only the sound of music.

The sound of the SA-6500 is really something to listen to. With a full 200 watts of power (IHF). To fill even a big room with music. And there's also a power band width of 5 to 60,000 Hz.

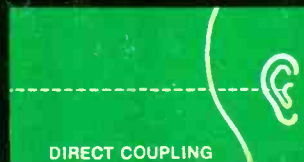
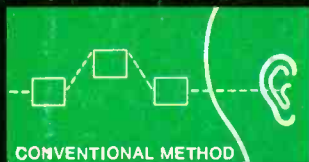

The SA-6500 also has two 4-pole MOS FET's. That provide $1.8\mu\text{V}$ FM sensitivity. To pull in FM stations that are too weak or too far to make it on their own. Integrated circuitry and a crystal filter improve the capture ratio. And there are low-filter, high-filter, and loudness switches. So the music comes out closer to the way it started out. And an FM linear dial scale and two tuning meters. To make the music you want just a little easier to find.

You can also find that music on the SA-6200. With 150 watts of power. Plus 2 RF stages and 6 IF stages. To provide selective

station tuning. And there are PNP low-noise silicon transistors in the differential amplifier drive-stage. To give almost noise-free performance. No matter who's performing.

For less money you can still get a lot of power. From our SA-5800. With a full 100 watts. The SA-5500. With 70 watts. Or our newest receiver, the SA-5200. With 46 watts. And some of the features you'll find in our more expensive stereo receivers.

So before you get your next receiver, see your franchised Panasonic Hi-Fi dealer. He'll show you what should be missing. So you don't miss out on anything.

FOR YOUR NEAREST FRANCHISED PANASONIC HI-FI DEALER, CALL TOLL FREE 800 243-6000. IN CONN., 1-800 882-6500.

Panasonic® Hi Fi 2-Channel Receivers

