

Popular Electronics®

WORLD'S LARGEST-SELLING ELECTRONICS MAGAZINE

AUGUST 1981/\$1

How Temperature Affects Components
Preview of the VHD Video Disc Player
Two Projects for Summer

Word-Processing Computer Systems



303092 DRK 6450M091 141D DEC83
L DARKNELL JR 08
645D WYRTLEWOOD DR
CUPERTINO CA 95014



**Reddy Chirra improves his vision
with an Apple.**

**Reddy is an optical engineer who's
used to working for big companies and using
big mainframes.**

**But when he started his own consulting
business, he soon learned how costly main-
frame time can be. So he bought himself a
48K Apple II Personal Computer.**

And, like thousands of other engineers

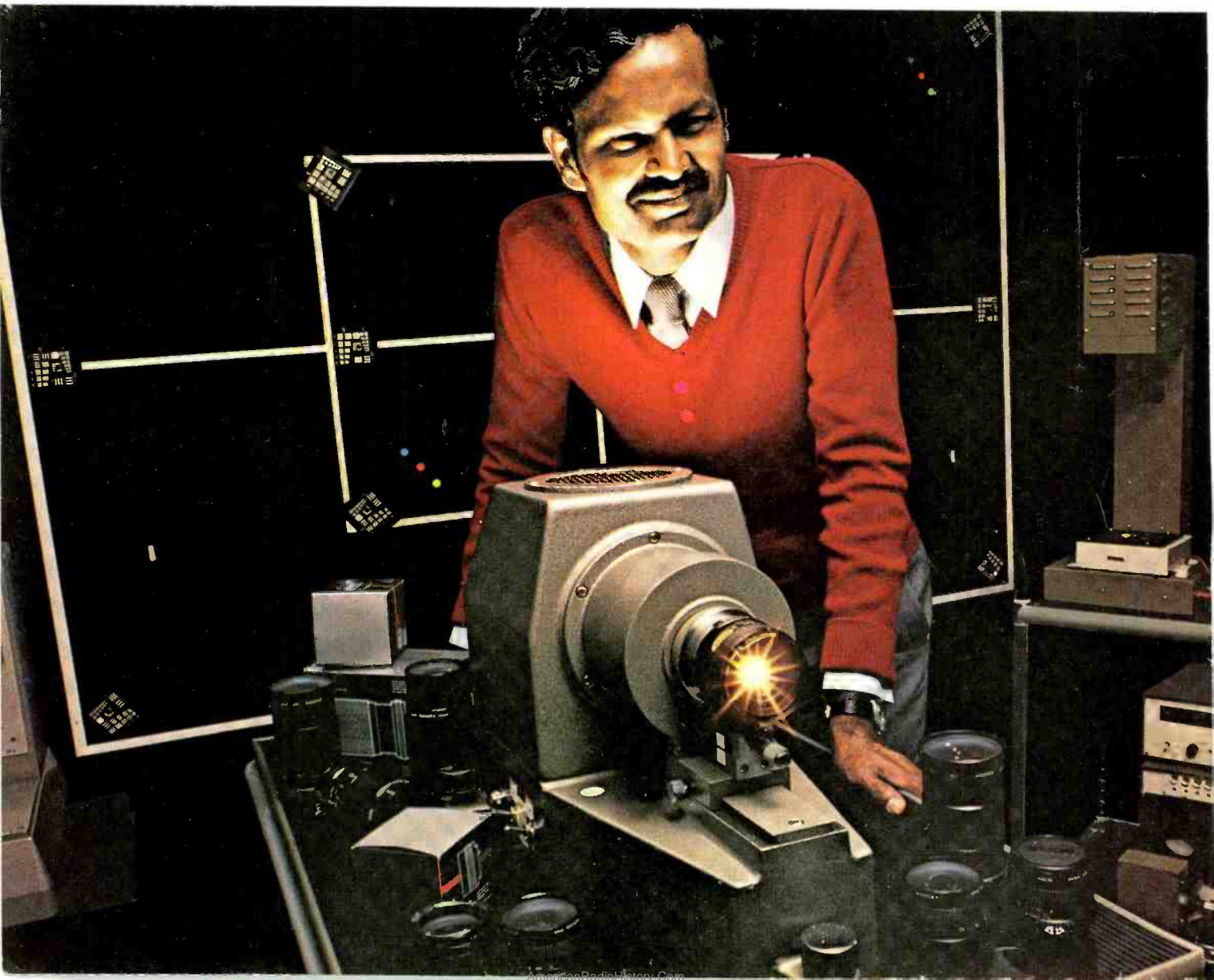

and scientists, quickly learned the pleasures of cutting down on shared time and having his own tamper-proof data base.

His Apple can handle formulas with up to 80 variables and test parameters on 250 different optical glasses.

He can even use BASIC, FORTRAN, Pascal and Assembly languages.

And Apple's HI-RES graphics come in handy for design.

Reddy looked at other microcomputers, but chose Apple for its in-depth documentation, reliability and expandability.

You can get up to 64K RAM in an Apple II. Up to 128K RAM in our new Apple III. And there's a whole family of compatible peripherals, including an IEEE-488 bus for laboratory instrument control.

Visit your authorized Apple dealer to find out how far an Apple can go with scientific/technical applications.

It'll change the way you see things.

The personal computer.



For the dealer nearest you, call (800) 538-9696. In California, call (800) 662-9238. Or write: Apple Computer Inc., 10260 Bandley Dr., Cupertino, CA 95014.

CIRCLE NO. 6 ON FREE INFORMATION CARD

A NEW STANDARD OF RECORD CARE

DISCWASHER D4 SYSTEM



NEW D4 FLUID

Inherently more active against record contamination. Inherently safe for record vinyl. Preferentially absorptive formula carries all contamination off the record.

NEW D4 FABRIC

Unique directional fibers preferentially remove fluid and contamination. D4 fabric results in clearly better cleaning, better drying and ultimately residue-free surfaces.

UNMATCHED VALUE

The Discwasher D4 System is enhanced by the durability and aesthetics of the hand-finished walnut handle. Included in the D4 System are the DC-1 Pad Cleaner and new instructions.

discwasher[®]
PRODUCTS TO CARE FOR YOUR MUSIC

1407 N. Providence Rd.
Columbia, Missouri 65201

CIRCLE NO. 16 ON FREE INFORMATION CARD

Popular Electronics

WORLD'S LARGEST-SELLING ELECTRONICS MAGAZINE

Feature Articles

WORD PROCESSING / Loren Werner	29
<i>How computers can expedite the written word.</i>	
VHS MEETS BETA / Stan Prentiss	38
<i>Comparison of video-cassette-recorder models in the two formats.</i>	
SOME LIKE IT HOT / Thomas R. Fox	44
<i>A quiz on how operating temperatures affect circuit components.</i>	

Construction Articles

HIGH-SPEED ELECTRONIC FUSE / C.M. Lenny and C. Davenport	48
<i>"Blows" within microseconds to protect sensitive components.</i>	
A BATTERY-OPERATED FLUORESCENT LAMP / Lawrence M. Walden	53
<i>Performs dc-to-ac conversion for camping lights.</i>	
"COINSHOOTER" METAL DETECTOR / William Lahr	55
<i>Reacts to coins and ignores chunks of iron and steel.</i>	
A SIGNAL-PROCESSOR PATCH BOX / Michael N. Stosich	60
<i>Switching facility allows rearrangement of outboard audio gear.</i>	

Equipment Reviews

SINCLAIR RESEARCH ZX8Q PERSONAL COMPUTER	17
GENERAL ELECTRIC'S IVHD3042W VIDEO HIGH DENSITY DISC PLAYER	21
KEF ELECTRONICS MODEL 303.2 SPEAKER SYSTEM	25
SABTRONICS MODEL 8000B FREQUENCY COUNTER	51

Columns

ENTERTAINMENT ELECTRONICS / Ivan Berger	50
<i>Stylus Replacement—Original and Brand "X"</i>	
COMPUTER BITS / Carl Warren	62
<i>This is the year of software.</i>	
COMPUTER SOURCES / Leslie Solomon	64
SOLID-STATE DEVELOPMENTS / Forrest M. Mims	67
<i>Solid-State Speech.</i>	
EXPERIMENTER'S CORNER / Forrest M. Mims	76
<i>Remote Sensing, Part 2</i>	
DX LISTENING / Glenn Hauser	81
<i>Science & Technology Programs.</i>	
PROJECT OF THE MONTH / Forrest M. Mims	90
<i>Simple, BCD Keyboard Encoder.</i>	

Departments

EDITORIAL / Art Salsberg	6
<i>A Bridge to Tomorrow.</i>	
LETTERS	7
NEW PRODUCTS	12
LIBRARY	83
OPERATION ASSIST	84
NEW LITERATURE	91
ADVERTISERS INDEX	91
PERSONAL ELECTRONICS NEWS	106

COVER PHOTO BY DON CARROLL. Copyright © 1981

COPYRIGHT © 1981 BY ZIFF-DAVIS PUBLISHING COMPANY. All rights reserved. Popular Electronics (ISSN 0032-4485) August 1981, Volume 19, Number 8. Published monthly by Ziff-Davis Publishing Co., at One Park Ave., New York, NY 10016. Richard P. Friese, President; Selwyn Taubman, Treasurer; Bertram A. Abrams, Secretary. One year subscription rate for U.S. and Possessions, \$15.00; Canada, \$20.00; all other countries, \$23.00 (cash orders only, payable in U.S. currency). Second Class Postage Paid at New York, N.Y. 10016 and at additional mailing offices. Authorized as second class mail by the Post Office Dept., Ottawa, Canada, and for payment of postage in cash. POPULAR ELECTRONICS including ELECTRONICS WORLD, Trade Mark Registered. Indexed in the Reader's Guide to Periodical Literature. Ziff-Davis also publishes Boating, Car and Driver, Cycle, Flying, Popular Photography, Skiing, Stereo Review, Electronic Experimenter's Handbook, and Tape Recording & Buying Guide. Forms 3579 and all Subscription Correspondence: POPULAR ELECTRONICS, Circulation Dept. P.O. Box 2774, Boulder, CO 80302. Please allow at least eight weeks for change of address, enclosing, if possible, an address label from a recent issue. Permissions. Material in this publication may not be reproduced in any form without permission. Requests for permission should be directed to John Babcock, Rights and Permissions, Ziff-Davis Publishing Co., One Park Ave., New York, NY 10016.

"Here's great news for electronics enthusiasts on small budgets.

Now you can take home a Fluke DMM for \$125.*"

Whether you're just starting out in electronics or moving up from an analog VOM to a digital multimeter, you'll be smart to make sure that you're getting your money's worth.

In your search for a basic-performance DMM, be sure to consider the new D 800 from Fluke. Priced at only \$125,* this dependable six-function handheld DMM is available now at select electronics supply stores throughout the U.S.

The D 800 offers 0.5% basic dc accuracy (five times better than analog voltmeters), a razor-sharp 3½ digit LCD readout, unsurpassed overload protection, and true, one-hand operation.

This hard-working basic measurement multimeter is designed from the inside out for long life and reliability. All D 800 specifications are traceable to the National Bureau of Standards.

As part of Fluke's new Series D line of low-cost digital multimeters, the D 800 carries a limited one-year parts and labor warranty and comes complete with the battery, and safety-designed test leads.

Ask your supplier about the D 800, then compare it feature-for-feature with any other low-cost DMM. You'll find that for only \$125,* there's never been more multimeter than the new D 800 from Fluke.



From the world leader in DMM's. Now we've designed one for you.



World leader in DMM's. Now we've designed one for you.

Fluke's new DMM is a real workhorse. It's built to last. It's built to give you the most accurate readings. It's built to give you the most reliable performance. It's built to give you the most complete features. It's built to give you the most complete protection. It's built to give you the most complete warranty. It's built to give you the most complete satisfaction.

World leader in DMM's. Now we've designed one for you.



Fluke's new DMM is a real workhorse. It's built to last. It's built to give you the most accurate readings. It's built to give you the most reliable performance. It's built to give you the most complete features. It's built to give you the most complete protection. It's built to give you the most complete warranty. It's built to give you the most complete satisfaction.



Fluke's new DMM is a real workhorse. It's built to last. It's built to give you the most accurate readings. It's built to give you the most reliable performance. It's built to give you the most complete features. It's built to give you the most complete protection. It's built to give you the most complete warranty. It's built to give you the most complete satisfaction.

*Suggested U.S. list price
For technical data circle no.
20 ON FREE INFORMATION CARD

If your dealer doesn't carry Series D Multimeters yet, call this number. We'll be happy to tell you who does. 1-800-426-9182

FLUKE

TWELVE STRONG HEATH/ZENITH YOUR

Pick a strong partner

A computer purchase is the beginning of a long term partnership between you and the people you buy from. Your ongoing need for software and accessories requires a partner who will stand by you with a growing line of products. And nowhere will you find a more complete line of hardware, software and accessories than at your Heathkit Electronic Center. Here are twelve strong reasons to make Heath/Zenith your partner.

1. The All-In-One Computer

The heart of the Heath/Zenith line is the stand-alone *89 Computer*. It's a complete system with built-in 5 1/4-inch floppy disk drive, professional keyboard and keypad, smart video terminal, two Z80 microprocessors, and two RS-232C serial I/O ports. It comes with 16K RAM, expandable to 64K.

2. Peripherals

These include the popular *Heath/Zenith 19 Smart Video Terminal*, loaded with professional features. And the *14 Line Printer*, priced as low as \$495. Other printer brands are on display, including high-speed, typewriter-quality printers.



3. Software

Word processing, includes reliable, easy-to-use Zenith Electronic Typing and powerful, full-featured WORDSTAR.

Small Business Programs, feature General Ledger and Inventory Control.

HUG, Heath Users' Group, offers members a library of over 500 low-cost programs for home, work or play.

4. Programming Languages



For your own custom programs, Microsoft languages are available in BASIC (compiler and interpreter), FORTRAN and COBOL.

5. Operating Systems

Three versatile systems give you the capability to perform your specific tasks.

CP/M by Digital Research makes your system compatible with thousands of popular CP/M programs.

UCSD P-System with Pascal is a complete program development and execution environment.

HDOS, Heath Disk Operating System gives you a sophisticated, flexible environment for program construction, storage and editing.

6. Utility Software

Expand the performance range of your computer with a broad selection of utility tools, including the best of *Digital Research* and the complete line of innovative *Softstuff* products.

7. Disk Systems

The 8-inch Heath/Zenith 47 *Dual Disk System* adds over 2 megabytes of storage to your



89 Computer. Diskettes are standard IBM 374Q format, double-sided, double-density.

The 5 1/4-inch 87 *Dual Disk System* adds 200K bytes of storage to your 89. Both disk systems feature read/write protection and easy plug-in adaptability.



8. Self-Study Courses

Learn at your own pace with *Programming Courses* that teach you to write and run your own programs in Assembly, BASIC, Pascal or COBOL.

A course on *Computer Concepts for Small Business* gives you the understanding to evaluate the ways a computer can benefit your business.

Personal Computing is a complete introduction to the fundamentals for the novice. Every Heathkit/Zenith course is professionally designed for easy, step-by-step learning.

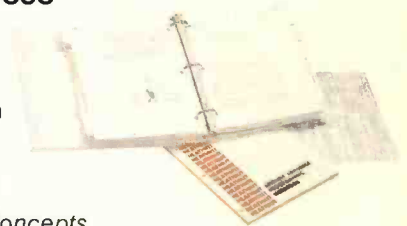

All Heath/Zenith Computer Products are available completely assembled and tested for commercial use. Or in easy-to-build, money-saving kits.

REASONS TO MAKE COMPUTER PARTNER

9. Expansion Options

Communicate with the outside world through a *Three-port EIA RS-232C Serial Interface*.

Expand RAM to 64K with easy-to-install *expansion chips*.

10. Accessories



Your Heathkit Electronic Center has the latest in modems, black-and-white and color video monitors, computer furniture and a full line of supplies, accessories, books and parts.

11. Service

No one stands by you like Heath/Zenith. We help you get your system up and running smoothly. Service is available from trained technicians, over the phone or at one of 56 Heathkit Electronic Centers.



12. Value

Your money buys you more because Heath/Zenith prices are among the industry's most competitive. Make your own comparison and find out how much you can save.

Complete, integrated computer hardware and software, designed to serve you and to grow with you — that's what to look for in a strong partner. And with Heath/Zenith you get it all under one roof.

All at your Heathkit Electronic Center

Pick the store nearest you from the list at right. And stop in today for a demonstration of the Heath/Zenith 89 Computer System. If you can't get to a store, send \$1.00 for the latest Heathkit® Catalog and the new Zenith Data Systems Catalog of assembled commercial computers. Write to Heath Co., Dept. 010-804, Benton Harbor, MI 49022.

Visit Your Heathkit Electronic Center*

where Heath/Zenith Products are displayed, sold and serviced.

PHOENIX, AZ 2727 W. Indian School Rd. 602-279-6247	MISSION, KS 596Q Lamar Ave. 913-362-4486	CLEVELAND, OH 28100 Chagrin Blvd. 216-292-7553
ANAHEIM, CA 330 E. Ball Rd. 714-776-9420	LOUISVILLE, KY 12401 Shelbyville Rd. 502-245-7811	COLUMBUS, OH 2500 Morse Rd. 614-475-7200
CAMPBELL, CA 2350 S. Bascom Ave. 408-377-8920	KENNER, LA 1900 Veterans Memorial Hwy. 504-467-6321	TOLEDO, OH 48 S. Byrne Rd. 419-537-1887
EL CERRITO, CA 6000 Potrero Ave. 415-236-8870	BALTIMORE, MD 1713 E. Joppa Rd. 301-661-4446	WOODLAWN, OH 10133 Springfield Pike 513-771-8850
LA MESA, CA 8363 Center Dr. 714-461-0110	ROCKVILLE, MO 5542 Nicholson Lane 301-881-5420	OKLAHOMA CITY, OK 2727 Northwest Expressway 405-848-7593
LOS ANGELES, CA 2309 S. Flower St. 213-749-0261	PEABODY, MA 242 Andover St. 617-531-9330	FRAZER, PA 630 Lancaster Pike (Rt. 30) 215-647-5555
POMONA, CA 1555 N. Orange Grove Ave. 714-623-3543	WELLESLEY, MA 165 Worcester Ave. 617-237-1510	PHILADELPHIA, PA 6318 Roosevelt Blvd. 215-288-0180
REDWOOD CITY, CA 2001 Middlefield Rd. 415-365-8155	DETROIT, MI 18645 W. Eight Mile Rd. 313-535-6480	PITTSBURGH, PA 3482 Wm. Penn Hwy. (Rt. 30) 412-824-3564
SACRAMENTO, CA 1860 Fulton Ave. 916-486-1575	E. DETROIT, MI 18149 E. Eight Mile Rd. 313-772-0416	WARWICK, RI 558 Greenwich Ave. 401-738-5150
WOODLAND HILLS, CA 22504 Ventura Blvd. 818-883-0531	HOPKINS, MN 101 Shady Oak Rd. 612-938-6371	DALLAS, TX 2715 Ross Ave. 214-826-4053
DENVER, CO 5940 W. 38th Ave. 303-422-3408	ST. PAUL, MN 1645 White Bear Ave. 612-778-1211	HOUSTON, TX 1704 W. Loop N. 713-869-5263
AVON, CT 395 W. Main St. (Rt. 44) 203-678-0323	BRIDGETON, MO 3794 McKelvey Rd. 314-291-1850	SAN ANTONIO, TX 7111 Blanco Road 817-341-8876
HALEAH, FL 4705 W. 16th Ave. 305-823-2280	OMAHA, NE 9207 Maple St. 402-391-2071	MIDVALE, UT 58 East 7200 South 801-566-4626
PLANTATION, FL 7173 W. Broward Blvd. 305-791-7300	ASBURY PARK, NJ 1013 State Hwy. 35 201-775-1231	ALEXANDRIA, VA 6201 Richmond Hwy. 703-765-5515
TAMPA, FL 4019 W. Hillsborough Ave. 813-886-2541	FAIR LAWN, NJ 35-07 Broadway (Rt. 4) 201-791-6935	VIRGINIA BEACH, VA 1055 Independence Blvd. 804-460-0997
ATLANTA, GA 5285 Roswell Rd. 404-252-4341	AMHERST, NY 3476 Sheridan Dr. 716-835-3090	SEATTLE, WA 505 8th Ave. N. 206-682-2172
CHICAGO, IL 3462-66 W. Devon Ave. 312-583-3920	JERICHO, L.I. NY 15 Jericho Turnpike 516-334-8181	TUKWILA, WA 15439 53rd Ave. S. 206-246-5358
DOWNERS GROVE, IL 224 Ogden Ave. 312-852-1304	ROCHESTER, NY 937 Jefferson Rd. 716-424-2560	MILWAUKEE, WI 5215 W. Fond du Lac 414-873-8250
INDIANAPOLIS, IN 2112 E. 62nd St. 317-257-4321	N. WHITE PLAINS, NY 7 Reservoir Rd. 914-761-7690	<small>*Units of Veritechnology Electronics Corporation in the U.S.</small>

Prices and specifications subject to change without notice.

HEATH/ZENITH

Your strong partner



EDITORIAL

A Bridge to Tomorrow

Tomorrow's world of consumer electronics always looks a bit clearer at this time of the year. The bridge is a series of manufacturers' press meetings and publicity news releases that, essentially, tout new models. Based on this, here's a sampling of what tomorrow's consumer electronics will be like.

- A revolutionary step anticipated next year (if you live in Japan or Europe) will be the introduction of the "Compact Disc" digital audio system promulgated by Sony and N.V. Philips. The system's 4.7-inch disc, whose digitally encoded information is picked up by a solid-state laser, produced exemplary sound when I heard it being played on a prototype model. Look for it in '83. Price will be \$800-\$1000 for the player and converter, plus about \$16 to \$25 per record album.

- Votrax' "Type-'N-Talk" speech synthesizer is easy to use and certainly dramatizes the use of computers. When the \$345 unit is connected to your computer's RS232C line, you simply type words (or even nonwords), followed by a talk command, and listen to the electronic speech playback. You should hear it pronounce typos!

- Open-reel tape enthusiasts, a diminish-

ing group, will be cheered by the development of an open-reel tape of higher coercivity and retentivity than standard ferrics as well as machines capable of using the tape. Jointly developed by Akai, Teac, Maxell and TDK, the new tape, called EE, delivers performance at 3¾ ips that's reportedly as good as conventional tape at 7½ ips.

- It's in the record—CBS Records' CX system albums, that is. An in-the-groove coding to expand dynamic range of the playback music can be achieved with use of a fairly inexpensive decoder available from a handful of manufacturers.

- Video cassette recording enthusiasts will doubtlessly welcome new video accessories, including touch-sensor switchers, sophisticated color-TV automatic commercial eliminators, etc.

- In communications, Electra appears to have increased the range capability of cordless telephones by using 49 MHz for duplex transmission rather than 1.7 MHz for one of the links. A range of up to 1000 feet is claimed.

- There are lots of happenings coming up in the computer field, of course. Ranking

among them has to be about-to-debut micro-computer systems from two corporate giants: Xerox and NEC. The latter's native language is N-BASIC by Microsoft.

- Into a miscellaneous category, might be tossed Whistler's "Fuelscan," which automatically indicates miles per gallon consumed while driving, miles to empty, and gallons in tank. All connection points are made behind the dash.

The foregoing are just a sample of what's coming up in electronic land. There is much more, naturally, including many new satellite communication systems, new video games, advanced color TV receivers, and so on. And somewhere down the pike we still anticipate a widespread viewdata TV system here. Now that 26 European countries have agreed on standards for a basic alpha-mosaic videotex, perhaps development of the system in the U.S. will be speeded up.

JOE MESICS

Publisher

ARTHUR P. SALSBERG
Editorial Director

HAROLD A. RODGERS
Executive Editor

LESLIE SOLOMON
Senior Technical Editor

JOHN R. RIGGS
Managing Editor

EDWARD I. BUXBAUM
Art Director

JOHN J. McVEIGH
Technical Editor

DAVID M. WEBER
Features Editor

ANDRE DUZANT
Technical Illustrator

CARMEN ROBLES
Production Editor

JEFF NEWMAN
Editorial Assistant

Contributing Editors

Carl Warren, Stan Prentiss
Glenn Hauser, Julian Hirsch, Forrest Mims

MARIE MAESTRI
Executive Assistant

OLIVIA WILSON
Promotion Coordinator

PEARL HARRINGTON
Assistant to the Publishing Director

SIDNEY HOLTZ
Publishing Director

Popular Electronics

Editorial and Executive Offices

One Park Avenue
New York, New York 10016
212 725-3500

Publisher
Joe Mesics
212 725-3568

New York Office
Advertising Manager:
Richard Govatski (725-7460)

Eastern Advertising Manager
Bonnie B. Kaiser (725-3580)
Richard B. Eicher (725-3578)

Midwestern Office
Suite 1400, 180 N. Michigan Ave.,
Chicago, IL 60601 (312 346-2600)
Sales: Ted Welch

Western Representative
Norman S. Schindler & Associates, Inc.
7050 Owensmouth Ave., #209
Canoga Park, CA 91303 (213 999-1414)
Sales: Norm Schindler, Jon Marshall

Representation in Japan
James Yagi
Oji Palace Aoyama
6-25, Minami Aoyama, 6 Chome, Minato-Ku
Tokyo, Japan (407-1930/6821, 582-2851)

Ziff-Davis Publishing Company

Richard P. Friese
Albert S. Traina

Furman Hebb
Phillip T. Heffernan
Sidney Holtz
Edward D. Muhlfeld
Philip Sine

Robert Bavier
Baird Davis
Edgar W. Hopper
George Morrissey

Selwyn Taubman
Bertram A. Abrams

President
President, Consumer
Magazine Division
Executive Vice President
Senior Vice
Presidents

Vice Presidents

Treasurer
Secretary

Editorial correspondence: POPULAR ELECTRONICS, 1 Park Ave., New York, NY 10016. Editorial contributions must be accompanied by return postage and will be handled with reasonable care; however, publisher assumes no responsibility for return or safety of manuscripts, art work, or models submitted.

The publisher has no knowledge of any proprietary rights which will be violated by the making or using of any items disclosed in this issue.



LETTERS

Synchronous-Motor Speed Control

I have an important suggestion for those who build the April 1981 cover project ("Synchronous Motor Programmable Control"). In 1959, I built what I think was the first variable-frequency power source for telescope clock drives. Like the author of your article, I tried to use a standard filament transformer as an output transformer, but I found that it failed dismally because its core losses were too high.

I found that I had to rewind the transformer to have twice the original number of turns per volt. This brought the losses down from 5 watts to about 1 watt, making 4 watts of useful output power available to the motor. Hence, I suggest a transformer with a 220-volt primary rating and a 40-volt center-tapped secondary rating.

The last I heard, the MM5369 programmable counter IC was readily available in its 60-Hz output version only, and it is my understanding that programming could be done only at the time of manufacture. Where can the 100-Hz version be obtained?—George W. Ginn, San Jose, CA.

Readers who built the project and who are having trouble getting their motors to run below 60 Hz might want to try Mr. Ginn's suggestion. Actually, the project was designed with transformer losses in mind—that is why the author specified the Signal Transformer Company's product.

Anyone who has had trouble obtaining the National Semiconductor MM5369 EST/N integrated circuit should try Circuit Specialists, Box 3047, Scottsdale, AZ 85257. That company sells the MM5369-EST/N for \$2.85 postpaid and the MM74C90N for \$1.82 postpaid.—Ed.

RTTY Sources

In "RTTY Meets the Computer" (May 1981), the Directory of Manufacturers should list, as the manufacturer of Info-Tech Equipment, Digital Electronics Systems, 1633 Wisteria Ct., Englewood, FL 33533.—G. D. Kelce, Englewood, FL.

Telephone Accessory Circuits

Cheers for the "Electronic Ringer" in your May issue (p. 70). However, is there a more convenient power supply that would not require a connection to the 120-volt line? Would two 9-volt batteries in series to provide a ground, +9 V, and +18 V work? —Jess Kaufman, Philadelphia.
Yes.—Ed.

AUGUST 1981

With Crown MULTI-MODE™ You're ready for real.



"MULTI-MODE™" describes an improved Crown output circuit that is audibly superior. It instantaneously changes its mode of operation as the signal level changes, for totally clear, undistorted sound.

The MULTI-MODE circuit makes at-home listening more real. From Bach to Bee Gees, you'll hear more of the music with MULTI-MODE.

At low signal levels, the MULTI-MODE circuit operates in a Class A mode, free from switching or notch distortion. As signal current increases, the circuit smoothly configures itself as an A + B amp, again with clear, clean output. At high signal levels, MULTI-MODE operates in an AB + B mode, pro-

viding all of the undistorted power needed.

Three new Crown POWERLINE amps bring you the sonic accuracy of MULTI-MODE and other circuit improvements. New ideas in front-panel displays and rear-panel convenience will enhance your enjoyment.

MULTI-MODE theory and operation, and the POWERLINE amps are described in the Crown Information Package. It also contains data on all Crown products for the home, a factory "tour," reprints of reviews, technical discussions of audio problems, prices and dealer lists. Send us the coupon and \$5 for your complete copy. Get ready for real.

CIRCLE NO. 13 ON FREE INFORMATION CARD



CROWN®

...WHEN YOU'RE READY FOR REAL!

The Crown Information Package is also available free from your dealer. If you need a list of Crown dealers, use the Reader Service Card number, or call 219/294-5571.

CROWN INTERNATIONAL, Dept. PEB
1718 W. Mishawaka Road, Elkhart, Indiana 46517
Here's my \$5 (outside U.S. and Canada, \$8). Send my Crown Information Package, with money-back guarantee.

Name

Address

City State Zip

Phone

At CIE, you get electronics career training from specialists.

If you're interested in learning how to fix air conditioning, service cars or install heating systems – talk to some other school. But if you're serious about electronics...even earning an Associate Degree... come to CIE – The Electronics Specialists.

John E. Cunningham

**Special Projects Director
Cleveland Institute of Electronics**



My father always told me that there were certain advantages to putting all your eggs in one basket. "John," he said, "learn to do one important thing better than anyone else, and you'll always be in demand."

I believe he was right. Today is the age of specialization. And I think that's a very good thing.

Consider doctors. You wouldn't expect your family doctor to perform open heart surgery or your dentist to set a broken bone, either. Would you?

For these things, you'd want a specialist. And you'd trust him. Because you'd know if he weren't any good, he'd be out of business.

Why trust your education and career future to anything less than a specialist?

You shouldn't. And you certainly don't have to.

FACT: CIE is the largest independent home study school in the world that specializes exclusively in electronics.

We have to be good at it because we put all our eggs in one basket: electronics. If we hadn't done a good job, we'd have closed our doors long ago.

Specialists aren't for everyone.

I'll tell it to you straight. If you think electronics would make a nice hobby, check with other schools.

But if you think you have the cool—and want the training it takes—to make sure that a sound blackout during a prime time TV show will be corrected in seconds—then answer this ad. You'll probably find CIE has a course that's just right for you!

At CIE, we combine theory and practice. You learn the best of both.

Learning electronics is a lot more than memorizing a laundry list of facts about circuits and transistors. Electronics is interesting because it's based on some fairly recent scientific discoveries. It's built on ideas. So, look for a program that starts with ideas—and builds on them.

That's what happens with CIE's Auto-Programmed® Lessons. Each lesson uses world-famous "programmed learning" methods to teach you important principles. You explore them, master them completely... before you start to apply them!

But beyond theory, some of our courses come fully equipped with the electronics gear to actually let you perform hundreds of checking, testing and analyzing projects.

In fact, depending on the course you take, you'll do most of the basic things professionals do every day—even use a Digital Learning Laboratory to apply the digital theory essential today to keep pace with electronics in the eighties.

Plus there's a professional quality oscilloscope you build and use to "see" and "read" the characteristic waveform patterns of electronic equipment.

You work with experienced specialists.

When you send us a completed lesson, you can be sure it will be reviewed and graded by a trained electronics instructor, backed by a team of technical specialists. If you need specialized help, you get it fast... in writing from the faculty specialists best qualified to handle your question.

People who have known us a long time, think of us as the "FCC License School."

We don't mind. We have a fine record of preparing people to take... and pass... the government-administered FCC License exams. In fact, in continuing surveys nearly 4 out of 5 of our graduates who take

the exams get their Licenses. You may already know that an FCC License is needed for some careers in electronics—and it can be a valuable credential anytime.

Associate Degree

Now, CIE offers an Associate in Applied Science Degree in Electronics Engineering Technology. In fact, all or most of every CIE Career Course is directly creditable towards the Associate Degree.

Find out more! Mail this card for your FREE CATALOG today!

If the card is gone, cut out and mail the coupon.

I'll send you a copy of CIE's FREE school catalog, along with a complete package of independent home study information.

For your convenience, I'll try to arrange for a CIE representative to contact you to answer any questions you may have.

Remember, if you are serious about learning electronics... or building upon your present skills, your best bet is to go with the electronics specialists—CIE. Mail the card or coupon today or write CIE (and mention the name and date of this magazine), 1776 East 17th Street, Cleveland, Ohio 44114.

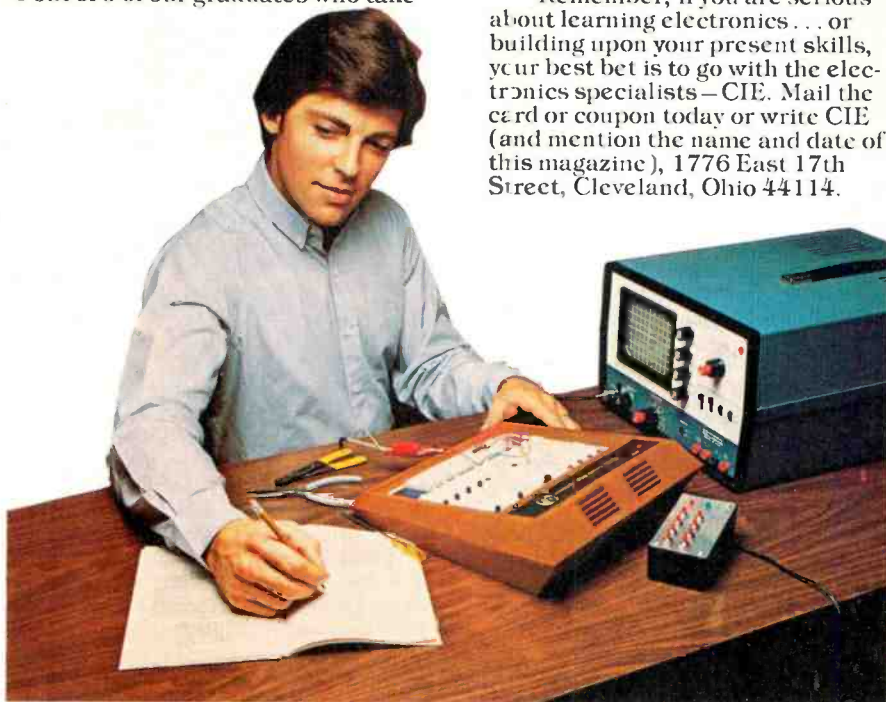

Pattern shown on oscilloscope screen is simulated.

CIE Cleveland Institute of Electronics, Inc.
1776 East 17th Street, Cleveland, Ohio 44114

PE-46

YES... John, I want to learn from the specialists in electronics—CIE. Send me my FREE CIE school catalog—including details about the Associate Degree program—plus my FREE package of home study information.

Print Name _____

Address _____ Apt. _____

City _____

State _____ Zip _____

Age _____ Phone (area code) _____

Check box for G.I. Bill information: Veteran Active Duty

Mail today!

NEW PRODUCTS

Additional information on new products covered in this section is available from the manufacturers. Either circle the item's code number on the Free Information Card or write to the manufacturer at the address given.

Voice-Activated Answering Machine



The ITT Perfect Answer 2 uses microprocessor technology to eliminate the need for a beeper when accessing recorded messages from a remote location. It also contains a built-in telephone with memory recall, and can be set to answer calls on the first or fourth ring. An external speaker is provided for call monitoring. The user responds vocally to a set of five beep tones that correspond to a code. The code is preset by the user and can be changed for security. A LED alphanumeric display acts as a call counter and announcement timer, and verifies the operating functions of the unit. A dual cassette system records incoming calls from a few seconds to three minutes in length, and outgoing announcements 2 to 30 seconds long with a beep tone inserted at any point. \$269.96.

CIRCLE NO. 99 ON FREE INFORMATION CARD

Video Camera



The QC-30 from Sharp weighs 3 lb and uses a battery that consumes 8.5 W. This

color camera is designed to accompany Sharp's portable VHS tape recorder, the VC-2250. The QC-30 offers a see-through optical viewfinder, adjustable 2X zoom lens and automatic iris, three LED indicators (for battery alarm, VTR start, and to warn of underexposure). There is a 3-position color temperature control for adjustment to variable lighting conditions. Additional features include a 10-pin connector jack, built-in VTR start/stop remote trigger switch, built-in condenser microphone, and an accessory shoe for a light-attachment. \$599.

CIRCLE NO. 97 ON FREE INFORMATION CARD

40-MHz Oscilloscope

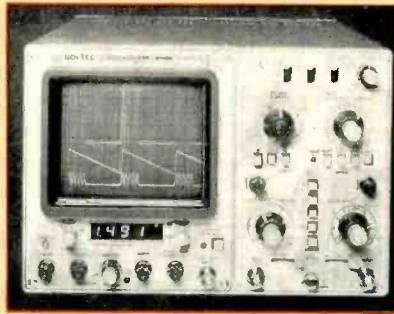

Soltec Corporation has introduced a 40-MHz oscilloscope (Model S40M) with a built-in digital multimeter. Features include a triple-trace display, a voltage-measurement circuit that provides a 3 $\frac{1}{2}$ -digit reading of the value of the waveform displayed, domed mesh CRT, single- or dual-trace X-Y capability, and vertical sensitivity of 2 mV to 10 V. The DMM display eliminates counting of CRT graticule lines and can be used independently of the CRT display. \$2,265.

CIRCLE NO. 98 ON FREE INFORMATION CARD

Battery Warning System



A device called the Battery Brain, developed by Electro Sensor Inc., uses a microprocessor to provide instant warning if there is a significant drop in voltage from a 12-volt battery or its charging system. The device, it is claimed, will sense a charging problem before the alternator light goes on. A display with two LED indicators (red and green) is connected to a vehicle's electrical system via solderless

clamps to the fuse box. A green light remains on at all times, even when the vehicle is not operating, if voltage parameters are normal. A red light indicates trouble. Drain from the battery is said to be negligible. \$29.95. Address: Electro Sensor, Inc., 10825 S. Central, Oak Lawn, IL 60453.

Pioneer Stereo Receiver



Pioneer's Model SX-3400 AM/FM-stereo receiver is rated to deliver 15 watts continuous power per channel into 8 ohms from 20 to 20,000 Hz with no more than 0.08% THD. Its phono section is said to accept 140 mV at 1 kHz without overload. The power amplifier section is direct coupled, and a PLL is used in the stereo demodulator. Specifications—amplifier section: frequency response, 30 to 15,000 Hz \pm 0.1 dB phono, 20 to 80,000 Hz \pm 3 dB AUX and tape; hum and noise, 70 dB phono, input shorted. FM section: 50-dB stereo quieting sensitivity, 32.9 dBf; S/N, 70 dB stereo, distortions, 0.3% stereo; frequency response, 20 to 15,000 Hz \pm 0.5/-1.0 dB; stereo separation, 30 dB from 30 to 15,000 Hz; alternate-channel selectivity, 60 dB; AM suppression, 50 dB. Size is 17 $\frac{1}{2}$ "W x 11 $\frac{1}{2}$ "D x 5 $\frac{1}{16}$ "H, and weight is 12 lb 2 oz.

CIRCLE NO. 100 ON FREE INFORMATION CARD

Sanyo Video Disc Player

Sanyo's first video disc player, the VDR3000, is based on RCA's CED system and plays up to one hour per disc side. Visual program search is possible at either 12 or 40 times normal speed in forward and reverse. Recall without picture can be



Gordon Cooper
Former Astronaut

**Gordon Cooper
thinks NASA computers
are out of this world.
But his personal computer
is the best on earth.**

I've been around computers most of my life, and I'm impressed with the Atari®800™. Nothing so complex has ever been so simple. It's as easy to set up as a stereo. It's so easy to operate, your kids can use it.

My life didn't end when I left NASA. Today, I'm a businessman and writer. I've even gone on the lecture circuit. I trust my Atari computer to help me.

So, if you're looking for a way to stay on top of your affairs, look into the Atari 800.

Ask your local computer dealer for a demonstration.

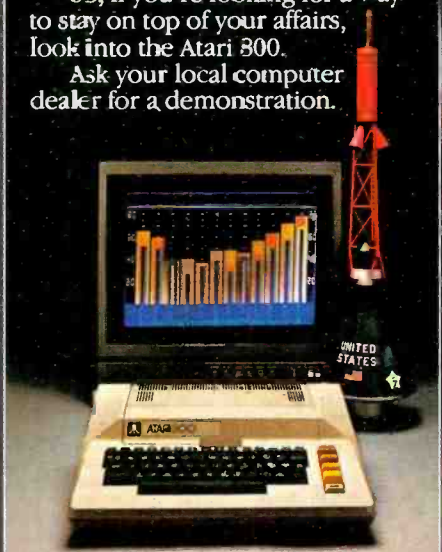

The ATARI® 800™ Computer

For further information write:
Atari Inc., Computer Division,
1196 Borregas Avenue, Dept. C-51
Sunnyvale, CA 94086

ATARI®
Computers for people.™

©1981. ATARI Inc. A Warner Communications Company

CIRCLE NO. 7 ON FREE INFORMATION CARD

SAVE BIG on CALCULATORS

TEXAS INSTRUMENTS

TI 59	\$175	TI MBA	50
TI 58C	80	TI BA2	39
TI PC100C	155	TI Bus Anal	15
TI 58/59 Lib	32	TI 35 SP	18
TI PROG	47	TI Inv. Anal	42
TI 57	29	TI 5040	60



TI 59

hp HEWLETT PACKARD CALCULATORS

HP-41C

HP-41C V

Optical Wand

Card Reader

Printer

Quad R.A.M. (for HP41C)

Mem. Module (for HP41C)



HP-41 APPLICATION PACS

	Mfr. Sugg.	Elek-Tek
All titles of 4K Pacs	30	25.50
All titles of 8K Pacs	45	38.00

(Not including Petroleum Fluids Pac)

HP-97	\$575
HP-67	295
HP-38C	115
HP-37E	59
HP-34C	115
HP-33C	69
HP-33E	49
HP-32E	43

*Hewlett-Packard has DISCONTINUED the System I and System II.

HP-85 COMPUTING SYSTEM



The HP-85 Personal Computing System for Professionals helps solve difficult engineering problems and simplifies financial analysis. The HP-85 is a powerful BASIC language computer with keyboard, CRT display, printer and tape drive complete in one compact unit. (HP-83 is the same as above but without the built-in printer and tape drive.)

	Mfr. Sugg. Ret.	Elek-Tek Price
HP-85 COMPUTER	\$3200	\$2600
HP-83 COMPUTER	2250	1800
as HP-85 but no Printer or Tape Drive)		
2631B PRINTER	3650	3000
7225A PLOTTER	2800	2450
(incl. Personality Module)		
GRAPHICS TABLET	2050	1650
VisiCalc™ PLUS	200	180
APPLICATION PACS	95	81

and all related accessories and software at SIZEABLE DISCOUNTS
VisiCalc™ is a trademark of Personal Software, Inc.

CALL TOLL FREE 800-621-1269 EXCEPT Illinois, Alaska, Hawaii

Accessories discounted too. Corporate Accounts Invited. Mastercharge or Visa by mail or phone. Mail Cash. Ck. Mon. Ord. Pers. Ck. [2 wks. to clear]. Add \$4.00 1st. item; \$1.00 ea. add'l shpg. & handl. Shipments to IL address add 6% tax. Prices subject to change. WRITE for free catalog.

ALL ELEK-TEK MERCHANDISE IS BRAND NEW, FIRST QUALITY AND COMPLETE

ELEK-TEK, inc.
5344 West Devon Avenue, Chicago IL 60646
(800) 621-1269 (312) 631-7800

CIRCLE NO. 18 ON FREE INFORMATION CARD

new products

effected using an elapsed time counter that searches the program at 200 times normal speed. A stop action control allows



a near freeze-frame effect by temporarily repeating four frames—producing an almost still picture. Comb filtering is incorporated into the video circuitry, and the disc soundtrack can be played through a hi-fi system. An optional remote control is available for all player functions. \$499.95.

CIRCLE NO. 96 ON FREE INFORMATION CARD

High-Performance FM Tuner



The Denon TU-900 FM tuner is said to offer a tuning precision of five significant figures rather than the usual four. Featuring a digital frequency display, the unit includes auto-lock touch tuning, two decoupled output circuits for direct recordings, and switchable bandwidth in the i-f section. Audio frequency response is rated at 20 to 15,000 Hz +0.2, -1.5 dB; S/N, 85 dB; THD, 0.035%; and alternate-channel selectivity, 50 dB (wide i-f) or 90 dB (narrow i-f). Capture ratio is 1.0 dB (wide), 1.5 dB (narrow). \$590.

CIRCLE NO. 95 ON FREE INFORMATION CARD

Parallel-Blade Heat Gun



Eddy Products has introduced an electric heat gun (UL listed) rated for 650° to 900° F. From a standard 115-volt line, the Mark III Model EP6-UL draws 14.3 A. The housing, handle, trigger guard, and stand are Lexan 500. The unit also includes built-in circuit breaker, suspended heating element, temperature adjustment, double-jacketed nozzle and shield, and special-application accessories. \$79.91. Address: Eddy Products, 280 S. 166th St., New Berlin, WI 53151.

Dual Power HF Transceiver



The Argosy transceiver from Ten-Tec features a switch that boosts power from 10 watts, QRP operation, to 100 watts, for SSB/CW. It provides coverage from 80 through 10 meters, operating in nine 500-kHz segments (four in the 10-meter band) with approximately 40 kHz vfo overrun on each band edge. A 100% duty cycle is tolerated for up to 20 minutes on all bands. Full break-in is offered on CW, plus PTT on SSB. A built-in sidetone has adjustable tone and volume control, with alc control on high power. Sensitivity is 0.3 μV for 10 dB S+N/N. A 2.5-kHz 4-pole crystal filter is included with 1.8-kHz, 500-Hz, and 250-Hz filters optional. A 50-dB notch filter is tunable from 200 Hz to 3.5 kHz; an i-f noise blanker is optional. The unit runs from 12-14 V dc or, optionally, from ac mains. \$549.

CIRCLE NO. 94 ON FREE INFORMATION CARD

Polk Floorstanding Speakers

The RTA 12B has two trilaminate-polymer bass-midrange drivers and a "dual isophase crossover network" that holds phase shift to ±9° from 100 Hz to 10 kHz. Other drivers include one 1" moving-coil high-frequency radiator, and one 12" planar fluid-coupled subwoofer. Dimensions are 39"H × 16"W × 117 1/8"D. Nominal impedance is 4 ohms, and recommended drive power is 10 to 500 W/channel. System resonance is 15 Hz; rated frequency response, 25 to 20,000 Hz, ±2 dB. \$500 each.

CIRCLE NO. 93 ON FREE INFORMATION CARD

"Servo Sub-Octavator" Extends Bass Response

KM Laboratories has introduced a "black box" (2 3/8"H × 14 1/2"W × 6"D) called the SSO 300 Servo Sub-Octavator®. Said to extend the bass response of any conventional loudspeaker/amplifier system by as much as an octave without requiring internal modifications, the SSO 300 has a rated frequency response of 0.7 Hz to 200 Hz (max. gain 3 dB). Other specifications include input impedance, 20 kΩ; output impedance, 220 Ω; THD at 0.5 V, 0.001%; response time, 125 ns; and S/N, 101 dB. Bass compensation is provided in 1 1/2-dB steps. Output impedance of the overall system with an 8-ohm speaker is negative, which is said to improve woofer transient response. Maximum output is 9 V rms (25 V peak-to-peak). \$399.

CIRCLE NO. 92 ON FREE INFORMATION CARD

Pocket Concert Hall

PRICE SLASHED

Was \$199, then \$179---We cut it to only \$118
NOW JUST \$69

Cybernet has a problem. They built over 100,000 of these fabulous Pocket Concert Halls. They built them to be better than the Sony Walkman, but by the time they got them here, the price had already come down on the Walkman (it's now as low as \$139 in some areas) and lots of cheap Hong Kong-made recorders had hit the market.

The Cybernet was built to sell for \$200 and wholesale for \$119. It has a very sophisticated dual flywheel tape drive system and superb electronics. The best way to test a portable is to play music and shake it. If the music wows badly, or even stops, you have a cheap unit.

Both Sony's and Cybernet's can pass this test. Not many others can. So, if you want the best sound and the most stable unit, Cybernet has 35,000 left. And at only \$69 (\$2.50 P&H), it's an incredible bargain. Remember this is a \$200 retail unit, and the January 1981 wholesale price sheet shows dealer cost at \$119.97. We'll be glad to send you a copy if you'd like to see it. Use DAK's Super Sale Order Number 9192. Of course you get DAK's 30 day risk free trial and Cybernet's one year warranty described below.

First there was silence. Then from nowhere, there explodes an awesome kaleidoscope of sound. Violins from the left, trumpets from the right, while the sounds of a vocalist seem to come from somewhere above.

You've just experienced a breathtaking experience in sound. It's better than sitting in the middle of a full symphony orchestra.

As you take off the almost weightless 1½ ounce headphones and tentatively look around for the orchestra, the realization of the experience sinks in.

Now you can enjoy more beautiful sound from your cassettes while you are jogging or washing the car than when you are sitting in front of your stereo.

SOMERSAULTS AND CARTWHEELS

If you were on a diet yesterday, you probably lost more weight than the trifling 16 oz. of the Pocket Concert Hall.

The Concert Hall goes where you go with a protective leatherette case that easily hangs on your belt or rides comfortably in your pocket. It also comes with an adjustable shoulder strap.

Whether you're into gymnastics, long walks, or just mowing the lawn, you'll enjoy the unbelievably rich stereo sound of the Pocket Concert Hall. And, to prove our point, we offer you a 30 day risk free trial.

ENGINEERED FOR STRESS

Most fine stereo equipment is designed to be lovingly placed on a shelf and never moved. Obviously, this isn't a practical way to listen when you're walking your dog or riding a bike.

The Pocket Concert Hall incorporates a special dual flywheel tape movement system with a unique anti-rolling mechanism resembling a fine clock. It keeps the music smooth and stable, even when you're doing cartwheels.

The Pocket Concert Hall is specifically designed for rough treatment. Other machines are really redesigned dictation recorders. The Pocket Concert Hall is designed to provide superb stereo music while you're on the move.

You can expect years of enjoyment from this finely crafted revolutionary new sound machine.



MUSIC AT YOUR COMMAND

You won't be 'roughing it' when you leave home. You can play all your cassettes since there is an equalization switch for Metal/Chrome or standard.

The sound is crisp and clean with a frequency response of 30-14,000hz. The entire system is operated by 4 AA batteries (included).

There are convenient lock-in fast forward and rewind buttons, plus cue and review. If you want to listen to a song again, just press the review button without ever leaving play.

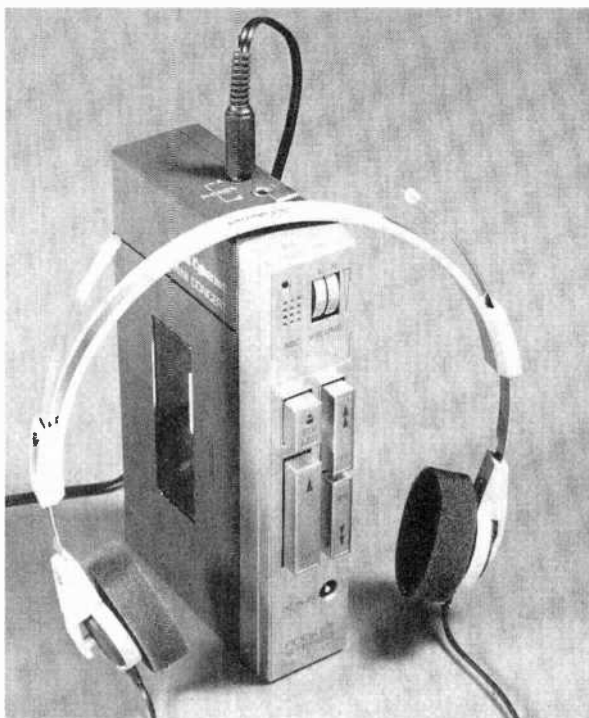

You can listen to the outside world by pushing the talk switch without taking off the feather-light stereophones. Dual volume controls, auto-stop and a battery condition/operation indicator light round out a full compliment of convenience features to enhance your musical enjoyment.

MULTINATIONAL GUARANTEE

Cybernet is an extremely large Japanese Company with a large presence here in the U.S. They manufacture component systems valued in the thousands of dollars and sophisticated wireless transmission systems.

Cybernet backs the Pocket Concert Hall not with the usual limited 90 day parts and labor guarantee, but with a limited full one year guarantee.

DAK is America's largest direct selling manufacturer of magnetic products. We add our own 30 day 100% satisfaction guarantee to protect your purchase.

TRY THE POCKET CONCERT HALL RISK FREE

Take your Pocket Concert Hall on walks, to the mountains or as you commute to work. Enjoy your favorite music wherever you are and experience incredible concert hall realism.

If for any reason you aren't 100% satisfied, simply return it in its original box for a courteous refund.

To order your Pocket Concert Hall risk free with your credit card, call our toll free hotline, or send your check for only \$118. Plus \$2.50 for postage and handling. Order No. 9114. (CA res add 6% sales tax).

Why settle for a radio station's choice of music and commercials when you can choose your favorite music on cassettes anywhere, any time.

DAK
INDUSTRIES
INCORPORATED

Call TOLL-FREE (800) 423-2636
In California Call (213) 984-1559
10845 Vanowen St., North Hollywood, CA 91605

CIRCLE NO. 58 ON FREE INFORMATION CARD

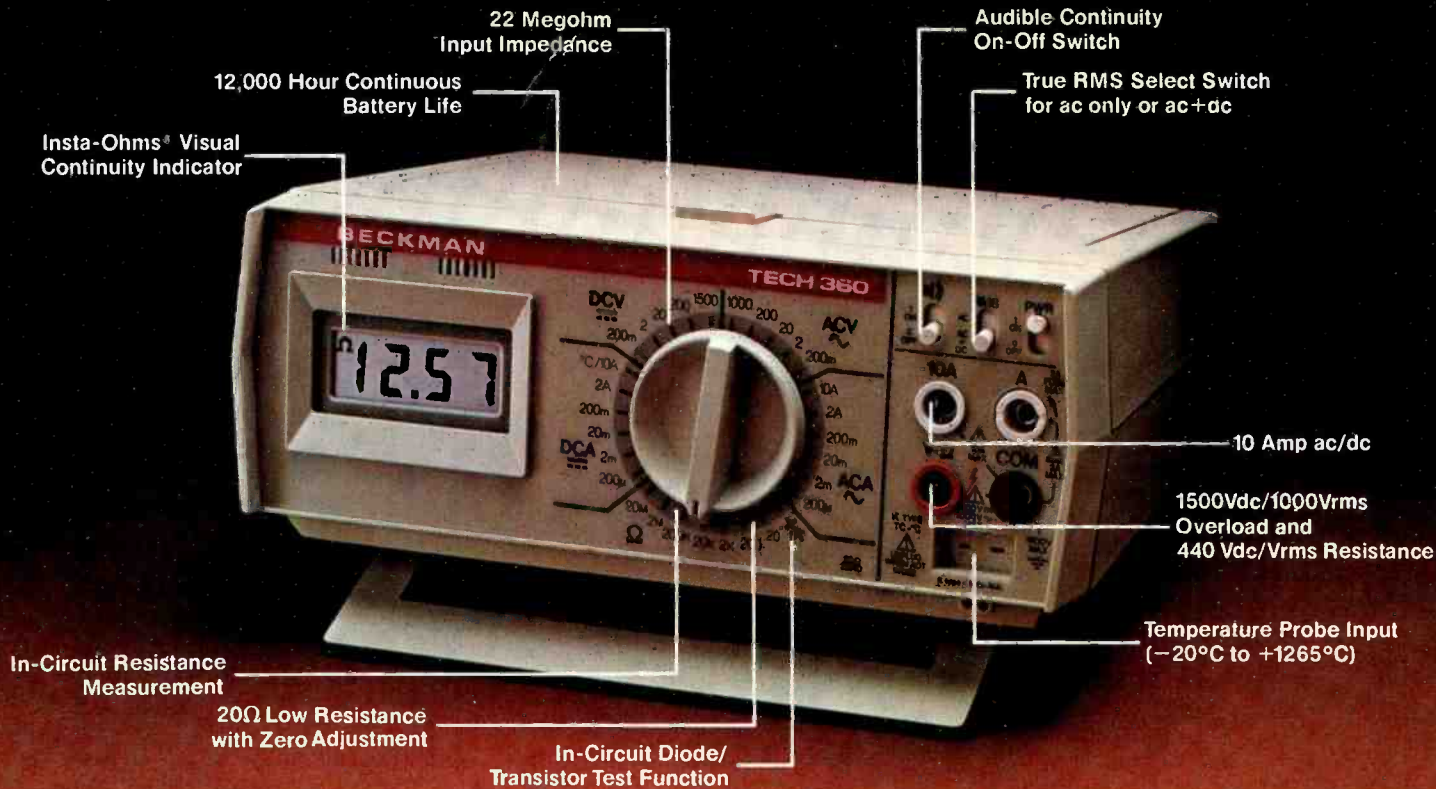

Introducing the TECH™ 360 DMM. Never has it been so easy to do so much for so little.

Beckman's TECH 360 bench/portable DMM puts unmatched capability and convenience at your fingertips.

You can select from 8 functions and 31 ranges with one turn of the single selector switch.

On or off the bench, you can accurately measure all complex waveforms with True RMS AC functions. Extend resistance measurement to 1/100 ohm resolution. Read temperatures from -20°C to 1265°C . Perform continuity checks

quickly, with audible and visible indications. Measure up to 10 amps without adding special adaptors. All with 0.1% basic Vdc accuracy.

12,000 hour battery life

Designed for ultimate ease of operation, the TECH 360 delivers 12,000 hours continuous service (up to 4 years of normal use) from standard heavy-duty batteries. You'll never have to search for power outlets or contend with ground loop errors. The expense of rechargeable battery packs is eliminated.

The TECH 360 is available for just \$289 (U.S. only), including batteries. The companion TECH 350 (without RMS and temperature measuring capability) is priced at \$229.

For information on the complete line of Beckman DMMs and accessories, call your local distributor today. For the one nearest you call: (714) 993-8803 or write Beckman Instruments, Inc., Electro-Products Group, 210 South Ranger Street, Brea, California 92621.



Convenient storage and multiple viewing angles are featured in the new line of Beckman bench/portable DMMs.

BECKMAN

CIRCLE NO. 10 ON FREE INFORMATION CARD

AmericanRadioHistory.Com

Popular Electronics Tests



The Sinclair Research ZX80 Personal Computer

THE Sinclair Research model ZX80 personal computer, is a no-frills Z-80A microprocessor-based system designed to be very inexpensive and easily portable. Like many video games and low-cost computers, the ZX80 comes equipped with a TV/GAME 60-dB isolation switch that permits use with any TV receiver. For the few users that would be expected to do so, the manufacturer supplies an application note that explains how to derive direct video for use with a monitor.

The design is unique in not using a video controller for the display. Sinclair opted instead for using the refresh counter of the Z-80A to control the video display and update it about 60 times a second. When a program is running, the screen is blanked then rewritten after the process, since the Z-80A has to share its resources.

The ZX80 is housed in a nonimpact plastic case that measures 6.5 in. x 8.5 in. x 1.5 in. The case also provides the necessary shielding to enable the unit to meet FCC class-B radiation requirements. The shielding is a thin metal coating that is apparently sprayed on the inside of the case. Necessary board grounding is effected via flexible

grounding straps located on the r-f modulator metal enclosure. (This arrangement, although workable to a degree, has some inherent difficulties that we will discuss later.) The plastic enclosure houses a forty-key, pressure-sensitive keyboard, built-in r-f modulator, 1K bytes of RAM, 4K bytes of system ROM, and a cassette interface.

The price of the unit is \$199.95 and includes the ac adaptor, cables for a tape recorder (not supplied), and an extremely well-written and useful 130-page user's and programming guide. Since BASIC is contained in ROM, nothing else is required for operation except a TV receiver. As yet, Sinclair offers no options, however, an 8K-byte enhanced BASIC (in ROM) that reportedly will sell for \$40, and a 16K-byte RAM expansion for less than \$100 are in the works. Currently, software support, is available from various aftermarket sources.

General Description. The Z-80A microprocessor, operating at a 3.25-MHz clock rate, creates the screen image. The black-on-white display, which is upper-case only, is limited to 24 lines by 32 characters (768 characters

per screen image) by the typical bandwidth (~ 3.5 MHz) of a typical TV receiver. The character generator also provides what Sinclair terms 24 standard graphic symbols. However, in reality, there are 10 graphic symbols and their inversions. The other four are the normal and inverse of the space character and the quote symbol. The graphic characters are formed on an 8 x 8 dot matrix that offers resolution somewhat better than that of the common 5 x 7 dot matrix though not quite the high resolution touted by Sinclair.

The integrated cassette interface operates at 250 baud. The basic tape format is frame sync information, pointers into the variable area, and compressed tokens representing both keywords and data. An interesting feature of the cassette system allows data and variable information to be saved at the same time, and restored at run time by invoking the GOTO (line no.) rather than RUN. The recorder volume setting has little or no effect on the operation of the system. The ZX80's 2K integer BASIC is limited, but it can't be considered a tiny BASIC. It is, rather, a subset of a full-scale integer BASIC with some unique attributes of its own.

(Continued on page 18)

For all practical purposes, the typical functions found in larger implementations of BASIC are included (string operators such as MIDS, LEFT\$, RIGHT\$, are not). Bit-wise Boolean operations are permitted using NOT, AND, or OR. The character string function CHR\$(s) becomes a main operator in most programs, and a unique function TL\$(s) which returns the string (s) minus its first character is provided. The TL\$ operator, can be employed for creating unique displays, while the function CODE returns the ASCII code for the first

character of string. This latter function essentially takes the place of ASC found in most BASICs. Even PEEK and POKE are included to permit the user to get to the memory. To further support these functions, USR permits the calling of a user-written machine language routine.

Interestingly, the BASIC is well suited to the machine architecture. To enter a program, you merely tap the Q key. This executes NEW and clears the work space for a new program. Next type in a line number, depress the letter O to generate the keyword PRINT. When

you do this the cursor is displayed as an inverse K to indicate a keyword. Your next entry would, in this case, be a "quote" which would generate an inverse S, indicating that a syntax problem exists (there is no "end quote" yet), and remain displayed until you have finished the line and ended it with a quote. Once you have the line typed in, you depress the key marked NEWLINE. This key acts the same as RETURN on other computers.

When a line is entered, all the system variables, line numbers, and pointers to the next line are stored in an area below the user RAM area. Then the program is stored, as are the working variables (A\$, for example) and an indicator for end of line. Next, a working space is opened to input new lines, or for editing, then a display area that holds 24 NEWLINE characters is provided for screen updating. This is followed by a stack area that contains information for jumps and GOTOS.

Since the code is compacted, a fair amount can be input into the 1K of available RAM. Sinclair exaggerates a little in saying that you can enter 100 32-character lines (which would be 3500 bytes, assuming two bytes for a line number, 1 byte for NEWLINE terminator and 1 byte per character), but you can come close to 3000 bytes. This is fairly easily done, since all the operators are stored as tokens and in a manner to provide maximum packaging. One technique used is to drop spaces and set bits to indicate where a space should appear.

Because of the unique implementation of the BASIC, editing is fairly simple. You LIST the program (depress the letter A), and then enter the editing mode by holding the SHIFT key and depressing NEWLINE. The cursor is moved to the desired line by holding down SHIFT and depressing one of the arrowed keys, 5 for left, 6 for down, 7 for up, and 8 for right. The chosen line then is redisplayed at the bottom of the screen, and can be edited by moving the cursor over the desired area and typing over material to be changed, including the line number. This gives you a quick way of copying lines into new line numbers.

When a program is run or a new line entered, the screen is blanked. For example, if you wrote a program to draw a maze, when you RUN, the screen will blank for a few seconds and redisplay with the maze drawn. Should your program ask for an input, the same thing happens once the data is entered. This is a bit disconcerting at first, but is not a disadvantage. It can be useful for creating certain games.

Quite honestly, the 130-page, spiral-bound operating manual supplied with the ZX80 is the best we have seen so far. The authors, realistically, assumed that the buyer of this machine would be a novice and wrote accordingly. Thus, the manual explains not only how to use the ZX80 but the basics of computer operation in general. In addition, there is a

GO ON-LINE TO THE WORLD.

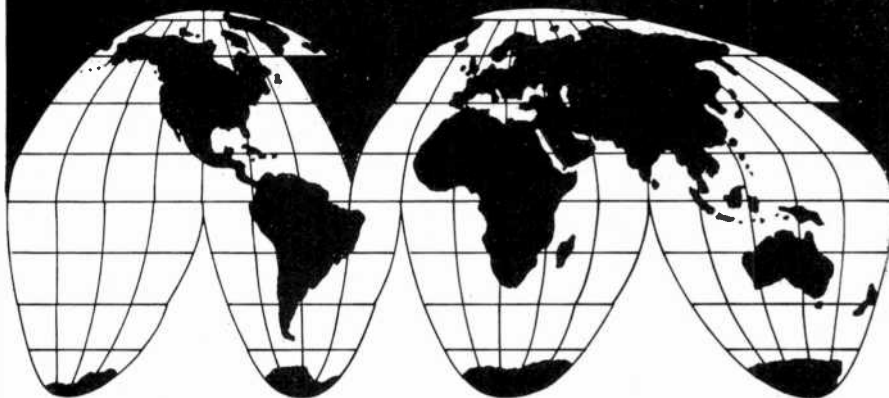

The CompuServe Information Service ties your personal computer or terminal into our large computers. You can read the electronic editions of major daily newspapers including The Washington Post, The New York Times, the San Francisco Chronicle, plus the AP newswire. Have easy access to valuable consumer and home-related information, games, entertainment features, electronic mail, nationwide bulletin board, newsletters from computer manufacturers—and more.

If your interest follows financial lines, we have the AP financial wire, Raylux Financial Advisory Service, Commodity News Service, Standard & Poor's Stock Reports and personal financial programs. Through our MicroQuote Service, you can get current and historical data on 40,000+ stocks, bonds and options, updated daily.

We've only just begun. Currently we're serving more than 10,000 customers—and we have room for lots more. We've only hinted at what's available and haven't mentioned the free 128K bytes of storage and the powerful languages and programming aids available to you. So get a demonstration of the CompuServe Information Service at a Radio Shack® Computer Center or many Radio Shack® outlets. Your hourly charge for all this is only 8½ cents a minute during evening and weekend hours.

CompuServe

Information Service Division
5000 Arlington Centre Blvd.
Columbus, Ohio 43220
(614) 457-8600

Radio Shack is a trademark of Tandy Corporation.

“Our reputation rests on digits, decimal points, and details. We wouldn't trust them to anything less than Scotch® Brand Data Cartridges.”

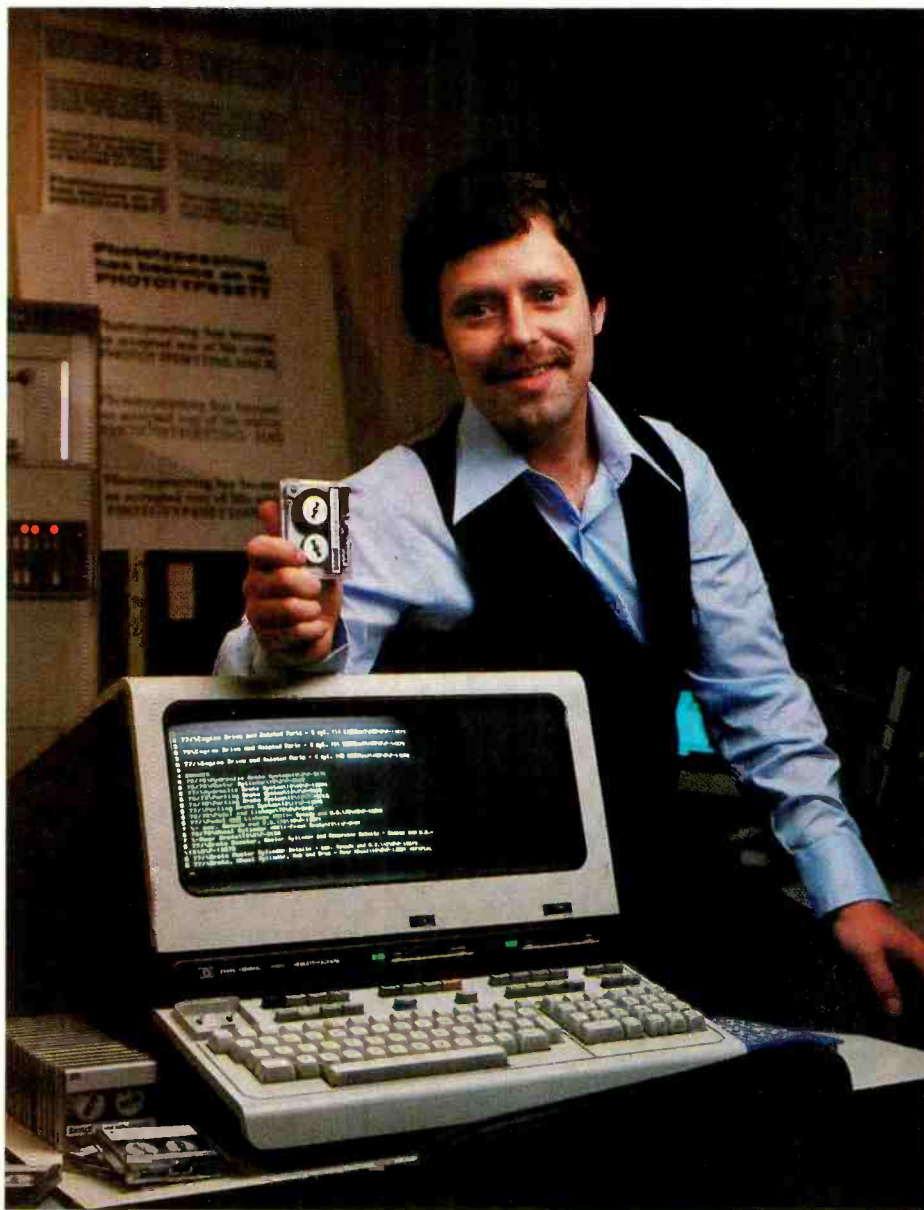

**Bill Birkett, Vice President,
Trade Graphics, Inc.,
Livonia, Michigan**

The unique design of a data cartridge provides great reliability, high storage capacity and long tape life. And where could you possibly get better data cartridges than Scotch Brand, made by 3M, the people who invented the data cartridge system itself?

3M controls every step in manufacturing. Top quality magnetic tape and precision components are part of every Scotch Data Cartridge. Over twenty-five years of service to the computer industry assure you of the utmost reliability.

Scotch Data Cartridges are available in miniature DC 100A, the standard-size DC 300A and now, an extra-length DC 300XL with 50% more storage capacity. They are compatible with most cartridge systems including Hewlett-Packard, IBM, NCR, Tektronix and TI.

To find out where you can find Scotch Data Cartridges or virtually any other data recording medium, call toll-free: 800-328-1300. (In Minnesota, call collect: 612-736-9625.) Ask for the Data Recording Products Division.

**If it's worth remembering,
it's worth Scotch
Data Recording Products.**



3M

Popular Electronics Tests



General Electric's IVHD3042W Video High Density Disc Player

THE Matsushita/JVC Video High Density (VHD) disc player is now off the drawing board and into hardware. Initial prototypes have been delivered to U.S. partner General Electric and Matsushita-owned Panasonic.

The disc itself is smooth-surfaced, 10.2" in diameter. It is made from compression-molded PVC plastic, carbon black, a lubricant, and other additives. Spinning at a constant 900 rpm, it is designed to play one hour per side. Because the force of the stylus on the disc is spread over more disc area than in the CED (Capacitance Electronic Disc) system, pressure on the surface is accordingly less. Stylus life, consequently, could amount to more than 1,000 hours, and recordings last for up to 10,000 plays. Dual audio channels can carry either full stereo or bilingual outputs.

Time-share picture and audio frames (54,000 per disc) are molded into the plastic as variable length pits of uniform depth, with tracking pits running alongside, and at right angles to them. The pickup head has only flat contact with the record, and may move freely over the disc's surface, permitting still pic-

tures and forward and reverse slow motion at 1/2, 1/4, 1/8, and 1/16 normal speed. Similarly, forward and reverse fast picture search (with picture) is possible at 2, 3, 4, and 5 times normal speed in the forward mode, and 2 and 3 times normal in reverse.

There is chapter and *time* access, but no frame identification. This will come later—at added expense. Meanwhile, the reduced method of picture identification will locate any specific image within about 15 frames, and frame-by-frame motion control can quickly move the stylus arm into the exact position for the frame desired.

The disc player will be introduced in Japan in October of this year, in the U.S. in January of 1982, and in Britain six months after that. Here, the system is to be marketed under the General Electric, JVC, Panasonic, Sharp and Quasar brand names. Meanwhile, negotiations for first-run movies, various shows, and other entertainment and educational programs are in progress.

Operation. Since the system we investigated is still a prototype, only a block

diagram (Figure 1) of the overall player was made available by General Electric. But even that is a good deal more than had been released previously.

The equipment is designed to operate in sequential steps, with lighted green indicators suggesting each succeeding step. The stylus is always in contact with the recording until play is completed, after which the player automatically moves to the unload position, and the time clock resets to zero.

Variations in capacitance (equating to frequencies from 6.1 to 7.8 MHz) are picked up from individual pits on the disc by an electrode attached to the stylus and in physical contact with the disc (Fig. 2). A 915-MHz oscillator provides a carrier for the signal, which is then peak-detected so that it contains the total video and audio information. A head amplifier receives this information and passes it to the tracking servo circuit, the dropout compensation (DOC) detector, and the video detector. Additional signal paths lead from the tracking servo circuit to the motor servo circuit, and to the stylus coils on either side of the input.

Three coils guide the stylus (Fig. 3).

Coil B is wound around the center magnet, but is not in contact with it; and the two A coils on either side of the center magnet are in electrical phase opposition. Coil B controls the tracking error, while the A coils correct for time-base abnormalities. Thus, the stylus arm can move both transversely and longitudinally. This affords excellent stylus

tracking as well as operations such as frame scan.

The video detector supplies four separate outputs: one for the sync separator; another for two audio bandpass amplifiers and their detectors; a third to the DOC switch; and a fourth directly to the luminance delay line, which delays the luminance signal so it will be properly

timed with the chroma. Chroma burst (color sync) is carried conventionally on the back porch of the horizontal sync pulse and reaches the burst gate via the sync separator. Chroma information, part of composite video, having been recorded at approximately 2.56 MHz is up-converted to the NTSC standard 3.58 MHz via the 6.14 MHz voltage-

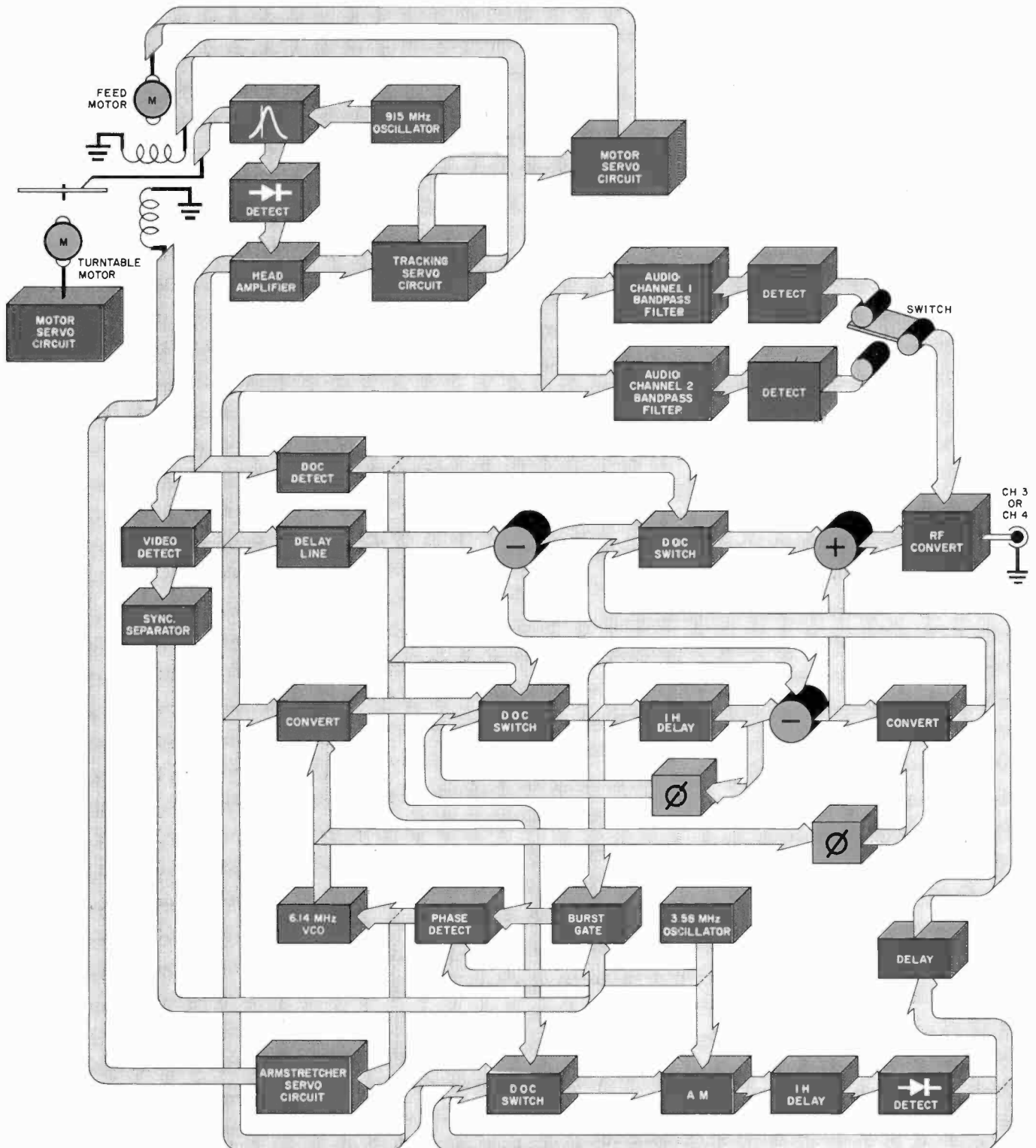
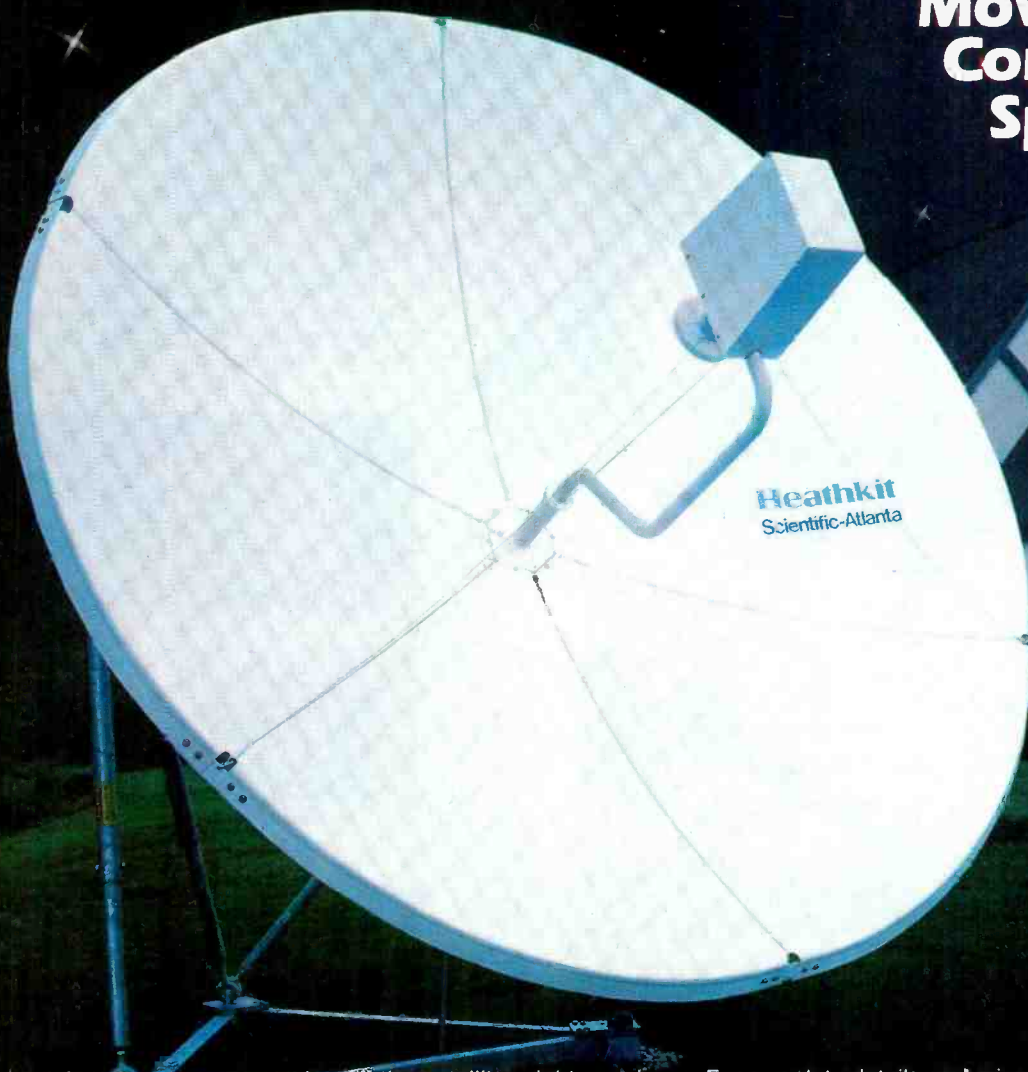

Fig. 1. Simplified block diagram of the VHD disc player.

Now the stars are within your reach

Movie Stars Concert Stars Sports Stars



Your favorite stars are coming off the satellites right now in one of the greatest selections of family and adult entertainment ever offered. And now there's a new satellite receiver system that puts it all within your reach - at a price that's within reach.

The new Heathkit Earth Station

It includes a 3-meter Satellite Antenna with a single-axis adjustable mount that lets you direct your antenna to receive signals from the entire satellite arc. It's a heavy-duty, commercial-quality antenna, made by Scientific-Atlanta and designed for long, reliable performance.

Special Low-Noise Amplifier and Down-Converter converts signals to 500 MHz band for transmission on ordinary TV cable.

The Receiver features electronically-synthesized tuning for stable, drift-free reception, and 24 channel selections for a broad variety of programming. It even includes a special Zenith Space Command Remote Control so you can change programs without leaving your easy chair.

Special Earth Foundation Kit anchors your antenna firmly to withstand winds of up to 100 mph.

Unique Site Survey Kit

You can trust Heath to do it right. The first step in establishing your station is the purchase of a special Site Survey Kit that includes everything you need to determine a clear line-of-sight to the satellites. So you know your location is correct before you buy the Station.

Easy-to-follow, step-by-step assembly

Like all Heathkit products, the Satellite Earth Station includes a clearly written manual that guides you every step of the way through assembly and installation. And over-the-phone assistance is always available.

For complete details and prices on the Heathkit Earth Station and 400 other electronic kits for home, work or play, send today for the latest free Heathkit Catalog or visit your nearby Heathkit Electronic Center:



Send for free catalog

Write to Heath Co., Dept. 010-806,
Benton Harbor, MI 49022

Visit your Heathkit Store

Heathkit products are displayed, sold and serviced at 56 Heathkit Electronic Centers in the U.S. See your telephone white pages for locations.



Heathkit Electronic Centers are units of Veritechnology Electronics Corporation.

Viewing of some satellite TV channels may require the customer to obtain permission from, or make payments to, the programming company. The customer is responsible for compliance with all local, state and federal governmental laws and regulations, including but not limited to construction, placement and use. For use only in Continental U.S. This device has not been approved by the Federal Communications Commission. It is not, and may not be, offered for sale or lease, or sold or leased, until the approval of the FCC has been obtained.

Heathkit

CIRCLE NO. 27 ON FREE INFORMATION CARD

Fig. 2. Drawing shows stylus tip and arrangement of pits on the surface of the disc.

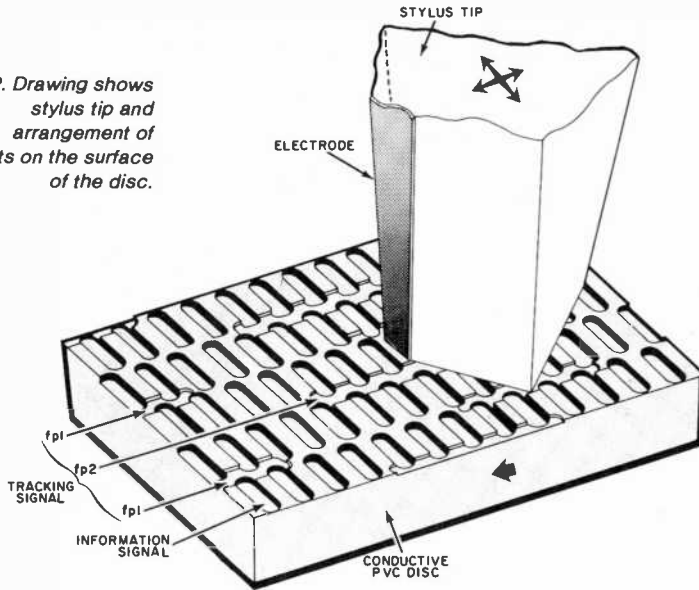
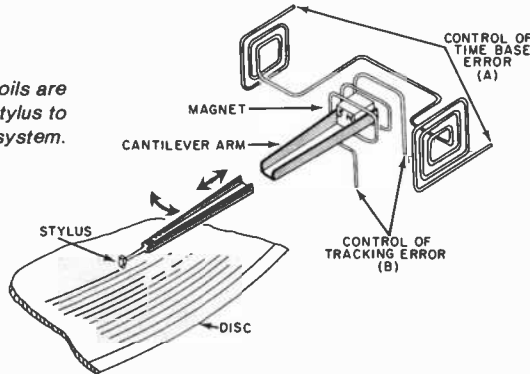

Fig. 3. Three coils are wound around the stylus to activate servo control system.



controlled oscillator. It is then passed to the dropout compensator switch, which is also supplied with feedback from the 1H (horizontal line) delay line. Should a dropout occur in a line of video information, the previous line is automatically substituted.

The output from the 3.58-MHz oscillator goes to a phase detector and to the AM block, where input comes via another dropout compensator switch. From that point, three-way connections lead to composite video, the DOC detector, and to a feedback circuit from a second

1H delay line and its 1H detector. This is part of a coincidence switching arrangement that permits the main DOC switch in the luminance processor to be activated just prior to final chroma addition at the r-f converter.

The armstretcher servo circuit also bears mention. Its sensing signal is derived from the 3.58-MHz oscillator's phase detector, and from the incoming chroma burst gate. A phase-locked loop corrects both the frequency of the 6.14-MHz voltage controlled oscillator and the positioning of the stylus.

Analysis. G.E.'s and Matsushita's product falls somewhere between RCA's Capacitance Electronic Disc (CED) and the Philips/Magnavox/Pioneer laser disc player. If recorded at only 1/2 hour per side, stop field/frame performance would theoretically be comparable to that of the laser unit. However, since each side is recorded for a full hour's play, any frozen picture occupies four fields or two frames. Where relatively still scenes are displayed, there's very little movement visible in the freeze frame, but where there is rapid motion in the picture, the jitter is rather pronounced.

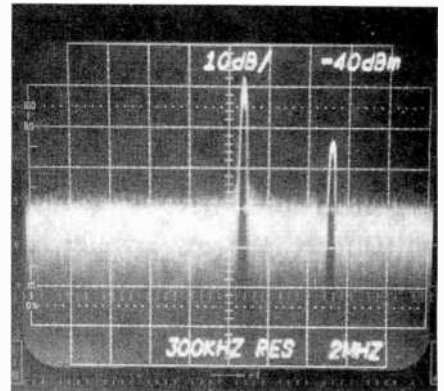

Video and audio carriers show 43 and 26 dB S/N ratios.

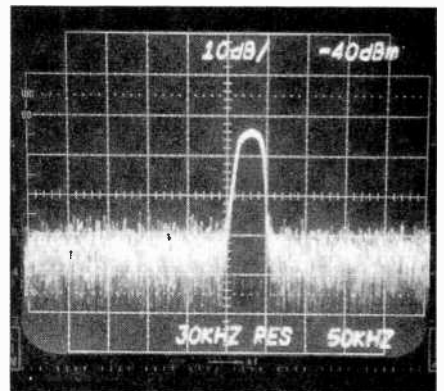

Audio carrier has 20-kHz bandwidth at 3 dB down.

GENERAL ELECTRIC MODEL 1VHD3042W VIDEO DISC LABORATORY DATA

Parameter	Measurement
Designed luminance bandwidth:	3.1 MHz
Designed audio bandwidth:	20 kHz, confirmed
Video S/N:	42 dB, confirmed
Audio S/N:	60 dB claimed, 25 dB confirmed
Power drain:	30 W, confirmed
Acceptable power supply variation:	105-130 V ac, confirmed
Dimensions:	18.1"W × 15.8"D × 5.1"H
Weight (est.):	28.5 lb

NOTE: Instruments used in these measurements are: Tektronix 7L 12 spectrum analyzer; Sencore PR57 variable power supply; Tektronix C-5A and Minolta XD-11 cameras.

Otherwise, this versatile player does essentially everything that the 1/2-hour-per-side laser disc can do, with very little stylus and disc wear. Signal-to-noise ratios are much the same for Magnavox, RCA, and G.E./Matsushita at modulator outputs. There are, however, base-band ports for both audio and video in the G.E./Matsushita equipment that can reduce apparent noise through a more direct signal path. Stereo sound and bilingual channel reproduction are excellent, while picture quality probably comes very close to the 3.1-MHz design standard. Color rendition is exceptional for a player of this type.

—Stan Prentiss.

CIRCLE NO. 103 ON FREE INFORMATION CARD

POPULAR ELECTRONICS

Audio Product of the Month

CHOSEN BY THE EDITORS OF POPULAR ELECTRONICS

KEF Electronics Model 303.2 Speaker System



THE lowest-priced speaker system in the KEF line, Model 303.2, has an 8-inch woofer operating in a sealed enclosure and a 1-inch soft-dome tweeter. Although it is the size and shape of a typical small "book-shelf" system, for best results the 303.2 should be located a few feet from any walls and from one to three feet above the floor. An optional stand is available for floor mounting.

The KEF 303.2 is 20 $\frac{3}{8}$ " H \times 10 $\frac{1}{2}$ " W \times 9" D and weighs 18 pounds. It is normally supplied with black molded plastic end caps and a black grille cloth; optionally, it can be purchased with brown ends. User-replaceable grille cloths are available in beige, blue, red, green, or grey. The optional stands, ULS40, are steel tubes based on a 13" diameter steel disc, supporting the speaker 12" above the floor. The stand is also available in brown to match the speaker. Model 303.2 sells for \$450 per pair and is not available as single units. The ULS40 stands are \$85 per pair.

General Description. In part, the moderate price of the 303.2 is possible because its enclosure is constructed of unfinished particle board. This is then covered on four sides by a colored "stretch cloth" sleeve and capped at both ends by molded plastic pieces. The system has no user-adjustable level or balance controls, and its insulated spring-loaded connectors are recessed into the lower rear edge. The speaker can be placed in the open without presenting an unfinished appearance from any point of view.

Sensitivity is relatively high for a sealed system, with a rating of 88-dB sound pressure level at a 1-meter distance for a 1-watt input of pink noise. Amplifiers rated at from 10 to 50 watts output into 8-ohm loads are acceptable as driving sources.

(Continued overleaf)

(continued from previous page)

The woofer system resonates at 68 Hz with a Q of 0.7. In the horizontal plane, the output is guaranteed to be within ± 2 dB of the axial response over a ± 20 -degree angle, up to 10,000 Hz. Vertically, in a ± 5 -degree angle the output is within ± 2 dB of the axial response up to 20,000 Hz. The rated axial response, at a 2-meter distance, is 70 to 20,000 Hz ± 3 dB (down 10 dB at 50 and 25,000 Hz).

Although the 303.2 does not have the elaborate electronic protection system featured in the costlier KEF Reference Series speakers, it can withstand an input of up to 20 volts RMS from 20 to 2,000 Hz, and to 10 volts rms between 2,500 and 20,000 Hz.

Laboratory Measurements. Close-miked woofer response of the KEF 303.2 was uniform within ± 2 dB from 70 to 1,000 Hz. The averaged output from the left and right speakers, measured in the reverberant field of the room at a 10-to-15-foot distance from the speakers, was corrected for the known absorption characteristics of the room. The result was an extremely flat response at the highest frequencies (only 1 dB overall variation from 4,000 to 20,000 Hz) with only slight variations in

output through the lower midrange. Splicing this curve to the woofer curve yielded a composite frequency response within ± 2.5 dB from 65 to 20,000 Hz. High frequency dispersion was good, as shown by the moderate divergence in response at positions on- and off-axis.

Woofer distortion was measured with close microphone spacing at inputs of 1 watt and 10 watts (based on the rated 8-ohm impedance). At 1 watt, distortion was about 0.2% at 100 Hz, increasing to 0.8% at 70 Hz and 5% at 40 Hz. At a 10-watt input the distortion was about 0.7% at the upper bass frequencies and still less than 10% at 40 Hz. Sensitivity was exactly as rated, with a measured SPL of 88 dB at 1 meter when the speaker was driven by 2.83 volts of pink noise in an octave bandwidth centered at 1,000 Hz.

The impedance minimum was about 6 ohms at 20 Hz and between 10,000 and 15,000 Hz. Maxima were 25 ohms at 73 Hz and 50 ohms at 1,600 Hz. Over most of the audio range the impedance was between 8 and 10 ohms, justifying the 8-ohm rating.

User Comment. On a variety of program material, the KEF 303.2 demonstrated its musical and eminently listen-

able quality with no irritating distortions or colorations. Although the low-frequency output is limited by design and size, the speaker never lacked bass. On the contrary, it often showed a comfortably "warm" quality, probably associated with the slightly elevated output (by 2 or 3 dB) between 80 and 200 Hz.

We installed the speakers on their stands about two or three feet from any walls. Imaging was excellent, and there was no tendency to focus on the speakers themselves as sound sources. Instead, a unified sonic panorama formed across the end of the room, behind the plane of the speakers.

The 303.2 presented an attractive appearance, and the choice of colors for the grille, top and bottom plates, and stands provides numerous possibilities for making the speaker visually harmonious with its surroundings. We tried changing the grille cloths to see if it was as easy as claimed. It was, requiring only a screwdriver and a few minutes.

On the whole, the KEF 303.2 is a neatly engineered package and reasonably priced. It costs more than most "budget" speakers, but its standard of performance is appreciably higher.

—Julian D. Hirsch

CIRCLE NO. 101 ON FREE INFORMATION CARD

The printer you
always wanted
but could
never afford,

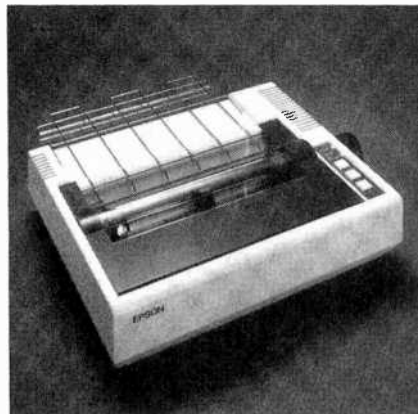

now you
can afford.

Epson.

The most revolutionary thing about the Epson MX-80 isn't the bidirectional printing or the logical seeking function. It isn't even the disposable print head — although that's pretty revolutionary. The most revolutionary thing about the MX-80 is the price. How, you may ask, could a printer that does as much as the MX-80 cost less than \$650?

Frankly, it wasn't easy. But the MX-80 could only have come from the world's largest manufacturer of print mechanisms. Epson.

The world's first disposable print head. When it wears out, just throw it away. A new one costs less than a third the price of conventional heads, and you can install it yourself with one hand.

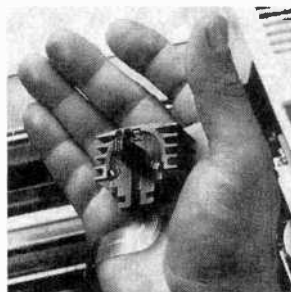

EPSON
EPSON AMERICA, INC.

23844 Hawthorne Boulevard, Torrance, California 90505 • Telephone (213) 378-2220

CIRCLE NO. 19 ON FREE INFORMATION CARD

We spent three long years designing the MX-80 from the ground up to have all the functions people wanted, to be reliable like all Epson Printers, and to be produced on a scale that would allow us to charge less for each one. The MX-80 is our proof that it can be done.

Among its features, the MX-80 prints 96 ASCII, 64 graphic and eight international characters in a tack-sharp 9x9 matrix. It prints bidirectionally at 80 CPS with a logical seeking function to maximize throughput. And it has the world's first disposable print head.

If you've ever wanted a printer that could do it all at a price you could afford, you've got to see the Epson MX-80.

Because seeing is believing.



SYBEX SPEAKS YOUR LANGUAGE . . .

THE PASCAL HANDBOOK by Jacques Tiberghien — A dictionary of every Pascal instruction, function, operator and reserved word covering virtually all versions of Pascal. 300 pp., 150 Ill., Ref. P320, 7" x 9", \$14.95

INTRODUCTION TO PASCAL (Including UCSD PASCAL) by Rodnay Zaks — A step-by-step introduction for anyone wanting to learn the language of PASCAL. Describes UCSD and Standard Pascals. 440 pp., 100 Ill., Ref. P310, 7" x 9", \$14.95

INSIDE BASIC GAMES by Richard Mateosian — Uses a games format to teach program design in BASIC. Games run on TRS-80, APPLE II, PET/CBM and others. 300 pp., 100 Ill., Ref. B245, 7" x 9", \$13.95

FIFTY BASIC EXERCISES by J.P. Lamoitier — Teaches BASIC by actual practice using graduated exercises drawn from everyday applications. All exercises written in Microsoft BASIC. 300 pp., 140 Ill., Ref. B250, 7" x 9", \$12.95

THE CP/M HANDBOOK by Rodnay Zaks — Complete instructions and reference handbook for CP/M — the industry standard in microcomputer operating systems. 336 pp., 100 Ill., Ref. C300, 5½" x 8½", \$14.95

PROGRAMMING THE Z80 by Rodnay Zaks — A complete course in programming the Z80 microprocessor and a thorough introduction to machine language. 620 pp., 200 Ill., Ref. C280, 5½" x 8½", 2nd Ed. \$14.95

PROGRAMMING THE 6502 by Rodnay Zaks — Machine language programming of the 6502 from

basic concepts to advanced data structures. 392 pp., 160 Ill., Ref. C202, 5½" x 8½", 3rd Ed., \$12.95

6502 APPLICATIONS BOOK by Rodnay Zaks — Real life application techniques: the Input/Output book for the 6502. 288 pp., 207 Ill., Ref. D302, 5½" x 8½", \$12.95

6502 GAMES by Rodnay Zaks — Third in the 6502 series. Teaches advanced programming techniques using games as a framework for learning. 304 pp., 140 Ill., Ref. G402, 5½" x 8½", \$12.95

YOUR FIRST COMPUTER by Rodnay Zaks — The most popular introduction to small computers, what they do and how to buy one. 280 pp., 150 Ill., Ref. C200A, 5½" x 8½", 2nd Ed., \$7.95

MICROPROCESSORS: FROM CHIPS TO SYSTEMS by Rodnay Zaks — Covers components, concepts and techniques from basic to advanced. 420 pp., 257 Ill., Ref. C201, 5½" x 8½", 3rd Ed., \$10.95

MICROPROCESSOR INTERFACING TECHNIQUES by Austin Lesea, Rodnay Zaks — Hardware and software interconnect techniques including D to A conversion, peripherals standard buses and troubleshooting. 464 pp., 400 Ill., Ref. C207, 5½" x 8½", 3rd Ed., \$15.95

PROGRAMMING THE Z8000 by Richard Mateosian — Architecture and function of the Z8000 and its family of support chips. Includes programming in Z8000 machine language. 312 pp., 124 Ill., Ref. C281, 5½" x 8½", \$15.95

MAIL TO: SYBEX
DEPT. PE71
2344 SIXTH STREET
BERKELEY, CA 94710



Phone Orders: 415/848-8233

NAME _____ SEND ME YOUR FREE CATALOG
ADDRESS _____
CITY _____ STATE _____ ZIP _____
ADD \$1.50/book UPS or 75¢/book 4th class mail (CA add tax) Total Amt. Enclosed _____
OR CHARGE MY VISA MC AM EX. CARD NO. _____
SIGNATURE _____ EXP. DATE _____

Radio Shack's \$399* TRS-80[®] Color Computer is for People Who Take Their Fun Seriously!

The TRS-80 Color Computer is the affordable computer that doubles as an action-packed electronic games machine! Just attach to any color TV—or use the \$399 TRS-80 Video Receiver shown—and plug in an Instant-loading Program Pak[™] (sold separately) to blast invaders from other galaxies, conquer dinosaurs from a prehistoric world, polish up your chess game, or maintain the family budget. Each game features vivid color graphics and action-packed sound effects. Or write your own programs in color BASIC—our outstanding tutorial manual makes it easy. Expand your system to include a more powerful BASIC, more memory (4K RAM is standard), joysticks, a printer, a modem, and disk or cassette storage—anytime!



Stop by your nearest Radio Shack and let us demonstrate how fun computing can really be. Now over 6100 Radio Shack stores and dealers, 150 Computer Centers and 135 service centers nationwide. Or write for a free TRS-80 catalog: Radio Shack, Dept. 82-A-86, 1300 One Tandy Center, Fort Worth, TX 76102.

*Retail prices may vary at individual stores and dealers. Some items require special order.

Radio Shack[®]
The biggest name in little computers[™]

Word Processing

Has computer technology made the ordinary typewriter as obsolete as the quill pen?

BY LOREN WERNER

WHAT'S faster than a speeding typewriter, corrects errors in a single keystroke and produces unlimited original letters without manual intervention? Answer: a word processor.

Word processors, as the name suggests, are computer systems and/or programs that assist in the generation and handling of written text. They help achieve high levels of productivity because they allow easy, efficient editing and formatting of text. Tasks that would be very time-consuming using conventional typewriters are sped up and additional capabilities far exceeding those of the standard typewriter are offered.

Error correction is one example of this. Usually a correction is as quick and simple as backspacing over the incorrect characters. And because nothing is printed until the user is satisfied that a document is correct, there is a saving of paper and avoidance of erasures.

Another powerful word-processing

capability is inserting new material into existing text. With a typewriter, this means extensive retyping. Using a word processor, material is inserted into existing text without retyping of old material. The user indicates where the new material is to be inserted, and then types it. The word processor automatically adds this material and reformats the text as necessary.

Also valuable is the word processor's ability to rearrange text. In conjunction with the insertion facility, it is possible to move sentences or whole paragraphs from one place in the text to another.

Word processors have a number of features to facilitate text formation. These include justification, pagination, and special type faces, as well as automatic centering and margin setting. One special printing feature available on some word-processing systems is proportional spacing—which makes finished text appear as if it were typeset and printed. This is useful to businesses producing manuals and other documents.

Efficient mass mailing is a benefit that a word processor can provide to a business user. In this application, both the mailing list and the form letter are stored in the processor. These are then merged—that is, the form letter is retyped once for each entry on the mailing list, giving every letter a unique heading. The processor can also print the addresses on all of the envelopes.

How They Work. Basically, word processors are of three types. The one

whose appearance most closely resembles the familiar typewriter is called the electronic typewriter. Machines of this type, made by Savin, Adler-Royal and IBM, among others, look like typewriters, but are larger. On electronic typewriters the normal keyboard is augmented by a number of special keys allowing one to perform functions such as DELETE, INSERT, FIND, and STORE. These units usually have a built-in high-speed printing system instead of the usual typewriter mechanism.

Electronic typewriters use computer memory elements to store text. Some machines have enough memory to hold one or two pages of text, while others can store up to 50 pages. Electronic typewriters increase efficiency by performing in the memory all revisions, deletions, insertions, and other changes. Text is printed when in finished form.

Besides memory, electronic typewriters also use computer-type mass storage devices. These allow one to store the contents of the memory on permanent removable media. Thus, a user can keep a library of documents on file. The documents can be read back into the electronic typewriter from the mass storage devices at any time to make more copies or further revise the documents.

Some electronic typewriters, like the one available from Savin, use a magnetic tape cartridge—very similar to a cassette tape—for mass storage. Other units, like the one from Adler-Royal, use floppy disks.

Word processing on an electronic

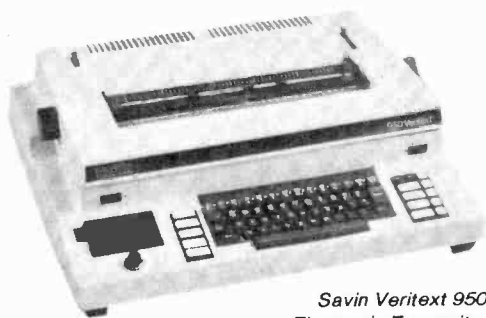

*Savin Veritext 950
Electronic Typewriter*

typewriter has the advantage of being easy to learn. Because the design and keyboard layout are similar to a standard typewriter, most operators find it easy to adjust to an electronic one. Since each major word-processing function is performed by pressing one of the clearly-marked buttons on the keyboard, using it for word processing is easy. Electronic typewriters are also relatively compact and easy to move.

One disadvantage, however, is that their input and output are printed directly onto the paper. This means the machine must retype a whole document when you want to see the changes you have made. This is time-consuming, even with a high-speed printer.

Some word processors avoid the problem of retyping by using a video monitor instead of paper to develop and correct documents. There are two such types—dedicated word processors that, like electronic typewriters, perform only functions associated with word processing; and small business and personal computers that perform many general computing functions in addition to word processing. The first word processor to use a video monitor was a dedicated word processor developed by Lexitron, called a videotyper.

When text is entered through the keyboard into memory, it appears on the monitor, and changes in the text appear as soon as they are made. Since most video monitors display a full page of text at a time, it is possible to see fairly extensive changes—such as the moving of whole paragraphs—immediately.

Like electronic typewriters, dedicated word processors use computer technology. A microprocessor controls all important functions, memory is used for storing text, and mass storage devices are used to create permanent, removable records. Dedicated word-processing units are generally larger than electronic typewriters and have a separate printer.

Because they are designed for use in business environments with high work volumes, dedicated word processors incorporate a number of features that help to increase throughput. Many systems, for example, allow the operator to type in a new document while a completed document is being printed.

Manufacturers of dedicated word processors also strive to enhance productivity by making their systems easy to use with a minimum of training. Thus, like electronic typewriters, most dedicated word processors have additional keys to perform those functions that are used most frequently. Operators are assisted by prompts on the video monitor that ask what the user wants, and tell what commands are necessary to accomplish the task.

DIRECTORY OF SOFTWARE VENDORS

Vendor & Address	Product	Target Computers
Apple Computer, Inc. 10260 Bandley Dr. Cupertino, CA 95014	Apple Writer	Apple Computers
Atari Inc. 1265 Borregas Ave. Sunnyvale, CA 94086	Atari Word Processor	Atari 800 with disk
Commodore Business Machines, Inc. 950 Rittenhouse Road Norristown, PA 19401	WordPro 1 WordPro 2 WordPro 3	Pet Computer
Cal Data Systems Box 178446 San Diego, CA 92117	Word Magic	TRS-80
Cromemco, Inc. 280 Bernardo Ave. Mountain View, CA 94040	Cromemco Word Processing System	Cromemco Computers
Digital Research Box 579 Pacific Grove, CA 93950	TEX	Any with CP/M
Digital Marketing 2670 Cherry Lane Walnut Creek, CA 94596	Copywriter	Any with CP/M
Interactive Microware, Inc. 116 S. Pugh St. State College, PA 16801	Pro-Type	North Star
Michael Shroyer Software 1198 Los Robles Dr. Palm Springs, CA 92262	Electric Pencil Electric Pencil II	Any with CP/M
MicroPro International 1299 4th St. San Raphael, CA 94901	WordStar, WordMaster	Any with CP/M

Advantages of dedicated word-processing systems are efficiency, capacity for very high throughput, and ease of use. The disadvantages are a relatively high price and little or no general computing capability.

Many businesses that require both word-processing and general-computing capability find the most cost-effective solution in a general-purpose business

computer that provides word processing through software. This is also an economical solution for owners of personal computers who want word processing. The necessary software is available for most popular personal and small business computers, including Apple, Pet, Heath, TRS-80, and Vector Graphic, among others.

When you develop a word processor

Vector Memorite Small Business System

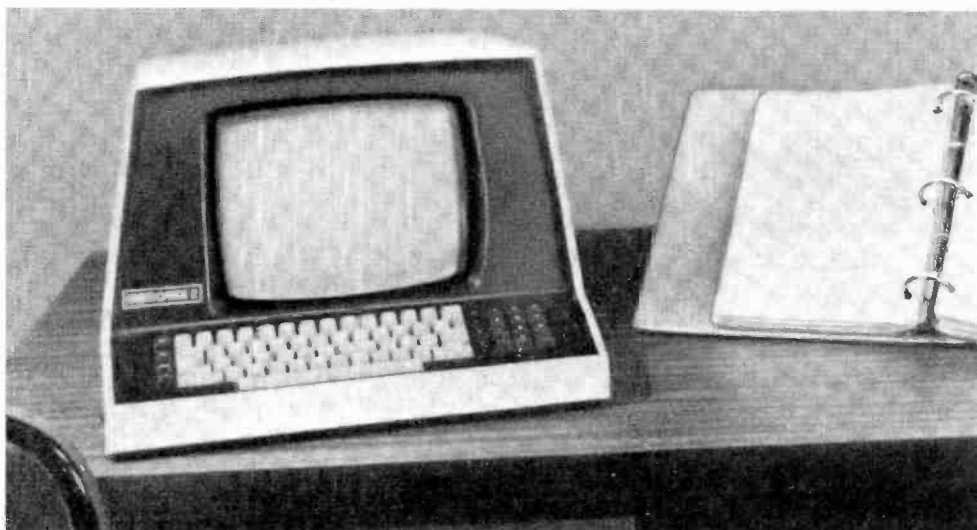

MicroSource 1425 W. 12th Pl. Tempe, AZ 85281	AutoScribe	North Star Computers.
Muse 330 N. Charles St. Baltimore, MD 21201	Super-Text	Apple II and Apple II Plus
North Star Computers 1440 Fourth St. Berkeley, CA 94710	North Word	North Star
Ohio Scientific Inc. 1333 S. Chillicothe Rd. Aurora, OH 44202	WP-3	OSI Systems
Radio Shack 1400 One Tandy Center Ft. Worth, TX 76102	ScripSit	TRS-80
R&B Computer Systems 1954 E. University Tempe, AZ 95281	Benchmark	CP/M, North Star
Small Business Applications 3220 Louisiana St. Suite 210 Houston, TX 77006	Magic Wand	CP/M compatible
Software Dynamics 2111 W. Crescent, Suite 9 Anaheim, CA 92801	Edit	Any based on 6800 series processors
Supersoft Assoc. Box 1628 Champaign, IL 61820	Super-M-List	CP/M compatible
Vector Graphics, Inc. 31364 Via Colinas Westlake Village, CA 91362	Memorite III	Vector Graphic computers
Zenith Data Systems Corporation 1000 Milwaukee Ave. Glenview, IL 60026	AutoScribe	Heath computers

using a general-purpose computer and commercial software, there arise a number of hardware and software considerations to examine in detail. Instead of leaving the design up to the manufacturer, as you do when buying a dedicated system or electronic typewriter, you must now decide how much memory and mass storage to include, what printer to use, and what software package provides

the capabilities that most closely meet your needs.

Configuring the Hardware. In general, most small business and personal computer systems have the same basic hardware components. And most use the same type of video monitor for operator interaction. All can interface with various types of printers.

One important decision that must be made is how much memory the computer will have. For word processing, each byte of memory can store one character; and most personal and small business computers have memory capacities in the range of 4,096 (4K) to 65,536 (64K) bytes. The best results invariably come from having as much memory as you can afford.

While some systems, like the Pet and TRS-80, will function as word processors with as little as 16K of memory, most word-processing software requires a minimum of 48K, and 64K is even better if your machine will accept it.

There are several reasons for this. First, the computer's memory must hold not only the document you are typing in, but also the word-processing software and the computer's operating system. If a document is too long to fit into the computer's memory, parts of it must be saved on a mass-storage device, which slows operation considerably. Second, the large memory will increase efficiency of other computing tasks as well.

Mass storage is another important hardware feature. Most computer manufacturers offer a number of choices for mass storage, including data cartridges, standard cassette tapes, floppy disk drives, minifloppy disk drives and Winchester hard disk drives. The storage capacity, speed, and price of these devices varies greatly, and your choice will depend on your own requirements.

Data cartridges and cassettes are called serial storage devices. (This means data is written on and read from these devices sequentially.) Their main advantage is low cost. A principal disadvantage is slowness: if the data you need is at the end of a cassette you may have to rewind a large amount of tape to access that data.

There are also several types of disk storage devices available for computer-based systems. They cost more than cassettes, but provide random access to data anywhere on the disk surface. This helps to enhance overall system speed for both word processing and general computing.

Among the several types of disk storage devices are floppy and minifloppy disks—8" and 5 1/4" in diameter, respectively. Storage capacity varies from about 90K bytes for the minifloppy to about 1 million bytes for the 8" disk. Since several disk drives can be used, it is possible to include several million bytes of mass storage in a single system.

Winchester hard disks are another type of rotating, random-access storage device. Unlike floppies, they are not removable. They do, however, offer very high storage volumes (from 5 million to about 35 million bytes) and very fast

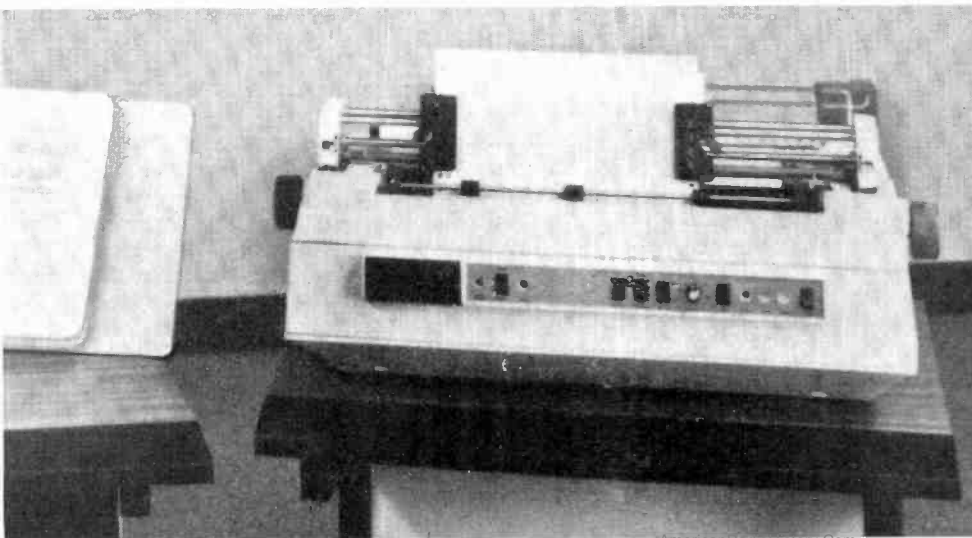

data access. Available in 5¼", 8", and 14" diameters, their capabilities can greatly enhance overall system response. For most word processing, however, they represent costly overkill.

One of the most critical hardware components is the printer. There are two basic types used with small computer systems. In one, the dot matrix printer, characters are formed with a pattern of dots. The most common grid size for each character is 7 by 9 dots. Dot matrix printing speeds range from about 120 characters per second (cps) to about 200 cps. Costs range from about \$500 to \$1200.

The other type of printer common to small business systems is called a formed-character printer. Like a typewriter, it works by striking type against a ribbon. Formed-character printers are slower than dot matrix printers, usually printing between 25 cps and 55 cps. Prices for them are generally higher than for dot matrix printers, ranging from about \$1800 to \$3500. Their print quality, however, is superior.

Print quality in dot matrix printers is far below that of the standard office typewriter. A dot matrix printer is adequate for rough drafts, but it simply cannot produce the letter quality required for business. Formed-character printers not only provide letter quality printing, but also allow very precise control of the printing function. In many formed-character printers, the computer can move the print head in increments as fine as 1/120 of an inch horizontally and 1/48 inch vertically. This allows a system to do subscripting, superscripting, and to produce boldface printing by overstriking characters with very slight shifting of the print position. One can also perform proportional spacing of characters—giving finished documents the look of typeset printing.

For the comfort and convenience of operating personnel, the keyboard is a hardware component worth considering. Each computer manufacturer usually offers only one keyboard, and each has its own distinct feel. System efficiency

depends, to a point, on operators being comfortable with the keyboard.

Choosing Software. The most crucial decision in word processing is selection of a software package. A wide variety is available from computer manufacturers and independent software sources. Word-processing packages range from relatively simple programs with only the basic functions, to more extensive packages rife with special features and capabilities.

Most makers of personal and small business computers offer word-processing packages. Apple's, for example, is called Apple Writer; Commodore has three packages called WordPros 1, 2, and 3; Heath sells the AutoScribe package under license from Zenith Data Systems Corporation; Radio Shack's TRS-80 uses a package called ScripSit; and Vector Graphic offers very comprehensive software called Memorite III.

As indicated by the Table such packages are also available from numerous independent vendors.

When comparing word-processing software it is important to remember that any given package may perform differently on different computers. One that gives fast response on a computer with 64K of memory may run much more slowly on a computer with only 48K of memory. Likewise, a package that must make extensive use of mass storage will probably run much faster when used with a system that contains a Winchester hard disk than on a system that uses floppy disks.

Beyond Word Processing. The leading edge of word-processing technology seems to be evolving toward a new generation of software and hardware. Already, sophisticated software packages offer enhancements that extend the power of word processors. Vector Graphic's Memorite III, for example, is compatible with a computer-based dictionary that checks text for spelling at a rate of about 1,000 words per minute. The spelling-verification program reads

files created by Memorite III, comparing text to a dictionary of the 30,000 most commonly-used words, plus 5,000 "spelling demons." Further, one can augment the main dictionary with custom dictionaries that recognize special words and proper names. MicroPro International reports that its word-processing package, WordStar, will soon include a spelling verification system.

Advances in software technology extend far beyond spelling verification and computer-aided instruction. As business embraces the evolving office of the future, word-processing software is continually developing to meet the challenge of integrating word processing and data processing. MicroPro, for example, offers a system of compatible software packages that perform data acquisition, data manipulation, word processing, and automated personalized mailing. Vector Graphic also offers combined word- and data-processing capability. The Memorite III software is compatible with Vector Graphic's EXECUPLAN software that allows one to perform statistical calculations, format formulas, and develop tables and charts. The files created by EXECUPLAN can be read by Memorite III, permitting their automatic merger into coherent documents.

As word processing and data processing begin to overlap, communication between word- and data-processing hardware becomes important. Many word-processing vendors are paying close attention to these requirements. Vendors are offering standard asynchronous, synchronous, and bisynchronous communications interfaces. Some vendors offer compatibility with communications networks. Lexitron's word processors, for example, can communicate on Raytheon's Raynet. Many vendors are now studying the requirements for Ethernet and other communication networks under development.

What is the potential for increased productivity and greater efficiency through integrated office systems? Vector Graphic Board Chairman Bob Harp sums it up: "Future word-processing systems will be clustered, able to share a central data base or function stand-alone. In a large installation with multiple systems sharing one or more common data bases, a secretary might develop a document on a word-processing system and send a message to her supervisor's video monitor saying the document is available for proofreading. The supervisor could then proofread and edit the document on the video monitor and send the edited document to the central processing unit for printing. The entire process could be conducted without using a single piece of paper until the final document is printed." ◇



Lexitron VT 1303
Word Processing System



Turn your Apple into the world's most versatile personal computer.

The SoftCard™ Solution. SoftCard turns your Apple into two computers. A Z-80 and a 6502. By adding a Z-80 microprocessor and CP/M to your Apple, SoftCard turns your Apple into a CP/M based machine. That means you can access the single largest body of microcomputer software in existence. Two computers in one. And, the advantages of both.

Plug and go. The SoftCard system starts with a Z-80 based circuit card. Just plug it into any slot (except 0) of your Apple. No modifications required. SoftCard supports most of your Apple peripherals, and, in 6502-mode, your Apple is still your Apple.

CP/M for your Apple. You get CP/M on disk with the SoftCard package. It's a powerful and simple-to-use operating system. It supports more software than any other microcomputer operating system. And that's the key to the versatility of the SoftCard/Apple.

BASIC included. A powerful tool. BASIC-80 is included in the SoftCard package. Running under CP/M, ANSI Standard BASIC-80 is the most powerful microcomputer BASIC available. It includes extensive disk I/O statements, error trapping, integer variables, 16-digit precision, extensive EDIT commands and string functions, high and low-res Apple graphics, PRINT USING, CHAIN and COMMON, plus many additional commands. And, it's a BASIC you can compile with Microsoft's BASIC Compiler.

More languages. With SoftCard and CP/M, you can add Microsoft's ANSI Standard COBOL, and FORTRAN, or

Basic Compiler and Assembly Language Development System. All, more powerful tools for your Apple.

Seeing is believing. See the SoftCard in operation at your Microsoft or Apple dealer. We think you'll agree that the SoftCard turns your Apple into the world's most versatile personal computer.

Complete information? It's at your dealer's now. Or, we'll send it to you and include a dealer list. Write us. Call us. Or, circle the reader service card number below.

SoftCard is a trademark of Microsoft. Apple II and Apple II Plus are registered trademarks of Apple Computer. Z-80 is a registered trademark of Zilog, Inc. CP/M is a registered trademark of Digital Research, Inc.

MICROSOFT

CONSUMER PRODUCTS

Microsoft Consumer Products, 400 108th Ave. N.E.,
Bellevue, WA 98004. (206) 454-1315

CIRCLE 37 ON READER SERVICE CARD

Only from NRI! Complete home entertain in one fast-track home-



ment electronics service study course.

Only NRI gives you so much training for your money. Look what you learn to service...

Color TV	Musical Instrument
Black & White TV	Amplifiers
Portable TV	AM/FM Tuners
Videotape Recorders	Tape Recorders
Video Disc Players	Speaker Systems
Cable TV Equipment	Record Players
Public Address Systems	Auto Radio
Portable Radios	Antennas
	Auto Stereo
	Microprocessor Controls
	Electronic Fire & Burglar Alarm Systems
	and more!

Master the world of entertainment electronics with training from NRI. Only NRI gives you so much in a single, unified course. You're prepared to enter this lucrative field at any point, specialize or be a generalist. From computer-controlled TV to videotape recorders to laser beam video disc players, NRI training is complete.

Learn at Home in Your Spare Time

And you learn right at home, at your convenience, without quitting your job or wasting time and gasoline going to night school. NRI "fast-track" training makes learning easier...NRI "hands-on" projects give you practical bench experience as you progress. You not only get theory, you actually build and test electronic circuits, equipment, a complete audio system or color TV.

Computer-Programmed TV, Videotape Recorder, or Stereo

As part of your training, you assemble and keep NRI's 25" (diagonal)

color TV. It's complete with built-in digital tuning that lets you program an entire evening's entertainment. As you build it, you study circuit operation stage by stage, see how electronic faults can be detected and corrected, get practical bench experience that gives you extra confidence.



Training Equipment and instruments included...yours to keep.

Or, as your practical experience project, you can elect to construct NRI's solid-state tuner and amplifier, complete with speakers. Or train with a fine videotape recorder. Any way you choose, you keep all equipment, get all 67 lessons covering home electronics completely.

Professional Instruments Included

Your training also includes the NRI Discovery Lab[®] where you'll build and study electronic circuits, perform practical experiments that make theory

come alive. You'll get professional instruments, too, like the 6-function, 26-range Beckman LCD digital multimeter. And as you assemble your TV, you even build key instruments so you know them from the inside out...a digital CMOS frequency counter, 5" solid-state oscilloscope, and a 10-function integrated circuit TV pattern generator.

NRI Training the Choice of the Pros

More than 60 years and a million students later, NRI is still first choice in home-study schools. A national survey of successful TV repairmen shows that more than half had home-study training, and among them, it's NRI 3 to 1 over any other school. We'll be happy to send you the survey summary on request. Find out how NRI can work for you.

Send for Free Catalog... No Salesman Will Call

Send today for our free 100-page catalog which shows all the equipment and instruments, complete lesson plans, opportunities in this wide-open field, and convenient time payment plans to fit your budget. Or explore other NRI opportunity courses like Microcomputers and Microprocessors, Communications Electronics, Electronic Design Technology, or Digital Electronics. Send the postage-paid card today and see what "complete" really means. If card has been removed, please write to us.



NRI SCHOOLS
McGraw-Hill Continuing
Education Center
3939 Wisconsin Ave.
Washington, D.C. 20016

We'll give you tomorrow.

BY STAN PRENTISS

VHS MEETS BETA



How the two basic formats for video cassette recorders compare in operation

AS IS well known by now, there are two major competing VCR systems on the market today. The Zenith VR9750J Beta and the Panasonic PV-1750 VHS are representative of the newest versions of each. While the two formats are similar in many respects, VHS and Beta are different enough to be mutually incompatible.

Both systems use a rapidly rotating head cylinder to helically scan a slow-moving magnetic tape, and both offer a similar array of ancillary features—e.g., remote control, a 14-day clock timer, frame advance, etc. Their electronic underpinnings are also similar in that both change the AM of a normal television signal to FM when a program is recorded. The color signal is down-converted to 629 kHz for VHS and 688 kHz

for the Beta so that the 18-octave, video frequency range (30 Hz to 4 MHz) can be relocated between 2 and 6 MHz, where it represents less than 2 octaves. Audio remains standard FM. Tapes are half-inch, and the azimuth of the record/play heads is tilted to minimize adjacent track pickup. Servo sync controls and direct-drive motors for capstan and head drives are still used. In both of the models tested, tuners are of the voltage-controlled varactor type with pushbutton controls.

Both machines are similar in overall complexity, so service costs will no doubt be comparable. Users should not be surprised to pay about \$150/year for service—heavy users, perhaps more. Those who try getting by with some of the “easy” trick head cleaners just com-

ing onto the market could face \$200 charges for new head assemblies. If you attempt to clean these recording/playback heads yourself, use only materials specifically recommended by the manufacturer. There's no reliable shortcut!

In both systems there is an approximately 3-dB signal loss between input and output, and another 1 to 5 dB loss across any 75-ohm vhf couplers and u/v signal splitters in the signal path. Those in areas of poor reception could have a problem. Thus, their equipment works best direct-coupled to an antenna.

Perhaps the most obvious difference between the two formats is the tape-transport mechanism. The VHS tape is wrapped only halfway around the head cylinder, and is completely removed from head contact when the tape is

Gain instant access to over 1,000 information and communication services for only \$15 an hour.

It's all at your fingertips when you join **THE SOURCE**,SM America's Information Utility.

The Source will improve the efficiency and reduce the expenses of your entire organization by giving you access to services that run the gamut. From electronic mail and hotel reservations to stock reports and a discount buying service. And you can gain access to The Source from almost any microcomputer, communicating word processor, or data terminal.

Source Mail™ is faster than U.S. Mail and less expensive than most long distance calls.

Source Mail is an electronic mail system that lets you send messages to anyone in the world who is a Source subscriber. Communicate with your field offices or sales staff around the country. Send messages to over 200 people simultaneously, and receive timely sales or status reports — if you wish, in hard copy form.

You can also use Source Mail to forward your mail to others with comments, store correspondence, and have your messages electronically scanned for spelling errors.

You can "chat" interactively with other Source subscribers and automatically get a printed record of the entire conversation.

Streamline your business operations.

Just feed The Source your figures and it will calculate your taxes, cash-flows, equity capital, lease vs. purchase of equipment, loan amortizations, the annual interest rate on installment loans, produce depreciation schedules and much, much more.

You can even write and store your own programs in The Source using such computer languages as BASIC, COBOL, FORTRAN, RPG II and assembly language. And, of course, we give you a private access code so that the programs and information you input into The Source are secure.

Use The Source as your electronic travel agent.

The Source gives you instant, specific national and international flight schedule information. And through the exclusive Travel Club™ you can use The Source to order airline tickets, rent a car and make your hotel reservations.



The Source also gives you access to the complete Mobil Restaurant Guide. So you can get in-depth reviews and recommendations on some 5,000 restaurants in thousands of localities across North America.

Get instant access to the stock market.

Whatever your investments — stocks, bonds, mutual funds, treasury bills, commodities, futures, precious metals, and more — The Source can give you investment information 22 hours a day. We

even go beyond mere financial reporting to give you economic, business and financial commentary from economists and securities analysts.

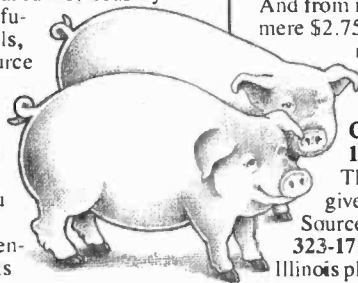

Get news hot off the UPI wire.

Now, no matter what's happening around the world or around the corner, you can find out about it straight from United Press International. And you can get any specific information you need simply by using our unique "keyword" access. Get the latest news on the prime lending rate. If you've heard an industry rumor, get the facts. If there's a conflict in a foreign country where you do business, find out about it.

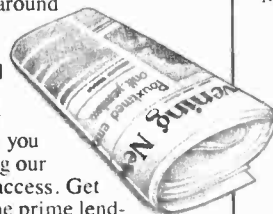

And that's only a fraction of what The Source can do.

Every one of these services alone is worth the remarkably low cost of a Source subscription. But there's so much more. The Source has an electronic personnel search network. It lets you barter your goods and services with other businesses. Find out current international monetary exchange rates. Order over 20,000 business or consumer items at discount prices. Order a printed document from anywhere in the world or request a complete research report on any topic. Manage your stock portfolio. Get a statistical analysis of consumer trends, potential markets, and much more.

And we're constantly adding new information and communication services.

Anyone can use The Source.

You don't have to know any computer language or have any programming skills to utilize The Source. It operates on simple, logical English commands and comes with a complete user's manual, master index and private access code. And you have local telephone access to The Source from over 300 U.S. locations.

You know an incredible bargain when you see one.

The Source is one of America's great business buys. For all the communication and information services you receive, all you pay is a \$100 one-time subscription fee and \$15 per hour during the business day when you are actually using The Source. From 6 p.m. to midnight, The Source is just \$4.25 per hour. And from midnight to 7 a.m. you pay a mere \$2.75 per hour! There is also a \$10 monthly minimum usage charge.

Call Toll-Free for 16-page Source Brochure.

This free, full color brochure will give you complete details on The Source. To order it just dial 1-800-323-1718 and ask for Operator 91. In Illinois phone 1-800-942-8881, Operator 91. Or if you prefer, mail us the attached coupon. If someone has beaten you to the coupon, call the above number or write The Source, 1616 Anderson Road, McLean, Virginia, 22102.

THE SOURCE
AMERICA'S INFORMATION UTILITY

Department TB-5
1616 Anderson Road,
McLean, Virginia 22102

— Please send me/my company your comprehensive 16-page brochure on The Source. I understand I am under no obligation.

Name (please print clearly)

Company

Address

City/State/Zip

— We need The Source for more than one location. Please contact us with quantity discount information.

THE SOURCE is a service mark of Source Telecomputing Corporation, a subsidiary of The Reader's Digest Association, Inc.

stopped. Beta uses a 360° full-head wrap which is in constant contact with the head cylinder. Tape wear for both systems, however, is about the same.

Cassette sizes are also different. VHS is slightly larger and holds more tape. Thus, the maximum playing time for VHS is six hours, compared to five hours for the Beta format.

Zenith/Betamax. The Zenith VR 9750J player/recorder has a number of features in common with last year's VR9700. These include "feather touch" external 14-channel tuning control; five hour maximum recording and playback during manual or programmed operation; speed-search forward and reverse at 7x for Beta II and 10x for Beta III; still picture in the stop (or pause) mode, with automatic release after five minutes to prevent undue tape or head wear; improved audio bandwidth; and a remote control for the tape transport.

The VR9750J, however, has additional features. Instead of two recording heads, it has three. As in the VR9700, the two prime heads are spaced 180 degrees apart and positioned at +7° and -7° azimuth. The third head is next to one of the other two, but with reversed azimuth. It is used only in stop action and slow motion. This arrangement makes possible dual scanning of a single field to make a two-field frame. This reduces extraneous movement. VHS, in contrast, scans both fields, allowing motion in the stop action frame.

Also, Zenith claims there is less noise in the new Beta machines. Since the heads are 27 micrometers wide and the tracks measure only 19 micrometers, there is sufficient overlap to cover the entire track without loss of picture. Further, the new model has additional integrated circuits for slow-motion control, as well as more delay lines. There are comb filters for both chroma and luminance, which should further clean up any color-video crosstalk and, theoretically, widen the luminance passband. Head life, we are told, should be at least 2,000 hours, even with heavy use, and some heads are known to have lasted as long as 8,000 hours. An external thumb-wheel potentiometer is now included to augment two internal adjustments: one for Beta II and the other for Beta III. Identified as the BRIGHTNESS BALANCE control, it is used only in the stop-field mode to minimize picture flicker. Zenith recommends setting up for minimum flicker in the display's center, rather than along the edges.

There is also a vertical sync lock control directly above the 75 - ohm video output on the unit's rear terminal board. During still mode, frame advance and slow motion, an internally generated

vertical drive pulse appears with the video signal. This sync control adjusts the phase of the pulse to prevent the picture from rolling or flipping when there is noise in the vertical interval.

Two additional features are worth

noting: slow motion tracking and automatic tape rewind. Normal tracking controls the phase (and therefore rpm) of the capstan motor in Beta II. Since capstan speed is 50 percent slower in Beta III, a separate thumbwheel control

**LABORATORY DATA
PANASONIC PV-1750**

Parameter	Measurement
SP baseband (monitor) playback response:	3.5 MHz
SLP baseband (monitor) playback response:	3 MHz
SP TV playback through modulator:	3.5 MHz
SLP TV playback through modulator:	3 MHz
SP/SLP TV chroma response through modulator:	4.08 MHz/6 dB down
Tuner/system input sensitivity (before snow):	vhf: -4.5 dBmV uhf: -0.5 dBmV
S/N at modulator output (Ch. 3):	SP: video: 49 dB SLP: video: 45 dB
S/N at modulator output (Ch. 3):	SP: audio: 30 dB SLP: audio: 28 dB
System signal loss, input to output: (Ch. 3 is recorder output)	vhf (Ch.6) in: -4.5 dBmV (Ch.6) out: -10 dBmV vhf (Ch. 6) in: -4.5 dBmV (Ch. 3) out: -9 dBmV uhf (Ch. 30) in: -0.5 dBmV (Ch. 30) out: -11.5 dBmV uhf (Ch. 30) in: -0.5 dBmV (Ch. 3) out: -9 dBmV
Wow/flutter:	Not discernible
Audio via TV receiver speaker and modulator (ballpark, but not a precise measurement at 3 dB down):	SP: 200 Hz to 3.5 kHz SLP: 300 Hz to 3 kHz
Power requirement (ac varied from 105 to 130 V):	62 W

**LABORATORY DATA
ZENITH VR9750J**

Parameter	Measurement
Beta II, III baseband (monitor) playback response:	3 MHz/10 dB down
Beta II, III TV playback through modulator:	3 MHz/10 dB down
Beta II, III baseband (monitor) chroma response in playback:	4.08 MHz/3 dB down
Beta II, III TV chroma response through modulator:	4.08 MHz/6 dB down
Tuner/system input sensitivity (before snow):	vhf: -6 dBmV uhf: -3 dBmV
S/N at modulator output (Ch.3):	Video: 49 dB Audio: 36 dB
System signal loss input to output:	vhf (Ch. 6) in: -6 dBmV (Ch. 6) out: -10.5 dBmV vhf (Ch. 6) in: -6 dBmV (Ch. 3) out: -8.5 dBmV uhf (Ch. 30) in: -3 dBmV (Ch. 30) out: -13 dBmV uhf (Ch. 30) in: -3 dBmV (Ch. 3) out: -8.5 dBmV
Wow/flutter:	Not discernible
Audio via TV receiver speaker and modulator (ballpark, but not a precise measurement for both Beta II and III at 3 dB down):	200 Hz to 3.9 kHz
Power requirement (ac varied from 105 to 130 V):	55 W

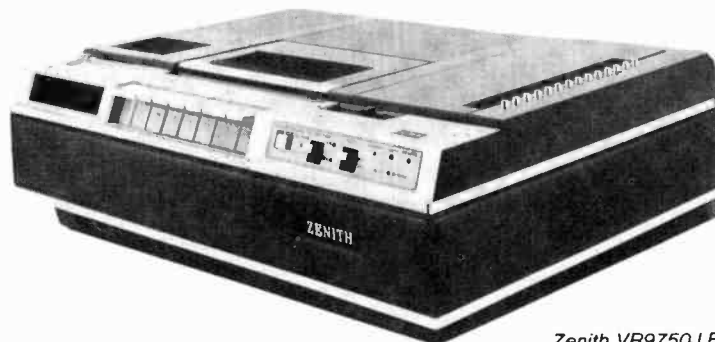

Zenith VR9750J Beta

**MANUFACTURER'S
SPECIFICATIONS
PANASONIC PV-1750**

Recording system: Two heads record; four heads playback; one pair for SP; one pair for LP/SLP

Programmed timer: Microprocessor controlled for 14-day, 8-program timer, including one daily repeat

S/N for video: >40 dB

S/N for audio: >40 dB (avg.)

Video/baseband input: 1 V/75 Ω

Audio input: RCA type: 100 kΩ; -20 dB
Microphone jack: 4 kΩ, -70 dB

Video output: RCA type: 1 V/75 Ω

Audio output: RCA type: -6 dB, 600 Ω

Tape speed: SP: 3.335 cm/s

LP: 1.667 cm/s

SLP: 1.112 cm/s

Play time: Up to 6 hours with NV-T120 cassette

Speed search: 9 times normal speed

Audio frequency response:

SP: 100 to 8000 Hz

LP: 100 to 6000 Hz

SLP: 150 to 5000 Hz (10 dB down)

Dimensions: 18¹⁵/₁₆"W x 6³/₈"H x 14⁵/₈"D

Power requirement: 62 W

Weight: 33 lb

**MANUFACTURER'S
SPECIFICATIONS
ZENITH VR9750J**

Recording system: Two heads record; three heads playback; for stop mode and slow motion

Programmed timer: Microprocessor controlled for 4 separate programs daily over 14 days, plus daily or weekly repeats.

S/N for video: >45 dB

S/N for audio: >40 dB

Video/baseband input: +1 V to -0.5 V/75 Ω sync negative

Audio input: Mini jack: 100 kΩ; -10 dB
Microphone: 600 Ω, -60 dB

Video output: 1 V/75 Ω sync. negative

Audio output: <10 kΩ; -5 dB

Tape speed: Beta II: 2 cm/s

Beta III: 1.33 cm/s

Play time: Up to 5 hours with L830 cassette

Speed search: 7 times normal speed in Beta II
10 times normal speed in Beta III

Audio frequency response:

Beta II: 50 to 10,000 Hz

Beta III: 50 to 7000 Hz

Dimensions: 19¹/₂"W x 7¹/₂"H x 15¹/₄"D

Power requirement: 60 W

Weight: 36.5 lb

has been added so that the tape will be scanned correctly in playback, without unnecessary noise and streaking.

In play, fast forward, or record, the VR9750J offers an automatic rewind when the cassette tape is exhausted. A sensor detects the metal leader at the tape's end and activates a solenoid. After 5 seconds, the tape starts rewinding.

The PV-1750 VHS Panasonic. This is the newest and most elaborate Matsushita cassette product available. Like its competitors, this machine builds upon older technology. It is a four-head programmable VCR that plays for 2, 4, or 6 hours. Visual cue and revue are accomplished at 9x normal speed, and there is variable slow motion, double speed, and still (stop) frame with picture and frame by frame advance. According to Panasonic, it will record seven mixed programs per day and another one per week

during a 14-day period. It has "soft touch" control and direct drive for the head cylinder, capstan and two additional heads.

The PV-1750 automatically unloads when it is in the pause mode for five minutes. At reel's end, the machine will automatically rewind its tape. The one-hour timer has memory, and backup in case of power failure. Head widths are 70 and 90 micrometers for standard play (SP), and 26 and 31 micrometers for long play (LP) and super long (SLP). The usual input and output video and audio connections are provided.

Remote control is considerably more extensive than in the Beta format, comprising CHANNEL, CHANGE, REWIND, STOP, RECORD/PLAY, PAUSE, DOUBLE SPEED (x2), and FRAME ADVANCE, in addition to SEARCH and SLOW/FAST speed-variable control. The counter and memory are much the same as Zenith's, and

the usual audio dub is available in both machines. There is also a "dew" light to warn of excess moisture or temporary equipment lockup.

Analysis. Our favorite technique for evaluating the performance of a VCR is to put multiburst and swept chroma through its baseband camera input and monitor the output. We also monitored the r-f modulators that feed the TV antenna terminals. Conventionally, the test signals come from NTSC video generators, which are supposed to produce more exotic and precise waveforms than their sidelock counterparts, but, in this instance, we found the swept multiburst and chroma functions to be more suitable since they easily cover most of the luminance, linearity response and chroma between 0.75 and 4.08 MHz. In the displays that follow, the top trace is always the reference. The lower traces are actual baseband and r-f responses—the latter being processed through a high-quality Zenith television receiver with a 4-MHz video bandpass.

Figure 1 illustrates both staircase and multiburst between 0.75 and 3.5 MHz in the record mode of the Zenith/Beta equipment. You can see 3 MHz in the lower trace at about 6 dB down, while the staircase is reasonably linear with only minor overshoots. In Fig. 2, still during record, chroma passes nicely and there is good burst response on the back porch of the horizontal sync pulse.

In Beta II playback (Fig. 3), however, the 3-MHz baseband response drops sharply, and overshoots are even more pronounced. Beta III results (Fig. 4) are quite similar. Still in baseband, the Beta II waveform in chroma playback (Fig. 5) shows loss of amplitude in both the 3.08- and 4.08-MHz portions, and Fig. 6 for Beta III principally indicates additional noise riding on the chroma response. There is, of course, some amplitude modulation apparent on the chroma displays in both Fig. 5 and Fig. 6.

For most VCR users, Figs. 7 and 8 are, by far, the most important, since they are taken at a receiver's video detector. As you see in Fig. 7, there is only a faint suggestion of 3-MHz multiburst showing, followed by an odd rise in the wave form, and then both symmetrical preshoots and overshoots on the staircase (which, by the way, are actually designed into the receiver's i-f's for accentuated light-to-dark transitions). Throughout Fig. 8 there is additional fuzziness in the swept-chroma information, and the 4.08-MHz portion is well down in amplitude compared to what it should be.

In Fig. 9, you see the marvelous detail produced by our Tektronix 7L12 spectrum analyzer. At 300-kHz resolution,



Panasonic PV-1750 VHS

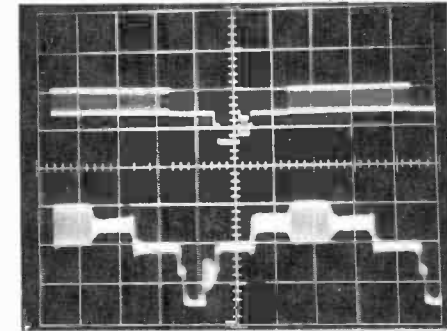
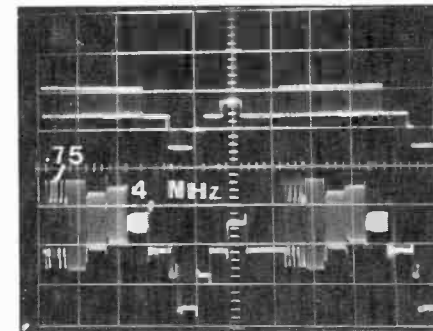
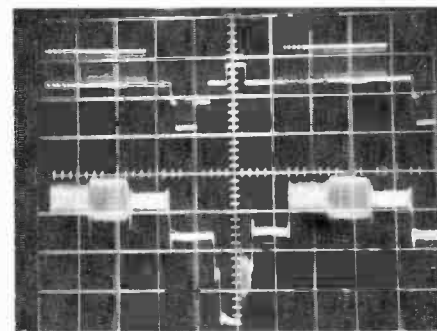
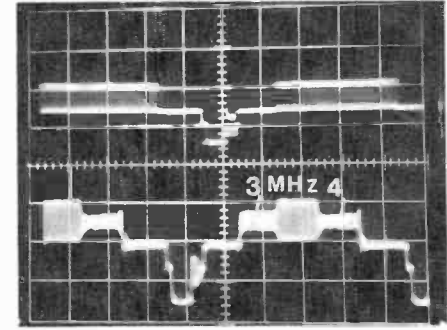
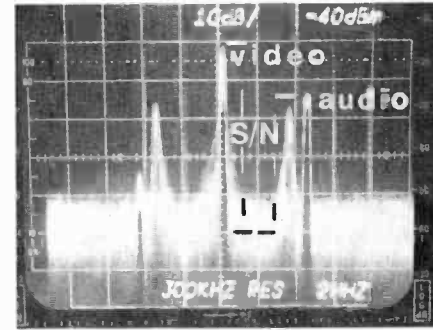
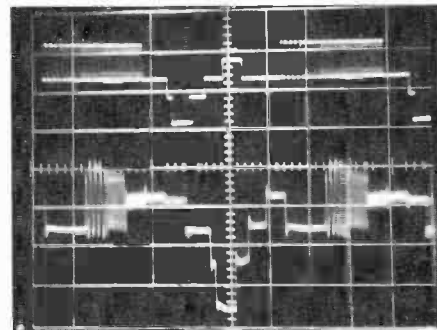
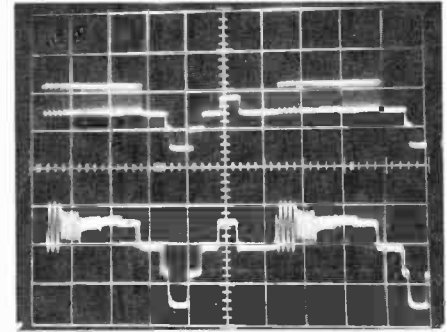
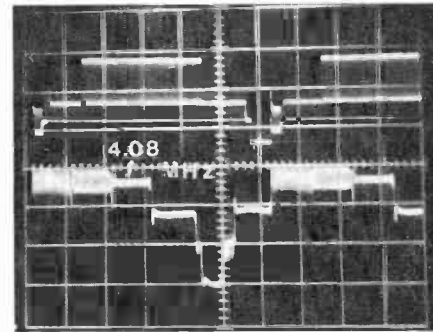
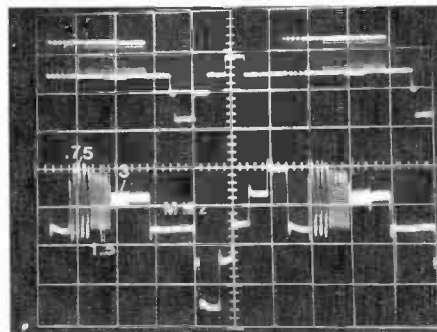
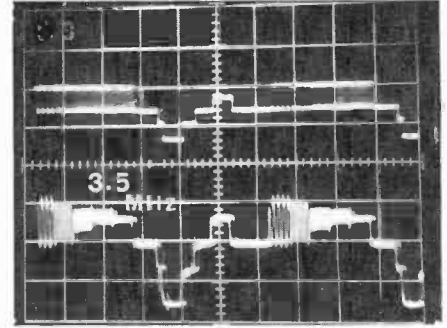
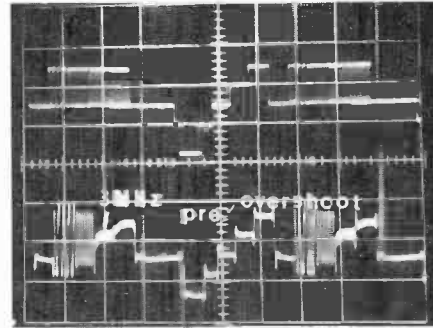
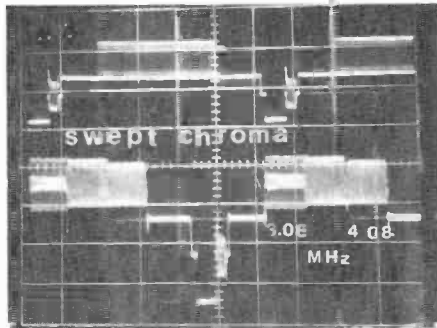
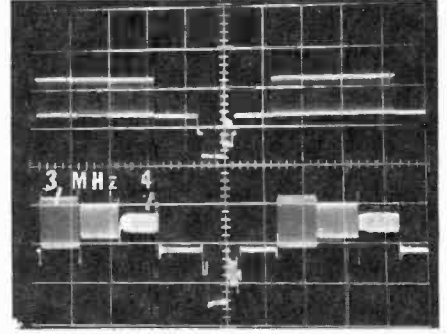
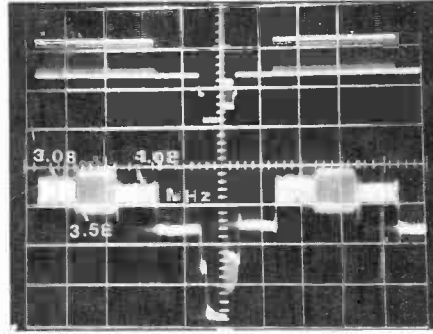
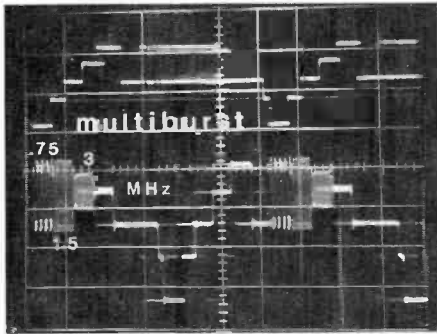

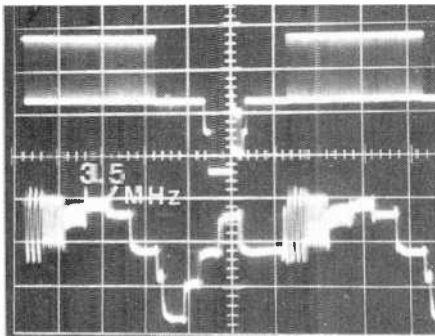

16

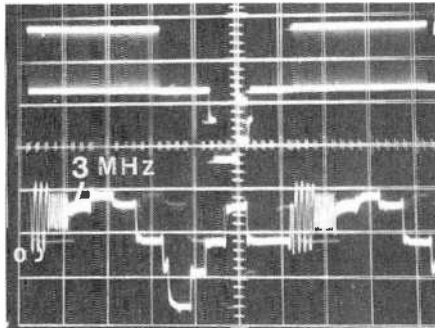

17

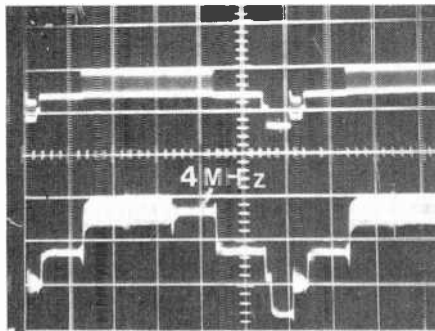

18

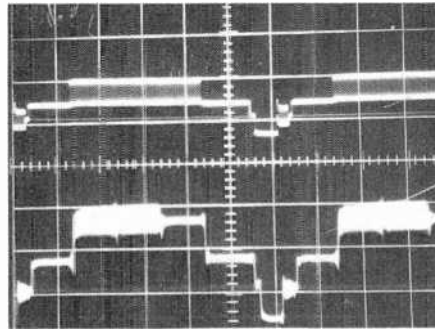

19

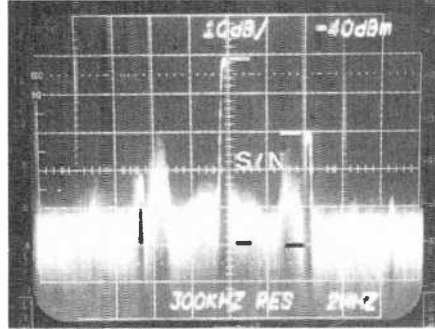

20

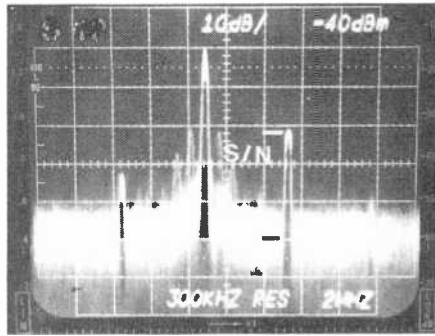

21

Figures 1 through 9 on the opposite page are performance characteristics for the Zenith/Beta system. Figure 1 is multiburst response during record; Fig. 2 still during record is swept chroma. Multiburst baseband response during playback for Beta II and Beta III are in Figs. 3 and 4; with similar chroma playback baseband in Fig. 5 (Beta II) and Fig. 6 (Beta III). Beta II/Beta III multiburst playback through the modulator is shown in Fig. 7 with swept chroma response in Fig. 8. Figure 9 is a spectrum analyzer display of the Beta's audio and video carriers at antenna terminals. Figures 10 through 21 are for the Panasonic PV-1750. Figures 10 and 11 are responses in luminance and chroma in record mode and SP. Baseband for SP and SLP are in Figs. 12 and 13, with swept chroma in Figs. 14 and 15. Figures 16 and 17 are responses through the r-f modulator for SP and SLP, while Figs. 18 and 19 are the same for swept chroma. Figures 20 and 21 are spectrum analyzer displays for the SP and SLP modes.

2-MHz per horizontal division and 10-dB per vertical division, and $-40 (+5.72)$ dBm down, you see the video carrier and its two sidebands and the unmodulated audio carrier on the right. With the noise center as reference, the video carrier has a S/N ratio of 49 dB, while the audio carrier shows 36 dB.

The Panasonic PV-1750 waveforms, Figs. 10 through 16, precisely match those for Beta. However, since there are some additional differences between SP and SLP that require illustrating, the Panasonic group continues to Fig. 21.

Figures 10 and 11 show good responses in luminance and chroma out to 4 MHz with the player in record mode in the SP position. As you can see, most of these are exceptional. Figures 12 and 13 are SP and SLP, respectively, with 3.5 MHz plainly visible in SP, and only about 3 MHz in SLP at baseband via camera and video input/output. Figures 14 and 15 show relatively little difference in swept chroma, except that the 4.08 MHz seems to be down a bit more. In Figs. 16 and 17, responses through the r-f modulator into the TV receiver are exceptional for a VCR, as are the other parameters, including a slightly distorted (rounding) staircase. Figures 18 and 19 show swept chroma passing through the modulator, with the 4-MHz portion, well down, as is to be expected. Figures 20 and 21 are spectrum analyzer displays for the SP and SLP modes. Observe that the S/N ratio is 49 dB for SP video and 30 dB for audio. In SLP, video drops to about 45 dB, and audio drops to 28 dB.

Conclusions. Both units represent an improvement over their respective predecessors. Images are more distinct, noise is reduced, control flexibility and range are enhanced, and record/play times are considerably longer than they were a few years ago.

But between the formats there are real differences. Beta has an audio S/N ratio about 5 or 6 dB better than VHS, and a frequency response extending to about 10 kHz. VHS, on the other hand, has a wider video bandpass, a video S/N ratio comparable with that of Beta, more program selections, and many more remote-control functions. VHS also plays an hour longer in extended play and has a lighted moisture (dew) sensor. Of course, if your receiver bandpass is too limited, the extra bandwidth of the Panasonic VHS player is of no practical consequence.

The absolute contest between the two systems would be a hookup with your own TV. Both units tested here are of superior quality. The decision as to which type of player is more suitable for you is yours alone. \diamond

SOME LIKE IT HOT...

*But which ones?
Test your knowledge of
how circuit components respond
to temperature.*





SOME electronic components, especially semiconductors, are extremely sensitive to temperature changes. Even passive components (resistors and capacitors, for example), which are normally insensitive to temperature variations, can undergo parameter changes that are sometimes sufficient to influence circuit behavior.





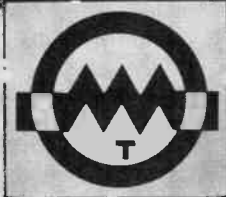
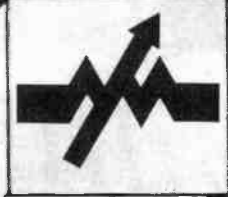
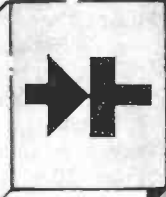

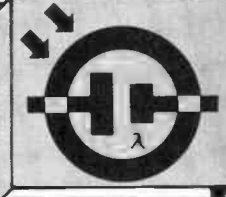
Here is a quiz that will check your knowledge of how the parameters of

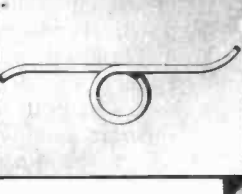
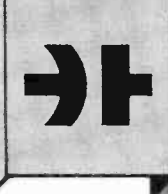
some common electrical components (as well as a few rare ones) change with temperature. The quiz gives you the common name and electrical symbol or pictorial representation of the components and the parameters of interest under temperature change (resistance, voltage, etc.).

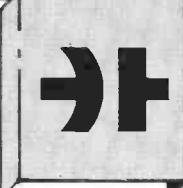
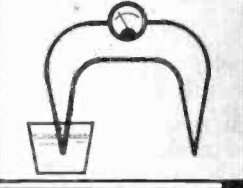
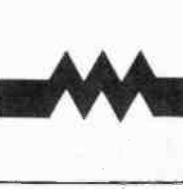
Your task is to answer the following questions about each component: (A) Does the parameter of interest increase

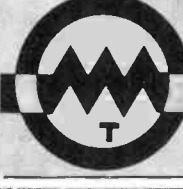
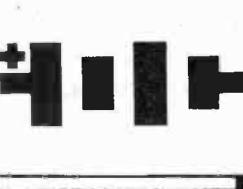
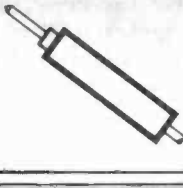
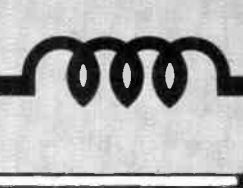
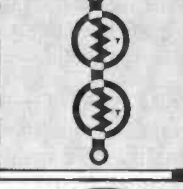
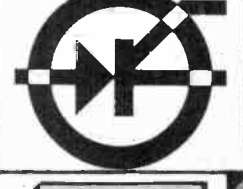
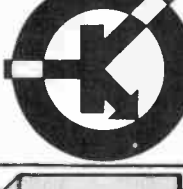
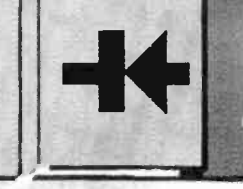
or decrease as the component's temperature increases from 68°F (20°C) to 95°F (35°C)? (B) Is the component frequently used in temperature measuring, control, or compensation circuits? As an example, for component No. 1, the thermistor, the answers are: (A) Decrease; (B) Yes. Answers for the rest are on the third page of the quiz. If you get 35 correct answers out of the total 50, you have done very well indeed.

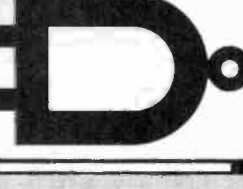
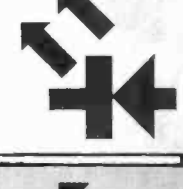
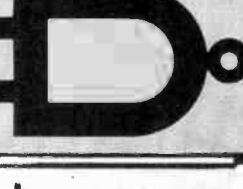
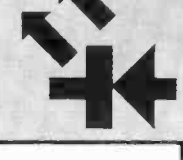
Component	Symbol	Parameter of interest	Component	Symbol	Parameter of interest
1 Thermistor		Resistance	5 Platinum wire		Resistance
2 Silicon diode		Forward voltage drop	6 Electrolytic capacitor (A1)		Capacitance
3 Silicon photovoltaic cell (Solar cell)		Power output	7 Polystyrene capacitor		Capacitance
4 Copper wire		Resistance	8 NPO-type capacitor		Capacitance

Component	Symbol	Parameter of interest	Component	Symbol	Parameter of interest
9 Class I ceramic capacitor		Capacitance	18 Copper-iron thermocouple		Current when temp. of test junction rises
10 Carbon composition resistor		Resistance	19 Lead-acid storage battery		Capacity
11 Positive temp. coef. silicon resistor		Resistance	20 Typical primary battery (Zn/C, for example)		Storage life
12 Insulated test lead		Insulation resistance	21 Inductor		Inductance
13 Thermistor (TC = -1000 ppm/°C) Sensor (TC = +1000 ppm/°C) (Pos. temp. coef.)		Resistance between points A and B (Assume perfect linearity)	22 Silicon controlled rectifier		Minimum trigger voltage
14 NPN silicon transistor		DC Beta (current gain)	23 Passivated alloy silicon diode		Reference voltage
15 Germanium diode		Reverse leakage current	24 7400 TTL gate		Threshold voltage
16 Red LED		Radiant power (light output)	25 CMOS gate		Transfer voltage
17 Red LED		Wavelength of light (Red = long wave, Violet = short wave)	26 Spark gap		Minimum spark voltage

QUIZ ANSWERS

1. See introduction.
2. (A) Decrease; (B) Yes. **Note:** The silicon diode has a relatively linear forward voltage vs. temperature characteristic. It is also low-cost and readily available. However, it is comparatively insensitive.
3. (A) Decrease; (B) No. **Note:** Keeping the cell cool raises efficiency.
4. (A) Increase; (B) No. **Note:** Except possibly at high temperatures, copper's variation of resistance is seldom taken into account in designs.
5. (A) Increase; (B) Yes. **Note:** Platinum makes probably the best of the metallic type of temperature probe. Its advantages are: it can be highly refined; it resists contamination; it is electrically and chemically stable; its resistance characteristic is quite linear; and its drift and error with age are negligible.
6. (A) Increase; (B) No. **Note:** Seldom used in critical circuits.
7. (A) Slight decrease; (B) No. **Note:** The capacitance of polystyrene units varies little with temperature.
8. (A) Almost no change; (B) No. **Note:** NPO (Negative-Positive-Zero) is a temperature compensating dielectric that has an ultrastable temperature characteristic. Used in certain types of ceramic capacitors.
9. (A) Most decrease (B) Yes. **Note:** Some types of Class I ceramic capacitors, which are usually made of titanium dioxide, are frequently used in compensation circuits.
10. (A) Increase; (B) No. **Note:** This workhorse of the resistor world has quite a high temperature coefficient and thus isn't used frequently in critical circuits that must be temperature stable. Carbon-film, metal-film, or wire-wound resistors are better choices for application in critical circuits.
11. (A) Increase; (B) Yes. **Note:** Because of its fairly linear resistance/temperature characteristic (especially with a properly chosen fixed resistor in parallel) this component has possible use in simple digital thermometers.
12. (A) Decrease; (B) No. **Note:** Keep this in mind when testing high-voltage circuits.
13. (A) None; (B) No. **Note:** The thermistor resistance decreases by 0.1% for every degree Celsius increase in temperature (remember, 1000 ppm/°C = 0.1%) and the Sensoristor resistance increases by an identical amount. Thus, the overall effect is zero.

14. (A) Increase; (B) Yes. **Note:** This effect has been used in inexpensive electronic thermometers. Also, it must be compensated for when designing a transistor circuit so that the transistor's operating point doesn't change significantly with temperature.

15. (A) Increase; (B) Yes. **Note:** A simple electronic thermometer can be constructed from a reverse-connected germanium diode, a battery, and a microammeter. The relatively high, temperature-dependent reverse leakage currents of germanium diodes make the silicon diode, whose leakage is far smaller, preferable in some applications.

16. (A) Decrease; (B) No. **Note:** Keep LEDs cool for increased brightness.

17. (A) Increase; (B) No.

18. (A) Decrease; (B) Yes. **Note:** Does this surprise you? Well, this is sort of a trick question. One normally thinks of a thermocouple's output as increasing with an increase in temperature. The fact is, a thermocouple's output increases with an increase in the *difference* in temperature between its standard junction and the test junction. Since the standard junction shown is at a constant 120°F, the thermocouple's output *decreases* until the test junction reaches 120°F, at which point the output is zero. For test junction temperatures above 120°F, the output increases with further increase in temperature. Since we are limited to a maximum temperature of 95°F, the output is said to *decrease* with increasing temperature.

19. (A) Increase; (B) No. **Note:** This answer is obvious to anyone who had no trouble starting his car on a relatively mild winter afternoon, but early the fol-

lowing morning, when it was bitter cold, had to jumper the battery to start the car. (Of course, thickening oil exacerbates the problem.)

20. (A) Decrease; (B) No. **Note:** This effect is more important than most people realize. One answer is to store batteries in as cool an area as possible. A standard battery will retain nearly all its original capacity for as long as two years if stored at 32°F. This same battery, if stored at 160°F (say in an attic), will have only about 15% of its original capacity after only 1 month of storage!

21. (A) Increase; (B) No.

22. (A) Decrease; (B) No. **Note:** A substantial increase in temperature can trigger a false alarm. (Although the author has never seen it done, he speculates that a simple fire alarm can be constructed using an SCR with its gate clamped to a constant voltage just below the minimum trigger point (at room temperature).)

23. (A) Almost none; (B) No. **Note:** This diode provides a reference voltage whose stability compares with that of standard cells.

24. (A) Decrease; (B) No. **Note:** Here is one reason why commercial-quality TTLs should be used only between 0°C and 70°C.

25. (A) Slight decrease; (B) No. **Note:** CMOS devices are less sensitive to temperature than TTLs. Plastic-cased CMOS are guaranteed to operate satisfactorily from -40°F to 185°F (-40°C to 85°C).

26. (A) Decrease; (B) No. **Note:** Spark gaps are frequently used to measure extremely high voltages. While this method may seem crude, it is accurate.◊

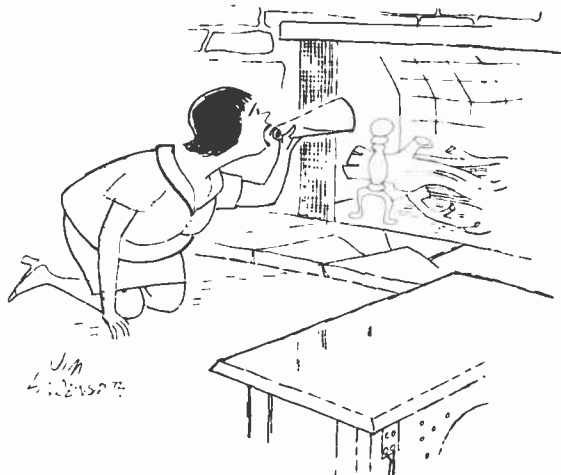

"I said, I think maybe the ghosts seem sharper now!"

Educator, Entertainer, Accountant.

Your Challenger Personal Computer.

Through the miracle of modern technology, a complete computer as powerful as the multimillion dollar room-sized computers of a few years ago can be put in a package the size of a typewriter and sells for as little as a color television set!

Through its years of microcomputer experience, Ohio Scientific has effectively channeled this tremendous computer power into a "friendly" computer with hundreds of personal uses, via a huge software library of programs for a broad range of personal, home, educational and business use.

This available software allows you to use and enjoy your computer without becoming an expert. The Challenger, however, is a powerful, general purpose computer which can be programmed in several languages by those who choose to.

Here are just a few of the popular uses of an Ohio Scientific Challenger Computer:

Education

The personal computer is the ultimate

educational aid because it can entertain while it educates. Software available ranges from enhancing your children's basic math, reading and spelling ability, through tutoring high school and college subjects, to teaching the fundamentals of computers and computer programming.

Entertainment

Many of the Challenger's games educate while they entertain, from cartoons for preschoolers to games which sharpen mathematical and logical abilities. But, entertainment doesn't stop here. The Challenger's graphics capabilities and fast operation allow it to display action games with much more detail than the best video games, providing spectacular action in games such as Invaders, Space Wars, Tiger Tank and more! All popular sports such as golf, baseball and bowling are available as simulated computer games as well as many conventional games such as chess where the computer plays the role of a formidable opponent.

Accounting

Your Challenger computer can keep track of your checkbook, savings account, loans, expenses, monitor your calorie intake and your biorythms.

If you are involved in a business, you can use it to do word processing; accounting, inventory control, order processing, customer lists, client records, mailing labels and planning.

And more:

This may seem like a lot of uses, but it's only the tip of the iceberg for a general purpose computer. For example, your Challenger can be expanded to control lights and appliances, manage your energy usage and monitor for fire and break-ins. Furthermore, it can communicate with you, with other computers and the new personal computer information services over the telephone.

In fact, the uses of general purpose, personalized computers are expanding daily as more and more people discover the tremendous capabilities

of these new technological wonders.

Ohio Scientific offers you four personalized computer systems starting at just \$549.



For a free catalog and the name of the dealer nearest you, call 1-800-321-6850 toll free.

OHIO SCIENTIFIC

a **MACOM** Company

1333 SOUTH CHILLICOTHE ROAD
AURORA, OH 44202 • (216) 831-5600

CIRCLE 46 ON READER SERVICE CARD

HIGH-SPEED ELECTRONIC FUSE

*"Blows" within microseconds
to protect sensitive components*

BY CHARLES M. LENNY AND CHESTER DAVENPORT

FUSES, in many cases, blow too slowly to prevent damage in solid-state circuits. Power transistors, which are prone to thermal runaway when passing excessive currents, are especially vulnerable to slow-opening fuses. The electronic "fuse" shown in the schematic is a basic crow-bar circuit that operates in a hundred microseconds or so—more than fast enough to save low-power transistors—and can safely handle load currents up to 60 amperes.

How It Works. When an overcurrent triggers *SCR1* into conduction, base drive is diverted from series-pass transistors *Q1* and *Q2*, which cut off and stop the flow of current to the load. Incandescent lamp *I1* has about a 10-ohm resistance when cold, and drops very little voltage. When *SCR1*

fires, the lamp glows, and the filament resistance increases to about 100 ohms, minimizing the load on *SCR1* and acting as an indicator to show that the circuit has tripped.

Potentiometer *R3* establishes the desired trip current. When the current passing through *R2* (and *R1* when *S1* is set to HIGH), exceeds the desired limit, transistor *Q3* turns on. The resulting positive voltage generated across *R5* turns on *SCR1*. Resistor *R6* limits the SCR gate current to a safe value. Diode *D1* permits operating the electronic fuse with an inductive load, removing any probability of punch-through of *Q1* or *Q2*.

Construction. At 60 amperes, resistors *R1* and *R2* can dissipate 45 watts each and should be provided with suitable heat sinking. A similar

heat sink should be used for *Q1*, *Q2* and *SCR1*. These two heat sinks should be mounted on two exterior sides of the selected chassis. A socket for *I1* can be mounted on top of the chassis. Input and output power connectors *S1*, and *R3* can be mounted on an empty side as desired. The Solitron SDT96306 can handle 70 amperes at 325 volts. A 2N3055 that can handle 15 amperes at 60 volts is an acceptable substitute.

Calibration of *R3* is performed by using various resistive loads to draw specific currents, with *R3* adjusted so that the lamp glows when the specific current is reached. A dial plate on *R3* is used to identify the calibration points. Remember that the trip current must be within the pass transistor's rating.

Since the SCR is powered by dc, once it fires it will remain in the conductive state until the applied dc voltage is removed. This can be done either by installing a series switch in either of the supply leads or by turning off the driving power supply. ♦

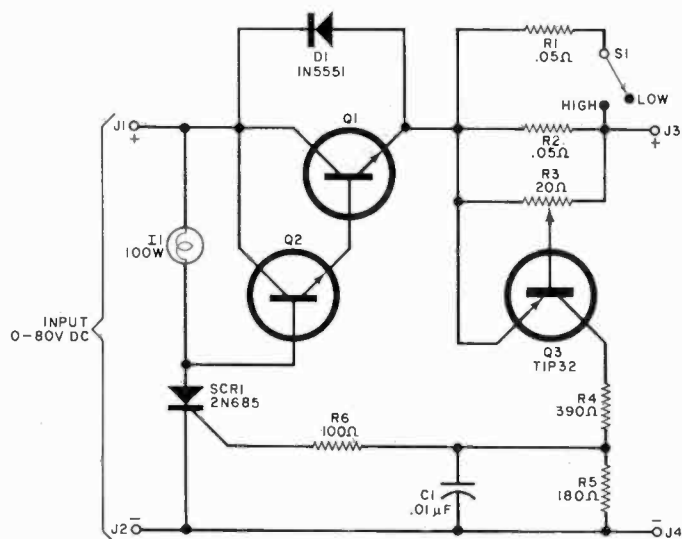

PARTS LIST

- | | |
|---|--|
| C1—0.01- μ F disc capacitor | R3—20- Ω , 5-W potentiometer |
| D1—1N5551 diode | R4—390- Ω , 10-W resistor |
| J1 through J4—5-way binding post, color coded | R5—180- Ω , 1-W resistor |
| I1—100-W incandescent lamp | R6—100- Ω , 1/2-W resistor |
| Q1, Q2—SDT96306 (70 amperes) or 2N3055 (15 amperes) | S1—Spst switch |
| Q3—TIP32 or any silicon transistor | SCR1—2N685 or similar SCR |
| R1, R2—0.05- Ω , 50-W resistor | Misc.—Suitable heat sinks (2), socket for I1, enclosure, terminal strips, mounting hardware. |

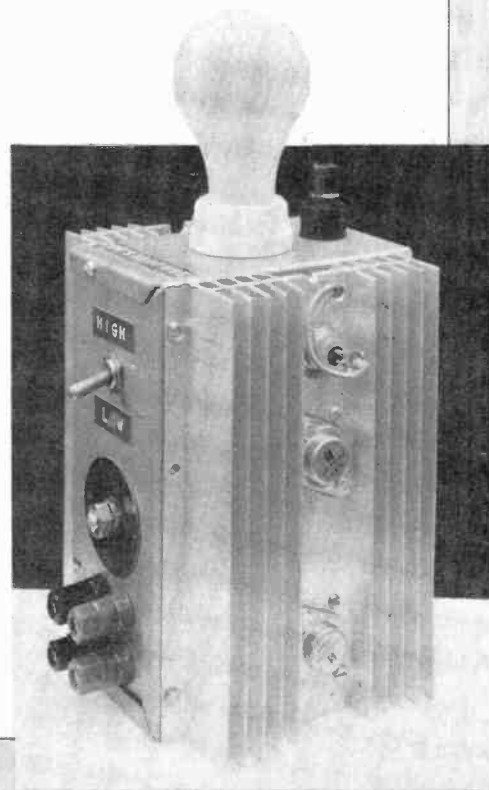

Ω WEST COAST / EAST COAST Ω

**Special
of the Month!**

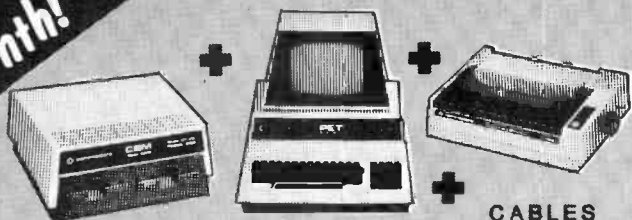

commodore

- 4032 COMPUTER \$1061
(8032 Add \$160)
- 4040 DISK \$1061
- 4022 PRINTER \$ 651
- CBM-IEEE CABLE \$ 33
- IEEE-IEEE CABLE \$ 41
- WordPro 3+ \$ 252

COMPLETE WORD PROCESSING SYSTEM = \$3099!

No Surcharge for Credit Cards Orders • We Accept C.O.D.'s
All Equipment Factory Fresh With MFT. Warranty • Stock Shipments Same Day or Next

**NEC
OKIDATA
APPLE**

**TELEVIDEO
COMMODORE**

**RADIO SHACK
AMDEK**

ATARI

- DIABLO 630 \$2099
- INTERTEC SUPERBRAIN 64K RAM \$2799
- QD SUPERBRAIN \$3195
- NEC 5510 SPINWRITER \$2495
- NEC 5530 SPINWRITER \$2495
- OKIDATA MICROLINE-80 \$ 399
- OKIDATA MICROLINE-82 \$ 529
- OKIDATA MICROLINE-83 \$ 799
- APPLE II PLUS 48K \$1189
- APPLE DISK w/3.3 DOS Controller \$ 545
- APPLE DISK w/o Controller \$ 435
- BASE II PRINTER \$ 599
- HAZELTINE 1420 \$ 799
- NORTHSTAR HORIZON II 32K QD \$2975
- ANADEX DP-9500 \$1295
- TELEVIDEO 912C \$ 669
- TELEVIDEO 920C \$ 729
- TELEVIDEO 950 \$ 959
- CBM 8032 COMPUTER \$1225
- CBM 8050 DISK DRIVE \$1449
- CBM 4032 COMPUTER \$1090
- CBM 4040 DISK DRIVE \$1090
- CBM 4022 \$ 679
- CBM VIC-20 \$ 289
- CBM C2N \$ 85
- RADIO SHACK II 64K \$3245
- RADIO SHACK III 16K \$ 839
- LEEDEX/AMDEK 100 \$ 139
- LEEDEX/AMDEK 100G \$ 169
- LEEDEX/AMDEK COLOR-1 13" Color Monitor \$ 349
- MICROTEK 16K RAMBOARD for Atari \$99.95
- MICROTEK 32K \$ 165
- ATARI 400 16K \$ 349
- ATARI 825 PRINTER \$ 619
- ATARI 850 INTERFACE \$ 139
- or both together \$ 749
- ATARI 810 DISK DRIVE \$ 449
- ATARI 800 32K \$ 769
- Call for price list of ATARI software
- NEC 12" MONITOR \$ 229



EPSON MX-80

PRICES ARE SUBJECT TO CHANGE WITHOUT NOTICE.

**WEST COAST
1-800-235-3581**

OMEGA SALES CO.
3533 Old Conejo Rd. #102
Newbury Park, CA 91320
1-805-499-3678
CA. TOLL FREE 1-800-322-1873



OMEGA
SALES
CO.

**EAST COAST
1-800-556-7586**

OMEGA SALES CO.
12 Meeting St.
Cumberland, RI 02864
1-401-722-1027

Ω MEGA SALES COMPANY

By Ivan Berger

Stylus Replacements—Original and Brand “X”

WHEN YOUR stylus wears down, three choices are open: replace the cartridge, replace the stylus with one from the original manufacturer, or buy a lower-cost replacement by someone else. Odd though it may seem, an original replacement stylus will often cost nearly as much as a new cartridge. Even though the suggested retail price of a replacement stylus is only about half that of a new cartridge, its cost to the dealer is usually close to the cost of the cartridge. But considering what goes into making a stylus, that is not as unreasonable as it may seem.

Compare a modern stylus assembly with one from even five years back: the cantilever is far thinner and more difficult to fabricate, and the stylus diamonds are ground into more complex shapes. The elliptical shape is largely giving way to new, line-contact “hyper-elliptical”, “Shibata”, “Van Den Hul”, “Pramanik”, and other shapes that are harder to grind.

Mounting those new shapes is another problem: where a spherical-tipped stylus can be simply inserted into a round hole, the other shapes must be precisely oriented. Audio-Technica, for example, uses lasers to “drill” precisely shaped and oriented holes in fragile, beryllium cantilevers for the square-shanked, linear-contact styli in its premium cartridges. Sonus bends a square shank and inserts its square-topped diamond into the end. Others use less exotic, but equally exacting methods.

That beryllium cantilever is just one example of the exotic—and hard-to-fabricate—materials used in many modern styli: Sony and Dynavector, for example, have cantilevers of diamond itself, Dynavector also has a ruby, and Bang & Olufsen uses a sapphire shaft to mount its diamond. (It took a year to find the right adhesive.) Shure’s top styli are more exotic in construction than in materials, with stepped shafts that look like telescopes under a magnifier. Add in the careful design and selection of the stylus suspension and damping materials, and you can see that a stylus replacement involves some exacting manufacture.

Because the stylus accounts for most of the cartridge’s cost to the manufacturer, he has to charge the dealer accordingly. Cartridge manufacturers are coy about the fact that they put unreal-

istically low retail prices on their styli (or unrealistically high ones on their cartridges, depending how you look at it), but I suspect it’s because buyers would be pained at hearing that the “replacement part” costs nearly as much as the whole cartridge. But since it costs the dealer a lot, it will cost you a lot, too, regardless of the difference in list prices. That’s why there is a market for lower-priced replacement styli. The question is: Are such “second-source” replacements as good as the originals?

The cartridge manufacturers say “No.” And though they’re obviously interested parties, their arguments make sense. Shure, for example, points out that only the cartridge’s original manufacturer knows all the original design criteria, including its materials, dimensions and their tolerances, and “the delicate relationship of parts”; only the original manufacturer has the tools and assembly experience. The original manufacturer has a bigger stake in quality, too—if your new Brand “X” stylus makes your Shure, Stanton, Empire or whatever sound worse than the competition, it’s likely to be the cartridge you should blame.

Shure, for example (and they’re hardly alone), runs samples of all its products through a series of “conformance” tests to make sure they perform within spec—then puts them through environmental tortures for a while, and tests them over again. The tests are now computerized (with a Commodore Pet, incidentally—not all “home” computers stay home), both to simplify the job (it even recalibrates itself for wear on the test disc) and so that production trends can be identified and isolated from the background noise of sample-to-sample variations. That lets the quality-assurance engineer find where production’s going wrong before defective parts start coming off the line.

Shure recently purchased 244 styli made by other companies to fit Shure cartridges, and ran them through its conformance tests: only about 2 percent passed, leaving too few for meaningful environmental tests. Though it may well be possible to get off-brand styli as good as the original, the odds, obviously, are not good.

Getting original replacement styli isn’t always easy, though. Many dealers

don’t stock them, both because customers complain about their prices and because supporting older cartridges as well as current models can mean carrying a lot of slow-moving inventory. Most cartridge manufacturers will help, though: Audio-Technica, for example, has a toll-free number (800-221-0906, or in New York State, 212-871-3303) for information on where to buy replacement styli.

If manufacturers say it’s best to replace styli only with those from the original source, there are others who say you shouldn’t replace them yourself, at all. “If you replace the stylus, you change the response,” says Len Chase, of New York’s Electronic Workshop. “Many of the cartridges I sell come with individual frequency-response graphs, and there are always minute variations between even those with consecutive serial numbers. The variations between original-replacement styli may be no greater than those between cartridges—but at least with the cartridge, you can see what you’re getting.”

Many moving-coil cartridges must be returned to the factory for stylus replacement, which ensures that only original-replacement styli will be used. The same is even true of a few nonmoving-coil designs, such as those made by Bang & Olufsen. B&O doesn’t sell replacement styli at all, pointing out that “the tolerances are so close that it’s difficult to take out part of the system, like a stylus assembly, and replace it at random. When our stylus assemblies are connected to the stylus body, they are adjusted with a tool which has a micrometer control, to get the gap right, and then sealed as an integrated unit.

“Each cartridge is supplied complete and checked, at a price marginally higher than a replaceable stylus for other cartridges of similar quality. With today’s technology, it is no longer a case of 50% of the cartridge cost being in the stylus assembly and 50% in the body; the body represents only a small fraction of the total. When we first introduced our integrated cartridges, in 1973, all we did was admit these facts.”

Shure disagrees on that point. When asked if noninterchangeable styli might not be better, Shure’s engineers replied: “If noninterchangeable styli became the vogue, our engineers have determined that we’d still build them the way we do now, but cement them together.” (Osawa and a few others, incidentally, come close to this approach, with styli that are held in place by set-screws, for rigidity.)

As so often happens in audio, there are logical arguments on both sides of the question of whether to replace styli at all. But if you do, it probably does make sense to use an original replacement unless your dealer will let you make an A-B comparison of how a given cartridge sounds with both original-brand and other-brand styli—and I doubt any will. Otherwise, as Shure says, “with an imitation stylus, it’s no longer our cartridge, as far as we’re concerned—it’s Brand ‘X’.” ◇

Popular Electronics Tests

The Sabtronics Model 8000B Frequency Counter

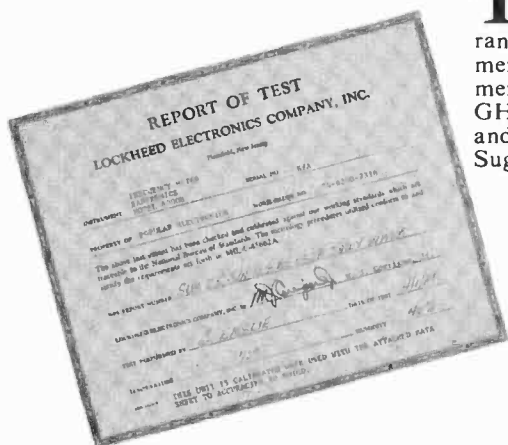

THE Sabtronics Model 8000B Frequency Counter is a low-cost, wide-range battery- or line-powered instrument capable of frequency measurements between 10 Hz and 1000 MHz (1 GHz). It measures 8"W x 6.5"D x 3"H and weighs 1.3 lb without the batteries. Suggested retail price is \$239.

General Description. The front panel, which holds a mini-digit readout of seven-segment red LEDs, is surrounded by a half-inch deep rim that protects against damage if the instrument is accidentally dropped on its front surface. Controls include the GATE TIME switch that allows selection of 0.1-, 1-, or 10-second counting periods, a RANGE switch that provides a choice of 10, 100, or 1000 MHz full scale, a POWER ON/OFF switch, and a SENSITIVITY control. Two BNC connectors are provided, with one used between 10 Hz and 100 MHz and having a 1-megohm input impedance and the other used for the 10- to 1000-MHz range, having a 50-ohm input impedance. A single red LED visible just below the display is used to indicate gate operation.

(Continued overleaf)

How to get 50% more sound without turning up the volume.

There's a whole range of sound in a live performance that you never hear from your stereo system. And it's not a question of turning up the volume.

The problem is in the records you play.

When recording engineers master a record, they electronically eliminate up to half the music. They literally compress the sound to make it "fit" on the vinyl record.

Fortunately, there's one solution to the problem: dbx Dynamic Range Expanders.

A dbx Dynamic Range Expander in your system restores most of the lost music. And it reduces annoying record surface noise by as much as 20 dB. So instead of a compressed 50 or 60 dB of dynamic range, you get a full 75 to 90 dB. The loud passages begin to thunder. The softs are truly subtle. All your music comes to life.

And you can use a dbx Dynamic Range Expander not only with your records, but also with tapes and FM broadcasts.

Visit your authorized dbx retailer for a demonstration of the 1BX, 2BX and 3BX Dynamic Range Expanders. Then select the model that's best for your system.

Because there's a lot more to music than has been reaching your ears.

dbx, Inc., 71 Chapel St., Newton, Mass. 02195 U.S.A. Tel. (617) 964-3210. Telex 92-2522. Distributed throughout Canada by BSR (Canada) Ltd., Rexdale, Ontario.

dbx

Making good sound better

CIRCLE NO. 14 ON FREE INFORMATION CARD

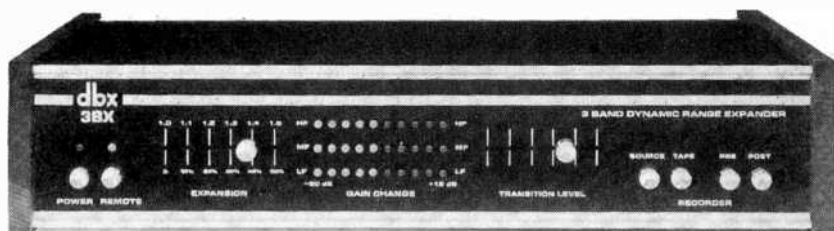
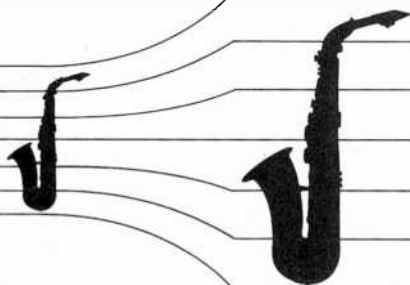

test equipment

The unit is provided with four large plastic feet with a two-position tilt stand affixed to the front pair. The external wall-mounted ac adapter connects to the EXTERNAL INPUT receptacle on the rear apron, which also contains the cover for the battery compartment.

Rated sensitivity is: < 20 mV, 10 Hz to 100 MHz; < 30 mV, 100 to 600 MHz; < 40 mV, 600 to 1000 MHz. The input is protected against 400 volts peak-to-peak at 10 Hz; protection declines with frequency to 3 volts peak-to-peak at 1000 MHz. Maximum rated resolution is 0.1 Hz on the 10-MHz range, 1 Hz on the 100-MHz range, and 10 Hz on the 600-to-1000-MHz range, all using the 10-second gate time. The internal time base operates at 10 MHz with a claimed temperature stability of ± 1 ppm between 0 and 40°C, an adjustability of ± 2 ppm, and an aging rate of less than 5 ppm/year. Rated accuracy is 1 Hz + 1 digit + timebase error. The power requirement is 4.8 to 6.5 volts dc at 300 mA from four C cells, or the optional ac adapter/charger.

Comments. The Model 8000B was checked by the Lockheed Electronics Instrumentation Measurements Laboratory, Plainfield, NJ, against standards traceable to the National Bureau of Standards. It met or exceeded its specifications in all respects but two. First, since there are only 9 digits in the readout, the upper limit on the frequency display is 999.99999 MHz. This by itself is minor, but it precluded checking the resolution using the 10-second gate. Second, since there was no access to the time base, its long-term stability could not be determined. Short-term stability can be inferred from the accuracy with which the standard frequencies were displayed. In fact, time-base error appears to be ± 3 ppm.

We used the counter to make a number of frequency measurements over a few weeks, and found it to be of great value. When used in conjunction with a low-cost audio generator, we found the combination allowed a far better "fine tuning" of frequency than the relatively rough dial of the generator alone. This was also true when using the 8000B with the r-f generators used for radio and TV alignment. It is always nice to know that the frequency being injected is correct.

A small, multiturn air coil was connected to the end of the scope probe we were using as the signal probe to allow us to probe some r-f circuits of a couple of CB and ham rigs we were aligning. This combination also worked well with some border-line microwave (about 800 MHz) gear we were installing.

With its relatively low price, optional battery operation, and extremely wide frequency range, the Model 8000B is an excellent and handy instrument. It is easy to use and comfortably exceeds the accuracy need for CB, ham, and audio applications.—Leslie Solomon.

CIRCLE NO. 104 ON FREE INFORMATION CARD

POPULAR ELECTRONICS

Two Projects for Summer:

A BATTERY-OPERATED FLUORESCENT LAMP

Portable, high-efficiency light source draws current from a vehicle's 12-volt storage battery, but leaves plenty of charge for engine starting.

BY LAWRENCE M. WALDEN

THE recreational vehicle is becoming more and more popular with campers who want a "home away from home." In such cases, the vehicle's 12-volt battery supply provides a convenient source of power for lighting around the camp. This is very handy, of course; but, for the amount of light they deliver, 12-volt incandescent lamps waste a lot of valuable battery power. Fluorescent lamps, on the other hand, produce good lighting at high efficiency. Unfortunately, they require a dc-to-ac converter.

The low-cost circuit described here not only performs the dc-to-ac conversion, it also provides automatic shut-

down when the battery reaches some predetermined voltage level, thus preventing a complete discharge. A LED indicator glows when the turnoff point is reached. Once turned off, the system draws only a few milliamperes.

Circuit Operation. When the 12-volt supply (Fig. 1) is applied to the circuit through fuse *F1*, switch *S1*, and the protective diode, *D1*, multivibrator *IC1* starts to oscillate at a frequency determined by the setting of *R2*. This is approximately 10 kHz. At this time, *Q1* is cut off to allow *IC1* to oscillate.

As the +12 volts are applied to the *R18*/zener diode *D2* network, 7.6 volts are applied to the emitters of *Q3* and *Q4*. At this time, the base of *Q4* is at zero voltage, thus turning this transistor fully on and developing approximately 7 volts across its collector resistor (*R12*). This voltage, applied via *R13* to the base of series-pass transistor *Q5*, turns the transistor on and allows the output of *IC1* to pass through *R7* to driver transistor *Q6*. The latter, in turn, drives power transistor *Q7* to its maximum output.

The collector load of *Q7* is formed by the 6.3-volt winding of transformer *T1*. Thus, as *IC1* oscillates, a high alternating voltage is developed across the 120-volt winding of *T1* and applied to the two series-connected fluorescent lamps (*L1* and *L2*), and across current-sensing resistor *R17*.

At lamp turnon, the voltage developed across *R17* is rectified and filtered by *D3* and *C5* and applied across lamp-current-adjust potentiometer *R16*. A preselected portion of this voltage is applied to the *R15*/*C4* network and to the base of *Q4*. When this voltage approximates the 7.6-volt emitter reference, *Q4* starts to reduce its conductance, thus lowering the

voltage developed across collector resistor *R12*. This action lowers the bias on series-pass transistor *Q5*, reducing the drive to *Q6*/*Q7* to lower the lamp drive and reduce the voltage across *R17*. The circuit stabilizes lamp current preset by *R16*.

At initial lamp turnon, approximately 1.3 amperes will flow through *Q7* until the fluorescent lamps fire. This ensures lamp start even in cold weather. Once the lamps strike, the current will range from about 0.9 ampere at 13.2 volts to about 1.1 amperes when the battery voltage drops to near 10.6 volts.

Low battery protection is provided by potentiometer *R6*. The selected voltage is applied via *R8* to the base of *Q3*. In normal operation, *Q3* is cut off since its base voltage is higher than the 7.6 volts applied to its emitter. If the battery voltage drops so that the base of *Q3* goes below the emitter voltage, *Q3* starts to conduct and its collector current flows through *R10* to the base of *Q2*. When *Q2* starts to conduct, the base drive of *Q3* is further reduced until both *Q2* and *Q3* are latched fully on. Once latched on, the collector of *Q3* will be approximately 6 volts, which are applied through *R11*, causing *LED1*—the low-voltage indicator—to glow. This voltage is also applied via *R5* to the base of *Q1* to bias this transistor fully on. When this occurs, pins 2 and 3 of *IC1* become fully positive, thus disabling the multivibrator. At this point, battery consumption drops to about 50 mA, since *Q1*, *Q2*, and *Q3* are the only active elements. Operating power should now be removed via *S1*.

Capacitor *C4* at the base of *Q4* is a high value to prevent oscillation, while *C3* at the base of *Q2* allows the circuit to stabilize before low voltage levels can be detected. Once the circuit is

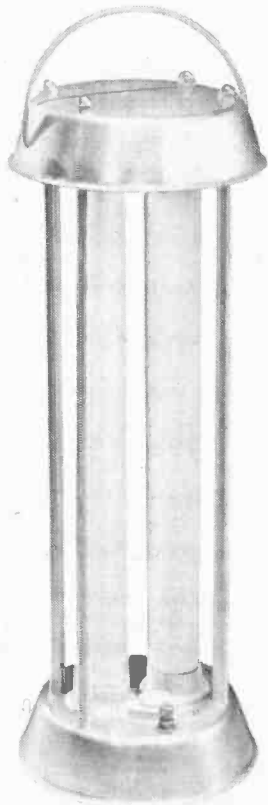

fluorescent lamp

working, it responds very rapidly to voltage drops.

Construction. Since there is nothing critical about the circuit, it can be constructed on a small piece of perf board using point-to-point wiring and sockets for IC1 and the seven transistors. Transistor Q7, transformer T1, power on/off switch S1, fuse F1, and the two fluorescent lamp sockets are mounted on the enclosure.

Select an enclosure that can support the circuit board, the transformer, a heat sink for power transistor Q7, and the sockets for the two fluorescent lamps. The two lamps can be mounted vertically on top of the enclosure, and provided with some form of transparent weather protection such as a plastic sleeve. If a metal enclosure is used, it can serve as the Q7 heat sink when a suitable insulator is used. Connection to the +12 volts can be made with a length of conventional two-conductor lamp cord having a cigarette lighter plug at one end. The author used 33 feet of lamp cord.

• Since the secondary of transformer T1 can develop as much as 1500 volts peak-to-peak across the output, and as much as 225 volts when the lamps are lit, suitable insulation must be used at these points. Also, keep these voltages in mind when performing the adjustments on the circuit.

Adjustments. Before applying power, remove the connection between low-voltage-adjust potentiometer R6 rotor to the +12-volt end. Then set lamp-current-adjust potentiometer R16 so that the rotor is at the ground end. Frequency-adjust potentiometer R2 should be set to the R1 side (highest resistance).

To make a complete test, use an adjustable power supply between 10 and 14 volts, with a capacity of at least 2 amperes. Connect an ammeter (about 2 amperes) in series with the positive battery connection, and a voltmeter (20-volt range) from the cathode side of D1 to ground. Connect the power source.

When S1 is turned on, the lamps

may not fire due to the low frequency of the multivibrator, and about 0.3 to 0.4 ampere will be drawn. Transformer T1 may also make sounds due to lamination movement, which indicates an operating circuit.

Slowly rotate frequency-adjust potentiometer R2 and note that the ammeter current increases and the lamps start to glow. Continue to increase the frequency very slowly until the lamps come to full brightness at a current of about 0.6 ampere. At this point, the supply current will suddenly jump to about 1.2 to 1.3 amperes. Advance the frequency for an additional 0.2 ampere, but not higher, as both output voltage and efficiency will drop.

If desired, the multivibrator can be "fine tuned" using an oscilloscope. To do this, turn the power off, set the controls as described above, remove the lamps and replace them with four 100-k Ω , 1/2-W resistors connected in series. Connect the scope leads across R17, and set the scope vertical to 5 volts/division. Turn the power on and

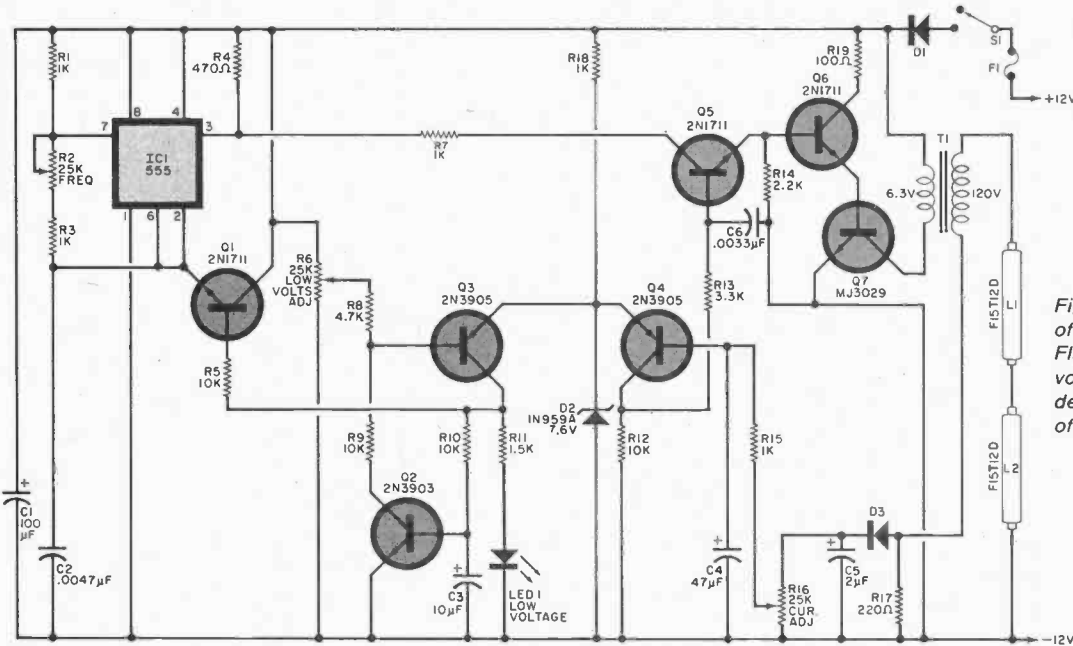

Fig. 1. Schematic diagram of the Battery-Operated Fluorescent Lamp. The low-voltage cutoff point is determined by the setting of potentiometer R6.

PARTS LIST

C1—100- μ F, 25-V electrolytic
 C2—0.0047- μ F, film capacitor
 C3—10- μ F, 60-V electrolytic
 C4—47- μ F, 50-V electrolytic
 C5—2- μ F, 50-V electrolytic
 C6—0.0033- μ F, 100-V film capacitor
 D1, D3—2-ampere rectifier diode
 D2—1N959A, 7.6-V zener diode
 F1—4-A fuse and holder
 IC1—555 timer
 L1, L2—15-watt daylight fluorescent lamps (F15T12D or similar)
 LED1—Red LED

Q1, Q5, Q6—2N1711 or similar npn silicon transistor
 Q2—2N3903 or similar npn silicon transistor
 Q3, Q4—2N3905 pnp or similar transistor
 Q7—MJ3029 npn power transistor
 R1, R3, R7, R15—1-k Ω , 1/4-W resistor
 R2, R6, R16—25-k Ω , pc potentiometer
 R4—470- Ω , 1/2-W resistor
 R5, R9, R10, R12—10-k Ω , 1/4-W resistor
 R8—4.7-k Ω , 1/4-W resistor
 R11—1.5-k Ω , 1/2-W resistor
 R13—3.3-k Ω , 1/4-W resistor
 R14—2.2-k Ω , 1/4-W resistor

R17—220- Ω , 2-W resistor
 R18—1-k Ω , 1/2-W resistor
 R19—100- Ω , 1-W resistor
 S1—Spst switch
 T1—6.3-V, 1.2-A transformer (Radio Shack 273-0050 or similar)
 Misc.—Perf board, sockets for IC1 and transistors, heat sink and thermal insulator for Q7, sockets (4) for fluorescent lamps, suitable enclosure, length of conventional lamp cord, automotive cigarette plug, transparent weather shield for lamps, adhesives, mounting hardware, etc.

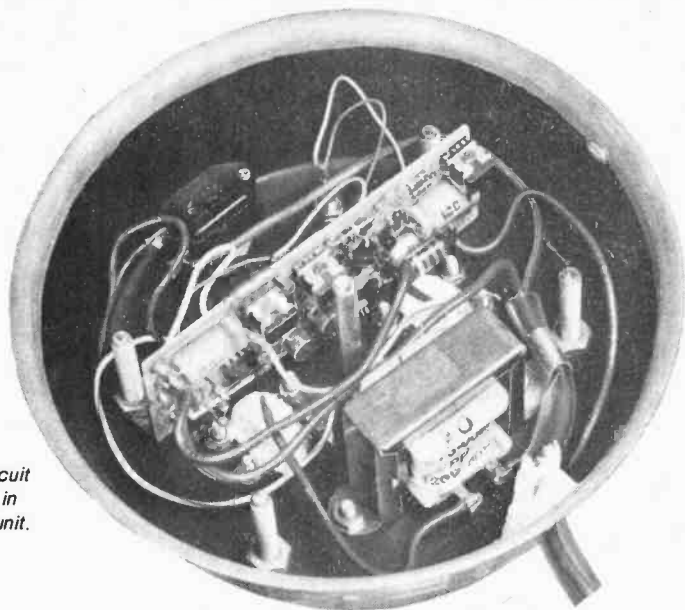

Lamp circuit mounted in base of unit.

note that about 0.5 ampere flows and a 3-to-4-volt waveform appears on the scope. Slowly increase the frequency (via *R2*) until the scope trace peaks at about 15 volts peak-to-peak. The supply current should reach about 1 ampere at this point. Do not

adjust the frequency higher than this, or the efficiency will be reduced. Turn the power off, remove the resistors, and replace the lamps.

To adjust the lamp current regulator with the lamps glowing, slowly rotate current-adjust potentiometer

R16 until the current approaches 0.8 ampere and there is a decrease in light output. Then slowly adjust *R16* until the current reaches 1 ampere. Lower the power supply to 10.6 volts, then re-adjust *R16* for 1.1 amperes current flow. This becomes the maximum current drain at the lowest operating voltage.

Increase the supply voltage from 10.6 to 13.2 volts and note that the light output remains constant as the current decreases. With 12 volts applied, about 1 ampere will flow, and with a 13.2-volt supply, the current drops to about 0.9 ampere.

To adjust the low-voltage cutoff, reconnect *R6* to the +12-volt line, and with the voltmeter still in the circuit, allow a 5-minute lamp warm-up. Reduce the power supply to 10.6 volts (or other desired low-voltage point) and slowly rotate *R6* until the lamps go off and *LED1* glows. Recheck this point several times. If, during operation, the lamps go out, the presence of glowing *LED1* indicates that the low battery voltage has been reached, and the circuit has not been accidentally removed from the power source. ◇

"COINSHOOTER" METAL DETECTOR

Advanced circuit reacts to coins and other precious metal objects while ignoring chunks of iron and steel

BY WILLIAM LAHR

SEARCHING FOR coins and other lost articles along beaches and in parks can be both profitable and fun. The Coinshooter, a novel and inexpensive electronic metal detector, can make such outings more productive. Employing a sophisticated, vlf induction-balance detection system that responds only to the proximity of non-ferrous metallic objects, it ignores items containing iron. Moreover, the project can be adjusted to compensate for the soil's mineral content, thus minimizing false indications.

The Coinshooter can detect a dime at an air gap of four inches or a half-dollar at nine inches. It cannot detect coins buried deep in the ground, but

will yield excellent results if the coins are at depths of from 1 to 3 inches. Unlike detectors that employ conventional beat-frequency oscillator circuits, the Coinshooter does not require the user to monitor the pitch of a continuous tone. Rather, it alerts the user to the proximity of nonferrous metal by generating one or more beeps. Also, it is lightweight (about 2 lb) and well balanced. Total construction cost is approximately \$35, and less if salvaged parts are used.

About the Circuit. The Coinshooter appears schematically in Figure 1. Coplanar search coils are formed by placing a receiving coil (*L3*) over a

folded-loop transmitting coil (*L1* and *L2*) so that there is little if any coupling between them unless there is metal present in the search field. A Colpitts oscillator comprising *Q1* and its associated passive components generates a 6.2-kHz signal that drives the transmitting coil. Transistors *Q2* and *Q3* amplify the low-level signal induced across receiving coil *L3* when no metal objects are present in the search field so that a 1-volt p-p signal appears at the collector of *Q3*.

Capacitor *C7* couples this signal to the noninverting input of voltage comparator *IC1A*. The input circuit of the comparator rectifies the ac signal, resulting in the generation of a slightly

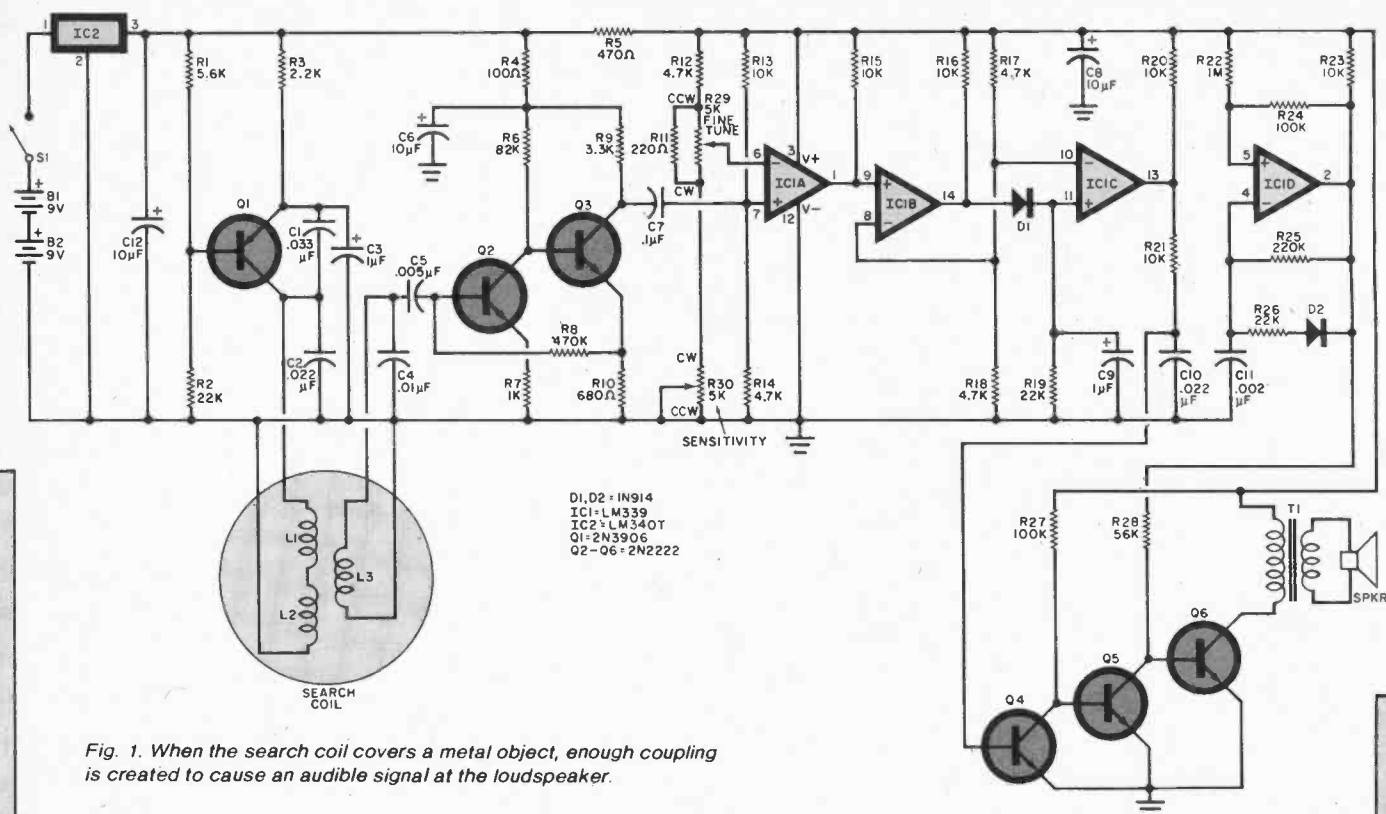

Fig. 1. When the search coil covers a metal object, enough coupling is created to cause an audible signal at the loudspeaker.

PARTS LIST

- B1, B2—9-V alkaline battery
- C1—0.033- μ F, 50-V Mylar capacitor
- C2, C10—0.022- μ F, 50-V Mylar capacitor
- C3, C9—1- μ F, 16-V tantalum capacitor
- C4—0.01- μ F, 50-V disc ceramic capacitor
- C5—0.005- μ F, 50-V disc ceramic capacitor
- C6, C8, C12—10- μ F, 16-V aluminum electrolytic capacitor
- C7—0.1- μ F, 50-V Mylar capacitor
- C11—0.002- μ F, 50-V disc ceramic capacitor
- D1, D2—1N914 silicon switching diode
- IC1—LM339 quad voltage comparator
- IC2—LM340T-8 +8-V regulator
- L1, L2—Air-core inductor: 175 turns of No. 30 wire wound 9 1/2 inches in diameter (see text)
- L3—Air-core inductor: 550 turns of No. 38 enamelled wire on 3 1/2" diam.
- Q1—2N3906 or similar pnp silicon switching transistor
- Q2 through Q6—2N2222 or similar npn silicon switching transistor

- The following, unless otherwise specified, are 1/4-watt, 5%-tolerance, carbon-composition fixed resistors.
- R1—5.6 k Ω
 - R2, R19, R26—22 k Ω
 - R3—2.2 k Ω
 - R4—100 Ω
 - R5—470 Ω
 - R6—82 k Ω
 - R7—1 k Ω
 - R8—470 k Ω
 - R9—3.3 k Ω
 - R10—680 Ω
 - R11—220 Ω
 - R12, R14, R17, R18—4.7 k Ω
 - R13, R15, R16, R20, R21, R23—10 k Ω
 - R22—1 M Ω
 - R24, R27—100 k Ω
 - R25—220 k Ω
 - R28—56 k Ω
 - R29—5-k Ω , linear-taper potentiometer
 - R30—5-k Ω , linear-taper potentiometer with shaft-actuated spst switch

- S1—Spst switch (part of R30)
- SPKR—2 1/4-inch, 8- Ω dynamic speaker
- T1—1k Ω :8 Ω miniature audio output transformer
- Misc.—Suitable enclosure, perforated or printed-circuit board, single-conductor shielded cable, hookup wire, No. 30 and No. 38 enamelled copper (magnet) wire, battery clips, battery holders, circuit-board standoffs, grommets or other suitable strain reliefs for shielded cable, PVC electrical tape or silicone cement or other suitable insulating material, 12-inch-by-12-inch sheet of 1/4-inch plywood, monofilament fishing line, 3/4-inch masking tape, epoxy, hot-melt, and PVC glues, 4 feet of 1/2-inch O.D., schedule 125 PVC pipe, 2 feet of 1/2-inch, schedule 40 PVC pipe, 90° elbow PVC pipe joint, 135° elbow PVC pipe joint, tee PVC pipe joint, PVC pipe cap, bicycle steering-bar handgrip, lead buckshot, resin sealant, white paint, solder, hardware, aluminum foil etc.

negative voltage that subtracts from the positive bias voltage supplied by divider R13/R14. Potentiometers R29 and R30 determine the magnitude of the reference voltage applied to the inverting input of IC1A and hence the detector circuit's sensitivity. They are adjusted so that the voltages at the two inputs are practically equal.

When the voltage at the noninverting input of the comparator becomes

more positive than that at the inverting input, the output terminal (pin 1) switches to the positive supply voltage. This positive pulse toggles comparators IC1B and IC1C, which are connected in cascade and whose inverting inputs are biased to one-half the positive supply voltage. The charging of C9 via D1 and the discharging of C9 through R19 stretches the pulse. Transistor Q4 is triggered

into conduction by the elongated pulse that appears at the output of IC1C, cutting off Q5.

When Q5 is cut off, Q6 amplifies the tone produced by the audio oscillator comprising IC1D and its associated passive components. The current flowing through the primary of audio-output transformer T1 and transistor Q6 increases the voltage drop across R5, and this upsets the

bias applied to the inverting input of *IC1A*. As a result, the outputs of *IC1A*, *IC1B*, and *IC1C* go low, transistor *Q4* cuts off, and transistor *Q5* saturates, shunting the base drive of *Q6* to ground and cutting that transistor off. This silences the loudspeaker and allows *C8* to charge again to the full positive supply voltage. The higher voltage across the capacitor allows *IC1A* to change state again if the non-ferrous metal object is still within the search field.

Iron objects or mineralized ground within the search field will produce an increase in the amplitude of the signal at the collector of *Q3* and thus a less positive bias at the noninverting input of *IC1A*. In contrast, the presence of coins or other nonferrous metal objects within the search field will cause a smaller signal to appear at the collector of *Q3* and a more positive bias at the noninverting input of the first voltage comparator. This allows the Coinshooter to locate coins and other items of interest while ignoring nails, bottle caps, and other junk pieces of iron and steel.

When a small nonferrous item quickly enters and exits the search field, the loudspeaker will generate a single beep. If the object enters and remains in the search field, a series of beeps will be produced. Its rate of repetition will vary with the settings of potentiometers *R29* and *R30*, the size of the object, and the distance between the object and the search coil. The pitch of the beep is determined by the values of *C11* and the resistances in the feedback loop, as well as by the supply voltage. Its frequency is nominally 1.3 kHz.

Power for the Coinshooter circuit is supplied by two series-connected nine-volt batteries. An IC voltage regulator provides a constant supply potential to the rest of the circuit until the batteries are nearly exhausted. Quiescent current demand is approximately 10 mA, so battery replacement should be infrequent if alkaline cells are used. If desired, the Coinshooter can be powered by a single nine-volt battery and the regulator IC omitted. However, the circuit is sensitive to changes in supply voltage, and this alternative is not recommended. But, if this approach is taken, an alkaline battery must be used.

Construction. Procure a circular form 9½" in diameter on which you can wind the transmitting coil. In assembling the prototype, a hamper lid was used, but a mixing bowl or cardboard cylinder would be suitable.

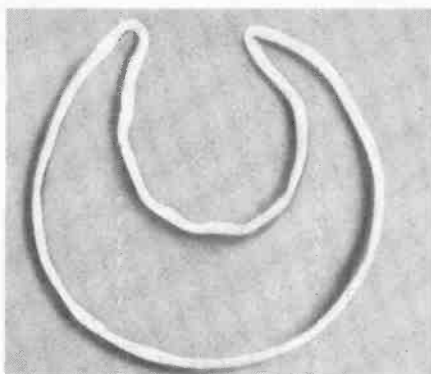

Fig. 2. Transmitting coil has been shaped to form L1 and L2.



Fig. 3. Positions of L1 and L2 are marked on a plywood disc.

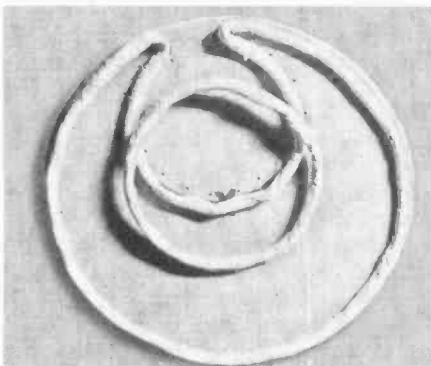

Fig. 4. The disc is shown with L1 and L2 tied in place and L3 on top.

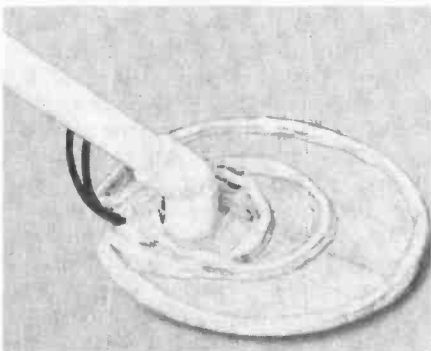

Fig. 5. The search-coil assembly with handle in place.

Wind a layer of masking tape ¾-inch wide around the form so that the adhesive side is exposed. The tape will hold the wire and make winding the coil much easier. Wind a total of 175 turns of No. 30 enamelled copper wire around the form, keeping the wire as close to the center of the tape as possible. The last turn should exit the coil at a point on the circumference 10 inches before the starting point is reached. Fold the tape around the coil and remove it from the form. Spiral-wrap the coil tightly with masking tape. Then shape the coil assembly as shown in Fig. 2 to form the transmitting coil. (*L1* is the large-diameter portion and *L2* is the small-diameter section.) The coils must be shielded so spiral wrap them (starting with *L1* opposite the lead wires) with 1" wide strips of aluminum foil. Cover the coils completely except for a ¼" gap between start and finish of the foil layer. Strip a 6" piece of hook-up wire and lay it on the foil so that 2" exits next to one of the lead wires. Then spiral wrap the coils tightly with masking tape, covering the foil completely.

Next, cut a disc seven inches in diameter from a sheet of ¼-inch plywood. Lay the shaped coil assembly on the disc and trace pencil lines around the inside of *L1* and both sides of *L2* (see Fig. 3). Remove the coil assembly and drill a series of ⅛-inch holes spaced ½ inch apart along the pencil lines. Then place the shaped coil assembly back on the disc and tie it down with monofilament fishing line, looping the line through the series of holes.

Obtain a circular form 3½ inches in diameter on which you can wind the receiving coil. In assembling the prototype, a glass ashtray was used, but a cardboard cylinder would also be acceptable. The form should have a slight taper to facilitate removal of the coil after it has been wound. Apply masking tape to the form as was done in winding the transmitting coil, and wind 550 turns of No. 38 enamelled copper wire, keeping the windings as close to the center of the tape as possible. When the coil has been wound, fold the tape around the windings and remove the coil from the form. Spiral-wrap the coil tightly with masking tape. Wrap the coil with foil and another layer of tape as on *L1* and *L2* being sure to cover the foil completely. If the two foil shields are allowed to touch when the coils are positioned, the detector will not function.

Now assemble the circuit of the Coinshooter. In the construction of the prototype, a small (5 inches by 1-

3/4 inches) perforated board and point-to-point wiring were used. Printed-circuit assembly techniques are also acceptable. Because the circuit operates at very low frequencies, parts layout is not especially critical. Use an IC socket or Molex Soldercons for IC1 rather than soldering the chip's pins directly to the circuit board.

Potentiometers R29 and R30 and the loudspeaker are not mounted on the board. Rather, they should be affixed to the enclosure housing the circuit board. Resistor R11 can be soldered directly across the outer lugs of potentiometer R29. A total of four holes (two 3/8 inch in diameter spaced 2 inches apart, and two 1/8 inch in diameter spaced 1/2 inch above and below the larger holes) should be drilled in the bottom of the project enclosure so that two shielded cables can exit the enclosure and self-tapping screws can provide mechanical support. Additional holes might have to be drilled for circuit-board standoffs.

Prepare the inner conductor and shield at one end of each of two 48-inch lengths of single-conductor shielded cable. Color-code both ends of one of the cables with a dab of enamel paint or nail polish. Connect the shields of the prepared ends of both cables to circuit ground. The inner conductor of the color-coded cable should be connected to the node C1, C2, and collector of Q1; the inner conductor of the other cable should be connected to the node C4, C5. These cables should exit the enclosure housing the circuit board through the two 3/8-inch holes previously drilled through its bottom. Be sure to outfit these holes with grommets or similar bushings that prevent chafing of their outer plastic jackets and that provide strain relief.

When the circuit board has been assembled and mounted in the enclosure along with the other components, place the transmitting-coil assembly and the receiving coil on a desk or on the floor away from any metal. Prepare the free ends of the two shielded cables and tin their inner conductors and shields. Using clip leads, connect the color-coded cable's conductors to the transmitting coil, and the other cable's conductors to the receiving coil. Connect the coil shields to the outer cable conductors. Apply power to the circuit and connect an oscilloscope probe between Q3's collector and circuit ground.

Referring to Fig. 4, position the receiving coil near the center of the plywood disc on which the transmitting coil has been mounted. Adjust the po-

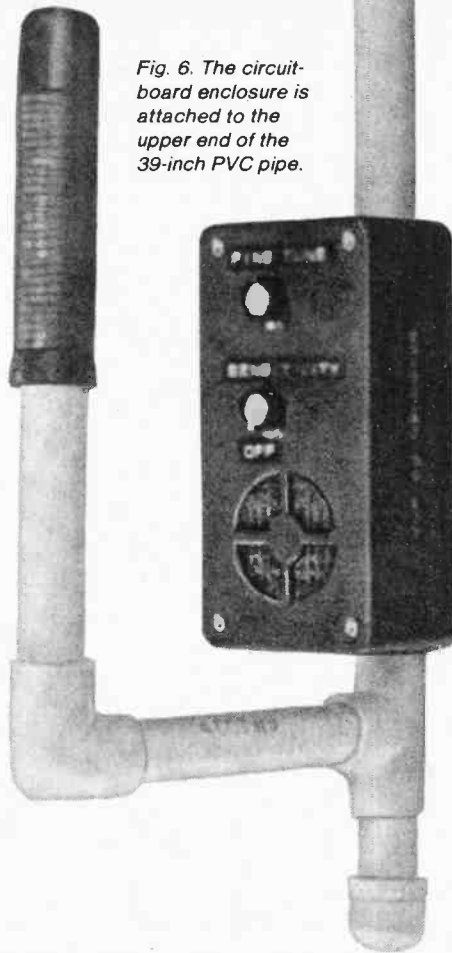

Fig. 6. The circuit-board enclosure is attached to the upper end of the 39-inch PVC pipe.

sition of the receiving coil for the minimum signal level at the collector of Q3 as indicated by the scope beam's vertical deflection. Trace a pencil line on each side of the receiving coil after the null position has been determined, and then remove the receiving coil from the disc. Drill a series of 1/16-inch holes, spaced 1/2 inch apart, along the pencil lines. Reposition the receiving coil on the disc and tie it down with monofilament fishing line, looping the line through the small holes.

Using hot-melt or epoxy glue, cement a 135° elbow PVC pipe joint in the area between L2 and L3 so that its open end points toward the gap in L1. (See Fig. 5.) Cut a 39-inch length of 1/2-inch O.D., schedule 125 PVC pipe, and drill four 1/4-inch holes in it, one above the other, approximately 2 inches in from each end. The two holes at one end of the pipe section should be 2 inches apart from each other, but the holes at the other end can be closer. Also drill two 1/8-inch holes spaced 1/2 inch above and below the two holes spaced 2 inches apart.

Slip the free ends of the shielded cables exiting the circuit-board enclosure through the 1/4-inch holes that are bracketed by the smaller holes and pass the cables through the pipe until

they protrude from the far end. Run a bead of hot-melt or epoxy glue on the pipe and attach the bottom of the project enclosure to the pipe. Added mechanical support can be introduced by driving self-tapping screws through the two small holes in the bottom of the enclosure and into the matching holes that were drilled into the pipe section.

Feed the free ends of the shielded cables through the two holes at the other end of the pipe. Insert that end of the pipe into the elbow joint attached to the plywood disc so that the circuit enclosure faces away from the coil assembly. Then glue the pipe to the elbow joint using PVC cement, maintaining the orientation of the enclosure with respect to the coil assembly. (Note that PVC cement sets quickly.) Solder the conductors of the color-coded cable to the transmitting coil and the conductors of the other cable to the receiving coil. The polarities of these connections are unimportant. Connect the coil shield leads to the outer cable conductors. Insulate the solder joints using PVC electrical tape, silicone cement, or some other suitable material. Then cement the cables to the plywood disc in the area between L3 and the gap in L1 using hot-melt or epoxy glue.

Cut 6- and 9-inch lengths of 1/2-inch O.D., schedule 40 PVC pipe. Referring to Fig. 6, assemble a handle using the lengths of pipe, a 90° elbow PVC pipe joint, a tee PVC pipe joint, a bicycle steering-bar handgrip and PVC cement. The handgrip is glued to the 9-inch section of pipe, and one of the two collinear openings of the tee should be glued to the 39-inch pipe section to which the circuit-board enclosure and the search coil assembly are attached. PVC cement is fast-setting, so work quickly and orient the handle with respect to the circuit-board enclosure as it is in Fig. 6. The remaining end of the tee will be left open until the detector is balanced.

Apply power to the circuit and reconnect the oscilloscope probe between the collector of Q3 and circuit ground. Suspend the search coil in the air away from any metal and rotate the shaft of R29 to its minimum-sensitivity setting. Monitor the scope trace and, if necessary, slightly adjust the position of L3 so that a 1-volt p-p signal appears at the collector of Q3. Pass a pair of pliers approximately three inches under the search-coil assembly while monitoring the scope trace. If the signal level decreases, shift L3 through the null point and repeat the test. The signal must in-

crease in amplitude when the pliers are brought near the search-coil assembly, or the detector will ignore coins and respond to the proximity of ferrous objects. Receiving coil *L3* should be positioned as close to the null point as possible yet still provide an increase in signal amplitude when iron or steel is brought near the search-coil assembly.

Next, pass a dime about three inches under the search coil and note the slight increase in signal level as displayed on the oscilloscope. Carefully fix the positions of the coils by bonding them to the plywood disc with quick-setting epoxy cement. When the epoxy has cured, remove the scope probe and button up the circuit-board enclosure. Advance the setting of the SENSITIVITY control until the speaker begins to beep. Then adjust the FINE TUNE control to silence the speaker. Pass a pair of pliers three inches below the search coil and note that the speaker remains silent. Then pass a dime three inches under the coil and note that the speaker starts to beep. The most sensitive area of the search coil is near its center.

The search-coil assembly can be coated with two thin applications of resin to seal it, and then it can be painted white so that it matches the PVC pipe. The coils must be bonded securely to the disc before the application of sealant and paint. To minimize the possibility of displacing the coils, use spray-on resin and paint.

If the coils have shifted position before the resin has cured, a compensating piece of iron or steel can be added to the search-coil assembly. Determine whether this has in fact happened by removing the top of the circuit-board enclosure and reconnecting the oscilloscope probe between the collector of *Q3* and circuit ground. Pass a ferrous object three inches below the search coil and monitor the scope trace. If the proximity of iron or steel causes a decrease in signal level, position a small steel washer on or near receiving coil *L3* to correct for the misalignment. Locate the required position by repeating the test for iron sensitivity and shifting the location of the washer until the correct response is obtained. Then fix the washer in place with epoxy cement.

Final Assembly and Use. Grasp the Coinshooter by its handgrip and check it for proper balance. The search-coil assembly should be parallel with and approximately 2 inches above the floor. Cut a 3-inch piece of 1/2-inch O.D., schedule 125 PVC pipe, and glue one end of it to a PVC pipe cap. Fill the pipe section with lead buckshot and tape its open end closed with PVC electrical tape. Then tape the shot-laden pipe section to the open end of the tee PVC pipe joint and recheck the balance of the project.

If it is unbalanced, untape the shot-laden pipe section, remove a little shot, tape the section closed again and

reattach it to the tee PVC pipe joint. Recheck the balance of the Coinshooter. If necessary, repeat this procedure until the Coinshooter is properly balanced and feels comfortable to the hand. When the correct amount of shot has been determined, remove the pipe section from the tee PVC pipe joint, seal the shot in the pipe section with epoxy, and cement the section to the tee after the epoxy has cured. This completes assembly.

Take the finished project outdoors and hold the search coil 4 to 6 inches above the ground. Apply power to the project and adjust its controls so that the speaker emits a slow series of beeps. Lower the search coil until it is approximately 2 inches above the ground. The beeping should stop. This occurs because most soil is mineralized and affects the Coinshooter much like ferrous objects do.

The detector is now at maximum sensitivity and will detect coins at depths of from 1 to 3 inches, depending on their sizes and positions. Ferrous objects will not trigger the circuit unless they are very large or very close to the search coil or both. The Coinshooter will detect aluminum cans, caps and pull tabs, but it responds best to coins. Raise the search coil from time to time to check for the slow beeps that indicate maximum detector sensitivity. Although the circuit is very stable, the FINE TUNE control might have to be adjusted occasionally to compensate for changes in ground mineralization, temperature, and, if an unregulated power supply is used, battery voltage.

Always hold the Coinshooter so that the search-coil assembly is 1 to 2 inches above and parallel to the ground. Try to keep the search coil at a constant height above the ground. Swing the loop back and forth in front of you, making overlapping arcs. It is best to search slowly, but a coin will usually be detected even if the search coil passes over it quickly. For best results, operate the circuit as close to its switching threshold as possible.

When an object has been detected, move the search-coil assembly over it from front to back and from side to side to pinpoint its location. Keep in mind that the center of the search-coil assembly is its most sensitive point. Probe for the object with a small screwdriver or similar digging tool. If you search for coins in parks and woodlands, do so without disturbing the landscape. Always fill any holes that you make with your digging tool and place any turf that has been disturbed back in its original position. ◇

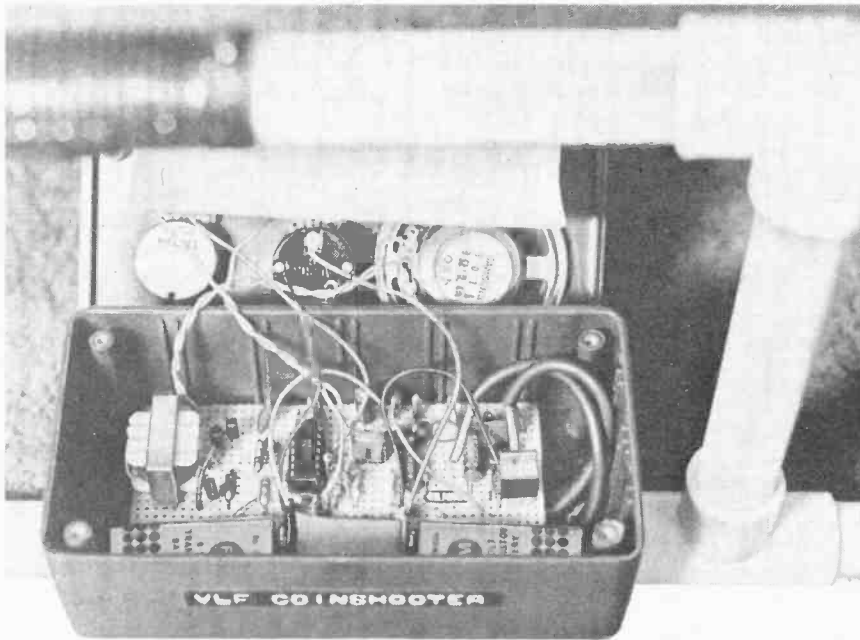

Photograph shows the circuit-board enclosure mounted on the PVC pipe. The top has been unfastened and laid aside.

A SIGNAL-PROCESSOR PATCH BOX

Simple switching facility allows easy rearrangement of outboard audio gear

BY MICHAEL N. STOSICH

A WIDE variety of outboard signal processors is available for connection to home audio systems, but using them is often a problem—particularly if several are in tandem and one wishes to make a tape of the processed signal. The problem, simply, is that preamps, integrated amplifiers, and receivers don't have enough connection facilities to conveniently accommodate all the extra "black boxes" one might need.

Let's say, for example, that you want to prepare a tape of a 78-rpm disc that is scratched, noisy, and lacking in bass. You would probably use something like an SAE 5000 impulse noise reducer to de-click it, then feed the signal to a Burwen 1201 to de-hiss it, and finally, run the signal through a graphic equalizer to boost the bass.

It is possible to hook all these up in tandem via the TAPE MONITOR on your control center—be it a receiver, integrated amp, or preamp—and bypass each with its own TAPE MONITOR when its use is not desired. However, you'll still have a problem dubbing tapes without reconnection, unless your system can handle two or more recorders and has dubbing facilities. Even then, you'll only be able to dub in one direction—if you want to use the signal-processing facilities. There is a better

way: a switching panel that can arrange and vary the interconnection of components via switching. A schematic is shown below.

The Panel. The switch box accommodates three recorders with provisions for a fourth one connected to a front-panel jack. You can listen to any phono, tuner, aux, or tape recorder with or without processing, and if desired, record that signal. You can also dub between any of the recorders while processing the signal and still use the other preamp functions. A MONO switch is located in the circuit, to allow output summation after the pop/scratch filter. The second external loop exists for the rare instance when you have a single-channel processing device. In that case, the sum of the two channels is fed to the single-channel device via the MONO switch. When the EP_2 switch is operated, a Y-connector is fed out to both tape feeds. Normal stereo processors can also be added to the EP_2 loop.

Construction. If you want to give your switch box a raw metallic look, use an aluminum rack panel. If you want to paint it, use a pre-painted panel of any color, and spray paint it as desired. You can also purchase an

anodized panel for a professional look.

Use an aluminum box that fits the panel which holds the 24 RCA jacks. Mount those jacks on the rear of the box and the 1/4-inch stereo jacks on the front. It is also possible to use another sheet of metal to mount the RCA jacks, and then mount the entire unit to the rear of the front panel, using 1- to 2-inch spacers. Shielded cable should be used wherever practicable, to minimize crosscoupling.

Operation. Connect the switch panel's amplifier jacks to the TAPE and MONITOR jacks of the preamp or receiver. When the preamp's MONITOR switch is on, it is extended to the switch panel. Then you can leave that switch depressed. Now connect your tape recorders and external processing devices to the panel.

To play a record or tuner with signal processing, simply play it as usual with the appropriate EQ switch. Thus, you can record the signal just as it sounds from the speakers. To hear the sound as it is being recorded, use the MONITOR. Signal processing will also work for any or all of the recorders in this scheme. When dubbing from one deck to another, it is possible to listen to the radio or phonograph by deactivating the MONITOR. ◇

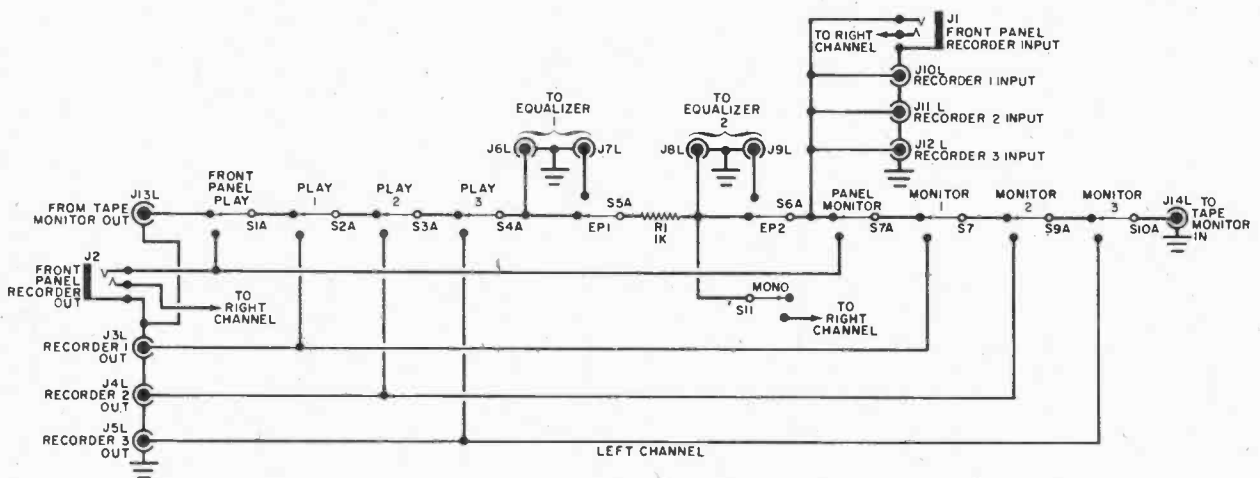

PARTS LIST

- | | |
|--------------------------------------|-------------------------------|
| J1, J2 — 1/4" stereo phone jack | R1, R2 — 1 kΩ, 1/2-W resistor |
| J3L through J14L, J3R through J14R — | S1 through S10 — Dpdt switch |
| RCA phono jack | S11 — Spdt switch |

THANDAR'S COMPLETE PORTABLE TEST BENCH

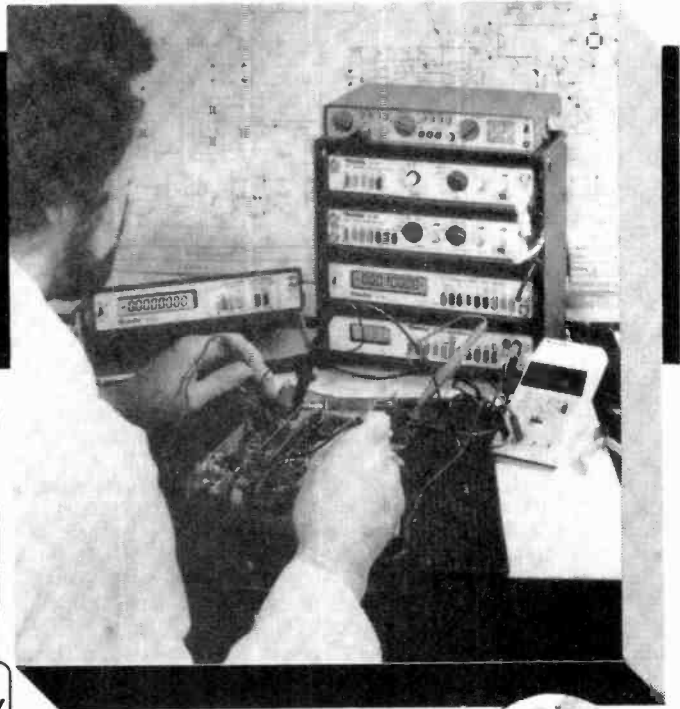

LCD HAND HELD MULTIMETER

\$79.95

TM354 3½ Digit

● DC Volts : 1mV to 1000V ● AC Volts : 1V to 500V AC rms ● DC current : 1µA to 2A
● Resistance : 1Ω to 2MΩ ● Diode Check
● Basic accuracy : ± (0.75% of reading + 1 digit) ● Battery life : Typically 2000 hours

**2000 hrs
BATTERY
LIFE**

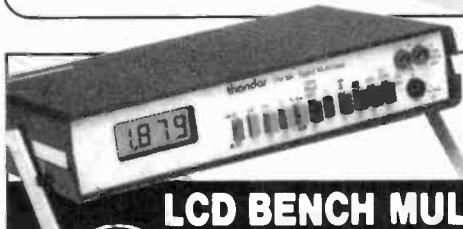

**4000 hrs
BATTERY
LIFE**

LCD BENCH MULTIMETERS

**\$199
inc. batts**

TM351 3½ Digit

● DC and AC Volts : 100µV to 1000V (750V AC rms)
● DC and AC current : 100nA to 10A (20A for 10 secs)
● Resistance : 100mΩ to 20MΩ ● Diode check ● Basic accuracy : ± (0.1% of reading + 1 digit) ● Battery life : up to 4000 hours

TM353 3½ Digit

● DC and AC Volts : 100µV to 1000V (750V AC rms) ● DC and AC current : 100nA to 2A
● Resistance : 1Ω to 20MΩ ● Diode check ● Basic accuracy : ± (0.25% of reading + 1 digit) ● Battery life : Typically >3000 hours ● \$159 (inc. batts).

LED MULTIMETERS

DM350 3½ Digit;

34 ranges; 0.1% basic accuracy;

DM235 3½ Digit; 21 ranges; 0.5% basic accuracy; \$69.95

PDM35 3½ Digit; Hand held; 16 ranges; 1% basic accuracy; \$39.95



\$99.95



PULSE & FUNCTION GENERATORS

\$159

TG100 100kHz Function Generator

● Frequency range : 0.1Hz to 100kHz
● Functions : Sine, Square, Triangle and DC from variable 600Ω output ● Output range : 1mV-10V peak-peak ● DC offset range : ±5V ● TTL output ● External sweep : ≥300:1 linear range

STOP PRESS TG102 2MHz Function Generator \$299

TG105 5MHz Pulse Generator

● Period : 200nsec to 200ms (5MHz to 5Hz) ● Pulse width : 100nsec to 100ms ● 50Ω output range : 0.1V-10V ● TTL output ● Sync. output ● Operating modes : run, external trigger, external gate, manual 1-shot or gate ● Complement and square wave ● \$199



GOLD MEDAL WINNER

\$259

SC110 SINGLE TRACE LOW POWER 2" OSCILLOSCOPE

This truly portable oscilloscope, the only British product to win a Gold Medal at the 1980 Brno Trade Fair, boasts the following specification: ● Bandwidth : DC to 10MHz ● Sensitivity : 10mV/div to 50V/div ● Sweep Speeds : 0.1µsecs/div to 0.5 secs/div ● Power Requirements : 4 to 10V DC from 4 "C" cells or AC adaptor ● Size and weight : 255 x 150 x 40mm; 800gms excl. batteries

FREQUENCY METERS

TF040 8-Digit LCD

● Frequency Range : 10Hz-40MHz (to 400MHz with TP600)
● Sensitivity : 40mV rms ● Timebase accuracy : better than 0.5 ppm ● Battery life : Typically 80 hours

TF200 8-Digit LCD

● Frequency Range : 10Hz-200MHz (to 600MHz with TP600) ● Sensitivity : 10mV rms 20Hz-100MHz, 30mV rms 10Hz-20Hz, 100MHz-200MHz ● Timebase accuracy : better than 0.3 ppm ● Battery life : Typically 200 hours ● \$299 (Inc. batts).

PFM200 8-Digit LED Hand Held Meter

● Frequency Range : 20Hz-200MHz (to 600MHz with TP600) ● Sensitivity : Typically 10mV ● Timebase accuracy : better than 2 ppm ● Battery life : Typically 10 hours ● \$99.95

TP600 600MHz Prescaler

● Frequency Range : 40MHz to 600MHz ● Sensitivity : 10mV ● Output : Typically 500mV peak-peak ● \$79



**\$199
inc. batts**

THANDAR SATISFACTION WARRANTY:

If for any reason, whatsoever, you are not completely satisfied with your purchase, return it within 30 days of purchase date for a full refund - it's as simple as that!

TO ORDER CALL TOLL FREE: 800-526-5311
We accept Master Charge or Visa

New Jersey Residents add appropriate Sales Tax. Prices shown in U.S. currency only.
POSTAGE AND HANDLING up to \$100 add \$3. Over \$100 add \$5.

THANDAR ELECTRONICS INC

P.O. Box 8247, Haledon, New Jersey, 07538 Tel: 201-790-3141

COMPUTER BITS

By Carl Warren

This Is the Year of Software.

A STRIKING difference between the sixth annual West Coast Computer Faire this past April and previous shows was the large number of software vendors in attendance. And this time, the software being shown was of great value and indicated the power possessed by microcomputers.

Sorcim for example, showed its latest piece of magic, called "Supercalc." This isn't just another electronic worksheet patterned off Personal Software's "Visicalc"; it's a powerful information-handling tool that happens to create spread sheets. The package lists for \$295 and works with the CP/M operating system. Data entry is facilitated by using single keystroke inputs for commands and menu selections. Somewhat similar to Supercalc is Ashton-Tate's dBase II. This comes in two flavors: a

\$700 package for large CP/M systems that support anything from 5.25-in. floppies to 10M byte Winchester, and a \$350 package for the Apple II. The latter version has some unusual hooks in it, requiring a Microsoft Z80 Softcard, and Apple CP/M. To ensure proper operation of the package, and to prevent it from being loaded to larger machines, the Apple version uses part of the 6502 instruction set for certain mathematical functions.

The dBase II package is delivered as a demo diskette and a system diskette. The demo diskette lets you do everything you can do with dBase II, up to a maximum of 15 records in any one database. The purpose is twofold: first, to let you decide if this is really the package for you; and, second, to let you configure the database(s) the way you want them

before committing yourself to the full package. If you decide it's for you—open the sealed and coded package.

I have been able to use dBase in a variety of ways. To make sure I fully understood the package (the documentation is good, but still needs refinement), George Tate, of Ashton-Tate, spent a day going over it with me.

One unique feature of dBase II is its built-in language. This nameless language was designed to permit the building of command files that will work on an automatic basis and require no operator intervention. However, the language is so powerful, using constructs very much like Pascal and Fortran, that you can create specialized applications.

Still on the information retrieval side, are four packages from Personal Software. Created to turn a personal com-

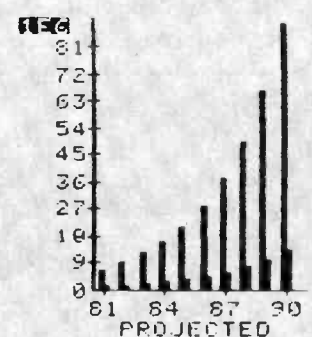
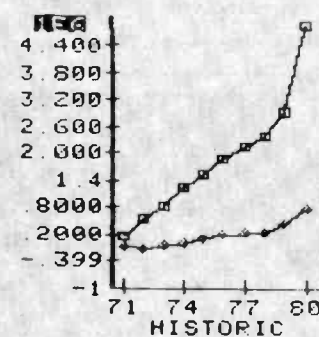
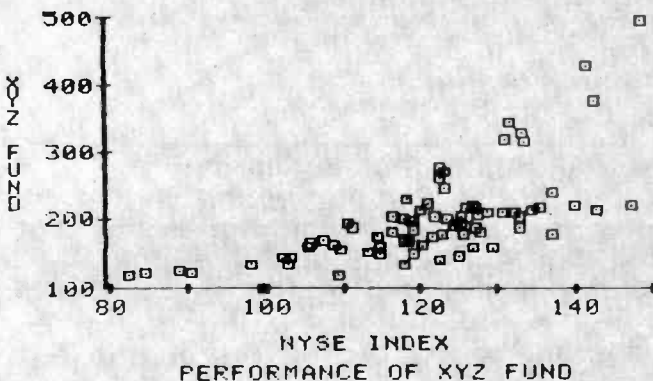
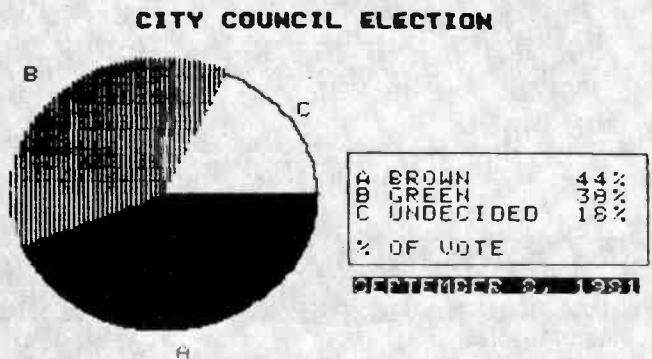
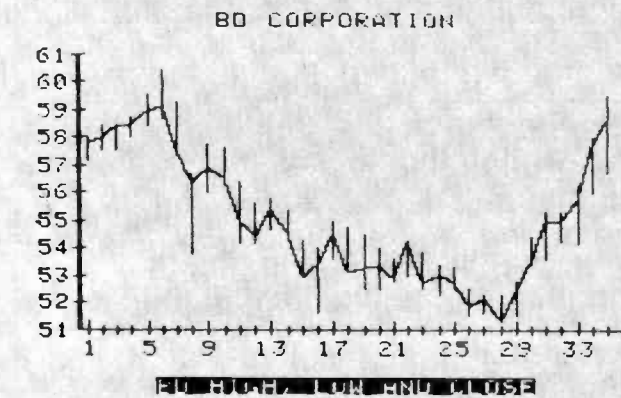

Sample printouts from the VisiPlot and VisiTrend / VisiPlot programs. Producible graphs include bar chart, scatter, pie, line, and high-low.

puter into a powerful intelligent worksheet, four generic software packages dubbed Visiplot, Visitrend, Visidex, and Visiterm provide powerful general capabilities. These include calculations, data plotting, and financial or statistical analysis. Moreover, the packages exhibit great flexibility. Currently designed to operate on the Apple computer, they are visually oriented, and require no special programming skill. Additionally, all the programs have a mutually consistent command structure. Visiplot, for \$179.95, produces high-resolution graphs and charts in six different formats and colors, without programming intervention on the part of the user. It can use numerical data entered directly or data generated by the popular Visicalc.

Visiplot's repertoire of "plots" includes bar graphs (cumulative and side-by-side), time-series-one plots, hi-lo charts, and scatter grams. A total of 645 data points is held in memory at one time and up to 150 data points can be plotted on a single graph. As an added feature, plots may be printed to either the Apple Silentype thermal printer, or the Integral Data Paper Tiger Models 440 and 445. Daisy wheel printers with graphics capability can also be used.

Combining the power of Visiplot with a forecasting program is Visitrend/Visiplot at \$259.95. This package speeds time-consuming statistical calculations. Among the many types of trend analysis that can be performed are: descriptive statistical analysis, multiple linear regression, trend-like forecasting, data transformations, cumulatively total data values, generation of fitted and residual series, moving average, smoothing—line of best fit—and lead/lag and percent change. Since Visitrend works in tandem with Visiplot, the results of the calculations can be displayed graphically. And, like Visiplot, it can accept data either from direct keyboard input or from Visicalc files.

The third program in the series, Visidex, stores and provides rapid retrieval of unrelated information. Priced at \$199.95, it permits information to be entered on the screen in free-form fashion in user-defined formats. Applications can include; tickler files, mail lists, to-do lists, memos, and virtually anything you now do on paper. Up to 36 six-letter keywords can be defined for any record, thus permitting access via multiple avenues. Also included in Visidex is a built-in calendar that facilitates retrieving information by date or, if your Apple is equipped with an onboard clock, automatically purge information on a given date or time or generate a reminder for you. This data can be sorted by keyword, numeric order, or by date and set for later print out.

The final package in the series, Visiterm, at \$149.95, permits the transfer of disk file information over the phone. It is designed to work with files created by the other information packages and in-

cludes such features as single-key macro definitions, a configuration feature to match host systems, scrolling, and entry of information in upper or lower case.

All these packages are available now from Apple and Personal Software dealers on 16-sector formatted diskettes. Although there has been controversy over the command structure used in Personal Software packages, I have found them easy to learn. Personal Software supplies very informative manuals with its products. Of course, they won't do you any good if you don't read them.

That North Star Book. Many of you have written requesting more information on North Star BASIC, and where to get that book I thought had been written. The book is entitled: "A User's Guide to North Star BASIC" by Robert R. Rogers. About 100 copies of the first edition are still available at \$14.95 plus \$2.50 UPS charges. You can order by contacting Robert Rogers at Scott Randolph Labs, 5924 Allday, Houston, TX 77036. Phone: 713-975-1807. The author is currently working on a new edition that might be available before year's end.

Let's Communicate. I know that many of you are looking for a method of getting onto MicroNet or setting up your own system. Here's how. Contact Microperipheral Corp. (2643 151st, NE, Redmond, WA 98052; 206-881-7544) and order the Microconnection for your favorite system. The modem is priced at \$199.50 with a terminal program; add another \$79.95 for the auto-dial/autoanswer module. With this in hand, you can set up your own network.

A question that has been asked about the Microperipheral modem is: why does it use a separate power supply, rather than deriving the power from the phone line? The answer, according to Microperipheral's Don Stoner, is that telephone line voltages tend to vary too much around the country, and, should a line spike occur, damage to the modem would be likely.

There seems to be a growing mass of evidence to support this design decision. A number of users on MNet have reported difficulties with modems powered from the phone line and have found it necessary to add pull-up resistors to force a higher voltage or add a power supply of their own. Pat McMullen, a technician with whom I do a great deal of work, and I ran a number of tests with various modems to determine whether or not they could work under a wide range of conditions. Our purpose was to choose a modem that could be implemented in a message network, of which we will divulge the number before the end of the year. We decided that the Microconnection met all our needs, and have it installed on the TRS-80, Heath H-89, and an S-100 bus system. Later, we will use it with the Apple II. So far, after two months, no problems. ♦

NEW!!! THE ELECTRIC MOUTH*



For S100, Elf II, Apple, TRS-80 Level II*

From \$99.95 kit

Now — teach your computer to talk, dramatically increasing the interaction between you and your machine.

That's right: the ELECTRIC MOUTH actually lets your computer talk! Installed and on-line in just minutes, it's ready for spoken-language use in office, business, industrial and commercial applications, in games, special projects, R&D, education, security devices — there's no end to the ELECTRIC MOUTH's usefulness. Look at these features:

- * Supplied with 143 words/letters/ phonemes/ numbers, capable of producing hundreds of words and phrases.
- * Expandable on-board up to thousands of words and phrases (just add additional speech ROMs as they become available).
- * Four models, which plug directly into S100, Apple, Elf II and TRS-80 Level II computers.
- * Get it to talk by using either Basic or machine language (very easy to use, complete instructions with examples included).
- * Uses National Semiconductor's "Digitaltalker" system.
- * Includes on-board audio amplifier and speaker, with provisions for external speakers and amplifier.
- * Adds a new dimension and excitement to programming: lets you modify existing programs and games to add spoken announcements of results, warnings, etc.
- * Installs in just minutes.

Principle of Operation: The ELECTRIC MOUTH stores words in their digital equivalents in ROMs. When words, phrases, and phonemes are desired, they are simply called for by your program and then synthesized into speech. The ELECTRIC MOUTH system requires none of your valuable memory space except for a few addresses if used in memory mapped mode. In most cases, output ports (user selectable) are used.

Spoken Material Included											
one	eighteen	at	dollar	inches	number	ss	c	t			
two	nineteen	cancel	down	is	of	second	d	u			
three	twenty	case	equal	it	off	set	e	v			
four	thirty	cent	error	kilo	on	space	f	w			
five	forty	400hertz tone	feet	left	out	speed	g	x			
six	fifty	80hertz tone	flow	less	over	star	h	y			
seven	sixty	20ms silence	fuel	lesser	parenthesis	start	i	z			
eight	seventy	40ms silence	gallon	limit	percent	stop	j				
nine	eighty	80ms silence	go	low	please	than	k				
ten	ninety	180ms silence	gram	lower	plus	the	l				
eleven	hundred	320ms silence	great	mark	point	time	m				
twelve	thousand	cent	greater	meter	pound	try	n				
thirteen	million	check	have	mile	pulses	up	o				
fourteen	zero	comma	high	milli	rate	volt	p				
fifteen	again	control	higher	minus	rv	wright	q				
sixteen	ampere	danger	hour	minute	ready	a	r				
seventeen	and	degree	in	near	right	b	s				

*"Elf II" and "The Electric Mouth" are reg. trademarks of Netronics R&D Ltd. "Apple" is a reg. trademark of Apple Computer Inc. "TRS-80 Level II" is a reg. trademark of Tandy Corp.

Continental U.S.A. Credit Card Buyers Outside Connecticut

CALL TOLL FREE 800-243-7428

To Order From Connecticut Or For Technical Assistance, Etc.,

Call (203) 354-9375

NETRONICS R&D LTD. Dept PE

333 Litchfield Road, New Milford, CT 06776

Please send the items checked below:

- \$100 "Electric Mouth" kit \$99.95
- Elf II "Electric Mouth" kit \$99.95
- Apple "Electric Mouth" kit \$119.95
- TRS-80 Level II "Electric Mouth" kit \$119.95

Add \$20.00 for wired & tested units. All plus \$3.00 postage & insurance. Conn. res. add sales tax.

Total Enclosed \$ _____

Personal Check Cashier's Check/Money Order

Visa Master Charge (Bank No. _____)

Acct. No. _____

Signature _____ Exp. Date _____

Print Name _____

Address _____

City _____

State _____ Zip _____

Recording engineers are trained... not born. Learn to engineer the sound of music...



Complete the **Multi-track Recording Technology** curriculum in one year, or earn the four year **B.S. Degree in Music Technology** via the Institute of Audio Research—New York University joint program.

Fall '81 Quarter starts
Thursday, September 24th.

Winter '82 Quarter starts
Monday, January 4th.

To obtain our 24-page descriptive brochure, simply write or call — (please mention this publication):



Institute of Audio Research

64 University Place
Greenwich Village
New York, N.Y. 10003
(212) 677-7580

Established
1969

Licensed by N.Y. State Dept. of Education
Approved for Veterans Training

COMPUTER SOURCES

By Leslie Solomon
Senior Technical Editor

Hardware

New Computer. The PMC-80 is designed to fill the niche left by Radio Shack's withdrawal of the TRS-80 Model I. It is fully compatible with the TRS-80 in software and operations. It features a high-speed cassette port, interfaces for disk, printer, RS232B, and an S-100 bus. The basic "Stripper" version that requires an external r-f modu-



lator and TV receiver is \$675 and includes 16K and built-in level-2 BASIC, while the "Startup" version that includes a video monitor is \$834. **Address:** Personal Micro Computers, Inc., 475 Ellis St., Mt. View, CA 94043 (Tel: 415-962-0220).

SS50 Multifloppies. The DMA Disk Controller uses DMA (direct memory access) for data transfer and can support any combination of 8", 5", single/double track (48/96 tpi), single/double density, and up to four drives total. It can be used with 6809 systems (\$548.68). The Double Density PIO Controller supports up to four 5" single/double headed, single/double track, single/double density drives (6809 version \$348.28). The 5/8 Disk Controller can be used with 6800/6809 systems and supports any combination of 8" or 5", single/double headed, single/double track, and up to four drives total. In 6800 systems only 5" drives can be used. This board is a replacement for the SWTP DC-1, -2, or -3 controller (\$226.58). Available software includes 6809 FLEX DOS, OS-9 for all three controllers, and UniFLEX for the DMA controller. **Address:** GIMIX Inc., 1337 West 37th Place, Chicago, IL 60609 (Tel: 312-927-5510).

TRS-80 Printer. Printer V for the TRS-80 is designed for business use and features a bidirectional, logic-seeking, 7x9 dot-matrix upper- and lower-case characters with descenders, and 132 col-

umns. It has software-selectable 5, 7.5, 10, or 15 characters/inch, 26 European characters, and 30 graphics patterns. Print speed is 160 characters per second, 60 lines per minute. The tractor feed handles fanfold paper up to 15" wide and up to 5 sheets, and is adjustable in 1/8-line increments. It has a full set of indicators, controls, and self test. \$1860. Sold in Radio Shack Computer Centers and stores.

S-100 Video Board. The VB3 Video Board for S-100 systems features 48, 80-character lines, upper/lower case, and true descenders. A second RAM block contains "attribute" bytes for user programming, low intensity, reverse video, underscore, strike through, thin line, or dot graphics. Bank switching occupies memory only when activated. It generates both US and European TV rates. Software includes CP/M-compatible driver and terminal simulator. Software controlled options include timing loop, top and bottom margins, horizontal position, inverted video, (2x4) graphic character, one level of gray, blinking character, underline, blankout character, and cursor. \$654 assembled/tested. A 24-line by 80-character version is \$565. **Address:** SSM Microcomputer Products Inc., 2190 Paragon Drive, San Jose, CA 95131 (Tel: 408-946-7400).

4 Winchester on one OSI C3-C. OSI C3-C (CD-23) users can now have up to four SA4008 (CD-23) hard disk systems on one computer. The board has a built in power supply, and the only connections to be made are the controller-to-interface cables, the ac power, and one 50-conductor cable to each drive. \$845. **Address:** Terry Electronic Assembly Co., Inc., Box E, 2117 Ohio St., Michigan City, IN 46360 (Tel: 219-874-6234).

H-89 Double Density. This new controller supports up to four 8" and four 5" disk drives. A 5" double-sided, 96-tpi drive holds 700K bytes, and an 8" double-sided drive holds over 1.2M bytes. Four drives give the user 7.6M bytes. The controller can handle any combination of 8" and 5" 40- or 80-track drives in either single- or double-sided versions. It is compatible with the Corvus 10 and 20M byte Winchesters, and Cameo 5+5 Cartridge Disk subsystem. Includes CP/M 2.2. \$595. **Address:** Magnolia Microsystems Inc., 2812 Thornydyke Ave., West, Seattle, WA 98199 (Tel: 800-426-2841).

Atari Upgrade. The MagiCard plug-in module for the Atari contains 1K bytes of RAM and a 2K ROM monitor that converts the system into a hobby computer. Commands include exam and fill memory, disassembly, and running user-written programs. Subroutines to display text or memory-mapped color graphics are also provided. Sample pro-

grams and a cassette interface program further extends the use. \$49.88. Address: Computer Magic Inc., Box 3383P, Fox Valley Center, Aurora, IL 60505.

PET Disk. The PEDISK II comes as 5" or 8" with a small disk controller board that fits inside the machine and contains the PDOS in ROM. Up to three drives can be controlled. The 5" size offers 143K bytes (\$595), and the dual 5" quad density system provides 572K bytes (\$1195). It is compatible



with all Commodore disk systems and can be used simultaneously. The PDOS II software package includes BASIC commands such as OPEN, CLOSE, INPUT, and PRINT, all used for file handling. The DOS also contains diagnostic and utility functions. Address: CGRS Microtech, Inc., Box 102, Langhorne, PA 19047 (Tel: 215-757-0284).

Low-Cost Printer. The Bytewriter-1 is an 80-column, 7 x 7 dot-matrix printer that accepts single sheet or roll paper up to 8 1/2" wide and prints at 60 lines per minute. The interface is similar, but not identical, to a Centronics parallel interface and has been designed to operate with the Apple II, Atari 400/800, and all models of the TRS-80. \$299 (interface cable slightly extra). Address: Microtek, Inc., 9514 Chesapeake Dr., San Diego, CA 92123 (Tel: 714-278-0633).

Software

ZX80/Microace Games. The Chest of Classics is a cassette containing four games for the Sinclair ZX80 and the Microace computers. The games are Life (machine language that allows 1000 generations per minute), Lunar Lander, Mindmaster, and K-Trek, a variation of Star Trek. Complete BASIC listings are provided as well as a color keyboard overlay. \$9.95. A free catalog and ZX80 coding sheets are available. Address: Lamo-Lem Laboratories, Box 2382, La Jolla, CA 92038 (Tel: 714-262-5681).

Data Abstraction Language. DATABS, a data abstraction language for the 8080 runs under CP/M and was inspired by the MIT developed CLU language. Types include boolean, char-

acter, single- and double-byte integer, and string. It allows user-defined types with dynamic storage mechanism. It supports UNIX+ style command line arguments and I/O redirection. Stream abstraction allows terminal and disk I/O. Requires 40K. Diskette includes the compiler, type and run-time support library, stream abstraction, and command line processor. \$49.95. Address: Softronics, 36 Homestead Lane, Roosevelt, NJ 08555.

TRS-80 Game. The Everest Explorer is a simulation game for the TRS-80. In it, the user needs to select manpower, food, fuel, shelter and oxygen to support the climb. Other factors include weather, climber condition, and morale. Uses Model I, Level II, and 16K. Cassette is \$14.95. A 32K disk version is \$20.95. Address: Acorn Software Products, 634 North Carolina Ave., SE, Washington, DC 20003 (Tel: 202-544-4259).

6809 UniFLEX. Written in 6809 assembler language, the UniFLEX operating system is a full disk, sort/merge package for easy operator interface and fast sorts. Any size or type file may be sorted with parameters supplied as part of the command line through the use of a parameter editor, or in an existing parameter file. It can also merge on previously sorted files. Other features include any size fixed or variable-length input records, fixed or variable-length fields, up to 250 input/output keys, key length up to 250 characters, supports ascending or descending and right or left justified keys, user-definable sorting sequence, run-time messages, and record select/exclude. License is \$100. Address: Technical Systems Consultants, Inc., Box 2570, West Lafayette, IN 47906 (Tel: 317-463-2502).

C Language. The C programming language is available for Cromemco Z-80A based, S-100 systems operating under multi/user, multi/tasking CROMIX operating system. It produces relocatable code that can be linked with FORTRAN, COBOL, and assembly language, or called from BASIC. This powerful language is effective for writing operating systems, languages, utilities and I/O drivers, communication software, database management systems, file management software, and fast graphics software. Available on 5" (CCC-S), or 8" (CCC-L) diskettes. \$595. Address: Cromemco, Inc., 280 Bernardo Ave., Mountain View, CA 94043 (Tel: 415-964-7400).

Stock Analysis. The STOCKPAK System for the TRS-80 is a Standard & Poor stock analysis and portfolio management package. It provides evaluation and management of a stock portfolio of up to 100 securities with as many as 30 transactions on each issue. It also allows analysis of 900 NY and American exchange and over-the-counter common stocks, and generates reports to guide

ESP

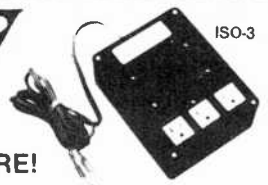

ISO-3
Pat. #4,259,705

DON'T BLAME THE SOFTWARE!

Power Line Spikes and Hash often cause memory loss or erratic operation. Often floppies, printer & processor interact!

OUR patented ISOLATORS eliminate equipment interaction AND curb damaging Power Line Spikes, Surges and Hash.

Filtered 3-prong sockets and integral Spike Suppression. 125 VAC, 15 Amp, 1875 W Total - 1 KW per socket.

ISO-1 ISOLATOR. 3 Filtered Sockets; 1000 Amp 8/20 usec Spike Suppressor \$62.95

ISO-4 ISOLATOR. 6 Filtered Sockets; 1000 Amp 8/20 usec Spike Suppressor \$106.95

ISO-3 SUPER-ISOLATOR. 3 DUAL filtered Sockets; 2000 Amp 8/20 usec Spike Suppressor \$94.95

ISO-7 SUPER-ISOLATOR. 5 DUAL filtered Sockets; 2000 Amp 8/20 usec Spike Suppressor \$154.95

Master Charge, Visa, American Express
TOLL FREE ORDER DESK 1-800-225-4876
(except AK, HI, MA, PR & Canada)

Electronic Specialists, Inc.

171 South Main Street, Natick, MA 01760

Technical & Non-800: 1-617-655-1532

CIRCLE NO. 17 ON FREE INFORMATION CARD



FREE!

1981
DISCOUNT
ELECTRONICS
CATALOG

JOIN THE PAK!

Send for our Free catalog and become a member of our exclusive Pak. Our members receive Poly Paks'

exciting catalog several times a year. We offer:

Penny Sales, Free

Premiums and Low,

Low Prices on a wide variety of

Electronic Products such as Computer Peripherals, Integrated Circuits, Speakers, Audio Equipment, Rechargeable Batteries, Solar Products, Semiconductors, and much, much more!

Take advantage of our 25 years as America's foremost Supplier of discount electronics.

RUSH ME YOUR FREEDISCOUNT CATALOG!

NAME: _____

ADDRESS: _____

CITY: _____

STATE: _____ ZIP: _____

CLIP AND MAIL COUPON TODAY TO:

POLY PAKS, INC.

P.O. BOX 942, P08
S. LYNNFIELD, MA. 01940

(617) 245-3828

CIRCLE NO. 44 ON FREE INFORMATION CARD



▲ **APPLE II+ (48K) \$1299.00**



TRS-80 MODEL III ▲ (48K) \$999.00

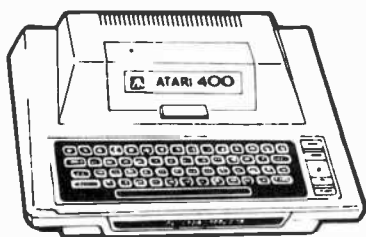

◀ **ATARI 400 (16K) \$339.00**

PRINTERS

- MICROLINE-80..... \$429.00
- MICROLINE-82..... \$599.00
- MICROLINE-83..... \$899.00
- EPSON MX-70..... \$419.00
- EPSON MX-80..... \$519.00
- EPSON MX-80FT..... \$619.00
- CENTRONICS 737.... \$749.00

TERMS Prices and specifications are subject to change. HARDSIDE accepts VISA & MASTERCARD Certified checks and Money Orders. Personal checks accepted (takes 3 weeks to clear). HARDSIDE pays all shipping charges (within 48 states) on all PREPAID Orders OVER \$100.00. On all orders under \$100 a \$2.50 handling charge must be added. C.O.D. orders accepted (orders over \$250 require 25% deposit); there is a \$5.00 handling charge. UPS Blue Label Air Freight available at extra cost. TRS-80, APPLE and ATARI are trademarks of Tandy, Apple Computer Co and Warner Communications respectively.

TSE-HARDSIDE
6 South St., Milford, NH 03055 (603) 673-5144
TOLL FREE OUT-OF-STATE 1-800-258-1780

CIRCLE NO. 24 ON FREE INFORMATION CARD

investment decisions. It records buy and sell transactions, price and dividend information, and splits. It is designed for Model I or Model III 32K business systems and includes four diskettes. Optional monthly updating is available from Standard & Poor. \$49.95. Sold at Radio Shack Computer Centers or stores.

Educational Programs. A series of programs written for an Apple II with 16K and disk, and especially designed as childrens teaching aids include hand/eye coordination programs such as Co-operation Maze, Write In Color, Make A Tune, and Computer Palette. Also counting programs such as Count to 10, Counting Fun, Counting Numbers Less Than 101, and Counting By *; and a series of programs in arithmetic, vocabulary, synonyms and antonyms, hard/soft consonants, syllables, word break-up, basic reading skills, etc. **Address:** Edutek Corp., 415 Cambridge #14, Palo Alto, CA 94306 (Tel: 415-325-9965).

Apple Word Processor. Using a 48K Apple II with disk and Applesoft in ROM, WRITE-ON!-I and II allows personalized letters, mailing labels, bills, checks, and the creation and maintenance of data files, merging, etc. Version II can preformat often-used text for faster printing. No computer training is required to use either version. Version I does not have data file merge. \$99.50 for version I, \$150 for II. **Address:** Rainbow Computing Inc., 9719 Resada Blvd., Northridge, CA 91324 (Tel: 213-349-5560).

PASCAL Utilities. Screen Handler is compatible with a variety of terminals making CRT data input simple. Extensive error checking and an easy-to-use system for storing and changing user prompts without reprogramming are provided (\$75). Output Formatter makes reports easy to design and program. It includes tab, automatic page and line counter during program execution, and top of form routine (\$37.50). Forms Generator includes an output formatter and additional software that allows an end user to redesign reports without programming (\$49.50). **Address:** HDP Inc., 222 E. Anapamu St., Santa Barbara, CA 93101 (Tel: 805-965-4477).

Music and Animation. The Rainbow Writer is a graphics, text, music, and animation program for the Apple II. The program creates special effects using color, animation, alphabets, shapes and sounds. It uses a simple menu-driven selection. Special character fonts can be created, or a selection can be made between nine sizes and 18 different colors of upper- and lower-case English or Greek letters. In the music mode, six chromatic octaves and special tonal effects can be produced. \$39.95. **Address:** Personal Software Inc., 1330 Bordeaux Drive, Sunnyvale, CA 94086 (Tel: 408-745-7841).

It was the music that moved us

MUSIC LIVES ON TDK

TDK cassettes are warranted for a lifetime.

© 1981 TDK Electronics Corp., Garden City, N.Y. 11530

CIRCLE NO. 52 ON FREE INFORMATION CARD

SOLID-STATE DEVELOPMENTS

By Forrest M. Mims

Solid-State Speech

BY NOW, you have probably heard samples of solid-state speech produced by such devices as the Speak & Spell® educational trainer manufactured by Texas Instruments or the Voice Challenger® chess game by Fidelity Electronics. If not, you are in for a treat—amazing progress has been made in the field of digital speech generation.

My first exposure to solid-state speech occurred in 1975, when two companies demonstrated talking calculators at a conference on electronic aids for the blind. Both machines produced intelligible spoken renditions of the symbols and numbers marked on their keys as well as visual displays.

The speech quality of Speak & Spell is at least as good as that of the talking calculators. This is true even though Speak & Spell requires considerably less memory per spoken word. This is the

result of highly sophisticated circuits that model the human vocal tract.

The latest speech-generation circuits are highly complex. The need for this complexity is explained by the nature of the human vocal tract. An in-depth dis-

ussion of the mechanism that converts streams of exhaled air into intelligence-bearing sounds is beyond the scope of this column. Suffice it to say that speech is generated by intricate cooperation of the diaphragm, lungs, vocal cords, air passages, resonant cavities (both fixed and adjustable ones), and the lips, tongue and teeth.

Generating Solid-State Speech.

There are three major methods of generating solid-state speech. The first is the equivalent of the magnetic tape recorder. Spoken words are digitized by an analog-to-digital converter (ADC) and stored directly in memory. Solid-state speech is produced when the contents of the memory are clocked out of the mem-

(Continued on page 72)

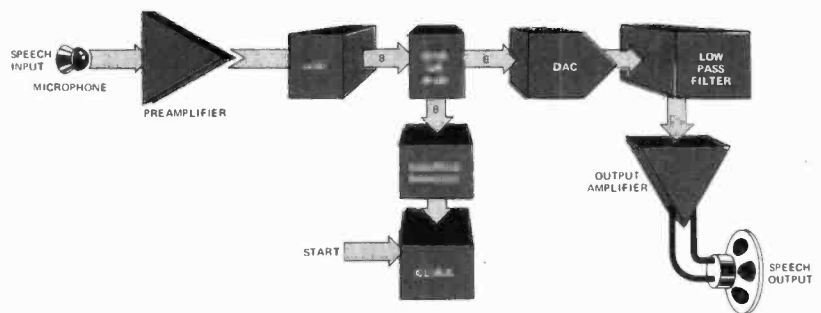

Fig. 1. Direct storage of speech in solid-state memory.

PMC PERSONAL COMPUTER
Ideal for small businesses, schools, colleges, homes, etc. Suitable for the experienced, inexperienced, hobbyist, teacher, etc.

EG3000 Series

WITH NEW EXTRA KEYS!

- 16K user RAM plus extended 12K Microsoft BASIC in ROM
- Fully TRS 80 Level II software compatible
- Huge range of software already available
- Self contained PSU, UHF modulator, and cassette
- Simply plugs into video monitor or UHF TV
- Full expansion to disks and printer
- Absolutely complete — just fit into mains plug.

ONLY **\$575**
POSTAGE, \$20

ONE YEAR GUARANTEE **SAVE DOLLARS**

SHARP PC1211

\$190

COMPUTER POWER THAT ONCE FILLED A ROOM CAN NOW BE CARRIED IN YOUR POCKET!

- Programs in BASIC
- "QWERTY" Alphabetic Keyboard
- 1.9K Random Access Memory
- Long Battery Life.

ONE YEAR GUARANTEE

TV GAME BREAK OUT KIT

Has got to be one of the world's greatest TV games. You really get hooked. Has also 4 other pinball games and lots of options. Good kit for up grading old amusement games.

MINI KIT PCB, sound & vision modulator, memory chip and de code chip. Very simple to construct. **\$30.00**
OR PCB **\$6.00** MAIN LSI **\$17.00**

TTL SALE

74LS00	\$0.15	74LS74	\$0.45	74LS365	\$0.75
75LS04	\$0.15	74LS86	\$0.55	74LS373	\$2.20
74LS05	\$0.29	74LS93	\$0.90	Z80A	\$5.50
74LS10	\$0.29	74LS157	\$1.20	Z80	\$4.20
74LS32	\$0.35	74LS165	\$1.75	REG. 7805	\$0.90

SOCKETS LOW PROFILE

14 PIN	\$0.10	18 PIN	\$0.15	24 PIN	\$0.25
16 PIN	\$0.10	20 PIN	\$0.15	40 PIN	\$0.30

10V Power Adapter 600ml. **\$6.90** UHF Modulators **\$9.90**

GET YOURSELF A NEW EPSON MX80 & MX70 PRINTER AND SAVE A FORTUNE

Price on application

Interface Cards for Apple, Pet, TRS80, and PMC
RS232 Interface Cards not necessary for parallel.

Full TRS80 **\$20**

ONE YEAR GUARANTEE

COMP PRO MIXER

Professional audio mixer that you can build yourself and save over \$200.

Only **\$199** for complete kit

power supply **\$50.00**

POSTAGE **\$20**

ACCESSIT AUDIO ADD-ONS

LOOK! MICROACE/SINCLAIR USERS

8K FLOATING POINT SUPER ROM PACK

WITH NEW MANUAL ONLY **\$35**

MICROACE/SINCLAIR VIDEO UPGRADE KIT

Only runs with NEW ROM (Smooth screen display) ONLY **\$29**

MICROACE/SINCLAIR 16K RAM PLUS EXPANSION BOARD

3 SLOTS WITH EXTRA POWER SUPPLY

16K ONLY **\$149** 4K ONLY **\$110**

MicroAce

A COMPLETE COMPUTER

A new generation of miniature computers

2K Kit ONLY **\$149**
Post and Packing FREE

IMMEDIATE DELIVERY

Sinclair is a Registered Trademark of Sinclair Research Ltd.

MicroAce Please make checks and money orders payable to **MicroAce** or phone your order quoting **Master Charge, Visa, Diners Club or American Express** number for immediate despatch. Add 6% Tax for Shipments inside California. **MicroAce**, 1348 East Edinger, Santa Ana, California, Zip Code 92705. Telephone: **(714) 547 2526**

EQUIPMENT AND TRAINING NO OTHER SCHOOL CAN MATCH.

**NTS HOME TRAINING INVITES YOU TO EXPLORE MICROCOMPUTERS,
DIGITAL SYSTEMS AND MORE, WITH STATE-OF-THE-ART EQUIPMENT
YOU ASSEMBLE AND KEEP.**

Without question, microcomputers are the state of the art in electronics. And NTS is the only home study school that enables you to train for this booming field by working with your own production-model microcomputer.

We'll explain the principles of troubleshooting and testing your microcomputer and, best of all, we'll show you how to program it to do what you want.

You'll use a digital multimeter, a digital logic probe and other sophisticated testing gear to learn how to localize problems and solve them.

Send for the full color catalog in the electronics area of your choice—discover *all* the advantages of home study with NTS!

NTS also offers courses in Auto Mechanics, Air Conditioning and Home Appliances. Check card for more information.

1.



We believe that training on production-model equipment, rather than home-made learning devices, makes home study more exciting and relevant. That's why you'll find such gear in most of NTS's electronics programs.

For instance, to learn Color TV Servicing you'll build and keep the 25-inch (diagonal) NTS/HEATH digital color TV.

In Communications Electronics you'll be able to assemble and keep your own NTS/HEATH 2-meter FM transceiver, plus test equipment.

But no matter which program you choose, NTS's Project Method of instruction helps you quickly to acquire practical know-how.

2.



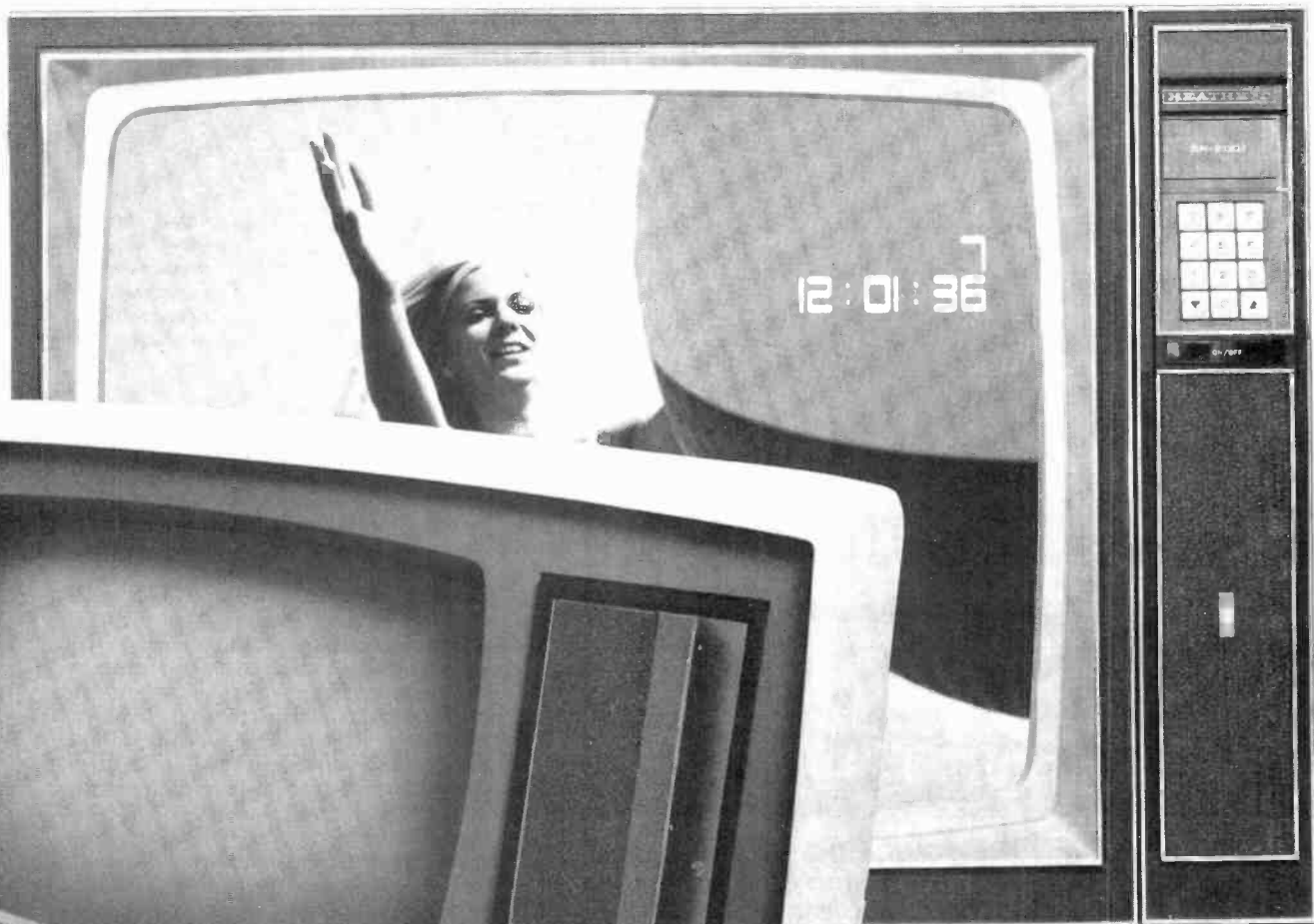

Simulated TV Reception

4.

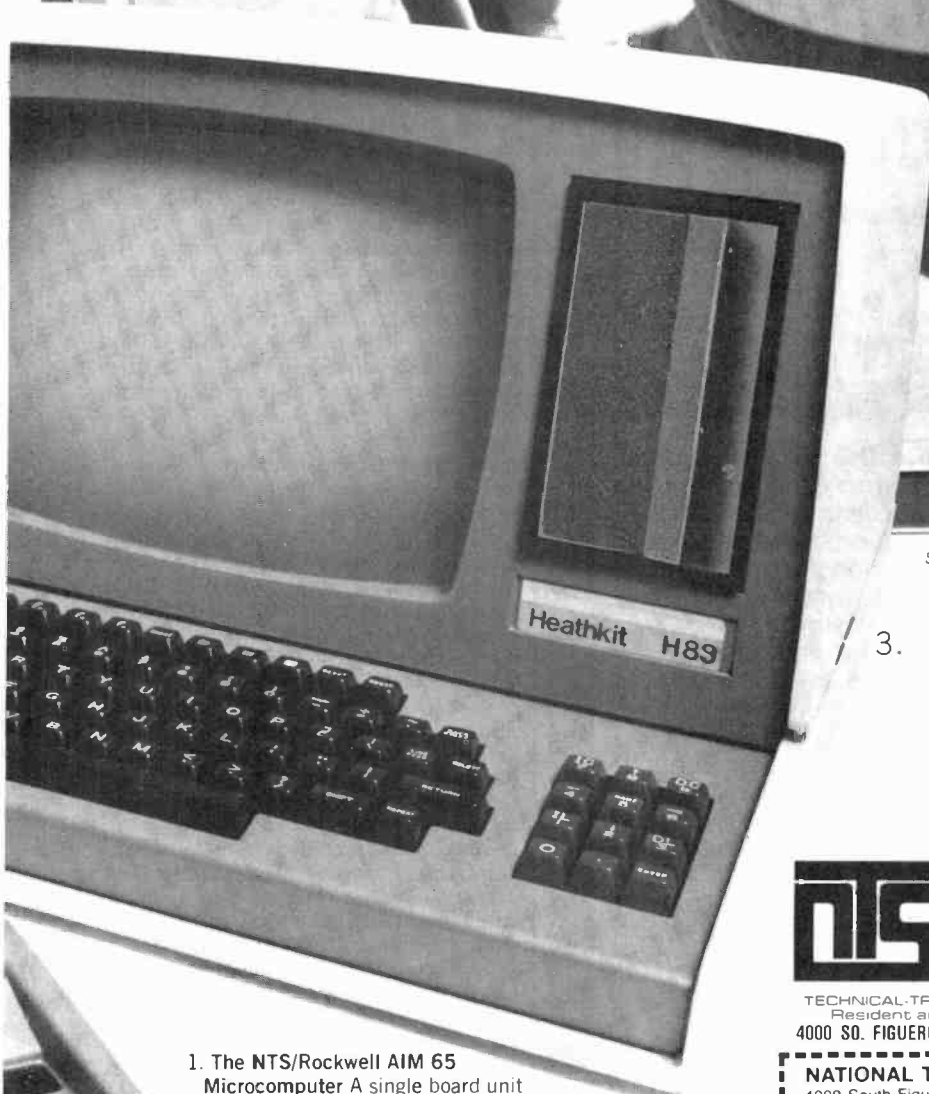

3.

1. The NTS/Rockwell AIM 65 Microcomputer A single board unit with on-board 20 column alphanumeric printer and 20 character display. A 6502-based unit 4K RAM, expandable.
2. The NTS/KIM-1 Microcomputer A single board unit with 6 digit LED display and on-board 24 key hexadecimal calculator-type keyboard. A 6502 based microcomputer with 1K RAM, expandable.
3. The NTS/HEATH H-89 Microcomputer features floppy disk storage, "smart" video terminal, two Z80 micro-processors, 16K RAM memory, expandable to 48K.
4. The NTS/HEATH GR-2001 Digital Color TV (25" diagonal) features specialized AGC-SYNC muting, filtered color and new solid-state high voltage tripler rectifier.

NTS NATIONAL TECHNICAL SCHOOLS

TECHNICAL TRADE TRAINING SINCE 1905
Resident and Home-Study Schools
4000 SO. FIGUEROA ST., LOS ANGELES, CA. 90037



NATIONAL TECHNICAL SCHOOLS

4000 South Figueroa Street. Dept. 205-081
Los Angeles, California 90037

Please rush FREE color catalog on course checked below

- | | |
|---|---|
| <input type="checkbox"/> MicroComputers/MicroProcessors | <input type="checkbox"/> Auto Mechanics |
| <input type="checkbox"/> Communications Electronics | <input type="checkbox"/> Air Conditioning |
| <input type="checkbox"/> Digital Electronics | <input type="checkbox"/> Home Appliances |
| <input type="checkbox"/> Industrial Technology | <input type="checkbox"/> Color TV Servicing |

Name _____ Age _____

Address _____

Apt. _____ City _____

State _____ Zip _____

- Check if Interested in G.I. information.
 Check if interested ONLY in classroom training in Los Angeles.

ory, processed by a digital-to-analog converter (DAC) and then smoothed by a low-pass filter and amplified. A block diagram of this appears in Fig. 1.

This direct-storage method was used very effectively in the first talking calculators. Unfortunately, however, considerable memory space is required for even small amounts of speech. For example, a system of this type might store speech in 8-bit samples loaded into memory at a clock rate of .8 kilohertz. One second of speech, therefore, would require 64,000 bits of memory.

The required amount of memory can

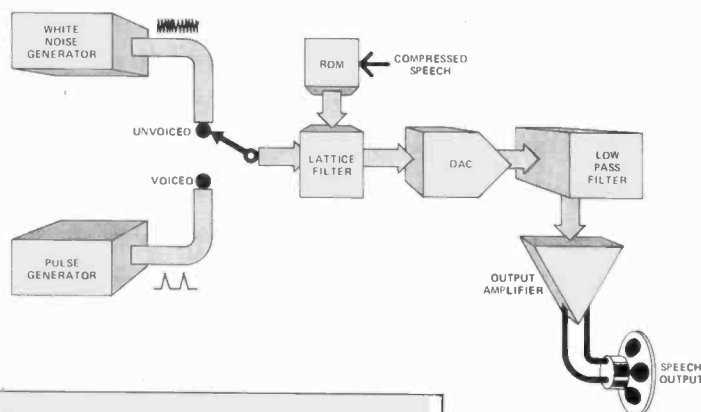
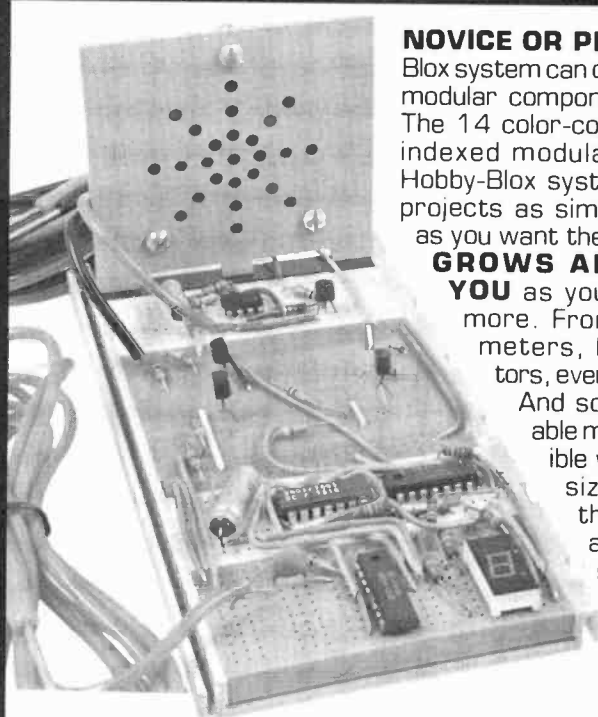

Fig. 2. The linear predictive coding method of speech synthesis.

YOU'LL NEVER OUTGROW THE HOBBY-BLOX™ MODULAR CIRCUIT BUILDING SYSTEM



NOVICE OR PRO, the Hobby-Blox system can offer you exciting modular component challenges. The 14 color-coded and cross-indexed modular units in the Hobby-Blox system can create projects as simple or complex as you want them to be.

GROWS ALONG WITH YOU as you learn and do more. From Digital Voltmeters, Pulse Generators, even Slot Machines. And solderless, reusable modules compatible with DIP's of all sizes make even the most elaborate systems a snap.

Patents Pending.
© A P PRODUCTS
INCORPORATED 1980.

FREE CATALOG and the name of your nearest Hobby-Blox dealer — call toll-free (800) 321-9688. In Ohio, call collect (216) 354-2101.



A P PRODUCTS INCORPORATED
9450 Pineneedle Drive
P.O. Box 603
Mentor, Ohio 44060
(216) 354-2101
TWX: 810-425-2250

In Europe, contact A P PRODUCTS GmbH
Baumlesweg 21 • D-7031 Weil 1 • W. Germany

be considerably reduced by storing only the relatively small number of basic speech sounds or *phonemes* required to produce any spoken word. This is what is done in the second major form of speech generation. Stored phonemes are electronically combined to produce any desired word in any language.

Unlike the method in which entire words are stored, the phoneme storage and reconstruction method provides truly synthesized speech. It also provides a virtually unlimited vocabulary. Unfortunately, as computer enthusiasts who have tried this method have found, stringing together phonemes produces unnatural, "robotic" sounding speech.

The third method of speech generation is also a form of synthesis. In this method, words are analyzed for distinguishing features that are quantized and stored in digital form. The compressed words are then reconstructed by sophisticated electronic processing.

Individual words consist of a small number of frequency and amplitude variations followed by intervals of redundant signal. By extracting the key frequency and amplitude variations and the time intervals between them and ignoring inconsequential signal, a word can be electronically dissected and compressed. Speech processed in this way can be loaded into much less memory than otherwise would be required. The procedure used for compression and conversion is called *parametric speech analysis* and requires sophisticated computer techniques and a good deal of human effort.

Two of the methods used to recreate compressed speech are *linear predictive coding* (LPC) and *adaptive predictive coding* (APC). The former, LPC, is the method used by Texas Instruments in its Speak & Spell, Speak & Read® and Speak & Math® learning aids. It is also used by General Instrument in its *Orator* SP-0250 speech processor chip.

An LPC synthesizer circuit (Fig. 2) is an electronic analog of the human vocal tract. In operation, a periodic train of pulses or a white-noise signal is applied to a sophisticated, digital lattice filter which, under the control of the compressed-speech data stored in the memory, reproduces the original speech pattern. A digital-to-analog converter transforms the digital output of the fil-

Albia Electronics

ALL NEW!

DM-10 LOW OHM METER MODULE

Measures resistance from 10 milliOhms to 20 Ohms. Now you can measure resistance down to 10 milliOhms with this low cost, easy to use DVM module. Check coil resistance, transformers, relays, chokes, printed circuit board copper paths and ground cables. Special zero balance control nulls out input cable resistance to insure accurate readings. Your DVM has to be set to 2V range during operation.

- Resistance range 10 milliOhms to 20 Ohms
- Zero Calibration control
- Battery powered (push to read battery saver circuit). Requires 1.9 Volt Battery (not included).
- Size 6.25" x 3.75" x 2" (Input cables not included or available)



Completely assembled and tested! Ready to use!

FREQUENCY METER MODULE LOW COST DM-11, "5Hz to 100MHz"

Measure frequencies from 5Hz to 100MHz on your digital voltmeter with a resolution of 3 1/2 digits — easy to use — perfect for field service — lab testing — home hobbyist! Connect the DM-11 to your DVM, set the DVM to the 2VDC range, connect a signal to the DM-11 via a BNC cable (not included) and measure the frequency of any source. Hi Lo Range LED's insure fast accurate readings.

- Input Sensitivity: < 100Hz < 80mV
- 100Hz — 60MHz < 30mV
- > 60MHz < 70mV
- Size 6.25" x 3.75" x 2"
- External 9V DC power supply included. (Model MMAC-2)
- BNC Input Cable Accessory (Model PSA-2 add \$14.95)

Completely assembled and tested! Ready to use!

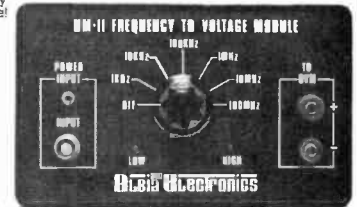

YOUR CHOICE

Any 2 For \$124.99
All 4 For \$239.99

\$69⁹⁵ EACH

8 CHANNEL SCOPE MULTIPLEXER, DM-12

Convert your single channel scope into a 4 or 8 channel instrument; just connect the DM-12, 8 channel scope multiplexer to your scope, clip the 8 input probes to the signals you want to view. Simple, easy, fast — can handle logic level TTL signals from 0V to 3MHz. Features separate spacing and trace amplitude controls and selectable sampling rate — all to insure easy clear scope display.

- 8 TTL compatible input channels (1 TTL load per channel) can drive 50 Ohm scope cable.
- Maximum full screen amplitude: 1.6 Volts adjustable.
- Trace amplitude and spacing controls.
- 4 or 8 channel selector switch.
- 8 color coded input cable, 24" long with insulated alligator clips.
- External 9 VDC power supply included (Model MMAC-2).
- Size 6.25" x 3.75" x 2"
- BNC Output Cable Accessory (Model PSA-2 add \$14.95).

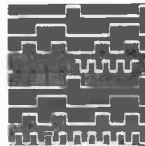
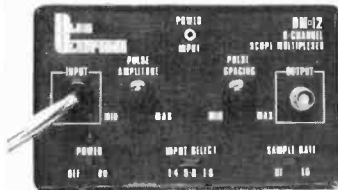

Completely assembled and tested! Ready to use!

LOW COST DM-8 CAPACITANCE METER MODULE

Connect this high quality low cost Capacitance Meter Module, DM-8 to your digital Volt Meter and turn it into a Digital Capacitance Meter — the Low Cost Way!

(When placing order specify the make and model DVM you're using so that factory modifications, if required, may be made before shipment is made.)

Completely assembled and tested! Ready to use!
INSTANT ORDER INFORMATION BELOW!

- Push to read range (button) from 1pF to 20,000pF
- Zero calibration control
- In one easy to use, self-contained package.
- Battery powered, with "push to read" battery saver circuit (9V batteries not included).
- Size 6.25" x 3.75" x 2"



LOW COST HIGH FREQUENCY COUNTER — NOW IN STOCK!!



The Albia Model DM-7, 8 Digit High Frequency Counter is easy to use, switch selectable time base input by a single BNC, nothing to build — nothing more to buy!

- 5 Hz to 550 MHz
- 8 big easy-to-read .43" high intensity LED display
- Crystal (± 3 ppm @ 25 C) controlled 0.1 or 1.0 sec. gate times
- Convenient benchtop size (7" x 10" x 3") durable attractive case

NEVER BEFORE AT THIS LOW PRICE

\$149⁹⁵ Includes Warranty

COMPLETELY ASSEMBLED • PRE-CALIBRATED • PRE-TESTED

REGULATED TRIPLE POWER SUPPLY BARGAIN PRICED ALBIA MODEL DM-6

A fully assembled and tested power supply that provides a solid, fully wired triple power supply including fixed 5V @ 1 Amp, 5V to 15V @ 0.5 Amp, and -5V to -15V @ 0.5 Amp — all supplies regulated, short proof. Each supply has short indicator LED. Complete and ready for use in a durable (8" x 6" x 3 1/2") metal case.

\$99⁹⁵ Includes Warranty

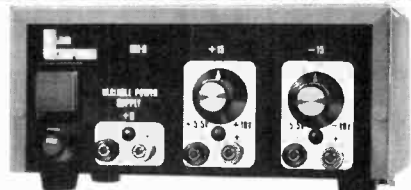

FREE!!
NEW 1981
SPRING/
SUMMER
CATALOG

Exciting new products! Send today!!

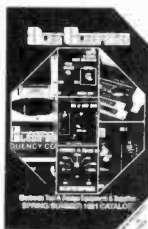

ALBIA SATISFACTION WARRANTY: If for any reason, whatsoever, you are not completely satisfied with your purchase, return it within 30 days of purchase date for a full refund — it's as simple as that!

FOR FAST AND DEPENDABLE DELIVERY SERVICE
CALL TOLL FREE: 1-800-243-6953 9 AM to 5 P.M. E.S.T.

WE ACCEPT MASTER CHARGE, VISA AND AMEX CREDIT CARDS
Connecticut Residents add 7 1/2% Sales Tax • Prices shown in U.S. currency only. Foreign orders add 15%.

ALBIA ELECTRONICS INC

24 Albia St. • New Haven, CT 06512

POSTAGE & HANDLING	
ORDERS	ADD
UP TO \$10.00	\$1.95
\$10.01 - \$25.00	3.75
\$25.01 - \$50.00	4.65
\$50.01 - \$100.00	6.45
ORDERS OVER \$100.00 WITHIN UNITED STATES	7.55

FREE ALBIA "TEMPLATE" WITH EVERY ORDER RECEIVED September 15, 1981



solid-state developments

ter into an analog signal, which is then smoothed by a low-pass filter and used to drive a speaker.

The LPC method synthesizes speech at rates from 1200 to 2400 bits per second. Texas Instruments implements LPC with a three-chip set consisting of a TMC 0280 synthesizer, a TMC 0350 16,384 x 8-bit ROM and a TMC 0270 microprocessor-controller.

National Semiconductor has recently introduced a speech-synthesizer chip set that uses a somewhat simpler approach. Words are compressed and stored in a standard 16K, 32K or 64K ROM and reconstructed by a special-purpose,

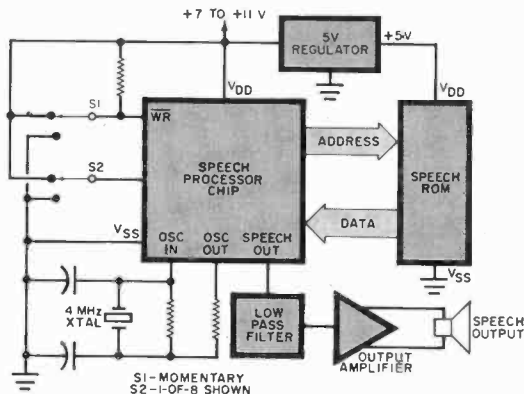

Fig. 3. National Semiconductor's speech processing system.

speech-processor chip. The latter contains a programmable frequency generator and a variable-gain DAC.

National's speech-processor chip can directly address up to 256 words or expressions stored in up to 128K of ROM. Much larger vocabularies can be obtained by cascading additional ROMs.

A simplified circuit diagram of a complete synthesizer made from National's speech-processor chip and an external ROM is shown in Fig. 3. This chip is available with a custom-encoded ROM or preassembled into National's DT1000 DIGITALKER®.

The DT1000 comes on a single circuit board complete with a speech-processor chip, a ROM, a microprocessor, and an output amplifier. It can generate any of 144 preprogrammed words, selected by a self-contained keyboard.

The DT1000 sells for \$495. If that seems high, consider the fact that National charges \$599 to custom encode just *one* word of male speech. Female speech requires a higher data rate, and the cost is \$700 per word! The customer supplies a high-quality tape recording of the desired words or phrases, and National compresses and loads the digitized version in the ROM. The synthesized output preserves the original inflection, emphasis, and timbre of the speaker's voice.

Summing Up. If you have yet to hear a sample of solid-state speech, be sure to visit a store that sells Speak & Spell or similar talking products. For a sample of National's very realistic-sounding synthesized speech, dial 408-737-3939 (a toll call). You'll hear an assortment of common phrases such as "Please call your office;" "Going up;" "The temperature is . . .;" and others in male, female and children's voices.

Soon, it seems, electronic speech will be a common part of everyday life. You can already buy talking clocks, calculators, toys and games. Next will come talking vending machines, elevators, appliances, test equipment, aids for the blind, automobiles and many other devices which now convey information to their users via analog or digital meters, readouts or gauges.

For More Information. If you are interested in solid-state speech, rather than directing your inquiries to this column, it would be better to contact di-

DON LANCASTER MAKES IT SIMPLE.

SAMS BOOKS MAKE IT ECONOMICAL.

If you're an electronics buff, here's your chance to learn from one of the most popular authors in electronics. For a limited time, Sams is offering a special discount on some of our best-selling Lancaster books.

LEARN ABOUT TTLs, CMOS, ACTIVE-FILTERS, VIDEO GRAPHICS. SAVE 15%!

TTL COOKBOOK (#21035)
A complete guide to transistor-transistor logic. Learn what TTL is, how it works, and how to use it! Includes many practical applications including many digital counters and instruments. \$9.50

CMOS COOKBOOK (#21398)
Everything you need to understand CMOS, how to power it, and how to use it. Even has a minicatalog of over 100 devices, including pinouts and use descriptions. \$10.50

ACTIVE-FILTER COOKBOOK (#21168)
A practical, user-oriented approach to active-filters. Includes uses for active-filters in brainwave research, electronic music, quadrature art, and psychedelic lighting. \$14.95

THE CHEAP VIDEO COOKBOOK (#21524)
A complete guide to super low cost alphanumeric and graphic microprocessor-based video displays. Includes do-it-yourself construction details and documented and debugged support software. \$5.95

SON OF CHEAP VIDEO (#21723)
The latest circuits to get alphanumeric and graphics video out of a microcomputer onto a video screen. Includes details on a \$7 complete video display system and a \$1 super-simple full transparency concept and other hands-on hardware projects. \$8.95

Mail to: Howard W. Sams & Co., Inc., 4300 West 62nd St.
P.O. Box 7092, Indianapolis, IN 46206.

	Quantity
TTL COOKBOOK #21035	\$ 9.50
CMOS COOKBOOK #21398	\$10.50
ACTIVE-FILTER COOKBOOK #21168	\$14.95
THE CHEAP VIDEO COOKBOOK #21524	\$ 5.95
SON OF CHEAP VIDEO #21723	\$ 8.95

ORDER ALL 5 BOOKS AND SAVE AN ADDITIONAL 15%!

<input type="checkbox"/> PAYMENT ENCLOSED	<input type="checkbox"/> CHECK	Amount of order	\$
<input type="checkbox"/> MONEY ORDER	<input type="checkbox"/> VISA	Deduct 15% if ordering all 5 books	\$
<input type="checkbox"/> MASTERCARD Interbank No. _____		Add local sales tax where applicable	\$
(Minimum credit card purchase \$10)		Shipping & handling costs	\$ 2.00
		Total Amount of Order	\$

Account No. _____ Expiration Date _____
 Name (print) _____ Signature _____
 Address _____
 City _____ State _____ Zip _____

Prices subject to change without notice. Offer expires 12/31/81. AD111
 For the name of your nearest Sams Book outlet, or to order by phone, call toll-free 1-800-428-3696.

Visit Sams at Wescon. Booth Nos. 1516 & 1518.

CIRCLE NO. 54 ON FREE INFORMATION CARD

AmericanRadioHistory.Com

solid-state developments

rectly the companies that produce various kinds of electronic-speech generators. These devices employ sophisticated hardware and software, and some of the firms that make them have prepared information and specification sheets explaining their products in detail.

Some of the manufacturers of solid-state speech modules and chips are:

Texas Instruments
M/S 308
Box 225012
Dallas, TX 75265

National Semiconductor Corp.
2900 Semiconductor Dr.
Santa Clara, CA 95051

Microelectronics Div.
General Instrument Corp.
600 West John St.
Hicksville, NY 11802

Telesensory Systems, Inc.
3408 Hillview Ave.
Box 10099
Palo Alto, CA 94304

Stynetic Systems, Inc.
Flowerfield Buildings 1
Saint James, NY 11780

Votrax Division
Federal Screw Works
Troy, MI

Other firms are also involved with or preparing to enter the speech-synthesis business. As developments occur, they will be described here.

New Products. Datal-Intersil (11 Cabot Blvd., Mansfield, MA 02048) has introduced a miniature 3½-digit LED digital panel meter that sells for \$38.50 in single-unit quantities. The new meter, designated the DM-31, measures only 3.5" × 2.0" × 0.5" and utilizes large (0.56" high) digits. It reads from 0 to ±1.999 volts dc. Write to the company for additional specifications.

National Semiconductor (2900 Semiconductor Dr., Santa Clara, CA 95051) has introduced a new voltage-regulator chip, the LM330, that it claims has a lower minimum input-to-output differential voltage than any other fixed-output regulator—0.32 volt at 150 milliamperes. Conventional 5-volt regulators require an input of at least 7 volts. The LM330, however, will provide a 5-volt output even if the input voltage falls to 5.32 volts.

The LM330 offers the possibility of longer operating intervals between cell replacement or recharging in battery-powered equipment. It also makes it possible to power such equipment with a 6-volt battery.

The automotive version of the LM330 is the LM2930. Both these new chips are made using a new, deep-diffusion process. They are protected against reverse-polarity connection and will be available for under a dollar. Write to National for additional information. ◇

AUGUST 1981

SIMPLE SIMON 7+11 PART KITS

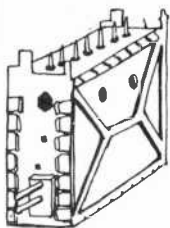

MITSUMI UHF TUNER

\$34.95

Freq. Range UHF 470 .889 mHz
Channels 14-83 Output Chan 3

1 VT1-SW	Varactor UHF Tuner Model UES-A55F	\$34.95
2 CB1-SW	Printed Circuit Board Pre-Drilled	\$18.95
3 TP7-SW	P.C.E. Potentiometers 1-20K 1-1K & 5-10K OHMS, 7-pieces	\$5.95
4 FR35-SW	Resistor Kit ¼ W 5% Carbon Film 32-pieces	\$4.95
5 PT1-SW	Power Transformer PRI-117VAC, SEC-24VAC 250MA	\$6.95
6 PP2-SW	Panel Mount Potentiometers & Knobs 1-1KB1 & 1-5KAT W SW	\$5.95
7 SS14-SW	IC's: 7 ea. Diodes 4 ea. Regulators 2 ea. Heat Sink 1 ea.	\$29.95
8 CE9-SW	Electrolytic Capacitor Kit 9 ea	\$5.95
9 CC33-SW	Ceramic Disk Capacitor Kit 50 W V 33 ea	\$7.95
10 CT-SW	Variable Ceramic Trimmer Capacitors 5-65PF 5 ea	\$5.95
11 L4-SW	Coil Kit 2 ea. 18MH S 1 ea. 22MH S Inductances pre-wound and 1 ea. T37-12 Ferrite Toroid Core with 3 ft. of #26 Wire	\$5.00
12 ICS-SW	1 C Sockets Tin Inlay 5 ea. 8 Pin	\$1.95
13 SR-SW	2 ea. 14 Pin Speaker Oval 4x5' & With Prepunched Wood Enclosure	\$14.95
14 MISC-SW	Misc. Parts Kit Includes Hardware, 6 32 & 8 32 Nuts & Bolts, H U Wire Ant Terms DPDT ANT SW Fuse Fuseholder etc.	\$9.95
*When Ordering All Items 1 Thru 14 Total Price		\$139.95

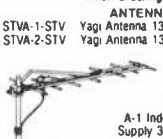

Min. Order Amount is \$19.95. Add 10% Shipping and Handling. Over \$40.00 Add 5% Calif. Residents Add Also 6% for Sales Tax.

SIMPLE SIMON ELECTRONIC KITS

11850 S. Hawthorne Blvd., Hawthorne, California 90250, Tel: (213) 675-3347
VISA — MASTERCHARGE ACCEPTABLE

CIRCLE NO. 49 ON FREE INFORMATION CARD

LEARN MICROPROCESSING on your own computer!

You Learn How To:

- Design & code micro-processor software
- Use logic & Bit Manipulation Techniques
- Enter & execute programs on your own computer
- Understand Microprocessor Architecture & Support Chips
- Control Programmable Input/Output Ports
- Implement Real-Time Interrupt Handling & Data Transfer
- Design your own microcomputer



8085 MICROPROCESSOR TRAINING UNIT \$299.95

You Will Receive:

- A fully tested and assembled 8085A Microcomputer with 1K RAM, 1K EPROM and 1K PROM Memory, Programmable I/O, Keyboard Unit, CPU Card, Display and Operating System, 44 pin edge connector can be configured to any bus structure, area on CPU Card for Custom wire-wrap design or user defined interface circuitry, completely expandable
- Complete Step-by-Step Instruction Manual
- Complete User's Manual with programs included
- 352 page 8085A Cookbook takes you from basic microprocessor concepts to actual design of an 8085A Microcomputer
- 344 page 8080/8085 Software Design Book 1 with over 190 executable program examples plus detailed examination of all 244 instructions and typical assembly language program for the 8080/8085 Microprocessor

Satisfaction Guaranteed. If not completely satisfied you may return the product within 30 days for a full refund.

RATED BEST VALUE BY INSTRUCTORS

PRCCOM	CREDIT CARD ORDERS CALL TOLL-FREE	VISA MasterCard
3928 148th N E Dept PE8 REDMOND, WA 98052	1-800-426-6254 EXT 28	
YES! I want to start learning Microprocessors. Please rush me		
— 8085AAT Microprocessor Training Unit at \$299.95 plus \$3.00 P & H		
8085 Cookbook 21687 \$13.95		
8080/8085 Software Book 21541 \$10.95		
NAME _____	ADDRESS _____	
CITY _____	ST. _____	ZIP _____
CARD NO _____	EXP. DATE _____	
SIGNATURE _____		

CIRCLE NO. 42 ON FREE INFORMATION CARD

Enjoy SATELLITE TV Now



Save thousands of dollars!
Now you can choose from three complete systems, which have the same superb electronics. Prices are: 10 ft. dish \$2495, 13 ft. dish \$2595, and our 16 ft. (5 m.) dish system for only \$2695. Complete system has dish antenna, feed horn, polarity rotor, LNA, cables, receiver and TV modulator—everything. Why pay more? Our 16 ft. system will outperform any 10 ft. system—even those costing thousands of dollars more. Satellite TV is so much better than simple Cable TV. More selection, news, movies, sports, Vegas shows, Spanish, French, Russian, religi-

ous, plenty of family and adult entertainment. Over 20 program services on just one satellite. You get perfect color and crystal clear reception, especially with our larger dishes that connect to any TV set. And to a whole condo or apartment complex! Have your local dealer install one or do-it-yourself in a weekend.

Don't wait any longer. Our big (8×11 in.) Handbook is loaded with details, photos, aiming data, and signal strength maps. Explains how much system you need. For the do-it-yourselfer, we show where to find full schematic plans and circuit boards. **Satisfaction Guaranteed.**

GLOBAL TV ELECTRONICS, INC.

235 S. Maitland Avenue
P. O. Box 219-K, Maitland, Florida 32751

Send \$7.95 Today! Add \$2.00 for first class (airmail). Canadian send \$10.10 US or \$12.50 Canadian, Foreign send \$12.00 US funds - airmail only. Or in the USA, call our 24 hour C.O.D. order line **1-305-862-5068** now.

Name _____
Full Address _____
Zip/PC _____

EXPERIMENTER'S CORNER

By Forrest M. Mims

Remote Sensing—Part 2

LAST month, we discussed the basics of remote sensing. We also assembled a dual-wavelength green-leaf detector which relies upon the unique *reflectance signature* of green vegetation.

Leaves, as you might recall, reflect red light poorly but reflect near-infrared radiation very well. This generates a characteristic reflectance signature which makes it possible to use a red LED and a near-infrared LED as a pair of narrow-band radiation *detectors*. This is done in the leaf-detector circuit described last month in Part 1 of this series.

NASA's Image Classification Circuit. An expanded version of the leaf-detector circuit has been developed for NASA's Langley Research Center by Roland L. Hulstrom, Roger T. Schappell and John C. Tietz of the Martin Marietta Corporation. Like the circuit I described, NASA's circuit also teams a red sensor and a separate near-infrared sensor to detect green vegetation. Moreover, these two detectors also permit the detection of water, bare land, clouds and snow.

Figure 1 is the schematic for this new circuit as given in a recent NASA Tech Brief. The circuit, an expanded version of which is slated to be flight-tested aboard one or more Space

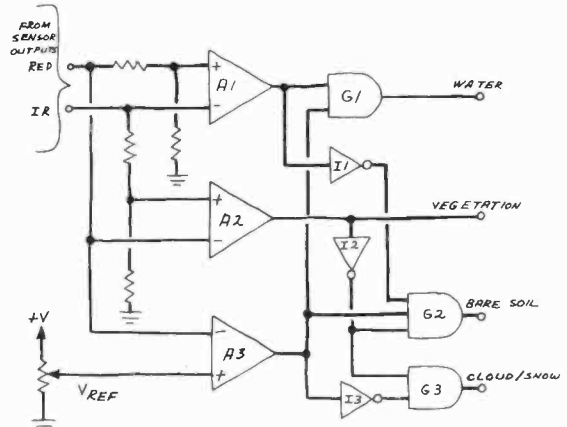

Fig. 1. Earth satellite picture classification circuit.

Shuttle missions, is designed to automatically reduce the quantity of unwanted imagery transmitted to earth from camera-carrying earth satellites.



PROFESSIONALS · HOBBYISTS · EDUCATORS · STUDENTS

Give yourself a break · let MENTOR get the headache! The state of the art approach to circuit design is here expanding the capabilities of the *Apple II computer.

MENTOR allows a greater allocation of your design time to creative processes by virtually eliminating calculator usage and time consuming text reference.

PROFESSIONALS & HOBBYISTS: Feel like your married to that calculator? With MENTOR you can utilize a vast number of formulas for the design of AC, DC, filter and communication circuits to determine unknowns quickly and efficiently.

EDUCATORS: A MENTOR in the classroom aids students in the understanding of the interrelationships within electronic circuits freeing your time for other demanding tasks.

STUDENTS: Feel like it's impossible to remember seemingly millions of formulas?... you don't have to!!! MENTOR does it for you.

MENTOR is also an invaluable aid in the process of circuit analysis. High resolution graphics are included to illustrate filter circuits. Equations and their background information along with step-by-step procedures for use of each formula are fully documented in an attractively designed, 3-ring padded binder.

Since we believe in offering only the best, MENTOR comes to you on high quality Maxell diskette. Ask your local Apple dealer for a demonstration of MENTOR or order direct from the address below. MENTOR retails at *\$124.95. Please include check or money order plus *5% shipping and handling.

SYSTEM REQUIRED: Apple II or Apple II Plus, Applesoft in ROM or Language Card, 48K RAM, DOS 3.3

*CA residents include 6% sales tax

*Foreign include \$13. shipping (U.S. funds)

*Apple II is a trademark of Apple Computer, Inc.

16411 Del Mar · Huntington Beach, CA 92649
TCB 783 on THE SOURCE

CIRCLE NO. 70 ON FREE INFORMATION CARD

The Mean Little Kit

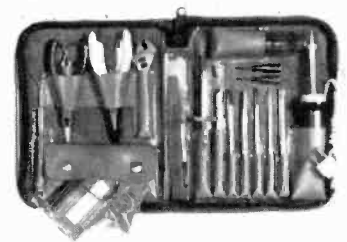

New compact 24-piece kit of electronic tools for engineers, scientists, technicians, students, executives. Includes 7 sizes screwdrivers, adjustable wrench, 2 pair pliers, wire stripper, knife, alignment tool, stainless rule, hex-key set, scissors, 2 flexible files, burnisher, miniature soldering iron, solder aid, coil of solder and desoldering braid. Highest quality padded zipper case. 6 x 9 x 1 3/4" inside. Satisfaction guaranteed. Send check, company purchase order or charge Visa or Mastercard. We pay the shipping charges.

JTK-6 Tool Kit \$82.00



Free Catalog!

Page after page of hard-to-find precision tools. Also contains complete line of tool kits and tool cases. Send for your free copy today!

JENSEN TOOLS INC.

1230 S. PRIEST DR. TEMPE, AZ. 85281

CIRCLE NO. 35 ON FREE INFORMATION CARD

NASA explains the objective behind the design of the new circuit as follows. Earth-observation satellites generally do not make decisions about the usefulness of the data being sent to earth. As a result, a significant amount of time and money is spent in sorting out the useful data. A great saving could be realized if circuits aboard the satellite could recognize useless imagery or actually look for specific features. The circuits do not have to be very smart to be useful. For example, about 70% of the earth's surface is water. Of the 30% that is not water, about one-third to one-half will be obscured by clouds at any given time.

This means that a satellite might get one clear picture of land out of perhaps five or six observations. The amount of unwanted, more or less useless data that is stored, processed and indexed could, therefore, be greatly reduced by a circuit that simply blocked transmission of the 80% of the images that is of water and clouds.

A simple circuit has been developed to classify picture elements by spectral signature alone. No pattern recognition is required. Computer simulations and field measurements have confirmed that the four basic features—vegetation, bare land, water and clouds or snow—can be separated by radiance measurements at two discrete wavelengths: 650 and 850 nm.

It's very significant that the reflectance signatures of four key topographic features can be classified by examining only two wavelengths of their reflected radiation. From last month, you already know that green vegetation has a very low reflectance at 650 nanometers—typically less than 5 percent. At 850 nanometers in the near infrared, the reflectance of vegetation is typically from 45 to 55 percent.

Soil usually has a higher reflectance at near-infrared wavelengths than in the visible portion of the spectrum. The transition between low and high reflectance is more gradual than for vegetation, and occurs in the visible region. This means that the difference in soil reflectance at 650 and 850 nanometers is not as dramatic as it is for green leaves.

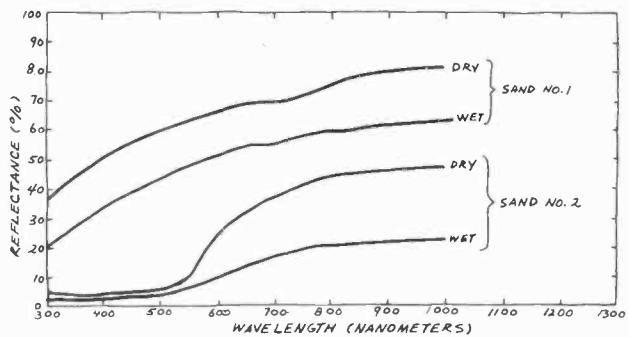

Fig. 2. Spectral reflectance of two different sands.

Figure 2 shows the reflectance curves of two highly reflective soils (actually, sands). Sand number 1 is white beach sand from Ft. Walton Beach, Florida. Sand number 2 is a darker sand from Monument Valley, Utah. Note that both sands, like all other soils, reflect less light when they are wet. These reflectance curves, and many others, can be found in "The Spectral Reflectance of American Soils" by H. R. Condit (*Photogrammetric Engineering*, Sept. 1979).

Water's reflectance at 650 and 850 nanometers is the reverse of that of leaves, because water reflects red light but absorbs near-infrared wavelengths. Clouds and snow have much higher reflectances than soil, but the differences in reflectance at 650 and 850 nanometers are similar to that of some soils.

Remarkably, the two wavelengths selected by NASA for its Image Classification Circuit are very close to the optimal detection regions of the GaAsP LED (650 nanometers) and the new (AlGa)As "super" LED (880 nanometers). A practical version of NASA's circuit can be made by using two such

KEY SWITCH S.P.S.T. 125 VOLTS RATED 4 AMPS \$ 3.50 EA.	4PDT PRINTED CIRCUIT 12 VDC 14 pin style 3 amp contacts BRAND NEW P.C. Mount \$ 2.75 EA.
COMPUTER GRADE CAP. 1,700mfd NEW 150 VDC \$2.00 2 1/2" DIA X 4 3/4" 6,400mfd 60 VDC \$2.50 1 3/8" DIA X 4 1/4" 22,000mfd 15 VDC \$2.50 2" DIA X 2 1/2" HIGH CLAMPS TO FIT CAPACITORS 50c ea	SUPER SMALL PHOTO-FLASH 170 MFD 330 VOLT 1 1/4" X 7/8" 2 for \$1.50 10 for \$ 7.00
SUB MINI L.E.D. .079" X .098" 20 mA 1.75v 10 for \$1.00 200 for \$18.00 400 for \$32.00 1000 for \$70.00	40 MFD 350 VOLTS 2 1/8" INCH X 3/4" INCH 2 FOR \$1.50
TRANSFORMERS 120 volt primaries 6 VOLTS at 150 mA \$1.25 12 V.C.T. at 500mA \$2.50 16.5 V. at 3 AMPS \$6.50	1/4" PHONE JACK MOLDED PLASTIC NO SWITCH 10 FOR \$1.00 100 FOR \$9.00 500 FOR \$40.00 1000 FOR \$70.00
DPDT RELAY AROMAT HL2-P-DC24 compact size 10 amp contacts P.C. mount \$ 3.00 each 10 for \$27.50	FLASHER L E D Litronix FRL-4403 diffused red led with built in flashing unit 11 package pulse rate 3Hz Av 20 ma 2 for \$1.70 22/44 EDGE CONNECTOR TIN SOLDER TAIL 156" X 200" \$1.35 each 10 for \$12.50

ALL ELECTRONICS CORP.
 905 S. Vermont Ave.
 P.O. BOX 20406
 Los Angeles, Calif. 90006
 (213) 380-8000
 Mon. - Fri. Saturday
 9 AM - 5 PM 10 AM - 3 PM
SEND FOR FREE CATALOG

TERMS
 • Quantities Limited
 • Min. Order \$10.00
 • Add \$2.00 Shipping USA
 • Calif. Res. Add 6%
 • Prompt Shipping

CIRCLE NO. 3 ON FREE INFORMATION CARD

NEW 16 K-RAM PERSONAL COMPUTER

\$249

SPECIAL FACTORY SALE!!

For \$249, you get the new Interact Model "R" Computer, 16K-RAM, 2K-ROM, 8080A Microprocessor, color, sound, full 53 keyboard, high speed cassette, AC adapter, R.F. Modulator, Black Console Case, 90 days parts and labor warranty, owners' guide, FCC approved.

SPECIAL FACTORY PACKAGE SALE \$344.

(Lists for over \$740.00)

Everything you get for \$249. PLUS: Level II users manual, Level II basic program tape, Level II command cards, Level II basic examples book, two 8 axis controllers, Diagnostic program tape, Diagnostic manual, Service manual, Cassette head Alignment tape, Schematics and parts list, Service and warranty money saver card, PLUS 3 tape programs (everything you need to learn to operate, program and service your computer)

15 DAY FREE TRIAL

Return within 15 days complete and undamaged for refund of purchase price.

DON'T MISS THIS FANTASTIC SALE!! ORDER NOW! Send certified check, money order, or check to: **PROTECTO Enterprises, Box 550, Barrington, Ill. 60010** (Phone 312-382-5244 to order). WE HONOR VISA AND MASTERCARD ORDERS. Add \$15 for insurance, handling and shipping via UNITED PARCEL SERVICE. Illinois Residents add 6% Sales Tax.

CIRCLE NO. 45 ON FREE INFORMATION CARD

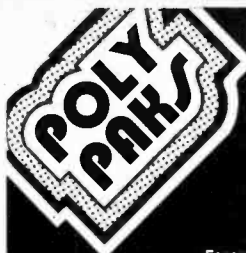

PENNY SALE

Buy 1 Jumbo Pak for \$2.99 and get the 2nd for One Penny.

Order today by calling us on our new toll-free number.

For orders only. **800-343-3086**

- 400-PRE-FORMED 1/4 WATTERS, popular values, some 5 & 10% ers. (#6246)
- 35-UPRIGHT ELECTROS. 100%, assorted values & voltages, marked (#3226)
- 75-CABLE TIES, 4" non-slip white plastic, like Ty-wrap. (#5218)
- 50-MINI POTS, pc style, single turn, assorted values. (#3345)
- 150-PC. CAPACITOR SPECIAL, asst. mylars, polys, micas, etc. 100% mat. (#6264)
- 175-1/4 WATT RESISTORS, asstd. carbons, carbo-films, some 5%ers. (#5797A)
- 60-POLYSTYRENE CAPS, assorted types, styles & sizes, all good. (#2729)
- SURPRISE PAK Assortment of IC's, caps, pots and parts of every desc. (#6648)
- 175-HALF WATTERS, 100% color coded resistors, asst. values. (#3046)
- 175-MOLEX SOCKETS, "on a strip", make your own pc sockets. (#6255)
- 400-PREFORMED 1/4 WATTERS, assorted values, precut for PC appl. (#6622)
- 24-MINI-BULBS, ASST. VOLTAGES & base styles, some colored. (#6757)
- 125-LONG LEAD DISK, prime, marked caps, assorted material. (#2598)
- 50-SLIDE SWITCHES, various shapes, sizes and types (#2726)
- 25-MICRO MINI REED SWITCHES, 1" long, for alarms, relay systems, etc. (#6283)
- 50-THERMISTORS, various types & styles, neg. coefficient, 100% (#4089)
- 200-PRE-FORMED DISCS, caps w/leads for PC use, mixed values. (#2605)
- 50-AXIAL ELECTROS, asst. values, volts, sizes, what a buy! (#3227)
- 100-PLESSY CAPS, ceramic blocks in assorted sizes & values. (#6221)
- 3-WATCH GUTS, 5-function, LED style, assorted sizes, untested (#6287)
- 6-TIME DELAYS, solid state, asst. from 450 mSec to 8 Sec. (#6758)
- 100-PLASTIC TRANSISTORS, untested, to-92, asst. types (#2604)
- 75-TRANSISTOR ELECTROLYTICS, epoxy encapsulated, asst. values. (#6238)
- 20-SLIDE VOLUME CONTROLS, various values & types, for Hi-Fi, etc. (#3057)
- 500-PC.-HARDWARE SURPRISE, (approx.) 1 lb. asst. screws, washers, etc. (#6271)
- 100-POWER RESISTORS, 3 to 7 watt power resistors. (#6281)
- 50-2 WATT RESISTORS, assorted carbons, films etc. some 5% ers. (#6238)
- 24-SKINNY TRIM POTS, multi & single turn, asst. values & types. (#6285)
- 40-CRYSTALS, assorted types, some H6/U, some frequency marked. (#6256)
- 20-9V BATTERY CLIPS, snap connector, coded, insulated leads. (#6286)
- 4 HEAVY DUTY LINE CORDS, 2 cond. 6ft., 16 gauge (#6292)
- 200-PRECISION RESISTORS, 1/2 W, assorted wattages, 1%, axial (#2428)
- 30-PANEL SWITCHES, assorted rotary, micro, slide, etc. (#6629)
- 20-PAIRS-RCA PLUGS & JACKS, popular for Hi-Fi, speakers, etc. (#6630)
- 4-2N3055 NPN TRANSISTORS, 115 watts, 15 amps, TO-3, 100% mat. (#6633)
- 5-LINE CORDS, heavy-duty, 18 gauge, 6', molded plug, 2-cond. (#6499)
- 20-2N3055 HOBBY TRANSISTORS, manuf. fallout, TO-3, U-test. (#6624)
- 25-PLASTIC POWERS, 25 watt, npn & pnp, 50-200 mvceo, TO-220. (#6237)
- 150-"4000" RECTIFIERS, IN4000 series, may include; 50 to 1000V (#2417)
- 30-SCRs & TRIACS, assorted values, 10 Amp TO-220, untested. (#6337)
- 60-IN914 SWITCHING DIODES, 4 nsec, axial, glass, untested. (#6332)
- 30-INSTRUMENT KNOBS, for half round shafts, some w/pointers (#6498)
- 35-STEREO INDICATORS, tiny red 1.5V bulbs, for Hi-Fi replacement. (#6244)
- 40-EDGE CONNECTORS, asst. 4 & 6 pin, 2-sided, pc leads. (#6364)
- 6-MINI-MOTORS, type RE56, 1.5-6VDC, color-coded wire leads. (#6718)
- 25-NE-2 BULBS, neon, for 110 VAC, requires resistor, (not incl.) (#2613)
- 150-METALLIC RESISTORS, mostly 1/2 watters, asst. val. 1-5% tol. (#6280)
- 40-VOLUME CONTROLS, assorted values & types. (#6331)
- 25-2N3904 TRANSISTORS, 100% material. (#6370)
- 28ft. -COLORED 20 MIL FIBERS, 2' lengths, assorted colors. (#6768)
- 125-ONE WATT RESISTORS, top names, mostly carbons, some 5%ers (#3300)
- 200 PC. SEMICON SPECIAL, asst. diodes, zeners, etc. untested. (#6284)
- 40-STRAIN RELIEFS, asst. types in various sizes & shapes (#6756)
- 1-UHF TUNER, 3-gang, 300 ohm, direct drive type (#6658)
- 200-TUBULAR CAPS, asst. tubulars, 100mmf to 0.1mf to 600 WVDC (#6254)
- 60-MINI LAMP SOCKETS, asst. screw, bayonet, & snap-in's. (#6789)
- 150-SUBMINI IF TRANSFORMERS, asst. transistor radio types (#6259)
- 10-PUSHBUTTON ALARM SWITCHES, spst n.c. 1A 125 VAC. (#6287)
- 25-DATA ENTRY SWITCHES, asst. 1/2" square keyboard switches. (#6687)
- 10-MOTORS MOTORS, asst. size hobby motors, 1-1/2 to 12 volts. (#251A)
- 150-TERMINAL STRIPS, asst. screw & solder lug types. (#6251)
- 50-TO-5 TRIACS, asst. 50 to 600 PIV, 70% yield, gold plated, 3 leads. (#6321)
- 200-HI-QUALITY RESISTORS, 1/8, 1/2, & 1 watters, 1% & 5%. (#6627)
- 40-MYLAR UPRIGHT CAPS, asst. epoxy, plastic, polystyrene, etc. (#6634)
- 20-HOBBY LEDs, asst. types styles & colors, mostly dims. (#6225)
- 12 FT.-FIBER OPTIC RIBBON, 3/8" wide ribbons conduct light. (#6770)
- 100-PIN SOCKETS, inline male & female crimp-on connectors. (#6902)
- 100-ASSORTED SPACERS, nylon spacers, washers, grommets, etc. (#6617)

"JOIN THE PAK"
DON'T MISS OUR 25th
ANNIVERSARY CATALOG



P.O. BOX 942, PE-8
S. LYNNFIELD, MA. 01940

Total Amount of Order \$ _____

INCLUDE SHIPPING AND HANDLING: U.S., ADD \$3.; FOREIGN, ADD \$7.
MASS. RES. ADD 5% SALES TAX.

NAME _____

ADDRESS _____

CITY _____

STATE _____ ZIP _____

Enclosed is CHECK, MONEY ORDER
Charge my MASTERCARD VISA

ACCT. # _____ EXP. DATE _____

Orders only **800-343-3086** Other calls 1-617-245-3828

ORDERING INSTRUCTIONS • Indicate quantity on line or box near item desired • Complete coupon section • Cut out Ad and mail to Poly Paks, Inc.

Send me your FREE catalog

CIRCLE NO. 43 ON FREE INFORMATION CARD

experimenter's corner

LEDs as detectors. The green-leaf detector circuit described last month shows how LEDs can be coupled to a circuit like the one shown in Fig. 1.

A detailed report on NASA's image-classification circuit is available for \$6.00 (paid in advance) from the National Technical Information Service, Springfield, VA 22161. The report is entitled "Experimental and Simulation Study Results for Video Landmark Acquisition and Tracking Technology" (NASA CR-158997). Request the publication by name and by the identification number LAR-12589.

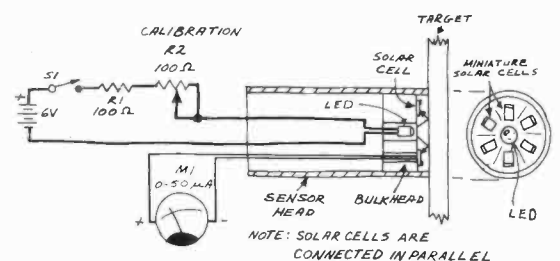

Fig. 3. Construction of a simple, low-cost reflectometer.

An Inexpensive Narrow-Band Reflectometer. Sometimes, it is important to know the reflectance of an object at only one wavelength. Since 1970, I have measured the reflectance at 940 nanometers of scores of different objects. These measurements make possible the accurate prediction of the detection range of various infrared travel aids for the blind.

Soon, I plan to repeat many of these measurements at the 880-nanometer wavelength emitted by the new, (AlGa)As high-power emitters. I will use the simple reflectometer illustrated in Fig. 3. This ultrasimple system requires no sophisticated electronics. The reading on the 0-to-50- μ A meter is doubled to obtain the target's reflectance in percent.

OLYMPIC SALES SINCE 1947 COMPANY

216 S. Oxford Ave.
Los Angeles, CA 90004
(213) 739-1130
PHONE ORDERS:
TOLL FREE
out of Cal 800-421-8045
in Calif. 800-252-2153
Telex: 67 34 77
Cable: "OLYRAV" LSA

	Retail	Your Cost
HP-85 Microcomputer	3250.00	2595.00
HP-83 Microcomputer	2250.00	1795.00
16K Exp. mem. module	295.00	259.95
Graphics plotter 7225	2450.00	2089.95
Personality mod. for 7225	750.00	679.95
2631B Impact printer, hvy duty	3950.00	3295.00
Opt. 020 for 2631B	150.00	129.95
8 disk drives to choose from		
82902S	1300.00	1149.95
9895A 8" dual drive	6850.00	5950.00
Graphics tablet 9111A	2050.00	1699.95
HP-41CV 2.2K bytes of memory	325.00	259.95
HP-41C Calculator	250.00	188.95
Card reader for 41CV/41C	215.00	168.95
Printer for 41CV/41C	385.00	284.95
Optical wand for 41CV/41C	125.00	97.95
Quad Ram - 4 mem. mods.	95.00	84.95
Memory mod. for 41C	75.00	26.95
HP-97 Programmable printer	750.00	579.95
HP-67 Programmable calculator	375.00	297.95
HP-34C Programmable scientific	150.00	117.95
HP-38C Programmable business R/E	150.00	119.95
HP-32E Advanced scientific	55.00	48.95
HP-37E Business management	75.00	58.95

Apple Computer
APPLE COMPUTERS II & III
We are an authorized Apple servicing dealer
16K 32K-48K 128K Graphics tablet
Drive with controller DOS 3.3 and others
80 column cards: VisiCalc add more and more
We have the best prices on Apple computers in America - "CALL US!"

Texas Instruments

	Retail	Your Cost
TI-99/4 Home Computer	\$950.00	\$379.95
We carry a large inventory of software, & accessories		
TI-59 Programmable calculator	295.00	199.95
TI-58C Programmable calculator	130.00	93.95
PC 100C Printer/plotter for 59/58	225.00	149.95
NEW! Calculator Watch w/Alarm TI 810-11		29.95
Many features & 1 yr guarantee from TI		
TI 584-11 Alarm Chron. Dual Time Zone		19.95

SEIKO (USA) WATCHES - (Limited Offer!)
Current models & MORE!
These models guaranteed by Seiko anywhere Your within USA
Retail Cost
FJ113 Divers watch, 300 ft.; S/S 195.00 79.95
YH006 Ladies quartz LCD, gltline 295.00 79.95
YH002 Ladies quartz LCD, gltline 250.00 74.95
YH016 Ladies quartz LCD, gltline 225.00 69.95
YH003 Ladies quartz LCD, slvrtine 215.00 69.95
And many more compare our prices with the nearest Seiko dealer.

CASIO WATCHES We will beat your price!
Your Cost
CA 80 Calc/stopwch w/alarm & more! on Casio 44.95
CA 801 Calc/stopwch w/alarm all metal 59.95
W 100 Divers stopwatch 300 ft wtr res & more 34.95
W 150C Divers stopwatch 300 ft wtr res S/S case 48.95
W 150 Divers stopwatch 300 ft wtr res all metal 53.95

ATARI Computer

	Retail	Your Cost
400 SPECIAL PRICE! 16K	595.00	339.95
No language inc., opt'l basic,		54.95
800 16K Computer	1080.00	759.95

MATTEL INTELLIVISION

Most animated TV game
Retail \$325.00
Y/C: \$239.95

SONY

NEW! MANY ITEMS FROM SONY - call for AT DISCOUNTED PRICES! information

AMDEK(Leadex) Quality Monitors
100 12" B/W, 12 MHz 179.00 129.95
100-80 12" B/W, metal cab., 199.00 159.95
space for floppy
100-G 12" Green, 12 MHz 199.00 159.95
300-G 12" Green, 18 MHz 249.00 189.95
Color I 13" Color, NTSC comp. 449.00 329.95
input, audio amp & speaker
Color II 13" Color, RGB input, 999.00 699.95
hi res graphics, speaker

ATARI VIDEOTAPES

TV GAME	Minimum 3 tapes/Mixed O.K.
Retail \$225.00	SONY L500, 2 hr \$11.89
Your Cost	L750, 3 hr 14.69
\$137.95	RCA VK250, 6 hr 13.95

All goods subject to availability; this ad supersedes all previous ads; we are not responsible for typographical errors; we will meet or beat any advertised price if our competition has the goods on hand. Minimum shipg & handling \$4.95. All orders subject to verification and acceptance.

CIRCLE NO. 41 ON FREE INFORMATION CARD

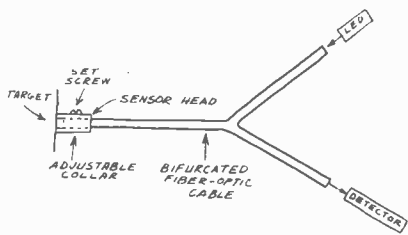

Fig. 4. How to build a fiber-optic reflectometer.

To make a reflectance reading, the sensor head is first placed against a Kodak photographic test card or a similar target with a known reflectance. The CALIBRATION potentiometer is adjusted until the reference target's reflectance is indicated on the meter. If, for example, the reference target has a reflectance of 90 percent (as does the Kodak test card), the CALIBRATION control should be adjusted for a meter reading of 45 μ A.

You need not duplicate exactly the arrangement shown in Fig. 3 to make a working reflectometer. To reduce erroneous readings to a minimum, the solar cells should be mounted in a ring around the source LED. It is important that ambient light be kept away from both the target and the solar cells when measurements are being taken.

When making a measurement, place the sensor head firmly against the target. The output of the LED will fluctuate with changes in temperature and battery voltage, so the circuit should be recalibrated just before each reading is taken.

L. A. Lott and D. L. Cash have described a more sophisticated reflectometer in a paper entitled "Spectral Reflectivity Measurements Using Fiber Optics," which appeared in the April 1973 issue of *Applied Optics* (pp. 837-840). In their device, one branch of a "Y"-configured, bifurcated fiber-

FOR ONLY \$129.95 Learn Computing From The Ground Up

Build a Computer kit that grows with you, and can expand to 64k RAM, Microsoft BASIC, Text Editor/Assembler, Word Processor, Floppy Disks and more.

EXPLORER/85

Here's the low cost way to learn the fundamentals of computing, the all-important basics you'll need more and more as you advance in computer skills. For just \$129.95 you get the advanced-design Explorer/85 motherboard, with all the features you need to learn how to write and use programs. And it can grow into a system that is a match for any personal computer on the market. Look at these features: 8085 Central Processing Unit, the microprocessor "heart" of the Explorer/85. (Join the millions who will buy and use the 8080/8085 this year alone)... Four 8-bit plus one 6-bit input/output ports from which you can input and output your programs, as well as control exterior switches, relays, lights, etc... a cassette interface that lets you store and reload programs you've learned to write... deluxe 2,000 byte operating system/monitor makes it easy to learn computing in several important ways... It allows simpler, faster writing and entering of programs... It permits access by you to all parts of the system so you can check on the status of any point in the program... It allows tracing each program step by step, with provision for displaying all the contents of the CPU (registers, flags, etc.)... and it does much more.

You get all this in the starting level (Level A) of the Explorer/85 for only \$129.95. Incredible! To use, just plug in your 8VDC power supply and terminal or keyboard/display — if you don't have them, see our special offers below.

- Level A computer kit (Terminal Version) ... \$129.95 plus \$3 P&I.*
- Level A kit (Hex Keypad/Display Version) ... \$129.95 plus \$3 P&I.*
- Level B — This "building block" converts the motherboard into a two-slot S100 bus (industry standard) computer. Now you can plug in any of the hundreds of S100 cards available.
 - Level B kit ... \$49.95 plus \$2 P&I.*
 - S100 bus connectors (two required) ... \$4.85 each, postpaid.
- Level C — Add still more computing power; this "building block" mounts directly on the motherboard and expands the S100 bus to six slots.
 - Level C kit ... \$39.95 plus \$2 P&I.*
 - S100 bus connectors (five required) ... \$4.85 each, postpaid.
- Level D — When you reach the point in learning that requires more memory, we offer two choices: either add 4k of a memory directly on the motherboard, or add 16k to 64k of memory by means of a single S100 card, our famous "JAWS".
 - Level D kit (CHECK ONE) ... \$49.95 plus \$2 P&I.*
 - 16k S100 "JAWS" ... \$149.95 plus \$2 P&I.*
 - 32k S100 "JAWS" ... \$199.95 plus \$2 P&I.*
 - 48k S100 "JAWS" ... \$249.95 plus \$2 P&I.*
 - 64k S100 "JAWS" ... \$299.95 plus \$2 P&I.*
- Level E — An important "building block" — it activates the 8k ROM/PROM space on the motherboard. Now just plug in our 8k Microsoft BASIC or your own custom programs.
 - Level E kit ... \$3.95 plus 50¢ P&I.*

MICROSOFT BASIC — It's the language that allows you to talk English to your computer! It is available three ways:

- 8k cassette version of Microsoft BASIC (requires Level B and 12k of RAM minimum; we suggest a 16k S100 "JAWS" — see above) ... \$99.95 postpaid
- 8k ROM version of Microsoft BASIC (requires Level B & Level E and 4k RAM, just plug into your Level E sockets. We suggest either the 4k Level D RAM expansion or a 16k S100 "JAWS") ... \$99.95 plus \$2 P&I.*
- Disk version of Microsoft BASIC (requires Level B, 32k of RAM, floppy disk controller, 8" floppy disk drive) ... \$325 postpaid

TEXT EDITOR/ASSEMBLER — The editor/assembler is a software tool (a program) designed to simplify the task of writing programs. As your programs become longer and more complex, the assembler can save you many hours of programming time. This software includes an editor program that enters the programs you write, makes changes, and saves the programs on cassettes. The assembler performs the clerical task of translating symbolic code into the computer-readable object code. The editor/assembler program is available either in cassette or a ROM version.

- Editor/Assembler (Cassette version; requires Level B & 8k (min) of RAM — we suggest 16k "JAWS" — see above) ... \$59.95 plus \$2 P&I.*
- Editor/Assembler (ROM version, supplied on an S100 card; requires Level B and 4k RAM (min) — we suggest either Level D or 16k "JAWS") ... \$89.95 plus \$2 P&I.*

8" FLOPPY DISK — A remarkable "building block." Add our 8" floppy disk when you need faster operation, more convenient program storage, perhaps a business application, and access to the literally thousands of programs and program languages available today. You simply plug them into your Explorer/85 disk system — it accepts all IBM-formatted CP/M programs.

- 8" Floppy Disk Drive ... \$499.95 plus \$12 P&I.*
- Floppy Controller Card ... \$199.95 plus \$2 P&I.*
- Disk Drive Cabinet & Power Supply ... \$69.95 plus \$3 P&I.*
- Drive Cables (set up for two drives) ... \$25.00 plus \$1.50 P&I.*

CP/M 2.2 Disk Operating System, includes Text Editor/Assembler, dynamic debugger, and other features that give your Explorer/85 access to the thousands of existing CP/M-based programs ... \$150.00 postpaid.

NEED A POWER SUPPLY? Consider our AP-1. It can supply all the power you need for a fully expanded Explorer/85 (note: disk drives have their own power supply) Plus the AP-1 fits neatly into the attractive Explorer steel cabinet (see below).

AP-1 Power Supply kit (8V @ 5 amps) in deluxe steel cabinet ... \$39.95 plus \$2 P&I.*

NEED A TERMINAL? We offer you choices the least expensive one is our Hex Keypad/Display kit that displays the information on a calculator-type screen. The other choice is our ASCII Keyboard/Computer Terminal kit, that can be used with either



1. Plug in Neitronics Hex Keypad/Display
2. Add Level B to convert to S100
3. Add 4k RAM
4. Plug in Level E, hex keypad, Microsoft BASIC, Text Editor/Assembler in ROM
5. Add two S100 boards
6. Add your own custom circuits (prototyping arms)
7. Connect terminal

CRT monitor or a TV set (if you have an RF modulator) ... \$25.00 postpaid.

Hex Keypad/Display kit ... \$69.95 plus \$2 P&I.*

ASCII Keyboard/Computer Terminal kit featuring a full 128 character set, u&i case, full cursor control, 75 ohm video output, convertible to handout output, selectable baud rate, RS 232-C or 20 mA I/O, 32 or 64 character by 16 line format ... \$149.95 plus \$3 P&I.*

Steel Cabinet for ASCII Keyboard/Terminal ... \$19.95 plus \$2.50 P&I.*

RF Modulator kit (allows you to use your TV set as a monitor) ... \$5.95 postpaid.

12" Video Monitor (10MHz bandwidth) ... \$139.95 plus \$3 P&I.*

Deluxe Steel Cabinet for the Explorer/85 ... \$49.95 plus \$3 P&I.*

Fan for cabinet ... \$15.00 plus \$1.50 P&I.*

ORDER A SPECIAL-PRICE EXPLORER/85 PAK — THERE'S ONE FOR EVERY NEED.

Beginner Pak (Save \$28.00) — You get Level A (Terminal Version) with Monitor Source Listing (\$25 value) AP-1, 5-amp. power supply, Intel 8085 Users Manual ... (Reg. \$199.95) SPECIAL \$199.95 plus \$4 P&I.*

Experimenters Pak (Save \$53.40) — You get Level A (Hex Keypad/Display Version) with Hex Keypad/Display, Intel 8085 User Manual, Level A Hex Monitor Source Listing, and AP-1, 5-amp. power supply ... (Reg. \$279.95) SPECIAL \$219.95 plus \$6 P&I.*

Special Microsoft BASIC Pak (Save \$103.00) — You get Levels A (Terminal Version), B, D (4k RAM), E, 8k Microsoft in ROM, Intel 8085 User Manual, Level A Hex Monitor Source Listing, and AP-1, 5-amp. power supply ... (Reg. \$439.70) SPECIAL \$339.95 plus \$7 P&I.*

Add a Rom-Version Text Editor/Assembler (Requires Levels B and D or S100 Memory) ... \$99.95 plus \$2 P&I.*

Starter 8" Disk System — Includes Level A, B floppy disk controller, one CDC 8" disk-drive, two-drive cable, two S100 connectors; just add your own power supplies, cabinets and hardware ... (Reg. \$1065.00) SPECIAL \$999.95 plus \$13 P&I.* 32k Starter System, \$1049.95 plus \$13 P&I.* 48k Starter System, \$1099.95 plus \$13 P&I.* 64k Starter System, \$1149.95 plus \$13 P&I.*

Add in any of above Explorer steel cabinet, AP-1 five amp power supply, Level C with two S100 connectors, disk drive cabinet and power supply, two sub-D connectors for connecting your printer and terminal ... (Reg. \$225.95) SPECIAL \$199.95 plus \$13 P&I.*

Complete 64K System Wired & Tested \$1850.00 plus \$26 P&I.*

Special Complete Business Software Pak (Save \$625.00) — Includes CP/M 2.2 Microsoft BASIC, General Ledger, Accounts Receivable, Accounts Payable, Payroll Package ... (Reg. \$1325) SPECIAL \$999.95 postpaid

*P&I stands for "postage & insurance." For Connecticut orders, double this amount.

Continental Credit Card Buyers Outside Connecticut:

TO ORDER
Call Toll Free:
800-243-7428

To Order From Connecticut, or For Technical Assistance, Call (203) 354-9375

CP/M is a reg. trademark of Digital Research

★ (Clip and mail entire ad) ★

SEND ME THE ITEMS CHECKED ABOVE
Total Enclosed (Conn. Residents add sales tax) \$ _____
Paid by:

Personal Check Cashier's Check/Money Order

VISA MASTER CARD (Bank No. _____)

Acct. No. _____ Exp. Date _____

Signature _____
Print Name _____
Address _____
City _____
State _____ Zip _____

NETRONICS Research & Development Ltd.

333 Litchfield Road, New Milford, CT 06776

Components Express, Inc.

"Have you kissed your computer lately?"
1380 E. Edinger, Unit CC Santa Ana, CA 92705 (714) 558-3972

BROAD BAND MICROWAVE RECEIVER SYSTEM 1.8GHZ to 2.4 GHZ



only \$295.
With built-in-converter to channel 2, 3, or 4 of any standard TV set.

- 24" Dish
- Feed-Horn Receiver
- Mounting Bracket
- Mounting Clamp
- Instructions
- 300 Ohm to 75 Ohm Adapter
- 750 Ohm to 300 Ohm Adapter
- 60 Feet Coax Cable with Connectors
- 3 Feet Coax Cable with Connectors

RANGE: Line of sight to 250 miles
SCOPE: Will receive within the frequency band from satellites primary microwave stations, and repeater microwave booster stations
CONTENTS: Completely packaged in 19"x19"x4 1/2" corrugated carton complete with list

WARRANTY: 180 days for all factory defects and electronic failures for normal useage and handling. Defective sub assemblies will be replaced with new or re-manufactured sub assembly on a 48 hour exchange guarantee.

This system is not a kit and requires no additional devices or equipment other than a TV set to place in operation.

Dealer inquiries invited

The Micrōb 004

Finally.... A reasonably priced robot for the hobbyist...

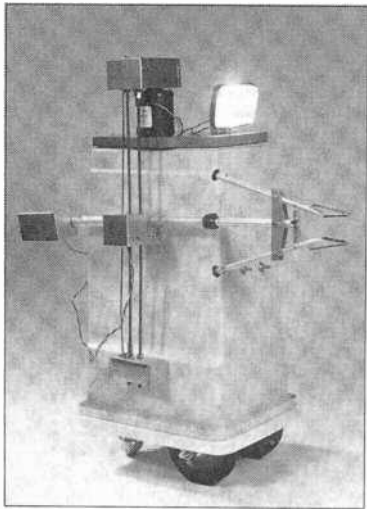

Computer or Radio controlled
Approx 38" high
Weight 40-55 lbs

The Micrōb 004 is one of the most complete kits on the market today and can be ready to go in less than a weekend's work. When hooked up to a 4K (or 16K) color computer the Micrōb seems to acquire human intelligence. It prints its maneuvers and discoveries on the computer's video screen and acts upon changes in its environment.

\$695.00 *

- can be controlled by micro-computer (TRS-80 4K or 16K color computer recommended)
- can be controlled by radio control
- arm can: rotate, move up and down, claw opens and closes.
- all electric motors included
- runs on 12 volt auto battery (not included)
- options such as video camera "eye" are available
- 12 volt work lamp included
- one piece fiberglass body (access panel in rear) with XLR connections for patching
- most wiring and solder joints (connections) completed

- Specify
- radio control switching (5 channel radio recommended, but not included)
- computer controlled or both (add \$50.00)
- video camera (add \$350.00)

(customer must pay shipping)
MRT accepts cheques, money orders,
Visa & Master Charge

Dealership inquiries welcome.

P.O. Box 189,
Rothsay, New Brunswick
CANADA, E0G 2W0
phone 1-506-693-0175
after hours 1-506-847-2729

Name _____
Address _____
Phone _____

MRT MICRO ROBOTICS TECHNOLOGIES LTD.

CIRCLE NO. 39 ON FREE INFORMATION CARD

	74XX	74CXX	74LSXX	74SXX
ZENERS				
500 mw	00 \$.22	\$.37	\$.27	.44
3.0 to 100V 16¢	02 .22	.37	.27	.44
1 watt	04 .24	.37	.29	.48
3.0 to 100V 24¢	06 .32	.37	.45	.54
	08 .25	.55	.29	.48
	10 .22	.37	.27	.44
	14 .55	.95	.87	.95
	20 .21	.37	.27	.44
	27 .23	-	.29	.45
	30 .22	.37	.27	.44
	37 .36	-	.39	.65
	38 .36	-	.39	.65
	40 .22	.37	.27	.44
	47 .65	-	.79	.44
	54 .22	-	.27	.44
	73 .32	.75	.39	.69
	74 .43	.95	.39	.75
	76 .32	.75	.39	.75
	83 .59	1.25	.75	1.50
	85 .75	1.25	1.08	1.50
	86 .33	.75	.39	.72
	90 .47	.95	.48	.89
	93 .42	.95	.48	-
	95 .59	.95	.65	-
	96 .59	-	.99	-
	107 .39	1.25	.39	1.50
	121 .35	-	.45	1.10
	123 .53	-	.99	1.25
	125 .45	-	.75	.95
	131 .59	-	.89	1.50
	151 .59	2.10	.75	1.10
	153 .69	-	.75	1.10
	154 1.19	3.75	1.65	1.10
	156 .69	-	.95	1.10
	157 .65	2.50	.75	1.35
	161 .75	1.50	.75	-
	162 .75	-	.99	-
	163 .75	1.25	.99	-
	165 .75	1.25	.99	-
	174 .79	1.10	.95	1.35
	175 .79	1.10	.95	1.35
	188 .75	-	3.50	3.50
	189 .75	-	3.50	3.50
	193 .75	1.50	.99	1.50
	195 .82	1.50	.89	1.50
	221 1.10	2.10	1.10	2.00
	240 .-	-	1.75	2.25
	241 .-	-	1.99	2.25
	242 .-	-	1.65	2.25
	243 .-	-	1.75	2.25
	245 .-	-	1.99	2.45
	279 .72	-	.65	-
	299 .-	-	3.75	-
	351 .63	-	.69	-
	366 .63	-	.69	-
	367 .63	-	.69	-
	373 .-	2.95	1.75	2.95
	374 .-	2.95	1.75	2.95

REGULATORS	PRICE
LM340TXX	
or 78XX	85¢
POSITIVE	
LM320TXX	
or 79XX	89¢
NEGATIVE	
VIDEO & I.F.	
MC1330	\$1.59
MC1349	1.25
MC1350	1.15
MC1358	1.47
ASSOC.	
LM380	\$1.45
NE565	1.19
MC1458	.45

SEND FOR FREE CATALOG. WE LIST AND STOCK OVER 2000 TYPES OF I.C.'s, 5000 DIODE TYPES & OVER 3000 TRANSISTOR TYPES. HARD TO FIND OR DISCONTINUED DEVICES - THOUSANDS IN STOCK!! FREE WOODEN NICKEL WITH ORDER

LINEAR	PRICE
LM300H	\$1.00
LM301N	.49
LM307N	.49
LM317K	3.95
ua741P	.45
ua747N	1.00
NE555V	.29

experimenter's corner

optic cable carries light to the target. The reflected light is carried through the second branch of the cable to a detector. The low light levels involved necessitate the use of a detector amplifier.

I've assembled such a fiber-optic reflectometer, and it works quite well. The small size of the sensor head means that the reflectance of very small objects, or different parts of the same object, can easily be measured. Figure 4 is a simplified diagram of such a device. See Lott and Cash's paper for more detailed information.

Remote Sensing of Water Vapor. If you read the "Solid-State Developments" in the February 1981 issue of this magazine, you may recall that 940-nanometer radiation is strongly absorbed by water vapor in the atmosphere, but that absorption at 880 nanometers is negligible. This provides a characteristic signature which permits the remote sensing of water vapor by dual-wavelength *transmission spectroscopy*.

Figure 5 is a simple circuit I've designed to demonstrate this method of detecting water vapor. It is a dual-wavelength transmission spectrometer with an audio output.

In operation, a GaAs:Si 940-nanometer emitter and an (AlGa)As 880-nanometer emitter are both pointed at a silicon phototransistor that drives an amplifier. The two LEDs are alternately driven by pulses with a duty cycle of 50 percent that are generated by an astable multivibrator made from two of the four NAND gates in a 7400.

Initially, the receiver will generate a tone coinciding with the pulse rate at which the LEDs are driven. The position of the silicon detector is then adjusted to null out the tone.

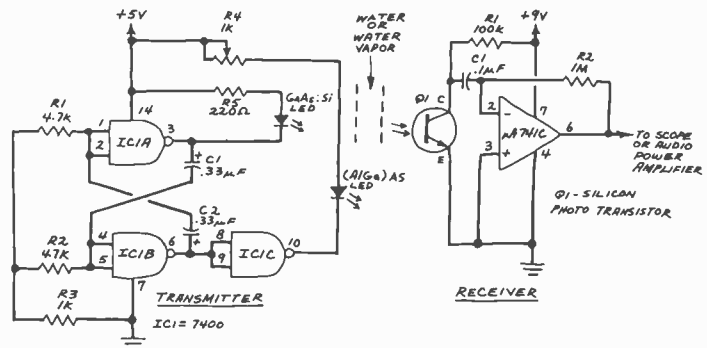

Fig. 5. Dual-wavelength water-vapor detector.

Operation of the circuit can be demonstrated by placing a small, transparent container between the two LEDs and the detector. If necessary, align the detector to cancel any tone output from the receiver. When water is poured into the container, radiation from the 940-nanometer LED will be suppressed, but that from the 880-nanometer emitter will be largely unaffected. Consequently, the null condition will be disturbed and a tone will be emitted by the receiver.

This simple circuit proves that an 880-nanometer LED can be teamed up with a 940-nanometer LED to detect water. Detecting water vapor is more difficult, but it can be done. One way to demonstrate the detection of water vapor is to allow steam to pass between the two LEDs and the silicon detector. More sophisticated versions of this dual-wavelength circuit are possible, but I will leave their design to those of you interested in remote sensing.

Summing Up. In this two-part series, we have only touched upon the field of remote sensing. Although you might not derive much practical benefit from the circuits with which we have experimented, you should now have a better appreciation of how some remote-sensing devices operate.

Remote sensing is an excellent subject for science-fair projects and low-cost research. Many good articles and some books on the subject have been published. For more information, visit a good technical library. Perhaps you will be able to design a simple remote sensor for detecting soil moisture or crop diseases.

scorpio electronics

3198 H AIRPORT LOOP DRIVE COSTA MESA, CALIF 92626
VISA CREDIT CARD ORDERS, PLEASE DIAL... \$10 min.
MASTER CARD 800 854-7458 ADD \$1.50 FRT.

DX LISTENING

Science & Technology Programs

By Glenn Hauser

YOU can keep up with scientific developments by listening to several weekly programs available on shortwave radio. All times and days given are in GMT. An asterisk means the program time will change to one hour later when the station ceases observing DST. Frequencies may change too so check future listings in the magazine.

AFRTS. *CBS Radio* has a weekly "Science Editor", produced at UCLA, which has been running for many years, but unfortunately is cleared by only a few affiliates (since it is noncommercial) and then at inconvenient times. It is, however, heard easily via *AFRTS* shortwave, Thursday at 0430-0444* on 17765, 15330, 11790 and 6030 kHz; repeated at 0930* on 9590, 9530 and 6030. A shorter version has been appearing on the widely-heard *WBBM*, 780, Chicago, Monday at 0522*.

Radio Australia. This station has several science series, headed by the excellent "Australian Inventor", produced by Keith Smith, whose enthusiasm for seeking out new and unusual ideas is quite obvious. He also invites listener contact by offering free plans for a solar hot water heater and other items. Saturday 1240 on 9580 and 17795; Sunday 0340 on 17795. "The Body Program" (about human physiology, medicine, etc.) airs Sunday at 0540 on 21680, 17890, 17870 and 15160; better at 1140 on 9580, 17795, 5995. These two eclipse a more traditional "This Week in Science," Saturday 0140 on 21740 and 17795; 0740 on 15115, 11740 and 9570; Sunday 1440 on 17795, 11705, 9770, 9710, 6060.

BBC World Service. Two major weekly science series are perhaps the best on the air: "Science in Action", Friday at 1615 on 21710, 17830, 15260; Sunday at 2209 on 21690, 15420, 15260, 9590; and "Discovery", described as "advanced developments in science," which is on its usual summer vacation. It had been scheduled for Wednesday at 0330 on 15070, 9410, 6175, 5975; Thursday at 1430 on 15070, 21710, but the times could change in October. "Nature Notebook" (10 minutes) is paired with "Farming World" (19), which has broader appeal than you might think, Wednesday at 1215 on 25650, 21710, 11775, 9510; Thursday at 0630 on 15070, 9510, 9410, 6175. "New Ideas" is the BBC's invention programme, Saturday at 0530 on 15070, 9510, 9410, 6175; 1115 on 21710, 11775, 9510; 2230

on 21690, 15420, 9590; and Monday at 1725 on 21710. Furthermore, *BBC* documentary programs frequently have scientific subjects, in blocks on Monday at 1345 on 15070, 21710; Wednesday at 0230 on 9410, 7325, 6175 and 5975. Dates and programs are: July 20-22, "Medical Hypnosis"; July 27-29, "The Modern Nurse"; August 3-5, "Vaccination"; August 17-19, "Is Medicine Necessary?"; August 24-26, "The Psychology of Prejudice."

Radio Canada International puts a "Spotlight on Science," Sunday around 1830-1845 on 17820 and 15260. "As It Happens" has a regular science news segment, "Eureka," on Thursdays sometime during its sesquihour, at 2130* on 17875 and 15325; 2230* on 9755 and 5960 (also on *CBC* domestic Radio starting at 6:30 p.m. local). "Morning-side" has a "World of Science" segment on Tuesdays sometime between 9:13 a.m. and noon local time (also carried on *CBC Northern Quebec Shortwave Service* at 1313-1459* on 11720, 9625). "Quirks & Quarks" hosted by Jay Ingram is *CBC's* major science show, always striving to entertain as well as inform, Saturdays at 12:05-12:59 p.m. local (also on *CBCNQSW* at 1605* on 11720, 9625). Also very well done is "The Food Show" with a strong consumer angle, Sundays at 8:30 a.m. local (also on *CBCNQSW* at 1230* on 9625, 6065).

Radio Moscow. "Science & Engineering" is a long-running series (also available free on request to U.S. stations by tape), broadcast in the North American Service, Thursdays at 2315*; Fridays 0115*, 0415*, 0615* (often starting 10-15 minutes later) on up to 16 frequencies at once.

Voice of America. "Space & Man" ranges far more widely than the title implies. It's on Wednesday at 1215 on 9565; 1812 on 15410, 21485, 26040; Thursday at 0015 on 17860, 15205, 11740, 9650, 6130, 5995. "New Horizons" airs Sunday at 1115 on 9565; 1912 on 15140; Monday at 0115 on 17860, 15205, 11740, 9650, 6130, 5995. "New Products USA" is also on Sunday at 1307 on 9565, 2108 on 15410; Monday at 0109 on 17730, 15205, 11740, 9650, 6130, 5995. "Science in Africa" presents some interesting, though rather padded and slow-paced interviews with African scientists, Sunday at 1734 & 2034 on 26040, 21485, 15410.

Kol Israel's weekly science magazine

NEW INDOOR ACTIVE ANTENNA

Covers 300 KHz - 30 MHz.
For SWL, BCL, VLF DXers.

Rivals long

wires

\$79⁹⁵
(+ \$4.00 shipping)

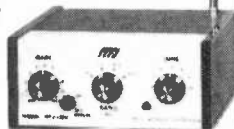

MFJ-1020 NEW INDOOR ACTIVE ANTENNA sits on your desk ready to listen to the world. Rivals, can often exceed, reception of outside long wire. Unique **Tuned** Active Antenna minimizes intermod, provides RF selectivity, reduces noise outside tuned band. Also use as preselector for external antenna. Covers 300 KHz to 30 MHz in five bands. Adjustable telescoping antenna. Controls: Tune, Band Selector, Gain, On-Off/Bypass. LED, FET, bipolar circuitry. Phono jack for external ant. 6x2x6 inches. 9-12 VDC or 9 V battery for portable use. 110 VAC with optional AC adapter. \$7.95.

Order from MFJ and try it. If not delighted, return within 30 days for refund (less shipping).

One year unconditional guarantee.

Order yours today. Call toll free 800-647-1800. Charge VISA, MC. Or mail check, money order.

CALL TOLL FREE ... 800-647-1800

MFJ Enterprises, Inc.
BOX 494, MISS. STATE, MS 39762

CIRCLE NO. 56 ON FREE INFORMATION CARD

SAVE!

MONEY • TIME • FREIGHT

QUALITY STEREO EQUIPMENT AT LOWEST PRICES.

YOUR REQUEST FOR QUOTATION RETURNED SAME DAY.

FACTORY SEALED CARTONS—GUARANTEED AND INSURED.

SAVE ON NAME BRANDS LIKE:

PIONEER	SANSUI
KENWOOD	DYNACO
SHURE	SONY
MARANTZ	KOSS

AND MORE THAN 50 OTHERS
BUY THE MODERN WAY
BY MAIL—FROM

illinois audio

BANK CARDS ACCEPTED

12 East Delaware

Chicago, Illinois 60611

312-664-0020

800-621-8042

CIRCLE NO. 30 ON FREE INFORMATION CARD

SEE YOUR DEALER TODAY

DEMAND THE ORIGINAL

'Firestik'

The #1 Helically Wire-Wound and Most Copied Antenna in the World!

27MHz AM/FM/SSB CB

2 METER • MARINE TELEPHONE
LAND MOBILE TELEPHONE

FIBERGLASS ANTENNAS
AND ACCESSORIES.

**NEW
CORDLESS
TELEPHONE
ANTENNA**

INCREASES DISTANCE
5 TO 20 TIMES

Dealer & Distributor Inquiries Invited
SEND FOR FREE CATALOG

'Firestik' Antenna Company

2614 East Adams/Phoenix, AZ 85034

Name _____
Street _____
City _____
State _____ Zip _____

Serving the CB and
Communications Market Since 1962.

5-YEAR REPLACEMENT WARRANTY

CIRCLE NO. 22 ON FREE INFORMATION CARD

Audiomatic electronics

ATARI		TEXAS INSTRUMENTS	
400 (16K) w/o Basic	349	99/4 Computer System	399
800 (32K)	799	Disk Controller	449
410 Recorder	65	Speech Synthesizer	129
810 Disk	459	RS-232 Interface	179
825 Printer	625	Memory Expansion	329
830 Modem	159	RF Modulator	45
850 Interface	149	Controller	29
Asteroids	29.95		
Computer Chess	29.95	HEADPHONES	
Space Invaders	15.95	Koss Pro 4AAA Special	49.99
Star Raiders	29.95	Koss HVXLC	48.99
All Accessories & Software in Stock.		Koss HVX	42.99
Call for Prices		Sennheiser HD 430	75.99
		Sennheiser HD-222 New	73.99
		Sennheiser HD-420	52.99
		Audio-Technica ATH-7	99.99
SOFTWARE FOR ATARI		JENSEN Car Stereo	
Swiftly Prog. Aids I (Cassette)	13.95	Call for prices on Car Stereos	
Swiftly Space Chase (Cassette)	13.95	SPEAKERS	
Swiftly Time Bomb (Cassette)	13.95	J1033 (6x9) Triax II	84.99/pr
Swiftly File-It (Disk) data base	29.99	J1037 (6x9) Coax II	64.99/pr
Visicalc (Disk)	169.95	J1041 (5x) Coax II	54.99/pr
Letter Perfect (Word Proc.)	119.99	J1126 (4x) Coax II	54.99/pr
DataSoft Text Wizard (Disk)	85.99	J1065 (6x9) Triax II	62.99/pr
Computer Magic on Cassette)		J1069 (6x9) Coax II	40.99/pr
Horse Word Derby	17.99		
Avoid	17.99	BLAUPUNKT Car Stereo	
Tri-Bomb	17.99	CR-2001 In-dash	259.99
		New Yorker	299.99
		CR-3001	469.99
		CR-5001	349.99
		BEA-200	169.99
		PHONO CARTRIDGES	
		Shure V15 Type IV	105.99
		Shure V15 Type III HE	86.99
		Shure M97 HE	56.99
		Audio Technica AT155LC	109.99
		Audio Technica AT140LC	64.99
		Audio Technica AT125LC	39.99
		Stanton 881S	82.99
		Stanton 581 EES	62.99
		Stanton 581 EEE	56.99
		Empire 2000Z	54.99
		Empire 400TC	22.99
		Pickering XSV4000	68.99
		Pickering XSV5000	87.99
		Pickering XV15-750E	33.99
		VIDEO RECORDERS	
		JVC HR 5700	899.99
		SONY SL-5800	1099.00

Instructions for Ordering
To place your order for any of this computer hardware and/or software, please order by mail only, enclosing a bank check, cashier's check, or money order in the amount of your order, and add 5% for shipping and handling (minimum \$5.00), + Sales Tax (if required). NO PHONE OR CREDIT CARD ORDERS ACCEPTED. You may call for price quotations on items not listed. All prices are subject to change without notice.

COMPUTER DIVISION
Audiomatic electronics
WRITE FOR FREE CATALOG
(212)686-5500
1263 Broadway New York, N.Y. 10001

CIRCLE NO. 8 ON FREE INFORMATION CARD

dx listening

is called "Spectrum," Monday at 2010 on 21495, 17645, 15582, 15415; Tuesday at 0015 & 0215 on 15583, 11637, 9815.

Radio RSA (South Africa). "Science World" is scheduled at approximately: Wednesday at 2145 on 11900, 9585; Thursday at 0245 on 9585, 9615, 5980 and 3980; 1337 on 25790, 21535, 15220.

Radio Japan. "Science & Industry" is on Thursday at 1215 on 9505; 1915 on 17755; 2315 on 17755; Friday at 0005 on 17825, 15430; 0150 on 21640, 17825, 17725, 15235.

All India Radio General Overseas Service airs "Science Today", on the 3rd Wednesday of the month at 1400 on 15335, 11810; 1820 and 2220 on 11620. Reception is spotty in North America; best around the equinoxes.

HCJB increased its popular science programming last year; religious messages may be included too. "World of Science" is on Sunday at 0130 on 17885, 15360, 9745; 0600 on 11915, 9745, 6095; 0915 on 6130; 1945 on 26020, 21480, 17790; Tuesday at 2330 on 15180; Thursday at 0345 on 15360 and 9745. And, "Nature Trail," Friday at 0700 on 11900, 9745, 6130; Saturday at 0615 on 15235, 11835 and at 1215 on 15115, 11740.

Radio Deutsche Welle broadcasts a "Science Journal" to areas other than North America, but we can sometimes hear it, Saturdays 0455 on 11765, 9765, 9565, 7225, 7150; 1224 on 21600, 17875, 17765, 15410. Here only, we go into programs not in English since reception is so much better during German transmissions, for "Wissenschaft und Forschung", Wednesday at 2325-2340 on 21560, 15410, 11765, 9735, 9700, 6075; Thursday at 0325-0340 on 11795, 9735, 6145, 6100, 6085, 3995.

Radio Bucharest gives a Romanian "Science Magazine" Saturday at 0420 on 11940, 11840, 9690, 9570 (usually best), 9510, 5990. Several other stations have such a token feature.

National Public Radio has several science shows available to its 200+ member stations, which are free to air them later (or not at all) than these network feed times: "Radio Smithsonian" Mondays 2230-2259*, Wednesdays 1900-1929*. Ira Flatow, perhaps best known for a poster showing him interviewing penguins in "Antarctica", contributes "Science Modules" Thursdays 1715-1744*, Saturdays 1500-1529.* "Science World," a reading service for the blind, Friday at 1930 to 1959.* "The Nature of Things", brief popular science talks from Vermont, fed Fridays 1730* but meant to be played back one at a time. "New Dimensions", hour-long conversations from the San Francisco foundation of the same name (check with your local NPR station for time). And, not least, NPR carries "BBC Science Magazine", a melding of programs mentioned under BBC above, including a "Frontiers of Knowledge" segment, Wednesday at 2330-2359* and Thursday at 1905-1934*.

POPULAR ELECTRONICS

**FREE McIntosh
STEREO CATALOG
and FM DIRECTORY**

Get all the newest and latest information on the new McIntosh catalog. In addition you will receive an FM station directory that covers all of North America.

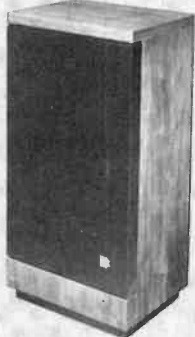

**SEND
TODAY!**

McIntosh Laboratory, Inc.
East Side Station P.O. Box 96
Binghamton, N.Y. 13904

PE

NAME _____
ADDRESS _____
CITY _____ STATE _____ ZIP _____

If you are in a hurry for your catalog please send the coupon to McIntosh.
For non rush service send the Reader Service Card to the magazine.

CIRCLE NO. 40 ON FREE INFORMATION CARD

ELECTRONICS LIBRARY

Learning Level II

by David A. Lien

Features and functions of Level II BASIC used in the TRS-80 microcomputer are explained in this book. Coverage picks up where Level I finishes, providing every update needed to make Level I's manual fully compatible with Level II. Starting with setting up the system, the book details important BASIC capabilities with emphasis on how to implement them. Throughout the text, the real meaning of each error message is explained. One section of the manual shows how to convert Level I programs, including all programs in the Level I manual, into Level II format.

Published by CompuSoft Publishing, 8643 Navajo Rd., San Diego, CA 92119. Soft cover. 352 pages. \$15.95 + \$1.45 postage and handling. (California residents, include 6% tax.)

Electronics Engineering for Professional Engineers' Examinations

by Charles R. Hafner

Concentrating on the electronic aspects of the electrical-engineering licensing examination, this book includes problems, solutions, and extensive reference materials. Worked-out problems illustrate every major concept, while separate appendices supply data needed for quick answers to questions on such subjects as network synthesis, transistor and small-signal equations, network-transfer functions, and Laplace transforms. Semiconductor circuits, ac and dc circuits and transient analysis, servos and feedback theory, and instrumentation are dealt with in detail.

Published by McGraw-Hill Book Co., 1221 Avenue of Americas, New York, NY 10020. Hard cover. 309 pages. \$19.50.

The Master IC Cookbook

by Clayton L. Hallmark

Important information on 7400-series TTL and 4000-series CMOS digital ICs and a wide range of popular experimenter/hobbyist linear ICs is given in this encyclopedic book. The digital sections include logic diagrams, pinouts, power dissipation, propagation delay, and truth tables. Additional information such as quiescent current, TTL-load driving capability, and supply-voltage ranges are given for CMOS ICs. The linear section contains schematics, pinouts, block diagrams, theory of operation, and technical specifications for many op amps, regulators, PLLs, and other devices.

Published by Tab Books, Blue Ridge Summit, PA 17214. Soft cover. 476 pages. \$9.95.

AMAZING DEVICES

(((PHASERS)))

PPF-1 PHASER PAIN FIELD — This device recently developed and patented in our labs is being evaluated by law enforcement agencies for riot and crowd control. It is now available but soon will come under the jurisdiction of weapons and infernal machine control making it unavailable to the public. The device is hand-held and looks like a BUCK ROGERS ray gun. It is hazardous if not used with discretion.

PPF-1 PLANS \$15.00

IPG-1 INVISIBLE PAIN FIELD GENERATOR — This amazing, simple hand-held device is about the size of a pack of cigarettes and generates a directional field of moderate to intensive pain in the lower part of the head up to a range of 50'. Device is simple and economical to make.

IPG-1 PLANS \$7.00 IPG-1K ALL PARTS \$39.50

IPG-10 ASSEMBLED & TESTED FOR ANIMAL CONTROL \$49.50

LASERS

RUBY LASER RAY PISTOL — Produces highly intense red beam, capable of burning. A hazardous device. PLANS, PARTS, SOURCES \$15.00

HIGH-POWERED CARBON DIOXIDE BURNING AND CUTTING. Complete plans and all parts sources \$15.00

SOLID STATE IR 12 WATTS with built in power supply plans \$8.00 Complete kit with collimator \$74.00

POCKET LASER pulsed, visible red, plans \$7.00

Complete kit \$39.50 Also complete plans and parts sources for RUBY, YAG, NEODYMIUM, HeNe ARGON, OYE, NITROGEN and many more lasers.

SECURITY

SNP-2 SNOOPER PHONE — Dial home or office phone while on vacation activating sensitive mike without phone ringing. Excellent property protection and intrusion device.

SNP2 PLANS \$7.00

SNP2K ALL PARTS \$49.50

SNP2K ASSEMBLED AND TESTED \$99.50

LONG RANGE XMTR PLANS \$7.00

SEE-IN-THE-DARK PLANS \$10.00

DIRECTIONAL SHOTGUN MIKE PLANS \$8.00

SUPER SENSITIVE PARABOLIC MIKE PLANS \$8.00

SOUND & TELEPHONE OPERATED TAPE RECORDER \$7.00

CATALOG ON PLANS, KITS & FINISHED UNITS \$1.00

Send check or money order to:

SCIENTIFIC SYSTEMS, Dept. Q1, Box 716

AMHERST, N.H. 03031

CIRCLE NO. 48 ON FREE INFORMATION CARD

Bearcat® 210XL Super Scanner

Look what you get with the Bearcat 210XL. Exciting, new spaceage styling. No-crystal, pushbutton tuning. New, 18 channel, 6-band coverage of over 6000 frequencies. And features like 2 scan speeds. Automatic Squelch, Search, and Lockout. Direct Channel Access. Selective Scan Delay. And much more. There's never been a Scanner like the Bearcat 210XL.



"TAKE IT FROM A SMART OPERATOR"

BEARCAT 210XL SCANNER \$229.

Add \$7.00 per scanner for U.P.S. ground shipping in the continental U.S. Send your cashier's check or money order to our address below or order by phone if you have a Visa or Master Charge card.

COMMUNICATIONS ELECTRONICS™

854 Phoenix □ Box 1002 □ Ann Arbor, Michlgan 48106 U.S.A.
Call TOLL-FREE (800) 521-4414 or outside U.S.A. (313) 994-4444
CIRCLE NO. 1 ON FREE INFORMATION CARD

Experience The World's Most Versatile Microcomputer

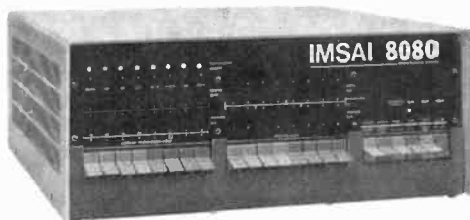

IMSAI 8080

Kit \$599.00

Assembled \$799.00

- Includes:
- 22-Slot Motherboard with Sockets
 - 28 Amp Power Supply
 - MPU-A 8080 2 Mhz. Processor
 - Programmer's Front Panel

Send Check or Money Order to



Computer Division of the Fischer-Freitas Corporation

910 81st Avenue, Bldg. 14 • Oakland, CA 94621

415/635-7615

Imesai is a trademark of the Fischer-Freitas Corporation

CIRCLE NO. 31 ON FREE INFORMATION CARD

ETCO

CABLE TV CONVERTERS AND OTHER GOOD STUFF!

SMASHING ALL SALES RECORDS - OUR NEW 30 CHANNEL CABLE TV CONVERTER!

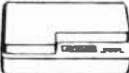

Converts mid & super band cable channels for viewing on your TV set.
No. 342EA047

39⁹⁵
\$34.95 ea. / 5

HOT NEW IMPORT! REMOTE CONTROL 30 CHANNEL CABLE TV CONVERTER!

89⁹⁵
\$79.95 ea. / 5
\$74.95 ea. / 10

Includes remote TV on/off switch and fine tuning control!
No. 342VA275



ETCOMK11 WIRELESS - THE ULTIMATE CABLE TV CONVERTER!



Set TV to channel 3 and the hand held remote control does the rest!
No. 342ZA008

189⁰⁰

VICOR 2000 CONVERTER ELIMINATES PROBLEMS WHEN VIDEOTAPING FROM CABLE TV

89⁹⁵
\$79.95 ea. / 5
\$74.95 ea. / 10

Restores your VCR's color balance programming. Restores remote channel control. Enables videotaping of one cable program while watching another.
No. 342VA950



UNUSUAL FACTORY SURPLUS MID-BAND - SUPER-BAND CABLE TV TUNER



Converts cable channels to a common IF frequency. Experimenters - build cable converter decoders, etc. With schematic. No. 342VA342

19⁹⁵
\$17.50 ea. / 10

FACTORY SURPLUS UHF TUNERS

4⁹⁵
\$3.95 ea. / 10

Brand new production surplus. All solid state. Ideal for experimental work building cable TV converters, etc. No. 342ZU099



MINIATURE FM WIRELESS MICROPHONE



Hides in the palm of your hand. Reception on any standard FM radio or receiver.
No. 342VA482

29⁹⁵
\$27.50 ea. / 5
\$24.95 ea. / 10

QUARTER-MILE WIRELESS MICROPHONE & RECEIVER SYSTEM

69⁹⁵
\$49.95 ea. / 5

FCC approved crystal controlled wireless mike & receiver. All battery operated. Electrical wide range response. VU meter.
No. 342VA093



FACTORY SURPLUS UHF / UHF "TWIN" VARACTOR TUNERS!



Admiral No. NC 3143-1. BRAND NEW! Ideal for building or repairing electronically tuned TV "FRONT ENDS". A hard to find item at a sensational price!
No. 342VC308

39⁹⁵
\$34.95 ea. / 5

DUMPING! NORELCO ENDLESS LOOP CASSETTES!

4⁹⁵
\$4.49 ea. / 10

Impossible to find at any price!
3 minutes - No. 342VA605
6 minutes - No. 342VA606



IN STOCK - THE MURA CORDLESS TELEPHONE SYSTEM!



Answer & originate calls with this new touch-tone telephone. 400 ft. range! "Rechargeable" battery. Number recall! Paging feature! Use with rotary, touch systems.
No. 211VA133

144⁸⁸
\$129.95 ea. / 5

SALE OF QUARTZ BATTERY-OPERATED CLOCK MOVEMENTS!

9⁹⁵
\$8.95 ea. / 5

Accuracy of 1 min / year up to 4 years operation on 1 alkaline C cell. Imported from West Germany. No. 342VA561



20 AMP REGULATED 12VDC POWER SUPPLY!



1.8 wdc no load. 12.5 wdc full load. Easily handles ham station, marine-radio, SSB loads up to 400w PEP. Brand new, factory packed 110 VAC. No. 342VA394

69⁸⁸
\$59.88 ea. / 5

FREE OUR LATEST 98 PAGE FASCINATING CATALOG jam packed with unique items, electronic programs and unusual offers. Write or circle the information card number below.

ETCO ELECTRONICS NORTH COUNTRY SHOPPING CENTER PLATTSBURGH, N.Y. 12901

Check with order, please. Visa & Mastercard OK. (Sorry, no C.O.D.'s. Add 1% for UPS or Handling (Excess refunded). N.Y. State residents add 7% sales tax. Dealer & Export inquiries invited. Our telephone order desk never closes. Call 1 518 561 8700

CIRCLE NO. 21 ON FREE INFORMATION CARD

OPERATION ASSIST

If you need information on outdated or rare equipment—a schematic, parts list, etc.—another reader might be able to assist. Simply send a postcard to Operation Assist! POPULAR ELECTRONICS, 1 Park Ave., New York, NY 10016. For those who can help readers, please respond directly to them. They'll appreciate it! Only those items requiring equipment not available from normal sources are published.)

Toshiba RT-450X AM/FM stereo cassette recorder. Need schematic and service manual. Bill Stottlemeyer, Route 1, Box 125, Corinth, MS 38834.

Hewlett-Packard model 206A audio signal generator. Need schematic and service manual. P. Young, 16W761 White Pines, Bensenville, IL 60106.

Grunow model 833 AM radio. Need schematic. H.L. Schultz, 610 Young Rd, Erie, PA 16509.

Hoffman model W7304A color TV. Need service manual and schematic. William C. LeDuc, 3 House Ave, Troy, NY 12180.

Micronta tachometer model #22-914. Need operating manual. Carl McCormick, 6723 Old Morrisport Rd., Shreveport, LA 71107.

Heathkit HR-10-B receiver. Need any information available. David Weisenthal, 29 Northview Ave., Montclair, NJ 07043.

Beckman model 6121 frequency counter. Need manual, schematic or any available information. Charles Patterson, 723 S. Broadway, Tarrytown, NY 10591.

Systems Electronics model 57 scopes. Need schematic and manual. Ken Dolan, Electronic Services, 286 S. Seymour St., Napa, CA 94558.

Accurate Instrument Co., model 152 VTVM. Need operating manual, calibration procedures and schematic. Wayne Cox, 558 East Northern Ave., Springfield, OH 45503.

Audimation Corporation model SRA-100 power amplifier. Need schematic or any information available. Jonathan Kafus, 98-19 64th Avenue, Rego Park, NY 11374.

Xetex Electronics model OS-15 scope. Need schematic and service manual. Walter S. Jackson, 281 Irish Road, Barwyn, PA 19213.

Hickok 288X signal generator. Need meter transformer and schematic. Bill Springer, 923 Nelda, Houston, TX 77088.

Video Brain model 101 computer. Need manuals and information on cartridge availability. Jim Porta, 8709 Gainsborough Dr., Louisville, KY 40291.

Hammarlund HQ145-X receiver. Need owner's manual, alignment data and schematic. F. Scoville, Box 243, Sewell St., Lake George, NY 12845.

Clough-Brengle model 23AA ac capacity ratio bridge. Need owners operation manual. H.B. Claremont, Box 581, Dolan Springs, AZ 86441.

Polarad spectrum analyzer, model SA-84WA. Need technical manual. Russell S. Watson, c/o Howard McAuliffe Inc., 15 Industrial Park Place, Middletown, CT 06457.

Uher model 7000D tape recorder. Need schematic diagram or service manual. James O. Moshier, 3031 Dunham Dr., Wichita, KS 67216.

Roberts 1040A tape recorder. Need schematic and parts list. Joseph Wright, 518 W. Santa Fe, Olathe, KS 66061.

RCA model WO-870A oscilloscope. Need replacement power transformer. Emil Huddy, 54451 Road 200, North Folk, CA 93643.

Eric Electronics model ST-100 tuner and 40P amplifier.

CALCULATOR SAVINGS

HP HEWLETT PACKARD

- HP 32E Scientific \$42.95
- HP 33C Programmable 68.95
- HP 34C Adv. Program 114.95
- HP 37E Financial 58.95
- HP 38C Adv. Financial 114.95
- HP 41C Alpha Program 187.95
- HP 41CV (Full Memory) 237.95
- Card Reader 41 164.95
- Printer 41 289.95
- Optical Wand 41 92.95
- Memory Module 41C 23.95
- Quad Memory 41C 76.95
- HP 67 Programmable 287.95
- HP 97 Desk Program 579.95
- HP 85 Desk Computer 2495.00
- HP 83 Desk Computer 1695.00
- 16K Memory Module 249.95



Call for Low Prices on all Calculator and Computer Accessories

TEXAS INSTRUMENTS

- | | | | | | |
|--------|----------|---------|----------|---------------------|----------|
| TI 35 | \$189.95 | TI 59 | \$189.95 | TI 99 4A Const. | \$399.95 |
| TI 55 | 29.95 | PC 100C | 159.95 | Language Tutor | 129.95 |
| TI 57 | 39.95 | Program | 49.95 | Språk & Sær | 59.95 |
| TI 58C | 89.95 | TI 5040 | 67.95 | Business Analyst II | 319.95 |

Call for Low Prices on All TI Calculators and Watches

- | | | |
|----------------|--|--------|
| Sharp | PC 1211 Handheld Computer | CALL |
| | CE 121 Cassette Interface | 49.95 |
| | CE 122 Printer Cassette Interface | 149.95 |
| | EL 5100 Alphanumeric scientific programmable | 69.95 |
| | EL 7001 Miniature typewriter and calculator | 99.95 |
| | CT 660 E Talking digital alarm clock | 59.95 |
| Casio | FX 602P Slim programmable 512 steps | 99.95 |
| | FX 702P Handheld computer | 159.95 |
| | FX 3600P Slim programmable 38 steps | 34.95 |
| | M 10 Compact musical keyboard | 124.95 |
| | MT 30 Compact musical keyboard | 159.95 |
| | W 100 Water sports alarm chro. 325 feet | 34.95 |
| | CA 90 Calculator alarm chrono watch | 44.95 |
| Pearlco | S 202 Microcassette tape recorder | 79.95 |
| | S802 Two speed two hour recorder | 99.95 |
| | S801 Olympus smallest two hour | 139.95 |
| | X 01 New electronic Recorder | 199.95 |
| Craig Olivetti | M 100 Language translator | 69.95 |
| | Phras 35 electronic portable typewriter | 279.95 |

For faster delivery use cashiers check or money order. Add shipping 1% of your order (\$3.00 min.). East of Missis. Riv. add \$1.50. CA Res. add 6%. Subject to availability. VISA and MC accepted.

ORDER 800-421-5188
TOLL FREE Information line (213) 633-3262 Outside CA AK HI

tam's INCORPORATED
Tam's Dept. PE-8
14932 Garfield Ave.
Paramount, CA 90723
(213) 633-3262

CIRCLE NO. 57 ON FREE INFORMATION CARD

WOULD YOU LIKE TO BE A TECHNICAL EDITOR FOR Popular Electronics?

If you know your electronic circuits and would delight in examining and writing about new technical devices and systems, as well as having contact with the designers, we'd like to hear from you.

This is a career opportunity in New York City, with good starting salary and an excellent benefits package. Send resume and salary history and requirements in confidence to:

Ziff-Davis Publishing Co.
Att: Joan Fila
Personnel Dept.
One Park Ave.
New York, NY 10016

An Equal Opportunity Employer. M/F

operation assist

Need any information available. Robert W. Stevenson, 1700 Oakmont Dr. 4, Walnut Creek, CA 94595.

Waterman S-11-A scope. Need schematic. Kenneth G. Van-divar, Rte. 4, Box 412, Cleveland, OH 30528.

Chicago Industrial Instruments Co., model 504 VTVM. Need schematic and source for transformer #482. Harold Cressin, 7511 Patapasco Dr., Sykesville, MD 21784.

Hammarlund HQ-140-X receiver. Need case or address of dealer. George Kelm, Box 160, Yap Island, Guam 96943.

Belden model BC-388 shortwave receiver. Need schematic and owner's manuals. S.H. Hwang, Kangseoku Youmchang Dong 95-3, Seoul, Korea.

Hallcrafters S-38D receiver. Need schematic or any information available. Mike Cranston, 2411 Donovan, Bellingham, WA 98225.

Relax Acizor model #16 exercise machine. Need schematic. Jack W. Gallarda, 1171 Ort Lane, Merbin, OR 97532.

Tektronix model 545 oscilloscope. Need service manuals. Ed Petro, RR1, Box B-1, Flat Rick, IN 47234.

Calbest FM stereo generator model MX 625SG and Ballantine model 300 or 300L/18 voltmeter. Need operating manuals, service manuals and schematics. Luis E. Gelardi, 2123 Aaron St., Los Angeles, CA 90026.

Westinghouse TV chassis V-2483-1. Need power transformer 410V066C01 or source. William J. Wayland, 670 Andrews St., Southington, CT 06489.

Sylvania Electric oscilloscope type 403, signal generator 216, and voltage calibrator type 304. Need schematics and manuals. Stan Heide, R4-6320 7th St., Kenosha, WI 53142.

Knight model KG-686 generator. Need schematic and manuals. John Schneider, 1501 West Jean Circle, Lincoln, NB 68522.

RCA model 117, serial #015511 radio. Need schematic and source for replacement speakers and components. H. Minshall, 20 New Dutch Lane, Fairfield, NJ 07006.

Hammarlund model HQ-120 receiver. Need schematic, tube diagram and operating manual. Jeffrey Boutin, P.O. Drawer E, Lanesborough, MA 01237.

Hallcrafters Skynder SX 24. Need copy of original circuit and component layout. Ron Lucking, 62 Ember Farm Way, East Molesey, Surrey, London, England.

Weston model 547, no. 2432 radio tester. Need any information available and adapters. W.A. Kernaghan, Box 2065, Sierra Vista, AZ 85635.

Concertone 803A tape recorder. Need schematic and operation manual. Wray Jay Sheen, 3511 Marshfield Ave., Park City, UT 60085.

RCA aircraft direction finder model DZ MI 8814. Need manual and schematic. E.C. Ozag, 823 N. Marion St., Oak Park, IL 60302.

Hallcrafters model SX-101A receiver and RCA WO-88A oscilloscope. Need schematics, operation and alignment manuals. Bob Roy, 3054 E. El Moro, Mesa, AZ 85204.

Harvey Wells model MTR-25 radio telephone. Need schematics, parts list and operating manuals. Patrick Meyer, 6320 S.E. Jennings, Portland, OR 97222.

Howard Radio Corp., model 450, serial 450-211 receiver. Need schematic, parts list or any information available. Henry Nimitz, 226 S. 4th St., Millville, NJ 08332.

Raytronic Laboratories, model CB-54A CRT analyzer. Need schematic and operating manual. Picarella TV, 306 Bailey Road, Crystal City, MO.

Sandborn model B1 chart recorder. Need instruction manual and recording tape. Frank A. Wojcik, 5417 E. 17th St., Indianapolis, IN 46218.

Century model FC-2 tube tester. Tube chart needed. L.D. Barr, 36646 Riviera Dr., Fremont, CA 94536.

Carol Electronics Corp., model OS-8E/U oscilloscope. Need schematic and operating manual. George Windolph, Box 3305, 1901 N. 18th St., Quincy, IL 62301.

Conar model 600 TV. Need instruction manual and troubleshooting guide. Paul Slopak Jr., 2206 N. Sheridan Rd., Peoria, IL 61604.

Tennele MS-2 memory scan. Need schematic and service information. Alan A. Griffin, Box 18012, Wichita, KS 67218.

Measurements model 65-B signal generator. Need dial drive belt part #H-6469 or H-5334. K.M. Schurak, 2842 N. Linder Ave., Chicago, IL 60641.

Iomec Inc., cartridge disk drive model 20, serial #X13.

MODEL II



\$459⁰⁰ DISCOUNT
Off List
64K 1 DRIVE \$3440.00

No Taxes on Out of State Shipments

Immediate Shipment On Most Items

\$DISCOUNTS

TRS-80[®] DEALER A301

26-3001 4K Color.....	\$353.00
26-1145 RS-232 Board.....	84.00
26-1140 "O" K Interface.....	249.00
26-1160 Mini Disk.....	419.00
26-1172 Modem.....	135.00
Fast 100 CPS Centronics 730 Printer.....	577.00
Text Quality Centronics 737 Printer.....	737.00

1-800-841-0860 Toll Free Order Entry
MICRO MANAGEMENT SYSTEMS, INC.

DOWNTOWN PLAZA SHOPPING CENTER
115 C SECOND AVE. S.W.
CAIRO, GEORGIA 31728
GA. & EXPORT PHONE NO. (912) 377-7120

FREE
COMPUTER
CATALOG
UPON
REQUEST

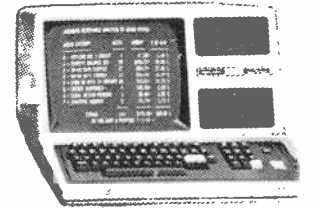

26-1061 4K I.....	\$629.00
26-1062 16K III.....	865.00
26-1063 32K III	
2 Drives, RS232.....	2225.00

Largest Inventory in S.E. U.S.A.

CIRCLE NO. 38 ON FREE INFORMATION CARD

Our Invisible Shield!

MuMetal Shield
between independent
magnetic systems.
Model AT155LC
illustrated.

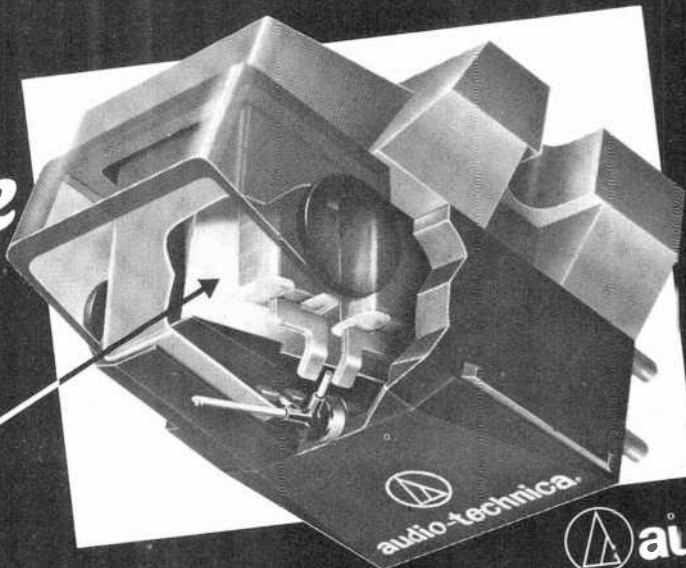

Deep within each new Audio-Technica Dual Magnet™ cartridge are TWO separate, completely independent magnetic systems. Separate magnet, pole pieces, and coils for each stereo channel. Now, to insure the ultimate in stereo separation, we've installed a magnetic barrier between the two systems. It's the thoughtful, innovative extra step typical of every Audio-Technica design. Hear the Audio-Technica difference today.

audio-technica

 **apple computer**

Complete Microprocessors line, peripherals & Terminals

APPLE II PLUS		Disk 130K controller	\$575 00
48K	\$1215 00	SORAC IQ120	795 00
LANG SYS		TI-99/4	499 00
W/PASCAL	395 00	Epson MX-80	call us
Green Monitor	174 00	Color Monitor	call us
Leedex 100 Mon	139 00	TI-810	1695 00
IDS 445G	call us		
TI-745	1440 00		

Texas Instruments

TI-55	\$ 29 95	TI-59	194 00
Accessories	Call us	TI-55 II	39 95
TI-58C	81 00	Speak & Spell	49 95
PC100C	149 95	TI Programmer	47 95
		MBA	49 95

HEWLETT-PACKARD

System I	call us	HP-41C Mem	26 00
System II	call us	Module	call us
HP-33C	75 00	HP-41CV	call us
HP-34C	119 00	HP-67	299 00
HP-38C	114 99	HP-97	579 00
HP-41C Prog	189 00	Quad Ram	call us
HP-41C Printer	289 00	Application Pac	call us
HP-41C CRD RDR	169 00		

HP 83, HP 85 and accessory call us for prices

SCM TYPEWRITER SPECIALS

SCM 2200	\$ 269 00	INTREPID	\$274 00
SCM 2500	285 00	CLASSIC 12	144 00

All units shipped in original cartons with accessories according to manufacturer's specification. Send money orders personal check 12 weeks to clear. In Illinois add 6% sales tax. Add \$6.95 minimum shipping & handling charges per unit. We ship UPS. Subject to availability. Written warranty for specific products can be obtained free upon request. Above prices are for mail order and prepaid only. Prices and specifications subject to change without notice. Send mail orders.

Nabik's, Inc.

519 DAVIS EVANSTON ILL 60201 TEL 312-869-6144

Put Professional Knowledge and a COLLEGE DEGREE in your Electronics Career through HOME STUDY



Earn Your DEGREE

No commuting to class. Study at your own pace, while continuing your present job. Learn from easy-to-understand lessons, with help from your home-study instructors whenever you need it.

In the Grantham electronics program, you first earn your A.S.E.T. degree, and then your B.S.E.T. These degrees are *accredited* by the Accredited Commission of the National Home Study Council.

Our *free* bulletin gives full details of the home-study program, the degrees awarded, and the requirements for each degree. Write for *Bulletin ET-81*.

Grantham College of Engineering
2500 So. LaCienega Blvd.
Los Angeles, California 90034

operation assist

Need schematics or any information available. Alex Boyce, 109 South Irving St., Ridgewood, NJ 07450.

Wyle Computer Products, Inc. model 8220 CRT/key-board terminal. Need schematic, parts list and any information available. Pete Zboinski, 75A East 2nd Street, Dugway, UT 84022.

Candle micro TV, model MT-510. Need schematic and service manual. Paul Hanke, 12 Buckingham Pkwy., Maplewood, NJ 07040.

Metropolitan Electric Inst., model 999 signal generator. Need schematic. Al Hillard, 2202 Pleasant St., Miles City, MT 59301.

Honeywell model 500 Digi-test tester. Need schematic or service manual. Paul Hockey, Box 220, Welaka, FL 32093.

Standard model SR606SU receiver. Need schematic or manual. Rudolph N. Claffer, 1990 Ellis Avenue, Bronx, NY 10472.

Compucorp model 122/125 calculator. Need schematic and information on logic structure and signals. Electrolab, model 100 voltmeter. Need schematic. Wendell Caley, 17 Canton Rd., Quincy, MA 02171.

R-390A/URR military radio receiver. Need two complete i-f. strips. G. Lindquist, Box 391, Madison, WI 53705.

Crown model CSC-640 SW 4-band radio cassette. Need schematic and transistor D355-6YD2. Eduardo Krapivka, Rivadavia 8481-7C, Buenos Aires, Argentina 1407.

Johnson Viking Messenger. Need operation manual and schematic. John Pat Sanders, Box 26, Spivey, KS 67142.

Hallcrafters model S-120 receiver. Need schematic diagram, operating manual and alignment data. W.E. Schroedter, 6108 N. Sherman Blvd., Milwaukee, WI 53209.

Wolensak model T1600 tape recorder and The Voice of Music tape recorder. Need schematics and parts information. Tony Meyer, Box 206, Thoreau, NM 87323.

B&K model 1076 TV analyst. Need schematic. Larry Mills, 2858 S.E. Harrison St., Portland, OR 97214.

Hewlett-Packard model 608C signal generator. Need schematic. Daniel F. Lill, Box 2043, Cheyenne, WY 82001.

Hammartund PS600 shortwave receiver. Need operating manual, schematic and service manual. B. Berg, 1619 Elizabeth Lane, Alamogordo, NM 88310.

Sony TC105 tape recorder. Need schematic and assembly data. B.R. Lipscombe, 6520 Selma, #266, Los Angeles, CA 90028.

Estey model 432 guitar amplifier. Need schematic or power output tube number. W.L. Weinand, 4 Friendship Court, Troy, MO 63379.

Marantz model 4230 receiver. Need owners manual and schematic. Oliver Croley, 972 Wellington #4, Memphis, TN 38126.

Philips model 4422 tape recorder. Need schematic and parts list. A. Drogowski, Box 80, Hahnville, LA 70057.

Knight Kit Star Roamer shortwave radio. Need schematic or assembly manual. Dale L. Schneider, 4416 S. 112th., E. Ave., Tulsa, OK 74145.

Globe Star model 8677-2 transceiver. Need schematic and service manual. Gerald V. Pike, 42 East Earle St., Cumberland, RI 02864.

Grundig model KS550, 551, 552 receiver/amplifier. Need schematic and service information. Brian Junk, 38 N. Bréese Dr., Madison, WI 53705.

Takachlho model AT-R2 E4-E7 telephone answering machine. Need schematic and instruction manual. G. Cook, Box 14E, Centerville, MO 63633.

Precision Radiation Instruments, Inc., model 107B geiger counter. Need manual, schematic or any other information available. Brandt Springman, 2042 Lakewinds Dr., Reston, VA 22091.

Philco model 700B-C generator. Need operating instructions. D.J. Kelley, 38373 S.E. Coupland Rd., Estacada, OR 97023.

RCA model AR598 radiola. Need schematic. E.F. Cornwell, W8BGR, Box 23, Maylene, AL 35114.

HIPLØT™ DMP SERIES DIGITAL PLOTTERS...

the ideal graphic output devices for the small system user

- Plot surfaces of 8½" x 11" (DIN A4) and 11" x 17" (DIN A3) for plotting on paper, Mylar, or Vellum
- Standard models with RS-232-C and parallel interfaces Intelligent models with RS-232-C and Centronics® compatible interfaces
- Easily interfaced to TRS-80™, Apple™, Atari*, and other popular microcomputers
- UL listed-Certified FCC Class B
- Prices start at only \$1085*

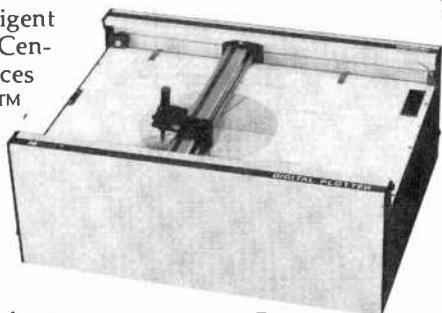

available Now with 6 Pens

Why wait? Add hardcopy graphics to your system. For complete information contact Houston Instrument, One Houston Square, Austin, Texas 78753, (512) 837-2820. For rush literature requests, outside Texas, call toll free, 1-800-531-5205. For technical information ask for operator #5.

houston instrument
GRAPHICS DIVISION OF
BAUSCH & LOMB

* U.S. suggested retail price.

Centronics® Registered trademark of Centronics Data Computer Corp.

TM HIPLØT is a trademark of Houston Instruments

Apple is a trademark of Apple Computers, Inc.

TRS-80 is a Trademark of Tandy Corp.

* Atari is a trademark of Atari, Inc.



All-In-One Computer



Computer Peripherals



Amateur Antenna Tuner



Oscilloscopes



Giant screen projection TV



Rechargeable Camp Light



Educational Programs



Chart Recording Depth Sounder



R/C Gear



Computerized Weather Station

FREE HEATHKIT® CATALOG



Dual Wattmeter



Hand-held Digital Multimeter



Groundtrack® Metal Locator



Digital Electronic Scale



Car Thermometer

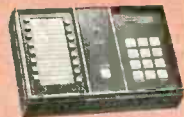

One-button Phone Dialer



Pro-Series Audio Components



Speedometer/Tachometer



4-band Shortwave Radio

400 electronic kits: test instruments, computers, amateur radio gear, electronic educational programs, color televisions, stereo components, R/C gear, home products, energy conservation devices, marine and aviation gear, and more — things you've always wanted and needed, now at low kit prices from Heath.

Discover the fun of kit building — it's a great way to relax in your spare time and share a rewarding

pastime with your whole family. The useful items you build will reflect the pride of your craftsmanship, too. The famous Heathkit illustrated manuals make it easy for anyone to build reliable, professional-quality kits.

SEND FOR YOURS NOW!

The 104-page catalog is Free! If coupon is missing write: Heath Company, Dept. 010-802, Benton Harbor, MI 49022

Heathkit Heath Company, Dept. 010-802
Benton Harbor, MI 49022

Send my free Heathkit Catalog now.
I am not currently receiving your catalog.

Name _____

Address _____

City _____ State _____

CL-727 Zip _____

FREE CATALOG

THANDAR INSTRUMENTS

ORDER ANY TWO INSTRUMENTS & TAKE A 3% DISCOUNT



3 1/2 Digit LED Multimeter
DM 235 \$ 69.95

SC 110



3 1/2 Digit LED Multimeter
DM 350 99.95

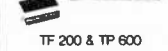

3 1/2 Digit LED Multimeter
PDM 35 39.95



8 Digit LED Hand Held Freq Meter
PFM 200 99.95



Single Trace Portable Oscilloscope
SC 110 259.00



8 Digit LCD Frequency Meter
TF 040 199.00



8 Digit LCD Hand Held Freq Meter
TF 200 299.00



100 KHz Function Generator
TG 100 159.00



2 MHz Function Generator
TG 102 299.00



5 MHz Pulse Generator
TG 105 199.00



3 1/2 Digit LCD Bench Multimeter
TM 351 199.00



3 1/2 Digit LCD Bench Multimeter
TM 353 159.00



3 1/2 Digit LCD Hand Held Multimeter
TM 354 79.00



600 MHz Prescaler
TP 600 79.00

Introducing the full featured, expandable color computer!



Commodore only
VIC-20 \$299.95



ANCRONA
STORES DO NOT ACCEPT MAIL ORDERS
MAIL ORDER
P.O. BOX 2208 P CULVER CITY, CA 90230

Minimum Order \$10.00 Add \$2.00 to cover postage and handling. Master Charge and Visa welcomed. Please include your charge card number, Interbank number and expiration date. Some items are subject to prior sale. Not responsible for typos. Store pricing may vary from Mail Order pricing. We reserve the right to substitute manufacturer.

ATLANTA
3330 Piedmont Rd. N.E.
Atlanta, GA 30305
(404) 261-7100

CULVER CITY
11080 Jefferson Blvd.
Culver City, CA 90230
(213) 390-3595

HOUSTON
2649 Richmond
Houston, TX 77098
(713) 529-3489

PORTLAND
1125 N.E. 82nd Ave.
Portland, OR 97220
(503) 254-5541

SANTA ANA
1300 E. Edinger Ave.
Santa Ana, CA 92705
(714) 547-8424

SUNNYVALE
1054 E. El Camino Real
Sunnyvale, CA 94087
(408) 243-4121

TUCSON
4518 E. Broadway
Tucson, AZ 85711
(602) 881-2348

PROJECT OF THE MONTH

By Forrest M. Mims

Simple BCD Keyboard Encoder

THE November 1978 "Project of the Month" was a hexadecimal keyboard encoder assembled from four TTL chips (a 7400, a 74173 and a 74193). Many circuits require only one decade of decimal entry (0 through 9). The circuit in Fig. 1 implements this function with only three readily available CMOS chips. Because this new circuit is a CMOS design, its power consumption is considerably less than the TTL circuit presented earlier.

In operation, an astable oscillator made from two cross-coupled inverters (*IC1A* and *IC1B*) supplies clock pulses to *IC2*, a 4017 decade counter/decoder, and to *IC3*, a 4518 dual BCD counter. Initially, both counters are disabled by the application of appropriate logic levels to their respective enable inputs (a logic 1 at pin 13 of *IC2* and a low at pin 10 of *IC3*). The LED readout, therefore, displays the status of the outputs of *IC3* immediately after power is applied.

The keyboard is activated by closing any of the ten input switches *S0* through *S9* and then toggling RESET switch *S10* from ground to +V_{DD} and back to ground. If desired, the BCD output can be cleared to 0000 (all LEDs glowing) by toggling RESET switch *S10* prior to selecting a data input switch.

Assume *S3* is closed. All inactive outputs of the 4017 are low, so the keyboard (*S0* through *S9*) bus goes low and enables both *IC2* and, via *IC1C*, *IC3*. Both counters then begin a synchronized count of the pulses, applied to their CLOCK inputs.

When the fourth clock pulse has been counted, pin 7 of *IC2* goes to logic 1 and, via closed switch *S3*, disables both counters. The LEDs then display the BCD equivalent of the se-

lected switch: 0100. Counter *IC3* stores and presents at its outputs the BCD equivalent of the selected switch, even if the selected switch is opened and another is closed. Only after *S10* has been momentarily toggled will a new switch closure be detected and indicated by the output LEDs.

What happens if two or more input switches are closed when *S10* is toggled? The first closed to be scanned by the 4017 is selected. This is a form of priority encoding. The October 1978 "Experimenter's Corner" described the operation and use of the 74147 priority encoder. This TTL chip accepts up to ten inputs and presents at its outputs the BCD equivalent of the highest priority or most significant input while ignoring all others.

Going Further. The output LEDs shown in Fig. 1 are optional. They permit the operation of the circuit to be verified but are unnecessary in many practical applications. Of course, they can be retained. Alternatively, the outputs can be decoded by a BCD-to-seven-segment decoder/driver such as the 4511 or 4543 for display on a LED or liquid-crystal readout.

The basic circuit shown in Fig. 1 can also be modified for different applications. For example, recall that the 4518 contains two BCD counters, only one of which is used. The second counter can be clocked in parallel with the first (and the 4017) to provide a storage register which can remember a previous keystroke.

Other modifications may require the addition of one or more chips. For example, a 4066 quad bilateral switch can be connected to the outputs of the second counter to provide a 3-state output. ♦

Fig. 1. A BCD keyboard encoder circuit using CMOS chips for low power consumption.

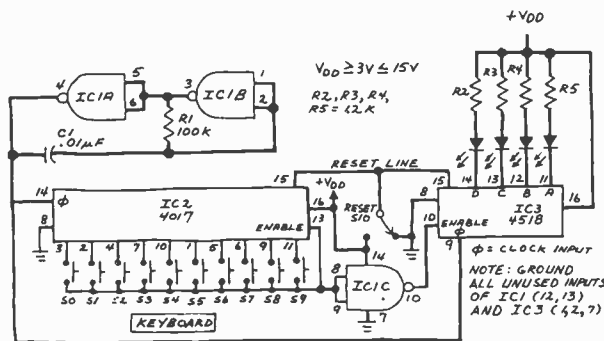

NEW LITERATURE

VCR and Disc Player Accessories

Video connectors of various styles and sizes, video adaptors, cables, and other accessories for video cassette recorders and disc players are described in a catalog issued by RMS Electronics. Also described is a switch to convert a TV receiver to operate with Atari and Mattel video games and computers. The connectors and adaptors are all UL approved. Address: RMS Electronics, Inc., 50 Antin Pl., Bronx, NY 10462.

Satellite Communications

The Satellite Communications Div. of Digital Communications Corp. is offering a new Satellite Capabilities Brochure. The 12-page publication provides an overview of products such as PSK modems and earth stations. Address: Digital Communications Corp., 11717 Exploration Ln., Germantown, MD 20767.

Tool Kit Catalog

Catalog No. 25 from Techni-Tool describes, in 240 pages, 10,000 products from 800 manufacturers for electro-mechanical assembly, maintenance, and laboratory work. A "Design-a-Kit" form provides an efficient way to design one's own custom tool kit from off-the-shelf items. Address: Techni-Tool, Inc., 5 Apollo Rd., Plymouth Meeting, PA 19462.

Scanners and Receivers Catalog

A variety of radio scanner receivers used by professional law enforcement agencies, governmental authorities, and ham radio operators is described in a new catalog from Communications Electronics. It also features computer products, cordless telephones, wireless intercoms, and scanner receiving antennas. Address: Dept. A38, Communications Electronics, Box 1002, Ann Arbor, MI 48106.

Inorganic Electrolyte Batteries

Four sizes (1/2AA, AA, C, and D) of Tadiran lithium thionyl chloride (inorganic electrolyte) batteries are described in a new 6-page catalog. Used as power sources for CMOS circuits, memories, and other instrumentation requiring high reliability, the batteries are said to provide long life, high energy density and wide operating temperatures. Each cell's nominal working voltage is 3.4 V. At room temperature, shelf life is said to be greater than 10 years. Address: Plainview Electronics Corp., 28 Cain Dr., Plainview, NY 11803.

Sound Systems

Catalog #210-K, in 16 pages, describes the Bogen line of sound equipment for PA systems. Included are 10/20/35/60/100-watt integral amplifiers as well as 60/125/250-watt power models. Also covered are: telephone paging amplifiers, mixer-preamplifiers, tuners, receivers, equalizers, speakers, microphones, stands, and accessories. Address: Bogen Div., Box 500, Paramus, NJ 07652.

Video Training Tape Catalog

A guide to Sony's Training Tape Library is available in a catalog covering three categories of tapes. The first, Basic Fundamentals, describes courses on a wide variety of video-related subjects. The second category, Technical Training, explains Sony tapes dealing with specific video products, covering subjects such as operation for the nontechnician to detailed technical information. The last section covers Special Programs, which describe new equipment for dealers. Address: Sony Video Communications, Tape Production Dept., 700 W. Artesia Blvd., Compton, CA 90220.

Equipment Rental Catalog

A 32-page catalog lists 47 separate categories of electronic equipment available for short-term rental from Genstar Rental Electronics. Equipment includes analyzers, meters, computers, PROM programmers, tape recorders, and data terminals. All items are described and the 30-day rental price is given. Used equipment sales facilities are also listed. Address: Genstar Rental Electronics, Inc., 19527 Business Center Dr., Northridge, CA 91324.

RFI Shielded Cases

A line of blank, standard-size, and custom RFI shielded cases and accessories is described in a catalog from Compac. Cases are effective from 60 to over 100 dB at 100 MHz and are available with an optional nickel-plate finish. Various configurations and outlines are shown. Accessories described include coaxial attenuators, terminations, filters and feed-throughs, r-f connectors, mounting bars, etc. Address: Compac, 279 Skidmore Rd., Deer Park, NY 11729.

IC Hardware Catalog

The Cambion IC Packaging Hardware Catalog 131 contains 52 pages of information on four sizes of general-purpose "Cambi-Cards" for dual in-line wrapost sockets, pin-jack assemblies for breadboarding changes, and high-density cards for discrete mounting. Also described and listed are buttable socket cards, extenders, card files with hardware and accessories, pins, cord kits, plugs, and jacks. Address: Cambion, 445 Concord Ave., Cambridge, MA 02238.

(Continued on page 101)

Popular Electronics

ADVERTISERS INDEX

RS no.	ADVERTISER	PAGE no.
2	Albia Electronics	73
3	All Electronics Corp.	77
4	Ancrona Corp.	90
5	AP Products	72
6	Apple Computer	Cover 2, 1
7	Atari	13
8	Audiomatic	82
9	Audio-Technica	85
10	Beckman Instruments Inc -EPG	16
	Classified Advertising	102-105
	Cleveland Institute of Electronics, Inc.	8, 9, 10, 11
1	Communications Electronics	83
11	Components Express	79
12	Compu Serve	18
13	Crown International	7
58	DAK	15
14	DBX	52
15	Digi-Key Corp.	96
16, 55	Discwasher	2, Cover 4
17	Electronic Specialists	65
18	Elek-Tek Inc.	14
19	Epson	26
21	ETCO	88
22	Firestik	82
20	Fluke	3
	Global	75
23	Godbout Electronics, Bill Gratham College of Engineering	100 86
24	Hardside	66
25, 27	Heath Co.	4, 5, 23, 87, 88, 89
28	Hewlett-Packard	Cover 3
29	Houston Instrument	86
30	Illinois Audio	81
31	Imesai	83
32	Institute of Audio Research	64
33	Jameco Electronics	94, 95
34	JDR Microdevices	92, 93
35	Jensen Tools	76
36	J&R Music World	20
70	Korsmeyer, Inc.	76
56	MFJ Enterprises	81
	Micro Ace	67
40	McIntosh Laboratory, Inc.	82
	MICROCOMPUTER MART	101
38	Micro Management Systems	85
39	Micro Robotics Tech	80
37	Microsoft	33
	Nabih's	86
	Natl. Technical Schools	68-71
	Netronics, R & D Ltd.	79, 63
	NRI Schools	34-37
46	Ohio Scientific	47
41	Olympic Sales	78
	Omega Sales Corp.	49
42	Paccom	75
43, 44	Poly Paks	65, 78
45	Protecto Enterprises	77
47	Quest Electronics	100
	Radio Shack	28, 99
54	Sams Books	74
48	Scientific Systems	83
	Scorpio	80
49	Simple Simon Kits	75
	Source, The	39
51	Sybec	27
57	Tams	84
52	TDK	66
	Thandar	61
53	3-M	19

16K Memory 8/\$16.95

4116 300ns

ALL MERCHANDISE 100% GUARANTEED

CALL US FOR VOLUME QUOTES

LS SERIES

74LS00	.25	74LS163	.95
74LS01	.25	74LS164	.95
74LS02	.25	74LS165	.95
74LS03	.25	74LS166	2.40
74LS04	.25	74LS168	1.75
74LS05	.25	74LS169	1.75
74LS08	.35	74LS170	1.75
74LS09	.25	74LS173	.80
74LS10	.25	74LS174	.95
74LS11	.35	74LS175	.95
74LS12	.35	74LS181	2.15
74LS13	.45	74LS189	9.95
74LS14	1.00	74LS190	.00
74LS15	.35	74LS191	1.00
74LS20	.25	74LS192	.85
74LS21	.35	74LS193	.95
74LS22	.25	74LS194	1.00
74LS26	.35	74LS195	.95
74LS27	.35	74LS196	.85
74LS28	.35	74LS197	.85
74LS30	.25	74LS221	1.20
74LS32	.35	74LS240	1.85
74LS33	.55	74LS241	1.85
74LS37	.55	74LS242	1.85
74LS38	.55	74LS243	1.85
74LS40	.25	74LS244	1.75
74LS42	.55	74LS245	2.85
74LS47	.75	74LS247	.76
74LS48	.75	74LS248	1.25
74LS49	.75	74LS249	.99
74LS51	.25	74LS251	1.30
74LS54	.35	74LS253	.85
74LS55	.35	74LS257	.85
74LS63	1.25	74LS258	.85
74LS73	.40	74LS259	2.85
74LS74	.45	74LS260	.65
74LS75	.50	74LS266	.55
74LS76	.40	74LS273	1.65
74LS78	.50	74LS275	3.35
74LS83	.75	74LS279	.55
74LS85	1.15	74LS280	1.98
74LS86	.40	74LS283	1.00
74LS90	.65	74LS290	1.25
74LS91	.89	74LS293	1.85
74LS92	.70	74LS295	1.05
74LS93	.65	74LS298	1.20
74LS95	.85	74LS352	1.55
74LS96	.95	74LS353	1.55
74LS107	.40	74LS363	1.35
74LS109	.40	74LS365	.95
74LS112	.45	74LS366	.95
74LS113	.45	74LS367	.70
74LS114	.50	74LS368	.70
74LS122	.45	74LS373	1.85
74LS123	.95	74LS374	1.80
74LS124	2.99	74LS377	1.45
74LS125	.95	74LS378	1.18
74LS126	.85	74LS379	1.35
74LS132	.75	74LS385	1.90
74LS136	.55	74LS386	.65
74LS137	.99	74LS390	1.90
74LS138	.75	74LS393	1.90
74LS139	.75	74LS395	1.65
74LS145	1.20	74LS399	1.70
74LS147	2.49	74LS447	.37
74LS148	1.35	74LS490	1.95
74LS151	.75	74LS668	1.69
74LS153	.75	74LS669	1.89
74LS154	2.35	74LS670	2.20
74LS155	1.15	74LS674	9.65
74LS156	.95	74LS682	3.20
74LS157	.75	74LS683	2.30
74LS158	.75	74LS684	2.40
74LS160	.90	74LS687	2.40
74LS161	.95	74LS688	2.40
74LS162	.95	74LS689	2.40

7400 SERIES

7400	.19	74128	.55
7401	.19	74132	.45
7402	.19	74136	.50
7403	.19	74141	.65
7404	.19	74142	2.95
7405	.22	74143	2.95
7406	.22	74144	2.95
7407	.22	74145	.60
7408	.24	74147	1.75
7409	.19	74148	1.20
7410	.19	74150	1.35
7411	.25	74152	.65
7412	.30	74152	.65
7413	.35	74153	.55
7414	.55	74154	1.40
7416	.25	74155	.75
7417	.25	74156	.65
7420	.19	74157	.55
7421	.35	74159	1.65
7422	.29	74160	.85
7423	.29	74161	.70
7425	.29	74162	.85
7426	.29	74163	.85
7427	.29	74164	.85
7428	.45	74165	.85
7430	.29	74167	1.00
7432	.29	74167	1.00
7433	.45	74170	1.65
7437	.29	74172	5.95
7438	.29	74173	.75
7440	.19	74174	.89
7442	.49	74175	.89
7443	.65	74176	.89
7444	.69	74177	.75
7445	.69	74178	1.15
7446	.59	74179	1.75
7447	.69	74180	.75
7448	.69	74181	2.25
7450	.19	74182	.75
7451	.19	74184	2.00
7453	.23	74185	2.00
7454	.23	74186	18.50
7460	.23	74190	1.15
7464	.39	74191	1.15
7465	.39	74192	.79
7470	.35	74193	.79
7472	.29	74194	.85
7473	.34	74195	.85
7474	.35	74196	.79
7475	.45	74197	.75
7476	.35	74198	.75
7480	.59	74199	1.35
7481	1.10	74221	1.35
7482	.95	74246	1.35
7483	.50	74247	1.25
7484	.50	74248	1.85
7485	.65	74249	1.95
7486	.35	74251	.75
7489	4.95	74259	2.25
7490	.35	74265	1.35
7491	.40	74273	1.95
7492	.50	74276	1.25
7493	.49	74279	.75
7494	.65	74283	2.00
7495	.55	74284	3.75
7496	.70	74285	3.75
7497	2.75	74290	.95
74100	1.00	74293	.75
74107	.30	74298	.85
74109	.45	74351	2.25
74110	.45	74365	.65
74111	.55	74366	.65
74116	1.55	74367	.65
74120	1.20	74368	.65
74121	.29	74376	2.20
74122	.45	74390	1.75
74123	.55	74393	1.35
74125	.45	74425	3.15
74126	.45	74426	.85
		74490	2.55

T.V. CIRCUITS

MC1330	1.89
MC1350	1.29
MC1358	1.79
LM380	1.29
LM386	1.50
LM565	.99
LM741	.29
LM1310	2.90
LM1800	2.99
LM1889	2.49

MISC.

8T26	1.69	3242	9.95
8T28	2.49	AY5-1013	3.95
8T95	.99	TR1602	4.95
8T96	.99	IM6402	7.95
8T97	.99	1771	24.95
8T98	.99	1791	36.95
1488	.99	UPD765	39.95
1489	.99	8272	39.95
DM8131	2.95		

CMOS

74C00	.35	74C373	2.75	4018	.95	4093	.95
74C02	.35	74C374	2.75	4019	.45	4099	1.95
74C04	.35	74C901	.80	4020	.95	14409	8.95
74C08	.35	74C902	.85	4021	.95	14410	8.95
74C10	.35	74C903	.85	4022	1.15	14411	9.95
74C14	1.50	74C905	10.95	4023	.35	14412	12.95
74C20	.35	74C906	.95	4024	.75	14419	2.95
74C30	.35	74C907	1.00	4025	.35	4502	.95
74C32	.50	74C908	2.00	4026	1.65	4503	.65
74C42	1.75	74C909	2.75	4027	.65	4508	1.95
74C48	2.10	74C910	9.95	4028	.80	4510	.95
74C73	.65	74C911	10.00	4029	.95	4511	.95
74C74	.85	74C912	10.00	4030	.45	4512	.95
74C76	.80	74C914	1.95	4034	2.95	4514	1.25
74C83	1.95	74C915	2.00	4035	.85	4515	2.25
74C85	1.95	74C918	2.75	4040	.95	4516	1.55
74C86	.95	74C920	17.95	4041	1.25	4518	1.25
74C89	4.50	74C921	15.95	4042	.75	4519	1.25
74C90	1.75	74C922	5.95	4043	.85	4520	1.25
74C93	1.75	74C923	5.95	4044	.85	4522	1.25
74C95	1.75	74C925	6.75	4046	.95	4526	1.25
74C107	1.00	74C926	7.95	4047	.95	4527	1.95
74C150	5.75	74C927	7.95	4049	.55	4528	1.25
74C151	2.25	74C928	7.95	4050	.55	4531	.95
74C154	3.25	74C929	19.95	4051	.95	4532	1.95
74C157	1.75	74C930	19.95	4053	.95	4538	1.95
74C160	2.00	4000	.35	4060	1.45	4539	1.95
74C161	2.00	4001	.35	4066	.75	4543	2.70
74C162	2.00	4002	.25	4068	.40	4555	.95
74C163	2.00	4006	.95	4069	.35	4556	.95
74C164	2.00	4007	.29	4070	.35	4581	1.95
74C165	2.00	4008	.95	4071	.30	4582	1.95
74C173	2.00	4009	.45	4072	.30	4584	.95
74C174	2.25	4010	.45	4073	.30	4585	.95
74C175	2.25	4011	.35	4075	.30	4702	12.95
74C192	2.25	4012	.25	4076	.95	4724	1.50
74C193	2.25	4013	.45	4078	.30	80C07	.95
74C195	2.25	4014	.95	4081	.30	80C95	.85
74C200	5.75	4015	.95	4082	.30	80C96	.95
74C221	2.25	4016	.45	4085	.95	80C97	.95
		4017	1.15	4086	.95	80C98	1.20

DIP SWITCHES

4 position	.85
5 position	.90
6 position	.90
7 position	.95
8 position	.95

CONNECTORS

RS232 MALE	3.25
RS232 FEMALE	3.75
RS232 HOOD	1.25
S-100 ST	3.95
S-100 WW	4.95

TRANSISTORS

PN2222	10/1.00	100/8.99
2N3904	10/1.00	100/8.99
2N3906	10/1.00	100/8.99
2N3055	.79	10/6.99
IN4148		25/1.00
IN4004		10/1.00

LINEAR

LM301V	.34	LM741V	.29
LM308V	.98	LM747	.79
LM309K	1.49	LM748V	.59
LM311	.64	LM1310	2.90
LM317T	1.95	MC1330	1.89
LM317K	3.95	MC1350	1.29
LM318	1.49	MC1358	1.79
LM323K	4.95	LM1414	1.59
LM324	.59	LM1458V	.69
LM337K	3.95	LM1488	1.39
LM339	.99	LM1489	1.39
LM377	2.29	LM1800	2.99
LM380	1.29	LM1889	2.49
LM386V	1.50	LM3900	.59
LM555V	.39	LM3909V	.98
LM556	.69	LM3914	3.95
LM565	.99	LM3915	3.95
LM566V	1.49	LM3916	3.95
LM567V	1.29	75451V	.39
LM723	.49	75452V	.39
LM733	.98	75453V	.39

74S00 SERIES

74S00	.44	74S74
-------	-----	-------

4K STATIC RAMS 8/18.95

2114 LOW POWER 450ns

ALL MERCHANDISE 100% GUARANTEED

CALL US FOR VOLUME QUOTES

8200

8202	45.00
8205	3.50
8212	1.95
8214	3.90
8216	1.85
8224	2.50
8226	1.85
8228	4.95
8237	19.95
8238	4.95
8243	4.50
8250	14.95
8251	5.50
8253	9.85
8253-5	9.85
8255	5.25
8255-5	5.25
8257	9.00
8259	7.00
8272	39.95
8275	29.95
8279	10.50
8279-5	10.50
8282	6.65
8283	6.65
8284	5.80
8286	6.65
8287	6.65
8288	25.00
8289	49.95

6800

6800	6.95
6802	11.95
6809	37.95
6810	4.60
6820	4.95
6821	4.95
6828	9.95
6834	16.95
6840	14.95
6843	42.95
6844	44.95
6845	29.95
6847	15.95
6850	4.75
6852	5.75
6860	10.95
6862	11.95
6871	25.95
6875	6.95
6880	2.95

Z80

Z80	8.95
Z80A	9.95
Z80B	19.95
Z80-PIG	6.50
Z80A-PO	8.50
Z80-CTC	6.50
Z80A-CTC	8.65
Z80-DART	15.25
Z80A-DART	18.75
Z80-DMA	17.50
Z80A-DVIA	27.50
Z80-SIC/0	23.95
Z80A-SIO/0	28.95
Z80-SIC/1	23.95
Z80A-SIO/1	28.95
Z80-SIC/2	23.95
Z80A-SIO/2	28.95
Z80-SIC/9	17.95
Z80A-SIO/9	22.95

MPU'S

8035	16.95
8039	19.95
8080A	3.95
8085	12.95
8086	99.95
8088	39.95
8155	11.95
8156	11.95
8185	29.95
8185-2	39.95
8741	39.95
8748	69.95
8755	49.95

6502

6502	6.95
6502A	12.95
6504	6.95
6505	8.95
6520	4.95
6522	9.95
6532	14.95
6551	14.95

IC SOCKETS

1-100 100pcs		
8 pin ST	.13	.11
14 pin ST	.15	.12
16 pin ST	.17	.13
18 pin ST	.20	.18
20 pin ST	.29	.27
22 pin ST	.30	.27
24 pin ST	.30	.27
28 pin ST	.40	.32
40 pin ST	.49	.39
ST = SOLDDetail		
8 pin WW	.59	.49
14 pin WW	.69	.52
16 pin WW	.69	.58
18 pin WW	.99	.90
20 pin WW	1.09	.98
22 pin WW	1.39	1.28
24 pin WW	1.49	1.35
28 pin WW	1.69	1.49
40 pin WW	1.99	1.80
WW = WIREWRAP		

BEFORE YOU BUY CALL JDR FOR THE BEST PRICE.

800-538-5000
800-662-6233
(CALIFORNIA RESIDENTS)

LEDS

Jumbo Red	10/1.00
Jumbo Green	5/1.00
Jumbo Yellow	5/1.00
5082-7760 .43"CC	.79
MAN74 .3"CC	.99
MAN72 .3"CA	.99

DYNAMIC RAMS

100pcs			
4027	(250ns)	2.50	2.00
4116-150	(150ns)	8/21.95	2.65
4116-200	(200ns)	8/19.95	2.35
4116-300	(300ns)	8/16.95	2.00
4164	(200ns)	CALL	CALL

STATIC RAMS

100pcs			
2101	(450ns)	1.95	1.85
2102-1	(450ns)	.89	.85
21L02-1	(LP) (450ns)	1.29	1.15
2111	(450ns)	2.99	2.49
2112	(450ns)	2.99	2.79
2114	(450ns)	8/18.95	2.25
2114L-2	(LP) (200ns)	8/22.95	2.45
2114L-3	(300ns)	8/21.95	2.45
2113L-4	(LP) (450ns)	8/18.95	2.25
4044-4	(450ns)	3.49	3.25
4044-3	(300ns)	3.99	3.75
TMM2016	(200ns)	CALL	CALL
MB6116	(200ns)	CALL	CALL

LP = LOW POWER

APPLE OWNERS

EXPAND YOUR 48K COMPUTER TO 64K

SUPER RAM • II

- PLUG IN SLOT 0
- GOLD PLATED CONTACTS
- INCLUDES 5 JUMPER OPTIONS
- INCLUDES 5 RAM-RAM OPTIONS
- ENJOY THE BEST OF BOTH WORLDS
- 6K RAM (RANDOM ACCESS MEMORY)
- THIS IS SOPHISTICATED FIRMWARE
- EXPANDS YOUR 48K APPLE TO 64K OF PROGRAMMABLE MEMCRY
- ELIMINATES THE NEED FOR APPLESOFT™ OR INTEGER BASIC ROM CARD
- ALLOWS YOU TO RUN APPLE'S NEW FORTRAN PACKAGE ALSO PASCAL AND PILOT
- KEYBOARD CONTROL SELECTION OF RAM OR MOTHER BOARD ROM LANGUAGE
- INCLUDES: INSTALLATION INSTRUCTIONS AND APPLICATIONS NOTES
- THE SOFTWARE DEVELOPED BY VARIOUS VENDORS FOR YOUR (64K) SHOULD NOW WORK AS THEY ADVERTISED
- THE MOST VERSATILE RAM EXPANSION ON THE MARKET TODAY

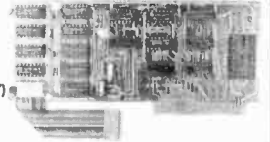

UNIQUE 1 YEAR WARRANTY!! \$168.00

SUPER FAN II

"COOL IT"

- TAN COLOR
- SAVE DOWN TIME
- LONG LIFE MOTOR
- LOW NOISE IS A MUST
- SAVE REPAIR CHARGES
- INCREASES RELIABILITY
- CLIPS ON—NO HOLES OR SCREWS
- MINIMUM QUIETNESS IS DUE TO THE DRAW EFFECT OF AIR THROUGH YOUR COMPUTER AND A SPECIAL FAN AND MOTOR DESIGN
- T-HOSE EXTRA PLUG-IN CARDS CAN CAUSE EXTRA HEAT

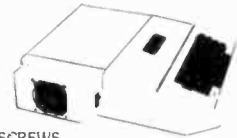

HOW TO HOOK IT UP

1. Clip it on your APPLE
2. Unplug your 120V cable (you won't need it)
3. Plug short 120V cable from Super Fan II to the back of your computer
4. Plug the supply cable from Super Fan II to your 120V power source
5. Turn on the rocker switch and a built-in red ready light comes on
6. You are all set "COOL IT"

UNIQUE 1 YEAR WARRANTY!! \$69.00

*APPLE IS A TRADEMARK OF APPLE COMPUTER INC.

EPROMS

				8pcs
1702	256 x 8 (1us)	4.95	4.50	
2708	1024 x 8 (450ns)	3.95	3.50	
2716	(5v) 2048 x 8 (450ns)	6.95	5.95	
2758	(5v) 1024 x 8 (450ns)	9.95	8.95	
2716-1	(5v) 2048 x 8 (350ns)	12.95	11.95	
TMS2716	2048 x 8 (450ns)	9.95	8.95	
TMS2532	(5v) 4096 x 8 (450ns)	21.95	19.95	
2732	(5v) 4096 x 8 (450ns)	17.95	16.95	

PROMS

74S188	(82S23)	OC	32 x 8	3.95
74S287	(82S129)	TS	256 x 4	4.75
74S288	(82S123)	TS	32 x 8	4.45
74S387	(82S126)	OC	256 x 4	5.75
74S471		TS	256 x 8	9.95
74S472	(82S147)	TS	512 x 8	16.85
74S474	(82S141)	TS	512 x 8	17.85
74S570	(82S130)	OC	512 x 4	7.80
74S571	(82S131)	TS	512 x 4	7.80



JDR MICRODEVICES, INC.
1101 South Winchester Blvd.
San Jose, California 95128
800-538-5000 800-662-6263 (Callf.)
408-247-4852

TERMS: For shipping include \$2.00 for UPS Ground; \$3.00 for UPS Blue Label Air; \$10.00 minimum order. Bay Area Residents add 8 1/2% sales tax Callf. Residents add 8% sales tax. We reserve the right to limit quantities and substitute manufacturer. Prices subject to change without notice.

7400

SN7400N	.25	SN7472N	.25	SN74156N	.75
SN7401N	.20	SN7473N	.25	SN74157N	.69
SN7402N	.25	SN7474N	.35	SN74160N	.89
SN7403N	.25	SN7475N	.35	SN74161N	.89
SN7404N	.25	SN7476N	.35	SN74162N	.89
SN7405N	.25	SN7477N	.50	SN74163N	.89
SN7406N	.35	SN7478N	5.00	SN74164N	.89
SN7407N	.35	SN7479N	.99	SN74165N	.89
SN7408N	.35	SN7480N	.99	SN74166N	1.25
SN7409N	.25	SN7481N	.99	SN74167N	2.75
SN7410N	.25	SN7482N	.99	SN74168N	2.95
SN7411N	.25	SN7483N	1.75	SN74169N	1.95
SN7412N	.35	SN7484N	.99	SN74170N	4.95
SN7413N	.40	SN7485N	.99	SN74171N	1.39
SN7414N	.25	SN7486N	.99	SN74172N	.99
SN7415N	.69	SN7487N	.45	SN74173N	.89
SN7416N	.69	SN7488N	.69	SN74174N	.99
SN7417N	.69	SN7489N	.45	SN74175N	.89
SN7418N	.25	SN7490N	.99	SN74176N	.99
SN7419N	.25	SN7491N	.69	SN74177N	.99
SN7420N	.25	SN7492N	.69	SN74178N	.99
SN7421N	.25	SN7493N	.69	SN74179N	.99
SN7422N	.45	SN7494N	3.00	SN74180N	1.49
SN7423N	.25	SN7495N	1.49	SN74181N	2.25
SN7424N	.25	SN7496N	.69	SN74182N	2.25
SN7425N	.25	SN7497N	1.49	SN74183N	2.49
SN7426N	.25	SN7498N	.39	SN74184N	2.49
SN7427N	.25	SN7499N	.39	SN74185N	1.25
SN7428N	.49	SN7500N	1.95	SN74186N	1.25
SN7429N	.49	SN7501N	1.95	SN74187N	1.25
SN7430N	.25	SN7502N	1.95	SN74188N	1.25
SN7431N	.25	SN7503N	1.95	SN74189N	1.25
SN7432N	.25	SN7504N	1.95	SN74190N	1.25
SN7433N	.25	SN7505N	1.95	SN74191N	1.25
SN7434N	.25	SN7506N	1.95	SN74192N	1.25
SN7435N	.25	SN7507N	1.95	SN74193N	1.25
SN7436N	.25	SN7508N	1.95	SN74194N	1.25
SN7437N	.25	SN7509N	1.95	SN74195N	1.25
SN7438N	.25	SN7510N	1.95	SN74196N	1.25
SN7439N	.25	SN7511N	1.95	SN74197N	1.25
SN7440N	.25	SN7512N	1.95	SN74198N	1.25
SN7441N	.25	SN7513N	1.95	SN74199N	1.25
SN7442N	.25	SN7514N	1.95	SN74200N	1.25
SN7443N	1.10	SN7515N	1.95	SN74201N	1.25
SN7444N	1.10	SN7516N	1.95	SN74202N	1.25
SN7445N	.75	SN7517N	1.95	SN74203N	1.25
SN7446N	.75	SN7518N	1.95	SN74204N	1.25
SN7447N	.69	SN7519N	1.95	SN74205N	1.25
SN7448N	.69	SN7520N	1.95	SN74206N	1.25
SN7449N	.20	SN7521N	1.95	SN74207N	1.25
SN7450N	.20	SN7522N	1.95	SN74208N	1.25
SN7451N	.20	SN7523N	1.95	SN74209N	1.25
SN7452N	.20	SN7524N	1.95	SN74210N	1.25
SN7453N	.20	SN7525N	1.95	SN74211N	1.25
SN7454N	.20	SN7526N	1.95	SN74212N	1.25
SN7455N	.20	SN7527N	1.95	SN74213N	1.25
SN7456N	.20	SN7528N	1.95	SN74214N	1.25
SN7457N	.20	SN7529N	1.95	SN74215N	1.25
SN7458N	.20	SN7530N	1.95	SN74216N	1.25
SN7459N	.20	SN7531N	1.95	SN74217N	1.25
SN7460N	.20	SN7532N	1.95	SN74218N	1.25
SN7461N	.20	SN7533N	1.95	SN74219N	1.25
SN7462N	.20	SN7534N	1.95	SN74220N	1.25
SN7463N	.20	SN7535N	1.95	SN74221N	1.25
SN7464N	.20	SN7536N	1.95	SN74222N	1.25
SN7465N	.20	SN7537N	1.95	SN74223N	1.25
SN7466N	.20	SN7538N	1.95	SN74224N	1.25
SN7467N	.20	SN7539N	1.95	SN74225N	1.25
SN7468N	.20	SN7540N	1.95	SN74226N	1.25
SN7469N	.20	SN7541N	1.95	SN74227N	1.25
SN7470N	.20	SN7542N	1.95	SN74228N	1.25

ok DIPIC INSERTION TOOL WITH PIN STRAIGHTENER

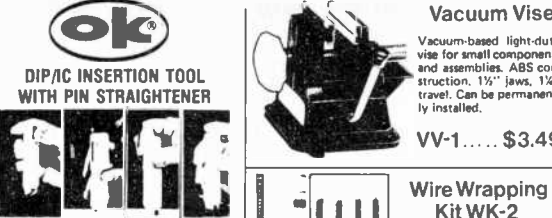

Inserts both 14 and 18 pin packages. Narrow profile permits work on closely spaced items. Pin straightener built into handle.

Part No. Price
INS-1416 14 pin 16 pin \$3.49
MOS-1416 14 pin CMOS safe 7.95
MOS-2428 24 pin CMOS safe 7.95
MOS-40 36-40 pin CMOS safe 7.95

Vacuum Vise

Vacuum-based light-duty vise for small components and assemblies. ABS construction. 1 1/2" jaws. 1 1/2" travel. Can be permanently installed.

VV-1.....\$3.49

Wire Wrapping Kit WK-2

Contains WSU-30 wrap tool, 50 feet of Kynar 30 AWG white wire, 50 pieces each pre-terminated wire in 1", 2" and 4" lengths, stripped 1" both ends.

WK-2.....\$12.95

74LS

74LS00	.29	74LS192	1.15
74LS01	.29	74LS193	1.15
74LS02	.29	74LS194	1.15
74LS03	.29	74LS195	1.15
74LS04	.29	74LS196	1.15
74LS05	.35	74LS221	1.19
74LS06	.35	74LS240	1.95
74LS07	.35	74LS241	1.95
74LS08	.35	74LS242	1.95
74LS09	.35	74LS243	1.95
74LS10	.29	74LS244	1.95
74LS11	.29	74LS245	1.95
74LS12	.29	74LS246	1.95
74LS13	.29	74LS247	1.95
74LS14	.29	74LS248	1.95
74LS15	.29	74LS249	1.95
74LS16	.29	74LS250	1.95
74LS17	.29	74LS251	1.95
74LS18	.29	74LS252	1.95
74LS19	.29	74LS253	1.95
74LS20	.29	74LS254	1.95
74LS21	.29	74LS255	1.95
74LS22	.29	74LS256	1.95
74LS23	.29	74LS257	1.95
74LS24	.29	74LS258	1.95
74LS25	.29	74LS259	1.95
74LS26	.29	74LS260	1.95
74LS27	.29	74LS261	1.95
74LS28	.29	74LS262	1.95
74LS29	.29	74LS263	1.95
74LS30	.29	74LS264	1.95
74LS31	.29	74LS265	1.95
74LS32	.29	74LS266	1.95
74LS33	.29	74LS267	1.95
74LS34	.29	74LS268	1.95
74LS35	.29	74LS269	1.95
74LS36	.29	74LS270	1.95
74LS37	.29	74LS271	1.95
74LS38	.29	74LS272	1.95
74LS39	.29	74LS273	1.95
74LS40	.29	74LS274	1.95
74LS41	.29	74LS275	1.95
74LS42	.29	74LS276	1.95
74LS43	.29	74LS277	1.95
74LS44	.29	74LS278	1.95
74LS45	.29	74LS279	1.95
74LS46	.29	74LS280	1.95
74LS47	.29	74LS281	1.95
74LS48	.29	74LS282	1.95
74LS49	.29	74LS283	1.95
74LS50	.29	74LS284	1.95
74LS51	.29	74LS285	1.95
74LS52	.29	74LS286	1.95
74LS53	.29	74LS287	1.95
74LS54	.29	74LS288	1.95
74LS55	.29	74LS289	1.95
74LS56	.29	74LS290	1.95
74LS57	.29	74LS291	1.95
74LS58	.29	74LS292	1.95
74LS59	.29	74LS293	1.95
74LS60	.29	74LS294	1.95
74LS61	.29	74LS295	1.95
74LS62	.29	74LS296	1.95
74LS63	.29	74LS297	1.95
74LS64	.29	74LS298	1.95
74LS65	.29	74LS299	1.95
74LS66	.29	74LS300	1.95
74LS67	.29	74LS301	1.95
74LS68	.29	74LS302	1.95
74LS69	.29	74LS303	1.95
74LS70	.29	74LS304	1.95
74LS71	.29	74LS305	1.95
74LS72	.29	74LS306	1.95
74LS73	.29	74LS307	1.95
74LS74	.29	74LS308	1.95
74LS75	.29	74LS309	1.95
74LS76	.29	74LS310	1.95
74LS77	.29	74LS311	1.95
74LS78	.29	74LS312	1.95
74LS79	.29	74LS313	1.95
74LS80	.29	74LS314	1.95
74LS81	.29	74LS315	1.95
74LS82	.29	74LS316	1.95
74LS83	.29	74LS317	1.95
74LS84	.29	74LS318	1.95
74LS85	.29	74LS319	1.95
74LS86	.29	74LS320	1.95
74LS87	.29	74LS321	1.95
74LS88	.29	74LS322	1.95
74LS89	.29	74LS323	1.95
74LS90	.29	74LS324	1.95

DISCRETE LEADS

XC569 .200" red	5/51	MV50 .085" red	6/51
XC569 .200" green	4/51	XC209R .125" red	5/51
XC569 .200" yellow	4/51	XC209G .125" green	4/51
XC569 .200" clear	4/51	XC209Y .125" yellow	4/51
XC22R .200" red	4/51	XC269R .185" red	5/51
XC22G .200" green	4/51	XC269G .185" green	4/51
XC22Y .200" yellow	4/51	XC269Y .185" yellow	4/51
MV10B .170" red	4/51	XC269C .185" clear	4/51

6 VOLT MINI LAMP - INCANDESCENT

800-147 Clear w/5 leads 8/51
80620 Rad w/10 leads 9/51

5MM RED LED METAL MFG. HOW. 2-4 LEADS
RL-2 \$3.95 ea. or 3/\$1.00

C.A. - Common Anode DISPLAY LEADS

Type	Polarity	Ht	Price
MAN 1	C.A.-red	270	2.95
MAN 2	5x7 D.M.-red	300	4.95
MAN 3	C.C.-red	125	25
MAN 4	C.A.-green	300	1.25
MAN 5	C.C.-green	300	1.25
MAN 6	C.A.-orange	300	.75
MAN 7	C.C.-orange	300	.75
MAN 8	C.A.-yellow	300	1.25
MAN 9	C.C.-yellow	300	.99
MAN 10	C.A.-orange	300	.49
MAN 3630	C.A.-orange ± 1	300	.99
MAN 3640	C.C.-orange	300	.99
MAN 4610	C.A.-orange	400	.99
MAN 6610	C.C.-orange-DO	560	.99
MAN 6620	C.A.-orange ± 1	560	.99
MAN 6650	C.C.-orange ± 1	560	.99
MAN 6660	C.C.-orange-DO	560	.99
MAN 6670	C.A.-orange-DO	560	.99
MAN 6700	C.C.-red	560	.99
DLO300	C.C.-orange	300	1.25
DLO307	C.A.-orange	300	1.25
DLG500	C.C.-green	500	1.25

C.C. - Common Cathode DISPLAY LEADS

Type	Polarity	Ht	Price
DLG507	C.A.-green	500	1.25
DL704	C.C.-red	300	1.25
DL707	C.C.-red	300	1.25
DL728	C.C.-red	500	1.49
DL741	C.A.-red	600	1.25
DL765	C.A.-red ± 1	630	1.49
DL747	C.C.-red	600	1.49
DL750	C.C.-red	600	1.49
DLO847	C.C.-orange	800	1.49
DL0850	C.C.-orange	800	1.49
DL1319	C.C.-red	110	25
FND358	C.C. ± 1	357	.99
FND359	C.C.	357	.75
FND503	C.C. (FND500)	500	.99
FND507	C.C. (FND510)	500	.99
HOSP-3401	C.C.-red	800	1.50
HOSP-3403	C.C.-red	800	1.50
5082-7750	C.A., R.H.O.-red	430	1.25
5082-7760	C.C., R.H.O.-red	430	1.25
5082-7700	4x7 sig. dig. RHD	600	22.00
5082-7702	4x7 sig. dig. LHD	600	22.00
5082-7704	Overpage, chr.(±1)	600	19.95
4N28	Photo Xistor Opto-Isol.	600	1.95
MTC11	Photo Xistor Opto-Isol.	600	1.95
MOC3010	Optically Isol. Triac Driver	1.25	

74C

74C00	.39	74C95	1.59	74C221	1.95
74C01	.39	74C107	1.59	74C240	2.59
74C02	.39	74C151	2.95	74C244	2.49
74C03	.39	74C154	3.95	74C274	2.59
74C04	.39	74C160	1.60	74C281	2.89
74C05	.39	74C161	1.60	74C301	3.00
74C06	.39	74C162	1.60	74C303	3.00
74C07	.39	74C163	1.60	74C311	1.15
74C08	.39	74C164	1.60	74C312	1.15
74C09	.39	74C165	1.60	74C313	1.15
74C10	.39	74C166	1.60	74C314	1.15
74C11	.39	74C167	1.60	74C315	1.15
74C12	.39	74C168	1.60	74C316	1.15
74C13	.39	74C169	1.60		

National Semiconductor Clock Modules



12VDC AUTOMOTIVE/ INSTRUMENT CLOCK

APPLICATIONS:

- In-dash auto/clocks
- After-market auto/ RV clocks
- Aircraft/marine clocks
- 12VDC oper. instr. powered instruments

Features: Bright 0.3" green display. Internal crystal time base. ± 0.5 sec./day accur. Auto. display brightness control logic. Display color filterable to blue, blue-green, green & yellow. Complete—just add switches and lens.

MA1003 Module \$16.95

CLOCK MODULES

MA1023 .7" Low Cost Digital LED Clock Module	8.95
MA1026 .7" Dig. LED Alarm Clock/Thermometer	18.95
MA5036 .3" Low Cost Digital LED Clock/Timer	6.95
MA1002 .5" LED Display Dig. Clock & X'former	9.95

TRANSFORMERS

102-P22 X'former for MA1023 Clock Modules	3.49
102-P22 X'former for MA1026 Clock Modules	3.49
102-P20 X'former for MA5036 Clock Modules	3.49



8 OHM SPEAKER

2 1/4" - 8 Ohm - .25 watt

\$1.25 ea. 2/\$1.95 ea. 10/\$7.95 ea.



BATTERY HOLDER

- Holds 2 ea. C cells
- Aluminum Case
- 5" leads

\$.45 each 10/\$3.95



BATTERY HOLDER

- Holds 4 ea. C cells
- Plastic case
- 9" leads

\$.49 ea. 10/\$4.25

EPROM Erasing Lamp



- Erases 2708, 2716, 1702A, 5203Q, 5204Q, etc.
- Erases up to 4 chips within 20 minutes.
- Maintains constant exposure distance of one inch.
- Special conductive foam liner eliminates static build-up.
- Built-in safety lock to prevent UV exposure.
- Compact - only 7-5/8" x 2-7/8" x 2"
- Complete with holding tray for 4 chips.

UVS-11E \$79.95

JOYSTICKS

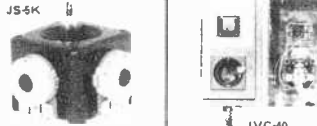

JS5K	5K Linear Taper Pots \$5.25
JS-100K	100K Linear Taper Pots \$4.95
JVC-40	40K (2) Video Controller in case \$5.95

6-Digit Clock Kit

- Bright .300 ht. comm. cathode display
- Uses MM5314 clock chip
- Switches for hours, minutes and hold modes
- Hrs. easily viewable to 20 ft.
- Simulated walnut case
- ± 15 VAC operation
- 12 or 24 hr. operation
- Incl. all components, case & wall transformer
- Size: 6 1/2" x 3 1/8" x 1 1/4"

JE701 \$19.95

NEW! JE215 Adjustable Dual Power Supply

General Description: The JE215 is a Dual Power Supply with independent adjustable positive and negative output voltages. A separate adjustment for each of the supplies provides the user unlimited applications for IC current voltage requirements. The supply can also be used as a general all-purpose variable power supply.

FEATURES

- Adjustable regulated power supplies, pos. and neg. 12VDC to 15VDC
- Power Output (each supply):

 - 5VDC @ 500mA, 10VDC @ 750mA, 12VDC @ 500mA, and 15VDC @ 175mA

- Two, 3-terminal adj. IC regulators with thermal overload protection
- Heat sink regulator cooling
- LED "on" indicator
- Printed Board Construction
- 12V AC input
- Size: 3-1/2" w x 5-1/16" h x 2" D

JE215 Adj. Dual Power Supply Kit (as shown) \$24.95
(Picture not shown but similar in construction to above)	
JE200 Reg. Power Supply Kit (5VDC, 1 amp) \$14.95
JE205 Adapter Brd. (to JE200) ±5, ±9 & ±12v. \$12.95
JE210 Var. Pwr. Sply. Kit, 5-15VDC, to 1.5amp. \$19.95

MICROPROCESSOR COMPONENTS

8080A/8080A SUPPORT DEVICES

INVS8080A	CPU	6.50
DP9212	8-Bit Input/Output	3.25
DP9214	Priority Interrupt Controller	3.95
DP9216	8-Directional Bus Driver	3.95
DP9224	Clock Generator/Driver	3.95
DP9226	Bus Driver	3.49
DP9228	System Controller/Bus Driver	4.95
DP9238	System Controller	4.95
INVS8443	I/O Expander for 48 Series	3.95
INVS8556	Asynchronous Counter Element	1.95
DP9251	Prog. Comm. I/O (USART)	7.95
DP9253	Prog. Interval Timer	14.50
DP9255	Prog. Peripheral I/O (PPIS)	3.95
DP9257	Prog. DMA Controller	19.95
DP9259	Prog. Interrupt Control	11.95
DP9275	Prog. CRT Controller	49.95
DP9279	Prog. Keyboard/Display Interface	15.95
DP9300	Prog. Bus Receiver	6.95
DP9303	System Timing Element	6.95
DP9306	8-Bit Bi-Directional Receiver	3.95
DP9307	8-Bit Bi-Directional Receiver	3.95
DP9308	8-Bit Bi-Directional Receiver	3.95

DATA ACQUISITION (CONTINUED)

A0C000CCN	8-Bit A/D Converter (8-Ch, Multi.)	5.25
A0C001CCN	8-Bit A/D Converter (8-Ch, Multi.)	10.95
DAC1000LCN	10-Bit D/A Conv. Micro. Comp. (8.25k Lin.)	13.95
DAC1001LCN	10-Bit D/A Conv. Micro. Comp. (8.25k Lin.)	8.95
DAC1002LCN	10-Bit D/A Converter (0.25% Lin.)	4.49
DAC1003LCN	10-Bit D/A Converter (0.25% Lin.)	4.95
DAC1004LCN	10-Bit D/A Converter (0.25% Lin.)	5.95
CO4051N	8-Ch. Anal. Multiplexer	1.19
AV-S-1011	30K AUAD UART	5.75
RAM'S		
2101	256x1 Static	1.49
1103	1024x1 Dynamic	1.99
2101 (8081)	256x1 Static	3.95
2102	1024x1 Static	1.75
2110	1024x1 Static	1.95
2111 (8111)	256x1 Static	1.95
2112	256x1 Static MOS	5.75
2114	1024x1 Static 4500s Low Power	4.95
2114L	1024x1 Static 3000s Low Power	7.95
2114L	1024x1 Static 4500s Low Power	6.95
2114L	1024x1 Static 3000s Low Power	7.95
2117	16,384x1 Dynamic 500ns (housemarked)	3.95
4114N (UPD4114)	16K Dynamic 250ns (MMS200N-4)	1.95
4114N	16K Dynamic 250ns	49.95
MM5217Z	60Kx1 Fast 70ns	1.95
S101	256x1 Static	4.95
MM5261	4096x1 Dynamic Fully Decoded	2.95
MM5262	2Kx1 Dynamic	4.95
MM5263	4096x1 Dynamic	4.95
MM5264	16K Dynamic (UPD416C)	5.25
MM5265	8K Dynamic (lower wt. at 416C)	19.95
MM5266	Control Oriented Processor	9.95
MM5267	4K Dynamic (6-pin)	14.95
MM5268	4K Dynamic (6-pin)	14.95
MM5269	4K Dynamic (6-pin)	14.95

6800/6800 SUPPORT DEVICES

MC6800	MPU	14.95
MC6802CP	MPU with Clock and RAM	19.95
MC6801AP1	128x1 Static RAM	4.95
MC6821	Peripheral Inter. Adap. (MC6800)	7.49
MC6828	Priority Interrupt Controller	8.95
MC6830L8	128x8-Bit ROM (MC6800)	14.95
MC6830L16	256x8-Bit ROM (MC6800)	14.95
MC6852	Synchronous Serial Data Adapter	6.95
MC6860	0-60000s Digital MUX/DEM	10.95
MC6862	20000s Modulator	12.95
MC6880A	Quad 3-State Bus. Trans. (MC6825)	2.25

MICROPROCESSOR CHIPS

Z80 (80C)	CPU (MK 3800ns) (7MHz)	13.95
Z80A (7801)	CPU (MK 3800ns) (4MHz)	13.95
CDP1802	CPU	19.95
7850	MPU	36.95
INVS8201ADC	CPU - 4-Bit Slice (84k Bytes Memory)	15.95
MC6801AP2	MPU w/Clock (84k Bytes Memory)	19.95
INVS8035N-4	MPU - 8-Bit (6MHz)	14.95
INVS8035N-4	CPU - 5.1k Chns 8-Bit (128 Bytes RAM)	19.95
INVS8040N-4	CPU (26k Bytes RAM)	24.95
INVS8040N	CPU (64 Bytes RAM)	24.95
INVS8073N	CPU w/Basic Micro Interpreter	29.95
PM80	CPU - 16-Bit	29.95
INVS8000	CPU - 16-Bit	29.95
TVS9902UL	MPU - 16-Bit	49.95

SHIFT REGISTERS

MM5500H	Dual 25-Bit Dynamic	.50
MM5501H	Dual 10-Bit Dynamic	.50
MM5501H	Dual 100-Bit Static	.50
MM5501H	Dual 64-Bit Accumulator	1.95
MM5502H	256-Bit Dynamic	3.95
MM5503H	1024-Bit Dynamic/Accumulator	1.95
MM5504H	500/512-Bit Dynamic	.89
MM5505H	Octal 80-Bit	9.95
MM5506H	Octal 80-Bit	9.95
250V (40A4)	1024-Bit Dynamic	3.95
251N	Hex 32-Bit Static	2.95
252V	Dual 128-Bit Static	2.95
252V	512-Bit Dynamic	.99
252V	1024-Bit Dynamic	.99
252V	Dual 256-Bit Static	2.95
252V	Dual 256-Bit Static	4.00
252V	Dual 240-Bit Static	4.00
252V	Quad 80-Bit Static	6.95
J31PC	Fifo (Quad 8)	2.95

DATA ACQUISITION

AF10-1CN	Universal Active Filter 2% (100Hz)	5.95
AF12-1CJ	Touch Tone Low Pass Filter	19.95
AF12-1CJ	Touch Tone Low Pass Filter	19.95
LW4804H	Super Gain Op Amp	1.00
LW4812	Constant Current Source	1.00
LW4812	Temperature Transducer	1.40
L7352N	JFET Input Op Amp	1.10
LF398N	Sample & Hold Amplifier	3.95
LF398N	Temp. Comp. Prec. Ref. (±0.1mV/C)	4.95
DAC0801LCN	8-Bit D/A Converter (0.25% Lin.)	4.95
DAC0802LCN	8-Bit D/A Converter (0.25% Lin.)	2.25

PROMS/EPROMS

1102A	2K UV Erasable PROM	5.95
2708	8K EPROM	5.95
2716	16K EPROM (±5V, ±5V, ±12V)	10.95
2732 (Intel) (2610T)	16K EPROM (Single ±5V)	14.95
2732 (Intel) (2610T)	32K EPROM	14.95
2708	8K EPROM (60ns) (Single ±5V)	14.95
2708	8K EPROM	14.95
2716	16K EPROM (Open Collector)	4.95
82512 (15S208)	32K Tri-State Bipolar PROM	19.95
82512 (15S208)	32K Tri-State Bipolar PROM	19.95
82515	8K EPROM	29.95

ROM'S

25131 (401)	Character Generator (Lower Case)	10.95
25131 (201)	Character Generator (Lower Case)	10.95
2513N	Character Generator	10.95
MM5220N	2048-Bit Read Only Memory	1.95

NMOS READ ONLY MEMORIES

MC68700	128x8 7 ASCII Shifted w/Green	13.50
MC68700	128x8 7 Math Symbol & Pictures	13.50
MC68750P	128x8 7 Alpha, Control Char. Gen.	13.50

MICROPROCESSOR MANUALS

M-720	User Manual	7.50
M-CDP1802	User Manual	7.50
M-2650	User Manual	5.00

SPECIAL FUNCTION

D50052CN	Dual MOS Clock Driver (6M2)	3.50
D50053CN	Dual MOS Clock Driver (6M2)	1.95
INS171N-1	Flopdy Dly. Controller	26.95
MM5501N	Commutator/Control Char. Gen.	4.95
MM5516N	Microprocessor Real Time Clock	6.95
MM5516N	Microprocessor Compatible Clock	11.95
CO4051N	Microcontroller with 64-Digit RAM	5.95
CO4051N	Microcontroller with 64-Digit RAM	7.49
CO4051N	Microcontroller with 64-Digit RAM	1.25

TELEPHONE/KEYBOARD CHIPS

AV-54100	Push Button Telephone Dialer	14.95
AV-54000	Rotary Dialer	14.95
AV-54000	CMOS Clock Generator	4.95
AV-52376	Keyboard Encoder (86 keys)	11.95
HD0085-5	Keyboard Encoder (16 keys)	7.95
7K2502	Keyboard Encoder (16 keys)	5.99
7K2502	Keyboard Encoder (26 keys)	7.95
MM53180N	Push Button Pulse Dialer	7.95
MM53180N	16/14-Key Serial Keyboard Encoder	6.95

ELECTRONIC TOY MOTORS

Typical Power Source	Operating Voltage Range	TYPICAL CHARACTERISTICS				SMALL TORQUE				
		NO LOAD	AT MAXIMUM EFFICIENCY	SMALL TORQUE	SMALL TORQUE					
Speed (RPM)	Current (mA)	Power (mW)	Eff. (%)	Temp. Rise (°C)	Eff. (%)	OE IN				
UMV CELL	1.5-6.0	3.0	9200	0.20	0.750	0.90	0.260	1.30	57.0	< .97

MABUCHI RE280 \$.99 each . . . 10/\$7.50 . . . 100/\$50.00

GLOBAL SPECIALTIES

QUICK TEST SOCKETS & BUS STRIPS

Model	Length	Width	Center Channel	S Test Points	Bus Strips	Price	Length	Width	Center Channel	S Test Points	Bus Strips	Price
EXP48	6.0"	1.0"	n/a	n/a	4 (160)	\$ 4.75	11.00	5.5"	6.2"	118	112.5"	11.00
EXP300	6.0"	2.1"	3"	94(170)	2(80)	\$12.00	11.00	6.5"	6.2"	20	52.75"	11.00
EXP325	1.8"	2.1"	3"	22(110)	2(20)	\$ 3.50	11.00	5.5"	5.8"	14	53.75"	11.00
EXP350	3.6"	2.1"	3"	46(230)	2(40)	\$ 6.75	11.00	6.5"	6.2"	21	36	54.44"
EXP600	6.0"	2.4"	6"	94(170)	2(80)	\$14.75	11.00	12.5"	11.5"	24	75.75"	11.00
EXP650	3.6"	2.4"	6"	46(230)	2(40)	\$ 8.75	11.00	14.5"	11.5"	16	53.80"	11.00

\$10.00 Min. Order - U.S. Funds Only
 Calif. Residents Add 6% Sales Tax
 Postage - Add 5% plus 1% Insurance

Spec Sheets - 25¢
 Send 52¢ Postage for your
 FREE 1981 JAMECO CATALOG

Jameco ELECTRONICS

PHONE ORDERS WELCOME
 (415) 592-8097

MAIL ORDER ELECTRONICS - WORLDWIDE
 1355 SHOREWAY ROAD, BELMONT, CA 94002
 PRICES SUBJECT TO CHANGE

POWER CORD SALE

1-9	842-812	100	1/2 Conductor - 55 Ft. - 100 - 102 - 101
35	10-99	25	

Radio Shack is America's Parts Place™

No Minimum Order! No Waiting! Low Prices!

Phenolic PC Boards for Projects & Prototyping

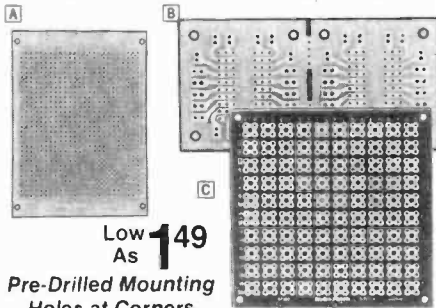

Low As **1.49**

Pre-Drilled Mounting Holes at Corners

- A** IC-Grid Breadboard. Has .100x.100 centers for DIP ICs, sockets, and headers. Labeled on both sides for faster layouts and easier pin identification. 750 contact points. 2 3/4 x 3 3/4". 276-158 1.95
- B** Dual IC Board. Accepts two 14 to 20-pin, or four 6 or 8-pin DIP devices. Provides four contact points for each device pin. 1 3/4 x 3 3/4". 276-159 1.49
- C** Component Board. 100 pads, each with 4 contact points. 5/32" spacing for discrete devices. Indexed with letters and numbers. 3 1/2 x 3 1/2". 276-160 1.95

Be Creative With This Sound Generator IC!

NEW LOW PRICE!

5.99 Was 6.99
in 1981 Catalog

SN76488. This IC, a handful of parts, and your imagination will create an almost infinite variety of sounds. Includes analog and digital circuitry — microprocessor compatible. Built-in 125 mW audio amp. 28-pin DIP with data. 276-1766 Now 5.99



LED Bar-Graph Display

Low As **3.79**

- 10 bright red LEDs in one 20-pin DIP. Ideal for audio metering. Use with the driver ICs listed below. 276-081 3.79
- LM3914N. Ten adjustable analog steps, bar or dot mode. End stackable to 100 steps. 8-25VDC. 18-pin DIP. 276-1707 4.99
- LM3915N. As above, but with 3 dB log steps. 18-pin DIP. 276-1708 4.99



Dynamic Transistor Checker Tests All Types, In or Out Of Circuit

Save \$4

Reg. 16.95 **12.95**

- Has Sockets Plus Color-Coded Test Clip Leads
- Output Jacks for External Meter or Oscilloscope

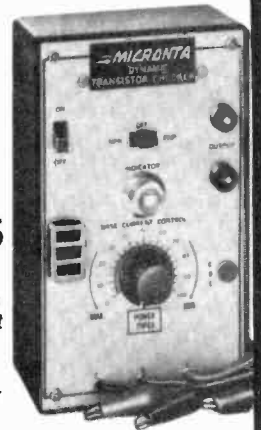

Micronta Transistor Checker. This versatile tester indicates relative current gain, "opens" and "shorts" rapidly. The base current control permits matching of similar transistors. The output jacks for an external meter or scope even let you test very low current types. 6 1/4 x 3 x 2 1/2". With complete instructions. Requires "C" battery. 22-024 Sale 12.95

16K Dynamic RAM

NEW LOW PRICE!
5.95



Was 13.95 in 1981 Catalog

4116. 100% prime! Access time under 250 ns. 1 ms refresh. Ideal for computer memories. 16-pin DIP. 276-2505 Now 5.95

NEW! Ohm's Law "Computer"



This handy slide rule puts Ohm's Law right in your pocket! Reverse side has parallel resistance calculator. 271-1211 Only 49¢

DPST Reed Relay

Only **99¢**



Ideal for low-power circuits. Coil: 12VDC, 375-800 ohms. Contacts: 0.5A @ 125VAC. PC pins on .100" centers. 1 1/2 x 9/16 x 7/16". 275-229 99¢

Semiconductor Guide

Save 41%
Reg. 2.99
1.75



Cross reference/substitution listing for over 118,000 semiconductor devices, data on ICs and more! 276-4004 Sale 1.75

0-15VDC Panel Meter



NEW!
8.95

Precision movement, easy to read face. Ideal for projects, battery chargers, etc. 2 3/4 x 2 1/4 x 1 1/4". Round 1 1/8" mtg. hole. 270-1754 8.95

Miniature 6-Amp DPDT Switch

Reg. 3.19
Save 22%
2.49



Black handle with center off position. Rated 6A at 125VAC. Solder lug terminals. 275-664 Sale 2.49

Electret Mike Element

Save 38%
Reg. 3.99
2.49



Unidirectional. 100-15,000 Hz hi-fi response. Requires 2-10VDC. 2 5/64" dia. x 1 1/2" long. 6" leads for easy hookup. 270-091 Sale 2.49

41-Detent Stereo Pots

NEW! 1.99
Each

1/2"-long, 1/4"-dia. shafts. 40% loudness tap. Require 3/8" mounting hole.

Value	Cat No
5k	271-1730
10k	271-1731
100k	271-1732
500k	271-1733

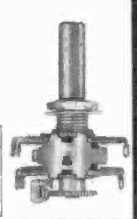

100kΩ Joystick

NEW! 4.95



For Video Games, R/C Vehicles and Microcomputers

Twin linear taper controls with one removable 1"-long shaft. Body: 1 1/16" square. With mtg. screws. 271-1705 4.95

DC Hobby Motors

Pkg. of 3 **NEW!**
Only **1.49**



Great for models, robots, etc. Work as DC generators for use in wind speed indicators, too. 1 1/2-VDC. 3600 RPM (typical). 273-208 Pkg. of 3/1.49

Bright Green LEDs

NEW!
89¢ Pkg. of 2



Miniature (T-1 size) LEDs with diffused lens. Long life—ideal for displays, status indicators, even electronic jewelry! 276-037 Pkg. 2/89¢

Color-Coded Jumper Lead Sets

Low As **3.69**



10-Piece Set
Ten 14" leads with insulated mini-clips at ends. 278-1156 Set/3.69
Four 30" leads with insulated mini-clips at ends. 278-001 Set/3.69

Start Your Next Project at The Shack®

Radio Shack®

A DIVISION OF TANDY CORPORATION · FORT WORTH, TEXAS 76102
OVER 8000 LOCATIONS WORLDWIDE

MUSICIANS: BUILD YOUR OWN MIXING CONSOLE!

For PA or recording use, building your own saves money while giving excellent performance... and the MusiKits listed below are just what you need to get going.

These are the same kits described in Craig Anderton's bestselling book, "Home Recording for Musicians". These kits include PC board, quality components, switches, and pots but DO NOT include instructions since the book contains all schematics, assembly procedures, and applications needed to successfully use and apply these kits.

10 day trial: We recognize that "do it yourself" isn't for everybody. So, order the book and look it over; if the building process looks too complex, return the book in resalable condition within 10 days for full refund.

"Home Recording for Musicians". This is the book that has shown thousands of musicians how to make quality recordings using common, inexpensive equipment. Covers mixing, miking, consoles, noise reduction, how to build a very high performance monaural mixer, and much more. 190 pages, softcover; \$9.95.

Project #13-15 - Bipolar $\pm 15V$ power supply suitable for powering the kits described below. Up to 250 mA per side; includes transformer. \$15.00.

Project #28 - Main Mixer. You can make a quality mono mix down from a four or eight track recorder with nothing more than this module. \$25.65.

Project #29 - Cue System Mixer. Adds extra output bus for cue function. \$29.50.

Project #30 - Reverb System Mixer. Adds extra bus for reverb; includes drive and recovery amp but does not include springs. \$34.50.

Project #31 - Preamp/Input Selector Module. Gain variable from X1 to X20; also includes input selector switch, and low pass rolloff filter to minimize microphone "Popping". \$19.25.

Project #32 - Tone Control Module. Bass/Treble, Boost/Cut shelving type equalizer. \$19.25.

Project #33 - Noise Gate Module. Suppresses tape hiss and also allows for special effects. \$33.35.

The following projects are not described in the "Home Recording" book, and include assembly instructions.

Project #34 - Budget Noise Reduction System. Uses Pre-Emphasis/De-Emphasis techniques. Requires more care in usage than expensive noise reduction systems, but does the job well and costs very little. \$24/channel, \$90/four channels.

Project #35 - Octave Doubling Fuzz. Includes one normal fuzz channel and one "octave doubling" fuzz channel to give a bigger-than-life guitar sound. \$30.00.

Project #8 - Compressor. Increase sustain without distortion and add some gain at same time if needed. Also good for keeping levels constant while recording. \$22.50.

Project #21 - Phase Shifter. 4 stage phase includes wide range speed, depth, offset and volume controls. Add/subtract switch provides filter-like effects; also includes vibrato option. Uses opto-isolators rather than FET voltage control elements for low noise/low distortion operation. \$51.35.

TERMS: Cal res add tax. Allow 5% shipping; excess refunded. Orders under \$15 add \$2 handling. VISA[®] and Mastercard[®] orders (\$25 min) call (415) 562-0636, 24 hrs. Include street address for UPS. More information? Send 52 cents in stamps for our MusiKit flyer (US and Canada only) or circle the bingo number.

SEND FOR OUR FLYER
FOR MORE MUSIKITS[™]

GODBOUT
ELECTRONICS
BOX 2355, OAKLAND AIRPORT, CA 94614

CIRCLE NO. 23 ON FREE INFORMATION CARD

BACK ISSUES AVAILABLE...



If you've missed any of the previously published issues of Popular Electronics Magazine a wide selection is still available. Copies may be ordered for issues published during the past 12 months. In the event a particular issue ordered is out of print your payment will be returned promptly.

Order by mailing \$3.00 per copy (postage & handling included) to Popular Electronics, P.O. Box 278, Pratt Station, Brooklyn, N.Y.

(Outside U.S.A. copies are \$4.00 each.)

Please be sure to enclose payment and identify the specific issues you wish to receive.

QUEST ELECTRONICS

P.O. Box 4430C
Santa Clara, CA 95054

Will call: 2322 Walsh Ave.
(408) 988-1640 TWX 910-338-2139

Same day shipment. First line parts only. Factory tested. Guaranteed money back. Quality IC's and other components at factory prices.

INTEGRATED CIRCUITS

74LS00 TTL		MOS MEMORY RAM		PROM		MICROPROCESSOR		IC SOCKETS		DISPLAY LEADS		
74LS00	29	2101-1	3.85	1702A	8.95	6502	10.95	501	1.20	MAN1	CA 270	2.90
74LS02	28	2102-1	3.95	2708	5.10	5904	9.95	14	1.10	MAN2	CA 275	3.80
74LS04	35	2102AL-4	1.45	27161	18.00	6522	9.95	8	1.50	MAN7-74	CA 300	1.00
74LS08	25	2102AL-2L	1.65	2716 5 vpp	10.50	6800	9.95	16	1.60	DL704	CA 300	1.25
74LS09	35	2103A-4	4.50	6802	14.50	6802	14.50	16	1.60	DL707 DL707R	CA 300	1.00
74LS10	35	2107B-4	3.75	2732	28.50	6820	4.95	18	2.70	DL727 728	CA 300	1.90
74LS13	55	2111-1	3.75	8758	19.50	6858	5.95	20	2.90	DL747 750	CA 300	1.95
74LS14	1.00	2112-2	3.95	8741A	55.00	8004	3.95	2	1.00	IND359	CA 307	7.90
74LS20	35	2114A-5	25.00	8748	55.00	8085	12.55	5	1.50	IND500 507	CA 300	1.35
74LS22	35	2114L 300ms	4.00	8748-8	55.00	8086	75.90	50	2.50	IND510 512	CA 300	1.25
74LS28	35	4116 200ms	3.75	875A	55.00	280	9.95	18	6.70	IND808 807	CA 300	2.70
74LS30	35	84116 200ms	23.95	N82523	2.95	280A	11.95	12	4.60	3 dip 1 Rubber	CA 300	1.30
74LS33	60	MMS200	4.00	N82523	4.75	8212	2.90	18	4.90	10 dip display	CA 300	1.25
74LS38	50	MMS280	9.95	N825126	4.75	8214	3.95	18	6.70	7570 Cleare photocells	39	
74LS44	45	MMS320	9.95	N825129	4.75	8216	2.50	2	1.00	DIL111 Her	CA 30	9.50
74LS45	65	MMS330	5.00	N825131	6.50	8224	3.45	2	1.00	MAN580	CA 40	1.10
74LS47	60	PD4110-7	3.00	N825136	8.75	8228	6.35	4	1.00	MAN640	CA 40	1.30
74LS49	75	PD4110-7	3.00	N825157	8.75	8231	15.90	5	1.00	MAN710	CA 40	1.20
74LS50	1.00	PS010	8.95	DM8177	2.90	8253	15.90	5	1.00	MAN740	CA 60	1.95
74LS51	45	8255	2.95	8223	3.50	8255	5.75	10	5.00	MAN790	CA 60	1.35
74LS52	45	8255	2.95	8223	3.50	8255	5.75	10	5.00	MAN810	CA 60	1.35
74LS53	45	8255	2.95	8223	3.50	8255	5.75	10	5.00	MAN870	CA 60	1.35
74LS54	45	8255	2.95	8223	3.50	8255	5.75	10	5.00	MAN910	CA 60	1.35
74LS55	45	8255	2.95	8223	3.50	8255	5.75	10	5.00	MAN970	CA 60	1.35
74LS56	45	8255	2.95	8223	3.50	8255	5.75	10	5.00	MAN990	CA 60	1.35
74LS57	45	8255	2.95	8223	3.50	8255	5.75	10	5.00			
74LS58	45	8255	2.95	8223	3.50	8255	5.75	10	5.00			
74LS59	45	8255	2.95	8223	3.50	8255	5.75	10	5.00			
74LS60	45	8255	2.95	8223	3.50	8255	5.75	10	5.00			
74LS61	45	8255	2.95	8223	3.50	8255	5.75	10	5.00			
74LS62	45	8255	2.95	8223	3.50	8255	5.75	10	5.00			
74LS63	45	8255	2.95	8223	3.50	8255	5.75	10	5.00			
74LS64	45	8255	2.95	8223	3.50	8255	5.75	10	5.00			
74LS65	45	8255	2.95	8223	3.50	8255	5.75	10	5.00			
74LS66	45	8255	2.95	8223	3.50	8255	5.75	10	5.00			
74LS67	45	8255	2.95	8223	3.50	8255	5.75	10	5.00			
74LS68	45	8255	2.95	8223	3.50	8255	5.75	10	5.00			
74LS69	45	8255	2.95	8223	3.50	8255	5.75	10	5.00			
74LS70	45	8255	2.95	8223	3.50	8255	5.75	10	5.00			
74LS71	45	8255	2.95	8223	3.50	8255	5.75	10	5.00			
74LS72	45	8255	2.95	8223	3.50	8255	5.75	10	5.00			
74LS73	45	8255	2.95	8223	3.50	8255	5.75	10	5.00			
74LS74	45	8255	2.95	8223	3.50	8255	5.75	10	5.00			
74LS75	45	8255	2.95	8223	3.50	8255	5.75	10	5.00			
74LS76	45	8255	2.95	8223	3.50	8255	5.75	10	5.00			
74LS77	45	8255	2.95	8223	3.50	8255	5.75	10	5.00			
74LS78	45	8255	2.95	8223	3.50	8255	5.75	10	5.00			
74LS79	45	8255	2.95	8223	3.50	8255	5.75	10	5.00			
74LS80	45	8255	2.95	8223	3.50	8255	5.75	10	5.00			
74LS81	45	8255	2.95	8223	3.50	8255	5.75	10	5.00			
74LS82	45	8255	2.95	8223	3.50	8255	5.75	10	5.00			
74LS83	45	8255	2.95	8223	3.50	8255	5.75	10	5.00			
74LS84	45	8255	2.95	8223	3.50	8255	5.75	10	5.00			
74LS85	45	8255	2.95	8223	3.50	8255	5.75	10	5.00			
74LS86	45	8255	2.95	8223	3.50	8255	5.75	10	5.00			
74LS87	45	8255	2.95	8223	3.50	8255	5.75	10	5.00			
74LS88	45	8255	2.95	8223	3.50	8255	5.75	10	5.00			
74LS89	45	8255	2.95	8223	3.50	8255	5.75	10	5.00			
74LS90	45	8255	2.95	8223	3.50	8255	5.75	10	5.00			
74LS91	45	8255	2.95	8223	3.50	8255	5.75	10	5.00			
74LS92	45	8255	2.95	8223	3.50	8255	5.75	10	5.00			
74LS93	45	8255	2.95	8223	3.50	8255	5.75	10	5.00			
74LS94	45	8255	2.95	8223	3.50	8255	5.75	10	5.00			
74LS95	45	8255	2.95	8223	3.50	8255	5.75	10	5.00			
74LS96	45	8255	2.95	8223	3.50	8255	5.75	10	5.00			
74LS97	45	8255	2.95	8223	3.50	8255	5.75	10	5.00			
74LS98	45	8255	2.95	8223	3.50	8255	5.75	10	5.00			
74LS99	45	8255	2.95	8223	3.50	8255	5.75	10	5.00			
74LS100	45	8255	2.95	8223	3.50	8255	5.75	10	5.00			

RCA Cosmac 1802 Super Elf Computer Kit \$106.95

The Quest Super Elf is the right choice for the person who has a need to learn more about computers. From an understanding of the hardware and how it goes together to beginning programming with machine language on up through basic.



Tremendous Value
The Super Elf is a tremendous value as it combines video, digital displays, LED displays, and music, all on a single board for \$106.95. Its unique ability for single step debugging, display of state and mode of the computer and display of addressing as an inexpensive option gives it an "easy to use" capability not available anywhere at the price.

Inexpensive Expansion
The Super Elf expansion capability is virtually unlimited and you can do it inexpensively one step at a time. Expansion includes cassette interface, additional memory, color video, Basic, ASCII keyboard, printer, floppy, S-100 bus, RS232, etc.

software, including a series of lessons to help get you started and a music program and graphics target game. Many schools and universities are using the Super Elf as a course of study. OEM's use it for training and R&D. A monthly newsletter, Quest-data is devoted exclusively to software for the Super Elf and there are many software books available at low cost. You can do a tremendous amount with the software available and there is more coming every day. Of course, you can do your own programming which is fun and very rewarding.

Strong Software Support
The Super Elf comes complete with power supply and detailed 127 page instruction manual which includes over 40 pages of

Free 14 Page Brochure
Send or call for a free brochure on all details and pricing of the Super Elf and its expansion. We will get it right out to you!

60 Hz Crystal Time Base Kit \$4.40
Converts digital clocks from AC line frequency to crystal time base. Outstanding accuracy.

Ohio Scientific Computer Products
CIP Series 2 \$447.00
with monitor/TV combo \$599.00
CIPMF Series 2 \$1225.00
with monitor TV/Combo \$1349.00
Superboard II \$289.00

Rockwell AIM 65 Computer
4K version \$450.00

Modem Kit \$60.00
State of the art, orig. answer. No tuning necessary. 103 compatible 300 baud. Inexpensive acoustic coupler plans included. Bd. only \$17.00.

Video Modulator Kit \$9.95
Convert TV set into a high quality monitor w/o affecting usage. Comp. kit w/full instr.

Z80 Microcomputer
16 bit I/O, 2 MHz clock, 2K RAM, ROM Bread-board space. Excellent for control. Bare Board \$28.50. Full Kit \$9

MICROCOMPUTER MART RATE: 1" x 1 Column (1-5/8") \$150. 1-1/2" x 1 Column (1-5/8") \$225.00. 2" x 1 Column (1-5/8") \$300.00. **GENERAL INFORMATION:** Frequency rates available. Payment must accompany copy except credit card—Am. Ex., Diners, MC, VISA (supply Expiration date)—or accredited ad agency insertions. Orders are not acknowledged. They will appear in next available issue after receipt. Closing date: 1st of the 2nd month preceding cover date (for example, April issue closes February 1st). Send order and remittance to MicroComputerMart, **POPULAR ELECTRONICS**, One Park Avenue, New York, NY 10016. Direct inquiries to (212) 725-3485.

TEXAS

TEXAS COMPUTER SYSTEMS
Radio Shack
Authorized Sales Center, OFFERS
LOWEST PRICES

TRS-80
COMPUTERS

Call TOLL FREE for the BEST PRICES on all Radio Shack® Computers and accessories
• FREE SHIPPING on most items
• No out of state sales tax charged.

NEW—Purch. DOUBLE DENSITY for Model I! Twice the disk space. Easy to install, no modifications. Copies single density to DOUBLE DENSITY to convert existing software. Less than \$200.
TOLL FREE 800-351-1473
Texas Residents 915-597-0673
TEXAS COMPUTER SYSTEMS
106 E. 10th, Brady, Tx. 76825
Radio Shack® Authorized Sales Center FTS1
1983 Reg. U.S. Patent & Trademark

RADIO SHACK®
TRS-80™s
Computers
Buy Direct From
Pan American
Electronics, Inc.

Discounts • Free Shipping
TOLL FREE ORDER NUMBER
• 800/531-7466 •

Dept. 67 • 1117 Conway Avenue
Mission, Texas 78572
Texas & Principle No. 512-581-2765
Telex Number 767339

NEW Showroom/Warehouse
2912 N. Main • Ft. Worth, Texas
Phone (817)625-6333 • Telex 767339

TM Registered Trademark of Tandy Corp

NEW YORK

Cromemco

Tomorrow's Computers Today!
BEST PRICING — WARRANTY SERVICE
COMPUTER CENTER
31 E. 31st St. & 480 Lex. Ave
N.Y., NY 10016 N.Y., N.Y. 10167
(212) 889-8130

THE NEC
PERSONAL COMPUTER
The End of the Compromise

We Have It
SYNAPSE VIDEO
P.O. BOX 962 / N.Y., N.Y. 10009
(212) 860-5776

NEW HAMPSHIRE

Free Software Catalog

Instant Software Inc.
Dept. PE-1
Peterborough, NH 03458

- Northstar
- Exidy
- OSI
- TRS-80
- Apple
- PET
- Heath
- TI 99/4
- Atari

WISCONSIN

OHIO
SCIENTIFIC
SYSTEMS

We'll Beat Any Price!
We also carry
Apple Computers

Write or call for prices
TOLL FREE 1-(800) 558-4237
COMPUTERS PLUS INC.,
2749 South 108th St.
Milwaukee, WI 53227
(414) 321-1770

MASSACHUSETTS



Model 111 16 K • \$859
TOLL FREE
1-800-343-8124

computer plus

245A Great Road
Littleton,
MA 01460

THIS is only one of hundreds of unusual values . . .
Get your **FREE CATALOG** today!

PENNSYLVANIA

DISTRIBUTORS FOR

- 3M
- Texas Instruments
- Apple
- Ohio Scientific
- Verbatim
- Etc

Call or Write
ERIE COMPUTER COMPANY
"Since the Beginning"
2131 W. 8th St., Erie, Penn. 16505
(814) 454-7652 — Ask for Don Wolfe

CALIFORNIA

The Original
ByteShop®

1415 W. El Camino Real
Mountain View, CA 94040
(415) 969-5464

OHIO
SCIENTIFIC

Get The Catalog & Our Low Prices
Data Products Maintenance
9460 Telstar
El Monte, CA 91731
(213) 350-4191 (714) 994-4180

OHIO SCIENTIFIC
MICRO-COMPUTERS

A.A. Office
Equipment Company
2140 American Avenue
Hayward, CA 94545
(415) 782-6110

ILLINOIS

BEST PRICES AVAILABLE
APPLE PRODUCTS
48K Apple \$1,090. Plus \$20 Shipping
Call for best deals on Altos
THE COMPUTER ROOM
2218 Plainfield Rd., Joliet, IL 60435
For information call: (815) 725-0396
Certified check for immediate shipment. Personal checks delayed for bank clearance. Add \$22.00 for major credit (MC/VISA/Amer. Express) NO C.O.D.

COMPUTER
RETAILERS

Increase Your Sales Responses!!!

Your computer store ad in
THE MICROCOMPUTER MART

will enable you to reach **POPULAR ELECTRONICS'** Electronics Activist audience . . . an audience that utilizes microcomputer equipment for business AND personal purposes.

For further details, call
(212) 725-3485.

NEW LITERATURE

(Continued from page 91)

Microprocessor Crystal Guide

The complete line of Sentry gold-plated crystals is described in "Microprocessor Crystal Guide," with information on frequencies available and applications. Calibration tolerance is ±0.005% at 26°C and temperature tolerance is over ±0.005% from -30° to +60°C. Address: Sentry Mfg. Co., Crystal Park, Chickasha, OK 73018.

Microcomputer Book Catalog

A new catalog from dilithium Press lists over 65 books for teaching and general purposes in the microcomputer field. Books of special interest to computer en-

thusiasts in other fields are also included as well as software for the TRS-80 Level II and the 8K Pet. Address: dilithium Press, 30 NW 23rd Pl., Portland, OR 97201.

IEC Video Recorder Standard

The International Electrotechnical Commission has issued Publication 602: "Type B Helical Video Recorders" to define the electrical and mechanical parameters for the professional "Segmented Field" video recording system on one inch tape. The recording format is known commercially as the BCN-Recording System and has been accepted by IEC member countries. The video signal is recorded in segments of 52 lines, which leads to 6 segments for each of both video heads for composing

a complete frame in pal and SECAM. For NTSC, only 5 segments are needed. The 29-page standard is 33 Swiss francs from: Information Officer, IEC, 1, Rue de Varembe, 1211 Geneva 20, Switzerland.

Display System Brochure

A four-page brochure, "Display Design Ideas," tells how to build your own electronic display assembly using Beckman's SM-810-001 display system. Three types of assembly interfaces are described: Keyboard, Host Computer, and Keyboard & Computer. The 40-character displays require eight data lines and six control lines and are TTL compatible. Address: Beckman Instruments, Inc., 350 N. Hayden Rd., Scottsdale, AZ 85257. □

Electronics Classified

CLASSIFIED RATES: Per Word, 15 Word Minimum. **COMMERCIAL:** \$3.00. **EXPAND-AD*:** \$4.50. **DISPLAY:** 1" x 2 1/4", \$370.00. 2" x 2 1/4", \$740.00. 3" x 2 1/4", \$1,110.00. **GENERAL INFORMATION:** Frequency rates and prepayment discounts available. Payment must accompany order except credit card—Am. Ex., Diners, MC, VISA (include exp. date)—or accredited ad agency insertions. Copy subject to publisher's approval; must be typewritten or printed. First word set in caps. Advertisers using P.O. Boxes MUST supply permanent address and telephone number. Orders not acknowledged. They will appear in next available issue after receipt. Closing date: 1st of the 2nd month preceding cover date (e.g., Mar. issue closes Jan. 1). Send order & remittance to: Classified Advertising, Popular Electronics Magazine, 1 Park Avenue, New York, NY 10016. Direct inquiries to Rose Lynch, (212) 725-7686.

FOR SALE

FREE! Bargain Catalog—I.C.'s, LED's, readouts, fiber optics, calculators parts & kits, semiconductors, parts. Poly Paks, Box 942PE, Lynnfield, Mass. 01940.

GOVERNMENT and industrial surplus receivers, transmitters, sniperscopes, electronic parts, Picture Catalog 25 cents. Meshna, Nahant, Mass. 01908.

ELECTRONIC PARTS, semiconductors, kits. **FREE FLYER.** Large catalog \$1.00 deposit. **BIGELOW ELECTRONICS**, Bluffton, Ohio 45817.

RADIO—T.V. Tubes—49 cents each. Send for free catalog. Cornell, 4213 University, San Diego, Calif. 92105.

SAVE UP TO 50% on name brand test equipment. Free catalog and price list. Salen Electronics, Box 82, Skokie, IL 60077.

TELETYPE EQUIPMENT: Copy Military, Press, Weather, Amateur, Commercial Transmissions. Catalog \$1.00. **WEATHER-MAP RECORDERS:** Copy Satellite Photographs, National-Local Weather Maps. Learn How! \$1.00. Atlantic Sales, 3730 Nautilus Ave., Brooklyn, NY 11224. Phone: (212) 372-0349.

SOUND SYNTHESIZER KITS—Surf \$19.95, Wind \$19.95, Wind Chimes \$24.95, Musical Accessories, many more. Catalog free. PAIA Electronics, Box J14359, Oklahoma City, OK 73114.

BUILD AND SAVE. TV EARTH STATION. DETECTIVE ELECTRONICS. TV De-Scramblers. Video Recorders, Color Cameras, advanced Telephone Projects. **BROADCAST ELECTRONICS.** 50 page color catalog of unusual electronic projects **AIR MAILED \$3.00;** with 3 hour audio cassette dramatization of our catalog \$5.00. Don Britton Enterprises, PO Drawer G, Waikiki, Hawaii 96815.

UNSCRAMBLERS FOR any scanner. Several models available. Free literature. Capri Electronics, 8753T Windom, St. Louis, MO 63114.

UNSCRAMBLERS, seven models available to decode police, ambulance, and fire coded transmissions. Other scanner devices. Tone encoders/decoders. Telephone accessories, etc. Free Catalog. **KRYSTAL KITS**, Box 445, Bentonville, AR 72712. (501) 273-5340.

POLICE/FIRE SCANNERS, crystals, antennas, CBs, Radar Detectors. HPR, Box 19224, Denver, CO 80219.

PRINTED CIRCUIT supplies, chemicals, tools, artwork, plating solutions. Major credit cards. Catalog \$2.00, refundable. **CIRCULEX**, Box 198, Marcy, NY 13403.

RECONDITIONED TEST EQUIPMENT \$1.00 for catalog. **WALTER'S TEST EQUIPMENT**, 2697 Nickel, San Pablo, CA 94806, (415) 758-1050.

Buy Gov't Surplus

SAVE To 85%

SURPLUS CENTER Box 82209-PE Lincoln, Nebraska Zip Code 68501

Send 60¢ For Big Bargain Catalog

1000's Of Bargains: Surplus, Excess Inventory, Brand Name New Equipment

COMPRESSORS • WINCHES • GEAR MOTORS
TELEPHONES • WELDERS • POWER PLANTS
SERVICING INSTRUMENTS • ELECTRONICS
FIRE/BURGALAR ALARMS • PAINT GUNS
TAPS • BINOCULARS • TOOL BOXES
HYDRAULICS • AIR TOOLS • PUMPS

BUY DIRECT

NEW ELECTRONIC PARTS. Continuously stocked. Stamp brings catalog. Daytapro Electronics, 3029 N. Wilshire Ln., Arlington Hts., IL 60004.

ELECTRONIC CATALOG. Over 4,500 items. Parts, & components. Everything needed by the hobbyist or technician. \$2.00 (U.S. funds) \$4.00 Foreign Postage & handling, refundable with first \$15.00 order. T & M Electronics, 472 East Main St., Patchogue, NY 11772. (516) 289-2520.

SPEAKERS SAVE 50%. Build your own speaker system. Write: McGee Radio Electronics, 1901 McGee Street, Kansas City, Missouri 64108.

PRINTED CIRCUIT BOARDS, your artwork. Quick delivery. Reasonable. Atlas Circuits, Box 974, Waynesville, NC 28786. (704) 456-3739.

CABLE TV DESCRAMBLERS AND CONVERTERS. MICROWAVE ANTENNAS AND DOWN CONVERTERS. Plans and parts. Build or buy. For information send \$2.00. C&D Company, P.O. Box 21, Jenison, MI 49428.

FIBER OPTIC SPECIALS—100 foot spool of fiber \$3.00—Experimenter's kit \$6.00—High Power LED with matched Detector \$10.00—Data Link construction plans (detailed) \$5.00. Catalog with samples \$1.00. **FIBERTRONICS**, Box 322-A, Primos, PA 19018.

SCRAMBLED TELEVISION—Encoding/Decoding. New publication. Complete theory, circuits. \$9.95. Workshop, Box 393PEJ, Bethpage, NY 11714.

Telephone Listening Device

Record telephone conversations in your office or home. Connects between any cassette or tape recorder and your telephone or telephone LINE. Starts automatically when phone is answered. Records both sides of phone conversation. Stops recorder when phone is hung up. This device is not an answering service.



Each \$18.95
Qty. Disc Avail

Super Powerful Wireless Mic

10 times more powerful than other mics. Transmits up to 1/4 mile to any FM radio. Easy to assemble kit. 15V battery (not incl.)



Each \$18.95
Qty. Disc Avail

Call (305) 725-1000 or send \$18.95 + \$1.00 shipping per item to USI Corp., P.O. Box PE-2052, Melbourne, FL 32901. COD's accept. For catalog of transmitters, voice scramblers and other specialty items, enclose \$2.00 to USI Corp.

CHEMICALS, Apparatus, Project Books, Wide Selection. Catalog send \$1.00 to Pioneer Corp., 14a Hughey Street, Nashua, NH 03060.

TEST EQUIPMENT, new and used. Catalog \$1.00. PTI, Box 8756; White Bear Lake, MN 55110.

QUALITY AUDIO COMPONENTS, Multi-Track Equipment, Programmable Calculators, Accessories. Competitive Pricing! Prompt Delivery! Knowledgeable staff! Service Facility! Credit Cards accepted. **FREE CATALOG. SOUND IDEAS**, Dept. SR, PO Box 340, Cary, N.C. 27511. (919-467-8462).

SATELLITE TELEVISION INFORMATION—Build or buy your own Earth Station. U.S.\$4.00 Satellite Television, RD 3, Oxford, NY 13830.

UNSCRAMBLE CODED MESSAGES from police, fire and medical channels. Also telephone recording adaptor. Same day service. Satisfaction guaranteed. Don Nobles Electronics, Inc. Rt. 7, Box 610-A, Hot Springs, AR 71901. (501) 623-6027.

PCB as low as 15¢ sq-in. FREE DRILLING. International Enterprise, 6452 Hazel Circle, Simi Valley, CA 93065.

SUBSCRIPTION TELEVISION EDUCATION MANUAL! Two scrambling decoding systems, theory, circuits. Decoder dealers listed. \$14.95. Microwave Television Manual: ABEX, P.O. Box 26601-P5, \$16.25. Kits available. Information package: \$2.00. San Francisco, CA 94126.

TELEVISION DOWNCONVERTERS and decoders \$99.95 up. Details for Stamp. GW Electronics, POB 688, Greenwood, IN 46142.

POLICE SCANNERS WHOLESALE PRICES. VISA/MC Phone orders accepted. (415) 573-1624. Free catalog. Scanners Unlimited, 1199A Laurel Street, San Carlos, CA 94070.

TOP QUALITY SPEAKERS AND KITS. Send \$2.00. Speaker Warehouse, 809 North Route 441, Hollywood, FL 33021.

AMATEUR SCIENTISTS, Electronics Experimenters... Construction plans - drawings, schematics, parts lists. Over 60 items. Catalog - \$1.00. Technical Writers Group, Box 5994, University Station, Raleigh, NC 27650.

SHORTWAVE LISTENERS! Free catalog. High quality SWL equipment! Radio West, 2015 S. Escondido Blvd, Escondido, CA 92025. (714) 741-2891. The Only all SWL store in the Known World.

TO RECEIVE FREE UNINTERRUPTED movies, Sports shows. Send \$199.95 for complete ready to install **AMATEUR MICROWAVE SUBSCRIPTION T.V. ANTENNA**, or \$9.95 for complete plans, fully guaranteed and refundable against purchase of Antenna. Philips-Tech Electronics, Dept Sp-12, 5025 North 68th Street, Scottsdale, Arizona 85253.

LOWEST PRICES ELECTRONIC PARTS, confidential catalog free. KNAPP, 4750 96th St. N., St. Petersburg, FL 33708.

Satellite TV

FOR THE HOME

Sick of Network TV?

Our receiver lets you get over 75 channels of television directly from earth-orbiting cable TV satellites! HBO, Showtime, super stations, sports and movies worldwide.



We don't just sell information! We Manufacture Hardware!

From offshore oil rigs, data links to hotels and backyard installations, we wrote the book. Constantly updated, our 94 Page technical information book and catalog gives you all the facts. Inexpensive dishes, feeds, telemetry software, kits and more. Recommended reading by NASA, The Office of Consumer Affairs and quality companies like Rockwell/Collins. Send \$7.95 today!

CALL
24-hrs. C.O.D. Hotline
(305) 339-7600

SPACECOAST™
RESEARCH CORPORATION
P.O. Box 442-A, Altamonte Spgs, FL 32701



SATELLITE VISION

SATELLITE VISION

We manufacture the highest spec 3-meter data & video dish in the world (13db gain)! We also sell direct. Immediate delivery or you pick up. Complete details including satellite TV information, aiming service and discount schedule. Send \$1.25 for postage & handling to:

TIGER TENNAS
P. O. Box 561
Casselberry, Florida 32707



BUY DIRECT

"FONO-NET"™ Accurate-quick test of phonograph amplifiers with any Audio Generator. Individually calibrated. Guaranteed. \$29.95 postage paid. **QUANTITY DISCOUNTS.** R.C. Davidson, Inc., 3005 Bagley Avenue, Los Angeles, CA 90034.

ELECTRIC CAR PARTS. Catalog contains parts, plans, instructions. Send \$3.00 to: Electric Vehicle Components Catalog, Flight Systems, Dept. EV8, Box 25, Mechanicsburg, PA 17055.

MICROWAVE TV downconverter, prebuilt \$140.00. Specify output channel. Complete system, \$294.95. Free information. **TEM MICROWAVE**, 22518 97th Ave. No., Corcoran, MN 55374. 612-498-8014.

PICTURE TUBE REBUILDING equipment new and used. **ATOLL TELEVISION**, 6425 Irving Park, Chicago, Illinois 60634.

ROBOT KITS, PARTS, MATERIALS BOOKS. Send \$3 for subscription to catalog and newsletter. **ROBOT MART**, 19 West 34th St., New York, NY 10001.

FREE SPEAKER CATALOG! Woofers, mids, tweeters, hardware, crossovers, grille cloth, plans, kits, information, much more. Discount Prices. Universal Sound, Dept PE, 2253 Ringling Blvd., Sarasota, FL 33577. (813) 953-5363.

ATARI SPACE INVADERS IS MORE FUN WITH THE RAPID FIRE Variation. Doesn't LIMIT YOU to FIRING ONLY ONE LASER each time. APPLIES INSTANTLY!! NO MODIFICATION TO YOUR COMPONENTS! NOW SPECIALLY PRICED! \$5.98 COMPLETE. BALIS, Box 522, Brooklyns, NY 11215.

SATELLITE TELEVISION . . . HOWARD/COLEMAN boards to build your own receiver. For more information write . . . ROBERT COLEMAN, Rt. 3, Box 58-APE, Travelers Rest, S.C. 29690.

SATELLITE TELEVISION RECEIVERS \$300, dishes \$100. LNA'S, downconverters. Catalog \$5.00. Satellite Systems Development, Box 184, Milpitas, CA 95035.

DECODE Morse and RTTY signals off the air with our MORSE-A-WORD or RTTY READER. MORSE-A-KEYER keyboard also available. Quality kits or factory wired. Call or write for details. MICROGRAFT, Box 513PE, Thiensville, WI 53092. (414) 241-8144.

RF MODULATORS! Special versions for SATELLITE TELEVISION, COMPUTERS, CCTV. Also Monitors, Cameras, Kits. FREE catalog. Phone (402) 987-3771. Dealers welcomed. ATV RESEARCH, 13-P Broadway, Dakota City, NE 68731.

SPEAKERS in any room. No wiring. Up to 100 watts. For information send \$3.95 to D to R Enterprises, 323 N. Brockway, Palatine, IL 60067.

SATELLITE TV

RECEIVE 200 CHANNELS ANYWHERE!

That's what the ads say. Yes, you can receive 75 to 200 channels, but not just anywhere.

We offer an independent computer analysis of your location, anywhere in the world. Our computer will tell you which satellites you can receive, where to point your antenna, & how strong the signals are likely to be.

The cost? Only \$19.95 postpaid (Air Mail \$2.00 extra). Save hundreds--even thousands--of dollars. Send Money Order, check, or charge it on your VISA or Master Card.

Call Toll Free 24-hrs! 800-228-2606
In Nebraska, 800-642-8777

SATELLITE COMPUTER SERVICE
Dept. PE, 1808 Pomona Drive
Las Cruces, NM 88001 U.S.A.

SUBSCRIPTION TV DECODER KIT \$39.00. Includes parts, manual, and etched board. Manual only \$4.60. MICROWAVE TV DOWNCONVERTER KIT \$169.00. Assembled \$220.00. Catalog \$2.00. J&W Electronics, P.O. Box 61, Cumberland, RI 02864.

EPROMS 2732 FUJITSU prime 450ns single 5V supply \$17.50. Sabadia Export Corp., Box 16969, Temple Terrace, FL 33687. Telex 803712.

SAVE MONEY--guaranteed lowest prices on video equipment, accessories and tapes anywhere. Call Mr. Dee 1-800-241-6270.

AUDIO FREQUENCY GENERATOR. Digital readout. 15Hz-50KHZ. No range switching. Vernier, Sine wave, T.T.L. square. Detailed plans \$7.50. W/O Digital readout \$3.50. P.C.B.'s and parts available. SCHROEDER ELECTRONICS, P.O. Box 171, Rolla, MO 65401.

RF POWER TRANSISTOR - TUBE CATALOG FREE. MRF453/MRF455A/SK1451 - \$14.00; MRF454/SRF2072/MRF2769 - \$17.00; MRF245/MRF247 - \$27.00; 2N4048 - \$6.20; Exclusive Repair Center for PALOMAR PRIDE, etc. Westcom, 1320 Grand, San Marcos, CA 92069. (714) 744-0728.

DIGITAL REVERB September 80 issue PE, PCB \$18. Critical IC's \$23. Memory set \$50. SASE for reprint. Videort, Box 10327, Stanford, CA 94305.

TV BAND MICROWAVE ANTENNAS



Factory
Direct
Fully
Assembled

- Many Uses
- 10 Day Trial
- Suitable Indoors
- Limited Time Offer

FROM
\$169.50
w/ Vol. Discounts

"Down Converter" microwave signals to VHF television band Commercial grade rod or parabolic dish type.
NOTE: Many versions of our product are available. Let the buyer beware. We fully guarantee ours in writing. We want your recommendation. Weekdays 9-4:30, Sat. 10-2 PAC STD TIME "Clip and Save this Ad"

CALL FOR FREE INFORMATION PACKET **1-800-634-6062**

WORLD RADIO TELEVISION HANDBOOK 1981, 600 pages, \$15 postpaid. BCB log, \$7.50. FM Atlas, \$4. List. SASE. Donald Erickson, 6059 Essex, Riverside, California 92504. (714) 687-5910.

FOIL COPYGUARD

- RESTORES SYNC WHEN VIEWING RENTED TAPES.
- CONNECTS EXTERNALLY VIA JACKS TO MOST VCR'S (VHS, BETA).
- EASY ASSEMBLY. • LOW POWER CONSUMPTION.

4995 kit (less case) or write for more information.

Video Technica

P.O. Box 2108
Downey, CA 90242

EPROM's custom programmed, prime IC's. Super prices. Write: BLAC Electronics, Box 155, Littleton, NH 03561.

GIVE AWAY FREE - ON-TV, Showtime, HBO, microwave MDS, Converter/Decoders, and make money. Information \$5 and SASE. DOT, Box 200E, Chicago Ridge, Illinois 60415.

SATELLITE PARABOLIC ANTENNA, including polar mount. Fiberglass and steel construction f/d-.45, 12' -41db — \$1,150.00. Satronics Communications, P.O. Box 2924 Sta. A, Champaign, IL 61820. (217) 398-2873.

SAVE MONEY--guaranteed lowest prices on video equipment, accessories and tapes anywhere. Call: Mr. Dee, 1-800-241-6270.

POWER-ETCH. ETCH 1 or 2 sided PCB in 2 to 6 minutes. Detailed instructions \$3.00. Power-Tech, 4826 San Juan Ave., Suite 156, Fair Oaks, CA 95628.

Z80 PROGRAMMING LANGUAGE. Super powerful 3K system. \$24. Systemed, Box 18, Mountain City, TN 37683.

FREE — Send for information, Voltmeter Memory Adapter. Protects solid state circuits from costly damage. BELL & BELL Enterprises, Box 542PE, Clearfield, Utah 84015.

HOT DIGGITY!

COMPUTEMP 2...

A COMPUTER-ACCURATE THERMOMETER/CLOCK!

Microcomputer electronics makes the amazing Computemp 2 possible.

Choose your program
Indoor/Outdoor Temp...
Outdoor Temp/Time...
Indoor Temp/Time.

- Automatically records day's high and low temp and time they occurred. Plus these features:
- Time & Temperature Alarm
- Easy to read LED Display
- F° or C° Temperature Display
- Re-programs at the touch of a button
- Fully warranted
- Perfect gift

Computemp 2... a great value at \$69.95!



CALL TOLL FREE **800-227-1617** EXT 109
CA RESIDENTS: 800-772-3545 EXT. 109
\$3.00 shipping — no COD's.

SEND CHECK OR MONEY ORDER TO
RODCO PRODUCTS
P.O. BOX 944 P
COLUMBUS, NE 68601



NEED A COMPACT ANTENNA?

McKAY SETS THE STANDARD

with the DA100D Outdoor Antenna and the DA9-DL4 Combination Indoor Loop Antenna

For specs and details contact dealers:
HARVEY RADIO New York City
HENRY RADIO Los Angeles CA
BARRY ELECTRONICS New York City
GILFER ASSOCIATES Park Ridge New Jersey
ELECTRONIC EQUIPMENT BANK (D.C. area) Vienna VA
BRIDGE WATER CUSTOM SOUND HARVEY, ILL
AUDIO PERFECTION Bloomington MINN
STANDARD SUPPLY CO. Salt Lake City Utah
THE BASE STATION Concord CA
J-MAR ELECTRONICS Toronto Canada

800/854-7769 Local 714/621-6711
except CA, Alaska, Hawaii TWX 910-581-4990



McKAY DYMEK COMPANY
111 S College Ave PO Box 5000
Claremont CA 91711 U.S.A.

MICROWAVE DOWNCONVERTERS BUILT — IN preamp - highest gain. Downconverter board, plans - \$15.00. Power Supply Board, Plans - \$5.00. Antenna Cookbook - \$5.00. All three for \$20.00. MICRO ENGINEERING, P.O. Box 17231, Minneapolis, MN 55417.

SCRAMBLED T.V. DECODER CIRCUIT DESIGNS, Parts, Suppliers, Theory, Technical Advice. \$10.00 Money Order Only. Quest, Box 1722, Costa Mesa, CA 92627.

CIRCUIT BOARDS. Do your own. Easy plans with etchants. \$10.00 Money order only. Quest, Box 1722, Costa Mesa, CA 92627.

REMOTE CONTROL BSR SYSTEM X-10 plug-controllers turn lights and appliances on, off via remote modules. Simply plug lamps into modules, then modules into wall outlets. Same as Sears, Leviton, Radio Shack. Free delivery. Lowest PRICES NATIONWIDE: Lamp, Grounded Appliance Module, 2-Prong Appliance Module, Button Wall Switch, each \$15. Timer Console \$49, Timer Console Non-Sleep \$64. Ultrasonic Controller \$28, Ultrasonic Hand Unit, \$15. COMPLETE BSR X-10 LINE! One-year warranty. VISA/Master Card. (801) 328-8855. Also Mini Controller, Telephone Controller, Duplex Wall Receptacle, more. FREE LITERATURE. Interface Electronics, 745 Pacific Ave., Salt Lake City, Utah 84104.

\$10 ELECTRONIC BUG ZAPPER. 10,000 VOLTS. Plans \$5. Contemporary Concepts, Box 1381, Johnson City, Tennessee 37601.

COMPUTER EQUIPMENT

SURPLUS*COMPUTER PERIPHERALS: "Selectric" i/O typewriter bargains. World's largest selection. Send 25¢ for bargain-packed flyer. CFR, Box 144, Newton, NH 03858.

WANTED — Sell your unwanted computer through us. Big savings for buyers in pre-owned equipment. Buyers/sellers — Send SASE or 25¢ for details, Autocomp, Box 246, Glenham, NY 12527.

INTERACT COMPUTERS — Software, service. Best prices. Send for catalog: MICRO VIDEO, Box 7357, Ann Arbor, Michigan 48107.

COMPUTERISTS AND COMPUTER CLUBS! Why pay full price for software? We have it all for most any system and will not be undersold! Guaranteed! Write for free listings. Pacific Discount Software, 3205 Production Circle, Oceanside, Cal. 92054. 714-439-6201.

SAVE 90% Build Your own Minicomputer. Free Details. Diga-tek, 2723 West Butler Dr., Suite 20C, Phoenix, AZ 85021.

TRS-80 COLOR COMPUTER Complete Kits for the 4K. Computer. 16K. Memory Conversion \$59.95. 32K. Memory Conversion \$119.95. 32K. Memory Conversion (for the 16K. Machine) \$59.95. Kit less memory (specify) \$12.00 each. Culppeper Computer, 502-B South East St., Culppeper, VA 22701.

EPROM PROGRAMMING FROM TYPED LIST! \$20 + 4¢ per address. Copies \$12.50. Prices include Eprom. New 2716 \$7.45! Eprom erasing \$1.50. Add \$2.00 shipping. MASELCO, 4319 57th St., Woodside, NY 11377.

USED COMPUTER TERMINALS. Printers, Moderns, Surplus Electronic parts. Catalog \$1.00. RONDORE COMPANY, THE COMPUTER ROOM, 2522 Butler St., Dallas, TX 75235. (214) 630-4621.

AT THE RECENT ADCIS convention, the University of Delaware Sound Synthesizer (UDSS) was announced. Containing its own Z-80 microprocessor, the UDSS can be used with most any microcomputer or terminal, including all versions of the PLATO terminal. Fully programmable in the domains of frequency and time, the UDSS has 32 harmonics for each of its four voices which are optionally expandable to eight voices. Tremolos and vibratos can be made by means of amplitude and frequency modulation respectively. Glissandos and portamentos can be defined, and programmable memories are included to permit real-time performance controls. An article describing the background, design goals, features, and ease-of-use of the synthesizer is available from the Office of Computer-Based Instruction which is producing the UDSS. Copies of this article, pricing information, and more technical information can be obtained by calling or writing to the Office as follows: Deborah G. Mellor, Office of Computer-Based Instruction, Newark Academy Building, Main and Academy Streets, Newark, DE 19711. (302) 738-8161.

AIM your SATELLITE TELEVISION ANTENNA ACCURATELY using azimuth & elevation data computed for your location ANYWHERE WORLDWIDE. Chart shows which of 44 satellites are within your reception area. You will also receive our 9 page booklet showing future launches, frequencies, formats, antenna/feedline data, list of satellite TV suppliers. \$10.00. COMPUSAT, Cartographic Division, 643 South Route 83, Elmhurst, IL 60126.

AMATEUR RADIO

RADIO AMATEUR CALLBOOKS 1981 Directories of Radio Amateurs around the world. U.S. Callbook \$20.50; Foreign Callbook \$19.50, shipping included. See your dealer or write for FREE catalog. Radio Amateur Callbook, Dept. PE, 925 Sherwood Dr., Lake Bluff, IL 60044.

C.B. EQUIPMENT

GET MORE CB CHANNELS AND RANGE! Frequency Expanding, boosters, speech processors, how-to-books, plans, modifications. Catalog \$2. CB CITY, Box 31500PE, Phoenix, AZ 85046.

CABLE TV

500 PHILIPS 32 CHANNEL CABLE TV converters and VCR programmers. \$17,800 prepaid to your door. Sample \$48. Bimbom, 3655 Ridgewood, Suite 103, Montreal, Canada H3V 1B4. (phone 514-739-0614). (U.S. inquiries).

39.95
ADD \$2.50 FOR POSTAGE
30 CHANNEL CABLE TV CONVERTER
FREE!
UNUSUAL 96 PAGE ELECTRONIC PARTS & IDEAS CATALOG!
ORDER No. 198AE047
EACO ROUTE 9N, PLATTSBURGH, N.Y. 12901
Tel.: (518) 561-8700.

PLANS AND KITS

PRINTED CIRCUIT Boards from sketch or artwork. Kit projects. Free details. DANOCINTHS Inc., Dept. PE, Box 261, Westland, MI 48185.

LASERS HANDBOOK with burning, cutting, Ruby Reds, CO's complete plans, books, and parts. Send \$4.00 to: Famco, Dept. PE, Box 1902, Rochester, NH 03867.

GIANT SCREEN TV projection system converts any television into 7-foot picture. Lens & instructions \$14.95. (Dealers welcome). Bell Video, 4616 Belair Rd., Baltimore, MD 21206.

BUILD AN ORCHESTRA THE WE RSI WAY
Preview the world's most advanced Do-It-Yourself Organs, Planos, Synthesizers, Amps, etc. Send \$6.00 for our famous "Sight & Sound" pack.
WE RSI Electronics, Inc., Dept. M2, P.O. Box 5318, 1720 Hempstead Rd., Lancaster, PA 17601.

UNIQUE TV DECODER plugs between UHF and VHF tuners on tube or solid-state sets. Plans \$3.95; DECODER ANTENNA receives multi-polarized signals. Plans \$3.95; Antenna Kit \$19.95. Helico, P.O. Box 304, Bridgewater, MA 02324.

BUILD YOUR OWN SPEAKERS. Save 50%. Designs include miniatures, subwoofers, satellites, multi-amp and State of The Art ultra speakers. Plans, parts, crossovers and kits available. No compromises - These are well engineered designs. High quality drivers and components. Write for free catalog. YE OLDE SOUNDE BOX, Box 75, Webster City, IA 50595.

SUBSCRIPTION TELEVISION DECODER: Best design available; no internal connections to television! Complete plans, \$10.00. Negative Ion Generator, Telephone Memory Dialer, plans \$4.00 each. PARTS AND KITS AVAILABLE! For info send SASE. COLLINS ELECTRONICS, Box 6424, San Bernardino, CA 92412.

GRANT CLOCK KIT Plans \$2.50. Microprocessor Trainer Plans \$5.00. Complete List of Kits and Products FREE. Paccom, 3928 148th N.E., Redmond, WA 98052.

DOWNCONVERTERS: Microwave T.V. Build your own. Simplified instruction booklets. \$9.95. Kits and boards available. A&D Electronics, P.O.Box 5128, Lexington, KY 40505.

FREE CATALOG! Plans, printed circuit boards, Kits, and assembled Products. Nicolas Electronics, 15 Bertona, Nepean, Ontario, K2G - OW3.

PLANS - Monophonic Organ Synthesizer \$9.50. Kits available upon request. For information, SASE Mad 13, P.O. Box 6742, Concord, California 94524.

TESLA COIL - 40' SPARKS! Plans \$7.50. Information 75 cents. Hurlington Electronics, Box 2009-P, Huntington, Conn. 06484.

ROBOTIC CATALOG-MOTORS, gears, hardware, electronics, \$3.00. Newsletter, \$8.00/yr. MOUDY ELECTRONICS, R.D.2, Box 427-P, Hollidaysburg, PA 16648.

FM STEREO TRANSMITTER Module. Tunes FM band. Audiophile Specifications. Applications: Broadcasting, MPX alignments. Complete kit, \$59.95. Stellatron, 4942 Whitsett - 205, N. Hollywood, CA 91607.

DECODERS EXTERNAL TYPES Plans with PC board, 15Khz pulse, 63Khz Sinewave, 50-120 Mhz gated cable, 2000-2500Mhz Microwave. \$25.00 each parts, Kits available. Hobbi Shack, P.O. Box 235, Jersey City, NJ 07303.

MINIATURE FM TRANSMITTER. Installs inside telephone handset in seconds. Uses Phone power. Monitor calls on FM band. Plan \$7.00. Omicron Laboratory, Box 11034, Knoxville, TN 37919.

NASA Powerfactor controller available in kit for \$26.50. Includes circuit board, electronic parts, and plans for 120VAC motors to 1 HP. RODCAR; 2720 Biloxi Lane; Dept. A; Mesquite, Texas 75150.

TESLA COIL RESONANT TRANSFORMERS. 50,000V - 5,000,000 volts, 520W - 3,000 kilowatts, Arcs - 100". Illustrated Construction manual includes: 5 Powerful coil plans (Tube, Sparkgap), 25 high-voltage high-frequency experiments, electrical theory, designing procedures, part suppliers. PLUS Nikola Tesla's Historical: 100,000,000 volt standing-wave magnifying transmitter, Ball Lightning Production... Manual \$15.00. Information/color photo \$2.00. B&L Scientific, 215 W. First St., Suite 105-47G, Tustin, CA 92680.

DIGITAL AND SOUND EFFECTS PROJECTS. Send stamp for information. Waveform, 7 Bradford Ave., Pittsburgh, PA 15205.

ALARMS

Burglar-Fire Protection
Protect Your Life, Home, Business, Auto, etc.
• Our catalog shows how. Install your own alarm systems and devices and save \$\$\$\$.
We offer FREE write-in engineering service.
FREE CATALOG Lowest Prices on Reliable, High-Quality Alarm Systems and Devices
Burdex Security Co. Box 82802-PE Lincoln, Ne. 68501

BURGLAR, FIRE, CAR! Finest equipment! Save! Free Catalog. AAS, 186A Oxmoor Road, B'ham, AL 35209.

BURGLAR/FIRE ALARMS. Inexpensive. Install yourself. Send 50¢ for information. Multisystems, Box 80331, Baton Rouge, Louisiana 70898.

ALARM SYSTEMS: Perimeter; Complete Kits reasonably priced. Catalog \$3.00 refundable. Blue Gator Enterprises, Box 551E, Earletoe, Florida 32631.

HIGH FIDELITY

DIAMOND NEEDLES and Stereo Cartridges at Discount prices for Shure, Pickering, Stanton, Empire, Grado, Audio Technica, Osawa, Satin and ADC. Send for free catalog. LYLE CARTRIDGES, Dept. P, Box 69, Kensington Station, Brooklyn, New York 11218. Toll Free 800-221-0906 9AM - 8PM except Sunday.

WANTED

GOLD, Silver, Platinum, Mercury, Tantalum wanted. Highest prices paid by refinery. Ores assayed. Free circular. Mercury Terminal, Norwood, MA 02062.

GOVERNMENT SURPLUS

MANUALS for Govt Surplus radios, test sets, scopes. List \$1.00 (cash). Books, 7218 Roanne Drive, Washington, D.C. 20021.

JEEPS—\$58.00!!—CARS—\$35.00!!—700,000 ITEMS!!—GOVERNMENT SURPLUS!!—Most COMPREHENSIVE DIRECTORY AVAILABLE tells how, where to buy!!—YOUR AREA—\$3.—MONEYBACK GUARANTEE!!—"Surplus Information Services", Department GE-8, Box 99249, San Francisco, California 94109.

WANTED: MILITARY SURPLUS ELECTRONICS, we need ARC-51BX, ARC-94, ARC-102, 618T, RT-823/ARC-131, FM-622, Wilcox RT-823/ARC-131, or 807A, APX-72, Antenna Couplers 490T, CU-1658A, CU-1669A, TOP DOLLAR PAID. Write or phone Bill Slep, 704-524-7519. Slep Electronics Company, Highway 441, Otto, NC 28763.

BUY DIRECT FROM GOVERNMENT! 500,000 items (including JEEPS)... low as 2¢ on dollar! Directory - \$2.00. Disposal. Box 19107-HH, Washington, DC 20036.

TUBES

RADIO & T.V. Tubes—49 cents each. Send for free Catalog. Cornell, 4213 University, San Diego, Calif. 92105.

TUBES: "Oldies". Latest. Supplies, components, schematics. Catalog Free (stamp appreciated). Steinmetz, 7519-PE Maplewood, Hammond, Ind. 46324.

TUBES-RECEIVING, Industrial and Semiconductors Factory Boxed. Free price sheet including TV, Radio and audio parts list. Transletronic, Inc., 1365 39th St., Brooklyn, New York 11218. Telephone: (212) 633-2800. Toll free: 800-221-5802.

HUGE INVENTORY! Thousands of types. Wholesale prices. FREE CATALOG! ETCO Electronics, DEPT. 290, Plattsburgh, NY 12901.

PERSONALS

MAKE FRIENDS WORLDWIDE through international correspondence, illustrated brochure free. Hermes-Verlag, Box 110660-Z, D-1000 Berlin 11, W. Germany.

CORRESPONDENCE FOR FRIENDSHIP IN PHILIPPINES, MALAYSIA. Free information AACC-(PE), Box 1542, Canoga Park, Calif. 91304.

INSTRUCTION

UNIVERSITY DEGREES BY MAIL! Bachelors, Masters, Ph.D.'s. Free revealing details. Counseling, Box 317-PE08, Tustin, California 92680.

LEARN WHILE ASLEEP! HYPNOTIZE! Astonishing details, strange catalog free! Autosuggestion, Box 24-ZD, Olympia, Washington 98507.

LEARN ELECTRONIC ORGAN SERVICING at home. Completely revised course covers latest models including digital, LSI's, synthesizers, etc. NILES BRYANT SCHOOL, PO Box 20153, Sacramento, CA 95820.

PASS FCC EXAMS
TESTS-ANSWERS FOR FCC FIRST AND SECOND CLASS COMMERCIAL LICENSE
The Original FCC Tests-Answers exam manual that prepares you at home for FCC First and Second Class Radioteletype licenses. Newly revised multiple choice exams cover all areas tested on the actual FCC exam. Plus - Self-Study Ability Test. Proven! \$12.95 postpaid. Moneyback Guarantee
COMMAND PRODUCTIONS
Radio Engineering Division
P.O. Box 26348, P. San Francisco, CA 94126

MEDICAL ELECTRONICS TECHNOLOGY, home study. Troubleshoot medical instruments. WTI, P.O. Box 124, Pine-dale, CA 93650.

COLLEGE DEGREES BY SPECIAL EVALUATION OF EXISTING Credentials & Job Experience. Fast, Inexpensive, (614) 863-1791. Guidance, Box 13151-A7, Columbus, Ohio 43213.

YOU CAN NOW EARN A Bachelor, Master, or Doctoral Degree without leaving home. Courses are under faculty guidance. Kensington University, (P.O. Box 2036-M), 512 E. Wilson, Glendale, CA 91209.

ATTENTION ELECTRONIC TECHNICIANS
Highly Effective Home Study BSEE Degree Program for Experienced Electronic Technicians
Our New Advanced Placement Program grants Credit for previous Schooling & Professional Experience. Advance Rapidly! Our 36th Year!
FREE DESCRIPTIVE LITERATURE!
Cook's Institute of Electronics Engineering
DESK 15, P.O. BOX 20345, JACKSON, MS 39209

COLLEGE DEGREES - COURSES - AND DIPLOMAS by mail. Learn how to get an accredited College degree without leaving home. Inquire: Educum Service, 10315-PE, Woodley Ave., #111, Granada Hills, CA 91344.

FOR INVENTORS

PATENT AND DEVELOP your invention. Registered Patent Agent and Licensed Professional Engineer, Send for FREE PATENT INFORMATION every inventor should have. Richard L. Miller, P.E., 3612-E Woolworth Building, New York, NY 10007. (212) 267-5252.

MANUFACTURER SEEKING Patented, Unpatented Inventions. Generous royalties. Advantek International, 1100 17th NW, Washington, DC 20036.

INVENTORS Patent your invention. Free initial consultation. We are registered by the U.S. Government. VICTOR J. EVANS & CO., 4637 Eastern Ave., N.E., Washington, DC 20018. Since 1898.

INVENTIONS WANTED

FREE CONSULTATION • NO IDEA TOO SMALL

Disclosure registration. Potential cash or royalties from manufacturers seeking new ideas. For free information on how to register your ideas. Call or write.

AMERICAN INVENTORS CORP.

59 Interstate Dr. Dept PE
West Springfield, MA 01089 (413) 737-5376
A Free Based Service Company

BUSINESS OPPORTUNITIES

FREE CATALOGS. Repair air conditioning, refrigeration. Tools, supplies, full instructions. Doolin, 2016 Canton, Dallas, Texas 75201.

MECHANICALLY INCLINED individuals desiring ownership of Small Electronics Manufacturing Business — without investment. Write: BUSINESSES, 92-K7 Brighton 11th, Brooklyn, New York 11235.

MECHANICALLY INCLINED INDIVIDUALS

Assemble electronic devices in your home. Knowledge, or experience not necessary. Get started in spare time. Above average profits. \$300 - \$600/Wk possible. Sales handled by others. No investment — Write for free details.

ELECTRONIC DEVELOPMENT LAB

Box 1560PE, Pinellas Park, FL 33565

ERASE DEBTS with little-known law — create wealth!! Details FREE — Blueprints, No. EE8, LaGrangeville, NY 12540.

BORROW \$25,000 "OVERNIGHT." Any purpose. Keep indefinitely! Free Report! Success Research, Box 29070-GH, Indianapolis, IN 46229.

FREE BOOK "2042 Unique Proven Enterprises." Fabulous "unknowns," second inflation income. Haylings-M. Carlsbad, CA 92008.

ATTENTION — T.V. MEN/related fields! HI-PROFIT/LUCRATIVE. YOU can rebuild CRT's for \$3 to \$10 when you own our patented equipment. Lakeside, 4071 Elston, Chicago, IL 60618. (312) 583-6585.

BIG MONEY IN BUSINESS PRINTING! 25% COMMISSION PLUS BIGGEST CASH BONUS! Build your own profitable year around business. Show tremendous line of salesbooks, register forms, unit sets, letterheads, envelopes, invoices, statements, business cards and dozens of other printed products. Lowest prices in industry. Something for every business and professional person. Free sales kit includes ad specialties, calendars, signs and ad matches. No experience needed. Our catalogs are easy to understand. We're over 50 but still young and aggressive, so we can show you the road to a very profitable full or part time career. Free sales kit. National Press, Dept. 170, North Chicago, IL 60064.

MAILORDER OPPORTUNITY! Start profitable home business without experience or capital. Write for free book, case histories, plus complete details. No obligation. Mail Order Associates, Dept 91, Montvale, NJ 07645.

BORROW \$30,000 without interest! All eligible. Repay anytime. Free details. Infohouse, Box 1004, PE8, New York, NY 10003.

WANT YOUR OWN RADIO STATION? Investment/experience unnecessary. Free information. "Broadcasting", Box 130-A8, Paradise, CA 95969.

SPARE TIME FORTUNE in Vinyl Repair. Huge demand creates exceptional profits. We supply everything. Details free. VIP, 2012 Montrose, Chicago, IL 60618.

\$700 PER MONTH EARNINGS possible filling out income tax forms at home or tax office during tax season. We show you how. Simple, quickly learned. Details mailed free. No salesmen. Hurry. Big demand. Federated Tax, 2012 Montrose, Chicago, IL 60618.

14 UNUSUAL WAYS Hobbies Make EXTRA MONEY! FREE details. Write: Entrepreneur, 2311 Pontius Ave., Suite E652, Los Angeles, CA 90064.

GROUND FLOOR OPPORTUNITY WITH NEW COMPANY! Best marketing plan available in the United States today. A superior product line, better incentives and excellent bonus programs combined, offer the most success-oriented plan yet to be announced. Write or call for free information. Enhance Marketing Group, (P), P.O. Box 26563, Salt Lake City, Utah 84126. (801) 467-0473.

MAKE DURABLE BUILDING PLASTIC EASILY. Waterproof, Fireproof, Economical. Bays Laboratory, 2086-2075 Drive, Cedaredge, CO 81413.

REAL ESTATE FORECLOSURES: Representatives needed for this profitable business. No cash required. Free information. Horizon Financial Corporation, Dept. PE 114 Twelfth Avenue, St. Petersburg Beach, FL 33706.

START AN ELECTRONICS NEWSLETTER. No writing ability necessary! Lucrative opportunity. Inquiries \$1.00 (refundable): Publishing, Box 232-PE, (Asst), Boston, MA 02123.

EMPLOYMENT OPPORTUNITIES

ELECTRONICS/AVIONICS EMPLOYMENT OPPORTUNITIES. Report on jobs now open. Details FREE. Aviation Employment Information Service, Box 240E, Northport, New York 11768.

JOBS OVERSEAS - Big money fast. \$20,000 to \$50,000 plus per year. Call 716-842-6000, ext. 4008.

MANUFACTURER'S REPS WANTED for growing electronics firm. Commission basis, we supply promotional materials. Excellent opportunity. Call or write: P.O. Box 2494, Toledo, Ohio 43606. 419-473-0985.

EXCITING POSITIONS AVAILABLE

Rapidly expanding corporation is looking for motivated individuals with practical electronic experience who are either self taught or formally trained for an exciting developing field in design of logic circuits using microprocessors and LSI controllers. Excellent opportunities and good starting pay. Send resume _____
_____ Attention Adrienne.

CREATIVE ENGINEERING, INC.

47 West Jefferson St., Orlando, FL 32801

REAL ESTATE

BIG . . . NEW . . . FREE FALL CATALOG! Over 2,800 top values coast to coast! UNITED FARM AGENCY, 612-EP West 47th, Kansas City, MO 64112.

RUBBER STAMPS

RUBBER STAMPS, BUSINESS CARDS. Many new products. Catalog. Jackson's, E-100, Brownsville Rd., Mt. Vernon, Ill. 62864.

PRINTING OR RUBBER STAMP. Letterheads 500 — \$12.50, envelopes 500 — \$13.50, postage \$2.00. G.S. Graphics, 19411 N.W. 48 Ct., Carol City, FL 33055.

BOOKS AND MAGAZINES

ELECTRONIC MUSIC and home recording in Polyphony magazine. Advanced applications, interviews, projects, computer music. Sample \$2.00. Subscription (6 issues), \$12.00 US/\$14.00 foreign. POLYPHONY, Box P20305, Okla. City, OK 73156.

LOTTERIES make some people millionaires, so can micro-computers. New publication shows how. \$5.00. NEO PUBLISHING, P.O. Box 1368, L.I.C., NY 11101.

FREE CLASSIFIED AD WITH SUBSCRIPTION! Thousands of electronic items for sale or trade each month. Only \$5.00 (in U.S.) to Nuts & Volts, POB 1111-P, Placentia, CAL 92670.

MUSICAL INSTRUMENTS

MUSICAL INSTRUMENTS' HOT LINE! Incredible prices: Amps, PA gear. All instruments. Huge selection. Sam Ash, established 1924. 800-645-3518. NYS: (212) 347-7757.

MOTION PICTURE/VIDEO

VIDEOTAPES - 8MM/16MM MOVIES. TWO 72 page catalogs \$1.00. Both \$1.50. Reelimages, Box 137-PE, Monroe, Connecticut 06468.

RECORDS & TAPES

RECORDS — TAPES! Discounts to 73% All labels; no purchase obligations; newsletter; discount dividend certificates. 100% guarantees. Free details. Discount Music Club, 650 Main St., Dept. 5-0881, New Rochelle, NY 10801.

VINTAGE BROADCASTS. Thousands on reel or cassette. Catalog: \$2.00. BRC, 17173 Westbrook, Livonia, MI 48152.

DO-IT-YOURSELF

PRINTED CIRCUIT Boards with running water! Technological breakthrough. Precise reproduction. Ideal for beginners. Free info. COVAL, Dept. PE8, 2706 Kirby, Champaign IL 61820.

PATENT INVENTIONS YOURSELF. Free examination 100 page book. Pay \$5.00 later if satisfied. Send name, address: "DO-IT-Yourself Patent Guide-PEY," P.O. Box 2774, Pittsburgh, PA 15230.

SAVE \$\$\$! Satellite Television Manual, Source Catalogue. Dishes, receivers, complete systems. Design, programming. Illustrations, photos. \$4.95. Westcolony, Dept-D, Box 9471, Fresno, CA 93792.

WELDING ALUMINUM? It's easy with the LUMIWELD Process. Designed for "Do-It-Yourselfers". Joins Aluminum to Copper. No special skills or expensive equipment. Money-back guarantee. For details: Send S.A.S.E. Dept. PE., ALUMISMITHS Inc., P.O.B. 517, DeLand, FL 32720. Featured in Pop. Sci. March, 1980.

CAR-GUARD. Protect your car from theft. Inexpensive. Easy detailed plans. \$2.50. HSC, Rt 1, Box 388, Mora, MN 55051.

HYPNOTISM

FREE Hypnotism. Self-Hypnosis. Sleep Learning Catalog! Drawer H400, Ruidoso, New Mexico 88345.

MISCELLANEOUS

MPG INCREASED! Bypass Pollution Devices easily. REVERSIBLY!! Free details — Posco GEE8, LaGrangeville, NY 12540.

AUTOMOBILE RE-TUNING FOR MAXIMIZED ECONOMY. DETAILS FREE! Techneering, Box 12191DD, Norfolk, VA 23502.

Shelf Conscious?

Now you can organize your copies of
Popular Electronics

Now your magazines can be a handsome addition to your decor, well organized, and easy to find, thanks to these durable library-quality cases or binders. They're made of luxury-look leatherette over high-quality binders board. And both styles are custom-designed for this or any magazine you save, with size, color, and imprint selected by the publisher. FREE transfer foil included for marking dates and volumes.

Magazine binders hold a year's issues on individual snap-in rods, combining them into one volume. \$7.95 each; 3 for \$22.50; 6 for \$42.95. Mixed titles OK for quantity prices.

Open-back cases store your issues for individual reference. \$6.95 each; 3 for \$19.75; 6 for \$37.50. Mixed titles OK for quantity prices.

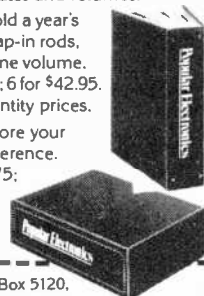

Popular Electronics, P.O. Box 5120, Philadelphia, PA 19141

Please send: Cases Binders Quantity

Popular Electronics: _____
(Other titles): _____

ENCLOSED IS \$ _____ * Add \$1.00 per order for post. & handling. Outside USA add \$2.50 per unit ordered. Send U.S. funds only. CHARGE ORDERS accepted for American Express, VISA, or MC. PHONE 24 HRS. TOLL FREE 800-431-2731. NY State only 800-942-1940. BY MAIL include credit card name, #, and exp. date. MINIMUM CHARGE ORDER \$10.

Print Name _____

Address _____

City/State/Zip _____

* Residents of PA add applicable sales tax.

ELECTRONICS WORLD®

Personal Electronics News

STANDARDS FOR TELETEXT IN THE U.S. are called for in a petition filed with the Federal Communications Commission by the National Association of Broadcasters. Though filed in support of a similar petition by the United Kingdom teletext industry urging adoption of its Ceefax system, the NAB action does not endorse any specific system. Rather, it asks that standards be set as soon as possible. Opposition to the establishment of teletext standards comes from the cable industry, which claims that because of the currently fluid technology such action would be premature. Under supervision of the FCC's broadcast bureau, the cable industry has been participating in trials of video text systems similar to teletext.

SATELLITE EARTH STATIONS IN KIT FORM will be added to the Heathkit line this year. The antenna and other items of essential hardware will be manufactured by Scientific-Atlanta of Atlanta, Georgia, but, according to a company spokesman, "Heath will add significant value to the system in styling and design of the in-home receiver console and convenience features like Zenith 'Space Command' remote control which are not presently available in other home satellite receivers."



A NATIONWIDE ELECTRONIC MAIL NETWORK connecting New York and a group of other cities including Los Angeles, San Francisco, Chicago, Boston, Washington, and Hartford is now a reality. "Q Mail," as the system is called, can transmit a standard-sized letter across the country in 45 seconds and can handle legal-sized documents, charts, diagrams, and hand-written material as well, using Rapicom 1000 digital facsimile transceivers. The system has started with 12 service locations and is expected to expand to 60 by the end of 1981.

WIRETAPPING IS A MAJOR CONCERN of business executives says Sharper Image, which retails a \$49 phone attachment that detects wiretaps and other forms of telephone eavesdropping. The San Francisco company sold 1000 Phone Guards in the first 11 days that the device was offered in its catalog. A random survey of buyers revealed that 47% were concerned about wiretapping by business rivals; 40% were fearful of eavesdropping by company operators, supervisors, and others where they work; 12% wanted extension privacy at home; and 1% were trying to shield their private recreational activities from law-enforcement officials.

DIGITAL SOUND FOR THE HOME came one small step closer as Philips and Sony demonstrated working prototypes of their jointly developed Compact Disc system late in May. Based on the technology used in the laser video disc, the 120-mm ($4\frac{3}{4}$ " diameter disc is 1.2 mm (0.05") thick and plays in stereo for one hour per side. Rated frequency response is flat 20 to 20,000 Hz with S/N, dynamic range, and channel separation all in excess of 90 dB. Harmonic distortion is said to be less than 0.05%, and wow and flutter are unmeasurable.

Unlike the prototype shown by Philips in 1979, the current Compact Disc uses a 16-bit, linear quantization; sampling frequency is 44.1 kHz. The error-correcting system is capable of handling error bursts up to 4000 bits long, and, when this figure is exceeded, can conceal errors up to 14,000 bits long.

Compact Disc players should be available from Sony late in 1982, with those from Philips following in 1983. Introductory prices, say the manufacturers, will be competitive with those of high-quality phonograph playback equipment. The discs themselves are slated to retail for about 30% more than conventional discs of premium quality.

CONFERENCES BY TELEVISION are the goal of an application filed by AT&T with the FCC requesting permission to construct and operate facilities for an initial 11-city video teleconferencing service. Both satellite and terrestrial digital transmission facilities will be used to provide "Picturephone" with audio-visual communications between conference rooms that may be either public rooms or private rooms constructed on a customer's premises. Facilities will include a graphics display unit, a hard copy machine, and video tape recording capability. Initially, the service is scheduled to be in operation in December 1981 between New York and Washington, DC with 39 other cities to be added in two years.

The Professional Alternatives: The HP-41C And The NEW HP-41CV.



Now Hewlett-Packard offers you a choice in full performance alphanumeric calculators. The new HP-41CV has five times more built-in memory than the HP-41C. Both calculators are powerful yet easy to use. You can communicate with words as well as numbers. For example, label and call up programs by name and receive meaningful prompts while executing programs. Continuous Memory retains programs and data even while the machines are off. Need lots of memory? Choose the HP-41CV. If your needs are more modest, select the HP-41C. The HP-41C can grow with you by adding memory modules.

BOTH OFFER CONTINUAL GROWTH POTENTIAL

By themselves the HP-41C and HP-41CV may be all the calculator you'll ever need. But if you need more capability, you can expand your calculator into a complete computational system. Each calculator has four ports which allow you to plug in a Printer/Plotter, an "Extra Smart" Card Reader or an Optical Wand for reading bar codes. Application Pacs and Solution Books offering complete solutions are also available. And now, HP offers a new service: Custom Modules (ROM's) from your software for high volume, unique problem-solving needs. Costs are reasonable. Call us.

ONLY FROM HEWLETT-PACKARD

Powerful yet easy to use calculators. A full line of peripherals and software. A time-proven logic system-RPN. No equals key. Less keystrokes. Computation is displayed as you proceed. The new HP-41CV and the HP-41C are available now, with new low prices. For details and address of nearest dealer, CALL TOLL-FREE 800-547-3400, Dept. 254A; except Hawaii/ Alaska. In Oregon, 758-1010. Or write Hewlett-Packard, Corvallis, OR 97330, Dept. 254A.

611/07

HP-41C, \$250; HP-41CV, \$325; Optical Wand, \$125; Printer/Plotter, \$385; Plug-in Card Reader, \$215; Quad Memory Module (brings HP-41C to HP-41CV memory capacity), \$95; Memory Module, \$30; Application Pacs, most are \$30; Solution Books, \$12.50.

Prices are suggested retail excluding applicable state and local taxes—Continental U.S.A., Alaska and Hawaii.

CIRCLE NO. 28 ON FREE INFORMATION CARD

 **HEWLETT
PACKARD**

IN LESS THAN 30 SECONDS...



CLEAN RECORDS,



CLEAR SOUND.



Safe record care is easy with the D4™ System. In less than 30 seconds, you can remove harmful microdust and other debris that can cause permanent damage to your favorite recordings. Studies prove it.

But if scientific studies mean nothing to you, let the sound prove that D4 works. It's dirt free and static free sound ... clearly better sound.

The Discwasher D4 Record Care System. It's worth the little time it takes ... and it doesn't take long to discover it works.

discwasher®
PRODUCTS TO CARE FOR YOUR MUSIC

1407 North Providence Road, Columbia, MO 65201 USA
A DIVISION OF JENSEN an ESMARK Company

CIRCLE NO. 55 ON FREE INFORMATION CARD