

# Popular Electronics®

WORLD'S LARGEST-SELLING ELECTRONICS MAGAZINE

JUNE 1980/95¢

## **First Look!** RCA's New XL-100 Color TV "Space Battle" Computer Program Repel Small Animals with Harmless Pulses **Home Video Recorders Come of Age!**

● How they work ● How to buy ● What's coming up



**In This Issue:**

303692 DRX 6450M051 341D DEC83  
L. CARKNELL JR DR 6450 HYTELEBDD CA 95014  
CUPERTINO CA 95014

ie "Source" and  
ie-Sharing Systems



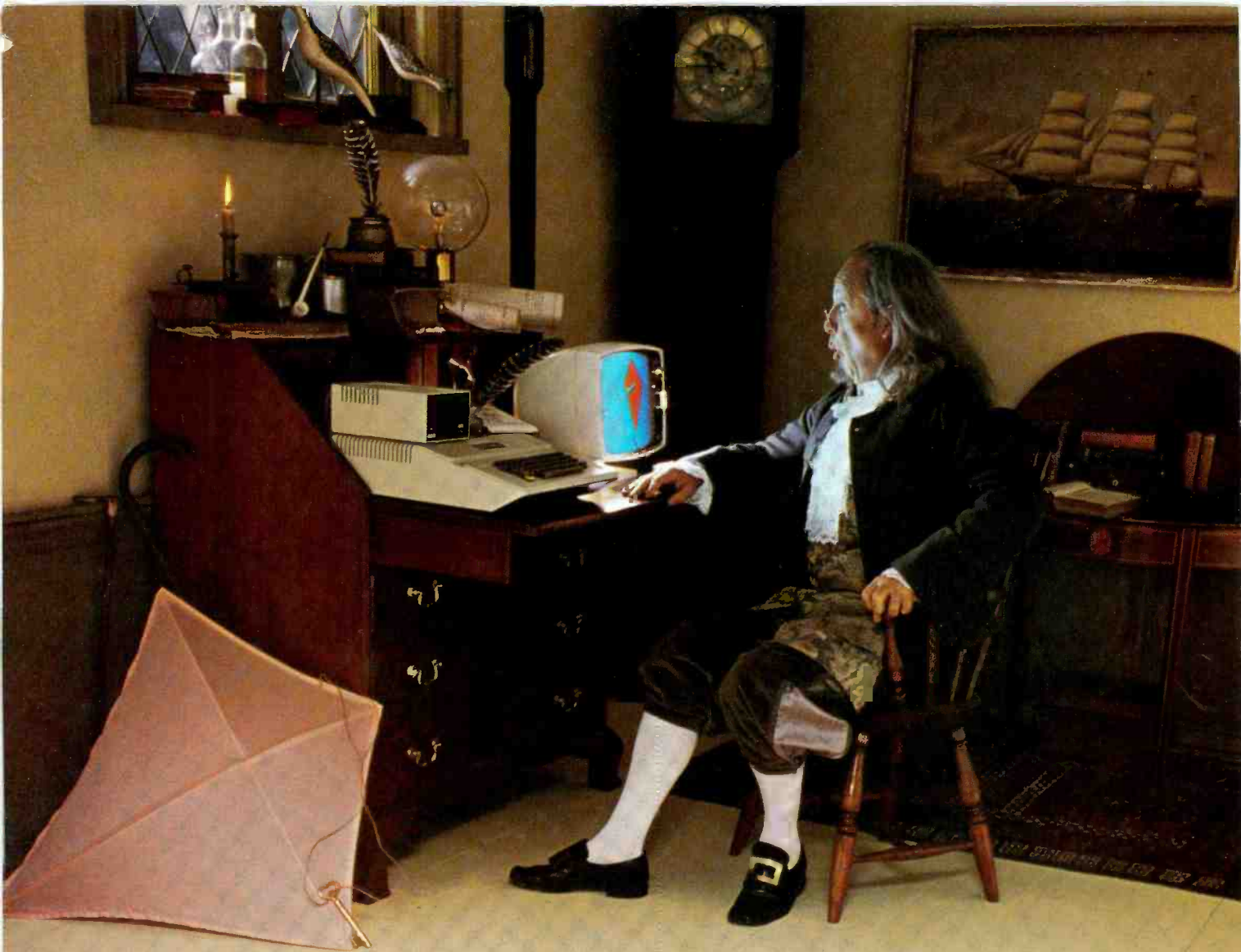

# What kind of man owns his own computer?

Rather revolutionary, the whole idea of owning your own computer? Not if you're a diplomat, printer, scientist, inventor . . . or a kite designer, too. Today there's Apple Computer. It's designed to be a *personal* computer. To uncomplicate your life. And make you more effective.

## It's a wise man who owns an Apple.

If your time means money, Apple can help you make more of it. In an age of specialists, the most successful specialists stay away from uncreative drudgery. That's where Apple comes in.

Apple is a real computer, right to the core. So just like big computers, it manages data, crunches numbers, keeps records, processes your information and prints reports. You concentrate on what you do best. And let Apple do the rest. Apple makes that easy with three programming languages—including Pascal—that let you be your own software expert.

## Apple, the computer worth not waiting for.

Time waiting for access to your company's big main-frame is time wasted. What you need in your department —

on your desk — is a computer that answers only to you . . . Apple Computer. It's less expensive than timesharing. More dependable than distributed processing. Far more flexible than centralized EDP. And, at less than \$2500 (as shown), downright affordable.



## Visit your local computer store.

You can join the personal computer revolution by visiting the Apple dealer in your neighborhood. We'll give you his name when you call our toll free number (800) 538-9696. In California, (800) 662-9238.

Apple Computer, 10260  
Bandle Drive,  
Cupertino,  
CA 95014.



CIRCLE NO. 7 ON FREE INFORMATION CARD



# Olivetti Break- through

*The world's smallest electronic printer will never run out of paper, ink or batteries thanks to Olivetti, JS&A and some incredible new technology.*

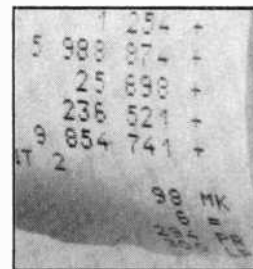

*The new pocket-sized Olivetti calculator slides open to unveil one of the most advanced printing heads ever developed.*

It's a major breakthrough. That calculator shown above is the most advanced printing calculator in the world.

## SLIP TOP PRINTER

The new Olivetti Logos 9 is only 1" x 2½" x 4⅝" — smaller than many cigarette packages. It has a full 12-digit liquid crystal display with add mode and full-floating or fixed position decimal.

To turn the unit into a printer, you simply slide up the top of the unit to expose the world's smallest and one of the most precise printing heads. The printing head prints letters and numbers, identifies each entry and even clearly separates groups of three whole numbers for easy readability.

## PLENTY MORE

If its size and printing head are breakthroughs, so is its paper system. The paper is loaded in special cartridges with enough paper per cartridge for 1300 entries. All you do is simply pop a cartridge into the bottom of the unit each time you change rolls. It's the most convenient way ever designed to change a roll of paper for a printing calculator.

But if you're like most Americans, you'd be concerned about paper supply. Where do you get those special cartridges, and how do you know if you can get them years from now?

That's where JS&A comes in. A 32-roll supply — all you'll ever need for three full years — is only \$16. That's enough paper for 41,000 entries or approximately 52 line entries each working day for three full years.

But even more important, within one year stationery stores will stock the cartridges, and we predict that the Olivetti cartridge will become a standard in the industry.

## NO INK CARTRIDGES

The paper is a new type that looks exactly like conventional paper. But the paper, when struck, leaves a clear sharp image without the use of ink. So there's no messy cartridge required and no space needed to store one. You'll never need ink again.

The rechargeable batteries last for 8,000 lines when you use just the printer and 80 hours using just the liquid crystal display. The batteries can be recharged 500 times, so theoretically the batteries should last for 300 rolls of paper, or more than nine times the life of your paper supply. The batteries can also be easily replaced.

## POWERFUL COMPUTER

The features looked great. The world's smallest size, the paper roll convenience, the no-ink system, the battery life and the large 12-digit liquid crystal display were enough to convince us, but would the new Olivetti be considered a toy? Then we learned about its computational power and features which we feel are better than many of the most professional full-featured printing calculators.

**Speed** It's the world's fastest small printer with a speed of 2.1 lines per second. The unit also has a buffer so if you enter data faster than the unit, it will still print out each entry.

**Memories** The Logos 9 has two separate memories. One is an accumulating memory, and the other is a fully independent memory. And the display and printer indicate which memory is on the paper tape.

**Printing Head** The totally new printing head is a semi-alpha numeric system which labels all entries with letters to indicate the entry. For example LP is list price and CNT means item count.

**Clock** The unit is so complete, Olivetti even threw in a digital clock function. Your unit will display accurate time when the 12-digit display is not in use.

**Gross Margin** It automatically computes everything from gross margins to discounts and retail pricing. You just enter your percentage mark-ups in its memory, and it will automatically compute the results while retaining the formula and percentage in memory.

**Plus More** It has automatic round off, letting you select which figure to round off to. You can add a column of figures and then average your calculations automatically. The full-information liquid crystal display will tell you everything from when you're in the printer mode to whether you have something in memory and in which memory.

The technological breakthroughs in the Logos 9 were possible because Olivetti was able to eliminate the many interface components between the integrated circuit and the printing head. This was all made possible because Olivetti designed the entire system, not just a few of the components as is the case with most calculators.

So there it was. Great features, great convenience and great value for only \$89.95 complete with batteries, charger and 90-day limited warranty. For \$16 more, you can get 32

cartridges — all the paper you'll ever need for three years or for \$10 more you can get 16 cartridges. So impressed are we with the Olivetti Logos 9 that we are making the following offer:

## FREE TRIAL OFFER

We urge you to test the Olivetti Logos 9 now. Order one for our 30-day no obligation trial. See the clear and easy-to-read paper tape and display. Use it as a pocket calculator, and carry it in your briefcase wherever you go. Experience the convenience of always having a printing calculator there whenever you need a permanent record of your transactions.

After 30-days of actual use, decide if you want to keep it. If you do you'll own the smallest, most advanced and convenient pocket printing calculator in the world. If for any reason you're not completely satisfied, simply return your unit within 30-days for a prompt and courteous refund, including your \$2.50 postage and handling. You can't lose.

Olivetti selected JS&A to exclusively introduce this exciting new product. With its solid-state design and high quality printing mechanism, the Olivetti should not require service. But if service is ever required, Olivetti maintains a convenient service-by-mail center as close as your mailbox.

To order your unit for our trial, simply send your money order or personal check for \$89.95 plus \$2.50 for postage and handling (personal check orders, allow 20 days to clear our bank) to the address below, or credit card buyers may call our toll-free number below. Add \$16 for 32 paper cartridges or \$10 for 16 cartridges. (Illinois residents please add 6% sales tax.)

Who would have imagined a printing calculator this small and this convenient with this much computational power just a few months ago? The Olivetti Logos 9 deserves your test. Order one at no obligation, today.

**JS&A** PRODUCTS  
THAT  
THINK®

Dept. PE One JS&A Plaza  
Northbrook, Ill. 60062 (312) 564-7000  
Call TOLL-FREE ..... 800 323-6400  
In Illinois Call ..... (312) 564-7000

©JS&A Group, Inc., 1980



**The easiest, least expensive way to generate  
spectacular multi-color graphics, sharp two-color alphanumeric:  
Your computer, a color tv set and the Percom Electric Crayon™.**

Add the Electric Crayon™ to your system and your keyboard becomes a palette, the tv screen your medium.

You dab and stroke using one-key commands to create dazzling full-color drawings, eye-catching charts and diagrams.

Or you run any of innumerable programs. Your own BASIC language programs that generate dynamic pyrotechnic images, laugh-provoking animations.

From a combined alphanumeric-semi-graphics mode to a high resolution 256- by 192-element full graphics mode, the microprocessor-controlled Electric Crayon™ is capable of generating 10 distinctly different display modes.

Colors are brilliant and true, and up to eight are available depending on the mode.

As shipped, the Electric Crayon™ interfaces a TRS-80\* computer. It may be easily

adapted for interfacing to any computer or to an ordinary parallel ASCII keyboard.

**But that's not all**

The Electric Crayon is not just a color graphics generator/controller.

It is also a complete self-contained control computer. With built-in provision for 1K-byte of on-board program RAM, an EPROM chip for extending EGOS™, its on-board ROM graphics OS, and a dual bidirectional eight-bit port — over and above the computer/keyboard port — for peripherals. The applications are endless.

Shipped with EGOS™, 1K-byte of display memory and a comprehensive user's manual that includes an assembly language listing of EGOS™ and listings of BASIC demo programs, the Electric Crayon™ costs only \$249.95.

**Options include:**

- LEVEL II BASIC color graphics programs on minidiskette: \$17.95.
- A 34-conductor ribbon cable to interconnect the Electric Crayon™ to a TRS-80\*: \$24.95.
- RAM chips for adding refresh memory for higher density graphics modes: \$29.95 per K-byte.
- Electric Crayon™ Sketchpad, a sketching grid of proportioned picture elements (pixels) in a tv aspect ratio. For 128 x 192 or 256 x 192 graphics modes. 11-inch by 17-inch, 25-sheet pads: \$3.95 per pad.

**SYSTEM REQUIREMENTS:** the video circuitry of the Electric Crayon™ provides direct drive input to a video monitor or modified tv set. An internal up-modulator for rf antenna input may be constructed by adding inexpensive components to the existing video circuitry.

Prices and specifications subject to change without notice.

™ = trademark of Percom Data Company, Inc.

\* = trademark of Tandy Radio Shack Corporation which has no relationship to Percom Data Company.



PERCOM DATA COMPANY, INC.  
211 N. KIRBY GARLAND, TEXAS 75042  
(214) 272-3421

Get into computer color graphics the easy, low-cost way with a Percom Electric Crayon™. Available at Percom dealers nationwide. Call toll-free, **1-800-527-1592**, for the address of your nearest dealer, or to order direct if there is no Percom dealer in your area.

CIRCLE NO. 57 ON FREE INFORMATION CARD





About the cover:

The photo exemplifies why VCRs, featured in this issue, have become so popular. One can buy prerecorded movies such as Warner Bros.' SUPERMAN for playback on TV or make your own home movies by adding a video camera. A portable VCR system, such as Panasonic's PV-3100 VHS, shown, adds on-the-go outdoor versatility.

(SUPERMAN is a trademark of DC Comics Inc.)

Cover photo by Don Carrol

**JOE MESICS**  
Publisher

**ARTHUR P. SALSBERG**  
Editorial Director

**HAROLD A. RODGERS**  
Executive Editor

**LESLIE SOLOMON**  
Technical Director

**JOHN R. RIGGS**  
Managing Editor

**EDWARD I. BUXBAUM**  
Art Director

**ALEXANDER W. BURAWA**  
Features Editor

**JOHN J. McVEIGH**  
Technical Editor

**ANDRE DUZANT**  
Technical Illustrator

**CARMEN ROBLES**  
Production Editor

**JEFF NEWMAN**  
Editorial Assistant

*Contributing Editors*  
**Carl Warren, Lee Feisenstein**  
**Glenn Mauser, Julian Hirsch, Forrest Mims**

**LINDA BLUM**  
Advertising Service Manager

**MARIE MAESTRI**  
Executive Assistant

**EDGAR W. HOPPER**  
Publishing Director

## Feature Articles

POPULAR ELECTRONICS TESTS NEW RCA XL-100 COLOR TV CHASSIS / *Stan Prentiss* \_\_\_\_\_ 45  
 VIDEO CASSETTE RECORDERS: RISING STARS OF HOME ENTERTAINMENT / *Ivan Berger* \_\_\_\_\_ 51  
*How VCRs work; how to buy them; and a preview of upcoming models.*  
 PLAY "SPACE BATTLE" ON YOUR VIDEO MONITOR / *Donald R. Schroyer* \_\_\_\_\_ 61  
*Exciting visual game program for 1802-based computers.*  
 ENGLISH BROADCASTS AUDIBLE IN NORTH AMERICA / *Glenn Hauser* \_\_\_\_\_ 87

## Construction Articles

DIGITALLY PROGRAMMED VARMINT ZAPPER / *Fritz Mueller* \_\_\_\_\_ 64  
*Electrified enclosure keeps away intruding animals.*  
 A LOW-COST 16-LED LOGIC MONITOR / *Tom Kronenwetter* \_\_\_\_\_ 69  
*Checks all signals on an IC simultaneously.*  
 BUILD A WAH-WAH PEDAL FOR SPECIAL MUSICAL EFFECTS / *Fred Puccetti* \_\_\_\_\_ 72  
*Low-cost add-on circuit livens up your music.*

## Columns

ENTERTAINMENT ELECTRONICS / *Harold A. Rodgers* \_\_\_\_\_ 18  
*The Pursuit of Realism.*  
 COMPUTER BITS / *Carl Warren* \_\_\_\_\_ 39  
*Time-Sharing Systems.*  
 COMPUTER SOURCES / *Leslie Solomon* \_\_\_\_\_ 42  
 EXPERIMENTER'S CORNER / *Forrest M. Mims* \_\_\_\_\_ 76  
*Optical Fiber Communications, Part 2.*  
 AMATEUR RADIO / *Karl Thurber* \_\_\_\_\_ 82  
*Hamfests are Fun!*

## Audio Equipment Reviews

AKG MODEL K-340 ELECTROSTAT DYNAMIC HEADPHONE \_\_\_\_\_ 22  
 SANSUI MODEL G-5700 AM/FM STEREO RECEIVER \_\_\_\_\_ 26  
 ONKYO MODEL A-7090 INTEGRATED STEREO AMPLIFIER \_\_\_\_\_ 30

## Departments

EDITORIAL / *Art Salsberg* \_\_\_\_\_ 4  
*New Video Test Reports.*  
 LETTERS \_\_\_\_\_ 6  
 OUT OF TUNE \_\_\_\_\_ 6  
 NEW PRODUCTS \_\_\_\_\_ 12  
 OPERATION ASSIST \_\_\_\_\_ 93  
 ADVERTISERS INDEX \_\_\_\_\_ 100  
 PERSONAL ELECTRONICS NEWS \_\_\_\_\_ 110

POPULAR ELECTRONICS (ISSN 0032-4485): Published monthly by Ziff-Davis Publishing Company, at One Park Avenue, New York, NY 10016. Philip B. Korsant, President; Selwyn Taubman, Treasurer; Bertram A. Abrams, Secretary. One year subscription, U.S. and Possessions, \$14.00; Canada, \$17.00; all other countries, \$19.00, cash orders only, payable in U.S. currency. COPYRIGHT © 1980 BY ZIFF-DAVIS PUBLISHING COMPANY. ALL RIGHTS RESERVED.

# Popular Electronics®

ZIFF-DAVIS PUBLISHING COMPANY  
Editorial and Executive Offices  
One Park Avenue, New York, New York 10016  
212-725-3500

Joseph E. Mesics  
Publisher (725-3568)

Richard F. Govatski

Advertising Manager (725-3939)

Bonnie B. Kaiser

Eastern Adv. Mg., (725-3580)

Midwestern Office

Ted Welch

Suite 1400, 180 N. Michigan Ave.,  
Chicago, IL 60601 (312-346-2600)

Western Office

3460 Wilshire Blvd., Los Angeles, CA 90054  
213-387-2100

Western Representative: Norm Schindler

Jon Marshall

7050 Owensmouth Ave., #209

Canoga Park, CA 91303 (213-999-1414)

Japan: James Yagi, Oji Palace Aoyama;

6-25, Minami Aoyama, 6 Chome, Minato-Ku,

Tokyo, 407-1930/6821, 582-2851

ZIFF-DAVIS PUBLISHING COMPANY

Philip B. Korsant, President

Furman Hebb, Executive Vice President

Phillip T. Heffernan, Sr. Vice President

Edward D. Muhlfield, Sr. Vice President

Philip Sine, Sr. Vice President,

Lawrence Sporn, Vice President, Circulation and Marketing

Richard Friese, Sr. Vice President

Baird Davis, Vice President, Production

George Morrissey, Vice President

Sidney Holtz, Vice President

Albert S. Traina, Vice President

Paul H. Chook, Vice President

Edgar W. Hopper, Vice President

Robert N. Bavier, Jr., Vice President

Selwyn Taubman, Treasurer

Bertram A. Abrams, Secretary

W. Bradford Briggs, Vice Chairman

ZIFF CORPORATION

William Ziff, Chairman

I. Martin Pompadur, President

Hershel B. Sarbin, Executive Vice President

POPULAR ELECTRONICS, June 1980, Volume 17, Number 6. Published monthly at One Park Avenue, New York, NY 10016. One year subscription rate for U.S. and Possessions, \$14.00; Canada, \$17.00; all other countries, \$19.00 (cash orders only, payable in U.S. currency). Controlled Circulation Postage Paid at Salem, Illinois 62881. Authorized as second class mail by the Post Office Department, Ottawa, Canada, and for payment of postage in cash.

POPULAR ELECTRONICS including ELECTRONICS WORLD. Trade Mark Registered. Indexed in the Reader's guide to Periodical Literature.

COPYRIGHT © 1980 BY ZIFF-DAVIS PUBLISHING COMPANY. ALL RIGHTS RESERVED.

Ziff-Davis also publishes Boating, Car and Driver, Cycle, Flying, Popular Photography, Skiing, Stereo Review, Electronic Experimenter's Handbook, Tape Recording & Buying Guide, Stereo Directory & Buying Guide, and Communications Handbook.

Editorial correspondence: POPULAR ELECTRONICS, 1 Park Ave., New York, NY 10016. Editorial contributions must be accompanied by return postage and will be handled with reasonable care; however, publisher assumes no responsibility for return or safety of manuscripts, art work, or models submitted.

Forms 3579 and all subscription correspondence; POPULAR ELECTRONICS, Circulation Dept. P.O. Box 2774, Boulder, CO 80302. Please allow at least eight weeks for change of address. Include your old address, enclosing, if possible, an address label from a recent issue.

Permissions. Materials in this publication may not be reproduced in any form without permission. Requests for permission should be directed to Jerry Schneider. Rights and Permissions, Ziff-Davis Publishing Co., One Park Ave., New York, NY 10016.

The publisher has no knowledge of any proprietary rights which will be violated by the making or using of any items disclosed in this issue.



Member Audit Bureau  
of Circulations



## Editorial

### New Video Test Reports

A long, long time ago, most people with a serious interest in electronics were aware of which television receivers had superior circuit designs and, as a consequence, produced the best video pictures in given reception areas. Since the advent of color television and solid-state circuitry, this knowledge has seemingly passed us by. Starting with this issue, POPULAR ELECTRONICS will change all this.

PE will now regularly feature a thorough evaluation of a video product—a color TV receiver, video cassette recorder, TV camera, or video disc player. Moreover, most models examined will be *previews!* That is, the home entertainment model reported upon will be the latest one, just barely reaching the dealers' shelves when the test report is published.

As a consequence, PE readers, who are major buyers of these "high ticket" products as a result of their generally high income bracket and affinity for things electronic, will be able to make judicious buying judgments. I'm sure, too, that you'll be pleased to be able to finally respond with confidence to all your relatives, friends and neighbors who continually ask you for recommendations on which model to buy. Now you will indeed be the fully rounded local expert on entertainment electronics.

Color television receivers, including projection TV, will become increasingly more important in our lives for both entertainment and education, of course. As you know, TV has already become the central component for a variety of new products and services: video cassette machines, electronic video games, personal computers, and cable TV programs. Coming up fast, too, are video discs, interactive two-way TV, and improved TV sound. Given the rising cost of automobile gasoline, restaurant prices, etc., it's expected that more and more people will chart an in-the-home entertainment course, which must include video and audio. The combined market for video cassette recorders and video disc players alone will reach \$4.2 billion in 1985, predicts Ken Ingram, Magnavox's Marketing Veep.

Stan Prentiss, a well-known TV receiver consultant, will be putting all the video products through their paces in his lab every month. He's authored 36 books on electronic equipment and hundreds of magazine articles.

Joining us this month, too, as a regular contributor is Carl Warren, who'll be handling the "Computer Bits" column every month. Carl was formerly chief editor of *Interface Age* magazine, and is currently Western editor for *EDN*, a professional electronic engineering magazine. For the latter, he covers microcomputers and peripherals, ferreting out new developments in these areas. Therefore, he'll be on the road for the greater part of his working week, where his technical reportorial expertise will provide PE readers with fast-breaking information in the small-computer field as well as practical-use computer tips.

*Art Salsberg*

POPULAR ELECTRONICS



# The home computer you thought was years away is here.



## C8P DF \$2,895

Ohio Scientific's top of the line personal computer, the C8P DF. This system incorporates the most advanced technology now available in standard configurations and add-on options. The C8P DF has full capabilities as a personal computer, a small business computer, a home monitoring security system and an advanced process controller.

### Personal Computer Features

The C8P DF features ultra-fast program execution. The standard model is twice as fast as other personal computers such as the Apple II and PET. The computer system is available with a GT option which nearly doubles the speed again, making it comparable to high end mini-computer systems. High speed execution makes elaborate video animation possible as well as other I/O functions which until now, have not been possible. The C8P DF features Ohio Scientific's 32 x 64 character display with graphics and gaming elements for an effective resolution of 256 x 512 points and up to 16 colors. Other features for personal use include a programmable tone generator from 200 to 20KHz and an 8 bit companding digital to analog converter for music and voice output, 2-8 axis joystick interfaces, and 2-10 key pad interfaces. Hundreds of personal applications, games and educational software packages are currently available for use with the C8P DF.

### Business Applications

The C8P DF utilizes full size 8" floppy disks and is compatible with Ohio Scientific's advanced small business operating system, OS-65U and two types of information management systems, OS-MDMS and OS-DMS.

The computer system comes standard with a high-speed printer interface and a modem interface. It features a full 53-key ASCII keyboard as well as 2048 character display with upper and lower case for business and word processing applications.

### Home Control

The C8P DF has the most advanced home monitoring and control capabilities ever offered in a computer system. It incorporates a real time clock and a unique FOREGROUND/BACKGROUND operating system which allows the computer to function with normal BASIC programs at the same time it is monitoring external devices. The C8P DF comes standard with an AC remote control interface which allows it to control a wide range of AC appliances and lights remotely without wiring and an interface for home security systems which monitors fire, intrusion, car theft, water levels and freezer temperature, all without messy wiring. In addition, the C8P DF can accept Ohio Scientific's Votrax voice I/O board and/or Ohio Scientific's new universal telephone interface (UTI). The telephone interface connects the computer to any touch-tone or rotary dial telephone line. The computer system is able to answer calls, initiate calls and communicate via touch-tone signals, voice output or 300 baud modem signals. It can accept and decode touch-tone signals, 300 baud modem signals and record incoming voice messages. These features collectively give the C8P DF capabilities to monitor and control home functions with almost human-like capabilities.

### Process Controller

The C8P DF incorporates a real time clock, FOREGROUND/BACKGROUND operation and 16 parallel I/O lines. Additionally a universal

accessory BUS connector is accessible at the back of the computer to plug in additional 48 lines of parallel I/O and/or a complete analog signal I/O board with A/D and D/A and multiplexers.

Clearly, the C8P DF beats all existing small computers in conventional specifications plus it has capabilities far beyond any other computer system on the market today.

C8P DF is an 8-slot mainframe class computer with 32K static RAM, dual 8" floppies, and several open slots for expansion.

## C8P \$950

Or get started with a C8P with cassette interface, 8K BASIC-in-ROM which includes most of the features of the C8P DF except the real time clock, 16 parallel I/O lines, home security interface and accessory BUS. It comes with 8K static RAM and Ohio Scientific's ultra-fast 8K BASIC-in-ROM. It can be expanded to a C8P DF later. Base price \$950. Virtually all the programs available on disk are also available for the C8P cassette system on audio cassette.

Computers come with keyboards and floppies where specified. Other equipment shown is optional.

For literature and the name of your local dealer, CALL 1-800-321-6850 TOLL FREE.

**OHIO SCIENTIFIC**  
1333 SOUTH CHILLICOTHE ROAD  
AURORA, OH 44202 • (216) 831-5600



# Letters

## Sundial Improvement

In the "Solar-Powered Sundial" (March 1980), it is possible for the NiCad batteries to be damaged when light sensors are fully illuminated and all four FETs are turned on. In this case, the FETs form a low-resistance path, effectively shorting the solar cells and the battery.

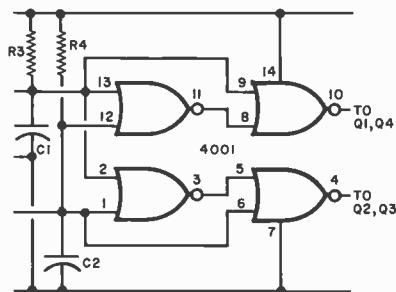

Here is a simple circuit I propose as a substitute. It replaces the CD4069 hex inverter

with a CD4001 quad 2-input NOR gate connected in what is essentially an exclusive-OR function. In this case, the voltage applied to the FETs is low when both light sensors are fully illuminated or both are dark. The FET bridge functions normally when there is a difference in illumination on the light sensors.—*D. O Shelton, Virginia Beach, VA 23460.*

## Testing the Econometer

In the "Automotive Econometer" (February 1980), in describing the preliminary checkout procedure, the SNS (sense) point should be grounded through a 1000-ohm resistor, not a jumper wire, to test the effects of

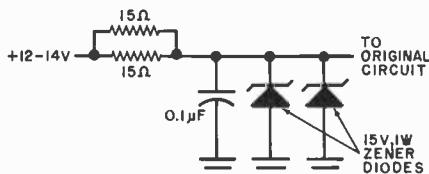

rotating *R3*. Also, those who want to add transient suppression to the project can add the circuit shown here between the positive supply and the remainder of the circuit.—*S. Wynman, Brooklyn, NY.*

## Relays Still in Use

I was pleased to see the article by Al Synor entitled "An Experimenter's Guide to Relay Control" in the February 1980 issue

of your fine publication. Relays may be old, but they continue to find use in many pieces of equipment today.—*Mark W. Persons, Brainerd, MN.*

## Darkroom Sentinel Rectifier

For the "Photo Darkroom Sink Sentinel" (February 1980), I find that the rectifier specified (Radio Shack #276-1626) has been discontinued. Can you recommend a substitute? —*W. E. Bunting, California, MD.*

*You can use any full-wave bridge rectifier rated for about 1 A, 50 PIV, such as Radio Shack's No. 276-1161.—Ed.*

# Out of Tune

In "Build a Hand-Held LED Spectrum Analyzer" (September 1979), in Fig. 1, *R31* should be *R1*; in Fig. 3, on *IC8C*, pins 8 and 9 should be interchanged and on *IC5*, the pin between 4 and 10 should be 7 not 9; in Fig. 6, at upper right, connected to *R81* and *R82*, should be *C33* not *C34* and in the center, connected to *Q11* and *R88*, should be *R83* not *R81*.

In "Electronic Scorekeeper for Recreation Rooms" (October 1979), in Fig. 1, on the left sides of *IC3* and *IC5*, the pins from top to bottom should read 2, 1, 6, 7 instead of 6, 2, 1, 7.

Introducing  
the one printer  
worth buying  
on reliability  
alone.



# Epson.

Here's something worth thinking about: of all the print mechanisms in use throughout the world today, more than half were manufactured by just one company. Epson. It's simply because we build a better printer.

Like our TX-80. Of the first 3,000 sold in Europe, the failure rate was about 1%. Now that's a phenomenal record. But it doesn't surprise us. Because that's how we built it.

The TX-80 prints a full 96 ASCII and 64 graphic characters in 80-columns at the rate of 125 CPS. It

utilizes a unique 5 x 7 dot matrix that allows the printing of descenders. It's controlled by an internal microprocessor, is available with friction or tractor-type paper feed, and comes packaged in a sturdy, all-metal cabinet. And you can get it with custom interfaces to fit your Apple II, TRS-80 or just about any other small computer.

The incredible reliability of our TX-80 is one reason nobody makes more printers than Epson. Here's the other: you can get one for about \$710.

Write to us. We'll tell you where.

# EPSON

EPSON AMERICA, INC.

23844 Hawthorne Boulevard, Torrance, California 90505 • Telephone: (213) 378-2220

CIRCLE NO. 27 ON FREE INFORMATION CARD



# Yamaha's PX-2 linear tracking turntable. A class of one.



Yamaha's new PX-2, the flagship of a remarkable new series of turntables from Yamaha, is destined to become the new standard of the audio industry. It is a masterpiece in the art of music reproduction. Totally in a class by itself.

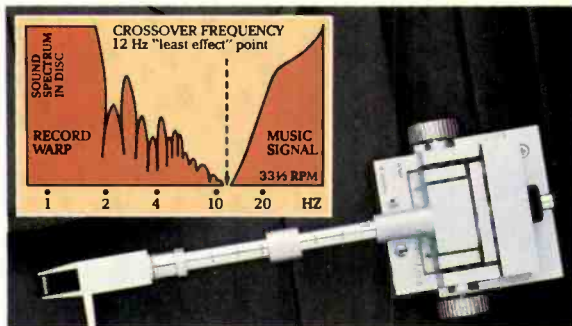

One of the major performance advancements on the PX-2 is Yamaha's unique optimum mass straight tonearm assembly. This design concept is Yamaha's direct challenge to the industry trend of low-mass tonearms. Among the most significant benefits of optimum mass is that it specifically addresses two of the most critical elements of music signal tonal quality—tonearm resonant frequency characteristics and high trackability with a wide range of cartridges. Tonearm mass is such a critical element in sound reproduction (especially in the low and high frequency ranges) that Yamaha has designed this optimum mass tonearm to insure its resonance frequency is at the "least effect" point. (See graph.) As a further benefit, the vast majority of available cartridges can be effectively

matched with the Yamaha tonearm. Even MC types.

But the optimum mass tonearm is only one factor that puts the PX-2 in a class by itself. There's much more. Like an extraordinary 80dB S/N ratio, with incredibly accurate tangential tracking—constantly monitored by an opto-electronic sensor. The PX-2 is also a study in durability with its solid, anti-resonant monolithic diecast aluminum base. And the combined effect of the hefty platter and the heavy-duty DC motor depresses wow and flutter to below 0.01%.

Yet with all this performance, the PX-2 is deceptively easy to operate. All the microprocessor-activated controls are easily accessible—without lifting the dustcover.

The balance of the turntables in our new line (the P-750, P-550, P-450 and P-350) all incorporate this same optimum mass tonearm philosophy. Each will set new standards for performance per dollar invested.



Visit your local Yamaha Audio Specialty Dealer for a personal test of our remarkable PX-2 and the other superb turntables in our new series. You'll hear music that's truly in a class by itself.

For more information write us at Yamaha, Audio Division, P.O. Box 6600, Buena Park, CA 90622.

\*Yamaha cartridges shown [MC-1X and MC-7] on both models are optional.



# NRI will train you at home to be an electronics professional in the growing world of communications.

Learn to service, repair, and install everything from microwave antennas to two-way radios...from radar sets to TV transmitters.

TV Tape Recorders



TV Broadcasting

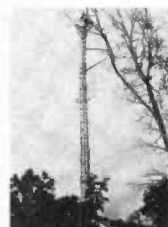

Antenna Systems



Marine Communications



Aviation Communications & Navigation Systems



Direction Finders, Loran

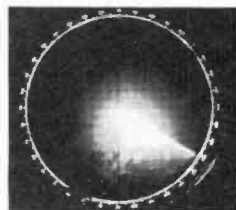

Radar



No other home-study course gives you such complete, professional training in so many fields of communication. No other gives you the actual bench training with kits and demonstration units specially designed for learning. Only NRI gives you the thorough preparation and training you need to achieve professional competence in the wide world of communications.

## Learn at Home in Your Spare Time

Learn at your own pace, right in your own home. There's no need to quit your job or tie up your evenings

with night classes. No time or gas wasted traveling to school... NRI brings it all to you. You learn with NRI-pioneered "bite-size" lessons and proven, practical "power-on" training.

## Build Your Own 2-Meter, Digitally Synthesized VHF Transceiver or 40-Channel CB

NRI training is "hands-on" training. You get honest bench experience as you build and test this industrial-quality two-way radio and power supply. You reinforce theory lessons as you induce and correct faults, study individual circuits and learn how they interface with others. Or, at your option, you can train with a full forty-channel mobile CB and base-station power supply converter.

You also build and keep for use in your work a transistorized volt-ohm

meter and digital CMOS frequency counter. NRI even gives you special lessons to get your Amateur License so



you can go on the air with your VHF transceiver.

## FCC License or Full Refund

In all, you get 48 lessons, 9 special reference texts, and 10 training kits... the training you need to become a professional. And NRI includes training for the required FCC radiotelephone license examination. You pass or *your tuition will be refunded in full*. This money-back agreement is valid for six months after the completion of your course.

## Free Catalog, No Salesman Will Call

NRI's free, 100-page full-color catalog shows all the equipment you get, describes each lesson and kit in detail, tells more about the many specialized fields we train you for. It includes all facts on other interesting areas like TV and audio servicing or digital computer electronics. Mail the postage-paid card and see how we can make you a pro.

If the card has been removed, write to:



**NRI Schools**  
McGraw-Hill Continuing  
Education Center  
3939 Wisconsin Ave.  
Washington, D.C. 20016



Mobile Radio



CB Radio



Aircraft Guidance & Landing Systems



Microwave Relay



AM & FM Broadcasting

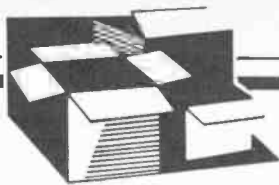

## New Products

Additional information on new products covered in this section is available from the manufacturers. Either circle the item's code number on the Free Information Card or write to the manufacturer at the address given.

### Cassette Deck Tracks Recording Time



The Beocord 8000, the first Bang & Olufsen cassette deck to incorporate a microprocessor, features the ability to plot tape usage in minutes and seconds of recording time and relate tape length to the duration of a recorded piece. In addition, if the processor is given a location in time, the machine automatically winds to the corresponding point on the tape and stops. An automatic memory makes it possible to return to the last starting point by pressing a return button. An illuminated display allows the processor to communicate with the user. Performance specifications for this two-headed (record/play and erase) deck include: wow and flutter less than 0.1%, frequency response 30 to 16,000 Hz,  $\pm 2.5$  dB (metal and chrome tapes), and S/N ratio better than 68 dB (metal tape and Dolby noise reduction). \$895.

CIRCLE NO. 88 ON FREE INFORMATION CARD

### Digital Delay System



The Koss K/4DS Digital Delay System delays and processes the signals from a stereo program source and feeds them to an additional pair of loudspeakers, generally placed to the rear of the listening space, to simulate natural reverberation. The system is designed for minimum com-

### Intellivision Home Computer



This system from Mattel Electronics consists of a Master Component, a 16-bit processor sophisticated game player that features both color video and audio output, and a Keyboard Component that can be coupled together to form a complete home computer. The Master Component con-

tains memory (RAM and ROM) and I/O ports. It also interfaces a pair of 12-button hand-held controllers, each having four player-action keys and a control disc for precise movement of on-screen objects. Video display is 160 horizontal by 192 vertical elements and 24 lines of 40 alphanumeric characters in 16 colors. The Keyboard Component features a 60-key typewriter-like keyboard and a digital cassette system. Combined, the pair holds 16K of RAM (10-bit words) and the memory can be expanded to 1000 8K pages. Two parallel I/O ports allow access to the bus. Over 20 cartridges for the Master Component and eight cassettes for the Keyboard Component are available. A microphone is supplied for audio input.

CIRCLE NO. 91 ON FREE INFORMATION CARD

### Updated Model 260 VOM



Simpson Electric Company's venerable Model 260 volt-ohm-milliammeter has been updated and is now available as Model 260-7. It features recessed insulated panel connectors to reduce shock hazard, a doubly fused protection network, and a transit mode to protect the meter movement during transport. The 260-7 measures both ac and dc voltage, direct current, resistance, dB and the ac

component of a mixture of ac and dc in 27 ranges and with a dc sensitivity of 20,000 ohms per volt. A varistor protects the taut-band meter movement. Options include mirror scale, relay overload protection, and roll top case. Accessories include temperature, low-power ohms and high-voltage probes. \$103.

CIRCLE NO. 92 ON FREE INFORMATION CARD

### Morse Code Teacher



The MFJ Enterprises MFJ-410 Professor Morse is a random Morse code generator and keyer. It sends either alphabetic only or alphanumeric characters and punctuation marks. The random code is sent in random length groups and never repeats itself. Speed is continuously adjustable from five to 50 wpm. Operation is from a 12-volt dc source from an ac adapter provided. \$152.95. Address: MFJ Enterprises, Inc., Box 494, Mississippi, MS 39762.

### Graphics Printer

The Silentype thermal printer enables an Apple II computer to print anything that can be displayed on the CRT monitor, including graphics, according to the manufacturer. Using a 7-dot printing element to produce a 5 x 7 dot matrix, it prints up to 80 characters per line on 8 1/2"-wide thermal paper. Resolution is 60 dots per linear inch (3600 dots per square inch), and speed is 240 dot-columns per second.



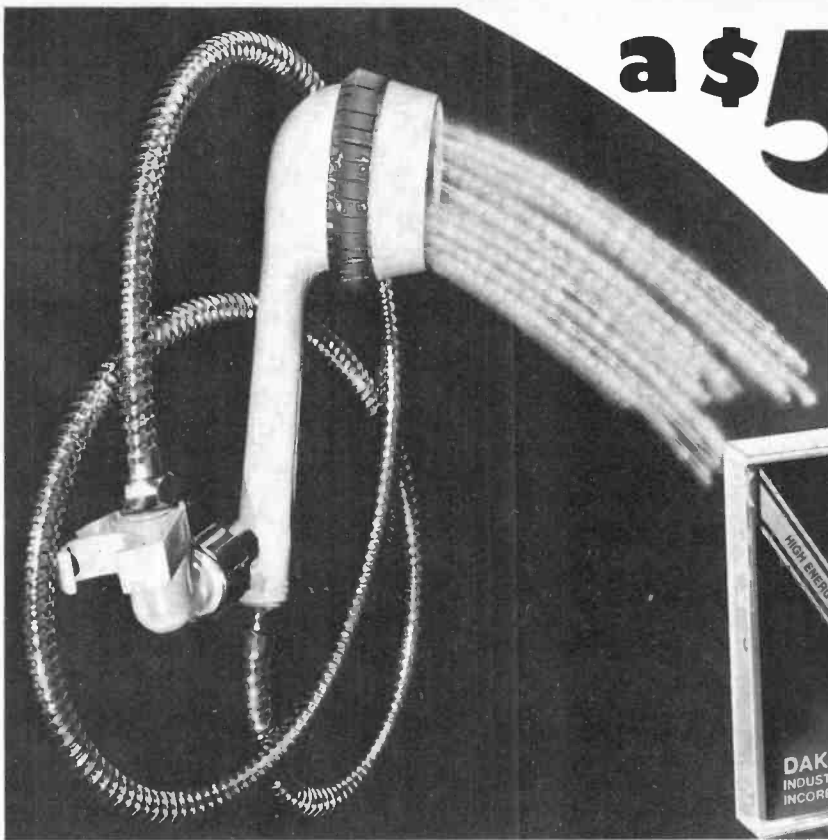

# a \$5 3 way shower massage?

Try 10 DAK high energy 90 minute cassettes risk free for only \$2.19 each and get a pulsating \$29 value shower massage for only \$5.



It's your choice. Think about the kind of music you like. You don't want to think about cassettes jamming, loss of high frequency response or tape hiss.

DAK manufactures a cassette that you can really forget about. Great sound, and no problems. And, for only \$5 we hope you will think a lot about your new pulsating 3 way shower massage.

### YOUR TIME IS PRECIOUS

Imagine yourself just finishing recording the second side of a 90 minute cassette and horrors, the cassette jams. Tape is wound around the capstan, your recorder may be damaged and you've just wasted 90 minutes of your time and perhaps lost a great recording off FM.

### MOLYSULFIDE

DAK manufactures enough tape for over one million cassettes per month. We developed polyester slip sheets, inside the cassette, with raised spring loaded ridges to guide each layer of tape as it winds. We coat them with a unique formulation of graphite and a new chemical called molysulfide.

Molysulfide reduces friction several times better than graphite and allows the tape to move more freely within the cassette.

**Hi frequency protection!** Friction within the cassette causes the build up of static electricity, (much as scuffing your shoes on a carpet in dry weather), which can erase high notes. Molysulfide reduces friction which is a very important consideration for often played tapes.

### MAXELL IS BETTER

Yes, honestly, if you own a \$1000 cassette deck like a Nakamichi, the frequency responses of Maxell UDXL or TDK SA are superior and you just might be able to hear the difference.

DAK ML has a frequency response that is flat from 40hz to 14,500hz  $\pm 3$ db. Virtually all cassette decks priced under \$600 are flat  $\pm 3$ db from 40hz

to about 12,500hz, so we have over 2000hz to spare, and you'll probably never hear the difference.

**No apology.** We feel that we have equaled or exceeded the mechanical reliability of virtually all cassettes and offer one of the best frequency responses in the industry. Maxell UDXL is truly the Rolls Royce of the industry, and DAK is comparable to the 100% US made Cadillac or Corvette!

**Price.** DAK manufactures the tape we sell. You avoid paying the wholesaler and retailer profits. While Maxell UDXL 90s may sell for \$3.50 to \$4.50 each at retail, DAK ML90s sell factory direct to you for only \$2.19 each complete with deluxe boxes and index insert cards.

### A 3 WAY \$5 SHOWER MASSAGE?

You'll be living in luxury. This powerful 3 way shower massage will massage and relax your tired muscles. You can use its powerful massaging action directly from its standard wall mount, or hold it in your hand and direct the spray exactly where you want it.

The shower massage has a three position power control: 1) it has a normal full spray like a shower head, 2) a combination of normal spray and gentle massaging action, and 3) full massage to relax your total body.

**It comes off the wall.** This hand held shower massage has a nearly 5 foot flexible chrome plated hose that allows you freedom of movement. You can direct the spray from any angle or height that you desire. To remove the hand unit from its wall mount, simply lift and turn. It's easy for all family members.

### EASY INSTALLATION

No plumber, no problems. Simply unscrew your old shower head, and screw in this deluxe massage. The wall mount is incorporated into the main unit and requires no installation. This fine shower massage even has its own built in filt-

er screen, and there is no maintenance required. Just relax and enjoy.

The hand unit is approximately 9 inches long, and the massage section is 3 inches in diameter.

### DAK TAKES A RISK

Obviously giving away quality shower massages is not going to make DAK rich. We are betting that you will buy our cassettes again, and we are putting our money where our mouth is!

Customers like you are very valuable in the form of future business. We anticipate receiving over 6000 orders and 4500 repeat customers from this ad to add to our list of over 70,000 actives.

### TRY DAK ML90 CASSETTES FREE

Try these high energy cassettes on your own recorder without obligation for 30 days. If you aren't 100% satisfied for any reason, simply return the tapes and shower massage for a full refund.

To order your 10 DAK ML 90 minute high energy cassettes at \$2.19 each and the \$29 value shower massage with your credit card, simply call the toll free number below, or send your check for \$21.90 plus \$5 for the shower massage and \$3 for postage & handling for each group of 10 cassettes to DAK.

(CA residents please add 6% sales tax)

DAK unconditionally guarantees all DAK cassettes for one year against any defects in material or workmanship.

Why not order an extra group of 10 DAK ML90 cassettes for yourself or a friend? We will add one free ML90 cassette to each extra 10 you buy and of course you can buy one \$29 value massage for \$5 with each group you buy.



Call TOLL-FREE ..... (800) 423-2636  
In California Call ..... (213) 984-1559  
10845 Vanowen St., North Hollywood, CA 91605

The interface card contains 2K of firmware that enables setting left and right margins, line spacing, length of paper ad-



vance, selection of eight intensities, uni- or bi-directional printing, printing of either of two high-resolution pages and normal or inverse printing modes. The printer is powered by the Apple II. \$595.

CIRCLE NO. 93 ON FREE INFORMATION CARD

### Studio Monitor Speaker

Cerwin Vega's Studio Monitor loudspeaker system is designed to be used in a bi-amplified configuration. It employs a horn-loaded high-frequency driver mounted within the voice coil of a 12-inch midrange driver and a separate woofer cabinet using an 18-inch driver. The midrange and tweeter are positioned to minimize phase distortion and are isolated by a special acoustic shield designed to prevent interaction and IM distortion. The bass section, said to be capable of producing audible output at 26 Hz, is rated to handle up to 500 watts. Controlled dispersion allows listeners positioned several feet apart to hear identical sounds. A complementary high-pass filter/bass equalizer is a part of the package.

CIRCLE NO. 94 ON FREE INFORMATION CARD

### CRT Enhancement Filter

The Polaroid CP-70 circular polarization contrast enhancement filter attaches easily to the bezel around the cathode-ray-tube display screen by means of self-adhe-

### Diskette Head Cleaner

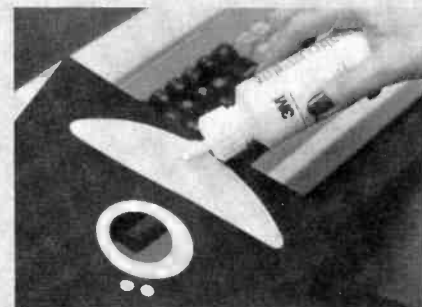

Scotch Head Cleaning Diskettes use a unique wet-and-dry method by which a proprietary cleaning solution is applied to the porous cleaning fabric in the diskette envelope. The cleaning diskette is then run in a normal manner for 30 seconds. Two-sided systems may be cleaned using the same approach. Each kit contains sufficient materials for 30 cleanings. Two sizes are available, Scotch 7400 for 8-inch diskettes and Scotch 7440 for 5 1/2-inch types. \$30.

CIRCLE NO. 84 ON FREE INFORMATION CARD

### Semiautomatic Turntable



The Luxman Model PD-264 turntable features, in addition to semiautomatic operation, direct drive, a straight tonearm with low mass, and front-panel controls. Designed to handle cartridges weighing from 4-11 grams and tracking at up to 3 grams stylus force, the unit has rated wow and flutter of 0.035% (wrms) and S/N ratio of at least 60 dB (IEC-B). It offers speeds of 33 and 45 rpm, both said to be adjustable through 6%. Additional features include a stroboscope, antiskate adjustment, and detachable dust cover, as well as controls for tonearm elevation and stylus height. \$225.

CIRCLE NO. 96 ON FREE INFORMATION CARD

sive brackets. Reflection problems are thereby reduced and display contrast enhanced to reduce operator eye fatigue. Unlike conventional absorption filters that simply reduce glare, circular polarization filters can discriminate against reflections. Complete kits are priced from \$26 for a formed, nonglare, plastic filter. Laminated-glass, antireflection filters that can be adjusted to lighting conditions are priced from \$68. Prices vary by the size of the display screen.

CIRCLE NO. 95 ON FREE INFORMATION CARD

### Computer-to-Selectric Interface



The ESCON interface made by iPEX International is said to fit any IBM Selectric typewriter (Model 72 or 82), without

### Wireless Vehicle Security System



Radio Shack's Archer Mobile Alert warns you of tampering with or an attempted theft of your vehicle by means of a radio transmitter and a pocket-sized receiver. The system includes two electronic sensors and can be expanded to include additional sensors and optional switches. Its dash-mounted transmitter feeds the vehicle's existing broadcast-band or CB antenna. When triggered, it transmits a coded signal that "beeps" the pocket receiver. Range is said to be up to one-half mile (0.8 km). The transmitter section draws power from a 12-volt, negative-ground source, while the pocket receiver uses two AA batteries. Use of the system requires an FCC CB license. \$99.95.

CIRCLE NO. 98 ON FREE INFORMATION CARD

(Continued on page 16)

**Not Just Another Limited Area Motion Detector!**

# guardex™

**Protects Every Square Inch Of Your Building**

**Turns On Lights Automatically**

**Powerful Electronic Siren**

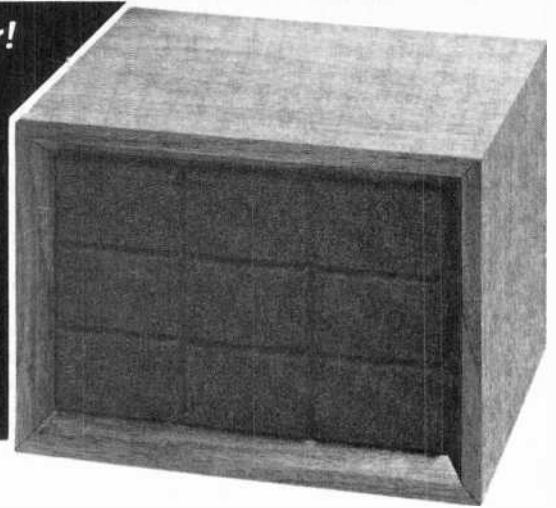

## Low Cost Computerized Burglar Alarm System Home - Office - Business

*The Guardex 8000 Alarm System is walnut grained and disguised to look like a small stereo speaker (6¾" x 9¾" x 8") and weighs less than 6½ pounds.*

### NO INSTALLATION

Just plug the Guardex 8000 alarm system in, make several simple control adjustments to suit your particular building and it works! There are no other wires to run. This totally self-contained burglar alarm can completely seal off every square inch of the surface of your building. It protects doors, windows, and what most alarms miss... your roof, walls and floors.

### HOW CAN ONE SMALL COMPUTER PROTECT MY WHOLE BUILDING?

Guardex 8000 Alarm System works on the principle of audio discrimination. This, put simply, is the process of electronically separating normal everyday sounds, such as voices, telephones, etc. from break-in type noises such as breaking glass, prying metal, or forcing a door open. The Guardex 8000 protects one story homes and offices up to 2000 square feet and open commercial buildings up to 10,000 square feet. The Guardex 9300 with wireless remote sensor capability is available for multi-story homes and offices or single story with more than 2000 square feet. Call the factory for more detailed information.

### TURNS ON LIGHTS AUTOMATICALLY

When the first break-in type sound is detected, the system will instantly turn on lights, radio, or other electronic equipment that you have plugged into the back of the alarm. These lights or other equipment will remain on for a period of five minutes, then automatically turn off.

### POWERFUL ELECTRONIC SIREN

The Guardex 8000 alarm is equipped with a loud built-in siren. If during the five minute period the lights or other electronic equipment has been activated, a second break-in sound is detected, (it can be only a second or two after the first break-in sound) the built-in siren will start blasting for 90 seconds. At the end of approximately 90 seconds the siren will shut off and the alarm listens again. If another break-in sound is heard, the siren will come on for another 90 seconds. If no other break-in sound is detected, the siren will stay off and at the end of the five minute period the lights will shut off and the alarm instantly resets.

### EXIT AND ENTRY DELAY

The Guardex 8000 alarm has a built-in exit delay allowing you approximately one minute to lock up and leave the building before the alarm is armed. When you enter your building you may find that just your normal entering sounds activate the siren. You may delay it from starting for up to 30 seconds by turning up the siren entry delay control.

### BATTERY BACK-UP

Burglars rarely cut power. However, to give you total protection from a burglar and possible power failure, our alarm has provisions for a battery back-up. (Batteries not included). 12 volt lantern batteries are available at most hardware stores.

### THE BURGLARY PROBLEM

The F.B.I. statistics show that at the present rate, one out of every four Americans are going to be burglarized. That is not a very pleasant fact, but it is true. You have a greater chance of being burglarized than being a victim of a fire or automobile accident. The time is now to help protect yourself and your valuables with a Guardex 8000 alarm system.

### OUTSIDE SIREN

The Guardex 8000 alarm is equipped with a loud, built-in siren, but if you desire an additional siren to mount outside or in an area away from the main alarm, they are available with 50 feet of wire for \$24.95. (Connecting terminals are provided on the back of the alarm).

### 30 DAY NO RISK TRIAL

This is your opportunity to purchase an alarm system directly from the factory for only \$199.95. Try it in your home or business for thirty days without risking one cent. Put our Guardex 8000 alarm to your own test. See for yourself! It will protect every window and door from break-in. If you are not completely satisfied, return the alarm within 30 days for a complete refund. To order your Guardex 8000 alarm, CALL TOLL FREE to charge your credit card or send your check to Guardian Electronics, Inc. in the amount of \$199.95. If you want the optional outside siren, add \$24.94. (California residents add 6% sales tax.)

(If you require more information, call during California business hours, Monday - Friday)



Dealer Inquiries Invited

**CALL TOLL FREE**  
**(800) 423-5499**

California residents:  
**(213) 889-1414 collect.**

**GE GUARDIAN ELECTRONICS, INC.**

31133 Via Colinas, Dept. PE. Westlake Village, Calif. 91361

*The rear control panel contains two standard AC plug receptacles for a table lamp, spot lights, radio, etc.; terminals for connecting optional outside siren and back-up battery (not included); entry delay time control and sensitivity control.*





**President VHF-FM  
Marine Transceiver**



American Radio Corporation's President Marine Electronics Division introduces its

Model 511, one of a series of vhf/FM marine transceivers. The President Model 511 is a 50-channel synthesized transceiver whose coverage includes one Canadian and three U.S. weather channels. Channel tuning is displayed on a variable-brightness, seven-segment LED readout. A CH16 pushbutton switch permits quick access to the distress/calling frequency, overriding the master rotary channel-selector switch. A second pushbutton switch chooses either 1 watt or 25 watts of output power. A protective circuit shuts down the transmitter output if the antenna is disconnected or damaged. To inhibit corrosion,

the transceiver is housed in a plastic enclosure. \$479.95.

CIRCLE NO. 99 ON FREE INFORMATION CARD

**A special offer on new  
Mesa Subwoofers for cars—**



Mesa 5 1/4" Round Flush Mount Bass Booster

Now \$41.95 PAIR

Mesa subwoofers—or "Bass Boosters"—are added to your present car stereo system—they don't replace your old speakers. It works this way: a separate crossover network contains a low cut filter. The high and midrange tones come through your existing (satellite) speakers. Lows come out through the Bass Booster. The result is superb stereo separation and more and lower bass than you'll get with any conventional set of car stereo speakers.

Available in two sizes—5 1/4" round flush mount kit (power handling capacity 10-30 watts RMS/channel; frequency response 42-200Hz).

And the 6" x 9" rear ledge mount

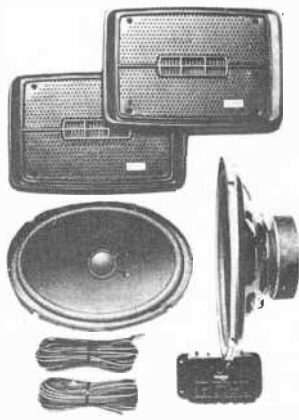

Mesa 6x9" Rear Ledge Mount Bass Booster

Now \$44.95 PAIR

kit (power handling 10-45 watts RMS/channel; frequency response 37-200Hz).

Both are compatible with any set of full range car stereo or mini speakers.

Each kit contains:

- 2-5 1/4" or 6" x 9" stereo subwoofer speakers with grills
- separate crossover network with low cut filter for bass separation
- 30 feet of cable and complete mounting instructions and templates for easy installation.

Both with 5-year limited warranty. 30-day money back guarantee\* if not completely satisfied.

Act today. Charge it if you prefer.

OK. SEND ME:

kits of Mesa 5 1/4" bass boosters @ \$41.95 ea.

kits of Mesa 6" x 9" bass boosters @ \$44.95 ea.

Include \$3.25 for shipping & handling. Illinois residents add 6% sales tax.

My check or money order for \$\_\_\_\_\_ is enclosed, made payable to: MBR Corporation, 2940 Malmo Drive, Arlington Heights, IL 60005.

Charge my:  Master Charge  Visa Card No. \_\_\_\_\_ Exp. Date \_\_\_\_\_

Name \_\_\_\_\_ Address \_\_\_\_\_

City \_\_\_\_\_ State \_\_\_\_\_ Zip \_\_\_\_\_

Signature \_\_\_\_\_

I understand I may return the bass booster intact within 30 days for a full refund if not completely satisfied.

CIRCLE NO. 44 ON FREE INFORMATION CARD

**Vehicle Computer  
Fits Most Models**

The Zemco driving computer is easily installed on almost any vehicle (except those with diesel or fuel-injected engines). Among the 28 functions it provides are current or average mph, fuel used and distance travelled since fill-up, and fuel remaining and distance-to-go until empty. The computer also forms a calibrated speedometer, a crystal-controlled clock, and will show both current and elapsed time. All measurements can be displayed in English or metric. An error display and display dimming for night use are also provided. \$120. Address: Zemco Inc., 12907 Alcosta Blvd., San Ramon, CA 94583.

**X-Y Chart Recorder Kit**

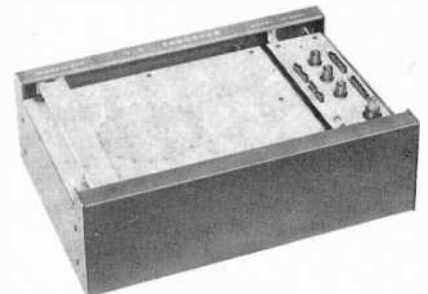

The Heath IR-5207 Chart Recorder kit claims accuracy of 0.5% full scale, and dead band and nonlinearity error less than 0.25% of full scale. Front panel input filters with pushbutton controls allow tailoring of response to each application. Features include calibrated 1-, 10-, 100-mV and 1-volt per inch ranges, integral paper holddown in either horizontal or vertical modes, zero control that allows the pen to be placed anywhere on chart with zero input on both coordinates, electric pen lift, calibrated X and Y sweep, and remote capability. It uses standard 8 1/2" by 11" paper. \$479.95

CIRCLE NO. 90 ON FREE INFORMATION CARD

**Microprocessor  
Power-Line Isolation**

The possibilities of a microcomputer system developing unexplained crashes, memory losses and program glitches due to power-line spikes, surges, etc. are claimed to be lessened by use of the Model ISO-3 Super Isolator, from Electronic Specialists. It provides three individually dual-pi filtered 3-prong ac sockets. The isolator can accommodate 1875 W, with each socket rated at 1000 W. \$79.95.

CIRCLE NO. 100 ON FREE INFORMATION CARD

NOW AVAILABLE!

# WATT WIZARD™

**POWER FACTOR CONTROLLER CUTS THE COST OF RUNNING ELECTRIC APPLIANCES BY AS MUCH AS 50% -- AND YOU CAN EVEN SEE THE SAVINGS!**

For over a year now, in magazines and newspapers the world over, there have been enthusiastic write-ups on a remarkable new device that can cut your electric bill while helping the U.S. save huge quantities of fuel.

"The NASA/Nola power saver," wrote a **Popular Science** senior editor, "was developed by Frank Nola at NASA's George C. Marshall Flight Center as an offshoot of a program to reduce power consumption in spacecraft motors. Nola calls it a PFC — power-factor controller. I prefer to call it a power saver, however, because that's what it does."

### NASA TESTED IT

According to Clyde S. Jones of NASA, "The device has been tested at Marshall Center on over 40 types of motors, with power savings ranging up to 60%, depending on the loading. The motors tested were both single-phase and three-phase, ranging from 1/2 H.P. to 5 H.P. Most motors will show up to 40-to-50% savings when running lightly loaded or unloaded, and some will show 5-to-7% savings at rated load."

NASA's Technical Support Package showed the test results and noted that "The Power Factor Controller applies to induction type electric motors — the most commonly used type in all major home appliances and the most commonly used by industry."

### HOW IT SAVES POWER

**Popular Electronics** explained it this way: "AC induction motors characteristically run at a nearly constant speed that's fixed by power-line frequency and independent of load and supply voltage. When heavily loaded, the motor draws line current that is nearly in phase with the applied voltage... Under light load conditions, the motor develops less torque by allowing more lag between the voltage and current. This reduces the power factor while leaving the current essentially the same in magnitude.

"Though the low power factor means that conversion of electricity to mechanical power is small, the large current causes considerable (heat) losses in the supply lines and motor windings. This is what reduces efficiency.

"To minimize this waste, Nola's device monitors the motor's power factor and, when it detects light load conditions, it reduces the supply voltage... The current, now more nearly in phase with the voltage, therefore does as much useful work as before, but it and the voltage are smaller, resulting in a net savings of electric power."

### THE SAVINGS CAN ADD UP

Like everything else, the cost of electric power keeps going up. Not only is the basic rate you pay going up, the power companies have now added on a "fuel adjustment" charge to help pay for running their generators. In 1980, 1981 and beyond, you'll pay more and more for the privilege of running your electric appliances.

*National Aeronautics  
and Space Administration  
Patent No. 4,052,648*

Right now, the typical consumer pays about \$8 per month to operate a 16.5 cu. ft. frost-free freezer... \$10 to run a 17.5 cu. ft. frost-free refrigerator... \$8.25 for an attic fan operating 12 hours a day... and about \$60 for an air conditioner used during summer months. It's not hard to figure out what you're paying per year just to run **one** of these appliances. And in many parts of the country, the cost is even higher.

That's why Nola's power saver can soon pay for itself, then start reducing your electric bills — the amount of savings, of course, depending on which appliance(s) you use it with.

There's just one catch. Until now, the device has not been **available** — except for industrial models priced at \$80 or more.

### INTRODUCING THE WATT WIZARD

Cynex, an American manufacturer of electrical and electronic products and a prime contractor for the U.S. Government, has been licensed by NASA to manufacture Frank Nola's power saver. Cynex calls it the Watt Wizard.

"The Watt Wizard," says Ray Beauchea, the firm's Marketing Director, "regulates the voltage fed into an induction motor, reducing or boosting power as required, when loads go up or down. Simply stated, it makes motors run more efficiently, especially when idling. It reduces motor heat, affording longer motor life and reducing the amount of air conditioning required for cooling (rooms) in summer months. It saves electric power, because kilowatt hours are greatly reduced. And it causes the motor to run quieter."

### SIMPLE TO USE

Cynex makes several models of the Watt Wizard (all with solid state design), including the 110 V AC plug-in model we're offering. It's for single phase fractional H.P. motors (less than 1 H.P.) which is the type used in most made-for-the-home freezers, refrigerators, window and attic fans, swimming pool pumps, furnace fans, vacuum cleaners, sewing machines, power drills, etc.

Simply plug the Watt Wizard into any electric outlet, then plug the appliance into the Watt Wizard. There's no wiring required. Unlike some competitor's models (if and when available), the appliance does **not** have to be turned on before being plugged into the power saver. You can leave the appliance — whether on or off — plugged into the Watt Wizard all the time. Or you can move the Watt Wizard to various locations, depending on which appliance is being used. (Better yet, order several Watt Wizards.)



MERCURY 1980©

### OTHER MODELS AVAILABLE

Air conditioners, washers and dryers require wire-in model. If you lack mechanical skill, you probably need an electrician to install it. We also offer it in 220 VAC single or three-phase.

### ADVANCE FEATURES

The Watt Wizard also includes two more unique features. It's fused, so if you accidentally overload the device, it won't burn out. Just change the fuse, which is available at any auto supply store.

And the Watt Wizard features an LED readout, so you can actually tell, at any moment, exactly how much power you're saving — 10%, 20%, 30%, 40% or 50%.

There's a "Power On" light, too. And the Watt Wizard comes with the manufacturer's 1-year limited warranty.

### LOW COST — AND A TAX CREDIT

We're offering the Watt Wizard for only **\$39.95**, with **immediate delivery**. Want two? Then it's just **\$37.95** each. Or splurge and get three at **\$34.95** each. Wire-in models for heavy duty motors are **\$6** more for each unit. Add just **\$2.50** postage/handling for each **order** (not each unit).

And next year, when you fill out your tax return, you can deduct a full 15% energy tax credit — for additional savings.

### 30-DAY MONEY-BACK GUARANTEE

Try the Watt Wizard for up to 30 days. If not completely satisfied, return it (insured) for a full refund.

The sooner you send for the Watt Wizard, the more you can save on your electric bills. To order, send your check or money order to the address below. Or charge it to your Visa, MasterCard, American Express or Carte Blanche credit card. If using your charge card, you can also order via our toll-free phone number:

**800-257-7850**

(In New Jersey, Call: **800-322-8650**)  
N.J. residents, add 5% sales tax.

Or mail your order to:

Dept P 3, Lakewood Plaza  
Lakewood, N.J. 08701



The Imagination People®

# FREE

The newest in home computers, fine stereo components, color TV, HAM radio, precision test equipment, innovative electronics for the home—all in easy-to-build, money-saving kits.

Send today for your **FREE Heathkit® Catalog**



If coupon is missing, write Heath Co., Dept. 010-662 Benton Harbor, MI 49022

Send to: Heath Co., Dept. 010-662 Benton Harbor, MI 49022.

Send my free Heathkit Catalog now. I am not currently receiving your catalog.

Name \_\_\_\_\_

Address \_\_\_\_\_

City \_\_\_\_\_ State \_\_\_\_\_

CL-724A Zip \_\_\_\_\_

audio

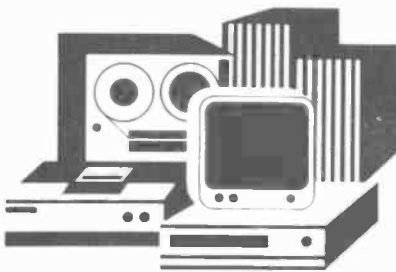

## Entertainment Electronics

By Harold A. Rodgers  
Executive Editor

### The Pursuit of Realism

CONVENTIONAL wisdom has it that someday audio technology will advance to the point at which we will be able to sit in our chosen listening environments, flip a switch, and treat our ears to the sound of music indistinguishable from that heard in the concert hall. After all, we need only play impeccably recorded program material—which may be looming on the horizon in the form of digital discs—through speakers designed for optimum dispersion and imaging and minimum distortion, using electronics from which all traces of TIM, SID, and other alphabetic nasties have been rigorously removed, to be home free. Frankly, I'd hate to have to fund the research and development program that would be needed to realize this technological miracle, all the more because close examination will show that it is more a pipe dream than anything realizable.

**The Glitch Overlooked.** One of the malign influences that stand to dash the hopes of the faithful is the ancient antagonist noise. Not noise in the recording or the circuitry used to reproduce it, but ambient noise in the playback environment. Circuit design is capable of producing amplifiers with S/N well in excess of 100 dB, and, while the present state of the art in digital hardware limits the best recordings that can be made to 96 dB or so of dynamic range, it is quite reasonable to suppose that digital recording systems capable of resolution beyond 16 bits could be developed. But wide dynamic range avails nothing if the lowest 10 or 20 dB of it are masked by room noise, and overriding such noise by brute force can be shown to produce "colorations" probably equal to or greater than those fussed over by some amplifier critics. Ironically, especially for those who look down their noses at mobile stereo on account of the hostile environment in which it must function, home surroundings are not totally friendly to audio even compared with those of the car; they are only less hostile.

**A "Thought Experiment."** For the sake of argument, let's assume that we have a playback system that is perfect in all respects—frequency response flat from dc to light, zero distortion, infinite S/N ratio, etc. Let's say further that it is reproducing a composition that has a dynamic range of 90 dB. If the recording environ-

ment had an ambient noise level of 30 dB SPL—which is very quiet—the level of the music, if it is to exceed that of the noise at all times, must range from just beyond that to a bit over 120 db SPL. This upper level approaches the threshold of pain for most individuals, and it seems reasonable to speculate that this factor, rather than the limited power of acoustic instruments, sets the upper boundary on dynamic range.

Now, when we play this recording back through our perfect system, we will have to play it loud enough to override the ambient noise in the listening environment. If we were fortunate enough to have a listening room as quiet as the super-quiet recording studio that has been postulated, the playback level would only go up by 3 dB, which might be tolerable. But typical residences are far noisier than that, a range of 45 to 50 dB SPL being more common. Under these circumstances we will have to play the music 10 to 15 dB louder than it was recorded in order to overcome the room noise.

As the original levels may have well approached the threshold of pain at their loudest, this additional level boost could make listening to the louder passages quite uncomfortable. And even if that can be tolerated, the elevated level will lead human loudness response to distort the subjective frequency balance. In addition, there is reason to believe that the nonlinear processing that the ear itself performs is level-dependent in a way that makes the same spectrum sound a little different when it is louder. Thus, while the reproduced sound may well preserve the musical values of the recorded original, it seems that the very process of playback in a nonideal environment is enough to change it somewhat. The fact that many, if not most people live in relatively densely populated areas adds social barriers against realistic reproduction of wide dynamic range, too. Few apartment dwellers can get away with playing music at levels in excess of 100 to 110 dB for very long, and even suburbs pose similar, if looser, restraints. And what happens if our neighbors want to hear realistic dynamics too? What does that do to the ambient noise levels in our apartments? The irony is compounded by the fact that the hours when ambient noise tends to be at a minimum are just those times when acoustic leakage of someone else's loud Wagner or



# HEAR WHAT YOU'VE BEEN MISSING!

*Listen with an 801 Omnisonic Imager™,  
a quantum leap forward in stereo reproduction!*

#### **OMNISONIC IMAGERY™ IS HERE!**

Our innovative state-of-the-art electronics create a totally unique sound environment never before possible. With an 801 Omnisonic Imager™, you can now experience the physiological sensation of what amounts to three-dimensional sound reproduction — what we call omnisonic imagery™ — from just two speakers! Sound appears to come from many sources in the listening area, depending on the quality of the signal source. A common reaction is to look about for other speakers. *And you don't have to sit rigidly fixed at a focal point between the speakers to enjoy omnisonic imagery™!*

#### **RETROFITS TO MOST STEREO SYSTEMS!**

Any unit with a tape monitor facility (internal tape loop) can mate with an 801 Omnisonic Imager™. It also has a built-in tape monitor button so you don't lose your existing tape monitor facility.

The 801 Omnisonic Imager™ works on any stereo source — FM, tapes, and records. You can record selections via the 801 Omnisonic Imager™ and replay them on conventional home-use stereo equipment.

Now that you've read all about our 801 Omnisonic Imager™, don't you think it's time to hear one? If we have stimulated your interest in seeking the finest sound reproduction in the purest sense, please ask your dealer for a live demonstration. If you have any questions, or need to know the name of the dealer nearest you, call or write to:

**OMNISONIX, LTD.**

P.O. Box 307  
Wallingford CT U.S.A. 06492  
(203) 239-6213

#### **THREE DIMENSIONS IN SOUND!**

Stereo without an 801 Omnisonic Imager™ produces sound from two distinct sources. Music from the speakers arrives at your ear, but most of it falls to the floor. The result is often "muddiness" and loss of presence. Only two dimensions result — volume level and stereo separation.

Stereo with an 801 Omnisonic Imager™ creates omnisonic imagery™ never before possible. Sound seems to come from the near and far. At times, it surrounds you, and appears to come from behind you and below you. The sound never has a chance to fall to the floor. It is so alive with movement that it envelopes you. Three dimensions — volume level, stereo separation, and omnisonic imagery™ are apparent with an 801 Omnisonic Imager™.

#### **LIFETIME WARRANTY!**

You get a lifetime warranty on the active circuitry, and one year on all other components (excluding case and line cord), provided your 801 Omnisonic Imager™ is used as specified.



Dealers — join our rapidly-growing network. Write to our Sales Dept. for details. Visit us in Booth D-22, Lobby Level at McCormick Place at the June CES, Chicago.

Omnisonic Imager™, Omnisonic Imagery™, HBX™, and Honeybox™ are trademarks of Omnisonix, Ltd.

CIRCLE NO. 53 ON FREE INFORMATION CARD

# McIntosh

## "A Technological Masterpiece..."



McIntosh C 32

### "More Than a Preamplifier"

McIntosh has received peerless acclaim from prominent product testing laboratories and outstanding international recognition! You can learn why the "more than a preamplifier" C 32 has been selected for these unique honors.

Send us your name and address and we'll send you the complete product reviews and data on all McIntosh products, copies of the international awards, and a North American FM directory. You will understand why McIntosh product research and development always has the appearance and technological look to the future.

Keep up to date.  
Send now - - -

McIntosh Laboratory Inc.  
Box 96 East Side Station  
Binghamton, NY 13904

Name \_\_\_\_\_

Address \_\_\_\_\_

City \_\_\_\_\_ State \_\_\_\_\_ Zip \_\_\_\_\_

If you are in a hurry for your catalog please send the coupon to McIntosh. For non-rush service send the Reader Service Card to the magazine.

CIRCLE NO. 46 ON FREE INFORMATION CARD

## audio

Stravinsky; or "Blood, Sweat, and Tears" will prove to be most annoying.

**Can We Use 90 dB of Dynamic Range?** I think the answer to that is—sometimes, but certainly not always. What then will we do with our fancy, purely digital recordings at times when either the laws of acoustics or the laws of the land decree that we may not enjoy their full potential. I can't say for certain, but I suspect that the preamp/control centers (or whatever) used in the music systems of the future will contain compressors or other means of restraining dynamic range that proves excessive.

**The Brighter Side.** Fortunately, if we are concerned with enjoying recorded music, rather than trying to fool ourselves into thinking that we hear a live performance, the outlook is far brighter. The processor in the middle of our heads that works on the signals from our ears has some very sophisticated tricks in its repertoire. For one thing, since the hearing sense can identify and *ignore* components of noise under some conditions, it is not always necessary that the music completely override noise in order to be heard. As an example, a listener might hear a soft string chord, as at the end of a movement, and not notice at all that a clock is ticking at a level slightly above that of the music. Of course, subliminal awareness of the ticking provides instant confirmation that "this is not a concert." Nonetheless, unless the noise gets very loud, the listener can probably still enjoy the music.

Another factor worth considering is that we all, presumably, really know where we are, at least most of the time,

and the effort of sustaining the illusion of the concert hall may actually distract us from the music itself. Consider a musical composition in which a sound similar to that of a telephone bell is used. When the sound occurs, most of us will probably direct our attention to the telephone to determine if it is really ringing or not—if we happen to be listening to a recording at home. At a live performance, expecting no messages, most people will interpret the sound differently and never even think of the telephone.

It is high time, in my view, that we accept recorded music for what it is—a medium related to but distinct from live music and certainly not limited to the imitation of live music. If we regard the two as equal in this sense, it is easy to see that they have different strengths and weaknesses and that a situation appropriate for one might be hard pressed to accommodate the other. Perhaps even more important, we could stop asking the impossible of our reproduction equipment, quash the indictments accusing it of imagined faults, and enjoy it more fully.

Having made what I hope is a reasonable case for abandoning concert-hall realism as the *sine qua non* for home reproduction, I'll do a quick stutter step and a head fake and tell you that it is possible under laboratory conditions. In fact, it can be done well enough to allow the acoustics of concert halls to be compared. The joker in the deck, however, is that the playback must be done in an anechoic chamber. Furthermore, if odd effects due to infiltration of extraneous sounds are to be avoided, elaborate soundproofing is also required. But, as we will see next month, the idea has interesting ramifications. ◇



## Audiophile Recordings

**BIZET: *Carmen, Suites No. 1 & 2*; GRIEG: *Suite from Peer Gynt, Op. 55, 46*.** St. Louis Symphony Orchestra, conducted by Leonard Slatkin. Telarc Digital 10048. Technically, there is little to say about this disc other than to acknowledge its excellence. Surfaces are quiet, the stereo image neatly fills the space between the speakers while projecting a good sense of depth, and a sense of space and ambience pervades it all. Slatkin and the orchestra do a good, professional job that manages to sound inspired every now and then. What is missing, for these ears, is solid, musical substance. With just a few excep-

tions, the classical offerings on specialty discs have been curtain raisers. How about something meaty, like a Beethoven Symphony, or the Brahms Requiem, or some Bartok String Quartets?

**TIP OF THE WEISBERG.** Tim Weisberg and his band. Nautilus NR7. Like the Telarc release preceeding, this disc was mastered by means of the Soundstream digital recording process, and, similarly, its sound is well-nigh impeccable. But rather than using few mikes and doing whatever is necessary to authentically portray instruments in a performance environment, this release unabashedly takes the path of virtuoso studio engineering. Actually, this becomes a part of the album's charm, for while there is no pretense of a natural sound, what one hears is tastefully done and very enjoyable. The liner notes make much of the idea that this is a rock group, not a jazz group. Yet, its esthetic has shed some of the Dionysiac aspect of rock and taken on some of the cool, Apollonian approach found in some jazz. On the other hand, the music really isn't jazz, either. We may have to settle for calling it unique.



Attractive Air Alive unit measures only 4½" x 4" x 1¾" and cleans a 20' x 15' x 8' room in up to 15 minutes.

# AIR ALIVE

**Uses "Nature's Air Cleaners" to electronically destroy odor, smoke, dust, and pollen. Now research shows it may do more!**

Little-understood particles, called negative ions, are said to be nature's best air cleaners. They attach themselves to dust, smoke, pollen or anything else floating in the air, and cause it to fall harmlessly to the ground. Now there is growing proof that negative ions may affect your moods, health and sense of well being.

### THE ION CONTROVERSY

For the past 20 years, scientists and scholars-world wide have been studying the effects of electronically charged particles in the air called negative ions.

Russian scientists have recently proven that the presence of ions in the air is essential to animal life. Research conducted at the University of California has shown that plant growth is stunted when the ion content in the air is decreased.

Some researchers claim there's evidence that negative ions can relieve allergic ailments and headaches, help control virus, retard the growth of bacteria, increase mental alertness and energy, reduce pain, tension, fatigue and depression and produce sound sleep.

Interestingly, while the number of those who believe that negative ions do, in fact, produce these benefits, has grown, the number of doubters has decreased over the years.

### THE ION IMBALANCE

The air is made up of molecules that contain either a majority of electrons, making them negative particles, or a majority of protons, making them positive particles.

Although nature produces a nearly equal number of positive and negative ions, there are a number of reasons why we are surrounded by an over abundance of protons: air pollution depletes the number of negative ions in the air, the static charge from synthetic fibers produces positive ions and natural earth radiation, that would normally produce negative ions, is retarded by concrete and asphalt covering the land.

In effect, we are breathing air that nature never intended us to breathe ... air that has been depleted of negative ions. What is needed is a way to correct this ion imbalance.

### NATURE'S AIR CLEANERS

There is almost no disagreement among scientists that negative ions are unmatched in their ability to cleanse the air of impurities. This is how they do it: negative ions attach themselves to dust, smoke and pollen, neutralize them and cause

them to fall harmlessly from the air.

Engineers and doctors have recently recognized this benefit and have begun to take advantage of it. Many now use commercial units that emit negative ions and effectively destroy odors and pollutants in the air.

It has only been during the last year that technology has developed an affordable consumer model. These units were first introduced in Europe where there is a high level of interest in the benefits of negative ions.

Now we are introducing one of the first consumer units to be sold in this country!

### ONE OF THE FIRST UNITS UNDER \$100

When we were offered the opportunity to introduce Air Alive to the American market, we jumped at the chance! Why? Because it's one of the first consumer models in this country to be sold for under \$100. And because it's manufactured by Western Systems, Inc., a pioneer in the ion generation field.

### MOST COMPACT UNIT ON THE MARKET TODAY

Air Alive measures only 4½" x 4" x 1¾" and puts out 3 trillion negative ions per second per cubic centimeter. That's as many or more than larger, more expensive units now on the market. It is so powerful that it cleans a 15' x 20' x 8' room in up to 15 minutes. Air Alive brings you more cleansing power in its compact size.

### WARRANTED FOR TWO FULL YEARS

Air Alive is an all solid state unit ... it has no moving parts. The unit is so trouble free that it is warranted by Western Systems, Inc. for two full years, in the unlikely event that anything should go wrong.



### FREE BOOK JUST FOR TRYING AIR ALIVE

Just for trying the Air Alive unit, we are offering a 160 page book entitled "The Ion Effect".

Absolutely Free!

It is yours at no additional charge. It's yours to keep even if you should return the Air Alive unit during our 30 day trial period. "The Ion Effect" traces one man's 10 year effort to discover the truth about the effects of ions. Judge for yourself the benefits of negative ions.

### OPTIONAL AUTO ADAPTER

Now Western Systems, Inc. brings something new to the American market that Europeans have used for years ... an optional auto adapter that allows you to use your Air Alive home model in your car, truck, van or RV. Hardware included for mounting under your dashboard and adapter plugs into your cigarette lighter.

### 30 DAY NO-RISK TRIAL

We believe Air Alive to be the most compact negative ion generator on the market today. It will destroy the dust, smoke, pollen and odors in the air in your home, office or car.

And we want you to decide for yourself whether or not you can benefit from the effects scientists are claiming that negative ions can have on your health and sense of well being.

We offer you a 30 day, no risk trial period on every Air Alive unit you order. If during that time you decide the Air Alive unit does not meet your expectations, for any reason, you can return it for a prompt refund of the purchase price.

### TO ORDER YOUR AIR ALIVE

Simply fill out the coupon and send it, along with your check or money order, to the address below. For even faster service, call Toll Free: 1-800-527-7066. In Texas call (214) 349-3120.

### MEDIA MARKETING, INC.

10155-9 Plano Road • Dallas, TX 75238

Yes! Send me \_\_\_\_\_ Air Alive units at \$79.95 ea. and \_\_\_\_\_ Auto Adapters at \$8.95 ea. Add \$3.50 postage, handling and insurance charge. Texas residents add 5% sales tax.

### I UNDERSTAND I HAVE A 30 DAY NO RISK RETURN OPTION.

Home Unit     Auto Unit

Name \_\_\_\_\_

Address \_\_\_\_\_

City \_\_\_\_\_

State \_\_\_\_\_ Zip \_\_\_\_\_

Check or Money Order enclosed.

Charge to:

Master Charge    Expires \_\_\_\_\_

VISA

Account Number \_\_\_\_\_

Signature \_\_\_\_\_

Order Toll Free: 1-800-527-7066

In Texas Call: 1-214-349-3120

© MMI-1979

PE 3





Audio  
Equipment  
Reviews

by Julian D. Hirsch

## AKG Model K-340 Electrostat- Dynamic Headphones

### An electrostatic driver and dynamic driver in tandem cover the audio range

**M**ODEL K-340, the newest stereo headphone from AKG, incorporates some of the unique design features of the earlier Model K-240, and in addition uses an electrostatic driver and a dynamic driver in a "two-way" configuration. A circumaural headphone whose soft urethane-filled ear cushions surround the wearer's ears, the K-340 does not press tightly on the head. Its light weight of 13.5 ounces (385 grams) makes it comfortable to wear for extended periods. The 9.8-ft (3-m) coiled cord is terminated with a three-conductor molded plug. Suggested retail price is \$189.00.

**General Description.** Although some of the sonic limitations associated with headphone listening are fundamental, AKG engineers found that the sense of

realism could be enhanced by the use of a "comb filter." This is because resonance and diffraction in the outer ear and ear canal convert a "flat" frequency response just outside a person's ears to a response with numerous notches across the frequency spectrum. Wearing headphones changes the resonance conditions in the ears, diminishing the comb effect greatly.

In the K-340, AKG employs six circular passive diaphragms around the driven cone, separating the volume in front of the cone from the rear volume in the earpiece. At low frequencies, the passive diaphragms are acoustically opaque, causing the driver to operate effectively in a small sealed enclosure for full bass response.

At about 200 Hz, where the enclosure resonance would tend to introduce a response peak, the passive diaphragms be-

# Ion Fountain™

YOUR ULTIMATE AIR FRESHENING/  
IONIZING SYSTEM. TOP QUALITY.  
LOW PRICE. STATE OF THE ART.



Breakthrough. The new Ion Fountain™ is in a class by itself. This negative ion generator gives you power to saturate your home or office with billions of refreshing ions. Without fans or any moving parts it puts out a pleasant breeze. A pure flow of ions pours from the top like water from a fountain, filling your room. The result? Your air feels like fresh ocean air—pure, crisp, and wonderfully charged.

The price? Only \$79.95. That's a price breakthrough because no other company can offer you a unit with higher ion output or better quality than the Ion Fountain™, even at triple our price.

#### HOW CAN WE DO IT?

Six years of experience helps. Plus a lot of ingenuity, aggressive research and a personal commitment to give our customers the best we can.

UTP Ion Research Center is a branch of our educational publishing company. And our commitment in publishing to give birth to new ideas and methods that enrich humanity is part of the Ion Research Center too. We're in business to serve you and your environmental needs.

#### WHAT ARE IONS?

Ions are electrically charged atoms in the air with either a positive or negative charge. The sun and cosmic rays as well as lightning and fast-moving water (like waterfalls, surf) generate trillions of negative ions every day. The more negatively ionized the air, the fresher and more alive it is. Air pollution, artificially controlled climates (with air conditioning and heating) and electronic equipment all produce excess positive ions, depriving the air of these small negative air ions and creating dead "stuffy" air.

#### WHAT'S THE SOLUTION?

Our rapid-growth technology, which sometimes takes its toll on the quality of our air, has also come up with the solution. Following Nature's model of the thunderstorm which uses a high electrical charge to purify, revitalize and stimulate the air, the UTP Air Energizer has been developed imitating this process. Both the thunderstorm and the Air Energizer fill the air with negative ions, restoring the natural electrical balance to the polluted, energy-depleted air. But the Ion Fountain can be used indoors in the home, office, workshop, laboratory, etc., keeping a fresh supply of ionized oxygen available night and day. This new breakthrough in fresh air control is not a cover-up

which masks or deodorizes. The unit actually removes the dust, smoke, bacteria and pollen particles from the air by attaching ions to them and causing them to sink to the earth where they can be vacuumed up rather than inhaled. At the same time ions electrically stimulate the energy-stripped air.

#### YOUR CHOICE OF TWO TOP-QUALITY UNITS!

There's only one unit that's better than the Ion Fountain. That's our own Executive System Four™. It sells for \$159. It has an even higher ion output. Plus! Our special Dial-An-Ion feature allows you to adjust the ion output anywhere from low to high. Not everyone knows that the need for ions varies. A large smoky room will require higher output than a small room. And some people want fewer ions while sleeping than while working. The new Executive System Four is our answer to this need for output flexibility.

#### FACTS YOU NEED TO KNOW The Ion Fountain™—System Five

*Ion density:* 430,000 ions per cm<sup>3</sup>/sec. at 1 meter. 1.55 million ions per cm<sup>3</sup> at 50 cms.  
*Use:* Large room or office—9000 cu. ft.  
*Warranty:* 1 year  
*Output voltage:* 15KV  
*Ozone:* Less than 2 parts per billion  
*Dimensions:* 5¾" x 4¼" x 2¾"

#### Executive System Four™

*Ion density:* Low to maximum of 540,000 ions per cm<sup>3</sup> at 1 meter. 1.6 x 10<sup>6</sup> ions per cm<sup>3</sup> at 50 cms.  
*Output voltage:* 15KV  
*Ozone:* Less than 2 parts per billion  
*Dimensions:* 11" x 5" x 4"  
*Use:* Large room or office 10,000 cu. ft.  
*Warranty:* 1 year

If the Executive System Four is better, why did we bring out the Ion Fountain? Not everybody is willing to pay \$159 for an air ionizing unit, no matter how good it is. Just like not everyone drives Rolls Royces. Most drive less expensive cars. The Executive System Four is for the person who wants the

absolute best quality and doesn't mind paying a little extra to get it. If you want highest ion output, flexibility, and a beautiful oak paneled case, buy the Executive System Four.

If you want something at half the price of the Executive System Four, but still better than any other units costing up to \$250, buy the Ion Fountain.

#### HOW TO GET ONE

To place your order now just send a check for \$79.95 plus \$3 shipping for the Ion Fountain. Or send \$159 plus \$4 shipping for the Executive System Four. Tell us your full street address as we cannot ship to Post Office boxes. (California residents add 6% sales tax.)

Our unit is dependable and trouble-free, but if by rare chance any problems occur our service-by-mail center sends off your unit within 24 hours of receipt or sends a replacement so you are not without fresh air and can enjoy your dust-free environment. And each Air Energizer is backed by a full one-year limited warranty.

#### HOW TO GET ONE FAST

Credit card holders can call our toll-free number below. Order a unit now and if you are not satisfied with its effects within 10 days simply return it for a full cash refund. Order your Air Energizer today.

# UTP

Read "The Golden Egg"

University of the Trees Press  
ION RESEARCH CENTER, Dept. PE4  
Box 644 BOULDER CREEK, CA95006  
Call Toll-Free . . . 800-538-0750  
In California call (408) 338-6663  
Send check or use your Master Charge,  
Visa or American Express card.

#### DETECT YOUR IONS

This simple but accurate detector instantly gives you a reading of ion intensity.  
The Econometer . . . (Pen Size) . . . \$7.50  
[If ordering separately include \$2.00 for shipping.]

**SURVIVAL!** Spirulina is a new wonder food supplement higher in protein than any other natural source. Very high in other nutrients too. Find out how you can be a commissioned representative of the Light Force Family and distribute Spirulina in either bulk or as special vitamin supplements. Generous commissions and opportunities available. Phone or write for your free information. (408) 338-9436. Please do not use the toll-free number for information.

CIRCLE NO. 63 ON FREE INFORMATION CARD

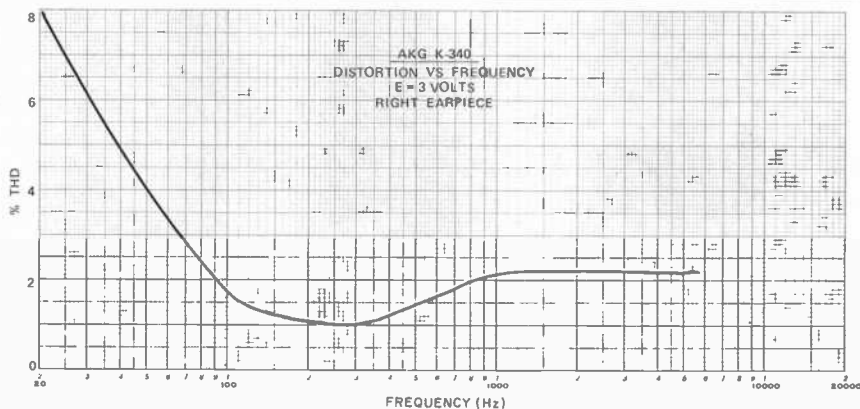

Percent total harmonic distortion versus frequency for right earpiece.

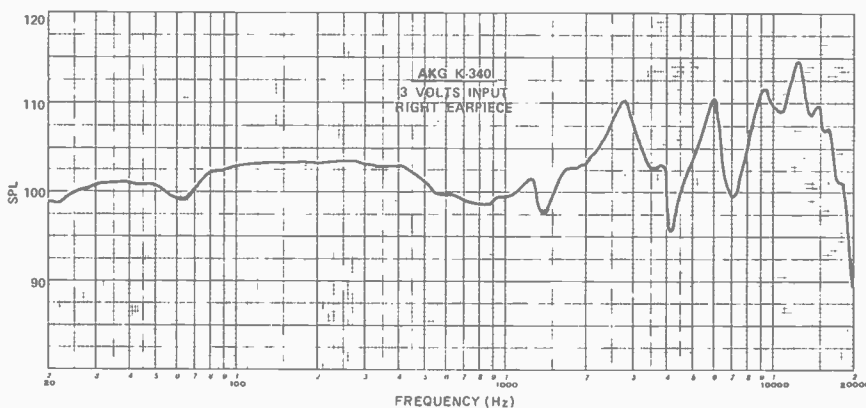

Acoustic output averaged 101.5 dB up to about 2000 Hz.

gin to become acoustically transparent. This expands the volume of the cavity and smooths out the midbass response. Flat bass and midrange output is achieved without recourse to a tight pressure seal on the wearer's head. At high frequencies, the passive diaphragms and the acoustic resistance elements behind them, introduce a comb filter effect that partially replaces the one suppressed by the presence of the phones.

To this point the design is basically similar to that of the K-240 phone still carried in the AKG line. The novelty of the K-340 lies in the use of an additional, electrostatic driver to extend and flatten its high-frequency response. Electrostatic headphones are reputed to offer clear and natural high-frequency reproduction, but their limited low-frequency output prevents them from generating high volume levels without distortion.

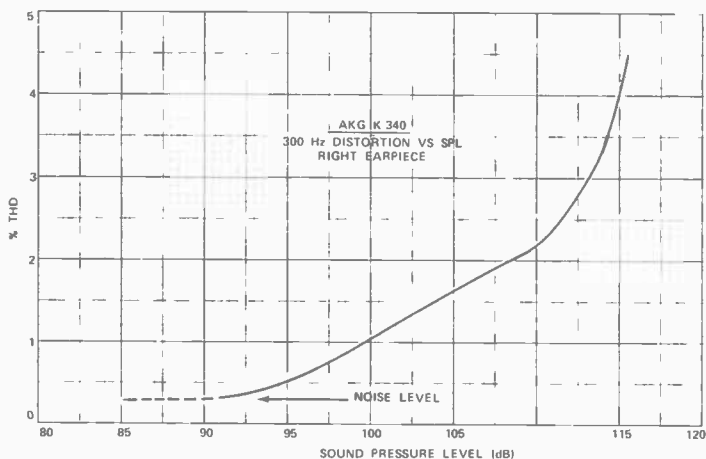

Harmonic distortion at 300 Hz versus SPL.

In the K-340, a dynamic transducer handles all frequencies up to about 4000 Hz, above which there is a 6-dB-per-octave crossover to an electrostatic transducer. A permanently polarized "electret" mounted concentrically with the dynamic driver provides the necessary electric field.

Each earpiece contains a miniature impedance-matching transformer, as well as a crossover network. Nominal impedance is about 400 ohms, suitable for connection to any amplifier headphone jack output.

Total sensitivity of the AKG K-340 is 0.63 volt (1 milliwatt) for an output SPL of 94 dB. Its IHF sensitivity rating at 5 volts input (63 milliwatts) is 112 dB SPL. The maximum rated continuous input per channel is 9 volts (200 milliwatts), corresponding to an SPL of 117 dB.

The K-340 phones have a dual bow metal bail that supports the earpieces and has self-adjusting slide fittings for the wide, soft padded band that actually contacts the wearer's head.

**Laboratory Measurements.** Measured on a slightly modified ANSI headphone coupler, the AKG K-340 had an overall frequency response remarkably like that of the much more expensive, fully electrostatic phones that serve as a calibration standard for our test setup. The high-frequency irregularities in the response curve are due as much to the coupler characteristics as to the headphones and may well represent the intended comb-filter effect. From 2000 Hz down, the K-340 had the flat, smooth response that we have previously measured only from a few of the finest headphones (most costing far more than the K-340).

If the higher frequencies are averaged, there appears to be a slight upward tilt to the response curve, with the maximum at 13,000 Hz about 8 to 10 dB higher than the low and midrange level. As the microphone we use for headphone measurements has its diaphragm resonance at that frequency and its response falls off rapidly at higher frequencies, the high-frequency response measurements probably reflect the microphone and coupler characteristics more than those of the headphone. This is typical of headphone measurements using a coupler.

Acoustic output of the phones averaged about 101.5 dB SPL up to about 2000 Hz with a 3-volt drive level. Impedance was slightly higher than 400 ohms from 20 to 4000 Hz, rising to a maximum of about 800 ohms at 12,000 Hz. Harmonic distortion was measured at 300 Hz, so that its components would fall in the flat response range of the phones. For an acoustic output of 90 dB (quite loud) the distortion was less than the system noise level (about 0.3%). It increased to 1.1% at 100 dB, 2.2% at 110 dB, and 4.5% at 114 dB. With a constant 3-volt input, distortion was 8% at 20 Hz, decreasing to 4% at 90 Hz and about 1% between 150 and 400 Hz. Measured distortion rose slightly to about 2%, at higher frequencies (1000 to 2000 Hz).



# Heart Computer

*Your heart can tell you three things that can help you live longer and stay healthier. The rest is up to you.*

JS&A has never offered a pulse meter. And for good reason.

If you've ever used one, you'll quickly discover that your heart does not beat like a clock. It's irregular. It might beat at 40 beats per minute for one instant and at 120 the next. Since most pulse meters measure each beat as it occurs, you never feel confident that you're getting a very good reading.

We also considered size. Each pulse meter we examined was large or cumbersome and awkward to carry or store.

## WE WAITED

We waited a few years. In the meantime, we discovered three ways your heart (through your pulse) helps you monitor your health.

**Pulse Rate** Your pulse rate can tell you if you are getting enough oxygen throughout your body. A high pulse rate indicates that your heart must pump faster to supply that oxygen and may indicate poor physical condition.

**Target Zone** Your pulse can tell you if your heart is beating fast enough during exercise. There's an area called the "Target Zone." Below this level, you're not exercising hard enough to do your heart or respiratory system any good. Above this level, you can be dangerously over-exerting yourself.

**Cardiac Recovery Time** The time it takes for your pulse rate to return to normal after you've exercised is the real measure of whether or not your exercise program is doing you any good. This time can be as healthy as one minute or as poor as several minutes.

The three things we learned convinced us that the ideal pulse meter must have the following features:

1. It must measure a series of heart beats and simultaneously compute the average to avoid the strange readings from irregular heart beats.

2. It must be small enough to use while exercising.

3. It should have a timing capability to determine the Cardiac Recovery Time.

It wasn't until a small Utah medical electronic instrument company created what we feel not only provides the capabilities listed above, but excels in other areas too.

## FITS ON FINGER

The unit is called the Pulsetach, and it fits right over your finger. It weighs less than an ounce and can be worn easily during most exercise programs.

The large liquid crystal display can easily be seen in normal room lighting or in bright sunlight, and because liquid crystal displays consume very little power, the readily-available watch batteries will last for years. The Pulsetach automatically turns itself off in five minutes if you forget.

The heart of the system is a powerful micro-

computer CMOS semi-conductor integrated circuit that will take up to 4 pulse beats, compute an average pulse rate, and then flash that rate on the liquid crystal display.

## FINGERTIP SCANNER

The sensor consists of a Gallium Arsenide infrared light-emitting diode which scans your fingertip hundreds of times a second to determine your pulse rate. This new system is one of the most accurate and is also used in sophisticated hospital systems.

The unit also contains a quartz-controlled timing circuit which will accurately time either your exercise period or your Cardiac Recovery Time. And you can switch back and forth between the pulse and chronograph mode while you are exercising.

We realize that the Pulsetach sounds like a very sophisticated unit. And it is. But as sophisticated as it is internally, it's an extremely easy unit to operate. There are just two buttons to press which operate the pulse reading and the chronograph timing circuit. A third button engages the audio circuit.



*The Pulsetach system fits comfortably on your finger while it monitors your heart and determines your Cardiac Recovery Time.*

## HEAR YOUR PULSE

The audio circuit simply beeps every time your pulse beeps. This feature lets you monitor your pulse by hearing it as you run or exercise and it can be shut off by pressing the button a second time. The timing circuit is quartz-controlled and extremely accurate.

The Pulsetach not only has combined all of the most advanced technology in an extremely small size, but it costs less than many other systems lacking its advanced features.

The Pulsetach can be used for joggers, athletes, all forms of exercise and even cardiac recovery patients, as it operates quite effectively with pacemakers.

## REAL WORKOUT

We suggest you order a Pulsetach for our 30-day no-obligation trial. When you receive your unit, give it a real workout. Notice how simple it is to operate and how easily you



*The Pulsetach will shortly become the number one selling system of its type in the nation.*

can read your pulse rate. Use it to stay in your Target Zone and to determine and then improve your Cardiac Recovery Time.

Monitor your Cardiac Recovery Time. Determine your Target Zone and see if you're really exercising in that area. Then use the Pulsetach to watch those important signs slowly improve thanks to the accuracy and information you get from the unit.

By knowing the important factors that help you monitor your health, you'll feel better, exercise more effectively, and many doctors feel you'll live longer.

## TWO UNITS AVAILABLE

To order your Pulsetach pulse meter, send your check for **\$119.95** plus \$2.50 postage and handling (Illinois residents add 6% sales tax) to the address below. (Allow 20 days for personal checks to clear.) Credit card buyers may call our toll-free number below.

You can also order the more expensive hospital unit that averages 16 beats and has all the features including the small size of the previous unit. It costs **\$169.95**.

We'll send your Pulsetach pulse meter complete with 90-day limited warranty and instructions which include information on determining your Target Zone, Cardiac Recovery Time and other helpful information.

Then after your test, if you're not fully convinced that the Pulsetach is the best unit of its kind, the most convenient, and the greatest value, return it within 30 days for a prompt and courteous refund including the \$2.50 charge for postage and handling. You can't lose.

Your Pulsetach is totally solid-state so service should never be required, but if it is, the manufacturer has a national service-by-mail facility backing each unit. JS&A is America's largest single source of space-age products—further assurance that your Pulsetach is backed by a substantial company.

We've waited an awful long time to jump into the pulse monitoring field. But what a great entry. Order your Pulsetach at no obligation today.

**JS&A PRODUCTS**  
**THAT THINK®**

Dept. PE One JS&A Plaza  
Northbrook, Ill. 60062 (312) 564-7000  
Call TOLL-FREE ..... 800 323-6400  
In Illinois Call ..... (312) 564-7000

©JS&A Group, Inc., 1980

However, those readings are compromised by the fact that the distortion products fell in the region of irregular frequency response.

**User Comment.** Despite their size, AKG K-340 phones are very light and comfortable to wear. The large ear cushions distribute their pressure over a large area of the head, and the headband can hardly be felt. Adjustment of the earpiece positions is one of the most convenient we have found.

The sound of the phones is both smooth and notably wide in their frequency coverage. Compared to our electrostatic refer-

ence phones, they sound very slightly bright (the average output above 8000 Hz or so is higher by as much as 8 dB). This can sometimes be heard as a slight accentuation of record hiss or FM background hiss, but it does not produce a significant coloration of music.

Playing as loud as a 120-watt amplifier could drive them—far louder than we would normally use—the phones sounded clean and never as though they were being pushed to their limits. Their high sensitivity and impedance makes it possible to drive them to reasonable levels from tape recorder or preamplifier outputs.

As to whether the special construction of the K-340 gives a sound more “natu-

ral” than that of conventional phones, we must defer judgment. In our experience, no headphone duplicates the loudspeaker listening experience, or vice versa, although the two can be made similar by signal processing. We can say that the response of the K-340 is at least as wide and smooth as that of any dynamic phone we have used, and it has much of the high-frequency clarity usually associated only with electrostatic phones. It plays without harshness or distortion at levels louder than most listeners could tolerate and is one of the most comfortable circumaural phones we have used. AKG has realized its stated design objectives very well.

CIRCLE NO. 101 ON FREE INFORMATION CARD

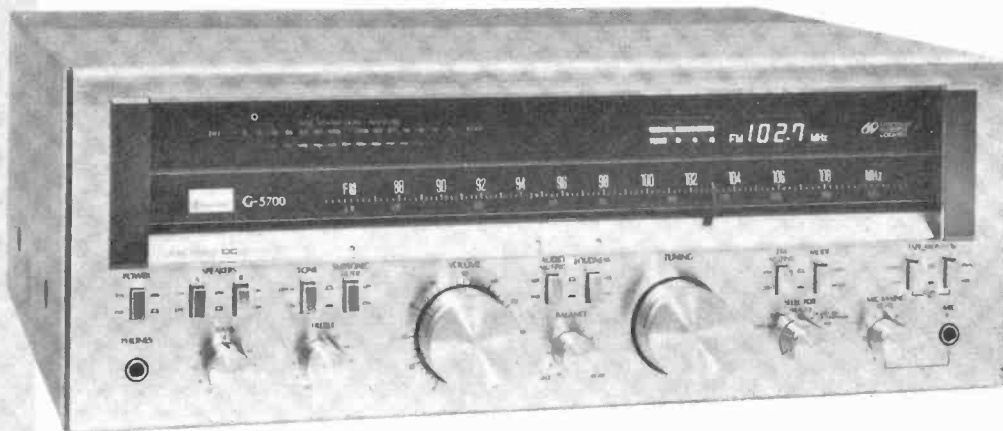

## Sansui G-5700 AM/FM Stereo Receiver

### Slide-rule dial and digital readout for easy tuning

**T**HE Sansui G-5700 AM/FM stereo receiver features a dc-coupled power amplifier and hybrid tuning display that combines conventional AM/FM dial with a four-digit fluorescent readout from a frequency counter. FM tuning accuracy is assured by a digital quartz-lock control system. Instead of the moving-pointer meters often used to indicate tuning and output power parameters, the G-5700 has solid-state displays for FM tuning accuracy, AM and FM signal strengths, and audio power output into 8-ohm loads.

The Sansui G-5700 carries an FTC rating of 75 watts per channel into 8-ohm loads from 20 to 20,000 Hz with no more than 0.03% total harmonic distortion (THD). It is furnished in a rosewood veneer wooden cabinet with overall dimensions of 18 1/4" wide X 16" deep X 7" high (46.5 X 40.5 X 17.7 cm). It weighs 30.4 pounds (13.8 kg). Suggested retail price is \$630.

**General Description.** Although the power amplifiers of the Sansui G-5700 are

direct-coupled from input to output, the tone-control amplifiers and phono preamplifiers are capacitively coupled at their inputs and outputs. The amplifiers (and speakers) are protected by a circuit that senses dc across the outputs or excessive current delivered to the load. Either condition makes a fast-acting relay disconnect the output loads.

The upper part of the silver-colored satin finish front panel of the G-5700 is a dial window, with long, clearly visible dial scales and a traveling pointer. Above the scales are the solid-state displays mentioned earlier. Though some of them operate in somewhat unorthodox ways, all read clearly and are easy to interpret. There is a green SAFELY OPERATE light showing that the protective system has connected the speakers, after an initial turn-on delay. If the protective system is tripped, the receiver is silenced and the light goes out. Power must then be shut off for a few seconds and reapplied to get it going again.

On the input selector there are positions

FOR TAPE/AUX. PHONO, FM AUTO, DOLBY FM DE-EMPHASIS, and AM. The MIC MIXING feature channels the output of a single (mono) microphone equally to both audio outputs, independent of the main volume control setting. However, the microphone signal does not appear at the tape recording outputs. The DOLBY FM DE-EMPHASIS mode changes the usual 75-microsecond de-emphasis time constant to the 25 microsecond constant required by Dolby decoding. The G-5700 does not have a built-in Dolby decoder.

The output transistors and their heat sinks are completely enclosed within the receiver cabinet, with cooling air passing by convection through slots in the top, rear, and bottom of the receiver enclosure. On the rear apron there are insulated spring connectors for the two sets of speakers, phono jacks for the signal inputs and the tape recorder connections, and binding posts for the antenna inputs. (There is also a hinged and pivoted AM ferrite rod antenna.) One of the two convenience outlets is switched.

(Continued on page 29)

# The Imagination Machine™

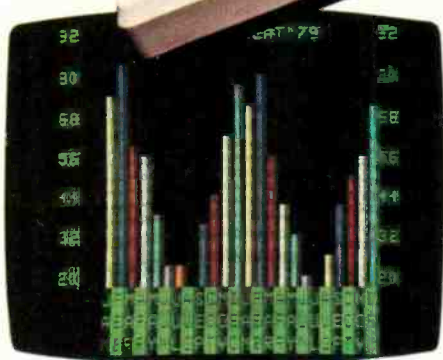

The only computer with color, sound, user programmability and expandability at \$599.

A built-in, dual-track cassette tape deck with 1500 baud rate, for APF's digitally recorded, "saturated," tape programs. A built-in sound synthesizer. And two, built-in, game style controllers, with joystick and numeric keypads.

When you want to go beyond APF's library of educational, home-and-personal management or entertainment programs... when you want to create your own programs... you can. The Imagination Machine is programmable in BASIC and 6800 machine language. The Imagination Machine

is also expandable. Just add our "Building Block", an optional, four-port expansion device, and you can hook up a printer, telephone modem, and additional memory cartridge or mini-floppy disk drive.

For the name of your nearest Imagination Machine dealer call, TOLL FREE: 1-800-223-1264. (New York residents call: (212) 758-7550) or write: APF Electronics, Inc. 444 Madison Avenue, N.Y., N.Y. 10022.

\$599. Manufacturer's suggested retail price.

**APF**electronics inc.

**"YOUR LIFE WILL NEVER BE THE SAME!"**

CIRCLE NO. 6 ON FREE INFORMATION CARD

AmericanRadioHistory.Com



All the facts you should know about CB antenna reliability and performance...

# "ours" vs. "theirs"



Precision machine ground tapered whip has less air resistance and less pattern distortion due to whip bending. Highest quality 17-7 PH stainless steel can be bent full circle and still snap back to perfect vertical!

True static ball tip for continuous dissipation of wind static build up and less noise! Also protects garage doors from nicks of unprotected whip tips. Safer, too.

Full 60-inch radiator surface for maximum range. Optimum length for non-critical tuning — use without fine tuning at 1.5 to 1 or better VSWR from channels 1 to 40!

Antenna Specialists' LEVERLOK™ quick release. Firm, positive electrical and mechanical connection, instant disconnect, with the twist of a lever.

Top grade silver mica transmitting capacitor for consistently lower VSWR under extremes of humidity and temperature.

Dual fine tuning set screws prevent detuning due to road and wind vibration. Assures positive electrical continuity, too, for reliable performance.

Stainless steel shock spring absorbs blows from branches and garage doors. Drastically reduces breakage of coil and mount common with untapered whips without shock spring.

Genuine G.E. Lexan® housing with tensile and compressive strength of 16,000 lbs. per square inch at temperature extremes from -200°F to +320°F! Unmatched ability to withstand punishing abuse.

Silver-plated phosphorous bronze spring contacts. The superior high frequency efficiency of pure silver. Plus spring contacts that will assure positive continuity after years of daily removal and re-installation!

Guaranteed satisfaction with 5-year limited warranty PLUS lifetime coil burnout warranty.

\$39.95 suggested retail price for demonstratively superior quality and performance.

No whip taper.

No static ball.

57-inch radiator surface.

Quarter turn quick release.

Ordinary ceramic transmitting capacitor.

Single fine tuning set screw.

No shock spring.

Less expensive plastic housing.

Semi-rigid, chrome-plated steel contacts.

12-month warranty limit.

\$42.50 suggested retail price.



## M-2000 SUPER SCORPION™



® "Stripes of Quality"

the antennaspécialists co.

a member of The Allen Group Inc.  
12435 Euclid Ave. Cleveland, Ohio 44106  
Export: 2200 Shames Drive  
Westbury, L.I., New York 11590  
Canada: A. C. Simmonds & Sons, Ltd.

Lexan is a registered trademark of General Electric Company



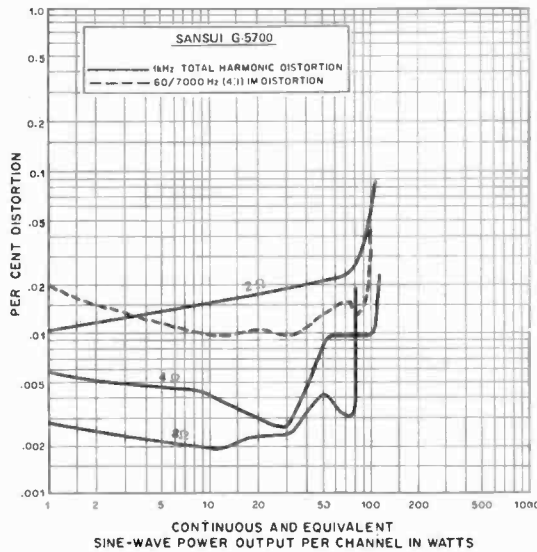

1000-Hz THD, both channels driven, left measured and IM distortion into 8-ohm load.

**Laboratory Measurements.** During preconditioning and high-power operation, the exterior of the cabinet became only moderately warm. Driving 8-ohm loads at 1000 Hz, the output clipped at 91 watts per channel, corresponding to an IHF Clipping Headroom rating of 0.8 dB. The receiver is not power rated for other load impedances, but its outputs clipped at 119 and 115 watts per channel, respectively, with 4-ohm and 2-ohm loads.

At 8 ohms, the 1000-Hz distortion was extremely low, reading 0.0032% at the rated 75 watts output, and only 0.02% at 85 watts, just before clipping. IM distortion was between 0.01 and 0.02% from 1 watt to more than 90 watts output. With 4-ohm loads, the 1000-Hz THD measured 0.025% as power reached 110 watts. Even with 2-ohm loads, distortion measured only 0.071% at 100 watts.

IHF Dynamic Headroom was 2.8 dB, somewhat better than average. Dynamic power into 4- and 2-ohm loads was the

same as the continuous clipping output power, indicating that this was limited by the maximum available output current. The protective circuit did not trip at this level.

At rated power, half power, and one-tenth power, the distortion was 0.15% worst-case, and typically much better than that. The power output indicators read high by as much as several hundred percent, a fault we would expect, however, to have little practical consequence.

To reach reference power output of 1 watt, an input level of 17 millivolts (mV) was required at the TAPE/AUX input, or 0.27 mV at the PHONO input. The corresponding A-weighted S/N ratios were 78 and 76 dB. Mic sensitivity was 0.75 mV, with a 74-dB S/N. The phono overload limit at 1000 Hz was 260 mV; and at 20 and 20,000 Hz, the respective overload inputs (referred to the 1000-Hz gain) were 249 and 97 mV. The microphone input overload point was very high at 400 mV.

Phono input impedance was 49 kilohms in parallel with 150 picofarads.

Sansui specifies the rise time and slew rate of the power-amplifier section as 1.4 microseconds and 56 volts per microsecond. As there is no access to the power-amplifier inputs, we measured through the AUX inputs. Rise time was 4 microseconds and the slew rate 22 volts/microsecond, both very adequate for this power rating. IHF Slew Factor exceeded our measurement limit of 25.

Tone control characteristics were typical of most amplifiers we have tested, with a variable bass turnover frequency and a hinged treble response. Loudness compensation boosted both low and high frequencies, and the subsonic filter, down 3 dB at 20 Hz, began to roll the bass response off slightly as high as 60 Hz. Flat within 0.5 dB overall from 30 to 20,000 Hz, and down 1 dB at 20 Hz, RIAA phono equalization was unaffected by most phono cartridges. We found some high-frequency roll-off when driving the phono input through a relatively high-inductance cartridge, but we suspect this was due to the effect of the preamplifier input capacitance on the cartridge. Microphone preamplifier response was flat within  $\pm 0.5$  dB from 100 to 20,000 Hz, rising to +3 dB at 50 Hz before dropping to -3 dB at 34 Hz.

FM tuner performance was excellent. IHF Usable Sensitivity was 10.3 dBf (1.8  $\mu$ V) in mono and 15 dBf (3  $\mu$ V) in stereo, while the more meaningful 50-dB quieting point was reached with 12 dBf (2.2  $\mu$ V) input in mono, and 35 dBf (30  $\mu$ V) in stereo. Ultimate distortion, at 65 dBf (1000  $\mu$ V), was 0.19% in mono and 0.12% in stereo, with respective S/N readings of 76 and 71.5 dB. The signal level indicators came on at inputs from 14 to 38 dBf (2.8 to 40  $\mu$ V).

Stereo FM frequency response was  $\pm 0.7$  dB from 50 to 15,000 Hz, and down 1.6 dB at 30 Hz. Channel separation was reasonably uniform with frequency, measuring about 35 dB through the midrange, 33 dB at 30 Hz, and 26 dB at 15,000 Hz. Capture ratio was 1.6 dB at 65 dBf, and 1.4 dB at 45 dBf (100  $\mu$ V), with corresponding AM rejection measurements of 67 and 60 dB. Image rejection was 50 dB. Alternate-channel selectivity was highly asymmetrical about the center-tuned frequency, reading 49 dB on one side and 79 dB on the other. Adjacent-channel selectivity readings were much closer and averaged 5.2 dB.

Muting and quartz-lock thresholds were identical at 13 dBf (2.4  $\mu$ V). There was no distinct stereo threshold, but the stereo light flickered at levels under 11 dBf (2  $\mu$ V). Leakage of the 19-kHz pilot carrier leakage into the audio was -60 dB, and hum level was -69 dB. The AM tuner frequency response was down 6 dB at 200 and 3700 Hz.

**User Comment.** The Sansui G-5700 handled with gratifying smoothness. FM

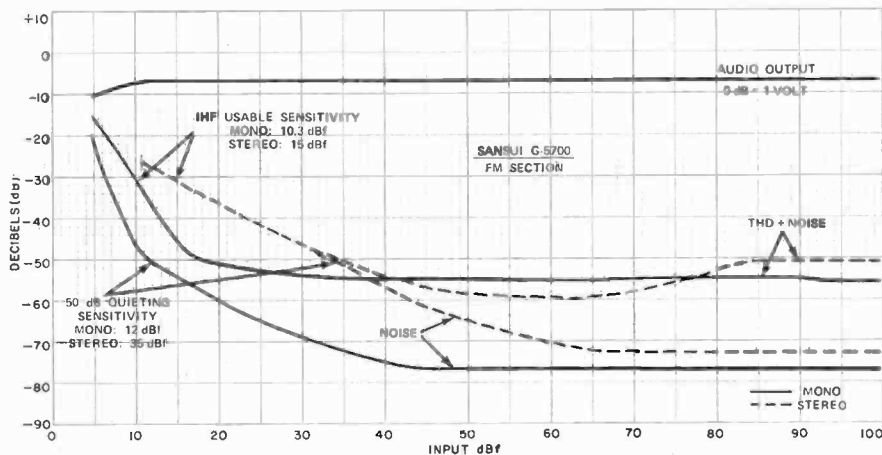

Noise and sensitivity curves for the FM section of the tuner.

tuning was notably quiet and free of transient noises, and the quartz-lock indication, along with unmuting of the audio, did not occur until a station was tuned in precisely. We found that the quartz-lock system produced very close to minimum distortion. Although at some signal levels an improvement could be made by adjusting the signal-generator frequency (touching the tuning knob disabled the

quartz lock), the reduction in distortion had no audible significance.

Except for its image rejection, which is borderline for its price class, just about every characteristic of the G-5700 was excellent. Though lacking a few amenities, such as two-way tape dubbing, separate preamplifier outputs and power-amplifier inputs, and selectable tone-control turnover frequencies, the Sansui G-5700 coun-

ters with a power amplifier whose unusually large current capacity lets it drive difficult speaker loads without distortion or protective shutdown. (The protective circuits, incidentally, are very effective.) If its balance of features suits your needs, the G-5700 receiver represents a highly functional, tastefully styled package at an attractive price.

CIRCLE NO. 102 ON FREE INFORMATION CARD



## Onkyo A-7090 Integrated Stereo Amplifier

### A rugged, high-current output stage with a "Super-Servo" circuit for dc stability

THE Onkyo A-7090 integrated amplifier is rated to deliver 110 watts per channel to 8-ohm loads from 20 to 20,000 Hz with no more than 0.018% total harmonic distortion (THD). It features Onkyo's "Super Servo" circuit, a secondary negative feedback loop in the power amplifier that reduces its gain at infrasonic frequencies without affecting the audio range. Also included in the unit is a head amplifier for moving-coil cartridges as well as the usual phono preamplifier. The

A-7090 is 16 1/2" wide X 16 3/16" deep X 6 1/8" high (41.8 X 41 X 15.5 cm) and weighs about 40 pounds (18 kg). Its suggested retail price is \$700.

**General Description.** The Onkyo A-7090 is dc coupled through its power amplifier section. Onkyo engineers felt that full amplifier gain down to zero frequency (dc) might promote damage due to infrasonic transients, yet they were unwilling to use large capacitors either in the feed-

back loop or output lines to roll off response.

The solution lay in the use of a second feedback path, with additional gain provided by an operational amplifier. This introduces a much higher feedback factor from about 1 Hz downward, reducing the gain at 6 dB per octave. This "Super Servo" circuit also maintains zero dc potential across the speakers.

The Onkyo A-7090 has a comprehensive protection system with four criteria

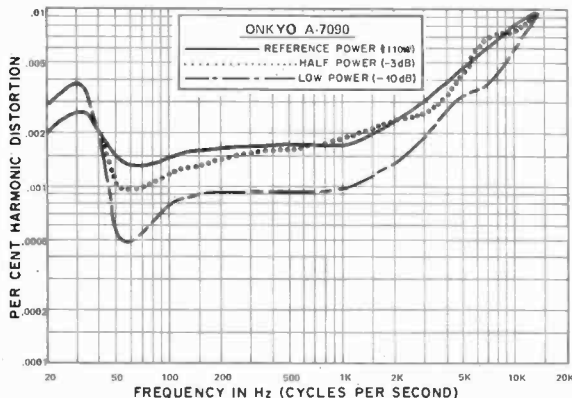

Distortion with 8-ohm load for three power levels.

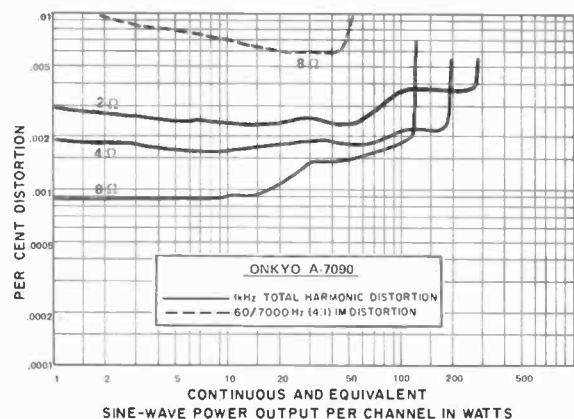

1000-Hz THD, both channels driven, right measured.

# Save on Scanners! NEW Rebates!

Communications Electronics™, the world's largest distributor of radio scanners, welcomes the addition of Fanon to our product line. Fanon introduces two new high performance hand-held scanners. More importantly, Fanon has a complete selection of useful accessories to compliment their *Slimline* models.

Electra Company, manufacturers of Bearcat brand scanners is offering consumer rebates on selected synthesized scanners purchased during May and June, 1980. Most items are in stock for immediate shipment, so purchase your scanner from CE now!

## NEW! Bearcat® 300

**The Ultimate Synthesized Scanner!**  
Allow 90-120 days for delivery after receipt of order due to the high demand for this product.  
List price \$519.95/CE price \$339.00

**4-Band, 50 Channel • Service Search • No-crystal scanner • AM Aircraft and Public Service bands • Priority Channel • AC/DC Bands: 32-50, 118-136 AM, 144-174, 421-512 MHz.**  
The new Bearcat 300 is the most advanced automatic scanning radio that has ever been offered to the public. The Bearcat 300 uses a bright green fluorescent digital display, so it's ideal for mobile applications. The Bearcat 300 now has these added features: Service Search, Display Intensity Control, Hold Search and Resume Search keys, Separate Band keys to permit lock-in/lock-out of any band for more efficient service search.

## Bearcat® 250

List price \$419.95/CE price \$279.00/\$20.00 rebate  
Your final cost is a low \$259.00

**50 Channels • Crystalless • Searches Stores • Recalls • Digital clock • AC/DC Priority Channel • 3-Band • Count Feature.**  
Frequency range 32-50, 146-174, 420-512 MHz.  
The Bearcat 250 performs any scanning function you could possibly want. With push button ease you can program up to 50 channels for automatic monitoring.

## Bearcat® 220

List price \$419.95/CE price \$279.00/\$20.00 rebate  
Your final cost is a low \$259.00

**Aircraft and public service monitor.** Frequency range 32-50, 118-136 AM, 144-174, 420-512 MHz.  
The Bearcat 220 is one scanner which can monitor all public service bands plus the exciting AM aircraft band channels. Up to twenty frequencies may be scanned at the same time.

## Bearcat® 211

List price \$349.95/CE price \$239.00/\$10.00 rebate  
Your final cost is a low \$229.00

Frequency range: 32-50, 146-174, 420-512 MHz.  
The Bearcat 211. It's an evolutionary explosion of features and function. 18-channel monitoring. With no-crystal three-band coverage. Dual scan speeds. Color-coded keyboard. Even a digital clock. All at a modest price. More scanning excitement than you bargained for.

## Bearcat® 210

List price \$319.95/CE price \$209.00/\$10.00 rebate  
Your final cost is a low \$199.00

**10 Channels • 3 Bands • Crystalless**  
Frequency range: 32-50, 146-174, 420-512 MHz.  
Use the simple keyboard to select the 10 channels to be scanned. Automatic search finds new frequencies. The 210 features patented selectable scan delay, push button lockout, single antenna, patented track tuning, AC/DC operation. With no crystals to buy. Ever!



## NEW! 50-Channel Bearcat 300

## FREE Bearcat® Rebate Offer

Buy a Bearcat model 250, 220, 211 or 210 between May 1 and June 30, 1980 any you'll get a coupon good for a rebate worth up to \$20.00. Mail this coupon along with proof of purchase and the Bearcat Stringed Card attached to the front of your new scanner to Bearcat Father's Day Rebate Offer, Electra Company, Box 29243, Cumberland, Indiana 46229. Offer good only on purchases made between May 1 and June 30, 1980. Coupon may not be reproduced and must accompany all proof of purchase requirements. Rebate requests must be postmarked by July 15, 1980. Offer good only in the U.S.A. Void where taxed or prohibited by law. Offer limited to one rebate per customer regardless of number of scanners purchased. Resellers, companies, clubs and organizations (profit and non-profit) are not eligible for rebate. Allow 4-6 weeks for delivery of rebate check. Please be sure to send in the correct amount for your scanner. You pay the listed CE price in this ad. Do not deduct the rebate amount since your rebate will be sent directly to you from Electra Company. Orders received without the correct amount will not be processed and will be returned.

## Bearcat® 12

List price \$179.95/CE price \$119.00  
**10 Channels • 3 Bands • AC or DC**  
Frequency range: 33-48, 146-174, 450-512 MHz.  
More features, more channels, more action. The Bearcat 12 has automatic squelch, individual lockout and more.

## NEW! Bearcat® 5

**The newest low-cost crystal scanner!**  
List price \$129.95/CE price \$94.00  
**8 Channels • 3 Bands • AC only**  
Frequency range: 33-50, 146-174, 450-508 MHz.  
The Bearcat 5 is a value-packed crystal scanner built for the scanning professional — at a price the first-time buyer can afford. Individual lockout switches.

## NEW! Bearcat®

### Four-Six ThinScan™

List price \$179.95/CE price \$119.00  
Frequency range: 33-47, 152-164, 450-508 MHz.  
The incredible, new Bearcat Four-Six Thin Scan™ is like having an information center in your pocket. This three band, 6 channel crystal controlled scanner has patented Track Tuning on UHF. Scan Delay and Channel Lockout. Measures 2 3/4 x 6 1/2 x 1." Includes rubber ducky antenna.

### Bearcat® ThinScan™

List price \$149.95/CE price \$99.00  
**World's smallest scanner!**  
There are now three models available. The BC 2-4 L/H receives 33-44 and 152-164 MHz. The BC 2-4 H/U receives 152-164 and 450-508 MHz. The Aircraft ThinScan™ model BC 2-4 AC receives 118-136 and 450-470 MHz. The Bearcat ThinScan™ measures 2 3/4" across. Just 1" deep. And 5/8" high.

## NEW! Fanon Slimline 6-HLU

List price \$169.95/CE price \$109.00  
**World's smallest 6-channel, 3-band scanner!**  
The new Fanon Slimline 6-HLU gives you six channels of crystal controlled excitement. Unique Automatic Peak Tuning Circuit adjusts the receiver front end for maximum sensitivity across the entire UHF band. Individual channel lockout switches. Frequency range 30-50, 146-175 and 450-512 MHz. Size 2 3/4" x 6 1/2" x 1." Includes rubber ducky antenna.

## NEW! Fanon Slimline 6-HL

List price \$149.95/CE price \$99.00  
**6-Channel performance at 4-channel cost!**  
Frequency range: 30-50, 146-175 MHz.  
If you don't need the UHF band, get this model and save money. Same high performance and features as the model HLU without the UHF band. Order crystal certificates for each channel.

## FANON SCANNER ACCESSORIES

CHB-6 AC Adapter/Battery Charger ..... \$15.00  
CAT-6 Carrying case for Fanon w/Belt Clip ..... \$15.00  
AUC-3 Auto lighter adaptor/Battery Charger ..... \$15.00  
SCMA-6 Mobile adaptor/amplifier/charger ..... \$49.00

## OTHER SCANNER ACCESSORIES

SP50 AC Adaptor ..... \$12.00  
SP51 Battery Charger ..... \$12.00  
SP57 Carrying Case for Bearcat 2-4 only ..... \$15.00  
SP58 Carrying Case for Bearcat 4-6 ThinScan™ ..... \$15.00  
FB-E Frequency Directory for Eastern U.S. .... \$15.00  
FB-W Frequency Directory for Western U.S. .... \$15.00  
B-31.2 V AA Ni-Cad's for Four-Six (Pack of 4) ..... \$15.00  
B-41.2 V AAA Ni-Cad's for ThinScan™ and Fanon. .... \$15.00  
B-5 Replacement memory battery for Bearcat 210 ..... \$5.00  
B-61.5 V AA Alkaline battery (Pack of 4) ..... \$3.00  
B-71.5 V AAA Alkaline battery (Pack of 4) ..... \$3.00  
A-135c Crystal certificate ..... \$4.00  
Add \$3.00 shipping for all accessories ordered at the same time.

## INCREASED PERFORMANCE ANTENNAS

If you want the utmost in performance from your scanner, it is essential that you use an external antenna. We have six base and mobile antennas specifically designed for receiving all bands. Order #A60 is a magnet mount mobile antenna. Order #A61 is a gutter clip mobile antenna. Order #A62 is a trunk-lip mobile antenna. Order #A63 is a 3/4 inch hole mount. Order #A64 is a 3/8 inch snap-in mount, and #A70 is an all band base station antenna. All antennas are \$30.00 and \$3.00 for UPS shipping in the continental United States.

## TEST ANY SCANNER FREE

Test any scanner purchased from Communications Electronics™ for 31 days before you decide to keep it. If for any reason you are not completely satisfied, return it in original condition with all parts in 31 days, for a prompt refund (less shipping/handling charges and rebate credits).

## Regency® K500

List price \$419.00/CE price \$279.00  
**40 Channel • Synthesized • Service Search Digital count • Weather with tone alert Search/Store • Priority Channel • AC/DC**  
Frequency range: 30-50, 144-174, 440-512 MHz.  
The new Regency Touch K500 is an advanced synthesized scanner with many new features.

## OTHER REGENCY® SCANNERS

Aircraft Touch 720-A ..... \$239.00  
Touch K100 ..... \$199.00  
NEW! Touch M100 ..... \$199.00  
E-106 ..... \$119.00  
R-106 ..... \$99.00  
R-804 ..... \$89.00

## World Scanner Association™

The WORLD SCANNER ASSOCIATION is sponsored as a public service by Communications Electronics™. When you join, you'll receive a quarterly newsletter with scanner news and features. You'll also get a wallet I.D. card, an Official Personalized WSA Membership Certificate, and the latest FCC news affecting monitoring such as frequency allocations. FREE classified ads for members so you can contact other scanner owners when you want to sell or buy a scanner. FREE membership in the WSA Buyer's Co-op. Your Co-op membership will allow you to get special discounts on scanners and scanner related products. Since the WSA Buyer's Co-op gives you group purchasing power, you can easily pay for your membership dues the first time you make a Co-op purchase. WSA is your united voice to governmental and public service agencies as well as scanner manufacturers. You'll get inside information on the latest scanner products before the general public. Since WSA is not affiliated with any scanner manufacturer, you can rely on accurate product reports. You get all this for only \$12.00 annual dues! And if you join before June 30, 1980, CE will pay \$2.00 of the cost of your first year's dues as a "charter member." You can charge your "charter membership" on Visa or Master Charge so join now! Add \$5.00 for foreign memberships. Allow 6-10 weeks to receive membership material.

## BUY WITH CONFIDENCE

To get the fastest delivery from CE of any scanner, send or phone your order directly to our Scanner Distribution Center. Be sure to calculate your price using the CE prices in this ad. Michigan residents please add 4% sales tax. Written purchase orders are accepted from approved government agencies and most well rated firms at a 10% surcharge for net 30 billing. All sales are subject to availability. All sales on accessories are final. Prices and specifications are subject to change without notice. Out of stock items will be placed on backorder automatically unless CE is instructed differently. International orders are invited with a \$10.00 surcharge for special handling in addition to shipping charges. All shipments are F.O.B. Ann Arbor, Michigan. No COD's please. Non-certified and foreign checks require four weeks bank clearance.

Mail orders to: Communications Electronics™, Box 1002, Ann Arbor, Michigan 48106 U.S.A. Add \$5.00 per scanner for U.P.S. ground shipping, \$9.00 for faster U.P.S. air shipping or \$30.00 for overnight delivery to most major U.S. cities via Federal Express or Airborne Air Freight. If you have a Master Charge or Visa card, you may call anytime and place a credit card order. Order toll free 800-521-4414. If you are outside the U.S. or in Michigan, dial 313-994-4444. You may also order via TWX 810-223-2400. Dealer inquiries invited. All order lines at Communications Electronics™ are staffed 24 hours.

WSA, Scanner Distribution Center™ and CE logos are trademarks of Communications Electronics™.  
† Bearcat is a federally registered trademark of Electra Company, a Division of Masco Corporation of Indiana.  
‡ Regency is a federally registered trademark of Regency Electronics Inc.  
Copyright © 1980 Communications Electronics™



**COMMUNICATIONS ELECTRONICS™**

854 Phoenix □ Box 1002 □ Ann Arbor, Michigan 48106 U.S.A.  
Call TOLL-FREE (800) 521-4414 or outside U.S.A. (313) 994-4444

**We're first with the best.™**

for its operation. A relay disconnects the load if: (1) less than five seconds has elapsed after power-on (for protection from start-up transients); (2) excessive output current is drawn; (3) dc appears across the load; (4) the output-transistor heat sinks get too hot.

The amplifier is finished in satin silver, with the upper part of its panel dominated by a window surrounding the LED power display. Calibrations are at 1, 3, 9, 18, 35, 70, 110, and 120 watts (based on 8-ohm loads). Buttons below the display increase its sensitivity by a factor of 10 or 100 (10 or 20 dB), so that a power output as low as 10 milliwatts will light the first LED.

Functions provided in the A-7090 include SUBSONIC and HIGH filters, as well as tape REC SELECTOR (for taping from the SOURCE or dubbing from either of two tape decks to the other), MUTING, LOUDNESS, and EPS (external processor switch). The last allows connections of an add-on signal processor such as an equalizer or a noise reducer into the signal path much as would "pre out/main in" jacks with removable jumper links. A headphone output is also provided.

The tone controls (BASS and TREBLE) have 21 detented positions with a center OFF setting. BASS turnover frequencies of 125 or 400 Hz and treble turnover frequencies of 2 or 8 kHz are switch selectable, or the tone controls can be bypassed entirely.

The remaining controls comprise a MODE knob, for STEREO, REVERSE stereo, or MONO operation, a MONITOR knob that connects the amplifier to the playback from either tape deck or to the selected program source, and a SELECTOR switch capable of choosing between MC (moving coil cartridge), PHONO 2, PHONO 1, TUNER, and AUX.

The rear apron of the A-7090 contains the various signal input and output jacks, plus six pairs of insulated binding post speaker terminals. Front-panel switching allows any (or none) of these pairs of speakers to be connected in any combination desired. There are two ac line fuses and three ac convenience outlets, one of them unswitched.

**Laboratory Measurements.** The pre-conditioning period at one third of rated power did not make the amplifier unduly warm, but the subsequent high-power testing left it quite hot above the output transistor heat sinks. In normal operation, it runs cool.

The outputs clipped at 130 watts per channel when driving 8-ohm loads at 1000 Hz (1HF Clipping Headroom = 0.7 dB). The A-7090 is not rated for operation into 4- and 2-ohm loads, but the respective clipping power outputs were 192 and 250 watts per channel. Exceptional current delivering capacity was demonstrated in dynamic output measurements with the 20-millisecond tone burst specified in the 1HF test standard. Clipping power output with this signal was 170 watts into 8

ohms, 300 watts into 4 ohms, and 400 watts into 2 ohms. 1HF Dynamic Headroom rating (8 ohms) was 1.9 dB.

Harmonic distortion of the Onkyo A-7090 was close to unmeasurable. For 8-ohm loads at 1000 Hz, the distortion was 0.001% or less from 0.1 watt to about 20 watts output, reaching 0.0019% at 110 watts and 0.06% at 120 watts. 1M distortion was 0.04% at 0.1 watt output, about 0.006% from 10 to 40 watts and 0.015% at 120 watts.

Performance with lower load impedances was equally impressive. Driving 4 ohms, the amplifier produced about 0.002% THD from 1 to 180 watts, reaching 0.0035% at 190 watts. The 2-ohm distortion was below 0.003% up to nearly 100 watts, 0.0038% at 200 watts, and 0.06% at the 250-watt clipping level.

When we drove 8-ohm loads at frequencies from 20 to 20,000 Hz the distortion was always well within the amplifier's ratings. The worst measurement we got was 0.01% at 20,000 Hz.

The power indicator lights read typically within 5% of the actual power outputs, showing unusual accuracy. A high-level input of 14 millivolts or a phono input of 0.19 mV drove the amplifier to a reference 1-watt output, and the S/N for both inputs (A-weighted) was 75 dB referred to 1 watt. Phono input overload was at 300 mV at 1,000 Hz, and at equivalent levels at 20 and 20,000 Hz. Phono input

ciencies, but to a moderate degree that made it more acceptable than most. The SUBSONIC filter had negligible effect in the audible range (it was down about 1 dB at 20 Hz) and the HIGH filter response was down 3 dB at 5000 Hz with a 12-dB-per-octave slope above that. These filters are rated to have 12-dB-per-octave slopes with cut-off frequencies of 15 Hz and 6000 Hz, respectively. RIAA phono equalization was accurate within +0, -1 dB from 35 to 20,000 Hz and down 2 dB at 20 Hz. The response changed by only about +1 dB at 20,000 Hz when measured through the inductance of a typical phono cartridge.

**User Comment.** Although we were unable to check the action of the Super Servo circuit per se, the performance of the Onkyo A-7090 as an audio amplifier left little to be desired. It is as clean an amplifier as one can find, and its power output will be more than sufficient for most home music systems.

Impressive as the A-7090 is in this respect, there are a few other amplifiers that can do about as well. What sets the A-7090 apart, in our view, is its control and operating features. Its tone controls and filters, for example, are exceptionally useful. Also, it has an input for a moving-coil cartridge and two for fixed-coil pickups as well. It is a pity that selectable terminating resistances and/or capacitances for at

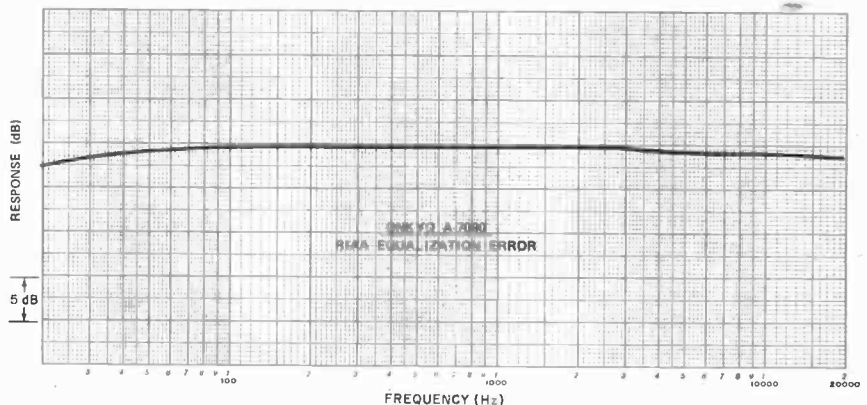

RIAA phono equalization curve for the amplifier.

impedance was 51,000 ohms in parallel with 170 picofarads. The MC input was not tested, but it is rated at ten times the gain of the regular phono inputs, with a 40-ohm input impedance.

Rise time and slew rate measurements were made through the AUX input. The slew rate was very good at 50 volts per microsecond; rise time was 4 microseconds. 1HF Slew Factor exceeded our measurement limit of 25.

By virtue of their switchable and well chosen turnover frequencies, the tone controls were able to produce exceptionally diverse curves. The loudness compensation boosted both low and high frequen-

least one of the moving-magnet inputs were not provided, but even so, the A-7090 is a phonophile's amplifier. In addition, it is able to accommodate two tape decks and a signal-processing accessory.

This is not a temperamental unit, and it operates easily (and safely) into very low load impedances at huge dynamic power levels. Its ability to drive two pairs of 4-ohm speakers is a rarity.

The Onkyo A-7090 is not inexpensive, but it is a lot of amplifier in every respect. We could find no significant fault with its design or performance; on the contrary, we found it most impressive.

CIRCLE NO. 103 ON FREE INFORMATION CARD





# CM-600 Circuit Mount

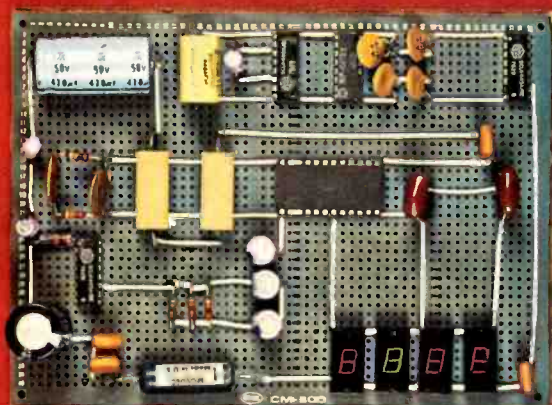
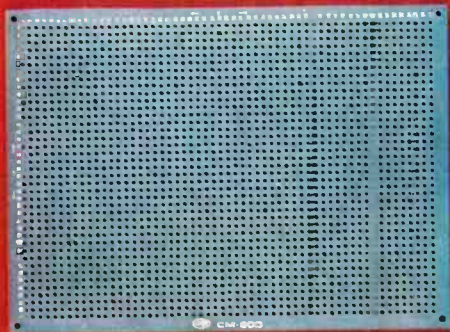

CM-600 \$6.95\*  
RW-50 \$2.98\*

## NEW CM-600 SOLDERLESS PROTOTYPE BOARD

CM-600 is a unique system for solderless construction of circuit prototypes, useful to both engineers and hobbyists. The CM-600 is a neoprene board  $4\frac{1}{2}$ " (114mm) x 6" (152mm) with 2280 holes on .100" (2.54mm) centers. Standard components including DIP's are mounted by simply inserting leads into the holes in the long life neoprene material. Interconnections are easily made using 20 or 22 AWG (0,8 or 0,65mm) wire jumpers. Positive contact is assured by the elasticity of the hole, which compresses the leads together. To remove components or leads, simply pull out. This facilitates easy circuit changes making it ideal for breadboarding experimental circuits. CM-600 also features numbered rows and columns for easy reference.

Accessory Kit RW-50 contains 50 pcs of AWG 20 (0,8mm) insulated jumper wires of assorted lengths from  $\frac{1}{2}$ " (13mm) to 4" (100mm). Both ends are stripped and bent 90° for easy insertion. In stock directly from

**OK Machine & Tool Corporation**  
3455 Conner St., Bronx, N. Y. 10475 U.S.A.  
Tel. (212) 994-6600 Telex 125091

\* Minimum billings \$25.00, add shipping charge \$2.50  
New York State residents add applicable tax

# If you have put off learning more electronics for any of these reasons, act now!

- I don't have the time.
- High school was hard for me and electronics sounds like it may be hard to learn.
- I can't afford any more education.
- I have a family now.
- I'm here. You're there. I've never learned that way before. I'm not sure it will work for me.

**Read the opposite page and see how you can get started today**

**Be honest with yourself. Are the reasons really excuses? You already know enough about electronics to be interested in reading this magazine. So why not learn more? If you need encouragement, read on and see how excuses can be turned into results.**

**You don't have the time.** Be realistic. All you have in life is a period of time. Use it. Try to know more tomorrow than you do today. That's the proven way to success. CIE studies require just about 12 hours of your time a week, two hours a day. You probably do have the time.

**Electronics sounds like it may be hard to learn.** You already know something about electronics or you wouldn't be reading this. Now, build on that. CIE Auto-Programmed® Lessons help you learn. Topics are presented in simple, logical sequence. All text is clear and concise for quick, easy understanding. You learn step by step, at your own pace. No classes to attend. Nobody pressures you. You can learn.

**You can't afford any more education.** Actually, you can't afford NOT to gain the skills that can put you ahead of the others. You know what inflation is doing to you now. Education—learning a skill—is an inflation-fighter that can be yours. If you are not able to pay full tuition now, CIE will lend you funds on a monthly payment plan.

**You have a family now.** All the more reason why you have the responsibility to advance yourself. For the sake of your family. Do you want them to have what you had or have more than you had? The choice is yours. Electronics is a rewarding career choice. CIE can help you to get started on that career.

**You're there. We're here. How does CIE help you learn?** First, we want you to succeed. You may study at home, but you are not alone. When you have a question about a lesson, a postage stamp gets you your answer fast. You may find this even better than having a classroom teacher. CIE understands people need to learn at their own pace. When CIE receives your completed lesson before noon any day of the week, it will be graded and mailed back the same day with appropriate instructional help. Your satisfaction with your progress comes by return mail. That's how CIE helps you learn.

**NOW, IF YOU AGREE CIE TRAINING CAN WORK FOR YOU, HOW ELSE CAN CIE HELP YOU?**

Cleveland Institute of Electronics is the largest independent home study school in the world that specializes exclusively in electronics. Although "big" does not always mean "best," it is evidence that CIE is a strong, successful institution with the people and resources to help you succeed.

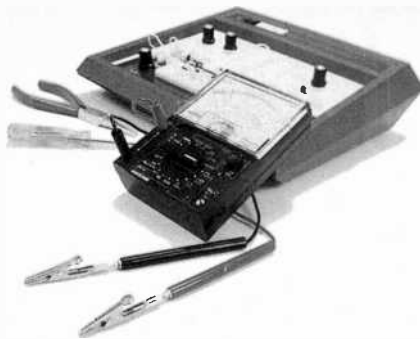

**Step-by-step learning includes "hands-on" training.**

The kind of professional you want to be needs more than theory. That's why some of our courses include the Personal Training Laboratory, which helps you put lesson theory into actual practice. Other courses train you to use tools of the trade such as a 5MHz triggered-sweep, solid-state oscilloscope you build yourself—and use to practice troubleshooting. Or a Digital Learning Laboratory to let you apply the digital theory that's essential today for anyone who wants to keep pace with electronics in the eighties.



**Your FCC License can impress employers.**

For some electronics jobs, you must have your FCC License. For others, employers usually consider it a mark in your favor. Either way, your License is government-certified proof of your knowledge and skills. More than half of CIE's courses prepare you to pass this exam. Surveys show that some 80% of CIE graduates who take the exam are successful.

**Find out more! Today. Now.**

There's a card with this ad. Fill it in and return. If some other ambitious person has already removed it, use the coupon.

You'll get a copy of CIE's free school catalog, along with a complete package of personal home study information.

For your convenience, we'll try to arrange for a CIE representative to contact you to answer any questions you may have.

If you are serious about a rewarding career, about learning electronics or building on your present skills, your best bet is to go with the electronics specialists—CIE. Mail the card or coupon today or write CIE (please mention the name and date of this magazine), 1776 East 17th Street, Cleveland, Ohio 44114.

This could be the best decision you've made all year.

**"If you're going to learn electronics, you might as well learn it right?"**

*John Cunningham  
Senior Technical Director*



**CIE Cleveland Institute of Electronics, Inc.**

1776 East 17th Street, Cleveland, Ohio 44114  
Accredited Member National Home Study Council PE-16

**YES...** I want to learn from the specialists in electronics—CIE. Send me my FREE CIE school catalog plus my FREE package of home study information. PE-16

Print Name \_\_\_\_\_

Address \_\_\_\_\_ Apt. \_\_\_\_\_

City \_\_\_\_\_

State \_\_\_\_\_ Zip \_\_\_\_\_

Age \_\_\_\_\_ Phone (area code) \_\_\_\_\_

Check box for G.I. Bill bulletin on Educational Benefits:  Veteran  Active Duty

**MAIL TODAY!**



# 1 GHz For Only \$139.95

8 Digits • 1 PPM TCXO • Factory Wired 500 MHz or 1 GHz

**\$139.95**  
5510 WIRED  
50 Hz to 1 GHz

**\$109.95**  
5500 WIRED  
50 Hz to 512 MHz



• 1 Hz Resolution to 50 MHz.

- 1 Meg Ohm, 50 Ohm, BNC Inputs
- 15 MV Sensitivity at 250 MHz Typ.

With the introduction of the 5510 DSI has filled a long standing void in the frequency counter market place. You now have the choice of selecting a 512 MHz model 5500 for \$110 or for only \$30.00 more you can buy an 8 digit 1 GHz counter model 5510. With this 1 GHz capability, the new world of 960 MHz is immediately available to you. Both the 5500 and 5510 are available with a rechargeable battery pack which includes the AC adapter and battery charger for one low price. Whether you select the 5500 or the 5510, you will receive the best price to quality features ratio in the industry. No wonder DSI has become one of the world's largest manufacturers of freq. counters.

**1.2 GHz Only \$199.95**  
5612 KIT

**512 MHz Only \$169.95**  
5600 KIT



10 MHz Proportional Oven

- .2 PPM 10° to 40° C Time Base
- .1 Hz Resolution to 50 MHz.
- External 10 MHz inputs outputs.
- 9 Bright .5 Inch LED Read-outs.
- 100% Factory Tested
- Kits 95% Factory Assembled.
- 50 Ohm, 1 Meg, BNC Inputs
- 10 MV Sensitivity at 250 MHz Typ.

Whether you select a 5600, 5612 Kit with 95% of the assembly completed by DSI or select a factory wired and calibrated frequency counter, you can count on DSI to solve all those difficult bench or field problems from measuring audio signals to checking a 960 MHz mobil radio (model 5612), servicing a VTR, trouble shooting a PLL signal in a TV or FM radio, etc. The 5600 or 5612 has the sensitivity and accuracy to meet any FCC landmobile, broadcast, RF, or telecommunications requirements. DSI offers a 10 HR rechargeable battery pack (BA56) option, and an audio multiplier (AM56), which will allow you to resolve a 1/1000 Hz signal in only ten seconds or 1/100 Hz signal in one second. DSI 5600 series offers just the right instrument for all your communication RF, TV servicing and industrial testing needs.

**FOR INFORMATION — DEALER LOCATION — ORDERS — OEM  
CALL 800-854-2049 CALIFORNIA RESIDENTS CALL 800-542-6253**

Model	Price	Frequency Range Typ	Accuracy Over Temperature	Sensitivity Typ			Number of Readouts	Power Requirements	Size H W D
				50-250MHz	@ 250-450MHz	@			
5600A-Kit	\$169.95	50Hz-550MHz	Proportional Oven .2 PPM 10° - 40° C	10-25mv	10-15mv	15-50mv	9	*115 VAC or 8.2-14.5 VDC	3 1/4" x 9 1/2" x 9"
5600A-Wired	\$199.95								
5612Kit	\$199.95	50Hz-1.2 GHz	Proportional Oven .2 PPM 10° - 40° C	10-25mv	10-15mv	15-50mv	9	*115 VAC or 8.2-14.5 VDC	3 1/4" x 9 1/2" x 9"
5612 Wired	\$239.95								
5500 Wired	\$109.95	50Hz-512MHz	TCXO 1 PPM 17° - 40° C	10-25mv	15-25mv	25-75mv	8	115 VAC or 8.2-14.5 VDC or NICAD PAK.	1 1/2" x 5" x 5 1/2"
5510 Wired	\$139.95	50Hz-1GHz							

Factory wired units carry 1 year limited warranty kits carry a 90 day limited warranty. Prices and/or specifications subject to change without notice or obligation.

\*With AC-9 Adapter

Prices effective March 1, 1980



**DSI INSTRUMENTS, INC.**

9550 Chesapeake Drive  
San Diego, California 92123  
(714) 565-8402

TERMS: MC — VISA — AE — CHECK — M.O. — COD  
in U.S. Funds. Please add 10% to a maximum of \$10.00  
for shipping, handling and insurance. Orders outside  
of USA & Canada, please add \$20.00 additional to  
cover air shipment. California residents add 6% Sales Tax

CIRCLE NO. 22 ON FREE INFORMATION CARD

- 5510 Wired ..... 139.95
  - 5500 Wired ..... 109.95
  - 5510/BAC Wired ..... 164.95
  - 5500/BAC Wired ..... 134.95
  - T600 BNC ANT (all models) 7.95
  - AC-9 AC Adapter(all models) 7.95
  - LC 5000 ..... 169.95
- INTERNAL BAT. ONLY AC-9 NOT REQUIRED.

- 5612 Kit ..... 199.95
- 5612 Wired ..... 239.95
- 5600A Kit ..... 169.95
- 5600A Wired ..... 199.95
- BA56 Rechargeable
- 10 Hr. Bat. Pack ..... 29.95
- AM-56 Audio Multiplier
- .001 Hz Resolution ..... 34.95



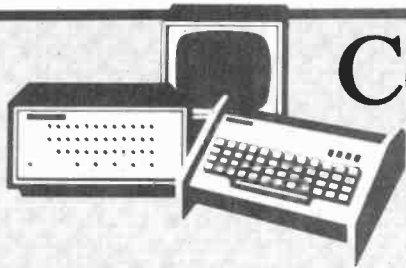

# Computer Bits

By Carl Warren

## Time-Sharing Systems

IT now can be said that personal computers have truly "grown up." The reason? They can access and use large data bases and have, in addition, the facilities of electronic mail.

Low-cost time-sharing offering these capabilities exists now and has been available for almost a year. Specifically, Telecomputing Corporation of America's (TCA) "Source" network and CompuServe's "MicroNet" system have made this feasible. Both systems are outgrowths of commercial concerns, but at lower costs during off-prime-time hours. The two systems make use of commercial computer networks (Tymnet and Telenet). CompuServe has its own proprietary network at lower cost and higher efficiency; but in certain cities, it utilizes the Tymnet network. Either one of the timesharing systems for the personal computer user can be of major benefit, since they both offer the following features:

- Access to several major data bases including the New York and American stock exchanges.
- Ability to send messages to other users either privately, or to all users at one time.
- Ability to correspond on-line with another user for "real time" message switching. This is a major feature with the Source, but of less importance to the MicroNet people.
- Availability of several high-level languages. Both systems offer BASIC, Pascal, Fortran, assembly language and a variety of other command languages.
- Access virtually from anywhere in the United States. However, there are some things to watch out for, which will be discussed later.
- Relative low cost when compared with commercial systems costs and what it would take to develop similar data bases.

**Choosing a Time-sharing Network.** This decision can be as important as the one you made when buying your first personal computer. Although both the Source and MicroNet are similar in several respects, they do differ in what they offer in terms of cost, functions offered, user software, and user interaction in the form of download capabilities.

The Source requires a \$100 one-time charge as a subscription fee. This fee covers initial costs of signing on to the system and gives you the necessary access numbers, password, and a 48-page loose-leaf notebook that covers fundamentals of us-

ing the system. Once you are on the system, the basic charge is \$2.75 per hour of connect time based on one-minute intervals. There is no charge for computer time or System Resource Units (SRUs). The connect time is based on nonprime-time hours of 6 p.m. to 6 a.m. local time, weekends and certain holidays. Charges during prime hours are calculated at the rate of \$15 per hour. This rate also applies to building programs that require more than 64K of user memory. However, large, over 64K, Source-Written programs can be used at the \$2.75 per hour rate, according to company officials.

The Source network is built around Prime minicomputers and, as a consequence, software that is available reflects functions associated with the Prime system. TCA does offer complete sets of documentation for the different languages at prices ranging from \$5 to \$20.

The MicroNet service, on the other hand, is a time-sharing system built around a cluster of ten Digital Equipment Corporation PDP 10s. Therefore, all software offered is DEC quality and compatible with most micro-based software. (A number of system software writers for microcomputers used DEC as a model.)

Furthermore, the MicroNet service has a different pricing structure than the Source. Its subscription fee is a surprisingly low \$9.00 one-time charge. As with the Source, this brings you the access number and password which you define and can change yourself at anytime, and an extremely well prepared 71-page user's manual covering all essentials of the system. Also provided with the manual are short update sheets that describe new features added and not yet incorporated into the manual. The manual is of central importance from a user's standpoint, of course. This one is typeset, making it easier on the eyes, and presents necessary commands in a tutorial format.

Everything that is in the manual is du-

plicated on the system. So the user can always obtain data on how to use a specific function by either asking for it or simply typing HELP. Connect time for MicroNet is \$5.00 per hour timed at one-minute intervals, during the nonprime-time hours of 6 p.m. to 5 a.m. No provisions have yet been made for prime-time operation.

Like the Source, users' guides are available for a fee. However, MicroNet has extended the philosophy a bit and is offering a number of documents via the net. And all it costs is the connect time. According to John Meier, the MicroNet marketing manager, as time goes by and various copyright clearances are received, more documents will be available directly through the system.

**Getting the Most Out of a Networking System.** This is a matter of prime importance since dollars are involved. One complaint has been that, even though both systems offer connect service through telephone ports around the country, the cost really adds up. For example, I live in a suburb of Los Angeles. The direct private network number for MicroNet is a Los Angeles number which costs 16 cents for the first minute of use and 10 cents for every minute or partial minute thereafter during peak hours—before 5 p.m. After 5 p.m. the cost is 30% less, but still significant. In some areas, this can represent a fair amount of dollars. What you might want to do is use the Tymnet system, which costs an additional \$4.00 an hour on MicroNet, but would in most cases still represent a saving. For the Source, the Tymnet and Telenet charges are part of the \$2.75 per hour connect time. A great deal of care must be taken to check your local phone book to get the area code for the phone number you are calling and to see if any toll charges exist.

Based on the foregoing, it would appear that a major disparity exists in the pricing structures used by the two systems, when in fact they are almost equal! The equality does not come from the direct pricing, but in the method of charging for various services. The Source makes an extra charge for anything over 64K. MicroNet allows you up to 128K at no extra charge and gives free storage, while the Source charges 3.3 cents per block (2048 characters) of storage per month.

**The Equipment Required.** To get on a system, you may need only a terminal with a modem or a full-blown microcom-

*The Model TC 3002, originate/answer acoustic coupled modem, from Tek-Com, provides a build-in direct-access connector and virtually noise-free coupling.*



puter system may be required. A number of manufacturers such as Apple, Heath and Radio Shack offer modems and have communication software available to assist in transferring and manipulating data between the network and small system. Whatever you plan to do, a good modem is imperative! Many such devices are on the market and offer different capabilities and price ranges. The Tek-Com TC 3002 coupler pictured here as an example is a heavy-duty model that's made for the commercial world. The originate/answer coupler is priced at \$265. Couplers made

especially for home computer users are generally about \$65 to \$70 less.

**Available Software.** To make a microsystem emulate a terminal and provide uplink/downlink functions, there are a number of packages available. On the MicroNet system, there is executive software for the Apple and Radio Shack TRS-80 that performs this function. They even provide a loader to allow downloading of the executive into your system for future use. All at no cost.

Gerry Kabelman, at the Heath users

group (HUG), called to tell me about a new piece of software they are making available to perform system communication. The package, called MCS, is written for the Heath H8 and H89 computer systems and sells for \$18 direct from HUG.

Lifeboat Associates also has a communication package called BSTAM that is for any CP/M system, including Heath and Radio Shack TRS-80 systems with modified versions of CP/M. This package sells for \$150.

**MORE INFORMATION**

Additional information about products discussed in this column can be obtained by contacting the companies:

**Compuserve (MicroNet)**  
Personal Computing Division  
5000 Arlington Centre Blvd.  
Columbus, OH 43220  
614-457-8600

**Heath Users Group (HUG)**  
Hilltop Road  
St. Joseph, MI 49085

**Lifeboat Associates**  
2248 Broadway  
New York, NY 10024  
212-580-0082

**Telecomputing Corporation of America (TCA)**  
1616 Anderson Rd.  
McLean, VA 22102  
800-336-3330

**Tek-Com**  
2142 Paragon Dr.  
San Jose, CA 95131  
408-263-7400

**Conclusion.** To get the best value dollar-wise from these time-sharing networks, both companies, TCA and Compuserve, recommend that users with microcomputer systems prepare as much of the work as they can offline, then use the network to either pass information into users' files or gather updated data, such as stock information. This way, minimum time can be spent on the network and excessive connect costs are avoided. ♦

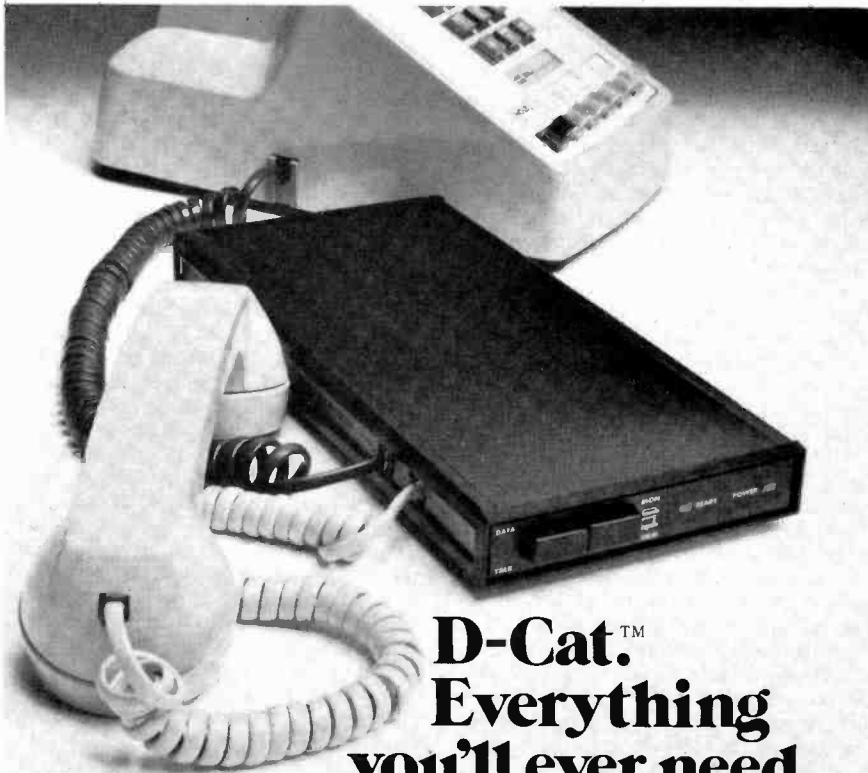

**D-Cat™  
Everything  
you'll ever need  
in a basic, direct modem.**

There's only one originate/answer modem that gives you the performance and reliability of a direct connect modem with the portability and price of an acoustic. Novation's new D-Cat.

D-Cat is the only direct modem that's FCC approved for handset jack connection with any modular phone. Use it at home or at work on a 50-pin, six line business phone. Talk to D-Cats, Cats, or any other Bell 103 compatible modem.

D-Cat also has all the features you want: full duplex capability, voice/data

monitor, up to 20 dB performance improvement over acoustic, hold function, privacy button, self-test, and a remarkable price. Only \$199.

But best of all, it's from Novation. The recognized world leader in personal communications.

**D-Cat by  
Novation**

Call for details:  
**(800) 423-5410**  
In California (213) 996-5060

Available at Avnet Electronics, Hamilton Electro, Hamilton Avnet, Kierulff Electronics, Byte Shops, Computerland, and your local computer store.

Novation, Inc., 18664 Oxnard Street, Tarzana, California 91356

CIRCLE NO. 47 ON FREE INFORMATION CARD



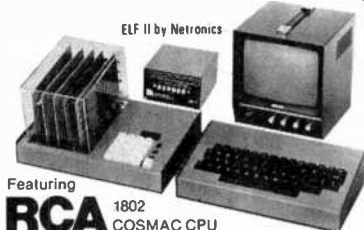

# Write and run programs—the very first night—even if you've never used a computer before!

You're up and running with video graphics for just \$99.95 — then use low cost add-ons to create your own personal system that rivals home computers sold for 5-times ELF II's low price!

Featuring **RCA 1802 COSMAC CPU**  
Own a powerful home computer system, starting for just \$99.95—a price that gets you up and running the very first night... with your own TV for a video display, \$99.95 ELF II includes RCA 1802 8-bit microprocessor addressable to 64k bytes with OMA, interrupt, 16 registers, ALU, 256 byte RAM, full hex keyboard, two digit hex output display, stable crystal clock for timing purposes, RCA 1861 video IC to display your programs on any video monitor or TV screen and 5-slot plug-in expansion bus (less connectors) to expand ELF II into a giant!

**ELF II Explodes Into A Giant!**  
Master ELF II's \$99.95 capabilities, then expand with GIANT BOARD... KLUGE BOARD... 4k RAM BOARDS... TINY BASIC... ASCII KEYBOARD... LIGHT PEN... ELF-BUG MONITOR... COLOR GRAPHICS & MUSIC SYSTEM... TEXT EDITOR... ASSEMBLER... DISASSEMBLER... VIDEO DISPLAY BOARD... and, another great reason for getting your ELF II now—

## BREAKTHROUGH!

Netronics proudly announced the release of the first 1802 FULL BASIC, written by L. Sandlin, with a hardware floating point RPN math package (requires 8k RAM plus ASCII and video display boards), \$79.95 plus \$2 p&h. Also available for RCA VIP and other 1802 systems Board includes area for a ROM version.

**Master This Computer In A Flash!**  
Regardless of how minimal your computer background is now, you can learn to program an ELF II in almost no time at all. Our *Short Course On Microprocessor & Computer Programming*—written in non-technical language—guides you through each of the RCA COSMAC 1802's capabilities, so you'll understand everything ELF II can do... and how to get ELF II to do it! Don't worry if you've been stumped by computer books before. The *Short Course* represents a major advance in literary clarity in the computer field. You don't have to be a computer engineer in order to understand it. Keyed to ELF II, it's loaded with "hands on" illustrations. When you're finished with the *Short Course*, neither ELF II nor the RCA 1802 will hold any mysteries for you.

In fact, not only will you now be able to use a personal computer creatively, you'll also be able to read magazines such as BYTE... INTERFACE AGE... POPULAR ELECTRONICS and PERSONAL COMPUTING and fully understand the articles. And, you'll understand how to expand ELF II to give you the exact capabilities you need!

If you work with large computers, ELF II and the *Short Course* will help you understand what they're doing.

**Get Started For Just \$99.95, Complete!**  
\$99.95 ELF II includes all the hardware and software you need to start writing and running programs at home, displaying video graphics on your TV screen and designing circuits using a microprocessor—the very first night—even if you've never used a computer before.

ELF II connects directly to the video input of your TV set, without any additional hardware. Or, with an \$8.95 RF modulator (see coupon below), you can connect ELF II to your TV's antenna terminals instead.

ELF II has been designed to play all the video games you want, including a fascinating new target/missile gun game that was developed specifically for ELF II. But games are only the icing on the cake. The real value of ELF II is that it gives you a chance to write machine language programs—and machine language is the fundamental language of all computers. Of course, machine language is only a starting point. You can also program ELF II with assembly language and tiny BASIC. But ELF II's machine language capability gives you a chance to develop a working knowledge of computers that you can't get from running only

pre-recorded tape cassettes.  
**ELF II Gives You The Power To Make Things Happen!**  
Expanded, ELF II can give you more power to make things happen in the real world than heavily advertised home computers that sell for a lot more money. Thanks to an ongoing commitment to develop the RCA 1802 for home computer use, the ELF II products—being introduced by Netronics—keep you right on the outer fringe of today's small computer technology. It's a perfect computer for engineering, business, industrial, scientific and personal applications.

Plug in the **GIANT BOARD** to record and play back programs, edit and debug programs, communicate with remote devices and make things happen in the outside world. Add Kluge (prototyping) Board and you can use ELF II to solve special problems such as operating a complex alarm system or controlling a printing press. Add 4k RAM Boards to write longer programs, store more information and solve more sophisticated problems.

ELF II add-ons already include the ELF II Light Pen and the amazing ELF-BUG Monitor—two extremely recent breakthroughs that have not yet been duplicated by any other manufacturer.

The ELF-BUG Monitor lets you debug programs with lightning speed because the key to debugging is to know what's inside the registers of the microprocessor. And, with the ELF-BUG Monitor, instead of single stepping through your programs, you can now display the entire contents of the registers on your TV screen. You find out immediately what's going on and can make any necessary changes.

The incredible ELF II Light Pen lets you write or draw anything you want on a TV screen with just a wave of the "magic wand." Netronics has also introduced the ELF II Color Graphics & Music System—more breakthroughs that ELF II owners were the first to enjoy!

**ELF II Tiny BASIC**  
Ultimately, ELF II understands only machine language—the fundamental coding required by all computers. But, to simplify your relationship with ELF II, we've introduced an ELF II Tiny BASIC that makes communicating with ELF II a breeze.

**Now Available! Text Editor, Assembler, Disassembler And A New Video Display Board!**

The Text Editor gives you word processing ability and the ability to edit programs or text while it is displayed on your video monitor. Lines and characters may be quickly inserted, deleted or changed. Add a printer and ELF II can type letters for you—error free—plus print names and addresses from your mailing list!

ELF II's Assembler translates assembly language programs into hexadecimal machine code for ELF II use. The Assembler features mnemonic abbreviations rather than numerics so that the instructions on your programs are easier to read—this is a big help in catching errors.

ELF II's Disassembler takes machine code programs and produces assembly language source listings. This helps you understand the programs you are working with... and improve them when required.

The new ELF II Video Display Board lets you generate a sharp, professional 32 or 64 character by 16 line upper and lower case display on your TV screen or video monitor—dramatically improving your unexpanded \$99.95 ELF II. When you get into longer programs, the Video Display Board is a real blessing!

**Now Available!**

- A-D/D-A Board Kit includes 1 channel (expandable to 4) D-A, A-D converters, \$39.95 plus \$2 postage & handling.
- PILOT Language—A new text-oriented language that allows you to write educational programs on ELF II with speed and ease! Write programs for games... unscrambling sentences... spelling drills... "fill in the missing word" tests, etc. PILOT is a must for any ELF II owner with children. PILOT Language on cassette tape, only \$19.95 postpaid!
- Game Package on cassette tape (requires 4k RAM), \$9.95 plus \$2 postage & handling.

Clip Here and Attach to Your Order Below!

**Netronics R&D Ltd., Dept PE-6**  
333 Litchfield Road, New Milford, CT 06776

Yes! I want my own computer! Please rush me—

- RCA COSMAC ELF II kit at \$99.95 plus \$3 postage and handling (requires 6.3 to 8 volt AC power supply)
- RCA 1802 User's Manual \$3 postpaid
- Tom Pitman's Short Course On Microprocessor & Computer Programming teaches you just about everything there is to know about ELF II or any RCA 1802 computer. Written in non-technical language, it's a learning breakthrough for engineers and laymen alike \$5 postpaid
- Deluxe Metal Cabinet with plexiglas dust cover for ELF II \$29.95 plus \$2 \$0 p&h
- I am also enclosing payment (including postage & handling) for the items checked below!
- I want my ELF II wired and tested with power supply, RCA 1802 User's Manual and Short Course—all for just \$149.95 plus \$3 p&h.

**PHONE ORDERS ACCEPTED!**  
Call (203) 354-9375

Total Enclosed \$ \_\_\_\_\_ (Conn. res. add tax)

CHARGE IT! Exp. Date \_\_\_\_\_

Visa  Master Charge  Bank # \_\_\_\_\_

Account # \_\_\_\_\_

**ALSO AVAILABLE FOR ELF II**

- GIANT BOARD™ kit with cassette I/O, RS-232 C/TTY I/O, 8 bit P/I/O decoders for 14 separate I/O instructions and a system monitor/editor \$39.95 plus \$2 p&h
- Kluge (Prototype) Board accepts up to 36 IC's \$17.00 plus \$1 p&h
- 4k Static RAM kit. Addressable to any 4k page to 64k. \$89.95 plus \$3 p&h
- Gok paired 86-pin connectors (one required for each plug in board) \$5.70 ea. postpaid
- Expansion Power Supply (required when adding 4k RAM) \$34.95 plus \$2 p&h
- Professional ASCII Keyboard kit with 128 ASCII upper/lower case set 96 printable characters, onboard regulator, parity logic selection and choice of a hand-sharing signals to mate with almost any computer \$64.95 plus \$2 p&h
- Deluxe metal cabinet for ASCII Keyboard, \$19.95 plus \$2 p&h
- Video Display Board kit lets you generate a sharp professional 32 or 64 character by 16 line upper and lower case display on your TV screen or video monitor—dramatically improving your unexpanded \$99.95 ELF II. \$115 inside ASCII Keyboard cabinet) \$89.95 plus \$2 p&h
- ELF II Tiny BASIC on cassette tape. Commands include SAVE LOAD ± × ÷ !!
- 26 variables A-Z LET. IF/THEN INPUT PRINT. GO TO GO SUB RETURN END REM CLEAR LIST RUN PLOT PEEK POKE Comes fully documented and includes alphanumeric generator required to display alphanumeric characters directly on your TV screen without additional hardware. Also plays tick-tack-toe plus a drawing game that uses ELF II's hex keyboard as a joy stick. 4k memory required \$14.95 postpaid
- Tom Pitman's Short Course on Tiny Basic for ELF II \$5 postpaid
- ELF-BUG™ Deluxe System Monitor on cassette tape. Allows displaying the contents of all registers or your TV at any point in your program. Also displays 24 bytes of memory with full addresses, blinking cursor and auto scrolling. A must for the serious programmer! \$14.95 postpaid
- Text Editor on cassette tape gives you the ability to insert, delete or edit lines and words from your program, while they are displayed on your video monitor. (A/C printer and you can use ELF II to type error-free letters plus insert names and addresses from your mailing list: \$19.95 postpaid
- Assembler on cassette tape translates assembly language programs into hexadecimal machine code for ELF II use. Mnemonic abbreviations for instructions (rather than numerics) make programs easier to read and help prevent errors. \$19.95 postpaid
- Disassembler on cassette tape takes machine code

By Netronics

**ASCII/BAUDOT, STAND ALONE**

# Computer Terminal COMPLETE FOR ONLY \$149.95

The Netronics ASCII/BAUDOT Computer Terminal Kit is a microprocessor-controlled, stand alone keyboard/terminal requiring no computer memory or software. It allows the use of either a 64 or 32 character by 16 line professional display format with selectable baud rate, RS232-C or 20 ma. output, full cursor control and 75 ohm composite video output.

The keyboard follows the standard typewriter configuration and generates the entire 128 character ASCII upper/lower case set with 96 printable characters. Features include onboard regulators, selectable parity, shift lock key, alpha lock jumper, a drive capability of one TTY load, and the ability to mate directly with almost any computer, including the new Explorer/85 and ELF products by Netronics.

The Computer Terminal requires no I/O mapping and includes 1k of memory, character generator, 2 key rollover, processor controlled cursor control, parallel ASCII/BAUDOT to serial conversion and serial to video processing—fully crystal controlled for superb accuracy. PC boards are the highest quality glass epoxy for the ultimate in reliability and long life.

### VIDEO DISPLAY SPECIFICATIONS

The heart of the Netronics Computer Terminal is the microprocessor-controlled Netronics Video Display Board (VID) which allows the terminal to utilize either a parallel ASCII or BAUDOT signal source. The VID converts the parallel data to serial data which is then formatted to either RS232-C or 20 ma. current loop output, which can be connected to the serial I/O on your computer or other interface, i.e., Modem.

When connected to a computer, the computer must echo the character received. This data is received by the VID which processes the information, converting to data to video suitable to be displayed on a TV set (using an RF modulator) or on a video monitor. The VID generates the cursor, horizontal and vertical sync pulses and performs the housekeeping relative to which character and where it is to be displayed on the screen.

Video Output: 1.5 P/P into 75 ohm (EIA RS-170) • Baud Rate: 110 and 300 ASCII • Outputs: RS232-C or 20 ma. current loop • ASCII Character Set: 128 printable characters—

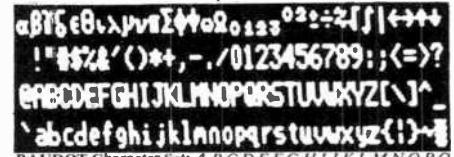

BAUDOT Character Set: A B C D E F G H I J K L M N O P Q R S T U V W X Y Z . ? \* 3 # ( ) , 0 1 2 3 4 5 6 7 8 9 / + = > ?  
! " \$ % & ' ( ) \* + , - . / 0 1 2 3 4 5 6 7 8 9 : ; < = > ?  
@ A B C D E F G H I J K L M N O P Q R S T U V W X Y Z [ \ ] ^ \_ ` a b c d e f g h i j k l m n o p q r s t u v w x y z { | } ~  
BAUDOT Character Set: A B C D E F G H I J K L M N O P Q R S T U V W X Y Z . ? \* 3 # ( ) , 0 1 2 3 4 5 6 7 8 9 / + = > ?  
! " \$ % & ' ( ) \* + , - . / 0 1 2 3 4 5 6 7 8 9 : ; < = > ?  
@ A B C D E F G H I J K L M N O P Q R S T U V W X Y Z [ \ ] ^ \_ ` a b c d e f g h i j k l m n o p q r s t u v w x y z { | } ~

Continental U.S.A. Credit Card Buyers Outside Connecticut  
**CALL TOLL FREE 800-243-7428**

To Order From Connecticut Or For Technical Assistance, Etc. Call (203) 354-9375

**Netronics R&D Ltd., Dept. PE-6**  
333 Litchfield Road, New Milford, CT 06776

Please send the items checked below—

- Netronics Stand Alone ASCII Keyboard/Computer Terminal Kit, \$149.95 plus \$3.00 postage & handling.
- Deluxe Steel Cabinet for Netronics Keyboard/Terminal in Blue/Black Finish, \$19.95 plus \$2.50 postage and handling.
- Video Display Board Kit alone (less keyboard), \$89.95 plus \$3 postage & handling.
- 12" Video Monitor (10 MHz bandwidth) fully assembled and tested, \$139.95 plus \$5 postage and handling.
- RF Modulator Kit (to use your TV set for a monitor), \$8.95 postpaid.
- 5 amp Power Supply Kit in Deluxe Steel Cabinet (± 8VDC @ 5 amps, plus 6-8 VAC), \$39.95 plus \$2 postage & handling.

Total Enclosed (Conn. res. add sales tax) \$ \_\_\_\_\_

By—

Personal Check  Cashiers Check/Money Order

Visa  Master Charge (Bank # \_\_\_\_\_)

Acct. # \_\_\_\_\_ Exp. Date \_\_\_\_\_

Signature \_\_\_\_\_ Print Name \_\_\_\_\_

Address \_\_\_\_\_ City \_\_\_\_\_

State \_\_\_\_\_ Zip \_\_\_\_\_

Send Me More Information

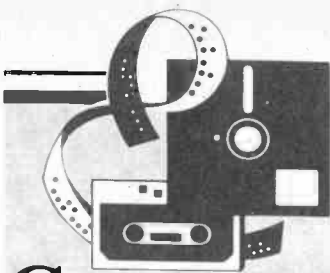

# Computer Sources

By Leslie Solomon  
Technical Director

## Hardware

**A Turtle Robot.** With the introduction of the microprocessor and microcomputer, the art of robotics took on a new meaning. Assuming a reasonably good knowledge of electronics and mechanics, a determined person could build his own robot. Some of these have been described in the various journals, demonstrated at computer shows, and even shown on network TV news. However, they are still very complex, requiring the mating of electronic and mechanical knowhow. Building a homebrew robot requires too much time to collect or design the various mechanical elements; too much difficult software has to be written and debugged.

Now, we have an answer—the Terrapin Turtle, available as a \$400 kit and designed by Dan Hillis of MIT's Artificial Intelligence Lab. The robot is 7" in diameter and 5" high. It can move at 6" per second, rotate at 120° per second, and make noises via its built-in speaker. The Terrapin has blinking LED "eyes," uses its clear plastic shell as a touch sensor for all four sides, and can be equipped with a

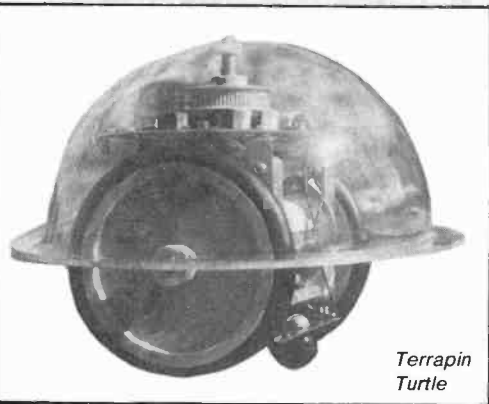

Terrapin  
Turtle

pen to draw specified designs on a smooth surface.

A 10-foot flexible cable connects the turtle to any digital computer via a standard parallel interface. Power requirement is 12 to 18 volts dc at one ampere. Data requirement is 8 bits in, 4 bits out at TTL level.

The Turtle can "map" a room by using its touch sensor dome to "feel out" the walls and storing the two-dimensional measurements in the host computer's memory. The same technique can be used

to run a maze, and store its features in memory.

The eight bits control right and left drive motors, the LED "eyes," a pen, the horn, and the tones fed to the horn. The four dome touch sensors send four bits back to the computer to indicate contact and direction.

For those that find assembly language programming a chore, Terrapin provides a detailed explanation of how to use BASIC to control the Turtle. The well-written manual explains everything in detail. Address: Terrapin Inc., #205, 678 Massachusetts Ave., Cambridge, MA 02139 (Tel: 617-482-1033).

### S-100 and 9900 CPU System.

When the S-100 bus is combined with a 16-bit TI 9900 CPU, you get either a high-end personal computer or a small-business/research type. Two systems are available and both feature 32K of RAM and two 8" floppy disks. They come with DOS, BASIC, word processor, editor, assembler, linker and other utilities. The scientific version (\$4495) uses PASCAL and a floating-point package. The business version (\$4895) uses extended BASIC, General Ledger, Accounts Payable and Receivable and Payroll. A Network Operating System for multi-users is available, as is support for hard disk. Address: Interface Technology of Maryland, Box 745, College Park, MD 20740.

**Apple APU.** The Model 7811B Arithmetic Processor Unit is intended to increase the execution speed of Applesoft II programs and the number of math functions available. The system employs an AMD9511 APU and plugs into one of the Apple expansion slots. The CCSOFT interpreter is loaded from the diskette provided, and the system is ready to go. The CCSOFT interpreter is identical to Applesoft, except that CCSOFT sends arithmetic functions to the APU for fast execution. Additional functions include ASIN(x), ACOS(x), LOG10(x), SINH(x), COSH(x), TANH(x), INVERSE(x) and PI. Address: California Computer Systems, 250 Caribbean Dr., Sunnyvale, CA 94086 (Tel: 408-734-5811).

**TRS-80 CLOAD Helper.** The Data Dubber connects between a cassette player and the TRS-80 and reduces the critical "window" in which data can be received to make the volume setting less critical. It uses an IC to reduce noise, volume variations, static and distortions by regenerating the original CSAVE data pulses. The device can also be connected between two cassette players to duplicate a tape. \$39.95. Address: The Peripheral People, Box 524, Mercer Island, WA 98040.

**Real-Time Analyzer.** The VTU02 for the TRS-80 and the AIB232 for the Apple divide the audio spectrum from 20 Hz to 20 kHz into 31 third-octave bands, and display these bands with the relative am-

plitudes on the computer CRT. The units can be used for measuring sound and noise levels, optimizing the equalization of a hi-fi or PA system, checking the frequency response of audio components and for speech and sound pattern recognition. The Apple unit features a color display. Data can be stored and compared with past or future data. Access is via BASIC programs provided. VTU02 (TRS-80) is \$595. AIB232 (Apple) is \$545. Address: Eventide Clockworks, Inc., 265 W. 54th St., New York, NY 10019 (Telephone: 212-581-9290).

**Sorcerer Serial I/O.** The Sorcerer Parallel-to-Serial Interface makes any RS232 or 20-mA printer look like a Centronics parallel line printer to the Sorcerer. It uses the I/O drivers already in the system, and features X-ON, X-OFF, and Data Terminal Ready handshaking. It will operate at any of 16 standard baud rates. \$119.95. Address: Mark Longley, 2403 De La Cruz Boulevard, Santa Clara, CA 95050.

## Software

**Apple Worksheet.** The VisiCalc program for the Apple forms an electronic worksheet having 63 columns and 254 rows. At the juncture of any row and column, any digits or words can be typed. The display scrolls as required. When a calculation is required, the formula is typed in and the program automatically performs all arithmetic functions, net present values, and transcendental functions. If any data is changed (the "what if?" function), the worksheet displays the new results. VisiCalc can be used by managers to plan budgets, compare actual results to forecast, and modify projections; by financial analysts to determine rate-of-return under varying assumptions; by accountants to develop statements and proformas; by tax accountants to compute the effects of alternatives; and by engineers and scientists on calculations requiring transcendental functions, scientific notation and 11-digit accuracy. Requires 32K and disk. Address: Personal Software Inc., 592 Weddell Drive, Sunnyvale, CA 94086 (Tel: 408-745-7841).

**"Eliza" for TRS-80.** Eliza, an exercise in the simulation of artificial intelligence, is now available for a TRS-80 Level II with 16K of RAM. The program interacts with the user in an almost human fashion, and appears to have an understanding of what is being discussed. The cassette also includes Talking Eliza that permits Eliza to communicate via a TRS-80 Voice Synthesizer. \$14.95 at Radio Shack Computer Centers and stores.

**1802 Assembler/Editor.** Operating with the North Star disk system, the ASMB-1802 may be used to develop assembly language programs for the 1802 on a host Z80/8080 system. Programs are off loaded to target processor for test. The



complete 1802 instruction set is supported as well as pseudo-operations for conditional assembly, data and string definitions and multiple-location counter program developments. On diskette for \$75. Address: Allen Ashley, 395 Sierra Madre Villa, Pasadena, CA 91107 (Tel: 213-793-5748).

**Apple Word Processor.** "Easywriter" is an 80-column word processor that features global search and replace, underlining, bidirectional printing and file appending. This word processor uses the Sup'R'Terminal hardware board to generate the Apple video display text. "Easymailer" is a form-letter module that automatically inserts information from a name and address file, or user definable file, into an Easywriter text file. "Easy-mover" automatically dials the destination telephone number, connects to the computer and moves Easywriter text out, and saves the transmitted text on disk. Address: Unlimited Software, 793 Vincente St., Berkeley, CA 94707 (Tel: 415-525-4046).

**Goodies.** Captain Cosmo's Whizbang is a collection of software and hardware tips for the 1802. It includes two paper tape operating systems, a Morse-code keyboard/keystroke, an animated video robot face program, a video scratchpad program, and several smaller programs. Hardware includes RAM expansion, EPROM card, paper tape interface, I/O ports, memory address display, and others. \$5. Address: Jeff Duntemann, 301 Susquehanna Rd., Rochester, NY 14618 (Tel: 716-473-2986).

**TRS-80 FORTRAN.** Radio Shack's Model I TRS-80 FORTRAN is in a compiler form for fast execution. The user can write programs in FORTRAN using EDIT-80 to store lines for compilation. The editor includes interline and interline editing, find, substitute, and page formatting commands. EDIT-80 also permits reading and editing BASIC files. The package is supplied in a three-ring binder with two program diskettes and includes a FORTRAN users manual, compiler (F80), FORTRAN-80 reference manual, LINK-80 (L80) with manual, EDIT-80 and manual, and FORTRAN subroutine library (FORLIB/REL). Requirements are Level II and 16K of RAM, expansion interface with 16K of RAM, and at least one disk drive. \$99.95 at Radio Shack Computer Centers and stores.

**String/File Handling.** The STRING/80 Bit is a collection of string and file handling routines for CP/M. The routines are relocatable and use Microsoft FORTRAN convention of register handling. Features include chain or pass control by calling the program name. CP/M calls, kill, rename a file, directory search, reset and disk drive assignments are supported. Several FORTRAN programs and source codes are included. Software includes source code for utility library and all demos. \$95 on 5- or 8-inch CP/M compatible soft-sectored diskette. Address: Key Bits Inc., Box 592293, Miami, FL 33159.

**Space Shuttle.** Landing simulator program uses the high-resolution mode of an Apple II, requires 48K of RAM, and is written in Applesoft and assembly language. It is an "out-of-the-window" view with text display of flight data, ejection, landing gear, runway stripes, warnings, wheel/speed brakes, etc. Modelled after a real Nasa Shuttle Mission Simulator, it contains everything but roll motion. The 10-page instruction manual also has a brief introduction to gliding flight. Cassette is \$15; diskette is \$21. Address: Harvey's Space Ship Repair, Box 3478, Univ. Park, Las Cruces, NM 88003 (Tel: 505-522-1482).

**TRS-80 Duplex ASCII Terminal.** The TERM80 allows a TRS-80 computer to be used as a full duplex ASCII terminal. It features all RS232 options via the keyboard. In addition, terminal characteristics may be changed/checked at any time even on line; operation is true full duplex with upper and lower case; all keys auto-repeat after 1.5 seconds; received data may be echoed on a printer; and an optional handshake ensures no character loss over 1200 baud. Diskette is \$24.95. Address: Percom Data Co., 211 N. Kirby, Garland, TX 75042 (Tel: 800-527-1592).

**NEW**

Traditional

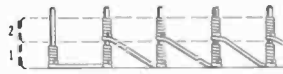

Wire-Wrapping

JUST WRAP



Wire-Wrapping

**WHY CUT?  
WHY STRIP?  
WHY NOT ...**

**JUST WRAP™** WIRE WRAPPING TOOL

- AWG 30 Wire
- .025" Square Posts
- Daisy Chain or Point To Point
- No Stripping or Slicing Required
- JUST WRAP™
- Built In Cut Off
- Easy Loading of Wire
- Available Wire Colors:
- Blue, White, Red & Yellow

**PATENTED U.S.A.  
FOREIGN PATENTS PENDING**

JUST WRAP TOOL WITH ONE 50 FT. ROLL OF WIRE		
COLOR	PART NO.	U.S. LIST PRICE
BLUE	JW 1 B	\$14.95
WHITE	JW 1 W	14.95
YELLOW	JW 1 Y	14.95
RED	JW 1 R	14.95
REPLACEMENT ROLL OF WIRE 50 FT.		
BLUE	FJW B	\$ 2.98
WHITE	RJW W	2.98
YELLOW	RJW Y	2.98
RED	FJW R	2.98
JUST WRAP-UNWRAPPING TOOL		
	JW 1	\$ 3.49

\*Minimum billings \$25.00, add shipping charge \$2.00/New York State residents add applicable tax



**OK Machine & Tool Corporation**

3455 Conner St., Bronx, N.Y. 10475 U.S.A.  
Tel. (212) 991-6600 Telex 125091



# Do more than ever before— spend less than you planned



## Heath makes the All-In-One Computer more versatile

Many satisfied customers know Heath takes the risk out of buying a balanced computer system. With the Heathkit All-In-One Computer, you get 16K Random Access Memory (expandable to 48K), keyboard, video terminal and floppy disk system — together in one self-contained, compact unit — for up to hundreds of dollars less than comparable systems.

Heath now makes the All-In-One Computer more versatile than ever! The new Heathkit H77 Floppy Disk System gives the All-In-One even more data storage and recall capacity. Combined, the All-In-One and H77 Floppy Disk give you up to 300K

bytes of on-line data storage — enough to hold entire files. You can mount operating system and program disks at the same time, to make computing even faster.

You can run programs written in MICROSOFT™ BASIC™ and Assembly Languages, and all current software written for the popular Heathkit H8 Computer.

Heath User's Group (HUG) will share with you a library of over 500 programs to make your computer serve you in ways you never imagined.

There's no better way to learn about computer systems — and save money — than by building one yourself.

Concise, easy-to-follow Heathkit assembly manuals show you the way, from start to finish. And a nationwide network of service centers protects your computer investment.

Join the Heathkit computer family today — and pocket the savings!

For complete details on Heathkit computer systems, as well as nearly 400 other electronic kits for your home, work or pleasure, send today for your free, value-packed Heathkit catalog. Or pick up your copy at the nearest Heathkit Electronic Center.

# Heathkit®

SEND FOR FREE CATALOG

VISIT YOUR HEATHKIT STORE

Write to: HEATH COMPANY,  
DEPARTMENT 010-664,  
BENTON HARBOR, MI 49022



In the U.S. and Canada, visit your nearby Heathkit Electronic Center where Heathkit products are also displayed, sold and serviced. See the white pages of your phone book. In the U.S., Heathkit Electronic Centers are units of Veritechnology Electronics Corporation.

CIRCLE NO. 33 ON FREE INFORMATION CARD

CP-184



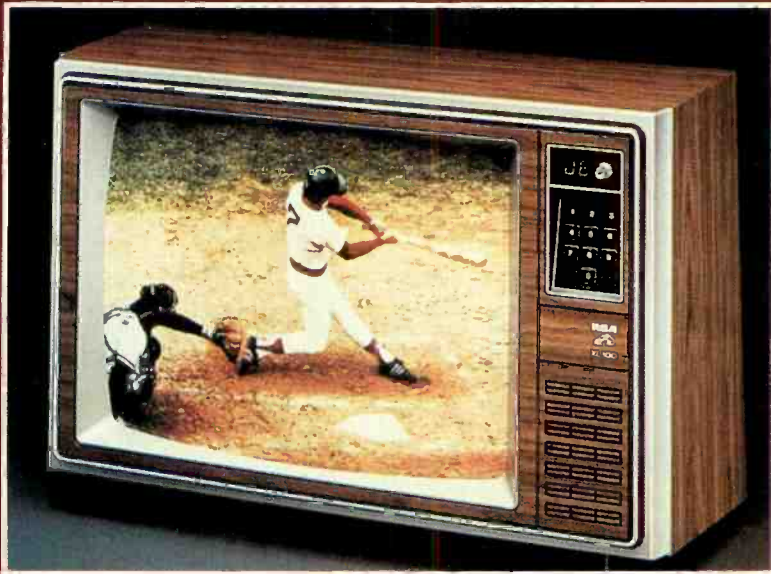

**T**HE new 1980-81 XL-100 color-TV chassis introduced only recently by RCA's Consumer Products Division emphasizes new technology, reduced parts count, and lower power consumption. New technology includes SAW (surface acoustic wave) filters and more sophisticated ICs, including one that processes most luminance and chroma functions. A few discrete transistors are used in these chassis, mainly in the power supply, sweep circuits, and final picture-tube drivers. The entire circuit assembly fits on a single "planar" printed-circuit board that measures 121 sq in.

Three chassis are included in this totally new line of moderately priced color receivers—13" CTC 107, 17" and 19" CTC 108, and 25" CTC 109. The only notable difference among the three is a few extra turns on the flyback trans-

# Popular Electronics Tests

## *New RCA XL-100 Color TV Chassis*

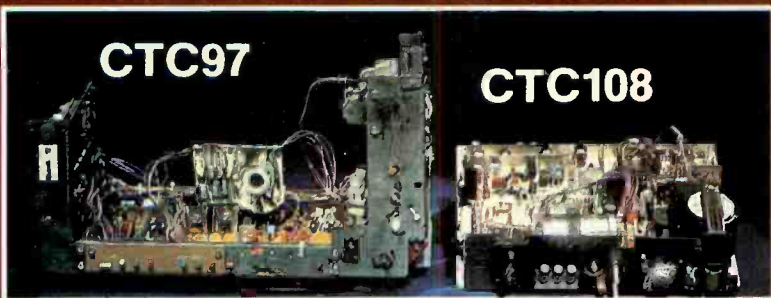

*Use of integrated circuits in the CTC 108 chassis results in a total of 76 fewer parts than in the older CTC 97 chassis.*

former of the CTC 109 console series to obtain additionally high voltage for the larger picture tube. Therefore, the following description (for the CTC 108 chassis) generally includes the salient features of all receivers in the new line.

The 19" Table Model FER450, with a suggested retail price in the area of \$400, is the one that this preview report is based on. It will likely be in retail stores at this time or shortly thereafter. It features a 10-button channel-selector keypad, with LED digital readout for any vhf or uhf channel.

**General Description.** The chassis combines video i-f and final amplifiers, automatic gain control (agc), automatic frequency control (afc), and synchronous video detection circuits into a single IC. A second IC houses the complete

# We've got it all together.



Weller



Weller



Xcelite



Wiss



Nicholson



Boker

**Boker  
Crescent  
Lufkin  
Nicholson  
Weller, Wiss  
Xcelite**

Take a quick look round this ad and you'll agree that "All together" is no exaggeration. Whether you're making or mending, cutting or joining, measuring or stripping, there's a Cooper tool that's just right for the job. Don't take chances on tools. Specify Cooper and get 'em right the first time!



Lufkin



Crescent



Crescent

# from Cooper The Toolmaker.



**The Cooper Group**

BOKER® CRESCENT® LUFKIN® NICHOLSON® WELLER® WISS® XCELITE®  
P.O. Box 728, Apex, North Carolina 27502 Tel: (919) 362-7511. Telex: 579497.  
CIRCLE NO. 17 ON FREE INFORMATION CARD



## XL-100 chassis

audio system, while a third large-scale integration (LSI) chip performs *all* chroma and luminance processing. Furthermore it has SAW filters, which are being used more frequently in TV receivers because of considerably simplified input circuits and the better selectivity they make possible due to sharper passband skirts. Here are highlights on circuit operation in this new chassis.

The tuning system is a carryover from last year and features a 10-button frequency-synthesized manual-scan tuning arrangement with combined uhf/vhf tuners and SELECT/LOCK switch for complete channel access in any area. The keyboard connects to a frequency-synthesizer (U1), operational-amplifier (U2), and LED display driver (U3). There is also a prescaler for U1 and an MST005 tuner module that connects to a CABLE/NORMAL switch on the rear of the receiver for 11 CATV channels A-2 through I (uhf displayed channels as 31, 35, 39, 43, 47, 51, 55, 59, 63, 67, and

71), called the midband cable channels. Sound and picture keyboard changes are instantaneous.

When a signal reaches the photoetched input electrodes of a SAW filter (SF 301 in the RCA chassis), a surface wave is generated. This deforms the internal lithium-niobate material and creates "waves" similar to those made when a stone is dropped into a still pond. When these waves encounter the output, a reverse piezoelectric effect restores the electrical signal. Length and spacing of electrodes in the SAW device determine frequency characteristics.

The SAW filter used in the new XL-100 offers excellent response between the 41.25-MHz sound carriers and the 47.25-MHz lower adjacent-channel sound carrier trap. (See Fig. 1.) Color begins at 41.25 MHz, color suppressed subcarrier at 42.17 MHz, and video carrier at 45.75 MHz. This single device actually determines the overall i-f pass-band response.

Following the SAW filter and its discrete preamplifier are the i-f, aft, agc, & video detector circuits, contained in one multifunction IC (Fig. 2). This IC, the RCA TA7607, requires only a few external components: a tunable aft crossover between pins 7 and 10, and a similar LC circuit between pins 8 and 9 for the synchronous detector. Other than the 47.25-MHz sound trap preceding the SAW filter, there are only six tuned circuits following the tuner that require adjustment.

Three amplifiers, all agc controlled, and another amplifier that supplies push-pull aft outputs for the tuners make up the i-f section. With its crossover LC tuning, the aft detector produces a dc voltage for tuner oscillator corrections within some 30 to 50 kHz.

Any undue noise through the video amplifier is normally shunted to ground by the noise inverter, which traditionally removes sync and agc momentarily until annoying microsecond-duration im-

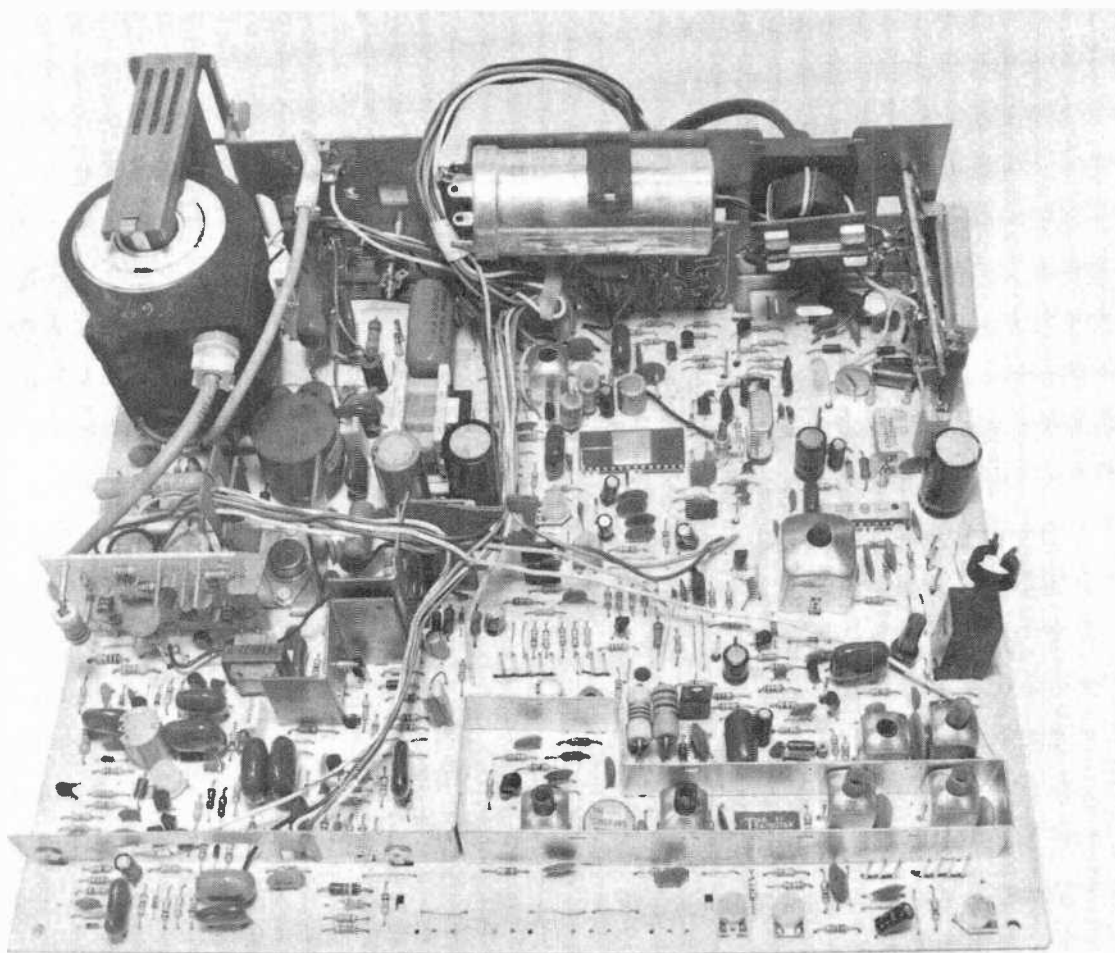
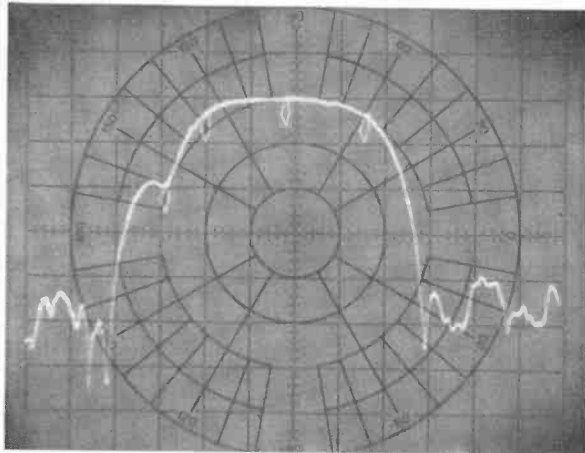

Photo shows that all receiver components, except for a few discrete parts, are mounted on a single pc board.

**CHASSIS MODEL CTC 108  
LABORATORY DATA**



10 dB/div.

39.75 41.25 42.17 44.00 45.75 47.25

Fig. 1. Scope trace shows how response of SAW filter determines bandpass for all of TV chassis.

Fig. 2. Entire i-f, aft, agc, and video detector functions are contained on a single monolithic IC.

pulses have passed. A dc adjustment sets the bias so r-f agc doesn't operate until the i-f's are almost at saturation.

Sound i-f and audio-output IC U201 is an RCA CA3134 that can deliver up to 3 watts through a capacitor into a 32-ohm speaker (Fig. 3). Some features of

this IC are current limiting and thermal shutdown, low quiescent current, excellent 50-dB AM rejection, -3-dB sensitivity of 200  $\mu$ V, differential peak detection, and electronic control of volume. Gain is controlled by feedback and dc bias applied to the internal amplifiers.

(Text continued on page 50.)

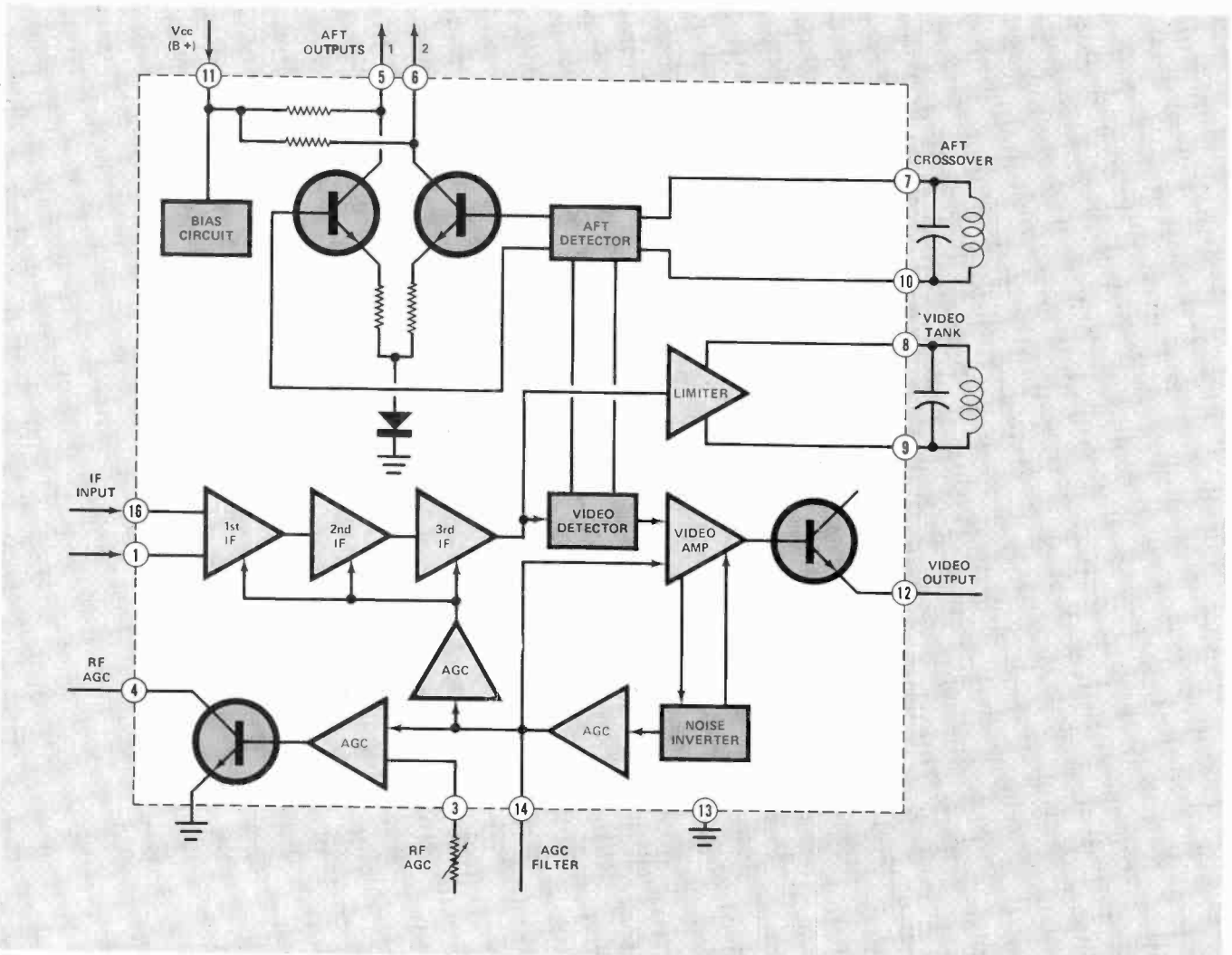

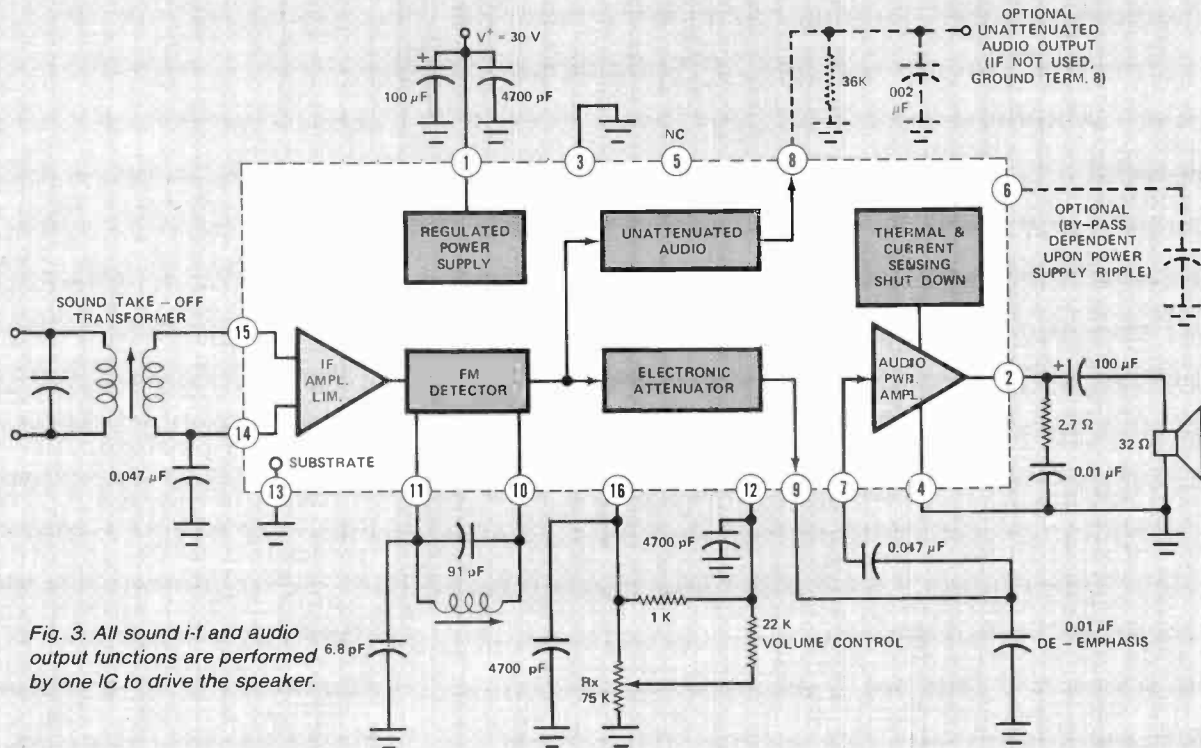
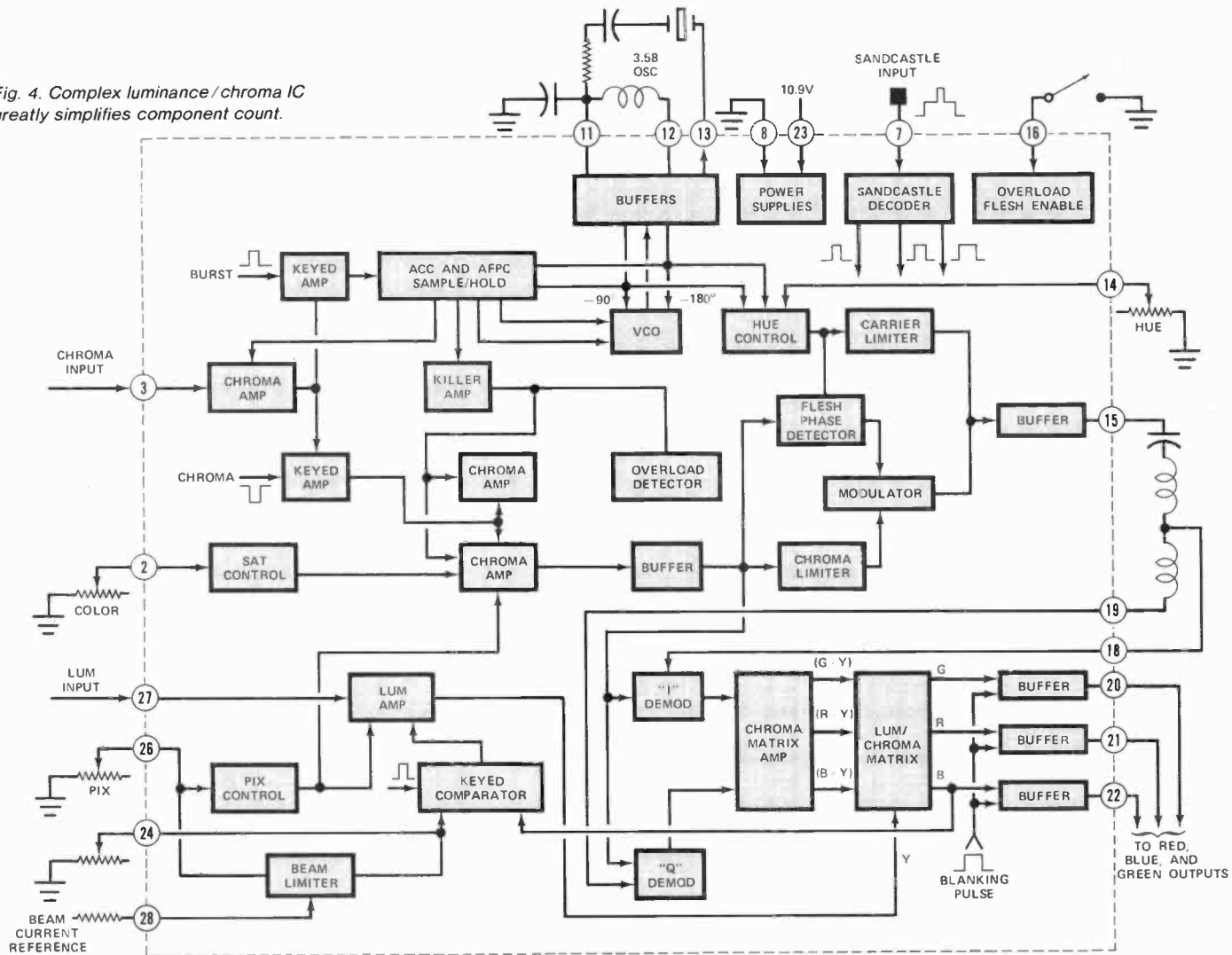

Fig. 3. All sound i-f and audio output functions are performed by one IC to drive the speaker.

Fig. 4. Complex luminance / chroma IC greatly simplifies component count.





## XL-100 chassis

The recovered audio can be delivered unattenuated (pin 8) or electronically attenuated (pin 9).

Audio signals at pin 9 of *U201* are coupled through a .047- $\mu$ F capacitor, de-emphasized by another capacitor, and fed to the internal audio amplifier via pin 7. Audio output from pin 2 is routed to outboard Darlington power output stages that are current-limited or/and shut down by separate shunt transistors.

A complex 28-pin LSI device (shown in block-diagram form in Fig. 4) processes all luminance and chroma, after delay-line and burst keyer inputs, to provide signals for the final red, green, and blue amplifier stages before the cathode ray tube. The chroma portion is last year's CA3151 device, which appears in both the CTC 99 and CTC 101 chassis.

Burst and chroma, peaked and band-pass-limited to the usual 1 MHz, are routed to the first chroma amplifier, which delivers signals to both chroma and burst pulse-keyer amplifiers. Here, color killer, automatic color control (acc), and automatic phase control detectors (afpc) receive color burst that is detected and applied to sample-and-hold circuits. Burst amplitude is also sampled by the acc amplifier, which establishes gain correction for the first chroma amplifier. In the absence of color, the killer amplifier biases the second chroma amplifiers off. An external potentiometer offers manual phase shifting for these and the hue control stages, whose signals then proceed to the flesh phase detector, carrier limiter, and buffer.

Flesh-tone phase correction through the buffer is also aided by the flesh detector. Chroma from the second Amp is buffered and limited. Both signals then enter a modulator, where output increases or decreases according to the signal phase. The result is chroma signals constantly amplitude-modulated by flesh-tone-corrected information from the flesh phase detector. Flesh-tone correction cannot be defeated.

The luminance portion is considerably less involved than chroma, but there are interesting circuits here too. Delayed and 3.58-MHz-chroma-trapped video is amplified and gain-controlled by both Pix-ganged brightness and chroma control, as well as the brightness-beam current limiter connected between high voltage resupply and the flyback transformer. Feedback from the blue output amplifier and beam current are sampled in the keyed comparator, and automatic limiting occurs in the luma amplifier.

The horizontal circuits use discrete transistors, and even include the perennial pair of automatic phase control diodes with 15,734-Hz broadcast sync

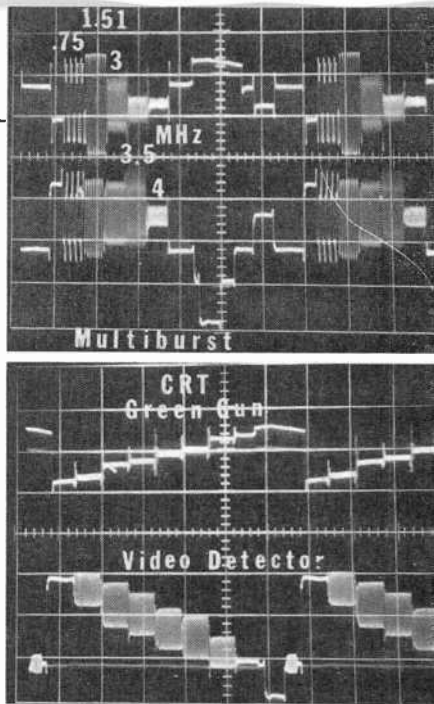

*In top photo, upper trace is multiburst at CRT showing usable 3.5-MHz information; lower trace shows 4 MHz at video detector. In lower photo, top trace is typical staircase with some transients at CRT's green cathode. Lower trace shows excellent reproduction of color bars at video detector.*

input and integrated flyback feedback. However, since the horizontal oscillator has improved noise immunity, pull-in range is greater than heretofore possible, and there is no agc gating pulse drain. Hence, there is little necessity for operator manipulation, and the dc bias for horizontal frequency is controlled by a factory-set potentiometer.

Afc diodes and a dc level, preset at the factory, control the switching rate of the horizontal oscillator. This consists of two transistors in parallel with collectors connected together and emitters sharing a common resistor. The first half of this circuit rate-modulates the second, which is inverted and switched by a separate pair of feedback transistors, locking the horizontal switch portion to its nominal 15,734-Hz color repetition rate. The usual transistor driver, its current transformer, single-stage horizontal output, and damper diode efficiently do the rest.

Half-wave rectifiers in series with flyback secondary taps furnish various operating voltages for the remainder of the receiver, as is usual. Stacked diodes among the upper flyback windings deliver dc anode voltage to the cathode ray tube. A three-transistor and diode X-ray/overcurrent shutdown circuit samples regulated B+ and high voltage. If either is excessive or too much current is drawn, it biases the horizontal driver into continuous conduction, shutting down the high voltage, flyback-diode generated dc voltages, and the receiver.

Operating power in addition to that sourced from the flyback originates

from a bridge rectifier connected directly to both sides of the ac line, which places this chassis about 30 volts above ground. A single 600- $\mu$ F capacitor supplies ripple filtering for the fairly complex B+ regulator. In stabilizing the raw 150-volt output, regulator action reduces it to 33 volts for the supply's regulator-error, control-amplifier, and oscillator circuits (this is a switching power supply). The oscillator feeds the primary of the coupling and driving transformer. An SCR in the secondary of the transformer delivers current and regulated B+ to the primary winding of the flyback, the collector of the horizontal output transistor, and line and load regulating auxiliary flyback operating voltages.

Regulated B+ is compared with the 33-volt reference zener potential at its emitter by the regulator-error amplifier. High B+ makes the SCR deliver less current and reduces B+ output; subnormal B+ causes the reverse action.

**Comments.** Although the actual circuitry is quite elaborate, this is a very compact and sparsely populated chassis. All components are soldered into place on the single pc board, however, which makes service in the home extremely difficult, if not impossible. On the other hand, as reliability should prove very high, servicing might not be much of a problem.

High- and low-voltage regulation are exceptional, assuring better-than-average performance under fluctuating power conditions. (See Laboratory Data Table.) Automatic gain control (agc), though not ultra-effective, should serve well in most areas. Overall video band-pass is very good indeed and, coupled with very good tuner sensitivity and even better CRT signal-to-noise ratio, ensures crisp picture quality. While there is some horizontal overscan in the picture (common in color receivers), a width control can be adjusted to minimize it. Like other low-power chassis, this one is not isolated from the power line, so an isolation transformer should be used if, for any reason, servicing is required.

This receiver obviously has a number of points to recommend it. It is sensitive enough (assuming a good antenna is used) to pull in signals in most areas. If you live in an area served by cable TV, the midband channels (in addition to A-1 and A-2 for those odd areas) would be a distinct asset. Clearly, this new chassis offers high performance in its moderate price class. Anyone in the market for a color-TV receiver in these inflation-ridden times would do well to consider it.

— Stan Prentiss



# VIDEO CASSETTE RECORDERS:

## Rising Stars of Home Entertainment

BY IVAN BERGER

**T**HE more you know about what goes on inside home video cassette recorders, the more you'll marvel at how little they cost, all things considered. But a price that is relatively small for the technology involved can still loom large in the household budget. And when suggested retail prices range from \$735 (for Sears' Model 5305) to \$1775 (for Magnavox's 8273), it pays to know just what you're getting for the extra money so that you'll be able to make good value judgments. Let's start by looking at some of the technology that makes VCRs "high ticket" machines.

**How VCRs Work.** Audio tape recorders are hard pressed to handle signals up to 20,000 Hz, but home video recorders handle signals well above 2 MHz—and at slower tape speeds than used by audio cassette recorders. This might seem paradoxical since any user of a multi-speed audio recorder can confirm that the faster the tape-to-head speed, the higher the frequencies you can record. Furthermore, higher speeds gobble up tape and thereby increase recording costs. Home VCRs solve this problem much as professional video recorders always have: they feed tape slowly, for economy's



# My new home, portable video recorder. Panasonic calls it Omnivision. I call it "Reggievision."

"This Panasonic portable Omnivision™ VHS™ video tape recorder is like an all-star team. The PV-3100 recorder with its optional programmable tuner/timer (PV-A35P) lets you record up to 6 hours of TV at home and 8 different shows over 14 days when you're making a road trip.

"When there's nothing good on TV, make your own shows—either indoors or outdoors—by adding a Panasonic PK-700 color-sound camera. And look at these major league features: A motorized 6-to-1 zoom lens, automatic exposure control, color balance and a telescoping condenser mike.

"The portable recorder comes complete with a Panaloid™ rechargeable battery, so you can shoot for up to 1 hour. And for an extra hour of taping, there's an

optional battery pack. There's also an optional car-battery adapter. (The Panasonic portable video recorder has almost as many options as my contract.)

"And this Omnivision ought to win the MVP (Most Valuable Panasonic) award with its special features that let you

freeze any frame. Or advance slowly frame by frame and see every detail of the action.

"With all this going for it, just one more touch would make it perfect—a name with a certain inimitable style and

grace. Which is, of course, why we call it "Reggievision."

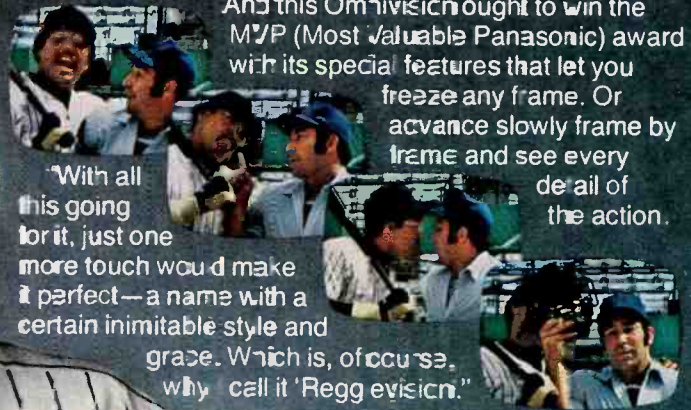

**Panasonic**  
just slightly ahead of our time.

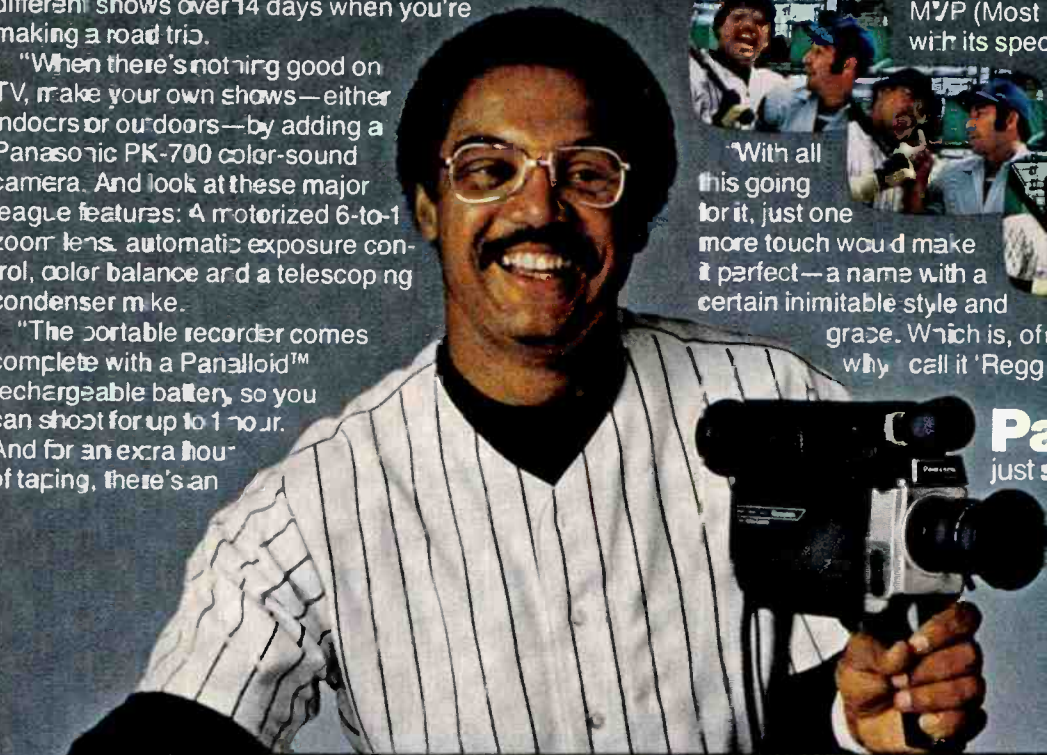

TV picture simulated.

CIRCLE NO. 56 ON FREE INFORMATION CARD



# video recorders

sake, while sweeping the heads across the tape at the high speeds needed to achieve video frequencies. This system, used in both VHS- and Beta-format recorders, is called "helical scan." The heads are mounted on a wheel which spins them diagonally across the tape so that the path followed by each head is a portion of a helix.

In reality there are two heads on the drum, spaced 180° apart. A pair of heads is used because a video picture is made up of alternating "fields" of lines—the odd lines in one field and the even ones in the other—which are interlaced to make a complete "frame" on the picture tube's screen. In the U.S., a frame has 525 lines, and 60 fields appear each second. Each sweep of a single head across the tape therefore records one complete field of 262½ horizontal lines. The switchover between heads occurs in the brief interval between fields and should not be visible on the screen. The tape wraps halfway around the drum so that the two heads contact the tape alternately. (On some new VHS-format decks, there are actually four heads, though only two are used at any given moment.) Obviously, there is a tape head synchronization challenge here. Some other technical problems are created because recorded tracks on the tape are packed close together for high recording density. This saves tape, but adds crosstalk and noise problems. Here's how they're solved.

Crosstalk is alleviated by a technique called "azimuth recording." Head gaps are not at right angles to the track, as in audio recorders, but are tilted a few de-

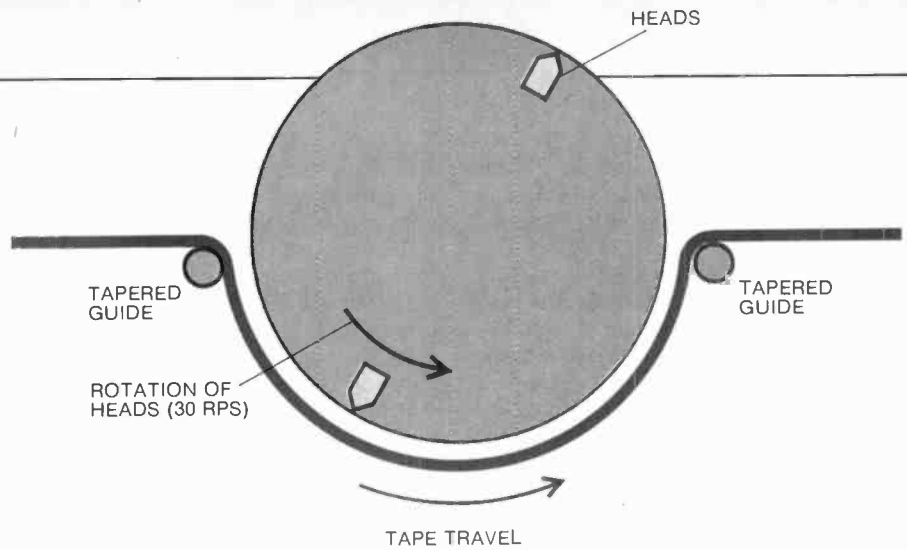

In half-wrap helical scan format, tape is wrapped around rotating head drum so that second head begins to write as first head finishes.

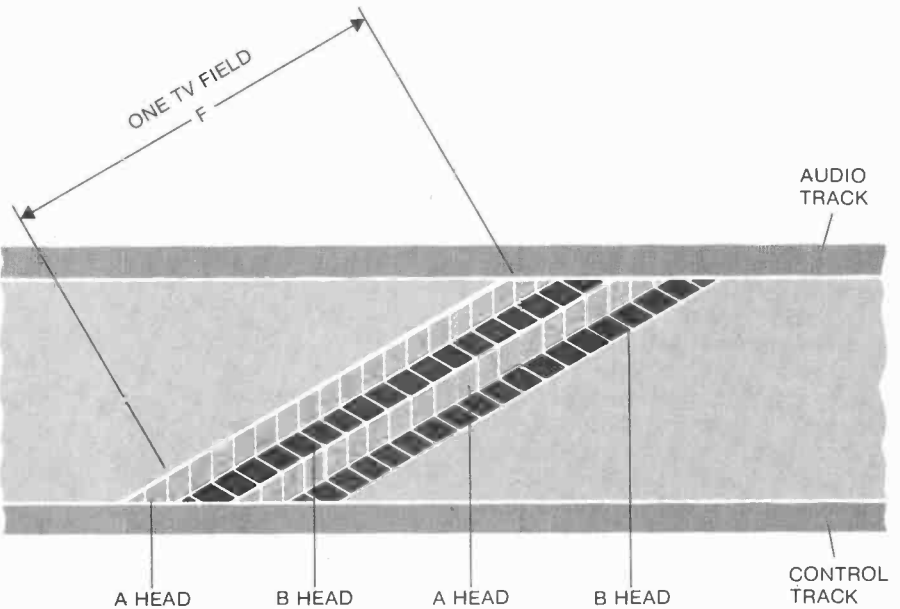

Audio and control tracks are recorded by stationary heads. Video heads write diagonal tracks. Azimuth angle is alternated on adjacent racks to avoid crosstalk.

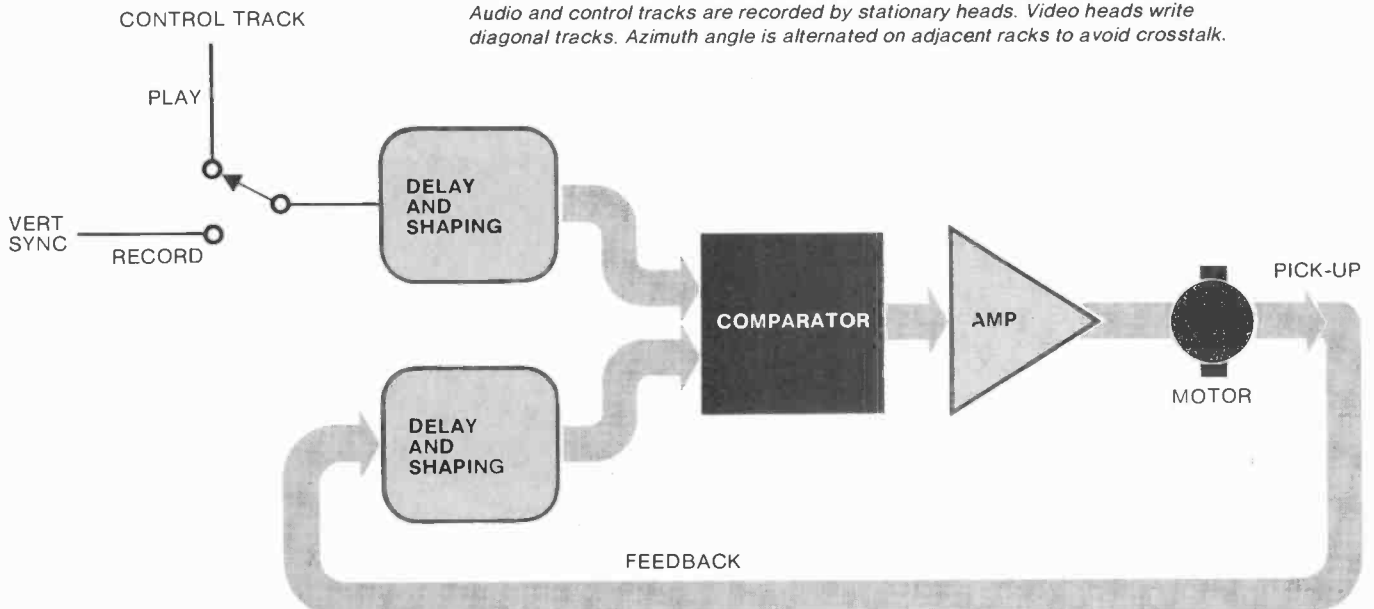

Vertical sync signal on control track is used with feedback system that causes video heads to scan correct tracks.

## video recorders

degrees (6° for VHS recorders, 7° for Beta decks). The two heads incline in opposite directions, leaving crosstalk signals from adjacent tracks 12° or 14° out of alignment to the head contacting the tape. At video frequencies, the purposeful "misalignment" greatly attenuates crosstalk. At lower frequencies, such as those used by the chroma signal, azimuth differences are not enough to reduce crosstalk sufficiently, so adjacent tracks are recorded in opposite phase, permitting cancellation of undesired signals in playback.

It's equally vital that each head line up with the correct track during playback. To ensure this, the recorded tapes also carry a track of vertical sync pulses (60 Hz) that control the head-drum's servo motor. A separate, stationary "control" tape head is employed for this purpose. Moreover, a fine-tuning control is incorporated for user adjustment of tracking accuracy.

Narrow tracks and slow speeds exacerbate noise and dropout problems, which appear as short streaks on a TV picture. To handle noise, high-frequency pre-emphasis is added to the luminance or brightness signal during recording, but reduced when the signal is strong enough to override the noise. For dropout compensation, decks contain delay lines that store one line of video, ready for substitution in the event a line is dropped. Substituting another line is not noticeable since a few sequential lines contain almost the same information.

**Beta vs VHS.** Beta and VHS tape formats are similar in their basic technology. The main differences between them are in the size of the cassette (the VHS version is larger and holds more tape) and in the way the tape is wrapped around the head drum.

Beta-format decks have a single, swinging arm that draws the tape out of the cassette and wraps it around the drum and the stationary audio, control-track and erase heads, in a rather complex path. VHS decks pull the tape out with two parallel arms providing tension between it and the head drum. The VHS "M-load" system (so-called because of the shape of its tape-path) is slightly quicker, but the tape must be released from this path before fast-forward or rewind. Therefore, while a Beta machine can go directly from play into rewind or fast-forward, a VHS deck requires a few seconds for the tape to unload from the heads before proceeding—and wait again for the tape to reload before you resume play. VHS counters with the advantage of longer recording time (currently 6 hours maximum to Beta's 5),

and slightly greater popularity (60% of the market to Beta's 40%). In practical terms, greater popularity may make VHS tapes and commercially recorded software slightly easier to find, and you may locate a few more friends to swap tapes with if you choose VHS.

**Times, Speeds, and Operating Features.** Most Beta and VHS decks now offer the user a choice of two or three recording speeds: slower speeds to use less tape while sacrificing some picture quality, or higher speeds to attain better picture quality at the expense of using more of the tape. (The difference in quality is not always obvious, however; some machines seem to record equally well—or equally badly—at normal and low speed, a point you will want to check when you are shopping for your recorder.)

Most Beta decks offer two recording

speeds (×1 and ×2) giving maximum recording times of 3 hours, 20 minutes or 5 hours, respectively, with L-830 tape (3 or 4½ hours on the more readily available L-750). Few, if any current decks can record at the original Beta speed (1½ hours maximum on L-750 tape), but most Sony models can still play it back. All of today's two-speed Beta decks can record both the long-playing Beta speed (×2) and the extra-long-play speed (×3). Approximately one-third of all current Beta decks play only the ×2 speed.

VHS decks have as many as three recording speeds, for recording capacities of 2, 4, or 6 hours. However, nearly half the decks on the market have only one or two speeds. Of these, the most common (and probably the oldest) models are those offering the 2-hour and 4-hour speeds while JVC, MGA, Mitsubishi, and Sharp have 2-hour/6-hour

### VCR formats

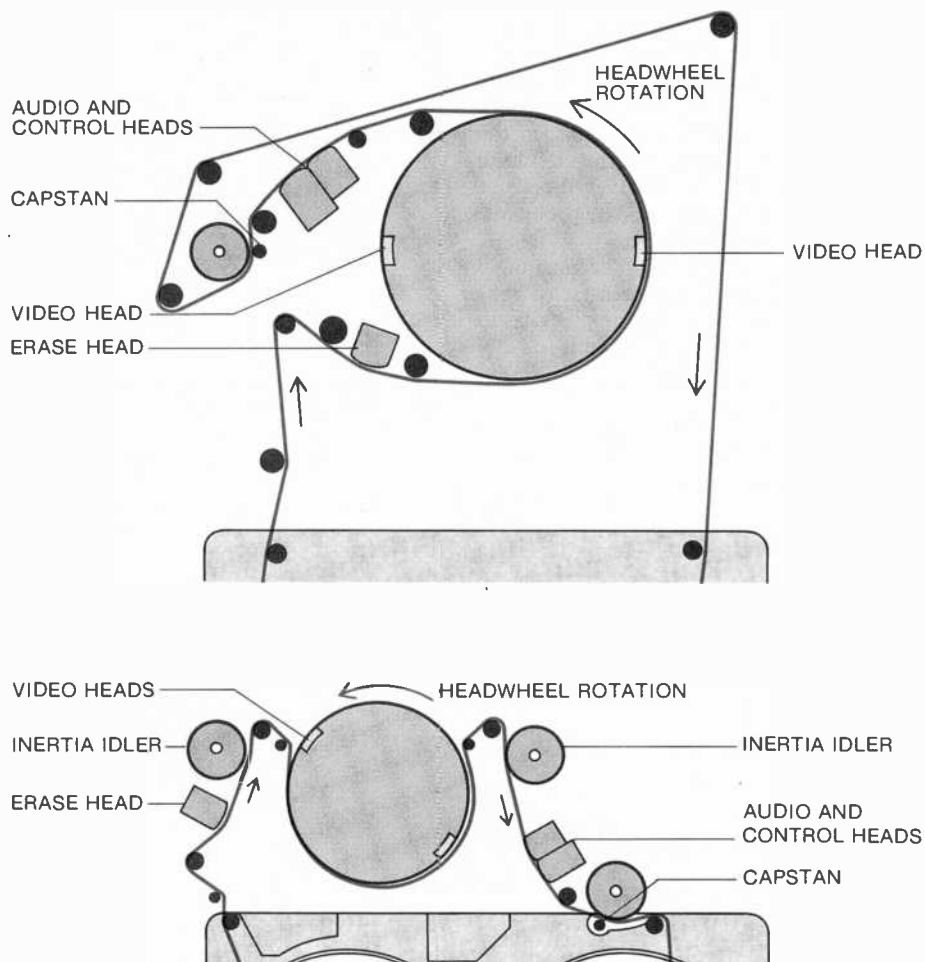

One of principal differences between Beta (top) and VHS (bottom) formats is the way the tape is wrapped around the head drum.

# IT IS BETTER TO GIVE AND RECEIVE.

You'll receive a rebate up to \$20 if you give dad a Bearcat® No-Crystal Scanner for Father's Day.

Get Dad into all the real excitement of scanning. Or get him a more sophisticated scanner. Either way, you'll get yourself a nifty rebate. Up to \$20.

**Get a \$10 Rebate on the Bearcat 210.** America's best selling Scanner Radio. The amazing 10 channel, 5 band crystalless Scanner that tunes in over 6000 frequencies with pushbutton ease. Features automatic search, selective scan delay, and more.

**Get a \$10 Rebate on the Bearcat 211.** America's mid-priced, spaceage circuitry Scanner. Has 18 channel, 6-band capacity. Automatic search. Direct channel access. Dual scan speed. Automatic squelch. And digital clock.

**Get a \$20 Rebate on the Bearcat 220.** The Scanner radio that tunes in FM public service frequencies—plus AM aircraft communications with pushbutton ease. Features automatic search.

**Get a \$20 Rebate on the Bearcat 250.** America's exciting, 50 channel synthesized Scanner. It searches, stores, remembers, and brings home live action. Dual scan speeds. Scan delay. Automatic squelch. Direct channel access. Every feature you want.

See your Bearcat Scanner dealer now, for the greatest gift you can give Dad. And get a rebate for remembering him so well this Father's Day.\*



\*Rebate offer good on consumer purchases made between May 1, 1980 and June 30, 1980. Offer good only in U.S.A. Void where taxed or prohibited by law. Restricted to one rebate per customer regardless of the number of scanners purchased.



Electra Company.  
Division of Masco Corp. of Indiana.  
300 East County Line Road.  
Cumberland, Indiana 46229.

## BEARCAT® SCANNERS

The number one way to real excitement.

CIRCLE NO. 23 ON FREE INFORMATION CARD

AmericanRadioHistory.Com



## video recorders

models. JVC also has some 2-hour-only models, and Akai's Activideo portable records only in the 4-hour mode.

As with most VCR features, it's hard to pin down what extra speeds cost you. The more speeds, the more other features the deck is likely to have. Oddly enough, the average price of 1-speed VHS decks (about \$1200) is slightly higher than the average for 2/4 hour models (about \$1150), while the average prices of 2/6-hour and 2/4/6-hour VHS decks are both about \$1350. In Beta decks, however, single-speed operation will probably save you about \$200 over two-speed, though you'll find some other features missing, too. Beta  $\times 2$  decks average about \$1050,  $\times 2/\times 3$  decks about \$1250. Note, also, that different areas have different discount structures, so the foregoing may not always hold true.

Then there are "extra" playback speeds on some new VHS and Beta decks: still-frame, frame-by-frame advance, slow-motion, fast-motion, and high-speed scanning. Of these, the high-speed scan function will probably be most often used. With it, you can see where you are on the tape as you fast-forward or rewind your way through it. (Some video decks call this feature Cue and Review.) Tape speed may be a bit less in this fast-search mode than in normal fast-forward or rewind, though not necessarily by much. (Mitsubishi, for

example, has fast-search at  $15\times$  normal speed, and Sony's BetaScan is  $13\times$ .) But finding what you want is usually quicker, as you needn't switch to "play" to check the tape.

Not all decks with visible search can scan the tape in both directions. Fast-playback speed, usually about 3 times normal, is also available on some decks. This can be used to speed up commercial breaks when playing back off-the-air tapes (especially if you can trigger fast play by remote control), or to home in on a program segment that the faster visible-search feature might overshoot.

Still-frame, which lets you watch any single frame as a still picture or, in some cases, advance through the tape one frame at a time, is found on more and more home decks. If this feature is important to you, check for freedom from "noise bars" (bands of "snow") across the picture. Some decks have variable-speed slow motion (often adjustable all the way down to still-frame), while others offer variable speedup.

As features usually come in packages, it's hard to pin down exactly what any one costs. But in general, freeze-frame is the easiest feature to find, and is very prevalent among decks in the \$1000-\$1500 range. Fast playback, though nearly as common, comes only in slightly more expensive decks—\$1125-\$1525. Fast visible search, the least expensive of these special-speed features, is avail-

able in \$1000-\$1350 decks, while slow motion is common in the \$1200-\$1500 range. Variable-speed playback is available on \$1125-\$1400 decks, including many with slow motion.

**Secondary Features.** All VCRs have tape counters that help the user fast-wind to any desired location on the tape—provided he's noted down the counter number and remembered to reset the counter to zero at the beginning of the tape. Quite a few also have memory rewind that stops tape rewind (or fast-forward) at the point when the counter resets to zero.

Some VCRs automatically put a cue signal on the tape at any point where recording is begun, and come to a halt from fast-winding when any of those cue signals is reached. If you record 12 half-hour shows on a 6-hour tape, you can fast-wind directly to the start of each of them. If you recorded two shows in a row on the same channel, though, the tape would only stop at the start of the first show. I've encountered this on Panasonic, Quasar and RCA VCRs, all made by Matsushita, and it may exist on other brands.

Sharp's VC-6800 has APLD (Auto Program Locate Device), an interesting variant on this idea that can record up to 99 cue tones on the tape, wherever you want them. To reach any given cue, you punch in its number and start fast-wind-

## home VCR sampler



Sony SL-5600 has visual fast-search and can record up to four different programs over a 14-day period.



Microprocessor-controlled Sharp VC-6700 can fast-wind to any tape location programmed on its 10-key pad.

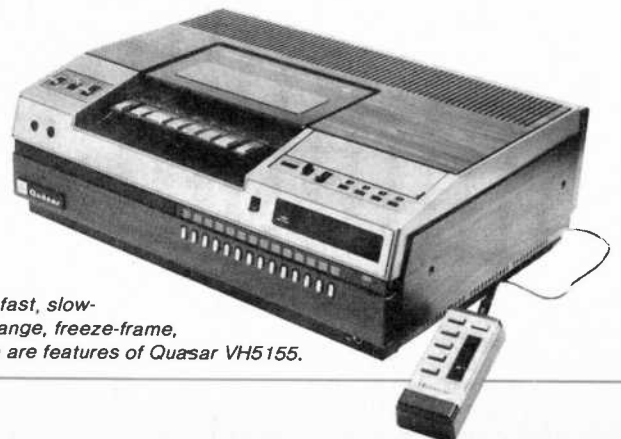

Remote-controlled fast, slow-motion, channel change, freeze-frame, and frame advance are features of Quasar VH5155.

ing toward it. The tape will automatically stop at the correct point. Alternatively, you can key in a tape-counter number and have fast-wind stop automatically when it is reached. These features appear to be unique to this \$1295 deck, for the moment.

VCRs have long had built-in tuners and timers to let them tape programs off the air, even when unattended. Only the portables, which have tuner/timer units as accessories, lack these features.

Tuners now tend to fall into two classes. First is the old standby mechanical system, with one detented knob for tuning vhf channels and a second for uhf. Typically, these are found in decks costing from about \$750 to \$1350. Next is electronic tuning, with direct, single-touch selection of any desired station, usually via 12 or 14 pushbuttons, each of which can be tuned to any channel. Such tuning generally adds about \$100 to the price, though other features are sometimes included as well. Make sure, however, that there are enough buttons to cover all the channels on the air or cable in your area.

A VCR's built-in tuner has its obvious applications: taping one program while you watch another or, with the timer, taping *in absentia*. But it can have other uses, too. A VCR with remote channel switching can make that function available to a TV receiver that lacks it. And in some cases, especially with older TV sets, the VCR may have the more sensitive tuner. The reverse, of course, is also possible.

Timers are also getting more sophisticated. While those of older machines and today's less expensive models could only record a single program, those of today's "programmable" models can tape anywhere from 3 to 7 programs per week, switching channels automatically (thanks to electronic tuners) and turning the tape off between shows. Sony and Zenith have models that can operate over a 2-week period. Most programmable sets (including the 2-week models) can be set for up to 4 programs. Prices of such sets fall mostly into the \$1000-\$1500 range. Toshiba's two programmables (around \$1300) can only store three programs. Decks that can store 5 programs (Sanyo's VCR-5500), 6 programs (JVC's HR-6700U and Mitsubishi's HS-300U) or even 7 programs (Sharp's VC-6800) cover a narrower price-range (\$1300-\$1500) than the 4-program models, but average only about \$30 more. Long-term programming is a great asset with low tape speeds and long recording times.

Programmable timers can be rather formidable to operate, though. Howev-

er, more experience on the part of designers is leading to better human engineering. An example is the change from arbitrary day numbering (e.g., today is "Day 0") to the use of day names. And a few VCRs have battery back-up to ensure they'll stay programmed during brief power interruptions.

**Shooting on Location.** A growing number of owners of VCRs are moving them from their sedentary positions next to the TV sets to mobile operation (with cameras) in the production of home "tapes." Portables are getting lighter (under 12 pounds, with batteries, for some current models) and may get lighter yet (the Funai, for example, will weigh 9.5 pounds). Currently, portables deliver an hour or more of recording time per battery charge.

Portable video equipment costs—and weighs—more than comparable home movie gear. But video offers lower operating cost. Tape costs far less than film and processing, even if you don't reuse it! And instant-playback via the TV set is more convenient than using a projec-

tor and screen that must be stored and set up for each use.

If a portable tickles your fancy, pay attention to such factors as battery life and how easily the controls can be operated when the recorder is hanging from your shoulder. If you'll be shooting major projects, look for one whose batteries can be recharged externally—that way you can recharge a spare while using up the charge in the other.

Cameras offer a wide choice of options: optical viewfinders are less expensive, lighter and draw no current from the battery. But electronic viewfinders—miniature black-and-white TV screens—show exactly how the taped image will look and allow focus or exposure inaccuracies to be corrected. Electronic finders can also be pressed into service as playback monitors.

Zoom and power-zoom lenses can add special effects and make it easier to frame your subject. But they, too, add cost, weight, and, in the case of power zooms, some added battery drain.

Check also to see how easily your camera can be set to match the color of

### *portable VCR sampler*



*Typical portable setup has recorder, tuner-timer and color camera, as in this Akai Activideo system.*

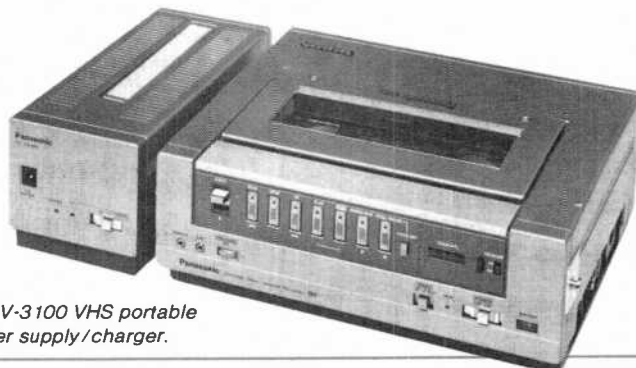

*Panasonic PV-3100 VHS portable with ac power supply/charger.*

the light by which you're shooting. (Daylight is comparatively blue, incandescent light comparatively red.) Many color cameras have built-in, calibrated compensation systems to match the light precisely, while others have color filters to do the same job more cheaply—and less accurately.

Portables are modular systems, consisting of recorder, battery, camera, charger, and tuner/timer (usually combined with a charger). You can use them in several combinations, so they're

### Do We Need Disc and Tape?

By this time next year, we may be flooded with video formats: Beta (two speeds), VHS (three speeds), the BASF and Toshiba LVRs, the Funai, and perhaps even the Philips system—plus three disc systems. One of those disc systems, the MCA/Philips laser-scanned system, is already on sale in seven U.S. cities (perhaps more, by the time you read this). Magnavox, which first offered this disc to the public, is about to be joined by Universal-Pioneer (already selling players to industrial markets).

Meanwhile, RCA has promised national distribution of its Selecta-Vision disc system by early 1981, and Matsushita (parent of Panasonic and Quasar) has announced plans to introduce the VHD disc system developed by affiliate JVC. Neither disc system is compatible with the other—nor with the Magnavision disc.

Why disc and tape? For the same reasons that we have both in audio. Tape systems can record, disc systems can't. On the other hand, discs offer much less expensive duplication, plus instant access to any part of the recording.

Discs have been touted as the low-cost alternative to tape for those who want to play commercially recorded programs. Both players and discs, it's been predicted, will be less costly than VCRs and video cassettes. But VCR prices and tape consumption have been coming down, while prices of the Magnavision disc player and discs (so far the only ones available) have been creeping up. LVR systems, with fewer parts and faster tape duplication, could wind up costing less than disc players and recordings.

usually priced separately. When shopping, be sure you know what the quoted price includes. You'll find that, even without a camera, a portable system will cost more than an equivalent, single-unit, stay-at-home VCR—about \$1200–\$1300 without tuner/timer, about \$1350–\$1800 with (Akai's Activideo is an exception, at \$1125 with tuner/timer). So far, the only programmable portable seems to be J. C. Penney's. The basic recorder costs \$1075 in its 2/4/6-hour version (\$975 for 2/4-hour recording), with a choice of battery charger (\$115), dual-dial mechanical tuner (\$249), electronic tuner/timer (\$295), or programmable 4-program/7-day tuner/timer (\$389). However, Panasonic will shortly offer programming for its new 3000-series portables, and Quasar may soon as well.

**Four-head VHS Decks.** Some of the new, 6-hour VHS decks have four heads: one pair for the 2-hour speed and the other for the 6-hour and (on 3-speed decks) 4-hour speeds. Each pair of heads makes tracks of different widths, maybe even four dissimilar ones. The reason is that slow-speed recording requires thinner diagonal tracks, with heads to match. However, using such heads for 2-hour recording would sacrifice signal-to-noise ratio. In addition, narrow-track 2-hour tapes would play back very noisily on wide-track, 2-hour heads, which pick up noise on each side of the recorded track. With one wide-gap and one narrow-gap head pair, there's no problem.

Even the two members of each pair may have dissimilar track widths—at least on those decks which have such special effects as still-framing. (On Panasonic's 3-speed, still-framing decks, for example, the 2-hour heads are 70 and 90 microns wide; the slow-speed heads are 26 and 31 microns.) Using asymmetrical tracks offsets the noise bars inherent in still-frame operation, so that they can be made to occur outside the visible portions of the frame. On decks without still-framing, heads are symmetrical.

**Up the Price List.** What does your money buy in VCRs? The first \$700 to \$1000 (suggested retail price) brings basic technology: a recorder, mechanical tuner/timer, and probably a pause control and memory rewind.

At higher prices, you'll get more recording time (which may pay for itself in tape economy) and programmability, which makes that longer recording time more useful. You'll get aids in locating programs or program segments, and such extras as fast-motion, slow-motion, freeze-frame or frame-by-frame ad-

vance—which you may or may not need. Features like these are sold as packages, like new-car options, which makes it hard to assign costs precisely.

Your local dealer's reputation is worth considering, too. Some are more cooperative in handling service and other problems than others. (Unfortunately, but predictably, the dealers with the biggest discounts tend to be the least helpful after the sale.) Manufacturers' warranties almost all cover a full year on parts, and 90 days on labor. However,

### Stepping-Stone to Digital Sound

Digital sound recording requires tremendous bandwidth—by audio standards. By video standards, though, that bandwidth is nothing special. PCM adapters are already available (from Optonica, Sanyo, Sharp, Sony and Toshiba, so far) to make and play back digital recordings on home VCRs. But these adapters cost far more than the VCRs do. Cost (and the infrequency with which home recordists really need to record something with about 85 dB of dynamic range) limit their sales largely to professional markets. And so far, only one digital recording is available on home VCR tape: Ry Cooder's *Bop Till You Drop*, now available with Sanyo's PCM adapter.

If the video disc catches on, though, it could prove the perfect medium for digital sound at home. The format and its convenience are already familiar to audiophiles, and playback-only equipment should cost far less than record/play gear will. So far, Matsushita's VHD system seems likeliest to engender a matching audio disc system. Prototypes of that audio disc (called AHD) have already been shown, as have prototypes of players to handle both the video and audio discs. Philips has shown a prototype audio disc that uses the same laser technology as its video disc system, but requires a separate player. On the other hand, the Philips Compact Disc, only 4½ inches in diameter, could lead to in-dash players for car sound, or possibly even portables. RCA (surprisingly for one of the world's largest record companies) has said nothing about a possible digital audio disc based on Selectavision . . . at least, not yet.

there are some exceptions. Sony's is a bit shorter (90 days for parts and labor), while longer warranties are offered by Curtis Mathes (4 years parts, 90 days labor), MGA Mitsubishi (1 year/6 months), Sanyo and Sears (both 1 year on parts and labor).

The VCR designers' goal has been to make their products as easy to use as audio cassette decks—and, perhaps, as popular. With refinements now offered, they're beginning to approach that goal. VCR sound quality, though, is lagging far behind. Audio tracks are narrow (and about to get narrower, with the coming introduction of stereo sound), and tape speeds are slow (no current home video format runs at even half of audio cassette speed). Consequently, frequency response rarely exceeds 12,500 Hz, if it goes that high, and signal-to-noise ratios run to around 40 or 45 dB. (Dolby is coming, though.) This will suffice for much of what TV sound has to offer, but it cannot capture the medium at its best on those occasions when the networks and PBS broadcast music with the full fidelity they're capable of transmitting (up to 15 kilohertz).

**Some Future Formats.** Beta and VHS recorders have a lot in common. Their tape cassettes are dual-hub designs, a bit like audio cassettes, but large

## specifications of VCR formats

Tape Format	Tape Speed (ips)	Tape Consumption (sq ft/hr)	Cassette Size (in.) (mm)	Maximum Tape Time (hr)
<b>Standard</b>				
Beta I	1.57 <sup>1</sup>	19.7	6.1 × 3.8 × 1 156 × 96 × 25	1.7
Beta II	0.79	9.8	same as Beta I	3.3
Beta III	0.53	6.4	same as Beta I	5
VHS SP	1.31	16.4	7.4 × 4.1 × 1 188 × 104 × 25	2
VHS LP	0.66	8.2	same as VHS SP	4
VHS EP	0.44	5.5	same as VHS SP	6
<b>Nonstandard</b>				
Akai VT-350 <sup>2</sup>	2.75	34.3	6.0 × 3.9 × 1 151 × 98 × 23	1/2
BASF LVR	157.4	17.2	4.5 × 4.2 × .67 114 × 106 × 17	3
Funai CVC	n.a.	n.a.	4.2 × 2.7 × .5 106 × 68 × 12	1/2
Toshiba LVR	216.5	18.4	n.a.	2
Philips 2000	0.96	6.0	7.2 × 4.4 × 1 183 × 110.5 × 26	8

*Notes:*  
 1. Recorders for this speed no longer made, though some current decks can play it.  
 2. Black and white only.

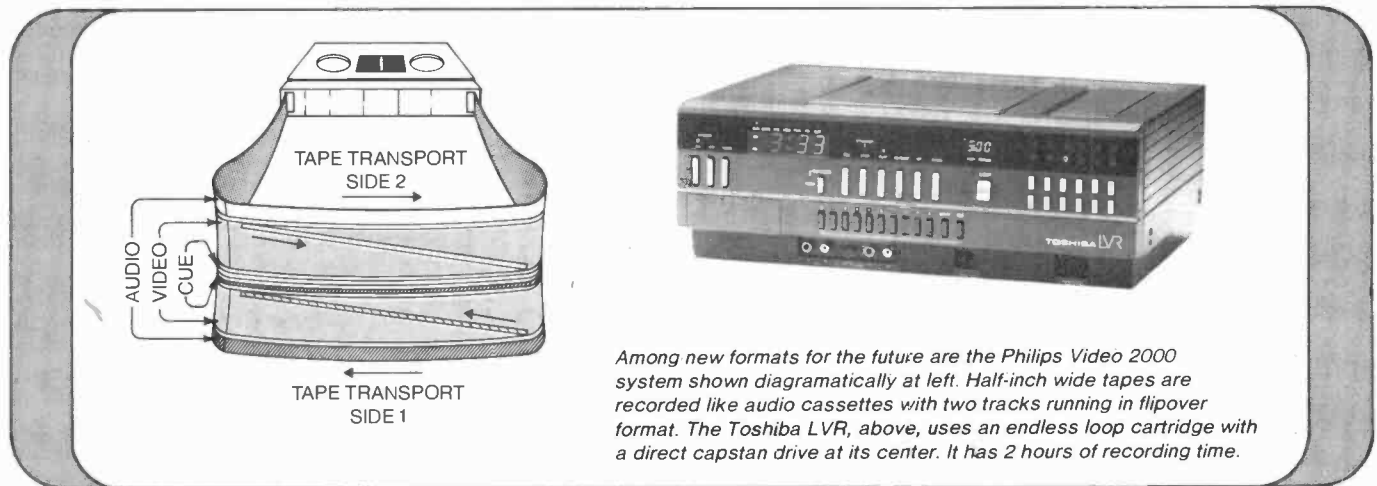

Among new formats for the future are the Philips Video 2000 system shown diagrammatically at left. Half-inch wide tapes are recorded like audio cassettes with two tracks running in flipover format. The Toshiba LVR, above, uses an endless loop cartridge with a direct capstan drive at its center. It has 2 hours of recording time.

enough to hold half-inch tape, and greater lengths of it. (The VHS cassette is larger and holds more than the Beta.) Unlike audio cassettes, however, VHS and Beta cassettes only play in one direction, and have protective lids over the tape (the lids open automatically when the cassette is loaded).

Video 2000, a new system now being sold in Europe by Philips, also uses tapes one-half inch wide, but they are recorded in a dual-track, flipover format

like the audio cassette's. In addition to servo control of the head drum, the Video 2000 has its heads mounted on piezoelectric crystals that can be electrically adjusted to "fine-tune" head positions so they'll precisely match the track. This allows higher track density and better tape economy. It also ensures perfect tracking of tapes recorded on other decks. A "cue" track on the tape can be used to help locate specific portions of the recording. Tape speed is higher than

in VHS or Beta, improving audio; but economy is served too, since only half the tape is used in each pass.

Grundig (which helped develop the system) and Siemens have also adopted it, and Blaupunkt (which has shown prototypes of a similar, but incompatible system) may do so as well. Magnavox (now owned by Philips) may possibly bring the Video 2000 into the U.S.

Totally unlike any of these systems are two new ones due this year from





**TEXAS INSTRUMENTS**  
electronic calculators

TI-35 NEW	\$24.95	TI-5100	\$39.95
TI-50	33.50	Programmer	48.95
TI-55	34.95	MBA	59.95
TI-58C NEW	109.95	Business Analyst I	21.95
TI-59	209.95	Business Analyst II	39.95
TI-56/59 Libraries	28.95	Business Card NEW	39.95
TI-30SP	17.95	Language Translator NEW	279.95
PC-100C	146.95	Digital Thermostat NEW	104.95
TI-1750	19.95	Speak & Spell	65.00
TI 5015	64.95	Modules	ea. 14.95
TI 5040	94.95	Chrono Alarm 806-31	39.95

World Time Alarm-Chrono 807-3 . . . 89.95



**INTRODUCING THE HP-85!**



HP-67	\$299.95
HP-92	399.95
HP-97	584.95
HP-33C NEW	109.95
HP-34C NEW	124.95
HP-38C NEW	124.95
HP-31E	41.95
HP-32E	54.95
HP-33E	73.95
HP-37E	59.95
HP-38E	94.95
HP-41C NEW	CALL
HP-85 . NEW	3250.00

The HP-85 is a powerful BASIC language computer complete with keyboard, CRT display, printer, and tape drive - all in one compact unit.



**TI HOME COMPUTER 99/4**  
Console only . . . . . \$ 799.95



**IMAGINATION MACHINE** . . . . . 595.00



**16K MEMORY** . . . . . 999.95



6200 NEW EXECUTIVE	99.95
5813 NEW PROGRAMMABLE	34.95
5100 NEW LCD Alphanumeric	89.95



**COMMAND** . . . . . 39.95  
Each Module . . . . . 14.95

WE WILL BEAT OR MEET ANY COMPETITOR'S PRICE ON MOST ITEMS IF HE HAS MERCHANDISE ON HAND. All units shipped in original factory cartons with accessories according to manufacturer's specification. CALL TOLL FREE (800) 854-0523 (outside CA) or (714) 549-7373 (within CA) Visa and MasterCard, money order, Pers. Ck. (14 Working Days to Clear), COD accepted MIN \$4.95 for shipping in USA. We ship AIR on request CA residents add 6% sales tax. All merchandise subject to availability. Prices good only with this ad for limited time only. Send orders to Dept. POPEL.

WRITE OR CALL FOR FREE CATALOG



3211 SOUTH HARBOR BOULEVARD, SANTA ANA, CA 92704 • 6 Stores in California

CALL TOLL FREE (800) 854-0523 (outside CA) • (714) 549-7373 (within CA)

**PROFESSIONAL DISCOUNTS**

CIRCLE NO. 15 ON FREE INFORMATION CARD

**BUILD A MASTERPIECE OF SOUND**

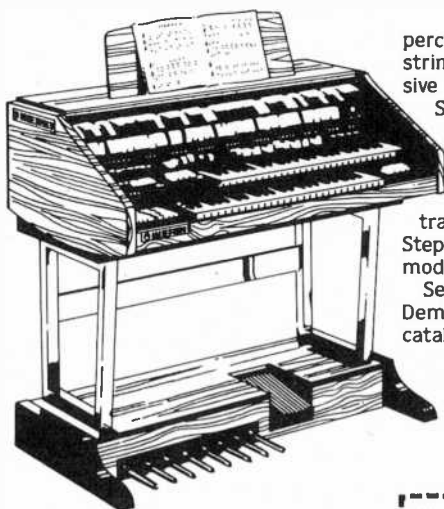

percussion and sustain. Wersi's famous string orchestra and bass guitar. Exclusive Sound Computer for 32-128 "One Stop Sounds" (total organ presets). Transposer. And lots more.

Build your own masterpiece of sound. No technical knowledge required. Just follow the clearly illustrated, easy to understand instructions. Step by step. Choose from at least 10 models. (Also factory assembled.)

Send \$6.00 with coupon for your Wersi Demo-Package (LP with 104-page color catalog).



Wersi has combined select features of the electronic music field, added its own creations and years of research by top engineers and musicians, to produce an incomparable line of organs.

Space-age technology. True-to-life voicing with full drawbar system. Polyphonic

Wersi Electronics, Inc. Dept. 11 1720 Hempstead Road Lancaster, PA 17601  
Wersi Organs & Kits Dept. 11 14104 E. Firestone Blvd. Santa Fe Springs, CA 90670

Enclosed is \$6.00 for my Demo-Package (LP with 104-page color catalog.)

Name \_\_\_\_\_  
Address \_\_\_\_\_  
City \_\_\_\_\_ State \_\_\_\_\_ Zip \_\_\_\_\_

**video recorders**

Toshiba and BASF. Neither system has a revolving head drum. Instead, they move the tape rapidly past a fixed head. To get reasonable recording times, both systems also use multiple tracks (300 for Toshiba, 72 for BASF).

Both systems also bear the same initials: LVR. But from that point on, all similarities (even what the initials stand for) cease. Toshiba's Longitudinal Video Recorder uses an endless loop of tape, running at 5.5 meters (18 feet) per second; the 135-meter loop runs through the recorder in only 24.6 seconds on each track. With 300 tracks, the total recording time is two hours.

In BASF's case, "LVR" stands for Linear Video Recorder. This system does not use an endless loop, but instead reverses at the end of each of its 72 tracks. With a tape length of 600 meters (1968 feet) and a speed of 4 meters (13.1 feet) per second, each track lasts 150 seconds, or two-and-one-half minutes. Track-switching time is a bit longer than Toshiba's (100 as opposed to 28 ms), but occurs only about one-sixth as often. While Toshiba's tape will measure the standard half inch (13 mm), BASF's will only be 8 mm wide.

Both systems have advantages over helical-scan systems: mechanisms can be simpler (Toshiba claims a one-third saving in parts), and cost lower (Toshiba hints at recorders for about \$500, and playback-only machines for about \$300). Access to any part of the tape is quicker, too: Toshiba cites a maximum access time of 8.4 seconds to get from the first to the last track of its LVR, with 33 seconds the worst possible access time to any point on the tape. Both also open the possibility of cheaper commercially recorded cassettes. Tape costs will be low and duplicators will be able to make copies in far less time than required for helical-scan tapes.

BASF's LVR, already sold in Europe, will be built in a California plant now in operation, and should be on the market soon. Toshiba's will probably be available late this year. Toshiba also hopes to have the ultimate video portable—a camera with recorder built in—in about 2 years. As BASF's cassette is even smaller, they're likely to come out with a similar product.

But the smallest tape cassette is probably Funai's. Its CVC (Compact Video Cassette) system records for 30 minutes, and uses quarter-inch tape, so its cassette is only about one-fourth the BASF cassette's size, and its player is about the size and weight of a large portable audio cassette recorder. Technicolor may import it into the U.S. Other than that it's a helical-scan system, few details have yet been released.



# PLAY "SPACE BATTLE" ON YOUR VIDEO MONITOR

Here's an exciting visual game program for computers using an RCA COSMAC 1802 CPU

BY DONALD R. SCHROYER

**T**HIS program for 1802-based systems equipped with an 1861 video display, puts you and your opponent in command of a pair of space vehicles. The ships move in accordance with commands entered via the hex keypad, and fire their weapons via a pair of pushbutton switches tied to input lines EF3 and EF4. When a player has scored eight hits against his opponent, the losing ship

is displayed as destroyed. At the end of the game, the score is displayed. About 2K of memory is required.

**The Program.** This consists of an initialization routine, six subroutines, the main program, six data pointers and six data locations. These are shown in Tables I through IX.

The Input and Movement subroutine

shown in Table I inputs data via the hex keypad. Depressing keys 0, 4, 8, or C results in movement of the left ship. Keys 0 and 4 move the ship downward with 0 causing motion at twice the speed of key 4. Keys 8 and C move the left ship up with the rate of movement doubled when key C is depressed. Keys 1, 5, 9, or D freeze the left ship where it is.

Keys 3, 7, B, or F operate the right

ship in a like manner. Keys 2, 6, A, or E freeze the right ship. If your system has a hex display, the last two movements will be displayed.

In operation, movement of the two ships is accomplished by changing R(7) the left ship position pointer, and R(8) the right ship position pointer. The ships are moved up by subtracting 08 from the pertinent position pointer. Downward motion is performed by adding 08 to the pointers. To double the speed, 10 is added or subtracted. The subroutine tests the last position of each ship to assure that neither moves out of the screen's display area.

The Load Counter R(5) subroutine of Table II replicates the data pointed to by R(3) at the display location pointed to by R(7). The data pointed to by R(3) forms the silhouette of the left ship. The silhouette of the right ship, pointed to by R(4) is loaded into the display area pointed to by R(8).

The Left Fire Counter R(A) subroutine of Table III tests the switch wired to EF4. If this line is low, the data flag is set and R(9) is called, otherwise the main program continues. The Right Fire Counter R(B) subroutine of Table IV tests EF3 in the same manner.

The Weapons Counter R(9) subroutine of Table V is brought into play only when called by subroutines R(A) or R(B). When entered, the Weapons subroutine tests the data flag and fires either the left or right ship's weapon as appropriate. The weapons of both ships cannot be fired simultaneously, and this is compensated for in the main program. The Weapons subroutine also tests each firing to see if a hit has been scored. If so, the score stored in R(E).1 is incremented by adding 10 for a left hit and 01 for a right hit. Register R(E).1 stores the left score in the high four bits and the right score in the low four bits. The Weapons subroutine tests to see if either score is equal to eight. If so, the game ends with the score displayed, otherwise the program continues.

The Interrupt Counter R(1) shown in Table VI displays a two-page segment of memory in a 64 x 64 format. This display area is from 0400 to 05FF.

Table VII, Main Counter R(F), is a sequence of calls to the various subroutines. Since the Weapons subroutine cannot simultaneously fire both ship's weapons, the left and right fire subroutines alternate. Once the program is running, the alternation gives each player roughly an even chance of firing first if both fire switches are operated simultaneously. The main program inserts a delay routine between each call to R(C) and R(5) to slow the ship's movements for easier control.

## TABLE I—INPUT AND MOVEMENT COUNTER R(C)

0200 DF  
 0201 F8 06 B6 A6 E6  
 0206 6C FA F0 AE  
 020A FA 20 32 0F 16 16  
 0210 8E F6 F6 F6 F6 56  
 0216 F8 06 A6  
 0219 72 FA 0F AD  
 021D FA 02 32 22 16  
 0222 8D 56 F8 06 A6 8D 56  
 0229 8E F4 56 64  
 022D F0 32 55  
 0230 F0 FB 03 32 69  
 0235 F0 FB 0C 32 7D  
 023A F0 FB 0F 32 91  
 023F F0 FB 04 32 A5  
 0244 F0 FB 07 32 B9  
 0249 F0 FB 08 32 CD  
 024E F0 FB 0B 32 E1  
 0253 30 F3  
 0255 97 FB 05 3A 5F  
 025A 87 FC 58 33 F3  
 025F 87 FC 10 A7  
 0263 97 7C 00 B7  
 0267 30 F3  
 0269 98 FB 05 3A 73  
 026E 88 FC 51 33 F3  
 0273 88 FC 10 A8  
 0277 98 7C 00 B8 30 F3  
 027D 97 FB 05 32 87  
 0282 97 FB 03 32 F3  
 0287 87 FF 10 A7  
 028B 97 7F 00 B7 30 F3  
 0291 98 FB 05 32 9B  
 0296 98 FB 03 32 F3  
 029B 88 FF 10 A8  
 029F 98 7F 00 B8 30 F3  
 02A5 97 FB 05 3A AF  
 02AA 87 FC 50 33 F3  
 02AF 87 FC 08 A7  
 02B3 97 7C 00 B7 30 F3  
 02B9 98 FB 05 3A C3  
 02BE 88 FC 49 33 F3  
 02C3 88 FC 08 A8  
 02C7 98 7C 00 B8 30 F3  
 02CD 97 FB 05 32 D7  
 02D2 97 FB 03 32 F3  
 02D7 87 FF 08 A7  
 02DB 97 7F 00 B7 30 F3  
 02E1 98 FB 05 32 EB  
 02E6 98 FB 03 32 F3  
 02EB 88 FF 08 A8  
 02EF 98 7F 00 B8  
 02F3 86 FB 07 3A FB  
 02F8 16 30 2D  
 02FB E2 30 00

## TABLE II—LOAD COUNTER R(5)

014F DF  
 0150 83 A6 93 B6  
 0154 F8 00 AE  
 0157 97 73 87 52  
 015B 46 57 1E  
 015E 8E FB 0A  
 0161 32 6D  
 0163 87 FC 08 A7  
 0167 97 7C 00 B7  
 016B 30 5B  
 016D 72 A7 F0 B7  
 0171 84 A6 94 B6  
 0175 F8 00 AE  
 0178 98 73 88 52  
 017C 46 58 1E  
 017F 8E FB 0A  
 0182 32 8E  
 0184 88 FC 08 A8  
 0188 98 7C 00 B8  
 018C 30 7C  
 018E 72 A8 F0 B8  
 0192 30 4F

## TABLE III—LEFT FIRE COUNTER R(A)

0194 DF  
 0195 3F 94 F8 01 F6  
 019A D9 30 F1 00 00

## TABLE IV—RIGHT FIRE COUNTER R(B)

019F DF  
 01A0 3E 9F F8 00 F6  
 01A5 D9 30 F6 00 00  
 01F0 DF 3F 94 30 F0  
 01F5 DF 3E 9F 30 F5

Fig. 1. To implement the space battle program, the circuit shown here must be duplicated, with one attached to EF3 and the other connected to EF4.

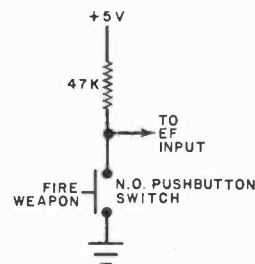

**TABLE V—WEAPONS  
COUNTER R(9)**

0300 DF  
0301 7A 7B  
0303 33 07  
0305 30 79  
0307 87 FC 19 A6 97 7C 00 B6  
030F 96 73 86 52 F8 00 AE E6  
0317 F8 FF 56 16 1E  
031C 8E FB 06 3A 17  
0321 F8 FF F2 E2 3A 2C  
0327 F8 FF 56 30 5C 22  
032D 94 73 84 73  
0331 F8 10 A4 F8 06 B4  
0337 F8 00 AE 98 73 88 52  
033E 44 58 1E 8E FB 0A  
0344 32 50  
0346 88 FC 08 A8 98 7C 00 B8  
034E 30 3E 9E FC 10 BE  
0354 72 A8 72 B8 72 A4 72 B4  
035C 72 A6 F0 B6 F8 00 AD BD  
0364 1D 9D FB 01 3A 64  
036A F8 00 AE F8 00 56 16 1E  
0372 8E FB 07 3A 6D 30 E8  
0379 88 FC 27 A6 98 7C 00 B6  
0381 96 73 86 52 F8 00 AE E6  
0389 F8 FF 73 1E 8E FB 06  
0390 3A 89  
0392 F8 FF F2 E2 3A 9D  
0398 F8 FF 56 30 CD 22  
039E 93 73 83 73  
03A2 F8 10 A3 F8 06 B3  
03A8 F8 00 AE 97 73 87 52  
03AF 43 57 1E 8E FB 0A 32 C1  
03B7 87 FC 08 A7 97 7C 00 B7  
03BF 30 AF 9E FC 01 BE  
03C5 72 A7 72 B7  
03C9 72 A3 72 B3  
03CD 72 A6 F0 B6  
03D1 F8 00 AD BD 1D  
03D6 9D FB 01 3A D5  
03DB F8 00 AE  
03DE F8 00 56 26 1E  
03E3 8E FB 07 3A DE  
03E8 9E FA 88 32 00  
03ED C0 01 C0

**TABLE VI—INTERRUPT  
COUNTER R(1)**

01CE 72 70  
01D0 C4 22 78 22 52  
01D5 F8 04 B0 F8 00 A0  
01DB C4 C4 E2  
01DE 80 E2 20 A0 E2  
01E3 3C DE  
01E5 80 E2 20 A0 E2  
01EA 34 E5 30 CE

**TABLE VII—MAIN  
COUNTER R(F)**

0650 3F 50 37 52 D5 DC  
0656 F8 00 AD BD 1D  
065B 9D FB 02 3A 5A  
0660 D5 DA DB DC  
0664 F8 00 AD BD 1D  
0669 9D FB 02 3A 68  
066E D5 DB DA  
0671 30 55

**TABLE VIII—  
INITIALIZATION**

0100 71 00  
0102 F8 06 B2 BD BF  
0107 F8 05 B7  
010A F8 04 B8  
010D F8 03 B9  
0110 F8 02 BC  
0113 F8 01 B1 B3 B4 B5 B6  
011A BA BB A9 AC  
011E F8 D0 A1 F8 3F A2  
0124 F8 AA A3 F8 B4 A4  
012A F8 50 A5 AF  
012E F8 CC A6  
0131 F8 C0 A7  
0134 F8 07 A8 AD  
0138 F8 95 AA F8 A0 AB  
013E F8 00 BE  
0141 F8 01 5D 1D  
0145 F8 02 5D  
0148 E6 69 E0  
014B 70 2F

**TABLE IX—DATA  
POINTERS**

**Left Ship**  
01AA 00 00 F2 F7 24  
01AF 28 78 38 00 00  
**Alternate (see text)**  
01AA 00 00 18 FF 3C  
01AF 18 3C FF 00 00  
**Right Ship**  
01B4 00 00 06 FF CE  
01B9 86 0F 0F 00 00  
**Alternate (see text)**  
01B4 00 00 03 3F 7F  
01B9 D4 3E 3E 00 00  
**Blast**  
0610 28 04 50 99 4E  
0615 39 88 34 45 A2  
**End of Program**  
01C0 F8 06 A6 B6 E6  
01C5 9E 56 64 26 30 C9  
**Display Area**  
0400 - 05FF; 00 loaded in display  
; memory locations

In addition to the mentioned pointers, register R(6) serves as a temporary pointer to save and increment other pointers. The stack pointer is R(2) with the stack starting at 063F.

Memory location 0607 contains the current move instruction for the left ship, while 0608 contains the same data for the right ship. At Initialization (Table VIII), the contents of these two locations are 01 and 02, respectively. As stated earlier, R(E).1 holds the current score and is loaded with 00 on initialization. R(E).0 is an index counter used in loading the ship silhouettes and firing the weapons. R(D) is used to load 0607 and 0608 and for delays encountered in the main program.

Table IX contains the remainder of the program. Both the left and right ship are illustrated. Location 0610 to 0619 contains the blast that occurs after every hit and the debris of the destroyed ship. If the ship is moving fast enough at the time of a hit, debris is shown scattered in its wake.

**Hardware.** The only hardware connection required is a pair of circuits similar to that shown in Fig. 1, with one connected to EF3 and the other to EF4. These are the weapon firing switches.

**Playing the Game.** Load the program from Tables I through IX, making sure that the correct code is placed at the correct addresses. Since the 1802 starts running at address 0000, key in C0 01 00 starting at address 0000. Save the program on cassette if you have this provision.

To begin the game, reset and run the computer, then depress and release the INPUT switch on an ELF II, or bring the EF4 line low then high. The two ships will appear in opposite diagonal corners.

The left ship cannot move until the right player has made a move. Once the right player has moved, the left ship will move according to the keypad data last entered. To fire the weapon, depress the appropriate FIRE WEAPON pushbutton switch. When the program is restarted after eight hits, each ship can be moved across the screen to remove "ghosts".

**Program Changes.** If you desire another look for the spaceships, try the alternate versions shown in Table IX. You can even design your own ships using graph paper. Make the first and last two bytes 00 or the ships will leave a trail as they move.

The winning score can be 1,2,4 or 8 as determined by address 03EA. To change ship speeds, locations 065D and 066A can be loaded with higher numbers to slow the ships down. If you desire more speed, use 01 or NOP's. ♦

**Note:** A cassette tape of the program for Space Battle is available from Donald R. Schroyer, 209 Brinker St., Latrobe, PA 15650, for \$10.00.



**I**F dogs and other small animals wreak havoc with your flowerbeds, or small "varmints" strew the contents of your trash cans over the area, this project is for you.

The Varmint Zapper described here uses a single strand of bare wire to create an "electric" fence. This wire is fed with a sequence of digitally programmed high-voltage pulses to create a penetrating but harmless electrical shock to anything making contact with the bare wire. You can also attach the wire to your garbage can (insulated from ground) or any other metallic enclosure that you want to protect.

**Circuit Operation.** The operation of the circuit, shown in Fig. 1, is similar to

that of the capacitor-discharge ignition systems used in many vehicles.

The 117-volt ac developed across 1:1 isolation transformer *T1* is half-wave rectified by *D3* and charges *C6* via the primary of TV flyback transformer *T2*. The primary should be electrically separated from the high-voltage secondary.

When electronic switch *SCR1*, connected across the *C6-T2* network, is on, it forms a short circuit across the network. Then *C6* rapidly discharges through the transformer primary. The sudden change in current flow produces a high voltage at the secondary of *T2*. In a typical installation, about 15 or 16 kV will be developed. It is this voltage that is applied between the bare wire fence and ground.

by Fritz Mueller

Delivers a penetrating yet  
harmless electric shock  
to intruding animals

# Digitally Programmed Varmint Zapper



The C6-T2 network forms a resonant circuit. When it bursts into oscillation, the first half cycle of reverse voltage back biases the SCR, thus opening the electronic switch. The positive-going transient is bypassed via D4. Capacitor C5, damped by the low value of R9, attenuates any r-f transients generated by the sudden turn-off of D4. Neon lamp NE1 glows to indicate the presence of the high dc voltage across the C6-T2 network. Resistor R10 provides current limiting for NE1.

The 10-volt dc required by binary counter IC1 is developed by dropping resistor R1, rectifier D1, and filter capacitor C1. It is maintained at 10 volts by zener diode D5. Further filtering is added by R2 and C2.

The clock pulses to be counted by IC1 are developed from the half-wave rectified line voltage from D2. Noise is reduced by filter R3 and C3 before the pulses are applied to the IC.

The SCR is triggered into conduction by the positive-going pulses generated across R8 each time unijunction transistor Q2 fires. This occurs when C4, charged toward the 10-volt line via R6, reaches the UJT trigger level. When Q1, connected across C4, conducts, the trigger pulses are inhibited. Transistor Q1 is kept in conduction during each positive half of the supply by bias across R4. During the negative half cycles, Q1 is not biased by R4. Binary counter IC1 is continuously counting line pulses applied to pin 1. Its outputs are connected

so that four of its stages provide positive-going pulses through diodes D6 through D9 and R5 to turn Q1 on and off during the negative half cycles. This results in a rapid sequence of four SCR turn-on pulses followed by a 1.5-second space. The sequence is then repeated.

Each individual shock exceeds about 50 mA for a very short time, and currents of such intensity produce effects best described as "bite" or "sting." What renders the shock harmless without losing effectiveness is timing. Small, nervous animals will be instantly swayed by the first shock. The 2-second program is aimed to impress larger, more stubborn creatures. After the first four shocks, the varmint has time to move away from the unpleasant sensation.

(Continued on page 66)



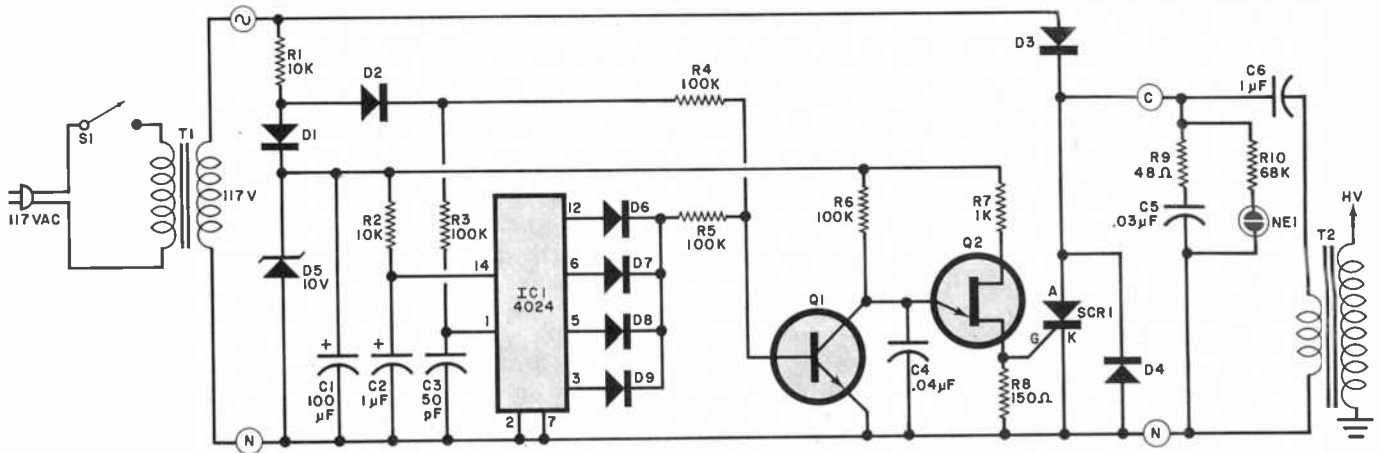

Fig. 1. Digital pulses from IC1 cause SCR1 to discharge C6 through primary of T2 to produce high voltage. Circled letters and symbol refer to foil pattern.

PARTS LIST

- |   |   |  |
|---|---|--|
| C1—100- $\mu$ F, 10-volt electrolytic                     | IC1—4024 CMOS binary counter                  | R8—150-ohm, 1/4-watt resistor  |
| C2—1- $\mu$ F, 10-volt tantalum                           | NE1—Neon lamp assembly                        | R9—48-ohm, 1/4-watt resistor   |
| C3—50-pF disc   | Q1—General-purpose npn silicon transistor     | R10—68,000-ohm, 1/4-watt resistor  |
| C4—0.04- $\mu$ F disc                                     | Q2—Any UJT                                    | S1—Spst switch   |
| C5—0.03- $\mu$ F disc                                     | R1—10,000-ohm, 1/2-watt resistor              | SCR1—200-PIV, 1-ampere SCR   |
| C6—1- $\mu$ F, 200-volt paper                             | R2—10,000-ohm, 1/4-watt resistor              | T1—117:117-volt isolation transformer  |
| D1, D2, D3, D4—200-volt PIV rectifier (1N4001 or similar) | R3, R4, R5, R6—100,000-ohm, 1/4-watt resistor | T2—TV flyback transformer (see text)   |
| D5—10-volt zener  | R7—1000-ohm, 1/4-watt resistor                | Misc.—Suitable enclosure, high-voltage feedthrough, press-on type, bare wire for fence, insulators, mounting hardware. |
| D6, D7, D8, D9—1N914                                      |   |  |

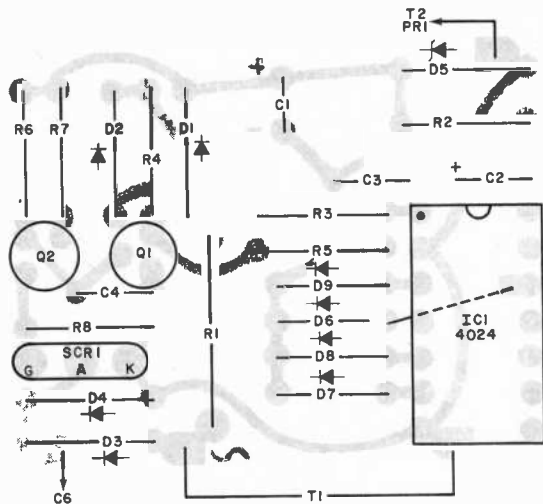
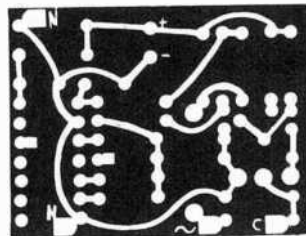

Fig. 2. Actual-size foil pattern for the printed-circuit board is shown below. Component installation diagram at left.



**Construction.** The circuit can be assembled on a small pc board using the foil pattern shown in Fig. 2. It can also be Wire-Wrapped using conventional techniques. Note that C5, C6, R9, R10, the neon lamp, and both transformers are not mounted on the board.

The output transformer, T2, can be salvaged from a discarded small-screen TV receiver. You must be able to locate the two primary leads (between 2 and 8 ohms dc resistance), and both sides of

the high-voltage winding, one end of which is the CRT anode connector.

The use of a very high-voltage flyback transformer is not recommended. Corona discharge and possible flashover at the fence insulators may make the system inoperative after a short while. However, you can try using an automotive ignition coil.

Select an enclosure capable of holding the small pc board, the selected flyback transformer, the line isolation trans-

former and the associated off-board components.

Power switch S1 and the neon lamp assembly can be mounted on the front side, while the high-voltage lead from T2 is coupled to a high-voltage feedthrough located on the top of the enclosure. Place a "HIGH VOLTAGE" warning at the feedthrough.

**Use.** The fence can be formed from a length of bare wire (#17 galvanized steel is recommended) strung between insulators. Plastic rods, or small plastic or glass bottles affixed to wood stakes, can be used as a substitute. Make sure that no part of the bare wire "fence" touches, or comes close to, the actual ground.

To use the fence, connect the bottom end of the T2 secondary to a good earth ground, then connect the fence to the high-voltage feedthrough. When the power is turned on, the neon lamp should glow indicating the presence of the operating dc voltage across the C6-T2 network. If the fence is contacted, the neon lamp will blink on and off with each pulse.

The electrified fence can be installed so as to surround the area you want kept free from marauding animals, or, you can connect it directly to an insulated garbage can or other metallic container or enclosure.  $\diamond$



ITEM NO.  
WK-7

CMOS SAFE

# IC INSERTION/EXTRACTION KIT

**KIT INCLUDES**

- MOS-1416 14-16 CMOS SAFE INSERTER
- MOS-2428 24-28 CMOS SAFE INSERTER
- MOS-40 36-40 CMOS SAFE INSERTER
- EX-1 14-16 EXTRACTOR
- EX-2 24-40 CMOS SAFE EXTRACTOR



**OK MACHINE & TOOL CORPORATION**  
3455 CONNER ST., BRONX, N.Y. 10475 U.S.A.  
PHONE (212) 994-6600 TELEX NO. 125091



PRINTED IN U.S.A.

PATENT PENDING

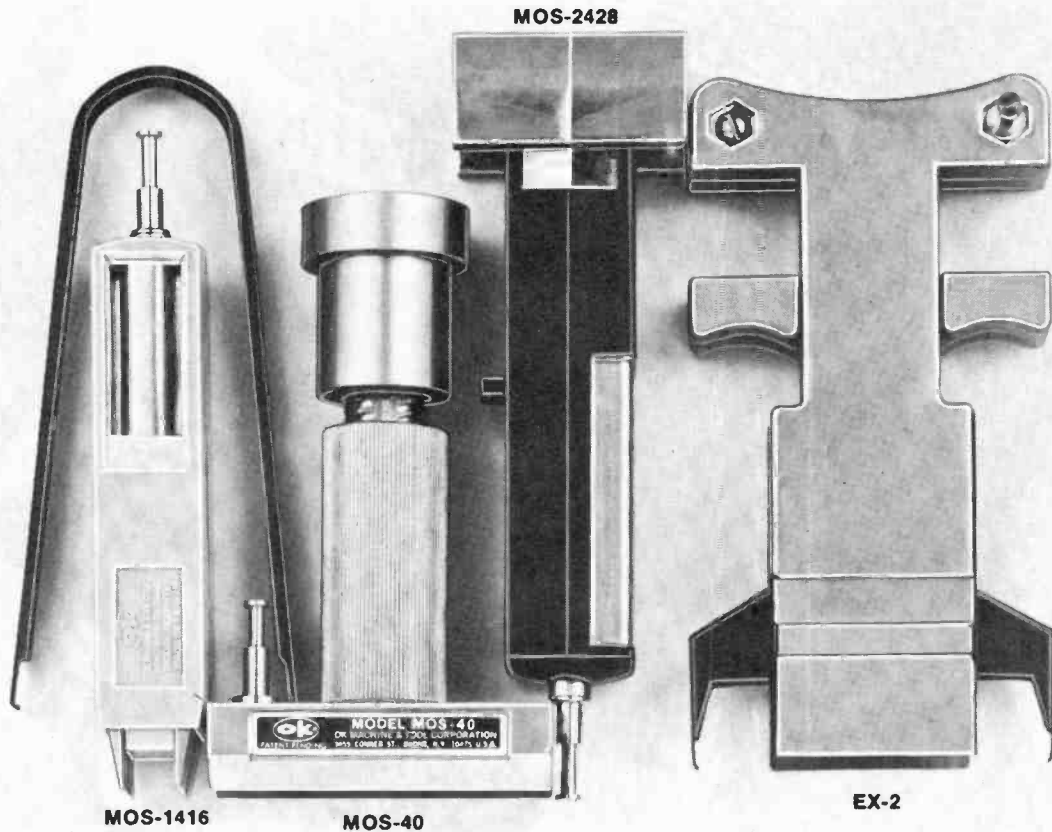

WK-7	COMPLETE IC INSERTER/EXTRACTOR KIT	\$29.95
------	------------------------------------	---------

### INDIVIDUAL COMPONENTS

MOS-1416	14-16 PIN MOS CMOS SAFE INSERTER	\$ 7.95
MOS-2428	24-28 PIN MOS CMOS SAFE INSERTER	\$ 7.95
MOS-40	36-40 PIN MOS CMOS SAFE INSERTER	\$ 7.95
EX-1	14-16 PIN EXTRACTOR TOOL	\$ 1.49
EX-2	24-40 PIN CMOS SAFE EXTRACTOR TOOL	\$ 7.95

MINIMUM BILLING \$25.00. ADD SHIPPING CHARGE \$2.00. NEW YORK RESIDENTS ADD APPLICABLE TAX.

**OK MACHINE & TOOL CORPORATION 3455 CONNER ST., BRONX, N.Y. 10475 (212) 994-6600/TELEX 125091**

# IMMORTAL MUSIC SHOULDN'T BE KEPT ON MORTAL TAPE.



Good music never dies. Unfortunately, a lot of cassette tapes do. At Maxell, we've designed our cassettes to be as enduring as your music. Unlike ordinary cassettes, they're made with special anti-jamming ribs that help prevent tape from sticking, stretching and tearing.

And Maxell cassettes come with something else you won't find on most others. An unconditional lifetime warranty.

So if you'd like to preserve your old favorites for the years to come, keep them in a safe place. On one of our cassettes.



IT'S WORTH IT.

# A LOW-COST 16-LED LOGIC MONITOR

BY TOM KRONENWETTER

Checks all signals  
on an IC simultaneously

USING single-LED logic probes is the most common way to check the logic operation of a digital IC. This is fine as long as all you want to know is whether a particular pin is high or low or is switching between these two states. But most logic circuits require that correct *timing* be maintained between a number of signals from the same IC. This is something that a single-LED probe cannot test.

The logic monitor described in this article allows *all* of the pins of an IC to be examined simultaneously, which means that timing can be observed. The monitor reads out via 16 LEDs, each connected via a high-input resistance driver to a pin of the IC. Interconnection between the monitor and the IC is through a length of ribbon cable terminated to a clip that clamps on to the IC.

The project can be constructed for 8-,

14- or 16-pin DIP packages. If desired, it can be expanded to handle 40-pin devices. The monitor is powered from the circuit under test. Operating characteristics are given in Table I.

**Basic Circuit.** As shown in Fig. 1, the basic circuit consists of a relatively high-input resistance (100,000 ohms) Darlington transistor driving a LED. Resistor *R2* ensures that when the input is logic 0 (low), the transistor will be cut off and the LED will remain dark. This circuit is duplicated for each required pin connection. Current-limiting resistor *R3* is common to all LEDs.

**Construction.** In constructing the logic monitor, a solderless breadboard (see photo) is used. In this breadboard, the five holes across each row are interconnected inside the plastic housing.

Start assembly in one corner of board. Skip two holes and install a LED in third and fourth holes with the LED cathode in hole 4 as shown in Fig. 2. Install the transistor in the second column with the collector lead in the same row as the LED cathode, the base lead in the fifth row hole and the emitter lead in the sixth row hole. The cathode of the LED is thus connected to the transistor collector internally.

Cut one lead of a pair of 100,000-ohm resistors to 0.7" and the other lead to 0.3". Each of these resistors will be mounted vertically. Insert the short lead of *R2* into the second hole past the LED, then bend the longer lead over and insert it into the hole adjacent to the LED. Thus *R2* is connected between the base and emitter of *Q1*. Insert the long lead of the remaining resistor into the hole above the base of *Q1* so



that it connects to the base of Q1. The short upper lead of this resistor will be connected to the cable later on.

If you are making a 16-pin arrangement, follow the above assembly procedure seven more times to produce eight LEDs on one side. If you are making a 14-pin array, then only seven LEDs are needed.

To complete the assembly, start the component installation at the diagonally opposite corner (no hole spaces), and work up the other side. Resistor R3 is installed in a hole near the last LED.

Cut 32 one-inch long jumpers from #22-gauge solid insulated wire and strip 0.3" of insulation from each end. Sixteen of these jumpers are used to interconnect the 16 ground points to form a common bus. The remaining jumpers are used to couple the anodes of all the

LEDs into a common bus. This bus is then connected to R3.

At this time, each LED must be identified as to pin number. Make up some small stick-on labels, each identified in numerical sequence from 1 to 16, and affix one to the top of each transistor. The sequence should be 1 through 8 from top to bottom on the left side, and 9 through 16 from bottom to top on the right side.

The final step is wiring the 1.5-foot ribbon cable from the clamp-on connector to the breadboard. Lay the connector down with its color-coded side facing up. Using Fig. 3 as a guide, from the tip of the brown conductor at one edge of the cable, measure a diagonal 3-inches long to the blue conductor on the opposite side of the cable. Use masking tape to mark this diagonal. Cut the ribbon cable

with scissors along the upper edge of the masking tape. Separate the leads to a length of about one-inch, then strip about 0.2" of insulation from each lead. Tin each lead and form into small closed loops so that they will fit over the ends of the leads at the top of each R1.

Place the prepared end of the cable in the center of the breadboard, rainbow side up. Connect the second shortest lead (green) to the short lead of the R1 for the first LED. This corresponds to pin 1 of the connector. The shortest lead (blue) is connected to the R1 associated with the sixteenth LED. Using the cable color-code chart shown in Table II, connect the remainder of the ribbon-cable leads to their respective R1's.

When all the connections are completed, fold the ribbon cable over on itself, slightly above the breadboard,

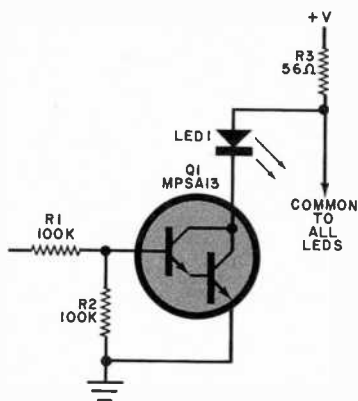

Fig. 1. Basic circuit consists of a Darlington transistor driving a LED.

**PARTS LIST**

- LED1—Red LED (FLV-117 or similar, 16 required)
- Q1—MPSA13 Darlington transistor (16 required)
- R1, R2—100,000-ohm, 1/4-watt resistor (32 required)
- R3—56-ohm, 1/4-watt resistor
- Misc.—Solderless breadboard (AP Products Model 234), 16-pin clamp-on logic clip with cable (AP Products Model LC 160), small tie wrap, #22 AWG wire, labels.

**TABLE I—  
OPERATING CHARACTERISTICS**

Input impedance:	100,000 ohms
Logic threshold:	2.2 volts dc
Operating voltage range:	4 to 15 volts dc
Maximum current drain:	200 mA

**TABLE II—  
CABLE COLOR CODE**

Pin	Color
1	Green
2	Orange
3	Brown
4	White
5	Purple
6	Green
7	Orange
8	Brown
9	Red
10	Yellow
11	Blue
12	Gray
13	Black
14	Red
15	Yellow
16	Blue

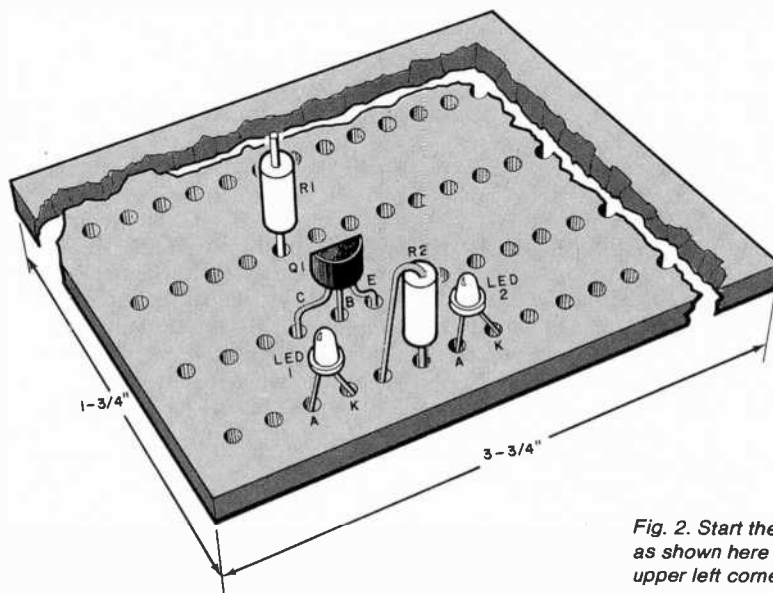

Fig. 2. Start the assembly as shown here in the upper left corner of board.

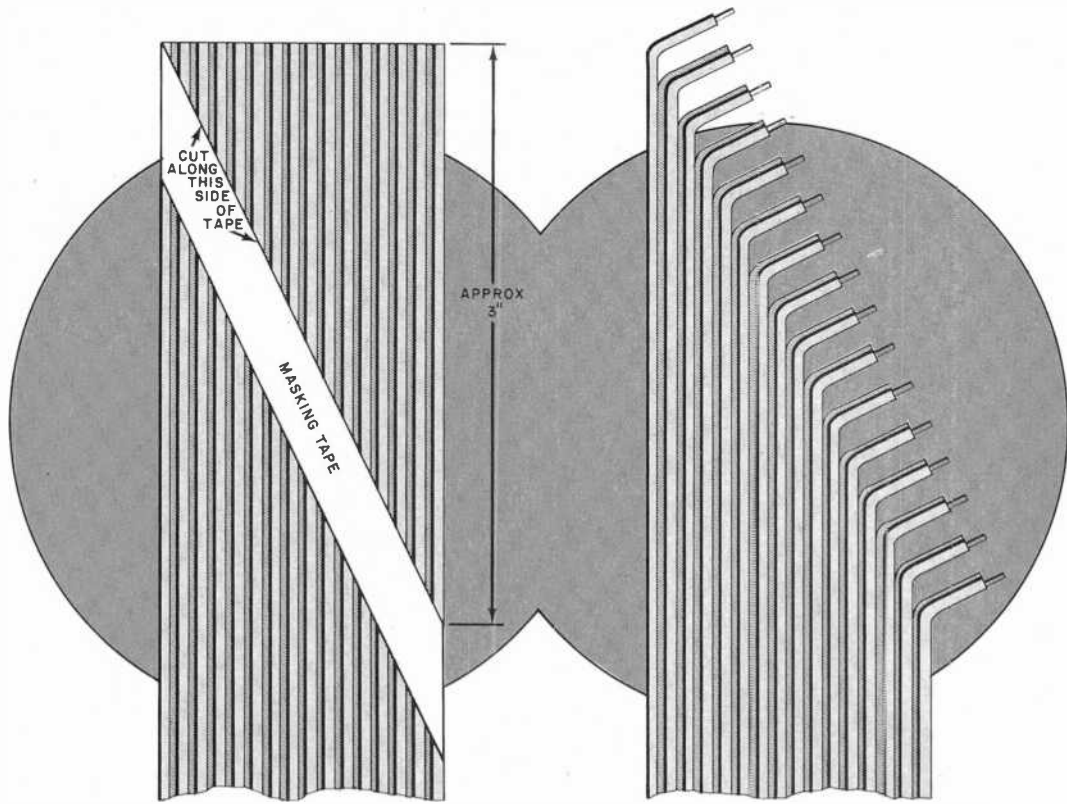

Fig. 3. The 16-lead ribbon cable is prepared as shown here with the leads cut diagonally so that they can be connected easily to circuits on the board.

and use a tie wrap to act as a strain relief for the cable.

Most 16-pin DIP packages use pin 16 as the dc source and pin 8 as ground. If you want to follow this convention, jumper input 16 (blue) to the common LED bus, and input 8 (brown) to the common ground bus. This means that the sixteenth LED will always glow and the eighth LED always remain dark.

Some digital IC's, the 7490 as an example, use pin 5 as the dc input and pin 10 as the ground. In this case, the circuit shown in Fig. 4A may be used. Here, two silicon diodes are used to pick off the dc voltage from either the pin-16 or pin-5 inputs for application to the common dc bus. A separate ground lead can be connected between the monitor common-ground bus and the ground of the circuit under test. It is also possible to keep each input isolated from either dc or ground, and use a separate lead connected between the monitor dc bus and the 5 volts of the circuit under test as shown in Fig. 4B. In this latter case, all the LEDs will be active. The human eye can distinguish flashing of the LEDs at rates up to about 15 Hz. Above that frequency the LEDs will appear to be constantly "on."

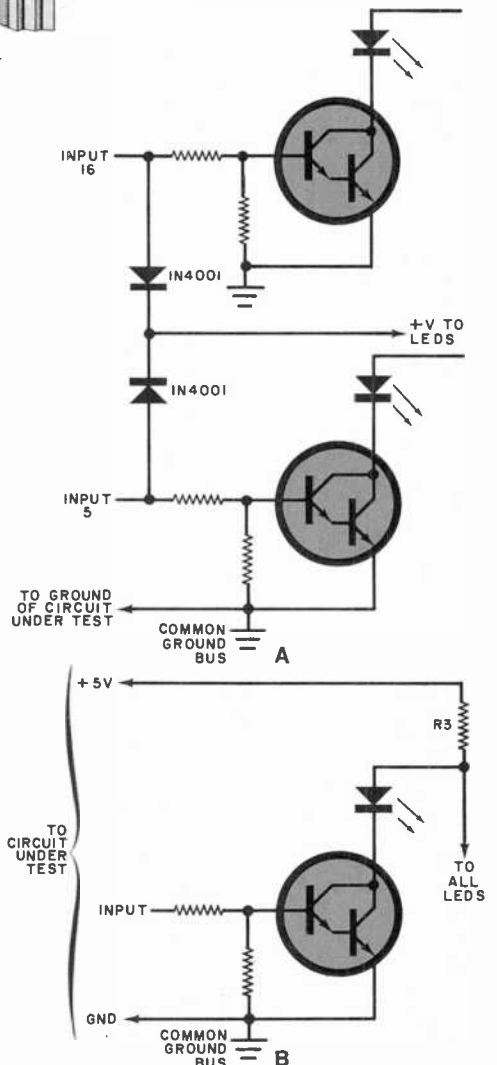

Fig. 4. If pin 5 of the IC to be tested is the dc input and pin 10 is ground, use the circuit at (A). To keep each input isolated from dc or ground, use the connections at (B).



**build a  
WAH-WAH  
PEDAL**  
for  
special  
musical  
effects



## Liven up your music with this easily operated low-cost add-on circuit

BY FRED PUCCETTI

**“WAH-WAH”** is one of several interesting effects used by electric guitarists to “spice up” the sounds generated by their instruments. This effect, named in imitation of its sound, is commonly employed by synthesists and electric pianists as well. It is achieved by sweeping the center frequency of a bandpass filter while the output of the instrument is fed through it. Typically, the filter is controlled by means of a foot pedal.

Presented here is a Wah-Wah pedal designed with the performing artist in mind. It employs a high-performance quad operational amplifier and a battery power source, making it well-suited to stage or studio work. Parts count is low, so the Wah-Wah Pedal is easy to build. A kit including a rugged foot-pedal mechanism is available for \$55.

**About the Circuit.** The Wah-Wah pedal is shown schematically in Fig. 1. Signals from the instrument being played are presented to input jack *J1A*, one portion of a three-conductor, double closed-circuit, 1/4-inch (6.3-mm) phone jack. The input signals drive a second-order, two-pole active bandpass filter

comprising operational amplifiers *IC1A*, *IC1B*, *IC1C*, and their associated passive components. The center frequency of this filter can be varied by means of potentiometer *R7*.

When this potentiometer is adjusted for minimum resistance, the center frequency of the filter is approximately 2500 Hz. When the potentiometer's effective resistance is increased to its maximum value of 500,000 ohms, the filter's center frequency decreases to approximately 1050 Hz. These filter responses are shown in Fig. 2, a photo of the CRT traces generated by a spectrum analyzer. The analyzer was driven by a signal generator with the project inserted in series between the generator and the analyzer, and the project's frequency-control potentiometer (*R7*) was alternately set to provide for minimum and maximum resistance.

The upper and lower limits of the range over which the active bandpass filter's center frequency can be swept are determined by the stages comprising *IC1A* and *IC1B* and their associated passive components. Inverting amplifier *IC1C* provides a slight amount of voltage gain so that signals appearing at

output jack *J2* are at a suitable level. That sets this project apart from older, discrete Wah-Wah designs that did not compensate for any insertion loss introduced by the bandpass filter. An additional benefit provided by *IC1C* is buffering, which prevents the load from interacting with the filter and affecting its frequency response.

The remaining op amp, *IC1D*, is not used. In accord with good design practice, its inputs are grounded. Power for the circuit is provided by a bipolar supply consisting of two 9-volt batteries in series. Diodes *D1* and *D2* protect against the inadvertent application of reverse supply voltages. Tantalum capacitors *C3* and *C4* function as power-supply bypassing components. Note that there is no separate power switch. This is because the switching contacts of *J1B* (part of input jack *J1*) automatically connect the battery supply to the rest of the project whenever the instrument patch cord is inserted into *J1*. The only switch in the project is *S1*, a heavy-duty, push-on/push-off switch activated by the foot-pedal mechanism. It either bypasses signals around the Wah-Wah circuit or inserts it into the signal path.

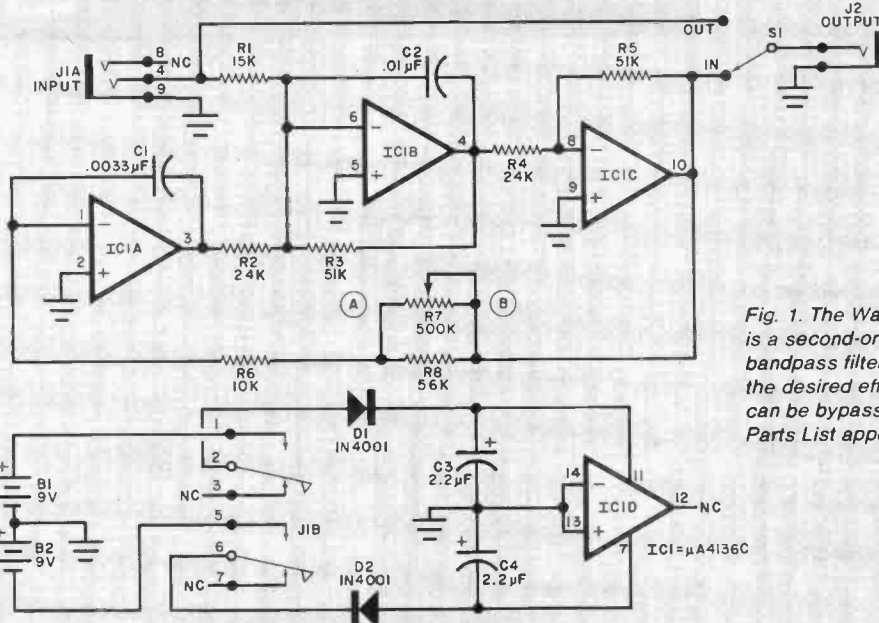

*Fig. 1. The Wah-Wah Pedal circuit is a second-order, two-pole active bandpass filter that provides the desired effect. The filter can be bypassed by means of *S1*. Parts List appears on next page.*

# wah-wah pedal

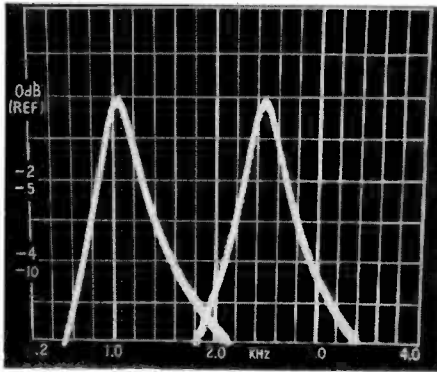

Fig. 2. Bandpass filter's frequency response when the foot pedal is fully up (left) and down (right).

## PARTS LIST

- B1, B2—9-volt transistor battery
  - C1—0.0033- $\mu$ F, 5%-tolerance polystyrene
  - C2—0.01- $\mu$ F, 5%-tolerance polystyrene
  - C3, C4—2.2- $\mu$ F, 16-volt tantalum
  - D1, D2—1N4001
  - IC1— $\mu$ A4136C quad operational amplifier or equivalent
  - J1—Three-conductor, double closed-circuit  $\frac{1}{4}$ -inch (6.3-mm) phone jack (Radio Shack No. 274-277 or equivalent)
  - J2—Monaural, open-circuit  $\frac{1}{4}$ -inch (6.3-mm) phone jack
- The following are  $\frac{1}{4}$ -watt, 5%-tolerance, fixed carbon-composition resistors, unless specified otherwise.
- R1—15,000 ohms
  - R2, R4—24,000 ohms
  - R3, R5—51,000 ohms
  - R6—10,000 ohms
  - R7—500,000-ohm, linear-taper potentiometer (see text and note below)
  - R8—56,000 ohms (see text)
  - S1—Spdt, heavy-duty, push-on/push-off switch (Alcoswitch MPG-106D or equiv.)
  - Misc.—Foot-pedal potentiometer drive mechanism and enclosure (DeArmond Model 1600 or equivalent), printed-circuit board or perforated board, IC socket or Molex Soldercons (if desired), battery holder, battery clips, hookup wire, solder, hardware, etc.

**Note**—The following is available from PAIA Electronics, Inc., Box 14359, Oklahoma City, OK 73114: complete kit of parts including IC1 and passive components, etched and drilled printed-circuit board, DeArmond Model 1600 foot pedal (which includes 500,000-ohm potentiometer R7), switch S1 and jacks, No. 1230K, for \$54.95, plus \$3.00 postage and handling (U.S.). Also available separately: DeArmond Model 1600 foot pedal (which includes 500-000-ohm potentiometer R7) only, No. 1230PED, for \$39.95 plus \$3.00 postage and handling (U.S.); etched and drilled printed-circuit board only, No. 1230PCB, for \$7.95 postpaid (U.S.). Oklahoma residents, add state sales tax.

**Construction.** The Wah-Wah circuit is simple, so either printed-circuit or point-to-point wiring techniques can be employed to reproduce it. The full-size etching and drilling guide for a suitable printed-circuit board appears in Fig. 3 together with the corresponding full size component placement guide.

Use of a socket or Molex Soldercons with IC1 will simplify replacement of that component should it later become defective. Be sure to observe polarities and pin basing when mounting the IC, diodes, and tantalum capacitors on the circuit board. Employ the minimum amount of heat and solder consistent with the formation of good connections. When all components have been mounted on the board, examine your work for solder bridges, cold solder joints, etc.

A number of components (B1, B2, J1, J2, R7 and S1) are not mounted on the circuit board. Rather, they are secured to the enclosure associated with the foot-pedal mechanism that drives potentiometer R7. This makes for a compact, con-

venient package. You can either construct an enclosure and foot-pedal mechanism from scratch or use a commercial product that has been specially designed for musical applications. The author recommends the DeArmond Model 1600 foot-pedal assembly, which contains a 500,000-ohm potentiometer and a worm-gear mechanism to drive the potentiometer. This is the foot pedal that he used in the construction of his prototype.

Figure 4 is a bottom view of the prototype with its bottom cover removed to show the worm-gear drive, the potentiometer, circuit board and other components mounted in the foot-pedal enclosure. A hole has been drilled along the long axis of the enclosure near the top below the pedal to accommodate bypass switch S1. This heavy-duty, push-on/push-off switch required a large mounting hole. Extreme care was taken when drilling this hole so that the rubber-topped metal pedal plate was not damaged by the drill bit. Figure 5 is a side view showing how S1 was mounted so

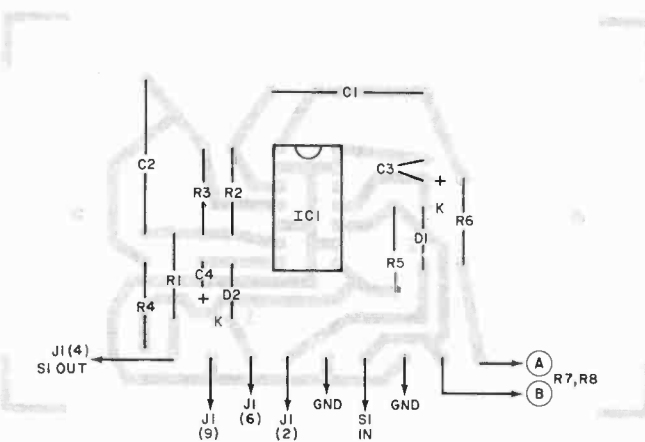
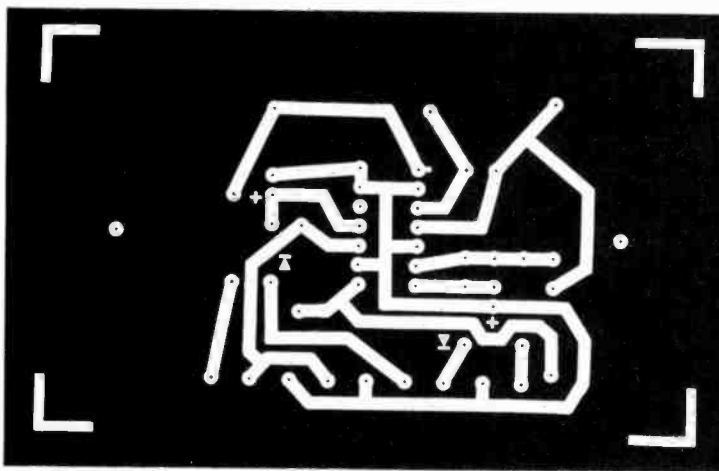

Fig. 3. Full-size etching and drilling guide (above) with corresponding parts placement guide below.

that it could be actuated by a full depression of the foot pedal.

The DeArmond Model 1600 foot pedal includes two monaural, open-circuit phone jacks. Its output jack (labelled AMPLIFIER) can be used as *J2*, but the input jack (INSTRUMENT) should be removed and replaced with a three-conductor, double closed-circuit 1/4-inch (6.3-mm) phone jack. This jack will fit in the space formerly occupied by the monaural, open-circuit input jack and will function as *J1*.

To mount the circuit board in the foot-pedal enclosure, a hole must be drilled in each of the mounting studs on the underside of the enclosure. Drill these holes 3/16" (4.8 mm) deep, taking care not to penetrate all the way through the enclosure. If a tap-set drill is available, it can be used to tap out the holes to the appropriate tap size. In the prototype, 10-32 tap-set holes were drilled and tapped to accommodate the screws that were used to hold the printed-circuit board in place. Spacers were inserted between the circuit board and the mounting studs to ensure that there is sufficient clearance for the board. If a tap-set drill is not available, holes should be drilled 3/16" (4.8 mm) deep using a No. 35 drill, and the board secured to the mounting studs using 6-32 self-tapping screws and circuit board standoffs.

Figure 4 shows how the battery holder that retains the two 9-volt batteries is mounted in the foot-pedal enclosure. It is secured in place using one of the two

retaining screws of the worm-gear assembly. The photograph also shows how the circuit board, switch, jacks, batteries, and potentiometer are interconnected using battery clips and hookup wire. A close inspection of the photo reveals the installation of a fixed resistor (*R8*) across the 500,000-ohm potentiometer. It is placed in parallel with potentiometer *R7* to reduce the maximum effective resistance of the potentiometer, which is built into the DeArmond Model 1600 foot pedal, to 50,000 ohms. If a home-brew or some other foot pedal is used, *R8* can be omitted and a 50,000-ohm linear-taper potentiometer installed as *R7*. Note that the center lug (the wiper) of the potentiometer and the lug furthest away from the input and output jacks should be connected together.

**Checkout and Use.** Install fresh 9-volt transistor batteries in the holder and attach the battery clips to them. Then plug one end of a patch cord into the output jack of an electric guitar or similar signal source and the other end into jack *J1*. Use a second patch cord to route signals from output jack *J2* to the input jack of an instrument amplifier. Strike a note or chord and listen to the output of the amplifier while you pump the foot pedal up and down. If you hear no variation in timbre, depress the foot pedal fully until you hear the click of *S1*. Then repeat the process by striking a note or chord and rapidly pumping the foot pedal up and down. You should

then hear the output of the guitar modified by the "wah-wah" sound.

Back the pedal off to its fully up position by pressing down with your heel and strike a chord. Bass notes should predominate over treble notes in the output of the amplifier. Next, move the pedal to its (almost) fully down position by applying pressure with your toes. Do not press the pedal with so much force that *S1* latches into its OUT position. Then strike the same chord that was struck previously and monitor the output of the amplifier. You should hear a predominance of treble notes over bass notes. If the opposite response is heard, potentiometer *R7* has been reverse-wired and the leads running to it from the circuit board should be transposed.

You can combine the Wah-Wah pedal with other signal processors, such as a fuzz-box, sustain, and a flanger, to create your own special sounds. Experiment with each of the signal processors you have to determine how much of any one effect should be added to the sound of your instrument at any given time. Keep in mind that too much of any sound effect can disturb your audience and that too little of it can bore them. The best bet is to apply judicious amounts of the sound effects available to you in a sequence dictated by your interpretation of the music you are going to play. This will not only entertain your audience, but also leave in their minds the impression that you are truly a creative musician. ◇

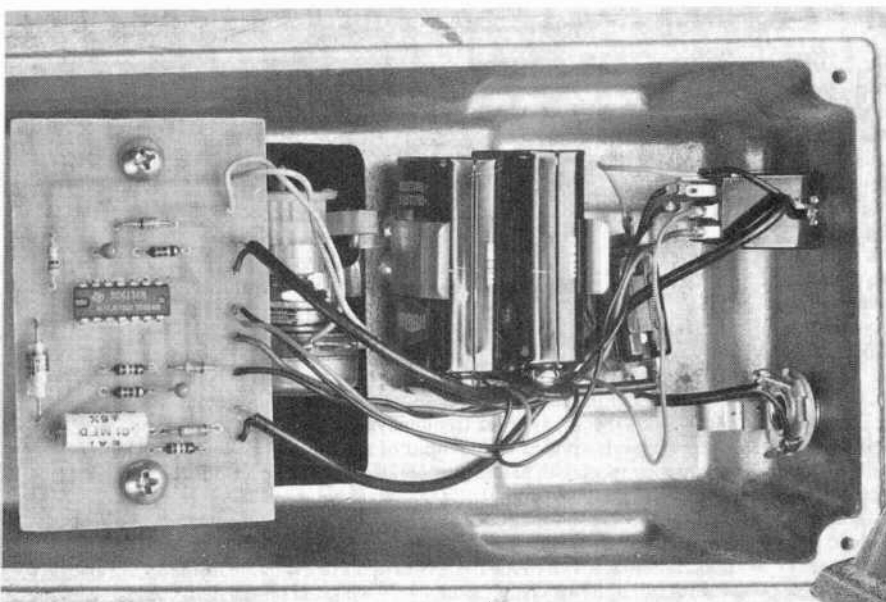

Fig. 4. Bottom view of prototype shows how the pc board and other components fit inside the foot-pedal enclosure.

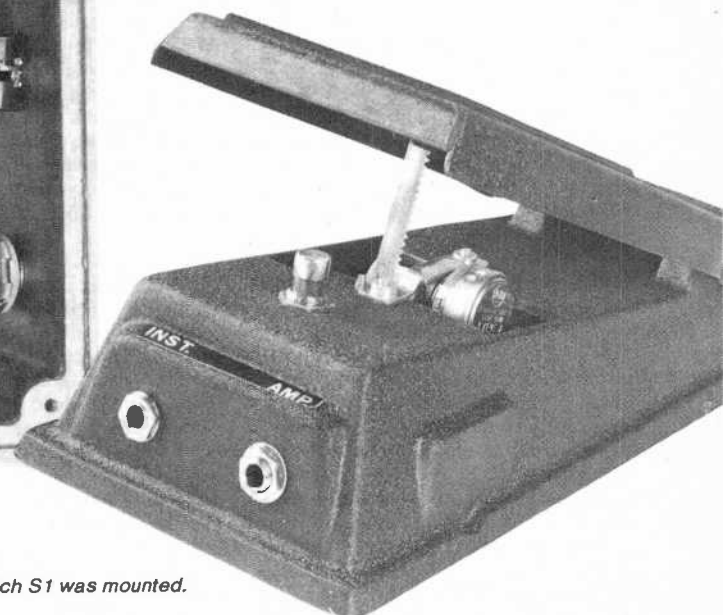
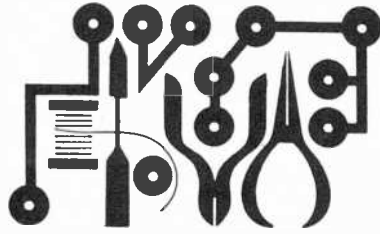

Fig. 5. View of pedal showing how switch *S1* was mounted.

# Experimenter's Corner



By Forest M. Mims

## Optical Fiber Communications (Part 2)

IN this second of a two-part primer on optical fiber communications, we'll experiment with several transmitter and receiver circuits suitable for communicating through optical fibers and free space. If this fascinating form of communications appeals to you, be sure to review Part 1 before designing your own optical link. You might also refer to last month's Project of the Month, because the simple amplitude-modulated light-wave transmitter and receiver presented there are ideal for fiber links. You'll then be well prepared to try the circuits shown in this column.

I have built and tested all these circuits. Nevertheless, I suggest that you assemble versions on solderless breadboards before making permanent units. This will allow you to make gain and modulation adjustments and to perform preliminary operating tests to determine whether or not a particular circuit is suitable for your application.

**Selecting Emitters and Detectors.** Double-heterostructure injection lasers generate higher power levels over greater bandwidths than light-emitting diodes, but their high cost rules out their use for all but the most affluent experimenters. Fortunately for the rest of us, LEDs provide enough power for fiber links of a kilometer or more. GaAs: Si LEDs are very powerful, but the 940-nm wavelength they radiate is readily absorbed by most fibers. Therefore, GaAs (900 nm), GaAlS (780 to 900 nm) and even common GaAsP (650 nm) red LEDs are better choices.

Among the devices that are suitable detectors are phototransistors, solar cells, photodiodes, PIN photodiodes and even LEDs. Phototransistors are excellent for low-bandwidth links, but they must be shielded from ambient light. PIN photodiodes are the best choice for high-bandwidth applications. For 2-way communications over a single fiber, use a LED as a dual-function emitter/detector.

**Operating Tips.** Some of the circuits we'll be using employ operational amplifiers with large feedback resistances to provide very high gain. These circuits will probably oscillate violently (at least mine did) unless you take the following precautions. Connect a 0.1- $\mu$ F disc ceramic capacitor directly across the power-supply pins of the op amp. The capacitor should have short leads. Avoid long component leads and interconnection wires. Use miniature shielded cable (Radio Shack 278-752 or similar) to connect components such as detectors and microphones to the input of an op amp if the distance involved is more than a few centimeters. *Never* use an earphone to monitor the output of an untested receiver! If the circuit oscillates, the resulting sound pressure level can quite easily exceed the threshold of pain.

**PFM Transmitter.** Transmitting voice and other analog information as a stream of light pulses rather than an amplitude- (intensity-) modulated continuous light carrier offers several important advantages. Perhaps the most important is noise immunity. Unlike the signal transmitted by an AM light-wave system, all bursts of light in a pulsed system have the same amplitude. This means a threshold circuit can be connected to the receiver to automatically block noise pulses having an amplitude smaller than that of the information-carrying pulses.

Another important advantage is the fact that most LEDs and certain types of injection lasers emit far more power when driven by brief current pulses than when operated more or less continuously as in an AM system. Other advantages of pulse communications include increased bandwidth, reduced (continuous) operating power

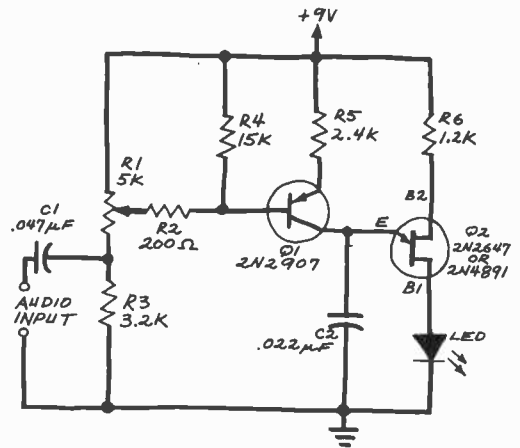

Fig. 1. Simple unijunction transistor PFM transmitter.

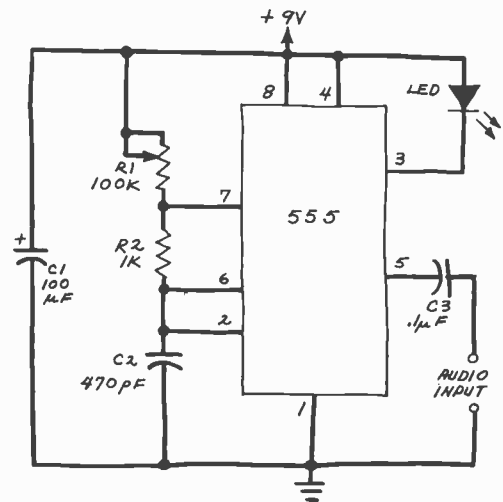

Fig. 2. A light-wave transmitter designed around a 555.

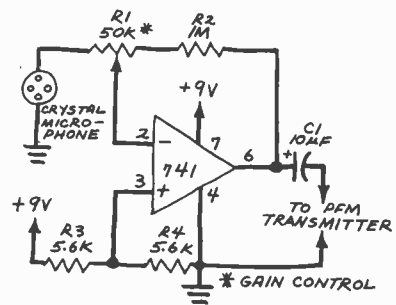

Fig. 3. Microphone preamplifier for PFM transmitter.

and interesting data encryption and multiplexing possibilities.

A pulse frequency-modulated (PFM) transmitter is fairly simple. In quiescent operation, the circuit produces a continuous stream of pulses at a specified center frequency, usually above the audio range. Audio signals applied to the input of the modulator cause the center frequency to vary in direct proportion to both the amplitude and frequency of the input signal.

Figure 1 is the schematic diagram of a simple unijunction-transistor PFM transmitter I first described in this column in May 1976. (Back issues of POPULAR ELECTRONICS are available at many libraries.) Although this circuit works very well, the pulses delivered to the LED do not have enough duration and amplitude for maximum optical power generation.

Figure 2 is an even simpler circuit designed around a 555 timer IC. This modulator delivers more current to the LED. When powered by an 8-volt rechargeable battery, the peak current as measured across a 1-ohm resistor in series with the LED is 320 milliam-



An Extraordinary Offer to introduce you to the benefits of Membership in

# ELECTRONICS BOOK CLUB

take any **6** of these 24 unique electronics books **\$1.99** for **ALL SIX** (values to \$103.70) for only

with a Trial Membership in the Book Club that guarantees to save you 25% to 75% on a wide selection of electronics books

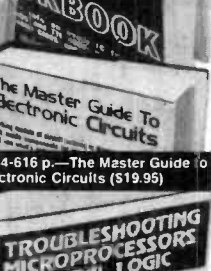
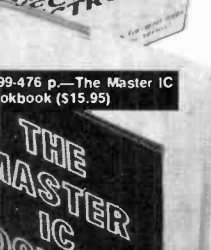
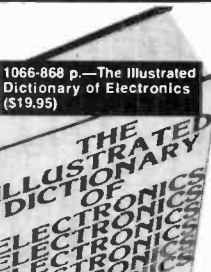
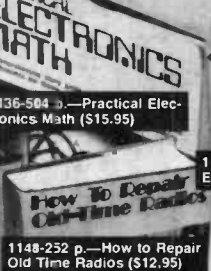
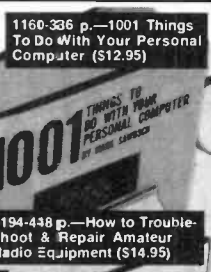
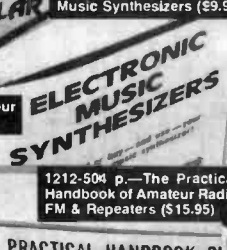
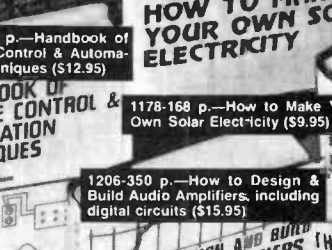
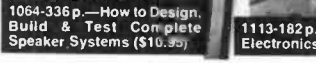
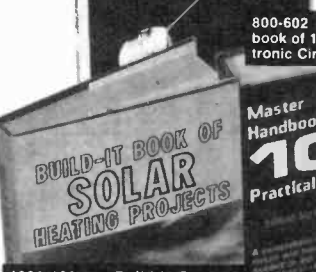

### Facts About Club Membership

- The 6 introductory books of your choice carry publisher's retail prices of up to \$103.70. They are yours for only \$1.99 for all 6 (plus postage/handling) with your Trial Membership.
- You will receive the Club News, describing the current Selections, Alternates, and other books, every 4 weeks (13x a year).
- If you want the Selection, do nothing, it will be sent to you automatically. If you do not wish to receive the Selection, or if you want to order one of the many Alternates offered, you simply give instructions on the reply form (and in the envelope) provided, and return it to us by the date specified. This date allows you at least 10 days in which to return the form. If, because of late mail delivery, you do not have 10 days to make a decision and so receive an unwanted Selection, you may return it at Club expense.
- To complete your Trial Membership, you need buy only four additional monthly Selections or Alternates during the next 12 months. You may cancel your Membership any time after you purchase these four books.
- All books—including the Introductory Offer—are fully returnable after 10 days if you're not completely satisfied.
- All books are offered at low Member prices, plus a small postage and handling charge.
- Continuing Bonus. If you continue after this Trial Membership, you will earn a Dividend Certificate for every book you purchase. Three Certificates plus payment of the nominal sum of \$1.99 will entitle you to a valuable Book Dividend of your choice which you may choose from a list provided Members.

May we send you your choice of 6 of these practical time-and-money-saving books as part of an unusual offer of a Trial Membership in Electronics Book Club?

Here are quality hardbound volumes, each especially designed to help you increase your know-how, earning power, and enjoyment of electronics. Whatever your interest in electronics, you'll find Electronics Book Club offers practical, quality books that you can put to immediate use and benefit.

This extraordinary offer is intended to prove to you through your own experience, that these very real advantages can be yours...that it is possible to keep up with the literature published in your areas of interest, and to save substantially while so doing. As part of your Trial Membership, you need purchase as few as four books during the coming 12 months. You would probably buy at least this many anyway, without the substantial savings offered through Club Membership.

To start your Membership on these attractive terms, simply fill out and mail the coupon today. You will receive the 6 books of your choice for 10-day inspection. YOU NEED SEND NO MONEY. If you're not delighted, return the books within 10 days and your Trial Membership will be cancelled without cost or obligation.

ELECTRONICS BOOK CLUB, Blue Ridge Summit, Pa. 17214

### ELECTRONICS BOOK CLUB

Blue Ridge Summit, Pa. 17214

Please open my Trial Membership in ELECTRONICS BOOK CLUB and send me the 6 books circled below. I understand the cost of the books I have selected is only \$1.99 for all 6, plus a small shipping charge. If not delighted, I may return the books within 10 days and owe nothing, and have my Trial Membership cancelled. I agree to purchase at least four additional books during the next 12 months after which I may cancel my membership at any time.

800 1006 1050 1064 1066 1070 1077 1108  
1111 1113 1136 1148 1160 1163 1167 1169  
1178 1183 1184 1194 1199 1206 1212 1234

Name \_\_\_\_\_ Phone \_\_\_\_\_

Address \_\_\_\_\_

City \_\_\_\_\_

State \_\_\_\_\_ Zip \_\_\_\_\_

(Valid for new Members only. Foreign and Canada add 15%.) PE-680

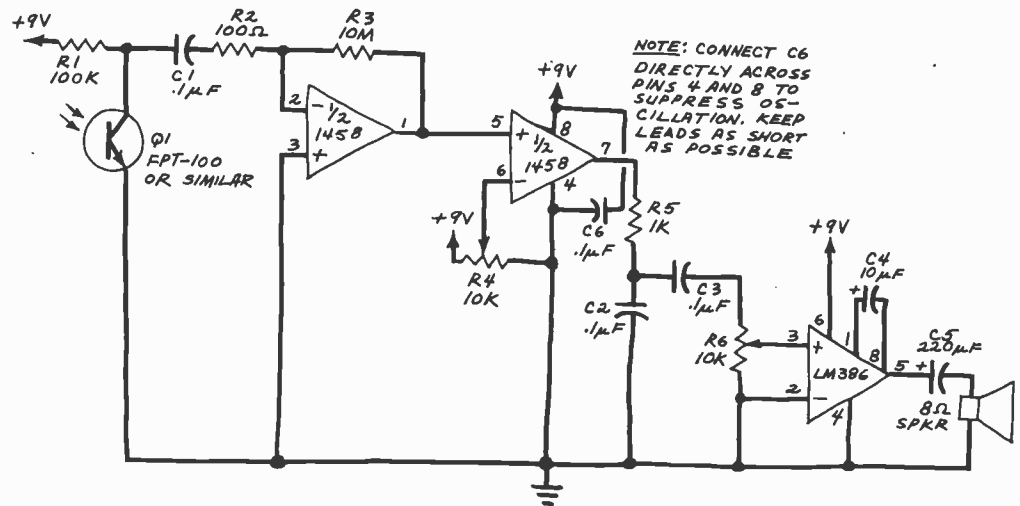

Fig. 4. A PFM receiver with a threshold detector and demodulator added.

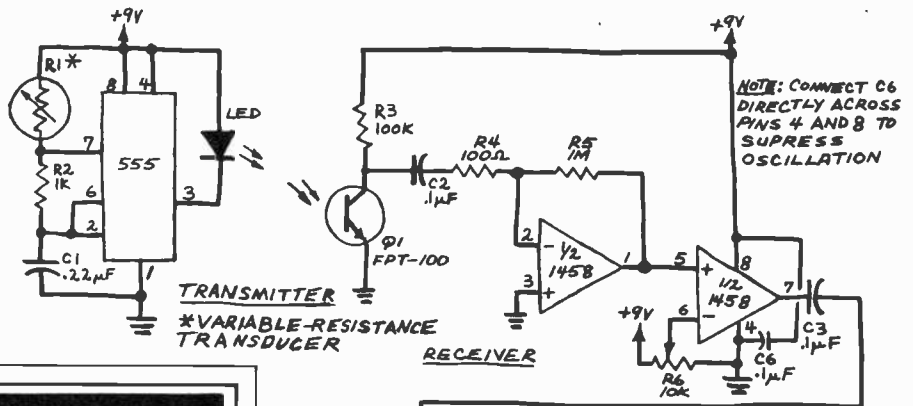

Fig. 5. An analog light-wave transmission system using a 555 astable oscillator transmitter with a receiver similar to that shown in Fig. 4.



**ATARI<sup>®</sup> 400™**  
8K RAM \$499.

---

**TRS-80™**  
Level II, 16K  
**\$669.**

---

Eaton LRC 7000 +  
Printer **\$369.**



To order call TOLL FREE 1-800-258-1790 (in NH call 673-5144). Ask for our complete computer catalog featuring over 150 hardware items, 350 software items, and magazines for your TRS-80, Apple, Atari and Pet personal computers. Call or send \$1.00 to "Ye Complete Computer Catalog", 6 South St., Milford, NH 03055.



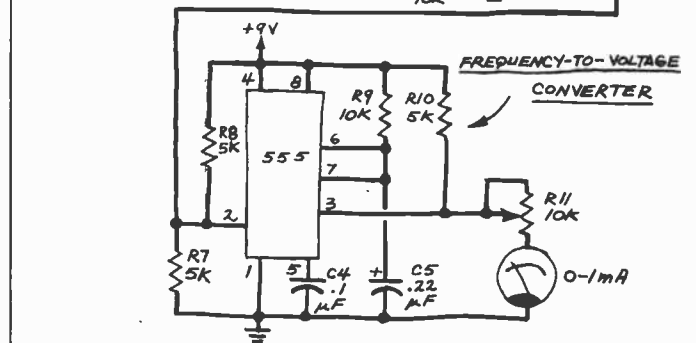

peres. This is from three to six times the maximum allowable LED current in an amplitude-modulated continuous-carrier light-wave system.

The pulse duration is a brief 400 nanoseconds. This keeps both the duty cycle of the LED and average power consumption of the circuit very low, but reduces the effectiveness of a phototransistor detector because its response time is slower than that of a PIN photodiode.

For best results, *R1* should be adjusted to give a center frequency between 20 and 30 kHz. You don't need a frequency counter to make this adjustment. You can monitor a suitable light-wave receiver (see below) while adjusting *R1* for optimum sound quality.

Initial tests and adjustments are simplified if you connect the output of a transistor radio (via its earphone jack) to the input of the modulator. The modulator works best when the amplitude of the input is 2 to 4 volts peak-to-peak. For voice operation, connect any standard audio amplifier to the modulator's input. Figure 3 is the schematic of a microphone preamplifier that I like to use.

(Continued on page 80)

# SAVE

on  
add-ons  
for

# APPLE® and TRS-80®

## NEW DISK APEX OPERATING SYSTEM FOR THE APPLE®

Fully Professional DOS for the Apple II. The result of two years of extensive development, APEX provides a complete program development and file management system, both powerful and useable. A comprehensive command set allows the user to perform almost any imaginable disk operation. Here are some of APEX features:

- Command structure similar to CPM and main frame systems. Contains 20 command words, with ability to treat external programs as transient commands to the operating system.
- Easy program interface. Simple communications between the DOS and user program.
- Capable of handling 5 inch, 8 inch, and hard disks.
- Safety features to protect against accidental data loss. Features include backup files, directory, read-after-write & limit checks.
- 4 times faster than CPM.
- Auto default structure eliminates tedious typing by automatically setting up command strings, file names, etc.
- Functional on both single and multi-drive systems. Includes utilities for file copy.
- Device handler structure for interfacing peripherals.

The APEX package includes all of the tools for a complete assembly language development system, high speed two pass resident assembler and a powerful macro editor.

The complete APEX package with operating system, assembler, editor and manuals, also includes utilities to maintain files on single or multiple drive systems.

# \$99

**RELATED SOFTWARE**  
XPLO \$79  
FOCAL™ \$59

## SAVE ON APPLE II 16K



FREE MEMORY UPGRADE KIT TO 48K WITH PURCHASE OF APPLE II 16K (MTI ONLY) **\$1195**

**INTRODUCTORY OFFER**  
SAVE \$300 TRS-80 Graphics  
List \$1099



OKIDATA  
MICROLINE 80  
OUR PRICE  
**\$799**

**INTRODUCTORY OFFER**  
MTI MINI FLOPPY  
FOR APPLE  
**\$419**  
ONLY

## MTI APPLE 8" DISK SYSTEM

- \*One SA800R Floppy
- \*2 Drive Chassis & Power Supply
- \*Controller, Cable and DOS

# \$1449

### \*DRIVES FOR ANY MICROCOMPUTER\*

Does not include power supply & cabinet.

Pertec FD200	\$282	FD250	\$399
Shugart SA400 (unused)	\$286	SA800	\$379
MPI B51	\$279	B52	\$349

### PRINTERS

Centronics 779	\$1069	ANADEX	\$ 950
Centronics 737	\$ 950	700-1	\$1195
Centronics 701-1	\$1795	702-2	\$1995
Spinwriter-NEC			\$2595

### NEW! LINE PRINTER BASE 2

Fast, 80, 132 col., graphics & tractor (ST) \$599

## NEWDOS/80

A NEW enhanced NEWDOS for the TRS/80®

Powerful Disk Operating System for the TRS-80®, designed for the sophisticated user and professional programmer who demands the ultimate.

NEWDOS/80 is not meant to replace the present NEWDOS 2.1 which satisfies most users, but is a planned enhancement, which significantly extends NEWDOS 2.1's capabilities. Compatible NEWDOS/80 is supplied with NEWDOS 2.1 and includes enhanced NEWDOS+ utility programs. Some of the features are:

- New BASIC commands with variable record lengths up to 4095.
- Mix or match drives. Use 35, 40 or 77 track 5" disk drives or 8" disk drives, or combo.
- Security boot-up for BASIC or machine code application programs.
- New editing commands that allow program lines to be deleted from one location and moved to another or to allow the duplication of a program line with the deletion of the original.
- Enhanced RENUMBER that allows relocation.
- Program chaining.
- Device handling for routing to display and printer simultaneously.
- CDE function; striking of C, D and E keys allows user to enter a mini-DOS without disturbing program.
- Compatible with NEWDOS & TRSDOS.
- Superzap 3.0 and 2.1 utilities.

# \$149

### LIMITED UPGRADE OFFER

NEWDOS owners up-grade to NEWDOS/80 and receive trade in allowance toward purchase of NEWDOS/80 by including in your order:

- Serial # on your NEWDOS diskette
- Where purchase, amount paid.

In most cases that purchase price will be subtracted from the price of NEWDOS/80. Add \$10 for postage and handling. (Limited offer—good for 30 days only.)

## DISK DRIVE SALE!

Shugart SA400 with power supply and chassis, the disk that Radio Shack sells for \$499 SAVE \$130

TF-Pertec FD200, 40 track, use both sides	\$389
TF-5 MPI B51, 40 track	\$389
TF-70 Micropolis, 77 track with 195K storage	\$639
TDH-1 Dual sided drive, 35 track	\$499
New DOS+ 40 track	110
35 track	\$99
AJA Business Program	\$289
Radix Data Base Program	\$99.95

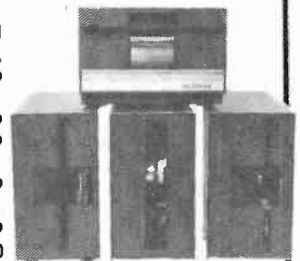

### MOD I "8" DISK SYSTEM

- One SA800R Floppy
- 2 Drive Chassis and Power Supply
- DOS and Cable

**\$1095**

### MOD II

2 Drive Expansion System Only

# \$1405

## DISK DRIVE EXPANSION SYSTEM

MTI List Price

• 2 Shugart SA400 drives with power/chassis	\$738
• 1 Two - Drive Cable	\$25
• 1 Expansion Interface 32K	\$499
• 1 35-Track DOS+	\$99

TOTAL MTI LIST PRICE  
SPECIAL PRICE ONLY

# \$1,361

# \$1249

®Registered TM's of Tandy Co. & Apple



3304 West MacArthur  
Santa Ana, CA 92704  
(714) 979-9923



ALL PRICES DISCOUNTED.  
FREIGHT FOB/FACTORY

ASK FOR OUR  
FREE CATALOGUE



7310 E. Princeton Ave.  
Denver, CO 80237  
(303) 741-1778

pparat, Inc

# THE BIG PLUS + Graphic Equalizer

ASSEMBLED  
\$200

KIT  
\$120

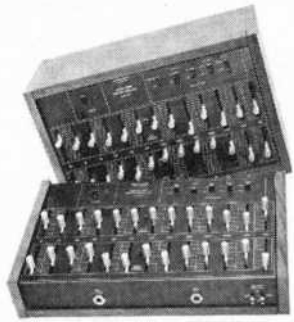

LOADED with Quality Features!

- Stereo . . . Eleven Bands Per Channel • Extremely Low Noise & Distortion • LED Peak Indicators • Center Detent ("flat") sliders • Built-in "record" Switching • Line and Microphone Level Inputs/Outputs • Regulated Power Supply • Fully Guaranteed • Horizontal or Vertical Cabinets • Kit or Fully Assembled • Plus Much, Much More!

**Absolutely equals or exceeds overall performance and features of any graphic equalizer made today!**

AARON-GAVIN INSTRUMENTS, INC.

17231 Corla Avenue Tustin, California 92680

Yes! I've enclosed \$ \_\_\_\_\_; RUSH me:  assembled equalizers at \$200.00 p.p.d.  cabinet  send brochure  
 unassembled equalizer kits at \$120.00 p.p.d.  Horizontal (flat)  Vertical (up-right)  
 California residents include 6% sales tax

Name \_\_\_\_\_ Visa & Master Charge orders accepted  
 Address \_\_\_\_\_ Card No. \_\_\_\_\_  
 City \_\_\_\_\_ State \_\_\_\_\_ Zip \_\_\_\_\_ Exp. Date \_\_\_\_\_ Bank No. \_\_\_\_\_

Dealer inquiries invited  
CIRCLE NO. 2 ON FREE INFORMATION CARD

T.I./M.M.I.  
74LS240  
74LS241  
74LS243  
74LS244  
74LS373  
74LS374  
\$245  
LIMIT 10 EACH

IN STOCK  
74S373  
74S374  
\$325

2708  
1024X8 EPROM  
\$745  
450ns AMD, SGS

4116  
16Kx1 Static RAM  
MEMORY ADD-ON FOR THE  
TRS-80 OR APPLE II  
8 for \$59.95 to 450ns

2114L  
1024x4 Static RAM  
450 ns  
\$475

8038C  
VCO Waveform Gen  
w/sine  
\$265

16K  
STATIC  
RAM  
S-100 MEMORY ADD-ON  
\* FULLY STATIC OPERATION  
\* USES 2114 TYPE STATIC RAMS  
\* 8 VDC INPUT AT LESS THAN 1 AMP  
\* BANK SELECT AVAILABLE BY BANK PORT AND BANK BYTE  
\* PHANTOM LINE CAPABILITY  
\* ADDRESSABLE IN 4K BLOCKS IN 4K INCREMENTS  
\* LED INDICATORS FOR BOARD/BANK  
\* SOLDER MASK ON BOTH SIDES OF BOARD  
ASSEMBLED & TESTED \$26900

2716  
16K EPROM  
\$27.95  
TI, HIT, INT.  
450ns single+5v

S-100 16K ADD-ON  
BARE BOARD  
WITH DOCUMENTATION AND  
DETAILED INSTRUCTION BOOK \$28.95

LOGIC  
PROBE  
KIT  
\$17.95

## CONCORD COMPUTER COMPONENTS

1971 SOUTH STATE COLLEGE • ANAHEIM, CA. 92806

VISA-MASTERCARD  
CHECK OR M.O.  
NO C.O.D.

(714)937-0637

MINIMUM ORDER-\$10.00  
ADD \$1.50 FOR FRT  
CAL. RES. ADD 6%

CIRCLE NO. 16 ON FREE INFORMATION CARD

## experimenter's corner

**PFM Receiver.** You can receive signals from a PFM transmitter with any light-wave receiver if the center frequency of the transmitter is higher than approximately 15 kHz. For best results, however, a threshold detector and demodulator should be added as shown in Fig. 4.

Note how this circuit uses one half of an MC1458 (other dual op amps can also be used) as a preamplifier and the second half as a comparator or threshold detector. Demodulation (actually, integration) of the transmitted intelligence is provided by R5 and C2. The recovered audio is then amplified by the LM386 power amplifier. Potentiometer R6 controls the signal level at the input of the LM386 and is therefore used as a gain control.

Potentiometer R4 permits adjustment of the comparator. Standard dual op amps such as the MC1458, however, may have insufficient bandwidth for the threshold circuit to work properly. In such cases, the narrow incoming pulses from the transmitter are stretched by the preamp and detector stages until they merge to form an amplitude- rather than pulse-modulated signal. You can obtain true threshold detection by using selected 1458's or using the LF353 or another of the better-quality dual op amps. For optimum results, you might prefer to use individual op amps rather than a dual IC to prevent inadvertent triggering of the comparator at very high preamp-gain levels.

Once the receiver is working, you can reduce the gain of the preamp by increasing the value of R2. And you can change the values of R5 and C2 to alter the tone response.

Use care when tinkering with the receiver, because inadvertently touching a lead might produce an ear-splitting squeal from the speaker. To protect your ears, you can insert a few hundred ohms of series resistance between C5 and the speaker, at least until the receiver is ready to be buttoned up and there is no chance of inadvertently touching off a spasm of shrieks and whoops.

**Analog Data Transmission System.** In the October and November 1979 installments of this column, we experimented with voltage-to-frequency converters and an analog light-wave data-transmission system designed around a pair of 9400 V/F chips. The LM331 V/F converter can also be used in this application. Since those columns appeared, V/F chips have become more widely available. Nevertheless, I have long wanted to design an analog light-wave transmission system around the even more widely available 555 timer chip. Figure 5 is the realization of that desire.

The transmitter is a basic astable oscillator that supplies current pulses to a LED. Resistance R1, which controls the pulse rate, can be a cadmium-sulfide photoresistor (for light sensing), a thermistor (for temperature sensing), a strain gauge (for pressure sensing) or some other variable-resistance transducer. It can even be a FET if remote monitoring of a voltage is desired.

The front end of the receiver is essentially identical to the preamp and threshold detector stages shown in Fig. 4. The 555 and its associated components form a frequency-to-voltage converter. Output monitoring is provided by a 0-to-1-mA meter movement.

This circuit works best over a 0-to-360-Hz frequency range (1 mA = 360 Hz), but this can be extended by altering the values of R9 and C5. The threshold potentiometer (R6) requires careful adjustment, particularly if slow op amps are used. Potentiometer R11 permits calibration of the output meter.

The receiver's front-end phototransistor must not be exposed to ambient light if the system is to operate properly. LEDs and PIN photodiodes, which can also be used as detectors, are less susceptible to the deleterious effects of ambient light.

**Going Further.** For more information about optical-fiber communications, see W.S. Boyle's excellent article "Light-Wave Communications" in the August 1977 issue of *Scientific American*. A good general introductory book is *Light-Beam Communications* (F. Mims, Howard W. Sams, 1975), and a more technical text is *Fundamentals of Optical Fiber Communications* (edited by M.K. Barnoski, Academic Press, 1976). You can keep abreast of the latest developments in this field and get the names and addresses of fiber manufacturers by reading such trade magazines as *Laser Focus* and *Electro-Optical Systems Design*. All these and many other publications on light-wave communications are available at well-stocked libraries. ◇



# Reel Versatility At a Cassette Deck Price. The New Realistic® Upgrader.

Upgrading is for music lovers who can hear the difference. For them, Radio Shack has made "the difference" affordable . . . for example 30-28,000 Hz ( $\pm 3$  dB) frequency response, extended dynamic range, low distortion, low noise — you get it all in the easy-to-be-creative open reel format. Tape handling is no problem because the TR-3000 is totally logic controlled. A pushbutton-activated solenoid system controls all tape movement — you can switch functions instantly, without tape spills or snarls. Pause and mute controls even let you edit, electronically, as you record.

The TR-3000 has three motors. A precision servo-controlled capstan motor reduces wow and flutter to less than 0.06% WRMS. And two high-torque reel motors maintain constant tape tension for smooth, fast winding. Separate play, record and erase heads give you "off-the-tape" monitoring. Individual mike and line input controls work like a built-in mixer. High/low bias and EQ switches for an optimum match with any tape.  $7\frac{1}{2}$  and  $3\frac{3}{4}$  ips speeds. And lots more. Realistically priced at only \$499.95.\* Check its superb sound and specs at one of our 7000 locations today!



## Radio Shack®

The Nationwide Supermarket of Sound®

\*Retail price may vary at individual stores and dealers, Cat. No. 14-700. Illustrated metal reels an extra option.

## 9 GREAT NEW AUDIO BOOKS!

**21 CUSTOM SPEAKER ENCLOSURE PROJECTS YOU CAN BUILD**  
A step-by-step guide to innovative, efficient audio speakers, with complete design and construction details! From simple closed-box systems to complex omnidirectional speakers, you get complete descriptions, design and construction details for 21 good-looking build-it projects—virtually every brand of audio/stereo speaker you could possibly want. They're all proven ideas, too—each project has actually been designed, constructed, and tested—and all the bugs worked out! Included a mini-cube, open window, dual cone six, 2-way closed box speakers, an expandable system, the Colonial, the Maxi, 3-way closed box speakers, a compact 2-way, a traditional, the Heavyweight, a tri-linear, reflex speakers, an energy-saver, the Doppelganger, the Titan, several equalized systems, two omnis, and car and van speakers 240 p. 177 il.

Paper \$7.95; Hardbound \$12.95 Order No. 1234

### HOW TO DESIGN AND BUILD AUDIO AMPLIFIERS

A complete course in designing and building audio circuits for ALL electronics applications! Whether your need is for a preamp, an amplifier, a power amplifier, a mixer, a tone modification circuit, power supply, or a special accessory, you'll find all the necessary data to create practical, completely modern circuits. Includes plenty of specialized info on hybrid equivalent circuits, equivalent-T circuits, circuit characteristics of JFETs, equivalent noise generators, power amplifiers and power ratings, thermal circuits and limits, etc. 350 p. 249 il.

Paper \$3.95; Hardbound \$15.95 Order No. 1206

### HOW TO DESIGN, BUILD & TEST COMPLETE SPEAKER SYSTEMS

THE complete speaker-building book with all the data you need to create virtually ANY speaker system from simple speaker-in-a-box setups to complex multi-driver systems and omnidirectionals. It's a complete do-it-yourself manual that includes all the info needed to design and build your own customized setups. Teaches you the basics of speaker design, fundamentals of system testing, and the practical techniques of speaker system construction, so that even a beginner can design and build his own. 336 p. 175 il.

Paper \$7.95; Hardbound \$10.95 Order No. 1064

### HOW TO BUILD A SMALL BUDGET RECORDING STUDIO

Contains everything you need to design, build and operate your own recording studio. The 12 studios include a budget AV recording studio, a studio built in a residence, a multitrack studio in a garage, a TV mini-studio, a small studio for instruction and campus radio, and more. Covered are floor plans, control and monitoring rooms, likely cost, walls and ceiling treatment, reverberation time, observation windows, room proportions, acoustical treatment, noise considerations, etc. 336 p. 401 il.

Paper \$8.95; Hardbound \$12.95 Order No. 1166

### ELECTRONIC MUSIC SYNTHESIZERS

How to build—or buy and use—your own modern electronic music synthesizer! Explains the advantages and disadvantages of the Moog (Minimoog, Polymoog and modular systems), ARP 2600, Odessy, PAIA (Gnome and QZ), Oberheim, RMI keyboard computer, and EML Synkyne synthesizers. Plus, there's a full section on how to build your own—keyboards, an op amp organ, the digital Poly-Syngan, oscillators, drones, filters, tunable noise stage, modulators, voltage control—you'll see how you can construct them all! 168 p. 127 il.

Paper \$5.95; Hardbound \$9.95 Order No. 1167

### HOW TO SELECT & INSTALL YOUR OWN SPEAKERS

THE complete hands-on manual of speaker selection and installation—with all the data you need to install any speaker anywhere—auto, home, school, or Super Bowl! Shows you how to evaluate available store-bought systems, analyze sound distribution problems, properly position speaker units, assess acoustic quality, build speaker enclosures, wire up speaker equipment, and adjust systems until you get precisely the sound you want. 238 p. 131 il.

Paper \$5.95; Hardbound \$9.95 Order No. 1034

### THE ABC BOOK OF HI-FI/AUDIO PROJECTS

A complete guide to making ANY hi-fi/audio system more versatile, more powerful, more sophisticated with step-by-step instructions on how to build, modify, and install everything from amplifiers to power supplies! With the over 100 projects included you can build a complete system from scratch. Each project is accompanied by a complete schematic wiring diagram and a detailed parts list. Many have PC board layouts ready for photo pickup. 182 p. 131 il.

Paper \$5.95 Order No. 921

### MICROPHONES: HOW THEY WORK & HOW TO USE THEM

Takes all the mystery out of microphones, shows you how to record almost anything at a professional level, clearly explains how to get different sound effects and better stereo, and fully describes mike positioning techniques. You learn about the different types of mics and accessories available, how to choose just the right one for your needs, how to get the most out of spec sheets, and how to interpret polar patterns plus single- and multi-microphone applications, various monitoring schemes, and mike placement, phasing, and recording data for over 60 different types of instruments and voice sounds from soloists to choirs, to interviews and conference recording, hand-held and podium mikes, film and stage sound, recording outdoors, etc. 224 p. 92 il.

Paper \$6.95; Hardbound \$10.95 Order No. 875

### HANDBOOK OF MULTICHANNEL RECORDING

An up-to-the-minute how-to for layman and pro who want to make quality recordings of musical groups. Covers it all—everything you have to know to make the highest-quality professional audio tape recordings. You learn all the money- and time-saving tricks a master recording engineer acquires in a lifetime, plus how to employ the modern techniques involved in dubbing, special effects, mixing, reverb, echo, and synthesis. 322 p. 196 il.

Paper \$8.95; Hardbound \$10.95 Order No. 781

SEND NO MONEY! We'll invoice you on 10-DAY FREE TRIAL. C/P entire ad to order. 100% guaranteed or your money refunded.

TAB BOOKS DEPT. PE-680  
BLUE RIDGE SUMMIT PA 17214

CIRCLE NO. 26 ON FREE INFORMATION CARD



# Amateur Radio

By Karl T. Thurber, Jr., WBFX/4

## Hamfests Are Fun!

**I**F YOU are a beginner in amateur radio, one of the best ways to get "maximum exposure" to all aspects of this fascinating hobby is to hop aboard the hamfest circuit. A hamfest is a distant cousin of the CB jamboree and coffee-break. All year round, but especially from the earliest days of spring through the start of the football season, hams from all over set up, participate in, and travel to hamfests and other "eyeball" meetings with fellow hobbyists, manufacturers' representatives, and equipment dealers.

A hamfest, as its name implies, is a grand meeting of radio amateurs. The term covers a lot of ground. For example, there are hamfests that are strictly horse-trading swap meets and flea markets. These are usually sponsored by small, local clubs for their own members and nearby hams. The main activity at such a hamfest is the purchase, swapping and selling of components and equipment. Usually held in a school cafeteria, parking lot or other convenient location, this type of ham event often includes an old-time radio auction and a bid table, where the bidding is written rather than verbal.

Attending such a hamfest can be a good way to find used equipment at a low price or a rare but indispensable component for a new project. If you're a rank beginner, it's probably best to have a more experienced ham accompany you. The multitude of "nameless" equipment and strange-looking components may prove frustrating without some expert guidance. Nevertheless, the public (including prospective amateurs) is always welcome at these get-togethers and is free to browse and shop among the vendors and individual hams displaying their communications, computing and test equipment as well as such specialized ham wares as name badges and tags, QSL cards, and so forth.

**Something For Everyone.** Most hamfests are more than just swap meets, however. They frequently include educational activities such as technical seminars. Discussions on such topics as Novice operating procedures, contest operations, DXing, antennas, radioteletype, slow-scan television, vhf operations, emergency communications, traffic-handling, and amateur applications for microprocessors predominate. Usually, a member of the club sponsoring the hamfest who is a leader in that particular aspect of ham radio chairs the seminar. Needless to say, sitting through a few of these sessions is a good way to broaden one's knowledge of radio in a hurry. They are often the vehicle by which the latest advances are introduced to the ham audience.

Most of the smaller hamfests cater to amateurs exclusively. However, the larger ones—especially those two-day, weekend events—cater to the entire family because hams are more likely to travel a good distance with their families if there will be entertainment for them too. Thus, spouses' and children's events are increasingly popular. Typical activities for nonhams include bingo, musical entertainment, tours of local historic sites and attractions, shopping excursions, cartoon and magic shows, and special drawings for door prizes.

Almost all hamfests are well attended by dealers and manufacturers' representatives who want to build up clientele and display their products. This is especially true at the larger hamfests, where high-volume dealers and name-brand manufacturers display their

## AMAZING SCIENTIFIC and ELECTRONIC DEVICES

ALL NEW AMAZING DEVICES NOW AVAILABLE IN CONSTRUCTION PLANS, KITS OR COMPLETED ITEMS. All plans include itemized parts lists with given sources.

### LASERS—CONSTRUCTION PLANS

#SSL1	- POCKET SOLID STATE 9000A .....	\$9.00
#LPH2	- POCKET VISIBLE RED OPTICAL VERSION ...	\$8.00
#RUB1	- RUBY/YAG RAY GUN .....	\$15.00
#LC1	- CO2 BURNING, CUTTING .....	\$15.00
#LBT1	- LIGHT BEAM COMMUNICATORS—1 mile .....	\$10.00

### ULTRASONICS—CONSTRUCTION PLANS

#PPF1	- PHASOR PAIN FIELD .....	\$15.00
#PSP1	- PHASOR SHOCK WAVE PISTOL .....	\$8.00
#PG1	- INVISIBLE PAIN FIELD GENERATOR .....	\$7.00
#HT9	- ULTRASONIC LISTENING DEVICE .....	\$10.00

### SCIENTIFIC—CONSTRUCTION PLANS

#BTC3	- 250kV HIGH FREQUENCY TESLA COIL .....	\$9.00
#TC4	- 1.5 Million Volt HIGH FREQ. TESLA COIL ...	\$12.00
#IOG1	- ION, PLASMA & FORCE FIELD Generators .....	\$8.00

### SECURITY & PERSONNEL DEFENSE CONSTRUCTION PLANS

#TASAR	- INFO & PURCHASE PACK—Elect. Dart gun ...	\$10.00
#SHG4	- SHOCK GUN .....	\$8.00
#VWPM5	- VOICE ACTIVATED Wireless Phone Monitor ...	\$10.00
#FB7	- LONG RANGE WIRELESS MIKE .....	\$7.00
#SNP2	- SNOOPER PHONE LISTENING DEVICE .....	\$7.00
#MMD1	- MOVEMENT AND MOTION DETECTOR .....	\$10.00

For a more complete listing of over 500 different plans, kits and completed products in the fields of LASERS, INFRASONICS, ULTRASONICS, NUCLEAR, HIGH ENERGY, FORCE FIELD, PLASMA, ION, CHEMICAL, ELECTRONIC and SCIENTIFIC PERSONNEL PROTECTION, SECURITY and SAFETY DEVICES, send \$1. for our catalog to:

INFORMATION UNLIMITED, INC  
Dept Q1, P.O. Box 716  
Amherst, N.H. 03031.

CIRCLE NO. 69 ON FREE INFORMATION CARD

# When quality counts

Do not be fooled by the low prices, these brand new lab quality frequency counters have important advantages over instruments costing much more. The models 7010 and 8010 are not old counters repackaged but 100% new designs using the latest LSI state-of-the-art circuitry. With only 4 IC's, our new 7010 offers a host of features including 10 Hz to 600 MHz operation, 9 digit display, 3 gate times and more. This outperforms units using 10-15 IC's at several times the size and power consumption. The older designs using many more parts increase the possibility of failure and complexity of troubleshooting. Look closely at our impressive specifications and note you can buy these lab quality counters for similar or less money than hobby quality units with TV xtal time bases and plastic cases!

Both the new 7010 and 8010 have new amplifier circuits with amazingly flat frequency response and improved dynamic range. Sensitivity is excellent and charted below for all frequencies covered by the instruments.

Both counters use a modern, no warm up, 10 MHz TCXO (temperature compensated xtal oscillator) time base with external clock capability - no economical 3.579545 MHz TV xtal.

Quality metal cases with machine screws and heavy gauge black anodized aluminum provide RF shielding, light weight and are rugged and attractive - not economical plastic.

For improved resolution there are 3 gate times on the 7010 and 8 gate times on the 8010 with rapid display update. For example, the 10 second gate time on either model will update the continuous display every 10.2 seconds. Some competitive counters offering a 10 second gate time may require 20 seconds between display updates.

The 7010 and 8010 carry a 100% parts and labor guarantee for a full year. No "limited" guarantee here! Fast service when you need it too, 90% of all serviced instruments are on the way back to the user within two business days.

We have earned a reputation for state-of-the-art designs, quality products, fast service and honest advertising. All of our products are manufactured and shipped from our modern 13,000 square foot facility in Ft. Lauderdale, Florida.

When quality counts...count on Optoelectronics.

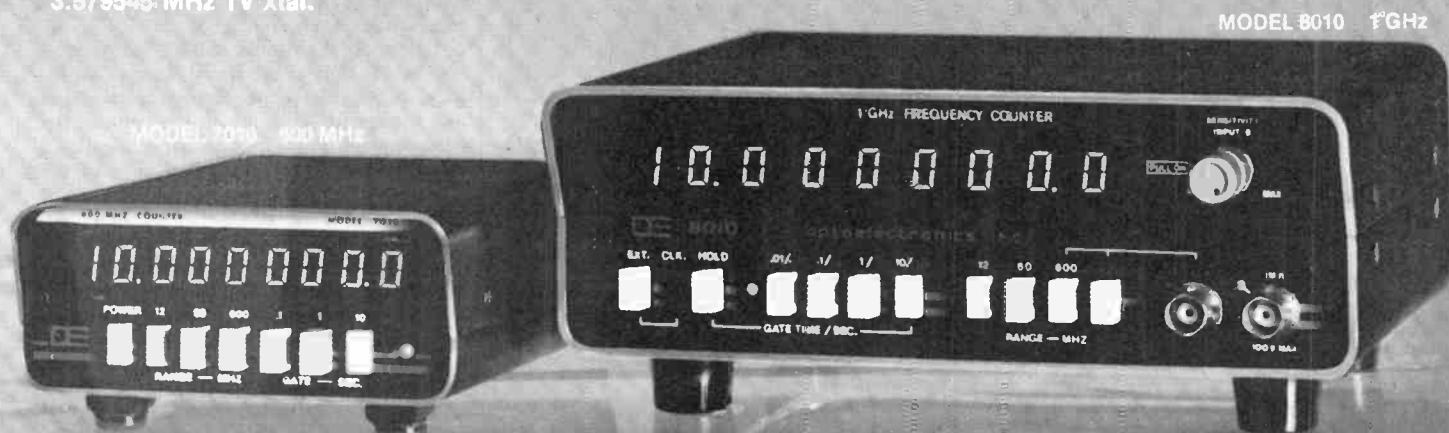

- 100% U.S.A. FACTORY ASSEMBLED
- 100% PARTS & LABOR YEAR GUARANTEE
- CERTIFIED NBS TRACEABLE CALIBRATION
- EXTERNAL CLOCK INPUT
- DISPLAY HOLD FUNCTION
- 9 RED LED DIGITS 4" HIGH
- .1 Hz RESOLUTION
- 0.1 PPM 10 MHz TCXO TIME BASE
- LAB/PORTABLE-AC ADAPTER INCLUDED
- 1 MEGOHM & 50 OHM INPUTS
- STATE-OF-THE-ART LSI DESIGNS
- COMPREHENSIVE USER MANUAL PROVIDED

● COMPACT SIZES—7010- 1-3/4" Hx4-1/4" Wx5-1/4" D 8010- 3" Hx7-1/2" Wx6-1/2" D

MODEL	\$ PRICE	RANGE 10Hz to	LED DIGITS	SENSITIVITY			HI-Z INPUT 10Hz - 60 MHz	GATE TIMES	RESOLUTION			TCXO TIME BASE		EXT CLOCK INPUT	NI-CAD BATT PACK
				25-250 MHz	250-450 MHz	450 MHz-1GHz			12 MHz	60 MHz	MAX. FREQ.	20°-40°C	FREQ.		
7010 #7010.1	145.00 225.00	600 MHz	9	5-20 mV	10-30 mV	20-40 mV to 600 MHz	1-10 mV	{3} .1, 1, 10 SEC	.1Hz	1 Hz	10 Hz 600 MHz	1 PPM 0.1 PPM	10 MHz	YES OPTION \$25.	YES OPTION \$15.
8010 #8010.1	325.00 405.00	1 GHz	9	1-10 mV	5-20 mV	10-25 mV	1-10 mV	{8} .01-20 SEC	.1 Hz	1 Hz	10 Hz 1 GHz	1 PPM 0.1 PPM	10 MHz	YES STD	YES OPTION \$39.

\* Has precision 0.1 PPM TCXO time base.

#### MODEL 7010

#7010 600 MHz Counter - 1 PPM TCXO \$145.00  
#7010.1 600 MHz Counter - 0.1 PPM TCXO \$225.00

#### OPTIONS

#Ni-Cad-701 Ni-Cad Battery Pack & charging circuitry  
Installs inside unit \$ 15.00  
#EC-70 External Clock input, 10 MHz \$ 25.00  
#CC-70 Carry Case, Padded Black Vinyl \$ 8.95

#### MODEL 8010

#8010 1 GHz Counter - 1 PPM TCXO \$325.00  
#8010.1 1 GHz Counter - 0.1 PPM TCXO \$405.00  
#8010.1-13 1.3 GHz Counter - 0.1 PPM TCXO \$495.00

#### OPTIONS

#Ni-Cad-801 Ni-Cad Battery Pack & charging circuitry  
Installs inside unit \$ 39.00  
#CC-80 Carry Case, Padded Black Vinyl \$ 9.95

#### ACCESSORIES

#TA-00 Telescope Ant with Right Angle BNC \$ 9.95  
#P-100 Probe, 50 ohm, 1x \$13.95  
#P-101 Probe, Lo-Pass, Audio Usage \$16.95  
#P-102 Probe, Hi-Z, General Purpose. \$16.95

master charge

VISA

CIRCLE NO. 54 ON FREE INFORMATION CARD

ORDER FACTORY DIRECT • CALL TOLL FREE



**Optoelectronics inc**

5821 N.E. 14th Avenue, Fort Lauderdale, Florida 33334

**1-800-327-5912**

FROM FLORIDA (305) 771-2051/2

TERMS: Orders to U.S. and Canada, add 5% for shipping, handling and insurance to a maximum of \$10.00. All other orders add 10%. C.O.D. collection fee \$1.00. Orders under \$15.00 add extra \$1.00 handling. Regular checks must clear before order is shipped. Florida residents add 4% sales tax.

newest gear. This type of hamfest is great if you're in the market for a new radio because it's possible to compare specifications and get that "hands-on feel" of the competing equipment that you're considering for purchase. Some manufacturers even set up complete on-the-air stations, allowing you to operate their gear as you would your own ham shack. (Remember to bring along your license!)

Don't be surprised if you become "hooked" on the spot by a particularly fine piece of equipment that you're able to inspect and try out. If you find yourself sold on the gear, you'll find that it's often possible to buy the equipment at a substantial discount,

either directly from the manufacturer or from a dealer. You'll save on shipping costs and sometimes even sales tax as well.

Contests of every description are popular hamfest activities. These include QSL card design contests, Morse code sending and receiving proficiency matches, homebrew-equipment construction competitions, and even humorous events such as "left-foot CW sending" contests. Some hamfests award door prizes to the oldest and youngest hams present, the most-recently-licensed ham, the ham that's traveled the farthest to attend, and the largest all-ham family in attendance at the hamfest.

Reflecting the upsurge in interest in com-

puters and microprocessors, most hamfests include a healthy display of computer equipment and software alongside familiar amateur gear, and many hamfests are really combination ham and computer events. Don't be surprised to see sophisticated computer interfaces that allow one to send and receive Morse code automatically, displaying the characters sent (by means of a keyboard) and received on the computer's video display, not to mention equipment that does the same for RTTY signals. Indeed, some of the more computer-oriented meetings have become more "computer events" than actual hamfests!

**The Big Times.** At the top of the hamfest tree are the major amateur conventions. These are usually sponsored by or in some way affiliated with the American Radio Relay League (ARRL), the national association of radio amateurs. ARRL conventions are conducted on division and state levels, and a national convention is held each year, in different cities on a rotating basis. These events are a cross between less-formal hamfests and formal business conventions. Most regular hamfest activities are present, although swapping and horse-trading usually take a back seat to technical seminars and manufacturers' displays. The most significant difference is that business meetings, membership sessions and the election of officers can be held. Normally, these affairs run two or three days.

Last year's national ARRL convention was held in July at the Baton Rouge Centroplex, a first-class civic center, auditorium and convention complex on the bank of the Mississippi River. The national convention's activities are representative of most of the larger ham conventions, so it's worthwhile to mention some of the activities included. There were more than 25 technical and operating forums, spouses' and children's tours, a hospitality suite for the spouses, breakfast and luncheon meetings, a formal banquet, an FCC question-and-answer session, ARRL membership and directors' meetings, and even church services—conducted by ham clergymen, of course. A very special feature was the Saturday-midnight mystical initiation of amateurs into the "Royal Order of the Wouff Hong," a semisecret, fraternal amateur association dating back to at least 1923 and dedicated to the memory of the League's founder, the late Hiram Percy Maxim. Capping the closing day's activities for hams who felt themselves particularly lucky were the main prize drawings—a feature popular at all of the larger hamfests and at a number of the smaller ones as well.

**Hamfest Locations.** Where are all of these social activities held? Just about everywhere that hams live! Some of the larger and more famous events are the Dayton, Birmingham, Atlanta, SAROC (Nevada), and Jackson's Mill Hamfests. Most ARRL divisions and state groups sponsor annual events, and the 1980 annual ARRL convention will be held in Seattle.

Attending hamfests, swap meets and amateur radio conventions is an excellent way to get a single-dose "maximum exposure" to all aspects of ham radio. And, if your own radio club doesn't sponsor such an event, try to get one going. Remember—hamfests are fun! ♦

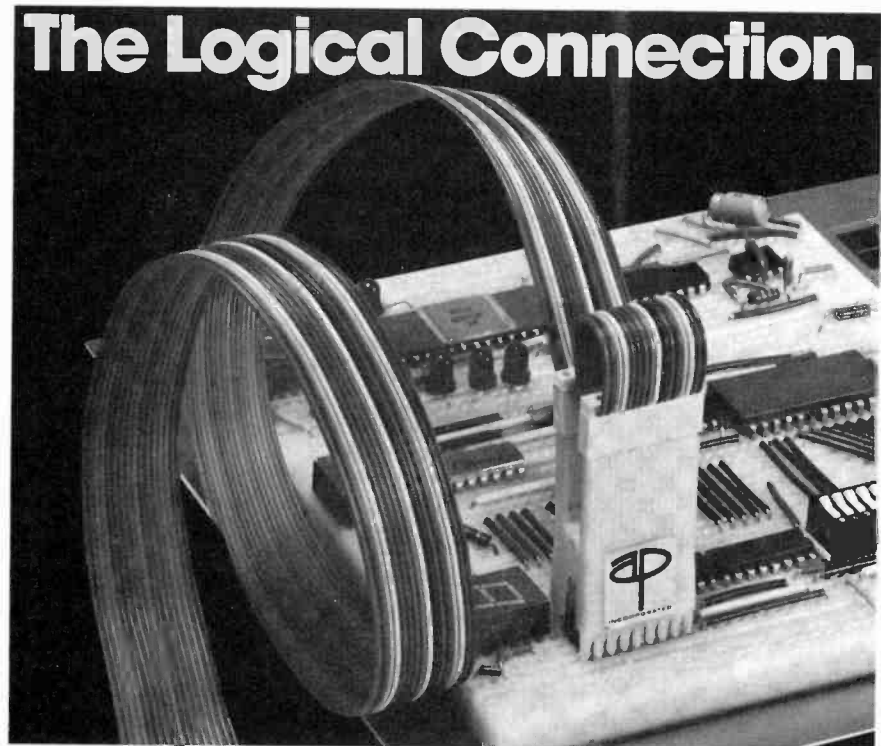

## A P PRODUCTS' faster and easier reach to outboard logic.

A P PRODUCTS' Logical Connections are the answer to "faster and easier" connections between 16, 24, and 40-contact DIPs and any remote logic-testing device.

Each unit is a complete, tested and ready-to-use cable assembly with the test clip installed on one end while the other end of the 18" flat ribbon

cable is available with either an open end or a DIP plug.

The test clip termination end is a pair of single-row socket connectors which attach to the pins of an A P test clip. A 1-1/2" cable loop between connectors allows for free actuation of the test clip, and probe holes in the backs of all connectors provide access to individual lines.

Order from your A P distributor today. For the name of the distributor nearest you call Toll-Free 800-321-9668.

Send for our complete A P catalog, *Baumesweg*, The Faster and Easier Book. Faster and Easier is what we're all about.



**A P PRODUCTS INCORPORATED**  
1359 W. Jackson St.  
Painesville, Ohio • 44077  
Phone: [216] 354-2101

In Europe, contact A P Products GmbH  
Baumesweg 21 • D-7031 Weil 1 • Germany  
Phone: [07157]62424 • TLX: 841 07 23384

For one typical application of an A P Logical Connection, see article in this issue on page 69  
CIRCLE NO. 8 ON FREE INFORMATION CARD



SEE YOUR DEALER TODAY

DEMAND THE ORIGINAL

# 'Firestik'<sup>®</sup>

"THE FUEL-SEEKER"

**DON'T TAKE NO FOR AN ANSWER!!  
THE #1 WIRE-WOUND AND MOST  
COPIED ANTENNA IN THE WORLD!**

Rugged, Shatterproof Fiberglass

**CB**

Antennas and accessories for marine, RV, truck, auto, van and motorcycles, etc.  
SIX COLORS  
Clear, Spun-Gold, Silver-Gray, Black, Red and White

Watch for the New Film  
**SMOKEY and the BANDIT II**  
starring **BURT REYNOLDS**  
and 'Firestik' Antennas!

A TOUCH OF CLASS!

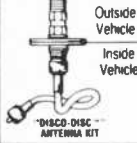

RIGID URMOR®  
SINGLE SHROOK  
RAIL OR SIDE MOUNT KIT

SEND FOR FREE CATALOG

'Firestik' Antenna Company  
2614 East Adams/Phoenix, AZ 85034

Name \_\_\_\_\_  
Street \_\_\_\_\_  
City \_\_\_\_\_  
State \_\_\_\_\_ Zip \_\_\_\_\_

Serving the CB and  
Communications Market Since 1962.

**5-YEAR REPLACEMENT WARRANTY**

CIRCLE NO. 28 ON FREE INFORMATION CARD

## Make Custom S-100 Boards EASY... with VECTOR 8800R2

- +Positive Photo Resist coating over 2 oz. copper on 2 sides.
- Accurate S-100 standard size (5.3 in. x 10 in.) with pre-etched gold contacts, 50 per side, 0.125 sp.
- 2 mylar sheets and strong etching bag supplied free with 8800R2.
- Expose with sunlamp - No camera or darkroom needed.

copper free borders both sides

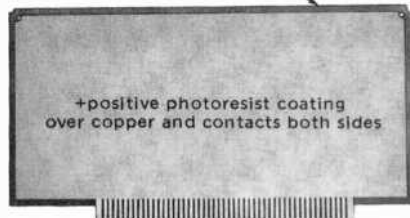

+positive photoresist coating  
over copper and contacts both sides

\$19.95 ea.

Simply expose board to film master image, etch and drill holes. Film may be photographically prepared or homemade using clear mylar supplied. Make circuit art work with Vector R407 rub transfer art work set (\$2.65) or use alternate stick on tape. If not available locally factory order - include \$3.00 shipping, U.S. only.

prices subject to change without notice

**Vector Electronic Company**

12460 Gladstone Ave.  
Sylmar, CA 91342

700979

CIRCLE NO. 64 ON FREE INFORMATION CARD

Start Computing For Just \$129.95 With An  
8085-Based Professional Computer Kit—

# Explorer/85

100% compatible with all 8080A and  
8085 software & development tools!

No matter what your future computing plans may be, Level "A"—at \$129.95—is your starting point.

Starting at just \$129.95 for a Level "A" operating system, you can now build the exact computer you want. Explorer/85 can be your beginner's system, OEM controller, or IBM-formatted 8" disk small business system...yet you're never forced to spend a penny for a component or feature you don't want and you can expand in small, affordable steps!

Now, for just \$129.95, you can own the first level of a fully expandable computer with professional capabilities—a computer which features the advanced Intel 8085 cpu, thereby giving you immediate access to all software and development tools that exist for both the 8085 and its 8080A predecessor (they are 100% software compatible)—a computer which features onboard S-100 bus expansion—plus instant conversion to mass storage disk memory with either 5-1/4" diskettes or standard IBM-formatted 8" disks.

For just \$129.95 (plus the cost of a power supply, keyboard/terminal and RF modulator, if you don't have them already), Explorer/85 lets you begin computing on a significant level...applying the principles discussed in leading computer magazines...developing "state of the art" computer solutions for both the industrial and leisure environment.

### Level "A" Specifications

Explorer/85's Level "A" system features the advanced Intel 8085 cpu, an 8355 ROM with 2k deluxe monitor/operating system, and an 8155 ROM-I/O—all on a single motherboard with room for RAM/ROM/PROM/EPROM and S-100 expansion, plus generous prototyping space.

(Level "A" makes a perfect OEM controller for industrial applications and is available in a special Hex Version which can be programmed using the Netronics Hex Keypad/Display.)

PC Board: glass epoxy, plated through holes with solder mask

• I/O: provisions for 25-pin (DB25) connector for terminal serial I/O, which can also support a paper tape reader...provision for 24-pin DIP socket for hex keyboard/display...cassette tape recorder input...cassette tape recorder output...speaker output...LED output indicator on SOD (serial output) line...printer interface (less drivers)...total of four 8-bit plus one 6-bit I/O ports •Crystal Frequency: 6.144 MHz • Control Switches: reset and user (RST 7.5) interrupt...additional provisions for RST 5.5, 6.5 and TRAP interrupts onboard • Counter/Timer: programmable, 14-bit binary • System RAM: 256 bytes located at F800, ideal for smaller systems and for use as an isolated stack area in expanded systems...RAM expandable to 64k via S-100 bus or 4K on motherboard.

System Monitor (Terminal Version): 2k bytes of deluxe system monitor ROM located at F000 leaving 0000 free for user RAM/ROM. Features include tape load with labeling...tape dump with labeling...examine/change contents of memory...insert data...warm start...examine and change all registers...single step with register display at each break point, a debugging/training feature...go to execution address...move blocks of memory from one location to another...fill blocks of memory with a constant...display blocks of memory...automatic baud rate selection...variable display line length control (1-255 characters/line)...channelized I/O monitor routine with 8-bit parallel output for high speed printer...serial console in and console out channel so that monitor can communicate with I/O ports.

System Monitor (Hex Version): Tape load with labeling...tape dump with labeling...examine/change contents of memory...insert data...warm start...examine and change all

Netronics R&D Ltd., Dept. PE-6  
333 Litchfield Road, New Milford, 06776

Please send the items checked below—

- Explorer/85 Level "A" Kit (ASCII Version), \$129.95 plus \$3 p&h.
- Explorer/85 Level "A" Kit (Hex Version), \$129.95 plus \$3 p&h.
- 8k Microsoft BASIC on cassette tape, \$64.95 postpaid.
- 8k Microsoft BASIC in ROM Kit (requires Levels "B," "D," and "E"), \$99.95 plus \$2 p&h.
- Level "B" (S-100) Kit, \$49.95 plus \$2 p&h.
- Level "C" (S-100 6-card expander) Kit, \$39.95 plus \$2 p&h.
- Level "D" (4k RAM) Kit, \$69.95 plus \$2 p&h.
- Level "E" (EPROM/ROM) Kit, \$5.95 plus 50¢ p&h.
- Deluxe Steel Cabinet for Explorer/85, \$49.95 plus \$3 p&h.
- ASCII Keyboard/Computer Terminal Kit (features a full 128 character set, upper & lower case, full cursor control, 75 ohm video output convertible to baudot output, selectable baud rate, RS232-C or 20 ma. I/O, 32 or 64 character by 16 line formats, and can be used with either a CRT monitor or a TV set (if you have an RF modulator), \$149.95 plus \$2.50 p&h.
- Hex Keypad/Display Kit, \$69.95 plus \$2 p&h.
- Deluxe Steel Cabinet for ASCII Keyboard/Terminal, \$19.95 plus \$2.50 p&h.
- Power Supply Kit (± 8V @ 5 amps) in deluxe steel cabinet, \$39.95 plus \$2 p&h.
- Gold Plated S-100 Bus Connectors, \$4.85 each, postpaid.
- RF Modulator Kit (allows you to use your TV set as a monitor), \$8.95 postpaid.
- 16k RAM Kit (S-100 Board expands to 64k), \$199.95 plus \$2 p&h.
- 32k RAM Kit, \$329.95 plus \$2 p&h.
- 48k RAM Kit, \$459.95 plus \$2 p&h.
- 64k RAM Kit, \$589.95 plus \$2 p&h.
- 16k RAM Expansion Kit (to expand any of the above up to 64k), \$139.95 plus \$2 p&h each.
- Intel 8085 cpu User's Manual, \$7.50 postpaid.
- Special Computer Grade Cassette Tapes, \$1.90 each or 3 for \$5, postpaid.
- 12" Video Monitor (10 MHz bandwidth), \$139.95 plus \$5 p&h.
- North Star Double Density Floppy Disk Kit (One Drive) for Explorer/85 (includes 3 drive S-100 controller, DOS, and extended BASIC with per-

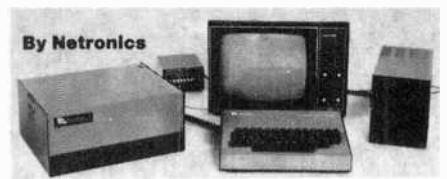

registers...single step with register display at each break point...go to execution address. Level "A" in the Hex Version makes a perfect controller for industrial applications and can be programmed using the Netronics Hex Keypad/Display.



Hex Keypad/Display.

### Hex Keypad/Display Specifications

Calculator type keypad with 24 system defined and 16 user defined keys. 6 digit calculator type display which displays full address plus data as well as register and status information.

### Level "B" Specifications

Level "B" provides the S-100 signals plus buffers/drivers to support up to six S-100 bus boards and includes: address decoding for onboard 4k RAM expansion select-able in 4k blocks...address decoding for onboard 8k EPROM expansion select-able in 8k blocks...address and data bus drivers for onboard expansion...wait state generator (jumper select-able), to allow the use of slower memories...two separate 5 volt regulators.



Explorer/85 with Level "C" card cage.

### Level "C" Specifications

Level "C" expands Explorer's motherboard with a card cage, allowing you to plug up to six S-100 cards directly into the motherboard. Both cage and cards are neatly contained inside Explorer's deluxe steel cabinet.

Level "C" includes a sheet metal superstructure, a 5-card gold plated S-100 extension PC board which plugs into the motherboard. Just add required number of S-100 connectors

### Level "D" Specifications

Level "D" provides 4k or RAM, power supply regulation, filtering decoupling components and sockets to expand your Explorer/85 memory to 4k (plus the original 256 bytes located in the 8155A). The static RAM can be located anywhere from 0000 to EFFF in 4k blocks.

### Level "E" Specifications

Level "E" adds sockets for 8k of EPROM to use the popular Intel 2716 or the TI 2516. It includes all sockets, power supply regulator, heat sink, filtering and decoupling components. Sockets may also be used for soon to be available RAM IC's (allowing for up to 12k of onboard RAM).

### Order A Coordinated Explorer/85 Applications Pak!

Experimenter's Pak (SAVE \$12.50)—Buy Level "A" and Hex Keypad/Display for \$199.90 and get FREE Intel 8085 user's manual plus FREE postage & handling!

Student Pak (SAVE \$24.45)—Buy Level "A," ASCII Keyboard/Computer Terminal, and Power Supply for \$319.85 and get FREE RF Modulator plus FREE Intel 8085 user's manual plus FREE postage & handling!

Engineering Pak (SAVE \$41.00)—Buy Levels "A," "B," "C," "D," and "E" with Power Supply, ASCII Keyboard/Computer Terminal, and six S-100 Bus Connectors for \$514.75 and get 10 FREE computer grade cassette tapes plus FREE 8085 user's manual plus FREE postage & handling!

Business Pak (SAVE \$89.95)—Buy Explorer/85 Levels "A," "B," and "C" (with cabinet), Power Supply, ASCII Keyboard/Computer Terminal (with cabinet), 16k RAM, 12" Video Monitor, North Star 5-1/4" Disk Drive (includes North Star BASIC) with power supply and cabinet, all for just \$1599.40 and get 10 FREE 5-1/4" minidiskettes (\$49.95 value) plus FREE 8085 user's manual plus FREE postage & handling!

Continental U.S.A. Credit Card Buyers Outside Connecticut  
**CALL TOLL FREE 800-243-7428**

To Order From Connecticut Or For Technical Assistance, Etc. Call (203) 354-9375

sonalized disk operating system—just plug it in and you're up and running!), \$699.95 plus \$5 p&h.

Power Supply Kit for North Star Disk Drive, \$39.95 plus \$2 p&h.

Deluxe Case for North Star Disk Drive, \$39.95 plus \$2 p&h.

Experimenter's Pak (see above), \$199.90 postpaid.

Student Pak (see above), \$319.85 postpaid.

Engineering Pak (see above), \$514.75 postpaid.

Business Pak (see above), \$1599.40 postpaid.

Total Enclosed \$ \_\_\_\_\_

(Conn. res. add sales tax) By—

Personal Check  M.O./Cashier's Check

Visa  MasterCard

(Bank # \_\_\_\_\_)

Acct. # \_\_\_\_\_

Signature \_\_\_\_\_ Exp. Date \_\_\_\_\_

Print Name \_\_\_\_\_

Address \_\_\_\_\_

City \_\_\_\_\_

State \_\_\_\_\_ Zip \_\_\_\_\_

Send Me Information

They look expensive.  
They sound expensive.  
But they're not because you  
build them yourself.

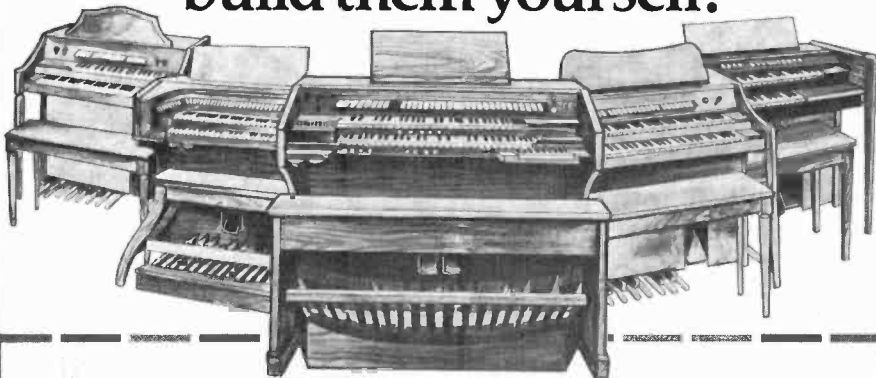

### The Magnificent Schober Electronic Organs.

Imagine the pride and joy of owning one of the world's great organs. And for up to 50% less than an instrument of comparable sound and quality. Schober organ kits come in 5 different styles and sizes to fit your musical taste and budget.

**Mail this coupon today for free information.**

The Schober Organ Corp., Dept. PE-90  
43 West 61st Street, New York, N.Y. 10023

Send me free catalog.

Name \_\_\_\_\_

Address \_\_\_\_\_

City \_\_\_\_\_ State \_\_\_\_\_ Zip \_\_\_\_\_

CIRCLE NO. 61 ON FREE INFORMATION CARD

# SAVE!

MONEY • TIME • FREIGHT

- ♪ QUALITY STEREO EQUIPMENT AT LOWEST PRICES.
- ♪ YOUR REQUEST FOR QUOTATION RETURNED SAME DAY.
- ♪ FACTORY SEALED CARTONS—GUARANTEED AND INSURED.
- ♪ SAVE ON NAME BRANDS LIKE:

PIONEER	SANSUI
KENWOOD	DYNACO
SHURE	SONY
MARANTZ	KOSS

AND MORE THAN 50 OTHERS  
BUY THE MODERN WAY  
BY MAIL—FROM

**ia**  
**illinois audio**

BANK CARDS ACCEPTED

12 East Delaware  
Chicago, Illinois 60611  
312-664-0020

CIRCLE NO. 39 ON FREE INFORMATION CARD

# Price Without Sacrifice.

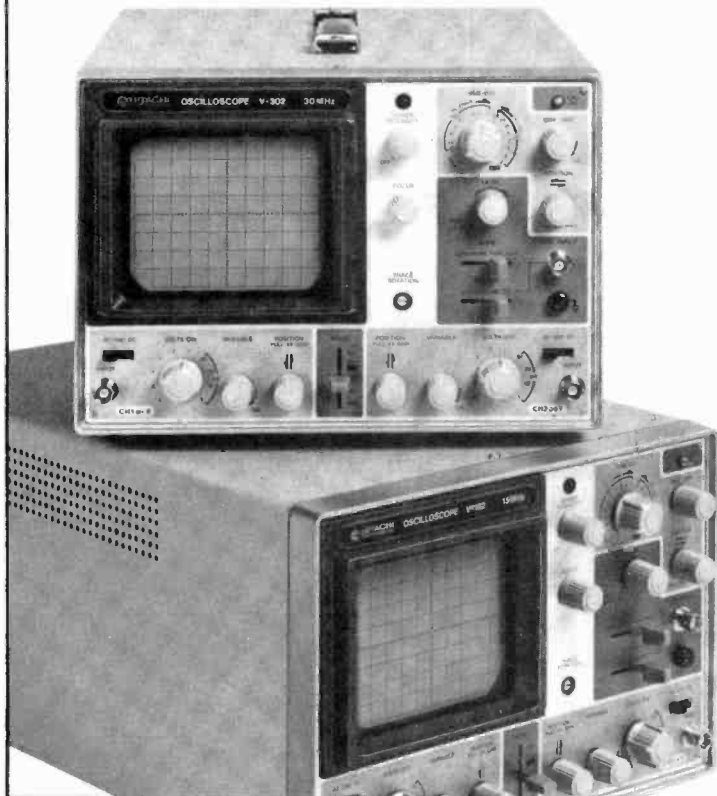

## HITACHI V-302 & V-152

Put a proven Hitachi dual-trace oscilloscope on your bench for as little as \$695. Our V-152 15MHz model includes unprecedented sensitivity (1 mV/div.)...10X sweep magnification...front panel XY operation...trace rotation...Z-axis input...and more. Need greater bandwidth? Our V-302 model is the only 30MHz dual-trace scope with signal delay line priced under \$1000, with all the above features, to make your testing operations fast, easy, and accurate. Reliability is exceptional, too. (As you'd expect from a manufacturer with over 20 years of experience "outscoping" the competition.) So exceptional, in fact, that Hitachi quality is backed by a 2-year warranty...the longest in the industry. Whether you use it for teaching or repairs, for video, audio, or computer testing, you can't find more scope for your dollar than at Hitachi. Write for more details.

**Hitachi...The measure of quality.**

- V-152 15 MHz Dual Trace . . . \$695\*
- V-302 30 MHz Dual Trace . . . \$945\*

\*Probes included.

**HITACHI**  
Hitachi Denshi America, Ltd.  
175 Crossways Park West  
Woodbury, NY 11797  
(516) 921-7200

CIRCLE NO. 36 ON FREE INFORMATION CARD

# English Broadcasts Audible in No. America

by Glenn Hauser

TIME <sup>1</sup> CDT	TIME UTC/GMT	STATION	QUAL. <sup>2</sup>	FREQUENCIES, kHz <sup>3</sup>
4:00-4:15 a.m.	0900-0915	BBC	A	15070, 11955, 11750, 9640, 9510, 6195
4:00-4:15 a.m.	0900-0915	R. Japan*	B	9505
4:00-4:30 a.m.	0900-0930	NSB, Tokyo	C	6115 (exc. Sun.)
4:00-4:30 a.m.	0900-0930	V. of Vietnam	C	12033, 10040, 7470
4:00-5:30 a.m.	0900-1030	R. Australia*	B	15145 or 9670
4:00-6:00 a.m.	0900-1100	AFRTS-Washington	A	11805, 9700, 9575, 6030
4:15-6:00 a.m.	0915-1100	BBC	C	17790, 17695, 15070
4:30-5:30 a.m.	0930-1030	V. of Germany	C	17780
5:00-5:15 a.m.	1000-1015	UN Radio	A	15250, 11090-LS8 1 9565, (Sat. only)
5:00-5:30 a.m.	1000-1030	R. Japan	B	9505
5:00-5:30 a.m.	1000-1030	R. Korea	C	11725, 9570, 9525
5:00-5:30 a.m.	1000-1030	V. of Vietnam	C	12033, 10040, 7470
5:00-fade out	1000	R. Australia	B	6045, 5995
5:00-11:02 a.m.	1000-1602	ABC, Perth	B	9610
5:30-6:30 a.m.	1030-1130	Sri Lanka Br. Corp.	C	17850, 15120, 11835 (not all Eng.)
5:30-7:00 a.m.	1030-1200	V. of Asia, Taiwan	D	5980 (Sun 1030-1040) (time varies)
5:30-8:00 a.m.	1030-1300	CBC Northern Service	B-C	9625, 6065 (not all English)
5:55-6:55 a.m.	1055-1155	R. Thailand	C	11905, 9655
6:00-6:15 a.m.	1100-1115	R. Japan	B	9505
6:00-6:30 a.m.	1100-1130	R. Mogadishu	D	9585
6:00-6:56 a.m.	1100-1156	R. RSA	C	25790, 21535
6:00-7:45 a.m.	1100-1245	TWR-Bonaire	A	15255 (Sat-1330, Sun-1415)
6:00-7:50 a.m.	1100-1250	R. Pyongyang	C	9977
6:00-8:00 a.m.	1100-1300	R. Australia	A	9580
6:00-8:30 a.m.	1100-1330	BBC	A-B	25650, 21710, 21660, 21550, (11775, 1100-1130 + 1300-1330 only) 11750, 9510, 6195
6:00-9:00 a.m.	1100-1400	R. Moscow	B	17810, 15150, 15130, 12010 (9600 + 600 via Cuba)
6:00-9:00 a.m.	1100-1400	4VEH, Haiti	B	11835, 9770
6:00-10:00 a.m.	1100-1500	VOA	B	11715, 9585
6:00-11:00 a.m.	1100-1600	AFRTS-Washington	A	15430, 15330, 11805, 9700
6:15-6:30 a.m.	1115-1130	Vatican R.	C	21485, 17840 (not Sun.)
6:30-6:45 a.m.	1130-1145	R. R.I. Yogyakarta	C	5046
6:30-6:50 a.m.	1130-1150	R. Nacional, Angola	D	11955, 9535, 7245
7:00-7:15 a.m.	1200-1215	R. Japan	B	9505
7:00-7:15 a.m.	1200-1215	V. of Kampuchean People	C	11938, 9694
7:00-7:20 a.m.	1200-1220	Vatican R.	B	21485 (not Sun.)
7:00-7:30 a.m.	1200-1230	Kol Israel	C	25640, 17612.5
7:00-7:30 a.m.	1200-1230	R. Tashkent	C	15460, 15125, 11925, 11730
7:00-7:45 a.m.	1200-1245	V. of Germany	B	21600, 17875, 17765, 15410
7:00-7:45 a.m.	1200-1245	R. Berlin International	C	21540, 21465, 17700, 15165
7:00-7:55 a.m.	1200-1255	R. Peking	B	15520, 15300 †
7:00-8:00 a.m.	1200-1300	V. of Turkey	C	17820, 11800
7:00-8:00 a.m.	1200-1300	H.C.J.B., Ecuador	A	26020, 15115, 11740
7:15-7:30 a.m.	1215-1230	V. of Greece	D	21455 †, 17835 †, 11730
7:20-7:50 a.m.	1220-1250	R. Ulan Bator, Mongolia	D	12068, 9553 or 6383, 4950 (no: Sun) †
7:30-7:55 a.m.	1230-1255	Austrian R.	B	21655
7:30-7:55 a.m.	1230-1255	R. Tirana	D	11965, 9515
7:30-8:00 a.m.	1230-1300	R. Sweden	C	21690
7:30-8:00 a.m.	1230-1300	BBC (English by radio)	C	21695
7:30-10:51 a.m.	1230-1551	WYFR, Family Radio	A	21615, 17845 (Sun. only)
7:45-8:30 a.m.	1245-1330	R. Korea	C	9815 †
8:00-8:15 a.m.	1300-1315	R. Japan	B	9505
8:00-8:30 a.m.	1300-1330	R. Finland	B	15400
8:00-8:30 a.m.	1300-1330	R. Bucharest	C	17850, 15250, 11940
8:00-9:00 a.m.	1300-1400	R. Australia	C	11705, 9770, 6080
8:00-9:30 a.m.	1300-1430	H.C.J.B., Ecuador	A	26020, 17890, 15115, 11740
8:00-10:50 a.m.	1300-1550	R. RSA	B	25790, 21535, 15220
8:00 a.m. 6:00 p.m.	1300-2300	CBC Northern Service	B-C	11720, 9625 (not all English)
8:15-8:45 a.m.	1315-1345	Swiss R. International	C	21570, 21520
8:30-9:20 a.m.	1330-1420	R. Nederland	C	17605
8:30-9:30 a.m.	1330-1430	R. Finland	B	15400 (Sun. only)
8:30-10:00 a.m.	1330-1500	All India R.	C	15335, 11810
8:30-11:00 a.m.	1330-1600	BBC	B-C	25650, 21710, 21660, 21550, 15400 (from 1430), 15070
8:30 a.m. 5:00 p.m.	1330-2200	R. Moscow (via Cuba)	B	11840
8:57-11:55 a.m.	1357-1655	V. of Philippines	D	11950, 9579 (Sun-1555)
9:00-9:30 a.m.	1400-1430	R. Japan	B	9505
9:00-9:30 a.m.	1400-1430	R. Portugal	C	21475 (not Sun.)
9:00-9:30 a.m.	1400-1430	R. Sweden	B	21615
9:00-9:30 a.m.	1400-1430	R. Norway	B	21730, 17840 (Sun only)
9:00-9:30 a.m.	1400-1430	V. Rev. Party, N. Korea	D	4557, 4109
9:00-9:30 a.m.	1400-1430	R. Tashkent	C	15460, 15125, 11925, 11730
9:00-9:45 a.m.	1400-1445	R. Berlin International	C	21540, 21465, 17700
9:00-10:00 a.m.	1400-1500	R. Moscow	B	17810, 15150, 15130, 12070, 12010, 11790, 9790, 9580, 7170
9:00-10:00 a.m.	1400-1500	V. of Indonesia	C	15200, 11789
9:00-12:30 a.m.	1400-1730	R. Australia	C	17795, 9770
9:30-10:00 a.m.	1430-1500	R. Finland	B	21475, 15400
9:30-10:25 a.m.	1430-1525	R. Nederland	B	21480
9:30-11:00 a.m.	1430-1600	H.C.J.B., Ecuador	A	26020, 17890, 15115
9:30-11:00 a.m.	1430-1600	Burma Br. Ser.	D	5985, 5040

# DISCOUNT PRICES!

Top Quality  
Money-Back Guarantee  
All Factory Prime

## MICROPROCESSOR IC'S

Z-80	8.95	6800	6.75
Z-86A	10.95	6802	11.50
8088A	5.50	6502	9.50
8088A	11.95	6504	9.50
Z8001	189.00	6505	9.50
Z8002	139.00	2901	8.95

## MICROPROCESSOR SUPPORT IC'S

8212	2.49	280-PIO	6.95
8284	3.90	280A-PIO	8.25
8286	2.49	280-CTC	6.95
8284	2.95	280A-CTC	8.25
8226	2.25	280-DMA	24.95
8228	4.75	280A-DMA	32.95
8238	4.90	280-SIO/0	33.95
3251	5.95	280A-SIO/0	37.95
8253	19.50	280-SIO/1	33.95
8255	5.70	280Z-SIO/1	37.95
8257	19.50	280-SIO/2	33.95
8259	19.50	280A-SIO/2	37.95
6810	4.75	6860	8.95
6820	3.90	6520	6.75
6821	3.90	6522	9.75
6840	4.10	6532	19.95
6852	3.90	6551	13.75

## MEMORY • RAMS • PROMS • EPROMS

2114L-450 ns	4.50	2101-450 ns	1.95
2114L-200 ns	5.95	21102-250 ns	1.10
4044-450 ns	4.25	21102-450 ns	.99
4116-200 ns	7.95	2111-450 ns	2.95
4116-150 ns	12.95	2112-450 ns	1.95
4096-5	3.50	2147-85 ns	19.95
MCM 6604 AC	3.50	2708-450 ns	8.95
AM 9060 COC	2.95	2716-450 ns	25.95
51D1-3	4.95	2732-450 ns	79.95

## SOUND GENERATORS

SN76477	Complex Sound Generator	249
AY-3-8910	GI Sound Gen (Add \$3.00 for manual) 64 Pgs	11.95

## UARTS

AY-5-1013A	3.95	AY-3-1015A	5.10
AY-3-1014A	6.50	TR1602A	3.50

## LINEAR

LM 301N-8	32	LM 340T Series	1.15
LM 301AH	32	LM 387N-8	.99
LM 307N-8	25	LM 393N-8	.99
LM 307H	25	LM 3900N-14	.58
LM 308H	75	LM 3909N-8	.99
LM 311N-8	59	LM 739DC-14	.99
LA 319H	90	LM 741CN-14	.19
LM 320K Series	1.35	RC 1556N-8	1.25
LM 320T Series	1.15	LM 4250CH	.95
LA 323K	4.95	CA 3130T	2.25
LM 339N-14	.98	LM 4136N-14	.95
LM 340K Series	1.35	LM 383T	1.25

## SOCKETS

	Low Wire Wrap #3			Low Wire Wrap #3			
	Profile	Gold	Tin	Profile	Gold	Tin	
8 Pin	14	49	29	22 Pin	28	99	69
14 Pin	16	57	37	22 Pin	16	99	70
15 Pin	20	61	41	24 Pin	36	110	85
18 Pin	10	89	59	28 Pin	39	139	110
20 Pin	28	99	69	40 Pin	55	175	140

## SPECIALS OF THE MONTH

While Supply Lasts

ECL 10146L RAM 1024X-29 ns	6.95
AM 3705 PMOS 8-Ch Multiplexer	8.95
MM 500H Dual 25-Bit Shift Register	4.95
TR1671 Asyn/Sync Receiver - Transmitter	16.95
95H90 Hi-Speed Div 10/11 Prescaler	10.95
MCT6 Dual Opto Isolator 1500V	.99
ICL 7107 CPL 3 1/2-Digit A/D Conv. LED	11.50
AY-5-2376 Keyboard Encoder 88 Keys	10.50
AY-5-3600 Keyboard Encoder 90 Keys	9.95
1488 or 1489 Liner Driver/Receiver	.99
18-Pin Low Profile Sockets End Stackable	1.10

**HOW TO ORDER** - Pay by check, credit card, or C.O.D. Foreign pay in U.S. Funds. Order by phone or mail. \$100 minimum. Prices valid thru last day of cover date. Shipping - \$2.00 for the first 2 lbs. For surface airt 35c for ea. add'l lb. For air add 70c for each add'l lb. Foreign - Add 10% for shipping and handling. C.O.D.'s add \$1.85. Guaranteed satisfaction or your money back. We reserve the right to limit quantities. Some items subject to prior sale. We are not responsible for typos. SEND FOR OUR FREE FLYER Contains complete list of 741 S00 IC'S

**Components Express, Inc.**

1380 E. Edinger, Unit PE  
Santa Ana, CA 92705  
(714) 558-3972

"Have you kissed your computer lately?"

CIRCLE NO. 14 ON FREE INFORMATION CARD

# TUNE IN!

## Build the World Famous CHROMA-CHIME KIT

Give your friends a warm welcome. Yes, think how delighted and amazed they will be to hear the musical Chroma-Chime play when they press the front door bell!

The Chroma-Chime uses a microcomputer to play 24 well-known tunes instead of the regular ding-dong bell or buzzer. This British designed unit uses a Texas Instruments TMS 1000 specially programmed with a complete repertoire of tunes built in. The kit is simplicity itself for ease of construction. Absolutely everything needed is supplied, including:

- \* Resistors, Capacitors, Diodes, Transistors, I.C. Socket and all hardware
- \* Texas Instruments TMS 1000 microcomputer
- \* Comprehensive kit manual with full circuit details
- \* Ready drilled and legended PCB included

only \$39.95 incl. p & p

When built, simply substitute for your old door chime or bell, no additional wiring needed, can be operated either from a 16 volt AC transformer or from two regular 9 volt batteries.

Plays 24 well-known tunes including:

- Star Spangled Banner
- William Tell Overture
- Greensleeves
- Mozart Sonata
- Oh come all ye faithful
- plus many other popular favourites.

- \* No previous microcomputer experience necessary
- \* All programming retained is on chip ROM
- \* Fully guaranteed.

TMS 1000 N-MP0027A Microcomputer chip available separately if required. Full 24 tune device supplied with data sheet and fully guaranteed only \$12.50 incl. p & p.



To order, send either a personal check or money order, alternatively we can deduct from your Visa or Master Charge account.

Absolutely no risk, money back if not delighted. \$39.95 Inclusive of air mail, direct to the USA. Delivery may take 14 to 28 days.

Ordering from the UK is just like any other place in the USA. 10,000's already sold!

To: CHROMATRONICS, RIVER WAY, PE-80 HARLOW, ESSEX, ENGLAND. Our phone (01144) 279 418611

Please send me \_\_\_\_\_ kits  
NAME \_\_\_\_\_  
ADDRESS \_\_\_\_\_

I enclose checks value \$ \_\_\_\_\_ or debit my Visa/Master Charge account no: \_\_\_\_\_

Signature \_\_\_\_\_  
Dealers note: Available in kit or ready built from: Timely Products Sales Inc. Chicago, Tel: (312) 263 6231



9:30 a.m.-5:00 p.m.	1430-2200	UN Radio	A	21670, 15410 (when in session)
9:35-10:20 a.m.	1435-1520	R. Nepal	D	3425 or 7105 or 9590
10:00-10:15 a.m.	1500-1515	R. Japan	C	9505
10:00-11:00 a.m.	1500-1600	V. of Rev. Ethiopia	D	9560
10:00-11:00 a.m.	1500-1600	BBC	B	17830, 15260 (Sat, Sun)
10:00-11:00 a.m.	1500-1600	R. Moscow	B	12070, 12010, 11790, 11870, 9790, 9580, 7170
10:00-12:30 a.m.	1500-1730	BESHKJ, Jordan	D	9560
10:30-11:00 a.m.	1530-1600	R. Afghanistan	D	4775
10:30-11:00 a.m.	1530-1600	R. Yugoslavia	C	15300, 15240
10:30-11:00 a.m.	1530-1600	Swiss R. International	B	21570
10:30-11:15 a.m.	1530-1615	NSB, Tokyo	C	9595, 6055 (exc. Sun)
10:30-11:30 a.m.	1530-1630	V. of Vietnam	C	12033, 10040, 7470
10:45-11:00 a.m.	1545-1600	R. Canada International	A	17820, 15160
11:00-11:15 a.m.	1600-1615	R. Japan	C	9505
11:00-11:15 a.m.	1600-1615	R. Pakistan	C	21755, 21635, 21486, 17910, 17660 †
11:00-11:30 a.m.	1600-1630	R. Korea	B	11830, 9720
11:00-11:30 a.m.	1600-1630	R. Norway	B	15175 (Sun only)
11:00-12:00 a.m.	1600-1700	R. Moscow	B	15210, 12070, 12010, 11870, 11790
11:00 a.m.-12:09 p.m.	1600-1709	BBC	B	21710, 21550, 17880
11:00 a.m.-1:00 p.m.	1600-1800	AFRTS-Washington	A	17765, 15430, 15330, 11805
11:00 a.m.-6:00 p.m.	1600-2300	VOA	A	26040, 21485, 17870, 17710, 15445, (15410 to 2200)
11:05-11:55 a.m.	1605-1655	R. France International	B	25820, 21675, 21620, 21580, 17860, 17850, 17720, 15315, 15300
11:10-11:55 a.m.	1610-1655	BRT, Belgium	C	17730 †
11:30 a.m.	1630	R. Singapore	C	11940 (fade-in time varies)
11:45-12:00 a.m.	1645-1700	R. Canada International	A	17820, 15325
12:00-12:15 p.m.	1700-1715	R. Japan	C	9505
12:00-12:15 p.m.	1700-1715	Vatican R.	C	17900
12:00-12:30 p.m.	1700-1730	R. Pakistan	C	15470, 11675
12:00-1:00 p.m.	1700-1800	HCBJ, Ecuador	B	26020, 21480, 17790 †
12:00-1:00 p.m.	1700-1800	WYFR, Family Radio	A	21615, 15160
12:00-1:00 p.m.	1700-1800	R. Moscow	B	15210, 12070, 12010, 11870, 11790
12:09-12:45 p.m.	1709-1745	BBC	B	17830, 15260 (Sat & Sun only)
12:15-1:05 p.m.	1715-1805	V. Of Germany	C	21600
12:45-3:00 p.m.	1745-2000	BBC	C	17705, 15400, 15070, 12095 (11820 from 1800)
12:45-5:30 p.m.	1745-2230	All India R.	C	11620
1:00-1:15 p.m.	1800-1815	R. Japan	B	9505
1:00-1:30 p.m.	1800-1830	R. Canada International	A	21630, 17820, 15260
1:00-1:30 p.m.	1800-1830	R. Norway	C	15175 (Sun only)
1:00-1:45 p.m.	1800-1845	R. Korea	C	15255, 11830
1:00-2:00 p.m.	1800-1900	V. of Vietnam	C	15012, 10040
1:00-2:00 p.m.	1800-1900	R. Moscow	B	15210, 12070, 12050, 12010, 11870, 11790
1:00-2:00 p.m.	1800-1900	WYFR, Family Radio	A	21615, 15425
1:00-2:00 p.m.	1800-1900	V. of Nigeria	C	15119, 15185
1:00-2:00 p.m.	1800-1900	R. Uganda	C	15250
1:00-3:00 p.m.	1800-2000	R. Australia	C	11800 or 15200, and 21630 †
1:00-4:00 p.m.	1800-2100	R. Kuwait	C	11665 †
1:00-5:00 p.m.	1800-2200	B.S.K. Saudi Arabia	C	11854
1:00-5:00 p.m.	1800-2200	AFRTS-Washington	A	21570, 17765, 15430, 15345, 15330
1:00 p.m.-1:25 a.m.	1800-0625	R. New Zealand	C	15345, 17860 or 11835
1:15-1:45 p.m.	1815-1845	Swiss R. International	C	21585, 17830, 17760
1:15-2:15 p.m.	1815-1915	R. Bangladesh	D	15285, 11765 (both vary) †
1:30-1:35 p.m.	1830-1835	UN Radio	A	21670, 19505-SSB, 15410 (Fri)
1:30-2:00 p.m.	1830-1900	V. of Revolution, Guinea	C	15308 (varies) (Mon and Fri) (irregular)
1:30-2:30 p.m.	1830-1930	V. of Iran	D	9022
1:45-2:00 p.m.	1845-1900	R. Senegal	C	11895
1:45-2:15 p.m.	1845-1915	Sri Lanka Br. Corp.	C	17850, 15120, 15115, 11870
2:00-2:10 p.m.	1900-1910	R. Tahiti	C	15170, 11825 (exc. Sun)
2:00-2:15 p.m.	1900-1915	R. Japan	C	15270
2:00-2:30 p.m.	1900-1930	R. Canada International	A	17875, 15325
2:00-2:30 p.m.	1900-1930	R. Afghanistan	A	21630, 17820, 15260
2:00-3:00 p.m.	1900-2000	HCBJ, Ecuador	C	15076 (varies)
2:00-3:00 p.m.	1900-2000	R. Moscow	C	26020, 21480, 17885, 15405 †
2:00-5:00 p.m.	1900-2200	WYFR, Family Radio	B	15210, 12050, 12010, 11870, 11790
2:45-4:15 p.m.	1945-2115	R. Free Grenada	A	21615, 21525, 15130
3:00-3:15 p.m.	2000-2015	R. Japan	C	15104 (time varies and irregular)
3:00-3:30 p.m.	2000-2030	R. Algiers	B	15270
3:00-3:30 p.m.	2000-2030	R. Canada International	C	15230, 15157, 11810, 11646 or 11615, 9610, †
3:00-3:30 p.m.	2000-2030	Kol Israel	A	17875, 17820
3:00-4:00 p.m.	2000-2100	R. Moscow	B	21675, 17645, 11610
3:00-4:15 p.m.	2000-2115	BBC	B	15210, 15180, 12050, 12010, 11870, 11790
3:00-11:00 p.m.	2000-0400	R. Moscow (via Cuba)	A	21710, 17840, 15260, 15070, 6175
3:10-4:40 p.m.	2010-2140	R. Habana Cuba	C	600
3:30-4:20 p.m.	2030-2120	R. Nederland	A	11920
3:30-4:30 p.m.	2030-2130	V. of Vietnam	B	21640, 17695, 17605, 15220
3:30-4:30 p.m.	2030-2130	V. Turkey	C	15012, 14992, 10040
3:50-4:00 p.m.	2050-2100	R. Free Europe	C	11955
3:50-4:40 p.m.	2050-2140	R. Habana Cuba	B	15290 † (Fri.)
4:00-4:15 p.m.	2100-2115	R. Japan	C	17750, 9770
4:00-4:45 p.m.	2100-2145	R. Nacional, Venezuela	B	15270
4:00-4:50 p.m.	2100-2150	R. RSA	C	15400 (irr; time + freq. vary)
4:00-5:00 p.m.	2100-2200	R. Andorra	B	21535, 17780, 15155
4:00-5:00 p.m.	2100-2200	V. of Nigeria	D	6215 (Sun. only)
4:00-5:00 p.m.	2100-2200	R. Moscow	C	15185, 15119
			B	17720, 15180, 12050, 12010, 9500

CIRCLE NO. 11 ON FREE INFORMATION CARD



4:00-6:00 p.m.	2100-2300	CBC Radio	A	17875, 15325 (Mon. - Fri.)
4:15-6:00 p.m.	2115-2200	BBC	A	21710, 15420, 15260, 15070, 6175
4:15-7:00 p.m.	2115-2400	R. Free Grenada	B	15045 (time varies)
4:30-5:00 p.m.	2130-2200	R. Canada International	A	17820, 15150, 11945 (17875, 15325 Sat./Sun. only)
4:30-5:00 p.m.	2130-2200	KGEI, San Francisco	C	15280
4:30-5:00 p.m.	2130-2200	HCBJ Ecuador	C	26020, 21480, 17735, 15405 †
4:30-5:00 p.m.	2130-2200	R. Sofia	B	15135, 11750 †
4:30-5:30 p.m.	2130-2230	R. Baghdad	C	9745
4:40-5:40 p.m.	2140-2240	V. of Free China	C	17890, 15270, 11825
5:00-5:15 p.m.	2200-2215	R. Japan	C	17755, 15230 (via Portugal)
5:00-5:30 p.m.	2200-2230	V. Chile	B	17798, 17791, 15150 †
5:00-5:30 p.m.	2200-2230	R. Norway	C	17795, 15345, 15175 (Sun. only)
5:00-5:45 p.m.	2200-2245	BBC	A	21710, 15420, 15260, 15070, 9590, 6175
5:00-6:00 p.m.	2200-2300	WYFR, Family Radio	A	21525, 15130, 11855
5:00-6:00 p.m.	2200-2300	R. Moscow	B	17720, 15455, 15180, 15140, 12050, 11750
5:00-6:00 p.m.	2200-2300	V. of Turkey	B	11955, 9515, 7215
5:00-7:00 p.m.	2200-2400	AFRTS-Washington	A	25615, 21570, 15430, 15345, 15330
5:00-7:00 p.m.	2200-2400	CBC Southern Service	A	9755, 5960 (Mon.-Fri.)
5:00-8:00 p.m.	2200-0100	VOA	A	21460
5:15-5:30 p.m.	2215-2230	R. Yugoslavia	C	9620
5:30-6:00 p.m.	2230-2300	Kol Israel	A	21675, 21555, 15582, 15105, 11637, 9815
5:45-6:00 p.m.	2245-2300	BBC	A	15420, 15260, 15070, 9590, 6175
5:45-6:00 p.m.	2245-2300	SOORE, Uruguay	C	11885, 9515 (time varies)
5:45-6:00 p.m.	2245-2300	UN Radio	A	15225, 11830 (Fri)
6:00-6:30 p.m.	2300-2330	R. Japan	C	17755
6:00-6:30 p.m.	2300-2330	R. Korea	C	15570, 15375, 11820 †
6:00-6:30 p.m.	2300-2330	R. Sweden	B	15275, 11705
6:00-6:30 p.m.	2300-2330	R. Vilnius	B	15405, 11790, 11770
6:00-6:50 p.m.	2300-2350	Rdf. Argentina	C	11710 (Mon-Fri)
6:00-7:00 p.m.	2300-2400	4VEH, Haiti	B	11835, 9770
6:00-7:30 p.m.	2300-2430	BBC	A	15420, 15260, 15070, 11910, 9590, 9580, 9410, 7325, 6175, 6120, 5975
6:00-7:50 p.m.	2300-2450	R. Pyongyang	C	9977
6:00-8:00 p.m.	2300-0200	R. Moscow	A	15425, 15245, 15100, 12050, 12030, 11960, 11750, 11735, 9685, 9665, 9600, 9530
6:00 p.m.-12:06 a.m.	2300-0506	CBC Northern Service	B.C	9625, 6195 (not all English)
6:05-6:20 p.m.	2305-2320	Austrian R.	C	12015, 9770, 5945 (Sun only)
6:35-6:55 p.m.	2335-2355	SODRE, Uruguay	C	11885, 9515 (time varies)
6:45-7:45 p.m.	2345-2445	R. Japan	C	17825, 15270
7:00-7:15 p.m.	0000-0015	R. Japan	C	17755
7:00-7:25 p.m.	0000-0025	R. Tirana	B	9750, 7065
7:00-7:30 p.m.	0000-0030	Kol Israel	A	21555, 15582, 11637, 9815
7:00-7:30 p.m.	0000-0030	R. Norway	C	15345, 9605 (Mon only)
7:00-7:30 p.m.	0000-0030	R. Canada International	A	9755, 5960
7:00-7:55 p.m.	0000-0055	R. Peking	B	17855, 17680, 15520, 15120
7:00-8:00 p.m.	0000-0100	R. Sofia	B	15330
7:00-8:00 p.m.	0000-0100	AFRTS-Washington	A	25615, 21570, 15330, 15345
7:00-9:00 p.m.	0000-0200	R. Luxembourg	C	6090
7:00-9:00 p.m.	0000-0200	VOA	A	17730, 15205, 11740, 9650, 6, 30
7:00-12:00 p.m.	0000-0500	FEBC Philippines	C	17810
7:00 p.m.-4:00 a.m.	0000-0900	UN Radio	A	6055 (when in session)
7:05-8:55 p.m.	0005-0155	Spanish Foreign R.	B	11880, 9630
7:15-8:00 p.m.	0015-0100	BRT, Belgium	C	15385, 15175 †
7:30-7:50 p.m.	0030-0050	SODRE, Uruguay	C	11885, 9515 (time varies)
7:30-8:00 p.m.	0030-0100	R. Budapest	B	17710, 15220, 11910, 9835, 9585 6105 (Wed., Fri. only)
7:30-8:00 p.m.	0030-0100	R. Prague	C	6055
7:30-8:00 p.m.	0030-0100	R. Kiev	B	15525, 11735, 9800
7:30-8:00 p.m.	0030-0100	La Cruz del Sur, Bolivia	D	4875 (Mon only)
7:30-9:00 p.m.	0030-0200	HCBJ, Ecuador	A	15250 †
7:30-9:30 p.m.	0030-0230	BBC	A	15260, 15070, 11835, 11750, 9580, 9410, 7325, 6175, 6120, 5975
7:30-9:30 p.m.	0030-0230	HCBJ, Ecuador	B	9745, 11915
7:50-8:35 p.m.	0050-0135	TWR-Bonaire	B	11925
8:00-8:15 p.m.	0100-0115	R. Japan	C	17755
8:00-8:15 p.m.	0100-0115	Vatican R.	B	11845, 9605, 6015
8:00-8:20 p.m.	0100-0120	RAI, Italy	B	11800, 9575 or 15315
8:00-8:25 p.m.	0100-0125	Kol Israel	A	21555, 15582, 11637, 9815
8:00-8:30 p.m.	0100-0130	R. Canada International	A	5960, 17820, 9755
8:00-8:30 p.m.	0100-0130	R. Budapest	B	17710, 15220, 11910, 9835, 9585, 6105 (not Mon.)
8:00-8:45 p.m.	0100-0145	R. Berlin International	C	11975, 9730
8:00-8:55 p.m.	0100-0155	R. Prague	B	11990, 9740, 9540, 7345, 5930
8:00-8:55 p.m.	0100-0155	R. Peking	B	17855, 17680, 15520, 15120
8:00-9:00 p.m.	0100-0200	V. of Free China	C	17890, 15345, 11825
8:00-11:30 p.m.	0100-0200	AFRTS-Washington	A	25615, 21570, 15330, 15345
8:00-9:00 p.m.	0100-0200	WYFR, Family R.	B	15130
8:00-10:00 p.m.	0100-0300	AWR, Guatemala	B	18266, 12177, 6088
8:00-10:30 p.m.	0100-0330	R. Australia	B	21740, 17795
8:00-11:50 p.m.	0100-0450	R. Habana Cuba	A	11930, 11725
8:20 p.m.-12:10 a.m.	0120-0510	R. Belize	C	3285, 834
8:20-8:50 p.m.	0120-0150	V. of Germany	A	11865, 9605, 9565, 9545, 6145, 6100, 6085, 6040
8:30-8:45 p.m.	0130-0145	V. of Greece	B	11730, 9655, 9515
8:30-8:55 p.m.	0130-0155	Austrian Radio	B	9770, 5945
8:30-8:55 p.m.	0130-0155	R. Tirana	B	9750, 7120



# THE ONE-STOP MUSIC SHOP AT WHOLESALE PRICES!

## THIS MONTH'S SUPER SPECIALS!

### CAR STEREO

**SANYO CASSETTE IN-DASH WITH RADIO**

FT-1498	\$259.90
FT-2400	224.90
FT-449	139.90
FT-646	154.90
FT-4490-2	164.90
FT-1496	159.90
FT-645	94.90
FT-644	106.90

**PIONEER CASSETTE IN-DASH WITH RADIO**

KP-4000	5129.90
KP-3500	144.90
KP-5005	144.90
KP-8000	154.90
KP-8005	154.90
KP-4000	175.90
KE-2000	184.90
KE-2002	209.90
KE-3000	234.90
KE-3002	274.90
KPX-9000	184.90
KPX-9500	209.90

**JENSEN CASSETTE UNDERDASH**

JH101 (6x9 Separates)	594.50
JH65 (6x9 Trax-50 Watts)	62.50
JH33 (6x9 Trax II-100 Watts)	78.50
JH101 (4x10 Trax-45 Watts)	62.50
JH102 (4x10 Trax II-50 Watts)	78.50
JH174 (5% Trax-50 Watts)	62.50
JH174 (5% Trax II-75 Watts)	78.50
JH69 (5x9 Coax-45 Watts)	39.50
JH37 (5x9 Coax II-90 Watts)	58.50
JH77 (5% Coax-45 Watts)	39.50
JH41 (5% Coax II-75 Watts)	48.50

### POWER AMPS/EQUALIZERS

AD-312 (12 Watts)	\$39.90
AD-320 (20 Watts)	47.90
AD-350 (70 Watts)	135.90
AD-30 (5 Band Eq.)	94.90
AD-50 (5 Band Eq.)	159.90
GM-12 (12 Watts)	31.90
GM-40 (20 Watts)	52.90
GM-120 (120 Watts)	129.90
CD-7 (7 Band Eq.)	129.90

### CAR SPEAKERS

TS-M2 Tweeter	28.90/P.R.
TS-T3 Tweeter	39.90/P.R.
TS-168 Three Way	84.90/P.R.
TS-694 6x9 Coax	59.90/P.R.
TS-693 3 Way	89.90/P.R.
TS-X6 2 Way Surface	69.90/P.R.
TX-X9 2 Way Surface	134.90/P.R.

### BLANK TAPES

**CASSETTE TAPES**

Ampex Grand Master II C-90	3.11
AASF Pro I C-90	2.78
AASF Pro II or III C-90	2.99
Fujifilm X for II C-90	2.99
Scotch La Noise C-90's Pa	4.99-5.3
Scotch Master III C-90	3.29
Sony LNX C-90	1.64
Sony HFX C-90	2.35
Sony Ferrichrome C-90	3.25
TDK D-C-60	1.19
TDK D-C-90	1.58
TDK D-C-120	2.10
FDK D-C-180	2.99
TDK AD-C-60	1.98
TDK AD-C-90	2.45
TDK AD-C-120	3.48
TDK SA-C-60	2.15
TDK SA-C-90	3.16

**REEL-TO-REEL TAPES**

Scotch 212 1800 FT	4.35
Scotch 207 1800 FT	5.15
TDK L-1600 1800 FT	5.22

**VIDEO TAPES BETA FORMAT**

TDK L-500 (2 Hour)	12.95
Sony L-500 (2 Hour)	12.95
Fuji L-500 (2 Hour)	12.95
Scotch L-550 (2 Hour)	12.50
Sony L-750 (3 Hour)	17.50

**VHS FORMAT**

Maxell T-120 (4 Hour)	14.95
TDK T-120 (4 Hour)	14.95
JVC T-120 (4 Hour)	13.95
Fujifilm T-120 (4 Hour)	14.95
Scotch WK-250 (4 Hour)	14.95

MINIMUM ORDER 12 TAPES-100% GUARANTEED  
Call or write for super low prices on Maxell tapes.

### CARTRIDGES

**audio-technica**

AT-205S	134.95
AT-155S	89.95
AT-145A	49.95
AT-125A	39.95
AT-10	12.95

**STANTON**

#815	79.95
681EE-S	59.95
681EE	49.95
680EE	27.95
500E	14.95

**EMPIRE**

2000Z	54.50
2000T	29.50
2000E/III	18.50
EDR 9	114.50

**SWANSON**

XSU5000	89.90
XSV3000	45.90
XV19750	34.90
XV15625	24.50
XV15400	21.50
974E	9.90

**PICKERING**

V15 Type IV	89.90
V15 Type III	62.50
M95HE	34.90
M95ED	29.90
M91ED	20.50
M44E	14.90
M70E1	9.90

### ACCESSORIES

**DISCWASHER**

Complete System	10.95
Disk	34.95
Discorganizer	9.95
16 oz. D3 Rehl	10.95
Zenostat Anti-static Gun	14.95
SC-1 Styfus Cleaner	4.95
Discfoot	15.95
Fuzzbuster II Radar Detector	82.90
Beam Box FM-8 Antenna	34.50
Beam Box FM-10 Antenna	64.50

**HEADPHONES**

Koss Pro 4AA	39.90
Koss Pro 4AAA	46.50
Koss HV/LC	34.50
Koss HV/LA	31.50
Sennheiser HD414	42.50
Sennheiser HD424	64.50
Sennheiser HD420	49.50
Sennheiser HD430	72.50

### RECORDS

Pop, Rock, Jazz, R&B

All 7.98 List ..... **\$4.99**

All 8.98 List ..... **\$5.49**

All 9.98 List ..... **\$5.99**

50¢ additional for cassette or 8-track, please specify.  
Minimum order ..... \$25.00

WE STOCK THE COMPLETE SCHWANN CATALOG.

**HOW TO ORDER:** For immediate shipment, send money order or certified check. Two weeks delay on personal checks. Please add \$3.50 per order for shipping & handling (\$6.50 for orders outside continental U.S.). N.Y.S. residents add tax. Payment must be in U.S. dollars only. No C.O.D.'s. All merchandise 100% guaranteed, brand new & factory fresh.



**33 PARK ROW, DEPT. PE, NEW YORK, N.Y. 10038**  
TO ORDER: CALL MON-SAT 9AM-6PM EASTERN TIME  
**TOLL FREE (800) 221-8180**  
ALL OTHER MATTERS: CALL (212) 732-8600

CALL OR WRITE FOR FREE 160 PAGE CATALOG

CIRCLE NO. 41 ON FREE INFORMATION CARD

# Get A GNOME

the original micro-synthesizer

Every day more people discover that PAIA's GNOME is the most versatile, cost effective special effects device on the market today.

John Simonton's time-proven design provides two envelope generators, VCA, VCO and VCF in a low cost, easy to use package. Use alone with it's built in ribbon controller or modify to use with guitar, electronic piano, polytonic keyboards, etc.

The perfect introduction to electronic music and best of all, the GNOME is only \$59.95 in easy to assemble kit form. Is it any wonder why we've sold thousands?



PAIA 1020 W. Wilshire Blvd. Oklahoma City, OK 73116

- ( ) Send GNOME MICRO-SYNTHESIZER Kit (\$59.95 plus \$2.00 postage)
- ( ) GNOME MICRO-SYNTHESIZER (Fully Assembled) \$100.00 plus \$2 postage
- ( ) Send FREE CATALOG

name \_\_\_\_\_  
 address \_\_\_\_\_  
 city \_\_\_\_\_ state \_\_\_\_\_ zip \_\_\_\_\_  
 visa \_\_\_\_\_ mc \_\_\_\_\_ card no. \_\_\_\_\_

Dept. 6 P (405) 843-9626  
 PAIA 1020 W. Wilshire Blvd. Oklahoma City, OK 73116  
 CIRCLE NO. 55 ON FREE INFORMATION CARD

## CALCULATOR SPECIALS

### HEWLETT PACKARD

Model	Your Cost
HP-31E Scien	\$ 41.95
HP-32E Scien	58.95
HP-33E Prog	72.95
HP-33C Prog	99.95
HP-34C Prog	134.95
HP-37E Finan	62.95
HP-38E Finan	94.95
HP-39C Finan	134.95
HP-67 Prog	299.95
HP-92 Finan	399.95
HP-97 Prog	579.95
HP-41C Prog	274.95
Card Reader /41C	199.95
Printer /41C	364.95

Waiting list for "C" models



### TEXAS INSTRUMENTS

TI-30SP	\$16.95	TI-57	\$49.95	PC-100C	\$146.95
TI-35	22.95	TI-58C	99.95	TI-99/4	999.95
TI-55	34.95	TI-59	209.95	TI-5040	89.95
TI Translator	\$239.95	Thermostat	\$99.95		
Speak & Spell	59.95	Chrono alarm	34.95		
Craig Translator	\$149.95	Casio ML-81	\$44.95		
Sharp EL-5100	87.95	Sharp EL-6200	87.95		

### SEIKO SPECIALS In stainless steel

Chronograph	\$ 79.95	Alarm	\$ 79.95
Multi alarm glidne	139.95	Alm chr cntdn	124.95
Solar alm chr	149.95	Music alm chr	139.95
World time alarm	149.95	Calculator alarm	149.95
Digital analog	129.95	Mem bank calndr	99.95

For faster delivery use cashiers check or money order. Add shipping. 1% of your order (\$2.50 min.) East of Miss. Riv add \$1.00. CA res. add 6%. Subject to availability.

Order toll-free **800-421-5188** Outside CA, AK, HI  
 For technical information call (213) 633-3262

**tam's** Tam's Dept. PE6  
 INCORPORATED 14932 Garfield Av  
 Paramount, CA 90723  
 (213) 633-3262

CIRCLE NO. 62 ON FREE INFORMATION CARD

8:30-9:25 p.m.	0130-0225	R. Bucharest	C	11940, 11840, 11735, 9690, 9570, 5990
8:30-9:30 p.m.	0130-0230	R. Japan	C	21640, 17825, 17725, 15235
8:45-9:15 p.m.	0145-0215	Swiss R. International	B	15305, 11715, 9725, 6135
9:00-9:15 p.m.	0200-0215	R. Japan	C	17755
9:00-9:25 p.m.	0200-0225	Kol Israel	A	15582, 15105, 11637, 9815
9:00-9:25 p.m.	0200-0225	R. Warsaw	C	15120, 11815, 9525, 7270, 7145, 6135, 6095
9:00-9:30 p.m.	0200-0230	R. Canada International	A	11940, 9655, 5960
9:00-9:30 p.m.	0200-0230	R. Norway	B	11870, 11860, 9610 (Mon only)
9:00-9:30 p.m.	0200-0230	R. Budapest	B	17710, 15220, 11910, 9835, 9585, 6105
9:00-9:50 p.m.	0200-0250	R. RSA	B	17770, 15265, 115155, 11900
9:00-9:55 p.m.	0200-0255	R. Peking	B	17680, 15600, 15120
9:00-10:05 p.m.	0200-0305	TIFC, Costa Rica	C	9645, 5055
9:00-10:30 p.m.	0200-0330	R. Cairo	B	12050, 9475
9:00-11:00 p.m.	0200-0400	R. Moscow	A	12030, 11770, 11750, 11720, 9700, 9665, 9600, 9530
9:00-11:30 p.m.	0200-0430	AFRTS-Washington	A	21570, 17765, 9755, 6030
9:00-12:00 p.m.	0200-0500	WYFR, Family R.	A	11740
9:30-9:45 p.m.	0230-0245	R. Pakistan	C	21590, 17830
9:30-9:45 p.m.	0230-0245	UN Radio	A	15240, 6035 (Sat. only)
9:30-9:55 p.m.	0230-0255	R. Tirana	B	9750, 7120
9:30-10:00 p.m.	0230-0300	R. Lebanon	D	17485 †
9:30-10:00 p.m.	0230-0300	R. Sweden	C	11705, 9695
9:30-10:15 p.m.	0230-0315	R. Berlin International	C	11975, 9730
9:30-10:25 p.m.	0230-0325	R. Nederland	A	9590, 6165
9:30-10:30 p.m.	0230-0330	BBC	A	11750, 9580, 9410, 7325, 6175, 6120, 5975
9:30-12:00 p.m.	0230-0500	HCJB, Ecuador	A	15250 †, 11915, 9745
10:00-10:15 p.m.	0300-0315	R. Japan	C	17755
10:00-10:15 p.m.	0300-0315	R. Budapest	B	17710, 15220, 11910, 9835, 9585, 6105 (Wed. & Fri.) (Mon. to 0330)
10:00-10:25 p.m.	0300-0325	R. Warsaw	C	15120, 11815, 9525, 7270, 7145, 6135, 6095
10:00-10:30 p.m.	0300-0330	R. Canada International	A	11940, 11845, 9655, 9535, 5960
10:00-10:30 p.m.	0300-0330	R. Portugal	B	11925, 6025 (Mon-0320)
10:00-10:30 p.m.	0300-0330	R. Kiev	B	11830, 11735, 9800
10:00-10:30 p.m.	0300-0330	R. Australia	C	15260 (Fri.)
10:00-10:50 p.m.	0300-0350	V. of Free China	C	17890, 15270, 11825
10:00-10:55 p.m.	0300-0355	R. Prague	B	11990, 9740, 9540, 7345, 5930
10:00-10:55 p.m.	0300-0355	R. Peking	B	17680, 15300, 15120, 12055
10:00-11:00 p.m.	0300-0400	RAE, Argentina	C	9690 (Tue-Sat)
10:00-11:00 p.m.	0300-0400	Radiobrás, Brazil	C	15290 †
10:00-11:00 p.m.	0300-0400	R. Baghdad	C	11935
10:00-11:15 p.m.	0300-0415	R. Uganda	B	15325 (irregular)
10:00-11:26 p.m.	0300-0426	R. RSA	B	11900, 9585, 7270, 5980, 4990
10:00-11:30 p.m.	0300-0430	R. Cultural, Guatemala	B	3300 (Mon. 0030-)
10:00 p.m.-1:00 a.m.	0300-0600	HRVC, Honduras	B	4820
10:00 p.m.-2:30 a.m.	0300-0730	VOA	A	17865, 15240, 9670, 5995
10:30-10:55 p.m.	0330-0355	R. Tirana	B	7300, 6200
10:30-10:55 p.m.	0330-0355	Austrian Radio	C	9770, 5945
10:30-11:00 p.m.	0330-0400	R. Australia	B	21680, 17890, 17870, 17795, 17725
10:30-11:15 p.m.	0330-0415	R. Berlin International	B	11975, 11890, 5955
10:30-11:45 p.m.	0330-0445	BBC	A	9410, 6175, 5975
10:30-11:00 p.m.	0330-0400	R. Finland	C	11755, 9760
10:30-12:00 p.m.	0330-0500	R. Tanzania	D	15435
10:30 p.m.-1:00 a.m.	0330-0600	R. Habana Cuba	A	11760, 11725
10:40-10:47 p.m.	0340-0347	V. of Greece	B	11730, 9650, 9515
10:50-11:10 p.m.	0350-0410	RAI, Italy	C	21561 †, 17795, 15330
10:51-10:58 p.m.	0351-0358	V. of Yerevan	C	17870, 15405, 15180 (Sun, Wed, Thu, Sat)
11:00-11:15 p.m.	0400-0415	R. Japan	C	17755
11:00-11:30 p.m.	0400-0430	R. Bucharest	C	11940, 11840, 11735, 9690, 9570, 5990
11:00-11:30 p.m.	0400-0430	R. Canada International	A	11845, 9655, 9535, 5960
11:00-11:30 p.m.	0400-0430	R. Norway	B	11860, 9645 (Mon only)
11:00-11:30 p.m.	0400-0430	R. Mozambique	C	4855, 3265
11:00-11:45 p.m.	0400-0445	R. Korea	C	15570, 11820
11:00-11:55 p.m.	0400-0455	R. Peking	B	17680, 15300, 15120, 12055
11:00-12:00 p.m.	0400-0500	R. Australia	B	21680, 21525, 17890, 17870, 17795, 17755, 17725, 15320, 15240, 15160
11:00 p.m.-1:00 a.m.	0400-0600	R. Moscow	B	12030, 11790, 11770, 9610, 9530
11:00 p.m.-3:00 a.m.	0400-0800	R. Moscow	B	15180, 15100, 12050, 12000, 11720, 11690, 9710
11:00 p.m.-5:00 a.m.	0400-1000	V. of Cuba	B	600
11:05-11:50 p.m.	0405-0450	FEB, Seychelles	C	11850 †
11:30-11:55 p.m.	0430-0455	Austrian R.	B	12015 or 15260
11:30-12:00 p.m.	0430-0500	Swiss R. International	B	11715, 15305 or 9725
11:30-12:00 p.m.	0430-0500	R. Sofia	B	11750 †
11:30 p.m.-1:30 a.m.	0430-0630	TWR, Swiziland	C	7290, 5055 †
11:30 p.m.-2:00 a.m.	0430-0700	AFRTS-Washington	A	15330, 9755, 6030
11:45-12:00 p.m.	0445-0500	Vatican R.	C	6190 or 6210
11:45 p.m.-12:45 a.m.	0445-0545	BBC	A	15070, 9510, 6175, 5975
11:55 p.m.-1:00 a.m.	0455-0600	V. of Nigeria	C	15119, 15185, 7255
12:00-12:15 a.m.	0500-0515	Kol Israel	B	21555, 15582, 15105, 11638
12:00-12:15 a.m.	0500-0515	R. Japan	C	15270
12:00-12:30 a.m.	0500-0530	R. Portugal	B	11925, 6185, (Mon-0520)
12:00-1:00 a.m.	0500-0600	R. Australia	C	21680, 17890, 17870, 17725, 15240
12:00-2:00 a.m.	0500-0700	HCJB, Ecuador	B	9745, 6095, 11915
12:00-3:00 a.m.	0500-0800	R. Kuwait	C	21545 †
12:15-1:15 a.m.	0515-0615	Spanish Foreign R.	B	11880, 9630

12:22-12:30 a.m.	0522-0530	UN Radio	A	9540, 6055 (Sat)
12:30-12:50 a.m.	0530-0550	V. of Germany	A	11905, 11705, 9650, 9545, 6185, 6100, 5960
			B	9715, 6165
12:30-1:25 a.m.	0530-0625	R. Nederland	A	9540, 6055 (Sat)
12:45-1:00 a.m.	0545-0600	UN Radio	B	15070, 11955, 11860, 9640, 9510, 6175
12:45-2:30 a.m.	0545-0730	BBC	C	15270
			C	17875, 15275, 11905, 11765, 9700
1:00-1:15 a.m.	0600-0615	R. Japan	B	21655, (Mon only)
1:00-1:30 a.m.	0600-0630	V. of Germany	C	21680, 21525, 17870, 17725, 17755, 15240, 15160
1:00-1:30 a.m.	0600-0630	R. Norway	C	9690 (Tue.-Sat.)
1:00-1:30 a.m.	0600-0630	R. Australia	C	21535, 17780, 15220
			B	11960, 11825, 9760, 9590, 6140 (Mon-Fri)
1:00-2:00 a.m.	0600-0700	RAE, Argentina	B	9485, (Sun. to 1000)
1:00-2:00 a.m.	0600-0700	R. RSA	C	15295, 12350, 9750
1:15-1:30 a.m.	0615-0630	R. Canada International	B	21680, 17725, 15240, 9670 or 15145
			B	9675, 9720
1:25-3:00 a.m.	0625-0800	TWR, Monte Carlo	B	11960, 11825, 9760, 9590, 6140 (Mon-Fri)
1:25-3:55 a.m.	0625-0855	V. of Malaysia	C	11950, 9579
1:30-2:00 a.m.	0630-0700	R. Australia	C	15270
1:30-2:00 a.m.	0630-0700	Radio Warsaw	C	15305, 9535, 6165
1:45-2:00 a.m.	0645-0700	R. Canada International	D	9670 (Sat only) (irregular)
			C	10010, 9840, 7512
			B	21680, 17725, 15145, 11740, 9570
			A	11840, 6135 (Sat)
			A	11840, 6135 (Sat)
			B	9770, 9715
			B	15070, 11955, 9640, 9510
			C	11945, 6105
			C	5950
			B	9505
			B	9715
			C	11765 or 11890

**Explanatory Notes:**  
1. Times in first column are EDT. For EDT add 2 hours, EDT, add 1 hour, MDT, subtract 1 hour, PDT, subtract 2 hours. Days of week are in GMT.  
2. Quality: A—strong signal and very reliable reception; B—regular reception; C—occasional reception under favorable conditions; D—rarely available. These ratings are for locations in the central USA. European and African stations in general, more reliably received in eastern North America; Asian and Pacific stations are more reliably received in western North America. North American stations are received well except in areas too close to the transmitter site.  
3. The information in the listing is correct to press time. However, frequencies and schedules are constantly changing. Listen for "DX Digest" on R. Canada International for late changes. Sunday at 1807, 1915 (for Europe), 2036, GMT Monday at 0213 and 0417.  
4. R.—Radio; V.—Voice  
5. \*—frequency change

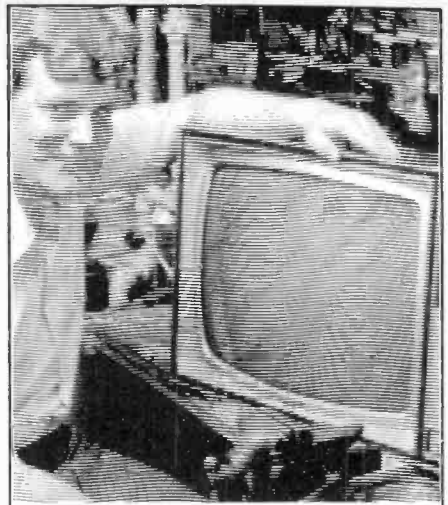

## NOW—the best in Electronics training can cost you less—

No school, large or small, gives you better electronics training than E.T.I. Nor, at a fairer price. Compare quality, price, service, background. ETI has been training men & women for entry into or advancement in electronics since 1909, utilizing the very latest in educational techniques. Only ETI combines Autotext programmed learning, "listen & learn" cassettes and "hands-on" projects designed for learning at home, quickly, easily. Wide course choice.



SEND TODAY for all new FREE catalog or for faster service, use the toll free telephone number below, day or night. No obligation—no salesmen will call.

**ETI**  
**ELECTRONICS TECHNICAL INSTITUTE**  
**FOUNDED 1909**  
153 W. Mulberry St., Dept. 10060  
Lancaster, Ohio 43130

**FOR FASTER SERVICE -**  
**TELEPHONE FREE 24 HRS A DAY**  
1 800 621 5809  
Illinois residents - 800 972 5858

ETI Home Study, Dept. 10060  
153 W. Mulberry, Lancaster, Ohio 43130

Please rush FREE catalog on electronics opportunities, and training. I'm interested in  
 Basic  Career  Specialized  
 Advanced

NO SALESMAN IS TO CALL ON ME, EVER.

Name \_\_\_\_\_  
Address \_\_\_\_\_  
City, state, zip \_\_\_\_\_  
Ohio Registration NO. 0683H

## Put Professional Knowledge and a COLLEGE DEGREE in your Electronics Career through HOME STUDY

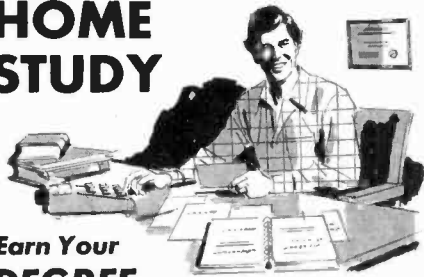

### Earn Your DEGREE

No commuting to class. Study at your own pace, while continuing your present job. The Grantham home-study program leads first to the A.S.E.T. and then to the B.S.E.T. degree. Our free bulletin gives full details. Write for *Bulletin ET-80*.

**Grantham College of Engineering**  
2500 So. LaCienega Blvd.  
Los Angeles, California 90034

**GRANTHAM'S FCC LICENSE STUDY GUIDE**  
—377 pages, 16 FCC-type practice tests, 1465 questions with answers and discussions—covering third, second, and first class radiotelephone license exams. Preparation for each separate class of license is presented in a separate section of the book. \$15.75 postpaid. Order from:

GSE Publications  
P. O. Box 35499, Los Angeles, Calif. 90035

Discone™ Model DCX

## MAKE YOUR SCANNER REALLY PERFORM!

...with Hustler multi-band monitor antennas.

Whether it's mobile or base, Hustler has the antenna that provides exceptional scanner performance, resulting from advanced engineering and use of quality materials.

If you want real performance... get Hustler!

*Clearly the choice of those who know quality.*

See your dealer or write:

**HUSTLER** INC.  
3275 North B. Ave., Kissimmee, Florida 32741

MOM Magnetic Mount

CIRCLE NO. 38 ON FREE INFORMATION CARD

CIRCLE NO. 24 ON FREE INFORMATION CARD

**MICROCOMPUTER MART RATE:** 1" x 1 Column (1-5/8") \$125. 1-1/2" x 1 Column (1-5/8") \$187.50. 2" x 1 Column (1-5/8") \$250.00. For frequency rates, please inquire. **GENERAL INFORMATION:** Payment must accompany copy except when ads are billed on credit cards—American Express, Diners Club, Master Charge, VISA (supply Expiration date)—or when ads are placed by accredited advertising agencies. Ads are not acknowledged. They will appear in the first issue to go to press after closing date. Closing date: 1st of the 2nd month preceding cover date (for example, April issue closes February 1st). Send order and remittance to MicroComputerMart, POPULAR ELECTRONICS, One Park Avenue, New York, NY 10016. For inquiries, contact (212) 725-3485.

**GEORGIA**

**Radio Shack** DEALER  
**COMPUTER CENTER**



**15% Discount on TRS-80's-1 & Accessories**

Popular 16K LEVEL 2 SYSTEM.....\$722.00  
Fast 100 cps Centronics 730 PRINTER.....\$800.00  
Highly Reliable LOBO DRIVERS.....\$375.00

**MICRO MANAGEMENT SYSTEMS**  
DOWNTOWN PLAZA SHOPPING CENTER  
115 C SECOND AVE. S.W.  
CAIRO, GEORGIA 31728  
912-377-7120  
TRS-80 is a Registered Trademark of Tandy Corp

**ILLINOIS**

*midwest microcomputer*

- All your business & personal computer needs.
- Extensive Software & Peripherals Stock.

708 S. Main St.  
(312) 495-9889 Lombard, IL 60148

**CALIFORNIA**

**The Original ByteShop®**

1415 W. El Camino Real  
Mountain View, CA 94040  
(415) 969-5464

**FREE! software catalog for Apple II**

SALES • SERVICE • LEASING  
of  
APPLE • ATARI • DEC  
Plus all PERIPHERALS & SUPPLIES  
Open Tuesday through Sunday  
VISA and MASTERCHARGE

**RAINBOW COMPUTING, INC.**  
9719 Reseda Blvd.  
Northridge, Ca 91324  
(213) 349-5560

**HUGE DISCOUNTS**

PET-8K - \$778.12 | T1 99/4 - \$936.33  
HORIZON 1-32K-D-ASM - \$2259.70  
DYNABYTE DB 8/2-48 - \$3633.22

Similar Discounts on all Items. Call for Prices.

**MICROPROCESSOR APPLICATIONS**  
P.O. Box 462, Woodacre, CA 94973  
(415) 488-0992  
VISA - MASTER CHARGE HONORED

**OHIO SCIENTIFIC MICRO-COMPUTERS**

A.A. Office  
Equipment Company  
15296 E. 14th St.  
San Leandro, CA 94578  
(415) 357-1737

**OHIO SCIENTIFIC**

Get The Catalog & Our Low Prices  
Data Products Maintenance  
9460 Te stor  
E Monte, CA 91731  
(213) 573-5991 (714) 994-4180

**NEW HAMPSHIRE**

As advertised in  
80 Microcomputing &  
Kilobaud Microcomputing Magazines

**TRS-80 16K LEVEL II**

**FREE CATALOG \$730<sup>00</sup> plus frt.**

MAIL ORDER MICROS  
POB 427 • Marlboro NH 02845  
REPT 25 803-824-3041

**OHIO**

**BAND-ORCH, INC.**

**Complete Ohio Scientific Line**

337 East State Street  
Alliance, Ohio 44601  
(216) 821-2600  
VISA/Master Charge

**TEXAS**



As a Radio Shack® Authorized Sales Center owned & operated by Pan American Electronics, Inc., we can sell them for less. *No taxes* collected on out-of-state shipments. *We pay shipping & insurance.*

**TOLL FREE 800/531-7466**  
Texas & Main No.  
512/581-2765  
1117 Conway  
Mission, Texas 78572

**LOOK!! TRS-80\* Computer Owners MEGASAVINGS!**

• Brand new Percom mini-disk systems: Single-Drive — \$325; Double-Drive — \$650; Triple-Drive — \$975.

• 16K-Byte Memory: 8 prime 4116 ICs — \$64.95

Introductory prices good for a limited time only. Prices do not include shipping, or sales tax if applicable.

**CALL Toll-free 1-800-527-4196**

**ACCESS UNLIMITED**

315 N. Shiloh • Ste. D1 • Garland, TX 75042  
(214) 494-0206

**NEW JERSEY**

**COMPUTER MART OF NEW JERSEY**

501 Route 27  
Iselin, N.J. 08830  
(201) 283-0600

**The Microcomputer People®**

**PENNSYLVANIA**

**TRS-80 OWNERS**

Control or sense anything with our Model 4051 Input/Output Module.

**CNI Electronic Associates, Inc.**  
RD 2, Box 129AA, Orefield, PA 18069  
(215) 395-6444

**SPECIAL OFFER!** ~~\$109~~ Car Stereo Only **\$59<sup>50</sup>**  
**HIGH QUALITY, EASY-TO-INSTALL, IN-DASH CAR STEREO CASSETTE TAPE PLAYER WITH AM-FM-MPX RADIO**  
8-TRACK MODEL **\$55<sup>50</sup>**

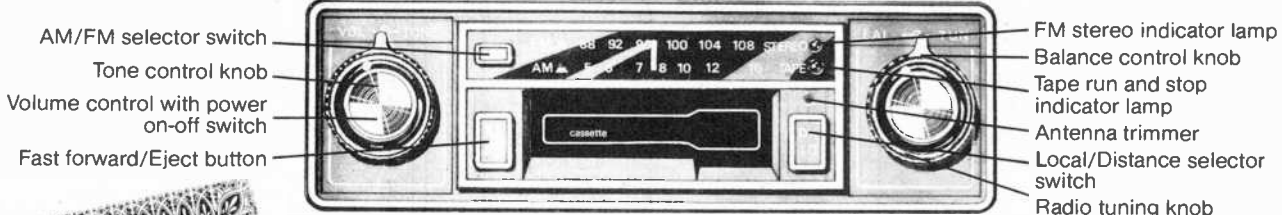

**CAR STEREO CASSETTE PLAYER**  
 FOREIGN CAR  DOMESTIC CAR  8-TRACK

Name \_\_\_\_\_ Address \_\_\_\_\_  
City \_\_\_\_\_ State \_\_\_\_\_ Zip Code \_\_\_\_\_

CHECK  MONEY ORDER  
 MASTER CHARGE  VISA

# \_\_\_\_\_

Shipping/handling charges add \$2.00.  
Illinois residents add 6% sales tax.

**CHADE INTERNATIONAL INC.** P.O. Box 338, Wheeling, IL 60090 • (312) 459-8208



# Operation Assist

If you need information on outdated or rare equipment—a schematic, parts list, etc.—another reader might be able to assist. Simply send a postcard to Operation Assist, POPULAR ELECTRONICS, 1 Park Ave., New York, NY 10016. For those who can help readers, please respond directly to them. They'll appreciate it. (Only those items regarding equipment not available from normal sources are published.)

Collins type COL-52245 radio transmitter. Need schematic and instruction booklet. Dewain S. Channell, 8 Anchor Rd., Lynn, MA 01094.

Holden Electronics Co., model M125C, SN 635 amateur amplifier. Need schematic and/or repair manual. Chris Pierson, 30 College Dr., Kennesaw, GA 30144.

Precise model 308 oscilloscope. Need schematics. Chybinski, 10215 65th St., Seattle, WA 98178.

Hy-Gain model 828G vhf/uhf 4-channel scanning monitor. Need schematic, parts list and service manual. Neil E. Peple, 4926 W. Clarendon Ave., Phoenix, AZ 85031.

Hallcrafters model CR-3000 AM-FM stereo/multi-band SW receiver. Schematic and manual needed. Rick Rodriguez, 670 N. Ridge, Lombard, IL 60148.

Electronic Research Associates, Inc., model SL-36-2M (serial number 24822) 0-36 V, 2A power supply. Need schematic and technical manual. Kenneth L. Coleman, 108 Gallivan Lane, Uncasville, CT 06382.

Tennelec MCP 1 scanner. Need operation manual and schematic. Robert Heine, 2428 So. Glendale, Apt. 204, Wichita, KS 67210.

Nytone, model NS-12 stereo amplifier. Need schematic, parts list and owner's manual. Tim Tochor, 31 Myrtle St., St. Thomas, Ont., Can. N5R-2E6.

Jetronics Ind., model R-853/UR AM/FM receiver. Need schematic. H. L. Ekas, Rt. 4, Box 183, White Oak, KY 41474.

Superior Instruments model-76 C. R. bridge and signal tracer. Need schematic and operating manual. Ken Fridley, 3142 18th St., Eureka, CA 95501.

Southwestern Industrial Electronics model R voltmeter, model OS-7/U circular sweep scope, Kay model 121A vhf/uhf sweeping oscillator, and Krohn-Hite model 330A ulf filter. Need any available information. Joe Parr, 6095 Sutter St., Ventura, CA 93003.

U.S. Navy surplus communications equipment models RT-91/ARC-2 and R-392/URR and National model MFS general coverage vhf receiver. Need maintenance manuals, schematics and parts source. John J. DeBert, Box 8, New Almaden, CA 95042.

Magnavox model 1ST 286R stereo console. Need schematic and service manual. Darryl Sale, 851 Castro, San Leandro, CA 94577.

Lafayette model KT-126 stereo amp. Need schematic. Wes Preston, 6318 S.E. 88th, Portland, OR 97266.

Marantz model RC-4 remote control. Need schematic, parts list or actual unit (working or not). Paul T. Matchok, 21 West End Ave., Bogota, NJ 07603.

RCA model SRT-301 pushbutton tape recorder. Need schematic and service manual (Sams 224). Donald P. Seyler, 827 Mitman Dr., Fairborn, OH 45324.

Singer-Metrics model SA-3, type T-200 Panadaptor. Need manual/electronic schematic and alignment information. Paul Schmidt, 345 W. King St., Banning, CA 92220.

Central Electronics model B "Sideband Slicer" multiphase Q-multiplier. Schematic and operating instructions needed. R. I. Garber, 3535 Greenbrier Blvd., Apt. 34A, Ann Arbor, MI 48105.

Ace Electronics Industry model FR-1 Rhythm Ace rhythm box. Need schematic and manual or address of company. Homer Thompson, 24116 Le Bern Dr., North Olmstead, OH 44070.

Knight-Kit model T-60 transmitter. Assembly manual needed. Roy Tolbert, RFD 2, Jefferson, GA 30549.

Triplett model 3212 vacuum tube tester. Need schematic,

parts list and operating manual or tube steep chart. Joseph J. Calicchio, 226 Hutton St., Jersey City, NJ 07307.

Magnavox model 860300 stereo amplifier. Need schematic. Bill Doran, 106 Tyler Terrace, Newton, MA 02159.

Fairchild channel F video entertainment system (original). Need schematics, parts list and manual. E. Enock, 220 Pelham Rd., New Rochelle, NY 10805.

Admiral model PL17F31B, chassis #15D1BR black and white TV. Schematic needed. Tim Wikert, 171 N. Wall St., Covington, OH 45318.

Precision Apparatus Co., model E-400 sweep generator. Need schematic, parts list and manual. James V. Houck, 330 E. Chestnut St., Coatesville, PA 19320.

Triumph Mfg. Co., model 841 oscillograph. Need schematic and operation manual. Chris Potampa, 2537 Via Anita, Palos Verdes Peninsula, CA 90274.

Magnas model 1700 organ. Need schematic and wiring diagram. C. Solywoda, 99 Cherry St., Torrington, CT 06790.

Qualitron model 1439 Financial calculator. Need operating manual or manufacturer's address. Victor Ptasnik, 809 West 3rd St., Kewanee, IL 61443.

Topp-Juliette model R-2121X stereo AM/FM radio. Need schematic. C. E. Wilhalp, Box 4424, Rocky Mount, NC 27801.

Midland model 13-801 CB transceiver (3-channel). Need schematics and manuals. G. Yuval, State University of New York at Buffalo, Dept. of Computer Science, 4226 Ridge Lea Rd., Amherst, NY 14226.

Measurements model 65B signal generator and model 62 VTVM. Need schematics and/or service manual. P. Young, 16 W. 761 White Pines, Bensenville, IL 60106.

## Dr. Watt is no fly-by-night energy saver.

The National Aeronautics & Space Administration holds the basic patent.\* Their device was developed to get the highest efficiency possible out of motors which would run on solar energy.

EnerCon, under license from N.A.S.A., developed Dr. Watt to cut the power used by induction motors of 1/2-hp., or less. The kind that run home appliances. Your refrigerator and freezer. Your washer and sump pump. The power tools you have in your workshop.

### Dr. Watt doles out power.

The motors in your home don't need all the power they pull all the time. For example: Your washing machine's motor runs "full blast", even when you're doing a light load, even when the tub's not turning. It doesn't have to pull all that power, but it does. Dr. Watt measures the amount of power needed, cuts it down to the minimum, and delivers only that power to the motor.

### Reduce kilowatt hours up to 60%.

Depending on the function of the motor, you can save from 10% to 60% of the power it is using now. The motor will run quieter, cooler, and last longer, too.

Start to save today. Order Dr. Watt now. If you're not satisfied, for any reason, return the unit within thirty days for a full refund.

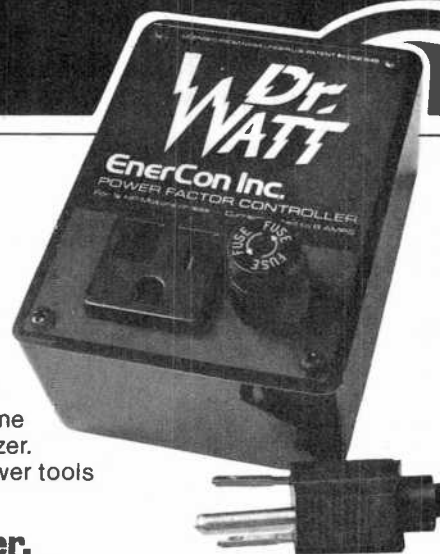

Please send me (Number) \_\_\_\_\_ Dr. Watts @ \$29.95 ea. (Ohio residents add 4 1/2 % sales tax.) Plus \$2.95 postage and handling. \$ \_\_\_\_\_ Total.  
 Enclosed find my  check  money order.  
 Bill my  VISA or  Master Charge, Account# \_\_\_\_\_ Exp. date \_\_\_\_\_

Name \_\_\_\_\_

Address \_\_\_\_\_

City \_\_\_\_\_ State \_\_\_\_\_ Zip \_\_\_\_\_

Or you may order via our TOLL FREE NUMBER:  
 800-321-3562. Ohio residents call (216) 585-0610.  
 \*Licensed under N.A.S.A. Under Patent #4,052,648  
 UL/CSA approval applied for.

**Dr. WATT**  
**EnerCon Inc.**  
 30044 Lakeland Boulevard  
 Wickliffe, Ohio 44092  
 Dept. E-1

CIRCLE NO. 68 ON FREE INFORMATION CARD

# Now get OHIO SCIENTIFIC personal computer products with guaranteed, quick, mail order delivery.



**ONLY \$299**

## Ohio Scientific Superboard II

The first complete computer system on a board. Includes keyboard, video interface and audio cassette interface. 8K BASIC-in-ROM; 4K RAM. Requires power supply +5V at 3 Amp.

**"We heartily recommend Superboard II for the beginner who wants to get into microcomputers with a minimum cost. A real computer with full expandability."**

POPULAR ELECTRONICS, MARCH, 1979

**"The Superboard II is an excellent choice for the personal computer enthusiast on a budget."**

BYTE, MAY, 1979

## Ohio Scientific C4P Series.



**The Challenger 4P.** A 4-slot computer with one open slot. Highly sophisticated 16 color video interface. 32 rows x 64 columns, upper and lower case. 8K BASIC-in-ROM, 8K RAM. 200-20KHz programmable tone generator. AC remote interface. Expandable to 32K RAM and two mini-floppy drives. **\$750.**

**The Challenger 4P MF.** Mini-floppy version of the 4P. Two to three times faster than competitors. More I/O built-in than any other in its class. 24K RAM. Real time clock. Modem interface. Printer interface. Foreground/Background operation and much, much more. **\$1795.**

## Ohio Scientific C1P Series.



**The Challenger 1P.** The best bargain in personal computer anywhere! 8K BASIC-in-ROM. 4K RAM. Cassette based with 53-key keyboard. B&W video interface, 30 rows x 30 columns. Upper and lower case. **\$399.**

**Ohio Scientific C1P MF.** Mini-floppy version of the C1P. 8K BASIC-in-ROM. 20K RAM and OS-65D software. Fully expandable. **\$1250.**

## Accessories

**AC-3P** 12" B/W monitor, TV \$ 125

**AC-15P** 12" Color monitor \$ 450

**AC-16P** 2-8 Axis Joysticks with cable \$ 39

**AC-11P** Answer/Originate 300 baud modem with cable \$ 199

**AC-17P** Home Security Starter Set. 1 fire detector, 2 window alarms, 1 door unit. \$ 249

**AC-18P** 8 1/2" aluminum paper printer. Upper/lower case. \$ 695

**AC-9TP** Centronics 799 110cps tractor feed, business printer with interface \$ 1250

**AC-12P** AC-Remote starter set. Console. 2 lamp modules, 2 appliance modules, OS 65D home control operating system \$ 175

**Disk Drives**

**CD 3P** Single 5" mini floppy \$ 499

**CD 2P** Dual 8" Disk with interface and OS-65D DOS \$ 1599

## Power Supplies

**PS 1.** 5-volt @ 3 amps regulated. For use with Superboard II \$ 29

**Boards (Assembled and tested)**

**CM 9P.** 24K Static. \$ 399

**610.** 8K Static. Expandable to 24K and dual mini-floppy controller. \$ 298

**CA-14A.** Votrax® voice synthesizer. \$ 399

**CA-15** Universal Telephone Interface, rotary or touch tone \$ 499

**CA-15V** UTI with Votrax® \$ 799

**CM-6** 48K Dynamic memory board. \$ 499

**4KP.** 4K static RAM chip set \$ 69

**CA12.** 96 line parallel I/O \$ 175

## Books:

How to Program Microcomputers, By William Barden \$ 8.95

Basic and Personal Computer By Dwyer & Critchfield \$ 12.95

Howard Sams C1P Service Manual \$ 7.95

Howard Sams C4P Service Manual \$ 15.95

## Freight Policies

All orders of \$100 or more are shipped freight prepaid. Orders of less than \$100 please add \$4.00 to cover shipping costs. Ohio Residents add 5.5% Sales Tax.

## Guaranteed Shipment

Cleveland Consumer Computers & Components guarantees shipment of computer systems within 48 hours upon receipt of your order. **Our failure to ship within 48 hours entitles you to \$35 of software, FREE.**

## Ohio Scientific 8P Series.



**Challenger 8P.** Ohio Scientific's mainframe-class. Personal computer. 8 slots with 6 open. Cassette based with 8K BASIC-in-ROM. 8K static RAM, expandable to 32K RAM, and dual 8-inch floppy disk drive. **\$950.**

**Challenger 8P DF.** A top of the line personal and small business computer. 32K RAM, expandable to 48K. Features dual 8" floppy disk drives. Audio output 200 20KHz. DAC for voice generation. Keypad interfaces. Joystick (2) interfaces. AC Remote. Real Time Clock. Printer & Modem interfaces. And more. **\$2895.**

## To Order:

Or to get our free catalog **CALL 1-800-321-5805 TOLL FREE.**

Charge your order to your **VISA** or **MASTER CHARGE ACCOUNT** Ohio Residents Call: (216) 464-8047.

Or write, including your check or money order, to the address listed below.

**Hours:** Call Monday thru Friday 8:00 AM to 5:00 PM E.S.T.



**TO ORDER: CALL  
1-800-321-5805  
TOLL FREE**

ELECTRONICS Market Place

## SOFTWARE

<b>Cassettes</b>		MDMS Checking and Savings Account
Add Game	\$ 6.00	
BASIC Tutor Series	\$29.00	\$29.00
Torpedo	\$ 6.00	
Address Book	\$ 8.00	
Programmable Calculator	\$12.00	
Savings Account	\$ 6.00	
Breakout	\$ 6.00	
Battleship	\$ 6.00	
Bowling	\$ 6.00	
Destroyer	\$ 6.00	
Space War	\$ 6.00	
Star Trek	\$ 6.00	
Tiger Tank	\$12.00	
		MDMS Personal Calendar/Address Book \$29.00
		Home Control II \$29.00
		DAC I Music Generation \$39.00
		Baseball I & II, Golf, Bowling, Hockey \$39.00
		Poker, Black Jack, Spades, Hearts, more \$29.00
		Tiger Tank, Space Attack, Etch-A-Sketch, more \$29.00

<b>Disks</b>		Star Wars, Zulu 9, High Noon, more \$29.00
When ordering, specify Challenger 1P, 4P or 8P		Monster, Kite, Three Little Pigs, Humpty Dumpty and more (2 Disk Set) \$29.00
MDMS Education System	\$29.00	

Many, many more software systems are available to you. See our catalog for complete listings.

**CLEVELAND CONSUMER COMPUTERS & COMPONENTS**  
P.O. Box 46627  
Cleveland, Ohio 44146

# Active Electronic Sales Corp.

## Zilog

Z8001 \$195.00 16 Bit CPU with segmented address space to 8 Megabytes

Z8002 \$150.00 16 Bit CPU with non segmented address space to 64K bytes.

**All Products Stocked in Depth  
Largest Zilog Inventory**

Z80-CPU	2.5 MHz	\$10.40	Z80-SIO/0	2.5 MHz	30.50
Z80A-CPU	4.0 MHz	12.05	Z80A-SIO/0	4.0 MHz	36.70
Z80-PIO	2.5 MHz	6.65	Z80-SIO/1	2.5 MHz	36.00
Z80A-PIO	4.0 MHz	8.00	Z80A-SIO/1	4.0 MHz	44.10
Z80-CTC	2.5 MHz	6.65	Z80-SIO/2	2.5 MHz	36.00
Z80A-CTC	4.0 MHz	8.00	Z80A-SIO/2	4.0 MHz	44.10
Z80-DMA	2.5 MHz	\$22.35			
Z80A-DMA	4.0 MHz	28.00			

### MICROPROCESSOR CHIP SETS

Part No.	Price	Part No.	Price	Part No.	Price
8080A	\$5.95	6800	\$6.50	6502	\$9.95
8085	11.95	6802	11.95	6504	9.95
				6505	9.95
8212	2.75	6810	3.75		
8214	3.95	6820	4.95	6520	6.95
8216	2.95	6821	3.75	6522	9.95
8224	3.45	6850	3.95	6532	13.95
8226	2.95	6852	3.75	6551	13.95
8228	4.98				
8238	4.98				
8251	6.95				
8253	10.95				
8255	6.95				
8257	10.95				
8259	12.95				

### SCR's and TRIAC's

C106D	.34	SCR 5 amp 400V TO-220
TIC116B	.97	SCR 8 amp 200V TO-220
TIC126B	1.99	SCR 12 amp 200V TO-220
TIC216B	.99	Triac 6 amp 200V TO-220
TIC226D	.95	Triac 8 amp 400V TO-220
TIC236D	1.45	Triac 12 amp 400V TO-220
TIC246D	1.45	Triac 16 amp 400V TO-220

### Bi-Fet OP AMPS

TL064CN	2.00	Quad low power
TL071CP	.59	Low noise
TL072CP	1.19	Dual low noise
TL081CP	.49	J-FET input
TL082CP	.99	Dual J-FET input
TL084CN	1.95	Quad J-FET input

### MOS MEMORIES

#### MOS Static RAM's

Part No.	Price
2102LFPC	1.19
1K (1K x 1) Low Power 350ns 16 PIN	
2102LMPC	1.29
1K (1K x 1) Low Power High Performance 250ns 16 PIN	
2102-1PC	0.99
1K (1K x 1) 450ns 16 PIN	
P2111-45	3.50
1K (256 x 4) 450ns 18 PIN	
P2112-35	3.25
1K (256 x 4) 350ns 18 PIN	
2114L	5.95
Low Power 4K (1024 x 4) 300ns	

#### MOS Dynamic RAM's

TMS4060-30	3.25
4K (4K x 1) 300ns 22 PIN	
TMS4060-20	3.95
4K (4K x 1) 200ns 22 PIN	

#### UART's

AY5-1013A	3.95
0 to 40K BAUD 40 PIN	
AY3-1015	4.95
0 to 30K BAUD 40 PIN Single 5V supply	

#### 1K CMOS RAM

5101	5.95
1K (256 x 4) 450ns 22 PIN Low Power	

#### 4K CMOS RAM

P4315-45L 4K (4K x 1) 450ns 18 PIN	14.95
P650A	13.95
4K (4K x 1) 550ns 18 PIN 110MW	
P6513	16.95
4K (1K x 4) 450ns 18 PIN 110MW	

#### SHIFT REGISTERS

3341APC FIFO 1 MHz	5.50
3342PC 64 Bit Shift Register	4.45
3347PC 80 Bit Shift Register	3.95

#### ECL RAM

1041BADC/HM2106	Special 1.95
256 x 1 Bit Fully Decoded 15ns 16 PIN	

### EPROM'S

C2708	\$ 6.95
1K x 8 450 ns	
TMS2532	\$119.95
32K (4096 x 8) 450 ns	
TMS2716	\$24.95
16K (2K x 8) 450 ns	
(3 power supplies) T.I. Version	
C2716/TMS2516	Special \$19.95
16K (2K x 8) 450 ns	
(Single 5V supply—Intel version)	

### Special of the month

**16K MOS DYNAMIC RAM's (16 PIN)**

416-5 (300ns) CERAMIC \$5.95

416-3 (200ns) CERAMIC \$8.95

**1K BiPolar RAM (25ns)**

93425APC/2511-1 \$8.95

### 1980 IC MASTER

over 2700 PAGES

Complete integrated circuit data selector. Master guide to the latest I.C.'s including microprocessors and consumer circuits. 45,000 device types listed. 5,000 new device types added. Complete new section on MPU boards & Systems.

Free Quarterly Updates

Special \$49.95

### LINEAR I.C.'s

LM301AN-8	.34	LM723CH	.69
LM304CH	.89	LM723CN-14	.49
LM307N-8	.29	LM725CN-8	1.25
LM308N-8	.89	LM733CN-14	1.59
LM308CH	.95	LM739CN-14	1.29
LM309K	1.29	LM741CH	.65
LM310HC	1.49	LM741CN-8	.44
LM311N-8	.59	LM747CN-14	.59
LM311T (TO-220)	1.49	LM748CN-8	.39
LM318N-8	1.45	LM1458N-8	.49
LM318CH	1.75	LM1488N-14	.69
LM324N	.59	LM1489N-14	.69
LM339N	.59	LM3046N-14	.99
LM348N-14	.99	LM3302N-14	.55
LM358N-8	.79	LM3403N-14	.89
LM380N-14	1.19	LM3900N	.49
LM555N-8	.49	LM4136N-14	.99
LM556N-14	.49	ULN2003AN	.99

### SUMMER SPECIAL

10% qty discount on 100 pieces per device type (offer valid until August 31, 1980)

## "ACTIVE IS AGGRESSIVE"

### DUAL-IN-LINE — LOW PROFILE — I.C. SOCKETS

CONTACTS	PRICE	CONTACTS	PRICE
8 PIN	.07	22 PIN	.21
14 PIN	.11	24 PIN	.23
16 PIN	.13	28 PIN	.27
18 PIN	.17	40 PIN	.39
20 PIN	.19		

• LOWEST PRICES ANYWHERE FOR THE HIGHEST QUALITY. AN UNBEATABLE COMBINATION.

SOCKET SALE

### OPTO SALE

#### L.E.D. LAMPS

LED209	T-1 3 mm Red	.09
LED211	T-1 3 mm Green	.19
LED212	T-1 3 mm Yellow	.14
LED220	T-1 1/2 5 mm Red	.11
LED222	T-1 1/2 5 mm Green	.24
LED224	T-1 1/2 5 mm Yellow	.16

#### DISPLAYS

FND357	375' Common Cathode	.99
FND367	360' Common Cathode (high brightness)	1.24
FND500	500' Common Cathode	.99
FND507	500' Common Anode	.99
FND560	500' Common Cathode (high brightness)	1.24
FND567	500' Common Anode (high brightness)	1.24
DL704	300' Common Cathode	1.29
DL707	300' Common Anode	1.29
DL747	630' Common Anode	2.29

### CMOS

CD4000BE	.19	CD4021BE	.99	CD4046BE	1.25	CD4081BE	.29	CD4522BE	1.75
CD4001BE	.39	CD4022BE	1.29	CD4047BE	1.25	CD4082BE	.29	CD4526BE	.99
CD4002BE	.34	CD4023BE	.39	CD4048BE	.69	CD4083BE	.79	CD4527BE	1.45
CD4006BE	1.29	CD4024BE	.79	CD4050BE	.69	CD4086BE	.95	CD4528BE	.99
CD4007BE	.29	CD4025BE	.39	CD4051BE	.99	CD4093BE	.79	CD4531BE	.99
CD4008BE	.84	CD4026BE	1.79	CD4052BE	1.25	CD4098BE	1.75	CD4532BE	1.50
CD4009BE	.69	CD4027BE	.49	CD4053BE	1.25	CD4104BE	2.95	CD4538BE	1.15
CD4010BE	.69	CD4028BE	.89	CD4060BE	1.99	CD4502BE	1.45	CD4539BE	1.65
CD4011BE	.49	CD4029BE	1.29	CD4066BE	.89	CD4508BE	1.99	CD4533BE	3.95
CD4012BE	.39	CD4030BE	.79	CD4068BE	.34	CD4510BE	1.25	CD4555BE	.89
CD4013BE	.59	CD4033BE	1.79	CD4069BE	.34	CD4511BE	.99	CD4556BE	.89
CD4014BE	.89	CD4034BE	2.99	CD4070BE	.49	CD4512BE	.99	CD4581BE	2.25
CD4015BE	.89	CD4035BE	1.39	CD4071BE	.39	CD4514BE	2.45	CD4582BE	.99
CD4016BE	.59	CD4040BE	1.89	CD4072BE	.29	CD4515BE	2.45	CD4584BE	.89
CD4017BE	.89	CD4041BE	1.75	CD4073BE	.54	CD4516BE	1.75	CD4585BE	1.50
CD4018BE	.89	CD4042BE	.89	CD4075BE	.59	CD4518BE	1.25	CD4702BE	9.95
CD4019BE	.89	CD4043BE	.99	CD4076BE	1.29	CD4519BE	.89	CD4724BE	1.95
CD4020BE	1.39	CD4044BE	.99	CD4078BE	.45	CD4520BE	1.25		

### PLASTIC POWER TRANSISTORS

TIP30	.39	PNP	1 AMP	100V
TIP31	.42	NPN	3 AMP	100V
TIP32	.43	PNP	3 AMP	100V
TIP41	.59	NPN	6 AMP	100V
TIP42	.64	PNP	6 AMP	100V
TIP115	.59	PNP	2 AMP	60V
TIP120	.64	NPN	5 AMP	60V
TIP122	.74	NPN	5 AMP	100V
TIP125	.74	PNP	5 AMP	60V
TIP127	.85	PNP	5 AMP	100V
TIP2955	.83	PNP	15 AMP	60V
TIP3055	.70	NPN	15 AMP	60V
FT3055	.59	NPN	10 AMP	60V

#### ISOLATORS

ILD74	Dual Opto Isolator	1500V	1.29
ILQ74	Quad Opto Isolator	1500V	3.95
MCT6	Dual Opto Isolator	1500V	1.29
TIL111	Opto Coupler	1500V	.54
4N26	Opto Isolator	2500V	.54
4N32	Opto Isolator	2500V	.69
4N33	Opto Isolator	1500V	.65
4N36	Opto Isolator	2500V	.79
4N37	Opto Isolator	1500V	.85

74LS447N .59

BCD to 7 segment decoder/driver o/c

## Active Electronic Sales Corp.

P.O. BOX 1035 FRAMINGHAM, MASSACHUSETTS 01701

Over-the-counter sales, 12 Mercer Rd., Natick, Mass 01760

Behind Zsys on Rte. 9

Telephone Orders & Enquiries (617) 879-0077

MINIMUM ORDER \$10.00 • ADD \$2.00 TO COVER POSTAGE & HANDLING

Foreign customers please remit payment on an international bank draft or international postal money order in American dollars.

IN CANADA

5651 FERRIER ST. MONTREAL, QUEBEC H4P 2K5	4800 DUFFERIN ST. DOWNSVIEW, ONTARIO M3H 5S9	BAXTER CENTRE 1050 BAXTER ROAD OTTAWA, ONTARIO K2C 3P2	3070 KINGSWAY VANCOUVER, B.C. V5R 5J7
Tel.: (514) 731-7441	Tel.: (416) 661-1115	Tel.: (613) 820-9471	Tel.: (604) 438-3321

Accepted by:

- CHARGE
- VISA
- master charge





**MINIATURE SCREWDRIVER**



RUGGED CONSTRUCTION  
100% OF USES — 1/16" TIP

**2/\$1.00**

**MAGNETIC RETRIEVER TOOL**



Picks up plusive metal parts or tools in hard-to-reach places.

EXTENDS TO 26 1/2" — ROTATES 360° STRONG, LIFETIME MAGNET

**MRT-2281 \$3.95**

**CONTINENTAL SPECIALTIES**

**LOGIC PROBE KIT**



**SPECIFICATIONS**

Input Impedance: 300,000 Ohms.  
Thresholds: "Lo" 30%Vcc — "Hi" 70%Vcc  
Maximum Speed: 300 nsec., 1.5MHz  
Input Protection: ±50VDC continuous 117VAC for 15 sec.  
Power: 30mA @5V — 40mA @ 15V — 25V max. reverse voltage protected; 36" cable with color coded clips included.  
Operating Temp.: 0-50°C.  
Dimensions: 5.8L x 1.0W x 0.7D in. (1.47 x .25 x .18mm)  
Weight: 30 oz. (85 gm)

**LPK-1 \$21.95/Kit**

**Proto Clips**

14-PIN CLIP	PC-14	\$ 4.50
16-PIN CLIP	PC-16	\$ 4.75
24-PIN CLIP	PC-24	\$10.00
40-PIN CLIP	PC-40	\$16.00

**Proto Boards**

PB-6	\$17.95
PB-100	19.95
PB-101	22.95
PB-102	26.95
PB-103	44.95
PB-104	55.95
PB-203	99.95
PB-203A	155.00
PB-203A-Kit	131.00

**Jumbo 6-Digit Clock Kit**

- Four .630"ht. and two .300"ht. common anode displays
- Uses MMS313 clock chip
- Switches for hours, minutes and hold functions
- Hours easily viewable to 30 feet
- Simulated walnut case
- 115 VAC operation
- 12 or 24 hour operation
- Includes all components, case and wall transformer
- Size: 6 1/2" x 3 1/4" x 1 1/4"

**JE747 \$29.95**

**JE701**

- Bright .300 ht. comm. cath. oled display
- Uses MMS314 clock chip
- Switches for hours, minutes and hold modes
- Hrs. easily viewable to 20 ft.
- Simulated walnut case
- 115 VAC operation
- 12 or 24 hr. operation
- Incl. all components, case & wall transformer
- Size: 6 1/2" x 3 1/8" x 1 1/4"

**6-Digit Clock Kit \$19.95**

**Regulated Power Supply**

Uses LM309K. Heat sink provided. PC board construction. Provides a solid 1 amp @ 5 volts. Can supply up to ±5V, ±9V and ±12V with JE205 Adapter. Includes components, hardware and instructions. Size: 3 1/2" x 5" x 2 1/4"

**JE200 \$14.95**

**ADAPTER BOARD**

Adapts to JE200 — ±5V, ±9V and ±12V

DC/DC converter with +5V input. Toroidal hi-speed switching XMF8. Short circuit protection. PC board construction. Piggy-back to JE 200 board. Size: 3 1/2" x 2" x 9/16" H

**JE205 \$12.95**

**MICROPROCESSOR COMPONENTS**

<b>8080A/8080A SUPPORT DEVICES</b>		<b>MICROPROCESSOR MANUALS</b>	
8080A CPU	\$ 7.95	M-280 User Manual	\$7.50
8212 8-Bit Input/Output	3.25	M-CPI1802 User Manual	7.50
8214 Priority Interrupt Control	5.95	M-2650 User Manual	5.00
8216 Bi-Directional Bus Driver	3.49		
8224 Clock Generator/Driver	4.49		
8226 Bus Driver	3.49	<b>ROM'S</b>	
8228 System Controller/Bus Driver	4.95	2513(2140) Character Generator(lower case)	\$9.95
8238 System Controller	5.95	2513(3021) Character Generator(upper case)	9.95
8251 Prog. Comm 1/0 (USART)	7.95	2516 Character Generator	10.95
8253 Prog. Interval Timer	14.95	MMS230N 2048-Bit: Read Only Memory	1.95
8255 Prog. Periph. 1/0 (PPI)	9.95		
8257 Prog. DMA Control	19.95	<b>RAM'S</b>	
8259 Prog. Interrupt Control	19.95	1101 256K1 Static	\$14.99
		1103 1024K1 Dynamic	3.99
<b>8080A/8080 SUPPORT DEVICES</b>		2101(8101) 256K4 Static	3.95
MC6800 MPU	\$14.95	2102 1024K1 Static	1.75
MC6802CP MPU with Clock and Ram	24.95	71102 1024K1 Static	1.95
MC6810AP1 128x8 Static Ram	5.95	2111(8111) 256K4 Static	3.95
MC6810AP2 Periph. Inter. Adapt (MC6820)	7.49	2112 256K4 Static MOS	4.95
MC6828 Priority Interrupt Controller	12.95	2114 1024K4 Static 450ns	7.95
MC6830I8 1024X8 BI ROM (MC68A30-B)	14.95	2114L 1024K6 Static 450ns low power	10.95
MC6850 Asynchronous Comm. Adapter	7.95	2114-3 1024K4 Static 300ns	10.95
MC6852 Synchronous Serial Data Adapter	9.95	2114L-3 1024K4 Static 300ns low power	11.95
0-6500 Bps. Data MODEM	12.95	5101 256X4 Static	7.95
MC6862 2400 bps Modulator	14.95	5102 1024X4 Static 450ns	4.95
MC6880A Quad 3-State Bus. Trans. (MC8125)	2.25	7485 16K14 Static Tristate	1.75
		7489 16K14 Static	7.95
<b>MICROPROCESSOR CHIPS—MISCELLANEOUS</b>		745200 256X7 Static	4.95
Z80(780C) CPU	\$13.95	93421 4K Static	2.95
Z80A(780-1) CPU	15.95	UPD4114 4K Dynamic 16 pin	4.95
CDP1802 CPU	19.95	(MK4027) 16K Dynamic 16 pin 250ns	9.95
2650 MPU	19.95	UPD416 16K Dynamic 16 pin 250ns	4.95
6502 CPU	11.95	(MK4116) 4K Static	14.95
8035 8-Bit MPU w/clock, RAM, I/O lines	19.95	TMS4044-4K Static	14.95
PS855 CPU	19.95	45N 45N FAMOS	14.95
TMS9900L 16-Bit MPU w/hardware, multiply & divide	49.95	TMS4044-1024K4 Static	14.95
		2117 16,384K1 Dynamic	4/1.00
		<b>PROM'S</b>	
MMS00H Dual 25 Bit Dynamic	5.50	1702A 2048 FAMOS	55.95
MMS03H Dual 50 Bit Dynamic	5.50	2716NTEL 16K1 EPROM	59.95
MMS04H Dual 16 Bit Static	5.50	TMS2516 16K1 EPROM	39.95
MMS05H Dual 400 Bit Static	5.50	2716 16K1 EPROM power supply	89.95
MMS10H Dual 64 Bit Accumulator	5.50	2708 8K EPROM	10.95
MMS10H1H 500/512 Bit Dynamic	8.99	2716 T1 16K1 EPROM	29.95
2541 1024 Dynamic	3.95	*Requires 3 voltages. —5V, +5V, +12V	14.95
2518 Hex 32 Bit Static	4.95	6301-1(7611) 1024 Tristate Bipolar	3.49
2522 Dual 132 Bit Static	2.95	6330-1(7602) 256 Open C Bipolar	2.95
2524 512 Static	3.99	8253 32X8 Input Collector	3.95
2525 1024 Dynamic	2.95	8254 4096 Bipolar	10.95
2527 Dual 256 Bit Static	5.00	825123 32X8 Tristate	3.95
2528 Dual 250 Static	4.00	74186 512 TTL Open Collector	9.95
2529 Dual 240 Bit Static	4.00	74188 256 TTL Open Collector	3.95
2532 Quad 80 Bit Static	2.95	745287 1024 Static	2.95
3341 Flo	6.95		
7415870 4K4 Register File (TriState)	2.40		

**JE600 HEXADECIMAL ENCODER KIT**

**DIGITAL THERMOMETER KIT**

**FEATURES:**

- Full 8 bit latched output for microprocessor use
- 3 User Define keys with one being bistable operation
- Debounce circuit provided for all 19 keys
- LED readout to verify entries
- Easy interfacing with standard 16 pin IC connector
- Only ±5VDC required for operations

**FULL 8 BIT LATCHED OUTPUT—19 KEYBOARD**

The JE600 Encoder Keyboard provides two separate hexadecimal digits produced from sequential key entries to allow direct programming for 8 bit microprocessor or 8 bit memory chips. Three (3) additional keys are provided for user operations with one having a bistable output available. The outputs are latched and monitored with LED readouts. Also included is a key entry strobe.

**JE600 \$59.95**  
Hexadecimal Keypad only \$14.95

**JE300 \$39.95**

**FEATURES:**

- Dual sensors—switching control for indoor/outdoor or dual monitoring
- Continuous LED 5" ht. display
- Range: 40°F to 199°F / 40°C to 100°C
- Set for Fahrenheit or Celsius reading
- Accuracy: ±1% nominal
- Set for Fahrenheit or Celsius
- Sim. walnut case — AC wall adapter incl.
- Size: 3-1/4" H x 6-5/8" W x 1-3/8" D

**62-Key ASCII Encoded Keyboard Kit**

**JE610 \$79.95**  
62-Key Keyboard only \$34.95

**FEATURES:**

- 60 Keys generate the full 128 characters, upper and lower case ASCII set
- Fully buffered
- 2 user-define keys provided for custom applications
- Caps lock for upper case only alpha characters
- Utilizes a 2376 (40 pin) encoder read only memory chip
- Outputs directly compatible with TTL/DTL or MOS logic arrays
- Easy interfacing with a 16-pin dip or 18-pin edge connector

**HICKOK LX303 Portable LCD Digital Multimeter**

• 8 1/2 inch high, 3 1/2 Digit Liquid Crystal Display • Over 200 Hours of operation with a 9V battery  
• Automatic zero, polarity and over-range indicator • 1000V DC F.S. sensitivity • 7% basic accuracy  
• 19 ranges and functions • Rugged C-Shell case and removable cover, stores test lead set.  
• Full one year warranty.

**LX303 1% ACCURACY \$74.95**  
**LX304 5% ACCURACY \$89.95**

Part No. Description Price  
RC3 115V AC ADAPTER 7.50  
CC-3 PADDED CARRYING CASE 7.50  
VP-10 X10 DC PROBE ADAPTER (Up to 10K) 14.95  
VP-40 40K DC PROBE 35.00  
CS-1 10 AMP DC Current Shunt 14.95

\$10.00 Min. Order — U.S. Funds Only  
Spec Sheets — 25¢  
1980 Catalog Available — Send 41¢ stamp  
Postage — Add 5% plus \$1 Insurance (if desired)

**FREE 1980 CATALOG**

**Jameco ELECTRONICS**  
PHONE ORDERS WELCOME (415) 592-8097

MAIL ORDER ELECTRONICS — WORLDWIDE  
1355 SHOREWAY ROAD, BELMONT, CA 94002  
PRICES SUBJECT TO CHANGE

**The Incredible "Pennywhistle 103"**

**\$139.95 Kit Only**

The Pennywhistle 103 is capable of recording data to and from audio tape without critical speed requirements for the recorder and it is able to communicate directly with another modern and terminal for telephone "teaming" and communications. In addition, it is free of critical adjustments and is built with non-precision, readily available parts.

Data Transmission Method ..... Frequency-Shifting Keying, full-duplex (half-duplex selectable), 300 Baud

Maximum Data Rate ..... 300 Baud

Data Format ..... Asynchronous Serial (return to mark level required between each character)

Receive Channel Frequencies ..... 2025 Hz for space, 2225 Hz for mark

Transmit Channel Frequencies ..... Switch selectable: Low (normal) = 1070 space, 1270 mark, High = 025 space, 2225 mark

Receive Sensitivity ..... -46 dbm acoustically coupled

Transmit Level ..... -15 dbm nominal. Adjustable from -6 dbm to -20 dbm

Receive Frequency Tolerance ..... Frequency reference automatically adjusts to allow for operation between 1800 Hz and 2400 Hz

Digital Data Interface ..... EIA RS-232C or 20 mA current loop (receiver is optoisolated and non-polar)

Power Requirements ..... All components mount on a single 5" by 9" printed circuit board. All components included.

Physical ..... 120 VAC, single phase, 10 Watts

Requires a VOM, Audio Oscillator, Frequency Counter and/or Oscilloscope to align.

**TRS-80 16K Conversion Kit**

Expand your 4K TRS-80 System to 16K.

Kit comes complete with:

- 8 each UPD416-1 (16K Dynamic Rams) 1 250NS
- Documentation for conversion

**TRS-16K \$75.00**

**ok JUST WRAP™**

- 30 AWG wire
- .025" square posts
- Built-in cut off
- Includes 50 ft. wire
- No stripping or slitting required—just wrap

Part No.	Wire Color	Price
JW-1-B	Blue	\$14.95
JW-1-W	White	14.95
JW-1-Y	Yellow	14.95
JW-1-R	Red	14.95

**JUST WRAP™ Replacement Wire**

Part No.	Color	50 ft. roll	Price
R-JW-B	Blue	50 ft. roll	\$2.98
R-JW-W	White	50 ft. roll	2.98
R-JW-Y	Yellow	50 ft. roll	2.98
R-JW-R	Red	50 ft. roll	2.98

**JUST WRAP™ Unwrap Tool \$3.49**

**ok Vacuum Vise**

Vacuum-based light-duty vise for small components and assemblies. ABS construction. 1 1/2" jaws, 1 1/4" travel. Can be permanently installed.

**VV-1 \$3.49**

**ADJUSTABLE WRENCH**

- Two Sizes: 6" and 10"
- Professional Quality
- Chrome Vanadium Steel

**6" — AW-6 .. \$4.95 10" — AW-10 .. \$6.95**

**JOYSTICK VIDEO CONTROLLER**

- IDEAL FOR ALL VIDEO GAMES OR REMOTE CONTROL PROJECTS
- SMALL CASE SIZE: 1-1/2"H x 2-3/8"W x 4-5/16"L
- 2 MINIATURE POTENTIOMETERS—40K OHM EACH
- SPST PUSH BUTTON CONTROL
- 5-WIRE CONNECTION CABLE — 5 FEET LONG
- RUGGED PLASTIC CASE

**JVC-40 \$4.95 each**

<b>DIGITAL MULTIMETERS</b> Sinclair PDM35 Reg. \$69.95 Hickok LX303 \$49.95 Beckman TECH310 \$130. Model 2800	<b>MURAPHONE</b> Cordless Telephone System Reg. \$89.95 \$74.95 GTE Flip-Phone \$37.95	<b>Portable VOM Multitester</b> Model S-1995 20 KΩ VDC • 10 KΩ VAC	<b>100 MHz 8-Digit Counter</b> Model MAX100 Reg. \$150.00 Fully automatic \$127.50	<b>6" x 9" 3-Way Speaker</b> 20 oz. ceramic magnet Model BP2000-69TR \$14.95 ea.
<b>3 1/2-Digit Portable DMM</b> Model 2800	<b>HICKOK</b> Digital CB In-Line Tester Model 388 Reg. \$399.00 \$169.95	<b>Logic Monitor</b> Automatically displays static and dynamic logic Model LM-1 Works with DTL, TTL, TTL, and CMOS • 16 LED display \$59.95	<b>Telephone Answering</b> Model 1500 \$249.95 Call Control Reg. \$349.95 Model 1400 \$199.95	<b>FREE</b> 8 pc. Tool Set (value \$14.95) with \$200.00 purchase from this ad.
<b>Portable Oscilloscopes</b> 15 MHz Dual Trace Triggered Miniscope Model MS-15 Reg. \$319.00 \$269.95 30 MHz Dual Trace Triggered Miniscope Model MS-230 Reg. \$559.00 \$479.95	<b>Function Generator</b> Model 2001 Reg. \$185.95 \$157.95 • Sine-, square-, triangle- and separate TTL square wave output • Frequency range: 1Hz-100KHz	<b>Weller Xcelite</b> Attache Style Tool Case Model TC100/ST \$471 \$279.95 Service Master Tool Kit Model 99-SM Reg. \$69.95 \$47.50	<b>BK PRECISION</b> Portable Digital Capacitance Meter Model 820 Measures capacitance from 0.1pF to 1 Farad Resolves to 0.1pF • 10 ranges for accuracy and resolution 4 digit easy-to-read LED display • 0.5% accuracy \$190.00	<b>WAHL</b> Cordless Soldering Iron Model 7800 \$29.95 Thermal-Spot Model 8800 Circuit Tester \$29.95
<b>Logic Probe</b> Compact circuit powered Detects pulses as short as 50 μsec • DTL/TTL/HTL/CMOS compatibility Model LP-1 \$44.95	<b>Proto Preassembled Boards</b> Model PB-104 Fully assembled breadboard contains four OT-59S sockets, seven OT-59B bus strips and four 5-way binding posts \$49.95	<b>Proto Board with Built-in Power Supplies</b> Regulated Short-proof Reg. \$154.95 Model PB-203A \$129.95	<b>3 1/2-Digit 0.1% Digital Capacitance Meter</b> Model 3001 9 ranges from 1999 pF to 199.9 μF 0.1% of reading accuracy \$190.00 \$170	<b>In-Dash Car Stereos</b> 8-Track Tape Player with AM/FM/MPX Radio Model C-777 \$52.50 Cassette Tape Player with AM/FM/MPX Radio Model CAS-888 \$57.50
<b>RC Circuit Box</b> 36 resistors (15 1/2 to 10 MΩ) • 18 capacitors (100 pF to 0.22 μF) Reg. \$49.95 includes test leads VIZ Model WC 412A \$42.	<b>Magnifier Lamp</b> Precision ground and polished magnification lens Model MG10A \$49.95	<b>30 MHz Dual Trace with Delay Line</b> Model LBO-520 \$899.95	<b>DIGITAL MULTIMETER Simpson 461</b> Complete with nickel-cadmium batteries, AC charger/adaptor, test leads \$149.95	<b>Stereo Power Booster</b> Model POW-40 40W stereo \$24.95
<b>Chess Challenger 7</b> Reg. \$110.00 Model BBC \$79.95	<b>Weller Controlled Output Soldering Station</b> Model WTCPN Reg. \$77.50 \$49.95	<b>LEADER</b> 30 MHz Dual Trace with Delay Line Model LBO-520 \$899.95	<b>BSR X-10</b> Remote Control for Lights & Appliances 4 Pc. Standard Starter Kit • One (1) Standard Command Reg. \$87.95 Console • Two (2) Lamp Modules • One (1) Appliance \$79.50 Module 5 Pc. Ultrasonic Starter Kit • One (1) Deluxe Ultrasonic Reg. \$112.95 Command Console • One (1) Hand Held Remote Unit • Two \$99.95 1/2 Lamp Modules • One (1) Appliance Unit Lamp Module: \$14.50 Standard Command Console: \$36.00 Appliance Module: \$14.50 Ultrasonic Command Console: \$59.95 Wall Switch Module: \$14.50 with Hand Held Remote	<b>FORDHAM</b> 855 Conklin St. Farmingdale, N.Y. 11735 ADD FOR SHIPPING AND INSURANCE to \$250.00 ..... \$ 3.50 501.00 to 500.00 ..... 5.00 501.00 to 750.00 ..... 7.50 751.00 to 1000.00 ..... 10.00 over 1000.00 ..... 12.50 CDD's extra TOLL FREE (800) 645-9518 In N.Y. State call (516) 752-0050

# OUTSTANDING COMPUTER PRODUCTS

Note: Most CompuPro boards are available in 3 forms: unkit (sockets, bypass caps pre-soldered in place), assembled, or qualified under our high-reliability Certified System Component (CSC) program.

**NEW! S-100 DUAL PROCESSOR CPU BOARD** Introductory prices:  
**\$385 unkit, \$495 assm, \$595 CSC**

An 8088 CPU gives true 16 bit power with a standard 8 bit S-100 bus, while an additional 8085 CPU gives compatibility with CP/M and the vast library of software developed for the 8080. Finally — a CPU board that is downward compatible with existing software, upward compatible with hardware and software not yet developed, accesses 16 Megabytes of memory, meets all IEEE S-100 bus specifications, runs 8085 and 8086 code in your existing mainframe as well as Microsoft 8086 BASIC and Sorcim PASCAL/M™, and runs at 5 MHz for speed as well as power. The Dual Processor Board is built to the same stringent standards that have established our leadership in S-100 system components... and starting June 1st, you'll be able to plug it into your mainframe to experience computing power that, until now, you could only dream about.

Available June

**NEW! S-100 SPECTRUM COLOR GRAPHICS BOARD** Introductory prices:  
**\$339 unkit, \$399 assm, \$449 CSC**

Includes 8K of IEEE-compatible static RAM; full duplex bidirectional parallel I/O port for interfacing with keyboards, joysticks, and similar parallel peripherals; and a 6847-based graphics generator capable of displaying all 64 ASCII characters. Put these all together, and you've got 10 modes of operation — from alphanumeric/semi-graphics in 8 colors to ultra-dense 256 x 192 full graphics. With 75 Ohm RS-170 line output and video output for use with FCC approved video modulators. Need graphics software? Sublogic's 2D Universal Graphics Interpreter (normally \$35) is yours for \$25 with the purchase of any Spectrum board. Don't settle for B&W or stripped-down color boards — go for the full Spectrum of performance. Available June

TERMS: Cal res add tax. Allow 5% for shipping, excess refunded. VISA®/Mastercharge® call our 24 hour order desk at (415) 562-0636. COD OK with street address for UPS. Prices subject to change without notice.

**SPECIAL PRICE! TRS-80\* -I or -II MEMORY EXPANSION CHIP SET: \$69!!**

We've done it again... 8 low power, 250 ns 16K dynamic RAMs at a trendsetting price. Don't be impressed with fancy packaging or four color ads; our chip set gives all the performance you want at a price you can afford. Offer good while supplies last. Add \$3 for TRS-80 compatible DIP shunts and complete installation instructions.

\*TRS-80 is a trademark of the Tandy Corporation.

## OTHER S-100 PRODUCTS

Z-80A CPU Board	\$225 unkit, \$295 assm, \$395 CSC
8085 CPU Board	\$235 unkit, \$325 assm, \$425 CSC
Godbout Computer Enclosure	\$289 desktop, \$329 rack mount
8K Econoram IIA static RAM	\$169 unkit, \$189 assm, \$239 CSC
16K Econoram XIV static RAM	\$299 unkit, \$349 assm, \$429 CSC
32K Econoram X-32 static RAM	\$599 unkit, \$689 assm, \$789 CSC

12 Slot Motherboard	\$129 unkit, \$169 assm
19 Slot Motherboard	\$174 unkit, \$214 assm
25 Interfacer I I/O Board	\$199 unkit, \$249 assm, \$324 CSC
3P PLUS S Interfacer I/O Board	\$199 unkit, \$249 assm, \$324 CSC
Active Terminator Board	\$34.50 kit
Memory Manager Board	\$59 unkit, \$85 assm, \$100 CSC
2708 EROM Board (less EROMs)	\$85 unkit

**CompuPro™**

from

**GODBOUT**  
ELECTRONICS

**SEE COMPUPRO PRODUCTS IN PERSON AT FINER COMPUTER STORES WORLD-WIDE.**

Bldg. 725, Oakland Airport, CA 94614

CIRCLE NO. 30 ON FREE INFORMATION CARD





THESE GOLD IN THEM THAR PAKS!!



# \$2.99'S

ARE PAKS EVEN A 49'ER CAN DIG!



FREE! FREE!

WITH ANY \$30 ORDER, PICK A \$2.99er FREE!



- 200 PC-SEMICON SPECIAL, assorted semis of all types. Untested material, (#3300) ..... \$2.99
- 20-MOTORS MOTORS, assid. sizes speeds & types, 1.5-12 volts, (#2551A) ..... 2.99
- 200-LONG LEAD DISCS, prime, marked caps, assorted material, (#2598) ..... 2.99
- 100-PLASTIC TRANSISTORS, untested, TO-92, assit. types, (#2604) ..... 2.99
- 50-SLIDE SWITCHES, various shapes, sizes, and types, (#2726) ..... 2.99
- 75-TRANSISTOR ELECTROLYTICS, epoxy encapsulated, assit. value, (#2747) ..... 2.99
- 250-HALF WATTERS, 100%, color-coded resistors, assit. values, (#3046) ..... 2.99
- 25-SLIDE VOLUME CONTROLS, various values & types, for Hi-Fi, etc. (#3057) ..... 2.99
- 50-UPRIGHT ELECTROS, 100%, assorted values & voltages, marked, (#3226) ..... 2.99
- 20-ROCKER SWITCHES, white rockers, DPDT, solder lugs, 125V 4A, (#3302A) ..... 2.99
- 50-MINI POTS, pc style, single turn, assorted values, (#3345) ..... 2.99
- 20-LUMBO RED LEDS, 3V 10 mA, 100% good material, red dome lense, (#3369) ..... 2.99
- 100-TLX, 7400 series, incl. gates, flip-flops, etc. untested, (#6226) ..... 2.99
- 50-TRANSISTOR SOCKETS, assortment may include TO-19, 5, 6, 3, etc. (#3845) ..... 2.99
- 100-CABLE TIES, 4" non-slip white plastic, like Ty-wrap, (#5218) ..... 2.99
- 150-FEEDTHRU CAPS, assorted types & sizes, for RF, UHF, etc. (#5668A) ..... 2.99
- 250-1/2 WATT RESISTORS, assid. carbons, carbon-films, some 5%ers, (#5797A) ..... 2.99
- 100-PLESSY CAPS, ceramic blocks in assorted sizes & values, (#6221) ..... 2.99
- 30-HOBBY LEDS, assorted types & colors, mostly dims, some good, (#6225) ..... 2.99
- 100-TLX, 7400 series, incl. gates, flip-flops, etc. untested, (#6226) ..... 2.99
- 150 PC-HEATSHRINK, slip-over type, shrinks 50%, like Thermo-fit, (#6239) ..... 2.99
- 5-BRASS LOCKS, with key, 1 1/2" long, for doors, windows, etc. (#6253) ..... 2.99
- 250-MOLEX SOCKETS, "on-a-strip", make your own pc sockets, (#6255) ..... 2.99
- 4-LM-747 OP AMPS, 100% prime, dual linear op amp, DIP package, (#6262) ..... 2.99
- 50-RCA PHONO PLUGS, popular audio/speaker plugs, 100% material, (#3293) ..... 2.99
- 25-CRYSTALS, assorted types, some H6/U, some frequency marked, (#6256) ..... 2.99
- 150-SUBMINI IF TRANSFORMERS, assit. may include; osc. antenna, etc. (#6259) ..... 2.99
- 60-SQUARE OHM RESISTORS, prime resistors, assit. values, grab 'em! (#6261) ..... 2.99
- 30-MICRO MINI REED SWITCHES, long, for alarms, relay systems, etc. (#6263) ..... 2.99
- 200 PC-CAPACITOR SPECIAL, assit. mylars, polys, mica, etc. 100% good, (#6264) ..... 2.99
- 20-PUSHBUTTON ALARM SWITCH, SPST, momentary, NC, w/hardware, (#6267) ..... 2.99
- 500-PC-HARDWARE SURPRISE, (approx.) 1 lb. assit. screws, washers, etc. (#6271) ..... 2.99
- 30-9V BATTERY CLIPS, snap connector, coded, insulated leads, (#6286) ..... 2.99
- 6-WATCH GUTS, 5-function, LED style, assorted sizes, untested, (#6287) ..... 2.99
- 10-HEAVY DUTY LINE CORDS, white, 2 cond. 6 ft. 16 gauge, (#6292) ..... 2.99
- 20-SINGLE PIN CORDS, green/black/red, 3V 10mA, 100% (#6293) ..... 2.99
- 40-LED/TRANSISTOR SOCKETS, "snap-in", 3 pc leads, for TO-5, 18, 46, etc. (#6297) ..... 2.99
- 200-PRE-FORMED 1/2 WATTERS, popular values, some 5 & 10 %ers, (#6246) ..... 2.99
- 50-SCRs & TRIACS, assorted values, 10 Amp TO-220, untested, (#6337) ..... 2.99
- 1-CB CONVERTER, receives CB on car radio, 12 VDC operation, (#5193) ..... 2.99
- 40-EDGE CONNECTORS, assit. 4 & 6 pin, 2-sided, pc leads, (#6364) ..... 2.99
- 20-6 CELL BATTERY HOLDERS, for AA size cells, 9V clip receptical, (#6386) ..... 2.99
- 60-THERMAL DISCS, break at 257 F. 14 gauge axial leads, (#6367) ..... 2.99
- 4-0.8" HOBBY READOUTS, 4 digit panels, for Cathode, etc. untested, (#6384) ..... 2.99
- 25-TINY SLIDE SWITCH, only 3/7" cube, SPDT, PC leads, (#6385) ..... 2.99
- 50-TO-5 TRIACS, 50-600 prv., 3 lead TO-5 cans, 60%+ yield, (#6321) ..... 2.99
- 30-PLASTIC POWERS, 25 watt, npn & pnp, 50-200 bvcb0, (#6237) ..... 2.99
- 100-2 WATT RESISTORS, assorted carbons, films, etc. some 5%ers, (#6238) ..... 2.99
- 150 PC-HEAT SHRINK, like Thermo-Fit, assit. sizes, shrinks 50%, (#6239) ..... 2.99
- 25-MAGNETIC DISCS, Plastalloy 13/16 dia. x 1/8" discs, (#6294) ..... 2.99
- 150-PLUGS & SOCKETS, assorted types & styles, wide variety, (#6237) ..... 2.99
- 15-PA-263 PC BOARDS, for GE PA-263 stereo amps, pre-etched, (#2013) ..... 2.99
- 40-STEREO INDICATORS, tiny red 1.5V bulbs, for Hi-Fi replacement, (#6244) ..... 2.99
- 40-800V 1A RECTIFIERS, type IN4006, epoxy, axial leads, (#6245) ..... 2.99
- 4-2A 500V BRIDGES, silicon, full wave rectifiers, TO-5 case, (#6248) ..... 2.99
- 10-QUAD PHONO JACKS, 4 RCA jacks on 2 x 1 1/2" Bakelite strip, (#6249) ..... 2.99
- 50-MODULAR SWITCHES, by Centralab, "push-on" DPDT, 6PDT, etc., (#3150A) ..... 2.99
- 150-"4000" RECTIFIERS, IN4000 series, may include, 50 to 1000V, (#2417) ..... 2.99
- 15-THUMBWHEEL TRIM POTS, snap-in type, assorted values, (#6299) ..... 2.99
- 50-MAGNIFIED MAN-3's, 7 segment 0.1" high, w/"bubble" magnifier, (#6257) ..... 2.99
- 1-I.R. DIODE, 5-9 watts, hetero-junction coax, for Pulse mode, (#6445) ..... 2.99
- 200-BULBPLATES, assit. resistor-capacitor networks, various values, (#6282) ..... 2.99
- 150-METAL CAN TRANSISTORS, assit. 2N #s in TO-5, 118, some unmarked, (#2603) ..... 2.99
- 24-LM-340T VOLTAGE REGULATORS, untested TO-220, may incl. 5-24V, (#2635) ..... 2.99
- 150-POLYSTYRENE DISCS, assorted types & styles, w/assit. values, (#2729) ..... 2.99
- 100-PLASTIC LENSES, assorted styles & colors, (#6266) ..... 2.99
- 250-CERAMIC CAPS, assit. tubulars, NPO's, temp. coefficient, etc. (#5839) ..... 2.99
- 60-THERMISTORS, various types & styles, neg. coefficient, 100%, (#4089) ..... 2.99
- 25-IC SOCKETS, assit. 24, 28, & 40 pin sockets on G-10 board, (#6380) ..... 2.99
- 25-MINI PLUG & CABLE SETS, 3.5mm plug, 6' insulated 2 cond. leads, (#6269) ..... 2.99
- 20-RCA PHONO JACKS, popular HiFi jack on a Bakelite strip, (#6230) ..... 2.99
- 250-PRE-FORMED DISCS, capacitor type, for PC, mixed values, (#2605) ..... 2.99
- 50-AXIAL ELECTROS, assit. values, volts, sizes, What a buy!, (#6227) ..... 2.99
- 100-METALLIC RESISTORS, mostly 1/2 watters, assit. val. 1-5% tol. (#6280) ..... 2.99
- 100-POWERS POWERS, 3 to 7 watt power resistors, (#6281) ..... 2.99
- 15-IGNITION SUPPRESSION CAPS, for auto radios, decks, etc. 0.5 mf (#6224) ..... 2.99
- 200-COILS & CHOKES, assit. RF, OSC, IF, and peaking types, (#6283) ..... 2.99
- 50-POWER TAB TRANSISTORS, plastic NPN, TO-220, assit. types, untested, (#2425) ..... 2.99
- 24-SKINNY TRIM POTS, 300 ohms, single turn, assit. values & types, (#285) ..... 2.99
- 30-HOBBY OPTO COUPLERS, untested, mini DIP, 1500V isolation, (#2629) ..... 2.99
- 3-25A 50V BRIDGES, "block" type, with four lug-type leads, (#6311) ..... 2.99
- 100-DTL IC's, mostly dual JK flip flops, marked, 100% prime, (#6444) ..... 2.99
- 200-ONE WATTERS, assit. 1W resistors, mostly carbons, some 5%ers, (#6284) ..... 2.99
- 40-INSTRUMENT KNOBS, for half round shafts, some w/pointers, (#6498) ..... 2.99
- 15-LINE CORDS, heavy-duty, 18 gauge, 6', molded plug, 2-cond. (#6499) ..... 2.99

# Popular Electronics

## ADVERTISERS INDEX

READER SERVICE NO.	ADVERTISER	PAGE NO.
2	Aaton-Gavin/Instruments	80
3	Active Electronics/Sales Corp.	95
4	Africon Corporation	104
5	Antenna Specialists Co.	28
6	APF Computer	27
7	Apple Computer	Cover 2
8	AP Products	84
Bullet Electronics		105
10	Chade International, Inc.	92
9	Chaney Electronics	104
	Classified Advertising	106, 107, 108, 109
11	Chromotronics	88
12	Cleveland Consumer Computer	94
	Cleveland Institute of Electronics, Inc.	34, 35, 36, 37
1	Communications Electronics	31
13	Communications Technology Group	109
14	Components Express, Inc.	87
15	Compuque	60
16	Concord Computer Components	80
17	Cooper Group, The	46
18	DAK Industries	13
19	Delta Electronics	105
20	Digi-Key Corp.	103
21	Discwasher	Cover 4
22	DSI Instruments, Inc.	38
23	Electra Co. (Bearcat)	55
24	Electronic Technical Institute	91
25	Electronics Book Club	77
68	Enercon	93
27	Epson America	6
28	Firestik Antenna Corp.	85
	Fordham Radio Supply	98
29	General Engines Company	109
30	Godbout Electronics, Bill	98
	Grantham College of Engineering	91
31	Guardian Electronics	15
32	Hardside	78
33	Heath Co.	44
34	Heath Co.	18
35	Hewlett-Packard	Cover 3
36	Hitachi Instrument	86
37	Hobby World	105
38	Hustler	91
39	Illinois Audio	86
69	Information Unlimited	82
40	Jameco Electronics	96, 97
41	J&R Music World	89
	JS & A National Sales Group	1, 25
42	Maxell Corp. of America	68
	MICROCOMPUTER MART	92
43	Media Marketing	21
	Mercury International	17
44	MESA	16
45	Microcomputer Technology Inc.	79
46	McIntosh Laboratory, Inc.	20
	Netronics R & D Ltd.	41
	Netronics R & D Ltd.	85
47	Novation, Inc.	40
	NRI Schools	8, 9, 10, 11
48	Ohio Scientific	5
49	OK Machine & Tool Corp.	33
50	OK Machine & Tool Corp.	43
51	OK Machine & Tool Corp.	67
52	Olympic Sales	104
53	Ormsionix	19
54	Optoelectronics	83
55	PAIA Electronics, Inc.	90
56	Panasonic	52
57	Percom Data Company, Inc.	2
59	Poly Paks	100
60	Quest Electronics	99
	Radio Shack	81
61	Schober Organ Corp.	86
26	TAB Books	82
62	Tam's, Inc.	90
63	University of the Tree Press	23
64	Vector Electronics Co.	85
65	Wersi Electronics Inc.	60
66	Yamaha International Corp.	7



## ULTRA-SMALL LCD CHRONOGRAPH MODULE

• Only 2-3/8 x 1-1/2" • Multi-Function Memory Enables Module To Function As: STOPWATCH!

**\$24.50**

ELAPSED TIME INDICATOR!

Cat. No.  
92CU6403

DUAL ZONE TIMER!  
ALARM CLOCK!

SEND FOR FREE CATALOG  
**POLY PAKS**  
P.O. BOX 942-E6  
SO. LYNNFIELD, MA 01940

HOW TO ORDER  
We honor MASTERCARD, VISA, check, and C.O.D.  
(25% down/Minimum Order: \$10 Order by phone or  
mail. state Cat. No. & description, name & month  
of magazine. POSTAGE: U.S. add \$3. CANADIAN: add  
\$. FOREIGN: add \$10. [US funds]. Excess will be  
returned. OPEN ACCOUNTS: must be listed & rated in  
Dun & Bradstreet. Net: 30 PHONE: (617) 245-3828.





# PET 2001 professional computer



- PET 2001-8N Computer 8K bytes, large keyboard w/separate numeric pad and graphics \$795.00
- PET 2001-16N Computer 16K bytes, large keyboard with separate numeric pad and graphics \$995.00
- CBM 2001-16B Computer As above but has standard typewriter keyboard. No graphic keys \$895.00
- PET 2001-32N Computer identical to PET 2001-16N except with 32K bytes of memory \$1295.00
- CBM 2001-32B Computer identical to CBM 2001-16B except with 32K bytes of memory \$1295.00
- CBM 2022 Printer 80 column dot matrix printer with plain paper or forms handling tractor feed. Full graphics \$795.00
- CBM 2023 Printer 80 column dot matrix printer. Plain paper printer with full graphics \$695.00
- CBM 2040 Dual Floppy Dual drive intelligent mini floppy system. 341K net user storage capacity \$1295.00
- C2N External Cassette Cassette player/recorder to use with PET 2001/16/32 \$95.00
- PET to IEEE Cable Use this cable to connect your floppy or printer to any CBM Computer \$39.95
- IEEE to IEEE Cable Use this cable when connecting more than one peripheral to any CBM Computer \$49.95
- User Manual 160 pages covering all facets of user operation, programming and I/O for PET Computers \$9.95

## Professional Keyboard Kits!

Models 753 & 756 ASCII Keyboard Kits For Hobby or OEM Microprocessor Users

- Full 128 Character ASCII (756) 83 Keys, popular ASR-33 format (753) Rugged G-10 P.C. Board Tri-mode MOS encoding Two-Key Roll-over ASCII/TTL/DTL Compatible outputs 80 Strobe and Alpha Lock (756) Levitt and Pulse Strobo (756) Custom Keypads 3 User Definable Keys (753) Selectable Parity Low Bounce Keyswitches And Much More!!!
- 753K 63 Key phone style keyboard-Kit... \$65.95
- 753A Same as above assembled... \$79.95
- 756K 56 Key Full ASCII keyboard kit... \$69.95
- 756A Same as above assembled... \$92.95
- 701 Plastic enclosure for 753/756... \$15.00
- 702 Steel enclosure for 753/756... \$29.95
- 753MF Mounting Frame for 753... \$6.95
- 756MF Mounting Frame for 756... \$6.95

## AP Products

The all-new line of ACE All-Circuit Evaluators WITH POWER

- POWERACE 103 923103... \$124.95 Triple-output power supply for prototyping both linear and digital circuits.
- POWERACE 101 923101... \$79.95 The general purpose digital prototyping lab with FREE logic probe built in!
- POWERACE 102 923102... \$124.95 The general purpose digital prototyping lab with FREE logic probe built in!

## SD Systems Z-80 STARTER SYSTEM

The Z80 Starter Kit by SD Systems uses the powerful Z80 microprocessor as the heart of the complete microcomputer on a single board. Learn a step-by-step introduction to microcomputers, the PROM program and display, audio cassette interface, PROM programmer, wire-wrap expansion area, 4-channel Counter Timer and on Board RAM and PROM. Complete Operation and Instruction Manual included. ZBUG Monitor in ROM

Kit.....\$340.00 Assembled & Tested.....\$450.00

## MOTOROLA

MC140816	\$ 2.65	MC4052P	\$12.72
MC140817	3.20	MC4053P	12.72
MC140818	4.20	MC4054P	25.82
MC140819	3.97	MC6800P	10.97
MC14391	2.90	MC6802P	15.79
MC1456P1	1.32	MC6808P	13.35
MC1458P1	.66	MC6809P	35.84
MC14891A	1.42	MC6821C1P	10.89
MC14891B	1.42	MC6840P	9.80
MC14891C	1.42	MC6845P	33.87
MC14891D	1.42	MC8311P	5.00
MC14891E	1.42	MC14408PD	12.74
MC14891F	6.62	MC14411PD	14.61
MC1808P	1.07	MC4050P	14.77
MC1809P	1.07	MC4051P	14.77
		MC14489VPD	5.66

## 8038CP

Function Generator IC \$3.90 each

## LIQUID CRYSTAL DISPLAY

- High Contrast Ratio
- Wide Viewing Angle
- 0.5 in. Digit Height
- ULTRA Low Power Consumption LCD106... \$14.50

## 2708

8K EPROM \$10.50 ea

## EXIDY 32K SORCERER

- 32K RAM
- Dual Cassette I/O
- 4K ROM
- Z80 CPU
- 64x30 Video Display
- Character Graphics/User Defined Graphic Symbols
- Expandable to S-100 Bus
- Serial and Parallel I/O Ports

\$1395

## SYM-1

NEW LOW PRICE

## KIM-1 MICROCOMPUTER

Fully Assembled & Tested \$179.00



KTM-2 CRT/TV Kbd Term \$349

Including Documentation

## Power Supplies from ADETECH POWER

Model	Vdc	Amps	Model	Vdc	Amps
APS-5-3	5	3.0	APS-5-6	5	6.0
APS-12-1.6	12	1.6	APS-12-4	12	5.0
APS-15-1.5	15	1.5	APS-15-3	15	3.0
APS-24-1	24	1.0	APS-24-2.2	24	2.2
1-9	10 up	25 up	1-9	10 up	25 up
\$37.25	\$35.55	\$34.05	\$59.75	\$57.10	\$54.65

## HYBRID AUDIO POWER AMPLIFIERS

P/N	Matching Transformer
SI-1010G(10W)	TR10 \$ 7.90
SI-1020G(20W)	TR20 \$10.90
ASI-8(Socket for above)	.95
SI-1030G(30W)	TR30 \$12.90
SI-1050G(50W)	TR50 \$17.90
ASI-10(Socket for above)	.95

\*Note: One Transformer can power two audio amplifiers.

## Capacitance Meter

- Easy to use - plug in capacitor, push range button and read the value to 0.1%
- 0.5 in. liquid crystal display
- Exclusive "Charge/Zero" measurement circuit (patent pending) holds ±0.1% basic accuracy for a full year.
- Up to 200 hrs operation on standard 9V Batt.
- 8 easy pushbutton ranges cover 0.1pf to 1999 microfarads.
- Best of all it's easy on the budget - only

MODEL 938 \$149

## Intersil LED or LCD 3 1/2 DIGIT PANEL METER KITS

BUILD A WORKING DPM IN 1/2 HOUR WITH THESE COMPLETE EVALUATION KITS

Test these new kits for yourself with Intersil's low cost prototyping kits, complete with A/D converter and LCD display (for the 7106) or LED display (for the 7107). Kits provide all materials, including PC board, for a functioning panel meter. ICL7106EV (co.)...\$29.95 ICL7107 (LTD)...\$24.95

## Intersil 8 Digit - 10 MegaHertz Universal Counter Kit

- Resistors
- Capacitors
- Diodes
- Switches
- IC Socket
- Kit Includes: ICM7226AICD IC 10 MHz Quartz Crystal (8) 7 Segment, 3" LED Displays PC Board

Order Part Number ICM7226AEV...\$74.95

**ANCORNA** Send your check or Money Order to P.O. Box 2208P, Culver City, CA 90230. California residents add 6% sales tax. Minimum Order: \$10.00. Add \$1.00 to cover postage and handling. Master Charge and Visa welcomed. Please include your charge card number, interbank number and expiration date. PHONE ORDERS (213) 641-4064

TUCSON	CULVER CITY	SANTA ANA	PORTLAND
4518 E. Broadway Tucson, AZ 85711 (602) 881-2348	11080 Jefferson Blvd. Culver City, CA 90230 (213) 390-3595	1300 E. Estimote Ave. Santa Ana, CA 92705 (714) 547-8424	1125 N.E. 82nd Ave. Portland, OR 97220 (503) 264-5541
CANADA, B.C.	SUNNYVALE	ATLANTA	HOUSTON
4450 Fraser St. Vancouver, B.C. (604) 324-0707	1054 E. El Camino Real Sunnyvale, CA 94087 (408) 243-4121	3330 Piedmont Rd. N.E. Atlanta, GA 30305 (404) 281-7100	2849 Richmond Houston, TX 77068 (713) 526-3488

CIRCLE NO. 4 ON FREE INFORMATION CARD

### SOUND EFFECTS GENERATOR BASIC KIT

Now Chaney Electronics makes it possible to build your own sound effects generator without spending a fortune. We supply you with the 117677 sound chip plus an etched and drilled class epoxy PC board with schematic and layout instructions. This board makes it simple to build a generator capable of making sounds, locomotive whistles, etc. The complete digital supply for prototyping both linear and digital circuits.

Basic kit containing:  
1176477, PC board and instructions... \$23883 \$15.95

2N2222 TRANSISTOR FOR ABOVE... \$3.88 \$1.35 EACH

If you have already purchased the 1176477 chip you may buy the PC board and instructions only... \$23885 \$4.00

### Strobe Tube & Trigger

LED Flasher Kit \$2.49

### Digital Counting Module

Wheel of Fortune \$8.99

### LED Panel Mounting Kit

12 sets for \$1.00

### RO170 Rectifier

5 for \$1.00, 100 for \$15.00

### Tube Specials

370 mf 360V 150 \$3.95

Minimum order \$5.00  
Please include \$1.00 for postage  
Visa, MC and COD accepted  
Phone orders are welcome

**CHANEY electronics inc.**  
P.O. BOX 27038, DENVER, CO. 80227 (303) 781-5750  
Send for our free giant catalog of unique items!!!

CIRCLE NO. 9 ON FREE INFORMATION CARD

## Save on Calculators

**HEWLETT PACKARD**

Model Your Cost

HP-41C Scient	\$244.95
Card Reader/41C	177.95
Printer 41C	319.95
HP-34C Scient	123.95
HP-38C Bus	123.95
HP-38E Bus	93.95
HP-33C Scient	99.95
HP-33E Scient	72.95
HP-37E Bus. prog	58.95
HP-32E Adv. Scient	53.95
HP-31E Scient	41.50
HP-67 Scient Prog	297.95
HP-97 Scient Print	579.95
HP-92 Bus. Print	397.95

\*C stands for continuous memory

We carry an enormous stock of HP accessories. All units complete. One year guarantee by HP.

### TEXAS INSTRUMENTS

TI-59C	\$208.95	TI-5100	39.99	Speak and Spell	58.95
TI-58C	23.95	TI-5200	Call us	TI-Programmer	47.95
TI-57	48.95	TI-5225	Call us	Invest. Analyst	49.95
PC-100C	144.95	TI-5221	Call us	Bus. Card	38.95
PC-100A	169.95	TI-5230	Call us	MBA	57.95
TI-55	34.95			Bus. Analyst II	38.95
TI-5040	89.95			Business Analyst I	22.95
TI-5015	59.95			TI-50	35.95
TI-5025	67.95				

Huge inventory of TI accessories on hand at all times. Guarantee by TI.

### SPECIALS

320 Senco watches to choose from	SONY Betamax SL5600	\$1,049.95
Digiana SS	RCA Select VDT625	\$1,095.00
Carrier Typ "Tank" ladies	RCA Select VDT600	879.00
Carrier Typ "Tank" men	SONY TVs at unbeatable prices	Call us
Musical Alarm Chrono SS	Craig translator for bst price	Call us
Cable Watch with Alarm	TI Speaking translator	199.95
Dual Chronograph SS	TI tour station thermostat	89.95
Dual Time Zone SS	Navigonic fire computers	99.00
Memory Bank Calendar	APPLE CDMPTERS and peripherals	Call us
Divers 500Ft qt 60581	at unbeatable prices	Call us
Solar Alarm Chrono SS	Texas Instruments 99/4 Computer	1,099.95
Multi Alarm SS	Including color monitor	1,099.95
Worldtime alarm, perp bal	AP Computer "Imagination"	Call us
Single Alarm SS	ATARI 800 and 400 computers	Call us
Alarm Chronograph SS	89.95	Casio Sharp Canon Same-Pearl/Recorder-
	139.95	Polaroid Panasonic Amara-Liton-Borus

TI Watches 70 models to choose from \$7.95 up Chess games-Victor

Prices are f o b LA. Add \$4.95 for shipping/handled calcs in USA  
CA residents add 8% sales tax

We will beat any advertised price if the competition has the goods on hand  
Goods subject to availability Ask for our 130page catalog.  
Call Monday thru Saturday, 7AM to 6PM.  
Outside CA, toll free: 800-421-8045  
In CA, call below:

**OLYMPIC SALES COMPANY, INC.**  
216 South Oxford Avenue • P.O. Box 74545 • Los Angeles, CA 90045  
(213) 381-3911 or (213) 381-1202 • Telex 67-3477

CIRCLE NO. 52 ON FREE INFORMATION CARD

# MOVING?

Please let us know 8 weeks in advance so you won't miss a single issue of **POPULAR ELECTRONICS**.

Attach old label where indicated and print new address in space provided. Also include your mailing label whenever you write us about your subscription. It helps us serve you promptly.

Write to: P.O. Box 2774, Boulder, CO 80322, giving the following information:

Change address only

Extend subscription  Enter new subscription

1 year (12 issues) \$14.00  Bill me later

Payment enclosed (You get 1 extra BONUS issue—13 issues in all!)

NEW ADDRESS HERE 8COA

Name \_\_\_\_\_ (please print) Apt. \_\_\_\_\_

Address \_\_\_\_\_

City \_\_\_\_\_

State \_\_\_\_\_ Zip \_\_\_\_\_

Foreign postage: Add \$3 a year for Canada. \$5 a year (cash payment in U.S. currency only) for other countries outside U.S. and possessions. Please allow 30 to 60 days for delivery of first issue.

➔ AFFIX OLD LABEL ➔

If you have no label handy, print OLD address here:

Name \_\_\_\_\_ (please print) Apt. \_\_\_\_\_

Address \_\_\_\_\_

City \_\_\_\_\_

State \_\_\_\_\_ Zip \_\_\_\_\_

# BULLET ELECTRONICS

Box 401244P Garland, TX.  
75040 (214) 278-3553

## Sound Effects Kit 17.50

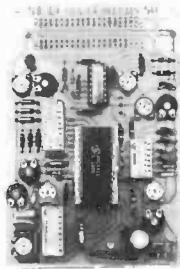

The SE-01 is a complete kit that contains all the parts to build a programmable sound effects generator. Designed around the new Texas Instruments SN76477 Sound Chp, the board provides banks of MINI DIP switches and pots to program the various combinations of the S.F. Oscillator, VCO, Noise One Shot and Envelope Control. A Quad Op Amp IC is used to implement an Adjustable Pulse Generator, Level Comparator and Multiplex Oscillator for even more versatility. The 3 1/2" x 5" PC Board features a prototype area to allow for user added circuitry. Easily programmed to duplicate Explosions, Phases Gun Steam Trains, or almost an infinite number of other sounds. The unit has a multiple of applications. The low price includes all parts, assembly manual, programming charts, and detailed 76477 chip specifications. It runs on a 9V battery (not included). On board 100mW amp will drive a small speaker directly, or the unit can be connected to your stereo with incredible results! (Speaker not included).

- 76477 CHIP IS INCLUDED. EXTRA CHIPS \$1.10 EACH
- \$17.50 LESS SPEAKER & BATTERY

**2N5191 NPN**  
V<sub>ceo</sub> = 60V P<sub>d</sub> 40W  
I<sub>C</sub> = 4A  
H<sub>fe</sub> 25-100 @ 1.5A  
HSE #

**SILICON POWER TRANSISTOR**  
3/\$1.00  
100/\$25.00

**PN2222 (2N2222A) MOST POPULAR NPN GEN. PURPOSE TRANSISTOR**  
TO - 90 V<sub>ceo</sub> = 40V  
P<sub>d</sub> = 5W  
H<sub>fe</sub> = 100 - 300  
10/\$1.00 100/\$9.00

### THE PERFECT TRANSFORMER

117VAC primary. 12VAC secondary @ 200mA  
Great for all you CMOS, or low power TTL projects. PC board mount.  
99c ea. 3/\$2.50

Size: 1.5" W x 1.25" D x 1.25" H



### AY3-8910 PROGRAMMABLE SOUND GENERATOR

The AY3-8910 is a 40 pin LSI chip with three oscillators, three amplitude controls, programmable noise generator, three mixers, an envelope generator, and three D/A converters that are controlled by 8 BIT WORDS. No external pots or caps required. This chip hooked to an 8 bit microprocessor chip or Bus (8080, Z80, 6800 etc) can be software controlled to produce almost any sound. It will play three note chords, make bangs, whistles, sirens, gunshots, explosions, bleets, whines, or grunts. In addition, it has provisions to control its own memory chips with two I/O ports. The chip requires +5V @ 75ma and a standard TTL clock oscillator. A truly incredible circuit.

\$14.95 W/Basic Spec Sheet (4 pages)  
60 page manual with 5-100 interface instructions and several programming examples. \$3.00 extra

### 1/2W RESISTOR ASSORTMENT

A good mix of 5% and 10% values in both full lead and PC lead devices. All new, first quality.  
(Asst.) 200 pieces/2.00

### ULTRASONIC RELAY KIT

INVISIBLE BEAM WORKS LIKE A PHOTO ELECTRIC EYE. USE UP TO 25 FT. APART. COMPLETE KIT. ALL PARTS & PC BOARDS. \$21.50

### 7 WATT AUDIO AMP KIT

SMALL SINGLE HYBRID IC AND COMPONENTS FIT ON A 2" x 3" PC BOARD (INCLUDED). RUNS ON 12VDC GREAT FOR ANY PROJECT THAT NEEDS AN INEXPENSIVE AMP. LESS THAN 1% THD @ 5 WATTS. COMPATIBLE WITH SE-01 SOUND KIT. \$5.95

### TUNES SYNTHESIZER

The AY3-1350 is a MOS microcomputer synthesizer of preprogrammed tunes for applications in toys, music boxes, and door chimes. The standard device has a set of 25 different popular and classical tunes. In addition there are 3 chimes making a total of 28 tunes. 28 pin IC.

#### FEATURES

- Minimal external components
- Automatic switch-off signal at end of tune for power saving
- Envelope control to give organ, or piano quality
- Sequential tune mode
- 4 door capability when used as door chime
- Operation with tunes in external PROM if required (2708)
- Single supply (+5V) operation
- Tunes include: STAR WARS, BEETHOVEN'S 9th & 5th, JINGLE BELLS, YANKEE DOODLE, STAR SPANGLED BANNER, CLEMENTINE, GOD SAVE THE QUEEN, O SOLE MIO, WESTMINSTER CHIME and DESCENDING OCTAVE CHIME PLUS MANY MORE!

WITH DETAILED SPECS AND INSTRUCTIONS \$14.50



## COMPONENTS

301 OP AMP & LEAD CAN	3/1.00	TIP30 TAB PNP POWER	3/1.00
723 VOLT REG TO LEAD CAN	.39	*MC1351P FM IC DISC IC	2.50
723 14 PIN DIP	3/1.10	100 800 GRAY PNP DRIVER	2.50
*13741 FET INPUT 741 MINI DIP	3/1.10	7805 5V 1A REGULATOR	.99
30000 @ 15V COMPUTER GRADE	2.10	*78M05 +VA 5V REG TO S	.49
2K402 PNP COMPONENT	8/1.00	LM3911 TEMP TRANSDUCER	1.10
2N6028 P.U.T. W/SPECS	.50	IC W/SPECS	1.10
LM3802 2W AUDIO IC W/SPECS	1.09	LM3302 QUAD COMPARATOR IC	.50
*M377 DUAL LM380 W/SPECS	2.50	555 TIMER IC	.49
LM3900 QUAD NOTION AMP	.99	*MC3401 QUAD NOTION AMP	.39
LM534 QUAD OP AMP	.55	IC W/SPECS	1.10
7812 1A 12V REG	.89	*INDICATES ITEM IS "HOUSE NUMBERED"	
IL-1 OPTO ISOLATOR MINI DIP	.80		
*MEM 631 DUAL GATE MOSFET			
DIODE PROTECTED, SIMILAR TO 40673	-.50	JUMBO GREEN LEDs	4/89
MV1524 VARICAP DIODE 10 PFD	.19	JUMBO RED	5/89
MS140 VARICAP DIODE	.39	MEDIUM RED (1/2")	.15
47 PFD NOM. 3:1 RATIO	.19	MEDIUM GRN OR YELLOW	.15
1M4003 1A 200V DIODE	15/1.00	BI POLAR LED	.15
		TWO COLOR RED/GRN	.59

★ CALL OR WRITE FOR FREE CATALOG. ★

### THE FINE PRINT

NO C.O.D.'S SEND CHECK, MONEY ORDER, CREDIT CARD + ADD 6% FOR SHIPPING TX. RES. ADD 6% TAX FOREIGN ORDERS (EXCEPT CANADA) ADD 10% (20% AIRMAIL) U.S. FUNDS ONLY PHONE ORDERS ON MASTER CHARGE & VISA ONLY (214) 278-3553



8-TRACK TAPE PLAYER PLUS

PUSH BUTTON AM AUTO RADIO!

Individually packed in original factory carton with styrofoam protection. Owner's manual with circuit diagram is included. Brand new!

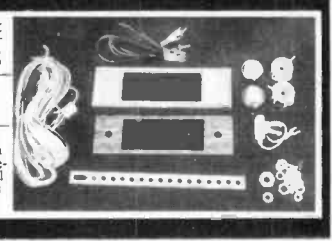

8-TRACK-AM RADIO

**39.95**  
\$3.00 SHPG  
Delta No. 5784P  
UNBELIEVABLE

# STEREO 8-TRACK AM AUTO RADIO

FACTORY CLOSEOUT! It's too good to be true.... this transistorized, solid state AM auto radio has stereo 8-TRACK TAPE PLAYER at half the price of the AM radio alone. Five pushbuttons can be pre-set to your favorite stations. Has provision for use of either 2 or 4 speakers. Balance control. Shaft spacing on radio is

adjustable both horizontally and vertically to fit most cars. Complete with mounting kit, knobs, alternator capacitor and distributor suppressor. Negative ground. Choke coil in positive lead for additional noise suppression.

Delta Does The Impossible Again! You Save \$\$\$\$

## Convert Your Car Into A Concert Hall!



**19.95 \$100 AM-FM AUTO RADIO**  
\$3 for SHPG  
Delta 5785P UNBELIEVABLE

FACTORY CLOSEOUT! One of America's largest manufacturers of auto radios has given up. We've been fortunate in acquiring the last auto radios in production. These are AM-FM sets... designed for new cars. All are tested 100% operational and come with knobs and push buttons. Ideal for installing in your auto, van, camper, boat, truck.

NEWS ITEM! Auto hi-fi has become as sophisticated as home hi-fi - and nearly as expensive. You can spend \$200 for simple components - which means hi-fi can be out of reach for many folks and 2nd cars. If you want hi-fi FM, you can start with the purchase of a \$100 radio for a mere \$19.95... This price will not last long - order today while our limited supply lasts!

## Mini & Foreign

SIZE: 6 1/4" wide... 1 1/4" high... 4 1/4" deep. Mtg. ctrs of knobs is 5 1/4". Note sizes may vary slightly; photo is representative sample.  
\$787P AM-FM... \$29.95 (\$3.00 shpg)  
\$787P AM only... \$19.95 (\$3.00 shpg)

**FREE 120-PG. 'SURPLUS' CATALOG**

**DELTA ELECTRONICS**

116 SECOND AVE  
WALTHAM, MASS.  
02154  
Minimum Order \$8.00  
TEL. (617) 388-4705

VISA  
Master Charge

CIRCLE NO. 19 ON FREE INFORMATION CARD

# HOBBYWORLD ELECTRONICS

19511 Business Ctr. Dr. Dept P6  
Northridge, Ca. 91324

## SEND FOR FREE FLYER FEATURING:

Page after page of exciting products. Computerized toys and games, personal computers, disk drives, integrated circuits, semiconductors. Add new dimension to your Apple, Atari, TRS-80, etc. with our special application boards and comprehensive software library. Hundreds of products available at terrific HOBBYWORLD prices.

Our line of name brand products include: ATARI, EXIDY, COMPUCOLOR, MATTEL, COLECO, ENTEX, FIDELITY, CALIFORNIA COMPUTER SYSTEMS and more, more, more. Circle our reader service number or write/phone for your free illustrated flyer today!

Call Toll-Free: USA (800) 423-5387

In Calif: (800) 382-3651

Local & Outside USA: (213) 886-9200

Your #1 Mail-Order Computer Store!

CIRCLE NO. 37 ON FREE INFORMATION CARD



# Electronics Classified

**REGULAR CLASSIFIED: COMMERCIAL RATE:** For firms or individuals offering commercial products or services, \$2.75 per word. Minimum order \$41.25. **EXPAND-AD\* CLASSIFIED RATE:** \$4.10 per word. Minimum order \$61.50. Frequency discount: 5% for 6 months; 10% for 12 months paid in advance. **PERSONAL RATE:** For individuals with a personal item to buy or sell, \$1.60 per word. **DISPLAY CLASSIFIED:** 1" by 1 column (2-1/4" wide), \$330. 2" by 1 column, \$660.00. 3" by 1 column, \$990.00. Advertisements will not be published which advertise or promote the use of devices for the surreptitious interception of communications. Closing Date: 1st of the 2nd month preceding cover date (for example, March issue closes January 1st). Send order and remittance to Classified Advertising, POPULAR ELECTRONICS, One Park Avenue, New York, N.Y. 10016. For inquiries, contact Linda Lemberg at (212) 725-7686.

## FOR SALE

**FREE! Bargain Catalog** — I.C.'s, LED's, readouts, fiber optics, calculators parts & kits, semiconductor parts. Poly Paks, Box 942PE, Lynnfield, Mass. 01940.

**GOVERNMENT and industrial surplus receivers, transmitters, sniperscopes, electronic parts, Picture Catalog 25 cents.** Meshna, Nahant, Mass. 01908.

**LOWEST Prices Electronic Parts.** Confidential Catalog Free. KNAPP, 4750 96th St N., St. Petersburg, FL 33708.

**ELECTRONIC PARTS, semiconductors, kits. FREE FLYER.** Large catalog \$1.00 deposit. BIGELOW ELECTRONICS, Bluffton, Ohio 45817.

**RADIO — T.V. Tubes — 49 cents each.** Send for free catalog. Cornell, 4213 University, San Diego, Calif. 92105.

**AMATEUR SCIENTISTS, Electronics Experimenters, Science Fair Students . . . Construction plans — Complete, including drawings, schematics, parts list with prices and sources . . . Robot Man — Psychedelic shows — Lasers — Emotion/Lie Detector — Touch Tone Dial — Quadraphonic Adapter — Transistorized Ignition — Burglar Alarm — Sound Meter . . . over 60 items.** Send \$1.00 (no stamps) for complete catalog. Technical Writers Group, Box 5994, University Station, Raleigh, N.C. 27650.

**SOUND SYNTHESIZER KITS — Surf \$16.95, Wind \$16.95, Wind Chimes \$22.95, Musical Accessories, many more.** Catalog free. PAIA Electronics, Box J14359, Oklahoma City, OK 73114.

**TELETYPE EQUIPMENT: Copy Military, Press, Weather, Amateur, Commercial Transmissions.** Catalog \$1.00. **WEATHER MAP RECORDERS: Copy Satellite Photographs, National-Local Weather Maps.** Learn How! \$1.00. Atlantic Sales, 3730 Nautilus Ave., Brooklyn, NY 11224. Phone: (212) 372-0349.

**BUILD AND SAVE TELEPHONES, TELEVISION, DETECTIVE, BROADCAST Electronics.** We sell construction plans with an Engineering Service. Speakerphones, Answering Machines, Carphones, Phonevision, Dialers, Color TV Converters, VTR, Games, \$25 TV Camera, Electron Microscope, Special Effects Generator, Time Base Corrector, Chroma Key, Engineering Courses in Telephone, Integrated Circuits, Detective Electronics. PLUS MUCH MORE. NEW Super Hobby by Catalog PLUS year's subscription to Electronic News Letter, \$1.00. Don Britton Enterprises, 6200 Wilshire Blvd., Los Angeles, Calif. 90048.

**NAME BRAND Test Equipment.** Guaranteed discounts up to 50%. Free catalog. Saten Electronics, Box 82, Skokie, IL 60077.

**UNSCRAMBLE CODED MESSAGES from Police, Fire and Medical Channels.** Same day service. Satisfaction guaranteed. Don Nobles Electronics, Inc., Rt. 7, Box 610, Hot Springs, Arkansas 71901. (501) 623-6027.

**UNSCRAMBLERS FOR any scanner.** Several models available. Free literature. Capri Electronics, 8753T Windom, St. Louis, MO 63114.

**CB RADIOS, VHF-UHF Scanners, Crystal, Antennas, Radar Detectors.** Wholesale. Southland, Box 3591, Baytown, TX 77520.

**PRINTED CIRCUIT supplies, chemicals, tools, artwork, plating solutions.** Major credit cards. Catalog \$2.00, refundable. CIRCOLEX, Box 198, Marcy, NY 13403.

**RECONDITIONED TEST EQUIPMENT \$1.00 for catalog.** WALTER'S TEST EQUIPMENT, 2697 Nickel, San Pablo, CA 94806, (415) 758-1050.

**NEGATIVE ION GENERATORS AND ACCESSORIES. (Kits).** Fascinating details — \$1.00. Golden Enterprises, Box 1282-PE, Glendale, Arizona 85311.

**SATELLITE TELEVISION — Build or buy your own earth station.** Article gives much hard to find, necessary information. Send \$3.00. Satellite Television, R.D. 3, Box 140, Oxford, NY 13830.

## SpeakerGuts.



The absolute latest in advanced speaker technology. *Wave Aperature™ Drivers, the Patented Nestrovic Woofer System,* raw speaker components selected for their excellence. Horns, crossovers, subwoofers, woofers, midranges, horn and dome tweeters. Over 30 in all. Build your own speaker system and we'll provide top quality speakers and design information. Send for FREE 48 page color catalog from the largest, most experienced speaker kit manufacturer in the world. **DON'T DELAY. Write today!**



Dept. 181, 735 N. Northlake Way  
Seattle, Washington 98103

**UNSCRAMBLERS, seven models available to decode police, ambulance, and fire coded transmissions.** Other scanner devices. Tone encoders/decoders. Telephone accessories, etc. Free Catalog. KRYSTAL KITS, Box 445, Bentonville, AR 72712. (501) 273-5340.

**POLICE/FIRE SCANNERS, crystals, antennas, CBs, Radar Detectors.** HPR, Box 19224, Denver, CO 80219.

### Telephone Listening Device

Record telephone conversations in your office or home. Connects between any cassette or tape recorder and your telephone or telephone LINE. Starts automatically when phone is answered. Records both sides of phone conversation. Stops recorder when phone is hung up. This device is not an answering service.

**Each \$18.95**  
Qty Disc Avail

**Super Powerful Wireless Mic**  
10 times more powerful than other mics. Transmits up to 1/4 mile to any FM radio. Easy to assemble kit. 15V battery (not incl.)

Call (305) 725-1000 or send \$18.95 + \$1.00 shipping per item to USI Corp., P.O. Box PE-2052, Melbourne, FL 32901. COD's accept. For catalog of transmitters, voice scramblers and other specialty items, enclose \$2.00 to USI Corp.

### TREMENDOUS BUYS In New And Gov't Surplus Equipment

**Dial Telephone "SUPER BUY"**

\* Save us the labor costs of cleaning and polishing and save \$555 on standard dial telephones. Work on any commercial system. Complete. (no parts missing) in good working order. Your choice of desk or wall models. These are take-outs from commercial service (not toys) instructions furnished.

Wall Model \$115 PPS  
Desk Model \$115 PE

**\$7.95**  
PRICE EACH

PREPAID IN U.S.A.  
Does not include HAWAII, ALASKA, P.R.

**FREE CATALOG Shows BIG SAVINGS ON**  
ELECTRONICS • ELECTRICAL • ALARM SYSTEMS • TELEPHONES • PUMPS • SHROUDED • GEAR MOTORS • VEHICLES • SURVIVING INSTRUMENTS • GENERATORS • COMPRESSORS • HYDRAULICS • POWER TOOLS • WELDERS • POWER PLANTS • CHEMICAL SPRAYING • TERPAULINS • MANY OTHERS

**Surplus Center Box 82209-PE Lincoln, Ne. 68501**

**NEW ELECTRONIC PARTS.** Continuously stocked. Stamp brings catalog. Daytpro Electronics, 3029 N. Wilshire Ln, Arlington Hts., IL 60004.

**TEST EQUIPMENT, new and used.** Catalog \$1.00. PTI, Box 8756, White Bear Lake, MN 55110.

**THE PLL DATA BOOK describes 35 CB devices.** Pin diagrams, functions, modifications, \$8.95. PLL Expanders, CB Specialties, catalog \$1. CB City, Box 1030PE, Woodland Hills, CA 91365.

## SATELLITE TV FOR THE HOME

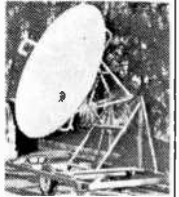

Our receiver lets you get over 75 channels of television directly from earth-orbiting cable TV satellites! **HBO, Showtime, super stations, sports and movies from around the world.**

**Sick of Network TV? Buy Complete or Build our kit and save!**

Our 24-channel receiver provides "studio quality" TV reception. Easy to install! Ultra low power consumption! Brilliant color! Works anywhere! FCC licensing no longer required. **Order today!** Complete details covered in our Home Earth Station manual. Send \$7.95 today (refundable against any purchase), or call:

**24-hour C.O.D. Hotline (305) 869-4283**

**SPACECOAST RESEARCH**  
Dept. H, P.O. Box 442, Altamonte Springs, FL 32701

**NEW CATALOG of low cost electronic parts.** Send for FREE copy. ALL ELECTRONICS CORP., Dept. F, 905 S. Vermont Ave., Los Angeles, CA 90006.

**RF POWER TRANSISTORS plus TV, audio, radio, VTR transistors, and more.** IC's, diodes, B & D Enterprises, P.O. Box 32, Mt. Jewett, PA 16740. (800) 458-6053

### LOUD AND CLEAR.

Read all about the K—the amazing speaker that has the power to reproduce even the lowest bass notes—loud and clear. Features the brilliant cornhorn design with Speakerlab innovations like Magnor™ damped horn drivers. One of the only kits available for this unique loudspeaker. Read about K's and all the other great Speakerlab speakers and parts in our free catalog.

**Speakerlab**  
To get yours, write  
SPEAKERLAB, Dept. 182  
735 N. Northlake Way  
Seattle, WA 98103

**DISCOUNT C.B., SCANNERS, ACCESSORIES, Free Catalog** Crystals: CB, Ham, Scanner. All Regs. Same day service. XTALS, Box 42-E, Prospect Hts., IL 60070.

**TRS-80 USERS™:** We have hardware and software. Write for current list. HARTMANN-LANG, Box 693, Chatham, NJ 07928.

**FREE CA3140 OpAmp with every order.** All top quality merchandise. Send for bargain catalog. KEY ELECTRONICS, Box 3506P, Schenectady, NY 12303.

**GUARANTEED TEST EQUIPMENT.** Surplus at surplus prices. List \$2.00 Refundable. Jack Watts Co., Box 25, Corona, CA 91720.

**BIOPHYSICAL TELEMETRY TRANSMITTER:** Transmits your heart, (EKG), signal to any ordinary FM radio. Transmitted data consists of an audio tone which is frequency modulated by your EKG signal. The tone allows you to monitor your heart rate and hear EKG frequency components which otherwise could not be heard. Built-in electrodes make it easy to use. Completely assembled, battery included. Approximate size: 4.4" x 2.4" x 1.2". Order Model BHT-14. \$27.50. OMNI-TEK INC., P.O. Box 726, Loveland, CO 80537.



ELECTRONIC CATALOG. Over 300 pages. Parts, schematics, etc. Everything needed by the hobbyist or technician. T & M Electronics, 472 East Main St., Patchogue, NY 11772. (516) 289-2520. \$2.00 Postage & handling, refundable with first \$15.00 order.

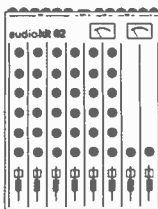

## MAKE IT

Audiokit 62, 6 in/2 out pro mic mixer perfect for live recording. Can be assembled in just hours. Features treble, bass, pan, cue, echo, gain control on all inputs. Kit . . . \$265. Assembled . . . \$395. Send check or money order to: Audiomarketing, 652 Glenbrook Rd., Stamford, CT 06906 or call us Toll Free at 800-243-2598.

SAVE 50%. Build your own speaker system. Write: McGee Radio Electronics, 1901 McGee Street, Kansas City, Missouri 64108.

SECRET TELEVISION CHANNELS IN YOUR HOME without set modifications. Latest movies, sports, night club acts, religion, it's all in your neighborhood, but kept secret from most people. Complete detailed plans on how you can start receiving these SECRET channels for \$100.00 or less. Send \$25.00 cash, check, or money order . . . or \$4.50 for more information, to: TELE-TEC, Dept. SATT., 8688 Royal Drive, Noblesville, IN 46060.

HOW TO BUILD CROSSOVERS. Send S.A.S.E. for catalog of crossover information publications. Mesalab, Dept. PE, 3942 Mesa Avenue, Sarasota, FL 33583.

KEYBOARDS for synthesizers and organs. Completely assembled with single/or dual contacts. Send for information: DEVTRONIX Organs, Dept. 71, 6101 Warehouse Way, Sacramento, CA 95826.

OSI CHALLENGER 1P — Superboard II. 90 page step-by-step programming manual. \$5.95 + \$1.00 P&H. TIS, Box 921-PE, Los Alamos, NM 87544.

PRINTED CIRCUIT BOARDS, your artwork. Quick delivery. Reasonable. Atlas Circuits, Box 974, Waynesville, NC 28786. (704) 456-3739.

SKIPMASTER halts CB skip noise, bleedover. Adjustable control, easy mounting for base, mobile. \$24.95. Matrix Communications, 611 Norwegian, Pottsville, PA 17901. (717) 622-3283.

SUPERIOR CONTACT FILES - Flexible, non-conductive, assortment of twelve, \$3.95 prepaid. Flex-Stone, Co., P.O. 1372, Concord, NH 03301.

PCB AS LOW AS 15¢ sq-in., Free Drilling. Also PTH. International Enterprise, 12507 Brent, Cerritos, CA 90701.

CALCULATORS measure Capacitance, Resistance, Light, Speed—much more, with revolutionary \$14.62 Module. Applications Circuits \$1.00. KALTEK, Box 7462-PE, Rochester, NY 14615.

VIDEO tapes, movies, equipment. Lowest prices. Free price list. VTR, Box 234, Herald, CA 95638.

RESISTORS 1/4W, 1/2W5%CF 2.2-ohm through 4.7-meg. stocked. .03¢ ea. plus \$1.00 shipping. No minimums. JR Industries, 5834-A Swancreek, Toledo, OH 43614.

PLANS PROJECTION TELEVISION \$10.00. Audible Short Circuit Tester \$6.00. Solar Collector \$4.00. Details \$2.00. Hughes Services, 1240 Jarvis, Chicago, IL 60626.

SATELLITE TELEVISION—SATELLITE WEATHERFAX. Will your receiving antenna clear local obstructions? Get ANTENNA AIMING DATA for geostationary satellites, custom computed for your latitude and longitude. Included is chart of U.S. and International satellites around the globe and instructions on how to find them in the sky. Send \$5.00 to: COMPUSAT, 643 South Route 83, Elmhurst, IL 60126.

UNSCRAMBLERS \$19.95 and up. Free information. Dealers inquiries invited. Oak Valley Enterprises, Route 1, Grand Marsh, WI 53936.

HORNS-WOOFERS-MIDS-TWEETERS at tremendous OEM savings. Aitec, Electro-Voice, Philips, Peerless Polydax and many others. Dozens of hard to find items used in major manufacturers most expensive systems. Huge selection of crossover network components, automobile systems, and musical instrument loudspeakers. Send \$2.00 for catalog, refundable with purchase. SRC Audio, Dept. PE6, 3238 Towerwood Dr., Dallas, TX 75234.

OLD RADIO, TV, Phono Schematics, send \$1.00, refundable, stating name to: Oldies, 6116 Mary Ellen Ave., Van Nuys, CA 91401.

BOOKS — Learn Electronics, Lasers, Robotics, Computers, TV, Solar, Etc. Catalog 30¢. DOT, 9721 Southwest Highway, Oaklawn, IL 60453.

FERRIC CHLORIDE PRINTED CIRCUIT BOARD ETCHANT. One pound double wrapped plastic packages. Dry just add water and etch. Satisfaction guaranteed. \$2.50 per pound, please include funds for shipping. Write for quantity discount. L.F. Carbaugh, P.O. Box 398, New Cumberland, PA 17070.

SAVE UP TO 46% on energy and reduce your electric bill with new Lite-Bulb Saver. For FREE brochure write: R.H.E. Enterprises, Dept. PE-680, P.O. Box 600128, North Miami Beach, FL 33160.

TRS-80 COMPUTERS, LIU-16K \$680.00, 16K Interface \$375.00, 70LPM Printer \$795.00. Brochure \$2.00 refundable. MICROCOMPUTER, 7316C Matthews-Mint Hill Road, Mint Hill, NC 28212.

SCRAMBLED TELEVISION—Encoding/Decoding. New publication. Complete theory, circuits. \$9.95. Workshop, Box 393PE, Bethpage, NY 11714.

DOLBY DECODERS FOR FM OR TAPE — ALSO KITS encode/decode. Reviews. Dolby calibration tapes. PEJ Integrex, Box 747, Haverstown, PA 19083.

AUDAX and SEAS raw drivers and speaker kits. Wholesale-Retail. For comprehensive catalogue of specifications, technical information, and accessories for the speaker builder, send \$2, refundable upon purchase to: The Speaker Works, Box 303, Dept. P.E., Canaan, NH 03741.

RADIO COMMUNICATIONS GUIDE, book gives shortwave and VHF/UHF Scanner frequencies. \$7.95. Handler Enterprises, Inc., Box 48, Deerfield, IL 60015. Catalog 25¢.

NEGATIVE ION POWER SUPPLIES. 14 KV add 115 VAC Line Cord. Have complete Ion Generator \$28. Progen, 319 Spruce St., Redwood City, CA 94061.

## COMPUTER EQUIPMENT

TRS-80 PARALLEL I/O. PPI-80 contains three 8-bit programmable ports with switch selectable address decoding. Plugs into keyboard or E/I. PCB and manual \$25.95. Quant Systems, Dept. PE, Box 628, Charleston, SC 29402.

BASICS of Servomechanisms and Operational Amplifiers - Clear text. "instant breadboarding" result in solid understanding of fundamental concepts. Cassette for TRS-80, Level II, 16K. \$12.50. Omni Systems Co., P.O. Box 29347, Minneapolis, MN 55430.

TELETYPE MODEL 33. Hard copy printer with tape punch and tape reader. Works with most computers. Refurbished—like new — 90 day guarantee. Low prices. For detailed Tech Brochure and Prices send \$1.00. INTELCALL, 202 Main St., Lakewood, NJ 08701. (201) 367-2667.

COMPUTERS — wholesale, buyer's guide and catalog \$1.00, specify needs. Lee Electronics, Caneyville, KY 42721.

TRS-80 SPEED CONTROL plans—very simple circuit allows wide range of control over speed of listing or running programs. Connect to TRS-80 Port, or any Z-80. \$15.00 check to: Golden Circuits, P.O. Box 404, Golden, CO 80401.

**Now decode exotic radio signals**

Field **D**ecodes a real computer that reads all kinds of coded radio transmissions. Not only Morse-code, but radioteletype, press-wire reports and ASCII computer talk. Figures code speeds. Built-in 24-hour clock. Wired, tested, 1-year warranty, 15-day trial. Easy hook-up to any receiver. \$467.95 UPS ship. Charge check or C.O.D. No risk!

1202 E. 23rd St.  
Lawrence, KS 66044  
(913) 842-7745

**Kantronics, Inc.**  
Amateur radio manufacturers.

TRS-80™ Programs: Arcade, Primary Math and Space War \$9.95 each or any two for \$17.95. Creative Computer Products, P.O. Box 1151, Plant City, FL 33566.

\$150 VALUE BASIC PROGRAMS FOR \$10. Zark Co., 44 Country Club Road, Willingboro, NJ 08046.

FLOPPY DISKS and COMPUTER PERIPHERALS at DISCOUNT PRICES. AB COMPUTERS, 115-E East Stump Road, Montgomeryville, PA 18936. (215) 699-5826.

COMPUTERS confusing, the DP Dictionary makes computerology easy. Included free. What's a computer. Send \$3.00 to: Qandew, Box 1488, Highbridge, MO 63049.

SECRET Guide to Computers. Free catalog. SCLEBI Publications, 20-P Hurlbut Street, Elmwood, CT 06110.

## PLANS AND KITS

FREE KIT Catalog contains Test and Experimenter's Equipment. Dage Scientific Instruments, Box 1054P, Livermore, CA 94550.

SPEAKERPLANS — Build ANY size speakers without special tools, experience. FOOLPROOF, illustrated instructions, parts sources. 80% SAVINGS! Rush \$4. SPEAKERPLANS. 334 Pursel, Phillipsburg, NJ 08865.

NEW-UNSCRAMBLER PLANS. State of art integrated circuit design. Fits all scanners. Complete plans, \$3.95. Innovative Marketing, Box 7577, Huntington, WV 25777.

TOP QUALITY SPEAKERS AND KITS. Send \$1.00. Speaker Warehouse, 809 North Route 441, Hollywood, FL 33021.

FIBER OPTIC EXPERIMENTER'S KIT. Includes fiber, cable, tools and instructions. Send \$6.00 to: FIBERTRONICS, Box 322, Primos, PA 19018.

PRINTED CIRCUIT Boards from sketch or artwork. Kit projects. Free details. DANOCINTHS Inc., Box 261, Westland, MI 48185.

**TIGER 500 SIMPLI-KIT**

**FOR THE DO-IT-YOURSELFER**

**NOW! a high quality CD ELECTRONIC IGNITION SYSTEM in kit form.**

Contains all components and solder to build complete Solid-State Electronic CD Ignition System for your car. Assembly requires less than 3 hours.

- Increases MPG 15%
- Eliminates 4 or 5 tune-ups
- Increases horsepower 15%
- Instant starting, any weather
- Plugs and Points last 50,000 miles
- Dual system switch

Fits only 12 volt neg. ground . . .  
Only \$26.95 postpaid

**TJ Star Corporation**  
P.O. Box 1727 Grand Junction, Colorado 81501

STUDIO II Conversion to Microcomputer! Plans \$5.00. Kits available. ARESKO, Box 1142, Columbia, MD 21045. (301) 730-5186.

BUILDING YOUR OWN SPEAKERS? Use dual transmission lines. Build a dual transmission regenerator; Accepts dual transmission lines; Subwoofer connections; Drive multi-speakers per cabinet; Three dimensional acoustic switch; Infinite power handling; Controls impedance, balance, separation, etc; Use with existing speakers too! Under \$15.00 to build. Plans, send \$6.00 to: D.T.R. SYSTEM, 1600 Woods Road #D, Winston-Salem, NC 27106.

LASERS HANDBOOK with burning, cutting, Ruby Reds, CO's complete plans, books, and parts. Send \$4.00 to: Famco, Dept. PE, Box 1902, Rochester, NH 03867.

PROFESSIONAL PRINTED CIRCUIT DESIGN. Send schematic for quote. Z. Liss, 2130 Allen Street, Allentown, PA 18104.

KIT CATALOG. Send 50¢ to GI KITS, Dept. PE, Box 2329, Garland, TX 75041. Electronic kits, solar art, P.C. paste-up pads, electronic word puzzles, electronic study courses. Discount coupons.

**100 NEW ELECTRONIC KITS!**

Top Quality • Most Wanted Features • Reasonable Prices  
Easy-to-Assemble

HI-FI • EXPERIMENTER'S EQUIPMENT  
AUTOMOTIVE & CB ACCESSORIES  
ALARM SYSTEMS • POWER SUPPLIES  
CATALOG FREE During Introductory Period  
Hurry! Send for Your copy TODAY!

**M. LORS & ASSOCIATES • Dept. PE-1**  
P.O. Box 518, Berwyn, IL 60402

STOP THE AGONY. Get yourself a set of Custom High Quality Speakers. For Ultra Unique Speaker Design Book send \$3.50 to: WOOD "N" THINGS WORKSHOP, P.O. Box 1043, Binghamton, NY 13902.

PRINTED CIRCUIT BOARDS, send your sketches or artwork, kit projects. Quick Service. Free Estimates. ELECTRONIC DESIGN CONCEPTS, 2780 Skyline Circle, Memphis, TN 38127.

SCOPE used as transistor tester, convert for under \$10.00. Plans \$1.50. AEE, Box 6531, Portsmouth, VA 23703.

BUILD WORKING ROBOT with plans! You build movable robot that you can control. It walks, moves its arms, and more! Send \$4.00 to: Ross Ramsey, Robot Plans, P.O. Box 126, Westchester Square, Bronx, NY 10461.

ATTENTION BSR X-10 REMOTE CONTROL SYSTEM OWNERS (BSR & Radio Shack, too). Simple accessory controls stereo volume from anywhere! Plans: \$3.50; special control element: \$5.00 postpaid from T.C.C., Dept. PE, P.O. Box 9241, North Hollywood, CA 91609.

## BOOKS AND MAGAZINES

ELECTRONIC MUSIC and home recording in Polyphony magazine. Advanced applications, interviews, projects, computer music. Sample \$1.50. Subscription (6 issues). \$8.00 US \$10.00 foreign. POLYPHONY, Box P20305, Okla. City, OK 73156.

"CRIME BY COMPUTER", \$6.95 Postpaid. 300 pages. Comp-U-Tronix, Box 3401, Kent, WA 98031.

SATELLITE TELEVISION BUYERS GUIDE. Exclusive comparisons plus how to install your own saving big \$. Worldwide movies, news, sports, religion, entertainment on your set. Well over 35 channels. Where to find all parts, kits, plans and distributors. Signal strength maps. Become a dealer. Book guaranteed. US funds please. \$12.95 postpaid or \$14.95 First Class (Airmail). Reed Publications, Box 219-X, Maitland, FL 32751.

FREE microcomputer book catalog. SCELBI Publications, 20-P Hurlbut Street, Elmwood, CT 06110.

## TELEPHONES & PARTS

TELEPHONES UNLIMITED, EQUIPMENT SUPPLIES, ALL TYPES. REGULAR, KEYED, MODULAR. Catalog call (714) 563-5555 or mail \$1.00 refundable. Box 1147E, San Diego, CA 92112.

## ALARMS

**Burglar-Fire Protection**



Protect Your Life, Home, Business, Auto, etc.

- Our catalog shows how. Install your own alarm systems and devices and save \$\$\$\$. We offer FREE write-in engineering service.

**FREE CATALOG** Lowest Prices on Reliable, High-Quality Alarm Systems and Devices

**Burdex Security Co. Box 82802-PE Lincoln, Ne. 68501**

POLICE DIALER \$29.95. Free burglar alarm equipment catalog. Sasco, 5619P St. John, Kansas City, MO 64123. (816) 483-4612.

BURGLAR, FIRE, CAR! Finest equipment! Save! Free Catalog. AAS, 186A Oxmoor Road, B'ham, AL 35209.

## HIGH FIDELITY

DIAMOND NEEDLES and Stereo Cartridges at Discount prices for Shure, Pickering, Stanton, Empire, Grado, Audio Technica, Osawa, Satin and ADC. Send for free catalog. LYLE CARTRIDGES, Dept. P, Box 69, Kensington Station, Brooklyn, New York 11218. Toll Free 800-221-0906 9AM - 8PM except Sunday.

AUDIO, VIDEO, ELECTRONIC PRODUCTS: Best Pricing, Delivery! Personalized Service! SONY, DBX, Mobile Fidelity, Hewlett-Packard, BSR X-10, Multi-Track Equipment, WYCO SALES, P.O. Box 887, Cary, NC 27511. 1-800-334-2483 (N.C. 919-467-8113).

IMPROVE ALL YOUR RECORDS: DBP10 Protractor quickly aligns to 1/2 degree. \$21.95. DB Systems, 347P, Jaffrey, NH 10452.

GOLD PLATED PHONO JACKS \$1.10, plugs 85c ea. \$1.00 handling. Reference Audio, Box 368P, Rindge, NH 03461.

## HOBBIES

..... GREAT OUTDOOR FUN. ....

SEARCH ELECTRONICALLY FOR ... gold, silver, coins and relics with White's Electronics mineral metal detectors. Pays for itself. U.S. Patented.

For your nearest dealer and free catalog

CALL TOLL FREE  
1-800-547-6911



White's Electronics, Inc. Dept PE-0  
Sweet Home, OR 97386.....

NEW 1980 LEATHERCRAFT CATALOG! 100 pages of over 2100 genuine leather kits, tools, supplies. Easy way to make extra money in your spare time. Send 50c for postage and handling to: Tandy Leather Company, P.O. Box 791, Dept. PEC-6, Fort Worth, TX 76101.

3 OLD LIBERTY HEAD NICKELS Only \$1.00. Issued before 1913. Limit 1 set. (Adults Only). Plus price lists. Littleton Coins, HL-17, Littleton, NH 03561.

## TUBES

RADIO & T.V. Tubes — 49 cents each. Send for free Catalog. Cornell, 4213 University, San Diego, Calif. 92105.

TUBES-RECEIVING, Industrial and Semiconductors Factory Boxed. Free price sheet including TV, Radio and audio parts list. Translateral, Inc., 1365 39th St., Brooklyn, New York 11218. Telephone: (212) 633-2800. Toll free: 800-221-5802.

TUBES: "Oldies", Latest. Supplies, components, schematics. Catalog Free (stamp appreciated). Steinmetz, 7519-PE Maplewood, Hammond, Ind. 46324.

## WANTED

GOLD, Silver, Platinum, Mercury, Tantalum wanted. Highest prices paid by refinery. Ores assayed. Free circular. Mercury Terminal, Norwood, MA 02062.

## GOVERNMENT SURPLUS

MANUALS for Govt Surplus radios, test sets, scopes. List \$1.00 (cash). Books, 7218 Roanne Drive, Washington, D.C. 20021.

JEEPS — \$19.30!! — CARS — \$13.50!! — 650,000 ITEMS!! — GOVERNMENT SURPLUS!! — Most COMPREHENSIVE DIRECTORY AVAILABLE tells how, where to buy!! — YOUR AREA — \$2. — MONEYBACK GUARANTEE!! — "Government Information Services", Department GE-26, Box 99249, San Francisco, California 94109.

## PERSONALS

MAKE FRIENDS WORLDWIDE through international correspondence, illustrated brochure free. Hermes-Verlag, Box 110660-Z, D-1000 Berlin 11, W. Germany.

MAILORDER SUCCESS! Interested? Free exposé. TWP-V, Box 6226, Toledo, Ohio 43641.

## INSTRUCTION

UNIVERSITY DEGREES BY MAIL! Bachelors, Masters, Ph.D.'s. Free revealing details. Counseling, Box 317-PE06, Tustin, California 92680.

LEARN WHILE ASLEEP! HYPNOTIZE! Astonishing details, strange catalog free! Autosuggestion, Box 24-ZD, Olympia, Washington 98507.

RADIO BROADCASTING: Become DJ, engineer. Start your own station — investment/experience unnecessary! Receive free equipment, records. Free details. Broadcasting, Box 130-A6, Paradise, CA 95969.

LEARN ELECTRONIC ORGAN SERVICING at home. Completely revised course covers latest models including digital, LSI's, synthesizers, etc. NILES BRYANT SCHOOL, PO Box 20153, Sacramento, CA 95820.

**PASS FCC EXAMS**

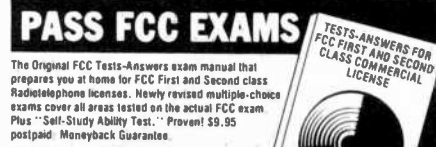

The Original FCC Tests-Answers exam manual that prepares you at home for FCC First and Second class Radiotelephone licenses. Newly revised multiple-choice exams cover all areas tested on the actual FCC exam. Plus "Self-Study Ability Test." Proven! \$9.95 postpaid. Moneyback Guarantee.

**COMMAND PRODUCTIONS**  
Radio Engineering Division

P.O. Box 26348-P  
San Francisco, CA 94126

MEDICAL ELECTRONICS TECHNOLOGY, home study. Troubleshoot medical instruments. University Reme, 5, Box 9622, Fresno, CA 93793.

COLLEGE DEGREES BY MAIL! No classes. Fast. Economical, Accredited. FREE Revealing details. Success, Box 13151-R6, Columbus, Ohio 43213.

HAMS: ADVANCED CLASS TEST GUIDE! Accurate! Send \$11.50 to Dick Bash - KL7IHP, Box 4325, San Leandro, CA 94579.

AVIONICS Aircraft Electronics. Accredited School. Excellent Employment Opportunities. Aero Technicians, P.O. Box 7PE, Rexburg, ID 83440.

BSEE DEGREE — New Advanced Placement Program in Electronics Engineering. Cook's Institute, Dept. C, Box 986, Rock Springs, WY 82901.

AMATEUR Radio books. Free catalog. SCELBI Publications, 20-P Hurlbut Street, Elmwood, CT 06110.

## FOR INVENTORS

PATENT AND DEVELOP Your invention. Registered Patent Agent and Licensed Professional Engineer. Send for FREE PATENT INFORMATION every inventor should have. Richard L. Miller, P.E., 3612 Woolworth Building, New York, NY 10007. (212) 267-5252.

PATENT SEARCHES. LOW FEE, Since 1940. Whitehurst, Box 8022, JFK Post Office, Boston, MA 02114.

CUSTOM PROTOTYPING from your ideas. Confidential. SUPER WIDGETS & Gizmos. (817) 387-2189.

**INVENTIONS WANTED**

FREE CONSULTATION • NO IDEA TOO SMALL

Disclosure registration. Potential cash or royalties from manufacturers seeking new ideas. For free information on how to register your ideas. Call or write

**AMERICAN INVENTORS CORP.**

59 Interstate Dr. Dept PE  
West Springfield, MA 01089 (413) 737-5376  
A Fee Based Service Company

NEW! "Patenting Your Invention Yourself!". \$29.95. Registered Patent Attorney, 7400 ZD Benjamin Franklin Sta., Washington, DC 20044.

INVENTORS Patent your invention. Free initial consultation. We are registered by the U.S. Government. VICTOR J. EVANS & CO., 4637 Eastern Ave. N.E., Washington, DC 20018. Since 1898.

CHEAP PROTECTION for your ideas. Inventor's Logbook. Verification format, permanent binding; moneyback guarantee. \$14.95. JorJan, Box 405PE, Ellensburg, WA 98926.

## BUSINESS OPPORTUNITIES

I MADE \$40,000.00 Year by Mailorder! Helped others make money! Details 25c. Torrey, Box 318-NN, Ypsilanti, Michigan 48197.

FREE CATALOGS. Repair air conditioning, refrigeration. Tools, supplies, full instructions. Doolin, 2016 Canton, Dallas, Texas 75201.

NEW LUXURY CAR WITHOUT COST! Free Report. Codex-ZZ, Box 6073, Toledo, Ohio 43614. (419) 865-5657.

MECHANICALLY INCLINED individuals desiring ownership of Small Electronics Manufacturing Business — without investment. Write: BUSINESSES, 92-K2 Brighton 11th, Brooklyn, New York 11235.

MILLIONS in Mail!!! Free Secrets. Transworld-17, Box 6226, Toledo, OH 43614.

## MECHANICALLY INCLINED INDIVIDUALS

Assemble electronic devices in your home. Knowledge, or experience not necessary. Get started in spare time. Above average profits. \$300 - \$600/Wk possible. Sales handled by others. No investment — Write for free details.

## ELECTRONIC DEVELOPMENT LAB

Box 1560PE, Pinellas Park, FL 33565

ERASE DEBTS with little-known law — create wealth! Details FREE — Blueprints, No. EE6, Box 100, LaGrangeville, NY 12540.

BIG MONEY! Interested? Free disclosure. Febre-V, Box 6073, Toledo, Ohio 43614. (419) 865-5657.

FREE BOOK "2042 Unique Proven Enterprises." Fabulous "unknowns", second inflation income. Haylings-M, Carlsbad, CA 92008.

DIGITAL WATCH REPAIR — Learn to repair digital watches — provide service to jewelry and department stores — part time or full time. We supply training — equipment — replacement parts. Zantech, Inc., 13 Greentree Rd., Trenton, NJ 08619. (609) 586-5088.

\$625-WEEKLY! Home mailing program. Free postage — supplies! — \$20 bonus! Write immediately. Treasure-7Y, Morrison, CO 80465.

BIG MONEY can be made in your spare time. "President", "Private", The Rubber Stamp Field could be "YOUR BREAK-THROUGH". Particulars FREE. Write: Steve, Room RC-376-JF, 1512 Jarvis, Chicago, IL 60626.

## SERVICES

PRODUCTS ASSEMBLED with American Labor and Know-How. Seek contracts from electronic firms and manufacturers to assemble your product. For details write: Production Development, Inc., 1320 Water St., Brownsville, PA 15417.

## EMPLOYMENT OPPORTUNITIES

ELECTRONICS/AVIONICS EMPLOYMENT OPPORTUNITIES. Report on jobs now open. Details FREE. Aviation Employment Information Service, Box 240E, Northport, New York 11768.

AMBITIOUS TECHNICIANS offered great future medical and industrial instruments. Prototyping, trouble shooting, design. Friendly, growing company 20 minutes NYC. Bailey Instruments, Saddle Brook, NJ 07662. (201) 845-7252.

HOW TO BECOME A COMPUTER PROGRAMMER... free details: Dept. CP3, Box 5734-PE6, Pittsburgh, PA 15208.

**Linda Aays**  
*Check it out!*

**Gould Scope Model OS1200**  
Dual Trace 25 MHz  
Reg. 1,299.00/Call

**DSI Counter**  
5600A/50 Hz - 512 MHz  
199.95

**DSI Multimeter LC5000**  
169.95

**DSI Counter**  
5500/50 Hz - 512 MHz  
134.95

**Gould Oscilloscope Model OS255**  
15 MHz Dual Trace  
Reg. 875.00/Call

**NLS Miniscope 15 MHz**  
Reg. 349.80/Call

**NLS Miniscope 15 MHz Dual Trace**  
Reg. 465.45/Call

**NLS Miniscope 30 MHz Dual Trace**  
Reg. 598.15/Call

**Beckman LCD Meter**  
Model 300 /99.95  
Model 310 /129.95

**Hickok Model LX304**  
Reg. 89.95/Call

**Hickok Model LX303**  
Reg. 74.95/Call

**Hickok Function Generator**  
Reg. 229.00/Call

**Weller Xcelite**  
Attache Tool Case  
Model IC100/ST  
Reg. 471.00/269.95

**Hitachi Scope Model V-151**  
15 MHz  
Reg. 545.00/Call

**Hitachi Scope Model V-152**  
15 MHz Dual Trace  
Reg. 695.00/Call

**Hitachi Scope Model V-301**  
30 MHz  
Reg. 745.00/Call

**Hitachi Scope Model V-302**  
30 MHz Dual Trace  
Reg. 945.00/Call

**Hitachi Scope Model V-550**  
50 MHz Dual Trace Delay  
Sweep 1,695.00/Call

**Hitachi Scope Model V-550B**  
Dual Trace 50 MHz Calib.  
Delay Sweep 1,745.00/Call

**Weller Elect Soldering Station EC2000**  
Reg. 125.00/99.95

**EC1000**  
Reg. 99.95/75.95

**Model WTCPN - Cont.**  
Output Solder Station  
Reg. 77.50/49.95

**Gould Scope Model OS260**  
15 MHz Dual Trace  
Reg. 1,199.00/Call

**Platt Tool Case**  
Reg. 99.95/69.95

**Weller Xcelite Service Master Model 99SM**  
44.95

**Roll Kit Model 99PR**  
18.95

**Leader LB0507, LB0508**  
Call for Prices

**Hickok 15 MHz Triggered**  
Reg. 599.00/Call

**Hickok 15 MHz Dual Trace**  
Reg. 849.00/Call

**Hickok 30 MHz Dual Trace**  
Reg. 1,149.00/Call

**Call for prices — You will not be disappointed. We have a large inventory of Test Equipment in a Modern Showroom on full display. Thousands of other products available; Tektronix, Hewlett-Packard, Fluke as well as replacement parts. Come in, call or write for catalog. Monday-Sunday 24 hours. Export inquiries invited. Call now 516-536-5724-5821-5163. Telex 640-596/TWX 510-225-7536**

**CTG** Communications Technology Group, Incorporated

448 Merrick Road Oceanside, N. Y. 11572  
1708 Rockaway Avenue Lynbrook, N. Y. 11563

CIRCLE NO. 13 ON FREE INFORMATION CARD

**INSTANT CASH COMMISSIONS** Full or part time. Free sales kit features America's largest line low-priced Business, Printing, Advertising Specialties, Signs, Calendars and other necessities used daily by business people. Profitable repeat order. No experience. No investment. No collections or deliveries. Write today. National Press, Dept. 061, North Chicago, IL 60064.

**MOTION PICTURE/VIDEO FILMS**

**CONSOLIDATION SALE** — Start a collection; add to yours! Sportlite offers down to earth prices on Univ. & Columbia S-8 Snd Films. "Dracula" (new version) 400' S-8 col/sd big scene edition \$53.95\* (reg. \$62.). "Bye-Bye Birdie" & "Thoroughly Modern Millie" 400' S-8 Sd Universal Entertainment, \$49.95 ea PPD (1ld offer). "Buck Rogers" & "Jaws I" (R.T. 10' +) 200' Sd Eastman color \$29.95 ea\* (reg. \$35.). Order Owens Sports Legend movie 400' S-8 col/sd \$46.95\*. A. Quinn "Requiem for a Heavyweight" only \$44. 400' B/W Snd. Now sells for \$52 reel. Auto racing special! 1911 Indy "500" 200' B/W sil. only \$15.95 ea & "American Auto Racing" (Movietone) squealing, skidding tires, flashbacks of '50's, 200' S-8 B/W Sd \$25.95. "Closeout '76 Indy '500" (J. Rutherford) 200' B/W sil. vivid color with script \$15.95 ea\* (save \$6.) VTR maj. league baseball, your choice World Series 1943-79 (Pirates/Orioles) \$76.95 ea del. Ea. a separate tape. Indicate Beta or VHS. Visa & Mastercharge. Ill res. +6% tax. \*Add \$1.50 ea ship. Catalogs: checks or money orders only: Hollywood Gold Video movie cat. \$1.50; Univ. S-8 film cat. \$1.25; Columbia film cat. \$1.25; Columbia VTR cat. 75c; Paramount features 40c; asst brochures Sportlite, Ring Classics, Cloud 9, 40c ea. **SPORTLITE FILMS**, Elect-6, Box 24-500, Speedway, IN 45224.

**DO-IT-YOURSELF**

**AUDIO ANALOG/SYNTHESIS**. Plans, parts, kits, etc. for the most exciting sound projects ever. Get on our mailing list, send 25c to: CFR Associates Inc., Newton, N.H. 03858.

**TIRED of idiotic TV commercials?** Plans to assemble and install remote volume squelch — \$1. Electronic knowledge not necessary. ULC of Salinas, 177 Webster #A217, Monterey, CA 93940.

**SECURITY BOOK**, how to install your own home alarm system. \$3.50. AEE, Box 6531, Portsmouth, VA 23703.

**REAL ESTATE**

**BIG . . . FREE . . . SUMMER CATALOG!** Over 2,700 top values coast to coast!! UNITED FARM AGENCY, 612-EP West 47th, Kansas City, MO 64112.

**RUBBER STAMPS**

**RUBBER STAMPS, BUSINESS CARDS**. Many new products. Catalog. Jackson's, E-100, Brownsville Rd., Mt. Vernon, Ill. 62864.

**HYPNOTISM**

**FREE Hypnotism, Self-Hypnosis, Sleep Learning Catalog!** Drawer H400, Ruidoso, New Mexico 88345.

**MISCELLANEOUS**

**MPG INCREASED!** Bypass Pollution Devices easily. **REVERSIBLY!!** Free details — Posco GEE6, Box 300, La-Grangeville, NY 12540.

**PROTECT YOUR AUTOMOBILE FROM THEFT!** Free Information. Fleming Sales, 3304 Tanterra Circle, Dept. PE6, Brookeville, MD 20729.

**PRINTED CIRCUITS**. Photo-sensitive boards and masters made without darkroom and chemicals. Easy, inexpensive. Materials readily available. Details \$3.00. Boreal Electronics, S.R. 140A, Menominee, MI 49858.

**NO FUEL MOTOR — PATENTED!** Soon to obsolete fossil fuels, solar, wind, nuclear, — all other sources of energy. Details \$10. Includes copy of patent. Jim Stoddard, Dept. PEA, P.O. Box 22469, Robbinsdale, MN 55422.

**FREE INFORMATION!** Fuel-energy tuning secrets explained. Techneering, Box 12191DD, Norfolk, VA 23502.

**MICROFILM EDITIONS AVAILABLE**. Copies of **POPULAR ELECTRONICS** Magazine are available on microfilm from Xerox University Microfilm, Ann Arbor, Michigan; Microfiche from Bell & Howell, Micro Photo Division, Wooster, Ohio.

**BEAT HIGH GAS PRICES!**



**Electrify Your Bike!**

**PEDALPOWER** exciting new bike drive tames tough hills. Be independent. Shop when you want. Fits all Bikes, Adult Trikes. Installs in minutes. Thousands sold. Recharges overnight. Travels 100 miles for a dime. Get your exercise without strain. Pedal easily with motor engaged to help improve your health. Visit friends. Travel to work or ride for fun. Starts without pedaling. Noiseless, nonpolluting. Virtually maintenance-free operation!

**CALL TOLL FREE 800-257-7955\***

For Free Booklet and Special Offer or write: **General Engines Co. 5809 Mantua Blvd. Sewell, NJ 08080**

\* In AK, HI, NJ call collect (609) 468-0270



CIRCLE NO. 29 ON FREE INFORMATION CARD

# ELECTRONICS WORLD

## Personal Electronics News

**MAGNAVOX EXPANDS VIDEODISC PLAYER DISTRIBUTION** by adding five new market areas to its three established regions in Atlanta, Seattle, and Dallas. U.S. consumers will now be able to buy the optical laser-beam-scan system in Phoenix, Pittsburgh, Minneapolis/St. Paul, Cleveland, and Buffalo, says Magnavox. By the end of 1980, the company expects to expand distribution of the videodisc players to all major markets, covering 65% of all TV households in the U.S. The videodisc player can be used with any TV receiver and has output jacks for home audio systems when discs are encoded in stereo.

**UPGRADED RCA COMMUNICATIONS SATELLITES** will be launched in 1981 by RCA American Communications if FCC approval is obtained. The new SATCOM III (the original was lost on Dec. 10, 1979) is for cable TV purposes. A second satellite, SATCOM IV, is intended to provide in-orbit restoration for failed transponders on other satellites. The new satellites are supposed to include on-board replacement amplifiers and associated switching matrices.

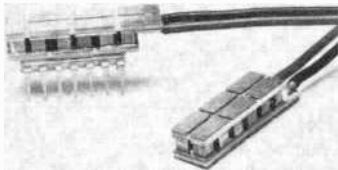

**THERMOELECTRIC COOLING OF DIP ICs** permits more circuitry on a chip when a new, small (0.3 x 0.9 in.) module introduced by Cambion Thermionic Corp., Cambridge, MA is sandwiched between IC and heat sink. Using a small dc power input, the cooler can pump up to 3.5 watts of heat from an 8-, 14-, 16-, or 18-lead IC. The process can also be reversed if it is necessary to regulate the temperature of an IC when the ambient is in the range of  $\pm 60^{\circ}\text{C}$ .

**A \$37-BILLION CONSUMER ELECTRONICS MARKET** has been predicted for 1985 by Business Communications Co., Inc., which valued the market at \$15.3 billion in 1979, up 12% over 1978. Home entertainment (audio, video, antennas, and cable-TV services) will continue to dominate consumer electronics sales, but its market share will decrease as the personal electronics and personal computer sectors gain momentum. The company predicts also that, before 1990, dollar volume in secondary video equipment will exceed that of color television receivers.

**INDUSTRIAL ROBOTS WILL SWEEP THE MARKET** following a 15-year period of "slow and painful" growth, reports International Resource Development. Encouraged by the success of sales in 1979, manufacturers are making the 1980 robot more adaptive to abnormal, as well as expected and prescribed, circumstances. And, if the report's predictions hold true, heuristic robots and those with reproductive capabilities may soon be found outside of science fiction. Manufacturers expected to be in the forefront of the robot explosion will be Unimation, Cincinnati Milacron, Texas Instruments, and Digital Equipment Corp.

**DIGITAL AUDIO PCM TAPE RECORDING** offering from Sanyo is a Beta-format videocassette of Ry Cooder's "Bop Til You Drop" for \$25. It's available from dealers who sell the Sanyo Plus 10 digital audio adaptor. The latter converts any VCR into a digital audio recorder and carries a suggested retail price of \$3995.95. The Cooder videocassette is said to be the first time an album recorded digitally has been made commercially available in the PCM format. Using PCM (pulse code modulation) techniques eliminates any background noise.

**ATARI PERSONAL COMPUTER SERVICE** facilities are reported available in approximately 20 service centers located nationwide and operated by Control Data Corporation. A variety of services for Atari 400 and 800 Systems, including warranty repair, safety and engineering changes, equipment upgrades and annual service contracts, is available.

**COLOR-TV PRODUCTION IN CHINA** got a boost when China National Technical Import Corp. signed a contract with Nissho-Iwai Co., Ltd. and Victor Co. of Japan, Ltd. to obtain five-million dollars worth of TV assembly and production facilities for Tianjim Radio, a government-run enterprise. With the new facilities, an annual production capacity of 150,000 sets is planned, with a possible increase to 300,000 sets soon.





# HP SOLVES MORE PROBLEMS...



## ...With a broader range of programmables and more extensive software solutions than anyone else.

Hewlett-Packard's extensive line of programmable calculators coupled with its vast range of software solutions lets you solve more problems more quickly and easily.

### MORE SOLUTIONS

With programmable calculators hardware is only half the story. Hewlett-Packard's superior software support lets you spend your time solving problems rather than writing programs to solve your problems.

HP offers a growing collection of software solutions, from aviation navigation to x-ray diffraction. For use on-the-job or at your leisure. And HP software is available in several convenient forms: hundreds of easy to use, step by step key-in programs for all HP programmables; and preprogrammed magnetic cards, plug-in modules, and soon, bar-coded programs for fully-programmables. Plus thousands of software solutions in HP's Users' Library. So when you buy a Hewlett-Packard program-

mable, you're buying a more useful, efficient, and complete problem solver.

### A PROGRAMMABLE FOR YOU

Hewlett-Packard has a full line of scientific and engineering programmables to choose from: six different programmables with a full range of capabilities. One of them is sure to meet your particular needs.

HP Scientific Programmables		
HP-33E	Scientific Programmable	\$ 90.00*
HP-33C	Scientific Programmable with Continuous Memory	\$120.00*
HP-34C	Advanced Scientific Programmable with Continuous Memory	\$150.00*
HP-67	Fully-Programmable Printing	\$375.00*
HP-97	Fully-Programmable Printing	\$750.00*
HP-41C	Alphanumeric Fully-Programmable with Continuous Memory	\$295.00*

The most extensive range of programmable calculators backed by the most extensive line of software solutions. It's an unbeatable combination and another example of Hewlett-Packard's commitment to the principle of "excellence by design."

For the address of your nearest HP dealer, CALL TOLL-FREE 800-547-3400 except from Hawaii or Alaska. In Oregon, call 758-1010. For details, send the attached coupon or write: Hewlett-Packard, 1000 N. E. Circle Blvd., Corvallis, OR 97330, Dept. 254 R.



HEWLETT-PACKARD  
Dept. 254 R  
1000 N. E. Circle Blvd.  
Corvallis, OR 97330

Please send details on HP programmable calculators and software solutions.

NAME \_\_\_\_\_

TITLE \_\_\_\_\_

COMPANY \_\_\_\_\_

ADDRESS \_\_\_\_\_

CITY \_\_\_\_\_

STATE \_\_\_\_\_ ZIP \_\_\_\_\_

\*Suggested retail price excluding applicable state and local taxes — Continental U.S.A., Alaska and Hawaii.  
Displays photographed separately to simulate typical appearance



# The disease is low frequency feedback



# The cure is DiscFoot

## DISCWASHER® **DiscFoot™** Hi-Technology Turntable Isolation System

- Works in combination with existing feet for dramatic reduction of feedback.
- Isolates better than original or "replacement" feet.

Home environments can "upset" a turntable by feeding back both speaker and footfall vibrations. Acoustic isolation of a turntable involves the complex variables of turntable weight, room/floor conditions and audio system placement. The Discwasher DiscFoot has been specifically designed to successfully isolate most turntables in the home environment.

### The "Material" Solution

The major components of the Discwasher DiscFoot System are new, "totally engineered" chemical complexes that behave radically different than other plastic, rubber or spring systems. These proprietary compounds are durable and precise in behavior, although difficult and expensive to synthesize. Laboratory and real-world tests justify the use of these unusual materials in the DiscFoot System.

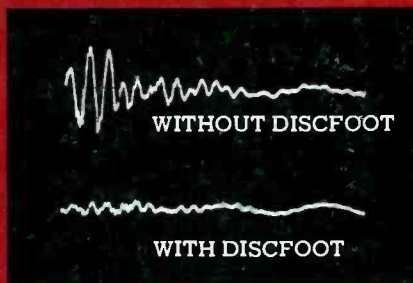

### The Telling Test

The oscilloscope photo shows the output of two identical audio systems on the same shelf with their styli contacting the platters. The shelf is being struck by a rubber mallet. The top trace shows a turntable with absorptive "replacement" feet. The lower trace shows a DiscFoot System operating in conjunction with the existing turntable feet. Note the dramatic (tenfold) improvement in shock and feedback isolation.

CIRCLE NO. 21 ON FREE INFORMATION CARD

The DiscFoot System contains four isolation feet, four platform caps, four furniture-protecting sheets and four special damping pads (to adapt DiscFoot units to certain turntables.) Additional single DiscFoot units are available for turntables weighing over 22 lbs. The system costs \$22.



Discwasher DiscFoot can be found at audio dealers interested in preserving your music.

**discwasher®**  
PRODUCTS TO CARE FOR YOUR MUSIC

1407 N. Providence Rd.  
Columbia, Missouri 65201