

# Popular Electronics®

WORLD'S LARGEST-SELLING ELECTRONICS MAGAZINE

MAY 1979/\$1.25

**PE Tests New "Sonic Hologram" Preamp  
Open Refrigerator-Door Alarm Saves Energy  
Build an R-F Impedance Bridge**

**The Upcoming New World of TV Reception**

**FARM PRICES AT CHICAGO  
CLOSING BOARD OF TRADE**

WHEAT	JUL 3.09	1/2 DOWN .00	3/4
SEP 3.13	3/4 UP .00	1/4	
DEC 3.18	3/4 DOWN .00	3/4	
MAR 3.21	UP .00	1/2	

CORN	JUL 2.55	1/2 DOWN .02	
SEP 2.56	3/4 DOWN .02	1/2	
DEC 2.58	1/2 DOWN .03	1/2	
MAR 2.64	1/2 DOWN .03	1/2	

SEE MASSEY FERGUSON FOR YOUR  
NEW 1978 TRACTOR

**TEMPERATURE CONVERSION CHART**

F	C	F	C	F	C
-20	-28.9	36	2.2	90	32.2
-16	-26.7	40	4.4	94	34.4
-12	-24.4	44	6.7	98	36.7
-8	-22.2	48	8.9	102	38.9
-4	-20.0	52	11.1	106	41.1
0	-17.8	56	13.3	110	43.3

**THE TOP 7 ROCK SONGS  
AVAILABLE AT ALL K-MART STORES**

- 1 SHADOW DANCING  
ANDY GIBB
- 2 BAKER STREET  
GERRY RAFFERTY
- 3 USE TA BE MY GIRL  
D' JAYS
- 4 YOU BELONG TO ME  
CARLY SIMON
- 5 IT'S A HEARTACHE  
BONNIE TYLER
- 6 STILL THE SAME  
BOB SEGER
- 7 WITH A LITTLE LUCK  
WINGS



**Tested  
In This  
Issue**

**Eumig Model CCD Stereo Cassette Deck  
Pioneer TVX-9500 TV Audio Tuner  
Sabtronics 8100 Frequency Counter**





# The Fisher CR5150 cassette deck. Gorgeous up close. Even better from a distance.

Great styling and state-of-the-art performance are two things this new Fisher cassette deck has plenty of.

But it's got something even more exciting: full-function remote control—without wires! It's the first tape deck ever to offer this sensational feature.

Think of it: by touching a button on the remote infrared transmitter, you can control Play, Record, Pause, Stop, Fast Forward, and Rewind modes—from up to 20 feet away! You can record, edit, search, and listen to cassettes—without leaving your easy chair. And the CR5150 is just plain fun to operate.

Wireless control would probably make the CR5150 a big seller even if its performance was only average. But Fisher went all out, and gave it 3 heads for 30-19,000 Hz response, dual-



process Dolby\*\* for 68dB S/N ratio, and a servo-controlled transport with 0.04% wow & flutter (WRMS). Superb specs that only a handful of ultra-high priced cassette decks can match.

Feature-wise, there's a built-in digital clock that will turn on the CR5150 deck (or your receiver)

to record anything you want at a preset time, whether you're home or not. The clock display doubles as an electronic tape counter with memory rewind. Silky-smooth, feather-touch buttons control the solenoid tape mechanism.

But considering the prices of other decks with similar performance and far less features, the Fisher CR5150 at \$650\* has to be one of the greatest values in high fidelity today. No matter how you look at it.

Available at better audio stores or the audio departments of fine department stores.

\*Manufacturer's suggested retail value. Actual selling price determined solely by the individual Fisher dealer.

New guide to buying high fidelity equipment. Send \$2 for Fisher Handbook, with name and address to Fisher Corp., Dept. H, 21314 Lassen St., Chatsworth, CA 91311.



The first name in high fidelity.®

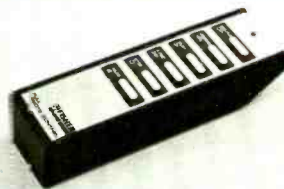

CR5150

Would you have bought?

# The Digital Watch Hoax

*Hundreds of consumers took part in an experiment. What it proved can be a lesson to us all.*

The story we are about to tell you is the absolute truth. The persons involved, however, will not be mentioned in order to protect their reputations.

It began about six months ago when an enterprising watch manufacturer in Hong Kong started producing watches that were exact copies of the Seiko chronograph alarm selling in the United States for \$300.

The Hong Kong version was sold to several American watch manufacturers for approximately \$25. These companies in turn contacted several American mail order companies and offered the watch to them for around \$50.

Soon, all you saw in newspapers and magazines were watches that looked like the Seiko but were selling for between \$60 and \$100. Although each watch had a different name, they were all made by the same manufacturer. Even JS&A was selling them.

Many of the other mail order companies had just started in business and were not financially stable. If service would ever be required and the company vanished, the watch would be useless.

A friend of ours, who was also in the mail order business, told us that for a low enough price the American consumer would be willing to buy anything, regardless of the stability of the company.

To prove his point, he made us an offer. If we could supply him with those digital watches, he would prove that the American consumer did not pay attention to who was offering the watch and only cared about price. We accepted his challenge. Prices had been dropping and the cost of our stainless steel model was now \$38.

Our friend ran a small ad in the southwestern edition of a consumer publication offering our watch for \$39.95. The ad cost him only \$72. It had no trial period, no accuracy claims and the name of the company used in the advertisement had never appeared before. His customers had to send in a check with their order and there was a \$3.00 postage and handling charge. Even the name of the watch was not shown.

When the response came in, even our friend was amazed. There were 38 orders, and he made a small profit. He delivered the watches and proved his point.

A smart consumer, however, would have never taken this gamble—at any price. He would have made sure the company was substantial, able to back their claims, and assure himself that the company would be around for awhile to service his purchase.



**\$39.95**

**Full Function Chrono Alarm**

You've seen it advertised for \$100. But now it's \$39.95. It's a full-function chronograph with alarm. In silver-tone at \$39.95, in gold-tone \$49.95. Please add \$3.00 postage and handling. Checks or money orders only. No COD's. Illinois residents please add 5% sales tax. Send to the address below:  
**JS&A Watch Factory**

*This ad was a hoax designed to prove the gullibility of the American consumer.*

Indeed, not all those who responded were gullible. There were 62 letters from people who did not buy but asked for either more information, the name of the manufacturer, or the right to return the watch if it wasn't any good. There were several inquiries made directly to the publication and a few to the Better Business Bureau.

There were more consumers who investigated the offer than those who took the bait despite the tempting price. That was encouraging for us.

But this story took an interesting twist after the experiment. The American watch companies handling the Hong Kong watch were getting overstocked. Prices were starting to drop and a few of the companies were indeed going out of business.

About this time, Texas Instruments introduced their new Chrono Alarm. It looked almost identical to the Seiko, but its features made it far superior.

The TI watch glows in the dark. A small tritium phosphor capsule, sealed by a laser beam, is located under the display. When the lights dim, the display appears to glow. You avoid the button pushing and component failures that are possible with watches that have miniature light bulbs inside.

And the features of the TI are the same as those of the Seiko plus a few more. The TI watch has a full-function chronograph, 12 or 24-hour time selectability, quartz accuracy to within 15 seconds per month, and a really fine quality case.

We felt that the TI Chrono Alarm had better

quality and more features than anything else on the market, but it was priced at \$125—higher than the Hong Kong watches.

So we tried another experiment. We offered the TI watch in a small advertisement in our catalog opposite an ad we created for the Hong Kong watch selling for \$69.95. The TI watch generated four times the number of orders than the Hong Kong version. It was this test that convinced us to offer the TI watch in a national advertising campaign.

We are not showing you the Texas Instruments watch in this ad. First, it looks identical to the Seiko version and secondly, if we showed it and you just read the headline of this ad, you might think that the TI watch was "The Digital Watch Hoax" which of course it isn't.

The TI watch will be sold in a few select stores shortly. Or you can order now directly from JS&A. We promise you prompt delivery and something even the stores don't offer—the opportunity to wear the TI watch and the right to return it anytime within 30 days for a prompt and courteous refund if you are not absolutely satisfied.

If you are looking for the very finest watch you can buy—even better than the Seiko and backed by two substantial companies, we urge you to consider the TI Chrono Alarm. JS&A is America's largest single source of space-age products—further assurance that your modest investment is well protected.

Send your check or money order for **\$125** for the stainless steel model or **\$150** for the gold-tone version plus \$2.50 postage and handling (Illinois residents, please add 5% sales tax) to the address shown below. Credit card buyers may call our toll-free number below.

We will promptly ship your watch, one-year limited warranty and complete instructions. Then prove for yourself how outstanding the Texas Instruments Chrono Alarm really is.

There's no gamble when you can own the finest. Order a Texas Instruments Chrono Alarm with complete confidence, at no obligation, today.

**JS&A PRODUCTS THAT THINK®**

Dept. PE One JS&A Plaza  
Northbrook, Ill. 60062 (312) 564-7000  
Call TOLL-FREE ..... 800 323-6400  
In Illinois Call ..... (312) 564-7000

©JS&A Group, Inc., 1979

# We've cut your final cost on Commodore PET™ personal computers!

Our Computer Products Division of Communications Electronics is pleased to introduce *four* new and improved models of the famous Commodore PET™ personal computer. For the first time ever, you can get 32K or 16K of RAM *built into* your PET computer. As an introductory offer, we have special price reductions on all our PET computers and new peripherals. All orders must be placed before July 31, 1979 to qualify for these special prices.

The PET, a 6502 based microprocessor system, when incorporated with our new Printer and Floppy Disk makes an ideal business system for most professional and specialized fields: medicine, law, dental, research, engineering, toolmaking, printing, energy conservation, education, etc. Our Business System as a management tool, delivers information to all levels of Business, previously attainable only with equipment many times more expensive. We have one of the most cost efficient business tools available today. Our system offers a wide range of applications from logging management strategy in major corporations to organizing accounts and inventory control of small businesses. Here are just a few of the many cost-saving uses in the corporation, professional office or small business: stock control, manufacturing costing, forecasting, customer records, mailing lists, purchasing, etc. The new PET with large keyboard, Floppy Disk and Printer, make a fantastic business system at a reasonable price...and now it's all available from the Computer Products Division of Communications Electronics.



NOW!  
32K

## PET 2001-32N Computer

Available May, 1979

List price \$1,195.00/CE price \$1,049.00

PET computer with 32K bytes of memory and large keyboard with separate numeric pad. Graphics are on keys. External cassette optional.

PET 2001-32B Computer

Available May, 1979

List price \$1,195.00/CE price \$1,049.00

PET with 32K bytes of memory but has standard typewriter keyboards and no graphic keys. External cassette optional.

PET 2001-16N Computer

Available May, 1979

List price \$995.00/CE price \$869.00

PET with 16K bytes of memory and large keyboard with separate numeric pad. Graphics are on keys. External cassette optional.

PET 2001-16B Computer

Available May, 1979

List price \$995.00/CE price \$869.00

PET with 16K bytes of memory but has no graphic keys and standard typewriter keyboard. External cassette optional.

PET 2001-8 Computer

Available NOW!

List price \$795.00/CE price \$695.00

Our best selling personal computer. This is the original PET with integral cassette and calculator type keyboard. 8K bytes of memory.

### PET 2001-32/16 SPECIFICATIONS

Dimensions: 16 1/2" wide by 18 1/2" deep, 14" high  
Shipping Weight: 49 pounds (UPS shipping OK)

#### MEMORY

Random Access Memory 32K or 16K bytes  
Read Only Memory (operating system resident in the computer): 14K bytes

8K+ — BASIC interpreter

4K — Operating system

1K — Machine language monitor

#### VIDEO DISPLAY UNIT

9" monochrome CRT

1000 character display, 40 x 25

8 x 8 dot matrix for characters

64 standard ASCII characters; 64 graphic characters

**KEYBOARD:** Business or Number Pad Version. Screen Control: home, clear, up, down, left and right; Editing: Character insertion and deletion

**OPERATING SYSTEM:** will support multiple languages (BASIC resident)

Machine language accessibility.

File management in operating system

## PET 2040 Floppy Disk

Available May, 1979

List price \$1095.00/CE price \$979.00

The Dual Drive Floppy is the latest in Disk technology with extremely large storage capability and excellent file management. As the PET disk is an "intelligent" peripheral, it uses none of the RAM (user) memory of the PET. The Floppy Disk operating system used with the PET computer enables a program to read or write data in the background while simultaneously transferring data over the IEEE to the PET. The Floppy Disk is a reliable low cost unit, and is convenient for high speed data transfer. Due to the latest technological advances incorporated in this disk, a total of 360K bytes are available in the two standard 5 1/4" disks, without the problems of double tracking or double density. This is achieved by the use of two microprocessors built into the disk unit. Only two connections are necessary — an A.C. cord and PET interface cord.

### 2040 Dual Drive Mini Floppy Disk Specifications Microcomputer system devices

Controller

6504 microprocessor

File interface

6502 microprocessor

Disk drives

(2) Shugart Associates SA390 drives

standard minifloppy (5 1/4" disk)

Activity LED's light when a file is open on that drive

Power requirements

50 wats @ 120 VAC

Other line voltage options to be announced

Packaging

18 gauge all steel cabinet

Dimensions: 15" wide, 14.35" deep, 6.5" high

Cover hinges from base for servicing

Diskette organization

Formatting is by the drive itself — any mini-floppy diskette

may be used

35 concentric tracks

Constant density recording on each track

Varying number of sectors per track —

innermost: 17 outermost: 21

176640 bytes on a single side

171520 bytes for user storage

Soft-sectoring

Diskettes for dual side recording may be used.

Data interface

IEEE-488

Standard 24-pin stacking connector

Device #8-15 by jumper option

Intelligent IEEE-488 peripheral which is controlled by two MOS 6500 microprocessors. Unlike any other system on the market, this Disk System contains common memory that is shared between the IEEE communication processor and the disk controller processor.

This configuration provides for a distributed processing environment that allows the floppy to execute a command while the PET prepares the next command or performs other program functions.

The disk recognizes a command set that supports a *high level* sequential file management system. Utility commands are also provided for direct access to any byte on the diskettes.

In addition, the system is capable of executing machine language programs read directly from diskettes or transmitted from the PET. This feature is useful for executing complete diagnostic programs, recovery of data, and custom operating systems. There is 340K net user storage capacity. A retrofit kit is required for operation with the PET 2001-8 computer.

### PET 2041 Single Drive Mini Floppy Disk

Available July, 1979

List price \$595.00/CE price \$539.00

The Mini Floppy Disk is a low cost unit with excellent specifications for a high speed data transfer and storage device. It operates through the memory expansion port of the PET, and is commanded in exactly the same way as the Commodore cassette systems, i.e. LOAD "NAME";4,SAVE "NAME";4;OPEN 1,4;CLOSE 1,4; PRINT #4;INPUT #4. The disk contains limited electronic components, and is therefore slower and less sophisticated than the 2040 Dual Drive Floppy Disk. However, three I.C.s are provided with this unit, which plug into the standard PET 2001-32/16. The Mini Floppy Disk has been designed for ease in operation by amateur and professional alike. The combination of the PET with the Single Drive Floppy Disk and a Commodore Printer is an ideal system for the professional small business man or hobbyist on a tight budget.

### PET 2041 Single Drive Floppy Disk Specifications

This is a single floppy disk drive which attaches to the memory bus of the PET 2001-32 or 2001-16. It is not as fast as the 2040 because it does not have its own microprocessor system to buffer data while the main PET is functioning.

A disk operating system is provided in (2) 6332 ROMs which are inserted into already existing sockets on the PET 2001-32 or 2001-16. Additionally, one existing 6332 is replaced by another ROM provided with the disk.

Disk Drive

Shugart Associates SA 390 Drive

Standard mini floppy (5 1/4 inch disk available from CE)

Power for the drive is provided from the PET 2001

The disk operating system addresses the 2041 by the same commands as the cassette operating system. It is referred to as Device #4. Diskette format is compatible with the 2040 as is all software and commands. The 2041 intelligent mini floppy has a net user storage of 170K bytes.

## PET External Cassette

Available NOW!

List price \$95.00/CE price \$85.00

Cassette player/recorder to use with PET models 2001/32/16/8.

We are introducing three new models of high quality printers to replace the PET 2020 printer. All three models are capable of full PET graphics.

PET 2021 Printer

Available May, 1979

List price \$549.00/CE price \$489.00

80 column dot matrix electrostatic printer with full PET graphics capability.

PET 2022 Printer

Available May, 1979

List price \$995.00/CE price \$889.00

The Tractor Feed Printer is a high specification printer that can print onto paper (multiple copies!) all the PET characters — letters (upper and lower case), numbers and graphics available in the PET. The tractor feed capability has the advantage of accepting mailing labels, using standard preprinted forms (customized), check printing for salaries, payables, etc. Again, the only connections required are an AC cord and PET connecting cord. The PET is programmable, allowing the printer to format print for: width, decimal position, leading and trailing zero's, left margin justified, lines per page, etc. It accepts 8 1/2" paper giving up to four copies. Bidirectional printing enables increased speed of printing.

PET 2023 Printer

Available May, 1979

List price \$849.00/CE price \$756.00

80 column dot matrix printer. Plain paper printer with full PET graphics.

### SERVICE KIT

For those of you who are handier than most, you may wish to order the PET 2001-8 service kit (Order Number 320405) which contains the following: Booklet "Testing the PET Computer", Cassette "PET test programs" two connectors, video display circuit schematic and supplement, parts location for the video display assembly, video display assembly component cross reference, 9 sheets of main logic board schematics, main logic board assembly component cross reference. All for \$32.00 postpaid.

### USER'S MANUAL

160 Page expanded user manual covering all facets of user operation programming and I/O for PET computers. (Order # 320845) \$11.00 postpaid.

### TEST A PET COMPUTER FREE

Use a Commodore PET computer at home or office for 10 days. Use it to speed your answers on complex calculations. Test the superior graphics on the CRT display. If for any reason you are not completely satisfied, return it in new condition with all accessories in 10 days, for a courteous and prompt refund (less shipping charges). It is your responsibility to pay for return insured shipping if you want a refund, repair or replacement.

### NATIONAL SERVICE

With your Commodore PET computer, we will send all operating and programming instructions and a 90 day limited warranty. If service is required on any Commodore PET product, purchased from Communications Electronics, just send your computer via insured UPS or U.S. Mail to one of our approved national service centers in Palo Alto, California or Norristown, Pennsylvania.

### THE SMALL PRINT

All sales are subject to availability. Prices and specifications are subject to change without notice. No COD's please. Cashier's checks may be processed immediately. Personal checks require 25 days bank clearance. Allow 4-6 weeks for delivery on some high demand products. Insured return shipping for repair, replacement or refund is your responsibility. All sales on peripherals, software and magnetic media are final and no returns are allowed.

### BUY WITH CONFIDENCE

To get the *fastest delivery* of your PET computer, send or phone your order directly to our Computer Products Division. Be sure to calculate your price using the CE prices in this ad. Michigan residents please add 4% sales tax. Foreign orders are invited at slightly higher cost. International customers please read special shipping information (in our catalog) before ordering. Calculate shipping costs as follows: all PET computers, floppy disks drives or printers add \$20.00 each for UPS ground shipping. Add \$5.00 shipping for PET external cassette. Mail orders to: Communications Electronics, Computer Products Division, Box 1002, Ann Arbor, Michigan 48106. If you have a Master Charge or Visa card, you may call and order toll free 800-521-4414 to place a credit card order. If you are outside the U.S. or in Michigan, dial 313-994-4444. All order lines at Communications Electronics are staffed 24 hours.

Copyright ©1979 Communications Electronics™



**COMMUNICATIONS ELECTRONICS™**

854 Phoenix □ Box 1002 □ Ann Arbor, Michigan 48106 U.S.A.  
Call TOLL-FREE (800) 521-4414 or outside U.S.A. (313) 994-4444

*We're first with the best.™*

FOR EXTENSIVE DETAILED SPECIFICATIONS ON ALL PET™ PRODUCTS, CIRCLE 1 ON FREE INFORMATION CARD

CIRCLE NO. 1 ON FREE INFORMATION CARD



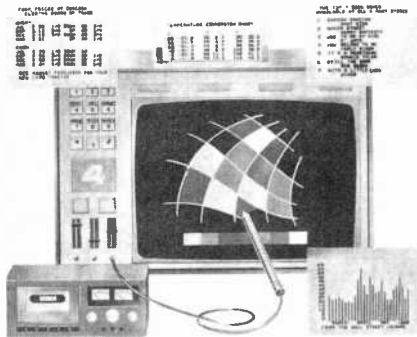

About the cover:

Tomorrow's standard TV receiver screen may be used for any of the diverse purposes shown on the cover—from light-pen drawings to facsimile printouts to extra channels for video newspapers, stock-market quotations, etc.

Cover Art by George Kelvin

<b>JOSEPH E. MESIC</b> Publisher	
<b>ARTHUR P. SALSBERG</b> Editorial Director	
<b>LESLIE SOLOMON</b> Technical Director	
<b>JOHN J. McVEIGH</b> Technical Editor	
<b>JOHN R. RIGGS</b> Managing Editor	
<b>HAROLD A. RODGERS</b> Senior Editor	
<b>ALEXANDER W. BURAWA</b> Features Editor	
<b>EDWARD I. BUXBAUM</b> Art Director	
<b>ANDRE DUZANT</b> Technical Illustrator	
<b>CARMEN VELAZQUEZ</b> Production Editor	
<b>RUTH POLSKY</b> Editorial Assistant	
Contributing Editors Hal Chamberlin, Lou Garner, Glenn Hauser Julian Hirsch, Ralph Hodges, Forrest Mims	
<b>JEFF NEWMAN</b> Assistant to the Editor	
<b>LINDA BLUM</b> Advertising Service Manager	
<b>MARIE MAESTRI</b> Executive Assistant	
<b>EDGAR W. HOPPER</b> Publishing Director	

## Feature Articles

<b>THE UPCOMING NEW WORLD OF TV RECEPTION/ Leslie Solomon</b> _____	49
<i>What the future holds for the use of TV in the home.</i>	
<b>TAPE BIAS/EQUALIZATION CHART/ Craig Stark</b> _____	73
<i>How to set your cassette deck for most of the tape formulations of the last few years.</i>	
<b>MICROCOMPUTER VIDEO BOARD BUYING DIRECTORY/ Staff</b> _____	74

## Construction Articles

<b>PERFORM COMPLETE IMPEDANCE MEASUREMENTS WITH THIS R-F BRIDGE/Don Morar</b> _____	63
<i>Measure R and X components over a wide frequency range.</i>	
<b>OPEN-DOOR "FRIDGE ALARM" STOPS FOOD SPOILAGE &amp; ENERGY WASTE/Eliot K. Rand</b> _____	68
<i>Sounds alarm after preset time when refrigerator door is left open.</i>	
<b>SOLID-STATE TURN INDICATORS FOR MOPEDS/Herbert L. Bresnick</b> _____	71
<i>Inexpensive electronic add-on increases driving safety.</i>	
<b>LINE-VOLTAGE COMPENSATOR/Harry J. Miller</b> _____	75
<i>Boost the supply to combat occasional voltage dips.</i>	

## Columns

<b>STEREO SCENE/ Ralph Hodges</b> _____	21
<i>Audio's Winter Wonderland</i>	
<b>EXPERIMENTER'S CORNER/ Forrest M. Mims</b> _____	77
<i>The Analog Comparator.</i>	
<b>HOBBY SCENE/ John J. McVeigh</b> _____	82
<b>DX LISTENING/ Glenn Hauser</b> _____	85
<i>How Many SWLs?</i>	
<b>COMPUTER BITS/ Hal Chamberlin</b> _____	88
<b>SOFTWARE SOURCES/ Leslie Solomon</b> _____	92
<b>PROJECT OF THE MONTH/ Forrest M. Mims</b> _____	93
<i>Miniature DC-DC Converter.</i>	

## Audio Test Reports

<b>PREVIEW OF CARVER C-4000 PREAMPLIFIER WITH "SONIC HOLOGRAM"/ Hal B. Rodgers</b> _____	25
<b>EUMIG MODEL CCD CASSETTE DECK/ Julian Hirsch, Hirsch-Houck Labs.</b> _____	39
<b>PIONEER MODEL TVX-9500 TV SOUND TUNER/ Julian Hirsch, Hirsch-Houck Labs.</b> _____	44

## Electronic Product Test Report

<b>SABTRONICS MODEL 8100 FREQUENCY COUNTER</b> _____	83
--	----

## Departments

<b>EDITORIAL/ Art Salsberg</b> _____	4
<i>Holography—Video and Audio</i>	
<b>LETTERS</b> _____	6
<b>OUT OF TUNE</b> _____	6
<b>NEW PRODUCTS</b> _____	8
<b>NEW LITERATURE</b> _____	14
<b>TIPS &amp; TECHNIQUES</b> _____	76
<b>ADVERTISERS INDEX</b> _____	112

POPULAR ELECTRONICS: Published monthly by Ziff-Davis Publishing Company, at One Park Avenue, New York, N.Y. 10016. Philip B. Korsant, President, Selwyn Taubman, Treasurer; Philip Sine, Secretary. One year subscription, U.S. and Possessions, \$13.00; Canada, \$16.00; all other countries, \$18.00, cash orders only, payable in U.S. currency. COPYRIGHT © BY ZIFF-DAVIS PUBLISHING COMPANY. ALL RIGHTS RESERVED.

ZIFF-DAVIS PUBLISHING COMPANY  
Editorial and Executive Offices  
One Park Avenue New York New York 10016  
212 725-3500

Joseph E. Mesics (725-3568)  
John J. Corliss (725-3578)  
Bonnie B. Kaiser (725-3580)

Midwestern Office  
Suite 1400 180 N. Michigan Ave.  
Chicago IL 60601 (312-346-2600)  
Midwest Representative Buzz Vincent

Western Office  
9025 Wilshire Boulevard Beverly Hills CA 90211  
213-273-8050 BRadshaw 2-1161

Western Representative Norm Schindler  
Suite 205 20121 Ventura Blvd  
Woodland Hills CA 91364 (213-999-1414)

Japan James Yagi Oji Palace Aoyama  
6-25 Minami Aoyama 6 Chome Minato Ku  
Tokyo 407 1930/6821 582-2851

#### ZIFF-DAVIS PUBLISHING COMPANY

Philip B. Korsant President  
Furman Hebb Executive Vice President  
Phillip T. Heffernan Sr. Vice President  
Edward D. Muhlfeld Sr. Vice President  
Phillip Sine Sr. Vice President Secretary  
Lawrence Sporn Sr. Vice President Circulation and Marketing  
Baird Davis Vice President Production  
George Morrissey Vice President  
Sydney H. Rogers Vice President  
Sidney Holtz Vice President  
Albert S. Traina Vice President  
Paul H. Chook Vice President  
Edgar W. Hopper Vice President  
Robert N. Bavier Jr. Vice President  
Selwyn Taubman Treasurer  
W. Bradford Briggs Vice Chairman

#### ZIFF CORPORATION

William Ziff Chairman  
I. Martin Pompadour President  
Hershel B. Sarbin Executive Vice President

POPULAR ELECTRONICS April 1979 Volume 15 Number 4. Published monthly at One Park Avenue New York NY 10016. One year subscription rate for U.S. and Possessions \$13.00 Canada \$16.00 all other countries \$18.00 (cash orders only, payable in U.S. currency). Second Class postage paid at New York NY and at additional mailing offices. Authorized as second class mail by the Post Office Department, Ottawa Canada, and for payment of postage in cash.

POPULAR ELECTRONICS including ELECTRONICS WORLD Trade Mark Registered Indexed in the Reader's Guide to Periodical Literature

COPYRIGHT © 1979 BY ZIFF-DAVIS PUBLISHING COMPANY ALL RIGHTS RESERVED

Ziff-Davis also publishes Boating Car and Driver Cycle Flying Popular Photography Skiing Stereo Review Electronic Experimenter's Handbook Tape Recording & Buying Guide Stereo Directory & Buying Guide & Communications Handbook

Material in this publication may not be reproduced in any form without permission. Requests for permission should be directed to Jerry Schneider Rights and Permissions, Ziff-Davis Publishing Co., One Park Ave., New York, NY 10016.

Editorial correspondence: POPULAR ELECTRONICS, 1 Park Ave., New York, NY 10016. Editorial contributions must be accompanied by return postage and will be handled with reasonable care; however, publisher assumes no responsibility for return or safety of manuscripts, art work or models.

Forms 3579 and all subscription correspondence: POPULAR ELECTRONICS, Circulation Dept., P.O. Box 2774, Boulder, CO 80302. Please allow at least eight weeks for change of address. Include your old address, enclosing if possible, an address label from a recent issue.

The publisher has no knowledge of any proprietary rights which will be violated by the making or using of any items disclosed in this issue.



# Editorial

## HOLOGRAPHY—VIDEO AND AUDIO

Some five years ago, I remember being impressed by a holographic image projected by a laser-beam system right here in our offices. It was a three-dimensional image of a woman in a glass jar, and I could observe a different view of the figure—left side, right side, front—as I moved around.

For whatever reason, visual holography has suddenly become a popular consumer subject in media and elsewhere. There's even a company that's marketing moving holographic images for promotional purposes (Man/Environment, Inc. Los Angeles, CA 90025). An article, "Holographic Memory," in *Psychology Today* (February 1979) explores the principle of re-creation of an image in three-dimensional format from laser light patterns as it applies to distribution and storage in the human brain. The article focuses on visual aspects.

Three-dimensional audio has not been entirely ignored either. We had binaural recordings long ago, which, of course, require the use of headphones and special recording techniques that place microphones where ears would be located on a model of a human head. Four-channel sound was another effort to make sound reproduction more realistic through imparting a sense of depth. Bell Labs' engineers, in turn, have experimented with pre-processing audio signals to speakers, using feedback loops to give a truer recreation of "concert hall" acoustics. Reports were that the effect was localized so that more than minor head movements would cause the enhanced stereo to be lost.

Other people have been working on audio systems that bear some resemblance to the Bell Labs' experiments. One such system will soon be commercially available from Carver Electronics. A subjective report on the prototype model appears in this issue. The three-dimensional function is called a "sonic hologram."

If not a true hologram, which consists of splitting a laser's beam and deflecting part of it toward a film plate and another part to the object, with a reconstruction process taking place to create a holographic image, it comes close enough in an audio sense. Interestingly, I found the three-dimensional effect to be only moderately localized. This would seem to indicate either a more sophisticated system than the one Bell Labs used or that my neural holograms were peaked for the occasion.

According to the *Psychology Today* article, the brain has a capacity for a vast array of holograms. It observes that there are patch holograms, drawing an analogy with the hundreds of lenses of an insect's eye that provide a composite image. It also points out that there are audio speaker systems composed of many small drivers that give the impression of a single image from one large driver. It further notes that an advantage to patches is that, when one moves across the control surface, the encoding is somewhat different, so movement can be sensed.

There's obviously much more to the hologram subject than discovered at this time. But judging from the recent spate of "hologram" applications, scientists and others are gaining increased knowledge of the subject, all to our advantage. The "sonic hologram" is an example of this.



# The Personal Computer Line by OHIO SCIENTIFIC

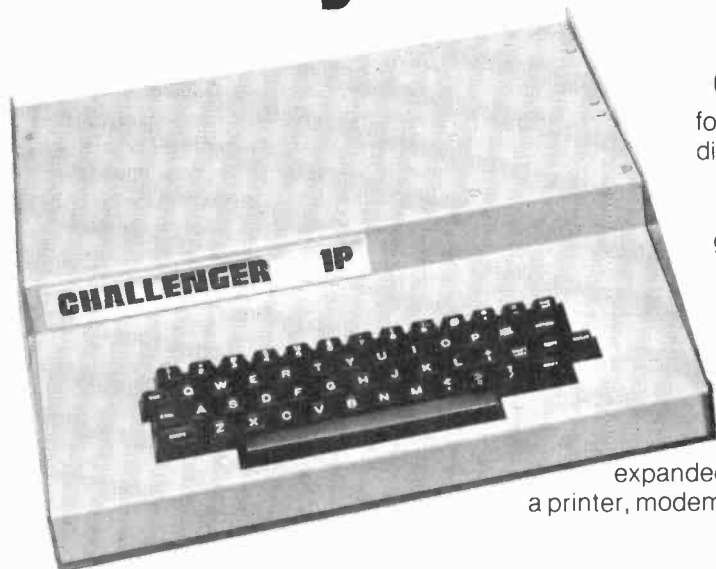

**C1P: \$349!** A dramatic breakthrough in price and performance. Features OSI's ultra-fast BASIC-in-ROM, full graphics display capability, and large library of software on cassette and disk, including entertainment programs, personal finance, small business, and home applications. It's a complete programmable computer system ready to go. Just plug-in a video monitor or TV through an RF converter, and be up and running. 15K total memory including 8K BASIC and 4K RAM — expandable to 8K.

**C1P MF: \$995!** First floppy disk based computer for under \$1000! Same great features as the C1P plus more memory and instant program and data retrieval. Can be expanded to 32K static RAM and a second mini-floppy. It also supports a printer, modem, real time clock, and AC remote interface, as well as OS-65D V3.0 development disk operating system.

**C2-4P: \$598!** The professional portable that has over 3-times the display capability of 1P's. Features 32 x 64 character display capability, graphics, full computer type keyboard, audio cassette port, and 4 slot BUS (only two used in base machine). It has 8K BASIC, 4K RAM, and can be expanded to 32K RAM, dual mini-floppies and a printer.

**C2-4P MF: \$1599!** It's a big personal computing mini-floppy system at a special package price. Contains the famous C2-4P microcomputer with 20K static RAM, 5" mini-floppy unit for instant program and data loading, RS-232 circuitry (for optional modem and printer), and four diskettes featuring exciting games, personal, business and education applications.

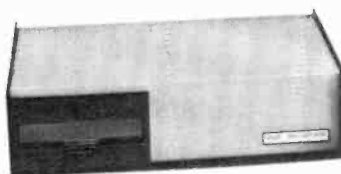

**C2-8P: \$799!** The personal class computer that can be expanded to a full business system. Has all the features of the C2-4P plus an 8 slot BUS (3-times greater expansion ability than the C2-4P). Can be expanded to 48K RAM, dual floppies, hard disk, printer and business software.

**C2-8P DF: \$2599!** A full business system available at a personal computer price! The system includes the powerful C2-8P microcomputer (32K RAM expandable to 48K), dual 8" floppy unit (stores 8-times as much information as a mini-floppy), and 3 disks of personal, educational and small business applications software. Has all the capabilities of a personal system including graphics plus the ability to perform Accounting, Information Management, and Word Processing tasks for small business. Contact your local Ohio Scientific dealer

All prices, suggested retail

## OHIO SCIENTIFIC

America's largest full-line microcomputer manufacturer  
1333 S. CHILLICOTHE RD., AURORA, OHIO 44202 (216) 562-3101

\* Monitors and cassette recorders not included. Ohio Scientific offers a combination TV/Monitor (AC-3P) for \$115.

CIRCLE NO. 43 ON FREE INFORMATION CARD



# Letters

## FILLING IN THE BLANKS

I enjoyed the Electra "Bearcat 250" Scanner Product Test Report in the February 1979

issue but wish to note two errors. The first is that frequencies can be selected in 5-kHz steps only in the 146-to-174-MHz band. Programming increments are 10 kHz in the 32-to-50-MHz band and 25 kHz in the 420-to-470- and 470.0125-to-512.0125-MHz bands. Error number two is that an external relay is *not* necessarily required for controlling a tape recorder if the recorder uses a grounded-shell microphone or an auxiliary input plug. Incidentally, the scanner's i-f is at 10.85 MHz. —R.G. Borde, Sunnyvale, CA.

## PHASE RESPONSE IS SIGNIFICANT

With reference to "Innovations in Speaker Design" (March 1979), at a propagation ve-

locity of 1134 feet per second, a 1-ms delay is not 6° of phase shift for a 1000-Hz frequency as claimed. It is almost an entire cycle (317.5°, to be precise). It is very easy to rig a demonstration in which phase response does not matter. It is equally easy to devise a demonstration in which frequency response, distortion, or noise does not matter. Once critical listeners—mixers, musicians, etc.—become familiar with complete record/reproduce channels that are phase compensated from microphone to loudspeaker, they adamantly refuse to go back. Their ears have been trained to respond to a new dimension of fidelity. This is the best proof of the significance of phase response I can think of. —Ted Uzzle, Cambridge, MA.

## ASSIST WAS HELPFUL

Thanks for "Operation Assist." I received five replies to my published request. Respondents were most helpful. —Pastor Petersen, Langford, SD.

## AM STEREO

We strongly object to "AM Stereo—Soon on the Air?" (December 1978) and particularly to the fact that the article was published without disclosing that author Joseph DeAngelo is an employee of the Broadcast Products Division of Harris Corporation, proponent of the Harris CPM AM stereo system.

In light of the pending FCC proceeding concerning AM stereo broadcasting, we would expect POPULAR ELECTRONICS to be interested in presenting technically accurate and impartial information to its readers regarding all five proposed AM stereo systems. For example, although the article presents the Harris System as being superior, the FCC (Oct. 1978 release) expressed concern with certain limitations (stereo coverage area and separation) that appear to be inherent characteristics of the Harris System. Also, ABC has publicly indicated support for the Kahn/Hazeltine AM Stereo System.—Edward A. Onders, Hazeltine Corp., Greenlawn, NY.

The author's company affiliation was inadvertently omitted. Sorry.—Ed.

# THE FUJI CHALLENGE

## Try the others. Then try ours.

When it comes to choosing the best tape, a minute of *listening* will tell you more than hours of specs. Because the best tape for *you* depends solely on the sound *you* like and the response of *your* deck.

At Fuji, we make the most advanced magnetic tape in the world—for video as well as audio. We'll match our specs against anyone else's, but we respectfully suggest you stop reading and start *listening*. Once you compare Fuji FX-I or II to any other premium tape, there's nothing more to say. We have confidence in your ears.

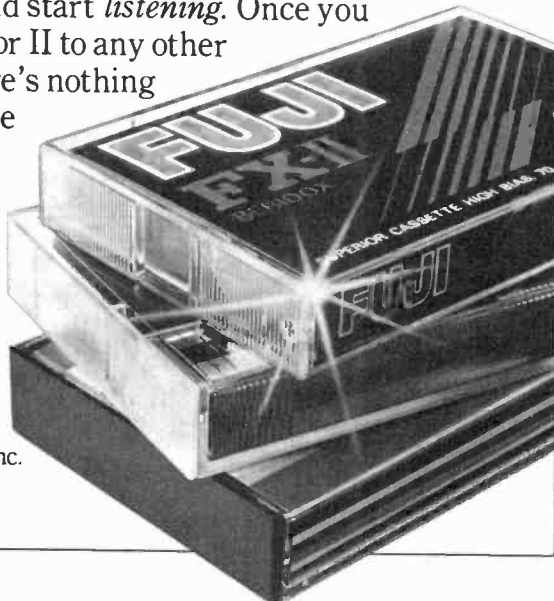

# FUJI

Magnetic Tape Division  
of Fuji Photo Film U.S.A., Inc.  
350 Fifth Avenue,  
New York, New York 10001

## Out of Tune

In the Audio Report on the Kenwood Model KT-917 FM Tuner (April 1979), in the sub-head in the third column, a typographical error gave the input figure as "200,000 microwatts" when it should have been "200,000 microvolts."

In "The Morse-A-Word, Part One: Theory and System Operation" (March 1979), in Fig. 2, there should be a pin 9 on IC5 connected to pin 6 of IC11. The foil pattern for the pc board, shown as Fig. 6 in Part Two of the article in the April issue, supplies the necessary connection.



# Burglar Alarm Breakthrough

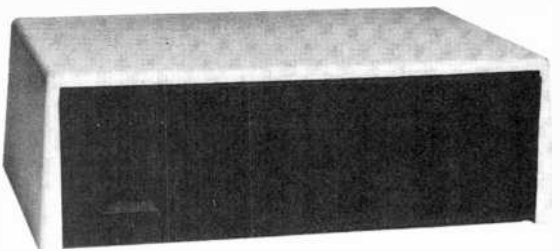

*A new computerized burglar alarm requires no installation and protects your home or business like a thousand dollar professional system.*

*The Midex security computer looks like a handsome stereo system component and measures only 4"x 10½"x 7."*

It's a security system computer. You can now protect everything—windows, doors, walls, ceilings and floors with a near fail-safe system so advanced that it doesn't require installation.

The Midex 55 is a new motion-sensing computer. Switch it on and you place a harmless invisible energy beam through more than 5,000 cubic feet in your home. Whenever this beam detects motion, it sends a signal to the computer which interprets the cause of the motion and triggers an extremely loud alarm.

The system's alarm is so loud that it can cause pain—loud enough to drive an intruder out of your home before anything is stolen or destroyed and loud enough to alert neighbors to call the police.

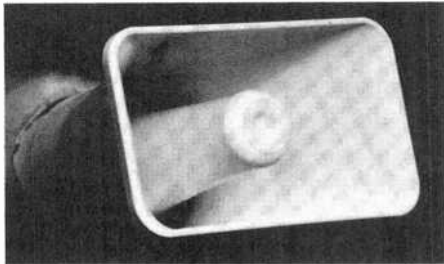

*The powerful optional blast horns can also be placed outside your home or office to warn your neighbors.*

Unlike the complex and expensive commercial alarms that require sensors wired into every door or window, the Midex requires no sensors nor any other additional equipment other than your stereo speakers or an optional pair of blast horns. Its beam actually penetrates walls to set up an electronic barrier against intrusion.

## NO MORE FALSE ALARMS

The Midex is not triggered by noise, sound, temperature or humidity—just motion—and since a computer interprets the nature of the motion, the chances of a false alarm are very remote.

An experienced burglar can disarm an expensive security system or break into a home or office through a wall. Using a Midex system there is no way a burglar can penetrate the protection beam without triggering the loud alarm. Even if the burglar cuts off your power, the four-hour rechargeable battery pack will keep your unit triggered, ready to sense motion and sound an alarm.

## ARRIVE HOME SAFE

There's personal danger in arriving home and finding a burglary in progress. And, if you surprise the burglar, you risk the chance of serious injury. With the Midex 55 protecting your home, you can open your front door with the confidence of knowing that no burglar lurks inside.

When the Midex senses an intruder, it remains silent for 20 seconds. It then sounds the alarm until the burglar leaves. One minute

after the burglar leaves, the alarm shuts off and resets, once again ready to do its job. This shut-off feature, not found on many expensive systems, means that your alarm won't go wailing all night long while you're away. When your neighbors hear it, they'll know positively that there's trouble.

## PROFESSIONAL SYSTEM

Midex is portable so it can be placed anywhere in your home. You simply connect it to your stereo speakers or attach the two optional blast horns.

Operating the Midex is as easy as its installation. To arm the unit, you remove a specially coded key. You now have 30 seconds to leave your premises. When you return, you enter and insert your key to disarm the unit. You have 20 seconds to do that. Each key is registered with Midex, and that number is kept in their vault should you ever need a duplicate. Three keys are supplied with each unit.

As an extra security measure, you can leave your unit on at night and place an optional panic button by your bed. But with all its optional features, the Midex system is complete, designed to protect you, your home and property just as it arrives in its well-protected carton.

The Midex 55 system is the latest electronic breakthrough by Solfan Systems, Inc.—a company that specializes in sophisticated professional security systems for banks and high security areas. JS&A first became acquainted with Midex after we were burglarized. At the time we owned an excellent security system, but the burglars went through a wall that could not have been protected by sensors. We then installed over \$5,000 worth of the Midex commercial equipment in our warehouse. When Solfan Systems announced their intentions to market their units to consumers, we immediately offered our services.

## COMPARED AGAINST OTHERS

**In a recent issue of a leading consumer publication, there was a complete article written on the tests given security devices which were purchased in New York. The Midex 55 is not available in New York stores, but had it been compared, it would have been rated tops in space protection and protection against false alarms—two of the top criteria used to evaluate these systems. Don't be confused. There is no system under \$1,000 that provides you with the same protection.**

## YOU JUDGE THE QUALITY

Will the Midex system ever fail? No product is perfect, but judge for yourself. All components used in the Midex system are of aerospace quality and of such high reliability that they pass the military standard 883 for thermal shock and burn-in. In short, they go through the same rugged tests and controls used on components in manned spaceships.

Each component is first tested at extreme

tolerances and then retested after assembly. The entire system is then put under full electrical loads at 150 degrees Fahrenheit for an entire week. If there is a defect, these tests will cause it to surface.

## PEOPLE LIKE THE SYSTEM

Wally Schirra, a scientist and former astronaut, says this about the Midex 55. "I know of no system that is as easy to use and provides such solid protection to the homeowner as the Midex. I would strongly recommend it to anyone. I am more than pleased with my unit."

Many more people can attest to the quality of this system, but the true test is how it performs in your home or office. That is why we provide a one month trial period. We give you the opportunity to see how fail-safe and easy to operate the Midex system is and how thoroughly it protects you and your loved ones.

Use the Midex for protection while you sleep and to protect your home while you're away or on vacation. Then after 30 days, if you're not convinced that the Midex is nearly fail-safe, easy to use, and can provide you with a security system that you can trust, return your unit and we'll be happy to send you a prompt and courteous refund. There is absolutely no obligation. JS&A has been serving the consumer for over a decade—further assurance that your investment is well protected.

To order your system, simply send your check in the amount of **\$199.95** (Illinois residents add 5% sales tax) to the address shown below. Credit card buyers may call our toll-free number below. There are no postage and handling charges. By return mail you will receive your system complete with all connections, easy to understand instructions and a one year limited warranty. If you do not have stereo speakers, you may order the optional blast horns at **\$39.95** each, and we recommend the purchase of two.

With the Midex 55, JS&A brings you: 1) A system built with such high quality that it complies with the same strict government standards used in the space program, 2) A system so advanced that it uses a computer to determine unauthorized entry, and 3) A way to buy the system, in complete confidence, without even being penalized for postage and handling charges if it's not exactly what you want. We couldn't provide you with a better opportunity to own a security system than right now.

Space-age technology has produced the ultimate personal security computer. Order your Midex 55 at no obligation, today.

**JS&A** PRODUCTS  
THAT  
THINK<sup>®</sup>

Dept. PE One JS&A Plaza  
Northbrook, Ill. 60062 (312) 564-7000  
Call TOLL-FREE ..... 800 323-6400  
In Illinois Call ..... (312) 564-7000

©JS&A Group, Inc., 1979

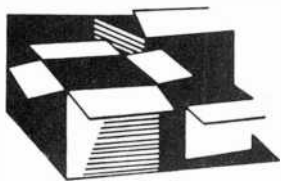

## New Products

Additional information on new products covered in this section is available from the manufacturers. Either circle the item's code number on the Free Information Card or write to the manufacturer at the address given.

### Polk Audio "Real-Time Array"

The "Real-Time Array Reference Monitor" Model R.T.A. 12 from Polk Audio claims, in addition to its frequency response of 27 to 20,500 Hz  $\pm 2$  dB, the ability to pass recog-

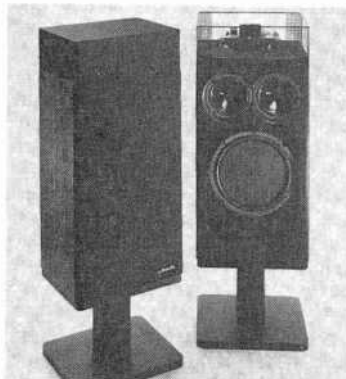

nizable square waves. Nominally rated at an impedance of 6 ohms, the system can be used with amplifiers in the range from 10 to 500 watts per channel and is said to produce a maximum sound pressure level of 120 dB with musical program material. The R.T.A. 12 uses a fourth-order electrical crossover between its two polymer laminate bass/midrange drivers and the one-inch soft-dome tweeter, and a fourth-order acoustic crossover between sub-woofer and bass/midrange drivers. \$350.

CIRCLE NO. 91 ON FREE INFORMATION CARD

### Antler Marine CB Antenna

Antler Antennas has introduced a new marine CB antenna to its line. The new "Sea-Sprite" antenna is a self-contained system that requires no ground plane. This allows the antenna to be used on fiberglass, wood, or metal boats, since the vessel is not part of the antenna system. The Sea-Sprite is a long-filament fiberglass stick. Its solid shaft is precision wound to provide ef-

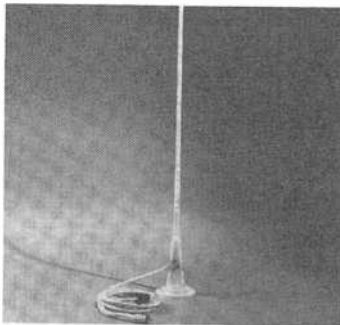

ficient SWR/r-f-gain characteristics and is sealed in a waterproof vinyl sheath. The molded base of the antenna hinges 180° to allow it to fold flat against the deck for out-of-the-way storage when not in use. For transmitting, the base snaps into a locked upright position. The antenna is provided with a factory-wired coaxial assembly. It is available in white, red, and black to accent or harmonize with boat colors. \$28.95.

CIRCLE NO. 92 ON FREE INFORMATION CARD

### Alphanumeric Dot Matrix Printer

American Micro Products has introduced two new 5 x 8 dot matrix printers to provide alphanumeric hard-copy computer printout. Both printers include a general specification manual, parts list, flow chart, and schematics describing the 8-bit paral-

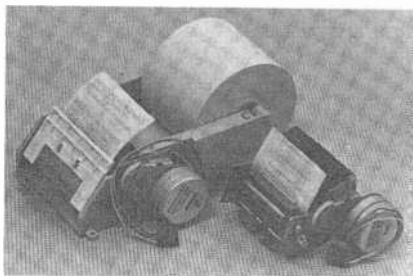

lel interface (Centronics type). The 12-column PL12 printer is \$59.95 and the 20-column PL20 is \$99.95. Optional micro-processor control chip and printed circuit board for the interface are \$99.95 and \$29.95, respectively. (The board is available for the PL20 only.)

CIRCLE NO. 93 ON FREE INFORMATION CARD

### Digital Wireless Security System

The Linear Corp.'s Model D-21 "Linear Alert" is a wireless security system in which a transmitter installed near a door or window and activated by any of a variety of sensor switches sends a coded digital radio signal to a receiver at a remote location. The receiver then activates an alarm.

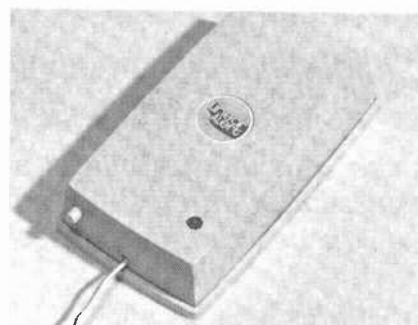

The code can be changed, with 256 possibilities, and the frequency can also be changed. Many different transmitters can be used near each other without interference. The solid-state transmitter circuit is powered by a 9-volt battery and draws 12 mA. Measures 4.8" x 2.6" x 1.1" (12.5 x 6.5 x 2.75 cm). Address: Linear Corp., 347 S. Glasgow Ave., Inglewood, CA 90301.

### Audio-Technica Moving-Coil Phono Cartridge

Audio-Technica's new Model AT30E moving-coil phono cartridge is said to overcome two traditional drawbacks commonly

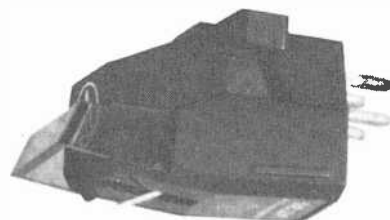

associated with such cartridges. First, it is relatively low in cost, retailing at a suggested price of only \$100. Secondly, it is one of the few moving-coil cartridges to feature a user-replaceable stylus. High compliance is claimed to offer unusually high tracking ability combined with moderate tracking forces for longer record life. Offered optionally is the Model AT630 transformer (\$95) that allows the cartridge to be matched to standard phono inputs.

CIRCLE NO. 94 ON FREE INFORMATION CARD

### OK Machine Digital Probe

OK Machine and Tool Corp.'s new PRB-1 digital logic probe is rated to detect pulses down to 10 ns and has a frequency range of 50 MHz. Automatic pulse stretching is to 50 ns (+ and -). It is compatible with RTL, DTL, HTL, TTL, MOS, CMOS and micro-

(Continued on page 10)



1101-546 pp.—How to Design & Build Your Own TV Games (\$14.95)



1035-434 p.—Instrumentation & Control Systems Engineering Handbook (\$19.95)

An Extraordinary Offer to introduce you to the benefits of Membership in

# ELECTRONICS BOOK CLUB

take any **6** of these 24 unique electronics books **\$1.99** for **ALL SIX** (values to \$95.70) for only **1**

with a Trial Membership in the Book Club that guarantees to save you 25% to 75% on a wide selection of electronics books



## Facts About Club Membership

- The 6 introductory books of your choice carry publisher's retail prices of up to \$97.70. They are yours for only \$1.99 for all 6 (plus postage/handling) with your Trial Membership.
- You will receive the Club News, describing the current Selection, Alternates, and other books, every 4 weeks (13x a year).
- If you want the Selection, do nothing; it will be sent to you automatically. If you do not wish to receive the Selection, or if you want to order one of the many Alternates offered, you simply give instructions on the reply form (and in the envelope) provided, and return it to us by the date specified. This date allows you at least 10 days in which to return the form. If, because of late mail delivery, you do not have 10 days to make a decision and so receive an unwanted Selection, you may return it at Club expense.
- To complete your Trial Membership, you need buy only four additional monthly Selections or Alternates during the next 12 months. You may cancel your Membership any time after you purchase these four books.
- All books—including the Introductory Offer—are fully returnable after 10 days if you're not completely satisfied.
- All books are offered at low Member prices, plus a small postage and handling charge.
- Continuing Bonus: If you continue after this Trial Membership, you will earn a Dividend Certificate for every book you purchase. Three Certificates, plus payment of the nominal sum of \$1.99, will entitle you to a valuable Book Dividend of your choice which you may choose from a list provided Members.

May we send you your choice of 6 of these practical time-and-money-saving books as part of an unusual offer of a Trial Membership in Electronics Book Club?

Here are quality hardbound volumes, each especially designed to help you increase your know-how, earning power, and enjoyment of electronics. Whatever your interest in electronics, you'll find Electronics Book Club offers practical, quality books that you can put to immediate use and benefit.

This extraordinary offer is intended to prove to you through your own experience, that these very real advantages can be yours...that it is possible to keep up with the literature published in your areas of interest, and to save substantially while so doing. As part of your Trial Membership, you need purchase as few as four books during the coming 12 months. You would probably buy at least this many anyway, without the substantial savings offered through Club Membership.

To start your Membership on these attractive terms, simply fill out and mail the coupon today. You will receive the 6 books of your choice for 10-day inspection. YOU NEED SEND NO MONEY. If you're not delighted, return the books within 10 days and your Trial Membership will be cancelled without cost or obligation.

ELECTRONICS BOOK CLUB, Blue Ridge Summit, Pa. 17214  
CIRCLE NO. 22 ON FREE INFORMATION CARD

## ELECTRONICS BOOK CLUB

Blue Ridge Summit, Pa. 17214

Please open my Trial Membership in ELECTRONICS BOOK CLUB and send me the 6 books circled below. I understand the cost of the books I have selected is only \$1.99 for all 6, plus a small shipping charge. If not delighted, I may return the books within 10 days and owe nothing, and have my Trial Membership cancelled. I agree to purchase at least four additional books during the next 12 months after which I may cancel my membership at any time.

101 295 300 582 806 931 966 1015  
1034 1035 1064 1071 1073 1076 1079 1082  
1088 1095 1097 1101 1108 1113 1111 1135

Name \_\_\_\_\_ Phone \_\_\_\_\_  
Address \_\_\_\_\_  
City \_\_\_\_\_  
State \_\_\_\_\_ Zip \_\_\_\_\_

(Valid for new Members only. Foreign and Canada add 10%.) PE-59

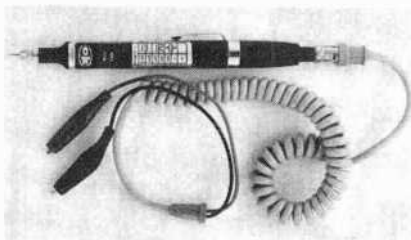

processor logic families, and also features 120,000-ohm impedance, power-lead reversal protection, and overvoltage protection to  $\pm 70$  volts dc. Its LEDs operate over a supply voltage range of 4 to 15 volts; an optional adapter can be used with supply voltages from 15 to 25 volts. Includes 6' coiled power cord and tip protector. \$36.95.

CIRCLE NO. 95 ON FREE INFORMATION CARD

## Apelco Marine Portable Radio

Apelco Marine Electronics' Model AF-6 is a six-channel, hand-held, battery-operated vhf radiotelephone designed for use



aboard small craft. It operates on eight penlight batteries or an optional nickel-cadmium power pack. Features include an internal telescoping antenna, an external antenna jack, and a meter for measuring transmitting voltage and signal strength. Comes with crystals for channels 6 and 16. Dimensions are  $8\frac{1}{2} \times 3\frac{1}{2} \times 1\frac{3}{4}$ " ( $22 \times 9 \times 4.5$  cm) and weight is 2 lb. \$299. Address: Apelco Marine Electronics, 676 Island Pond Rd., Manchester, NH 01303.

## Storm Scan Alarm System

The Storm Scan Alarm System (Cat. #72,456) from Edmund Scientific is said to detect the approach of severe thunderstorms and tornadoes associated with high electrical activity as far as 30 miles away. A "lightning lamp" indicates electrical discharges by emitting green flashes, while a

red burst lamp indicates intense electrical activity. It's claimed that advance warning of 20 minutes is given on an approaching storm. A meter also indicates storm intensity and triggers an audible alarm buzzer when the storm is near. The system measures  $3 \times 5 \times 7$ " ( $8 \times 13 \times 18$  cm), has a collapsible 18-inch antenna and weighs 3 lb. It operates from a 6-V battery. \$89.95.

CIRCLE NO. 96 ON FREE INFORMATION CARD

## Fujitsu Ten Car Speaker

The Model SSB-8G11 air-suspension speaker from Fujitsu Ten Corp. is designed for door installation. It has a detach-



able rain guard to shield it from internal moisture due to window leakage. The 4-inch, 8-ohm speaker is  $1\frac{1}{2}$  in. deep and each one is said to be capable of handling 20 Wrms. Features a cloth-rolled edge and wire-mesh grille. \$42.95 per pair.

CIRCLE NO. 97 ON FREE INFORMATION CARD

## Hand-Held 2-Meter Transceiver

Yaesu's Model FT-202R is a hand-held 2-meter transceiver that provides up to six channels (three supplied and three optional) for two-way communication. Frequency coverage is 144 to 148 MHz, and r-f output power is rated at 1 watt. The double-conversion receiver section's ratings include:  $0.32\mu\text{V}$  sensitivity for 20 dB of quieting; -60 dB or better spurious radiation;  $\pm 20$  kHz selectivity at -60 dB; 500 mW at 10% THD audio output. Features include: built-in speaker and condenser microphone; VOLUME, SQUELCH, and channel-selector controls; signal-strength/battery-condition meter. Power is from eight AA-size Ni-Cd or seven AA-size carbon-zinc cells (not supplied). Includes "Rubber Ducky" antenna and carrying case. Size is  $17.1 \times 67 \times 49$  cm, and weight is 400 g (about 14 oz). Address: Yaesu Electronics Corp., P.O. Box 498, Paramount, CA 90723.

## Technics SU-CO1 Preamp

Despite its minuscule dimensions of  $11\text{-}11/16$  by  $1\text{-}15/16$  by  $9/4$  inches, the Technics SU-CO1 control preamplifier boasts a solid complement of control features and a



head amp to accommodate moving-coil phono cartridges. Rated distortion for a 3-volt output is 0.005% worst case, and phono signal-to-noise ratios are 88 dB re 2.5 millivolts across 47,000 ohms for the moving-magnet section and 70 dB re 100 microvolts across 47 ohms for the moving-coil section. Phono equalization is said to be accurate within  $\pm 0.2$  dB. High-level S/N is rated at 100 dB. Similarly sized companion pieces are the SE-CO1 power amplifier and the ST-CO1 AM/FM stereo tuner. \$260.

CIRCLE NO. 98 ON FREE INFORMATION CARD

## Digital Instruments with 3/4-Inch Readout Line

Pope Scientific has introduced a line of three "Digi-King" instruments which feature  $3/4$ -inch digital readouts for reading at

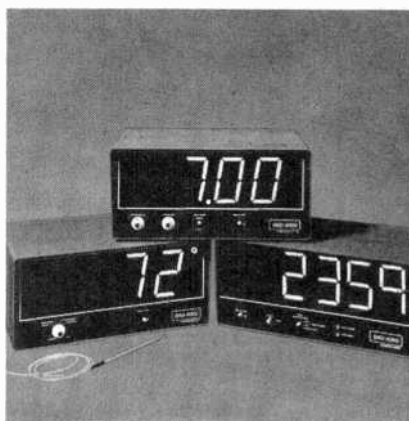

a distance. The first is actually a meter which will display any parameter capable of being expressed in millivolts from -1999 to +1999. The second is a thermometer which has a temperature sensor that can be used for surface, ambient, or immersion measurements and will display temperatures in Celsius, Kelvin, Fahrenheit or Rankine scales. It has an effective range of  $-55^{\circ}\text{C}$  to  $+150^{\circ}\text{C}$  ( $67^{\circ}\text{F}$  to  $302^{\circ}\text{F}$ ). The third instrument is a counter/

(Continued on page 12)



# Spend less. Test more.

**Integrated circuits are very private devices.** When something goes wrong, they just don't work. Which is tough enough when part or all of *one* IC goes bad. But often worse, because a single bad IC usually means a large, complex system that won't function properly.

Until now, you could spend a lot of money and time—and still only be guessing what was happening at any point in a logic system.



Logic Probe LP-1. Captures pulses as fast as 50 nanoseconds, to 10MHz. Latching memory. Bargain-priced at only \$44.95\*.

**CSC puts troubleshooting at your fingertips.** Now, there's a quicker, surer, less expensive way to get the information you need. CSC multi-family Logic Probes. Their LEDs light to show you at a glance the logic state at any point—and more. Catch fast pulses, even store them if you like. A flashing light signals pulse trains. And you can even approximate the duty cycle of asymmetrical waveforms.

**Nothing could be simpler.** No complex

settings, no sync, no wait. A switch selects the proper logic family. The probes derive their

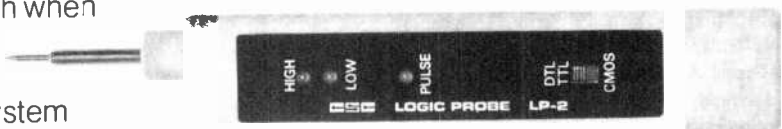

Logic Probe LP-2. All the basic features of LP-1, with pulses as fast as 300 nanoseconds, to 1.5MHz. Doesn't have LP-1's memory feature... but features even lower price: \$24.95\*!

power from the circuit under test. High input impedance prevents circuit loading. And all you do is touch the tip to any pin, pad or path for an instant picture of circuit conditions.

**Laboratory quality. Economy price.**

High speed. High precision. Even memory. CSC Logic Probes deliver all the performance you need for design, development, debugging and servicing. Making digital work less of a chore, more of a bargain. CSC for yourself!

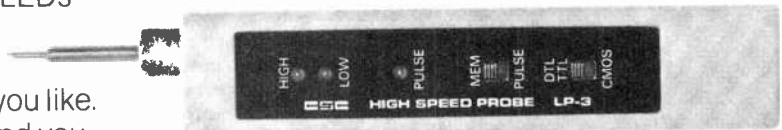

Logic Probe LP-3. Five times the speed of LP-1 at less than twice the price. Captures pulses as narrow as 10 nanoseconds, to over 50MHz. Latching memory. The new value standard, at \$69.95\*.

Call **1-800-243-6077** toll-free for details

CONTINENTAL SPECIALTIES CORPORATION



70 Fulton Terr., New Haven, CT 06509 (203) 624-3103, TWX 710-465-1227  
 OTHER OFFICES: San Francisco: (415) 421-8872, TWX 910-372-7992  
 Europe: CSC UK LTD. Phone Saffron-Walden 0799-21682, TLX 817477  
 Canada: Len Finkler Ltd., Ontario

\* Suggested U.S. resale. Available at selected local distributors. Prices, specifications subject to change without notice. © Copyright 1979 Continental Specialties Corporation

timer with a range of 2 million events or an elapsed time of 0.1 or 1.0 second increments. The Digi-King instruments are 14"W x 6"H x 9"D (36 x 15 x 25 cm). Address: Pope Scientific, Inc., Menomonee Falls, WI 53051.

## Pioneer Nonswitching Amplifier

Pioneer's Model SA-9800 integrated amplifier is built around new "Super-Linear RETs" (ring emitter transistors) in a non-switching design to reduce distortion. The amplifier is rated to deliver 100 W/channel continuously into 4 or 8 ohms from 10 to 20,000 Hz with no more than 0.005% THD. Frequency response is rated at 5 to 200,000 Hz +0/-2 dB, and S/N is 110, 90, and 72 dB through the AUX, moving-magnet, and moving-coil inputs, respectively. The amplifier features dual power supplies, full dc coupling, and a built-in head amplifier for moving-coil cartridges. Also featured is a fluorescent display that indicates peak power used (at 8 ohms) per channel in bar-graph form and indicates the program source selected; cartridge re-



sistive and capacitive load selection; subsonic and high filter switches; two-position turnover tone controls; attenuator-type volume control; and independent tape monitor and duplicate switches. \$750.

CIRCLE NO. 99 ON FREE INFORMATION CARD

## dbx Dynamic Range Expander

The new Model 2BX from dbx is designed to approach the performance of the 3BX at the top of the company's consumer expander line and shares some important features with that unit. Among them are the use of true rms detectors and voltage-controlled amplifiers. Operating in two bands

rather than the three bands of the 3BX, the 2BX alters its release time to suit the music and is said to maintain a stable stereo image. The model features two separate 10-LED displays for gain change indication. Harmonic distortion is rated at less than 0.1% at 1 kHz. Other specifications are: dynamic range, 110 dB; expansion, 1.0:1 to 1.5:1; frequency response, 20-20,000 Hz  $\pm$ 0.5 dB. \$450.

CIRCLE NO. 89 ON FREE INFORMATION CARD

## AP IC Test Clip Puller

The Super Grip II is a refined version of AP Products' basic IC test clip/puller. The new design features narrower nose clearance, which is claimed to permit easier attachment to ICs on densely packed boards. (ICs with as little as 0.04" between adjacent legs can be tested.) A new "duck bill" contour has been added to the contact tips to make secure contact on DIP pins. Offset pin rows are provided to attach test probes to the clip, and "button heads" on the ends of the pins prevent probes from slipping off. Super Grip II test clips are available in 8-, 14-, 16-, 16- (LSI), 18-, 20-, 22-, 24-, 28-, 36-, and 40-pin configurations.

CIRCLE NO. 100 ON FREE INFORMATION CARD

# Pair up for perfect reproduction

## With Osawa's Dynamic Duos

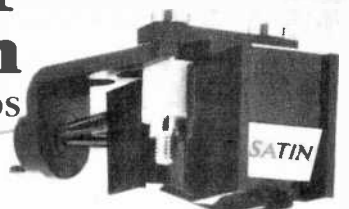
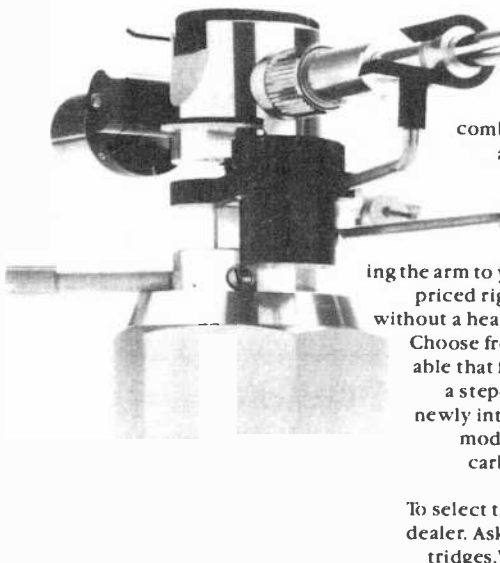

Advanced electronics are just not enough. For the most realistic music reproduction you need a high performance tonearm/cartridge combination to ensure smooth, wide frequency response and highly accurate tracking. The kind of top-quality performance that the Osawa duos deliver.

Start with the Ultracraft AC-300 MK-II tonearm that features adjustable oil damping. This eliminates resonances by fine tuning the arm to your cartridge. Then select the Osawa cartridge that's priced right for you. You can mount it directly on the tonearm without a headshell, thus reducing effective mass to the minimum. Choose from 6 Satin Moving Coil models, the only MCs available that feature user-replaceable stylus and that don't require a step-up transformer or pre-preamp. Or choose one of the newly introduced high-compliance Moving Permalloy (MP) models by Osawa. Top-of-the-line 300 MP offers a unique carbon-fiber cantilever that is extremely light weight yet extraordinarily strong.

To select the combination that's ideal for you, visit your Osawa dealer. Ask him for the Osawa "Consumer Guide to Phono Cartridges," and then get a complete demonstration. Whichever combination you select, the name Osawa assures you the ultimate in clean and faithful music reproduction.

OSAWA & CO. (USA) Inc./521 Fifth Avenue, New York, N.Y. 10017/Tel. (212) 687-5535-9/TELEX: 23-6593



# BEARCAT® SCANNERS ANNOUNCE AMERICA'S ONLY 50-CHANNEL, MICRO PROCESSOR CONTROLLED SCANNER. IT SEARCHES, STORES, REMEMBERS AND ALL BUT THINKS FOR YOU.

The new *Bearcat 250*.  
An unbelievable advancement  
in no-crystal scanning.

*Bearcat's* new, 250 is fully synthesized  
for punch-in programming. It searches,  
stores, and recalls every bit of programming,  
on a vast, 50-channel spectrum.  
Automatically.  
Unbelievable? Read and  
believe.



## CRYSTAL-LESS.

Micro processor controlled. Brings in every local frequency, automatically, without a crystal.

**50 CHANNELS.** Scans up to 50 channels in banks of 10 each. Scans any combination of banks at the touch of a button.

**SEARCH/STORE.** Seeks out and stores up to 64 active local public service frequencies automatically.

**SEARCH/RECALL.** Retrieves stored frequencies for simple entry into scan program.

**PRIORITY CHANNEL.** Samples a designated priority frequency on channel 1 every two seconds.

**DIGITAL CLOCK.** A genuine, LED quartz crystal digital clock. Shows hours, minutes, seconds.

**5-BAND COVERAGE.** Low, high, UHF, UHF-T. Plus 2 meter amateur ham band, and other UHF frequencies.

**COUNT.** Transmissions on each frequency counted automatically to determine which are most active.

**SCAN/SEARCH LOCKOUT.** A unique feature. Not only locks out channels while scanning, it also eliminates unwanted frequencies while searching.

## AND MUCH MORE!

Selective Scan Delay.  
Direct Channel Selection.  
Scan Speed Control.  
Automatic Squelch.  
Track Tuning Circuitry.  
Front-Mounted Speaker.  
Decimal Display.  
Quality Construction.  
AC/DC. UL listed. FCC Certified.

## THE INCREDIBLE, NEW BEARCAT® 250 SCANNER.

LEADING THE WAY TO REAL EXCITEMENT.

Copyright © 1978, Masco Corporation of Indiana  
CIRCLE NO. 21 ON FREE INFORMATION CARD

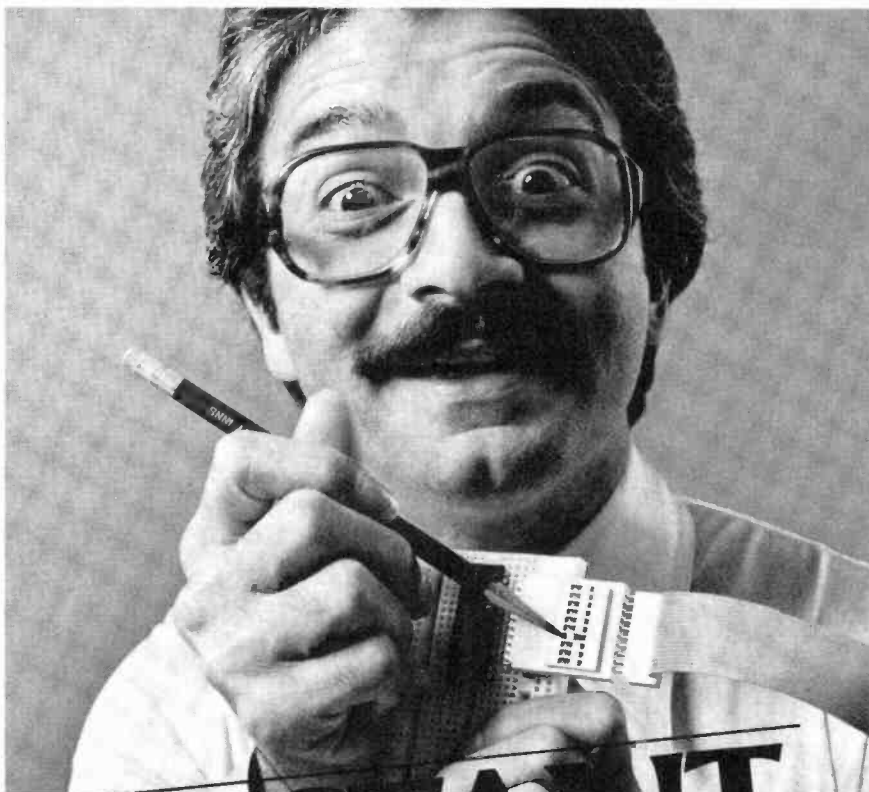

**INSTANT.**

**The way you check line-by-line with an A P Intra-Switch or Intra-Connector.**

You plug your Intra-Switch in-line with standard socket connectors, and instantly you've got a separate, independent on-off switch for each and every line in your flat ribbon cable. To switch, you nudge with a pencil point. It's that quick.

Imagine how much time and trouble Intra-Switch will save you in your diagnostic and quality testing, your programming and selective line inhibiting.

Or, plug in your Intra-Connector (see box) the same way, and you have an extra set of male contacts

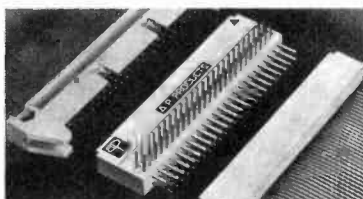

at right angles. Instant line-by-line probeability—and an easy way to tap your system and daisy chain it into new areas.

Both Intra-Connectors and Intra-Switches come in 20, 26, 34, 40 and 50-contact models.

Where? At your nearby A P dealer. Where's that? Phone (toll-free) 800-321-9668. And ask for the complete A P catalog, The Faster and Easier Book.

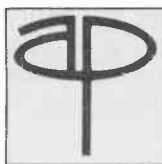

**A P PRODUCTS INCORPORATED**

Box 110A • 72 Corwin Drive  
Painesville, Ohio 44077  
Tel. 216/354-2101  
TWX: 810-425-2250

**Faster and Easier is what we're all about.**

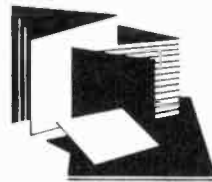

**New Literature**

**DU PONT CROLYN TECHNICAL BULLETIN**

Results of a headlife test program comparing Du Pont "Crolyn" chromium-dioxide videotape and competitive cobalt-doped iron-oxide videotape on 3/4" U-matic video recorders are available in a technical bulletin from the Du Pont Company. According to the bulletin, both chromium-dioxide and cobalt-doped iron-oxide tapes offered 4000 hours of headlife without picture deterioration. However, chromium-dioxide tape demonstrated an average of 2 decibels superiority in video signal-to-noise ratio. Address Du Pont Co., Magnetic Products Div., Photo Products Dept., Wilmington, DE 19898.

**MICRO SWITCH SENSING AND COMPUTER GLOSSARY**

Most of the high-level language of electronics (from bits, bytes, chips, and other little things to the "or" generation—sensor, semiconductor, monitor, editor, etc.) are defined in Micro Switch's "Glossary of Solid State Sensing and Computer Terminology." It also includes many of the acronyms commonly encountered, such as, MOS, ROM, COBOL, FET, FORTRAN, etc. Address: Micro Switch, Div. of Honeywell, 11 W. Spring St., Freeport, IL 61032.

**HEATH/SCHLUMBERGER INSTRUMENT CATALOG**

A catalog from Heath/Schlumberger features its new line of fully assembled and tested computers and peripherals and gives complete description and specifications for its electronic test instruments including oscilloscopes, laboratory-grade strip and X-Y recorders, power supplies, counters, multimeters, etc. The catalog also contains a complete listing of Heath/Schlumberger Continuing Education Programs for industrial training including ac and dc electronics, semiconductor devices, digital techniques, microprocessors, etc. Address: Heath/Schlumberger, Dept. 570-030, Benton Harbor, MI 49022.

**SHAKESPEARE CB ANTENNA BROCHURE**

A 4-page Directional Beam CB Antenna Brochure describes beam antennas and includes line drawings and vertical polarization radiation patterns. The group of antennas have fiberglass elements and boom. Address: Shakespeare Company, Electronics & Fiberglass Division, P.O. Box 246, Columbia, SC 29202.



# Clear Mosquitoes From a Third of an Acre\* or More With Patio Protector™

Discovered by the U.S.  
Department of Agriculture,  
perfected by Pestolite™ it  
actually draws over 300 different  
insects away from where you stay!



Patio Protector takes the best time of day away from the insects and gives it to you and your family to enjoy. It makes outdoor living and entertaining bug-free, buzz-free and bite-free!

## A Lure Like A Magnet

The government discovered it. A lure like a magnet. Irresistible to mosquitoes, flies, moths, gnats, wasps and beetles. Over 300 annoying flying insects in all.

This discovery, by the U.S. Dept. of Agriculture at its field laboratory in Gainesville, Fla., was as timely as it was extraordinary. Because we also learned about the dangers of D.D.T. just about then.

Naturally, this discovery was public property. But there were problems that remained to be solved. What the U.S.D.A. had proved, beyond doubt, was the fact that light sensitive, phototropic, insects would always respond to a particular kind of ultraviolet light. More, that the lure of the light extended far beyond the supposed ability of these insects to see. At the very minimum, one light could control an area as large as 1/3rd of an acre—14,250 square feet!

## Foolproof, Safe, Silent

The light attracted. But it didn't kill the insects. This is where Pestolite stepped in and created a simple, totally foolproof, completely safe and silent way to get rid of every bug attracted to the light. Without chemicals, electricity or polluting the environment.

Patio Protector can't harm your children or your pets. It only kills bugs. And so effectively it's approved by the Environmental Protection Agency, recognized by the Food & Drug Administration as well as the USDA even for use where food is packaged, in hospitals and commercial kitchens.

## Low, Low Cost

Pestolite's achievement is notable in other extremely important ways. The other companies that used this discovery came up with bug killers that are no more effective; in fact,

\*This is the area officially accepted as effective by the State of California! It signifies the tested and proved minimum insect control you can achieve under virtually any circumstances.

ignore the peskiest ones and electrocute the other insects with a popping sizzling sound. And their units sell for \$125.00 and \$150.00 more!

## Mosquitoes Come Out As the Sun Goes Down

So, with Patio Protector you get the best as well as the least expensive model by far. In the late afternoon or early evening you'll be able to relax in the shade, linger over your barbecue, stay by the pool, play tennis while it's cool—without being bothered by mosquitoes. Even after it rains you can forget about sprays, throw away those smelly citronella candles.

And you'll be able to stay outside as late as you like. Imagine watching TV, playing cards, sitting and talking, even reading or relaxing in a hammock as you enjoy the evening breeze. Yes, for the first time ever, you can spend summer evenings outside instead of cooped up in an air conditioned room or hiding behind screened doors and windows.

## Operating Procedure

Patio protector mounts in minutes, virtually anywhere. On a tree, any kind of fence, the side of your house, even a brick wall. Set it up about 25 feet from where you generally stay. Fifty feet may be even better. Then plug it in. Ordinary house current is all that's needed, though you may have to use an extension cord. The operating cost is less than 30 cents a month.

The ultraviolet light, with the exact frequency for maximum effectiveness, is produced by a unique, fluorescent-type bulb constructed of special glass and housed in scintillating reflectors. Often called "black light" because it's invisible to the human eye, it seems to compel the insects to come ever closer. Actually capturing them because they can't—or won't—fly away.

Just why it works no one knows. Not the scientists who discovered it, not the entomologists who tested and confirmed the phenomena. They do suspect, however, that the light's effectiveness is somehow connected with the constant early evening and night time propagation activity (sex) of these insects.

## The End Of Them

Captured, unable to escape or fly away, the mosquitoes, moths, gnats and other insects are caught in a down-draft (created by a small electric fan) and plunged into the water in the pan below where they're drowned. All you do is change the water about once a week, emptying the tray in the bushes where the birds eat all the bugs. It's a clean, simple, seconds-a-week procedure.

## CALL 800-621-5554

(In Illinois, call 800-972-5858)

These lines in operation 7 days a week

You can have the Patio Protector not for \$199.95 or \$160.00, but for just \$45.00, plus \$3.95 shipping and handling.

Moreover, because you can't get the Patio Protector in any store, we'll send it to you to try without risk or obligation for 15 days. It does what the government says, what we promise, or return it to us for a complete refund.

Credit card holders may call the toll free number above. Or you can send your check made out to Douglas Dunhill to the address below. (Illinois residents include 5% sales tax.)

Designed to stand up to all kinds of weather, to provide years of trouble-free service, Patio Protector is covered by an unconditional one-year warranty. The special UV bulb will be replaced free if it fails for any reason—except negligent damage—within 6 months.

Order your Patio Protector today. It is a bargain at the price, but the pleasure of bug-free, bite-free summers around the house is priceless.

## Douglas Dunhill

INC. AFFORDABLE QUALITY

Dept. 75-2344  
Ten Douglas Dunhill Dr., Oak Forest, IL 60452

© Douglas Dunhill Inc. 1979

CIRCLE NO. 18 ON FREE INFORMATION CARD

# **New from NRI!** **25" color TV that tunes** DIAGONAL **by computer, programs** **an entire evening's** **entertainment.**

Just part of NRI's training in servicing TV, stereo systems, video tape and disc players, car and portable radios.

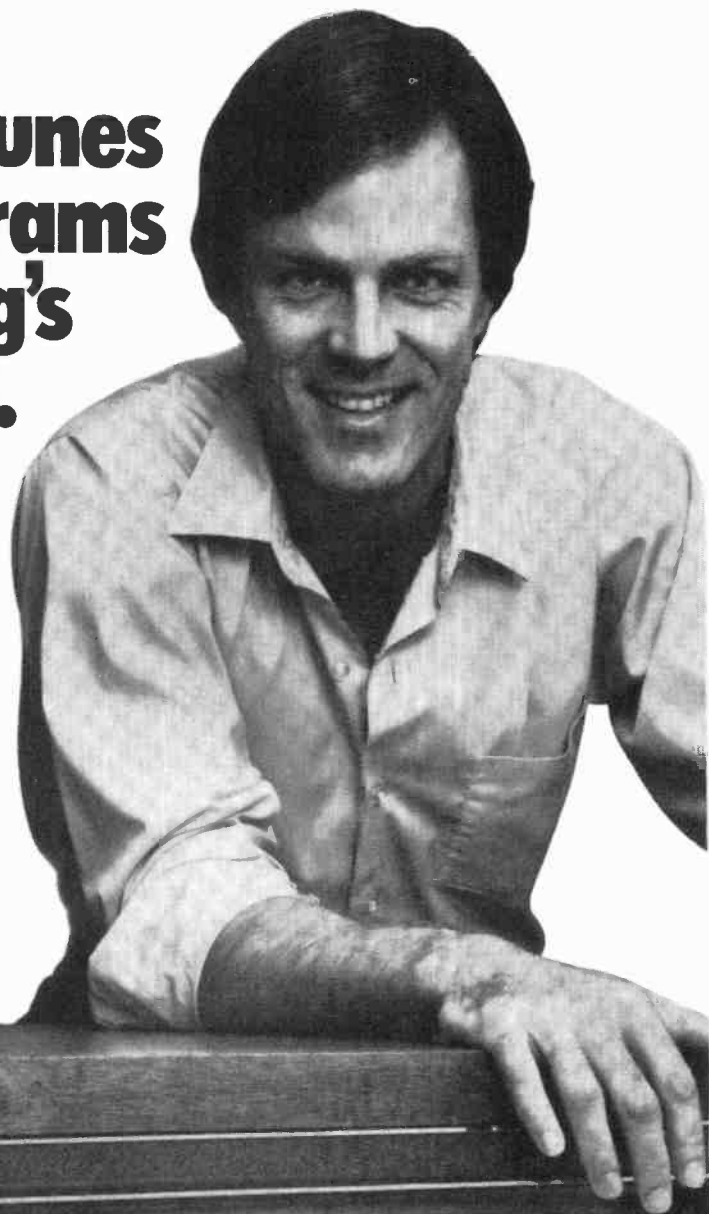

Only NRI home training prepares you so thoroughly for the next great leap forward in TV and audio... digital systems. Already, top-of-the-line TV's feature digital tuning, computer programming is appearing, and new digital audio recording equipment is about to go on the market.

NRI is the only home study school to give you the actual "hands-on" training you need to handle servicing problems on tomorrow's electronic equipment. Because only NRI includes this designed-for-learning, 25" diagonal color TV with electronic tuning, built-in digital clock, and computer programmer as part of your training. With this advanced feature, you can pre-program an entire evening's entertainment... even key lock it in to control children's viewing.

As you assemble it, you learn how digital tuning systems work, how to adjust and service them. You work with the same advanced features used in the new programmable TV's and video tape recorders. It's exclusive NRI training that keeps you up with the leading edge of technology.

**Exclusive Designed-for-learning Concept**

The color TV you build as part of NRI's Master Course looks, operates, and performs like the very finest commercial sets. But behind that pretty picture is a unique designed-for-learning chassis...



the only such unit in the world. Rather than retrofit lessons to a hobby kit or an already-built commercial set, NRI instructor/engineers have designed this television so each step of construction is a learning experience.

As you build it, you perform meaningful experiments. You see what makes each circuit work, what it does, how it interacts with other circuits. You even introduce defects, troubleshoot and correct them as you would in actual practice. And you end up with a magnificent, big-picture TV with advanced features. One you can sell or use in your home.

**Also Build Stereo, Test Instruments**

That's just a start. You demonstrate basic principles and circuits on the unique NRI Discovery Lab<sup>®</sup> then apply them as you assemble a fine AM/FM stereo receiver, complete with speakers. You also get practical experience as you build your own test instruments, including a 5" triggered sweep oscilloscope, CMOS digital frequency counter, color bar generator, and transistorized volt-ohm meter. Use them for learning, use them for earning as a full- or part-time TV, audio, and video systems technician.

**Complete, Effective Training Includes Video Systems**

Using NRI's exclusive methods, you learn far more than TV servicing. You'll be prepared to work with stereo systems, car radios, record and tape players, transistor radios, short-wave receivers, PA systems, musical instrument amplifiers, electronic TV games, even video tape recorders and tape or disc

video players. Your training covers just about every kind of electronic entertainment equipment available now or in the near future.

And because NRI has unmatched experience gained in over 60 years and a million students worth of training, your course is designed for ease of learning and practical utility. You need no previous experience of any kind. Starting with the basics, exclusive "bite-size" lessons cover subjects thoroughly, clearly, and concisely. "Hands-on" experiments reinforce theory for better comprehension and retention. And your personal NRI instructor is always available for consultation, ready with explanations, answers, and advice.

**Send for Free Detailed Catalog... No Salesman Will Call**

Get all the facts on this exciting course and its potential for you by mailing the postage-paid card today. Our free 100-page catalog includes color photos of all kits and equipment, complete lesson plans, convenient time payment plans, and information on other electronics courses. You'll also find out about NRI's new Computer Technology Course that includes your personal



microcomputer. Or Complete Communications with 2-meter transceiver that gets you ready for opportunities in broadcasting, 2-way radio, microwave, and other growing fields. If card has been removed, write to:



**NRI Schools**  
McGraw-Hill Continuing  
Education Center  
3939 Wisconsin Ave.  
Washington, D.C. 20016

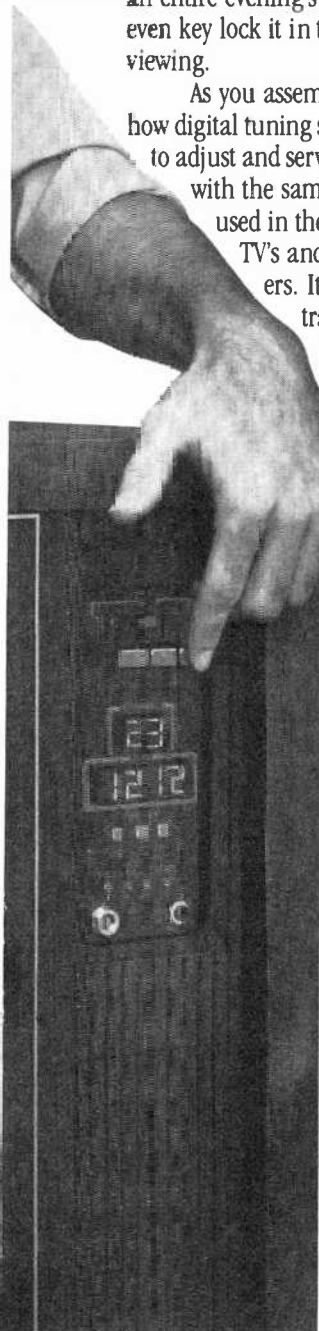

**"Overall amplifier performance rating: excellent.  
Sound quality: superb." Len Feldman\***



Len Feldman

## The Sansui AU-717 DC integrated amplifier.

When Len Feldman tested the Sansui AU-717 for Radio-Electronics a year ago, he concentrated primarily on its traditional, steady-state performance measurements. Power output capability. Total harmonic distortion. RIAA phono equalization accuracy. Signal-to-noise ratio. Usual tests, though applied to an unusual amplifier. Here's some of what he said:

"One clear advantage of DC design is apparent. Even at the low 20Hz extreme, the amplifier delivers a full 92 watts — the same value obtained for mid-frequency power — compared with its 85-watt rating into 8 ohms...

"The equalization characteristic of the pre-amplifier was one of the most precise we have ever measured, with the deviation from the standard RIAA playback curve never exceeding more than 0.1dB... The 380-mV overload figure for phono is far greater than would ever be required using even the highest output magnetic cartridges available."

At the time, dynamic response measurements — such as slew rate, rise time, and Transient Inter-Modulation distortion (TIM) — were still in their infancy. Indeed, even now, engineers have not yet fully agreed on a standard method of measuring TIM, though its audible effects have been increasingly recognized. Mr. Feldman sensed this when he commented: "Sansui claims that this unit has reduced transient intermodulation distortion...and, indeed, the model AU-717 delivered sound as transparent and clean as any we have

heard from an integrated amplifier..."

The fact is that while conventional amps are designed to reproduce sine-wave test signals — which have a smoothly-changing, endlessly repeating character — with negligible THD, they usually do so at the cost of increased TIM. The excessive negative feedback used to reduce steady-state distortion to the vanishing point can (and usually does) reduce the ability of the amplifier to respond fully to the dynamic, rapidly-changing, pulsive signals which are the music itself. Thus, you get the harsh, metallic sound of TIM.

That's why Sansui has not only led the way in DC amplifier design (circuits whose low-frequency response extends down to zero Hz), but has also concentrated on the high slew rate, fast rise time designs needed for the faithful reproduction of music, not just simple test signals. Slew rate is a high 60V/ $\mu$ Sec; rise time a fast 1.4 $\mu$ Sec. And the frequency response of the power amp of the AU-717 extends to a full 200,000Hz.

Visit your authorized Sansui dealer. You'll hear the difference Len Feldman heard, and you'll understand why the Sansui AU-717 is about the most popular integrated amplifier available today.

### SANSUI ELECTRONICS CORP.

Lynchurst, New Jersey 07071 • Gardena, Ca. 90247  
Sansui Electric Co., Ltd., Tokyo, Japan  
Sansui Audio Europe S.A., Antwerp, Belgium  
In Canada: Electronic Distributors

\*Reprinted in part from Len Feldman's test report in  
RADIO-ELECTRONICS, January, 1978.

CIRCLE NO. 52 ON FREE INFORMATION CARD

*Sansui*



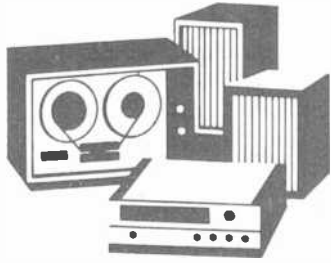

# Stereo Scene

By Ralph Hodges

## AUDIO'S WINTER WONDERLAND

**T**HERE WERE claims that it was the biggest winter Consumer Electronics Show ever. Certainly it kept the city of Las Vegas spinning, as purveyors of transportation, lodging, and food tried to keep up with the traffic; and it seemed there wasn't a place in town where you could go to get away from it.

Still, actual new product introductions were not as numerous as is customary at the June CES in Chicago. For example, I counted only about 20 new receivers actually seen for the very first time—a substantial quantity to be sure, but not up to Chicago standards. (This may reflect the seasonal nature of the receiver market; receivers sell well at Christmastime, and the June show anticipates Christmas. Purchases of separates are much less seasonal.) Tandberg actually announced discontinued production on several receivers, retaining only the two top-of-line models.

Moreover, many of the receiver introductions were unexceptional mid-line models. Prominent among the standouts was the Bose "Spatial Control Receiver," designed specifically to interface with the later series of the manufacturer's 901 loudspeakers. The receiver employs four power-amplifier sections. Each of these drives one of the angled rear-panel driver arrays of the 901 systems. By varying the equalization applied to the two pairs of amplifiers, the stereo image can be broadened or narrowed. For use with other loudspeakers, the variable equalization feature can be disabled and the two pairs of amplifiers bridged for conventional stereo.

Other receivers of note included five new models from Nikko, headed by the 100-watt-per-channel NR-1219, an \$800 125-watt unit (Model SA-5901) from Optonica, and an extension of the G-series Sansui receivers down to price levels of \$320 and \$270. Toshiba's recently introduced SA-7150 is the company's flagship model, with built-in Dolby noise reduction and phase-locked-loop frequency-synthesized tun-

ing for both FM and AM. Rotel created a small sensation with the \$310 RV-555, a diminutive "mini-system" with two small speakers and a vertically oriented receiver, all three in matched cabinets of virtually identical size. And Synergistics, like Bose best known for its loudspeakers, presented two new receivers.

### Progress on the Metal Muddle?

This was to be the show that revealed the first widespread commitments to the technology of metal-particle tape, and it probably fulfilled its promise, all things considered. By this time most of the major tape manufacturers have responded to questions on their capability and willingness to produce metal tape with a guarded affirmative. In Las Vegas, however, several of them followed the lead of 3M (which initiated the metal furor last year with its emergent Metafine product) and stood up to be officially counted as active supporters. At a pre-show press conference, Fuji announced full-production readiness, and privileged eyes were even allowed to gaze upon the first metal-particle TDK tapes seen publicly in the U.S. 3M freely distributed samples of blank Metafine cassettes to all of us who asked directly, so that we could go crazy trying to record them. And Nakamichi gave out prerecorded metal cassettes bearing its own brand name, so that we could go crazy trying to erase them.

Still, the metal muddle goes on. Most manufacturers of software and hardware would prefer not to take a final step into production until they see some rationalized standards. And standards, except for the *de facto* or "emerging consensus" variety, are not yet with us. "We're demonstrating the potential of the technology, not the final product," is what most of the hardware manufacturers showing metal-ready machines have been saying. But what, in terms of the show, have they been *doing*?

By 3M's count, 16 manufacturers, all but one of which are major market forces here, showed metal-ready cas-

sette decks at last October's Japan Audio Fair. It's interesting to note that well under half of these concerns openly displayed their machines in Las Vegas. (At least one brought his machine but kept it under close wraps in the back room. Another, Marantz, quietly pointed out metal-tape compatibility in one of its machines at last June's CES, but has remained pretty quiet about it ever since.) On the other hand, Las Vegas picked up three new metal-ready exhibitors: Nakamichi (Models 581 and 582), Eumig (Model FL-1000), and B.I.C. (Model T-4, which is the deluxe edition of this company's two-speed cassette decks, able to operate at 1 $\frac{1}{4}$  or 3 $\frac{3}{4}$  ips. In addition, B.I.C. demonstrated an under-dash two-speed car cassette player, the C1, which can handily play any tape the T-4 can record.) Also, Teac announced a retrofit program for the C-1 deck that will prepare it for metal at a cost of \$150. Contact your nearest Teac service facility for more information.

Add to the above the shown-in-Japan Aiwa AD-6700, JVC KD-A8, Lux K-12 and 5K50, Onkyo TA-2080, Sanyo RD5372 and RD5370, and the Technics RS-M95, and we have a substantial turnout. This is not to mention the Tandberg cassette and open-reel machines that were the first to announce readiness for metal-particle tape last year. (I have heard no other announcements for metal-ready open-reel decks—a pity, because the mid- and low-frequency capabilities of metal-particle tape would seem capable of improving the open-reel format substantially.) It would be rash to list projected prices for these recorders, even when available, because they are perforce still prototypes. Suffice it to say that they are virtually all three-head machines sporting all the deluxe features the industry can offer; even the least of them will therefore be expensive. The two Nakamichi models are particularly interesting, not only for their asymmetrically balanced transports (intended to prevent additive effects of resonant modes), but also for the little mechanism that unceremoniously shoves the cassette's pressure pad out of the way when the transports are engaged. In a characteristically bold move, Nakamichi has decided that cassette pressure pads do more harm than good when precision tape guidance is desired. It will be interesting to see how the rest of the industry reacts.

**May the Power Be With You.** If you are a trend follower, there is a chance

the power won't be with you, because the hottest thing in Japan today seems to be teeny-tiny amplifiers, tuners, cassette decks, and speaker systems ("micro" or "mini" components) that, in the power-amplifier category, run out of breath at not much above 40 watts per channel maximum. Many of these units are so "mini" that their front panels can be shown full-size in a magazine such as this. The rationales behind these products seem to be various: cosmetic appeal (particularly for the so-called women's market); scaling down to fit diminished living spaces; a dramatic demonstration of today's electronics miniaturization; and perhaps a sudden shrewd realization that super audiophiles have been happily buying and using power amplifiers with minuscule power outputs because they believe in them for other reasons.

Last year Mitsubishi led the way with some charmingly colorful and ingeniously crafted little gems of this genre; now Technics and Toshiba are hard on their heels, with many more companies to follow if these icebreakers can warm up the market. Note that these products are not direct outgrowths of the low-silhouette rack-mounting components widely seen of late. The low, wide configuration permits open assembly on a single master circuit board, which eases production. The mini components bear the approximate dimensions and proportions of a college dictionary, and many of them are rather crammed and complex inside. The preamplifiers and tuners are undoubtedly state-of-the-art, or very close to it; the power amplifiers are still small in every sense of the word, despite the occasional use of switching power supplies.

Elsewhere in amplifiers, the show offered engineering philosophies aplenty. U.S. Pioneer is firmly attached to its "nonswitching" amplifier configuration and brought three integrated-amplifier examples along: the SA-9800 (100 watts, \$750), SA-8800 (80 watts, \$550), and the SA-7800 (65 watts, \$450). Kenwood espouses high speed, and its new trio of integrateds (KA-907, 150 watts; KA-801, 110 watts; and KA-701, 80 watts) have prices between \$1,000 and \$450. The latest Sansui integrated amplifier, the AU-X1, also emphasizes speed; and at an output of 160 watts per channel and a slew rate of 260 volts per micro-second, it edges out the best of the Kenwoods by 10 watts and 30 micro-seconds. It also costs \$450 more. Incidentally, the technologies employed in

all these designs are complex, deserving of more expanded coverage than space permits here. The same is true of these manufacturers' latest tuners.

Manufacturers too numerous to mention, using the principle of floating bias point, are operating their output stages in class A at low levels and class AB at higher ones. Representative transition points are 5 watts (Rotel RB-2000) to 17.5 watts (Monogram 3100, 3200, and 3300). The latest Sony power amplifier, Model TA-N86B, makes no automated class transition. You can switch it to operate in class A for a maximum 18 watts out, class AB for 80 watts out, or bridged mono for 200 watts. Crown is more concerned with well-behaved protective circuits than exotic output stages, and much of the design effort for the new Model SA2 went into circuitry that closely monitors the operational state of the output transistors, limiting output only when safety is a factor.

Audionics and Infinity have meanwhile been thinking hard about driver stages rather than output stages. The answer they've both fastened upon—Audionics in the BA150 seen in prototype form last year and Infinity in the Hybrid Class A just being introduced—is vacuum tubes. Infinity's output stage uses transistors, and claims 150 watts per channel from a class-A configuration. Audionics gets the same output from a floating-bias vacuum-tube stage that is regulated by digital logic circuitry. Should you wish to go with tubes all the way, you no longer need turn to Audio Research or the other specialized companies. Word around the Show had it that Marantz intends to revive its classic Model 9 power amplifier and Model 7 preamplifier in kit form! These reports came to me a little late to check out, but even if there's some leg-pulling involved, the projected prices — \$1,000+ — might just persuade Marantz to sell you the necessary makings on special order. There was also a rumor that Marantz will offer a kit vacuum-tube tuner. If this turns out to be a revival of the justly legendary Marantz 10B, you are likely to have your kit-building and r-f-alignment skills taxed to the utmost.

Finally we come to one of the show highlights: the potential reconciliation of the mini-component phenomenon and the high-power trend. Carver Corporation's M-400 "Magnetic Field Amplifier" is rated at better than 200 watts per channel with more than acceptably low levels of noise and distortion. When it is understood that this performance is got-

ten out of a basically unadorned cube 6¾ inches per side, with no sign of a heat sink, and with a weight of about 12 pounds, it gives one pause.

After scrutiny of a rough block schematic and a conversation or two with the designer (who was secretive at the time because of pending patents), I propose that the magnetic-field amplifier works like this. Power enters from the wall socket, encounters heavy-duty devices that switch it to an appropriately high ultrasonic frequency, and then subjects it to push-pull amplitude modulation by the incoming audio signal. Then, and only then, does it run up against any sort of power transformer, which in this case is diminutive compared with those devices that must handle high currents at 60 Hz. The output of the transformer, stripped of its ultrasonic carrier, is perfectly capable of driving loudspeakers directly, although distortion would rise to undesirable levels at higher frequencies if it were done this way. This problem is solved in a manner yet unclear, and the amplifier, from all indications, proceeds to work. Intended asking price: approximately \$300.

Among other innovations from Carver Corp. is the "Sonic Hologram Generator" preamplifier, which incorporates in one unit all the heralded innovations that its designer has brought to signal processing over the years, plus a "hologram generator," which processes a stereo signal (at least it has no effect on a mono signal) in a way that was empirically derived, according to Bob Carver. I am told that a report on a prototype of this product will appear elsewhere in this issue, so I'll refrain from comment here. But after an extended listening session with program material of my choice, I found much that sounded attractive and nothing wrong that I'd care to stake my typewriter on verifying.

**The Last Gasp.** As this column comes breathlessly to a halt, apologies must be made for all that has been left out. Record players at the show appeared to be getting cheaper and in many cases better; moving-coil phono cartridges continue to prosper and proliferate; tape machines of all formats are, or can be made, more and more suited to the tapes you can actually buy today; loudspeakers, as usual, remain unknown quantities until they can be auditioned at length in congenial surroundings; and what is happening to high fidelity in automobiles is hardly to be believed. But we will save this for later. ◇

# YOURS FREE

Everything that's New and Exciting  
in Electronics...All in the  
NEW, Hot-Off-The Press

## HEATHKIT® CATALOG

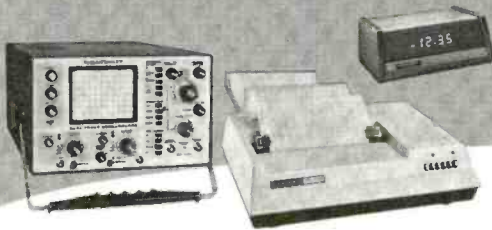

Read about nearly 400 exciting do-it-yourself kits including Amateur Radio Equipment, Personal Computers, Home Improvement Products, Stereo Hi-Fi, Programmable Color TV, Automotive, Aircraft and Marine Accessories, Test Instruments, R/C Modeling, Self-Improvement Programs and lots more! Something for everyone, and everything is easy to build and fun to use — it's the Heathkit way!



Send for your  
**FREE**  
Catalog today!

Heathkit products are displayed, sold and serviced coast-to-coast at Heathkit Electronic Centers. (Units of Schlumberger Products Corporation). See the white pages of your phone book. If coupon is missing, write Heath Company, Dept. 010-530, Benton Harbor, Michigan 49022.



HEATH	
<b>Schlumberger</b>	Heath Company, Dept. 010-530 Benton Harbor, Michigan 49022
Please send me my FREE Heathkit Catalog. I am not currently receiving your catalog.	
Name _____	
Address _____	
City _____	State _____
CL-694	Zip _____

**FREE CATALOG**

CIRCLE NO. 5 ON FREE INFORMATION CARD



# I've finally found a personal computer I respect.

## Compucolor II.

ratio available in a personal computer.

The complete system is only \$1495.\* And that price includes 8K user RAM, RS-232C compatibility and random access file capabilities.

Our 8 foreground and background colors will boost your comprehension, while introducing you to an exciting new dimension in BASIC programming. The vector graphics have 16,484 individually-accessible plot blocks. And the 13" diagonal measure screen gives you 32 lines of 64 ASCII characters. You also have the flexibility that comes with 16K Extended Disk BASIC ROM.

Compucolor II offers a number of other options and accessories, like a second disk drive and expanded keyboard, as well as expandability to 32K of user RAM. Of course we also have a whole library of low-cost Sof-Disk™ programs, including an assembler and text editor.

Visit your nearest computer store for details. And while you're there, do some comparison testing. With all due respect to the others, once you see it, you'll be sold on the Compucolor II.

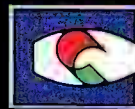

**Compucolor  
Corporation**



Unretouched photo of screen

\*U.S. Domestic price

Compucolor Corporation Post Office Box 569 Norcross, Georgia 30071 Telephone 404/449-5996

CIRCLE NO. 11 ON FREE INFORMATION CARD



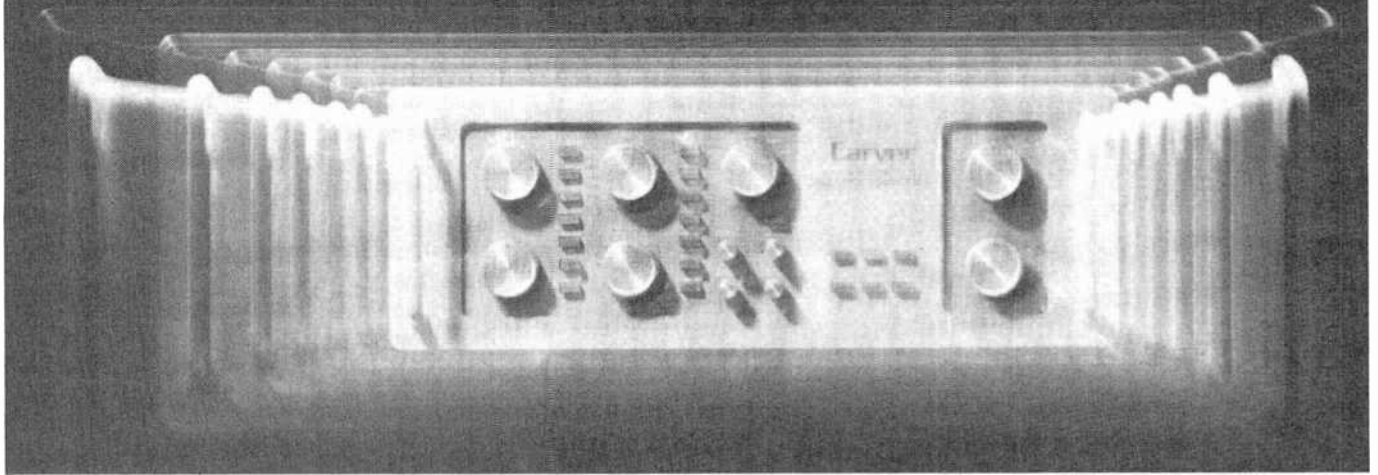

# A STEP BEYOND STEREO

## A Preview of the Carver C4000 Preamp

**T**O CALL the Carver C-4000 merely a preamplifier would be to lose sight of the underlying philosophy of its design. Actually it is much more than an RIAA phono stage and power-amplifier controller. This component is so replete with signal-processing functions that the designer obviously considers operations of this kind to be highly desirable, if not actually essential.

In addition to the customary RIAA equalization required for disc playback and optional equalization via gain and tone controls, the Model C-4000 contains peak-unlimiter/expander circuitry to enhance dynamic range, an "autocorrelator" to reduce noise in the program material, three channels of time delay (two real and one derived from the others), and a startlingly new function that has been dubbed a "sonic hologram generator." Also included are two power amplifiers for the delay channels, each capable of delivering about 25 watts to an 8-ohm load.

The C-4000 includes two phono inputs and provisions for two tape recorders with dubbing possible in both directions. Tone controls are of the usual bass and treble variety with treble turnover frequencies switchable between 8 kHz and 2 kHz and the bass operating with either a 40-Hz turnover or as a loudness control. Tone controls are defeatable and can be set separately for each channel. An additional EQ function available is a 2-dB shelving cut from 400 Hz downward. An infrasonic filter and 20 dB of output muting are also included, and if more signal processing is desired there is an external loop.

Of all the signal-processing modules included in the C-4000, the sonic hologram

generator is the most exciting and innovative. Other than the determination by Hirsch-Houck Labs that the hologram added nothing significant in the way of harmonics (better than 84 dB below 0.5 volt output at 1 kHz) or noise, evaluation of the device was accomplished by listening tests. The purpose of this function is to broaden the stereo image, increase the precision of localization of individual sound sources, and extract ambience in a manner reminiscent of quadraphonics (except that one pair of speakers is used).

**Sonic Hologram Listening Tests.** The intensity of the hologram effect and the listening positions from which it can be perceived depend strongly on the characteristics of the listening room and the loudspeakers. But in any case, sound realism is enhanced. Because the hologram is new and fairly radical in concept, subjective evaluation of it presented a conundrum of considerable proportions. In a sense, we had to develop an understanding of what it was supposed to do before we could tell how well it actually performed. Bob Carver, the designer, was lucid enough about his intentions, but it soon became clear that not even he understands the hologram completely. Moreover, the effect of the device is such that its own description of itself, if one may resort to such hyperbole, is more eloquent than anything Carver could say. Our experience with the hologram was, then, as much a learning situation as an evaluation, for what happened at each stage suggested new paths to be explored.

We heard the hologram first in a moderately large room (room A) with the listening posi-

### FEATURES

Inputs: phono 1, 2; tuner; aux 1, 2; tape 1, 2; external processor. Outputs: main 1, 2; tape 1, 2; external processor; delay channels (powered) left, right, center; delay channels (to power amps) left, right, center. Tone controls: bass (switchable turnover), treble (switchable turnover).

Signal processing: peak unlimiter/expander; autocorrelator; time delay; sonic hologram generator. AC power outlets: 3 switched, 3 unswitched (1 kW total). Dimensions: 19" W x 6 $\frac{3}{4}$ " H x 8" D (46 x 16.5 x 19.5 cm) Projected price: \$800 to \$900. Manufacturer: Carver Corp., 14304 N.E. 193rd Pl., Woodinville, WA 98072.



tion roughly 10 feet from a pair of front-firing loudspeakers designed for minimum time dispersion, and standing about seven feet apart in the center of the room. We were immediately struck by the effect. The music took on a pleasing three-dimensional quality and the performers seemed to be enveloped in a real space as long as the listener was located fairly precisely on the center line between the speakers. Movement of one's head more than a few inches from side to side weakened the illusion considerably; movement of a foot or two reduced it virtually to ordinary stereo.

A second test took place in a fairly small room (room B), also using front-firing speakers, but without phase correction. Here the results, though easily perceptible, were less striking, while the listening position was about as critical as before. Curiously, the hologram seemed to correct a deficiency of bass in the speakers. A second pair of speakers containing drivers angled toward the side was substituted, and the effect was further diluted to the point where it was almost disappointing. In this instance, however, the listening position, however, was less critical.

Yet another trial took place in a moderately sized rectangular room (room C), with the speakers standing rather far apart on the long wall. The speakers were somewhat unusual in that the woofer and tweeter were aimed forward while the midrange driver radiated to the rear. Once again the effect was modest in its intensity, though the tolerance for variation in the listening position became broad enough for two people seated side by side to perceive what little there was. Another odd side effect was that the music seemed louder when the hologram was switched in, which a sound-level meter appeared to confirm.

The final and, in our view, most successful test took place in a fairly large listening room (room D), using speakers without correction for time dispersion. Both speakers were set well away from the room boundaries, and a variety of listening positions were tried. In general, the hologram gave a pronounced and vivid impression at a listening position on the center line between the speakers and some 12 feet away. The effect was still most

intense at the center position, but there was less deterioration with lateral movement.

Curiously, we noticed that stereo image broadened more to the right side than to the left, an anomaly that we finally traced to a wall reflection. To minimize it we resorted to a more "classical" geometry, with the listening position and those of the loudspeakers forming an equilateral triangle. Using this arrangement, the result was positively breathtaking! When the lights were turned out, we could almost have sworn that we were in the presence of a real, live orchestra. An additional bonus was that two listeners side by side could enjoy the effect.

In most of the tests the time-delay system, with the left and right auxiliary speakers positioned to the sides approximately in the plane of the listener's ears and the center channel midway between the main pair and a little farther away, was synergistic with the hologram. It enhanced the sense of depth and enlarged the perceived space somewhat. When the listener was close enough to the main speakers to minimize room reflections, however, the contribution of the delay was small.

Those who live in small apartments with thin walls will be interested in another benefit that the hologram provides. An obvious solution to the problem of listening without disturbing neighbors is to position minispeakers close to one's ears and listen at a level that, though subjectively fairly loud, is moderate at any distance. Unfortunately, this usually produces some of the problems associated with headphone listening, such as sounds coming from inside the head. The hologram clears this up very nicely and makes for a thoroughly realistic listening experience.

**How it works.** Some insight into why the hologram acts as it does can be obtained from examination of its inner workings. Briefly, what the system does is to anticipate the amount of crosstalk reaching the left ear from the right channel and the right ear from the left channel and introduce corresponding cancellation signals. In essence, each channel receives an admixture of a phase-inverted and slightly delayed version of the contents of the other channel. The crosstalk, it should be made clear, is not a result of electrical deficiencies but of sound from the right speaker reaching the left ear and vice versa.

If the cancellation signals are mathematically correct, Carver says, the system works only if the listener's head remains absolutely fixed on the center line between the speakers, a result similar to that produced by a "binaural listening system for loudspeakers" demonstrated in prototype by another company. What Carver has done is to trade away a small—and seemingly negligible—part of the effect to allow the listener to move his head

“With the lights out, we could have sworn we were in the presence of a real-live orchestra.”



# YOU ASKED FOR IT YOU GOT IT DSI QUIK-KIT®

## 50 HZ TO 550 MHZ COUNTER KIT

**95% ASSEMBLED 100% TESTED**  
**Performance You Can Count On**

### FREQUENCY COUNTER APPLICATION:

- Ham Radio — Two Way Radio — CB
- Audio Amplifier & Receiver Repair
- Computer Maintenance & Construction
- A Must for TV & PLL Repair

**\$99.95**  
**MODEL 3550K**

includes built-in  
Pre-Amp & Prescaler



### DSI OFFERS THE BEST OF TWO WORLDS . . .

An unprecedented DSI VALUE . . . in a high quality, LSI Design, 50 HZ to 550 MHZ frequency counter kit. And, because it's a DSI innovation, you know it obsoletes all competitive makes, both in price & performance.

With 95% of the assembly completed by DSI, you are only one hour away from solving all of those difficult bench problems, from adjusting 60 HZ clock-time bases to setting the frequency of a 468 MHZ Mobile Radio.

**FACT:** Every 3550 QUIK-KIT® PC board is factory assembled and tested before shipment. **FACT:** The problems of bad LED's, IC's, and Capacitors are a thing of the past. **FACT:** No manufacturer except DSI offers a 550MHZ frequency counter with . . . 8 digits, .5 in. LED's, TCXO, 1HZ resolution and a one year warranty on parts for under \$100.00. **FACT:** We do not know how long we can hold this low, low price. **GO WITH THE LEADER . . . BUY A DSI FREQUENCY COUNTER KIT TODAY. SAVE TIME & MONEY AND BE ASSURED IT WILL WORK THE FIRST TIME.**

### DSI — GUARANTEED SPECIFICATIONS

**Time Base** TCXO 1PPM 65° to 85°F  
**Freq. Range** 50HZ to 550MHZ incl. two SO239 inputs  
**Resolution** 1HZ to 55MHZ, 10HZ to 550MHZ  
**Gate Time** 1 sec & 1/10 sec with Auto Decimal Point  
**Display** 8 digits, ½ inch LED with Leading Zero Blanking  
**Sensitivity** 25MV @ 25MHZ, 150MHZ, 250MHZ;  
75MV @ 450MHZ  
**Power** Batt., 12VDC @ 300Ma, 110VAC (with AC-9)

3550K Kit . . . . . \$99.95  
T-101 Ant. . . . . 3.95  
AC-9 AC Adp. . . . . 7.95  
Shipping, Handling, Ins. . . . . 10.00

3550W. Wired . . . . . 149.95  
T-101 (incl.) . . . . . NC  
AC-9 (incl.) . . . . . NC  
Shipping (incl.) . . . . . NC

**CALL TODAY TOLL FREE: (800-854-2049) Cal. Res. CALL (800-542-6253) TO ORDER OR RECEIVE MORE INFORMATION ON DSI'S FULL PRODUCT LINE OF FREQUENCY COUNTERS RANGING FROM 10HZ TO 1.3GHZ**



**DSI INSTRUMENTS, INC**

7924 Ronson Road, Dept. G, San Diego, CA 92111

CIRCLE NO. 15 ON FREE INFORMATION CARD

TERMS: MC - VISA - AE - Check - M.O. - GOD in U.S. Funds. Orders outside of USA & Canada, please add \$20.00 additional to cover air shipment. California residents add 6% Sales Tax.

“Phono equalization is accurate to within  $\pm 1$  dB across the audio band.”

and under optimum conditions move slightly off center. Interestingly, Carver's optimization was achieved empirically rather than by calculation, but whatever its genesis, it works.

**Lab Tests.** Since the Carver C-4000 is still in preproduction stages, Hirsch-Houck Labs tested a prototype that, while it gave generally excellent results, will undergo additional refinements before units are offered for sale. The lab was able to verify that all inputs are adequately sensitive and quiet and that the overload margin of the phono stage is sufficient. Harmonic distortion measured quite low at output signals up to 0.3 volt, and spectacularly low with signals up to 6 volts. (The nominal maximum output is 2.5 volts.) Signal-to-noise ratio was 74 dB (IHF "A" weighted) re 0.5-volt output through a high-level input and 70 dB through the phono input re 2.5-millivolts input—very good performance in both cases.

Phono equalization is accurate to within  $\pm 1$  dB across the audio band. The tone controls behave essentially as they should, although, somewhat unusually, they allow approximately 4 dB more boost than cut at extremes of the spectrum. Response of the 400-Hz shelving circuit is satisfactory, though the level at that frequency is down just 1 dB; the full 2-dB reduction is achieved by 200 Hz and is unchanged down to 20 Hz. A check of the phono stages for cartridge interaction showed that this effect is not present in any significant degree with three popular cartridges. The variable capacitive and resistive loads provided for the PHONO-1 input proved quite accurate.

Analysis of the time-delay section indicated some problems with alias distortion—essentially intermodulation with the switching frequency used to shift the signal along the delay line. Bob Carver explains that the delays used in the prototype are too long—some 50 or 85 milliseconds, at the user's option. This results in a switching frequency that is a little too low. The net result is the aliasing problem, which occurs despite the use of a low-pass filter with an extremely sharp rolloff at the delay

line input. Besides that, the sharp cutoff of the filter causes ripple in the passband, another source of coloration in the sound. The solution, which Bob Carver says he will apply in production models, is to reduce the delay times and speed up the switching frequency by about 40%. This should reduce aliasing to insignificant levels and at the same time relax demands on the filter, allowing a gentler cutoff and smoother passband.

The power amps for the delay line outputs showed measured THD on the order of 1% at all signal levels checked. Considering that these are provided more or less as a low-power-output convenience, their performance is certainly adequate for the purpose. Users who demand more pristine delayed signals can use the direct outputs to drive power amps of their choice.

**The Other Processors.** Action of the peak limiter/expander section is carried out by three subsections. The first, which comes into play at a nominal 0-dB level is a fast-attack/fast-release circuit that increases gain for peaks by 1.5 dB. Over the range down to -10 dB the signal passes unchanged. Between -10 and -20 dB, the signal is expanded downward by 2.8 dB, using a circuit that acts slowly in reducing gain and quickly in increasing it. Below -20 dB a circuit that acts slowly in both directions gives another 2 dB of downward expansion. The two downward expanders interact (their resistive elements are connected in parallel to form the shunt leg of a voltage divider) so that their relative gains depend to a degree on which acts first. This property, coupled with the different attack and release times and the modest ratios of expansion, produce a system that rarely, if ever, betrays its operation. The current expander/unlimiter, says Carver, represents an improvement over his earlier designs.

Similarly upgraded, according to its designer, is the "autocorrelator" noise reduction circuit. Where earlier designs strove for 10 dB of noise reduction, the present one settles for 8 dB in order to be less audible in its operation.

(Continued on page 32)

Fig. 1. Schematic of control circuit for one of the transmission gates of the autocorrelator.

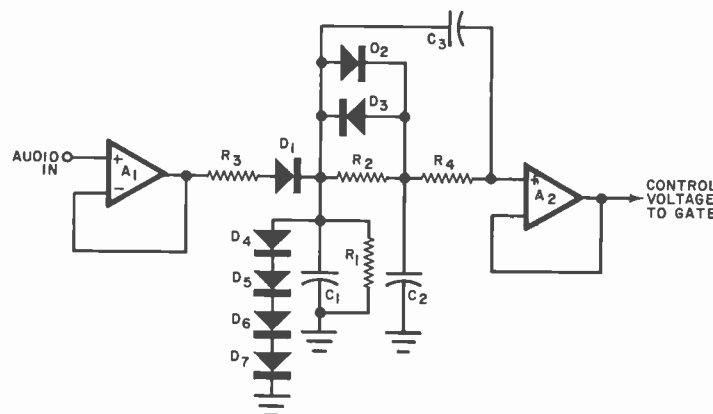



# THE ONLY THING IT HAS IN COMMON WITH OTHER 7-INCH TAPE DECKS IS THE SIZE OF ITS REELS.

Pioneer's new RT-707 has a lot more in common with today's most sophisticated 10-inch tape decks than it does with most 7-inch tape decks.

Because unlike other 7-inch tape decks, the RT-707 isn't filled with 15 year old ideas.

Take the drive system of the RT-707.

Instead of the old fashioned belt-drive system, the RT-707 is driven by a far more accurate and efficient AC Servo direct-drive motor. This motor generates its own frequency to help correct even the slightest variation in tape speed. Which all but eliminates wow and flutter. And because it doesn't generate heat like the belt-driven "dinosaurs" it doesn't need a fan. So all you'll hear is music with a clarity and crispness not possible on any 7-inch, or many 10-inch tape decks.

Our direct-drive system also makes pitch control possible. To help you regulate the speed of the tape and give you greater control over your recordings.

With technology like this it shouldn't surprise you that our super-sensitive heads will deliver

frequencies from 20 to 28,000 Hertz. And our pre-amp section is built to handle 30 decibels more than any other 7-inch tape deck without distorting.

But great sound isn't everything.

As you can see, the RT-707 is smaller and more compact than other tape decks. It's also rack-mountable. And unlike any other tape deck, it's stackable. So it'll fit right in with the rest of your components.

But frankly, all the revolutionary thinking that went into the RT-707 wouldn't mean much if it weren't also built to fit comfortably into your budget. It is.

See your Pioneer dealer for a closer look at this extraordinary 7-inch tape deck.

We think you'll find the only things that the RT-707 has in common with other 7-inch tape decks is the size of the reels.

And the size of the price.

High Fidelity Components  
**PIONEER**  
WE BRING IT BACK ALIVE.

©1977 U.S. Pioneer Electronics, 85 Oxford Drive, Moonachie, New Jersey 07074  
CIRCLE NO. 57 ON FREE INFORMATION CARD

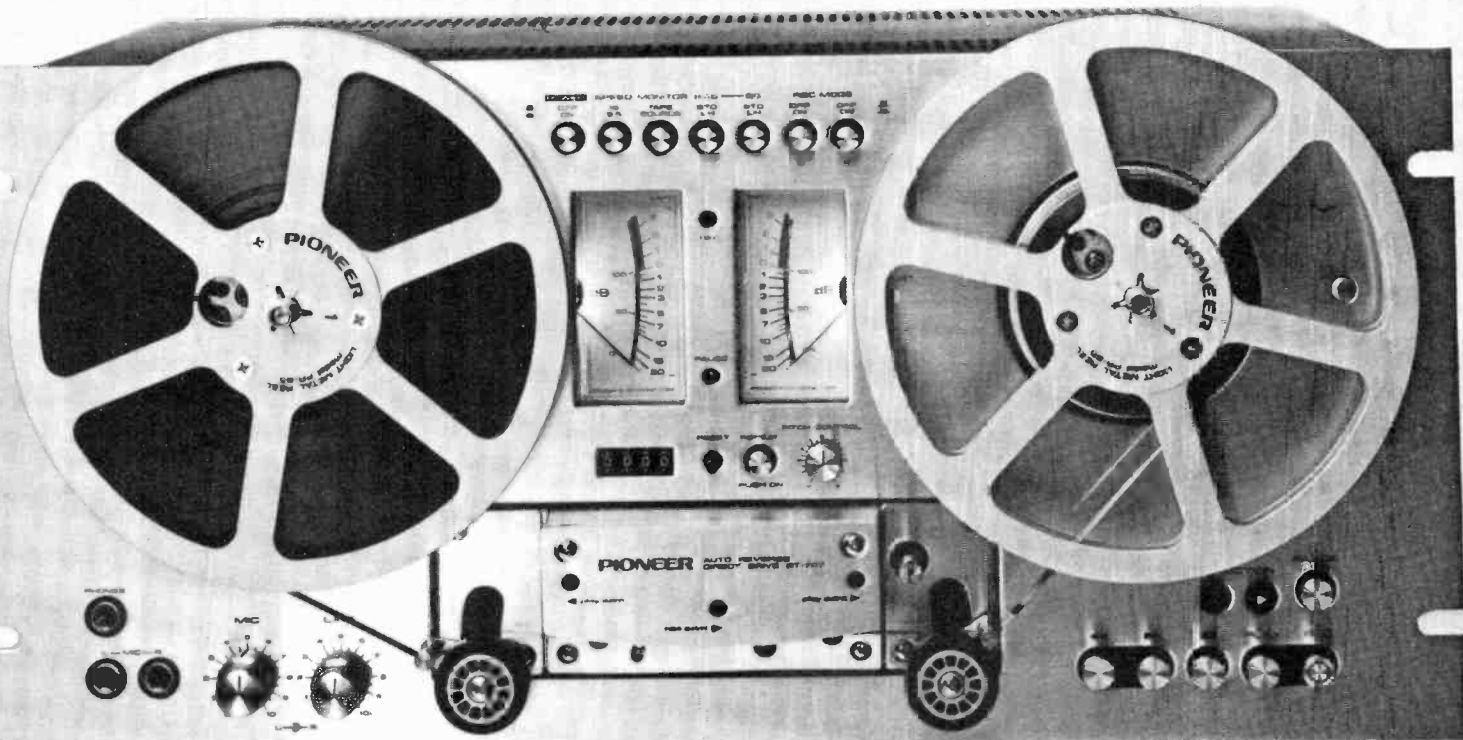

THE RT 707.



HEATHKIT fm/am digital tuner AJ-1600

power

Two analog meters with needle indicators are positioned on the left side of the display panel. To their right is a digital readout (DRO) showing the number '102.9' in green LEDs. Above the DRO are three small indicator lights labeled 'fm', 'stereo', and 'am'. To the right of the display is a large circular volume knob.

meter  
signal  
multipath

stereo  
Dolby rr  
fm  
blend  
mono

fm  
stereo  
stereo  
generator  
mute  
mono  
off

HEATHKIT preamplifier / control center AP-1600

This control panel features a variety of knobs and switches. From left to right, it includes a 'speakers' selector (off, 5, 10), a 'power' knob, a 'tone controls' section with 'left' and 'right' knobs (80Hz, 250Hz, 500Hz), a 'selector' knob (phono 1, phono 2, phono 3, phono 4, aux 2), a 'Cartridge' selector (1mV, 2mV, 3mV), a 'mode' selector (mono, stereo), a large 'volume' knob (0, 10, 20, 30, 40, 50, 60, 70, 80, 90, 100), and a 'balance' knob. Below these are 'bass' and 'treble' knobs (20Hz, 500Hz), 'filters' (low, high), an 'adapter' selector, a 'tape monitor' selector, a 'rec'd made' selector, and a 'loudness' knob.

HEATHKIT graphic output indicator AD-1701

A row of 11 red LEDs is used for level indication. Below the LEDs are labels for 'left' and 'right' channels, and a scale in dB: -6, -20, -45, -40, -38, -30, -20, -15, -10, -6, -3. To the right of the LEDs is a 'range' selector knob (10, 1, 0.1) and a 'power' knob.

HEATHKIT 2x125 watt power amplifier AA-1600

power high temperature left full power right full power

# HEATHKIT

# The Specs Will Turn Your Head. The Sound Will Stir Your Heart.

**New HEATHKIT® Pro-Series** has specs you can hear—and the flexibility to let you hear them just the way you like.

Starting from the top, the **AJ-1600 Pro-Series Tuner** gives you a high degree of signal control for distortion-free, noise-free reception: • Super-sensitive 1.8  $\mu\text{V}$  (mono) and 3.5  $\mu\text{V}$  (stereo) for reception of distant stations • Exceptional signal-to-noise ratios of 83 dB (mono) and 75 dB (stereo) • Extra-wide IF bandwidth reduces noise and improves separation • Bandwidth switch lets you select narrow band for minimal interference in crowded signal areas. • RF attenuator adjusts sensitivity for clearest, cleanest signal reception.

**The AP-1800 Pro-Series Preamp** gives you all the control you need to create the sound that suits your ear: • Dual-turnover tone and filter controls for more precise adjustment • Phono inputs include one with a built-in preamp for moving-coil cartridge • Selectable cartridge capacitance for flattest frequency response for your cartridge • Magnetic phono preamp designed for lowest noise with cartridge connected (rather than preamp shorted) for absolute quiet under real listening conditions. • Built-in infrasonic filter reduces rumble and low-frequency noise from your records • AP-1800 switches up to 1500 watts (maximum) of power.

**The AD-1701 Pro-Series Graphic Output Indicator** gives you accurate monitoring of peak power output to avoid overloads and speaker damage: • Super-wide dynamic range displays almost any source material • Switch to monitor peak or average values • Extremely fast response time detects transient bursts as short as  $\frac{1}{2}$  cycle of 20 kHz, so you're always right on top of the signal.

**The AA-1600 Pro-Series Amplifier** reproduces the entire musical spectrum with the clarity and definition demanded by the finest speaker systems: • **125 watts, minimum RMS, per channel into 8 ohms with less than 0.05% Total Harmonic Distortion from 20-20,000 Hz** • Hum and noise are a full 100 dB down for absolute silence • T.I.M. distortion is less than 0.05% for clean, well defined sound • A remarkable combination of power and clarity.

**The Pro-Series Rack** brings together all your components in a way that makes them look their best and gives you easy access to all controls.

Complete specifications and prices on Pro-Series components are in the Heathkit Catalog. Send coupon today for your free copy.

**NEW HEATHKIT® PRO SERIES**  
*Studio quality for your living room.*

# FREE HEATHKIT® CATALOG

with nearly 400 easy-to-build, money-saving electronic kits.

Every Heathkit product is backed by world-famous technical service and counsel-plus sales and service facilities at 54 Heathkit Electronic Centers\* coast-to-coast (\*units of Schlumberger Products Corporation).

See the white pages of your phone directory for the center nearest you.

If coupon is missing, write Heath Company, Dept. 010-530 Benton Harbor, MI 49022.



HEATH

Schlumberger

Heath Company, Dept. 010-530  
Benton Harbor, Michigan 49022

Please send me my FREE Heathkit Catalog.  
I am not currently receiving catalogs.

Name \_\_\_\_\_

Address \_\_\_\_\_

City \_\_\_\_\_ State \_\_\_\_\_

HF-317 \_\_\_\_\_ Zip \_\_\_\_\_

CIRCLE NO. 5 ON FREE INFORMATION CARD



*Fig. 2. Spectrum analysis of a 15-kHz sine wave mixed with pink noise. The upper trace is a reference level established with the autocorrelator switched off. With the autocorrelator on (lower trace), the noise is reduced by 8 dB except for the immediate neighborhood of the 15-kHz tone and at low frequencies.*

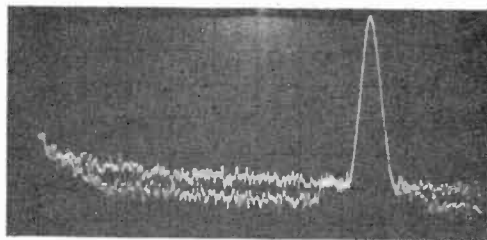

One problem that plagued the earlier version was its compromise attack/release time. If the system acts rapidly enough to prevent audible "breathing" through modulation of the noise level as the signal decays, changes in the signal envelope—as in a vibrato or tremolo—are also capable of modulating the noise and producing a coloration that can seriously affect the sound of a solo flute or violin. Carver overcomes this with a control circuit that attacks differently for large and small signals.

In Fig. 1, which shows control circuitry for one of the six transmission gates used in the unit, audio, after having traversed an appro-

appropriate band-pass filter, is buffered by  $A_1$ , passes through  $R_3$ , and is rectified by  $D_1$ . Capacitor  $C_1$  smooths the resultant dc, which charges  $C_2$  through  $R_2$  and passes on through  $R_4$  to  $A_2$ . This, in turn, feeds a control voltage to the gate that passes audio that is present at the input of  $A_1$  to the system output. Time constant  $R_2C_2$  is long, so that the circuit operates slowly. When the dc level across  $R_1$  and  $C_1$  increases to a point where the barrier potential of  $D_2$  is overcome, the diode conducts and bypasses  $R_2$ , allowing  $C_2$  to charge rapidly. Thus, the control voltage reacts slowly to small signals, rapidly to large ones.

When audio levels decrease,  $C_1$  discharges rapidly through  $R_1$  and  $C_2$  discharges slowly through  $R_1$  and  $R_2$  in series. If the difference between the voltage across  $C_1$  and  $C_2$  is enough to forward-bias of  $D_3$ ,  $R_2$  is again bypassed, which speeds up the discharge of  $C_2$ . Once again, the circuit responds quickly to large signals, slowly to small signals. Diodes  $D_4$  through  $D_7$  clamp the control voltage so that the gate is not overbiased. One gate operates from 200 Hz

## Comments from the listening panel . . .

*This component might well be called an "omnibus preamp" because it contains several signal processing stages not ordinarily found in a preamplifier. Of these, it is the "sonic hologram" circuit that is really the star of the show. The circuit processes only the front-channel signals. For maximum realism, however, it was my experience that the sonic hologram worked best when the time-delay system was driving three small speakers (one connected across the internal auxiliary amplifier's "hot" terminals). This is based on auditioning the equipment in a small room (room B) and in a medium-size room (C) with reflective speakers on the long wall.*

*Frankly, I tended to be skeptical about the ability of a device to substantially improve the spatiality of a sound field generated by only two speakers. But after listening to the Carver preamp connected to two different audio systems, I'm a believer! I found it simply amazing to hear an instrument apparently located several feet to the right and a few feet forward of a right-channel*

*speaker. The sonic hologram circuit adds dimensions to sound systems that they have never had. Moreover, its effect is convincing, not artificial.*

*The principal limitation is that of the area of maximum effect. Both the degree of improvement and size of the area of maximum effect varied in the two listening environments in which I heard the sonic hologram operate. In one room (B), the area (and degree) of maximum effect was fairly small. In the other (C), the area was larger, as was the degree of improvement.*

*In the second room, a more noticeable increase in average sound level was discerned. In both, the frequency response of the speakers (different units in each case) seemed broader than before the circuit was switched in. A serious deficiency in bass response of the first room's speaker was apparently rectified—even though the sonic hologram contains no boost in itself.*

*Accordingly, it's impossible to predict exactly what will happen when the preamplifier is connected to your system. I can state with a*

*high degree of certainty that your system will sound better than it ever has, but a lot of experimentation with speaker placement (and listening location) is warranted.*

*The rest of the preamp is fine, though not as dramatic as the sonic hologram unit. As a whole, it offers a high level of performance and the flexibility that those who purchase separate components seek. At first glance, the preamplifier's price tag might seem steep. However, this is much more than a preamp, and yields audible dividends that more than justify the investment it requires.*

—John J. McVeigh, Technical Editor

\* \* \*

*Carver's new preamp prototype is certainly a bold stroke of design innovation, combining a host of special signal-processing features, the most dramatic being its "sonic hologram." Listening to its performance for some 15 hours in three different locations, each with different equipment, convinces me that this new function indeed adds a sense of viv-*



downward. Five gates divide the interval between 1.5 kHz and 20 kHz into equal fractions of an octave.

Capacitor  $C_3$  represents a bit of psycho-acoustic trickery played on the ear so that high frequencies do not appear to be lost when the control voltage is not sufficient to open the gate. Some of the ripple from the rectified audio passes through  $C_3$  and is fed to the gate along with the control signal. Resistor  $R_4$  provides isolation so that  $C_2$  does not short out the ripple. When the gate is closed, a very small amount of ripple (a highly distorted version of the audio) bypasses the gate and goes to the system output. The level is so low that the ripple cannot be identified as such, but it substitutes for high frequencies that might otherwise be missed. When the gate is open, this low-level contribution is masked. The optimum result is achieved when the audio level at the input of  $A_1$  is scaled so that positive-going audio can pass through  $D_1$  while positive-going noise cannot. A spectrum analysis of noise reduction in the autocorrelator is shown in Fig. 2.

Audibly, we were not able to detect the op-

eration of the autocorrelator other than through the reduction in hiss. Flute and violin sounds in particular were very well handled. The system works best at reducing low-level noise yet further, but if its threshold is suitably adjusted, it will help noisy program material too. The automatic threshold adjustment provided works well for most normal material. It may be possible for some programs to "catch the system out." But none of the fairly wide variety of selections we used did.

From where we sit, the Carver C-4000 looks like one of the most interesting and provocative components to come along in some time. The peak unlimiter/expander, autocorrelator, and time-delay selections (with built-in power amps) are useful adjuncts to the highly competent basic circuitry. As such, they are most welcome. But the real star of the show is the sonic hologram, which constitutes a significant step forward in stereo imagery and the recreation of a sense of space. Another pleasant surprise, considering the unit's multiplicity of features, is its projected price, which is in the \$800 to \$900 range.

—Harold A. Rodgers, Senior Editor

**“The sonic hologram constitutes a significant step forward in stereo imagery and the recreation of a sense of space.”**

*id realism to sound reproduction.*

*The degree to which it enhances sound depends on many factors, though. For example, in two locations (rooms C and D) the listening position between speakers was not especially critical as far as getting the full "hologram" effect. But in one situation (room A), more than minor head shifts caused a marked dropoff in the effect. Program material makes a difference, too, as does the type and positioning of speakers. And, interestingly, so did a switch of cartridges. A Denon moving-coil model coupled with a Mark Levinson pre-preamp, for instance, produced more sound spaciousness with ordinary stereo than did a Shure Type V-15 IV. But the converse was true when the hologram was activated. I would recommend, too, that a "minispeaker" be used for center channel purposes, as it adds noticeably to a three-dimensional effect in some circumstances.*

*Adding sound delay to the "hologram" did not contribute any sound change in many instances. I must confess, though, in ordinary stereo it*

*clearly improved sound quality. The same held true, to a lesser degree, with the expander function, I found.*

*In sum, listening to the C-4000 in its hologram position was a thrilling sound experience for me. Plain old stereo will never be the same. I do hope, though, that Carver has plans down the pike to offer the "sonic hologram" generator in a less complete package; that is, the sonic hologram and sound delay functions only.*

—Arthur Salsberg,  
Editorial Director

\* \* \*

*Sitting in the optimum location and listening at first in conventional stereo, I found that switching in the sonic hologram generator made a difference that it would be a gross understatement to call dramatic. The sound became rich and solid, and there was a great apparent increase in bass. Instrumental sounds that had been confined to the region between the speakers suddenly stretched along the sides of the room nearly as far back as I was sitting (some 12 feet from the speakers).*

*Adding the delay channel extended the richness and depth all around me. When the delay and the hologram generator were switched out, the sound collapsed to ordinary stereo and was a pronounced let-down.*

*As I moved away from the optimum position, the almost palpable sense of reality first weakened and then disappeared. What did remain was the strengthened bass and a sense of ambiance that seemed at least as good as anything time-delay devices had produced in my listening room (B). Even though I knew only two speakers were in use, the fact was hard to accept.*

*On the basis of this brief exposure to the Carver C-4000, I am eagerly awaiting a production model that I can listen to at length. And I can only suggest that any audiophile who is skeptical of my glowing enthusiasm get one to hear for himself. The effect strains credibility—had I not experienced it, I probably would not believe it myself.*

—Julian Hirsch,  
Hirsch-Houck Laboratories.

---

# At CIE, you get electronics career training from specialists.

**If you're interested in learning how to fix air conditioners, service cars or install heating systems – talk to some other school. But if you're serious about electronics, come to CIE – The Electronics Specialists.**

---

*John E. Cunningham*

**Special Projects Director  
Cleveland Institute of Electronics**



**M**y father always told me that there were certain advantages to putting all your eggs in one basket. "John," he said, "learn to do one important thing better than anyone else, and you'll always be in demand."

I believe he was right. Today is the age of specialization. And I think that's a very good thing.

Consider doctors. You wouldn't expect your family doctor to perform open heart surgery or your dentist to set a broken bone, either. Would you?

For these things, you'd want a specialist. And you'd trust him. Because you'd know if he weren't any good, he'd be out of business.

### **Why trust your education and career future to anything less than a specialist?**

You shouldn't. And you certainly don't have to.

**FACT:** CIE is the largest independent home study school in the world that specializes exclusively in electronics.

We have to be good at it because we put all our eggs in one basket: electronics. If we hadn't done a good job, we'd have closed our doors long ago.

### **Specialists aren't for everyone.**

I'll tell it to you straight. If you think electronics would make a nice hobby, check with other schools.

But if you think you have the cool—and want the training it takes—to make sure that a sound blackout during a prime time TV show will be corrected in seconds—then answer this ad. You'll probably find CIE has a course that's just right for you!

### **At CIE, we combine theory and practice. You learn the best of both.**

Learning electronics is a lot more than memorizing a laundry list of facts about circuits and transistors. Electronics is interesting because it's based on some fairly recent scientific discoveries. It's built on ideas. So, look for a program that starts with ideas—and builds on them.

That's what happens with CIE's Auto-Programmed® Lessons. Each lesson uses world-famous "programmed learning" methods to teach you important principles. You explore them, master them completely... before you start to apply them!

But beyond theory, some of our courses come fully equipped with the electronics gear to actually let you perform hundreds of checking, testing and analyzing projects.

In fact, depending on the course you take, you'll do most of the basic things professionals do every day—things like servicing a beauty of a Zenith color TV set... or studying a variety of screen display patterns with the help of a color bar generator.

Plus there's a professional quality oscilloscope you build and use to "see" and "read" the characteristic waveform patterns of electronic equipment.

### **You work with experienced specialists.**

When you send us a completed lesson, you can be sure it will be reviewed and graded by a trained electronics instructor, backed by a team of technical specialists. If you need specialized help, you get it fast... in writing from the faculty specialists best qualified to handle your question.

### **People who have known us a long time, think of us as the "FCC License School."**

We don't mind. We have a fine record of preparing people to take... and pass... the government-administered FCC License exams. In fact, in continuing surveys nearly 4 out of 5 of our graduates who take

the exams get their Licenses. You may already know that an FCC License is needed for some careers in electronics—and it can be a valuable credential anytime.

### **Find out more! Mail this card for your FREE CATALOG today!**

If the card is gone, cut out and mail the coupon.

I'll send you a copy of CIE's FREE school catalog, along with a complete package of independent home study information.

For your convenience, I'll try to arrange for a CIE representative to contact you to answer any questions you may have.

Remember, if you are serious about learning electronics... or building upon your present skills, your best bet is to go with the electronics specialists—CIE. Mail the card or coupon today or write CIE (and mention the name and date of this magazine), 1776 East 17th Street, Cleveland, Ohio 44114.



Patterns shown on TV and oscilloscope screens are simulated.

## **CIE Cleveland Institute of Electronics, Inc.**

1776 East 17th Street, Cleveland, Ohio 44114

Accredited Member National Home Study Council

**YES...** John, I want to learn from the specialists in electronics—CIE. Send me my FREE CIE school catalog—including details about troubleshooting courses—plus my FREE package of home study information.

PE-89

Print Name \_\_\_\_\_

Address \_\_\_\_\_ Apt. \_\_\_\_\_

City \_\_\_\_\_

State \_\_\_\_\_ Zip \_\_\_\_\_

Age \_\_\_\_\_ Phone (area code) \_\_\_\_\_

Check box for G.I. Bill information:  Veteran  Active Duty

**Mail today!**



The Technics isolated-loop system.  
It's the one big difference  
between their decks and ours.

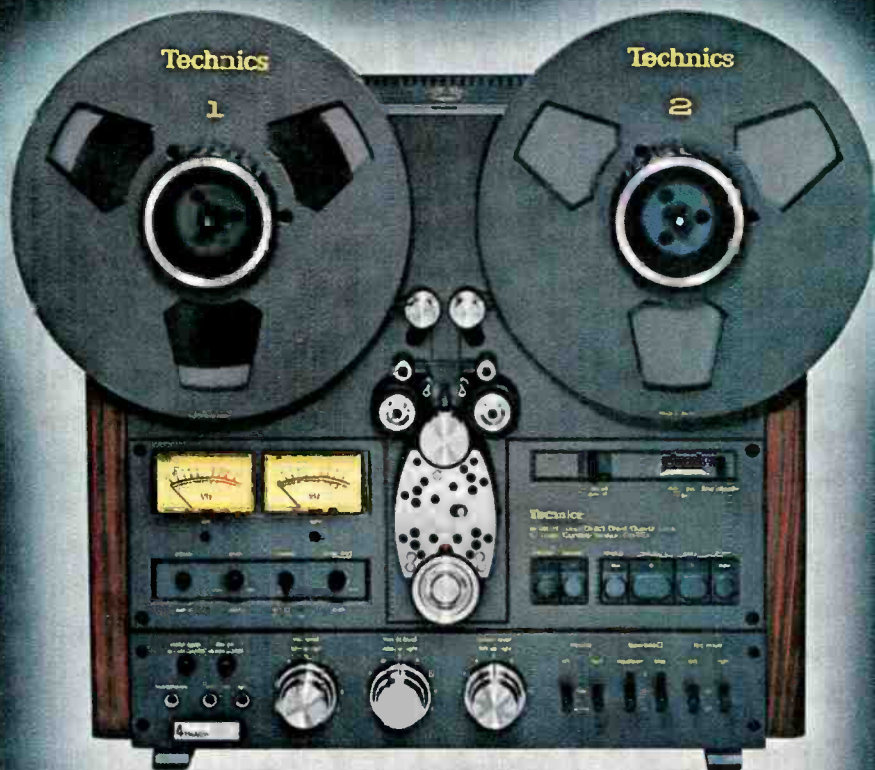

Every one of Technics four open reel decks has one thing in common: The performance of Technics isolated-loop tape transport system. And that means performance that's comparable to professional open reel decks costing thousands of dollars more.

By isolating the tape from external influences, our isolated-loop tape transport system minimizes tape tension to a constant 80 grams. This not only provides extremely stable tape transport and low head wear, it also reduces modulation noise and wow and flutter to the point where they're detectable on only sophisticated testing equipment.

Electronically, our line of isolated-loop tape decks are equally impressive. The reasons are as simple as their IC full-logic transport controls, highly accurate microphone amplifiers, FET mixing amplifiers and separate 3-position bias/EQ selectors.

And you'll get all this technology whether you choose the two-track RS-1500, the extended playing time of the 4-track RS-1506 (shown above), the convenience of the

4-track RS-1700 with auto-reverse or the studio features of the RS-1520.

There's also an optional full-feature infrared wireless remote control (RP-07C). With it you can get your hands on all this sophistication from up to 20 feet.

All four decks hit the competition right between the reels. Because all four have: **FREQ. RESP.** 30-30,000 Hz,  $\pm 3$  dB ( $-10$  dB rec. level) at 15 ips. **WOW & FLUTTER:** 0.018% WRMS at 15 ips. **S/N RATIO:** 57 dB (1506 & 1700) and 60 dB (1500 & 1520) NAB weighted at 15 ips. **SEPARATION:** Better than 50 dB. **START-UP TIME:** 0.7 sec. **SPEED DEVIATION:**  $\pm 0.1\%$  with 1.0 or 1.5 mil tape at 15 ips. **SPEED FLUCTUATION:** 0.05% with 1.0 or 1.5 mil tape at 15 ips. **PITCH CONTROL:**  $\pm 6\%$ .

Technics open reel decks. A rare combination of audio technology. A rare standard of audio excellence.

Cabinet is simulated woodgrain.

**Technics**  
Professional Series

CIRCLE NO. 58 ON FREE INFORMATION CARD



# Julian Hirsch Audio Reports

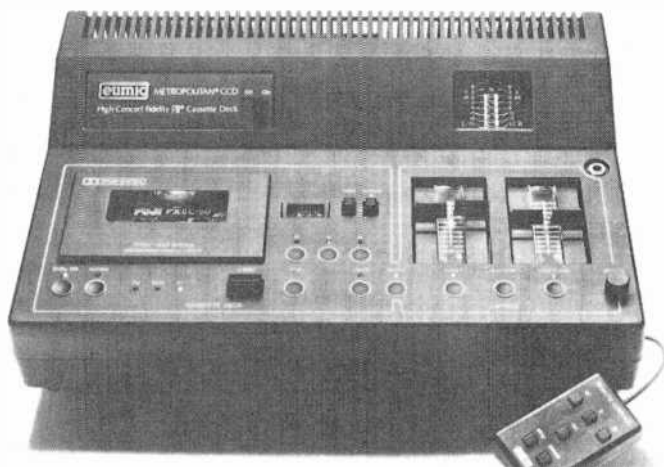

## Eumig 'CCD' Cassette Deck



The new Austrian-made Model CCD from Eumig is a three-head, top-loading cassette

deck with many unusual design and operating features. In particular, it has a low-mass servo-controlled capstan motor with optical feedback, solenoid control of all transport functions, full remote control as a standard feature, flexible dual inputs with mixing capability, and fast peak-responding LED recording level indicators.

The recorder is finished in black and has an upward-sloping rear section that contains the level indicators and ON/OFF power switch. The transport controls are light-touch pushbuttons, each of which has a status indicating LED near it. Input and output jacks are in the rear, microphone jacks are in the front, and various controls and switches are located on the front and underneath the recorder.

The Eumig Model CCD measures 17.1" W x 11.8" D x 5.4" H (43.4 x 30 x 13.8 cm) and weighs 16 lb (7.3 kg). A remote-control accessory supplied with the recorder duplicates all transport-control functions, including recording and fast forward and reverse. It measures about 3.5" x 2" x 1" thick (7.6 x 5.1 x 2.5 cm) and plugs into the recorder through an approximately 90" long (2.3 m) cable. Suggested price is \$1300.

**General Description.** A light touch on a button opens the door of the cassette compartment, while an additional, firmer pressure causes the cassette tray to tilt upward with a slow, damped motion for loading and unloading a cassette. Selection of bias and recording and playback equalization is automatic, using the special keying hole on the rear of a cassette to select operating conditions for chrome (Cr) tape; otherwise, the machine is set up for either ferric-oxide (Fe) or ferrichrome (FeCr) tape. A slide switch under the cassette cover permits the user to choose between these two tapes, since there is no special cassette keying to distinguish between them. The appropriate LED in front of the cassette compartment comes on to indicate the type of tape being played or recorded.

The deck has a memory-stop feature associated with its index counter. The stop works in either direction of tape motion in the fast-speed modes when the counter reaches 000. Two pairs of slide-type potentiometers are provided for recording level adjustments on each channel for each of the two inputs. An input is selected by touching a button in front of its level controls. Simultaneously, the scale markings for the selected controls light up and the appropriate INPUT LED lights up. Normally, touching the other input button will shut off the first input. However, both

inputs can be used simultaneously by holding down one button while touching the other.

Between the INPUT select buttons is another button labelled AUTO/MAN. Touching this button causes the manual level controls to be replaced with an automatic volume control (avc) circuit. This function would principally be used for speech recording. It can be used with either recording input but not with both simultaneously. When the avc is on, the lights for the level controls and the LED indicators extinguish. Normal manual control is restored with a second touch of the AUTO/MAN button. Plugging a microphone into one of the input jacks replaces the corresponding LINE input of INPUT 2 with the microphone signal.

The recording-level indicators are calibrated from -20 to +6 dB with LEDs that form a line whose length is proportional to the peak incoming signal level. Up to -3 dB, the LEDs are green; the 0-dB LED is yellow; and the +3- and +6-dB LEDs are red. Since the signal level is monitored after the recording equalization, the LEDs give a true picture of the peak levels applied to the recording head.

The transport controls are fully logic operated through solenoids. Any transport control button can be touched while the machine is running in any mode without risking damage to tape or deck. Even the button for the cassette compartment door can be operated while the tape is running. Pressing the OPEN button while the deck is operating causes the tape to stop. Then the compartment door opens and allows the tape to be lifted out of the deck by the tray. Only the record function cannot be engaged once the tape is in motion. The deck is placed in the record mode in a rather unorthodox manner. The PAUSE button must be touched first, then the REC button. After the levels have been set, another touch of the PAUSE button starts the recording process. Alternatively, the REC button can be pressed first, followed by two touches on the PAUSE button. While

recording, touching PLAY will instantly place the deck in the play mode.

As befits a true three-head recorder, the Eumig CCD has full off-the-tape monitoring capability. This includes a double Dolby system so that the playback is heard with the correct frequency response and noise level while a recording is being made. Certain operating sequences of the transport controls will also switch the monitor outputs from tape to source (but not from source to tape). One must keep an eye on the red MONITOR LED to determine which program is being heard. The Dolby NR button inserts and removes the Dolby noise-reduction circuits. There is also a headphone jack with its own independent PHONES level control.

Barely visible on the front surface of the deck are the two microphone jacks and two pushbutton switches. One button is for selecting the microphone sensitivity to accommodate high- and low-output microphones (the microphones can have balanced or unbalanced outputs and any impedance from 100 to 5000 ohms). The other button is a TEST switch that controls an internal 400-Hz oscillator used both for record head azimuth adjustment and Dolby-level adjustment.

Like the few other true three-head cassette decks with physically separate recording and playback heads, the Model CCD provides for an azimuth adjustment on its recording head. This permits one to compensate for any skew effects in the cassette that could alter the azimuth relationship between the tape and two heads. (The playback head is fixed, and is factory aligned against a standard test tape.) This record-head alignment is required to obtain the full high-frequency response of which the deck is capable, although Eumig states that "for most recordings this adjustment will probably not need to be made." The other manufacturers of three-head cassette decks are emphatic about the importance of making this adjustment for every cassette before recording and even when recording on the second side of a cassette after the deck has been adjusted for the first side.

To make the alignment, the deck is put into the record mode and the TEST button is engaged. In general, the green LEDs on the level display

## Product Focus

*Many, if not most, cassette recorders use servo-controlled dc motors for their capstan drive. They have the advantage over synchronous motors of being unaffected by line-frequency changes and are readily adjustable in speed and relatively inexpensive.*

*Most such motors use a tachometer generator of some sort on the motor shaft to generate an ac output voltage whose amplitude and frequency are proportional to the speed of rotation. Either voltage or frequency can be used to generate the correcting voltage that drives the capstan motor, by comparison against a stable reference voltage or frequency. The servo action maintains the motor at a constant average speed, but as a rule the mass of the motor is too great for the driving amplifier to correct for short-term fluctuations that can create flutter. A heavy flywheel, generally on the capstan shaft, is used to smooth out these fluctuations. The appreciable amount of time required for the flywheel to reach its operating speed demands that it be left turning, even while the deck is in PAUSE. To put the tape into motion, a rubber pressure roller is used to hold the tape against the rotating capstan.*

*In the Model CCD deck, Eumig has done things quite differently. The motor is a very-low-mass "coreless" rotor type. It is inherently able to respond to input voltage changes much faster than more massive motors. Also, there is no flywheel; in its place, on the capstan's shaft is a very-low-mass optical disc on which there are 2500 radial spokes. At normal tape speed, the spoke markings interrupt the light beam between a LED and a photocell to generate a 15,000-Hz signal. This signal is compared with a reference (it is not made clear whether the comparison is on a frequency basis or it is first changed to a dc voltage) and the error signal is amplified to drive the motor.*

*Instead of depending on the mass of a flywheel to eliminate flutter from the tape drive, Eumig actively eliminates it at the source by a very-fast-acting motor speed servo that can smooth out the drive pulsations at the capstan. The motor is able to respond in only milliseconds. The result is a flutter specification that would do justice to a good open-reel recorder operating at 7 1/2 ips (19 cm/s) or higher speeds, and one which our tests show is very handily met.*

will come on for only one channel. With the cassette cover open, a small nonmagnetic screwdriver (supplied with the recorder) is inserted into a slot in the well and turned until the LEDs for both channels come on for about the same percentage of the time, flashing on and off alternately. The TEST button can then be released and the tape returned to its beginning for making the recording.

To perform the Dolby alignment, for matching the input and output levels within 2 dB, the TEST tone and the Dolby system are switched on. This gives a steady indication for both channels on the display. Small individual thumbwheel controls on the front of the deck are then adjusted until the yellow LEDs in the display just begin to flicker. As before, the TEST button is released and the tape is returned to its beginning before making a recording.

Beneath the recorder are two pushbutton switches. One transfers INPUT 1 from phono jacks to a DIN connector and performs appropriate level and impedance changes. The other button permits one to insert a 19-kHz filter into the recording circuits to eliminate any possible interaction between the pilot carrier leakage in a tuner output and the Dolby system of the recorder.

### Laboratory Measurements.

The operating manual that accompanies the Model CCD makes no recommendations or suggestions about specific types of tape to be used with the deck. (It is, however, sufficiently complete in its description of the deck's operation and features.) An individually run frequency-response curve is supplied, also without reference to the tape or even the recording levels, making it of little value. We took advantage of the deck's monitoring capability to test some 16 tapes in an effort to find the one (or ones) that best matched the bias and equalization settings.

Among the ferric-oxide tapes, we tested BASF Professional I, Fuji FX-I, Maxell UD-XL I, Maxell LN, Memorex MRX3, Scotch Dyna-range, Scotch Master I, and TDK AD. It was obvious that the machine's bias was too low for the high-performance tapes in this group, all of which had a more or less rising high-end response at a -20-dB re-

ording level. However, Scotch Dynarange and Maxell LN yielded virtually flat response curves, with the slightly better high-frequency saturation of the Scotch tape making it our choice for the balance of the tests with Fe tape.

Among ferrichrome tapes there is much less choice. We tested BASF Professional II, Scotch Master III, and Sony FeCr. The deck was clearly not suitable for use with the first two, which had severe high-frequency losses. The Sony tape provided an acceptable, though not particularly good response compared to the other tape types. This is the tape we used for our FeCr tests.

As expected, the cobalt-treated ferric "chrome-equivalent" tapes gave the best results with the Model CCD. We tested BASF Professional II, Fuji FX-II, Maxell UD-XL II, Scotch Master II, and TDK SA. Although all gave acceptable results, the TDK SA had an impressively flat response that left no doubt that it was the best tape for this deck as it was biased and equalized.

The frequency response at  $-20$  dB with TDK SA was flat within  $\pm 0.5$  dB from 47 to beyond 20,000 Hz. The head "ripples" at low frequencies had little effect down to about 45 Hz, but the output dropped about 5 dB at 35 Hz and below, which applies to any of the tapes we used. At the high end, the response was down 3 dB at just beyond 21,000 Hz. The 0-dB record/playback response displayed the expected saturation effect. It dropped off beyond 2000 Hz and intersected the  $-20$ -dB curve at 10,500 Hz.

The Sony FeCr tape gave a response within  $+0.5/-3$  dB from 38 to 17,000 Hz at  $-20$  dB. However, its saturation at high levels was more pronounced than we are accustomed to seeing, even on cassette machines. The 0-dB response dropped steeply beyond 1000 Hz and intersected the  $-20$ -dB curve at 6300 Hz.

The response with Scotch Dynarange was nearly as flat, though not quite as extended, as the TDK SA response. At  $-20$  dB, it was within  $+0.5$  dB from 46 to 18,000 Hz, and the 0-dB response intersected the  $-20$ -dB curve at 10,000 Hz.

The playback equalization could be measured only for the 120- $\mu$ s (Fe) response since our standard

test tapes do not have the notches required for switching the deck to 70 $\mu$ s and there is no override feature. The low-frequency portion of the response from the TDK AC-337 test tape was very flat. However, beyond 1000 Hz, the output dropped off slightly to about  $-3$  dB at 12,500 Hz. Overall, it was within  $\pm 1.5$  dB from 40 to 12,500 Hz, which is respectable response for any cassette recorder.

The 19-kHz multiplex filter began to affect the frequency response as low as 10,000 Hz and less, but it decreased it by only about 8 dB at 19,000 Hz. Although the attenuation appeared to increase at higher frequencies, it was relatively low at the critical 19,000-Hz pilot carrier frequency.

The Dolby tracking of the recording and playback circuits was excellent. At  $-20$  dB, the frequency re-



**TOP RATED**

... by the people who sell it!  
... the people who buy it!  
... and the magazines who test it!

The BEARFINDER Speed Radar Detector is the finest all-around unit you can buy... at a price you can afford.

CAR & DRIVER magazine says that the BEARFINDER XK Two + Two is: **"Good; a first-class ticket to rapid transit!"**

Our dealers and distributors from coast-to-coast think the BEARFINDER is the finest in

sensitivity, selectivity, quality and overall performance. They call it the "performance leader."

Write us today and we'll send you a copy of CAR & DRIVER's February, 1979 report, 8 full pages of Speed Radar Detector testing facts.

We know our BEARFINDER XK is "the speed radar detector"... tops where it counts most... on the highway. With a BEARFINDER on your car's dash, you will, too!



BEARFINDER, INC.  
221 Crane St.  
Dayton, Ohio 45403

The Speed Radar Detector...  
for every safe and secure mile you drive!





## THE SPARKOMATIC SOUND. CAR STEREO FOR THE TRAVELIN' MAN WHO IS IN TOUCH WITH THE CHANGING TIMES.

Like time, the travelin' man and his music do not stand still. Curiously, car high fidelity has failed to keep pace. The equipment in the auto was ill-equipped to reproduce any level of sophisticated sound.

Sparkomatic's new High Power Car Stereo series has changed all that. Truly machines of the times. Driving enormously spacious sound throughout the elegantly understated space they occupy. Tuners with exceptional FM sensitivity, superb separation and efficient multipath signal rejection; integrated Cassette or 8-Track that's a breakthrough in disciplined distortion and wow and flutter; separate bass/treble and balance/fader controls to command the performance.

The power: a bone shaking 45 watts.

This Sparkomatic SR 2400 High Power Digital 8-Track AM/FM Stereo with Clock (or SR 3400 Cassette alternative) is a prime example of these components-like advancements. *Feather touch* controls send electronic impulses to activate all major fidelity functions. And the integrated tape player performs to the highest fidelity standards.

The timepiece itself is a statement in state-of-the-art digital accuracy.

Synchronize one of 20 models to your time and space. Sparkomatic High Fidelity Speakers add yet another dimension to your car sound.

Visit a Sparkomatic dealer for a demonstration.

### SPARKOMATIC

For the Travelin' Man™

For our free catalogs on Car High Fidelity write: "For The Travelin' Man", Dept. PE, Sparkomatic Corporation, Milford, PA 18337

CIRCLE NO. 56 ON FREE INFORMATION CARD

AmericanRadioHistory.com



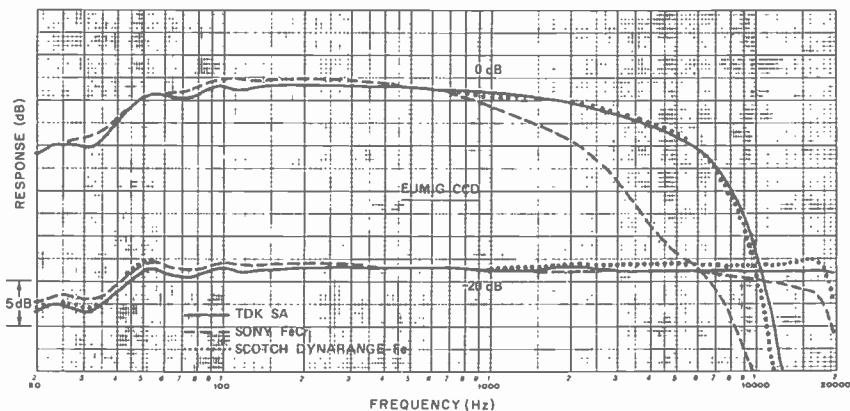

Frequency responses at 0 and -20 dB for three different tape types

sponse with and without Dolby changed by no more than 1 dB at any frequency up to 15,000 Hz. At -40 dB, the two curves were within 1 dB of each other up to our measurement limit of 20,000 Hz. Noticing that the response at -40 dB was rising slightly at 20,000 Hz, instead of falling as it did at -20 dB, we extended our -40-dB measurement to 40 kHz. The result was an impressive response of  $\pm 2$  dB from 40 to 23,500 Hz!

To produce a 0-dB recording level indication on the LEDs, a line input of 50 mV was needed. The microphone sensitivities were 0.068 and 0.77 mV for the two positions of the microphone attenuator. The corresponding overload levels were 7.7 and 52 mV. The playback output voltage, which is fixed, was 0.46 volt for FeCr tape, 0.57 volt for Scotch Dynarange, and 0.66 volt for TDK SA, all from a 0-dB recording input at 1000 Hz. A comparison with the

playback output from a TDK Dolby-level cassette revealed that the playback "Dolby level" of 200 nW/m corresponded to a recording made at -3 dB on the deck's own amplitude display, but there was no Dolby mark on the display scale, nor was any reference made to this matter in the manual.

The playback waveform from a 0-dB recording with any of the tapes was severely distorted. It contained from 5.6% to 7.1% of third-harmonic distortion. To obtain the usual refer-

the deck's measured (0.035%) flutter actually surpassed the remarkable claims made for it!

ence level of 3% third-harmonic distortion, we had to record the Dynarange and SA tapes at -2 dB and the FeCr tape at -4 dB. The S/N, relative to these levels, was respectively 48.5, 51.5 and 51 dB for the three we used in our tests in an unweighted measurement. Using the Dolby system and CCIR/ARM weighting, we measured S/N figures of 63.5, 65.5, and 62 dB for Fe, Cr, and FeCr tapes. The noise level through the microphone inputs increased by 2.6 or 15 dB, depending on the attenuator setting, at maximum gain, compared to the noise through the line inputs. The recording avc circuit attacked almost instantly to hold the gain effectively at -3 dB. There was negligible distortion from overloads of 30 dB or more. (The "pumping" of the background noise level as the gain fluctuates makes this feature unsuitable for music recording.)

The deck's measured flutter actually surpassed the remarkable claims made for it! With a TDK AC-342 test tape, the peak weighted flutter (DIN) was 0.05%, and the weighted rms flutter (JIS) was 0.035%. The same readings were

## Performance Specifications

Specification	Rating	Measured			
Tape speed	1 7/8 ips $\pm 1\%$	1 7/8 ips $+0.15\%$			
Frequency response (tapes not specified)	Fe: 30-16,000 Hz $\pm 3$ dB	46-18,000 Hz $\pm 0.5$ dB			
	CrO <sub>2</sub> : 20-20,000 Hz $\pm 3$ dB	47-20,000 Hz $\pm 0.5$ dB			
	FeCr: 20-20,000 Hz $\pm 3$ dB	38-17,000 Hz $+0.5/-3$ dB			
S/N (A-weighted)	Dolby	Unwtd	Dolby/		
	Off	On	CCIR/ARM		
	Fe	58 dB	66 dB	48.5 dB	63.5 dB
	Cr	60 dB	68 dB	51.5 dB	65.5 dB
	FeCr	64 dB	72 dB	51 dB	62 dB
Bias frequency	175 kHz	Not Checked			
Wow & flutter	0.05% wrms	0.035% wrms			
		0.05% wpk (DIN)			
Rewind time (C-60)	40 seconds	47 seconds			
Fast forward time (C-60)	NA	84 seconds			
Start-up time	Less than 0.04 s	Not checked			
Mixing control range	-65 to +15 dB	Not checked			
Afc range/response time	40 dB/0.01 s	Not checked			
Output level/impedance	500 mV/10k ohms	Not checked			
Headphone output	8-2000 ohms, 1/4" jack	Level OK (depends on tape)			

obtained in a combined record/playback measurement. The speed was 0.15% fast and did not change as a cassette was being played. The crosstalk from left to right channel at 1000 Hz, measured with a TDK AC-352 tape, was a relatively high -33 dB, which is still adequate for a full stereo effect.

The Model CCD is claimed to have a very fast rewind speed, and it did. It rewound a C-60 cassette in only 47 seconds, which is appreciably faster than the 80 or more seconds of a typical cassette transport. However, its fast forward was slower, taking 84 seconds to move the same amount of tape. Headphone volume through 200-ohm phones was excellent. The headphone amplifier built into this recorder makes it one of the very few cassette decks that can actually produce a loud listening level with just about any kind of dynamic phones.

**User Comment.** Functionally and operationally, this appears to be a well-conceived and executed deck. Its rather unusual features are easy to get used to; afterward, it is difficult to imagine a recorder smoother or easier to use. The solenoid-operated transport is astonishingly silent. We heard none of the thumps or clunks usually associated with solenoid operation. The tape heads move up to contact the tape with a "motor" rather than a linear-solenoid sound. This is apparently not far from the actual case, since one of the very few details supplied about

the inner workings of the deck in the Eumig literature is the fact that the head assembly is pivoted and moves through an arc to contact the tape. However this is accomplished, the heads appear to contact the tape firmly but slowly, with a minimum of impact. The record azimuth adjustment was easy to make and not very critical, unless one is concerned with the response at the highest audio frequencies (beyond 15,000 Hz).

Eumig also claims a start-up time of less than 40 ms for the low-mass capstan motor so that the PAUSE start and stop action (which actually shuts off the motor, instead of leaving it running with the pressure roller released, as is usually done) occurs instantly and with no audible wow. We confirmed this in use. In general, we were most impressed with the mechanical performance of the recorder.

We are less enthusiastic about the relatively low saturation level of the recording head. With most tapes, the 0-dB record/playback frequency response was not as wide as we have found on many other cassette decks in the upper-price range. Even the very measurable difference in response between the -20- and -40-dB recording levels with TDK SA tape suggests that the deck should be operated with a very low average recording level, which needlessly restricts its dynamic range. This is why we obtained S/N figures that, though very acceptable, are not quite as good as expected from a \$1300 cassette recorder.

True, the noise levels are low, but so is the maximum recording level.

When recording from FM broadcasts, the deck did a "perfect" job in the sense that operating the monitor button to listen to the incoming program or the tape playback resulted in absolutely no audible difference in the sound. When we tried recording FM tuner interstation hiss at various levels and making this comparison, we could always hear some difference in the extreme highs. The playback was usually slightly dulled, even at levels as low as -20 dB. With high-energy tapes such as TDK AD, which had a rising high-end response, the effect was the reverse, with the playback sounding slightly bright. In both cases the difference was slight, probably too small to detect when recording FM broadcasts or dubbing from most records.

Our conclusions are, of course, based on tests with just one sample of the Model CCD. Hence, we have no way of knowing how representative our test deck was of the company's entire production. If the Model CCD could be given just a few decibels of added headroom in recording, it would be unarguably one of the finest decks on the market at any price. This deck is ingeniously designed, ruggedly made, and highly versatile, with basically excellent performance—when using a limited number of suitable tapes and only when the maximum recording level is kept to -3 dB or less as read on the LED indicators.

CIRCLE NO. 101 ON FREE INFORMATION CARD



## Pioneer TVX-9500 TV Sound Tuner



The Pioneer Model TVX-9500 TV sound tuner is designed to take advantage of the wider bandwidth available now to TV networks for intercity audio transmission. This makes it possible for the audio enthusiast to obtain high-fidelity sound from TV programs. It is a compact accessory that contains separate vhf and uhf TV tuners, a high-quality FM i-f and quadrature detector, and audio outputs that can drive a high-level input of any hi-fi system. The TVX-9500 measures 16½" W × 13¾" D × 3¾" H (42 × 35 × 9.8 cm) and weighs roughly 11½ lb (5.2 kg). Suggested retail price is \$250.

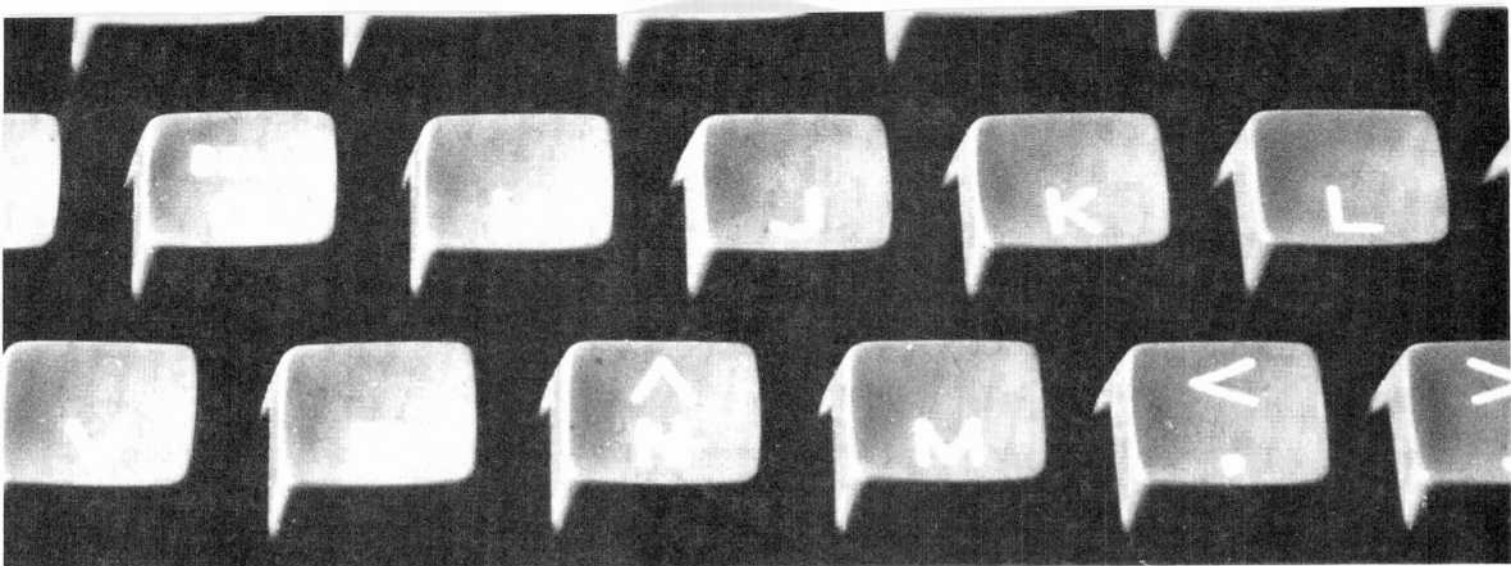

# Using a computer is easy... for onComputing readers.

Read onComputing to find out . . .

- What a micro-computer can do
- How to get started
- What's new in personal computers
- Where to buy your computer
- How to use your computer

The editors of **onComputing** realize that much of the material written about computers is not at all suited to the person who just wants to use a computer as a tool for business, education, home entertainment, laboratory work, or other applications. **onComputing** is dedicated to helping the computer user understand the capabilities of a microcomputer—in non-technical language.

**onComputing** is entertaining and informative. It contains practical articles on how to get started, including what you'll need for your application and what it will cost. It features book reviews, product reviews, information on what's

new in personal computers, where to buy a personal computer, and—how to use it.

**onComputing** is a totally new publication. It is issued quarterly and contains articles from some of the best known names as well as from competent amateurs. It is edited and produced under the guidance of an experienced staff of computer experts. The articles in **onComputing** have never appeared in any other publication. They are all fresh, informative, and valuable reading for anyone interested in using a computer—for fun or profit!

**onComputing**<sup>™</sup>  
GUIDE TO PERSONAL COMPUTING  
Start your subscription today.

EVERY THREE MONTHS **onComputing** will bring the latest developments in the field of personal computing: use, applications, books, selection—all in an easy-to-read style.

© onComputing, Inc. 1979

**onComputing** Subscription Department, P.O. Box 307, Martinsville, NJ 08836  
CHARTER subscription rate in effect during introductory period (April - May 31, 1979)  
U.S. 1 yr. (4 issues) @ \$7.50    Canada & Mexico 1 yr. (4 issues) @ \$9.00  
REGULAR subscription rate applies to all subscription cards postmarked after May 31, 1979  
U.S. 1 yr. (4 issues) @ \$8.50    Canada & Mexico 1 yr. (4 issues) @ \$10.00  
FOREIGN (to expedite service, please remit in U.S. funds drawn on a U.S. bank.)  
Europe (and all other countries, except above) 1 yr. @ \$12.00—surface delivery  
Bill VISA    Bill Master Charge    Bill me (North America only)

Charge Card Number \_\_\_\_\_ Expiration \_\_\_\_\_

Signature \_\_\_\_\_ Name (Please print) \_\_\_\_\_

Street/Apartment Number \_\_\_\_\_

City \_\_\_\_\_ State/Province/Country \_\_\_\_\_ Postal Code \_\_\_\_\_

7359

CIRCLE NO. 45 ON FREE INFORMATION CARD

**General Description.** The TVX-9500 resembles other Pioneer audio components in style. Across most of the width of the panel are 12 flat, mechanically interlocked pushbuttons that respond to a very light pressure and select the vhf TV channels from 2 to 13. Above each button is a red LED that glows when that channel is selected. Slightly to the right of the channel 13 button is a uhf button, which transfers tuner operation to the conventional rotary-detented uhf channel selector. The scale of the uhf channel selector is calibrated from 14 to 83, visible through a small window on the panel. It has a concentric fine-tuning ring. A small green LED, labelled TUNED glows only when a signal of sufficient strength is tuned.

On the rear apron are separate antenna inputs for uhf and vhf antennas (both 300-ohm balanced and 75-ohm unbalanced for vhf and 300-ohm balanced for uhf). Even though the audio output is monophonic, there are two audio output jacks to simplify connecting the TV audio to both channels of a stereo amplifier or receiver. Accessible through the bottom panel are a number of small control shafts, one for each vhf channel, that can be adjusted by hand or with a screwdriver. They are for tuning to the sound carrier frequency on each channel. As each is correctly tuned, the green TUNED LED on the front panel comes on. (While making this adjustment, a slide switch on the bottom panel must be set to defeat the afc and muting circuits. When all channels have been tuned correctly, the afc and muting are put back into service.) The audio outputs of the tuner are normally silent until a sufficiently strong signal has been received.

## the TVX-9500... dramatically upgrades TV sound

The performance specifications of the tuner are comparable to those of a good stereo FM tuner. They include a 65-dB signal-to-noise ratio (based on the 25-kHz maximum rated deviation of a TV-sound channel); 50-dB quieting sensitivity of 32 dBf (22  $\mu$ V); and frequency response of 50 to 10,000

Hz  $\pm 0.5/-1$  dB. Distortion is rated differently in two places in the brochure that describes the tuner, at either 0.07% or 0.13%.

Relatively simple circuits are used in this tuner, compared to those used in most stereo-FM tuners. The independent vhf and uhf "front ends" appear to be conventional TV tuners. A single-transistor i-f amplifier and a ceramic filter are followed by an integrated circuit that performs limiting and quadrature detection. A low-distortion audio amplifier, powered by bipolar supplies, delivers a nominal 400-mV output to a 4700-ohm load when the input signal has a  $\pm 25$ -kHz deviation.

**Laboratory Measurements.** We tested the TVX-9500 on vhf Channel 6, whose sound was within the tuning range of our Sound Technology FM signal generator. The muting threshold was 35 dBf, or 30  $\mu$ V (rated 34 dBf, or 28  $\mu$ V). At this signal level, the S/N was already 60 dB. We did not attempt to verify the 50-dB quieting sensitivity rating, since it fell below the muting threshold level.

Minimum distortion was reached at a 45-dBf (100- $\mu$ V) input and remained constant at higher inputs. The THD + N was 0.14% with a 25-kHz deviated signal, and the unweighted S/N was 64 dB (excellent tuner performance, when one considers that the 75-kHz deviation used in FM broadcasting would have added 10 dB to this figure). Capture ratio, rated at 1.0 dB, was not measured, owing to the muting action of the tuner. In any case, it could not be a significant specification, since cochannel or multipath interference of sufficient magnitude to interfere with sound quality would certainly result in a useless picture from the TV receiver.

The AM rejection improved from 52 dB to 58 dB as the signal level was increased from 45 to 75 dBf (rated at 50 dB at an unspecified input level). The audio frequency response was within  $\pm 0.15/-0.5$  dB from 50 to 15,000 Hz and was down 2 dB at 30 Hz. We noted that the tuner sound cut off when the modulation frequency exceeded 18,000 Hz. Perhaps the muting circuit interprets this high frequency as a noise signal, normally associated with insufficient signal strength. Audio output with 25-kHz deviation was 400 mV, exactly as rated.

**User Comment.** We have been

playing our TV sound through a hi-fi system for more than 20 years (deriving it from the detector output to bypass the TV audio system entirely). The result was sometimes much better than the normal TV sound, but more often was merely a more faithful reproduction of intercarrier "buzz" from our old TV receiver. Of course, the limited bandwidth of TV-network shows over most of that period made any improvement marginal at best.

When we used the TVX-9500, the difference was most dramatic. The quality was comparable in every way to that of most FM broadcast stations. This may have been due, in part, to the limitations of the broadcast material as well as to the improved TV sound standards and the TVX-9500. The point is that the sound was of full "hi-fi" quality and listening to it alone would give one no inkling that it came from a TV broadcast.

This is not a "sensitive" tuner in the sense that we use when talking about FM-tuner performance. It is more comparable to a TV receiver in its signal requirements, which is perfectly reasonable. Pioneer suggests connecting it to the TV antenna through a signal splitter to divide the signal between the picture and sound receivers. Alternatively, a separate antenna can be used for the TVX-9500. One thing that is *not* likely to prove satisfactory is a simple indoor dipole or "rabbit-ears" antenna. Even if the latter seems to give a satisfactory picture, it is unlikely that one could sacrifice half its output to share with the sound tuner without degrading the performance of the picture.

TV-sound tuners have been manufactured before, of course. As we recall them, they were rudimentary devices that could not be called "hi-fi" tuners. Furthermore, the TV program quality of that time made even their minuscule improvement unnecessary. Today things are different, and until such time as TV receivers with built-in high-quality audio systems become available (which may never happen), the TVX-9500 provides a very practical way to dramatically up-grade TV sound. We use the term "dramatically" intentionally, since there is nothing subtle about the improvement. Incidentally, if the speakers of a system are located on either side of the TV receiver, the sound will appear to emerge from the screen.

CIRCLE NO. 102 ON FREE INFORMATION CARD



# TRI-COLOR

## WIRE CUTTING AND STRIPPING DISPENSER



- 3 Rolls of wire in one convenient dispenser
- 3 Colors, Blue/White/Red, 50 ft. (15m) of each color
- AWG 30 (0,25mm) KYNAR® insulated wire
- Built-in cutting plunger cuts wire to desired length
- Built-in stripper strips 1" of insulation
- Easily refillable
- For wire-wrapping and other applications.

Model No. **WD-30-TRI**  
Patent Pending

WD-30-TRI	DISPENSER WITH WIRE	\$5.95
R-30-TRI	TRI-COLOR REPLACEMENT SPOOLS	\$3.95

Kynar® Permalat

MINIMUM BILLING \$25.00 / ADD SHIPPING CHARGE \$1.00 / NEW YORK STATE RESIDENT ADD APPLICABLE TAX

 MACHINE & TOOL CORPORATION 3455 CONNER ST. BRONX, N.Y. 10475 (212) 994-6600 Telex 125091  
Mark No. 37 on Inquiry Card



# COBRA'S PUNCH-THROUGH SOUND COMES TO CAR STEREO.

The same technology that brought a quality of sound to CB never before thought possible, now brings a quality of sound to car stereo never before heard.

Introducing Cobra's Punch-Through Sound.

AM/FM Stereo sound. 8-track or cassette sound. Big, booming sound that gives you great highs and low-down

lows. Because whichever

Cobra receiver you choose, you get a full 25 watts of power plus an FM sensitivity of 1.9 microvolts. And when you match your

Cobra receiver to

any one of Cobra's 2-way or 3-way speakers you get a sound that really sings. Add a Cobra graphic equalizer/amplifier and boost your power output to 60 watts. And get a sound you can feel.

See your Cobra radio dealer today. And when you buy a Cobra you also get a one year warranty and the assurance that there's a national network of factory service centers to help you with installation, service and advice.

Because whether it's CB or Autosound, if it comes from Cobra you know it's going to sound great.



## Cobra®

### Music Loud and Clear.

Cobra Communications Products  
DYNASCAN CORPORATION

6460 W. Cortland St., Chicago, Illinois 60635

Write for color brochure.



CIRCLE NO. 10 ON FREE INFORMATION CARD



BY LESLIE SOLOMON  
Technical Director

Popular Electronics®

MAY 1979

Photo courtesy Matsushita Electric Co.



## The Upcoming New World of TV Reception

*How information carried in the vertical interval can be used for a variety of personal and commercial purposes*

**M**OST PEOPLE are unaware of many things occurring on their TV receiver's screen because they're normally invisible. For example, a VIR (vertical interval reference) signal is being transmitted by some TV broadcasters to permit receivers with VIR circuitry to electronically compensate for signal variations that would otherwise deteriorate the quality of TV color intensity and tint. You don't see it on the TV screen, just as you don't see other pulses, but it's there nevertheless!

Besides these transmitted test and control signals, there are a number of unseen, experimental transmissions taking place—captions for the deaf, hundreds of pages (screensful) of alphanumeric data and simple graphics that cover weather forecasts, financial news, etc. Home video terminals are gaining in importance rapidly, using a TV signal's vertical blanking intervals. Experimental systems of this type are already working in Japan, Germany, and Great Britain, so we're not spearheading anything truly

new in this field. Indeed, the Electronic Industries Association (EIA) is trying to determine if U.S. broadcasters can utilize foreign technical standards for alphanumeric and graphics consumer TV communications.

In addition to the use being made of the vertical blanking lines of TV signals, computerized video/audio advances are making it feasible to develop a TV color "light pen" (see photo above), and TV facsimile machines are using stereo sound broadcasting (the latter an actuality in Japan, but not yet in the United States). With so much going on, then, it is interesting to examine some of the workings of these next-generation video electronic marvels.

**Using Special Signals.** Over the years, the FCC has authorized special signals to be "piggy-backed" on normal TV-program transmissions. These signals must not interfere with the normal program's picture or sound, of course.

There are four areas where such sig-

nals can be inserted. They include the horizontal blanking interval; the vertical blanking interval; the audio channel, using time and/or frequency multiplexing; and the video channel (which also employs time and/or frequency multiplexing). Of these possible options, research revealed that the best possibilities for accepting special signals are in the horizontal or vertical blanking intervals because they occur outside of the nominal screen viewing area (most TV receivers are overscanned horizontally and vertically). Hence, any special signals will not be visible on the screen, even if they modulate into white.

To understand why the vertical interval was chosen as the best spot for adding signals, let's examine the nature of both the horizontal and vertical intervals—the former first.

**Horizontal Interval.** The horizontal interval, illustrated in Fig. 1, consists of several portions, the most outstanding of which is the sync tip that synchronizes

the receiver's horizontal sweep circuits. Sync intervals are  $63.5 \mu\text{s}$  apart (reciprocal of the 15,734-Hz horizontal transmission frequency). Note the reference signal levels. Maximum carrier level at the sync tip is the maximum output power of the transmitter. Slightly below the maximum output is the reference black level. Anything greater in amplitude than this reference is "blacker-than-black" and will therefore be invisible. The blanking level is established in this non-visible zone.

The reference white level represents a low transmitter output power. A picture video signal can span the full range from black to white by swinging between the black and white reference levels. Zero carrier is never attained, since at that level the transmitter has no output.

A narrow "front-porch" leading element in the pulse forms the black framing bar seen at the right of the viewed image and is usually off-screen. Since this portion is a narrow  $1.27 \mu\text{s}$  in duration, not very much can be inserted in the way of special signals.

The sync pulse (about  $5 \mu\text{s}$  wide) synchronizes the receiver's horizontal circuit. The tips of the pulse appear to be a good place to insert special signals, but this could impose difficulties with sync-separation circuits. So it, too, cannot be used to accommodate new signals.

The "back porch" (about  $5 \mu\text{s}$  wide) forms the left-side black framing bar of the viewed image, which is also usually off-screen. This location has already

been allocated to the color burst consisting of eight cycles of the 3.58-MHz color signal. Adding another signal here could cause reception problems, so this area, too, is not a good prospect for inserting special signals.

**Vertical Interval.** The vertical interval was chosen to carry special signals owing to its long duration. Here's how it evolves. Each horizontal sweep "paints" a narrow line across the CRT screen. When it gets to the right side, the electron beam is blanked (made invisible) and the horizontal circuit causes the beam to rapidly retrace to the left side to continue the cycle. This retrace takes less than  $10 \mu\text{s}$ . The much slower vertical sweep causes the glowing line to move down a little for each successive horizontal sweep. This action produces the picture raster. But, what happens when the horizontal sweep reaches the bottom of the picture? Here is where the vertical blanking interval comes in.

At this point, internal blanking circuits cut-off the CRT electron beam so that it does not produce a glowing line on the CRT, and the vertical sweep circuit causes the now-dark beam to retrace to the top of the screen. The transmitted sync signals are arranged so that this invisible vertical retrace takes the time equivalent of 21 horizontal lines. Since each horizontal line is  $63.5 \mu\text{s}$  long, the vertical interval occupies a little more than  $1333 \mu\text{s}$ . But what is more important, it contains 21 horizontal lines that

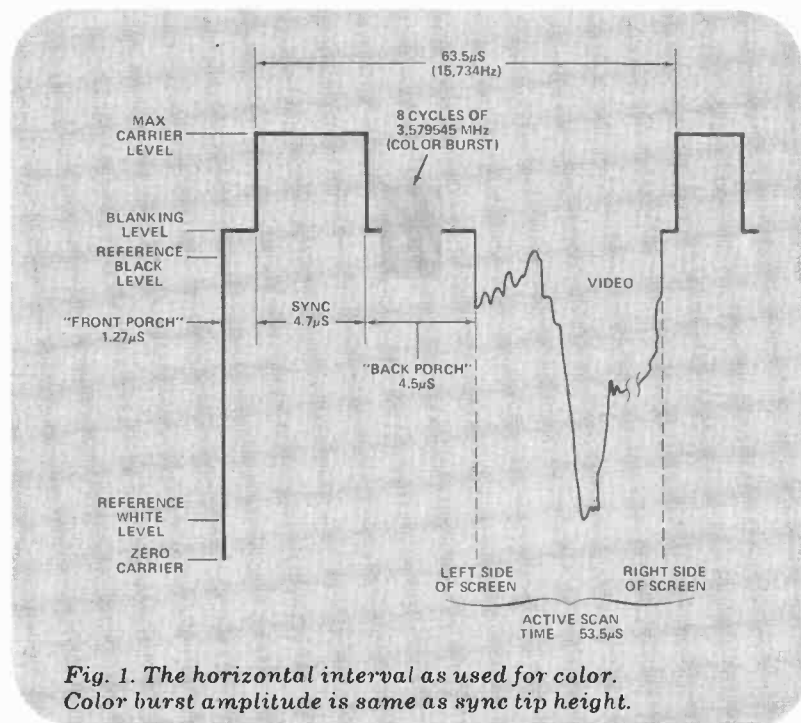

Fig. 1. The horizontal interval as used for color. Color burst amplitude is same as sync tip height.

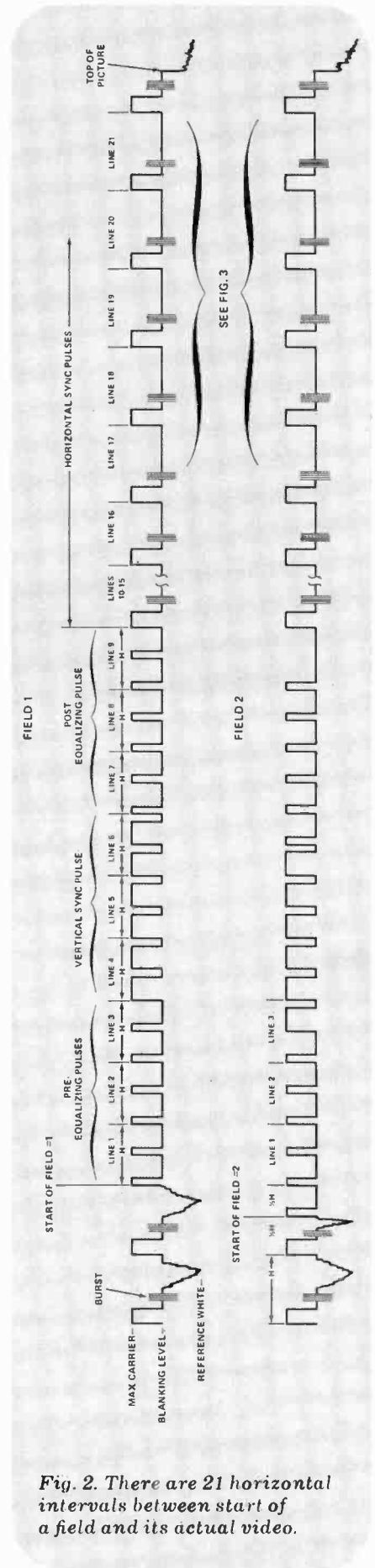

Fig. 2. There are 21 horizontal intervals between start of a field and its actual video.



are not used for the viewed image.

Also, engineering studies have shown that a smoother visual display will occur if one frame of video is divided into two fields, with one interlacing the other.

To avoid picture "tearing" (unsynchronized for several horizontal lines), horizontal sync pulses, or their equivalents in time, must be transmitted during the vertical interval. Also, since 525 horizontal scanning lines were specified for the NTSC (National Television System Committee) signal, each of the two viewed fields had to contain 262.5 lines. It was decided to produce the half line just before the start of field two (Fig. 2). Thus, one field begins with a complete horizontal line having its origin at the top left corner of the screen and ending with a half line at the bottom of the screen. The next field starts with a half line that has its origin at the top center of the screen and ends with a whole line at the bottom.

Note that all activity in the vertical-

blanking interval occurs in the blacker-than-black area so that it is not visible. All synchronization occurs on the positive-going edge of a pulse.

The first nine lines of a field are occupied by six (pre) equalizing pulses, the vertical-sync pulse, and six (post) equalizing pulses that occur at half-line intervals and are half the width of horizontal-sync pulses.

During vertical retrace, the receiver's horizontal oscillator is locked to its frequency by the equalizing pulses.

Without equalizing pulses, the horizontal oscillator may drift far enough off-frequency to require several lines to get it back into sync, causing the picture to "tear." Because they are at twice the horizontal frequency, the equalizing pulses permit the half-line start at the beginning of field two.

Vertical sync consists of one long pulse of three times the horizontal interval time, which is broken up into six sections by inverted equalizing pulses. The

positive-going edges of alternate sections provide the sync for the horizontal oscillator to assure that it maintains lock during the vertical sync interval. After the second set of equalizing pulses has passed, the signal reverts to conventional horizontal sync (with color burst) until the video starts again.

There are, then, a total of 21 real and equivalent horizontal lines from the beginning of the field to the start of that field's video. The first nine lines have been described, leaving lines 10 through 21 available for other use.

Back in 1967, RCA conducted a test of special signals on lines 10 through 17 for its "Homefax" system. The system used vertical-interval signals to produce facsimile copy on a printer attached to a TV receiver. Tests were also conducted in Japan, involving lines 14 through 21 and digital data transmission.

An expanded view of the currently used lines 17 through 21 is shown in Fig. 3. There are some similarities and some

*(Continued on page 55)*

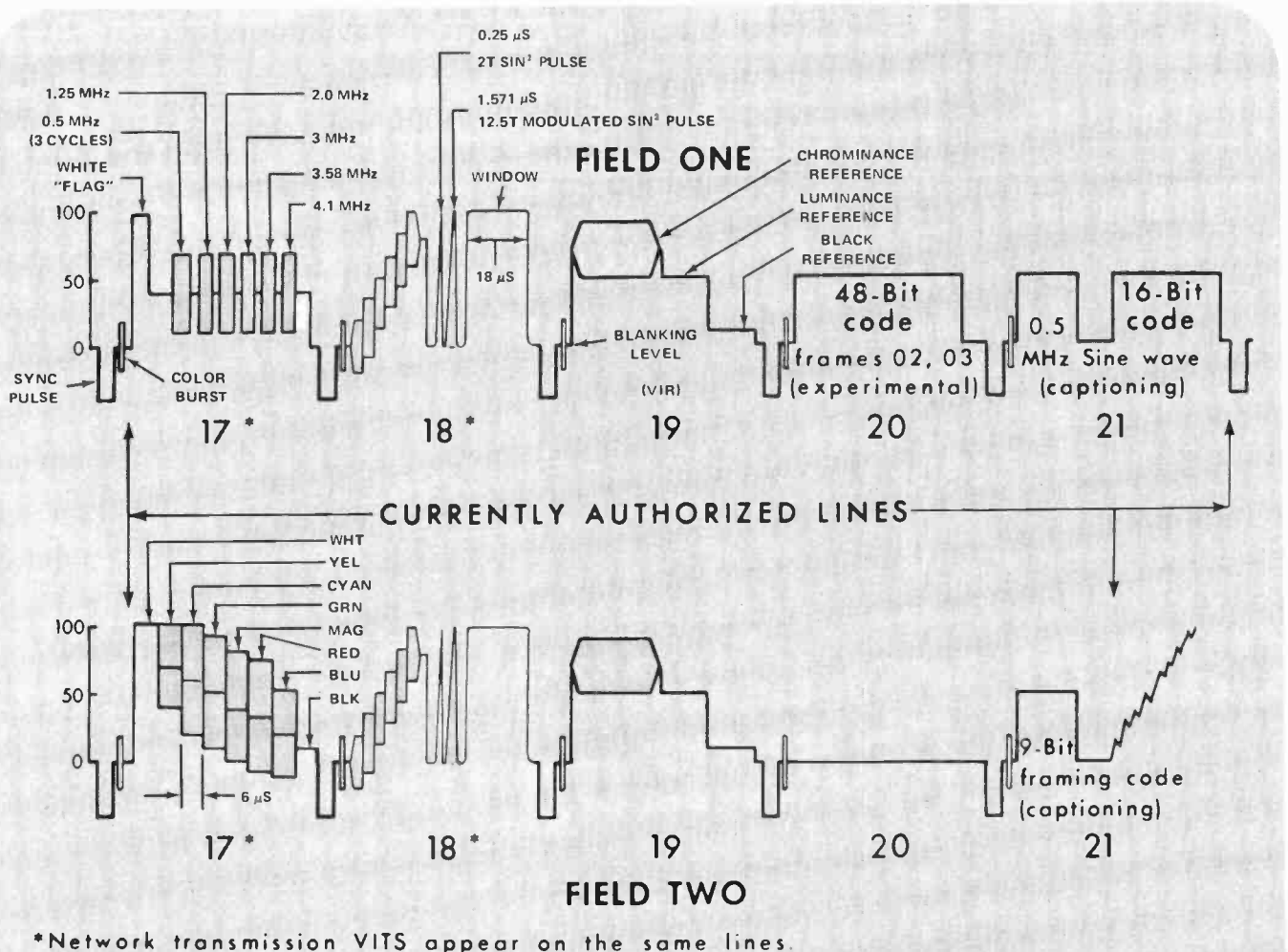

Fig. 3. The current authorized vertical interval use of lines 17 through 21.

<b>24 ISSUES</b> <b>APARTMENT LIFE</b> YOU PAY ONLY \$7.97 Reg. Rate: 24 iss./\$14.97	<b>18 ISSUES</b> <b>Field &amp; Stream</b> YOU PAY ONLY \$5.97 Reg. Rate: 18 iss./\$11.93	<b>12 ISSUES</b> <b>Popular Electronics</b> YOU PAY ONLY \$8.97 Reg. Rate: 12 iss./\$13.00	<b>26 ISSUES</b> <b>Sports Illustrated</b> PAY ONLY \$12.77 (Reg. Rate) Newsstand Rate: 26 iss./\$22.50
<b>6 ISSUES</b> <b>BACKPACK</b> YOU PAY ONLY \$7.87 Reg. Rate: 6 iss./\$15.00	<b>7 ISSUES</b> <b>FLY FISHERMAN</b> YOU PAY ONLY \$9.97 Reg. Rate: 7 iss./\$11.97	<b>12 ISSUES</b> <b>PHOTOGRAPHY</b> YOU PAY ONLY \$6.99 Reg. Rate: 12 iss./\$13.98	<b>12 ISSUES</b> <b>Stereo Review</b> YOU PAY ONLY \$4.99 Reg. Rate: 12 iss./\$9.98
<b>12 ISSUES</b> <b>Better Homes and Gardens</b> YOU PAY ONLY \$10.00 Newsstand Rate: 12 iss./\$12.00	<b>18 ISSUES</b> <b>FORTUNE</b> YOU PAY ONLY \$16.75 Newsstand Rate: 18 iss./\$36.00 (Reg. Rate)	<b>12 ISSUES</b> <b>Prevention</b> YOU PAY ONLY \$6.97 Reg. Rate: 12 iss./\$9.00	<b>25 ISSUES</b> <b>TIME</b> PAY ONLY \$14.97 (Reg. Rate) Newsstand Rate: 25 iss./\$31.25
<b>12 ISSUES</b> <b>Boating</b> YOU PAY ONLY \$9.97 Reg. Rate: 12 iss./\$15.00	<b>12 ISSUES</b> <b>HOUSE BEAUTIFUL</b> YOU PAY ONLY \$7.97 Reg. Rate: 12 iss./\$10.00	<b>12 ISSUES</b> <b>psychology today</b> YOU PAY ONLY \$6.97 Reg. Rate: 12 iss./\$12.00	<b>29 ISSUES</b> <b>TV GUIDE</b> YOU PAY ONLY \$9.88 Lowest Available Sub Rate
<b>12 ISSUES</b> <b>CAR &amp; DRIVER</b> YOU PAY ONLY \$5.99 Reg. Rate: 12 iss./\$11.98	<b>10 ISSUES</b> <b>LIFE</b> YOU PAY ONLY \$14.97 Lowest Available Sub Rate	<b>18 ISSUES</b> <b>REDBOOK</b> YOU PAY ONLY \$11.93 Newsstand Rate: 18 iss./\$22.50	<b>52 ISSUES</b> <b>TV GUIDE</b> YOU PAY ONLY \$18.00 Lowest Available Sub Rate
<b>10 ISSUES</b> <b>CUISINE</b> YOU PAY ONLY \$4.95 Reg. Rate: 10 iss./\$8.95	<b>18 ISSUES</b> <b>Mechanix ILLUSTRATED</b> YOU PAY ONLY \$5.96 Reg. Rate: 18 iss./\$11.90	<b>26 ISSUES</b> <b>Rolling Stone</b> YOU PAY ONLY \$12.00 Reg. Rate: 26 iss./\$18.00	<b>15 ISSUES</b> <b>us</b> YOU PAY ONLY \$8.97 Lowest Available Sub Rate
<b>12 ISSUES</b> <b>Cycle</b> YOU PAY ONLY \$5.99 Reg. Rate: 12 iss./\$11.98	<b>12 ISSUES</b> <b>Ms.</b> YOU PAY ONLY \$5.97 Reg. Rate: 12 iss./\$10.00	<b>7 ISSUES</b> <b>SKIING</b> YOU PAY ONLY \$5.99 Reg. Rate: 7 iss./\$8.98	<b>29 ISSUES</b> <b>U.S. NEWS &amp; WORLD REPORT</b> YOU PAY ONLY \$9.97 Reg. Rate: 29 iss./\$12.25
<b>16 ISSUES</b> <b>ESQUIRE</b> YOU PAY ONLY \$10.00 Newsstand Rate: 16 iss./\$20.00	<b>23 ISSUES</b> <b>Newsweek</b> YOU PAY ONLY \$13.25 Newsstand Rate: 23 iss./\$28.75 (Reg. Rate)	<b>4 ISSUES</b> <b>SPORT DIVER</b> YOU PAY ONLY \$9.97 Reg. Rate: 4 iss./\$12.00	<b>12 ISSUES</b> <b>working Woman</b> YOU PAY ONLY \$7.50 Newsstand Rate: 12 iss./\$15.00



# Call Magazines at Discount and SAVE up to 50%

Here's your chance for a real bargain bonanza on your favorite magazines. You may select as many as five of these titles at the special introductory rates shown—up to 50% off! To order, mail card or call—Toll-Free 800-247-2160

In Iowa, call toll-free 1-800-362-2860.

Magazines At Discount,

A division of Ziff-Davis Publishing Co., P.O. Box 601, Broomall, Pennsylvania 19008.





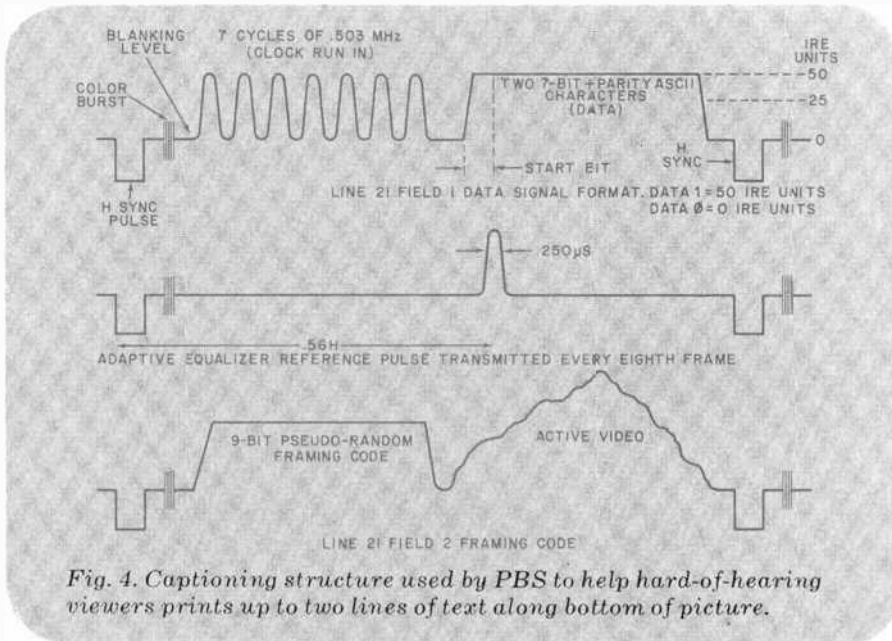

Fig. 4. Captioning structure used by PBS to help hard-of-hearing viewers prints up to two lines of text along bottom of picture.

differences between signals on both fields. It is possible to see these signals if you adjust the vertical hold of your TV receiver until the thick black bar rolls down into view. It may be difficult to make this bar stationary, but it can be kept in place long enough to see the signals. The vertical-interval signals are the one-scanning-line-thick dot-and-bar structures that can be seen on the five scanning lines immediately above the picture, at the bottom of the black bar. Some of these components may be in

color. Bear in mind that not all stations carry the same vertical-interval test signals (VITS), and non-network stations may not have any.

Lines 17 and 18 carry the VITS. When provided by a network, these signals are used to check network transmission facilities. Provided by a local station, they are used to check transmitter performance. These signals essentially emulate a complete video and chroma test signal that is continuously in operation, even when the normal TV picture is be-

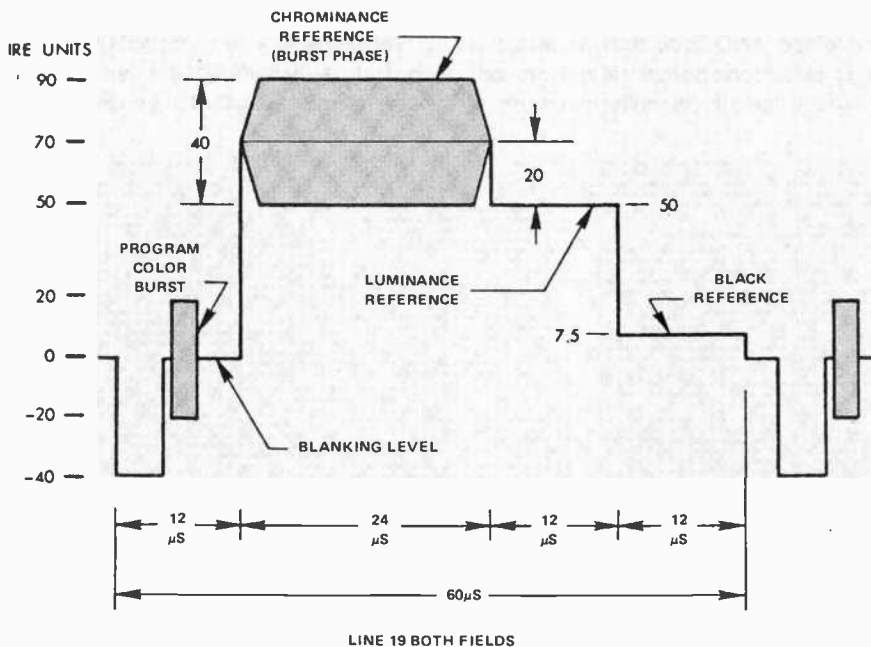

Fig. 5. Vertical interval reference (VIR) can be used to automatically control picture tint and level.

ing displayed. The signals do not interfere with the on-screen picture. Station technicians simply pick them off for making measurements.

Line 18 of both fields currently carries a "staircase" of the 3.57-MHz bursts (the chroma reference) at progressively lighter shadings for differential phase and gain checks of a transmitter. The two sine-squared pulses are used to make one-pulse checks of the system, since a single sine-squared pulse contains all the frequencies the system must pass. The larger of the two pulses modulates the chroma reference. These two pulses are followed by a white "window" that checks for transient ringing.

Signals on lines 17 and 18 are required to be radiated by remote-controlled TV transmitters. These lines are used for network transmission of test signals, which are different in format and which would be deleted prior to radiation by the remote-controlled station.

Line 20 of field one is currently an experimental line. Some network stations carry a source identification code during this interval.

Line 21 is used for picture captioning, a procedure used to help the estimated 13.4-million hearing-impaired people in the U.S. In 1975, Public Broadcasting System (PBS) began an "open" caption format for some of its news programs. It is currently being carried by 125 member stations.

As shown in Fig. 4, all of line 21 field one and the first half of line 21 field two are used for captioning purposes. The data signal is a non-return-to-zero (NRZ) format that uses standard 7-bit plus parity ASCII coding. The framing code used by the associated decoder is transmitted during the first half of line 21 field two, when data reference and test signals are present. The center waveform in Fig. 4 shows the reference pulse, transmitted every eighth frame, to be used by the decoder-associated multipath equalizing filter.

In operation, caption data is removed from the vertical interval and displayed at the bottom of the screen. The present PBS system is capable of transmitting written text at faster than 550 words/minute. It is expected that caption-decoding equipment will be ready for use to serve the hearing-impaired public in the not too distant future.

**Vertical Interval Reference.** The basic difference between the VIT (vertical interval test) and the VIR (vertical interval reference) signals is in applica-

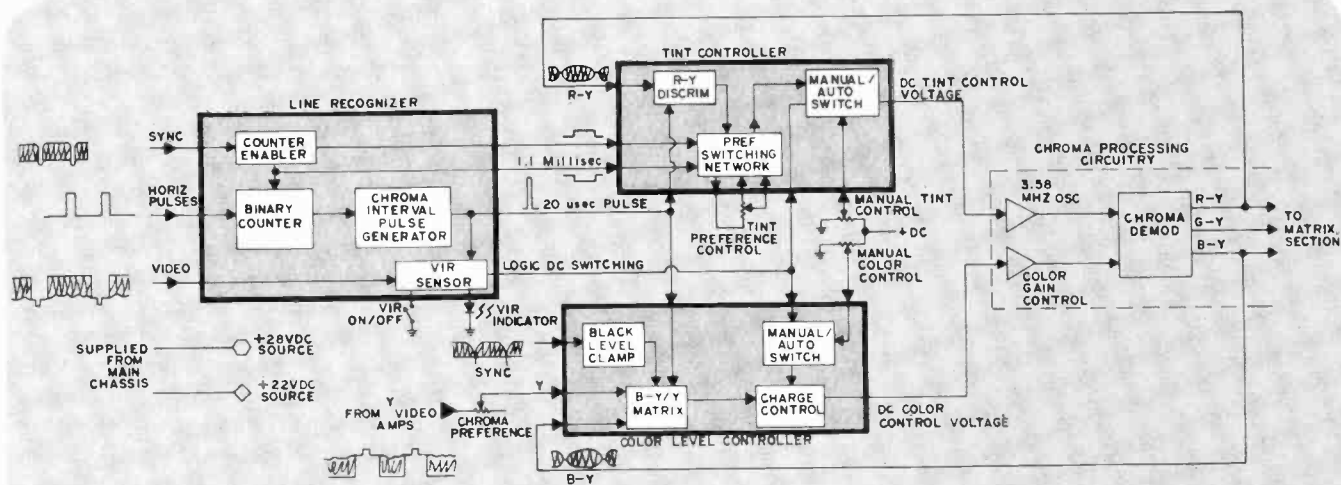

Fig. 6. General Electric VIR-II automatic color tint and level controller uses VIR on line 19.

tion. VIT signals are used to monitor transmission equipment and system performance, while VIR monitors the parameters of the color program being transmitted.

The VIR, shown in Fig. 5, occupies line 19 of both fields. The signal consists of a horizontal-sync pulse, color burst, chroma reference (same frequency as burst), luminance reference, and black reference.

Different color-TV manufacturers use different approaches to using VIR signals. The method used in General Electric's VIR-II system is shown in Fig. 6. When the chrominance and black reference levels are equal in amplitude at the receiver's R - Y output, chroma phase (color tint) conforms to that of the transmitted reference signal. When these two signals are equal at the blue drive output, the chroma level (color) is matched

to the transmitted reference signal.

Line 19 is selected as shown in Fig. 7. The vertical-sync pulse toggles a bistable flip-flop connected to the reset input of a seven-stage counter. Horizontal pulses are connected to the clock input. The delay allows the flip-flop to toggle on the second serration of the vertical-sync pulse. This allows both fields to toggle the flip-flop during the fourth scan line so that the count always begins at the same point in each field.

There is only one state where four of the outputs from the counter are all 1's simultaneously; that is at line 19. (Binary 1111 equals 15 scanned lines, which when added to the four preset lines, brings the total to 19 lines.)

Outputs from the counter are coupled to a diode AND gate that produces a 63- $\mu$ s pulse (one horizontal line interval) at exactly line 19. An inhibit line turns off

the flip-flop until the next field (vertical) sync pulse. The process then repeats.

The line-19 gate signal goes to a chroma-interval pulse generator where a 20- $\mu$ s pulse that corresponds to the chroma-reference interval on line 19 is created. When present, this signal generates the operating voltages for the tint and color-level controllers.

The VIR sensor (Fig. 6) detects the presence or absence of the VIR signal. If VIR is not present, the output voltage of this circuit causes the manual/auto logic to switch to manual operation of the color and tint controls. If it is present, the VIR indicator lamp comes on and the output of the circuit switches into auto so that the receiver itself controls the color and tint.

Since the key to using VIR depends on accurate location of the vertical-sync pulse, some means must be used to ac-

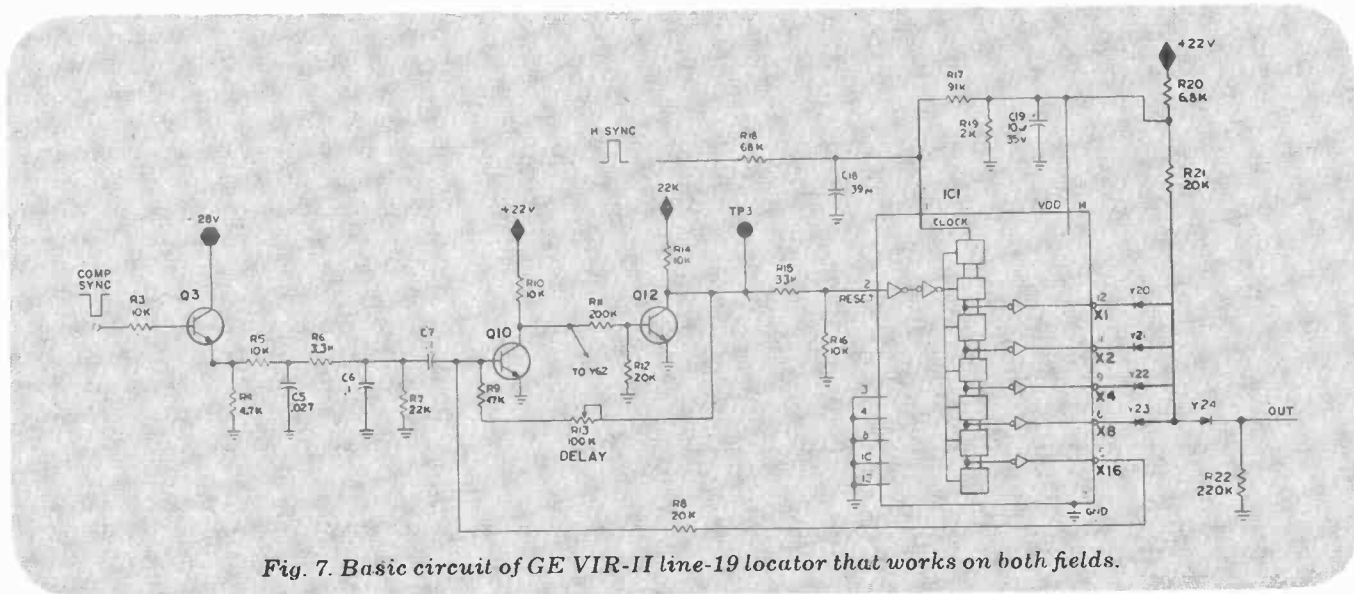

Fig. 7. Basic circuit of GE VIR-II line-19 locator that works on both fields.



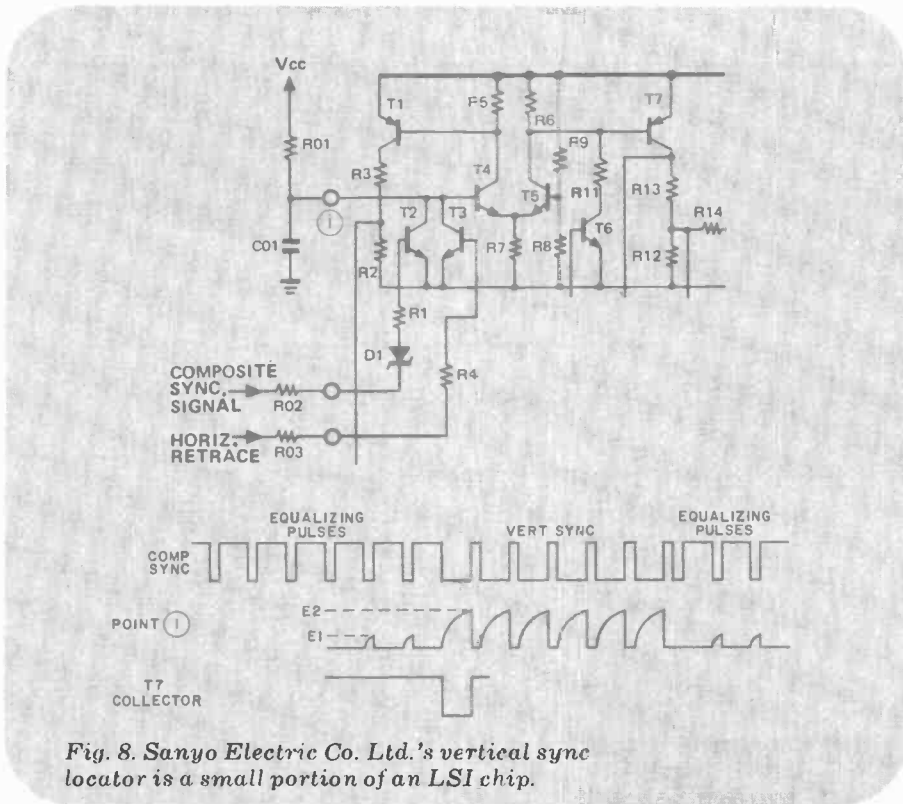

Fig. 8. Sanyo Electric Co. Ltd.'s vertical sync locator is a small portion of an LSI chip.

curately locate this pulse. With a half-line difference between the two interlaced fields, pulses removed by a conventional sync clipper will "skew" with each field.

**Manufacturer Circuits.** Shown in basic form in Fig. 8 is part of an LSI chip used in Sanyo's vertical-sync pulse locator circuit. The composite sync from a conventional sync separator causes Q2 to turn off during the period of these pulses. The horizontal-retrace pulse cuts off Q3 during this interval. When Q2 and Q3 are cut off, the Q4 base-circuit capacitor charges up during the equalizing and vertical-sync interval. When Q2 and Q3 are conducting, the capacitor discharges, keeping the base of Q4 at ground potential. Since the intervals between equalizing and vertical pulses are different, the pulses at the base of Q4 vary, as illustrated by the accompanying waveforms.

The base voltage of Q5 is set to a level about half-way between E1 and E2. Hence, only the higher-amplitude pulses get through. Once the vertical is clearly identified, another circuit locates line 19.

A pulse-width-to-height converter is used by Matsushita to remove the vertical sync from the composite waveform. The basic circuit and its associated waveforms are shown in Fig. 9. The

transistor turns on and supplies charging current to  $C_b$  through  $R_b$  when its base is high. When the base goes low, at time  $t_1$ , the transistor cuts off and  $C_b$  discharges through  $R_a$  and  $D_1$ . The voltage across  $R_a$  decreases according to the  $C_b R_a$  time constant.

When a high is applied to the base at time  $t_2$ , the transistor turns on and instantly raises the voltage across  $R_a$  and  $R_b$ . During time  $t_2$  to  $t_3$ , a charging current to  $C_b$  is produced via  $R_b$ . Depending on the amount of charging current, a gradually decreasing voltage, determined by time constant  $C_b R_b$ , appears across  $R_b$ .

At time  $t_3$ , the transistor cuts off. This discharges  $C_b$  and decreases the voltage across  $R_a$ . This voltage decrease depends on the cutoff time of the transistor. The pulse height across  $R_b$  is determined by the width of the vertical pulse segments. The pulses that appear across  $R_b$  are sent to a threshold circuit that allows only the vertical-sync pulses to pass. Once derived, the clean vertical sync operates a line-19 counter.

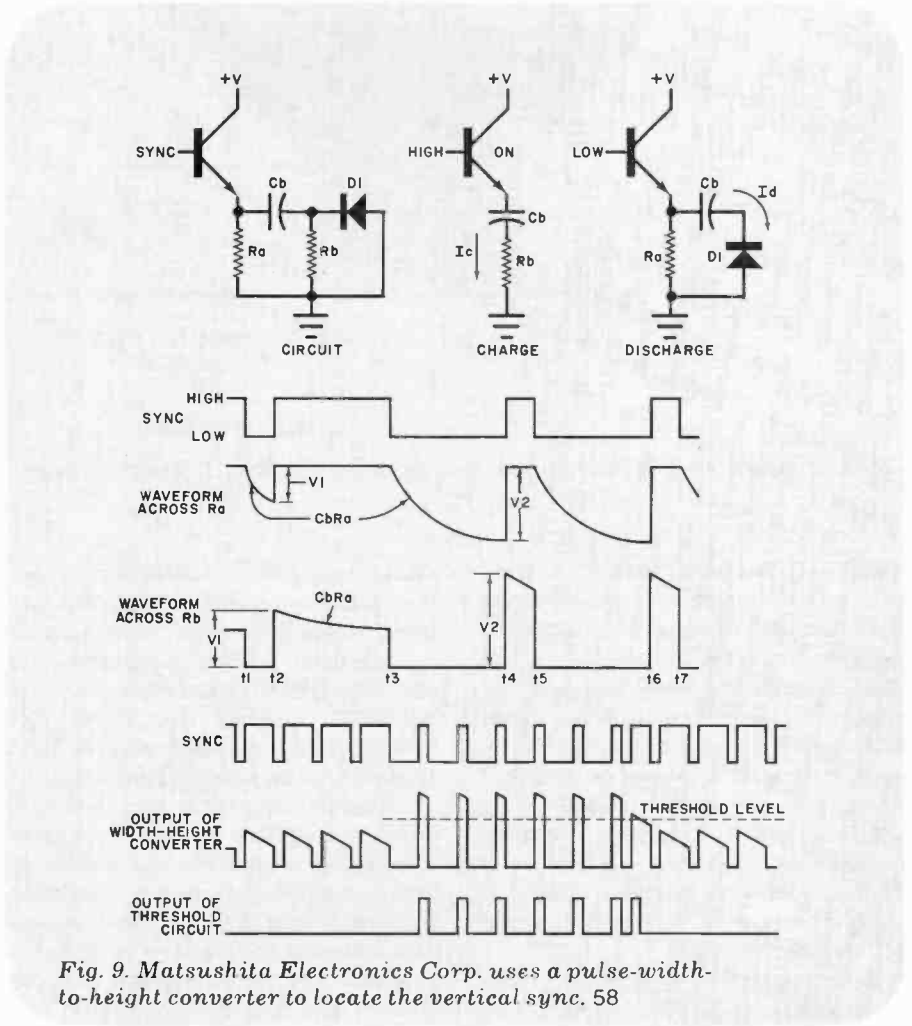

Fig. 9. Matsushita Electronics Corp. uses a pulse-width-to-height converter to locate the vertical sync. 58

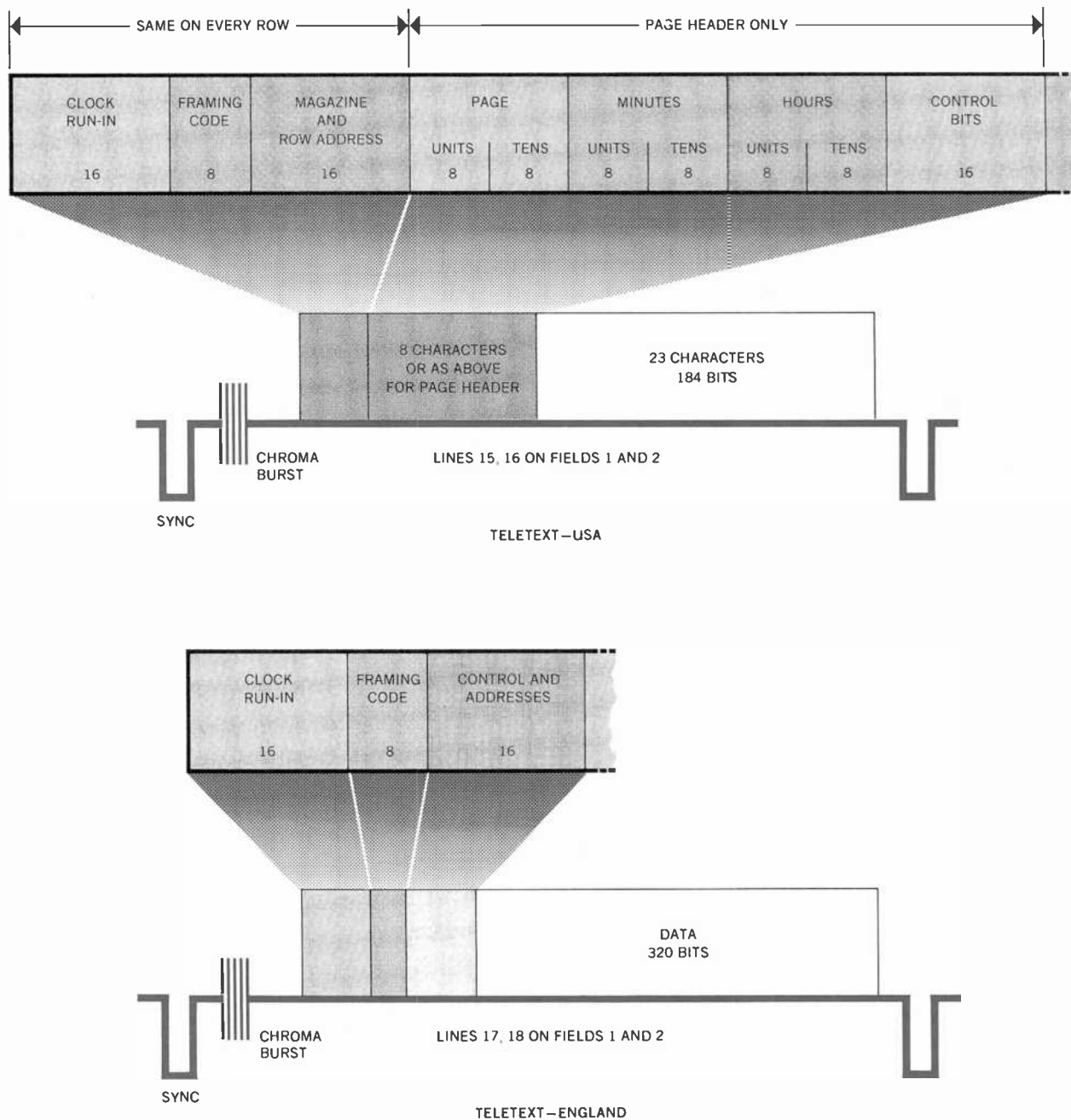

Fig. 10. Basic arrangement of the American and British Teletext systems.

**Teletext.** The term "Teletext" is used to describe a system for transmission of alphanumeric characters and simple graphics during the vertical interval. The data is extracted and displayed on-screen in place of conventional video. With such a display system, there is almost no limit to what can be "printed" on-screen—with color capability.

Several countries are using or experimenting with one form or another of Teletext. Only one TV station in the U.S. (KSL in Salt Lake City) is testing a form of Teletext at present.

In England, CEEFAX and Oracle (Optional Reception of Announcements by

Coded Line Electronics) systems have been used since 1974. CEEFAX is also being tested in Sweden, Australia, and New Zealand. Canada is experimenting with VIDEOTEXT, while France is using ANTIOPE. Sweden has tested EXTRATEXT for picture subtitling. Italy and Bavaria have tested digital encoding.

Japan is trying out a couple of systems. In one, both Japanese and other ideographic symbols can be transmitted. In the other, still pictures are transmitted a couple of lines at a time (within the vertical interval). The lines are stored on a magnetic medium until a full frame is present and then played back in real

time. Even music can be digitized.

KSL's Teletext and CEEFAX transmitted signals are similar (Fig. 10). American Teletext is licensed by the British, which explains the similarity. However, some differences between the two systems exist due to the different scanning rates in the two systems. Data transmission is via the NRZ technique, which allows reduced bandwidth. During encoding, discrete pulses are not used. Instead, data is transmitted as 0 (low) and 1 (high) voltage levels. If a series of 1's is transmitted, the signal remains high for all adjacent 1's instead of dropping to zero between each pulse. For multiple

0's, the signal simply remains low for all adjacent 0's. A clock signal determines whether a 1 or a 0 occurs at clock time.

Since all transmission paths are subject to distortion-inducing errors, particularly multipath in TV reception, code-protection schemes are used. The character code is 7-bit ASCII, with odd parity for a total of eight bits. The address code uses four parity bits in a Hamming code.

The clock's 16 run-in bits are used to lock the decoder clock in frequency and phase in a similar fashion to that used to lock the receiver's chroma oscillator to the color burst in a color receiver. The framing code indicates the start of the first 8-bit word; the 16 bits following the

framing code (address) identify which of the 20 rows is being transmitted. These signals are also protected by the Hamming code.

The page data identifies the page being received, while the hours and minutes bytes are used to insert the local time in the displayed image. Alternatively, they can be used to preset the system to accept data transmitted at a certain time. Remaining control bits perform system "housekeeping," while the rest of the line contains the actual data.

U.S. Teletex has 20 rows of 31 characters/row (UK system uses 23 rows of 40 characters) and operates at seven pages/second. ASCII characters are

transmitted with a choice of six colors, including white. Special video effects—flashing, boxing, and inversion—can be performed using nonvisible control characters. Up to 800 pages of "magazine" can be transmitted, using the 5.5-megabaud rate in lines 15 and 16. When this rate is spread over the entire TV screen, it drops to about 30 kilobaud. The pages are transmitted in a repeating cycle with any necessary updating.

In the Salt Lake City tests, the receivers used the Texas Instruments developed TIFAX decoders. These decoders contain a signal slicer that removes the pertinent lines from the two fields; one page of RAM; a character generator;

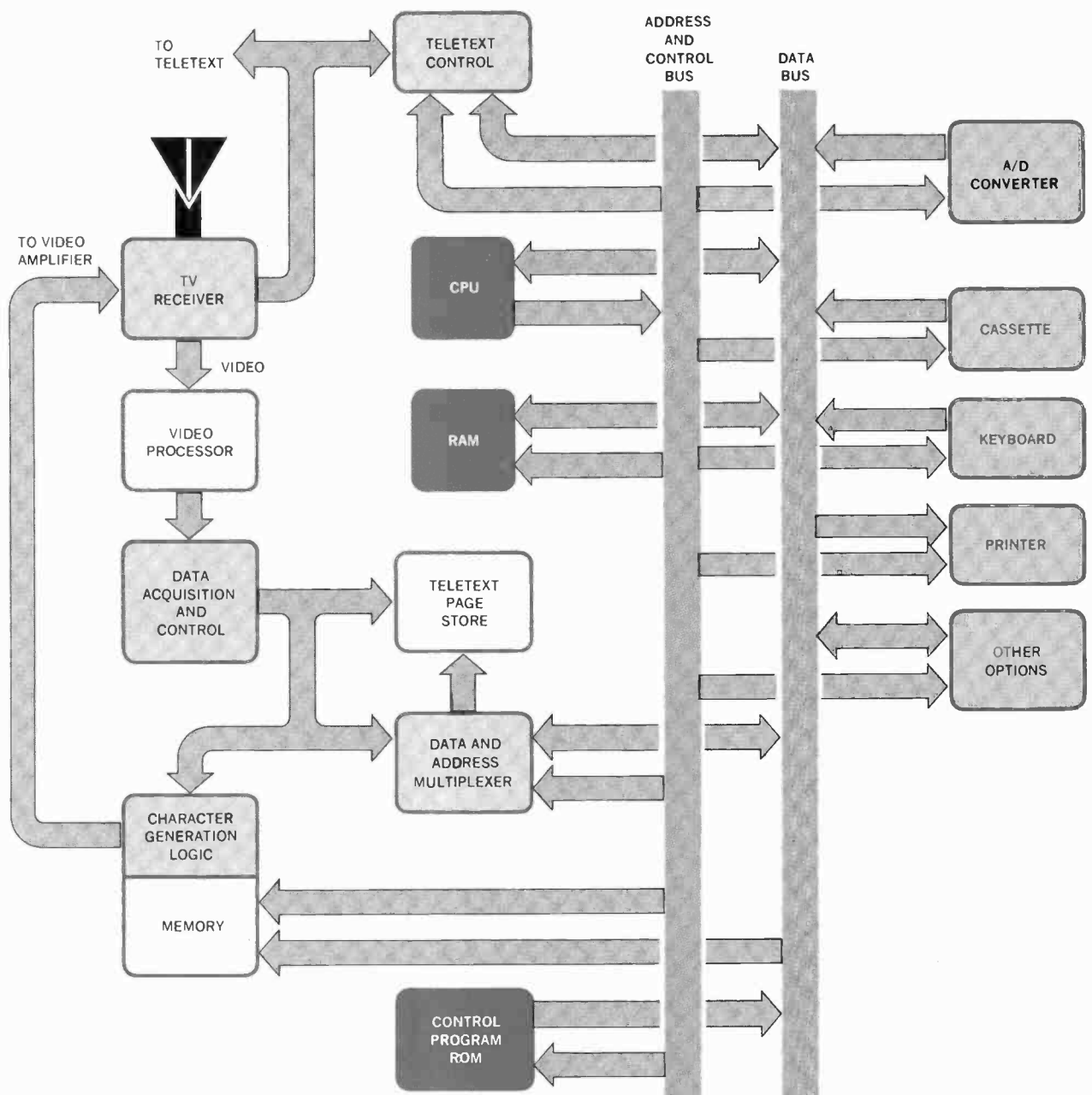

Fig. 11. Designed by ORACLE engineers, this small computer system gets software from Teletext.

color matrixing; and various timing and control logic. All subcircuits are implemented on LSI chips.

The Teletext keypad has four keys. One is used for conventional TV viewing; the second "calls" the Teletext and deletes the conventional video; the third allows for mixed TV and Teletext (Teletext in monochrome here); and the fourth is used for page selection. In use, the viewer selects a page number via the keypad. The page number appears at the upper left corner of the screen. A special "header" line displays the various pages available alongside the requested page header, which remains stationary. When the selected page header is received and decoded, the data it contains fills the screen. This page remains on-screen until it is deleted or another page request is made.

**Telecomputing.** Since the Teletext system is a digital CRT alphanumeric/graphics display (in color if desired), it operates like a "dumb" computer terminal. Even a dumb terminal, however, can be made "smarter" by adding a microprocessor and support logic.

Engineers at England's ORACLE have, in fact, designed and built such a

system, using the logic shown in Fig. 11. Note the similarity to any other small computer in that there is a bus system, CPU, some RAM, an operating system (control program) in ROM, and several I/O ports. What sets this system apart is that it gets its software via the Teletext system.

This "Telesoftware" is transmitted as conventional Teletext lines and is selected by the user from a "menu" that appears on one regular page. If a high-level language like BASIC is stored in ROM, there is a very wide variety of available programs. Programs can be longer than one Teletext page, since two or more pages can be merged. The number of programs available depends on how many lines the service allows before interference with the regular pages. It may well be that at some future time, other vertical-interval lines will be used just for computer programs. In addition to home computing, this system can be used for small business computing or to play arcade-type games.

Once the service is running and a bus has been established, there is almost no end to what peripherals can be plugged in. This will make the home TV receiver the ultimate video system in that it will in-

teract with the viewer. Perhaps one day, when cable facilities are adequate, two-way transmissions will come into being.

**Teleview.** General Instrument Corporation's version of a Teletext receiver is shown in block form in Fig. 12. This "Teleview" approach is similar to the British approach and looks like a basic computer. It uses a microprocessor-based controller that also contains an "operating system" in built-in ROM, RAM to store data, a video generator to drive the CRT color and luminance circuits, and a data acquisition module that accepts the Teletext data removed from the vertical interval by the Data Grabber.

Provisions are provided to accept optional telephone-line data (Viewdata) via a modem. Unlike conventional computers, the keyboard can be directly wired to the controller or operated via an optional infrared link. Other I/O ports to make hard copy and cassette recordings are in the works. At this writing, these circuits employ the GI-fabricated data acquisition chip No. G0977-11, video generator No. G0977-12, and No. PIC1650 microprocessor-based controller No. G0977-13. The infrared circuit uses AY-3-8471 and AY-3-8475 trans-

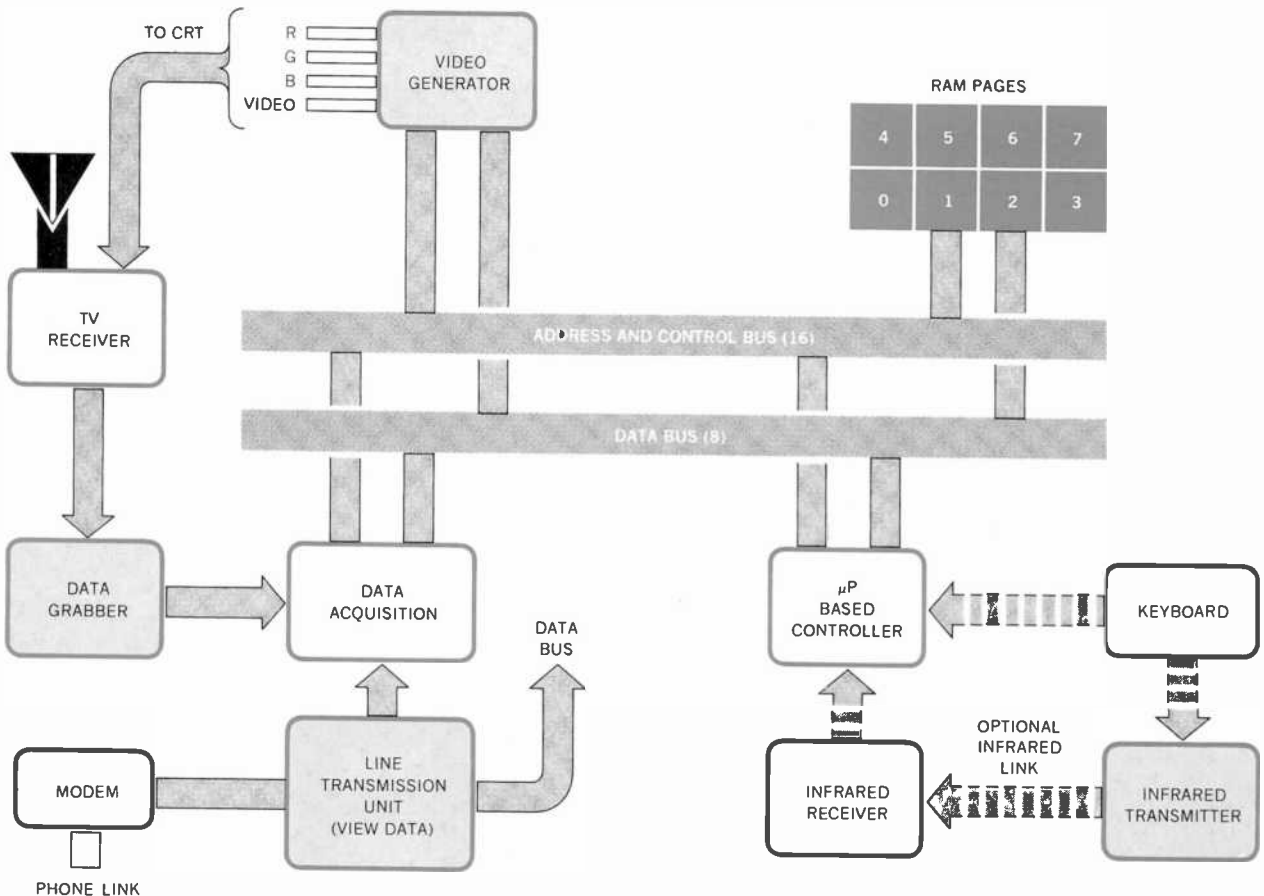

Fig. 12. General Instrument Corp.'s version of Teletext is called Teleview.



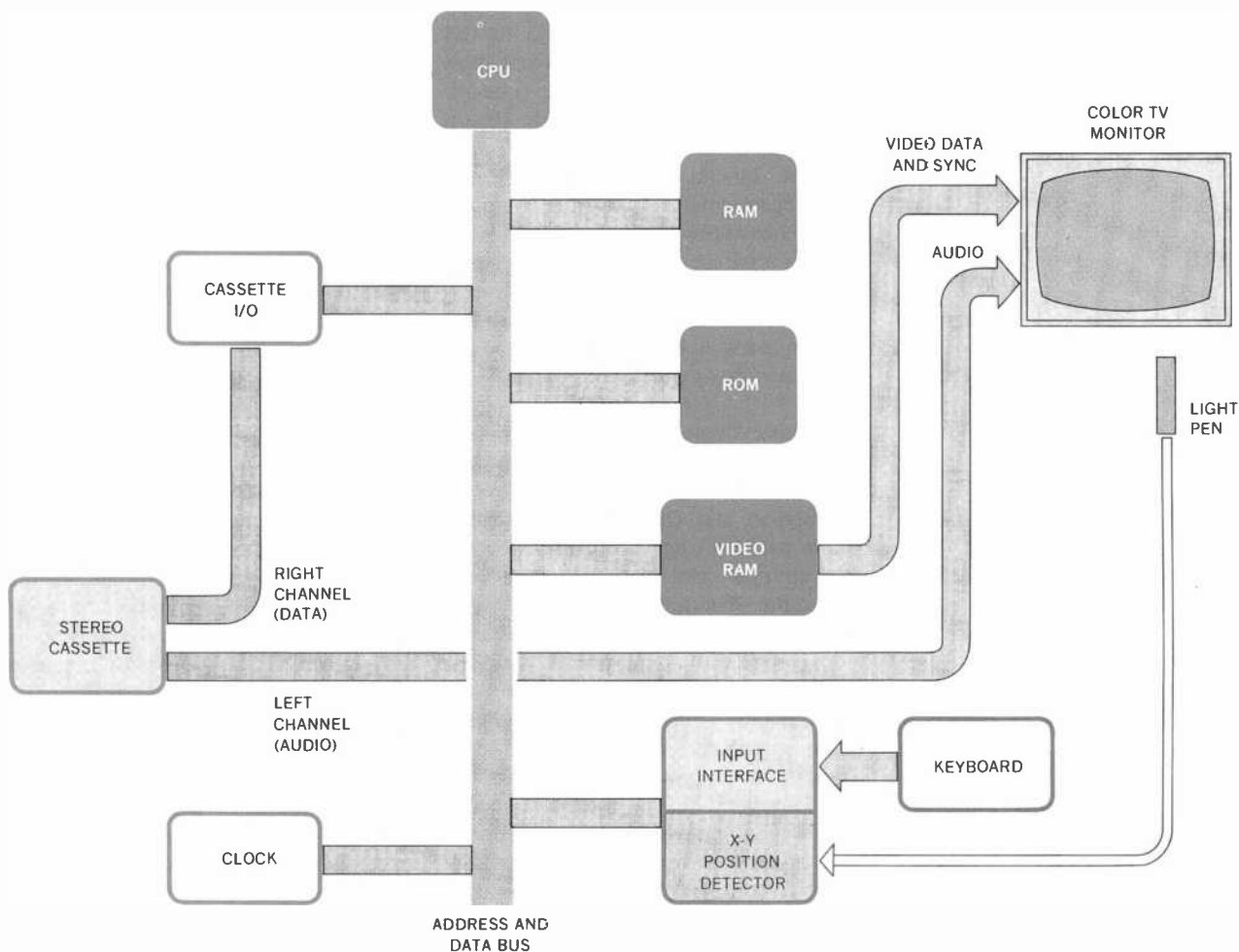

Fig. 13. Home education-amusement video system developed by Matsushita Electric Co.

mitter and receiver chips, respectively. The telephone-line transmission unit is soon to be released, as are other I/O port devices.

The single-chip PIC1650 microcomputer contains 32 8-bit registers,  $512 \times 12$  bit ROM, ALU, four sets of eight user-defined TTL-compatible I/O lines, real-time counter, and clock and uses a single 5-volt line. Both keyboard scanning and display can be performed simultaneously. This chip controls the address and data lines and uses eight bits for the keyboard, eight bits for the data bus, and sixteen bits for address and control signals.

The video generator defines which TV line is expected to contain Teletext data and sends a signal to the Data Grabber to accept that line just before the Teletext's clock run-in is expected. The received Teletext data is then decoded and is checked for any transmission er-

rors by the data acquisition module.

Pages of text are requested through the keyboard and controller. Teletext pages are identified by a three-digit code—such as 100 to 199, 200 to 299, etc.—called a "magazine." At present, page numbering goes to 899 (eight magazines). When a page is requested, its number appears at the upper left of the display. As the various pages "roll through," they are momentarily displayed until the requested page comes up. When the page number matches the selected code, the data is "dumped" into RAM for storage and display. Any page can be erased or updated as desired, and up to eight different pages can be stored and accessed without delay.

In the PICTURE mode, the normal TV image is seen on-screen and any special newsflash and subtitle pages appear in a box in the TV picture. Characters in other pages can be displayed by

operating a REVEAL/CONCEAL switch.

In the MIX mode, the TV picture is displayed and the incoming Teletext data appears in monochrome characters superimposed on the screen. Another user-selectable function includes an on-screen "clock box" to display time.

The Viewdata setup receives data via telephone lines. Because reception is asynchronous with the Televue system, a separate data path is required. Up to three characters can be received during a TV frame. Tests are still being made on the telephone-line option. Although no information is available, we can assume that other semiconductor manufacturers are developing their own versions of Teletext chips.

As a result of using phone lines, the capability of two-way data exchanges is inborn. For example, a subscriber could have a dialogue with a computer data bank to, say, call up his bank statement

# The best speaker kit isn't a kit at all!

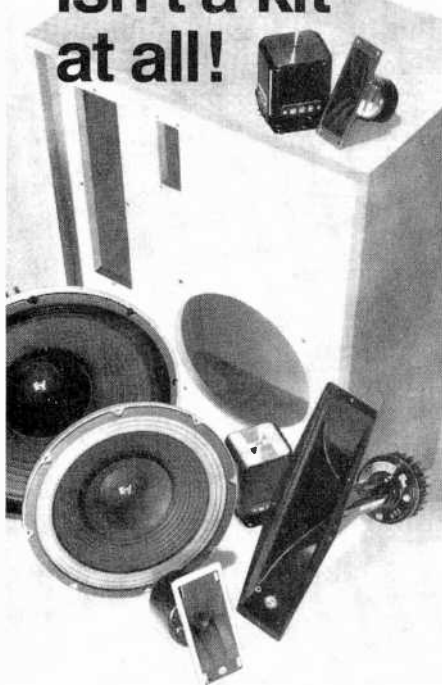

The best speaker kit is a system designed by Electro-Voice that allows you to choose your own level of performance; from a studio monitor to a modest bookshelf system, from a wide selection of woofers, tweeters, mid-range drivers and crossovers.

Then Electro-Voice provides detailed plans on how to construct the enclosures designed specifically for the drivers you chose.

Only Electro-Voice gives you all the options. But, then, Electro-Voice is known for their superb quality speakers — not for kits.

To get your component speaker catalog and construction plans package, just send \$1.00 to Electro-Voice Component Speaker Systems, 600 Cecil St., Buchanan, MI 49107.



600 Cecil Street, Buchanan, Michigan 49107

Electro-Voice Component Speaker Systems,  
600 Cecil St., Buchanan, MI 49107.

Please send me \_\_\_\_\_  
E-V component speaker packages.

I have enclosed \$1.00 for each  
package ordered.

Name \_\_\_\_\_

Address \_\_\_\_\_

City/State/Zip \_\_\_\_\_

PE-5-79

for private observation on-screen.

At this writing, it is expected that CBS will test the French ANTOIPE and British CEEFAX Teletext systems via KMOX (St. Louis, MO), while NBC will test Teletext in Washington, DC. At present, KSL, Salt Lake City, is the only station transmitting Teletext on a regular basis. A "new" TV channel for existing TV stations, called Info-Text™ (from Micro TV Inc., Philadelphia, PA) is already available in a minicomputer/decoders package to broadcasters for data transmission service. With such a system in operation, subscribers need not wait to get news, weather reports, etc.

**Fun and Teach.** At the most recent Consumer Electronics Show, January 1979, Matsushita Electric Co. (parent for Panasonic and Quasar) demonstrated some exciting video products that were not commercially available. One was called the "Fun and Teach" machine. It used an ordinary color TV receiver in conjunction with a light pen to "write" or "draw" directly on the TV screen (see lead photo). Furthermore, recordings were made for later playback on a standard audio cassette machine.

As shown in Fig. 13, the home education-amusement video system section is essentially a computer. It contains a microprocessor, 2K of RAM, an operating system in ROM, separate video-display RAM, a cassette I/O port, and a combined keyboard/light-pen I/O. Elements are interconnected by a combined address/data/handshake bus.

The video display features 96 vertical by 128 horizontal dots for graphics and 192 V × 256 H dots for alphanumeric character display. Seven colors are available: red, green, blue, yellow, cyan, magenta, and white. Displayed data can be stored on standard C-60 cassettes.

The system's stereo cassette recorder utilizes one channel for the data, the other for narration and music. I/O for the cassette is via a UART, with serial-to-parallel inputting from tape and parallel-to-serial when recording. The system speed is 4800 baud.

In use, a seven-color "palette" is displayed along the bottom of the screen (see front-cover illustration) when the light-pen program is selected. Touched to the desired color and then placed against the screen, the light pen permits the user to draw in the selected color. Colors can be changed as desired. With a little care, a series of frames can be drawn and recorded (along with suitable narration) so that basic animation with

it's own sound track can be created.

A selection of cassettes was prepared at the show. One contained a fairy tale in still color pictures and narration. Another was an "etch-a-sketch" type of program. Others contain foreign languages, with the text appearing on screen as a teaching aid. Also, the operating system permits the user to create his own tapes, using both on-screen data and voice and/or music.

Kindergartens and homes where there are small children would be good targets for the Fun and Teach machine. Children will be able to view nursery tales and narration and picture-book presentations and will also be able to draw on the screen in colors of their own choosing. Drawings can be stored on ordinary audio cassettes for later viewing.

The alphanumeric mode allows the usual home-computer data to be entered, displayed, and stored as desired. Thus, games and animation sequences can be created, accompanied by sound effects. Up to 350 video frames can be stored on a standard C-60 cassette.

Another Matsushita-developed working model consisted of a facsimile read-out machine attached to a color TV receiver. Printout of alphanumeric and graphics were accomplished in about one minute from a separately transmitted program using one of the stereo TV sound channels as authorized in Japan. The implication here is that one can get printouts at any time of news, etc., without interrupting TV viewing and listening in the process.

Clearly, new TV applications have been developed that promise to be implemented on a wide public basis in the near future. EIA subcommittees have already been formed to develop recommended broadcast standards for both multichannel television sound and Teletext data and graphics transmission. Moreover, the IEEE (Institute of Electrical and Electronic Engineers) has a summer meeting scheduled to explore the many facets of promised upcoming consumer TV uses. And according to a report, "The Home Terminal," by International Resource Development, Inc., New Canaan, CT, interactive TV such as the Qube experiment in Ohio and Viewdata in England, point to a strong consumer demand for these TV services. IRD predicts that this type of TV home terminal will appear on the U.S. market in 1982, with a price of \$1400, enabling users to pay bills and enjoy electronic mail services by video transmission techniques. ◇

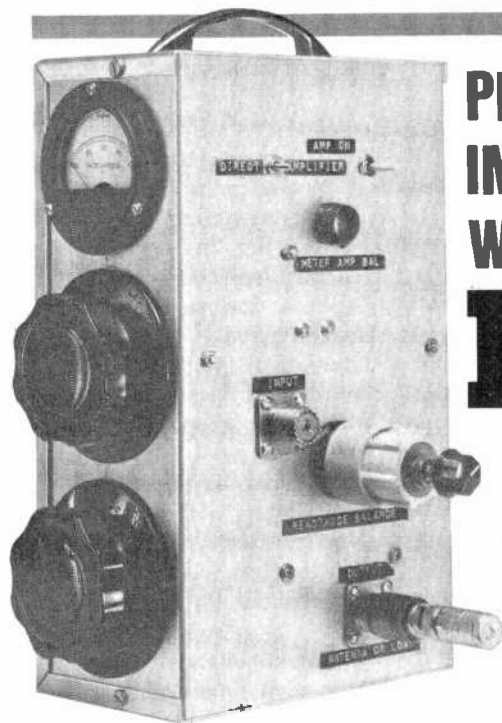

# PERFORM COMPLETE IMPEDANCE MEASUREMENTS WITH THIS **R-F BRIDGE**

BY DON MORAR, W3QVZ

Inexpensive bridge measures  $R$  and  $X$   
components over a wide frequency range

ONE OF the most useful instruments an experimenter who works with r-f circuits can have is an impedance bridge. The ideal bridge would permit accurate measurement of both the resistive and reactive components of an unknown impedance over a wide range of frequencies. Commercial r-f impedance bridges, although they satisfy these requirements, are priced well beyond the means of the average experimenter. On the other hand, those affordable bridges that have appeared as construction projects in amateur radio and hobby electronics magazines only tell half the story—the resistive component.

The bridge described in this article can measure the complex impedance of just about any load at frequencies between 3.5 and 54 MHz with a high degree of accuracy. Moreover, it can be inexpensively built using "junk box" components, and is smaller and lighter than its typical commercial counterpart. The only external items required for cali-

bration and operation are a group of nonreactive resistors, an r-f source such as a signal generator, and, of course, the impedance to be measured.

Among the project's features are a built-in null indicator (a microammeter) and an amplifier which can be switched into the null detector circuit to enhance its sensitivity. The value of the impedance's resistive component is read directly off the bridge's  $R$  dial, which is calibrated in ohms. The unit's  $X$  (reactance) dial calibration is scaled in terms of frequency. This is done because inductive and capacitive reactance vary with frequency, so an  $X$  dial calibrated directly in ohms would be accurate at only one specific frequency. Scaling the  $X$  dial's calibration in terms of frequency provides greater operating flexibility.

**About the Circuit.** The schematic diagram of a basic r-f bridge is shown in Fig. 1. It obviously resembles the classic Wheatstone bridge, which has four resistive arms. Two of these arms are usually derived from a potentiometer. The r-f bridge, however, employs a dual differential variable capacitor ( $C1C2$ ) so that measurements can be performed over a wide range of frequencies. If a potentiometer were used, its frequency-dependent intrinsic reactance would cause the bridge to yield false results.

Some readers might not be familiar with the dual differential capacitor. It is, essentially, two variable capacitors ganged so that when one section (capacitor) exhibits maximum capacitance, the other exhibits minimum capacitance.

The use of a dual differential capacitor provides a variable capacitance ratio between the two arms of the bridge that it comprises. This simplifies the calibration and use of the bridge. If the value of  $R1$  is a constant, the single control knob used to vary the setting of  $C1C2$  can be calibrated in terms of  $R1$  or in ohms.

To use the bridge the unknown impedance is connected as  $R_U$  and an r-f source is used to energize the network. The dual differential capacitor is then adjusted so that the bridge is balanced. When that happens, no voltage drop will exist across the bridge detector and no current will flow through it. The detector will indicate a null and the value of  $R_U$  can be read off the dual differential capacitor's control knob.

The bridge in Fig. 1 will only measure the unknown's resistive component. More complete information about the unknown (including its reactance) can be obtained by measuring it on the bridge shown in Fig. 2. This circuit re-

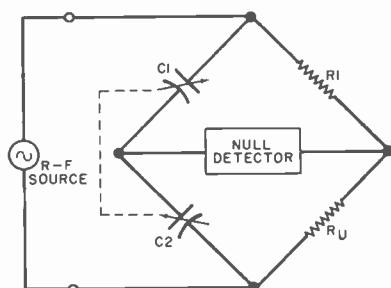

Fig. 1. Basic r-f bridge uses dual differential capacitor but gives only resistive information.

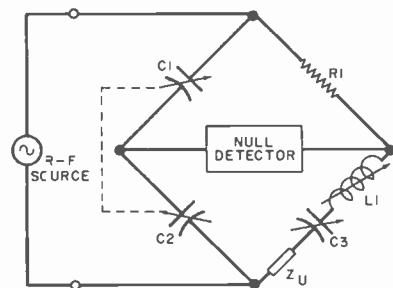

Fig. 2. More sophisticated bridge can measure reactance as well as resistances.



sembles that of Fig. 1, but two components ( $C3$  and  $L1$ ) have been added to the bridge's lower right arms. To underscore the bridge's greater measuring facilities, the unknown is no longer represented as a resistance ( $R_U$ ), but as a general impedance ( $Z_U$ ).

As in Fig. 1, dual differential capacitor  $C1C2$  is used to measure the real (resistive) component of the unknown com-

plex impedance. Variable inductor  $L1$  and variable capacitor  $C3$  make possible measurement of both the sign and magnitude of the unknown's imaginary (reactive) component. The bridge thereby provides the user with complete information about the unknown impedance.

The device is initially balanced at the frequency of interest with a purely resistive termination at  $Z_U$ . Variable capaci-

tor  $C3$  is placed at its midrange setting and inductor  $L1$  is adjusted for resonance. This cancels out any reactance which would otherwise be reflected into the other bridge arms. The nonreactive termination is then replaced with the unknown impedance. Its resistive component is balanced by varying  $C1C2$  and its magnitude read off the calibrated capacitor control knob scale. The unknown's imaginary component is balanced by shifting  $C3$  away from its mid-scale setting in either the clockwise (+, the standard sign for inductive reactance) or counterclockwise (-, the standard sign for capacitive reactance) direction to cancel out any reactance in the unknown.

If the unknown impedance has an inductive component, more capacitive reactance (that is, less capacitance) is required from  $C3$  to obtain a balance. Conversely, if the load has a capacitive component, more capacitance and less capacitive reactance is required. Once  $C3$  has been properly adjusted, the bottom right leg of the bridge will look purely resistive, and an excellent null will be obtained on the detector.

The scale of  $C3$ 's control knob should be calibrated in terms of the magnitude and sign of the reactance present at  $Z_U$ . Because inductive reactance varies directly with frequency and capacitive reactance varies inversely with frequency, the calibration of  $C3$ 's control knob must be scaled in terms of frequency. If it were calibrated directly in ohms, its calibration would hold true at one frequency only. A better approach is to perform the calibration at 1 MHz and frequency-scale it. The exact magnitude of the reactive component can then be determined by a simple arithmetic operation.

The complete schematic of the r-f impedance bridge is shown in Fig. 3. Resistive balancing is performed by dual differential capacitor  $C1$ . Noninductive resistor  $R2$  provides the reference against which the resistive component of the unknown impedance is measured. (The unknown is connected to LOAD jack  $J3$ .) Balancing and measurement of the unknown's reactive component (if any) is the task of  $L2$  and  $C2$ .

When the bridge is unbalanced, germanium diode  $D1$  rectifies r-f into pulsating dc which is filtered by  $L1$  and  $C3$ . If  $S1$  is placed in its DIRECT position, the filtered dc is applied to null indicator  $M1$ , a 0-to-200- $\mu$ A meter. For increased reso-

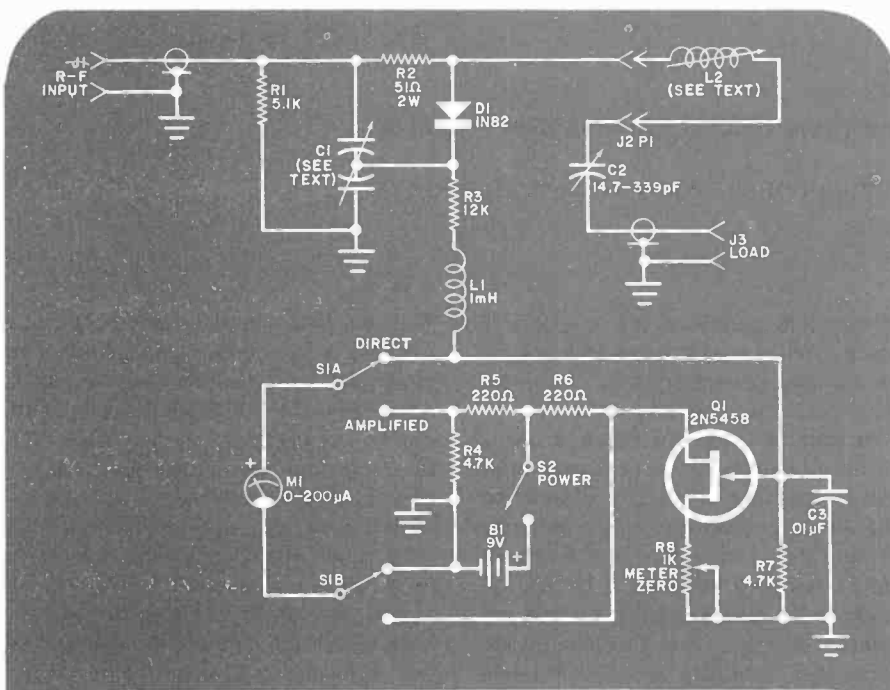

Fig. 3. Complete schematic diagram of the r-f impedance bridge. Amplifier  $Q1$  enhances sensitivity and increases null resolution.

### PARTS LIST

- B1—9-volt transistor battery
  - C1—Dual differential variable capacitor, 12-to-150 pF per section, Millen No. 28801 or equivalent (see text)
  - C2—14.7-to-339-pF variable capacitor (Millen No. 19335 or equivalent)
  - C3—0.01- $\mu$ F disc ceramic capacitor
  - D1—1N82 or equivalent germanium diode
  - J1, J3—SO-239 coaxial connector
  - J2—Standard Amphenol 4-prong jack
  - L1—1-millihenry inductor
  - L2—See text and Table
  - M1—0-to-200- $\mu$ A meter
  - P1—4-prong plug to match J2
  - Q1—2N5458 n-channel JFET
- The following, unless otherwise specified, are 1/4-watt, 5% tolerance, fixed carbon-composition resistors.
- R1—5100 ohms
  - R2—51 ohms, 2 watts
  - R3—12,000 ohms
  - R4, R7—4700 ohms
  - R5, R6—220 ohms
  - R8—1000-ohm potentiometer
  - S1—Dpdt toggle switch

- Misc.—10"  $\times$  6"  $\times$  3 1/2" (25.4  $\times$  15.2  $\times$  8.9 cm) aluminum utility box (Bud CU3010A or equivalent), 5 1/4"  $\times$  3"  $\times$  2 1/8" (13.4  $\times$  7.6  $\times$  5.4 cm) aluminum utility box (Bud CU3006A or equivalent), J.W. Miller No. 42000CBI or equivalent slug-tuned coil forms, plastic or metal threaded BX/Romex outdoor electrical-box plugs, 1/4-inch (3.8-cm) PVC pipe, PVC pipe adapters (1/2-inch or 1.3-cm threads to 1/2-inch or 1.3-cm pipe), cyanoacrylate cement, control knobs with 1/8-inch (3.3-mm) shaft hole, one small control knob with 1/4-inch (6.6-mm) shaft hole, two large Bakelite control knobs with 1/4-inch (6.6-mm) shaft hole threaded porcelain standoffs, one noninsulated and two insulated 1/4-inch (6.6-mm) shaft couplings, L brackets, battery clip, battery holder, perforated board, several nonreactive resistors whose values have been accurately determined, PL-259 coaxial connectors, convenient lengths of 50-ohm coaxial cable, enameled copper wire, hookup wire, solder lugs, solder, machine and self-tapping hardware, etc.

*Fig. 4. Photo of author's prototype. Note small shielding box (half of which has been removed) partially obscuring dual differential variable capacitor.*

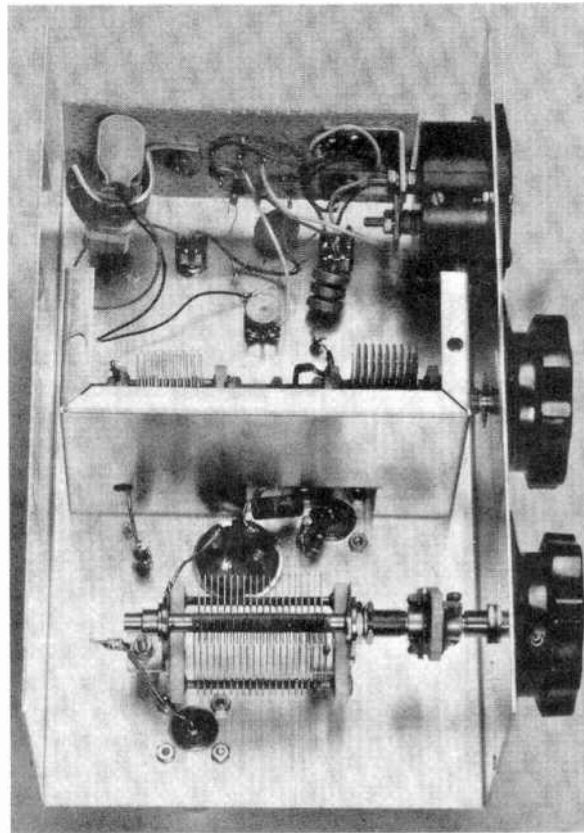

lution of the null, *S1* should be placed in its AMPLIFIED position. The filtered dc is then amplified by *Q1*, which in turn drives the meter movement. Use of the amplifier also increases bridge sensitivity so that the circuit is compatible with low-level signal sources such as solid-state "grid" dippers.

**Construction.** In any r-f bridge, it is essential that residual and stray reactances be kept to a minimum, and this project is no exception to that rule. Placement of components must be such that lead lengths in the r-f portion of the circuit are absolutely as small as possible. The layout established by the author, which can be seen in the photograph of his prototype (Fig. 4), yielded good results up to 54 MHz.

All of the components were mounted in an aluminum utility box measuring 10" x 6" x 3½" (25.4 x 15.2 x 8.9 cm). The frames and stators of variable capacitors *C1* and *C2* must be insulated from ground (the enclosure), necessitating the use of threaded porcelain spacers or their equivalent. Similarly, insulated couplings should be used with the capacitors' control shafts.

Dual differential capacitor *C1* is partially hidden in the photograph by one half of an aluminum utility box which mounts inside the main enclosure and shields the capacitor from the rest of the bridge. (The other half of the utility box has been removed to expose the capacitor for the photograph.) Dimensions of

the box shield used by the author are 5¼" x 3" x 2¼" (13.4 x 7.6 x 5.4 cm). Totally enclosing the differential capacitor within the grounded utility box helps keep stray reactances small.

To cover 3.5 through 54 MHz with one variable capacitor (*C2*) requires the use of several different inductors. However, band switching of the inductors is not used in this project because it would introduce too much stray reactance and degrade bridge performance. The author's solution to this problem is to use plug-in inductors. J.W. Miller coil forms (No. 42000CBI), ½-inch (1.3-cm) inner-diameter PVC pipe fittings, and 4-prong plugs are used in making the coils.

Details of coil construction are shown in Fig. 5. First, the various coils should be wound on slug-tuned forms. Coil winding data appears in the Table. After the coils are wound, they should be soldered to standard Amphenol four-prong plugs. (Bases removed from discarded four-prong vacuum tubes can be used instead of four-pin plugs.) Take the suggested PVC pipe fittings and modify them as shown in Fig. 5. Then affix each four-pin plug to a modified PVC fitting with cyanoacrylate cement (Eastman 910, "Krazy Glue," or equivalent).

Using a ¼-inch (6.5-mm) bit, drill out the center of a ½-inch (1.3-cm) plastic or metal threaded BX/Romex outdoor electrical-box plug to accommodate the Miller coil form's metal bushing. Mount the threaded plug in the PVC fitting and attach a knob to the coil form's tuning shaft to complete the coil assembly. Repeat this procedure for each inductor.

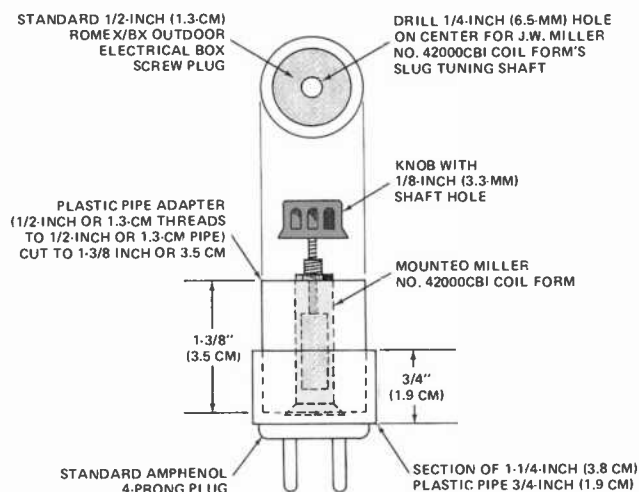

*Fig. 5. Assembly details for each plug-in coil (L2).*

Either a commercial dual differential capacitor or a home-brew one can be used for  $C1$ . The dual differential capacitor should have a capacitance of 12-to-150 pF per section. A Millen No. 28801 dual differential capacitor is suitable, but the author ganged two identical Hammarlund receiving-type variable capacitors rated at 12-to-150 pF each. If two capacitors are used, they should be ganged so that one is at maximum capacitance (plates fully meshed) when the other is at minimum capacitance (plates fully open). The other variable capacitor,  $C2$ , is rated at 14.7-to-339 pF. A Millen

should be installed between the two rotor shafts.

Other details of the construction of the author's prototype are apparent in Fig. 4. A portion of the small shield box has been cut away with a nibbling tool to provide room for  $J1$ ,  $R1$ ,  $R2$  and the lead connected to the rotor plates of  $C1$ . The null detector's amplifier is mounted on a small piece of perforated board which is mechanically supported by L brackets secured to the terminals of  $M1$ . Because parts placement is critical in the r-f portion of the project, it is best to duplicate the author's layout closely.

measure the resistors with a good-quality digital multimeter or use close-tolerance metal film components. Connect the resistors to PL-259 coaxial plugs, keeping lead lengths short.

Calibration should be performed at 3.5 MHz to minimize the effects of reactive strays. Apply the output of a signal generator oscillating at that frequency to  $J1$  and connect the first load resistor (the one with the lowest resistance) to  $J3$ . Also, install the 80-meter plug-in coil at  $J2$ . With  $S1$  in its DIRECT position and  $C2$  set at 50% dial rotation (plates half meshed), adjust  $C1$  and  $L1$  for the best null possible. Then place  $S1$  in its AMPLIFIED position and fine-tune for the deepest null you can obtain. Place a notch, tick mark, or other notation of the position on  $C1$ 's dial. Repeat this procedure for each calibrating resistor.

The author used Bakelite knobs with large skirts as the  $x$  and  $R$  control knobs. Calibration of the  $R$  knob was made by inscribing the appropriate point on the Bakelite skirt with tick marks and numerical values using an electric engraving tool. This technique permits direct calibration of the  $R$  knob in ohms. (Suitable Bakelite knobs are available from such surplus electronics dealers as Fair Radio Sales Co., Box 1105, Lima, OH 45802.) Alternatively, a knob with a silver skirt calibrated from 0 to 100 over 180 degrees of dial rotation can be used in conjunction with a graph of dial readings plotted against resistance values.

No direct calibration was performed on the  $x$  (reactance) dial. Rather, the following procedure was followed. Using a Southwest Technical Products digital capacitance meter cross-checked against a General Radio GR-650 bridge, the author made a plot of the capacitance of  $C2$  against dial rotation. Then the standard inductive and capacitive reactance formulas were employed to derive a plot of reactance below and above a resonant frequency of 1 MHz. Assuming that  $L2$  is adjusted to cancel out bridge reactance (including that of  $C2$  when its plates are half meshed), the graph shown in Fig. 6 plots the net reactive variation of  $X_C$  and  $X_L$  below and above the resonance at 1 MHz.

This graph can be used to calibrate the  $x$  control knob. For example, at 50% dial rotation, the reactance of the load is 0. At 75% dial rotation, the reactance is  $+j740$  or 740 ohms inductive. Similarly, at 25% dial rotation, the reactance is

Fig. 6. Calibration curve for the X (reactance scale) of  $C2$ 's control knob.

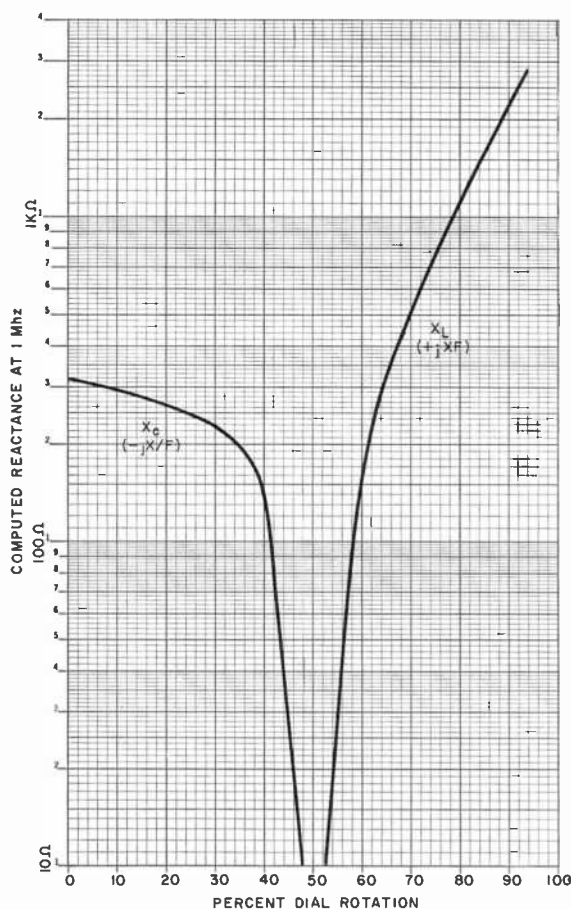

No. 19335 or equivalent component is acceptable.

The frames of both  $C1$  and  $C2$  should be mounted on insulated standoffs, and insulated shaft coupling should be used to connect their rotor shafts to the short shafts to which the  $R$  and  $x$  control knobs are attached. Note that if two capacitors are ganged to form a dual differential unit, a noninsulated coupling

**Calibration.** The resistance ( $R$ ) dial of the impedance bridge can be calibrated by using an assortment of ½-watt carbon composition resistors of various values within the 5-to-200-ohm range. The author measured the exact resistance of each component selected on a General Radio GR-650 bridge to enhance the accuracy of the calibration. If you don't have access to a highly accurate bridge,



-j250 ohms or 250 ohms capacitive. As was done with the R control knob, a Bakelite knob with a large skirt can be used and the skirt inscribed with an electric engraving tool. Alternatively, a knob with a silver skirt calibrated from 0 to 100 over 180 degrees of dial rotation can be used in conjunction with the graph of Fig. 6 to determine the sign and magnitude of the reactive component.

The accuracy of the x control knob's calibration depends on that of the graph of Fig. 6 and the degree of bridge balance (null sharpness) obtainable. The theoretical curve is apparently very accurate. How much a direct calibration would depart from the curve would depend on stray bridge reactance. The prototype yielded good, sharp nulls and its x calibration was very accurate.

**Using the Bridge.** Before an unknown impedance can be measured, it is necessary to balance the bridge. Apply an r-f signal to J1 and connect a non-reactive termination to J3. (The author employs a commercial 50-ohm, 5-watt nonreactive termination when performing this step.)

Any signal source producing 1 to 3 volts rms of r-f can be used. A grid-dip oscillator loosely link-coupled to J1 is satisfactory. The author employs a 4-turn coil of No. 16 enamelled copper wire large enough to accommodate the outer diameter of his grid-dip coil to apply r-f for 80- and 40-meter measurements and 2 turns of the same wire for measurements on 20, 15, 10, and 6 meters. Each coil is connected to a convenient length of 50-ohm coaxial cable, the

other end of which is terminated with a PL-259 connector.

Plug the appropriate coil for the frequency at which the measurement is to be performed into jack J2. Then set the x control knob to 0 ohms (50% rotation or midscale). Adjust C1 and L2 for a good null as indicated by M1. After initial adjustments, switch the amplifier into the meter circuit to increase the resolution of the null. If a complete null cannot be obtained, reduce the coupling between the signal source and the bridge.

After the bridge has been balanced, replace the purely resistive load with the unknown impedance. Alternately adjust C1 and C2 to obtain the best null and note the readings of the R and x scales. Impedance measurements are in rectangular form. An impedance with an inductive component is of the form  $Z = R + jXF$ , where R and X are the readings of the R and x scales, respectively. The operator +j denotes inductive reactance, and F is the frequency at which the measurement is performed. An impedance with a capacitive component is of the form  $Z = R - jX/F$ , where R, X, and F are as defined in the case of a partially inductive impedance. The operator -j denotes capacitive reactance.

As mentioned earlier, the x measurement involves frequency scaling. In the case of an inductive reactance, the exact magnitude is determined by *multiplying* the x scale reading by the frequency at which the measurement is performed. The exact magnitude of a capacitive reactance can be obtained by *dividing* the x scale reading by the frequency at which the measurement is made.

**In Conclusion.** Here are a few hints that you should keep in mind when using this project. Bridge measurements are of course frequency sensitive. The bridge must therefore be rebalanced after a frequency change of 1% or more occurs. Be sure to balance the bridge with a purely resistive test load before performing any measurements. Otherwise, inherent bridge reactances will cause a false reading.

Remember that the bridge requires very little r-f drive. This is no problem when a signal generator or grid-dip oscillator is used as the signal source because the output level of the generator or the coupling between the oscillator and the bridge can be easily reduced. However, if a transmitter is used to provide r-f for the impedance measurement of, say, an antenna or linear amplifier input stage, care must be taken not to overload the bridge. The transmitter's r-f output must be kept at a low level, and the bridge must not be left in the line when more than 0.1 watt of r-f power is flowing.

It is usually very inconvenient to perform impedance measurements directly at an antenna's feed point, so they are commonly performed at the transmitter end of the transmission line. This can result in misleading information if the line is not an integral multiple of an electrical half-wavelength. Note that a transmission line's electrical length is its physical length expressed in free-space wavelengths at the frequency of interest multiplied by the line's *velocity factor*. Solid-dielectric coax (RG-58, RG-59, RG-8, RG-11, etc.) has a velocity factor of approximately 0.66; polyfoam coax has a velocity factor of approximately 0.81.

If it is not convenient to add or subtract enough cable to make the transmission line an integral multiple of an electrical half-wavelength, a Smith chart can be used to transpose the measured impedance at the transmitter end of the line into the actual antenna impedance. To do this, the line length must be accurately determined by physical measurement or by measuring it with a grid-dip oscillator and the far end of the line shorted. Remember that you must employ the electrical length of the line when using the Smith chart.

You are now ready to start using your impedance bridge in r-f work. Its usefulness on your test bench or in your radio shack will be quickly appreciated. ◇

#### COIL WINDING DATA

Band	Approximate Frequency Range	Coil Data
80 M	3.4 to 4.2 MHz	28 turns of No. 30 enamelled wire, close wound
40 M	6.5 to 7.5 MHz	16 turns of No. 22 enamelled wire, close wound
20 M	13.0 to 15.0 MHz	8 turns of No. 16 enamelled wire, close wound
15 M	19.5 to 22.0 MHz	3½ turns of No. 16 enamelled wire, close wound
10 M	27.0 to 30.0 MHz	2½ turns of No. 16 enamelled wire, close wound
6 M	50.0 to 54.0 MHz	1 turn of No. 16 enamelled wire

All coils are to be wound on a J.W. Miller No. 42000CBI or equivalent slug-tuned form.

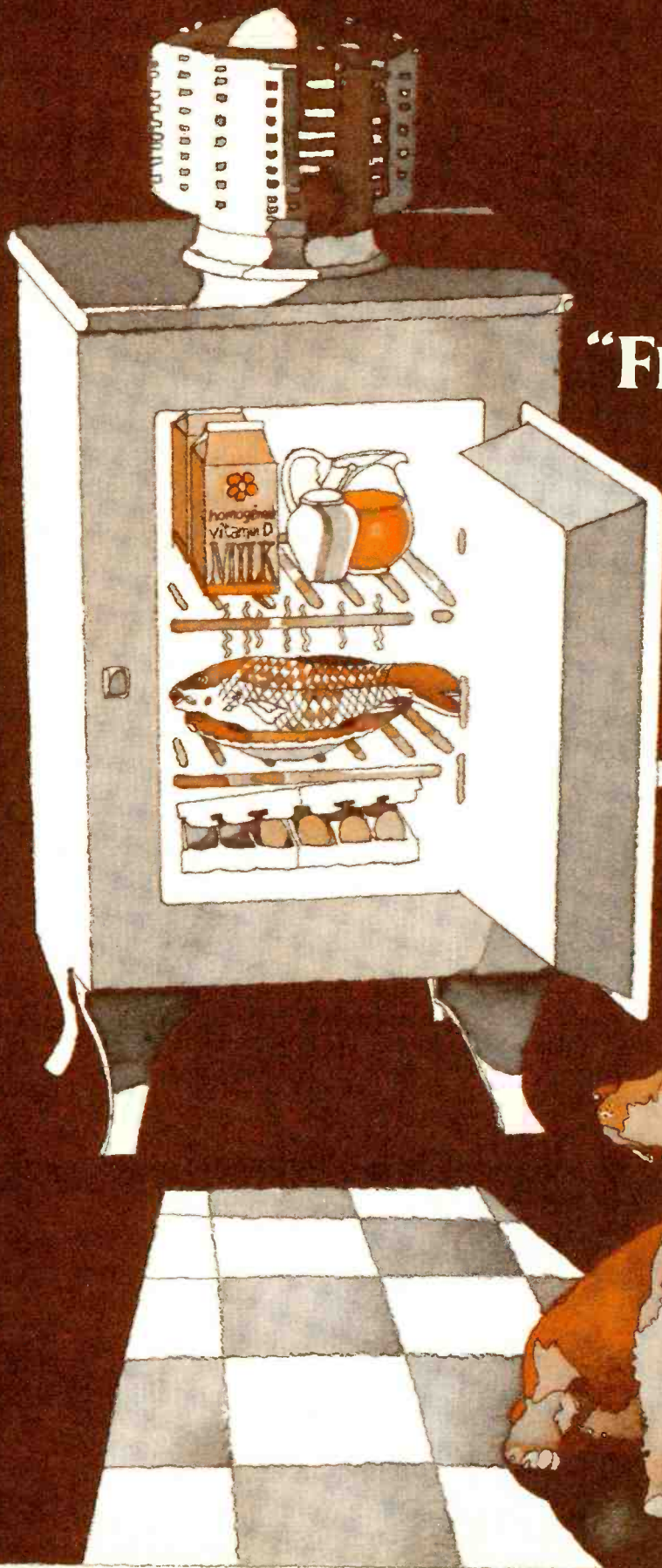

Open-Door  
"Fridge Alarm"  
Stops  
Food  
Spoilage  
&  
Energy  
Waste

**R**EFRIGERATORS are among the hungriest of household appliances in terms of electrical power consumption. Every time a refrigerator door is opened, cold air spills out and the warm air that replaces it must be cooled. Needless to say, it pays in dollars and cents to limit the time the door is open to as brief a period as possible. The low-cost Fridge Alarm described here maybe just what you need to limit the time you study the contents of your refrigerator or your child forgets to close the door.

The Fridge Alarm is a photoelectric device that is activated as soon as the door opens and the refrigerator's light goes on. It sounds an insistent two-tone signal if the door remains open past a given number of seconds.

**About the Circuit.** As shown in Fig. 1, when light strikes its photosensitive surface, *Q1* triggers into conduction and causes *Q2* to saturate. This places pin 1 of *IC1* close to ground potential and allows the timer to start operating (Fig. 2). Since the voltage across *C1* is initially zero, *IC1* is triggered into immediate operation. Timing is controlled by *R8*, *R1*, and *C1*.

During the timing sequence, the output of *IC1* at pin 3 remains high (almost at  $V_{CC}$ ) and keeps *IC2* and *IC3* cut off, since pin 1 of each of these integrated

circuits is connected to this line.

Most electrolytic and many aluminum capacitors can have sizable leakage currents. Hence, they should not be used in timing circuits. To avoid this problem, *C1* should be a tantalum capacitor. Using the time constants shown, *R8* can be set for periods of from 4 to 17 seconds. (This range was selected because 8 seconds is about the mean time for access to a refrigerator.) Because *C1* discharges through *D1* and the 15,000-ohm internal resistance of *IC1*, pin 7 is left unconnected.

If the light striking *Q1* is interrupted during the timing cycle, both *Q1* and *Q2* turn off and timing capacitor *C1* rapidly discharges through *D1* and *IC1*, resetting the timer. In darkness, *Q1* has a very high collector-emitter resistance. With *Q2* in cutoff, standby current is extremely low.

Should the light striking *Q1* be constant, the timing cycle will run its course and the output at pin 3 of *IC1* goes low. This effectively grounds pin 1 of both *IC2* and *IC3*, activating these ICs.

Integrated circuits *IC2* and *IC3* are wired to operate as astable multivibrators. The oscillating frequency of *IC2* is about 4 Hz. This 4-Hz signal "modulates" *IC3*, and the output of *IC3* directly drives a small loudspeaker.

The two-tone sound is created by al-

ternately shunting the *IC2* end of *R4* between  $V_{CC}$  and ground at a 4-Hz rate. When pin 3 of *IC2* is high, the parallel combination of *R4* and *R5* produces about a 500-Hz tone. When pin 3 is low, *R4* is effectively shunted to ground. This reduces the voltage at pin 7 of *IC3*. Since *C6* must now charge to 80% and then discharge to 40% of this new value to activate the comparators inside *IC3*, about a 330-Hz tone is generated. The two tones alternate at a 4-Hz rate as long as the circuit is activated.

**Construction.** All components, except *B1* (and its optional battery holder) and the small loudspeaker can be mounted on a printed circuit board. The actual-size etching-and-drilling guide and components-placement guide for the pc board are shown in Fig. 3.

The leads of *Q1* can be identified with the aid of an ohmmeter and light source if an unmarked phototransistor is used.

The project can be mounted inside a small translucent box that permits sufficient light to pass through and trigger *Q1* into conduction. Any of the various polyethylene refrigerator-type storage containers on the market will suffice as long as they are large enough to accommodate the circuit. The loudspeaker is best secured to the bottom of the container (after drilling a number of small holes for

## ***Sounds an alarm after preset time when refrigerator door is left open***

**BY ELLIOT K. RAND**



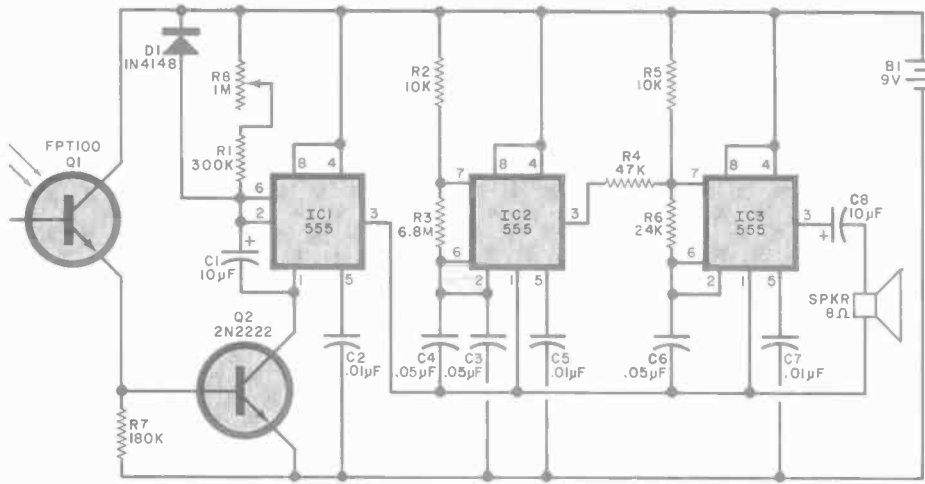

- C3, C4, C6—0.05- $\mu$ F disc capacitor  
 C8—10- $\mu$ F, 25-V aluminum capacitor  
 D1—1N4148 or similar diode  
 IC1, IC2, IC3—555 timer  
 Q1—FPT100 or equivalent  
 Q2—2N2222 or similar transistor  
 All resistors 1/4-watt, 10% tolerance:  
 R1—300,000 ohms  
 R2, R5—10,000 ohms  
 R3—6.8 megohms  
 R4—47,000 ohms  
 R6—24,000 ohms  
 R7—180,000 ohms  
 R8—1-megohm trimmer potentiometer  
 SPKR—Miniature 8-ohm loudspeaker  
 Misc.—Battery holder; translucent plastic refrigerator container (about 3" square); silicone-rubber cement; hookup wire; etc.

Fig. 1. Timing action of circuit is initiated by light striking Q1.

**PARTS LIST**

- B1—9-volt battery  
 C1—10- $\mu$ F, 25-V tantalum capacitor  
 C2, C5, C7—0.01- $\mu$ F disc capacitor

Note: The following items are available from Rand Laboratories, P.O. Box 468, Cape Canaveral, FL 32920: complete kit of parts including drilled case for \$9.95 postpaid. Also available; pc board only, \$4.25 postpaid. Florida residents, please add sales tax.

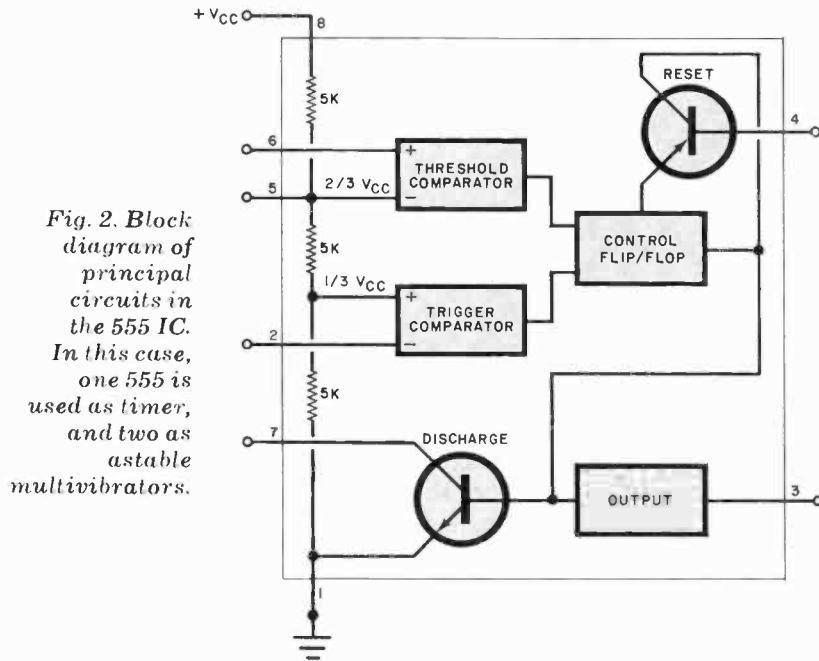

Fig. 2. Block diagram of principal circuits in the 555 IC. In this case, one 555 is used as timer, and two as astable multivibrators.

the sound to escape down through the shelf) with silicone-rubber cement. The speaker and pc board are interconnected with #20 wire so that the board can be positioned to allow maximum exposure of Q1 to the lamp.

The assembled alarm can be tested by placing it in a darkened location and shining a light on it. After a several-second delay, the alarm should sound. Count the number of seconds between the time the light goes on and the alarm sounds. Adjust R8 as needed for the desired delay between the two events.

Place the Fridge Alarm inside your refrigerator in a location where it will receive the maximum amount of light from the refrigerator's lamp. Make sure it is in a location where there will be no possibility of liquid spills on it. Equally important, make sure that the selected location will obviate any possibility of obstructing the light.  $\diamond$

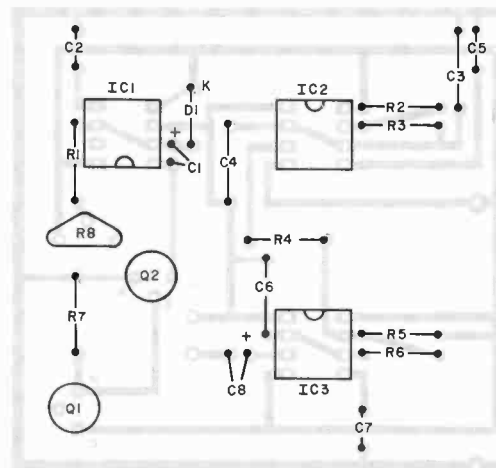
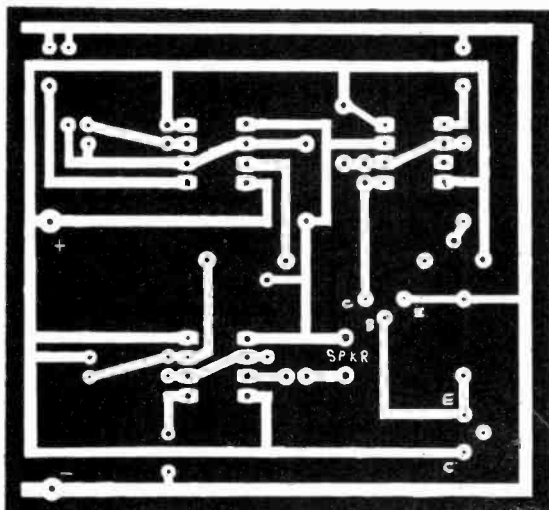

Fig. 3. Components are mounted on board as shown at left and enclosed in a translucent box.

BY HERBERT L. BRESNICK

# SOLID-STATE TURN INDICATORS FOR MOPEDS

Inexpensive electronic add-on  
increases driving safety factor

**M**OTORIZED bikes—mopeds—are becoming increasingly popular as laws prohibiting them are lifted. However, their low speed and, generally, young drivers, combine with the absence of lighted turn signal to cause safety problems.

Adding the turn-signal system described here will likely reduce accidents. It features a solid-state circuit, low-power lamps, can be used with a moped's 6-V negative-ground electrical system, and can be built for less than \$10. It can also be modified for use with a bicycle if a 6-V battery is added.

**Circuit Operation.** As shown in the diagram, a 555 timer (IC1) is used to

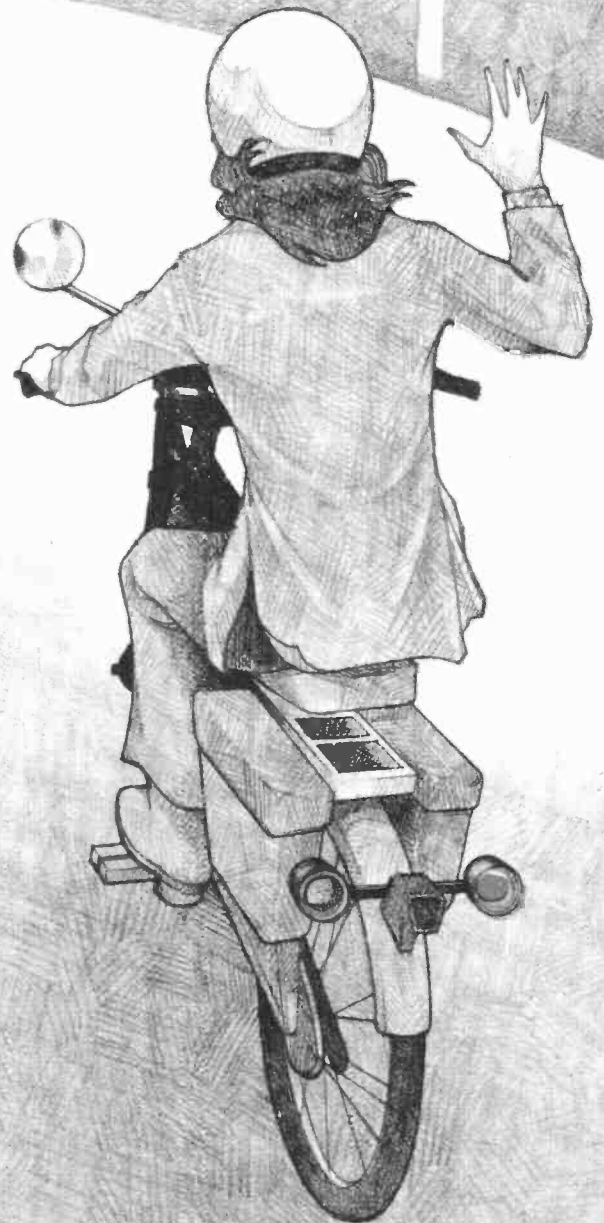

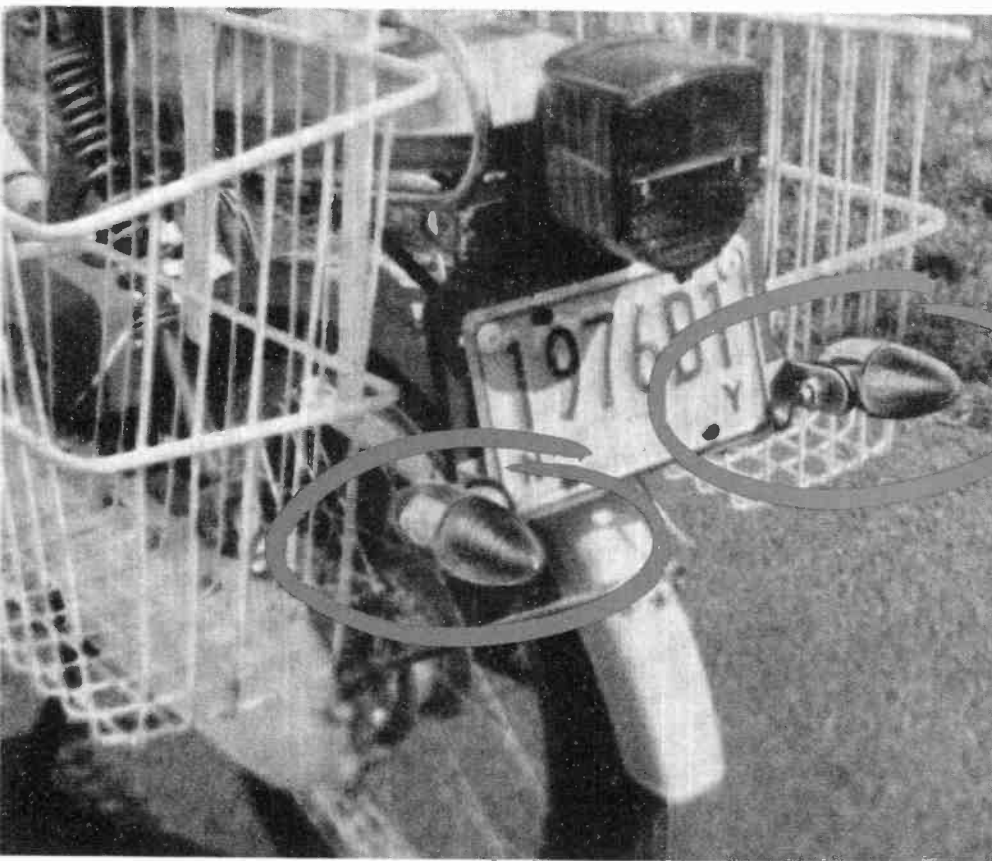

Photo shows how rear indicator lamps are insulated from moped frame by mounting them on the plastic license-plate holder. Connections to other parts of system must be through insulated flexible wire.

generate 1-Hz pulses. Note that this circuit will not operate until its pin 1 is connected to ground. When turn-select switch *S1* is placed in either its *L* (left) or *R* (right) position, this ground connection is made through either *D2* or *D3*, depending on the switch position selected. When one of these states occurs, *IC1* cycles at its 1-Hz rate, opening and closing relay *K1*. Relay contacts direct power to the selected lamps (*I1* and *I2* for left front and rear, *I3* and *I4* for right front and rear).

Ground for selected lamps is made through the switching member of *S1*. Thus, as long as *S1* is at one of its turn positions, the selected lamps will glow in 1-Hz cycles. When *S1* is placed in its center (off) position, the circuit is isolated and stops working.

Zener diode *D4* and capacitor *C3* maintain a smooth 6-V dc if the output of the motor-powered generator varies.

**Construction.** The circuit can be assembled on a small piece of perforated board, or a small printed circuit board can be designed.

The circuit can be mounted in a small plastic box that can be secured to the moped frame. The circuit ground should be made to a good metal connection on the moped frame, while the 6 volts is taken from a source that is live when the ignition key is turned on.

The rear turn-signal lamps are inexpensive "bullet-lamp" assemblies that use two GE #81 single-contact bayonet lamps, while the front turn-signal lamps are made from an AMF "rear directional light." Both of these are obtainable from most bicycle or discount shops. The AMF unit comes with turn-switch, lamps, case and battery holder. Lamps are replaced with GE #27 lamps. The battery holder is not used, and the wiring between the holder and lamps is removed.

The rear lamps must be insulated from the frame. The easiest way to do this is to mount them on the plastic rear license-plate holder. If you mount them to the metal frame, use some form of insulation between the lamp bracket and the metal surface.

Turn switch *S1* can be any large bat-handle switch having good detents and a center-off position. It can be mounted as desired on the handlebar.

Interconnections between the switch, power, lamps and the electronic circuit should be made with well-insulated flexible wire passed through a length of plastic tubing taped to the frame. ◇

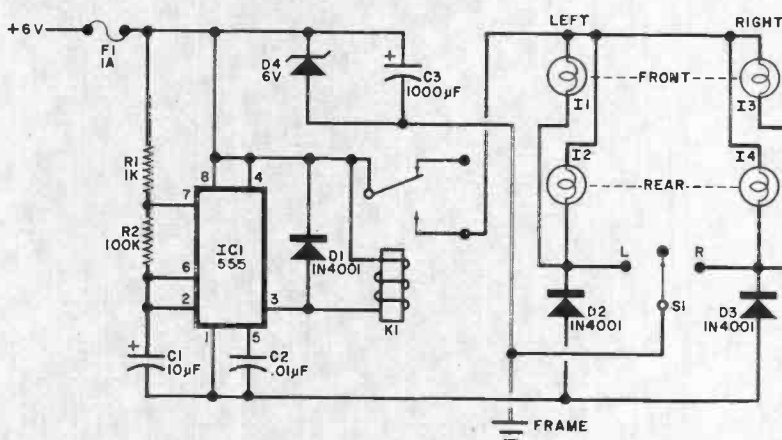

Fig. 1. When pin 1 of *IC1* is connected to ground through *S1*, the 555 timer generates 1-Hz pulses to open and close relay *K1*.

#### PARTS LIST

- |  |   |
|--|---|
| C1—10- $\mu$ F, 15-volt electrolytic   | IC1—555 timer   |
| C2—0.01- $\mu$ F, 15-volt disc         | K1—6-volt relay   |
| C3—1000- $\mu$ F, 15-volt electrolytic | S1—3-position large bat handle switch (center off)  |
| D1, D2, D3—1N4001 or similar diode     | Misc.—Plastic enclosure, perforated board, wiring, plastic tubing, mounting hardware, #27 1 amps. |
| D4—6-vol t. 1-watt zener diode         |   |
| F1—1-ampere in-line fuse               |   |
| I1-14—see text                         |   |



# TAPE BIAS/EQUALIZATION CHART

By Craig Stark

**M**OST stereo cassette decks nowadays have switches to set bias and equalization for each tape type. But tape formulations come and go, so keeping track of what tapes require which settings can be a challenge. To make recording and playback easier for you, listed below are most of the major high-fidelity cassette

formulations of the past few years. A line divides the current and discontinued tape formulations in each manufacturer's product lineup. The discontinued tapes are listed for the benefit of those who still have some of these cassettes on hand.

Cassette	Ferric	CrO <sub>2</sub>	Ferrichrome	Cassette	Ferric	CrO <sub>2</sub>	Ferrichrome
<b>Advent</b> (all)		X		<b>Meriton</b>			
<b>Ampex</b>				Ferri-Chrome Cassette			X
Grand Master	X			Chromium-Dioxide Cassette		X	
364 Series 20/20+	X			Low-Noise/High-Output Series	X		
363 Series Chromium Dioxide		X		Low-Noise Series	X		
371 Plus Series	X			<b>Nakamichi</b>			
370 Series low-noise/high-output	X			SX		X*	
350 Series "Super"	X			EX II	X*		
360 High-Frequency Series	X			EX	X*		
362 Extended-Frequency Series	X			Chromium Dioxide		X	
<b>BASF</b>				<b>Norelco</b> (Discontinued)			
Professional I	X*			300 Series	X		
Professional II		X		200 Series	X		
Professional III			X	100 Series	X		
Studio Series	X			<b>RCA</b> (Discontinued)			
Performance Series	X			Red Seal Cobalt Energized	X		
Chromdioxid		X		Vibrant Cassettes, Series CV	X		
LHSM Series	X			<b>Recoton</b>			
SKLH Series	X			Low-Noise, Series CD	X		
SKSM Series	X			<b>Royal Sound</b>			
<b>Capitol</b>				Chromium Dioxide		X	
"the music tape"	X			Ultra-Linear, Series ULC	X		
Capitol 1	X			Low-Noise, Series APC	X		
Capitol Chromium-dioxide		X		<b>Scotch</b>			
The Mod Series	X			Master I	X*		
<b>Columbia</b>				Master II		X*	
2CB800 Series	X			Master III			X
2CL Series	X			Dynarange Low-Noise/High-Density	X		
<b>Fuji</b>				Highlander Low-Noise	X		
FX-I	X*			Master	X		
FX-II ("Beridox")		X*		Classic			X
FL low-noise	X			Chrome Cassettes		X	
FX	X			High-Energy	X		
FC		X		Extended-Range	X		
<b>Hitachi</b>				<b>Sony</b> (Sony/Superscope)			
"Ultra-Dynamic" UDC Series	X			Ultra-High-Fidelity Cassettes	X*		
Low-Noise Series	X			Chromium-Dioxide CRO Series		X	
<b>Irish</b>				FeCr Cassettes			X
261 Professional Series	X			Duad			X
262 Low-Noise Series	X			<b>Soundcraft</b> (Discontinued)			
263 Chromium Dioxide Series		X		2SR-801 Series	X		
<b>Lafayette</b>				2SC Series	X		
XHE Criterion Series	X			<b>TDK</b>			
Criterion Series	X			SA, Super Avilyn		X*	
Low-Noise Series	X			AD	X*		
Chromium-Dioxide		X		Dynamic Series, D	X		
Criterion Ultra-Dynamic Series	X			Audua	X*		
Voice-grade	X			SD series	X		
<b>Maxell</b>				Krom series (KR)		X	
UD-XL I	X*			Maverick series	X		
UD-XL II		X*					
UD Series	X*						
LN Series	X						
<b>Memorex</b>							
MRX <sub>3</sub>	X*						
Chromium Dioxide		X					
MRX <sub>2</sub>	X						

**Note:** In each company listing, those tapes below the line are older, discontinued formulations; the others above are either current or near-current (i.e. may be still on some dealer shelves).  
 On Ferric tapes, those which can profit by a slightly higher-than-usual ("Japanese") bias are identified by an asterisk.  
 On CrO<sub>2</sub>-type tapes, those identified with an asterisk are not CrO<sub>2</sub> tapes, but so-called "70-microsecond ferrics," usually modified by cobalt.

# Microcomputer Video Board Buying Directory

Make & Model	Price <sup>1</sup> (\$)	Power Required (mA) <sup>2</sup>			ASCII <sup>3</sup> char set	Char per line	Lines	Graphics	Remarks <sup>4</sup>
		+8V	+16V	-16V					
<b>S-100</b>									
<b>CGRS Microtech</b> VB1B	130 (k) 170 (w)					64	16	128x48	Chars & graphics mixable.
<b>Dynabyte</b> Naked Terminal (VT801-1)	350 (w)	1.8A			128	80	24		BC, RV, AC, S; block-mode edit; KB interface; port-addressed, no driver software needed.
<b>Electronic Sys.</b> 6400	39 (b)	1.5A		30	128	64	16		BC, RV, AC.
<b>IMSAI</b> Basic VIO	190 (k) 335 (w)				96	80, 40	24 or 12	160	1K refresh memory; upper-case only (char set includes graphics chars); all standard screen formats exc. 80x24. 2K memory, all formats.
VIO-A	275 (k) 405 (w)				u/l				2K ROM firmware, all formats.
VIO-B	275 (k) 405 (w)				u				2K ROM firmware, all formats.
VIO-C	325 (k) 465 (w)				96	80, 40	24 or 12	160	2K refresh memory; upper/lower-case; ROM firmware; all standard screen formats. Converts VIO-A to VIO-C. Converts VIO-B to VIO-C. Converts Basic VIO to VIO-C.
VIO-AC	60 (k)								
VIO-BC	60 (k)								
VIO-CC	150 (k)								
<b>Interactive Micro Systems</b> IMS64-100	225 (w)	X	X	X	128	32, 64	16	color*	*BC, RV, AC; optional 64x64, 16-color graphics; 6802 intelligence.
<b>Ithaca Audio</b> SVP	25 (b)				128	64	16	no	BC, RV, AC.
<b>Jade Computer</b> JG-VB1B	35 (b) 100 (k) 150 (w)	2A			128	32, 64	16	128x48	BC, RV, AC; Erase to end-of-line; scroll; Greek chars.
<b>Micro Diversions</b> Screen-splitter	329 (k) 429 (w)	1.5A			128	86, 96	40	yes	BC, RV, AC; up to 3440 independent text "windows"; APL, Sci. & graphics character sets avail.; user-programmable char sets.
<b>MSD-Micro Syst. Dev.</b> MSOV-100	285 (k) 385 (k)	600	20	50	96	80	24	graph. char.	5x9 matrix for alpha, 6x10 for graphics & connected chars.; 32 graphics chars on ROM; gray scale; scrolling register; underline; programmable timer; 2 boards; BC, AV, AC.
<b>Polymorphic</b> VT1	210 (k) 280 (w)	1.6A	30	20	96	32, 64	16	64 (or 128) x48	Requires 2.5 MHz CRT bandwidth for 32-char line or 64-cell graphic line, 5.5 MHz for 64 char or 128-cell.
<b>Processor Tech.</b> VDM-1	199 (k) 295 (w)				u/l	64	16	no	BC, RV, AC, S.
<b>Solid State Music</b> VB1B	150 (k)	1.4A	30	15	128	64	16	128x48	RV, AC; composite & non-composite video.
<b>VAMP</b> Polygrafix	245* (w)					64	16	128-cell	*RV; 128 user-programmable char; piggy-back upgrade for Polymorphics VTI-64 card; \$525 w/VTI-64.

Make & Model	Price <sup>1</sup> (\$)	Power Required (mA) <sup>2</sup>			ASCII <sup>3</sup> char set	Char per line	Lines	Graphics	Remarks <sup>4</sup>
		+8V	+16V	-18V					
Vector Graphic Flashwriter	235 (w)	1.2A			128	64	16	128x48	RV; ½-intensity; keyboard port; composite or separate video and sync.
Western Data Systs. Pro/Ex 1	296 (k)	2A	125	125	64	40	24	block	BC, RV, AC; with on-board r-f modulator, plus 8K 2716 EPROM, MICROBUG OS.

Make & Model	Price <sup>1</sup> (\$)	Power Required (mA) <sup>2</sup>			ASCII <sup>3</sup> char set	Char per line	Lines	Graphics	Remarks <sup>4</sup>
		+8V	+12V	-12V					
SS-50									
F&D Associates VDB-1	29 (b)				u	32, 64	16	no	RV, AC; can be modified for lower case; 6800 software for scroll; erase, etc.
Gimix VID VID2	198 (w) 298 (w)	X X	X X	X X	64 256	64 80	16 24	no 640x384	BC, AC. BC, RV, AC; programmable char set; half-intensity; Eur. option.
Interactive Micro	225 (w)	X	X	X	128	32, 64	16	64x64	BC, RV, AC; 16-color, 64x64 color option; 6802 intelligence on-board.
Xitan VDB	369 (w)				96	80	25	160x75	Buffer memory holds two pages; keyboard port; lower-case descenders; 64 graphics chars; BC, RV, AC.
Xitek SCT-100	157 (k)	X			128*	64	16	limited	*Stand-alone, uses only 8V and ground from S-100 bus, interfaces via ports; ASCII or Baudot I/O; char set includes some Greek, graphics chars; part kit \$95.

1. (b)=bare boards, (k)=kit, (w)=wired.
2. in amps where indicated by "A".
3. u=upper case; l=lower case.
4. AC=Addressable Cursor; BC=Blinking Character; RV=Reverse Video; S=Scrolling.

# LINE-VOLTAGE COMPENSATOR

*Boosts the power-supply voltage when it drops too low*

In areas where low power-line voltage is common, a filament transformer can be used as a voltage booster. A 6.3-volt transformer can be used as shown in the figure. When the switch is placed in the BOOST position, the transformer acts as an autotransformer, increasing the voltage across the socket terminals by about 6 volts. When selecting a filament transformer for this application, determine how much current in amperes the load will draw. Then select a transformer whose secondary winding can safely handle this load current.

The dots shown near the transformer denote phasing of the windings. If you

BY HARRY J. MILLER

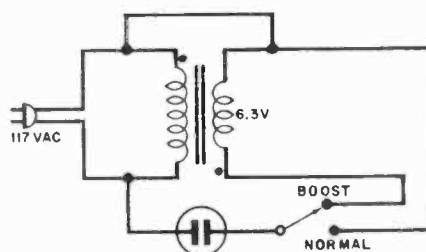

*With the switch in BOOST, line voltage is raised about 6V.*

do not know how the transformer is phased, you can determine this experimentally. Connect the secondary wires one way, power the circuit, place the switch in the BOOST position and measure the voltage across the power socket. If it is higher than the line voltage (the voltage across the primary), the transformer has been wired correctly. If the voltage across the socket is less than the line voltage, reverse the secondary wires. If the transformer has been incorrectly wired with respect to phase, it acts as a "bucking" autotransformer which has a lower output voltage than it has input voltage. ♦





## Tips & Techniques

### TWINLEAD CONNECTORS

Surplus crystal holders and sockets with a 1/2" (1.3-cm) pin spacing make excel-

lent connectors for 300-ohm "twinlead" transmission line. If the crystal holder's front plate is held in place with machine hardware, remove the machine screws and disassemble the crystal holder. If the holder is hermetically sealed, saw off its top. Heat the holder pins with your soldering iron and remove the thin metal plates that "sandwich" the quartz slab. Remove any excess solder plugging up the two pins. Next, strip the twinlead's insulation so that about 1" (2.5 cm) of each conductor is exposed. Tin the conductors, and slide them into the holder

so that their tips protrude from the ends of the pins. Solder the conductors and clip off any excess. Crystal sockets can be employed as antenna jacks to match the plugs you have fashioned. Because there are so many crystals ground for "odd" unusable frequencies available on the surplus market at low cost, you will find these twinlead connectors very economical. You might well have several such crystals in your junk box right now. —Harry J. Miller, Sarasota, Fl.

## Personal Computing... It All Comes Together at NCC '79.

Only during the National Computer Conference will you have an opportunity to experience personal computing to the fullest. And that's why the 1979 Personal Computing Festival, June 4-7 in New York's Sheraton Center Hotel, formerly the Americana, is different. As a conference within a conference, it will give you the chance to explore the complete spectrum of information processing while concentrating on those aspects of personal computing you won't want to miss...including equipment, applications, ideas, and new developments that have created excitement throughout the entire computing community.

Only at NCC '79 will you find such a panorama of computer products on display...ranging from micros to maxis, from processors to peripherals. Included will be the latest innovations in low-cost computing for business, professional, and home use.

Against the backdrop of the prestigious NCC, the Personal Computing Festival has attracted many well-known experts and personalities who will participate in an information-packed technical program and compete for prizes for the best presentations. Join them in exploring applications ranging from use of small business systems and financial analysis to personal networking, new information utilities, and aid to the handicapped.

You will also have ample opportunity to discuss new ideas and novel approaches to shared problems, to find out what to expect in the year ahead, and observe interesting and clever applications demonstrated by the individuals who developed them.

Plan now to take part in a unique personal computing experience at NCC '79. You can register for the Festival at the Sheraton Center Hotel, 52nd Street between 7th Avenue and Avenue of the Americas, for only \$15 which includes your copy of the



NCC '79 Personal Computing Proceedings. Registrations, excluding the Proceedings, also are available at \$5 for one day and \$9 for all four days. The Proceedings will be available separately at \$8. For additional information on NCC '79, including housing and registration procedures, contact AFIPS, 210 Summit Avenue, Montvale, N.J. 07645; telephone 201/391-9810. To obtain information on the special NCC Travel Service call toll-free 800/556-6882.

### PC BOARDS FORM PROJECT ENCLOSURE

With the price of quality cabinets continually increasing, it's possible to spend more for a simple project's enclosure than for all the components. However, there's another way to house your projects—use their pc boards as their own enclosures (see photo). If you are mak-



ing your own pc boards, study the schematic before doing any layout or etching. In most cases, you'll be able to break the circuit down into several sub-assemblies. For example, the project shown is a two-digit tachometer with four pc boards. The boards accommodate a clock, decade counters, displays and drivers, and support circuitry. If the circuit does not lend itself to such a functional breakdown, simply parcel it out onto separate board using a minimum amount of jumpers.

If you lay out each stage on its own board, place the ground foil along one edge and the supply voltage foil on the opposite side. It will then be possible to join the various boards together at the appropriate edges to form a "self" enclosure. Four pc boards can form a box with two open sides, five boards a box with one open side, and six a closed box. Breaking a project down into seven or more boards allows you to make eye-catching geometric shapes.

For an aesthetically pleasing look, use pc boards of various colors and place the component sides on the exterior of the "enclosure." The bottom board can be supported by four rubber feet on it. —James Temple, Bethpage, NY.

**NCC '79**  
PERSONAL COMPUTING FESTIVAL  
c/o AFIPS, 210 Summit Avenue, Montvale, N.J. 07645

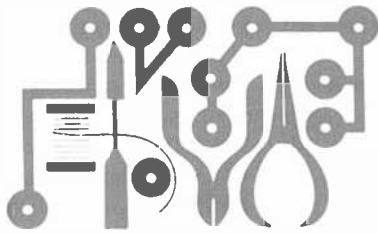

# Experimenter's Corner

By Forrest M. Mims

## THE ANALOG COMPARATOR

**T**HE ANALOG comparator is a circuit that compares an input voltage to a reference voltage and changes the state of its output when the input exceeds the reference. This decision-making ability has many important applications, several of which we will examine here.

A simple analog comparator can be made by using an operational amplifier without a feedback resistor. The role that a feedback resistor usually plays is to pass some of the amplified signal back to the inverting input of the op amp, thus reducing the amplifier's gain. Without the gain limitation imposed by a feedback resistor, the op amp operates at its maximum ("open-loop") gain. A small input voltage will then cause the output of the op amp to change state immediately. The resulting voltage swing is so dramatic that the comparator can be considered a switching circuit.

The operation of a noninverting analog comparator is shown in Fig. 1. A known reference voltage is applied to the comparator's inverting (-) input, and an unknown voltage to its noninverting (+) input. The LED indicates the status of the comparator's output.

In operation, the output of the comparator is at  $-V$  when the input voltage is more negative than the reference voltage which in this case is ground. The LED indicates this by glowing. When the

input voltage is more positive than the reference voltage, the comparator output switches from  $-V$  to  $+V$  and the LED is extinguished. Because the reference is ground, a very small positive voltage will trigger the comparator. In both cases, the voltage difference is measured in millivolts.

**Comparator Demonstration Circuit.** Unless you have previously worked with analog comparators, you will probably want to take a few minutes to breadboard the simple demonstration circuit shown in Fig. 2 before trying any of the circuits that will be described later.

The comparator in this circuit is a 741 op amp without a feedback resistor. A variable input voltage is provided by  $R1$ , a potentiometer operated as a voltage divider. Resistors  $R2$  and  $R3$  form a fixed voltage divider that provides a reference at half the supply voltage.

When the input voltage is below the reference voltage, the LED glows to indicate that the comparator's output is low (at ground). The LED switches off to indicate the comparator's output is high (at  $+9V$ ) as soon as the input voltage exceeds the reference voltage. With the values shown in Figure 2,  $R1$ 's wiper will be at the center of its rotation when the comparator switches, assuming that  $R1$  is a linear potentiometer.

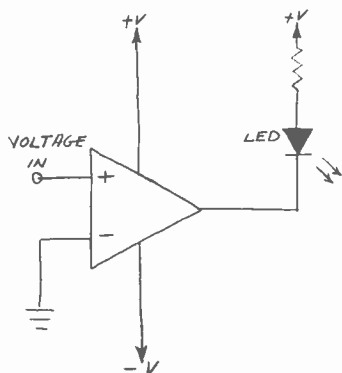

Fig. 1. Operation of a basic comparator circuit.

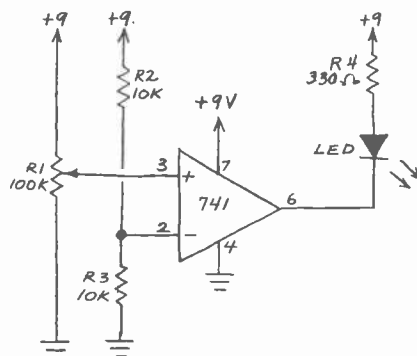
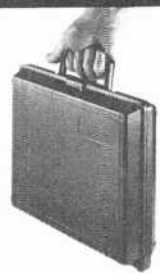

Fig. 2. Schematic of a demonstration comparator circuit.

# Now!



## A tool buddy for everybody!



# Xcelite®

## MULTI-PURPOSE TOOL KIT presents your 11 most used tools.

Professional or hobbyist, reach out your hand. Xcelite tool buddy TKX-11 has just the tool you want for tinkering, maintenance, or repair. Six different drivers — pocket clip, stubby, and regular — for slotted, Phillips, hex head screws and nuts. 10-foot inch/metric rule. Wire stripper/cutter. 6" slip joint plier, long nose plier with side cutter, adjustable wrench.

Compact, durable, double-wall caddy compartmented for easy choice and storage. A buddy you'll keep by your side.

New Gift Idea! For all occasions.

In stock at leading electronic distributors... nationwide.



## The Cooper Group Electronics Division

WELLER® · WISS® · XCELITE®  
PO BOX 728, APEX, NORTH CAROLINA 27502, 919/362-7511  
CIRCLE NO. 19 ON FREE INFORMATION CARD

# How do you really use a multimeter?

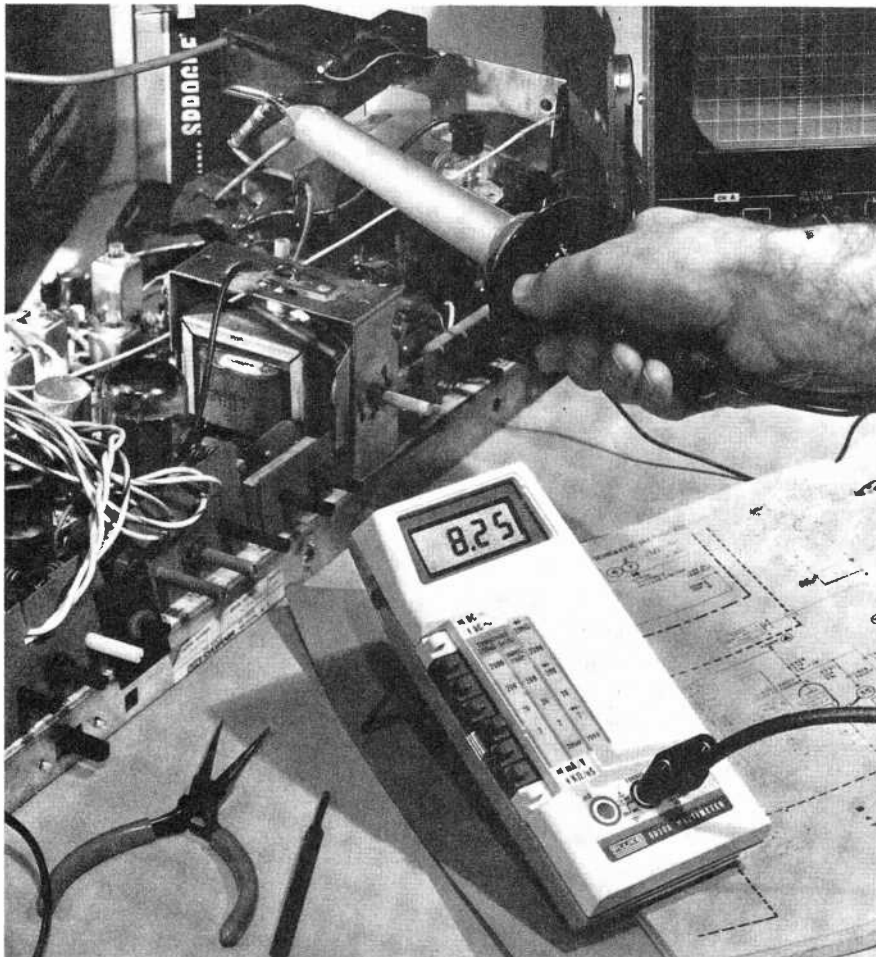

Usually at your bench, in the shop, shared with others. And, if it's a Fluke multimeter, you use it with confidence.

Now you can carry that same bench precision on the job. Introducing the new Fluke 8020A DMM for only \$169.

This rugged beauty packs more field-valuable features than any other DMM available, at any price. And that means field versatility when you need it most.

The 8020A has six resistance ranges, including a 20 megohm range for those special high-resistance TV components. Plus, you can measure focus dividers, pcb and capacitor leakage clear up to 10,000 megohms with the new conductance function. And conductance allows you to measure transistor beta—unique

with the 8020A.

Ever damaged your meter in the fly-back circuit? Rest easy. The 8020A is MOV-protected to 6000V against hidden spikes and transients.

Your 8020A comes with a full-year warranty, with worldwide service backup. Regardless of what happens to it, we'll fix it inexpensively and quickly, making the 8020A a truly cost-effective investment.

Call (800) 426-0361\*, toll free. We'll tell you the location of the closest Fluke office or distributor for the best value in DMMs around.

Price U.S. only.

\*Alaska, Hawaii and Washington residents — please call (206) 774-2481.

**Command Performance: Demand the Fluke 8020A.**

2510-8020



CIRCLE NO. 24 ON FREE INFORMATION CARD

## Sine- to Square-Wave Converter.

One of the simplest applications for a comparator is the sine- to square-wave converter shown in Fig. 3. The reference voltage is ground so the comparator switches its output to its maximum positive value when the sine-wave voltage exceeds ground potential. Similarly, the comparator output switches to its maximum negative value when the sine-wave voltage is at or below ground potential. The result is a square wave with the same period as the sine wave.

**Peak Detector.** Another simple but useful comparator application is the peak detector. As its name implies, the peak detector retains the maximum amplitude of a fluctuating input voltage for subsequent readout and analysis. Suitable transducers connected to the input of a peak detector permit the determina-

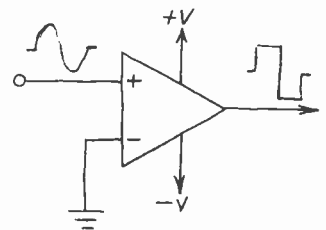

Fig. 3. Comparator as sine-wave to square-wave converter.

tion of such parameters as maximum wind velocity, temperature, light intensity, vehicle speed, and many others.

Figure 4 shows a basic peak detector circuit that you can easily assemble. To understand its operation, assume that  $C1$  is initially discharged (i.e., the RESET switch has been momentarily closed). This means that the reference voltage at the inverting input of the comparator is 0 and that a positive input voltage will immediately switch the output of the comparator to +9 volts. The comparator output will then begin to charge  $C1$  until the voltage across the capacitor equals the input voltage. As soon as the two voltages are equal, the comparator output immediately drops to ground potential and  $C1$  stops charging.

If a subsequent input voltage exceeds the charge stored in  $C1$ , the comparator output will again go high and allow  $C1$  to charge to the new peak voltage. This tracking process ensures that  $C1$  always retains the peak voltage applied to the input. When you want to track a new



(lower) peak voltage, close the RESET switch to discharge  $C1$ .

The peak detector circuit is subject to drift because  $C1$  will gradually lose its charge. Diode  $D1$  prevents discharge through the comparator, but discharge can take place through the output circuitry or through the dielectric leakage of the capacitor. For these reasons, it is important to use a low-loss polystyrene or Mylar capacitor for  $C1$  and a high-impedance monitoring circuit.

Last month's installment of this column described a simple high-impedance voltage follower you can use to interface the peak detector to a low-impedance device such as a panel meter or VOM. Without the high-impedance buffer,  $C1$  will quickly discharge when you attempt to measure the voltage across it.

**The Window Comparator.** The comparator circuits described thus far

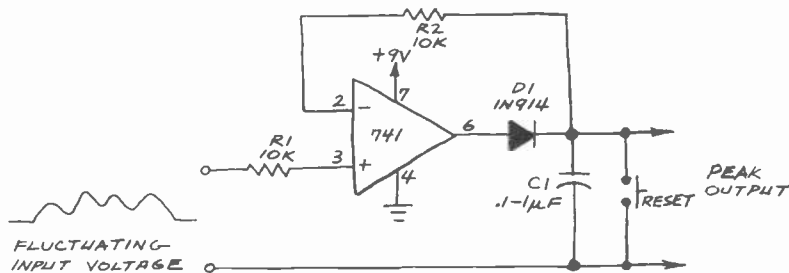

Fig. 4. Schematic of a simple peak detector.

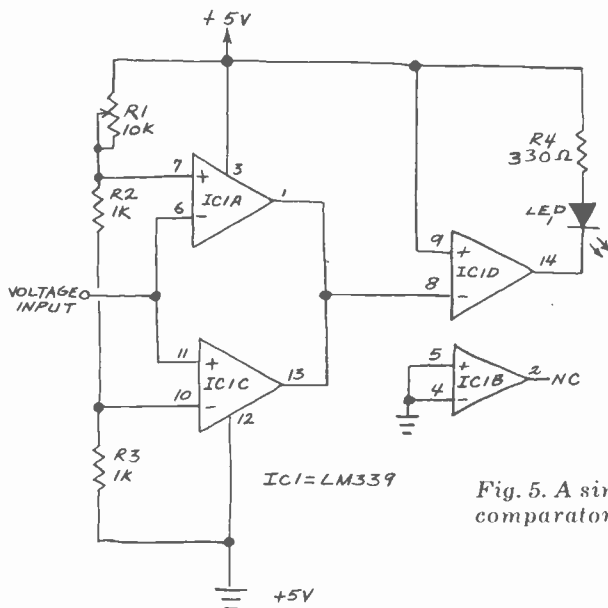

Fig. 5. A simple window comparator circuit.

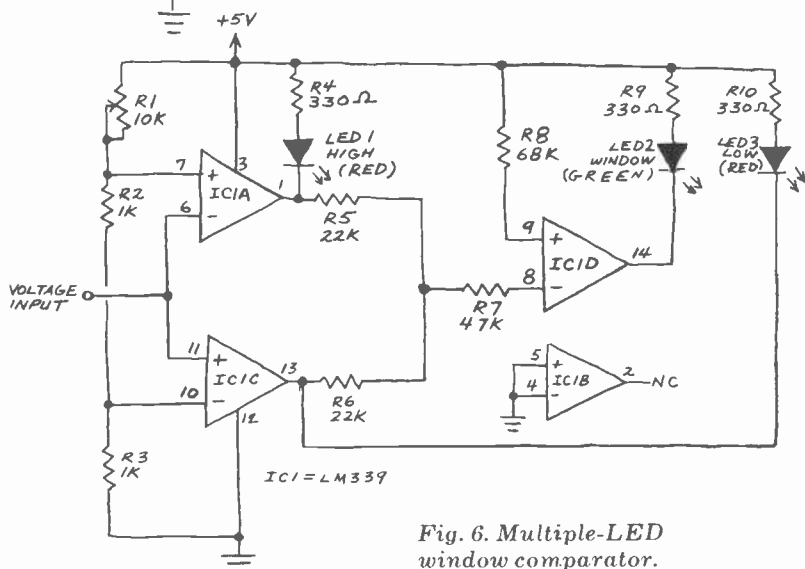

Fig. 6. Multiple-LED window comparator.

# FREE! EDMUND SCIENTIFIC CATALOG

Explore Astronomy, Biofeedback, Computers, Health, Lasers, Magnets, Microscopes, Optics, Photography, Weather... Over 4,000 Fascinating Items, More Than 160 Colorful Pages... The Exciting, FREE Edmund Catalog!

38 Years of Service!

No. 108  
Edmund Scientific Co. 1979

Yes! Rush me your FREE Catalog so that I can explore Edmund's World of Science.

Name \_\_\_\_\_  
Address \_\_\_\_\_  
City \_\_\_\_\_  
State \_\_\_\_\_ Zip \_\_\_\_\_

Clip and Mail Coupon Today to:  
Edmund Scientific Co., AV10  
Edscorp Bldg., Barrington, N.J. 08007

## ABOUT YOUR SUBSCRIPTION

Your subscription to POPULAR ELECTRONICS is maintained on one of the world's most modern, efficient computer systems, and if you're like 99% of our subscribers, you'll never have any reason to complain about your subscription service.

We have found that when complaints do arise, the majority of them occur because people have written their names or addresses differently at different times. For example, if your subscription were listed under "William Jones, Cedar Lane, Middletown, Arizona," and you were to renew it as "Bill Jones, Cedar Lane, Middletown, Arizona," our computer would think that two separate subscriptions were involved, and it would start sending you two copies of POPULAR ELECTRONICS each month. Other examples of combinations of names that would confuse the computer would include: John Henry Smith and Henry Smith; and Mrs. Joseph Jones and Mary Jones. Minor differences in addresses can also lead to difficulties. For example, to the computer, 100 Second St. is not the same as 10<sup>n</sup> 2nd St.

So, please, when you write us about your subscription, be sure to enclose the mailing label from the cover of the magazine—or else copy your name and address exactly as they appear on the mailing label. This will greatly reduce any chance of error, and we will be able to service your request much more quickly.

# Why buy a multi-capability counter for frequency-only measurements?



The 1911A multicounter makes accurate field transmitter frequency checks easy with the optional battery-pack and whip antenna.

For accurate readings in the presence of noise. Our new 1911/12A multi-counters have both trigger-level and attenuator controls.

For high resolution measurement of low frequency control tones in the period or period-average mode.

For economy. They're priced about the same as many frequency-only models, with totalize, autozero, autoranging, manual and automatic range selection, and more. Standard.

- 1911A for 250 MHz applications: \$495.\*
- 1912A for measurements to 520 MHz: \$620.\*

Call (800)426-0361, toll free, or write: John Fluke Mfg. Co., P.O. Box 43210, Mountlake Terrace, WA 98043.

\*(U.S. price)



1912A 520 MHz model

## Fluke Multicounters for Communications Service



7501-1911/12

CIRCLE NO. 25 ON FREE INFORMATION CARD

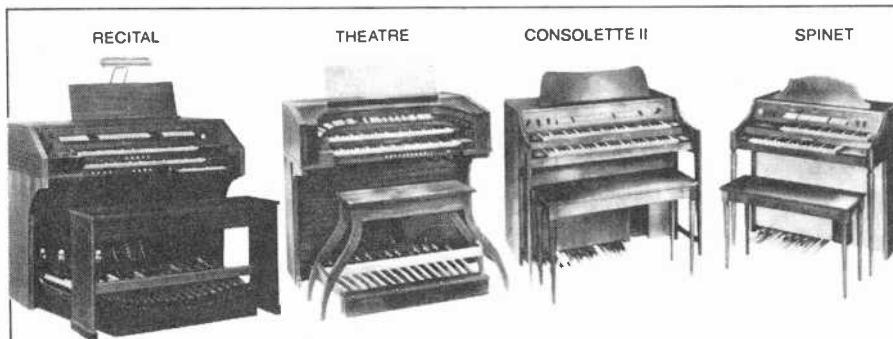

# You can assemble any of these Schober Organs

—and save 50% off store prices.

*This coupon will bring you the fascinating Schober color catalog which describes the organs and shows you how easy it is to assemble them from Schober's complete kits. Include \$1 if you want a 12-inch demo record.*

The *Schober* Organ Corp., Dept. PE-83  
43 West 61st Street, New York, N.Y. 10023

- Please send me the Schober Organ Kit Catalog.  
 Enclosed is my \$1 for the 12-inch demo record.

Name \_\_\_\_\_

Address \_\_\_\_\_

City \_\_\_\_\_ State \_\_\_\_\_ Zip \_\_\_\_\_

CIRCLE NO. 53 ON FREE INFORMATION CARD

operate in the noninverting mode. That is, they generate an output identical in polarity to the input voltage. However, a comparator can be operated in the inverting mode by simply reversing the two inputs. This makes possible many additional applications, one of which is called the limit or window comparator.

A window comparator can be made from three-fourths of an LM339 quad comparator as shown in Fig. 5. This chip was the subject of the January 1977 Experimenter's Corner. Unlike the 741, the LM339 is specifically designed to operate with a single-polarity power supply.

In operation, *IC1C* functions as a non-inverting comparator, but *IC1A* operates as an inverting comparator. Potentiometer *R1* and fixed resistors *R2* and *R3* form a divider chain that delivers slightly different voltages to the two comparators. These voltages define the upper and lower limits of the circuit's switching "window," which can be changed easily by varying *R2* and *R3*.

The output of each comparator in the LM339 is an uncommitted collector. This means two or more outputs can be tied together to achieve a logic OR function without using diodes or a logic gate.

When the input voltage is less positive than *IC1C*'s reference voltage, the output collector of this comparator is low. When the input voltage is more positive than *IC1A*'s reference voltage, its output collector is low. When either output is low, the other is pulled low, causing a LED connected between the two outputs and the positive power supply to glow.

If the input voltage falls in the window region between the two reference voltages, the output of each comparator is high. This will cause a LED connected to the outputs to be darkened.

It's usually desirable for an indicator to light when a desired condition is met. The third comparator in Fig. 5 serves this purpose by inverting the output of the window comparator. The LED then glows only when the input voltage falls within the window region.

An even more useful version of the circuit is shown in Fig. 6. Here, the third comparator is employed as a NAND gate. Three LED's connected to the outputs of all three comparators provide a HIGH/WINDOW/LOW indication. For best results, use a green LED for the WINDOW indicator and red LED's for the HIGH and LOW indicators. The green LED will glow when the input voltage is within the window. The red LED's will indicate that the input voltage is either above or below the window. The LED's should be

mounted in a vertical row with the HIGH LED on top, the WINDOW LED in the middle, and the LOW LED on the bottom.

If you use three different colors for the LED's, the circuit will tell you whether the input voltage is above, below, or in the window no matter how the LED's are mounted. A red LED connected to the output of IC1A, for instance, would indicate a HIGH voltage. A yellow LED at IC1C would indicate a LOW voltage. Finally, a green LED at IC1D would indicate an input voltage within the WINDOW.

Incidentally, the comparator used as a NAND gate in Fig. 6 can be replaced by a conventional TTL 7400 NAND gate. In

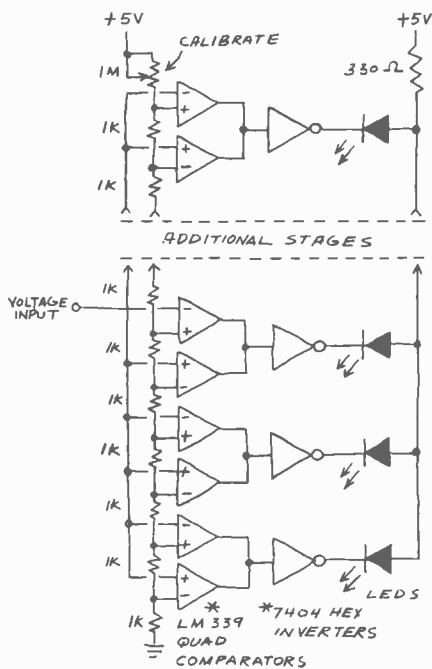

\*POWER SUPPLY CONNECTIONS NOT SHOWN  
GROUND UNUSED LM339 INPUTS

Fig. 7. A moving-dot voltage indicator.

fact, the first breadboard version of the circuit I assembled used a 7400. Similarly, the third comparator in Fig. 5 can be replaced by one of the inverters in a 7404 hex inverter or an npn transistor and a 10,000-ohm base resistor. Keep this in mind when building a window comparator in a complex circuit that includes digital logic chips. A 7400 with an unused gate will allow you to eliminate the extra resistors required by the comparator NAND gate.

### Moving-Dot Voltage Indicator.

The window comparator shown in Fig. 5 can be easily expanded to provide a moving dot LED voltage indicator and

Fig. 7 shows one possible configuration suggested by Bill Cikas of Rockford, IL.

Regular readers of this column might recall the moving-dot voltage indicator described in the October 1978 installment. Bill's circuit requires three functional blocks per dot while my earlier circuit uses 2.5 per dot. On the other hand, Bill's circuit requires one less IC (7) than mine (8). It's also more straightforward and easier to troubleshoot.

**Solid-State Oscilloscope Update.** The solid-state oscilloscope described in previous columns has resulted in more letters than any previous topic included in "Experimenter's Corner." In fact, the moving-dot voltage indicator in Fig. 7 is actually the vertical section of a solid-state scope designed and built by Bill Cikas.

I'll have more to say about this and other experimental solid-state scopes in a future column. In the meantime, I would like to hear from other experimenters who have successfully assembled and operated all-solid-state oscilloscopes. Please include a stamped, self-addressed envelope for a reply. ◇

## Build The World's Most Powerful 8-Bit Computer

### Featuring The Famous Intel 8085!

# Explorer/85™

Starting for just \$129.95 you can now build yourself a sophisticated, state-of-the-art computer that can be expanded to a level suitable for industrial, business and commercial use. You learn as you go... in small, easy-to-understand, inexpensive levels!

- Features Intel 8085 cpu/100% compatible with 8080A software!
- Onboard S-100 bus (up to 6 slots)!
- Onboard RAM and ROM expansion!
- Built-in deluxe 2K Monitor/Operating ROM!
- Cassette/RS 232 or 20 mA J4-1/2 8-bit parallel I/O and timer all on beginner's Level "A" system!

EXPLORER/85 gives you "big computer" features immediately, without turning you into an appliance operator, doomed to run pre-developed software for life. Simply connect EXPLORER to a terminal, video monitor or tv set and 8 volt power supply and start running programs, the very first night! Level "A" teaches you machine language and computer fundamentals. It lets you run exercise programs including programs to examine the cpu registers, examine memory, fill memory, move memory and make up games. You can load and play back these programs on an ordinary tape cassette—and display your efforts in any tv screen, video monitor or printer. (\$8.95 RF modulator required for tv use.) The simplified architecture of the Intel 8085 makes EXPLORER far easier to understand than computers using the older, more complex but less powerful 8080A. Then, when you're ready, EXPLORER can be expanded—by you—to rival the power of any 8-bit computer on earth. Or you can customize it to perform a dedicated task, thanks to onboard prototyping, RAM and ROM expansion capabilities.

#### LEVEL "A" SPECIFICATIONS

EXPLORER's Level "A" system features an advanced Intel 8085 cpu, which is 50% faster than its 8080A predecessor, yet 100% compatible with 8080A software which, you'll discover, exists by the ton. "Big computer" features include an 8355 ROM with 2K deluxe monitor/operating system which has two programmable 8-bit bi-directional parallel I/O ports, built-in cassette interface with tape control circuitry to allow labeling cassette files, and commands which include: "display contents of memory," "run at user location (go to)," "insert data," "move contents of memory," "examine registers individually or all," "fill command (to fill the contents of memory with any variable), automatic baud rate selection, programmable characters per line display output format, and more! An 8155 RAM—I/O chip contains 256 bytes of RAM, two programmable 8-bit bi-directional and one programmable 6-bit bi-directional I/O ports plus programmable 14-bit binary counter/timer, user interrupt and reset switches. Onboard expansion provisions exist for up to six S-100 boards, 4K of RAM and 8K of ROM, PROM or EPROM.

#### Netronics R&D Ltd., Dept P E 5, 333 Litchfield Road, New Milford, CT 06676

- |   |   |
|---|---|
| <input type="checkbox"/> Level "A": EXPLORER/85 kit (specify cu terminal or hex keypad input) \$129.95 plus \$3 p&h | <input type="checkbox"/> Deluxe Steel Cabinet for EXPLORER/85, \$39.95 plus \$3 p&h                 |
| <input type="checkbox"/> Power Supply kit, 5 amp, 8 volt, \$34.95 plus \$2 p&h.                                     | <input type="checkbox"/> Deluxe Steel Cabinet for Keyboard/Video Terminal, \$19.95 plus \$2 50 p&h. |
| <input type="checkbox"/> Intel 8085 User's Manual, \$7.50 ppd   | <input type="checkbox"/> RF Modulator kit, \$8.95 ppd.  |
| <input type="checkbox"/> ASCII Keyboard/Video Terminal kit, \$149.95 plus \$3 p&h                                   | <input type="checkbox"/> Total Enclosed (Conn res add tax) \$_____                                  |
| <input type="checkbox"/> Hex Keypad kit for hex version, \$69.95 plus \$2 p&h                                       | <input type="checkbox"/> VISA <input type="checkbox"/> Master Charge Exp. Date _____                |
| <input type="checkbox"/> Level "B": S-100/Onboard RAM/ROM Decoder kit (less S-100 connectors), \$49.95 plus \$2 p&h | Account # _____   |
| <input type="checkbox"/> Level "C": S-100 S-Card Expander kit (less connectors), \$39.95 plus \$2 p&h.              | PHONE ORDERS CALL (203) 354-9375  |
| <input type="checkbox"/> S-100 Bus Connectors (gold), \$4.85 each.  | Name _____  |
| <input type="checkbox"/> Level "D": 4K Onboard RAM kit, \$69.95 plus \$2 p&h.                                       | Address _____   |
|   | City _____  |
|   | State _____ Zip _____   |

CIRCLE NO. 41 ON FREE INFORMATION CARD

## The quick charge iron with 16 different quick change tips.



**ISORTIP®**  
QUICK CHARGE  
Cordless  
Soldering Iron  
completely  
recharges in  
3½-4 hours.  
Low voltage,  
battery powered,  
ground free  
isolated tip  
design.

16 snap-in tips  
to fit any job  
plus a PC  
Drill.

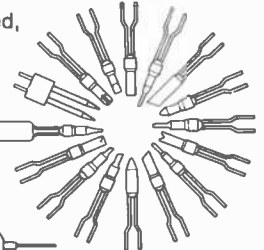

**WAHL CLIPPER CORPORATION**  
ORIGINATORS OF PRACTICAL CORDLESS SOLDERING  
• Sterling, Illinois 61081 • (815) 625-6525  
"Manufacturing Excellence Since 1919"  
CIRCLE NO. 59 ON FREE INFORMATION CARD

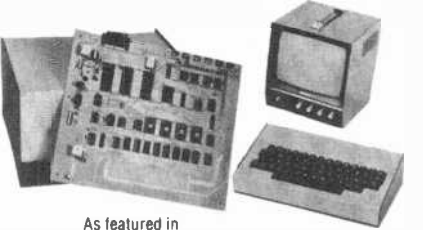

As featured in  
**POPULAR ELECTRONICS**  
EXPLORER/85 shown with Video Monitor and Keyboard/Video Terminal

**CHOICE OF HEX KEYPAD OR TERMINAL INPUT**  
If you plan to customize EXPLORER for dedicated use, we recommend that you order hex keypad input. But, if you are planning to go whole hog and blow EXPLORER up into a full size, state-of-the-art system with 8K or extended basic (coming soon), up to 64K of memory, floppy disks, telephone interface, printers, and all sorts of S-100 plug-ins—you'll be better off with the Keyboard/Video Terminal input. The \$149.95 EXPLORER Keyboard/Video Terminal includes full ASCII decoding with 128 ASCII upper/lower case set, 96 printable characters, onboard regulators and selectable display formats—32x16 for tv set or 64x16 for video monitor (not included).

**EXPAND EXPLORER, LEVEL-BY-LEVEL**  
Level "B", at \$49.95, adds S-100 signals plus onboard RAM/ROM decoding (includes all parts necessary to generate the signals for S-100 bus accessories. Just add two S-100 bus connectors and you have a complete S-100 compatible computer with a work of add-ons at your fingertips. Choose from hundreds of products to satisfy your individual needs. Level "B" kit also includes the address decoders for onboard RAM and ROM expansion, which are addressable anywhere in the 65K field.  
Level "C" expansion, at \$39.95, expands the S-100 bus to allow a total of six S-100 cards to be plugged into EXPLORER's motherboard and contained in EXPLORER's steel cabinet. Includes all hardware, mounting brackets, board guides, etc. Just add the number of S-100 bus connectors you need.  
Level "D" expansion, at \$69.95, gives you 4K of onboard static RAM utilizing 2114 IC's. Your board will also accept four 2716 EPROM's, which can be purchased separately. You now have an advanced mainframe that can be customized with the peripherals of your choice to fit any (or all) specific requirements. Each level of EXPLORER is separately regulated for the ultimate in stability. Factory service is available from Netronics. Order your EXPLORER today!

**ORDER FROM THIS COUPON TODAY!**  
Netronics R&D Ltd., Dept P E 5, 333 Litchfield Road, New Milford, CT 06676

Level "A": EXPLORER/85 kit (specify cu terminal or hex keypad input) \$129.95 plus \$3 p&h

Power Supply kit, 5 amp, 8 volt, \$34.95 plus \$2 p&h.

Intel 8085 User's Manual, \$7.50 ppd

ASCII Keyboard/Video Terminal kit, \$149.95 plus \$3 p&h

Hex Keypad kit for hex version, \$69.95 plus \$2 p&h

Level "B": S-100/Onboard RAM/ROM Decoder kit (less S-100 connectors), \$49.95 plus \$2 p&h

Level "C": S-100 S-Card Expander kit (less connectors), \$39.95 plus \$2 p&h.

S-100 Bus Connectors (gold), \$4.85 each.

Level "D": 4K Onboard RAM kit, \$69.95 plus \$2 p&h.

Deluxe Steel Cabinet for EXPLORER/85, \$39.95 plus \$3 p&h

Deluxe Steel Cabinet for Keyboard/Video Terminal, \$19.95 plus \$2 50 p&h.

RF Modulator kit, \$8.95 ppd.

Total Enclosed (Conn res add tax) \$\_\_\_\_\_

VISA  Master Charge Exp. Date \_\_\_\_\_

Account # \_\_\_\_\_

PHONE ORDERS CALL (203) 354-9375

Name \_\_\_\_\_

Address \_\_\_\_\_

City \_\_\_\_\_

State \_\_\_\_\_ Zip \_\_\_\_\_

DEALER INQUIRIES INVITED



By John McVeigh

## COMMON ANODE vs. COMMON CATHODE DISPLAYS

**Q.** A circuit calls for common-cathode LED displays, but the ones I have are the common-anode type. Is there a circuit that will allow me to use common-anode displays with common-cathode circuits, and vice versa?—Chris Iannuzzi, Warrenton, VA.

**A.** The common-anode display, connected to a chip designed to operate with such a display, is shown at A in the figure. When base current is applied to a driver transistor, it turns on and sinks current for the diode in a given segment. (For simplicity, only one diode per segment is assumed and only two segments are shown. Also, multiplexing details are omitted.) Note that all anodes in the display have a common connection to  $+V_{CC}$ . A common-cathode display is shown at B. Base current applied to a

segment's driver transistor causes the device to conduct and source current for the LED. All cathodes in the display have a common connection to ground.

As far as the display-driver IC is concerned, one for common-anode applications sinks current through its output stages, but one for common-cathode displays sources current at its outputs. To use a common-anode driver with a common-cathode display, the circuit shown at C can be used. Pull-up resistor R, whose value should be chosen so that a few milliamperes flow through the driver transistor when base current is applied, is connected to  $+V_{CC}$ . When the transistor conducts, the input of the inverter is grounded. Accordingly, the output of the inverter is high and sources current for the segment LED. When the driver transistor is cut off, the input of the inverter is high and the output low. The segment LED is darkened.

To use a common-anode display with a common-cathode driver IC, the circuit shown at D can be employed. When base current turns a transistor on, the voltage appearing across R causes the inverter output to go low and sink current through the LED. When the transistor is cut off, the input of the inverter is low and its output high. No voltage drop exists across the LED, no current flows through it, and it remains darkened.

If you use either of these converter circuits, be sure that the inverters can handle the amount of current required by the LED segments.

Have a problem or question on circuitry, components, parts availability, etc? Send it to the Hobby Scene Editor, POPULAR ELECTRONICS, One Park Ave., New York, N.Y. 10016. Though all letters can't be answered individually, those with wide interest will be published.

Interestingly, some manufacturers are now producing IC's that will work with either common-cathode or common-anode displays. At E, National Semiconductor's MM5402 and MM5405 clock chips' output stage is shown connected to a common-anode display. The SEGMENT pin, internally connected to the drain of the driver, is wired to the cathode of a segment LED. The OUTPUT COMMON pin, internally connected to the source of the driver, is grounded.

At F, the common cathode application is shown. The OUTPUT COMMON pin is connected to the positive supply voltage and the SEGMENT pin connected to the anode of one segment diode in the common-cathode display. The diode cathodes are grounded. Thus, the driver either sinks or sources display current, depending on how the output pins are connected, making the clock chips compatible with either type of display. Another nice feature of these clock chips is their ability to be directly connected to LED displays. Current limiting resistors are not required.

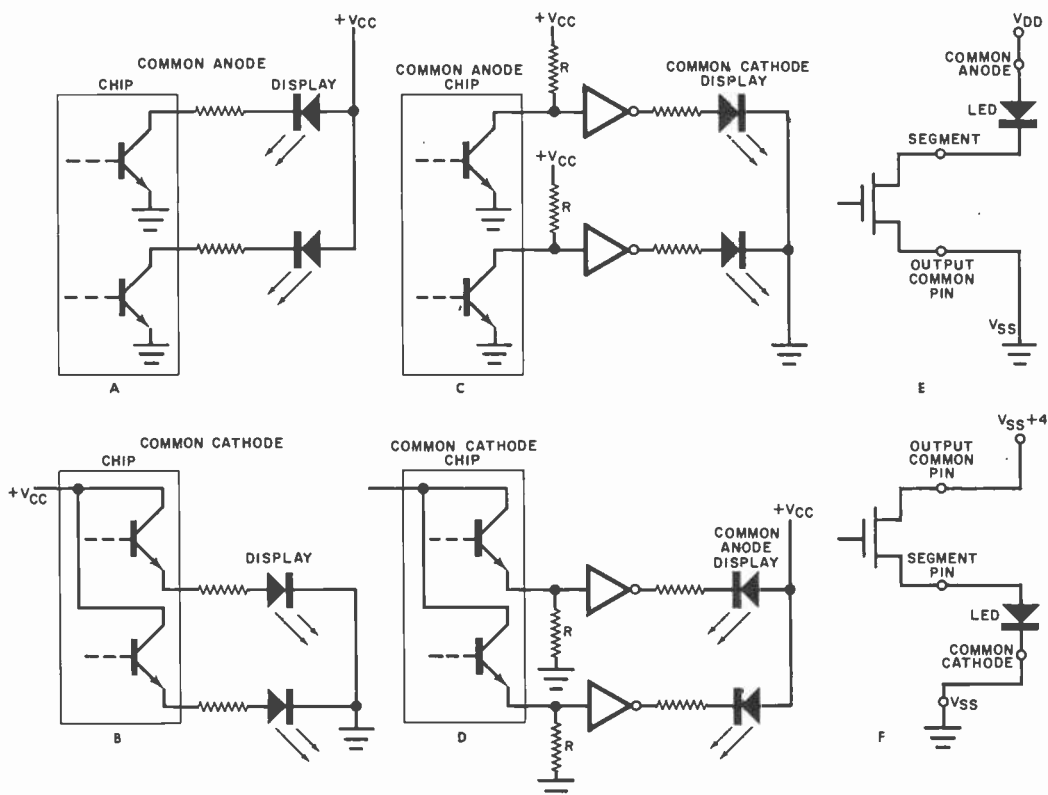



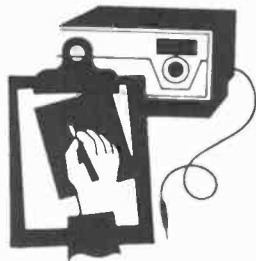

# Product Test Reports

## Sabtronics Model 8100 Frequency Counter



*100-MHz, 8-digit counter kit  
sells for only \$90*

**T**HE Sabtronics Model 8100 is one of a number of frequency-counter kits costing under \$100 that have recently appeared on the market. It has a guaranteed measuring range of from 20 Hz to 100 MHz (to 600 MHz with an optional prescaler, add-in facilities for which are provided in the basic instrument). The worst-case input sensitivity up to 100 MHz is specified at 25 mV rms. Three selectable gate times permit the frequency to be directly read from the instrument's eight-digit numeric display.

Built into the counter is a crystal time base that provides a rated measurement accuracy of better than 2 ppm (0.0002%), with a rated stability of  $\pm 1$  ppm. The input impedance is 50 ohms or 1 megohm, switch selectable. Input protection is to 150 volts rms up to 10 kHz, 90 volts rms between 10 kHz and 2 MHz, and 30 volts rms between 2 MHz and 100 MHz. Also included is a three-decade switchable attenuator for the input, a nicely rarely seen in an economy-priced frequency counter.

The Model 8100 frequency counter

measures 8" W x 6½" D x 3" H (20.3 x 16.5 x 7.6 cm). Supplied without batteries (8 AA cells are required), ac adapter, or input cable, it is priced at \$89.95. Available as options are an ac adapter and a 600-MHz prescaler.

**General Information.** The Model 8100 is a simple frequency counter to use and interpret. You simply set the input ATTENUATOR switch to X1, X10, or X100, depending on the level of the input signal. Then you connect the input cable to the desired points in the circuit under test, select the appropriate gate time, and read the frequency directly from the display. Frequencies are displayed in kilohertz to the left and hertz to the right of the decimal point. (The decimal point automatically appears in the proper location when the GATE TIME switch is set to any position.)

To operate the instrument, you set each of four switches to their appropriate positions. Power is applied to the counter and input impedance is simultaneously selected by placing the switch

# McIntosh

"A Technological  
Masterpiece..."



McIntosh C 32

## "More Than a Preamplifier"

McIntosh has received peerless acclaim from prominent product testing laboratories and outstanding international recognition! You can learn why the "more than a preamplifier" C 32 has been selected for these unique honors.

Send us your name and address and we'll send you the complete product reviews and data on all McIntosh products, copies of the international awards, and a North American FM directory. You will understand why McIntosh product research and development always has the appearance and technological look to the future.

Keep up to date.  
Send now - - -

McIntosh Laboratory Inc.  
Box 96 East Side Station  
Binghamton, NY 13904

Name \_\_\_\_\_

Address \_\_\_\_\_

City \_\_\_\_\_ State \_\_\_\_\_ Zip \_\_\_\_\_

If you are in a hurry for your catalog please send the coupon to McIntosh. For non-rush service send the Reader Service Card to the magazine.

CIRCLE NO. 39 ON FREE INFORMATION CARD

Put Professional Knowledge and a  
**COLLEGE DEGREE**

in your Electronics Career through

**HOME  
STUDY**

**Earn Your  
DEGREE**

by correspondence, while continuing your present job. No commuting to class. Study at your own pace. Learn from complete and explicit lesson materials, with additional assistance from our home-study instructors. Advance as fast as you wish, but take all the time you need to master each topic.

The Grantham electronics degree program begins with basics, leads first to the A.S.E.T. degree, and then to the B.S.E.T. degree. Our *free* bulletin gives complete details of the program itself, the degrees awarded, the requirements for each degree, and how to enroll. (We are located at 2500 S. LaCienega Bl., Los Angeles, Calif.) Write to our mailing address shown below for *Bulletin E-79*.

**Grantham College of Engineering**  
P. O. Box 35499  
Los Angeles, California 90035

Worldwide Career Training thru Home Study  
CIRCLE NO. 31 ON FREE INFORMATION CARD

Best price and delivery on . . .

**Exidy Sorcerer®**

— call us —



12" Video Monitor ONLY \$139

**NORTH STAR**

Complete MiniFloppy Disk System	
double density, Kit, List \$699	\$589
Assembled, List \$799	\$689
Horizon 1, double density, Kit, \$1599	\$1349
Assembled, List \$1899	\$1599
Horizon 2, double density, Kit, \$1999	\$1699
Assembled, List \$2349	\$1939

**SAVE 10%**  
on Radio Shack  
**TRS-80's**  
or accessories

— WRITE FOR FREE CATALOG

**MiniMicroMart, Inc.**

1618 James Street, Syracuse NY 13203  
PHONE: (315) 422-6666 TWX 710 541-0431  
CIRCLE NO. 44 ON FREE INFORMATION CARD

labelled 50Ω/1MΩ/OFF to one of its first two positions. Then, depending on the frequency being counted, the DIRECT/PRESC. switch is set to one or the other position. (We built and tested the basic 100-MHz version of the counter. Hence, we always set this switch to the DIRECT position during our tests.)

The GATE TIME switch must be set next to the appropriate position according to the frequency being counted. (The GAT. LED in the display blinks on briefly once every tenth of a second, every second, and every 10 seconds for the 0.1S, 1S, and 10S positions of the switch, respectively.) At this point, the frequency being counted appears in the display. If an overflow condition exists, the OFL. LED comes on, indicating that the GATE TIME switch must be set for a shorter interval than that selected.

**About the Kit.** This was a very easy kit to assemble, requiring approximately four hours to complete from the time we opened the carton in which it was shipped until the end of calibration and final assembly. Credit for this simplicity goes to the open and uncluttered layout of all parts and the explicitly illustrated and well-written assembly instructions. Moreover, we encountered no difficulties in assembling the kit.

With the exception of the input connector(s) and the two batteryholders, every electronic component that makes up the counter is mounted on either of two silk-screened printed circuit boards. The large main pc board is double-sided and has plated-through holes. Most of the components go on this large mother board, which contains all counting and decoding circuits and the time-base oscillator. The smaller display board is single-sided and contains the seven-segment LED displays, the segment and digit drivers, and the operating switches.

The only items needed for successful completion of the kit are a pair of long-nose pliers, diagonal cutters, a screwdriver, solder, and epoxy cement.

During assembly, we noted that all resistors had a 5% tolerance, even in those circuits where a 10% or 20% tolerance would have sufficed. Another plus is that the kit is supplied with sockets for all ICs, which reduces the possibility of damage to the ICs during installation and soldering.

**Laboratory Tests.** The frequency counter performed well within its published ratings in every important area of operation. Our test setup consisted of

both a very-low-frequency and a 500-MHz r-f signal generator for providing the wide range of frequencies required for making a frequency-range test on the instrument. We also used a very accurate laboratory-grade frequency counter to check the Model 8100's accuracy and a digital multimeter to monitor the signal level required for positive triggering.

Our frequency-range test revealed that the Model 8100 can accurately operate down to 1 Hz or less and to well beyond Sabtronics' guaranteed 100-MHz high end. In fact, the high-frequency limit was 134 MHz before we had to boost the input signal level to an amplitude to 25 mV, which is the level specified by Sabtronics for a 100-MHz display. (The frequency counter actually operated unambiguously out to 148 MHz with a 50-mV input and might reasonably have responded well beyond 150 MHz if we had boosted the input signal level to 100 mV.)

Sabtronics specifies the input sensitivity of the frequency counter to be 15 mV rms from 20 Hz to 70 MHz and 25 mV rms from 70 to 100 MHz. In our tests, however, the actual sensitivity was much better. It measured 10 mV rms or less between 1 Hz and 75 MHz and was typically an average of 3.8 to 7.1 mV over most of this range. Between 75 and 120 MHz, it was between 7.5 and 17 mV. The sensitivity dropped to 25 mV at 134 MHz and 50 mV at 148 MHz.

We performed the above tests first with the no-instruments calibration procedure detailed in the assembly manual supplied with the kit and again after precision calibration with instruments. When we compared the two sets of test data obtained, there was no significant difference in performance. (The test results given above were for calibration without instruments.)

We did not check the average aging rate of the instrument, which is rated at ±1 ppm/month for the first three months of continuous operation and ±5 ppm/month thereafter.

**User Comment.** Having used the Model 8100 frequency counter for several months, both on our workbench and in the field, we have come to appreciate its reliable and accurate performance under just about any testing condition imaginable. It is lightweight, portable, and relatively rugged. There is no doubt that the Model 8100 is suitable for experimenters, hams, and service personnel in shop or field.

CIRCLE NO. 104 ON FREE INFORMATION CARD  
POPULAR ELECTRONICS

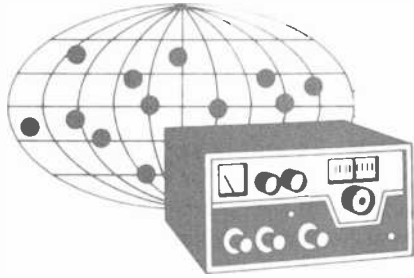

# DX Listening

By Glenn Hauser

## HOW MANY SWLS?

“THE REGULAR audience for shortwave broadcasting is vanishingly small.” That’s the position of the ham radio lobby, ARRL, expressed in its Oct. 1978 issue of the magazine *QST*. In an effort to bolster its own threatened position at the 1979 World Administrative Radio Conference, ARRL has tried to show that no more frequencies should be allocated for international shortwave broadcasting.

The ARRL position is based on a report it commissioned from the Stanford Research Institute, and then submitted to the FCC. In the *Review of International Broadcasting*, Lawrence E. Magne effectively debunks the S.R.I. report, showing among other things that the figures it gives on the size of the U.S. SWL audience are only a fraction of those obtained in a 1975 Gallup Poll commissioned by Radio Canada International. The previously confidential Gallup Poll figures were first published in Magne’s article.

The poll showed the following total figures for the U.S. adult audience of six leading international broadcasting stations. They are composed of three subtotals—those who listen less than once a month; those who listen one, two or three times a month; and those who listen once a week or more often. (The adult population of the U.S. was taken to be 142,000,000 as of 1975.)

BBC	4,544,000
Radio Canada International	4,402,000
Radio Moscow	2,840,000
Deutsche Welle	2,414,000
Radio Habana Cuba	2,272,000
Radio Nederland	1,988,000

These are not huge numbers, but they are far from being “vanishingly small” and only cover the audiences for six out of hundreds of stations. Moreover, the U.S. population is larger today, and SWL is enjoying a surge in popularity. Combined with many new easy-to-tune shortwave models, the audience can only be larger today. Does anyone think that Radio Shack, Panasonic, Sony, and Lafayette would introduce new SW models, as they recently have done, if the market were shrinking?

**Future Plans.** For further evidence of the viability of international shortwave broadcasting, we need only look into these “future plans,” all of which at press time had not yet taken place. Any dates mentioned should be considered approximate since construction invariably takes longer than the station had originally expected.

● *Adventist World Radio* is getting into shortwave broadcasting in a big way after several years of buying time on ex-

isting stations. AWR plans to build its own shortwave station in Liberia. Construction of four transmitters totalling 500 kW is to begin sometime this year. Already being built is another AWR station in Guatemala on AM and FM, with a separate shortwave service to be on the air in the 25-meter band by mid-1979.

● *Trans World Radio*, Monte Carlo, is replacing a pair of 100-kW shortwave transmitters with 500-kW units.

● *HCJB*, Ecuador, is installing a new 10-kW tropical band transmitter to provide regional service in Spanish and Quechua, probably on 3220 kHz, targeted for May. But HCJB minimizes its involvement in the Hawaiian shortwave project mentioned in this column last November.

● It had been reported that *Radio Voice of the Gospel*, which was nationalized out of Ethiopia, would make a comeback from Gabon’s new set of 500-kW shortwave transmitters. However, those senders have been slow in coming into regular service and RVOG is keeping its options open.

● Ever-eager to make missionary inroads into China, while avoiding the risk of nationalization, is the *Far Eastern Broadcasting Co.*, which is installing two 100-kW shortwave transmitters on the island of Saipan, which FEBC emphasizes is “American soil.”

● *Radio-TV Dominicana* is gearing up for an expanded international service, probably initially on 5970 and 9505 kHz, with programs produced by an Avery Schreiber look-alike, Teo Veras. The new service is to include DX features both from local and U.S. sources.

● *Radio Mexico* has expanded its transmission hours, showing up on new frequencies (including two already occupied by AFRTS), and has announced plans to begin broadcasts in English and Japanese. Another shortwave station is expected at the Autonomous University of Nuevo Leon, in Monterrey, probably on the 49-meter band.

● *Radio Nacional*, Venezuela, may upgrade its irregular international broadcasts from 10 to 50 kW on 15400 kHz. But this is eclipsed by the acquisition of a million-watt medium-wave transmitter to be installed on the Paraguana Peninsula and used for international broadcasts in several languages. If its frequency is clear, this should have no trouble getting into the USA. The transmitter operated formerly for a short time on 625 kHz from Costa Rica.

● *Radio Free Europe* has kept in service some 10-kW transmitters at Holzkirchen, West Germany. They’re no match for the megawatts of jamming they may face, so plans are to replace these with 250-kW senders.

● Something is going on in Sri Lanka. It had been widely reported that West Germany’s *Deutsche Welle* was building a

shortwave relay station here, perhaps to be used in conjunction with other stations, such as the *Voice of America* (which already has a low-powered station in Colombo), and *Radio France International* (which is also building a relay in French Guiana). But a DW spokesman says this is merely speculation, although DW does plan to put on a relay station somewhere in Asia.

- **Mongolia** is expanding its domestic radio network, with Soviet aid. New stations have already gone on the air at Altay and Choybalsan, on 4995 and 4850 kHz, and more are expected.

- **BBC** plans to set up a new relay station in Lesotho, to serve southern Africa.

- **Radio Nederland** is upgrading its domestic site near Lopik with several new 500-kW transmitters.

- **Radio Australia** has installed two new 100 kW Harris-Gates transmitters at its main site in Shepparton, Victoria, allowing older transmitters to be overhauled a pair at a time, with an ultimate gain of two senders when all are back on the air. And the Darwin relay station is to be revived, after several years of silence following cyclone damage.

- Upgraded international services are also in the offing from many other countries, including Kenya, New Zealand, Norway, Saudi Arabia, Sweden and Yugoslavia.

- Not all the news is good. *Radio Canada International* has suffered a \$1.5 million budget cut, part of a \$71 million overall CBC budget cut. RCI has had to cut its staff by 15%; that is, 36 people declared redundant; and RCI is obliged to move out of its quarters in the Maison de Radio-Canada in the city of Montreal.

**Conventions.** The big event each year for shortwave listeners is the annual ANARC (Association of North American Radio Clubs) convention. Anyone who is interested in DX listening is *welcome* to attend. No club membership is required. This year's convention takes place in Minneapolis, June 22-24. Equipment representatives are expected as well as personalities such as Bob Zanotti from Swiss Radio International. Ian McFarland of RCI, Stewart Spencer of the VOA, and Alfonso Montealegre of Radio Nederland. For full details, send a legal-size SASE to: ANARC 79, 3320 Grand Ave. South, No. 305, Minneapolis, MN 55408.

The equivalent in Europe takes place June 1-4 in Vienna. For details, contact EDXC Conference Committee, P.O. Box 11, A-1111 Vienna, Austria. Specially low accommodation rates are promised.

**Updating Listings.** The following changes and additions should be made in the "English Broadcasts" listings in the April issue:

GMT	Station	Frequencies, changes
0900-1000	R. Australia	Not 0800-, also not 9540
1100-1156	R. RSA	Not Sun. and not 21535
1100-1245	TWR, Bonaire	15255, ex-11815 (Sat.-1330, Sun.-1415)
1100-1330	BBC	9510, ex-5990
1230-1550	WYFR	21525, 17845 (Sun. only)
1400-1430	V. Rev. Party	4109, ex-4120
1500-1730	R. Australia	11870

**J&R** THE ONE-STOP MUSIC SHOP AT WHOLESALE PRICES

**BLANK TAPES**

**CASSETTE TAPES**

Ampeex Grand Master I C-90	\$2.14
Ampeex Grand Master I C-90	\$2.79
BA5F Studio C-90	\$1.99
BA5F Professional	
II or III C-90	\$2.99
Maxell UD C-90	\$1.82
Maxell UD C-90	\$2.85
Maxell UDXL I or II C-90	\$3.47
Maxell UDXL I or II C-90	\$3.47
Scotch low noise (Dynarange) C-90 / 3 pk.	\$4.99 for 3
Scotch Master I C-90	\$3.29
Scotch Master II or III C-90	\$3.29
Sony Ferrichrome C-90	\$3.88
TDK D C-90	\$1.20
TDK D C-90	\$1.68
TDK D C-120	\$2.10
TDK D C-180	\$2.99
TDK AD C-90	\$1.79
TDK AD C-90	\$2.52
TDK SA C-60	\$2.22
TDK SA C-90	\$3.18

Minimum Order 12 Tapes - 100% Guaranteed.

**CARTRIDGES** audio-technica

AT-20 SLA	\$19.00
AT-15 SA	\$8.50
AT-14 SA	\$48.95
AT-12 SA	\$4.90
AT-10	\$12.00

**SHURE**

V15 TYPE IV	\$89.90
V15 TYPE III	\$54.95
M95ED	\$29.75
M91ED	\$21.00
M44E	\$13.90
M70E	\$9.90

**PICKERING**

XSV3000	\$48.95
XV15/1200E	\$39.95
XV15/750E	\$32.50
XV15/625E	\$25.77
XV15/400E	\$22.45

**HEADPHONES**

**SENNHEISER**

HD-44	\$23.88
HD-400	\$26.28
HD-414	\$44.88
HD-424	\$85.28

**KOSS**

PRO 4AA	\$39.90
PRO 4 AAA	\$48.00
HV/1	\$29.97
HV/1LC	\$35.97
K6A	\$19.97

HOW TO ORDER: For shipment within 48 hours, send money order or certified check. Two weeks delay on personal checks. Please add \$3.50 per order for shipping & handling, \$9.50 for orders outside U.S.I. N.Y.S. residents add tax. No C.O.D. All merchandise 100% guaranteed, brand new & factory fresh.

**J&R MUSIC WORLD**

33 PARK ROW, DEPT. PE, NEW YORK, N.Y. 10038  
ORDER TOLL FREE (800) 221-8180  
CALL OR WRITE FOR FREE 96 PAGE CATALOG

**NOW...**

**Add-on Mini-Disc for the TRS-80\***

Dual and triple drives also available.

**only \$399.00 from PERCOM**

Requires 16K RAM, Level II BASIC and Expansion Interface.

**PERCOM DATA COMPANY, INC.**  
Dept. PE • 318 BARNES • GARLAND, TEXAS 75042  
Phone: (214) 272-3421  
To Order Call 1-800-527-1592

\*RADIO SHACK and TRS-80 are trademarks of Tandy Corporation which has no relationship to PERCOM DATA COMPANY, INC.

**For faster service**

**USE ZIP CODE**

**on all mail**

CIRCLE NO. 49 ON FREE INFORMATION CARD



GMT	Station	Frequencies, changes
1200-1230	Israel Radio	25640, not 26095
1700-1730	R. Pakistan	11672, 9465
1700-1800	WYFR	21615, 17845, 15160
1710-1755	BRT Belgium	17745, ex-17735
1800-1900	WYFR	21615, 21525, 17845, 15130
1800-2100	R. Kuwait	15345, ex-12085 (freq. changes)
1800-2130	AFRTS	21570
1900-1930	R. Afghanistan	11985, 11890, 15140, 15295 (freq. changes)
1900-2100	WYFR	21525, 17845, 15440
2000-0230	BBC	15070
2000-2030	R. Can. Int.	15325, not 11855
2100-2200	WYFR	15440
2115-0030	BBC	15420
2130-2400	AFRTS	25620, 21570, ex-21650, ex-17765
2200-2300	WYFR	15440, 9690
2200-2300	R. Can. Int.	17875, not 11860
2300-2400	VOA	26095, not 26895
0000-0100	AFRTS	25620, 21570, 15430 ex-21650, ex-17765
0030-0100	R. Kiev	15240, 15100, 11790, 9580; not 15180, 12000, 7150, 6020, 5980
0030-0430	BBC	11910
0100-0400	AFRTS	25620, 21570, 15430, 9685; not 17765, 17790
0145-0215	Swiss R. Int.	15305, ex-9660
0200-0250	R. RSA	15220, not 5980
0230-0300	R. Lebanon	11925, ex-11785 (freq. changes)
0300-0330	R. Kiev	17720, 15455, 15180, 12050, 11790, 9160; not 11860, 9780, 9580, 7245, 6020, 5980
0300-0500	WYFR	5985
0300-0600	V. of Voyageur	Probably off the air
0400-0700	AFRTS	15430, 15330, 9685; not 11805, 11790
0430-0500	R. Sofia	9765, not 9530
0500-0700	HCJB	9745, ex-9560
0600-0700	R. RSA	Add 21535
0615-0630	R. Can. Int.	11775, 9590; not 11845, 9635
0645-0700	R. Can. Int.	11775, 9590; not 11845, 9635
0700-0800	Malta Calling	9670 (Sat. only)

A completely revised listing will appear in the June issue. ◇

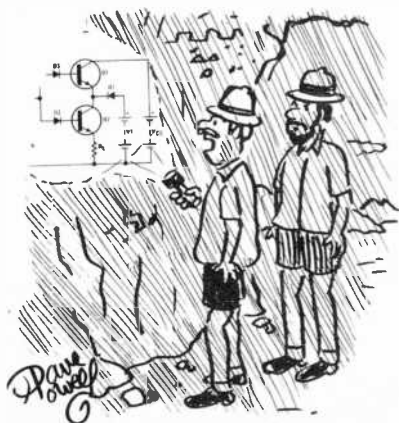

## The first complete guide to "the hottest games in town"

Here's all the technical know-how you need to design, program, modify, maintain, and troubleshoot electronic games—one of the fastest-growing areas in the home entertainment market. Whether you're a professional, a technician, or a hobbyist, this book gives you practical hands-on information about existing and future games (including those used with television receivers) and discusses typical hardware and software in realistic terms.



## ELECTRONIC GAMES

Design, Programming & Troubleshooting

By Walter H. Buchsbaum and Robert Mauro

335 pages, Illustrated, \$17.50

Fully illustrated with photographs and diagrams, the volume is backed up by material from the service literature of all major game manufacturers. Emphasis throughout is on the "how" and "why" of every important aspect of electronic games. In a field destined for spectacular growth, this pioneering A-to-Z guide can be relied on now and for years to come.

### Other McGraw-Hill books for the technician ... the experimenter ... and the hobbyist

#### HANDBOOK FOR ELECTRONICS ENGINEERING TECHNICIANS

Edited by Milton Kaufman & Arthur H. Seldman.  
560 pages, 695 illustrations, \$23.50

A working professional's guide to fundamentals, this first-of-its-kind book gives you quick, reliable aid in performing such "bread and butter" functions as predicting the performance of an amplifier, finding current in— or voltage across—an element in dc and ac circuits, and choosing the appropriate resistor, capacitor, transistor, and integrated circuit. No other work in the field offers so much complete, easy-to-apply data. An invaluable source of practical information, it brings together material formerly scattered throughout manufacturers' bulletins.

#### OSCILLOSCOPES, Functional Operation and Measuring Examples

By Rien van Erk, 270 pages, 248 illustrations, \$16.50

Specialists will find this book offers a wealth of useful technical data, but nonspecialists can also use it as a primer for oscilloscope basics, applications, and common errors. A compact, all-inclusive guide, it is the first to bridge the gap between oscilloscope operators' manuals and the actual application of the instrument to a problem at hand. It brings you completely up to date on new uses you may never have dreamed of for these versatile modern tools.

#### PERSONAL COMPUTING, Hardware and Software Basics

Electronics Book Series, 280 pages, illustrated, \$4.95

Personal computers are "big" right now—and of the role they're moving, they're sure to change the shape of things to come in electronics. New hardware, new software, and new applications are rapidly surfacing in this mercurial field, and this book gives you an easy-to-grasp nontechnical introduction. If you already know your hardware and software systems or even if you're a novice in the field, the book is an excellent guide. Drawing on the nation's leading computer and electronics engineering publications, the book varies in complexity from article to article, so you don't need to be an engineering "whiz" to use it right away.

#### ELECTRONICS DICTIONARY, Fourth Edition

Edited by John Markus, 768 pages, 1,173 illustrations, \$24.50

The undisputed authority, this Fourth Edition is better—and bigger—than ever. It's the perfect reference when you read or write the language of electronics. It helps you define, use, spell, and abbreviate 17,090 new and established electronics terms, including those that cover recent developments in fast-moving related fields. Recognized worldwide, it is an essential book for everyone who deals with electronics in any way, professionally or in leisure-time activities.

At bookstores, or direct from publisher  
for 15 days on approval

#### McGraw-Hill Book Company

Box 400, Hightstown, NJ 08520



Send me the book(s) checked below for 15 days' free examination. In that time, I will either remit for the book(s) I keep, plus local tax, postage, and handling, or return book(s) with no further obligation. I understand that if I remit in full, plus any tax, with this coupon, McGraw-Hill pays regular postage and handling charges; some return and refund privileges still apply.

- Electronic Games (008721-0), \$17.50
- Handbook for Electronic Engineering Technicians (033401-3), \$23.50
- Oscilloscopes (067050-1), \$16.50
- Personal Computing (019151-4), \$4.95
- Electronics Dictionary—4th Ed. (040431-3), \$24.50

Name \_\_\_\_\_

Address \_\_\_\_\_

City \_\_\_\_\_ State \_\_\_\_\_ Zip \_\_\_\_\_

Offer good only in U.S. Order subject to acceptance by McGraw-Hill

23-A476-4003-3

# Good soldering begins with the right solder selection

Different soldering applications require different alloys and different fluxes. Now Multicore makes soldering easy. Not only to select the right solder. But to use it. The flux is included in the solder as multiple cores.



**Send For Your Solder Sampler Kit**

5 special solders each in a metal dispenser. Totals over 60 lb.

**Electrical:** Best general purpose solder for all types of wiring. Savbit® formula protects soldering iron tip from wearing.

**Electronic:** A 60/40 tin/lead alloy, but extra thin (22 gauge).

**Stainless Steel and Silver Jewelry:** A tin/silver alloy with special flux; contains no lead. Blends in so well, you can hardly tell where it been used.

**Aluminum:** Special flux and silver alloy.

**Plumbing and Sheet Metal:** For most metal joining applications except aluminum.

**ALL 5 FOR \$8.95**

**Plus Bonus Pak of Emergency Solder**

A flat, tape-like solder that melts with a match, ideal for most on-the-spot emergency repairs.

**MULTICORE SOLDERS**

DEPT. E, WESTBURY, N.Y. 11590

□ Send me a "Solder Sampler Kit" at the special \$8.95 price (limit of one per person) and include my bonus Emergency Solder.

NAME \_\_\_\_\_

ADDRESS \_\_\_\_\_

CITY/STATE/ZIP \_\_\_\_\_

Price includes shipping and handling. Send Check or Money Order. N.Y. State residents add approx. sales tax.

ERSIN

**Multicore**  
SOLDERS

CIRCLE NO. 38 ON FREE INFORMATION CARD

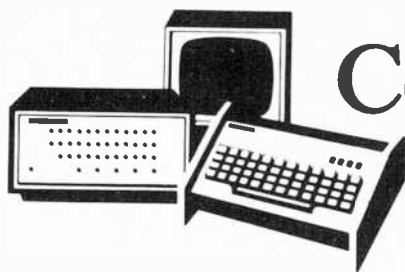

# Computer Bits

By Hal Chamberlin

## 16-BIT MICROPROCESSORS

**R**ECENTLY, there has been a great furor over the announcement of new 16-bit microprocessor ICs. The truth is that there are many 16-bit microprocessors already available so why should manufacturers, users, and the press take such a sudden interest in more of the same—if, in fact, they are the same? To find the answer to this question, let us briefly describe the 16-bit processors—past, present, and upcoming—known to this author. We will then see if such a summary, though it can't deal with each unit in depth, will show real differences among them.

**IMP-16 and INS8900 (PACE).** The IMP-16 was the first 16-bit microprocessor introduced (1974) and is still one of the most powerful in wide use. Its instruction set resembles that of the Data General NOVA minicomputer, but has many enhancements such as memory-to-register arithmetic. Its speed is 7  $\mu$ s for a memory-to-register add instruction. Full 16-by-16-bit hardware multiply is available as an option and executes in about 150  $\mu$ s. Memory up to 64K words (128K bytes) can be addressed.

Supplementing the IMP-16 in new designs is the INS-8900, which is a single IC rather than five or six devices. The instruction set is essentially the same as the IMP, but it has provisions for unlimited stack depth and five different interrupts. Hardware multiply/divide is not available. The standard version is slower than the IMP (10  $\mu$ s add rather than 7  $\mu$ s) though a twice-as-fast version has been rumored. In 1976, there was an abortive attempt to design a modular hobbyist oriented system around the PACE microprocessor.

**MCP1600.** This is a three (or more) IC set that may be *microprogrammed* by the manufacturer to mimic nearly any 16-bit processor desired. First available in 1975, this chip set is the basis of the LSI-11 microcomputer manufactured by

Digital Equipment Corp., which is used by Heath in its H11 microcomputer. The instruction set is precisely that of the PDP-11/40, a very powerful minicomputer. The LSI-11 can perform a 16-bit add from memory in 5.6  $\mu$ s. Hardware multiply (60  $\mu$ s), divide, and *floating point* are available as an option. Maximum memory size is 56K bytes excluding those addresses assigned to I/O.

Western Digital, creators of the MCP1600, also has microprogrammed the set to emulate a NOVA minicomputer. Although instruction timing is not available, it should be in the 4  $\mu$ s range for an add because of the much simpler NOVA architecture. Alpha Microsystems has also written a microprogram for its proprietary instruction set. Its AM-100 16-bit microcomputer has been on the market for more than a year and uses the S-100 bus. The AM-100 is claimed to be significantly faster and more powerful than the LSI-11.

**CP-1600.** A single-chip 16-bit microprocessor, the CP-1600 has been around nearly as long as those just described. Its architecture and instruction set resemble those of the PDP-11, but is substantially simplified to keep costs down. The standard version performs an add from memory in 4  $\mu$ s, while a reduced cost version (\$8 each in 100's makes it the least expensive 16-bitter so far) takes twice as long. One feature that has probably done the most to discourage popularity is its use of a 10-bit instruction word. This leads to inefficiencies in general-purpose systems where programs are stored in 16-bit read/write memory. Up to 64K words of memory can be addressed, however.

**MICRO NOVA.** This one-chip microprocessor, now in its third year, uses the NOVA-3 instruction set precisely. The manufacturer is Data General, developers of the NOVA minicomputer in the late 1960's and one of only three mini-

POPULAR ELECTRONICS

# TAPE DISCOUNTS



**TDK**

## CASSETTES

TDK-DC-45	1.19
TDK-DC-60	1.32
TDK-DC-90	1.79
TDK-DC-180	3.29
TDK-SAC-60	2.19
TDK-SAC-90	3.19
TDK-ADC-60	1.79
TDK-ADC-90	2.89

## 8-TRACK

TDK-45 D 8tk	1.89
TDK-90 D 8tk	2.29
TDK-45 AD 8tk	2.39
TDK-90 AD 8tk	3.19

## OPEN REEL

TDK-L 1800	5.49
TDK-S 1800	4.49



**maxell**

## CASSETTES

UDXL I OR II C-60	2.99
UDXL I OR II C-90	3.99
UDC-46	1.99
UDC-60	2.49
UDC-90	2.99
LNC-46	1.29
LNC-60	1.49
LNC-90	2.39
LNC-120	3.29

Minimum order 10 tapes

Lifetime Product Guarantee! Order Now!  
Orders shipped within 1-3 days. Please add \$2.00 for shpg. & hdg. per 10 tapes N.Y.S. residents add sales tax. NO COD's FREE CATALOG

**CONSUMERS CO**

P.O. Box 550 Dept. P05

Mt. Vernon, N.Y. 10551 Phone: (914) 664-2909

CIRCLE NO. 12 ON FREE INFORMATION CARD

computer manufacturers who also make microprocessor ICs. Since the NOVA instruction set does not include an add-from-memory instruction, its speed is difficult to compare. Load from memory, however, takes 2.9  $\mu$ s while register-to-register add requires 2.4  $\mu$ s. Hardware multiply is accomplished in 42  $\mu$ s. The NOVA instruction set normally provides for addressing of 32K words of memory, although a special mode that inhibits multiple-level indirect addressing allows 64K. Many designers have avoided the Micro Nova because of its odd non-TTL logic levels and the four supply voltages (+14, +10, +5, -4.25) required.

**9900.** The 9900 is probably the most popular of the currently available 16-bit microprocessors. Made by Texas Instruments, it is simultaneously innovative, powerful, and easy to use. The full 16-bit version boasts an instruction set similar to the PDP-11, but with an increase to 16 general-purpose registers and a unique memory-to-memory architecture. The registers are actually kept in memory, which allows very rapid response to interrupts by simply shifting the portion of memory devoted to registers. Since the number of on-chip registers is drastically reduced, a smaller, more economical IC chip is the result. Even though an "add from memory" requires no fewer than five memory cycles, it is executed in a respectable 6  $\mu$ s. Hardware multiply/divide is standard and multiply time is a very speedy 18  $\mu$ s. The input/output mechanism uses a unique semiserial technique that obviates the need for special I/O chips to accomplish simple I/O ports. Another striking feature is the 64-lead package that allows full 16-bit address and data buses without multiplexing. Because of its byte addressing feature, only 32K words of memory can be addressed.

The 9900 has been available to hobbyists for more than two years in the Technico System 16. The forthcoming TI personal computer is rumored to utilize the 9900 for its CPU.

**9440 Microflame.** This is another, though considerably newer, NOVA emulator microprocessor. Compared with the Micro Nova it is faster (2.4- $\mu$ s load and 1.25- $\mu$ s add) and much easier to interface and power. Hardware multiply/divide is not available in the 9940. It is unique in that bipolar integrated injection logic (I<sup>2</sup>L) is used rather than p- or n-channel MOS logic. A model (9445)



Featuring  
**RCA** 1802  
COSMAC CPU

Own a powerful home computer system, starting for just \$99.95—a price that gets you up and running the very first night... with your own TV for a video display. \$99.95 ELF II includes RCA 1802 8-bit microprocessor addressable to 64k bytes with DMA, interrupt, 16 registers, ALU, 256 byte RAM, full hex keyboard, two digit hex output display, stable crystal clock for timing purposes, RCA 1801 video IC to display your programs on any video monitor or TV screen and 5-slot plug-in expansion bus (less connectors) to expand ELF II into a giant!

**ELF II Explodes Into A Giant!**

Master ELF II's \$99.95 capabilities, then expand with GIANT BOARD... KLUGE BOARD... RAM BOARDS... TINY BASIC... ASCII KEYBOARD... LIGHT PEN... ELF-BUG MONITOR... COLOR GRAPHICS & MUSIC SYSTEM... TEXT EDITOR... ASSEMBLER... DISASSEMBLER... VIDEO DISPLAY BOARD... and—

**More Breakthroughs Coming Soon!**

Soon to be introduced: ELF II special application kits that give you the hardware and software you need to use ELF II for specialized purposes such as a telephone dialer... industrial controller... home photography... security system... police alert... motor controller... station output: monitor on a conveyor belt assembly line... and some new, super-lanastic games!

Also coming soon: PRDM Programmer... A-D, D-A Converter... Controller Board... and more! Unlike some heavily advertised hobby computers, ELF II doesn't limit you to pre-recorded programs. With ELF II you learn computing from the ground up... from machine language to assembly language to BASIC... in quick, clear and easy steps. ELF II is a powerful computing tool, but one that you can master with the same ease you once mastered a slide rule or pocket calculator.

**Master This Computer In A Flash!**

Regardless of how minimal your computer background is now, you can learn to program an ELF II in almost no time at all. Our *Short Course On Microprocessors & Computer Programming*—written in non-technical language—guides you through each of the RCA COSMAC 1802's capabilities, so you'll understand everything ELF II can do... and how to get ELF II to do it! Don't worry if you've been stumped by computer books before. The *Short Course* represents a major advance in literary clarity in the computer field. You don't have to be a computer engineer in order to understand it. Keyed to ELF II, it's loaded with "hands on" illustrations. When you're finished with the *Short Course*, neither ELF II nor the RCA 1802 will hold any mysteries for you.

In fact, not only will you now be able to use a personal computer creatively, you'll also be able to read magazines such as BYTE... INTERFACE AGE... POPULAR ELECTRONICS and PERSONAL COMPUTING and fully understand the articles. And, you'll understand how to expand ELF II to give you the exact capabilities you need!

If you work with large computers, ELF II and the *Short Course* will help you understand what they're doing.

**Get Started For Just \$99.95, Complete!**

\$99.95 ELF II includes all the hardware and software you need to start writing and running programs at home, displaying video graphics on your TV screen and designing circuits using a microprocessor—the very first night—even if you've never used a computer before.

ELF II connects directly to the video input of your TV set, without any additional hardware. Or, with an \$8.95 RF modulator (see coupon below), you can connect ELF II to your TV's antenna terminals instead.

ELF II has been designed to play all the video games you want, including a fascinating new target/missile gun game that was developed specifically for ELF II. But games are only the icing on the cake. The real value of ELF II is that it gives you a chance to write machine language programs—and machine language is the fundamental language of all computers. Of course, machine language is only a starting point. You can also program ELF II with assembly language and tiny BASIC. But ELF II's machine language capability gives you a chance to develop a working knowledge of computers that you can't get from running only

**Write and run programs—the very first night—even if you've never used a computer before!**

You're up and running with video graphics for just \$99.95 — then use low cost add-ons to create your own personal system that rivals home computers sold for 5-times ELF II's low price! pre-recorded tape cassettes.

**ELF II Gives You The Power To Make Things Happen!**

Expanded, ELF II can give you more power to make things happen in the real world than heavily advertised home computers that sell for a lot more money. Thanks to an ongoing commitment to develop the RCA 1802 for home computer use, the ELF II products—being introduced by Netronics—keep you right on the outer fringe of today's small computer technology. It's a perfect computer for engineering, business, industrial, scientific and personal applications.

Plug in the GIANT BOARD to record and play back programs, edit and debug programs, communicate with remote devices and make things happen in the outside world. Add Kluge (prototyping) Board and you can use ELF II to solve special problems such as operating a complex alarm system or controlling a printing press. Add 4k RAM Boards to write longer programs, store more information and solve more sophisticated problems.

ELF II add-ons already include the ELF II Light Pen and the amazing ELF-BUG Monitor — two extremely recent breakthroughs that have not yet been duplicated by any other manufacturer.

The ELF-BUG Monitor lets you debug programs with lightning speed because the key to debugging is to know what's inside the registers of the microprocessor. And, with the ELF-BUG Monitor, instead of single stepping through your programs, you can now display the entire contents of the registers on your TV screen. You find out immediately what's going on and can make any necessary changes.

The incredible ELF II Light Pen lets you write or draw anything you want on a TV screen with just a wave of the "magic wand." Netronics has also introduced the ELF II Color Graphics & Music System—more breakthroughs that ELF II owners were the first to enjoy!

**ELF II Tiny BASIC**

Ultimately, ELF II understands only machine language—the fundamental coding required by all computers. But, to simplify your relationship with ELF II, we've introduced an ELF II Tiny BASIC that makes communicating with ELF II a breeze.

Tiny BASIC saves you the time of having to code your individual instructions in machine language for ELF II. Instead, you simply type instructions on a keyboard—PRINT, RUN, LOAD, ETC. Your Tiny BASIC program automatically translates them into machine language for ELF II. Then it translates ELF II's output back into simple words and symbols for you.

**Now Available! Text Editor, Assembler, Disassembler And A New Video Display Board!**

The Text Editor gives you word processing ability and the ability to edit programs or text while it is displayed on your video monitor. Lines and characters may be quickly inserted, deleted or changed. Add a printer and ELF II can type letters for you—error free—plus print names and addresses from your mailing list!

ELF II's Assembler translates assembly language programs into hexadecimal machine-code for ELF II use. The Assembler features mnemonic abbreviations rather than numerics so that the instructions on your programs are easier to read—this is a big help in catching errors.

ELF II's Disassembler takes machine code programs and produces assembly language source listings. This helps you understand the programs you are working with... and improve them when required.

The new ELF II Video Display Board lets you generate a sharp, professional 32 or 64 character by 16 line upper and lower case display on your TV screen or video monitor—dramatically improving your unexpanded \$99.95 ELF II. When you get into longer programs, the Video Display Board is a real blessing!

**Ask Not What Your Computer Can Do... But WHAT CAN IT DO FOR YOU?**

Don't be trapped into buying an expensive dinosaur, simply because you can afford it. ELF II is more advanced and more fun to use than big name computers that cost a lot more money. With ELF II you learn to write and run your own programs. You're not just a keypunch operator. No matter what your interests are, ELF II is the fastest way to get into computers. Order from the coupon below!

**Netronics R&D Ltd., Dept PE-5**  
333 Litchfield Road, New Milford, CT 06776

**PHONE ORDERS ACCEPTED!**  
Call (203) 354-9375

Yes! I want my own computer! Please rush me—

RCA COSMAC ELF II language kit at \$99.95 plus \$3 postage and handling (requires 6.3 to 8 volt AC power)

Deluxe Metal Cabinet with plexiglas dust cover for ELF II \$29.95 plus \$2.50 p&h

I am also enclosing payment (including postage & handling) for the items checked below!

I want my ELF II wired and tested with power supply. RCA Programming Manual & Short Course—all for just \$149.95 plus \$3 p&h.

**ALSO AVAILABLE FOR ELF II —**

GIANT BOARD™ kit with cassette I/O, RS 232 C/TTY I/O, 8 bit I/O decoders for 14 separate I/O instructions and a system monitor/redior. \$39.95 plus \$2 p&h

Kluge (Prototype) Board accepts up to 36 IC's \$17.00 plus \$1 p&h

4k Static RAM kit. Addressable to any 4k page to 64k. \$89.95 plus \$3 p&h

Good plates 85-pin connectors (one required for each plug in board). \$5.70 ea. postpaid.

Expansion Power Supply (required when adding 4k RAM). \$34.95 plus \$2 p&h

Professional ASCII Keyboard kit with 128 ASCII upper/lower case set, 96 printable characters, onboard regulator, parity logic selection and choice of 4 hand shaving segments. To mate with almost any computer. \$64.95 plus \$2 p&h

Deluxe metal cabinet for ASCII Keyboard. \$19.95 plus \$2.50 p&h

Video Display Board kit lets you generate a sharp professional 32 or 64 character by 16 line upper and lower case display on your TV screen or video monitor—dramatically improving your unexpanded \$99.95 ELF II. (Ifs inside ASCII Keyboard cabinet) \$89.95 plus \$2 p&h

ELF II Tiny BASIC on cassette tape. Commands include SAVE, LOAD, etc. + (1)

26 variables A-Z, LET, IF/THEN, INPUT, PRINT, GO TO, GO SUB, RETURN, END, REM, CLEAR, LIST, RUN, PLOT, PEEK, POKE. Comes fully documented and includes alphanumeric generator (required to display alphanumeric characters directly on your TV screen without additional hardware. Also plays tick-tack-toe plus a drawing game that uses E.F.I.I.'s hex keyboard as a joystick. 4k memory required. \$14.95 postpaid

Tom Pittman's Short Course on Tiny Basic for ELF II \$5 postpaid

ELF-BUG™ Deluxe System Monitor on cassette tape. Allows displaying the contents of all registers on your TV at any point in your program. Also displays 24 bytes of memory with full addresses, blinking cursor and auto scrolling. A must for the serious programmer! \$14.95 postpaid

Text Editor on cassette tape gives you the ability to insert, delete or edit lines and words from your programs while they are displayed on your video monitor. (Add printer and you can use ELF II to type error free letters plus insert names and addresses from your mailing list.) \$19.95 postpaid

Assembler on cassette tape translates assembly language programs into hexadecimal machine code for ELF II use. Mnemonic abbreviations for instructions (rather than numerics) make programs easier to read and help prevent errors. \$19.95 postpaid

Disassembler on cassette tape takes machine code programs and produces assembly language source listings to help you understand and improve your programs. \$19.95 on cassette tape

SAVE \$9.95—Text Editor, Assembler & Disassembler purchased together, only \$49.95! (Require Video Display Board plus 4k memory.)

ELF II Light Pen, assembled & tested. \$7.95 plus \$1 p&h

ELF II Color Graphics & Music System Board kit \$49.95 plus \$2 p&h

ELF II connects directly to the video input of your TV set without additional hardware. To connect ELF II to your antenna terminals instead, order RF Modulator. \$8.95 postpaid

Coming Soon: A-D, D-A Converter, Controller Board and more!

Print Name \_\_\_\_\_  
Address \_\_\_\_\_  
City \_\_\_\_\_  
State \_\_\_\_\_ Zip \_\_\_\_\_  
DEALER INQUIRIES INVITED

Circle No. 42 on FREE INFORMATION CARD

## String Synthesizers Can Be: Just strings...

....But when designed by **Marvin Jones** they have:

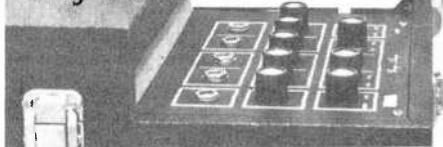

violins/cello/piano, variable chorusing, keyboard split, synthesizer interface, variable sustain controls, jacks for foot controls, dual violin/cello mixers, separate mixable piano output, stereo string & computer interface options.

### Stringz 'n' Thingz

just \$295 kit \$600 assembled  
from **FAIA** You're gonna love it!

#### TELL ME MORE

( ) Send Assembly & Using Manual \$5 refundable upon purchase Stringz 'n' Thingz.  
( ) SEND FREE CATALOG

name: \_\_\_\_\_

Address: \_\_\_\_\_

City: \_\_\_\_\_ State: \_\_\_\_\_ Zip: \_\_\_\_\_

**FAIA** ELECTRONICS Dept. 5-P.  
1020 W. Wilshire Blvd., Oklahoma City, OK 73116 (405) 843-9626

CIRCLE NO. 47 ON FREE INFORMATION CARD



**NATCAM** catalog  
Shopping center for small and precision tools

A fine selection of small tools, measuring instruments, hard-to-find items for shop, home and lab. Convenient one-stop shopping for technicians, engineers, craftsmen, hobbyists. Major credit cards accepted, satisfaction assured. Get your NATCAM catalog today.

**National Camera, Inc.**  
2000 West Union Ave., Dept. GGA  
Englewood CO 80110 USA

CIRCLE NO. 40 ON FREE INFORMATION CARD

that will be three times as fast is planned. The name "Microflame" has given rise to all sorts of whimsical names for associated products. Examples are the "Firebug" debugging system and "Spark 16" computer.

**6809.** At this point we start getting into microprocessors that have been announced but are not yet generally available. The Motorola 6809, for example, is an enhancement of the popular 6800 8-bit microprocessor. Its status as a 16-bit microprocessor is arguable, however, since the data bus is only 8 bits wide. This means that the efficiency advantage of 16-bit instructions is only partially realized, although it does make retrofitting to existing hardware easier. The 6809 retains all of the original 6800 instructions. Operation codes have been changed, however, which necessitates reassembly. Improvements include the addition of a second index register, another stack pointer, and a relocatable zero page. A 16-bit add from memory requires 5  $\mu$ s with the standard 2-MHz clock frequency. Hardware multiply is included. It is only 8x8, although the 10- $\mu$ s speed allows 16x16 multiply at a speed comparable to earlier 16-bit microprocessors. Memory up to 64K bytes can be addressed.

**8086.** This is Intel's entry into the current 16-bit microprocessor race. Although source code compatibility with its 8080 microprocessor is claimed, it is only through a rather complex translating assembler. Besides some carry-overs from the 8080, the instruction set is unique and as powerful as those of current minicomputers. Compared to the 8080, the biggest improvement is the inclusion of numerous addressing modes, though relative and indirect through memory are not available. The average speed of the 8086 is impressive: 1.6  $\mu$ s for a memory-to-register add and a mere 375 ns for a register-to-register add. Note the use of the term "average"; part of the speed improvement is owed to an instruction "lookahead" circuit which is rendered ineffective when a lot of conditional branch instructions are executed.

A definite departure from what we have seen so far is the ability to address 1-million bytes of memory! This extended addressing capability is through a memory bank switching scheme, however. Hence, only 128K (64K program storage and 64K data storage) can be reached by a program without the hassle of using a bank switch.



Get the  
Most Out of  
Your Computer  
with  
Creative Computing

**Software and Applications.** Pragmatic, well-documented programs with complete listings on data base systems, word processing, communications, simulations, investment analysis, games, music synthesis, computer art, business functions, building control and more.

**System Evaluations.** In-depth, probing evaluations of personal and small business systems every issue. Non-sense reviews of software from independents as well as the majors.

**Regular Features.** Operating Systems Q and A. Columns on the TRS-80, Apple and PET. Book reviews. Programming techniques. Short programs. Computer games. New products. Even a dose of fiction and foolishness.

We guarantee that Creative Computing will help you get more out of your personal, school, or business computer or we'll give you your money back!

3 years \$40 (Save \$32 over retail price)

2 years \$28 (Save \$20 over retail price)

1 year \$15 (Save \$9 over retail price)

Foreign:  Surface add \$9/yr.  Air add \$24/yr.

To order, send payment or bankcard (Visa or Master Charge) number and expiration date with your name and address to Creative Computing. Attn: Leslie P.O. Box 789-M, Morristown, N.J. 07960

Save time! Phone bankcard orders toll-free to:

**800-631-8112**  
(In NJ call 201-540-0445)

**creative computing**

P.O. Box 789-M, Morristown, NJ 07960

CIRCLE NO. 16 ON FREE INFORMATION CARD

## The world of electronics gee-wizardry



**-YOURS FREE.**

32-pages of test instruments — from the latest digital multimeters to the famous EICO scopes. Security systems. Automotive and hobbyist products. Kits and assembled. EICO quality. EICO value. For FREE catalog, check reader service card or send 75¢ for first class mail.

**EICO**® 108 New South Road  
Hicksville, N.Y. 11801

CIRCLE NO. 20 ON FREE INFORMATION CARD



# FREE **SWTP**

## CATALOG

Audio—Computers  
Instruments  
Kits & Assembled

COMPUTER  
PRODUCTS  
CATALOGUE



Southwest Technical Products Corporation  
219 W. RHAPSODY  
SAN ANTONIO, TEXAS 78216

CIRCLE NO. 55 ON FREE INFORMATION CARD

# SAVE!

MONEY • TIME • FREIGHT

QUALITY STEREO EQUIPMENT  
AT LOWEST PRICES.

YOUR REQUEST FOR QUOTA-  
TION RETURNED SAME DAY.

FACTORY SEALED CARTONS—  
GUARANTEED AND INSURED.

SAVE ON NAME BRANDS LIKE:

PIONEER	SANSUI
KENWOOD	DYNACO
SHURE	SONY
MARANTZ	KOSS

AND MORE THAN 50 OTHERS  
BUY THE MODERN WAY  
BY MAIL—FROM

# illinois audio

12 East Delaware  
Chicago, Illinois 60611  
312-664-0020

CIRCLE NO. 32 ON FREE INFORMATION CARD

**Z8000.** The Z8000 is Zilog's 16-bit con-  
tender. The Z8000 instruction set gives  
nearly every possible combination of in-  
struction type and data lengths of 4, 8,  
16, and 32 bits! Yes, there are instruc-  
tions that deal directly with 32-bit op-  
erands and registers. Naturally, with  
such instruction-set sophistication, hard-  
ware multiply and divide are available  
with up to 32-bit operands as well. Sales  
literature compares Z8000 speed with  
the PDP-11/45 minicomputer (a popular  
but expensive minicomputer that fills a  
rack) and declares the Z8000 winner  
with an add time of 1.75  $\mu$ s. Multiply is  
less speedy in comparison (17.5  $\mu$ s for  
16x16 and 88  $\mu$ s for 32x32) but is still  
quite respectable for a single-chip mi-  
crocomputer. Up to 8-million words of  
memory can be *directly* addressed by  
the Z8000. This is made possible by the  
32-bit registers, which is much more  
convenient than bank switching.

**MC68000.** This last processor is also  
the most powerful and farthest from be-  
ing available. In reality it is a 32-bit ma-  
chine with a 16-bit data bus. All 8 ac-  
cumulators and 8 index registers are a  
full 32-bits in length. This puts it in the  
maxicomputer league along with the  
IBM 370. At this time, exact specifica-  
tions are not available, but the add time  
is stated to be 1.5  $\mu$ s. Multiply/divide is  
said to be faster than the Z8000, but no  
figures are available. Programs can di-  
rectly address up to 16-million bytes of  
memory through use of the 32-bit index  
registers and a 24-bit program counter.

**Conclusions.** By now it should be ob-  
vious why there's a great interest in the  
recently announced 8086, Z8000, and  
MC68000 microprocessors. These ma-  
chines are at least three times faster  
than existing 16-bit units. Their ability to  
address vast quantities of memory  
promises to once more fill up computer  
cabinets with memory, this time with  
64K rather than 4K boards. The latter  
property makes programmers happy;  
the former makes everyone happy.

In short, the new microprocessors  
give more of what 16-bit (and 32-bit) ar-  
chitecture is good for. But don't expect  
to find a system using the new chips in  
computer stores right now. Of the top  
three, only the 8086 has actually been  
manufactured, so it might be well into  
1980 before personal systems using  
these chips are available. Meantime,  
LSI-11 and 9900-based systems still  
greatly outperform 8-bit-based systems  
and are available now. ◇

5 - PE

name \_\_\_\_\_

address \_\_\_\_\_

city \_\_\_\_\_

state \_\_\_\_\_

zip \_\_\_\_\_

## MAIL THIS COUPON AND WE'LL SEND YOU THE BEST SPEAKER CATALOG YOU EVER READ!

No kidding. Speakerlab's catalog took longer  
to write than some of our competitors have  
been in business. In fact, we created an industry  
by "building great kits so you can afford great  
speakers." Our catalog is an invaluable



manual of speaker function  
and design. And, it will  
introduce you to the finest  
speaker kits made  
anywhere...with the  
strongest money-back  
guarantee. Find out for  
yourself...FREE. FREE.  
that is. Mail the coupon now.

**Speakerlab®**  
Dept. I-PE, 735 N. Northlake Way  
Seattle, WA 98103

SEE YOUR DEALER TODAY

DEMAND  
THE #1 WIRE WOUND  
AND MOST COPIED  
ANTENNA IN THE WORLD!

**'Firestik®'**  
CITIZEN BAND  
2 METER AMATEUR  
MARINE MOBILE TELE  
LAND MOBILE TELE  
FIBERGLASS ANTENNAS



DEALER & DISTRIBUTOR  
INQUIRIES INVITED

SEND FOR  
**FREE**  
CATALOG



2614 E. ADAMS • PHOENIX, ARIZONA 85034

NAME \_\_\_\_\_

STREET \_\_\_\_\_

CITY \_\_\_\_\_

STATE \_\_\_\_\_

ZIP \_\_\_\_\_

CIRCLE NO. 48 ON FREE INFORMATION CARD



# Software Sources

By Leslie Solomon  
Technical Director

**8080 Small-Disk Program Development System.** PDS, short for "Program Development System," includes an assembler/editor, macro assembler with relocating linking loader, a string-oriented text editor and a trace debugger/disassembler. Specific features include breakpoint and single-step execution, register trace display; also source modules for floating-point arithmetic and I/O, trig functions, numerical and alphabetic sorting, matrix inversion, fast Fourier transform, and expression evaluation. PDS will run on 8080 systems, but can assemble both Z80 and 8080 programs. All I/O is done through DOS, so no I/O customizing is required. Files can be dynamically allocated. The debugger, linker and relocating loader are themselves relocatable, to satisfy in-

dividual system requirements. Minimum hardware requirements for PDS are 16K of RAM and one disk drive. North Star and Micropolis Mod II versions are available. \$99. Allen Ashley, 395 Sierra Madre Villa, Pasadena, CA 91107.

**6502 Assembler for PET.** This program accepts all standard 6502 Instruction mnemonics, pseudo-ops and addressing modes, and evaluates binary, octal, hex, decimal and character constants, symbols and expressions. Source programs can be read from cassette, and object programs assembled anywhere in memory. Both one- and two-pass assembler versions are included, together with a text editor, disassembler, and 30-page manual. \$25. From dealers or Personal Software, P.O. Box 136, Cambridge, MA 02138.

**Memory-I/O Display.** This program graphically displays memory and I/O ports within the host computer. The program displays "" for RAM, "+" for ROM, and "." for empty with addresses. Each character is a 256-byte increment. Hex addresses for continuous 8K blocks are displayed as well as broken (RAM and ROM) at any 256-byte point. I/O ports are displayed in hex. Program does not change existing memory when executed. The listing is \$5 from Practical Programming Co., Box 3069, North Brunswick, NJ 08902.

**WordWizard.** This advanced text editor, designed for use with this firm's Helios disk system, has a rather large number of features for document activity (create, edit, print, merge, etc.), editing functions (cursor control, tab, justify, search and block moves, etc.), and format statements (spacing, line formats, pagination, etc.), far too many to mention here (brochure available). Up to 110 text pages can be stored on a diskette, and horizontal scrolling allows viewing lines up to 128 characters long. All documents may include comments which will not appear on the print-out. \$295 with manual and two diskettes (Helios). Processor Technology, 7100 Johnson Industrial Drive, Pleasanton, CA 94566 (Tel: 415-829-2600).

## WEST COAST COMPUTER FAIRE

The fourth annual West Coast Computer Faire will take place May 11, 12 and 13, 1979, at the San Francisco Civic Auditorium and Brooks Hall. So far, over 100 booths have been allocated, and a number of papers will be presented, covering microcomputer subjects of interest to novices as well as experts. For further information, contact: Computer Faire, 333 Swett Rd., Woodside, CA 94062. Tel: 415-815-7075.

## THE MICROCOMPUTER MART COMPUTER RETAIL STORES

Advertisement

### CALIFORNIA

Omega Microcomputers  
Quality Personal — Business Systems  
3535 Torrance Blvd.  
Suite 10  
Torrance, CA 90503  
(213) 370-9456

Rainbow Computing  
Complete Apple II Line  
10723 White Oak Avenue  
Granada Hills, CA 91344  
(213) 360-2171

### COLORADO

Byte Shop  
3464 South Acoma Street  
Englewood, CO 80110  
(303) 761-6232

### ILLINOIS

American Microprocessors  
Equipment and Supply Corp.  
At the Chicagoland Airport  
20 North Milwaukee Avenue  
Half Day, ILL 60069  
(312) 634-0076

American Microprocessors  
Equipment and Supply Corp.  
6934 North University  
Peoria, ILL 61614  
(309) 692-5852

### MARYLAND

Computers Unlimited, Inc.  
Tomorrow's Technology Today  
907 York Road  
Towson, MD 21204  
(301) 321-1553

### MICHIGAN

The Computer Mart  
We Will Not Be Undersold  
560 W. 14 Mile Road  
Clawson, MI 48017  
(313) 288-0040

United Microsystems Corp.  
The Professional Computer Store  
2601 South State Street  
Ann Arbor, MI 48104

### NEW JERSEY

Computer Mart of New Jersey  
The Microcomputer People (R)  
501 Route 27  
Iselin, NJ 08830  
(201) 283-0600

### FLORIDA

Sara Tech Computers  
Discounts On All Major Brands  
400 Base Avenue  
Suite 225  
Venice, FLA  
(813) 485-3559

### OHIO

Ohio Microcomputer Specialists  
Imsai Personal and Business Systems  
1265 Grandview Avenue  
Columbus, OH 43212  
(614) 488-1849

### OKLAHOMA

Microolithics, Inc.  
Medical Systems-Differential Diagnosis  
2918 MacArthur Boulevard  
Oklahoma City, OK 73127  
(405) 947-5646

### PENNSYLVANIA

Personal Computer Corp.  
First in Pennsylvania  
Frazer Mall  
Lancaster Avenue and Route 352  
Frazer, PA 19355  
(215) 647-8463

### SOUTH CAROLINA

Byte Shop #32  
The Affordable Computer Store  
1920 Blossom Street  
Columbia, SC 29205  
(803) 771-7824

### NEW YORK

Datel Stores of New York  
The Complete Systems Store  
1211 Ave. of the Americas  
New York, N.Y. 10036

Dealers: For information about how to have your store listed in THE MICROCOMPUTER MART, please contact:  
POPULAR ELECTRONICS, One Park Ave., New York, N.Y. 10016 • (212) 725-3568.

# PROJECT OF THE MONTH

BY FORREST M. MIMS

## MINIATURE DC-DC CONVERTER

The LM3909 was originally designed as an LED flasher, but has many other applications. One that I've enjoyed experimenting with is a miniature power supply that allows a tiny watch battery to power a neon lamp or even a powerful semiconductor-laser pulser. Both these applications require 70 to 150 volts at relatively low current.

Figure A shows the circuit of the LM3909 dc-dc converter. In operation, the LM3909 rapidly switches *Q1* on and off at a rate determined by *C1*. The transistor can be considered a switch in series with choke *L1* and resistor *R2*. Each time *Q1* switches off, the magnetic field set up by the current flowing through *L1* collapses and induces a high voltage across the inductor. This voltage is rectified and stored in *C2*.

The LED is a bonus feature of the circuit. It glows to indicate when the circuit is operating. The neon lamp and 15,000-ohm series resistor shown in Figure A are optional. They provide a visual indication that the circuit is producing 70 or more volts. When powered by a 1.2-volt nickel-cadmium or 1.35-volt mercury "button" cell, the circuit produces enough voltage to flash the lamp when it is connected across capacitor *C2*.

If you don't like the orange glow of a neon lamp, try a green neon lamp (Radio Shack 272-1106 or equivalent). This lamp has a phosphor coating on its inside surface that glows green when illuminated by the radiation produced inside the lamp. In any case, be sure to use a quality lamp because some of the surplus neon lamps I've tried do not work well.

The key components of the circuit are *L1* and *R2*. In the prototype circuit, I used a

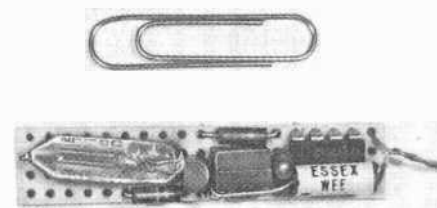

Fig. C. Photo of prototype version of the dc-dc converter.

miniature Essex choke with an inductance of 1000- $\mu$ H for *L1*. This choke is about the size of a 1/4-watt carbon composition resistor. If this choke is used, the resistance of *R2* should be between 75 and 85 ohms.

If you can't find this choke, experiment with others until you find one that produces enough voltage to light a neon lamp. You'll find that many different chokes will produce a useful output. One version of the circuit that I built uses a miniature 33-mH choke (Aladdin) with excellent results. The 1979 Allied catalog (401 E. 8th St., Fort

Worth, TX 76102) lists a number of sub-miniature r-f inductors on page 145 that should work fine.

If you don't use the 1000- $\mu$ H choke specified, you'll need to experiment with the value of *R2*. As the inductance is increased, *R2*'s value can be decreased. Actually, *R2* is not even necessary beyond a few millihenries.

Assembly of this circuit should present no problems once you've selected a choke and determined the resistance of *R2* (if it is necessary). I used a piece of perforated board with copper solder pads at each hole. Figure B is a pictorial view of the assembled circuit.

Begin by inserting the components into the top side of the board and interconnecting their leads with wrapping wire. Then solder all the connections to their respective solder pads. Figure C is a photograph of the complete prototype. This circuit includes a neon lamp and series resistor to illustrate its operation as a dc-dc converter. Don't forget that the circuit has many other possibilities.

For example, most semiconductor lasers require current pulses of many amperes for proper operation. The circuit in Figure A can power a four-layer-diode laser pulser with ease, especially if *L1* has an inductance of 10 to 35 mH. Recently, I built a midget laser transmitter using the circuit in Fig. A as a power supply (*L1* = 33 mH, no *R2*). The circuit is completely self-contained and includes lens, mercury "button" cell and switch in a 0.5" x 3" (1.3 cm x 7.6 cm) brass tube. If there is sufficient interest, I'll describe its construction as a future Project of the Month.

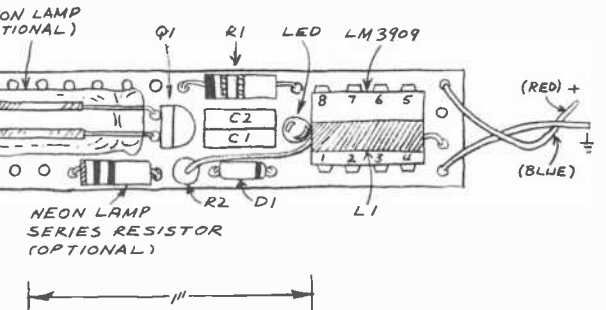
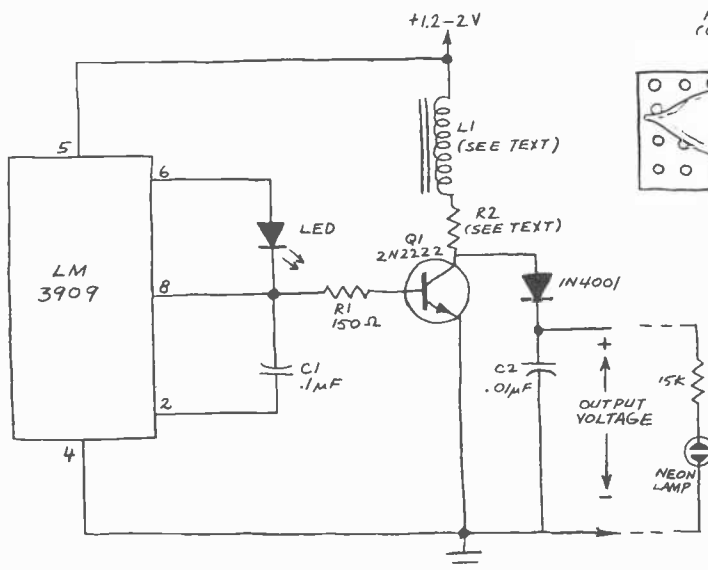

Fig. B. Arrangement of components on the board for the converter.

Fig. A. Miniature dc-dc converter circuit diagram.





# Active Electronic Sales Corp.

## Features.....

### BRAND NEW!

JUST RELEASED  
1979 IC MASTER  
2500 pages



Complete integrated circuit data selector. Master guide to the latest I.C.'s including microprocessors and consumer circuits.

Free Quarterly Updates **\$39.95**

## Texas Instruments Low Profile Sockets



Finest Quality Socket available in the world. Nobody can match Texas Instruments quality — a unique combination of I.C. technology and multi-metal expertise.

Over one million pieces in stock.

Contacts	Price	Contacts	Price
8 PIN	.08	22 PIN	.22
14 PIN	.12	24 PIN	.24
16 PIN	.14	28 PIN	.28
18 PIN	.18	40 PIN	.40
20 PIN	.20		

## GENERAL INSTRUMENT

### 1 Amp Rectifiers (Epoxy)

Part No.	Price
1N4001 50V	.029
1N4002 100V	.039
1N4002 200V	.045
1N4004 400V	.049
1N4005 600V	.055
1N4006 800V	.065
1N4007 1000V	.07

### 1.5 Amp Single Phase Silicon Bridge Rectifiers

Part No.	Price
W06M 600V	.34
W08M 800V	.39



## SWITCHING DIODES

Part No.	Price
1N914 (100V 4NS)	.027
1N4148 (100V 4NS)	.027

## L.E.D. LAMPS

LED209	T-1 3mm Red	.09
LED211	T-1 3mm Green	.14
LED212	T-1 3mm Yellow	.13
LED220	T-1-3/4 5mm Red	.11
LED222	T-1-3/4 5mm Green	.15
LED224	T-1-3/4 5mm Yellow	.14

MAJOR MANUFACTURER



## CMOS I.C.'S

CD4000BE	17	CD4042BE	59	CD4515BE	\$1.95
CD4001BE	17	CD4043BE	57	CD4516BE	.69
CD4002BE	17	CD4044BE	55	CD4518BE	.79
CD4006BE	87	CD4046BE	99	CD4519BE	.47
CD4007BE	17	CD4049BE	33	CD4520BE	.69
CD4008BE	75	CD4050BE	33	CD4522BE	.99
CD4009BE	39	CD4051BE	54	CD4526BE	.99
CD4010BE	39	CD4052BE	54	CD4527BE	\$1.09
CD4011BE	17	CD4060BE	54	CD4528BE	.69
CD4012BE	17	CD4060BE	99	CD4531BE	.74
CD4013BE	32	CD4066BE	44	CD4532BE	\$1.19
CD4014BE	73	CD4068BE	21	CD4539BE	.99
CD4015BE	69	CD4069BE	21	CD4543BE	\$1.39
CD4018BE	35	CD4070BE	29	CD4555BE	.65
CD4017BE	62	CD4071BE	21	CD4556BE	.65
CD4018BE	69	CD4073BE	21	CD4581BE	\$2.25
CD4019BE	39	CD4073BE	21	CD4582BE	.79
CD4020BE	69	CD4075BE	21	CD4584BE	.60
CD4021BE	69	CD4076BE	.79	CD4585BE	.90
CD4022BE	69	CD4077BE	25	40014PC	.59
CD4023BE	17	CD4078BE	21	40085PC	\$1.09
CD4024BE	49	CD4081BE	21	40097PC	.69
CD4025BE	17	CD4082BE	21	40098PC	.69
CD4026BE	\$1.39	CD4085BE	.69	40160PC	.89
CD4027BE	39	CD4086BE	.69	40161PC	.99
CD4028BE	57	CD4093BE	.40	40162PC	.89
CD4029BE	74	CD4104BE	\$2.25	40163PC	.99
CD4030BE	35	CD4502BE	.85	40174PC	.89
CD4033BE	\$1.45	CD4508BE	\$2.25	40175PC	.89
CD4034BE	\$2.25	CD4510BE	.86	40192PC	\$1.19
CD4035BE	.64	CD4511BE	.99	40193PC	\$1.19
CD4040BE	.74	CD4512BE	.59	40194PC	\$1.10
CD4041BE	.74	CD4514BE	\$1.95	40195PC	\$1.10

## MICROPROCESSOR CHIPS

Part No.	Price
8080A	<del>5.95</del> 5.50
6800	<del>8.95</del> 7.95

## INTERFACE SUPPORT CIRCUITS

Part No.	Price	Part No.	Price
8212	1.98	8255	5.95
8214	<del>4.95</del> 3.95	8257	9.95
8216	1.98	8259	14.95
8224	2.75		
8226	1.98	6810	<del>3.95</del> 3.50
8228	4.75	6820	<del>4.95</del> 3.95
8238	4.75	6821	<del>4.95</del> 3.95
8251	<del>5.95</del> 4.95	6850	<del>5.95</del> 4.95
8253	14.95	6852	<del>5.95</del> 4.95

## MOS Static RAM's

Part No.	Price
2102LFPC	\$1.19
1K 350NS (Low Power)	
2102-1PC	\$0.99
1K 450NS	
2114	\$7.50
4K (1K x 4) 300NS	
2114	\$6.50
4K (1K x 4) 450NS	

## MOS Dynamic RAM's

Part No.	Price
4K 4027	\$2.95
4K (4K x 1) 300NS 16 PIN	
416-3	\$9.95
200NS	
416-5	\$7.95
300NS	

## UART's

Part No.	Price
AY5-1013A	\$4.95
AY3-1015	\$5.95

## 1K CMOS RAM

Part No.	Price
5101	\$4.95
450NS (Low Power)	
5101	\$3.95
800NS	

## LINEAR I.C.'S

LM324N	.49	Quad Op Amp
LM339N	.49	Quad Comparator
LM555N-8	.29	Timer
LM556N-14	.59	Dual Timer
LM723CN	.34	Voltage Regulator
LM723CH	.39	Voltage Regulator
LM741CH	.37	Op Amp
LM741CN-8	.24	Op Amp
LM1458N-8	.39	Dual Op Amp

## VOLTAGE REGULATORS

PART NO.	UNIT PRICE	DESCRIPTION
LM323K	<del>5.50</del> \$4.95	3 Amp 5 Volt Regulator
78H05KC	\$5.75	5 Amp 5 Volt Positive Regulator TO3
7800UC Series TO-220/ILM340T	.79	Positive Voltage Regulators (Plastic) 1 Amp 5, 6, 8, 12, 15, 18, 24 Volts
78MOOHC Series TO-5/ILM340H	\$1.50	Positive Voltage Regulator 1/2 Amp 5, 6, 8, 12, 15, 18, 24 Volts
7800KC Series TO-3/ILM340K	\$1.60	Positive Voltage Regulator 1 Amp 5, 6, 8, 12, 15, 18, 24 Volts
78LOOAWC Series TO-92	.29	Positive Voltage Regulator 100 MA 2.6, 5, 6, 8, 12, 15 Volts
7900UC Series TO-220/ILM320T	\$1.10	Negative Voltage Regulator 1 Amp 5, 6, 8, 12, 15, 18, 24 Volts
79MOOHC Series TO-5/ILM320H	\$1.50	Negative Voltage Regulator 1/2 Amp 5, 6, 8, 12, 15, 20, 24 Volts
7900KC Series TO-3/ILM320K	\$1.95	Negative Voltage Regulator 1 Amp 5, 6, 8, 12, 15, 18, 24 Volts
78MGT2C	\$1.25	Dual In Line Adjustable 4 Terminal Positive Voltage Regulator
78GU1 TO-220	\$1.45	1 Amp Adjustable Positive Voltage Regulator
78S40PC	\$2.50	Switching Regulator

All new major manufacturer production material offered. Largest variety of device types available anywhere.

# Active Electronic Sales Corp.

P.O. BOX 1035 FRAMINGHAM, MASSACHUSETTS 01701

Over-the-counter sales, 12 Mercer Rd., Natick, Mass 01760 Behind Zayres on Rte. 9 Telephone Orders & Enquiries (617) 879-0077

IN CANADA 3 LOCATIONS

5651 FERRIER ST. MONTREAL, QUEBEC H4P 2K5 Tel: (514) 735-6425

4800 DUFFERIN ST. DOWNSVIEW, ONTARIO M3H 5S9 Tel: (416) 661-1115

MINIMUM ORDER \$10.00 • ADD \$2.00 TO COVER POSTAGE & HANDLING

Foreign customers please remit payment on an international bank draft or international postal money order in American dollars.

BAXTER CENTRE 1050 BAXTER ROAD OTTAWA, ONTARIO K2C 3P2 Tel: (613) 820-9471



DIODES/ZENERS			
QTY.			
	1N914	100v	10mA .05
	1N4005	600v	1A .08
	1N4007	1000v	1A .15
	1N4148	75v	10mA .05
	1N4733	5.1v	1 W Zener .25
	1N753A	6.2v	500 mW Zener .25
	1N758A	10v	" .25
	1N759A	12v	" .25
	1N5243	13v	" .25
	1N5244B	14v	" .25
	1N5245B	15v	" .25

SOCKETS/BRIDGES			
QTY.			
	8-pin	pcb	.20 ww .35
	14-pin	pcb	.20 ww .40
	16-pin	pcb	.20 ww .40
	18-pin	pcb	.25 ww .95
	20-pin	pcb	.35 ww .95
	22-pin	pcb	.35 ww .95
	24-pin	pcb	.35 ww .95
	28-pin	pcb	.45 ww 1.25
	40-pin	pcb	.50 ww 1.25
	Molex pins	.01 To-3 Sockets	.25
	2 Amp Bridge	100-prv	.95
	25 Amp Bridge	200-prv	1.50

TRANSISTORS, LEADS, etc.			
QTY.			
	2N2222	(2N2222 Plastic .10)	.15
	2N2222A		.19
	2N2907A	PNP	.19
	2N3906	PNP (Plastic Unmarked)	.10
	2N3904	NPN (Plastic Unmarked)	.10
	2N3054	NPN	.45
	2N3055	NPN 15A 60v	.60
	T1P125	PNP Darlington	1.95
	LED Green,	Red, Clear, Yellow	.15
	D.L.747	7 seg 5/8" High com-anode	1.95
	MAN72	7 seg com-anode (Red)	1.25
	MAN3610	7 seg com-anode (Orange)	1.25
	MAN82A	7 seg com-anode (Yellow)	1.25
	MAN74	7 seg com-cathode (Red)	1.50
	FND359	7 seg com-cathode (Red)	1.25

9000 SERIES			
QTY.			
	9301	.85	9322 .65
	9309	.35	9601 .20
	9316	1.10	9602 .45

MICRO'S, RAMS, CPU'S, E-PROMS			
QTY.			
	8T13	1.50	2107B-4 4.95
	8T23	1.50	2114 9.50
	8T24	2.00	2513 6.25
	8T97	1.00	2708 10.50
	74S188	3.00	2716 D.S. 34.00
	1488	1.25	2716 (5v) 59.00
	1489	1.25	2758 (5v) 23.95
	1702A	4.50	3242 10.50
	AM 9050	4.00	4116 11.50
			6800 13.95
			6850 7.95
	MM 5314	3.00	8080 7.50
	MM 5316	3.50	8080 7.50
	MM 5387	3.50	8212 2.75
	MM 5369	2.95	8214 4.95
	TR 1602B	3.95	8216 3.50
	UPD 414	4.95	8224 3.25
	Z 80 A	22.50	8228 6.00
	Z 80	17.50	8251 7.50
	Z 80 PIO	10.50	8253 18.50
	2102	1.45	8255 8.50
	2102L	1.75	TMS 4044 9.95

CUSTOMER NAME \_\_\_\_\_

STREET ADDRESS \_\_\_\_\_

CITY \_\_\_\_\_ STATE \_\_\_\_\_ ZIP \_\_\_\_\_

PHONE \_\_\_\_\_ CHARGE CARD #  AE  Visa  BA  MC \_\_\_\_\_ EXP. DATE \_\_\_\_\_

C.O.D. \_\_\_\_\_ WILL CALL \_\_\_\_\_ UPS \_\_\_\_\_ POST \_\_\_\_\_ NET 10th OF THE MONTH \_\_\_\_\_ PO # \_\_\_\_\_

ALL ORDERS SHIPPED PREPAID - NO MINIMUM - COD ORDERS ACCEPTED - ALL ORDERS SHIPPED SAME DAY  
 OPEN ACCOUNTS INVITED - California Residents add 6% Sales Tax. PRICES SUBJECT TO CHANGE WITHOUT NOTICE.  
**We accept American Express / Visa / BankAmericard / Master Charge**

C MOS	
QTY.	
	4000 .15
	4001 .15
	4002 .20
	4004 3.95
	4006 .95
	4007 .20
	4008 .75
	4009 .35
	4010 .35
	4011 .20
	4012 .20
	4013 .40
	4014 .75
	4015 .75
	4016 .35
	4017 .75
	4018 .75
	4019 .35
	4020 .85
	4021 .75
	4022 .75
	4023 .20
	4024 .75
	4025 .20
	4026 1.95
	4027 .35
	4028 .75
	4029 1.15
	4030 .30
	4033 1.50
	4034 2.45
	4035 .75
	4037 1.80
	4040 .75
	4041 .69
	4042 .65
	4043 .50
	4044 .65
	4046 1.25
	4048 .95
	4049 .45
	4050 .45
	4052 .75
	4053 .75
	4066 .55
	4069/74C04 .35
	4071 .25
	4081 .30
	4082 .30
	4507 .95
	4511 .95
	4512 1.10
	4515 2.95
	4519 .85
	4522 1.10
	4526 .95
	4528 1.10
	4529 .95
	MC 14409 14.50
	MC 14419 4.85
	74C151 1.50

**INTEGRATED CIRCUITS UNLIMITED**  
 7889 Clairemont Mesa Blvd., San Diego, California 92111  
 24 Hour Toll Free Phone 1-800-854-2211  
 (714) 278-4394 California Residents 1-800-542-6239  
 CABLE ADDRESS ICUSD

LINEARS, REGULATORS, etc.			
QTY.		QTY.	
	MCT2 .95	LM323K 5.95	LM380 (8-14 Pin) 1.19
	8038 3.95	LM324 1.25	LM709 (8-14 Pin) .35
	LM201 .75	LM339 .75	LM711 .45
	LM301 .45	7805 (340T5) .95	LM723 .40
	LM308 .65	LM340T12 .95	LM725 2.50
	LM309H .65	LM340T15 .95	LM739 1.50
	LM309K (340K-5) 1.50	LM340T18 .95	LM741 (8-14) .35
	LM310 .85	LM340T24 .95	LM747 1.10
	LM311D .75	LM340K12 1.25	LM1307 1.25
	LM318 1.75	LM340K15 1.25	LM1458 .65
	LM320H6 .79	LM340K18 1.25	LM3900 .50
	LM320H15 .79	LM340K24 1.25	LM75451 .65
	LM320H24 .79	LM373 2.95	NE555 .45
	7905 (LM320K5) 1.65	LM377 3.95	NE556 .85
	LM320K12 1.65	78L05 .75	NE565 .95
	LM320K24 1.65	78L12 .75	NE566 1.25
	LM320T5 1.65	78L15 .75	NE567 .95
	LM320T12 1.65	78M05 .75	
	LM320T15 1.65		

- T T L -				
QTY.		QTY.		QTY.
	7400 .10	7482 .75	74221 1.00	74LS02 .30
	7401 .15	7483 .75	74367 .95	74LS04 .30
	7402 .15	7485 .55	75108A .35	74LS05 .35
	7403 .15	7486 .25	75491 .50	74LS08 .35
	7404 .10	7489 1.05	75492 .50	74LS09 .35
	7405 .25	7490 .45	74H00 .15	74LS10 .35
	7406 .25	7491 .70	74H01 .20	74LS11 .35
	7407 .55	7492 .45	74H04 .20	74LS20 .30
	7408 .15	7493 .35	74H05 .20	74LS21 .35
	7409 .15	7494 .75	74H08 .35	74LS22 .35
	7410 .15	7495 .60	74H10 .35	74LS32 .35
	7411 .25	7496 .80	74H11 .25	74LS37 .35
	7412 .25	74100 1.15	74H15 .45	74LS38 .45
	7413 .25	74107 .25	74H20 .25	74LS40 .40
	7414 .75	74121 .35	74H21 .25	74LS42 .75
	7416 .25	74122 .55	74H22 .40	74LS51 .45
	7417 .40	74123 .35	74H30 .20	74LS74 .45
	7420 .15	74125 .45	74H40 .25	74LS76 .50
	7426 .25	74126 .35	74H50 .25	74LS86 .45
	7427 .25	74132 .75	74H51 .25	74LS90 .65
	7430 .15	74141 .90	74H52 .15	74LS93 .65
	7432 .20	74150 .85	74H53 .25	74LS107 .50
	7437 .20	74151 .65	74H55 .20	74LS123 1.20
	7438 .20	74153 .75	74H72 .35	74LS151 .85
	7440 .20	74154 .95	74H74 .35	74LS153 .85
	7441 1.15	74156 .70	74H101 .75	74LS157 .85
	7442 .45	74157 .65	74H103 .55	74LS160 .95
	7443 .45	74161 .55	74H106 .95	74LS164 1.20
	7444 .45	74163 .85	74L00 .25	74LS193 1.05
	7445 .65	74164 .60	74L02 .20	74LS195 .95
	7446 .70	74165 1.10	74L03 .25	74LS244 1.70
	7447 .70	74166 1.25	74L04 .30	74LS367 .95
	7448 .50	74175 .80	74L10 .20	74LS368 .95
	7450 .25	74176 .85	74L20 .35	74S00 .35
	7451 .25	74180 .55	74L30 .45	74S02 .35
	7453 .20	74181 2.25	74L47 1.95	74S03 .25
	7454 .25	74182 .75	74L51 .45	74S04 .25
	7460 .40	74190 1.25	74L55 .65	74S05 .35
	7470 .45	74191 1.25	74L72 .45	74S08 .35
	7472 .40	74192 .75	74L73 .40	74S10 .35
	7473 .25	74193 .85	74L74 .45	74S11 .35
	7474 .30	74194 .95	74L75 .85	74S20 .25
	7475 .35	74195 .95	74L93 .55	74S40 .20
	7476 .40	74196 .95	74L123 .85	74S50 .20
	7480 .55	74197 .95	74LS00 .30	74S51 .25
	7481 .75	74198 1.45	74LS01 .30	74S64 .15
				74S74 .35
				74S112 .60
				74S114 .65
				74S133 .40
				74S140 .55
				74S151 .30
				74S153 .35
				74S157 .75
				74S158 .30
				74S194 1.05
				74S257 (8123) 1.05
				8131 2.75

SPECIAL DISCOUNTS	
Total Order	Deduct
\$35-\$99	10%
\$100-\$300	15%
\$301-\$1000	20%

Table of electronic components including transistors, diodes, and integrated circuits with part numbers and prices.

litronix FOUR DIGIT ALPHANUMERIC DISPLAY DL-1416. Includes description and pricing.

OPCOA BICOLOR LED CSL310L. Includes description and pricing.

POWER SUPPLIES FROM ADTECH. Includes various power supply models and prices.

PET 2001 PERSONAL COMPUTER. Advertisement for the PET 2001 computer system with pricing and features.

FUNCTION GENERATOR KIT XR2206KB. Advertisement for the XR2206KB function generator kit.

LIQUID CRYSTAL DISPLAY LCD106. Advertisement for the LCD106 liquid crystal display.

SOCCER COMPUTER. Advertisement for the Soccer Computer system.

1802 SERIES. Advertisement for the 1802 series of integrated circuits.

DECODER/DRIVER/LATCH. Advertisement for decoder/driver/latch components.

Interroll LED or LCD 3 1/2 DIGIT PANEL METER KITS. Advertisement for meter kits.

KIM-1 MICROCOMPUTER. Advertisement for the KIM-1 microcomputer.

HICKOK LX303 DIGITAL MULTIMETER. Advertisement for the LX303 digital multimeter.

GRI KEYBOARDS AND ACCESSORIES. Advertisement for keyboards and accessories.

5% CARBON FILM RESISTORS. Advertisement for 5% carbon film resistors.

15 Megahertz PORTABLE MINI-SCOPES. Advertisement for portable mini-scopes.

ANCROMA. Advertisement for Ancroma products and services.





Transistor Checker

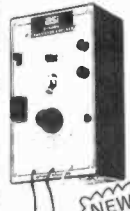

Completely Assembled - Battery Operated - The ASI Transistor Checker is capable of checking a wide range of transistor types...

Trans-Check \$29.95 ea.

Custom Cables & Jumpers

DB 25 Series Cables and Dip Jumpers section with various models and prices.

CONNECTORS

DB25P, DB25S, DB51226-1 connectors and their prices.

PRINTED CIRCUIT EDGE-CARD

Table with columns for spacing, pin type, and price for printed circuit edge-cards.

Solar Cells 2x2cm

Specifications for solar cells: 0.4 volts, 100mA, 41 MW.

the 3rd Hand

Product description for 'the 3rd Hand' circuit board, highlighting its ease of use.

JE701 6-Digit Clock Kit product listing with price of \$19.95.

REMOTE CONTROL TRANSMITTER & RECEIVER

Image and description of remote control transmitter and receiver kit.

INSTRUMENT/CLOCK CASE

Instrument/clock case product listing with price of \$3.49 each.

MICROPROCESSOR COMPONENTS

Large table listing microprocessor components like CPUs, RAMs, and ROMs with prices.

CONTINENTAL SPECIALTIES PROTO BOARDS

Proto Board 203 and Proto Board 203A product listings with prices.

BK Precision Model 2800 AC Adapter product listing.

100 MHz 8-Digit Counter product listing with price of \$134.95.

REGULATED POWER SUPPLY

JE200 and JE205 regulated power supply product listings.

\$10.00 Minimum Order - U.S. Funds Only. Spec Sheets - 25¢.

Jameco Electronics logo and contact information.

The Incredible

"Pennywhistle 103" Kit Only

"Pennywhistle 103" product listing with price of \$139.95.

TRS-80 16K Conversion Kit product listing with price of \$99.95.

COMPUTER CASSETTES product listing with price of \$14.95.

SUP 'R' MOD II UHF Channel 33 TV Interface Unit Kit product listing.

ELC WREAP Model P180 wire wrap utility product listing.

Model P180 Tool product listing with price of \$24.50.

IDEAL FOR TRS 80 CASSETTE CONTROLLER product listing.

63-Key Unencoded Keyboard product listing with price of \$29.50.

Hexadecimal Unencoded Keypad product listing with price of \$10.95/each.



Same day shipment. First line parts only. Factory tested. Guaranteed money back. Quality IC's and other components at factory prices.

INTEGRATED CIRCUITS

Table listing various integrated circuits including 7400 TTL, 7400N, 7401N, 7402N, 7403N, 7404N, 7405N, 7406N, 7407N, 7408N, 7409N, 7410N, 7411N, 7412N, 7413N, 7414N, 7415N, 7416N, 7417N, 7418N, 7419N, 7420N, 7421N, 7422N, 7423N, 7424N, 7425N, 7426N, 7427N, 7428N, 7429N, 7430N, 7431N, 7432N, 7433N, 7434N, 7435N, 7436N, 7437N, 7438N, 7439N, 7440N, 7441N, 7442N, 7443N, 7444N, 7445N, 7446N, 7447N, 7448N, 7449N, 7450N, 7451N, 7452N, 7453N, 7454N, 7455N, 7456N, 7457N, 7458N, 7459N, 7460N, 7461N, 7462N, 7463N, 7464N, 7465N, 7466N, 7467N, 7468N, 7469N, 7470N, 7471N, 7472N, 7473N, 7474N, 7475N, 7476N, 7477N, 7478N, 7479N, 7480N, 7481N, 7482N, 7483N, 7484N, 7485N, 7486N, 7487N, 7488N, 7489N, 7490N, 7491N, 7492N, 7493N, 7494N, 7495N, 7496N, 7497N, 7498N, 7499N, 7500N.

RCA Cosmac Super Elf Computer \$106.95

Compare features before you decide to buy any other computer. There is no other computer on the market today that has all the desirable benefits of the Super Elf for so little money. The Super Elf is a small single board computer that does many big things. It is an excellent computer for training and for learning programming with its machine language and yet it is easily expanded with additional memory, Tiny Basic, ASCII Keyboards, video character generation, etc.

The Super Elf includes a ROM monitor for program loading, editing and execution with SINGLE STEP for program debugging which is not included in others at the same price. With SINGLE STEP you can see the microprocessor chip operating with the unique Quest address and data bus displays before, during and after executing instructions. Also, CPU mode and instruction cycle are decoded and displayed on eight LED indicator lamps.

An RCA 1861 video graphics chip allows you to connect to your own TV with an inexpensive video modulator to do graphics and games. There is a speaker system included for writing your own music or using many music programs already written. The speaker amplifier may also be used to drive relays for control purposes.

A 24 key HEX keyboard includes 16 HEX keys plus load, reset, run, wait, input, memory program expansion board with...

...and monitor select and single step. Large, on board displays provide output and optional high and low address. There is a 44 pin standard connector for PC cards and a 50 pin connector for the Quest Super Expansion Board. Power supply and sockets for all IC's are included in the price plus a detailed 127 pg. instruction manual which now includes over 40 pgs. of software info, including a series of lessons to help get you started and a music program and graphics target game.

Many schools and universities are using the Super Elf as a course of study. OEM's use it for training and research and development. Remember, other computers only offer Super Elf features at additional cost or not at all. Compare before you buy. Super Elf Kit \$106.95. High address option \$8.95. Low address option \$9.95. Custom Cabinet with drilled and labelled plexiglass front panel \$24.95. NiCad Battery Memory Saver Kit \$6.95. All kits and options also come completely assembled and tested.

Questdata, a 12 page monthly software publication for 1802 computer users is available by subscription for \$12.00 per year.

Tiny Basic for ANY 1802 System

Cassette \$10.00. On ROM \$38.00. Super Elf owners, 30% off. Object code listing with manual \$5.00. Object list, manual and paper tape \$10.00. Original ELF Kit Board \$14.95.

Cassette Interface \$89.95

Improvements and revisions are easily done with the monitor. If you have the Super Expansion Board and Super Monitor the monitor is up and running at the push of a button. Other on board options include Parallel Input and Output Ports with full handshake. They allow easy connection of an ASCII keyboard to the input port. RS 232 and 20 ma Current Loop for teletype or other device are on board and if you need more memory there are two S-100 slots for static RAM or video boards. A Gobout 8K RAM board is available for \$135.00. Also a 1K Super Monitor version 2 with video driver for full capability display with Tiny Basic and a video interface board. Parallel I/O Ports \$9.85, RS 232 \$4.50, TTY 20 ma I/F \$1.95, S-100 \$4.50. A 50 pin connector set with ribbon cable is available at \$12.50 for easy connection between the Super Elf and the Super Expansion Board.

The Power Supply Kit for the Super Expansion Board is a 5 amp supply with multiple positive and negative voltages \$29.95. Add \$4.00 for shipping. Prepunched frame \$5.00. Case \$10.00. Add \$1.50 for shipping.

Auto Clock Kit \$15.95

DC clock with 4-50" displays. Uses National MA-1012 module with alarm option. Includes light dimmer, crystal timebase PC boards. Fully regulated, comp. instrs. Add \$3.95 for beautiful dark gray case. Best value anywhere.

RCA Cosmac VIP Kit \$229.00

Video computer with games and graphics. Fully assem. and test. \$249.00

Not a Cheap Clock Kit \$14.95

Includes everything except case. 2-PC boards. 6-50" LED Displays. 5314 clock chip, transformer, all components and full instructions. Orange displays also avail. Same kit w/80" displays. Red only. \$21.95 Case \$11.75

60 Hz Crystal Time Base Kit \$4.40

Converts digital clocks from AC line frequency to crystal time base. Outstanding accuracy. Kit includes: PC board, IC, crystal, resistors, capacitors and trimmer.

Digital Temperature Meter Kit

Indoor and outdoor. Switches back and forth. Beautiful, 50" LED readouts. Nothing like it available. Needs no additional parts for complete, full operation. Will measure -100° to +200°F. tenths of a degree, air or liquid. Very accurate. \$39.95 Beautiful woodgrain case w/bezel \$11.75

NiCad Battery Fixer/Charger Kit

Opens shorted cells that won't hold a charge and then charges them up. All in one kit w/full parts and instructions. \$7.25

PROM Eraser Will erase 25 PROMs in 15 minutes. Ultraviolet, assembled \$34.50

Rockwell AIM 65 Computer

6502 based single board with full ASCII keyboard and 20 column thermal printer. 20 char. alphanumeric display. ROM monitor, fully expandable. \$375.00. 4K version \$450.00. 4K Assembler \$85.00. 8K Basic Interpreter \$100.00. Power supply assembled in case \$60.00.

Multi-volt Computer Power Supply

8v 5 amp, ±18v .5 amp, 5v 1.5 amp, -5v .5 amp, 12v 5 amp, -12 option. ±5v, ±12v are regulated. Kit \$29.95. Kit with punched frame \$34.95. Woodgrain case \$10.00.

Video Modulator Kit \$8.95

Convert your TV set into a high quality monitor without affecting normal usage. Complete kit with full instructions.

2.5 MHz Frequency Counter Kit \$37.50

Complete kit less case \$37.50

30 MHz Frequency Counter Kit \$47.75

Complete kit less case \$47.75

79 IC Update Master Manual \$35.00

Complete IC data selector. 2500 pp. master reference guide. Over 500,000 cross references. Free update service through 1979. Domestic postage \$3.50. Foreign \$5.00. 1978 IC Master closeout \$19.50.

Stopwatch Battery \$26.95

Full six digit battery operated. 2-.5 volts. 3.2768 MHz crystal accuracy. Times to 59 min., 59 sec., 99 1/100 sec. Times std., split and Taylor. 7205 chip, all components minus case. Full instructions.

Hickok 3 1/2 Digit LCD Multimeter

Batt/AC oper. 0.1mv-1000v. 5 ranges. 0.5% accuracy. Resistance 6 low power ranges 0.1 ohm-20M ohm. DC curr. .01 to 100ma. Hand held, 1/2" LCD displays, auto zero, polarity, over-range. \$74.95.

S-100 Computer Boards

- 8K Static RAM Kit Gobout \$135.00
16K Static RAM Kit \$265.00
24K Static RAM Kit \$423.00
32K Dynamic RAM Kit \$310.00
64K Dynamic RAM Kit \$470.00
8K 16K EProm Kit (less PROMs) \$89.00
Video Interface Kit \$139.00
Motherboard \$39. Extender Board \$8.99

TERMS: \$5.00 min. order U.S. Funds. Calif residents add 6% tax. BankAmericard and Master Charge accepted. Shipping charges will be added on charge cards.

FREE: Send for your copy of our NEW 1979 QUEST CATALOG. Include 28¢ stamp.





## THE MOST ADVANCED TIMEPIECE OF ITS KIND IN THE WORLD!

LCD Quartz Alarm Chronograph with calendar and dual time zone!! Watch is the same as Seiko but you pay a lot more for the name! Features



- 24 hour alarm
- Chronograph counts up to 12 hrs., 59 mins. 59.9 sec.
- Precision of chrono up to 1/10 sec indicated by 10 moving arrows!!
- Lap time (with chrono running uninterrupted)
- Time displays by LCD for hour, min, sec, day, date of the week and AM/PM.
- Calendar gives out date-day
- Dual time zone for any two cities of the world at your own choice.
- With light switch to allow you to see the time in the dark!

\$65.50

ONE YEAR FULL WARRANTY!

## JUMBO 1" LED ALARM CLOCK MODULE

- Assembled not a kit!
- Features
- 1" 4 digits red LED display
  - 12 hours real time format
  - 24 hours alarm audio output (just add speaker)
  - Power failure indicator
  - Countdown timer 59 mins
  - 12 16V AC 50/60 Hz input
  - 10 min snooze control



\$8.50 EACH

#1 L M 701

Transformer \$1.75

## NEW MARK III 9 Steps 4 Colors LED VU



Stereo level indicator kit with arc shape display panel!! This Mark III LED level indicator is a new design PC board with an arc-shape 4 colors LED display (change color from red, yellow, green and the peak output indicated by rose red). The power range is very large, from 30dB to +5dB. The Mark III indicator is applicable to 1 watt - 200 watts amplifier operating voltage is 3V - 9V DC at max 400 MA. The circuit uses 10 LEDs per channel. It is very easy to connect to the amplifier. Just hook up with the speaker output!

IN KIT FORM \$18.50

## ELECTRONIC DUAL SPEAKER PROTECTOR

Cut off when circuit is shorted or over load to protect your amplifier as well as your speakers. A must for OCL circuits.



KIT FORM \$8.75 EA.

## FM WIRELESS MIC KIT

It is not a pack of cigarettes. It is a new FM wireless mic kit! New design PC board fits into a plastic cigarette box (case included!) Uses a condenser microphone to allow you to have a better response in sound pick-up. Transmits up to 350 ft! With an LED indicator to signal the unit is on.



# F M M 2

\$7.95

## BATTERY POWERED FLUORESCENT LANTERN



- FEATURES
- Circuitry designed for operation by high efficient, high power silicon transistor which enable illumination maintain in a standard level even the battery supply drops to a certain low voltage.
  - 9" SW cool/daylight miniature fluorescent tube.
  - 8 X 1.5V UM-1 (size D) dry cell battery.
  - Easy sliding door for changing batteries.
  - Stainless reflector with wide angle increasing illumination of the lantern.

\$10.50 EACH  
MODEL 888 R

## DIGITAL AUTO SECURITY SYSTEM

4 DIGITS  
PERSONAL CODE!!



- proximity triggered
- voltage triggered
- mechanically triggered

## 3-WAY PROTECTION!

This alarm protects you and itself! Entering protected area will set it off, sounding your car horn or siren you add. Any change in voltage will also trigger the alarm into action. If cables within passenger compartment are cut, the unit protects itself by sounding the alarm.

SPECIAL \$19.95

ALL UNITS FACTORY ASSEMBLED AND TESTED - NOT A KIT!



CASE 030

## PROFESSIONAL CASE

for our 0-30V Power Supply. It is a nice looking metal cast case with giant 4" volt/amp meter; output binding post and fuse holder, on/of switch and line cord!

ONLY \$21.50 EA.



0-30V POWER SUPPLY

## POWER SUPPLY KIT

0-30V D.C. REGULATED  
Uses UA723 and ZN3055 Power TR output can be adjusted from 0-30V, 2AMP. Complete with PC board and all electronic parts.

\$10.50 each

Transformer for Power Supply, 2AMP 24V x 2 \$8.50

## HICKOK LX303 DIGITAL LCD MULTIMETER



- 3 1/2 digits display
- 200 hours 9V battery life
- Auto zero; polarity; overrange indication
- 100MV DC F.S. sensitivity
- 19 ranges and functions
- D.C. volt: 0.1 MV to 1000 V
- A.C. volt: 0.1 V to 600 V
- Resistance: 0.1Ω to 20 MΩ
- D.C. current: 0.01ΩA to 100 MA

OUR PRICE \$71.45

## 60W + 60W STEREO AMPLIFIER

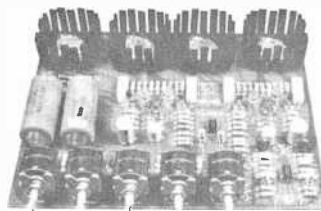

## COMPLETED UNIT - NOT A KIT!

OCL rear amp. & low noise pre amp. with bass, middle, treble 3-way tone control. Fully assembled and tested, ready to work. Total harmonic distortion less than 0.5% per channel at 8 Ω. Power supply is 36V 3A AC or DC. Complete unit assembled and tested

\$49.50 ea.

\$ 9.50 ea.

## GREEN COLOR 0.6" LED ALARM CLOCK



- 24 hr. alarm
- 10 min. snooze time
- AM/PM indicator
- Power interrupt indication
- Green color 0.6" display
- 110V AC 60Hz input
- Factory assembled,

NOT A KIT \$17.50 EACH

## LCD CLOCK MODULE!



- 0.5" LCD 4 digits display
- X'tal controlled circuits
- D.C. powered (1.5V battery)
- 12 hr. or 24 hr. display
- 24 hr alarm set
- 60 min. countdown timer
- On board dual back up lights
- Dual time zone display
- Stop watch function

NIC1200 (12 hr) \$24.50 EA.

NIC2400 (24 hr) \$26.50 EA.

## 1Watt AUDIO AMP



All parts are pre assembled on a mini PC Board  
Supply Voltage 6 ~ 9V D.C.  
SPECIAL PRICE \$1.95 ea.

## 5W AUDIO AMP KIT



2 LM 380 with Volume Control  
Power Supply 6~18V DC  
ONLY \$6.00 ea.

## ULTRA SONIC SWITCH KIT



Kit includes the Ultra Sonic Transducers, 2 PC Boards for transmitter and receiver. All electronic parts and instructions. Easy to build and a lot of uses such as remote control for TV, garage door, alarm system for counter. Unit operated by 9-12 DC. \$15.50

## ELECTRONIC WHEEL OF FORTUNE KIT

With 10 numbers split into black and white on dial. The LED turns when you hit the play switch, then it slows down and stops on one number. It sounds like a motor inside, but there is none. Lots of fun and easy to build. Kit comes with nice looking case, all electronic parts, P.C Board and LEDs. Battery not included



\$12.50

MINIMUM ORDER \$10.00 California residents add 6% sales tax and 10% shipping  
Out of state add 15% of total purchase for shipping charges, out of USA and Overseas add 25% of total purchase.  
SEND CHECK OR MONEY ORDER TO

5/79



## FORMULA INTERNATIONAL INC.

12605 CRENSHAW BOULEVARD • HAWTHORNE, CALIFORNIA 90250

For more information please call (213) 973-1921, (213) 679-5162

STORE HOURS 10-7 Monday - Saturday

SEND \$1.00 FOR DETAILED CATALOG





# Radio Shack: No. 1 Parts Place

## Low Prices and New Items Everyday!

ELECTRONICS Market Place

Top-quality devices, fully functional, carefully inspected. Guaranteed to meet all specifications, both electrically and mechanically. All are made by well-known American manufacturers, and all have to pass manufacturer's quality control procedures. These are not rejects, not fallouts, not seconds. In fact, there are none better on the market! Always count on Radio Shack for the finest quality electronic parts!

### TTL and CMOS Logic ICs

Full-Spec Devices  
Direct from  
Motorola and  
National Semiconductor



Type	Cat. No.	ONLY
7400	276-1801	35¢
7402	276-1811	39¢
7404	276-1802	35¢
7406	276-1821	49¢
7410	276-1807	39¢
7413	276-1816	59¢
7420	276-1809	39¢
7427	276-1823	49¢
7432	276-1824	49¢
7441	276-1804	99¢
7447	276-1805	99¢
7448	276-1816	99¢
7451	276-1825	39¢
7473	276-1803	49¢
7474	276-1818	49¢
7475	276-1806	79¢
7476	276-1813	59¢
7485	276-1826	1.19
7488	276-1827	49¢
7490	276-1808	79¢
7492	276-1819	69¢
74123	276-1817	99¢
74145	276-1828	1.19
74150	276-1829	1.39
74154	276-1834	1.29
74192	276-1831	1.19
74193	276-1820	1.19
74194	276-1832	1.19
74196	276-1833	1.29
4001	276-2401	49¢
4011	276-2411	49¢
4012	276-2412	69¢
4013	276-2413	89¢
4017	276-2417	1.49
4020	276-2420	1.49
4021	276-2421	1.49
4023	276-2423	69¢
4027	276-2427	89¢
4028	276-2428	1.29
4046	276-2446	1.69
4049	276-2449	69¢
4050	276-2450	69¢
4051	276-2451	1.49
4066	276-2466	99¢
4070	276-2470	69¢
4511	276-2447	1.69
4518	276-2490	1.49
4543	276-2491	1.89

### SN-76477 Sound/Music Synthesizer IC



**2.99** Featured in Oct. Popular Electronics

Creates almost any type of sound — music to "gunshots"! Built-in audio amp. Includes 2 VCO's, LF osc., noise gen., filter, 2 mixers, envelope modulator, logic circuit. 28-pin DIP. With data/applications circuits. 276-1765 ..... 2.99

### Analog Audio Delay IC MN 3002

**10.95**

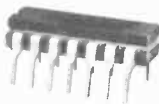

For Phase-Shifter, Reverb & Delay Circuits

"Bucket Brigade" device uses 512 shift registers to provide a continuously variable electronic delay for complex audio signals. Includes data sheet and applications circuits. 276-1760 ..... 10.95

### MC14553 3-Digit BCD Counter IC



**2.99**

For Low-Cost Digital Readout

CMOS chip replaces over 8 separate IC's in a digital display circuit. Input pulse shaping. Master reset pin. 16-pin DIP. 276-2498 ..... 2.99

### Top-Quality IC and PCB Accessories

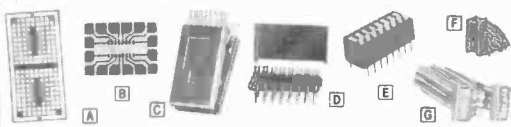

- PC Board. Mounts two 14 or 16-pin ICs or sockets for bread boarding. Copper clad. 2 1/2" x 5 1/2". 276-151 ..... 2.99
- PC Board. Mounts single 14 or 16-pin IC or socket. 276-024 ..... Pkg. of 2/99¢
- 16-Pin IC Test Clip. 276-1951 ..... 3.99
- 16-Pin DIP Header. With snap-on cover. 276-1980 ..... 1.29
- 8-Rocker 16-Pin DIP Switch. 276-1301 ..... 1.99
- Vertical 16-pin Socket. For LED displays. 276-1966 ..... 1.49
- 16-Pin DIP Jumper Cable. 18" long. 276-1976 ..... 3.99

### Project Boxes

#### Aluminum Cover

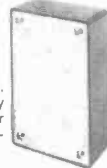

The popular, low-cost way to house your electronic experiments.

- 3 1/2" x 2 1/2" x 1 1/2". 270-230 ..... 1.19
- 4 x 2 1/2" x 2 1/2". 270-231 ..... 1.29
- 5 1/2" x 2 1/2" x 1 1/2". 270-233 ..... 1.49
- 6 1/2" x 3 1/2" x 2". 270-227 ..... 1.79
- 7 1/2" x 4 1/2" x 2 1/2". 270-232 ..... 2.49

### Miniature Hobby Motors



High-torque permanent magnet type. 1/16" dia. shaft.

- 12VDC. 350mA. 2x 1 3/16". 273-210 ..... 69¢
- 6-9VDC. 500mA. 1 1/2" x 3/4". 273-209 ..... Pkg. of 2/99¢

### 8080A Microprocessor and Support Chips

New — 100% Prime



All With Full Data and Specs

- 8080A Microprocessor. 2 μs cycle time. 276-2510. .... 12.95
- 8208 Bus Driver. 8-bit bidirectional. 276-2508. .... 5.95
- 8154 128x8-Bit RAM I/O. 40-pin DIP. 276-2511. .... 9.95
- 8212 I/O Port. Data latch and buffer. 276-2512. .... 4.95
- 8224 Clock and Generator Driver. 276-2524. .... 3.95
- 8228 System Controller and Bus Driver. 276-2528. .... 6.95
- 8251 Programmable Communication Interface. 276-2551. .... 9.95
- 8255 Programmable Peripheral Interface. 276-2555. .... 9.95

### RAM Memory ICs

Under 450 nS Access Time

- 2102 1024 x 1 Array. Low-cost static memory chip. 16-pin DIP. Buy 8 and save! 276-2501 ..... 2.49 Ea. or 8/14.95
- 2114L 1024 x 4 Array. NMOS static RAM. 18-pin DIP. 276-2504. .... 12.95

### SALE Handheld 6-Digit Frequency Counter

Reg. 99.95 **69.95**

- Lead Zero Blanking
- 100 Hz Up to 45 MHz
- kHz and MHz Decimals

Accuracy is 3 ppm at 25°C or less than 30 Hz at 10 MHz. Overload-protected 1-meg input. Sensitivity, 30 mV up to 30 MHz. 3x4 1/2". With mini-rod antenna, leads, case, Instructions. Requires 9V battery. 22-351 ..... Sale 69.95 AC Adapter. U.L. listed. 65-731 ..... 4.95



### Digital IC Logic Probe 24.95

Multi-Logic Family Compatibility from 5-15VDC

Detects one-shot low repetition rate, narrow pulses scopes miss. Combines level detector, pulse detector and pulse stretcher. Hi-LED indicates logic "1", Lo-LED is logic "0". Pulse LED displays pulse transitions to 300 nanoseconds, blinks at 3 Hz for high-frequency signals (up to 1.5 MHz). With cables. 22-300 ..... 24.95



### Custom Printed Circuit Board Kit



Everything you need for making high-quality custom PC boards. 276-1576 ..... 7.95  
Extra Resist Pen. 276-1530 ..... 1.29  
Extra Etching Solution. 276-1535 ..... 2.19

### Computer Data Manuals & Semiconductor Handbook

- Intel 8080/8085 Programming Manual. Handy reference for programming with Intel's assembly language. 62-1377 ..... 3.95
- Intel Memory Design Handbook. Explains use of Intel's memory components and support circuits in systems. 62-1378 ..... 3.95
- Intel Data Catalog. 928 pages of specifications on most of Intel's standard microcomputer-related products. 62-1379 ..... 4.95
- Semiconductor Reference and Application Handbook. Complete specs and applications for popular IC transistors, diodes. 276-4002 ..... 1.95

### Molded Connectors

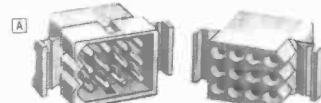

Rated 8A @ 250V. Standard .093" pin diameter

Fig	Pins	Type	Cat No	Each	Fig	Pins	Type	Cat No	Each
A	4	Male	274-224	99¢	B	4	Female	274-234	99¢
A	6	Male	274-226	1.19	B	6	Female	274-236	1.19
A	9	Male	274-229	1.39	B	9	Female	274-239	1.39
A	12	Male	274-232	1.49	B	12	Female	274-242	1.49

2-Pin Male & Female. (Not shown) 274-222 ..... Pair 89¢

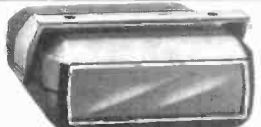
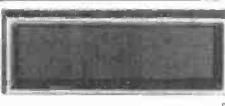

### Digital Project Accessories

- Bezel with Lens. High-contrast filter for LED displays. 3 1/2" x 1 1/2" lens opening. 270-301 ..... 3.95
- Deluxe Molded Display Case. Red lens. Mount up to four 0.6" or eight 0.3" LED digits. With brackets. 1 1/2" x 3 1/2" x 4 1/2". 270-285 ..... 3.95
- MA 1033 Clock Case. For car clock modules. Accepts 3 push-button switches (not inc.). With brackets, blue lens. 3 1/2" x 2 1/2" x 2 1/2". 270-303 ..... 5.95

WHY WAIT FOR MAIL ORDER DELIVERY?  
IN STOCK NOW AT OUR STORE NEAR YOU!

# Radio Shack®

A DIVISION OF TANDY CORPORATION • FORT WORTH, TEXAS 76102  
OVER 7000 LOCATIONS IN NINE COUNTRIES

Prices may vary at individual stores and dealers



**HICKOK 3 1/2 Digit Mini-Multimeter**

- 100 mV DC F.S. Sensitivity
- 19 Ranges and Functions
- 200 Hours 9V Battery Life
- Auto Zero, Polarity, Overrange Indication

Reg. \$74.95 **\$69.50**

**SENCORE TV-VTR-MATV and Video Analyzer**

Model VA48

Reg. \$975.00 **\$875.00**

**100 MHz 8-Digit Counter** \$119.00

- 20 Hz-100 MHz Range
- 6" LED Display
- Fully Automatic

Now Available **PS500 500MHz Prescaler \$52.95**

**BK PRECISION Digital Capacitance Meter**

Model 1500

Reg. \$249.95 **\$219.95**

**CODE-A-PHONE Telephone Answering Devices**

Model 1400

Reg. \$199.95 **\$179.95**

**BSR Changer Accessories**

Model BSR-128

Reg. \$24.95 **\$24.95**

**BK PRECISION 3 1/2-Digit Portable DMM**

- Overhead Protected
- Battery or AC operation
- 3" high LED Display
- Auto Zeroing

Model 2800

Reg. \$85 **\$85**

comes complete with test leads, operating manual and spare fuses

Model 2810 **\$110.50**

**Ungar Heat Gun**

Reg. \$65.00 **\$46.50**

**Weller Xcelite**

Model 99SM

Reg. \$42.95 **\$42.95**

**Logic Monitor**

- Automatically displays logic and dynamic logic
- Works with DTL, HTL, TTL and CMOS
- 16 LED display
- Circuit powered design

Model LM-1

Reg. \$52.95 **\$52.95** complete

**WAHL NEW ISO-TIP "Quick Charge"**

Model 7800

Reg. \$27.95 **\$27.95**

**6" x 9" 3-Way Speaker**

Model 7800

Reg. \$14.95 **\$14.95**

**NLS 15 MHz Mini Oscilloscope**

Model MS 15

Reg. \$318.00 **\$269.95**

- Battery or line operation
- Automatic and line sync modes
- Power consumption less than 15 W

NOW AVAILABLE

Dual Trace Version Model MS 215 Reg. \$435.00 **\$369.95**

**Service Master Attache Style Tool Kit**

Model 99SM

Reg. \$42.95 **\$42.95**

**Tool Cases**

Model TC-100/ST

Reg. \$269.95 **\$269.95**

**Roll Kit**

Model 99PR

Reg. \$15.95 **\$15.95**

**platt Attach Tool Case with 2 Removable Pallets**

Model 600T

Reg. \$89.00 **\$65.00**

**HICKOK Function Generator**

Model 270

Reg. \$169.15 **\$169.15**

**Trace Scope**

Model 1432P

Reg. \$780.00 **\$663.** with probes

**LEADER Instruments Corp 20 MHz. Dual Trace**

- Add, subtract modes on CH-1 & CH-2
- Front panel X-Y operation
- 17.5 nSec rise time

Model LBO-508

Reg. \$769.95 **\$654.50** with accessories

**BK PRECISION SUPER SPECIAL**

Model 1827

Reg. \$52.50 **\$52.50**

**In-Dash AM/FM 8 Track Stereo**

Model 2910

Reg. \$57.50 **\$57.50**

**HICKOK Substitution Box**

Model 2910

Reg. \$51 **\$51**

**Weller Controlled Output Soldering Station**

Model WTCP-N

Reg. \$76.00 **\$45.00**

**FREE 1979 Catalog**

**SENCORE POCKET CRICKET TRANSISTOR/FET TESTER**

Model TF 40

Reg. \$125.00 **\$99.95**

**Magnifier LAMP**

Model MG-10A

Reg. \$49.50 **\$49.50**

**700 Series**

Precision ground and polished magnification lens. Uses 27W T-9 Cytine Fluorescent

**30MHz Portable Frequency Counter**

Model 100

Reg. \$120.00 **\$59.95**

**Transistor Tester**

Model 100

Reg. \$22.00 **\$22.00**

**Auto Stereo 40 Watt Power Booster POW-40**

Reg. \$39.95 **\$24.95**

**VOM Multimeters**

20K ohm/v **\$19.95** with mirrored scale.

1K ohm/v **\$9.95**

**FORDHAM**

855R Conklin St. Farmingdale, N.Y. 11735

CIRCLE NO. 26 ON FREE INFORMATION CARD

# LEADER Test Instruments

## OSCILLOSCOPES

**The 30 MHz Dual Trace Oscilloscope with Delay**

- 5mV sensitivity.
- Built-in delay line.
- Single shot trigger (CH-1, CH-2).
- 5" P-D-A CRT assures brighter, sharper trace.
- 20 nSec sweep capability plus 11.7 nSec rise time.

MODEL LBO-520

LIST PRICE: \$1050 **OUR PRICE: \$888**

**25 MHz Dual Trace, Oscilloscope Delayed Sweep**

- Sweep delay, continuously variable from 1  $\mu$ Sec to 5 Sec.
- 5 mV/Div. Vertical Sensitivity with  $\pm 3\%$  acc.
- Rectangular CRT with internal graticule.
- 14 nSec rise time.
- CH-1 or 2 trigger; HF filter, and TV sync.

MODEL LBO-515

LIST PRICE: \$1395 **OUR PRICE: \$1180**

**The 20 MHz Dual Trace Oscilloscope**

- Add & subtract modes (with CH-2 invert).
- Front panel X-Y operation.
- 17.5 nanosec rise time.
- Automatic trigger from either channel, including TV sync.
- 10 mV sensitivity.

MODEL LBO-508

LIST PRICE \$769 **OUR PRICE: \$635**

**The 20 MHz Single Trace Triggered Oscilloscope**

- Outstanding trigger sensitivity over entire operational range.
- 10 mV sensitivity and 17.4 nSec rise time.
- X5 magnification ( $\pm 5\%$ ) delivers 100 nS/cm maximum speed for easy, precise readings.

MODEL LBO-507

LIST PRICE: \$549 **OUR PRICE: \$455**

## FLUKE DIGITAL MULTIMETERS

**8020A**

- 10,000 M $\Omega$  resistance meas with conductance function
- Extensive overload and transient protection
- Rugged construction — MIL-T-28800
- Hi/Lo power ohms for In-circuit resistance and diode testing
- 10 M $\Omega$  input impedance doesn't load circuit
- 200 hour battery life — low battery indicator
- Large LCD readout — 2000 counts
- 1 year calibration cycle — only 3 adjustments
- One-hand operation

OUR PRICE: **\$169**

**8010A**

- Large 3 1/2-Digit LCD's - view in any light
- Conductance function - resistance to 10,000 M $\Omega$
- AC measurements to 50 kHz and higher
- True RMS for ac accuracy
- Touch-Hold probe for tricky places (Y8008)
- Diode test and low power ohms
- One year accuracy reduces calibration costs
- COMMON floatable to 500V
- Recessed jacks reduce shock hazard
- Current mode fuse protection to 600V
- Voltage mode transient protection to 6 kV
- Autozero and autopolarity
- AC or dc current to 10 amps with 8010A
- Resistance resolution to 0.001 $\Omega$  with 8012A
- Built-in batteries and charger (Option -01)
- Rugged enough for field or bench

OUR PRICE **\$239**

**8012A**

OUR PRICE **\$299**

SEND FOR OUR CATALOG

**Call TOLL FREE:**

N.J. CALL: (800)526-2514 \* (201)227-7720

**AMPOWER INST., INC.**

26 JUST ROAD, FAIRFIELD, N. J. 07006

THE MEASUREMENT SPECIALISTS

"WE SERVICE WHAT WE SELL"

**FREE TEST LEADS WITH EVERY ORDER**

CALL TODAY

MasterCharge BankAmericard and COD Accepted add \$3.00 to cover shipping handling insurance N.J. res. add 5% tax.

CIRCLE NO. 4 ON FREE INFORMATION CARD





# Electronics Classified

**REGULAR CLASSIFIED: COMMERCIAL RATE:** For firms or individuals offering commercial products or services, \$2.50 per word. Minimum order \$37.50. **EXPAND-AD® CLASSIFIED RATE:** \$3.75 per word. Minimum order \$56.25. Frequency discount: 5% for 6 months; 10% for 12 months paid in advance. **PERSONAL RATE:** For individuals with a personal item to buy or sell, \$1.50 per word. No minimum! **DISPLAY CLASSIFIED:** 1" by 1 column (2-1/4" wide), \$300. 2" by 1 column, \$600.00. 3" by 1 column, \$900.00. Advertiser to supply film positives. For frequency rates, please inquire. **GENERAL INFORMATION:** Ad copy must be typewritten or clearly printed. Payment must accompany copy except when ads are to be billed on credit cards — American Express, Diners Club, Master Charge, VISA (supply expiration date) — or when ads are placed by accredited advertising agencies. First word in all ads set in caps. All copy subject to publisher's approval. All advertisers using Post Office Boxes in their addresses **MUST** supply publisher with permanent address and telephone number before ad can be run. Advertisements will not be published which advertise or promote the use of devices for the surreptitious interception of communications. Ads are not acknowledged. They will appear in first issue to go to press after closing date. Closing Date: 1st of the 2nd month preceding cover date (for example, March issue closes January 1st). Send order and remittance to Classified Advertising, **POPULAR ELECTRONICS**, One Park Avenue, New York, N.Y. 10016. For inquiries, contact Linda Lemberg at (212) 725-3924.

## FOR SALE

**FREE!** Bargain Catalog—I.C.'s, LED's, readouts, fiber optics, calculators parts & kits, semiconductors, parts. Poly Paks, Box 942PE, Lynnfield, Mass. 01940.

**GOVERNMENT** and industrial surplus receivers, transmitters, sniperscopes, electronic parts, Picture Catalog 25 cents. Meshna, Nahant, Mass. 01908.

**LOWEST Prices Electronic Parts.** Confidential Catalog Free. KNAPP, 4750 96th St N., St. Petersburg, FL 33708.

**ELECTRONIC PARTS,** semiconductors, kits. **FREE FLYER.** Large catalog \$1.00 deposit. **BIGELOW ELECTRONICS,** Bluffton, Ohio 45817.

**RADIO—T.V. Tubes—**36 cents each. Send for free catalog. Cornell, 4213 University, San Diego, Calif. 92105.

**AMATEUR SCIENTISTS,** Electronics Experimenters, Science Fair Students... Construction plans — Complete, including drawings, schematic, parts list with prices and sources... Robot Man — Psychedelic shows — Lasers — Emotion/Lie Detector — Touch Tone Dial — Quadraphonic Adapter — Transistorized Ignition — Burglar Alarm — Sound Meter... over 60 items. Send 50 cents coin (no stamps) for complete catalog. Technical Writers Group, Box 5994, University Station, Raleigh, N.C. 27650.

**SOUND SYNTHESIZER KITS—**Surf \$14.95, Wind \$14.95, Wind Chimes \$19.95, Musical Accessories, many more. Catalog free. **PAIA Electronics,** Box J14359, Oklahoma City, OK 73114.

**HEAR POLICE / FIRE Dispatchers!** Catalog shows exclusive directories of "confidential" channels, scanners. Send postage stamp. Communications, Box 56-PE, Commack, N.Y. 11725.

**UNSCRAMBLERS:** Fits any scanner or monitor, easily adjusts to all scrambled frequencies. Only 4" square \$29.95, fully guaranteed. Dealer inquiries welcomed. **PDQ Electronics,** Box 841, North Little Rock, Arkansas 72115.

**TELETYPE EQUIPMENT** for sale for beginners and experienced computer enthusiast. Teletype machines, parts, supplies. Catalogue \$1.00 to: **ATLANTIC SALES,** 3730 Nautilus Ave., Brooklyn, NY 11224. Tel: (212) 372-0349.

**WHOLESALE C.B.,** Scanners, Antennas, Catalog 25 cents. Crystals: Special cut, \$4.95, Monitor \$3.95. Send make, model, frequency. **G. Enterprises,** Box 461P, Clearfield, UT 84015.

**UNSCRAMBLE CODED MESSAGES** from Police, Fire and Medical Channels. Same day service. Satisfaction guaranteed. **Don Nobles Electronics, Inc.,** Rt. 7, Box 610, Hot Springs, Arkansas 71901. (501) 623-6027.

**BUILD AND SAVE TELEPHONES, TELEVISION, DETECTIVE, BROADCAST Electronics.** We sell construction plans with an Engineering Service. Speakerphones, Answering Machines, Carphones, Phonevision, Dialers, Color TV Converters, VTR, Games, \$25 TV Camera, Electron Microscope, Special Effects Generator, Time Base Corrector, Chroma Key. Engineering Courses in Telephone, Integrated Circuits, Detective Electronics. **PLUS MUCH MORE.** NEW Super Hobby Catalog PLUS year's subscription to Electronic News Letter, \$1.00. **Don Britton Enterprises,** 6200 Wilshire Blvd., Los Angeles, Calif. 90048.

**NAME BRAND Test Equipment.** Up to 50% discount. Free catalog. **Salen Electronics,** Box 82, Skokie, Illinois 60077.

**UNSCRAMBLERS FOR** any scanner. Several models available. Free literature. **Capri Electronics,** 8753T Windom, St. Louis, MO 63114.

**UNSCRAMBLER KIT.** Tunes all scramble frequencies, may be built-in most scanners, 2-3/4 x 2-1/4 X 1/2. \$19.95. Factory built Code-Breaker. \$29.95. Free Catalog: **KRYSTAL KITS,** Box 445, Bentonville, Ark. 72712. (501) 273-5340.

**WEATHER MAP RECORDERS:** Copy Satellite Photographs, National-Local Weather Maps. Learn How! \$1.00. **Atlantic Sales,** 3730 Nautilus Ave., Brooklyn, N.Y. 11224. Tel: (212) 372-0349.

**NAME BRAND TEST EQUIPMENT** at discount prices. 72 page catalogue free. **Dept. PE, North American Electronics,** 1468 West 25th Street, Cleveland, OH 44113.

**FREE**

**THE GREAT ELECTRONIC THINGS & IDEAS BOOK!**

HUNDREDS OF UNUSUAL PARTS, GADGETS & IDEA ITEMS. UNAVAILABLE IN STORES OR CATALOGS ANYWHERE! Bargain prices on everything! New items in every issue! Rush postcard for your copy!

**ETCO** ELECTRONICS Dept. 035, North Country Shopping Ctr., Plattsburgh, N.Y. 12901.

**B&K Test Equipment.** Free catalog. Free Shipping. Dinosaur discounts. **Spaceatron-AT,** 948 Prospect, Elmhurst, IL 60126.

**SURPLUS ELECTRONICS**

**ATTENTION HOBBYISTS — SEND FOR YOUR FREE CATALOG**

Great buys in tape drives, keyboards, power supplies, and transformers. We also have heat sinks, steel cabinets, I/O terminals, video displays, printers, and equipment cases. And of course components, fans, wire, and cable. Write now to

130 Northeastern Blvd  
Worldwide Electronics Nashua, N.H. 03060

**BUILD THE ARTISAN ELECTRONIC ORGAN...** The 20th century successor to the classic pipe organ. Kits feature modular construction, with logic controlled stops and RAM Pre-Set Memory System. Be an arti-san. Write for our free brochure. **AOK Manufacturing, Inc.,** Box 445, Kenmore, WA 98028.

## WRITE US AND WE'LL SEND YOU THE BEST CATALOG YOU EVER READ!

No kidding. **Speakerlab's** catalog took longer to write than some of our competitors have been in business. In fact, we created an industry by "building great kits so you can afford great speakers." Our catalog is an invaluable manual of speaker function and design. And, it will introduce you to the finest speaker kits made anywhere...with the strongest money-back guarantee. Find out for yourself...FREE. FREE. that is. Write now. Right now.



**Speakerlab®**  
Dept. C-PE, 735 N. Northlake Way  
Seattle, WA 98103

**THE BEST CB ANTENNA**

SEND FOR FREE **PAL** FULL LINE CATALOG AND DECAL

**PAL** Antenna Corp.

2614 EAST ADAMS · PHOENIX, ARIZONA 85034

**POLICE/FIRE SCANNERS,** crystals, antennas, CBs, Radar Detectors. **HPR,** Box 19224, Denver, CO 80219.

**TRANSISTORS FOR C-B Repair,** IC's and diodes TV audio repairs 2SC756A — \$2.40, 2SC1306 — \$2.95, 2SC1307 — \$3.85, PLOZAG — \$7.50, AN239 — \$5.50, STK439 — \$8.95. Many more. **FREE Catalog and transistor.** **B&D Enterprises,** Box 32, Mt. Jewett, PA 16740.

**CB RADIOS, VHF-UHF Scanners,** Crystal, Antennas, Radar Detectors. Wholesale. **Southland,** Box 3591, Baytown, TX 77520.

**CIRCUIT BOARDS** from production-ready artwork. Free details. **QUANTITY discounts.** **CM CIRCUITS, 22 Maple Ave., Lackawanna, NY 14218.**

**MONTHLY PICTURE FLYER.** Quality Surplus Electronic parts. Low Prices. **Star-Tronics,** Box 683, McMinnville, OR 97128.

**PRINTED CIRCUIT** supplies, chemicals, tools, artwork, plating solutions. Major credit cards. Catalog \$1.00, refundable. **CIRCOLEX,** Box 198, Marcy, NY 13403.

**RECONDITIONED TEST EQUIPMENT \$1.00** for catalog. **WALTER'S TEST EQUIPMENT,** 2697 Nickel, San Pablo, CA 94806. (415) 758-1050.

**CHEMICALS, Lab Supplies.** Lowest prices, fastest service anywhere. Listing 25¢. **Westech Corp.,** Box 593, Logan, Utah 84321.

**LOW, LOW Component Prices!** Ask for free flyer. Write: **EET,** 11 Revere Place, Tappan, NY 10983.

**NEGATIVE ION GENERATORS AND ACCESSORIES.** (Kits). Fascinating details—\$1.00. **Golden Enterprises,** Box 1282-PE, Glendale, Arizona 85311.

**Super Wireless Mic**

10 times more powerful than other mics  
Transmits up to 1/4 mile to any FM radio  
Easy to assemble kit. 15V battery (not incl.)  
Call (305) 725-1000 or send \$18.95 + \$1.00 shipping to **USI Corp., P.O. Box PE-2052, Melbourne, FL 32901. COD's accept.** For catalog of transmitters, voice scramblers and other specialty items, enclose \$2.00 to **USI Corp.**

**\$18.95**  
Qty. Disc Avail.

**OPTO ELECTRONIC DEVICES,** laser diodes, LED's, fiber optics for experimenter and electronic enthusiast. For free information, write: **Eastern Electronics,** P.O. Box 2204, Clifton, NJ 07015.

**VIDEO CASSETTES — Large Selection —** Pre-recorded, all ratings, for VHS & BETA. Also blank cassettes, L-500 @ \$14.00, L-750 @ \$19.00, VK-250 @ \$19.00, in lots of 10 or more. We accept MC and VISA. Send for free catalog. **Parker Electronics,** 123P Dutchess Turnpike, Poughkeepsie, NY 12603.

**SATELLITE TV**

**GET 50 CHANNELS!**

It's all true! No matter where you live receive movies, sports, pay television, sports from around the world! 24-hour programming! Crystal clear reception! For complete information, sources and design information, send \$1.95

**SPACECOAST RESEARCH**  
Dept. D, P.O. Box 442, Altamonte Springs, FL 32701

**New Technology!**

**CARBON FILM RESISTORS** 1/4W, 1/2W - 1.7 cents each. Free sample specifications. Other components. **COMPONENTS CENTER,** Box 295, W. Islip, New York 11795.

**SCANNERS, VIDEO RECORDERS, C.B.'s.** All brands discounted. **Bearcat 250.** \$279.95. **S.A.S.E** (large) speeds prices. **McDonald Electronics,** Box 1385(W), Rohnert Park, CA 94928. (707) 544-4388.

**FUNCTION GENERATOR** gives sinewave, squarewave, pulse, ramp, trianglewave from 0.1Hz to 0.1MHz — Assembled. Information 25¢. **Farell Research Corporation,** Box 386, Elizabeth, PA 15037.

**X-RAY MACHINE!** Build your own! Easy & inexpensive! Satisfaction Guaranteed! Plans & complete information book! \$3.75 Postpaid! **Vertex,** 129 St. Augustine, PE-5, Dallas, Texas 75217.

**STOCK MARKET ANALYSIS SYSTEM**

TECHNICAL ANALYSIS FOR THE MARKET TRADER WITH LITTLE TIME (15 MIN / DAY) FOR \$25 YOU RECEIVE DATA BASE PLUS TWO PROGRAMS ON CASSETTE AND HARD COPY INSTRUCTIONS WRITTEN FOR THE NOVICE.  
TRS 80 LEVEL I OR II 16K. PET 8K.

STEVEN E. SHAW P.E.  
SOFTWARE CONSULTANT  
PO BOX 1707 TAMPA, FL 33601

CIRCUIT BOARDS! 1 or 1000. Your artwork. Bargain prices, quality boards. Richard Allran, Box 974, Waynesville, NC 28786.

SHORTWAVE RECEIVERS for SWL, Scanners — Bearcat 210 & 250, XTALS, Microcomputers — Sorcerer, accessories. CALL TOLL FREE for pricing. 1-800-638-4486, or send SASE for literature: Comm Center Inc., Laurel Plaza, Rte. 198, Laurel, MD 20810.

FIRE/POLICE SCANNERS, discount prices. Write: Ron Barlocks Discount Scanners, 70 Mohawk Rd., Greensburg, PA 15601. Phone 412-836-6344.

RECEIVER for NBS time and frequency standard station WWVB, 60 KHz. Free brochure. Elemek, Inc., Dept. P, 6500 Joy Road, East Syracuse, NY 13057.

VIDEO TAPE RECORDER, (Cartrivision CT1) with service manual, spare heads & parts, 3 factory recorded cartridges & 8 blanks. Offer includes b/w camera with lens and accessories, and more. \$450.00. Vince Taylor, 1131 Meadowbrook, Los Angeles, CA 90019. (213) 935-7771.

FREE CATALOG! Strobes, LEDs, IC's, Calculators, Photo-Electronic Products, Unique Kits and Components. Chaney Electronics, Box 27038, Denver, CO 80227.

BARGAINS GALORE! Collectors, hams, experimenters, dealers! Buy-sell-trade through Electronics Trader monthly swap sheet, only \$6.00 year or send stamp for sample. Electronics Trader, Darwin, CA 93522.

## PLANS AND KITS

**AMAZING ELECTRONIC PRODUCTS**

LASERS SUPER POWERED, RIFLE, PISTOL POCKET - SEE IN DARK - PYRO. TECHNICAL DE-BUGGING - UNCRAMBLERS. GIANT TESLA - STUNWAND - TV DISRUPTER - ENERGY PRODUCING. SCIENTIFIC DETECTION, ELECTRIFYING, CHEMICAL, ULTRASONIC, CB, AERO, AUTO AND MECH DEVICES, HUNDREDS MORE - ALL NEW PLUS INFO UNLTD PARTS SERVICE.

INFORMATION unlimited  
CATALOG \$1 Dept. E8, Box 716, Amherst, NH 03031

FREE KIT Catalog contains Test and Experimenter's Equipment. Dage Scientific Instruments, Box 1054P, Livermore, CA 94550.

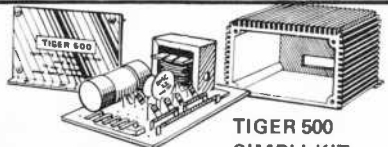

**TIGER 500 SIMPLI-KIT**

**FOR THE DO-IT-YOURSELFER**  
NOW! a high quality CD ELECTRONIC IGNITION SYSTEM in kit form. Contains all components and solder to build complete Solid-State Electronic CD Ignition System for your car. Assembly requires less than 3 hours.

- Increases MPG 15%
- Increases horsepower 15%
- Plugs and Points last 50,000 miles
- Eliminates 4 or 5 tune-ups
- Instant starting, any weather
- Dual system switch

Fits only 12 volt neg. ground...  
Only \$26.95 postpaid

**Tri-Star Corporation**  
P.O. Box 1727 Grand Junction, Colorado 81501

TV-OSCILLOSCOPE CONVERTER externally adapts TV into audio frequency oscilloscope. Info. \$1.00, Plans \$7.50, with P.C. \$15.00, TV-1 VHF modulator \$12.00, complete kit \$60.00. Evolutionics, Box 855-G, San Rafael, CA 94902.

PROJECTION TV... Convert your TV to project 7 Foot picture. Results equal to \$2,500 projector. Total cost less than \$20.00. PLANS & LENS \$16.00. Illustrated info. FREE: Macromocme, Washington Crossing, PA 18977.

FREQUENCY COUNTERS 50 MHZ \$59.95, 500 MHZ \$79.95, Flashing LED's \$1.00, Digital clocks \$12.95. Lectronix, Box 42, Madison Heights, Michigan 48071.

## BUILD YOUR OWN SYMPHONY OF SOUND!



It's fun and easy—takes just minutes a day! Complete kits for organs, pianos, strings, rhythms, amplifiers, synthesizers. Also factory assembled. 104-page catalog \$2.00

**WERSI**

Wersi Electronics, Inc.  
Dept. ZD, 1720 Hempstead Road  
Lancaster, PA 17601

PRINTED CIRCUIT Boards from sketch or artwork. Kit projects. Free details. DANOCINTHS Inc., Box 261, Westland, MI 48185.

CB/HAM ACCESSORIES, kits, parts, construction plans — catalog, Omnipolarized antenna, 300 MHz counter, Modulation booster. Plans \$3.00 each, \$7.50 all. PANAXIS, Box 130-A5, Paradise, CA 95969.

DOLBY ADD-ON ENCODES/DECODES RECORDINGS, FM. Quality components, complete kit. Calibration tapes. Comprehensive test report. IMPE INTEGREX, Box 747, Havertown, PA. 19083.

ELECTRONIC KITS under \$5, includes wireless mics., alarms, sirens, etc. Brochure. Elektrokit, 5 Redwood, Milford, Mass. 01757.

TESLA COIL — 40" SPARKS! Plans \$7.50. Information 75 cents. Huntington Electronics, Box 2009-P, Huntington, Conn. 06484.

TOP QUALITY IMPORTED KITS, IC's, foreign transistors. Free catalog. International Electronics, Box 567, Williamsville, NY 14221.

KEYED NUMBER ELECTRONIC LOCK. \$3.00 for complete plans, includes the keyboard. JLA, Box 661, Rouses Point, NY 12976.

FREE KIT CATALOG. Power Supplies and Powered Breadboards. Lowest Prices. Highest Quality. OMNI-PHASE ENGINEERING, Box 2482, Evergreen, CO 80439.

SWL's — Build a slow speed shaft turner, external connection to bandspeed. Details \$2.00 (Refundable). Lazy-Tuner Products, Box 42042C, Cleveland, Ohio 44142.

## TELEPHONES & PARTS

TELEPHONES UNLIMITED, Equipment Supplies. All types, Regular, Keyed, Modular. Catalog 50 cents. Box 1147E, San Diego, California 92112.

OMAK PHONE CENTER. All types of telephones — keyed, modular and decorator. Catalog \$1.00 (refundable). Box 38, Beardstown, IL 62618. (217) 323-3963.

## ALARMS

QUALITY BURGLAR-FIRE ALARM EQUIPMENT at discount prices. Free Catalog! Steffens, Box 624K, Cranford, N.J. 07016.

**Burglar - Fire - Smoke Alarm Catalog**

• Billions of dollars lost annually due to lack of protective warning alarms.

**FREE CATALOG** Shows you how to protect your home, business and person. Wholesale prices. Do-it-yourself. Free engineering service.



**Burdex Security Co.**  
Box 82802 PE-059 Lincoln, Ne. 68501

NEW BEEPER ALERT: Factory built audible device. Loud beep, beep, beep, or steady tone from one P.C. board. Operates on 4-12 VDC., \$15.95. ALERT ALARMS, 127 Main St., Derby, CT 06418.

PROFESSIONAL ALARM SYSTEMS and supplies at wholesale prices. FREE CATALOG. CAPCO, Box 5980-CPE5, Incline Village, Nevada 89450.

VEHICLE STOLEN — CAN BE LOCATED. "Information" Protect automobile, boat, trailer, airplane, home, office. Fowler Alarms, Box 64466-PE2, Los Angeles, CA 90064.

## HIGH FIDELITY

DIAMOND NEEDLES and Stereo Cartridges at Discount prices for Shure, Pickering, Stanton, Empire, Grado and ADC. Send for free catalog. LYLE CARTRIDGES, Dept. P, Box 69, Kensington Station, Brooklyn, New York 11218. For Fast Service call Toll Free 800-221-0906.

CUSTOM CASSETTE RECORDERS. 4 track, half-speed. Cassettes last four times as long! Also Time Compression; listen double speed without pitch change. Free catalog. SFB PRODUCTS, Box, E-385, Wayne, PA 19087.

## WANTED

GOLD, Silver, Platinum, Mercury, Tantalum wanted Highest prices paid by refinery. Ores assayed. Free circular. Mercury Terminal, Norwood, MA 02062.

## WANTED! CB DEALERS AND DISTRIBUTORS

**PAL** Antenna Corp.

2614 EAST ADAMS · PHOENIX, ARIZONA 85034

## TUBES

RADIO & T.V. Tubes—36 cents each. Send for free Catalog. Cornell, 4213 University, San Diego, Calif. 92105.

TUBES: "Oldies", Latest. Supplies, components, schematics. Catalog Free (stamp appreciated). Steinmetz, 7519-PE Maplewood, Hammond, Ind. 46324.

TUBES-RECEIVING, Industrial and Semiconductors Factory Boxed. Free price sheet including TV, Radio and audio parts list. Transletronic, Inc., 1365 39th St., Brooklyn, New York 11218. Telephone: (212) 633-2800. Toll free: 800-221-5802

BARGAIN Prices on Radio/TV, industrial, obsolete types. Free list. Conelco, Box 67, Trona, CA 93562.

## GOVERNMENT SURPLUS

MANUALS for Govt Surplus radios, test sets, scopes. List 50 cents (coin). Books, 7218 Roanne Drive, Washington, D.C. 20021.

JEEPS—\$59.30! — CARS—\$33.50! — 200,000 ITEMS! — GOVERNMENT SURPLUS — Most COMPREHENSIVE DIRECTORY AVAILABLE tells how, where to buy — YOUR AREA — \$2.00 — MONEYBACK GUARANTEE — Government Information Services, Department GE-65, Box 99249, San Francisco, California 94109.

GOVERNMENT SURPLUS. Buy your Area. How, where. Send \$2.00. SURPLUS HEADQUARTERS BUILDING, Box 30177-PE, Washington, D.C. 20014.

## PERSONALS

MAKE FRIENDS WORLDWIDE through international correspondence, illustrated brochure free. Hermes-Verlag, Box 110660/Z, D-1000 Berlin 11, Germany.

## INSTRUCTION

UNIVERSITY DEGREES BY MAIL! Bachelors, Masters, Ph.D's. Free revealing details. Counseling, Box 317-PE05, Tustin, California 92680.

LEARN WHILE ASLEEP! HYPNOTIZE! Astonishing details, strange catalog free! Autosuggestion, Box 24-ZD, Olympia, Washington 98507.

INTENSIVE 5 week course for Broadcast Engineers. FCC First Class license. Student rooms at the school. Radio Engineering Inc., 61 N. Pineapple Ave., Sarasota, FL 33577.

DEGREE PROGRAM IN ELECTRONICS ENGINEERING. Our 34th year! Free literature. Cook's Institute, Box 20345, Jackson, Miss. 39209.

1979 "TESTS - ANSWERS" for FCC First Class License. Plus - "Self Study Ability Test." Proven! \$9.95 Unconditional Moneyback Guarantee. Command Productions, Box 26348-P, San Francisco, CA 94126.

PASS FCC EXAMINATIONS — 1st - 2nd - 3rd - Radar. Proven method by Victor Veley, noted author-teacher. Part I, Workbook consisting of hundreds of problems with complete solutions. Part II, Question and Answer Manual has hundreds of practice questions. Complete course — Both Manuals, \$14.95 postpaid. Oeffinger Publishing, Box 1240, Garden Grove, Calif. 92642.

RADIO BROADCASTING: Become DJ, engineer. Start your own station — investment/experience unnecessary! Receive free equipment, records. Free details. Broadcasting, Box 130-A5, Paradise, CA 95969.

ASSEMBLING HEATHKIT VTVM? Plentiful detail photos, audiocassette instruction increase your success, satisfaction. Only \$9.75, postpaid. Specify IM5218 or IM5228. The Instruction Company, P.O. Box 2646, Stanford, CA 94305.

SHORTCUTS TO SUCCESS! Highly effective short specialized home study courses. 75 categories to choose. Advance rapidly! Diploma awarded. Our 34th year! Free literature. Cook's Institute, Desk 14, Box 20345, Jackson, Miss. 39209.

LEARN ELECTRONIC ORGAN SERVICING at home. Completely revised course covers latest models including digital, LSI's, synthesizers, etc. NILES BRYANT SCHOOL, PO Box 20153, Sacramento, CA 95820.

## MICROCOMPUTERS

ELECTRIC PENCIL + your TRS-80 = a super word processor. \$99.95 with lower-case modification instructions. Micro-Computer Specialists, Box 11295, Elkins Park, PA 19117.

## MAGNETS

MAGNETS. All types. Specials-20 disc, or 10 bar, or 2 stick or 8 assorted magnets. \$1.00. Magnets, Box 192-H, Randallstown, Maryland 21133.

## FOR INVENTORS

PATENT AND DEVELOP Your invention. Registered Patent Agent and Licensed Professional Engineer. Send for FREE PATENT INFORMATION every inventor should have. Richard L. Miller, P.E., 3612 Woolworth Building, New York, NY 10007. (212) 267-5252.

HAVE YOU AN INVENTION? We evaluate, develop, improve and market meritorious inventions and ideas. For free brochure write, call: Inventors Guild, P.O. Box 411, Fort Washington, PA 19034. (215) 233-5252.

INVENTORS: FREE INFORMATION on offering your invention for sale. Kessler Sales Corporation, Dept C-255, Fremont, Ohio 43420.

## BUSINESS OPPORTUNITIES

I MADE \$40,000.00 Year by Mailorder! Helped others make money! Torrey, Box 318-NN, Ypsilanti, Michigan 48197.

FREE CATALOGS. Repair air conditioning, refrigeration. Tools, supplies, full instructions. Doolin, 2016 Canton, Dallas, Texas 75201.

NEW LUXURY Car Without Cost. Free Details! Codex-ZZ, Box 6073, Toledo, Ohio 43614.

MECHANICALLY INCLINED individuals desiring ownership of Small Electronics Manufacturing Business — without investment. Write: BUSINESSES, 92-K2 Brighton 11th, Brooklyn, New York 11235.

MILLIONS in Mail!!! Free Secrets. Transworld-17, Box 6226, Toledo, OH 43614.

### MECHANICALLY INCLINED INDIVIDUALS

Assemble electronic devices in your home. Be your own boss. Get started in spare time. Little experience, Knowledge or Investment Necessary. Expect big profits: \$300 - \$600/Wk. Possible. Write for free literature telling how.

**ELECTRONIC DEVELOPMENT LAB**  
Box 1560PE, Pinellas Park, FL 33565

\$1200.00 MONTHLY Correcting Pupils' Lessons!!! Start Immediately. Free Report. Send self-addressed stamped envelope. Home, Box 98201-SJXN, San Diego, CA 92109.

BEAT THE RACES! Free Booklet! "Unlimited Lifetime Income From Thoroughbreds-Harness". Elias, Box 47BB, Brooklyn, NY 11219.

HOMEWORKERS NEEDED — Earn Extra Money Stuffing Envelopes! Send Stamped Envelope: Jadeway, Box 186-ZD, Gaines, MI 48436.

SECOND INCOME STUFFING ENVELOPES. \$750/1000 weekly possible! Rush stamped envelope and 25¢: ASHCO, Box 4394-PE5, Corpus Christi, TX 78408.

ERASE DEBTS with little-known law—create wealth! Details FREE—Blueprints, No. EES, Box 900, Bronx, NY 10471.

MAKE \$16.50 hourly. Produce rubber stamps. Equipment, know-how furnished. Free particulars. Write: Roberts, Room RC-376-IE, 1512 Jarvis, Chicago, IL 60626.

EARN \$1500 Monthly — Easy Home Income Mailing Circulars!! Free details: Mailhouse, Box ZD-68403, Portland, OR 97268.

## EMPLOYMENT OPPORTUNITIES

ELECTRONICS/AVIONICS EMPLOYMENT OPPORTUNITIES. Report on jobs now open. Details FREE. Aviation Employment Information Service, Box 240E, Northport, New York 11768.

RADIO-TV JOBS . . . Stations hiring nationwide! Free details: "Job Leads", 1680-PG Vine, Hollywood, CA 90028.

GOVERNMENT HIRING! Excellent listing of agencies that hire. Electronic Technicians \$10.00, Elect. Engineers \$10.00, Salaries, Instructions. WORLD AIR DATA, Box 5706, DERWOOD, MD 20855.

## DO-IT-YOURSELF

MODULAR TELEPHONES now available. Sets and components, compatible with Western Electric concept. Catalog 50 cents. Box 1147W, San Diego, California 92112.

AUDIO/ANALOG/SYNTHESIS. Plans, parts, kits, etc. for the most exciting sound projects ever. Get on our mailing list, send 25¢ to: CFR Associates Inc., Newton, N.H. 03858.

COMPLETE LINE Security Systems for home, Business. Send self addressed, stamped envelope. Darbar, Box 1147E, San Diego, CA 92112.

ELECTRONIC GAS DETECTOR PLANS, including IC amplifier. \$2.50. JR Industries, 5834-A Swancreek, Toledo, Ohio 43614.

FIVE LASER PLANS — \$10.00; Welding Burning Laser — \$9.00; Laserama Light Show — \$19.00; Catalog — \$2.00; Solaser, Box 1015, (PE79), Claremont, CA 91711.

## HOBBIES

COIN COLLECTING investments. Lincoln cent introductory offer: Two coins from each decade 1910's — present. \$1.50 postpaid. Ward Enterprises, PO Box 3091, Flint, MI 48502.

## REAL ESTATE

BIG . . . FREE . . . SUMMER CATALOG! Over 2,600 top values coast to coast!! UNITED FARM AGENCY, 612-EP, West 47th, Kansas City, MO 64112.

## RUBBER STAMPS

RUBBER STAMPS, BUSINESS CARDS. Many new products. Catalog. Jackson's, E-100, Brownsville Rd., Mt. Vernon, Ill. 62864.

## BOOKS AND MAGAZINES

FREE book prophet Elijah coming before Christ. Wonderful bible evidence. MEGIDDO Mission, Dept. 64, 481 Thurston Rd., Rochester, N.Y. 14619.

POPULAR ELECTRONICS INDEXES For 1977 now available. Prepared in cooperation with the Editors of "P/E," this index contains hundreds of references to product tests, construction projects, circuit tips and theory and is an essential companion to your magazine collection. 1977 Edition, \$1.50 per copy. All editions from 1972 onward still available at the same price. Add \$.25 per order for postage and handling. \$5.00 per copy, foreign orders. INDEX, 6195 Deer Path, Manassas, Va. 22110.

## UNDERSTANDING MICROPROCESSORS

New. Available June, 1979. 250 pages. \$4.95. Order #LCB4023. Check or money order: Texas Instruments, P.O. Box 3640, M/S84 Dept. PE579, Dallas, Texas 75285.



TEXAS INSTRUMENTS  
INCORPORATED

## HYPNOTISM

FREE Hypnotism. Self-Hypnosis. Sleep Learning Catalog! Drawer H400, Ruidoso, New Mexico 88345.

## MOTION PICTURE FILMS

IT'S SPORTLITE FOR FILM VALUES BY MAIL! Order Columbia Pictures S-8 400' color/sound features (20:00) — Charles Bronson "Breakout," Peter Falk "Machine Gun McCain;" Sean Connery "The Anderson Tapes;" Walter Matthau "Fail Safe;" and Brian's Song — Football — extra long. \$47.95 ea + \$1.50 shipping, reg. price \$54.95. Queen Boxer (female Bruce Lee), \$45.95 ea; Fab Harlem Globetrotters, 200' color/sound. \$29.95 ea PPD. Choice of champ. heavy fights: Ali-Spinks I; Ali-Shavers; Holmes-Norton — 400' S-8 Vivid Color Action Sound Features, \$48.95 ea delivered. Tear out this ad and order today! Universal 64-pg catalog \$1.20 (foreign \$2.). Columbia, Sportlite, Universal, Ring Classics order forms 35¢ ea with fliers. SPORTLITE FILMS, Elect-5/79, Box 24-500, Speedway, IN 46224.

## MISCELLANEOUS

MPG INCREASED! Bypass Pollution Devices easily. REVERSIBLY!! Free details — Posco GEE5, 453 W. 256, NYC 10471.

CB RADIO OPERATORS — Send your name, handle and license number. We will inscribe this information attesting to your status as a CB operator on a handsome scroll, suitable for framing. Send information printed or typed together with check or money order for \$4.95 to: Larry Bergman, P.O. Box 281, Cedarhurst, NY 11516.

AWARDS, projects, monthly newsletter. Electronics Workshop Club. Write for free information: ECEI, 156 W. Spring Street, Eldridge, Iowa 52748.

## 1979 Electronic Experimenter's Handbook



This latest edition includes a Micro-computer Buying Section in addition to a host of exciting construction projects with complete construction plans, parts lists, and printed circuit board patterns. PLUS—A Computer Buying Directory with product specifications, latest prices, and photos. Only \$2.50!

Order from ELECTRONIC EXPERIMENTER'S HANDBOOK, Dept. 01052, P.O. Box 278, Pratt Station, Brooklyn, NY 11205. Enclose \$3\* (\$2.50 plus postage and handling). Outside U.S.A. \$3.

\*Residents of CA, CO, DC, FL, IL, MI, MO, NY STATE and VT add applicable sales tax.

## 1979 COMMUNICATIONS HANDBOOK



Everything you want to know—about Ham Radio, SWL, Police-Fire Monitoring, CB, Marine Radio, and Radar Detectors. Features, specifications, latest prices, and photographs of equipment on the market are at your fingertips. Order your copy from COMMUNICATIONS HANDBOOK, Dept. 01063, P.O. Box 278, Pratt Station, Brooklyn, NY 11205. Enclosed is \$3\* (postage and handling included). \*Residents of CA, CO, DC, FL, IL, MI, MO, NY STATE and VT add applicable sales tax.

# When you want memory... COME TO THE LEADER.

CompuKit™ from Godbout memory boards are generally available in 3 forms: unkit (sockets, bypass caps pre-soldered in place for easy assembly); assembled and tested; or qualified under the Certified System Component (CSC) high-reliability program.

NOW WE HAVE BANK SELECT BOARDS! Low power, static, 4 MHz boards are perfect for Alpha Micro Systems, Marinchip, and similarly structured machines. Each board has two independently addressable and selectable banks.

Name	Storage	Buss	Addressable on	Design	Unkit	Assm	C5C
Econoram XII-16™	16K X 8	S-100	8K boundaries	static	\$369	\$419	\$519
Econoram XII-24™	24K X 8	S-100	8K boundaries	static	\$479	\$539	\$649
Econoram XIII™	32K X 8	S-100	16K boundaries	static	\$629	\$699	\$849

## ... AND HERE'S OUR STANDARD MEMORY LINE:

Name	Storage	Buss	Design	Speed	Configuration	Unkit	Assm	C5C
Econoram II™	8K X 8	S-100	static	2 MHz	dual 4K	\$149	\$164	N/A
Econoram IV™	16K X 8	S-100	static	4 MHz	single 16K	\$295	\$329	\$429
Econoram VI™	12K X 8	H8	static	2 MHz	1-8K, 1-4K	\$200	\$270	N/A
Econoram VII™	24K X 8	S-100	static	4 MHz	2-4K, 2-8K	\$445	\$485	\$605
Econoram IX™	32K X 8	Dig. Grp	static	4 MHz	2-4K, 1-8K, 1-16K	\$649	N/A	N/A
Econoram X™	32K X 8	S-100	static	4 MHz	2-8K, 1-16K	\$599	\$649	\$789
Econoram XI™	32K X 8	SBC	static	4 MHz	2-8K, 1-16K	N/A	N/A	\$1050

### SEE CompuKit™ PRODUCTS AT YOUR LOCAL COMPUTER STORE

**NEW!! • FULL FUNCTION S-100 I/O BOARD: \$189 unkit, \$249 assembled.**

Our new I/O board gives you unparalleled flexibility and operating convenience... we include features such as two independently addressable full RS232C ports, real LSI hardware UARTs, crystal-controlled Baud rates, operation with 2 or 4 MHz systems, low power consumption, and much, much more. But amazingly enough, all these features won't cost you more than other types of I/O boards that do a whole lot less. Looking for a good, full-feature I/O board? You've found it. We'll be glad to tell you all about it... just write for more information.

**16K MEMORY EXPANSION SET \$109 (3/\$320)**

For Radio Shack-80, Apple, Sorcerer machines, 250 ns chips for 4 MHz operation, DIP shunts, 1 year limited warranty. Includes instructions.

We break the price barrier on the TI 76477 sound generator chip: \$2.75!

MEMORY SPECIAL: 2102-L1 static low power, high speed RAMs 99¢ (orders of 10 or more only).

JUST IN: WESTERN DIGITAL 1791 MOS LSI DUAL DENSITY DISK CONTROLLER CHIP. PRIME, WITH PINOUT AND DATA, ONLY \$59.

# GODBOUT

BILL GODBOUT ELECTRONICS  
BOX 2355, OAKLAND AIRPORT, CA 94614

TERMS: Orders under \$15 add \$1 handling. Cal. res. add tax. Allow 5% for shipping, excess refunded. VISA®/Mastercharge® call our 24 hour order desk at (415) 562-0636. COD OK with street address for UPS (COD charge applies). Prices good through cover month of magazine.

CIRCLE NO. 30 ON FREE INFORMATION CARD

## FUN AND FREEDOM

### Electrify



Your



Bike!

Ride away with your own silent exciting electric drive system. New patented non-polluting Pedalpower installs in minutes on the front wheel of any Bike or Trike. Allows easy pedaling when desired. Over 20,000 sold. Powered by latest 12-volt battery. Recharges at home. Ride 100 miles for a dime. Be independent! Improve your health! Enjoy the outdoors! Simple single lever control allows you to go where you want to, when you want to. Rebate plan and Senior Citizen time payment plan available! MONEY BACK GUARANTEE. Save \$15.00 - call toll free: 800-257-7955\* - or send today for \$15.00 coupon and free illustrated booklet. **Added bonus:** Receive free information on complete line of Electric Cars, Electric Bikes and Trikes.

**General Engines Co.**  
Save \$15.00  
5383 Mantua Blvd.  
Sewell, N.J. 08080

\*In N.J., Alaska, or HI - Call Collect: (609) 468-0270  
CIRCLE NO. 29 ON FREE INFORMATION CARD

## Popular Electronics

### MAGAZINE CASES AND BINDERS

Available in your choice—

Cases or binders are the ideal way to save your valuable copies and keep them well protected. Magazines insert in cases—on individual metal rods in binders. Covered in black simulated leather they're embossed with magazine title. Gold transfer foil is provided for personalization. Designed to hold approximately 12 issues, they're attractive additions to any book shelf.

Cases and binders are available with magazine title embossed for any of your favorite magazines. Colors are pre-determined by publishers.

Cases—\$5.95 each; 3 for \$16; 6 for \$30. Binders—\$6.95 each; 3 for \$19; 6 for \$36. Outside U.S.A. add \$1.00 per unit ordered. Quantity prices apply to any combination of titles ordered for either cases or binders.

Popular Electronics, P.O. Box 278,  
Pratt Station, Brooklyn, N.Y. 11205

Please send:  Magazine Cases  Binders

TITLE \_\_\_\_\_ QUANTITY \_\_\_\_\_

ENCLOSED IS \$ \_\_\_\_\_ \*  
 CHARGE:  American Express  Diners Club  
 Visa  Master Charge  
Account # \_\_\_\_\_ Exp. Date \_\_\_\_\_  
Master Charge Interbank # \_\_\_\_\_  
(4 #'s over your name)

Signature \_\_\_\_\_  
Print Name \_\_\_\_\_  
Address \_\_\_\_\_  
City \_\_\_\_\_ State \_\_\_\_\_ Zip \_\_\_\_\_

\*Residents of CA, CO, FL, IL, MI, MO, NY STATE, DC and VT add applicable sales tax.

# Popular Electronics

## ADVERTISERS INDEX

READER SERVICE NO.	ADVERTISER	PAGE NO.
2	Active Electronics	97
3	American Antenna	Cover 4
4	Ampower Electronics Instrument Co., Inc.	107
6	Anconra Corp.	99
7	AP Products, Inc.	14
8	B & F Enterprises	108
9	Bearfinder, Inc.	41
	Cleveland Institute of Electronics Inc.	34, 35, 36, 37
10	Cobra, Product of Dynascan	48
1	Communications Electronics	2
11	Compucolor	24
12	Consumers Co.	88
13	Continental Specialties Corp.	Cover 3
14	Continental Specialties Corp.	11
19	Cooper Group, The	77
16	Creative Computing Magazine	90
17	Digi-Key Corp.	103
	Digital Research Corp.	106
18	Douglas Dunhill	15
15	DSI Instruments, Inc.	27
	Edmund Scientific Co.	79
20	EICO	90
21	Electra Co.	13
	Electro-Voice	62
22	Electronics Book Club	9
23	Fisher Corporation	Cover 2
24	Fluke	78
25	Fluke	80
26	Fordham Radio Supply	107
27	Formula International	104
28	Fuji Photo Film USA, Inc.	6
29	General Engines Co.	112
30	Godbout Electronics, Bill	112
31	Grantham College of Engineering	84
5	Heath Company	23, 30, 31
32	Illinois Audio	91
33	Integrated Circuits	98
34	International Components Corp.	106
35	J & R Music World	86
36	Jameco Electronics	100, 101
	JS & A National Sales Group	1, 7
60	McGraw-Hill Book Co.	87
39	McIntosh Laboratory, Inc.	83
	Micro Computer Mart	92
44	Mini Micro Mart	84
38	Multicore	88
40	National Camera Supply	90
41	Netronics R & D Ltd.	81
42	Netronics R & D Ltd.	89
	NRI Schools	16, 17, 18, 19
43	Ohio Scientific Instrument	5
37	OK Machine & Tool Corp.	47
45	onComputing	45
46	Osawa	12
47	PAIA Electronics, Inc.	90
48	PAL "Firestik" Antenna Corp.	91
49	Percom Data Co. Inc.	86
50	Poly Paks	94
51	Quest Electronics	102
	Radio Shack	105
52	Sansui Electronics Corp.	20
53	Schober Organ Corp. The	80
54	Solid State Sales	108
55	Southwest Technical Products Corp.	91
56	Sparkomatic	42
	Speakerlab, Inc.	91
58	Technics by Panasonic	38
57	U.S. Pioneer Electronics	29
59	Wahl Clipper Corp.	81

POPULAR ELECTRONICS



# You can't beat The System.

The Experimentor System™ — a quicker transition from imagination through experimentation to realization.

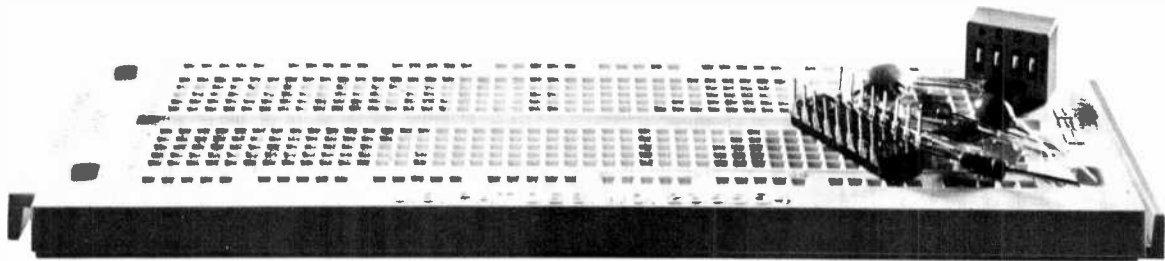

Experimentor solderless breadboard.

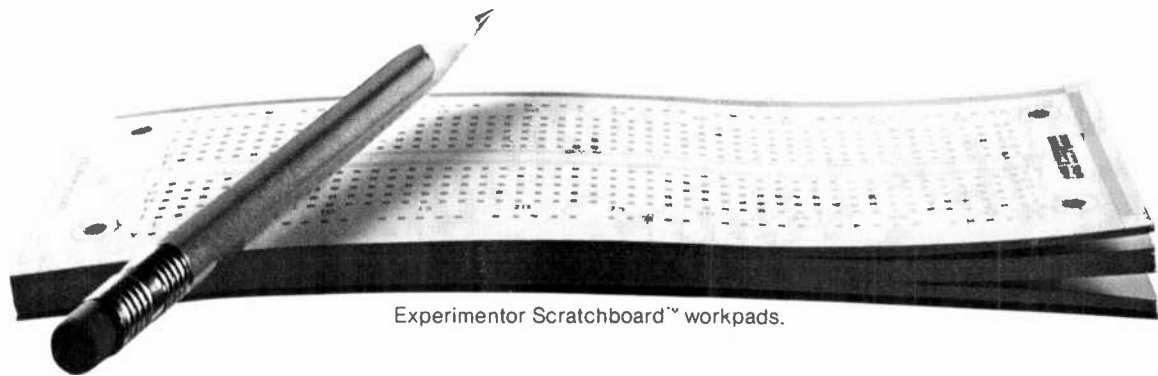

Experimentor Scratchboard™ workpads.

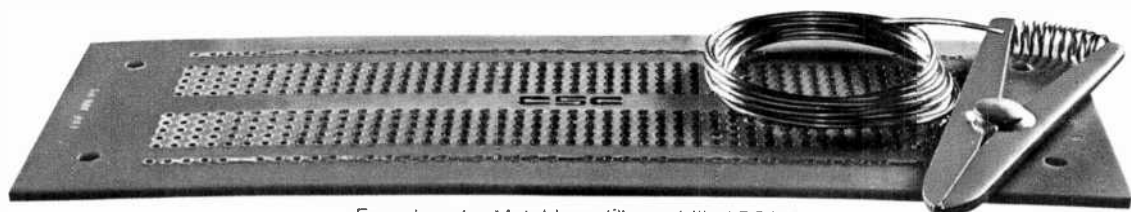

Experimentor Matchboard™ pre-drilled PCBs.

When you have a circuit idea that you want to make happen, we have a system to make it happen quicker'n'slicker'n ever before: The Experimentor System.

You already know how big a help our Experimentor solderless breadboards can be. Now we've taken our good idea one step farther. Twice.

We've added Experimentor Scratchboard workpads, with our breadboard hole-and-connection pattern printed in light blue ink. To let you sketch up a layout you already have working so you can reproduce it later.

With Experimentor Matchboard you can go from breadboard to finished nonstop! We've matched our breadboard pattern again, this time on a printed circuit board, finished and ready to build on. All for about \$2.69\*.

There's even a letter-and-number index for each hole, so you can move from breadboard (where they're molded) to Scratchboard™ (where they're printed) to Matchboard™ (where they're silkscreened onto the component side) and always know where you are.

When you want to save time and energy, you can't beat The Experimentor System.

CONTINENTAL SPECIALTIES CORPORATION

70 Fulton Terr., New Haven, CT 06509 (203) 624-3103, TWX 710-465-1227  
OTHER OFFICES San Francisco (415) 421-8872, TWX 910-372-7992  
Europe CSC UK LTD Phone Saffron-Walden 0799-21682, TLX 817477  
Canada Len Finkler Ltd., Ontario



Call toll-free for details  
**1-800-243-6077**

\* Suggested U.S. resale. Available at selected local distributors. Prices, specifications subject to change without notice. © Copyright 1979 Continental Specialties Corporation

CIRCLE NO. 13 ON FREE INFORMATION CARD

**We're  
so convinced  
our high-  
performance K40  
will outperform  
every CB antenna  
you're selling now,**



**WE'LL SELL YOU ONE FOR \$38.50 TO PROVE IT!**

The K40 is more than just a premium antenna.

It's specifically guaranteed, in writing, to outperform any antenna it replaces.

**1 TRANSMITS FURTHER.  
RECEIVES CLEARER.**

We mean just that! We'll back your customers 100% if the K40 doesn't transmit further or receive clearer than the antenna it replaces. We know it will. We've tested it with 771 CB'ers for one year.

**2 WHEN YOU PAY MORE, YOU EXPECT MORE.**

For a full year we'll let you replace any part your customer is not happy with. You make that decision, not us. Our guarantee includes rust. It includes broken whips. It includes everything.

**3 IT'S AMERICAN MADE.**

No need to be concerned about replacement parts. There is not one component that is made anywhere else but in America.

**4 MOUNTS ANYWHERE, EVERYWHERE.**

With the spectacular Unimount, you can fit your customer's K40 to any mounting surface — anywhere. And that's guaranteed too. 100%. That means this single K40 antenna can easily reduce your inventory by 50% by having one model that mounts anywhere. And still make more money because you get much, much more for each antenna sale.

**5 SOLD BY PROFESSIONAL DEALERS THAT TAKE PRIDE IN SERVICING CBER'S.**

Like pro-golf clubs, the K40 antenna is sold through pro-CB/ELECTRONIC stores only. It's not being sold to mass merchandisers. It's not being sold to Sears or Penney's or any retail outlets that cannot offer full time professional services to support the service full time CB'ers need. We control that because we personally qualify each and every retailer before we sign him on.

**6 HERE'S OUR DEAL.**

If you qualify (not every dealer does) we'll send you a complete Dealer Profit Package that includes 12 K40's, 3 Unimounts, and an award winning floor display. Take one and keep it for yourself. Sell the other eleven. If we can't prove the \$38.50 K40 will sell faster than any antenna you're selling now, we'll refund all your money. And you still keep your K40. Fair?

**REACH!**  
for your phone and dial, toll free,

**312-697-7400**

for your FREE K40.

**GO FOR IT.**

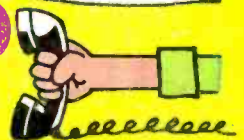

Our boys will be waiting for you at  
**AMERICAN ANTENNA, Elgin, Illinois.**  
An All-American Product by an All-American Company.

CIRCLE NO. 3 ON FREE INFORMATION CARD