

BUYER'S GUIDE TO ANTENNA ROTATORS

Popular Electronics®

WORLD'S LARGEST-SELLING ELECTRONICS MAGAZINE AUGUST 1976 / \$1

EASY-TO-BUILD 1-Hz TO 1-MHz FREQUENCY COUNTER

**DX Clubs on
International
Shortwave**

**Build A High-
Sensitivity Gas and
Fume Detector**

**Learn Electronic
Theory with
Calculators, Part II**

**Inexpensive
Electronic Keyer
Makes Morse Code
Easy**

TEST REPORTS

**Onkyo "Quartz Lock"
Stereo Receiver**

**B&O Beogram 1900
Manual Turntable**

**Realistic Phase-Lock
AM/SSB CB Transceiver**

**ANOTHER
BREAKTHROUGH!**



THE COSMAC 'ELF'

**A MICROCOMPUTER TRAINER
THAT'S POWERFUL,
EXPANDABLE AND
COSTS AS LITTLE AS \$80.**

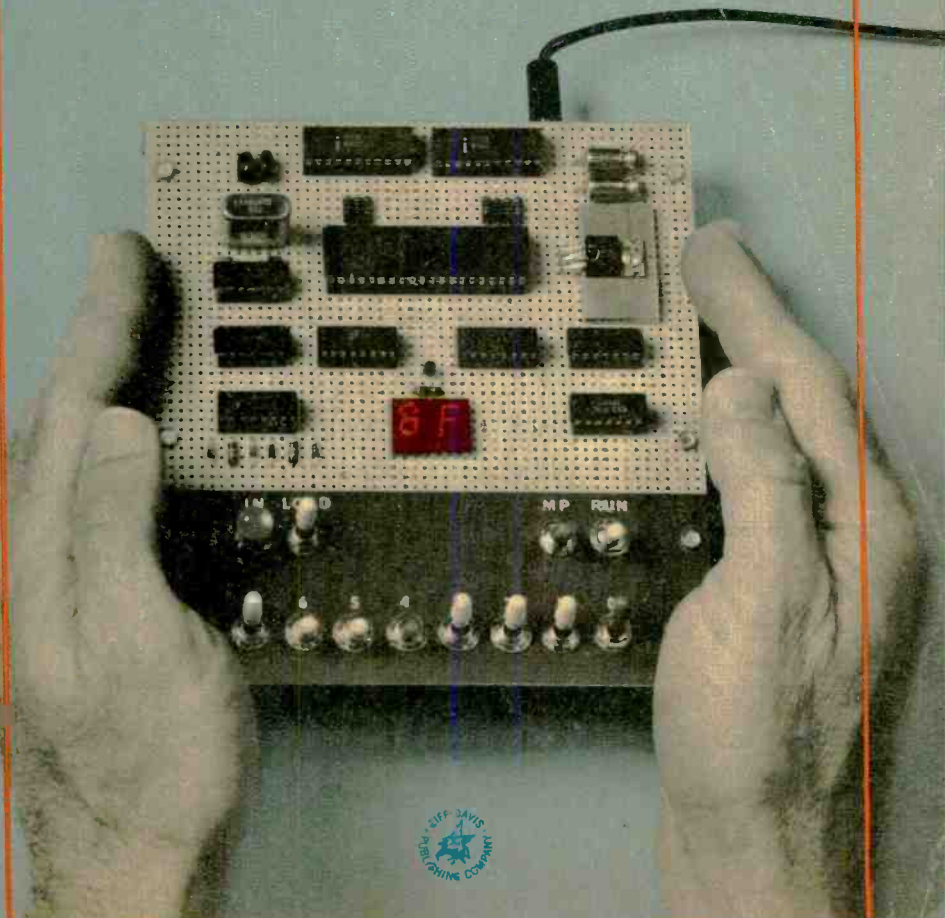

Experience is the best teacher. You might settle for any CB first time around. Understandably. A lot of people think they're all pretty much alike. But you'll soon discover that, like everything else, there are exceptions.

Ask the pros. America's long distance truckers. These guys talk CB day in and day out. And they demand the best. That's why truckers refer to the Cobra 29 as "The Diesel Mobile."

Listen to Cobra. You'll hear a big difference. Because the Cobra 29 gives you features which assure crystal clear reception. Like switchable noise limiting and blanking, to cut out practically all pulse and ignition interference. Add squelch control and RF gain and you've got exceptional—adjustable—receiver clarity. Even in the heaviest CB traffic. You also get Delta Tuning which makes up for the other guy, because even off-frequency transmitters are pulled in. Perfectly.

Talk to Cobra. And you know you're punching through. One glance at the

29's over-sized illuminated meter tells you just how much power you're punching out and pulling in. For voice modulation the DynaMike delivers at 100%. Same way with power: The 29 transmits at maximum power levels.

Sooner or later you'll get a Cobra. And you'll get engineering and craftsmanship second to none. Performance that will make your first CB seem obsolete. Reliability and durability that have set standards for the industry. Above all, you'll get power. The power to punch through loud and clear like nothing else. Because when it comes to CB radio, nothing punches through loud and clear like a Cobra.



Cobra

Punches through loud and clear.

Cobra Communications, Products of Dynascan Corp.
1801 W. Belle Plaine, Chicago, Illinois 60613

CIRCLE NO. 14 ON FREE INFORMATION CARD

**IF YOUR FIRST CB ISN'T A COBRA
YOUR SECOND ONE WILL BE.**



The small wonder



of the micro-world

Measuring just 11" wide x 11" deep x 5" high, and weighing a mere 7 pounds, the Altair™ 680b is a complete, general-purpose computer.

The secret to this revolutionary, small computer is its CPU board. This double-sided board fits along the bottom of the Altair case and plugs directly into the front panel board. It contains the new 6800 microprocessor, 1,024 bytes of RAM memory, a 256 byte PROM monitor, provisions for 768 bytes of additional PROM or ROM, and a single Interface port with a Motorola ACIA serial interface adapter which can be configured either RS-232 or TTY. A five level Baudot interface option is also available.

The Altair 680b can be programmed from front panel switches, or it can be interfaced to a video display terminal, or teletypewriter. Three additional circuit boards can be plugged inside the Altair 680b for further memory and interface expansion. The first of these boards is a 16K static RAM memory board.

Software already developed includes Altair 680 BASIC with all the features of the 8K BASIC previously developed for the Altair 8800. These include Boolean operators, the ability to read or write a byte from any I/O port or memory location, multiple statements per line, and the ability to interrupt program execution and then continue after the examination of variable values. This software takes only 6.8K bytes of memory space and a copy is included free with the purchase of the Altair 680 16K memory board.

Other software includes a resident two pass assembler. The Altair 680b is also compatible with Motorola 6800 software.

The Altair 680b is ideal for hobbyists who want a powerful computer system at an economic price. Altair 680b owners qualify

for membership in the Altair Users Group, and like other Altair owners, they receive a complimentary subscription to **Computer Notes** and complete factory support.

PRICES:

Altair 680b kit with complete, easy-to-understand assembly manual, operator's manual, and programming manual.....	\$466
Assembled Altair 680b.....	\$625
Altair 680b Turnkey model kit.....	\$395
Expander Card 680MB (required to expand 680).....	\$ 24
Altair 680BSM 16K static RAM board kit with 680 BASIC.....	\$685
Altair 680 BASIC when purchased separately.....	\$200
Baudot option.....	\$ 42

MAIL THIS COUPON TODAY

- Enclosed is a check for \$ _____
 BankAmericard # _____ or Master Charge # _____
 Altair 680b Kit Assembled Other (specify) _____
 enclose \$8 for postage and handling
 Please send free information package.

NAME _____

ADDRESS _____

CITY _____ STATE & ZIP _____

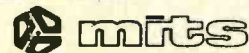

2450 Alamo SE/Albuquerque, NM 87106, 505-243-7821

NOTE: Altair is a trademark of MITS, Inc.

Price, specifications subject to change. Please allow up to 60 days for delivery.

/ **Kriket**® Speakers

**AFS' INTRODUCES THE FIRST ACOUSTICALLY DESIGNED
OUTDOOR REMOTE P.A. SPEAKER
AND THAT'S NO BULLHORN!**



Hey, you ten million CB enthusiasts. We've got an all-weather external mount speaker that looks good inside or outside any vehicle. Clears up garbled voices, knocks out static. Let you hear what's on the air -- even if you're away from your vehicle. Better than you believed possible.

Because AFS offers the first acoustically designed voice communications all-weather P.A. speaker, delivering outstanding intelligibility and clarity across the entire voice range.

AFS -- the only company with the patented "WORKING WALL"® enclosure, featuring cross-laminated, tubular fiberboard construction to deaden static, eliminate voice distortion.

**SPEAKERS ARE OUR ONLY BUSINESS.
THEY HAVE TO BE BETTER!**

Available to CB dealers everywhere.



World Wide Headquarters
Acoustic Fiber Sound Systems, Inc.
7999 Knue Road, Suite 116
Indianapolis, Indiana 46250
(317) 842-0620

Exclusive Canadian Distributor
Muntz Canada Ltd.
1149 Pioneer Road
Burlington Ontario, Canada
(416) 639-5373

AFS® /KRIKET® speakers are manufactured in the U.S.A. using American materials and craftsmen.

Copyright 1976 Acoustic Fiber Sound Systems, Inc.

Popular Electronics®

WORLD'S LARGEST SELLING ELECTRONICS MAGAZINE

FEATURE ARTICLES

BUYER'S GUIDE TO ANTENNA ROTATORS	<i>Kris Carrole</i>	39
<i>How they work and what's available.</i>		
DX PROGRAMS AND DX CLUBS ON SHORTWAVE	<i>Richard E. Wood</i>	53
<i>Ways to improve your SW listening pleasure.</i>		
LEARNING ELECTRONIC THEORY WITH HAND CALCULATORS	<i>Edward M. Noll</i>	58
<i>Part Two: Reactance, Time Constants, and AC Calculations.</i>		

CONSTRUCTION ARTICLES

BUILD THE COSMAC "ELF"	<i>Joseph Weisbecker</i>	33
<i>A Low-Cost Experimenter's Microcomputer.</i>		
A SIMPLE ELECTRONIC KEYS FOR SENDING MORSE CODE	<i>William J. Vancura</i>	44
IMPROVED GAS AND FUME DETECTOR	<i>C. R. Lewart</i>	46
<i>High-sensitivity detector uses latest components and circuits.</i>		
BUILD A LOW-COST 1-HZ to 1-MHZ FREQUENCY COUNTER	<i>Norman P. Huffnagle</i>	48
<i>Counter with 3-digit readout uses new CMOS chips.</i>		
FLOWER POWER	<i>James R. Squires</i>	50
<i>Photocell, transistor-diode ac power control system.</i>		

COLUMNS

STEREO SCENE	<i>Ralph Hodges</i>	14
<i>The Great Tube/Transistor Controversy.</i>		
HOBBY SCENE	<i>John McVeigh</i>	24
SOLID STATE	<i>Lou Garner</i>	73
<i>Simple Stopwatch Splits Seconds!</i>		
CB SCENE	<i>Ray Newhall</i>	82
<i>Is Class E Dead?</i>		
AMATEUR RADIO	<i>Herbert S. Brier</i>	86
<i>Lightning and the Radio Amateur.</i>		
EXPERIMENTER'S CORNER	<i>Forrest M. Mims</i>	91
<i>The 567 Tone Decoder.</i>		

PRODUCT TEST REPORTS

ONKYO MODEL TX-4500 AM/STEREO FM RECEIVER	66
BANG & OLUFSEN BEOGRAM MODEL 1900 RECORD PLAYER	68
REALISTIC MODEL TRC-57 NAVAHO CB TRANSCEIVER	70
SENCORE MODEL DVM32 PORTABLE DMM	72

DEPARTMENTS

EDITORIAL	<i>Art Salsberg</i>	4
<i>Planting Electronics Hobby Seeds.</i>		
LETTERS		6
OUT OF TUNE		6
<i>"Add Missing Segments" (Tips & Techniques, June 1976)</i>		
<i>"A Scientific Programmable Calculator" (May 1976)</i>		
<i>"Space War Game" (April 1976)</i>		
NEW PRODUCTS		9
NEW LITERATURE		12
NEWS HIGHLIGHTS		30
ELECTRONICS LIBRARY		88
OPERATION ASSIST		90
ADVERTISERS INDEX		113

POPULAR ELECTRONICS, August 1976, Volume 10, Number 2. Published monthly at One Park Avenue, New York, NY 10016. One year subscription rate for U.S., \$9.98; U.S. Possessions and Canada, \$11.98; all other countries, \$12.98 (cash orders only, payable in U.S. currency). Second Class postage paid at New York, NY and at additional mailing offices. Authorized as second class mail by the Post Office Department, Ottawa, Canada and for payment of postage in cash.

POPULAR ELECTRONICS including ELECTRONICS WORLD, Trade Mark Registered, Indexed in the Reader's Guide to Periodical Literature.

COPYRIGHT © 1976 BY ZIFF-DAVIS PUBLISHING COMPANY. ALL RIGHTS RESERVED.

Ziff-Davis also publishes Boating, Car and Driver, Cycle, Flying, Modern Bride, Popular Photography, Skiing and Stereo Review.

Material in this publication may not be reproduced in any form without permission. Requests for permission should be directed to Jerry Schneider, Rights and Permissions, Ziff-Davis Publishing Co., One Park Ave., New York, NY 10016.

Editorial correspondence: POPULAR ELECTRONICS, 1 Park Ave., New York, NY 10016. Editorial contributions must be accompanied by return postage and will be handled with reasonable care; however, publisher assumes no responsibility for return or safety of manuscripts, art work, or models.

Forms 3579 and all subscription correspondence: POPULAR ELECTRONICS, Circulation Dept., P.O. Box 2774, Boulder, CO 80302. Please allow at least eight weeks for change of address. Include your old address, enclosing, if possible, an address label from a recent issue.

Popular Electronics®

EDGAR W. HOPPER
Publisher

ARTHUR P. SALSBERG
Editorial Director

LESLIE SOLOMON
Technical Editor

JOHN R. RIGGS
Managing Editor

ALEXANDER W. BURAWA
Feature Editor

EDWARD I. BUXBAUM
Art Director

JOHN McVEIGH
Associate Editor

ANDRE DUZANT
Technical Illustrator

PATRICIA BROWN
Editorial Assistant

LOU GARNER
GLENN HAUSER
JULIAN D. HIRSCH
RALPH HODGES
ART MARGOLIS
FORREST MIMS
HAL CHAMBERLAIN
WILFRED M. SCHERER
Contributing Editors

JOSEPH E. HALLORAN
Advertising Director

JOHN J. CORTON
Advertising Sales

LINDA BLUM
Advertising Service Manager

PEGI McENEANEY
Executive Assistant

STANLEY NEUFELD
Associate Publisher

ZIFF-DAVIS PUBLISHING COMPANY
Popular Electronics

Editorial and Executive Offices
One Park Avenue New York, New York 10016
212-725-3500

Hershel B. Sarbin, President
Furman Hebb, Executive Vice President
John R. Emery, Senior Vice President, Finance, and
Treasurer

Phillip T. Heffernan, Senior Vice President, Marketing
Edward D. Muhlfeld, Senior Vice President, Sports Division
Philip Sine, Senior Vice President

Frank Pomerantz, Vice President, Creative Services

Arthur W. Butzow, Vice President, Production

Lawrence Sporn, Vice President, Circulation

George Morrissey, Vice President

Sydney H. Rogers, Vice President

Sidney Holtz, Vice President

Al Traina, Vice President

Philip Korsant, Vice President

Paul H. Chook, Vice President, Market Planning

Charles B. Seton, Secretary

Edgar W. Hopper, Vice President, Electronics Div.

William Ziff, Chairman

W. Bradford Briggs, Vice Chairman

Midwestern Office

The Pattis Group, 4761 West Touhy Ave.,
Lincolnwood, Illinois 60644, 312 679-1100

GERALD E. WOLFE, THOMAS HOCKNEY
Western Office

9025 Wilshire Boulevard, Beverly Hills, CA 90211

213 273-8050; BRadshaw 2-1161

Western Advertising Manager, BUD DEAN

Japan: James Yagi

Oji Palace Aoyama: 6-25, Minami Aoyama

6 Chome, Minato-Ku, Tokyo 407-1930/6821,

582-2851



The publisher has no knowledge of any proprietary rights which will be violated by the making or using of any items disclosed in this issue.



Editorial

PLANTING ELECTRONICS HOBBY SEEDS

A hobby is generally described as a pursuit of an interest outside one's regular occupation. In electronics, however, many hobbyists are on a busman's holiday. For example, a recent study revealed that over 44% of PE readers view electronics as both a career and a hobby, while an additional 13% note that they pursue the hobby because they're either employed in electronics or in an area where electronics knowledge is valuable.

Other interesting PE-reader demographics include: 14.4% have taken post-graduate work, which is included in 65.7% that are attending, have attended or have graduated from college. At the other end of the spectrum, 8.2% are under 18 years old and a total of 16.8% are students. Play these figures against almost 400,000 paid circulation and you'll appreciate the depth and diversity of our readership.

Most hobbyists try to get as much as they can out of their avocations. But electronics hobbyists are among the few that have the chance to give, which can be equally rewarding. For our readers attuned to education, and fortunate to have a hobby that can be shared, there is an excellent opportunity to personally plant the seeds for what might become a lifelong, fulfilling hobby for many people.

For example, a growing number of electronics enthusiasts take the time to teach youngsters about electronics—from how to get a Novice license to wiring a kit. Where can the newcomers be reached? Try churches, synagogues, local Parent-Teacher-Student Associations (PTSA's), Boy Scouts, fraternal organizations, and the neighborhood children for starters. One of our editors, for instance, has a string of neighborhood boys and girls who visit him (and his home computer) regularly. Interestingly, his is the only undamaged property in the area when Halloween ends.

Other electronics hobbyists visit veterans' hospitals to introduce them to electronics so that the patients can fill their otherwise boring days with meaningful efforts. And the hobbyists follow up with other visits to provide continuing guidance.

Some experienced electronics buffs work with local schools to refine science, math and vocational curricula, to develop programs for gifted children, etc. They've discovered that ivory-tower curricula specialists rarely know "where it's at," unfortunately, and too often develop "busy work" for advanced students, the equivalent of a fancy way to shoe a horse or some other useless pursuit.

In contrast, some of our readers have set up microcomputer training programs to introduce youngsters to computer science, binary, hexadecimal and octal arithmetic, all at little cost. Moreover, it has been proved that it's as easy to learn about computers as it is to learn multiplication. It's a lot more fun, too. Others have arranged for student trips to their homes to see how a radio amateur operates his rig, how a home microcomputer can perform astounding feats in print and video, and how to make professional-type tape recordings.

So the next time you're wondering about which sub-par TV program to watch, why not give some thought to the art of giving. You've got the knowledge, the experience, and a stimulating hobby in your corner.

POPULAR ELECTRONICS

SBE OPTI/SCAN.

The scanner that's only a light beam away from 16,000 frequencies.

OPTI/SCAN is, without question, the world's most advanced scanning receiver. It is the only crystal-less scanner that optically scans any station in the nation by the use of programmed cards with permanent memory. Simply program and insert the card, OPTI/SCAN does the rest. You can change cards even while driving without taking your eyes off the road. Built-in AC/DC operation.

Who needs a system as advanced as OPTI/SCAN? Anyone anywhere who wants a digital scanning receiver that will be ahead of all the others for years to come.

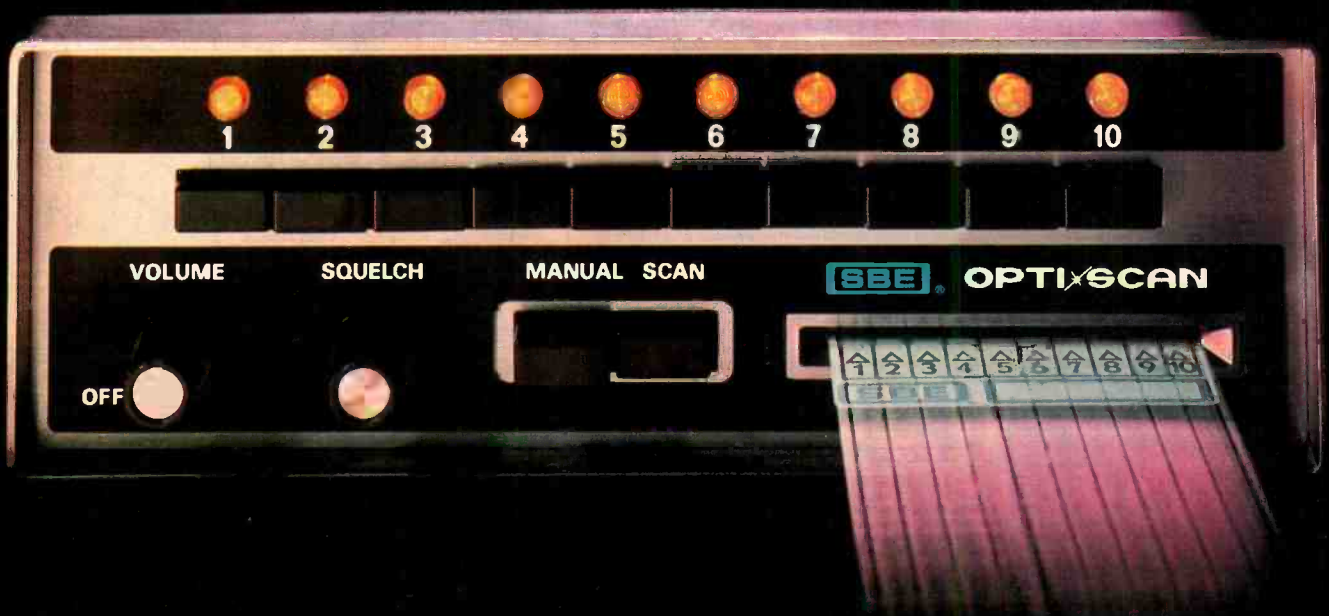

Better Communications through Creative Technology

For information write: SBE, Inc., 220 Airport Blvd., Watsonville, CA 95076

INTERNATIONAL OFFICES: E S Goud Marketing Co., Ltd. 109 Montee de Liesse, Montreal, Quebec, Canada H4T, 1S9 • Linear Systems, S.A., 5 Rue des Alpes, P.O. Box 163, 1211 Geneva 1, Switzerland

CIRCLE NO. 54 ON FREE INFORMATION CARD

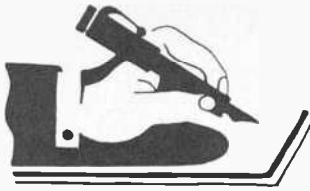

Letters

IN REBUTTAL

In rebuttal to A.D. Acton's comment in the April 1976 Letters Column, I for one appreciate having a source from which to buy parts and kits listed at the ends of parts

lists for POPULAR ELECTRONICS construction articles. I live in an area of the country where obtaining many parts is almost impossible. Without a parts or kit supplier, I would have to forego building many of the PE construction projects that appeal to me.

—Glenn A. Goss, *Elon College, N.C.*

SWL SPACE INVADERS

I am very disturbed with the "DX Listening" column. As I'm sure you are aware, the 40-meter Amateur Radio band covers the frequency range of 7.0 to 7.3 MHz. Most countries acknowledge these frequencies as belonging to hams and do not broadcast on them. Several communist countries, however, insist on transmitting on several

frequencies in the 40-meter band, causing considerable interference to the hams, who have legal ownership of this band.

I feel that your printing of frequencies of these illegal broadcasts aids and abets the invasion of the 40-meter band. I hope, therefore, that in the future you will delete any listing of international broadcasts on amateur frequencies.—*Onis Cogburn, K5VKQ, College Station, TX.*

The 7.0-to-7.1-MHz segment of the 40-meter band is allocated to Amateur Radio on a world-wide basis (to 7.3 MHz in Region II). In Regions I (Eurasia & Africa) and III (China, India, Iran, and Australasia), the 7.1-to-7.3-MHz portion is allocated to Broadcasting by the ITU. Many noncommunist countries use the "41-meter" band.



the PROFITMETER

AUTO ZERO/POLARITY
3½ DIGIT MULTIMETER KIT
WITH BRIGHT RED LED DISPLAY

\$79.95
+2.95 P & H

LESS TEST LEADS
& BATTERIES

214-369-7309

ALPHA ELECTRONICS, TEXAS
PO BOX 64683
DALLAS, TEXAS 75206

CIRCLE NO. 68 ON FREE INFORMATION CARD

WHERE'S MY CB LICENSE?

After five months, I still haven't received my license. I am frantic because I can't use my CB rig without a license for fear of being caught. As a result, I'm on the verge of selling my rig.

—Roger L. Triplett, *Louisburg, WV.*

As mentioned in last month's CB Scene, there's a new temporary permit that can put you on the air legally without delay. The form to be filled out was also printed last month. However, the address to which Form 505 is to be sent (Item 2, p 98) is simply: Federal Communications Commission, Gettysburg, PA 17326.

FREE McIntosh CATALOG and FM DIRECTORY

Get all the newest and latest information on the new McIntosh Solid State equipment in the McIntosh catalog. In addition you will receive an FM station directory that covers all of North America.



MX 113

FM/FM STEREO - AM TUNER AND PREAMPLIFIER

SEND TODAY!

McIntosh Laboratory, Inc.
East Side Station P.O. Box 96
Binghamton, N.Y. 13904
Dept. PE

NAME _____
ADDRESS _____
CITY _____ STATE _____ ZIP _____

If you are in a hurry for your catalog please send the coupon to McIntosh.
For non rush service send the *Reader Service Card* to the magazine.

CIRCLE NO. 43 ON FREE INFORMATION CARD

Out of Tune

In "Now You Can Build a Scientific Programmable Calculator" (May 1976), there is an error in the program for solving $x - 3 =$ on page 38. Steps 12, 13, and 14 (GO TO, 2, and 0) will cause the machine to subtract 11 from x instead of 1. It will also cause the program to "not count" the number of times it goes through a loop, and the ultimate answer to any x with this program will be 0. The proper instructions should be GO TO, 1, and 8, respectively.

In "Space War Game" (April 1976), type numbers were inadvertently omitted in the Parts List for IC7 through IC10. Integrated circuits IC7 and IC8 are 4023's, IC9 and IC10 4001's.

In "Tips and Techniques," June, 1976, the circuit for Alan Kong's tip is incorrect. To add a tail to a seven-segment "9", the bottom resistor should be connected to the "g" segment output, not the "d" segment output. The other input is correctly shown connected to the "a" segment output, and the collector of the top transistor is properly connected to the "d" segment driver. The circuit for adding a top tail to a seven-segment "6" is correct.

If you thought a rugged, professional yet affordable computer didn't exist,

think IMSAI 8080.

Sure there are other commercial, high-quality computers that can perform like the 8080. But their prices are 5 times as high. There is a rugged, reliable, industrial computer, with high commercial-type performance. And prices that are competitive with Altair's hobbyist kit. The IMSAI 8080. Fully assembled, it's \$931. Unassembled, it's \$599. And ours is available now.

In our case, you can tell a computer by its cabinet. The IMSAI 8080 is made for commercial users. And it looks jt. Inside and out! The cabinet is attractive, heavy-gauge aluminum. The heavy-duty lucite front panel has an extra 8 program controlled LED's. It plugs directly into the Mother Board without a wire harness. And rugged commercial grade paddle switches that are backed up by reliable debouncing circuits. But higher aesthetics on the outside is only the beginning. The guts of the IMSAI 8080 is where its true beauty lies.

The 8080 is optionally expandable to a substantial system with 22 card slots in a single printed circuit board. And the durable card cage is made of commercial-grade anodized aluminum. The Altair kit only provides 16 slots maximum in four separate sections, each section

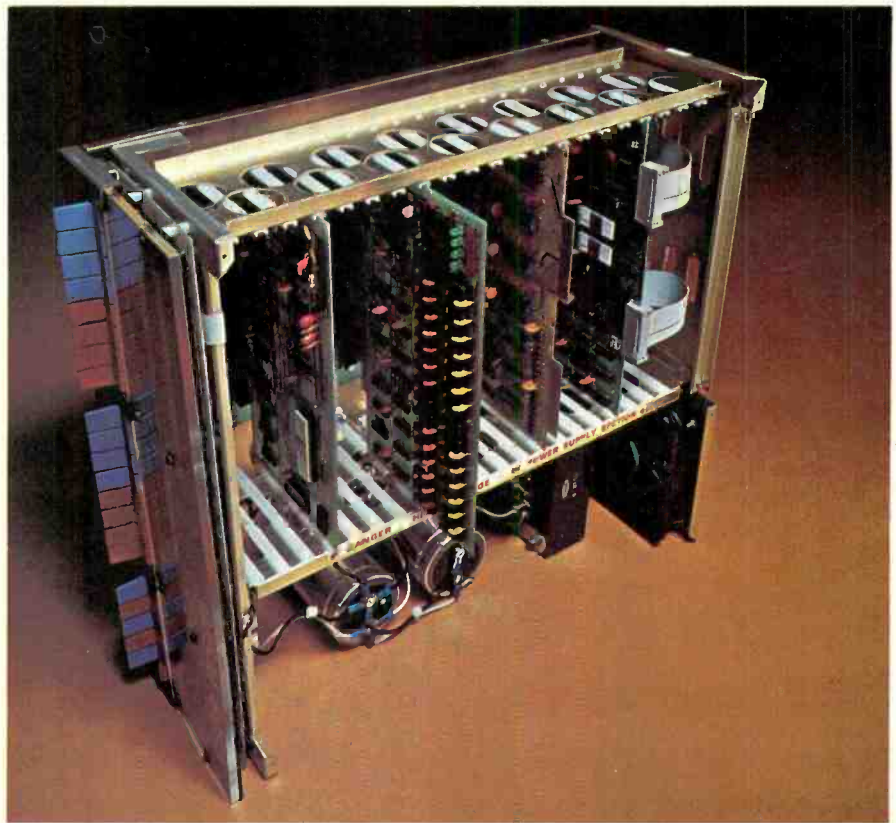

requiring 200 solder connections.

The IMSAI 8080 power supply produces a true 28 amp current, enough to power a full system. The Altair produces only 8 amps.

You can expand to a powerful system with 64K of memory, plus a floppy disk controller, with its own on board 8080—and a DOS. An audio tape cassette input device, a printer, plus a video terminal and a teleprinter. These peripherals will function with an 8-level priority interrupt system. IMSAI BASIC software is available in 4K,

that you can get in PROM. And a new \$139 4K RAM board with software memory protect.

Find out more about the computer you thought didn't exist. Get a complete illustrated brochure describing the IMSAI 8080, options, peripherals, software, prices and specifications. Send one dollar to cover handling.

Call us for the name of the IMSAI dealer nearest you.

Dealer inquiries invited.



IMSAI

IMS Associates, Inc. Dept. PE-8
14860 Wicks Boulevard
San Leandro, CA 94577
(415) 483-2093

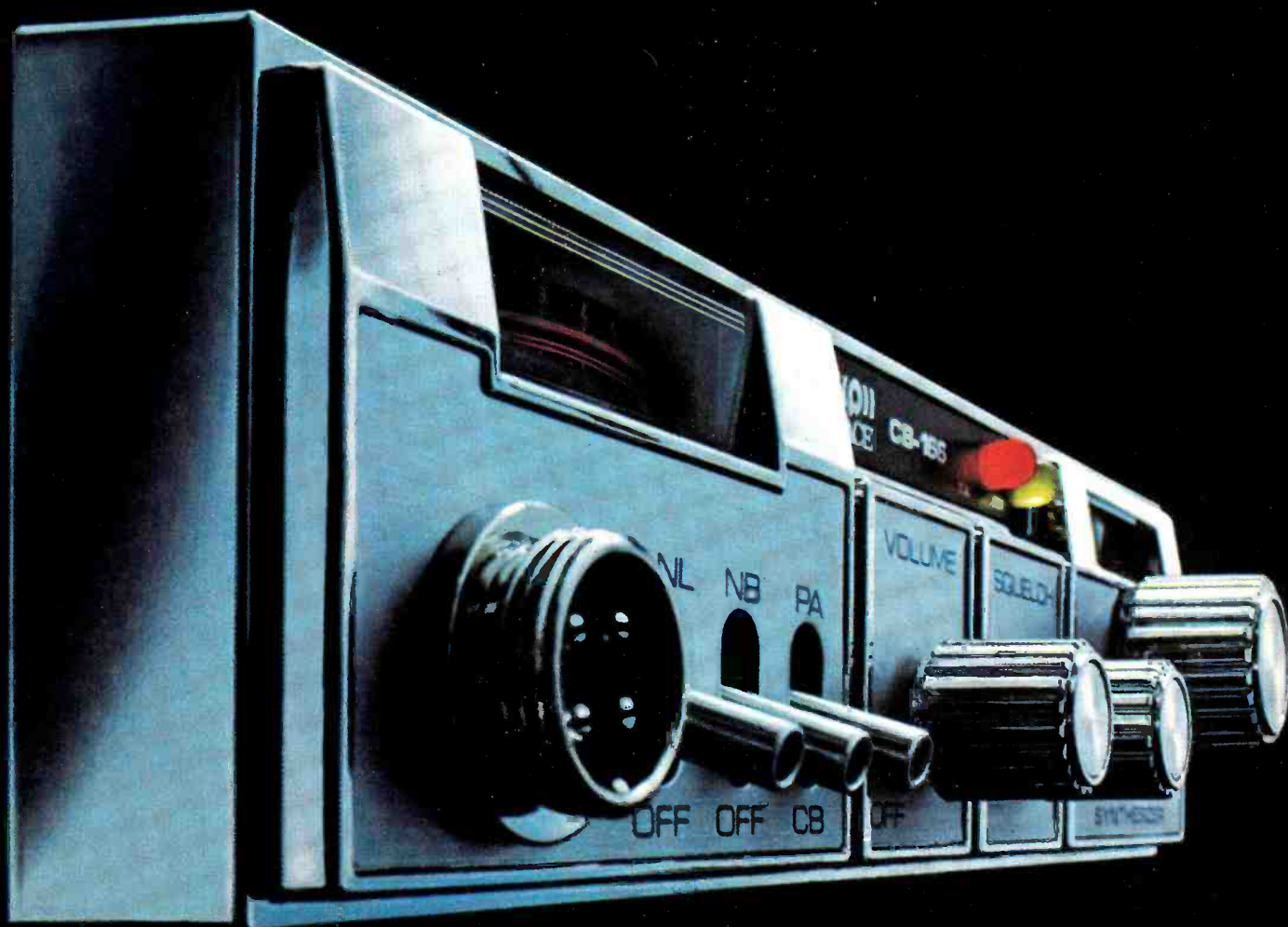

Pace. The best-selling CB in the world.

More people buy Pace than any other CB, based on estimates by Pathcom Inc.

Maybe it's because:

We wanted to be #1 — and we put our money & determination on the line to make the kind of radios that would make us the leader.

The warranty we offer — just ask anybody about it.

Our quality control — which means we don't just test an occasional sample off the line, we vibrate-test almost every mobile radio we make.

Our 23 models — the largest CB line in the world with suggested prices from \$50 to \$500. Which makes it easier to choose the right radio.

Is Pace for you? We think Number One deserves #1.

Write us — Pathcom Inc., (Los Angeles), Harbor City, CA. 90710.

PACE CB

When you've got a Pace,
you've got the world by the ears.

PACE TWO-WAY RADIOS. PRODUCTS OF PATHCOM INC.

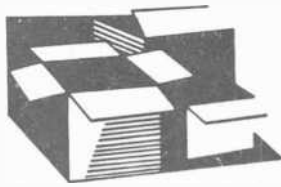

New Products

Additional information on new products covered in this section is available from the manufacturers. Either circle the item's code number on the Reader Service Card inside the back cover or write to the manufacturer at the address given.

SWR/FIELD-STRENGTH METER

Siltronic's Model SWR-3DX SWR power and field strength meter permits direct reading of SWR from 1:1 to 3:1 with an accuracy of 5%. The unit has two r-f power scales, reading from 0 to 20 watts and 0 to 200 watts with 10% accuracy. Includes antenna for field-strength measurements. Frequency range is 3.5 to 55 MHz. \$27.95.

CIRCLE NO. 84 ON FREE INFORMATION CARD

THORNTON DUAL-TRACE OSCILLOSCOPE

Thornton's Model 4D-10 portable solid-state oscilloscope features a 10-MHz bandwidth and dual-trace capability. Built in is a trace finder circuit that speeds searching for a lost trace. A single control is used for trigger level and polarity. Sensitivity is independently adjustable for the

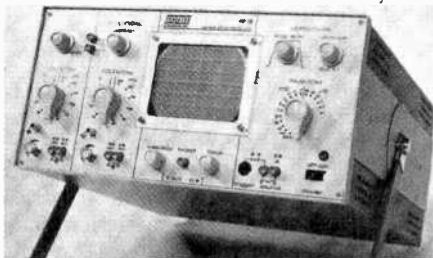

two input channels over a range of from 10 mV/cm to 50 V/cm in 12 calibrated ranges. A wide selection of sweep speeds (1 μ s/cm to 100 ms/cm in 16 ranges) is backed up by a $\times 5$ magnifier. Display size is 8 \times 6 cm. Display modes include A-only alternate and chopped. Input impedance is 1 megohm, which can be increased to 10 megohms with an optional probe. \$445.

CIRCLE NO. 85 ON FREE INFORMATION CARD

EMPIRE MANUAL RECORD PLAYER

Empire's new Model 698 manual record playing system features a newly designed tonearm, while retaining the belt-drive and anti-acoustic feedback system used in an earlier unit. The low-mass tonearm has a rear counterweight that is decoupled through a special rubber compound sus-



ADVENT BOOKSHELF SPEAKER SYSTEM

The Advent/3 is a two-way acoustic-suspension speaker system housed in a walnut-grained, vinyl-clad cabinet that measures 16" \times 10" \times 6 1/2" (49.6 \times 25.4 \times 16.5 cm). The 8-ohm system requires a minimum of 10 watts of driving power. Its frequency range is essentially the same as that of the original Advent loudspeaker, with the exception of the lowest half-octave of bass. Price is \$50.

CIRCLE NO. 89 ON FREE INFORMATION CARD

ZODIAC CB SERVICE MONITOR

The Swiss-made Model U-2 is a CB service instrument from Zodiac Communications Corp. It uses a frequency synthesizer for testing by CB equipment manufacturers and field service technicians. The portable instrument is powered by its own 12-volt battery. On the bench, it can be powered by an external 12-volt dc source. The instrument features a r-f signal generator, wattmeter, SWR meter, and field-strength meter. It generates 210 frequencies at 5-kHz intervals within the 26.49-to-30.11-MHz range, including all existing and proposed CB channel frequencies. It can also be used to measure sensitivity at the carrier frequency, passband in kilohertz, and adjacent-channel selectivity. Power output up to 5 watts, modulation up to 100%, and SWR up to 3:1 can also be measured.

CIRCLE NO. 91 ON FREE INFORMATION CARD

NAKAMICHI CASSETTE DECK

Nakamichi's Model 600 cassette "console" features a record-playback head. It's said to provide a frequency response of 40 to 18,000 Hz \pm 3 dB. (The signal-to-noise ratio is rated at better than 68 dB.) "Intermodulation Suppressor" circuitry makes possible a distortion of 0.5% at 0 dB and increases dynamic range to permit recording at levels up to +7 dB at reference 3% distortion. Special peak-reading meters have a



47-dB range. A pulse-controlled dc servo motor is used. Also included are: built-in Dolby noise reduction, 400-Hz calibration tone, MPX filter for FM recording, memory rewind and equalization switches.

CIRCLE NO. 92 ON FREE INFORMATION CARD

PIONEER AM/STEREO FM RECEIVER

Pioneer's Model SX-1250 AM/stereo FM

pension and a new removable cartridge shell. Touch-sensitive controls actuate the cueing system through a damped solenoid that is said to accurately raise and lower the stylus in the same groove every time. A photocell is used to electronically trigger the tonearm to lift at the end of record play. The units' antiskating device applies a diminishing force as the tonearm moves closer to the center of the record.

CIRCLE NO. 86 ON FREE INFORMATION CARD

NEW-TRONICS BASE STATION CB ANTENNA

In line with changes in FCC Rules permitting greater antenna heights, New-Tronics Corp. has announced availability of the Hustler Model 27-TD "Super Swamper" base station CB antenna. The antenna's design is based on the 0.64-wavelength principle used in commercial broadcasting to obtain optimum low-angle signal radiation. In CB, the 0.64-wavelength, 22 (6.7-m) radiating element of the Super Swamper is said to substantially improve performance to extend AM and SSB two-way omnidirectional radio communications over greater distances. Additionally, the antenna has extremely low SWR. \$52.95.

CIRCLE NO. 87 ON FREE INFORMATION CARD

MICRO GENERAL CHESS COMPUTER

Micro General Corp. has announced the introduction of the "Micro-80" chess computer that keeps exact time and move count for the most popular variations of time-controlled chess after being programmed. The computer keeps track of the type of game being played, as well as time and moves. The crystal-controlled timer always displays the time remaining to each player down to the second as well as the number of moves yet to be played. It also automatically adds unused thinking time to each player's "time bank" when applicable. A beeper in the lock provides warnings and end-of-game signals. The clock features STOP, CONTINUE, and RESET functions, a low battery power level indicator, and display blanking for power conservation. \$245.

CIRCLE NO. 88 ON FREE INFORMATION CARD

THE SILENCER

Your ears are burning with amplified noise. Even though your system is delivering sound accurately, it's also doing an efficient job of pumping out noise . . . accurately. Ideally, music should be recreated against a dead silent background. The Phase Linear 1000 accomplishes just that with two unique systems: The Auto Correlator Noise Reduction and the Dynamic Range Recovery Systems.

★ It improves the overall effective dynamic range and signal/noise ratio 17.5 dB in any stereo system with any stereo source.

★ The Auto Correlator reduces hiss and noise 10 dB without the loss of high frequencies and without pre-encoding.

★ The Dynamic Range Recovery System restores 7.5 dB of dynamic range without pumping and swishing.

★ Plus, it removes hum, rumble and low frequency noises, without the loss of low frequency music.

★ **WARRANTY:** 3 years, parts and labor

Even the finest stereo systems are limited in performance by the quality and nature of the recording. With the Phase Linear 1000, these limitations are overcome. Added to any receiver or preamplifier, it gives you the most significant improvement in sound reproduction for the money . . . more than any other single piece of equipment you could add to your system. Ask your dealer for an audition. The silence is deafening.



*Phase
Linear
1000*

Phase Linear Corporation,
20121 48th Avenue W.
Lynnwood, Washington 98036

CIRCLE NO. 47 ON FREE INFORMATION CARD

receiver is rated at 160 watts/channel (rms) into 8 ohms from 20 to 20,000 Hz at 0.1% or less THD. It has twin stepped tone controls for bass and treble adjustments, step-type volume control calibrated in decibels, two tape monitor circuits, pushbutton function selection with illuminated readout, separate access to preamplifier and power amplifier, five-gang tuning capacitor and dual MOSFET's in the FM front end, phase-locked loop IC for stereo FM decoding, and 25- μ s deemphasis switch for Dolby-encoded FM broadcasts. Among the more important specifications are: 1.5 μ V IHF usable sensitivity in mono (2.9 μ V in stereo); 80 dB mono, 74 dB stereo S/N; 11.5 (mono) and 36 dBf (stereo) for 50-dB quieting sensitivity; typically 0.3% maximum FM distortion; 83 dB alternate-channel selectivity; 35 dB stereo (FM) separation, 30 to 15,000 Hz; 110 dB image and spurious rejection; 120 dB i-f rejection.

CIRCLE NO. 93 ON FREE INFORMATION CARD

TRIPLETT HIGH-ACCURACY MULTIMETER

The Model 60-NA from Triplet Corp. is a portable precision VOM that features a large easy-to-read 4 1/2" (11.4-cm) anti-parallax mirrored scale. It has a dc accuracy of $\pm 1.5\%$ full-scale ($\pm 3\%$ on ac), plus a multiplier switch that permits more read-



ings to be taken at the upper portion of the scale for greater accuracy. Fifty separate ranges provide measurement capacity of up to 1000 volts ac and dc, 1000 mA dc current, up to $\times 100$ K ohms, and from -20 to +52 dB. Ac current up to 300 amperes can be measured when the VOM is used with the optional Model 10-C adaptor. Three fuses are used in the meter to provide burn-out-proof protection and for user safety. \$130.

CIRCLE NO. 94 ON FREE INFORMATION CARD

SCANNER USES MICROPROCESSOR

The Tennelec Model MCP-1 is said to be the first scanning receiver to use a computer-like microprocessor that lets the user tune in as many as 16,000 low- and high-vhf and uhf band frequencies. Sixteen different frequencies can be stored in memory through a calculator-like keyboard. The microcomputer system operates without channel crystals. Super-

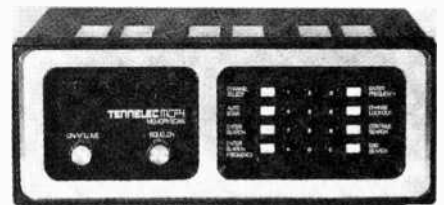

selective dual filters reduce station overlap for maximum radio reception. The receiver's search mode can be set to go through 256 channels in 5-kHz increments at 10 channels/second. Channels can be quickly entered into memory or changed by pressing the appropriate keys. The scanner has a six-digit, 7-segment LED frequency display.

CIRCLE NO. 95 ON FREE INFORMATION CARD

ESS STEREO POWER AMPLIFIERS

The Model 500A is one of a new Eclipse series of stereo power amplifiers introduced by ESS, Inc. It is rated at 250 watts minimum continuous power per channel, both channels driven into an 8-ohm load with no more than 0.25% THD. Frequency response is said to be 20 to 20,000 Hz ± 0.25 dB. Other specifications include: hum and noise, -102 dB; sensitivity, 0.75 volt; input impedance, 25,000 ohms. It has two 4 1/2" VU meters with three sensitivity ranges, pushbutton twin stereo speaker system selection, and two viscous damped level controls. Measures 19" W \times 13" D \times 7 1/2" H (48 \times 33 \times 19 cm) and weighs 49 lb (22 kg). \$826.00. Address: ESS, Inc., 9613 Oates Dr., Sacramento, CA 95827.

CRAIG MOBILE AM CB TRANSCEIVER

Economy is the key feature of the Model 4101 mobile AM CB transceiver from Craig Corp. The transceiver has a crystal-synthesizer network that provides full 23-channel coverage. Built-in are automatic noise limiter (anl), voice compression, and adjustable-squelch circuits. A LED modulation indicator monitors transmissions, while an ON AIR legend lights up when in



the transmit mode. A crystal filter system guards against adjacent-channel interference, and automatic protection is provided for transistor overload. Included are an external-speaker jack and detachable microphone. The reversible mounting bracket allows mobile installation from top or bottom. \$129.95.

CIRCLE NO. 97 ON FREE INFORMATION CARD

If you want an exciting future like this, it starts with an FCC license!

Get that license at home, the practical, step-by-step ETI way!

Just imagine yourself with the responsibility of running a radio or TV station. Or in command of an airport control tower. Imagine yourself as a technician on the job installing, troubleshooting or getting it all together for a two-way communications system at the local police or fire department. It's all great work and you can get it!

You may find hundreds of doors opening for you with that FCC license. An FCC license is required for thousands of exciting jobs. You'll be in demand! You'll be headed for a future doing a job you like. And you'll be getting a paycheck you'll like every bit as much. You'll have all the security and confidence that comes with being a licensed professional in an important career specialization.

Is FCC-license preparation hard to learn at home?

No. Sure, there is a lot to learn. And you'll need a thorough knowledge of the field. But through ETI's advanced instruction methods you can learn at home, expertly, and step-by-step, getting ahead as fast as your time and ambitions permit, because you set your own pace. Through ETI you get all the materials you need. You move ahead without missing a single day from your present job. Sooner than you expect, you'll be taking that FCC examination.

Exclusive five-year coaching agreement.

ETI offers you an exclusive five-year coaching agreement! When you complete the ETI FCC License Preparation Course, you should be qualified to pass the appropriate FCC examination. If



simply as possible, to pass the appropriate FCC examination. You are trained, detail by detail, to satisfy specific examination requirements for 3rd, 2nd, or 1st Class FCC Radiotelephone License examinations. And, by learning the ETI way, you approach that examination with confidence. You know what you need to know! And, if you want to combine FCC license preparation with more comprehensive electronics training, you may want to choose ETI's more detailed and thorough Communications Career Program.

you fail to pass, ETI will provide further coaching, until you do pass, for a period of up to five years.

Expert, personal help!

You get expert, personal help each step of the way. Electronics Technical Institute instructors are chosen for both their technical competence and their skill as teachers. They are licensed by the State of New Jersey. They care about you, because your success is their success. Each assignment you complete is a challenge to them. They comment... help... suggest... encourage... as well as correct and point you to the next step. They bring you along quickly!

Just what you need to know.

ETI's expertly perfected, practical FCC License Preparation Course is designed to do one thing: prepare you adequately, as quickly and

Get the facts FREE!

Don't cheat yourself out of finding out more. It's your future that's at stake. The facts are yours free and with no obligation. No salesman will call. The time to do it? Now! There'll never be a better time! Just fill out and return the coupon and

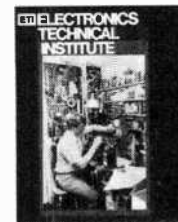

we'll tell you everything about a future that can mean everything to you! It's all there in a colorful, fully illustrated new 44-page catalog!

Electronics Technical Institute

Division of Technical Home Study Schools

Electronics Technical Institute, Dept. 2-473-086
Little Falls, New Jersey 07424

YES! I'm interested in a future with an FCC license. Rush me your free career information!

Send me information on these other fields of special interest:

- | | | |
|---|---|---|
| <input type="checkbox"/> TV/Audio Servicing | <input type="checkbox"/> Computers | <input type="checkbox"/> Business and Engineering |
| <input type="checkbox"/> Black and White | <input type="checkbox"/> Digital Electronics | <input type="checkbox"/> Electronics Fundamentals |
| <input type="checkbox"/> Color | <input type="checkbox"/> Computer Technology | <input type="checkbox"/> Electronics Drafting |
| <input type="checkbox"/> Solid-State | <input type="checkbox"/> Computer Programming | <input type="checkbox"/> Industrial Electronics |
| <input type="checkbox"/> CATV | | <input type="checkbox"/> Advanced Electronics |
| <input type="checkbox"/> Closed Circuit | | <input type="checkbox"/> Industrial Instrumentation |
| <input type="checkbox"/> Video Recorders | | <input type="checkbox"/> Electronics Technology |
| <input type="checkbox"/> Radio | | <input type="checkbox"/> Medical Electronics |
| <input type="checkbox"/> Hi-Fi Stereo | | |

Check here for Veterans information.

Name _____ (please print)

Address _____

City _____ State _____ Zip _____

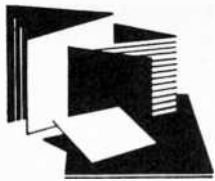

New Literature

HUSTLER CB & MONITOR ANTENNAS

New-Tronics' 20-page, illustrated catalog of Hustler CB and monitor antennas includes telescopic and dual antenna mod-

els, as well as mounting hardware, gutter clips, coax leads, matchers and phasing harnesses. Monitor antenna systems described include the Monitor Match Model 5M5, which accomplishes the functions of four separate antennas, and the Discone Model DCX, a wide-band antenna with complete coverage from 40 to 700 MHz. Address: Sales Department, New-Tronics Corporation, 15800 Commerce Park Drive, Brookpark, OH 44142.

SILTRONIX CB PAMPHLET

A new, pocket-sized pamphlet from Siltronix lists the popular trucker CB channels used on the major highways of

the continental United States. Listed by state, the booklet designates the most common trucker channels, giving specific exceptions and secondary channels. Also included is a table of commercial radio stations that make announcements warning drivers of weather conditions, detours, and other obstacles along major routes. Address: Siltronix, 269 Airport Rd., Ocean-side, CA 92054.

DISCRETE SEMICONDUCTOR GUIDE

A new 112-page guide from Intersil describes the company's complete line of field effect, dual field effect and dual bipolar transistors. Products are grouped by typical application with complete specifications and a comparison table of key parameters for each device. Applications are illustrated with detailed schematics, and there's a section on chips and wafers. A comprehensive cross reference and a complete listing of parts in alphanumeric order are also included. Address: Intersil, Inc., 10900 North Tantau Ave., Cupertino, CA 95014.

EDMUND CATALOG #762

Edmund Scientific announces its latest catalog #762. The 172-page, illustrated catalog describes over 4500 unusual and hard-to-find items in science, optics, and electronics, including a variety of telescopes, binoculars, microscopes, photographic attachments, tools, games, and puzzles. Solar-Chron, one of the many items featured, is a solar electronic digital wrist watch with nine solar cells that use the sun or incandescent light to obtain reserve power. Another item described is the pocket-sized Executive GSR Meter, a biofeedback monitoring device to help you learn about tension-reduction techniques. Address: Edmund Scientific Co., 380 Edscorp Bldg., Barrington, NJ 08007.

BOMAN ASTROSONIX LITERATURE

Boman Industries offers literature on its line of car sound systems and citizens band products. A 16-page, four-color brochure describes its Astrosonix line of in-dash and under-dash AM, AM/FM and AM/FM/MPX car radios, cassette and 8-track cartridge car stereos, speakers, booster amplifiers and accessories. Also offered is a six-page flier describing Boman's citizens band transceivers, some featuring AM/FM-MPX radio. Address: Boman Industries, 9300 Hall Rd., Downey, CA 90241.

VOLTAGE-SUPPRESSION MANUAL

A new 108-page "Transient Voltage Suppression Manual" from General Electric has 80 pages of text on transient cause, detection and protection. Also included are a selection guide and product specification sheets for selecting GE-MOV varistors. Available for \$2.50 (plus local tax) from GE Semiconductor, Electronics Park, Bldg. 7-49, Syracuse, NY 13201.

PASS THE WORD...

handic®

SWEDEN'S SOLID CB IS HERE

"You've got to hear it to believe it!" Because Handic is committed to quality . . . not to gimmicks, frills or flashing lights. Our 23 channel rigs are designed in Sweden, where the climate is tough and operating conditions tougher . . . and where CB is more than just a convenience, it's a vital communications link!

With Handic, adjacent channel spill-over problems are minimized — 80dB down @ 10KHz, not the usual 45dB down. Spurious emission is filtered down to 0.2 microvolts — 250% better than our own FCC requirements. (If all rigs were Handic, there would be a lot less TV!!) And Handic is required to maintain ± .003% crystal frequency tolerance in Sweden — exceeding our own FCC specs significantly. From "mic" to antenna, this is the kind of sophisticated circuitry found in every Handic rig. Remember, Handic CB's have their own special orange color . . . symbolic of CB excellence.

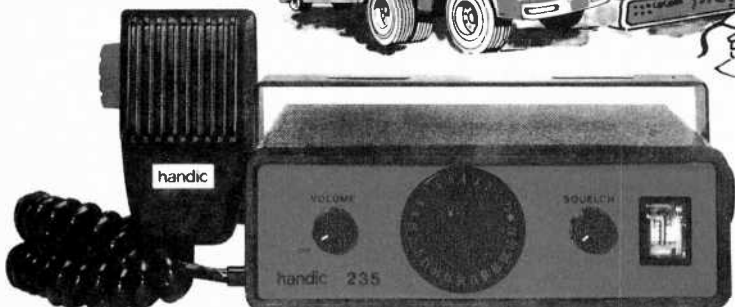
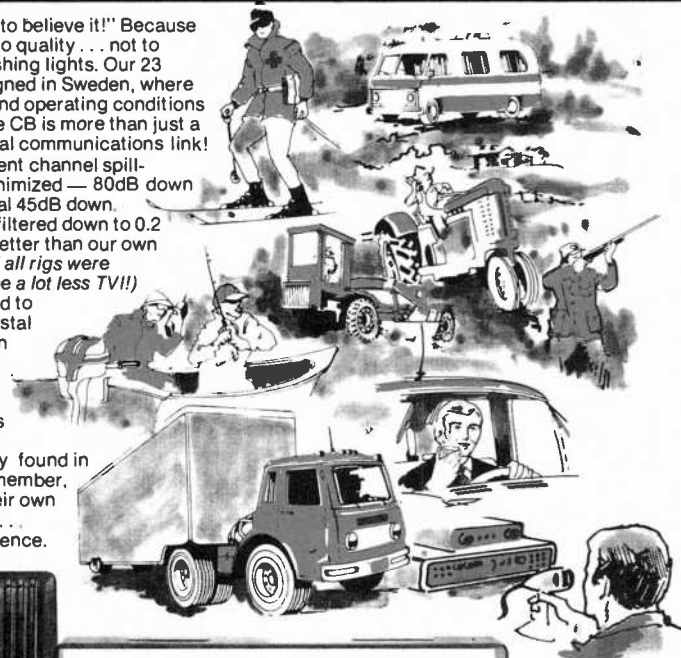

Handic CB radios include: mobilebase transceivers; handheld portables; scanners with FM radio option; antennas; microphones; selective call, and a full line of accessories.

handic® U.S.A. inc. Send For FREE Catalog!

14560 N.W. 60th Ave., Kennedy Bldg., Miami Lakes, Fla. 33014 (305) 558-1522
In Canada: Scotcomm Radio Inc. Chomedey, Laval, Quebec



THE DEPENDABLE CB FROM SWEDEN

Pocket CB

New integrated circuit technology and a major electronic breakthrough brings you the world's smallest citizens band transceiver.



The PocketCom measures approximately 3/4" x 1 1/2" x 5 1/2" and easily fits into your shirt pocket. The unit can be used as a personal communications link for business or pleasure.

SMALL ENOUGH FOR YOUR POCKET

Scientists have produced a personal communications system so small that it can easily fit in your pocket. It's called the PocketCom and it replaces larger units that cost considerably more.

MANY PERSONAL USES

An executive can now talk anywhere with anybody in his office, his factory or job site. The housewife can find her children at a busy shopping center. The motorist can signal for help in an emergency. The salesman, the construction foreman, the traveler, the sportsman, the hobbyist—everybody can use the PocketCom—as a pager, an intercom, a telephone or even a security device.

LONG RANGE COMMUNICATIONS

The PocketCom's range is limited only by its 100 milliwatt power and the number of metal objects between units or from a few blocks in the city to several miles on a lake. Its receiver is so sensitive, that signals several miles away can be picked up from stronger citizens band base or mobile stations.

VERY SIMPLE OPERATION

To use the PocketCom simply turn it on, extend the antenna, press a button to transmit, and release it to listen. And no FCC license is required to operate it. The PocketCom has two Channels—channel 14 and an optional second channel. To use the second channel, plug in one of the 22 other citizens band crystals and slide the channel selector to the second position. Crystals for the second channel cost \$7.95 and can only be ordered after receipt of your unit.



The PocketCom components are equivalent to 112 transistors whereas most comparable units contain only twelve.

A MAJOR BREAKTHROUGH

The PocketCom's small size results from a breakthrough in the solid state device that made the pocket calculator a reality. Mega scientists took 112 transistors, integrated them on a micro silicon wafer and produced the world's first transceiver linear integrated circuit. This major breakthrough not only reduced the size of radio components but improved their dependability and performance. A large and expensive walkie talkie costing several hundred dollars might have only 12 transistors compared to 112 in the Mega PocketCom.

BEEP-TONE PAGING SYSTEM

You can page another PocketCom user, within close range, by simply pressing the PocketCom's call button which produces a beep tone on the other unit if it has been left in the standby mode. In the standby mode the unit is silent and can be kept on for weeks without draining the batteries.

SUPERIOR FEATURES

Just check the advanced PocketCom features now possible through this new circuit breakthrough: 1) Incoming signals are amplified several million times compared to only 100,000 times on comparable conventional systems. 2) Even with a 60 decibel difference in signal strength, the unit's automatic gain control will bring up each incoming signal to a maximum uniform level. 3) A high squelch sensitivity (0.7 microvolts) permits noiseless operation without squelching weak signals. 4) Harmonic distortion is so low that it far exceeds EIA (Electronic Industries Association) standards whereas most comparable systems don't even meet EIA specification. 5) The receiver has better than one microvolt sensitivity.



EXTRA LONG BATTERY LIFE

The PocketCom has a light-emitting diode low-battery indicator that tells you when your 'N' cell batteries require replacement. The integrated circuit requires such low power that the two batteries, with average use, will last weeks without running down.



The PocketCom can be used as a pager, an intercom, a telephone or even a security device.

MULTIPLEX INTERCOM

Many businesses can use the PocketCom as a multiplex intercom. Each employee carries a unit tuned to a different channel. A stronger citizens band base station with 23 channels is used to page each PocketCom. The results: an inexpensive and flexible multiplex intercom system for large construction sites, factories, offices, or farms.

NATIONAL SERVICE

The PocketCom is manufactured exclusively for JS&A by Mega Corporation. JS&A is America's largest supplier of space-age products and Mega Corporation is a leading manufacturer of innovative personal communication systems—further assurance that your modest investment is well protected. The

PocketCom should give you years of trouble-free service, however, should service ever be required, simply slip your 5 ounce PocketCom into its handy mailer and send it to Mega's prompt national service-by-mail center. It is just that easy.

GIVE IT A REAL WORKOUT

Remember the first time you saw a pocket calculator? It probably seemed unbelievable. The PocketCom may also seem unbelievable so we give you the opportunity to personally examine one without obligation. Order only two units on a trial basis. Then really test them. Test the range, the sensitivity, the convenience. Test them under your everyday conditions and compare the PocketCom with larger units that sell for several hundred dollars.

After you are absolutely convinced that the PocketCom is indeed that advanced product breakthrough, order your additional units, crystals or accessories on a priority basis as one of our established customers. If, however, the PocketCom does not suit your particular requirements perfectly, then return your units within ten days after receipt for a prompt and courteous refund. You cannot lose. Here is your opportunity to test an advanced space-age product at absolutely no risk.

A COMPLETE PACKAGE

Each PocketCom comes complete with mercury batteries, high performance Channel 14 crystals for one channel, complete instructions, and a 90 day parts and labor warranty. To order by mail, simply mail your check for \$39.95 per unit (or \$79.90 for two) plus \$2.50 per order for postage, insurance and handling to the address shown below. (Illinois residents add 5% sales tax). But don't delay.

Personal communications is the future of communications. Join the revolution. Order your PocketComs at no obligation today.

\$39⁹⁵ NATIONAL INTRODUCTORY PRICE

Credit Card Buyers Call Toll Free

JS&A NATIONAL SALES GROUP

DEPT. PE JS&A Plaza
Northbrook, Illinois 60062

CALL TOLL-FREE .. 800 325-6400
In Missouri call... 800 323-6400

© JS&A Group, Inc., 1976



Stereo Scene

By Ralph Hodges

THE GREAT TUBE/TRANSISTOR CONTROVERSY

THE STORY, as it was told to me by a close and reliable source, goes like this. A few years ago a highly esteemed manufacturer of solid-state high-fidelity equipment was contacted by a talented group of audio amateurs who challenged him to equal the performance of their equipment — to their satisfaction — using any solid-state techniques he cared to apply. Their equipment used vacuum tubes exclusively in its signal-handling circuits and had been designed by ear as much as by instrument to satisfy the requirements of the supremely critical listener.

The manufacturer accepted the challenge and presented himself at the appointed time, with a spectrum analyzer, among other test gear, a supply of resistors and capacitors, and his stock, consumer-available electronics. He was given about a weekend to complete the test.

First, he analyzed the frequency response of the tube amplifier in one-third octave bands and matched the response of his own gear to that reference. Then he altered the noise spectrum of his amplifier to conform to that of the tube amplifier, adding hiss to his own designs as required. Finally, he injected just a touch of hum into his

electronics — a subaudible amount at normal listening levels, but enough to provide the subliminal sense of low-frequency potency that the tube equipment's hum level suggested. Reportedly, his manipulations were so successful that not one of his challengers could consistently distinguish his solid-state amplifier from their own specially designed tube equipment, nor could they say definitely which sounded better in the long run.

A Mountain Or a Molehill? If nothing else, this anecdote demonstrates just how serious the tubes versus transistors controversy has become in the audio industry. Manufacturers of highly advanced transistorized gear are beginning to pay some attention to the experienced audiophile's views on the virtues of vacuum-tube equipment, perhaps because these preferences are steadily becoming more widespread. Vacuum-tube amplifiers and preamplifiers are briskly being sold by Audio Research, Lux (which has even developed new output and driver tubes for its designs), and Dynaco (which has had so much success with its Mark III power amplifier that it is now introducing a new tube amplifier,

the 120-watt Mark VI). These three just account for the bulk of the market, but numerous smaller manufacturers are also making their contribution.

In the midst of all this activity, the manufacturers most involved are not overwhelmingly convinced that the tube itself is more desirable than the transistor. Dynaco's chief engineer, Wade Burns, says that the introduction of the Mark VI, "... does not contradict our feeling that in state-of-the-art audio equipment, tubes offer no distinct technical advantage over the use of modern semiconductors." And Wendell Diller, sales manager and spokesman for Audio Research, a company that deals exclusively in tube equipment, is surprisingly moderate in his views: "Tubes *per se* do not make an amplifier superior. A tube can be operated in a nonlinear fashion just as a transistor can be operated in a relatively linear fashion. We are not trying to start a tube fad. However, under the best conditions the tube is more linear than the bipolar transistor." If the major manufacturers of tube amplifiers are willing to concede that transistor designs can be decent or even equivalent reproducers, why is there such a polarization among amplifier users?

Defining the Difference. Analyzing the difference between tube and transistor amplifiers is not as easy as it first appears. Far from being nonlinear, a good solid-state amplifier is so linear that it can often embarrass the sine-wave signal generator used to test it. Modern tube designs can do just as well. The difference between the best of both types of amplifiers cannot amount to much more than 0.1% distortion of any sort (using standard measuring techniques). At any listening level you could stand, 0.1% distortion is lower in level than the sound of your heartbeat. You'd never hear it.

Denied any definitive help from their test gear, amplifier designers have lately fallen back on theoretical approaches and listening tests to cope with the responses from tube-oriented consumers. Bob Bird, chief engineer at ESS, neatly summarizes the listening-test criteria as centering on (1) sonic clarity, (2) bass definition, and (3) clipping characteristics. Bass definition is an area in which almost everyone, including tube proponents, feels that much vacuum-tube equipment falls short. Lawrence Niles of

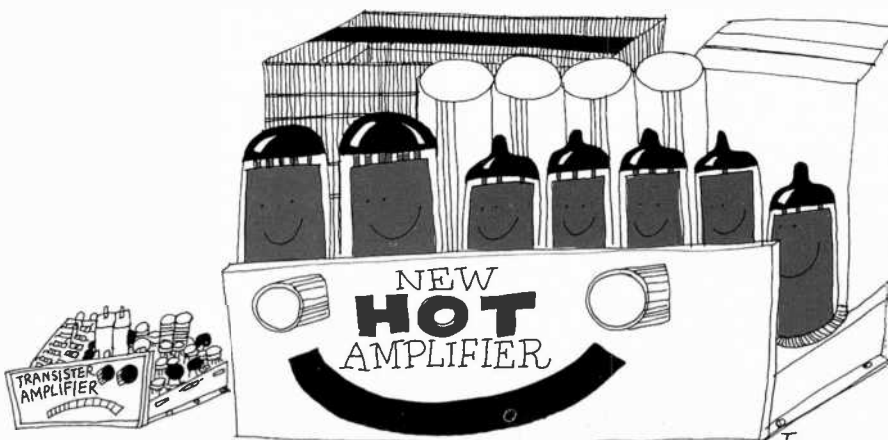

Switch to the CB antenna that beats the Citizens Bandits.

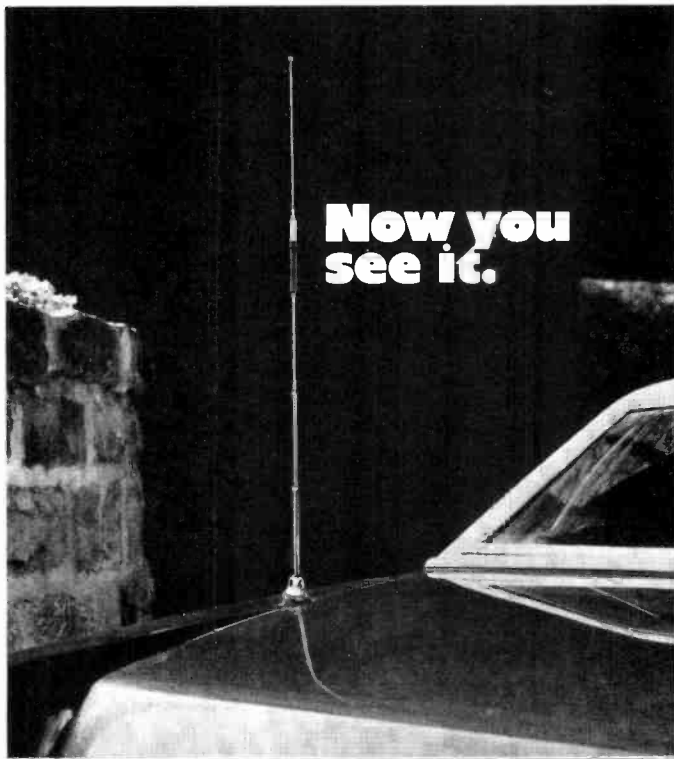

**Now you
see it.**



**Now they
don't.**



It's no wonder people are worried about CB thefts. All a thief has to do is spot a car with a CB antenna and he has his target.

But he can't spot ours.

Because the TennaPower Disappearing CB Electric Antenna hides inside the fender when it isn't being used.

But there's no hiding from it when it's up. Because it performs like gangbusters.

One flick of the switch extends it fully or drops it out of sight. And even turns your transceiver's power on or off, automatically, at the same time.

Our antenna is center-loaded for better range. Its unique "skinny" coil disappears into the fender. Our motor is lifetime lubricated. Our materials are virtually corrosion-proof. And the antenna is designed to obtain an optimum SWR of 1.5:1 or better.

And our Disappearing CB Electric Antenna gives you this big, exclusive advantage: it's made by Tenna. We're the world leader in electric car antennas. Because we've built over 5 million disappearing electric car radio antennas for GM, Ford, Chrysler and Rolls Royce.

So buy the TennaPower Disappearing CB Electric Antenna at a dealer near you who sells CB or car stereo. You can ask him about installation or you may want to do it yourself.

Then beat the Citizens Bandits with the CB antenna thieves can't see. We think you can see why.

**Tenna
Corporation** 
Cleveland, Ohio 44128

Where do the pros get their training?



Almost half of the successful TV servicemen have home study training and with them, it's NRI 2 to 1. It's a fact! Among men actually making their living repairing TV and audio equipment, more have taken training from NRI than any other home study school. More than twice as many!

A national survey*, performed by an independent research organization, showed that the pros named NRI most often as a recommended school and as the first choice by far among those who had taken home study courses from any school. Why? Perhaps NRI's 62-year record with over a million students . . . the solid training and value built into every NRI course . . . and the designed-for-learning equipment originated by NRI provide the answer. But send for your free NRI catalog and decide for yourself.



25" Diagonal Color TV... And 4-channel Quadraphonic Stereo.

As a part of NRI's Master Course in color TV/Audio servicing, you build a 25" diagonal solid state color TV with console cabinet. As you build it, you perform stage-by-stage experiments designed to give you actual bench experience. And you get a Quadraphonic system with 4 speakers. NRI's



instruments are a cut above the average, including a transistorized volt ohm-meter, triggered

sweep 5" oscilloscope, CMOS digital frequency counter and digital integrated circuit color TV pattern generator. They're top professional quality, designed to give you years of reliable service. You can pay hundreds of dollars more for a similar course and not get a nickel's worth extra in training and equipment.

Widest Choice of Courses and Careers.

NRI doesn't stop with just one course in TV/Audio servicing. You can pick from five different courses (including an advanced color course for practicing technicians) so you can fit your training to your needs and your budget. Or, you can go into Computer Technology, learning on a real, digital computer you build yourself. Communications with your own 400 channel digitally-synthesized VHF transceiver. Aircraft or Marine Electronics. CB, Mobile Radio, and more.

Free Catalog... No Salesman Will Call.

Send the postage-paid card for our free color catalog showing details on all NRI electronics courses. Lesson plans, equipment, and career opportunities are fully described. Check card for information on G.I. benefits. No obligation, no salesman will call. Mail today and see for yourself why the pros select NRI two to one!

If card is missing, write,

Two Famous Educators... NRI and McGraw-Hill.

NRI is a part of McGraw-Hill, world's largest publishers of educational material. Together, they give you the kind of training that's geared for success . . . practical know-how aimed at giving you a real shot at a better job or a business of your own. You learn at home at your convenience, with "bite-size" lessons that ease learning and speed comprehension. Kits designed to give you practical bench experience also become first-class professional instruments you'll use in your work.



NRI SCHOOLS
 McGraw-Hill Continuing Education Center
 3939 Wisconsin Avenue,
 Washington, D.C. 20016

*Summary of survey results upon request.

Epicure has advanced some possible explanations. The output section of any amplifier is essentially an "impedance-translating stage between the last voltage-gain stage and the speaker output terminals." Practically every vacuum-tube amplifier ever designed has used an output transformer to do this impedance translation, and, "... a transformer ... exhibits considerable phase shift at both low and high frequencies. The low-frequency phase shift is a likely explanation for the loss of low-frequency definition characteristic of some tube designs."

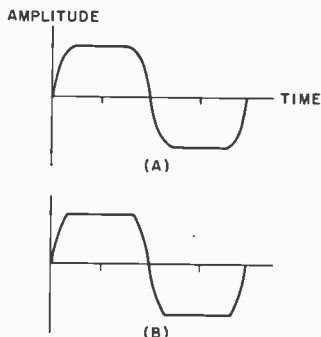

Fig. 1. Clipped waveforms in tube (A) and transistor (B) equipment.

A corollary to this is that the amplifier's output impedance tends to rise at low frequencies, which, in turn, reduces the damping factor at a point where it should be high, particularly with a vented-box (speaker system) design operating below resonance. This and problems like transformer hysteresis and core saturation, are the sources of a tube amplifier's major performance limitations in terms of bandwidth, distortion, and power handling." (Note, however, that a class-A vacuum tube amplifier can function *without* an output transformer. A suitably designed, high-power, wideband cathode follower could drive the speaker directly. This would avoid transformer-related problems. But, to my knowledge, no commercial amplifier has such an output circuit.)

"Sonic clarity" is a subjective concept that no one knows how to handle without performing listening tests. But clipping characteristics, although not so easy to generalize on as you might expect, are readily measurable, and some investigators of the tube-versus-transistor controversy have been having a field day with them.

How Does It Clip? As is well known an amplifier clips on signal peaks when the output signal voltage

reaches the upper and/or lower limits of the power supply voltage. However, just before this occurs, the active output devices (tubes or transistors) are being operated in the nonlinear regions of their input/output characteristic curves. It is in such nonlinear operations that the difference between tubes and transistors becomes apparent. As illustrated in Fig. 1, the rounded corners of tube clipping are quite different from the squared-off plateaus of a transistorized amplifier. This means that a heavy dose of spurious high-order harmonics is generated by a transistor amplifier when it clips, the almost universal consensus being that these harmonics just don't sound good.

In May 1973, Russell Hamm published a paper in the *Journal of the Audio Engineering Society* that is probably the most complete guide to the observable consequences of clipping available. Hamm, a recording engineer, investigated the differences between tube and solid-state recording equipment as heard by technicians and musicians. He got such re-

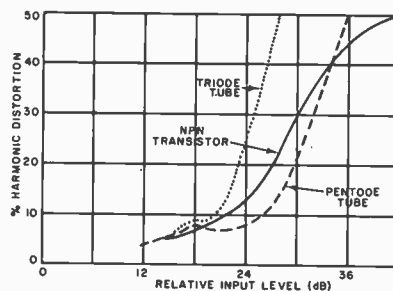

Fig. 2. Single-stage amplifier comparison of total harmonic distortion (THD).

sponses as, "With tubes there is a space between the instruments, even when they play loud ... Transistors make a lot of buzzing" and "Transistors give a 'shattered glass' sound that restricts the dynamics." He stated further that whenever he or his associates heard "an unusually loud and clear popular-music studio recording," they investigated and found in almost every case that the recording console involved used vacuum tubes in its critical circuits.

Hamm delved pretty deeply into the physics and psychoacoustics of the situation and discovered, among other things, that the vacuum tube's clipping characteristics are not so "gentle" in terms of total harmonic distortion as is generally believed (Fig.

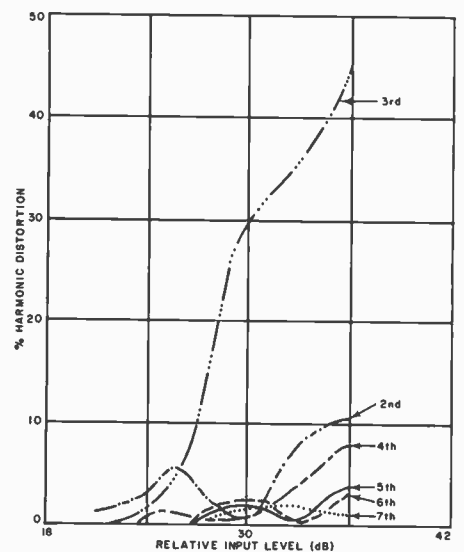
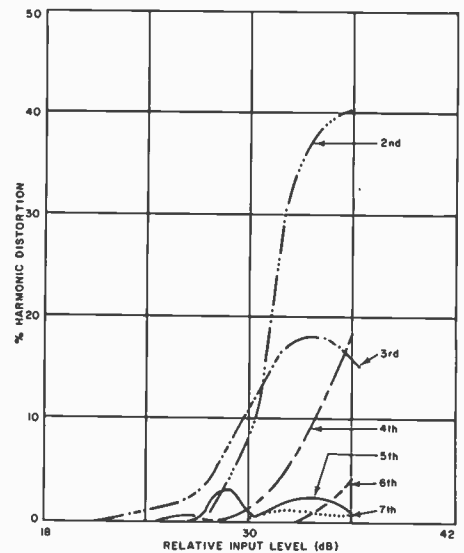

Fig. 3. Distortion components for two-stage triode amplifier (top) and for a multistage capacitor-coupled transistor amplifier (bottom).

2). But at the same time, he found reason to attribute the preference for tube sound to the spectral distribution of distortion products (Fig. 3). In a fascinating discussion based on the techniques for musical instrument design, Hamm suggested that the triode's generation of second-order harmonic distortion during overload made the sound fuller, which would account for the more satisfying dynamic range that listeners heard when tube electronics was used. He also identified harmonics above the seventh as the cause for the sharply defined "edge" we hear on tones from instruments like violins and trumpets. This "edge" is purportedly a loudness cue to the human ear. When we hear it unsupported by a strong second harmonic (presumably the result of transistor clipping), the sound is overly loud, annoying, and "glassy." When

FREE

The world's largest catalog
of easy-to-build, money-saving
electronic kits



- Power Supplies • Oscilloscopes • Frequency Counters
- VTVM's and VOM's • Ham Radio Gear • Color TV's
- Hi-Fi Components • Electronic Clocks • Electronics Learning Programs
- Auto, Fishing, Marine and Aircraft Accessories — over 400 kits in all!

Every Heathkit product comes with a fully-illustrated, step-by-step assembly manual that tells you everything you need to know to make kitbuilding fun and easy. Thousands of people have discovered the satisfaction—and savings—of handcrafting a fine piece of electronic equipment. You can build it better...let us show you how.

Send for your FREE Catalog today! ►
Heath Company, Dept. 10-20, Benton Harbor, Michigan 49022

HEATH		Schlumberger		Heath Company, Dept. 10-20 Benton Harbor, Michigan 49022	
Please rush me my FREE Heathkit Catalog					
NAME _____					
ADDRESS _____					
CITY CL-601A		STATE _____		ZIP _____	

SAVE A COUPLE OF HOURS ON YOUR NEXT PROJECT.

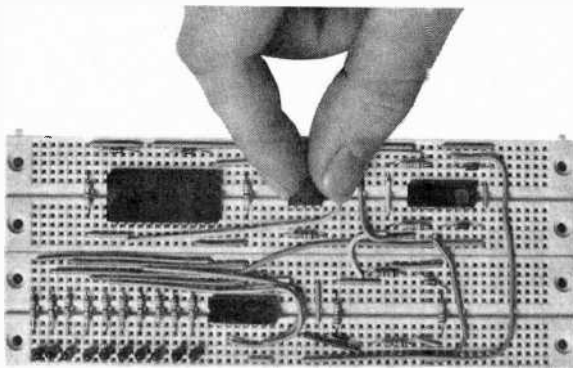

When you consider all the soldering, desoldering and resoldering done on every circuit you design and test, it adds up to a good portion of the time spent on most projects.

We have a better way. CSC QT Sockets and Bus Strips* The expandable interlocking solderless breadboarding system that provides dozens to thousands of plug-in tie-points for easy connection—and interconnection—of all types of components. From resistors and capacitors to LED's

and IC's. As fast as you can push a lead into a hole...almost as fast as you can think...you can wire, test and modify all kinds of circuits.

Next project, why not do it the easy way? Save time. And save money too, because QT Sockets and Bus Strips won't destroy component leads either. Ask your electronics dealer about CSC's many helpful breadboarding aids... or contact us for our catalog and distributor list.

EASY DOES IT.

CONTINENTAL SPECIALTIES CORPORATION



44 Kendall Street, Box 1942
New Haven, CT 06509 • 203-624-3103 TWX: 710-465-1227
West Coast office: Box 7809, San Francisco, CA
94119 • 415-421-8872 TWX: 910-372-7992
Canada: Len Finkler Ltd., Ontario

*U.S. Pat. No. D 235,554

the distortion products include a prominent second harmonic (as in the output of a clipping triode amplifier), the sound is naturally loud, rich, and full-bodied.

Hamm's descriptions of transistor behavior read like a tube enthusiast's critique of transistor amplifiers. But who, besides recording studios, operates his equipment in a state of almost constant overload? Also, most audio enthusiasts don't object to amplifier overload when they recognize it as such. They *do* object to poor sound on relatively quiet musical passages when the amplifier can't be close to exceeding its specified power output. And, apparently, they are hearing effects from transistor amplifiers that sound remarkably like Hamm's clipping symptoms — but without any obvious possibility of clipping in the amplifier.

TIM Again. Although the concept of transient intermodulation distortion (TIM) is being taken very seriously in Europe and elsewhere, it gets almost no attention here in the U.S. Perhaps that's because it's not widely understood that TIM (like any type of distortion) can arise from numerous causes, and therefore it's tricky to isolate. Also, the mechanism of TIM is so obvious that you'd not expect an amplifier designer to overlook it. Also, it's possible that TIM has been misnamed; maybe it should be called "feedback inertia," because it invariably arises when there are high-speed events within the amplifier that are too short in duration for the feedback to affect properly.

Most transistor amplifiers use large amounts of negative feedback. They use it for various reasons, such as to extend frequency bandwidth and maintain stability and to convert 0.5% distortion figure to 0.005%, which looks very good in the test labs. But the test labs employ a steady-state sinusoid signal to evaluate amplifiers, and they allow the amplifiers to cope with the signal for a finite period of time before measurements are made. It's just possible that the amplifier under test could go crazy at the first moment the test signal is applied to it, and then settle down to a comfortable accommodation a few milliseconds later. But music almost never stands still, and TIM devotees claim that an amplifier that can't keep up with the music signal is not suitable for audio

reproduction of the highest quality.

If the amplifier under test goes crazy in these critical first few milliseconds, it has TIM. What does this mean? First of all, it means that a small fraction of the input signal gets through without being "corrected" by negative feedback. Maybe that will result in 0.5% distortion rather than 0.05%, for that instant. This is trivial. What is not trivial is that the feedback-receiving stage of the amplifier is designed to work with a lot of negative feedback, and for a moment it's not getting it! Overload is a likely result — not overload of the output stage, which might coast effortlessly through the whole process, but overload of a preliminary driver stage. If you consider the possibilities of such a situation — poor overload recovery in the stage affected or in other parts of the amplifier, current limiting in subsequent stages, etc. — you'll begin to realize why some people describe all amplifiers as having special characteristics of their own. They may not always do so for the right reasons, but they do have justifiable cause. The audible symptoms seem to point to overload,

just as Russell Hamm describes it. The measurable symptoms point to driver or pre-driver stages as being responsible.

Why are tube designs comparatively free of this effect? I suggest it's because tube amplifiers don't employ a lot of negative feedback. And if you use a minimal amount of feedback, you'll get a minimum of TIM.

The Overall Outlook. Lots of people have theories why tubes sound different from transistors. Many others have theories why they don't. I believe that amplifiers, tube or transistor, can sound different from one another, for reasons essentially unrelated to the inherent characteristics of the active devices they employ. In support of my argument, I'll quote Tom Jelsing of Bang & Olufsen:

"When complete knowledge of the waveform at all stages in an amplifier is essential, it is not adequate to analyze the total transfer function from input to output in an amplifier with feedback. The transfer function must be analyzed at all points in the circuit, or at least at all possibly critical

points. Some of these (analyses) are more straightforward than others, but the analysis must be made if the designer is to be certain that the signal amplitudes do not exceed the dynamic range available at every point."

I'll also quote Tomlinson Holman of Advent:

"In 1976, tube technology must be considered to be very mature; transistor technology should be considered to be approaching adolescence. A comparison of the average tube unit with the average transistor unit would certainly demonstrate a lopsided balance in favor of the tube unit, simply because only a few high-quality tube units remain on the market at this time.

"I see no *inherent* advantage with any of the possible technologies: bipolar transistors, field-effect transistors, tubes, or integrated circuits. Tubes have frailties and can definitely age. Transistors can be nonlinear if tube-based designs are translated to solid state. Yet very fine transistor designs have evolved by treating transistors as what they are." Amen! ♦

3 GOOD REASONS FOR BUYING AN EMPIRE CARTRIDGE

1. YOUR RECORDS WILL LAST LONGER. Unlike ordinary magnetic cartridges, Empire's variable reluctance cartridges have a diamond stylus that floats free of its magnets. This imposes much less weight on the record surface and insures much longer record life.

2. YOUR RECORDS WILL SOUND BETTER. Empire sound is spectacular.

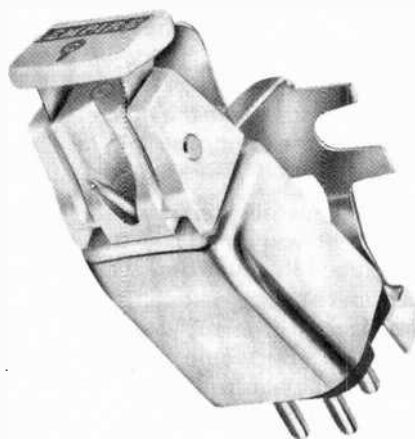

Distortion at standard groove velocity does not exceed .05%. Instruments don't waver; channel separation is razor sharp.

3. MORE CARTRIDGE FOR YOUR MONEY. We use 4 poles, 4 coils and three magnets in our cartridge (more than any other brand). Each cartridge must pass rigid tests before shipment.

For more good reasons to buy an Empire cartridge write for your free catalogue: EMPIRE SCIENTIFIC CORP., Dept. Z, Garden City, N.Y. 11530.

EMPIRE



Have a problem or question on circuitry, components, parts availability, etc.? Send it to the Hobby Scene Editor, POPULAR ELECTRONICS, One Park Ave., New York, NY 10016. Though all letters can't be answered individually, those with wide interest will be published.

By John McVeigh

ALARM EXIT DELAY

Q. I want to add an exit delay (about 30 seconds) to my 6-volt alarm system. Any ideas?

—Scott Goldman, Great Neck, NY

A. We've received a number of similar requests, some of which sought a circuit to turn off an alarm siren, say, five minutes after it was enabled. The circuit shown can perform either function. As an exit delay, push *S1* to activate. Then *T* seconds later ($T = 1.1RC$),

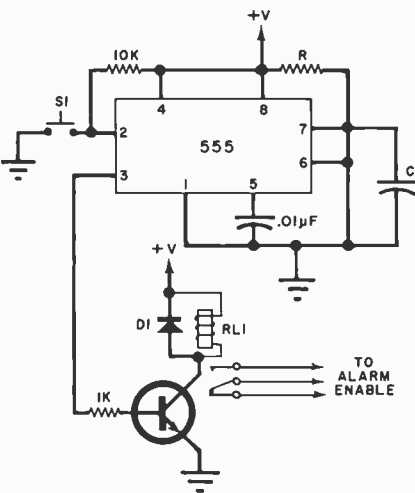

relay *K1* will be deenergized. Use the relay contacts to activate the alarm sensor circuit (however this is done in your alarm system). To turn off a siren, *K1*'s contacts can simply interrupt the siren power supply. To activate this circuit, pin 2 of the 555 must be momentarily brought to ground — through an inverted one-shot, or similar means. Use a momentary pushbutton for *S1*, a general-purpose diode for *D1*, and a low-voltage (6-18 V, depending on supply) dc relay for *K1*. Be sure to select a switching transistor (*Q1*) which can handle the relay coil's current.

REFRIGERATORS AND TURNTABLES

Q. Whenever my refrigerator turns on, I hear a loud pop through my speakers. But this only happens when I'm using my turntable. The problem isn't due to noise on the ac line, because it still happens with the turntable power cord unplugged.

—Tom Russell, Providence, RI

A. The noise could be due to one of two things. First, a physical vibration could cause a transient movement of the stylus. (You didn't mention whether or not you removed the tone arm from the disc when you removed the cord). Shock-mounting the turntable with foam rubber should take care of that. The more probable cause is the strong magnetic field generated by the compressor motor at the instant it turns on. It could induce a transient signal on the cable to the preamp, and thus be amplified and fed to the speakers. Alternatively, the field could induce a signal on a lead in the phono preamp itself. Such problems have no easy cure. But you'd best start by slipping the phono signal leads into a length of tubular copper braid, which should be grounded to the amplifier chassis. In turn, the chassis should be connected to a good earth ground. If the problem persists, you might have to shield the entire phono preamp circuit with fine screening bolted to the chassis. Finally, rotating the amplifier so that the lead picking up the signal is parallel to the field's line of force will weaken any residual induced signal.

24V to 12V

Q. I have a 24-volt, 1 ampere dc power supply. I would like to step down the output to 12V dc so I can power my auto tape player and CB mobile transceiver in the house. What do I need to accomplish this task?

—P.C., New Jersey

A. Three simple options come to mind. First, you could insert a 12-volt zener diode in series between the 24-volt output and the +12-volt lead of the tape player. However, at one ampere maximum, you would need a zener with a dissipation of 12 watts. That could be done by paralleling two matched 12-volt, ten-watt zeners. But high power zeners can be expensive. Alternatively, a 12-volt, low power zener, limiting resistor, and pass transistor could be used. A cheaper solution would be to use a 12-volt IC regulator. The Radio Shack No. 276-1771 is a suitable regulator in a T0-3

can. The INPUT pin should be connected to +24 volts (it is rated at +30 V max.), the OUTPUT pin to the +12-V lead of the player, and the case to an adequate heat sink and both chassis grounds. The regulator costs only \$1.59 as listed in the 1976 Radio Shack catalog. However, due to limitations of your power supply, only 1 A max. at 12 volts can be obtained. Many tape players and transceivers draw about 1.5 A. Getting more current output would mean modifying the power supply's transformer and built-in regulator.

HIGH-PASS FILTER

Q. Do you have a simple circuit for a high-pass TV filter for use with 75-ohm coaxial lines?

—Murray Becker, Brooklyn, NY

A. Here's a filter that can be used with coax-fed TV and FM receivers. Capacitors are silver mica types, rated in picofarads. The inductors are three

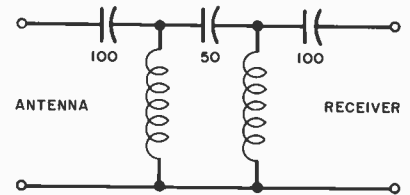

turns of No. 14 wire, 3/4" (19.05-mm) diameter, spaced eight turns to the inch. It will attenuate all signals below 40 MHz, but will pass TV and FM signals. For best results, the filter should be constructed in a shielded enclosure, but shielding will not always be necessary.

MOBILE STEREO AMPLIFIER

Q. I want to build the "Mobile Stereo Amplifier" in the February issue, but I can't find the NE540 or SE540 driver chips. Do you know of any sources?

—Michael McMahan, Urbana, Ohio

A. Surprisingly, I've received a large number of similar requests. I really didn't expect that to happen, because the 540 is offered by many surplus dealers in the back of PE. Some of them even sell a 540 and the complementary output transistors as one package. At any rate, referring to the June issue, you will find the following dealers offering the 540 driver IC: Solid State Sales (P. 108); James Electronics (P. 111); Quest Electronics (P. 117); and Digi Key (P. 118). In some recent issues of PE, I've counted as many as ten dealers offering the NE 540 or SE540!

NEED HARDCOPY?

If you are one of the many computer users who wants hardcopy printouts, but can't afford any of the available machines, your troubles are over. Our PR-40 is a universal printer that gives you clear easy to read hardcopy like the sample on the right with almost any computer. Our printer operates from any eight bit parallel I/O port. The printer has it's own character generator and memory buffer. This means that the computers only job is to feed data when the printer is ready. No special program is needed in the computer to convert the data to a form that the printer can use as each character is printed. The PR-40 is easy to use, easy to interface and easy to afford.

* SWTPC PR-40 ALPHANUMERIC PRINTER *

- * 40 CHARACTERS / LINE
- * 5 X 7 DOT MATRIX IMPACT PRINT
- * USES STANDARD 3 7/8" CALCULATOR PAPER
- * 75 LINE / MINUTE PRINT RATE
- * AUTOMATIC RIBBON REVERSE
- * 64 CHARACTER ASCII CHARACTER SET
- * 40 CHARACTER LINE MEMORY
- * TTL, SWTPC 6800, MITS COMPATIBLE

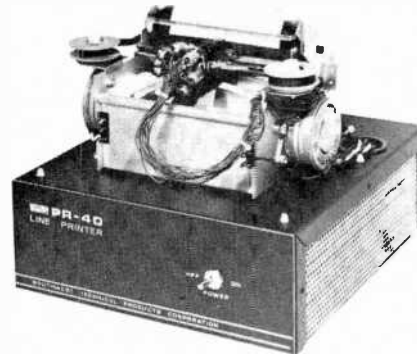

PR-40 LINE PRINTER KIT..... \$250.00 Ppd

HOW ABOUT PICTURES?

Games are more fun with pictures. Now you can add graphics displays to your game programs and on any type computer. Our GT-6144 operates from any eight bit parallel I/O port. It has it's own self contained memory, so memory space for the display is not robbed from your computer. The 9½ x 13 circuit board contains all you need to produce a graphic display like the one of the starship "Enterprise" shown on the left. Kit is less power supply, or chassis.

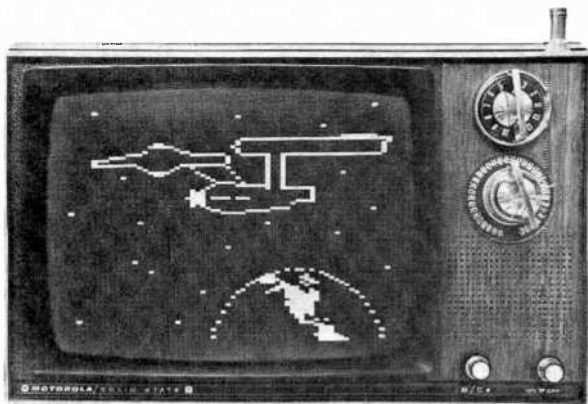

GT-6144 GRAPHICS TERMINAL KIT . \$ 98.50 Ppd



I know a bargain when I see it. Send the following:

- | | | | |
|--|----------|---|----------|
| <input type="checkbox"/> 6800 Computer | \$395.00 | <input type="checkbox"/> PR-40 Printer | \$250.00 |
| <input type="checkbox"/> GT-6144 Graphics Terminal | \$ 98.50 | <input type="checkbox"/> Just data (free) | |

NAME _____

ADDRESS _____

CITY _____

STATE _____

ZIP _____

Southwest Technical Products Corp.
Box 32040, San Antonio, Texas 78284

The better the training the better you'll

Send for
FREE
illustrated
career
guide

NTS guide
to careers in
Electronics

COMPU-TRAINER
TROUBLESHOOTER
VOM
IN-CIRCUIT TRANSISTOR TESTER

SOLID-STATE
OSCILLOSCOPE

ELECTRO-LAB

(Simulated TV Reception)

As an NTS student you'll acquire the know-how that comes with first-hand training on NTS professional equipment. **Equipment you'll build and keep.** Our courses include equipment like the **NTS/Heath Digital GR-2000 Solid State color TV** with first-ever features like silent varactor diode tuning; digital channel selection, (with optional digital clock), and big 315 sq. in. ultra-rectangular screen.

Also pictured above are other units — 5" solid state oscilloscope, vector monitor scope, solid-state stereo AM-FM receiver with twin speakers, digital multimeter, and more. It's the kind of better equipment that gets you better equipped for the electronics industry.

This electronic gear is not only designed for training; it's field-type — like you'll meet on the job, or when you're making service calls. And with NTS easy-to-read, profusely illustrated lessons you learn the theory behind these tools of the trade.

Choose from 12 NTS courses covering a wide range of fields in electronics, each complete with equipment, lessons, and manuals to make your training more practical and interesting.

Compare our training; compare our lower tuition. We employ no salesmen, pay no commissions. You receive all home-study information by mail only. All Kits, lessons, and experiments are described in full color. Most liberal refund policy and cancella-

and the equipment be equipped.

**COMPARE OUR
KITS AND LESSONS.
COMPARE OUR
TUITION.**



tion privileges spelled out. Make your own comparisons, your own decision. Mail card today, or clip coupon if card is missing.

NO OBLIGATION. NO SALESMAN WILL CALL

APPROVED FOR VETERAN TRAINING
Get facts on new 2-year extension

NATIONAL TECHNICAL SCHOOLS
TECHNICAL-TRADE TRAINING SINCE 1905
Resident and Home-Study Schools
4000 So. Figueroa St., Los Angeles, Calif. 90037

NATIONAL TECHNICAL SCHOOLS Dept. 205-086
4000 South Figueroa St., Los Angeles, Calif. 90037
Please send FREE Color Catalog and Sample Lesson.
NO OBLIGATION. NO SALESMAN WILL CALL.

Color TV Servicing Electronics Technology
 B & W TV and Radio Servicing Computer Electronics
 Electronic Communications Basic Electronics
 FCC License Course Audio Electronics Servicing

NAME _____ AGE _____

ADDRESS _____ APT # _____

CITY _____ STATE _____

Please fill in Zip Code for fast service _____

Check if interested in G.I. Bill information.
 Check If interested ONLY in classroom training in Los Angeles.

NEWS HIGHLIGHTS

TV Rivals Phones & Cars

It has taken only 30 years for television to rival both the telephone and motor vehicle in worldwide popularity, according to RCA. Based on latest available statistics, it is estimated that there are 364 million TV receivers worldwide, compared with 360-million phones and 300-million cars and trucks. The U.S. leads in all categories, with approximately 120-million TV receivers, 144-million phones, and 130-million motor vehicles. The U.S.S.R. comes in second with 50-million TV receivers, 15.8-million telephones, and 7-million vehicles, while Japan is third with 25.5-million, 41.9-million and 25-million respectively. The size of the worldwide TV market is impressive, considering that the industry growth began only in 1946, whereas the telephone is 100 years old and the car is almost 80 years old.

RCA Tube Business To GTE

RCA Corp. has sold machinery, parts, raw materials, work in process, and technical data related to the manufacture of Nuvistors and certain other receiving tubes produced at its plant in Harrison, N.J. to GTE Sylvania, Inc. On January 15, 1976, RCA announced its decision to cease manufacturing operations at its Harrison plant by July 30 and that efforts were being made to sell the manufacturing tools and equipment. With all receiving tube manufacturing ending in April, RCA stated its intention to close the Edison, N.J. warehouse and distribution center by the end of June 1976.

LED Watch Circuit Extends Battery Life

Gruen Industries, Inc., has announced a new electronic circuit that increases battery life by 65% in LED digital watches. The circuit was developed through Gruen's efforts to produce thinner, more fashionable solid-state watches for women without sacrificing the battery life. Batteries rated at 6600 cycles operated on an average of 25 cycles per day yield a life of 264 days in conventional LED watches. With Gruen's new circuit, the battery is said to last an average of 11,000 cycles, or 440 days. The new circuit will be used only in the company's Telstar lady's watches, but men's modules are slated for early development.

MDS Threatens Cable TV

Although it has been around for more than half a decade, Multipoint Distribution Service (MDS) has during the past year or so become a widespread concern in the cable TV world. Since mid-1975 when multiple system operators entered into agreements with the largest MDS owner to provide pay-TV service to communities via MDS technology, cable-TV operators have seen it as a growing threat to them. The cable-TV people feel that

MDS will "skim the cream off the urban market" by providing pay services to multi-dwelling housing units at costs far below those of wiring for cable. Others view MDS as a communication "link" with the potential for expanding the scope and flexibility of a cable system by providing a new means of delivering programming to cable headends.

Walkie-Talkies Move From 27 MHz

Acting on Docket 20119, the Federal Communications Commission has shifted the 100-mW walkie-talkie that can be operated without a license from the 27-MHz Citizens Band to 49.82 to 49.90 MHz. Manufacture of the 100-mW (27-MHz) CB transceivers is permitted to continue for a year, and their use will be permitted until 1983.

Calculators For The Blind

The American Foundation for the Blind has introduced two calculators—one braille and the other an audible unit—for blind and visually handicapped persons. The braille calculator was adapted by AFB's engineering division from a standard portable calculator. It is a five-function unit with floating decimal point, mounted in a box and equipped with a single braille cell. The cell, which uses four dots of the basic six-dot braille notation, is activated by depressing the "read" button at the front of the instrument. The digits and decimal point displayed on the visual readout are presented in sequence in the form of small pins which pop up to form a braille digit. The audible version has a 24-word vocabulary which announces every entry and result. It has six basic functions, accumulating memory, automatic constant, change-of-sign key, floating decimal point, and 8-digit display. The speech key can be pressed repeatedly to announce what is on display without initiating further calculations. The speaker is loud enough for small classrooms and there is an earphone for private listening. AFB's catalog, "Ideas for Better Living," describes these units along with several hundred other devices designed for the blind. Write to Aids and Appliances Division, AFB, 15 W. 16th St., New York, NY 10011, for a free copy.

Magnetic Recording Tape to Smithsonian

A piece of the world's first magnetic recording tape has been presented to the Smithsonian Institution by BASF Wyandotte Corporation. The company developed magnetic tape in Germany in 1932 and began commercial production in July 1934 at BASF's plant in Ludwigshafen, Germany. The 1934 tape was made of cellulose acetate, coated with carbonyl iron powder. It could be played on one side only and was further limited by a playing speed of one meter per second. Even so, this was an improvement over the steel wire which had been used until then since the magnetic tape was lighter than steel and could be cut and spliced.

ATTENTION DEALERS...

WE'RE SITTING ON THE LARGEST SELECTION OF

- ★ CBRADIOS
 - ★ CB ANTENNAS
 - ★ CB ACCESSORIES
- IN THE COUNTRY!



SEND \$5.00 FOR YOUR COPY OF OUR NEW

238 PAGE CATALOG

DEDUCTIBLE FROM YOUR FIRST ORDER!

238 PAGES! THAT'S ONE OF THE BIGGEST CATALOGS IN AMERICA!

LITERALLY!

...AND BENNIE'S ONE OF THE BIGGEST DISTRIBUTORS!



Bennies Warehouse Distribution Center

Sleeper!

The Realistic® STA-90 Will Change Your Ideas About Who's #1 in Hi-Fi Features, Value and Style!

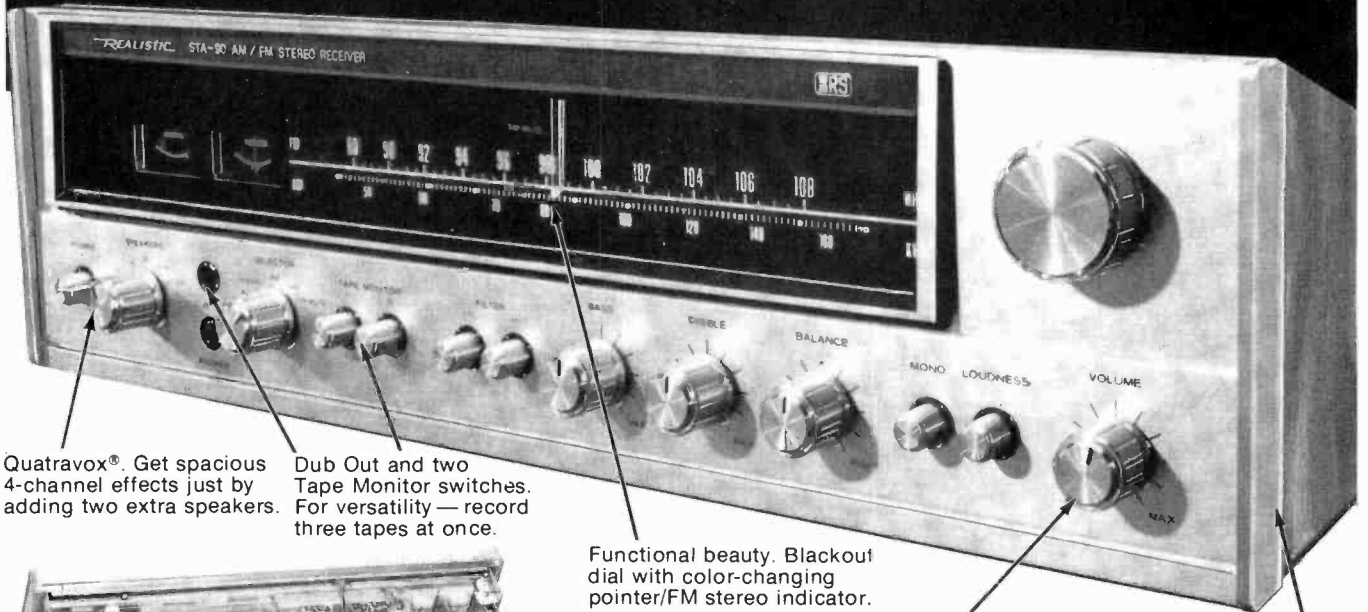

Quatravox®. Get spacious 4-channel effects just by adding two extra speakers.

Dub Out and two Tape Monitor switches. For versatility — record three tapes at once.

Functional beauty. Blackout dial with color-changing pointer/FM stereo indicator.

Solid metal knobs.

Walnut veneer case.

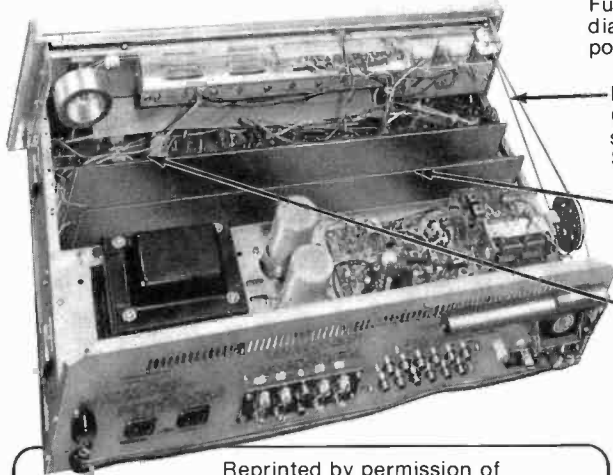

Dual-Gate MOSFET FM. Gets weak stations and still resists overload. Superior to FET designs.

Phase-locked loop FM stereo demodulator. For wider channel separation, almost zero distortion.

Direct-coupled amplifiers for powerful bass even at 20 Hz. 45 watts per channel, minimum RMS at 8 ohms from 20-20,000 Hz, with no more than 0.5% total harmonic distortion.

Amplifier Specs

Power Bandwidth: 17-35,000 Hz
 Response: 20-20,000 Hz \pm 2 dB
 IM Distortion: 0.3% at 30W
 Phono Overload: 150 mV
 Hum and Noise (dB):
 Phono 1, -60
 Aux 1, -75

FM Tuner Specs

Sensitivity: 2.0 μ V IHF
 S/N Ratio: 65 dB
 Separation: 35 dB at 1 kHz
 Total Harm. Dist.: 0.8%
 Capture Ratio: 2 dB
 Selectivity: 70 dB

Reprinted by permission of Stereo Review Magazine, March, 1976 issue.

"The total harmonic distortion (THD) was less than 0.025 per cent from under 1 watt to 50 watts output, reaching 0.46 per cent at 55 watts."



SOLD ONLY WHERE YOU SEE THIS SIGN:

Radio Shack®

A TANDY CORPORATION COMPANY
 OVER 4600 LOCATIONS • 50 STATES • 9 COUNTRIES

FREE 164-Page Catalog. Write to Radio Shack, P.O. Box 1052, Dept. #759, Fort Worth, TX 76101

Only 359.95 at participating stores and dealers. Prices may vary at individual stores. U.L. listed. Ask for 31-2063. See what a Sleeper looks like — today!

THERE are basically two ways in which you can get involved with microcomputers on the nonprofessional level. You can buy one of several reasonably priced hobby computer kits, add a TV or typewriter terminal, and learn to use high-level language. On the other hand, you can build your own inexpensive system from scratch. This permits you to experiment with simple applications that do not require an expensive terminal or a large memory. You can communicate with the computer in a relatively simple language.

The "Elf" microcomputer project gives you the latter category of computer system—for about \$80. It is an excellent hardware and software trainer that uses machine language and can be easily expanded to do just about anything a full-blown microcomputer can. Packaging, however, is up to you.

The basic Elf has toggle-switch input, hex LED display, 256 bytes of RAM, four input lines and a latched output line. It can be used to play games, sequence lights, control motors, generate test pulses, count or time events, monitor intruder-alert devices, etc. You can do all these things while learning how to program in order to produce a "real" output to determine whether or not the program you designed works. If you prefer not to control or time things, a simple LED can be used to indicate whether or not your program works.

Our focus here is on the construction of the low-cost computer and some simple examples of programming.

Design Details. The heart of the Elf microcomputer is the new RCA CDP1802 COSMAC microprocessor chip that sells for less than \$30. The chip can use any combination of standard RAM and ROM devices and can address up to 65,536 (65 k) bytes of memory. It has flexible programmed I/O and program-interrupt modes, an on-chip DMA (direct memory access), four I/O flag inputs directly tested by branch instructions, and a 16 × 16 matrix of registers for use as multiple program counters, data pointers, or data registers.

Other features of the 1802 chip include voltage operation between 3 and 12 volts dc at very low current drain, TTL compatibility, built-in clock, and simplified interfacing. There is also a built-in program load-

BUILD THE COSMAC "ELF"

A LOW-COST EXPERIMENTER'S MICROCOMPUTER

PART 1



*Simple-to-build computer trainer
can be expanded
for advanced applications.*

BY JOSEPH WEISBECKER

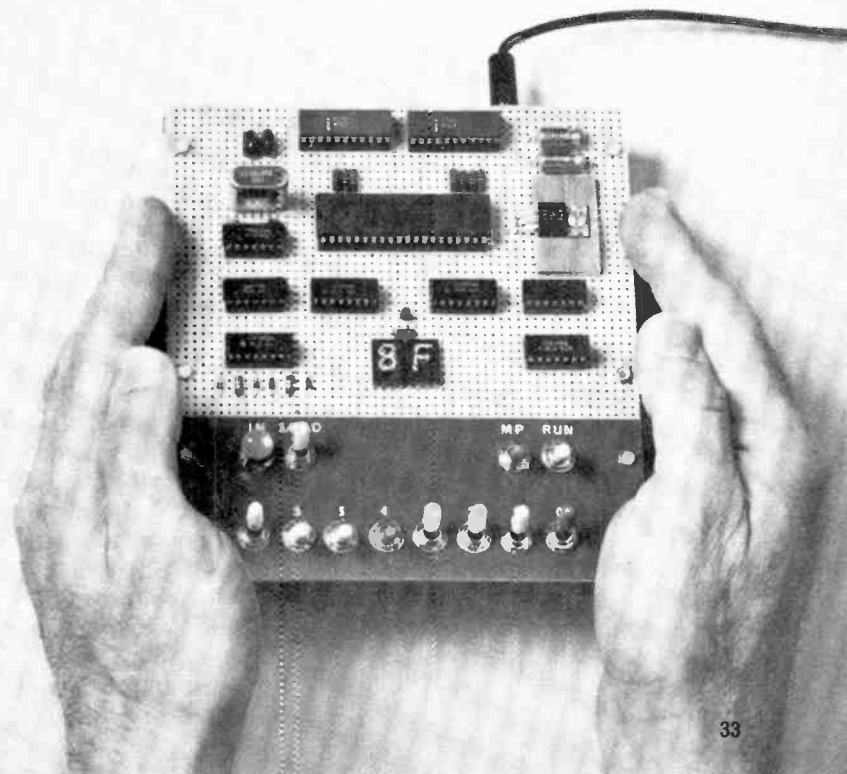

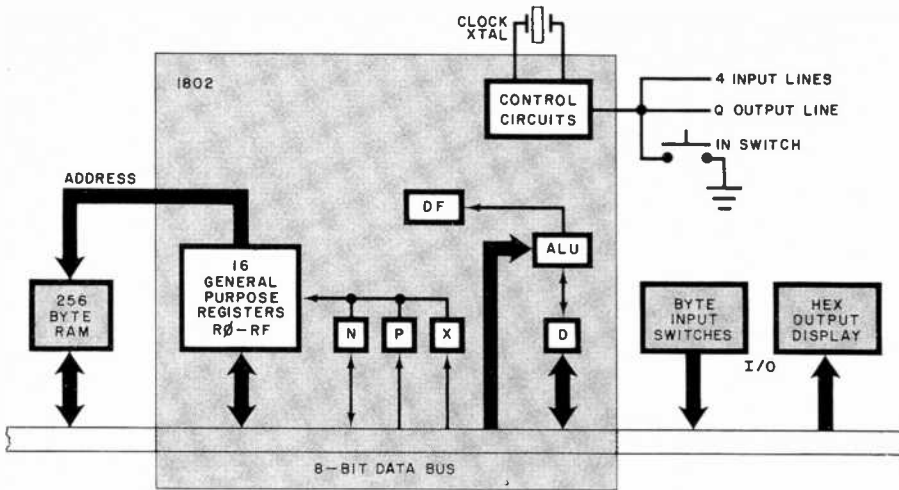

Fig. 1. Block diagram of basic computer. Up to 65K bytes of memory, 91 instructions, and varied I/O ports can be added as the system grows.

ing capability that allows you to load a sequence of bytes without having to toggle in a new address for each byte. No ROM is required for the minimum trainer system described here. The multiple program counters permit some interesting programming "tricks," and the many single byte instructions keep programs short.

A block diagram of the Elf system is shown in Fig. 1. The pinout for the 1802 microprocessor chip is shown in Fig. 2.

Basic Operation. The key to understanding the computer is the method used for addressing the memory. At first, the procedure may appear to be complicated, but you will soon see that it is not difficult.

The 1802 chip contains 16 general-purpose registers, each holding 16 bits (two bytes) of memory addresses or data. The registers are labelled R0 through RF to conform to the hexadecimal numbering system, as shown in Fig. 3. (In the diagrams, and in computer technology in general, a Danish zero—a zero with a slash through it—is used to distinguish zero from a capital letter O.) Hence, if we refer to the low-order, or least-significant, byte of R1, we can call it R1.0, while the high order byte of RF would be called RF.1.

There is also an 8-bit D register that is used to move bytes around. In the instruction set shown in part in the Instruction Subset Table, note that the 8N (8 with a digit) code will copy a low-order general register byte into register D. Writing this instruction as 81 in a program will cause R1.0 to be copied into D when the instruction is executed. We can then use instruction

BF (BN in the table, with B and a digit) to copy the D byte into RF.1. It takes two bytes, 81 BF, to transfer a byte from R1.0 to RF.1 via temporary holding register D. The byte in D can also be used in arithmetic operations per-

formed by the ALU (arithmetic logic unit) circuits.

There are three other important registers that are labelled N, P, and X. Each can hold a 4-bit digit that is used to select one of the 16 general-purpose registers. For example, if you wanted to talk about the general-purpose register selected by the hex digit in X, you would call it RX. RN would refer to the general-purpose register designated by the 4-bit digit currently contained in N; if the digit is 4, RN = R4.

The general-purpose registers can contain 16-bit memory addresses. Suppose register R3 contains data

0012. M3 would mean the memory location specified by the contents of R3, and M(0012) means memory location 0012 directly. MX means the memory location addressed by the contents of the general register selected by the current digit in X. If X = 3, MX = M3; if R3 = 0012, MX = M3 = M(0012).

Since the basic computer has only 256 bytes of memory, we use just the low-order bytes of the general registers to address the memory. In expanded-memory systems, you can use the high-order bytes of the general-purpose registers to select individual 256-byte pages of random-access memory (RAM).

The memory contains both instructions and data bytes. Instruction bytes tell the computer what to do with the data bytes. One-byte instructions have two hex digits, where high-order bits 7, 6, 5, and 4 tell the computer what type of operation to perform. Low-order bits, 3, 2, 1, and 0 are usually placed in the N register when a new instruction is fetched from memory.

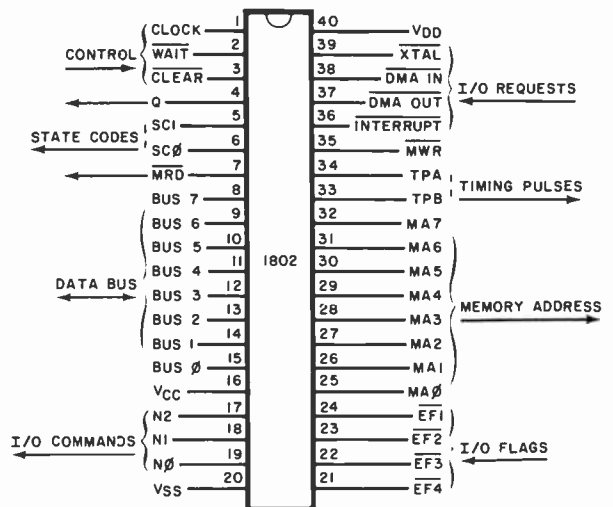

Fig. 2. Pin out for the CDP1802 COSMAC microprocessor.

Any one of the general-purpose registers can be used as a program counter. The program counter addresses instruction bytes in memory. Each time an instruction is fetched from memory, the program counter is

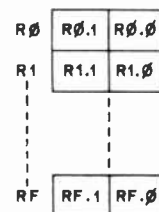

Fig. 3. The 16 registers in the 1802 are labelled R0 through RF (hex).

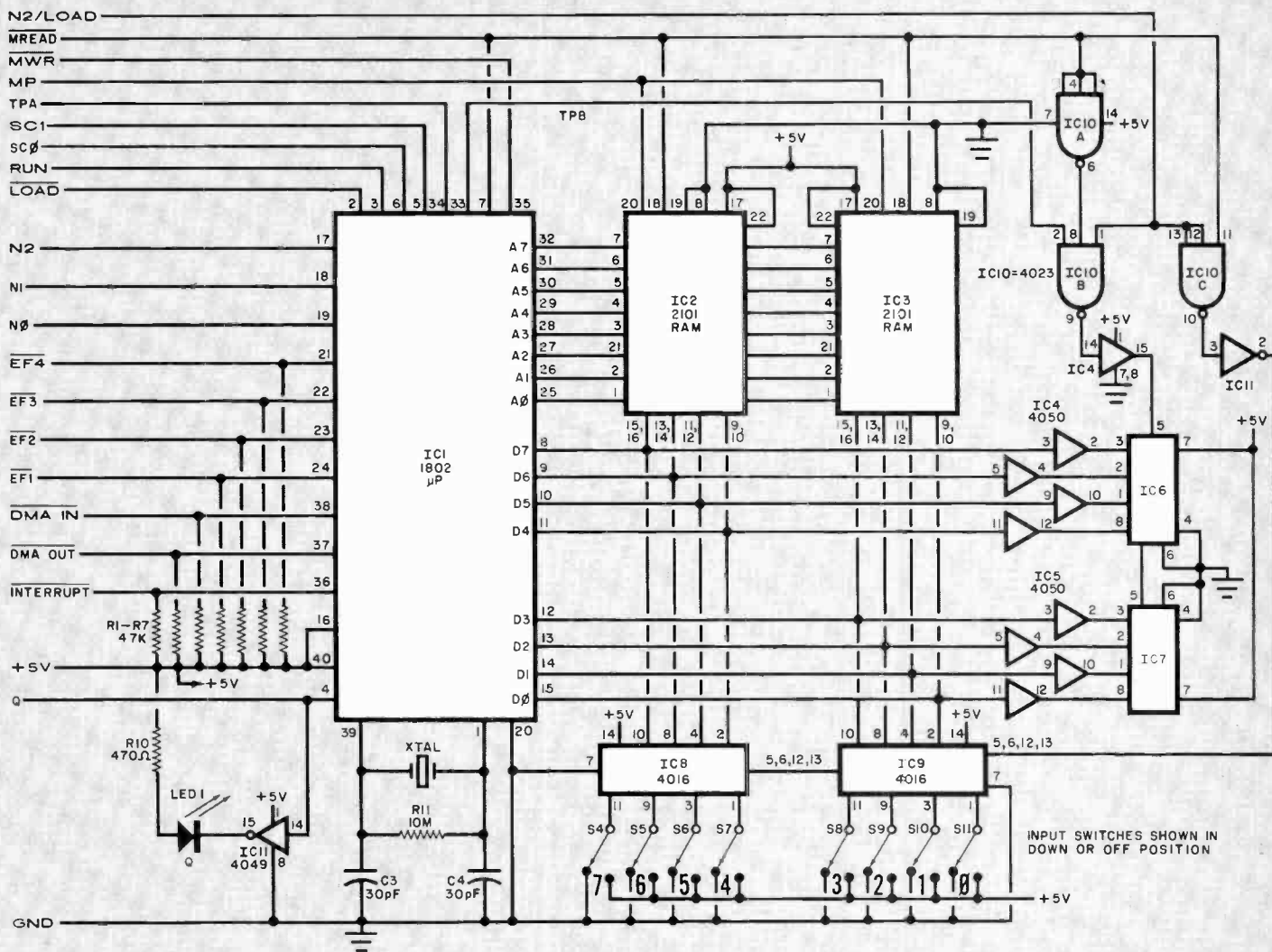

Fig. 4. Complete circuit for the Elf computer. Identified connections on the left go to the "front panel" with the eight data switches. The remaining can be left "floating" at 1802, or tied to terminal strip.

PARTS LIST

C1, C2—10- μ F, 16-volt electrolytic capacitor
 C3, C4—30-pF disc capacitor
 D1 through D6—IN914 switching diode
 IC1—CDP1802 COSMAC microprocessor chip (RCA)
 IC2, IC3—2101 (256 \times 4) static RAM IC
 IC4, IC5—4050 noninverting hex buffer IC
 IC6, IC7—Hex LED display (H-P No. 5082-7340)
 IC8, IC9—4016 quad bilateral switch IC
 IC10—4023 triple 3-input NAND gate IC
 IC11—4049 inverting hex buffer IC

IC12—4013 dual D flip-flop IC
 IC13—LM309K 5-volt regulator IC
 LED1—Red light-emitting diode
 R1 through R9—47,000-ohm, 1/4-watt resistor
 R10—470-ohm, 1/4-watt resistor
 R11—10-megohm, 1/4-watt resistor
 S1 through S11—Spdt toggle switch
 S12—Pushbutton switch with one set each normally open and normally closed contacts
 XTAL—1-to-2-MHz crystal (see text)
 Misc.—5 1/2" \times 4" (14 \times 10.1 cm) perforated board with 0.1" (2.54 cm) hole spacing;

5 1/2" \times 2" (14 \times 5.1 cm) piece of thin aluminum; 3/4" \times 3/8" (19.1 \times 9.5 cm) pine for chassis rails; 14-pin IC sockets (4); 16-pin IC sockets (3); 22-pin IC sockets (2); 40-pin IC socket; connector for power supply; 9-volt, 350-mA dc power source; 1 1/4" \times 3/4" \times 1/8" (31.8 \times 19.1 \times 3.2 mm) piece of aluminum; dry-transfer lettering kit; machine and wood hardware; hookup wire; solder; etc.
 Note: the CDP1802 COSMAC microprocessor chip is available from any RCA parts distributor as is the COSMAC user manual.

automatically incremented so that it points to the next instruction to be fetched. Branch instructions can be used to change the address in the program counter to permit jumping (branching) to a different part of the program when desired. The digit in the 4-bit P register specifies which 16-bit general-purpose register is being used as the program counter.

Timing Sequence. Since many of

the 1802 microprocessor's instructions are only one-byte long and require two machine cycles, the first cycle is always an instruction fetch, or memory read. The fetched instruction is executed during the next machine cycle, which could be a memory-read, memory-write, or register-transfer type of cycle.

Program execution always consists of a sequence of fetch-execute cycles, and the two SC0 and SC1 lines (see

Fig. 4 and Fig. 5) indicate what type of cycle is being performed according to the following criteria:

SC1 SC0 Type of Machine Cycle

0	0	instruction fetch
0	1	instruction execute
1	0	DMA in/out
1	1	interrupt

Direct memory access (DMA) and interrupt are special types of cycles, which we will discuss later.

Circuit timing is shown in Fig. 6.

Fig. 5. Control circuits for the computer. Connections at right go to similarly marked connections on main circuit.

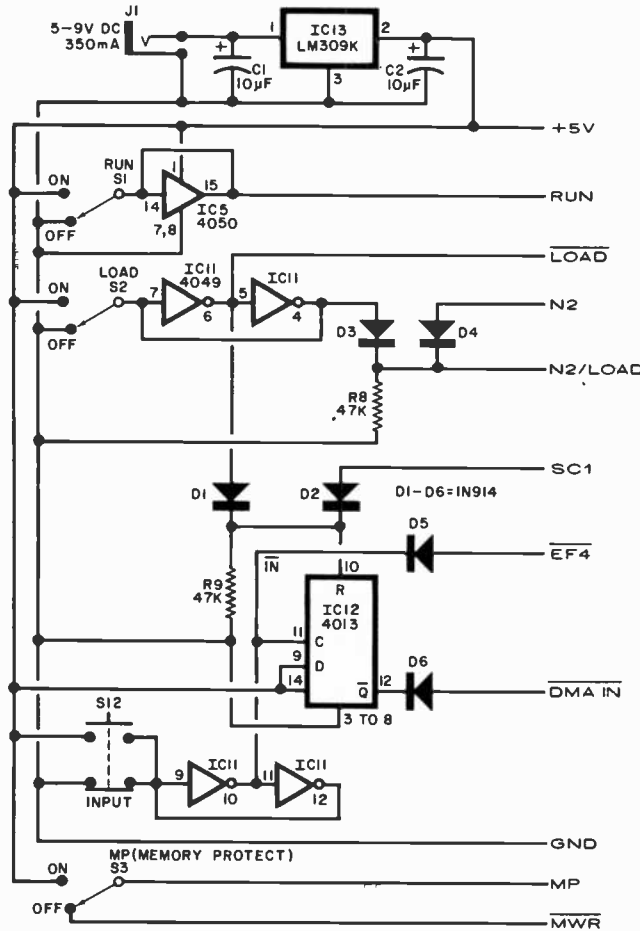

Note that each machine cycle requires eight clock pulses.

The microprocessor has an internal single-phase clock circuit. Connecting a crystal between pins 1 and 39 of the 1802 chip causes the clock to run continuously. If desired, XTAL, C3, C4, and R11 can be omitted and an external clock with a 5-volt swing can be substituted between pin 1 and ground.

During each machine cycle, timing pulses TPA and TPB are available at pins 33 and 34 of the 1802. TPA occurs at the beginning of each machine cycle and can be used to clock the high-order byte of a 16-bit memory address into a memory page-selection register. Note that the 1802 sends out memory addresses as two 8-bit bytes. The high-order byte appears on address lines A0 through A7 first. Then the low-order byte is held on the A0 through A7 lines for the remainder of the machine cycle. This low-order address byte can, by itself, specify one of 256 locations in the minimum 256-byte memory.

TPB occurs toward the end of the machine cycle and is used to clock a byte from the RAM into an output device (such as the hex display used here). An input byte, to be stored in the

RAM, is gated to the bus for the duration of the input (memory-write) machine cycle so that no time pulse is needed for input bytes.

The MREAD line is low during any memory-read machine cycle. When low, it opens the pin-18 RAM data output gates of IC2 and IC3, permitting the byte stored in the RAM location addressed by A0 through A7 to appear on the data bus. The RAM's access time is such that the output byte appears on the bus prior to TPB. The bus byte from the RAM can then be clocked into an internal register of the 1802 or clocked to an external register (such as the hex display) with TPB, depending on the type of instruction being executed.

When the 1802 is performing an instruction cycle that requires a byte to be stored in the RAM, the MREAD line is held high to disable the RAM output

bus gates. The microprocessor then causes the byte stored in the RAM to be gated onto the bus during the memory-write cycle. This byte can come from an internal register of the 1802 or from an input device (such as switches), depending on the type of instruction being executed. The 1802 then generates a low memory-write pulse (MWR) that causes the bus byte to be stored in the RAM location addressed by the A0 through A7 lines.

Circuit Operation. Using Fig. 4, Fig. 5, and the Instruction Subset Table, we can now discuss the logic of the Elf microcomputer. The RAM address is sent out on lines A0 through A7. Eight tri-state bidirectional bus lines are used to transfer the data bytes back and forth between the 1802's registers and the IC2-IC3 RAM. A RAM byte can be transferred to hex displays IC6 and IC7 via the data bus, using IC4 and IC5 to supply the current drive for the displays. Displays IC6 and IC7 contain latches to store the display byte.

The basic clock frequency of the processor is determined by XTAL, which should not go above 2 MHz in this circuit. The MREAD and MWR lines control the read and write cycles of the RAM, while TPA and TPB provide the timing pulses. TPA can be used for memory expansion address latching, TPB to clock bytes into output circuits. SC0 and SC1 indicate the type of cycle being performed by the 1802.

The N0, N1, and N2 lines are used to select input or output devices. In the Elf, selection can be made among four input and four output devices. The table details the values of the N0, N1, and N2 lines during the machine cycle in which an input or output instruction is executed. Instructions 69, 6A, 6B, 61, 62, and 63 are spares that can be used to add I/O devices or ports to the computer. When 6C is executed, the N2 line goes to a logic-1 state and the bus byte is written into the RAM. Since this is a write cycle, MREAD will be high. With both N2 and MREAD high, the output of gate IC10C will be low, putting the input toggle switch byte on

Fig. 6. Microprocessor timing. One machine cycle requires eight clock pulses. TPA and TPB control various functions, both on and off the computer.

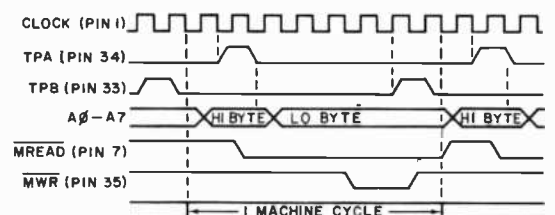

ONE BYTE INSTRUCTIONS				TWO BYTE INSTRUCTIONS					
1N	RN+1			30MM	GO TO MM				
2N	RN-1			31MM	GO TO MM IF Q=1				
8N	RN,0→D			39MM	GO TO MM IF Q=0				
9N	RN,1→D			32MM	GO TO MM IF D=00				
AN	D→RN,0			3AMM	GO TO MM IF D=00				
BN	D→RN,1			33MM	GO TO MM IF DF=1				
4N	MN→D,RN+1			38MM	GO TO MM IF DF=0				
5N	D→MN			34MM	GO TO MM IF EF1=1				
DN	N→P			3CMM	GO TO MM IF EF1=0				
EN	N→X			35MM	GO TO MM IF EF2=1				
7A	0→Q (LIGHT OFF)			3DMM	GO TO MM IF EF2=0				
7B	1→Q (LIGHT ON)			36MM	GO TO MM IF EF3=1				
F0	MX→D			3EMM	GO TO MM IF EF3=0				
F1	MX or D→D			37MM	GO TO MM IF EF4=1 IN				
F2	MX and D→D			3FMM	GO TO MM IF EF4=0 SWITCH				
F3	MX xor D→D			FAKK	KK→D				
F6	SHIFT D RIGHT, BIT 0→DF			F9KK	KK or D→D				
76	ROTATE D RIGHT, DF→B7, B0→DF			FAKK	KK and D→D				
FE	SHIFT D LEFT, BIT 7→DF			FBKK	KK xor D→D				
7E	ROTATE D LEFT, DF→B0, B7→DF			FDKK	KK-D→D, CARRY→DF				
F5	MX-D→D, CARRY→DF			FFKK	D-KK→D, CARRY→DF				
F7	D-MX→D, CARRY→DF			FCCK	KK+D→D, CARRY→DF				
F4	MX+D→D, CARRY→DF			7CCK	KK+D→DF→D, CARRY→DF				
ONE BYTE INPUT INSTRUCTIONS				1-BYTE OUTPUT INSTRUCTIONS					
69	BUS→MX,D	N2	N1	ND	61	MX→BUS,RX+1	N2	N1	ND
6A	BUS→MX,D	0	0	1	62	MX→BUS,RX+1	0	0	1
6B	BUS→MX,D	0	1	0	63	MX→BUS,RX+1	0	1	0
6C	INPUT SWITCH BYTE→MX,D	0	1	1	64	MX→HEX DISPLAY,RX+1	0	1	1
		1	0	0			1	0	0

Instruction Subset Table shows required sequence of steps.

the bus so that it can be stored at the memory location addressed by RX. This input byte will also be placed in the 1802's D register.

When a 64 instruction is executed, N2 is high and MREAD is low, making the output of IC10C high and preventing the input switch byte from getting onto the bus. Instead, gate IC10B generates an output clock pulse with TPB that clocks the RAM output byte into the hex display.

The four external flag input lines—EF1, EF2, EF3, and EF4—can be pulled low by external switches. These four lines can be tested by instructions 34, 3C, 35, 3D, 36, 3E, 37 and 3F. Note in Fig. 5 that the INPUT pushbutton switch, debounced by portions of IC11, is connected to the EF4 line. This means that EF4 = 1 when S12 is depressed and EF4 = 0 when S12 is in its normal position.

Latched output line Q can be set high by a 7B instruction or reset to low by a 7A instruction. The Q LED comes on when Q is high. The DMA IN, DMA OUT, and INTERRUPT lines can be pulled low to cause these operations to occur.

The LOAD and RUN lines control the operation of the microprocessor according to the following conditions:

LOAD	RUN	Mode
gnd	gnd	load
+5V	gnd	reset
gnd	+5V	—
+5V	+5V	run

RUN and LOAD switches S1 and S2 in Fig. 5 control the operation of the computer. With both switches set to

off, LOAD is +5V and RUN is at ground potential. This resets the 1802. Neither TPA nor TPB are generated in the reset state and R0 = 0000, P = 0, X = 0 and Q = 0 after the 1802 is reset. When the LOAD switch is set to ON, LOAD goes low and RUN stays low, forcing the system into the load mode. Now you can load a sequence of bytes into the RAM, starting at address 0000, by setting the bytes into the input toggle switches, one at a time, and operating the INPUT switch.

In the load mode, the 1802 does not execute instructions but waits for a low to appear on the DMA IN line. When this happens, the 1802 performs one memory write cycle during which the switch input byte is stored in memory. R0 is used to address memory during the DMA IN cycle. After the input byte is stored at the address specified by R0, this register is in-

INTRODUCTION TO PROGRAMMING.

Once you have built your Elf, you must learn how to load a sequence of bytes into memory and then go back and display the sequence. Let us write a simple program that can be loaded into the memory and run.

Suppose you want to program the computer to turn on the Q LED whenever the INPUT switch is set to ON. First, you must draw a flow chart that shows the required sequence of steps (Fig. 7). Locate the correct instructions in the Instruction Subset Table. A 7A instruction will perform Step 1. Load this instruction into M(0000). Note that when the INPUT switch is not depressed, EF4 = 0. A two-byte 3F 00 instruction will jump (branch) back to the 7 A instruction at M(0000) as long as the INPUT switch is not operated (EF4 = 0). This condition is known as a "loop," and the program will stay in this loop while it is waiting for the INPUT switch to be depressed. Load 3F 00 into memory locations M(0001) and M(0002) to perform the second step in the flow chart. All GO TO MM instructions shown in the Table put MM into the low-order byte of the program counter if a GO TO condition exists. Otherwise, the next instruction in sequence is fetched by the 1802.

Loading a one-byte 7B instruction into M(0003) takes care of Step 3, while a 30 01 instruction will jump back to the 3F 00 instruction at M(0001). Load the 30 01 instruction into M(0004) and M(0005) to complete the program.

You load this 6-byte program by placing the LOAD switch on the ON position, with

RUN and MP set to OFF, setting up the toggle switches for the hex number 7A, and depressing the INPUT switch. Release the INPUT switch, insert 3F and operate the INPUT switch again. Then load 00 and so on until the last byte, 01, has been stored at M(0005). If you "blow" the program, set MP to ON and LOAD to OFF. Then set LOAD to ON and operate the INPUT switch until you get to the byte immediately preceding the wrong entry. Set MP to OFF, set up the correct byte, and operate INPUT. Flip MP back to ON to protect what you have stored in memory.

To start the program running, set LOAD to the down position to reset the 1802 and set the RUN switch to ON. Nothing should happen until you depress the INPUT switch, at which time the Q LED should come on. Releasing the INPUT switch should cause the LED to extinguish. If you like, you can now observe the timing signals of the 1802 on an oscilloscope while the program is running.

Another simple program involves counting the number of times the INPUT switch is operated and then turning on the Q LED at the end of the count. The flow chart for this program is shown in Fig. 8. When you load and run this program, nothing will happen until you operate the INPUT switch five times, at which point the LED will come on and remain on. Note in Step 1 that you can change the number of times the INPUT switch is operated. Step 6 just loops on itself to terminate the program after the INPUT switch has been operated the specified number of times.

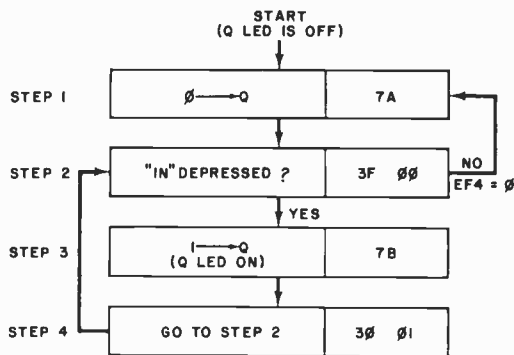

Fig. 7. Program turns on Q-LED when INPUT switch is operated.

cremented by one so that input bytes will be sequentially loaded into RAM locations. Line SC1 goes high during the DMA IN cycle so that the control circuits know when the input byte has been stored in the RAM.

Depressing and releasing INPUT switch S12 sets flip-flop IC12 (Fig. 5). The \bar{Q} output of this stage goes low, causing the required low on the $\bar{DMA\ IN}$ line. The 1802 responds to this request with a memory-write cycle during which SC1 is high. During this cycle, \bar{MREAD} is high and, since LOAD switch S2 is also ON, the N2/LOAD signal causes gate IC10C to go high, gating the switch input byte to the data bus and storing it in memory. When SC1 goes high, it also resets IC12, which causes $\bar{DMA\ IN}$ to return to its high state. The computer then waits for the next switch input byte and LOAD switch operation.

Following each DMA IN cycle, the 1802 holds the A0 through A7 lines at the address of the byte just stored in the RAM. \bar{MREAD} is also held low while waiting for the next input byte. This means that the previously loaded byte is being gated to the bus (from the

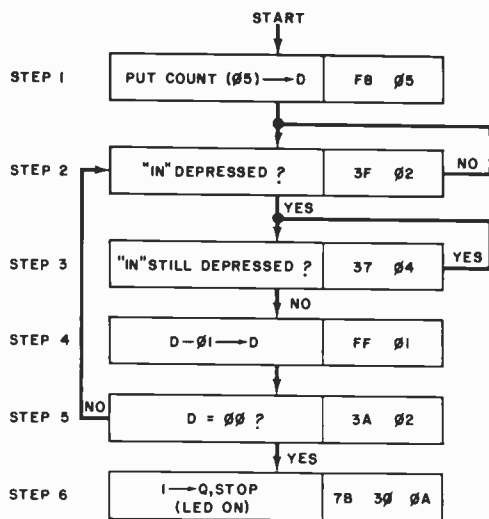

Fig. 8. Program counts number of times INPUT switch is operated.

RAM) while waiting for a new byte. This bus byte is continuously clocked into the hex display, since the LOAD switch is holding IC10B open.

A sequence of program bytes can be loaded into the RAM starting at M0 = M(0000) by setting the LOAD switch to the ON position, with the RUN switch set to OFF. Set the eight input switches, S4 through S11, to the desired byte code (in hexadecimal) and depress the INPUT switch to store the byte in the RAM. The value of this byte will be displayed with the hex displays IC6 and IC7. Repeat this procedure for each byte to be loaded. Setting the LOAD switch to OFF puts the 1802 back in the reset state where R0 = 0000, P = 0, X = 0, and Q = 0. If you wish to see what is stored in memory, set MP (memory-protect) switch S3 and the LOAD switch to ON. Now, each time you operate the INPUT switch, successive bytes in the RAM, starting with M(0000), will be displayed.

To change a byte, proceed to the byte just before the one to be changed. Flip the MP switch to OFF, set the input toggle switches to the hex value of the new byte, and depress the INPUT switch once. This new byte will be displayed and stored in the RAM at the location following the byte at which you stopped. Place the MP switch in the ON position. You can now continue to operate the INPUT switch to sequence through the RAM without modifying the bytes in memory.

To start the executive cycle of a program, set both the LOAD and RUN switches to OFF (to reset the 1802). Then set the RUN switch to ON. The program counter is always specified by the hex digit in register P, which can be set to zero by reset so that the program counter will always initially be R0. Set R0 to 0000 by resetting so that instruction fetching, or program execution, will always begin at M(0000). Instructions will continue to be fetched from the RAM and executed until the RUN switch is set to OFF, resetting the computer. Make sure that the MP switch is OFF when running programs so that computer operation is not inhibited.

Construction Notes. Hardware assembly is relatively simple, permitting the project to be put together with ordinary perforated board with 0.1" (2.54-mm) hole spacing and IC sockets, using either Wire Wrap® or a wiring pencil. (See photo.) The perf board measures 5½" L x 4" W (14 x 10.2 cm)

and is supported on a base made up of lengths of ¾" x ⅜" (19.1 x 9.5) pine. A sheet of thin aluminum provides the support for the eight toggle-type data switches. The LM309 voltage regulator IC (IC13) is mounted on a 1¼" x ¾" x ⅛" (31.6 x 19.1 x 3.2-mm) piece of aluminum to serve as a heat sink.

Do not mount the IC's (except the display devices) in their sockets until after all wiring is complete. Socket, switch, and component layout should be roughly the same as shown in the photo. Be sure to locate the crystal close to pins 1 and 39 of the microprocessor's socket. Then wire the circuit in accordance with the schematics in Figs. 4 and 5.

Any crystal with a frequency of between 1 and 2 MHz can be used in the Elf, or you can substitute a simple 555 or CMOS oscillator with a 5-volt signal swing between pin 1 of the 1802 and circuit ground, in which case, you will have to omit XTAL, C3, C4, and R11. There is no lower limit to the clock frequency, but most of the sample programs discussed in this series of articles are based on a clock frequency between 1 and 1.8 MHz.

Displays IC6 and IC7 are relatively expensive hex devices. They are the only TTL devices in the computer and, as a result, draw most of the power required by the circuit. If you wish to economize, you can substitute ordinary LED's for the displays. (Next month, we will discuss how to make the substitution.)

An inexpensive 9-volt, 350-mA dc battery eliminator, like those used as battery charger/eliminators for calculators, can be used to power the Elf.

When the computer is completely assembled, use a dry-transfer lettering kit to label all switches and positions, IC socket locations, and pins 1 of all sockets. Then, exercising the usual safety procedures for handling MOS devices, install the integrated circuits in their respective sockets.

Coming Up. In future articles, we will provide more programs as well as methods of adding other types of inputs and relay-control output circuits. We will also detail how to save programs in battery-powered COSMOS RAM's and describe a simple operating system that lets you read/write any memory location and inspect general register contents for program debugging purposes. Memory expansion, hex keyboard input, and an inexpensive video graphics display are other subjects we will cover in detail.

BUYER'S GUIDE TO ANTENNA ROTATORS

How they work and what's available.

BY KRIS CARROLE

TV AND FM signals usually come into a given reception area from all directions and at various strengths. Modern TV and TV/FM antennas are highly directional to provide maximum gain. It is obvious, therefore, that to obtain the best possible reception, an antenna must be accurately aimed in the direction from which a desired signal is coming. When two or more stations are located in different directions, the only practical way of aiming an antenna is with an antenna rotator system. Too, the weaker the signals, the more accurate must be the aiming ability of the rotator system.

Basically, an antenna rotator system consists of two parts. The drive unit does all the heavy work. It mounts atop a mast, just below the antenna, where it is subjected to the elements. The other part of the system, the control box, is usually located near the TV or FM receiver where it is safe from the elements and is easily accessible to the user.

All antenna rotator systems are a great convenience, but some provide more than others. A basic system simply provides a means of rotating an antenna, while a top-of-the-line automatic rotator system can make aiming an antenna easier than tuning a TV channel or FM station. There are rotators designed to bear relatively lightweight loads and others that can accommodate loads of up to 1000 lb (455 kg).

Types of Rotators. There are basically three types or categories of antenna rotator systems in common use. In order of increasing price range, they include manual, semiautomatic, and fully automatic models (see Table).

The manual rotator is a simple system. The controller contains two pushbutton switches (one for turn-left and another for turn-right commands). The antenna rotates while one of the buttons is held in the depressed position. It stops when the button is released. The pushbutton switches are designed so that when one is depressed, the other is locked out to prevent conflicting drive commands from burning out the drive motor. The only

visual indication of system operation is a light that comes on when the rotator comes to the mechanical stop at either end of rotation travel.

The major disadvantage of the manual rotator system is that each time you change a channel or station, you must experiment with the controls until you obtain the best possible reception. Except for knowing when the antenna is at one of the rotator's mechanical stop positions, there is no way of telling in which direction the antenna is pointing, short of going outside and looking at the antenna itself. There is no way of marking the controller for future reference to obtain a duplicate setting.

The big advantage of the manual

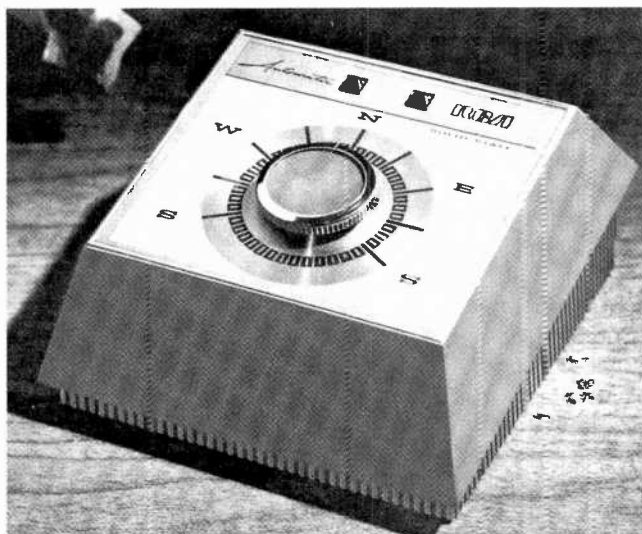

RCA's Model 10W707 fully automatic controller.

rotator system, of course, is its cost. If you don't mind experimenting with the controls and wish to save money, the manual rotator system might be just the thing for you.

The semiautomatic rotator system offers a bit more operating convenience at additional cost. It provides a visual indication of the antenna's position. The indicator is usually a compass-like dial with a pointer that indicates antenna direction. The pointer is driven by a small motor synchronized with the antenna drive. (Alliance uses a meter movement with a scale calibrated in N, E, S, W, and N to indicate antenna direction.)

The controls in the semiautomatic rotator system are the same pushbutton switches used in the simple manual systems. However, the fact that there is a visual direction indicator gives the advantage that channel and station directions can be marked on the dial for future reference.



Example of an in-line antenna rotator design. (Cornell-Dubilier Ham-11)

For most manufacturers, the only step up from a basic manual rotator system is to a fully automatic system. The fully automatic system has no pushbutton switches for the turn commands. Instead, the compass indicator becomes the antenna position selector. As you turn the selector knob to any position on the compass scale, the antenna rotates and automatically stops at the selected heading. Again, you can mark the dial for each channel or station that can be received in your area.

While all fully automatic systems offer a high order of operator convenience, Cornell-Dubilier's Model AR-33 deserves special mention. In addition to the standard compass-dial control, this system's controller has five pushbutton switches that allow the user to "key in" heading commands. Operation of any of the but-

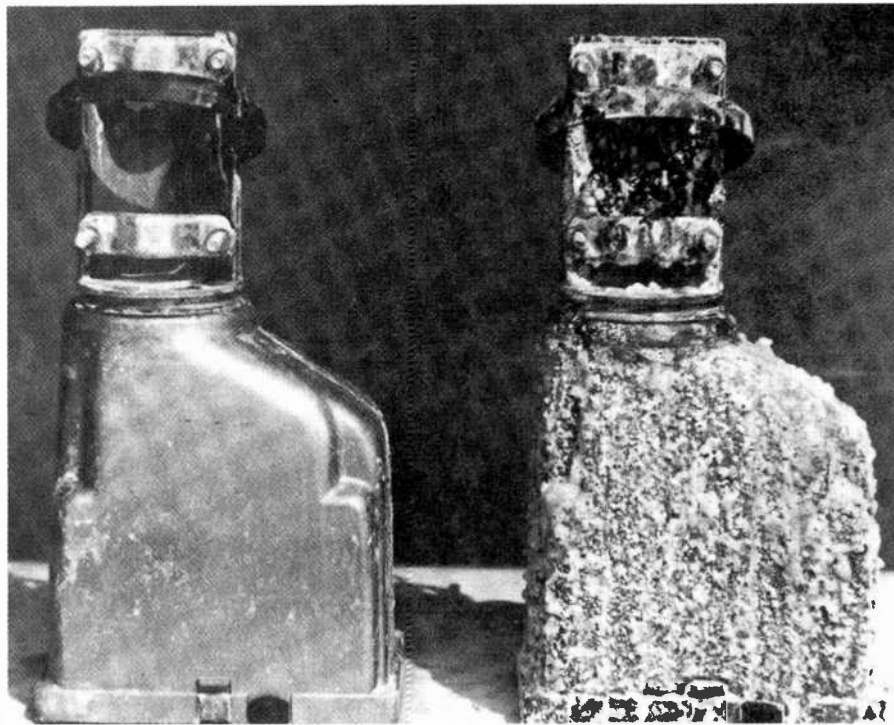

Photo shows effects of salt air (right) on rotator housing as opposed to rotator in normal atmospheric conditions (left).

tons relieves the user of having to turn the compass dial to select the direction for a given station. He just pushes the button, and the antenna automatically rotates to the heading which he had previously set in.

More About Automatics. You pay top dollar for a good automatic antenna rotator system, but with it you get more than just operational convenience. Materials and design considerations are top quality, and the accuracy of the system is greater. The latter is especially important if you happen to live in a deep-fringe reception area.

The less expensive automatic antenna rotator systems employ a small dc motor in the controller to turn the position indicator in unison with the drive motor at the antenna end. A cam-actuated switch in both the controller and antenna drive keeps the system in synchronization. However, because of electrical and mechanical tolerances, each control "step" requires from 3° to 6° of rotation. Since the system is electromechanically synchronized, it is possible for the motors to eventually move out of sequence.

The more expensive systems are totally electronic. The direction control



Blonder-Tongue SA-1000 manual rotator controller.

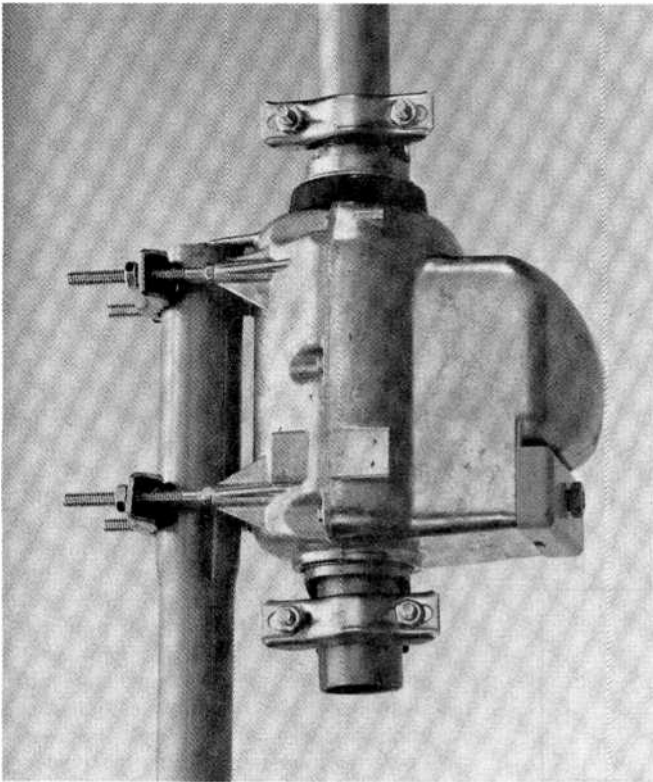

Radio Shack 15-1220 drive system is an example of the offset design.

in the controller forms half of a bridge circuit. The other half of the bridge is a disc potentiometer that is turned when the drive motor rotates the antenna; this pot is located in the drive unit. Turning the direction control unbalances the bridge, which then signals the drive unit to rotate the antenna until the bridge balances. When the bridge is balanced, antenna rotation ceases.

The elimination of mechanical elements in the all-electronic system brings the tolerance down to about 2° steps, providing as many as 60 more set points on the controller dial. Another extra of the all-electronic system is completely silent operation, except for the click of a relay at the end of rotation. Even the relay click is eliminated in Blonder-Tongue's Ultramatic



Alliance's T-45 controller uses meter indicator.

system, which uses SCR's for the switching.

Drive Units. No matter which model you choose, from simple manual to top-of-the-line fully automatic, the drive unit in the rotator system is the weakest link. It does all the heavy work and is generally subjected to a wide range of weather conditions. The drive unit must be able to bear up under the mechanical stresses placed upon it by weight and loading factors, heat, cold, water, ice, and corrosive elements (usually salt) in the air. To beat the elements, manufacturers have de-

vised quite reliable housing and sealing designs for their drive systems.

Inside the drive unit, a worm or spur (planetary) gearing system is used for the final power train between the motor and turning head to which the antenna is mounted. The spur gear has the greater efficiency, averaging about 80% to 90% as opposed to the 50% or so of the worm drive. This per-

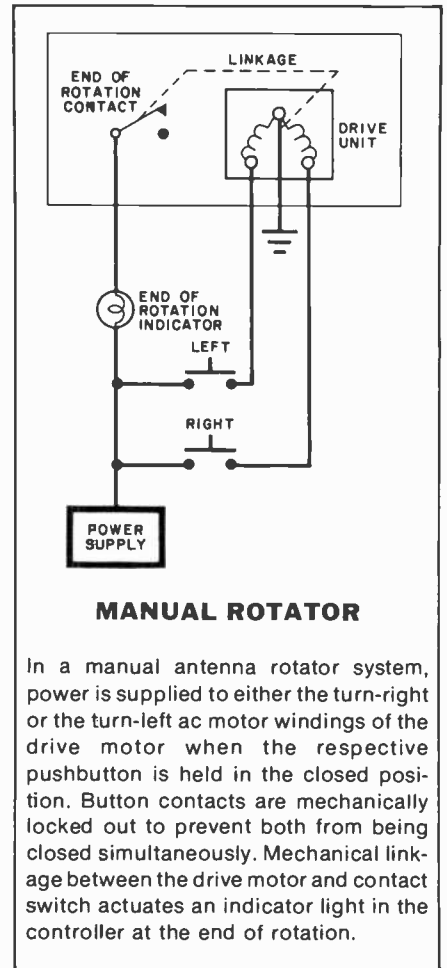

In a manual antenna rotator system, power is supplied to either the turn-right or the turn-left ac motor windings of the drive motor when the respective pushbutton is held in the closed position. Button contacts are mechanically locked out to prevent both from being closed simultaneously. Mechanical linkage between the drive motor and contact switch actuates an indicator light in the controller at the end of rotation.

SEMIAUTOMATIC ROTATOR

Operation of the metered semiautomatic antenna rotator is identical to that of the manual rotator. Mechanical linkage from the drive system, however, turns a potentiometer in the drive housing as the antenna rotates. The amount of current through the meter is proportional to the direction in which the antenna is pointing. Semiautomatic systems that use a revolving disc as an indicator are basically identical to fully automatic systems, except that the automatic-stop mechanism is not included.

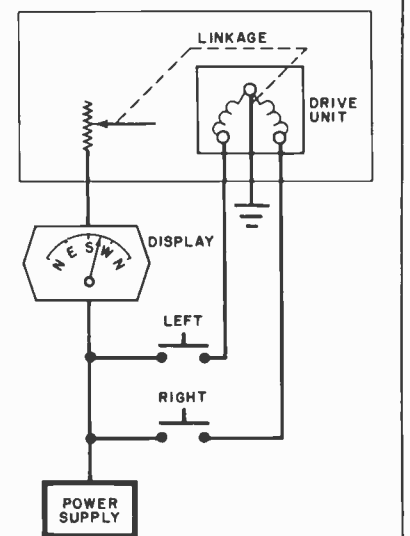

FULLY AUTOMATIC ROTATORS

As the control knob on a fully automatic antenna rotator system is turned, switches around the control disc are actuated. The power switch senses the change and turns on power to the system. The direction of change is mechanically sensed and stored by the memory cam. Power is supplied from the memory cam switches to the turn-left or the turn-right winding on the ac drive motor to rotate the antenna. Simultaneously, power is applied to the dc motor in the controller through the two sync switches that control the phase. The mechanical linkage in the drive turns the sync cam, actuating an internal sync switch. Inside the controller, a second sync cam and control disc and antenna position indicator are linked to the dc motor. Antenna position and indicator are kept synchronized by alternate action of the sync switches. The antenna rotates until the knob position and indicator agree. Power is then removed by the power switch and rotation stops.

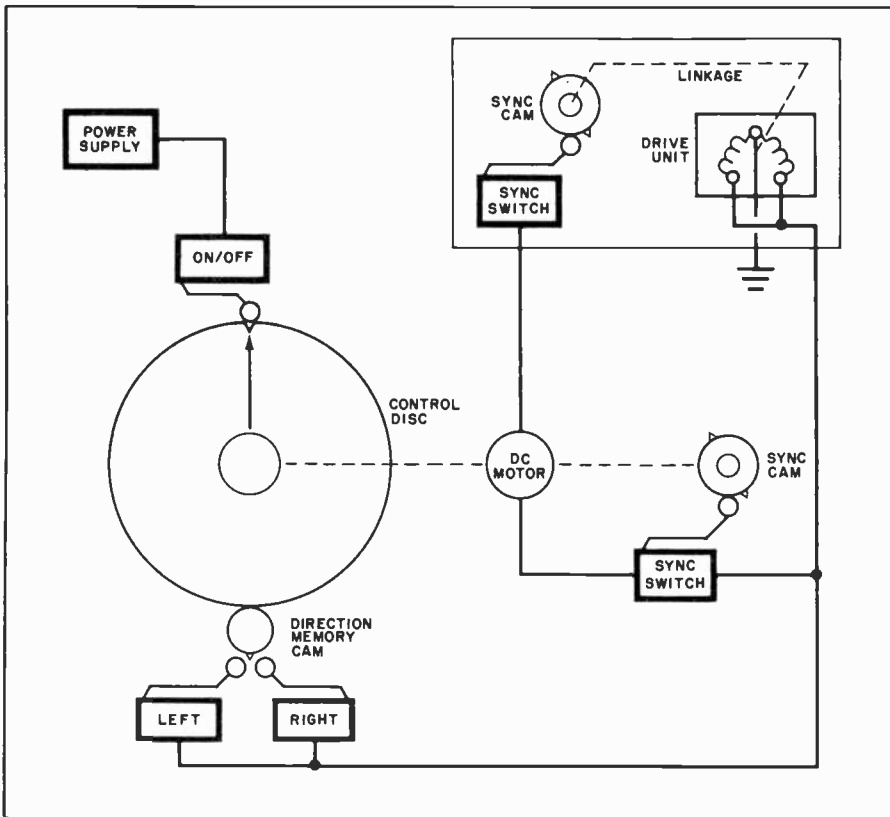

mits a higher starting torque for moving a heavy antenna and breaking through ice.

Although somewhat less efficient on start-up, the worm drive is better than the spur for stopping antenna rotation. The gear itself acts as a positive brake and is less prone to windmilling. However, unlike the spur, which uses the weight of the armature as a clutch, the worm drive can be stripped and permanently damaged if windmilling does occur.

In-line and offset drive arrangements are design considerations that depend primarily on the gearing system used in the drive unit's housing. It's simpler, for example, to package a worm drive in an offset arrangement than to try to use an in-line arrangement.

An offset system can usually be made more compact and lighter in weight than an in-line design. The result is less resistance to wind, since the top and bottom masts overlap to minimize the mounting area. However, the offset design lowers the center of gravity, placing more stress on the bottom mast. As a result, it is often necessary to lower the drive unit so that the additional strain is placed on the chimney or wall mounting brackets.

In-line arrangements evenly distribute antenna weight and wind stress

ELECTRONIC-CONTROL AUTOMATIC ROTATOR

The direction control knob in an all-electronic controller makes up half of a bridge circuit. Once the control is turned, the bridge is offset from null, in a positive or a negative direction, depending on the direction in which the antenna is to be moved. The offset voltage is buffered and used to actuate a relay or SCR. Turn-left or turn-right power is sent to the respective winding of the drive motor, and the antenna begins to rotate. The mechanical linkage from the drive motor repositions the wiper of a

wirewound potentiometer. (The ends of the pot overlap to provide full-rotation sensing.) The resistance of the drive-mounted pot is used as the other half of the bridge. When the resistance of the drive pot is the same as the controller pot, the bridge is balanced and the output is null. The relay then cuts out (or SCR turns off), removing power from the drive motor. A power indicator comes on while the antenna is rotating and shuts off when power is removed from the drive motor.

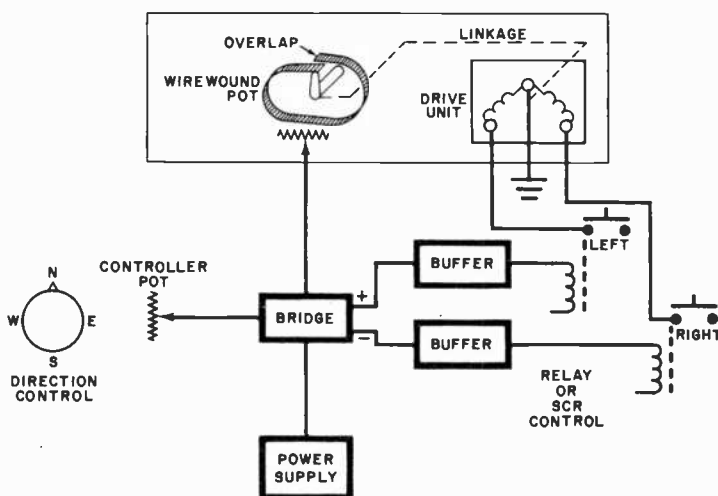

ANTENNA ROTATOR BUYER'S GUIDE

Manufacturer	Model No.	Control Type	Accuracy	Price	Remarks
Alliance	K-22	manual	N/A	\$38.95	
	T-45	semi	5°	46.95	Meter direction indicator
	U-100	auto	10°	54.95	
	C-225	auto	3°	69.95	All-electronic control
Blonder-Tongue	SA-1000	manual	N/A	64.70	
	U-1000	auto	2°	86.60	All-electronic, SCR control
Channel Master	9513A	semi	4°	49.95	Available wired for 220 V ac
	9512A	auto	4°	59.95	Available wired for 220 V ac
Cornell-Dubilier	SA10L	manual	N/A	39.95	
	AR-20XL	auto	6°	49.95	
	AR-22XL	auto	6°	74.95	Heavy-duty version of AR-20XL
	AR-40	auto	3°	94.95	All-electronic control
	AR-33	auto	3°	114.95	All-electronic & preset controls
	CD-44	semi	2%	129.95	For ham and CB antennas up to 500 lb
	HAM-II	semi	2%	159.95	Same as CD-44 for antennas up to 1000 lb
Radio Shack (Realistic)	15-1223	auto	3°	39.95	Dial resettable for initial correction
	15-1220	auto	2°	49.95	All-electronic control
RCA	10W606	auto	3°	54.95	Dial resettable for initial correction
	10W707	auto	2°	64.95	All-electronic control

throughout the entire mounting assembly. The major disadvantage of the in-line arrangement is that it must be larger to accommodate the two masts end to end.

The overall strength of either type of arrangement depends on the quality of the materials used, which is generally quite high. Hence, strength need not be much of a concern for most conditions. Of course, where the wind and/or weight loading stresses are se-

vere, special thrust-bearing brackets (turnable brackets that clamp to the masts) will give additional support.

The offset systems are more susceptible to problems when it comes to water and icing because the top of the drive mast must be open to accept the top mast. Special gasketing and mounting hardware inside the drive unit provide water sealing.

To move a massive antenna and break through ice, and also to provide

reliable operation for a long time, most drive systems are equipped with high-torque drive motors. Within the first year, a rotator system's torque can decline by as much as 10%, due mainly to the loss of lubricant efficiency, hysteresis losses in the motor, and changes in the characteristics of the starting capacitor in the controller. By providing a high initial torque rating for the drive motor, a longer useful life can be expected. Typically, you can expect 12 or more years of operation from today's antenna rotator systems.

If you live near the ocean, salt air will become your biggest enemy. There are few materials that will bear up to the corrosive action of salt and water. Even though new alloys of aluminum and zinc are being used in modern rotator drive systems, salt air is likely to reduce the life expectancy of the system by as much as 25%.

Installation Notes. For new antenna rotator installations, you'll have to plan on some extra-cost items, such as new masts, mounting brackets, and cable to connect the rotator's controller to the drive unit. These items are not usually included with the rotator system itself.

For runs up to 150' (45.7m), 20-gauge cable will be sufficient. For longer runs, use 18-gauge or larger cable. Also, if you're considering extra drops for control from several stations not located in a single room, you'll have to add wall jacks and additional cable when making your purchases.

When installing the rotator system, leave at least 24" (61 cm) of slack antenna cable to allow for the antenna's turning radius without interference. For initial alignment, check the drive housing for orientation marks.

The maximum heights of the top and bottom masts on the roof will depend on the type of rotator system and antenna you're using. To obtain greater antenna height than is recommended for your rotator/antenna setup, use extra guying and thrust bearings. However, before you take this step, check with your dealer to draw on his experiences with local wind and weather conditions.

According to most manufacturers, maintenance of antenna rotator systems is very easy—there's nothing to do. Actually, there is one thing you can do to extend the life of your rotator system — lubricate the drive unit periodically with the lubricant prescribed by the manufacturer. ♦

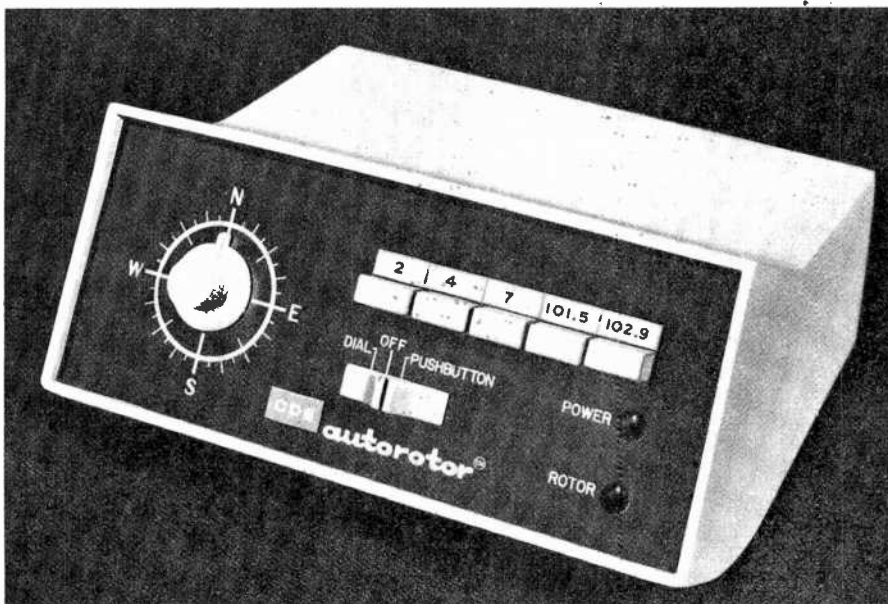

Cornell-Dubilier's AR-33 permits preprogramming for special channels. Unit is all electronic.

A Simple Electronic Keyer for Sending Morse Code

BY WILLIAM J. VANCURA, WB90BB

ONE WAY for the CW radio operator to send almost perfect Morse code is to use an electronic keyer. Most commercially available keyers are relatively expensive, but it is easy to build a low-cost keyer using TTL devices and a pair of 555 timer IC's.

The keyer features a variable clock (speed) rate and a side-tone oscillator. It can be used to key a CW transmitter

or as a CPO (code-practice oscillator). The circuit operates from any conventional 5-volt dc source. Since it draws only 40 mA of current, it can even be battery powered, providing many hours of operation from ordinary penlite (AA) cells.

Quad 2-input NAND gate IC1, as shown in the schematic diagram, eliminates most of the diodes commonly used in other keyer circuits and

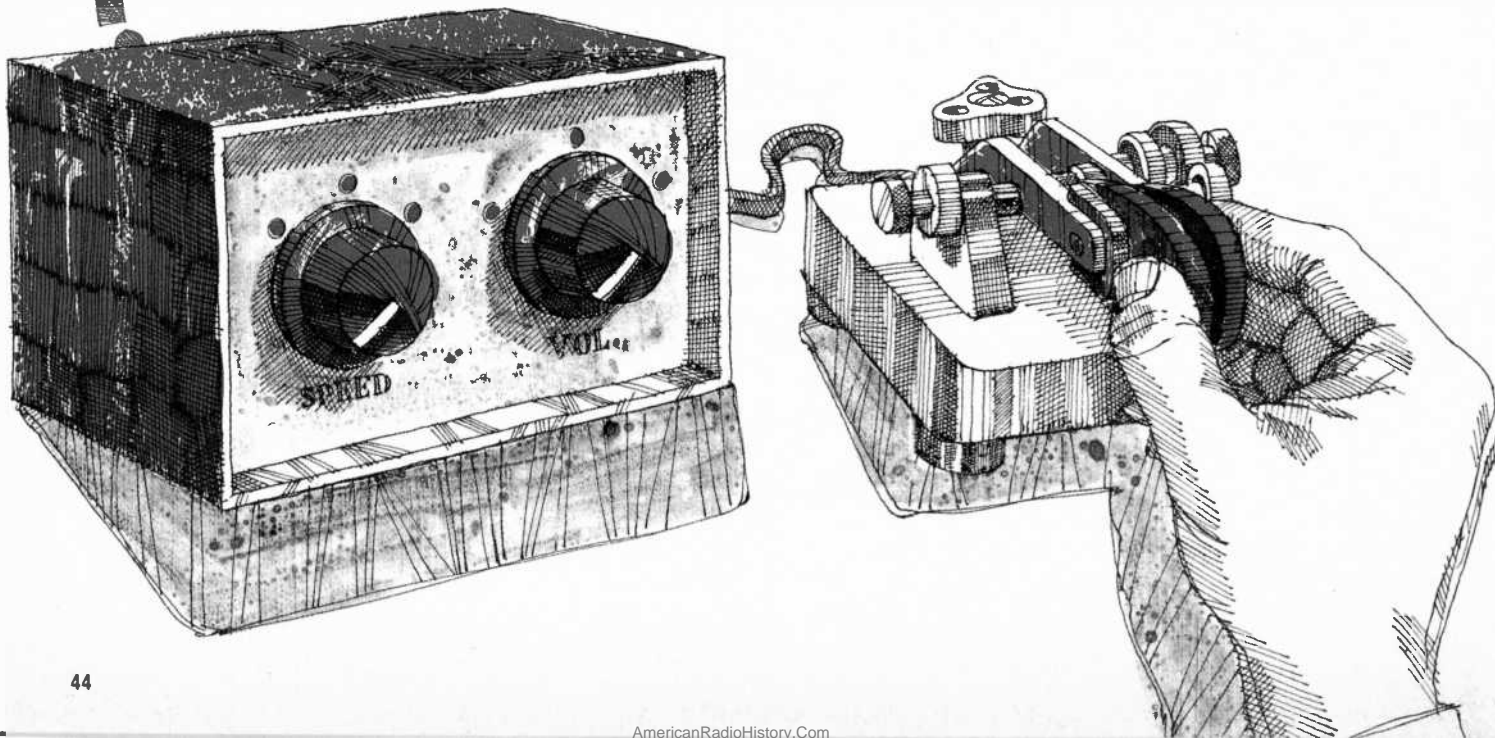

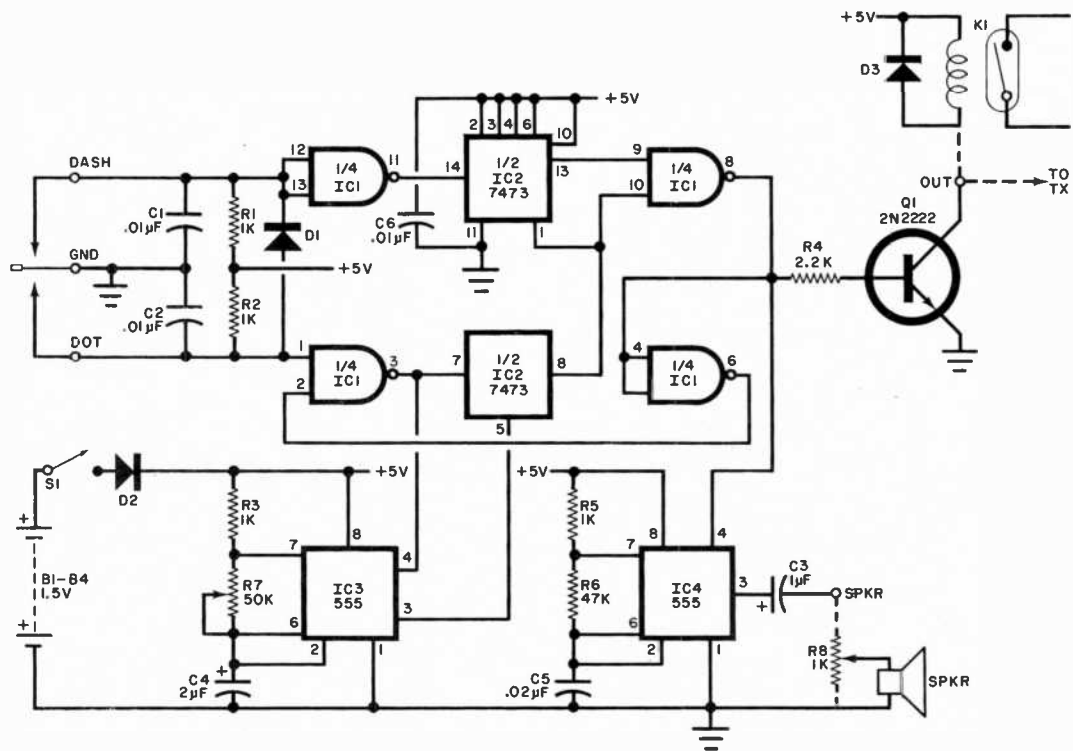

Relay circuit is for negative-grid keying, and slide-tone oscillator for code practice.

PARTS LIST

- B1,B2,B3,B4—1.5-volt cell
- C1,C2,C6—0.01- μ F disc capacitor
- C3—1- μ F, 16-volt electrolytic capacitor
- C4—2- μ F, 16-volt electrolytic capacitor
- C5—0.02- μ F disc capacitor
- D1,D2,D3—Silicon rectifier diode
- IC1—7400 quad 2-input NAND gate IC
- IC2—7473 dual flip-flop IC
- IC3,IC4—555 timer IC (can be a dual-timer IC)

- K1—Reed relay (Potter & Bromfield JR1000 or similar)
- Q1—2N2222 transistor
- R1,R2,R3,R5—1000-ohm, 1/2-watt resistor
- R4—2200-ohm, 1/2-watt resistor
- R6—47,000-ohm, 1/2-watt resistor
- R7—50,000-ohm, reverse-log taper potentiometer
- R8—1000-ohm potentiometer
- S1—Spst switch

- SPKR—8-ohm speaker
- Misc.—Perforated or printed circuit board; suitable metal chassis box; battery holder; control knob; paddle assembly; hookup wire; solder; machine hardware; etc.
- Note: Etched and drilled printed circuit board available for \$3.50 from: William Vancura, 4115 35 Ave., Moline, IL 61265

provides a TTL-level signal for the remainder of the circuit. Dual flip-flop IC2 generates the dashes and dots in a 3:1 ratio, with the spaces being one-dot wide. Timer IC3 serves as the system clock generator, with potentiometer R7 acting as the speed control. Timer IC4 generates an audio signal when gated, producing a side tone so that you can hear what you are sending.

Output transistor Q1 is required if you intend to use the circuit to key a transmitter. If negative grid keying is desired, add reed relay K1 to the circuit as shown. This relay isolates the keyer circuit from the voltages used in the transmitter.

The circuit can be assembled on a piece of perforated board, using a point-to-point wiring technique. Or you can design a printed circuit board. There is nothing critical about parts placement or lead routing.

If you prefer, you can substitute a dual-timer IC for the separate IC3 and IC4 timers shown. Speed-control potentiometer R7, which mounts on the front panel of the chassis box in which the keyer is to be housed, should have a reverse-log taper to improve linearity. The side-tone oscillator can be adjusted to produce a desired tone in the speaker.

If you plan to use the keyer with a transmitter, the circuit must be housed in a grounded metal chassis box to reduce the possibility of r-f interference. You can easily fabricate a paddle keyer. Mount it so that the contacts are inside the box, with the paddle arm exiting through a slot in the box. Make certain that the paddle arm moves freely, without contacting the metal chassis box.

After assembling the keyer, check out its operation in both the transmit and CPO modes. ◆



"You should listen more carefully, dear. Mother only called you a lazy CB."

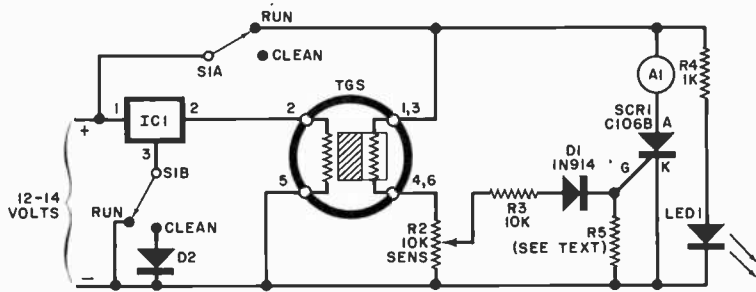

Fig. 2. Powered from a 12-volt dc source, this alarm is useful in trailers, campers, or boats. Operation is similar to home alarm.

(or perfume), or drink alcoholic beverages. If you do, the alarm will trigger falsely.

The entire circuit is simple enough to assemble with point-to-point wiring. Use a standard 7-pin vacuum-tube socket for the TGS gas sensor. The audible alarm device you use for A1 should be rated as 12 volts and not exceed the rating of the SCR in its current demand. If you plan to use this circuit in a potentially explosive atmosphere, use a noncontact type alarm, such as the Mallory Sonalert®. Also, R4 and LED1 serve as a power-on indicator system, which can be eliminated from the circuit if you wish to economize.

Mobile Alarm. The circuit for a gas alarm system for car, boat, trailer, etc., is shown in Fig. 2. This circuit is similar

to that shown in Fig. 1 except that it does not get its power from the 117-volt ac line. Regulator IC1 compensates for variations in the vehicle's battery voltage that occur when the generator/alternator cuts in and out. If such variations reach the sensor's filament, changes can occur in the sensor's resistance. Diode D2 increases the heater potential from the nominal 5-volt operating point to about 5.7 volts when S1 is set to CLEAN.

an amount proportional to the nearness to the source of the gas or concentration of gas.

The power supply for the gas measuring system is similar to that used in the mobile alarm circuit. The sensing element of TGS becomes one side of a bridge in this circuit, with the other sides consisting of R7 or R8 and both sides of potentiometer R10. The meter movement is connected across the bridge and R10 adjusted for bridge balance (0 indication on the meter). When gas is introduced to the sensor, the resistance of TGS decreases, unbalancing the bridge. When this occurs, the meter pointer starts moving upscale by an amount directly proportional to the amount of unbalance in the bridge. Resistor R6 limits the total current through the Taguchi Gas Sensor.

To operate the system, first set S1 to CLEAN for 2 minutes, switch to RUN, set S2 to the desired sensitivity range, and null the meter with R10. Accurate

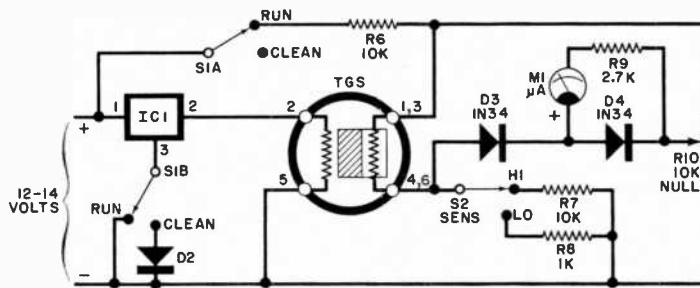

Fig. 3. This 12-volt dc detector uses a meter readout instead of alarm for quantitative leakage measurements and locations.

PARTS LIST

- A1—12-volt signalling device (buzzer, Mallory Sonalert®, etc.)
- D1—IN914 diode
- D2—50-volt, 1-ampere silicon diode
- D3, D4—IN34 germanium diode
- IC1—5-volt regulator IC (Radio Shack No. 276-2770 or similar)
- LED1—Any red light-emitting diode
- M1—50- μ A meter movement (Lafayette Radio No. 99R51146 or similar)
- The following resistors are 1/2-watt, 10%:
- R1—15 ohms
- R3, R6, R7—10,000 ohms
- R4, R8—1000 ohms
- R5—See text
- R9—2700 ohms
- R2, R10—10,000-ohm linear-taper potentiometer
- S1—Dpdt switch
- S2—Spdt switch
- SCR1—C106B silicon controlled rectifier (Radio Shack No. 276-1079 or similar)
- T1—12.6-volt, 1-ampere center-tapped transformer
- TGS—Model 812 Taguchi Gas Sensor (Available from Southwest Technical Products Corp., Dept. PE-1, 219 W. Rhapsody, San Antonio, TX 78216 at \$6.95 each)
- Misc.—Suitable enclosure; 7-pin tube socket for sensor; perforated board; machine hardware; hookup wire; solder; etc.

The value of R5 should be selected in the same manner as for the home alarm. Unlike the home alarm system, the mobile system's alarm cannot be turned off via R2 because of the dc flowing through the SCR unless A1 is a mechanical buzzer that interrupts the current flow.

To operate the system, first place S1 in the CLEAN position for 2 to 3 minutes. Then set the switch to RUN.

Turning R2 down and flipping S1 to CLEAN, and back to RUN, will turn the buzzer off.

Gas Measuring System. The circuit shown in Fig. 3 is particularly interesting because it provides a quantitative measurement of gas concentration, rather than the simple go/no-go indication of the previous circuits. This circuit can be used for any gas measurement from vehicular engine tuneups to gas-leak detection. In use, the meter's pointer swings up-scale by

meter calibration requires specialized equipment, which your local service station might use to perform antipollution emissions checks.

The major problem with the sensor is that it does not differentiate between carbon monoxide and carbohydrates. However, comparing the exhaust readings of your vehicle's exhaust with those obtained with a commercial gas analyzer will give you reasonably good calibration.

In the gas measuring configuration, the gas sensor should be physically separated from the electronics package. Use a flexible four-conductor cable between sensor and electronic package.

When making measurements, you can set the detector to high sensitivity first and, if necessary, switch to the lower sensitivity range. Operated this way, the detector should be able to locate almost any gas leak along a complex arrangement of pipes. ♦

BUILD A LOW-COST 1-Hz to 1-MHz Frequency Counter

*Sophisticated,
low-cost counter
with 3-digit
readout uses
state-of-art
CMOS chips.*

BY NORMAL P. HUFFNAGLE

A FREQUENCY counter can be as useful in working with electronic equipment as an oscilloscope, yet it is often the last piece of test gear the hobbyist and experimenter buys. The main reason for this save-for-last attitude stems from the fact that commercially made counters are relatively high priced. Now, however, the easy availability of inexpensive "surplus" IC's and low-current LED displays

makes it possible for you to build a low-cost, three-digit frequency counter with a range from 1 Hz to about 1 MHz). By shopping carefully (see the ads at the back of this magazine), you should be able to build your frequency counter for just about \$25 to \$30.

Circuit Operation. A frequency counter consists of a wave shaper that

should have a reasonably high input impedance and a series of decade counting units. The wave shaper "conditions" the input signal to give it the clean-edged waveform necessary to trigger the decade counting units. The outputs of the counters drive numeric displays. The entire operation is controlled by a time base that enables the counter for a precise period of time. During the enable in-

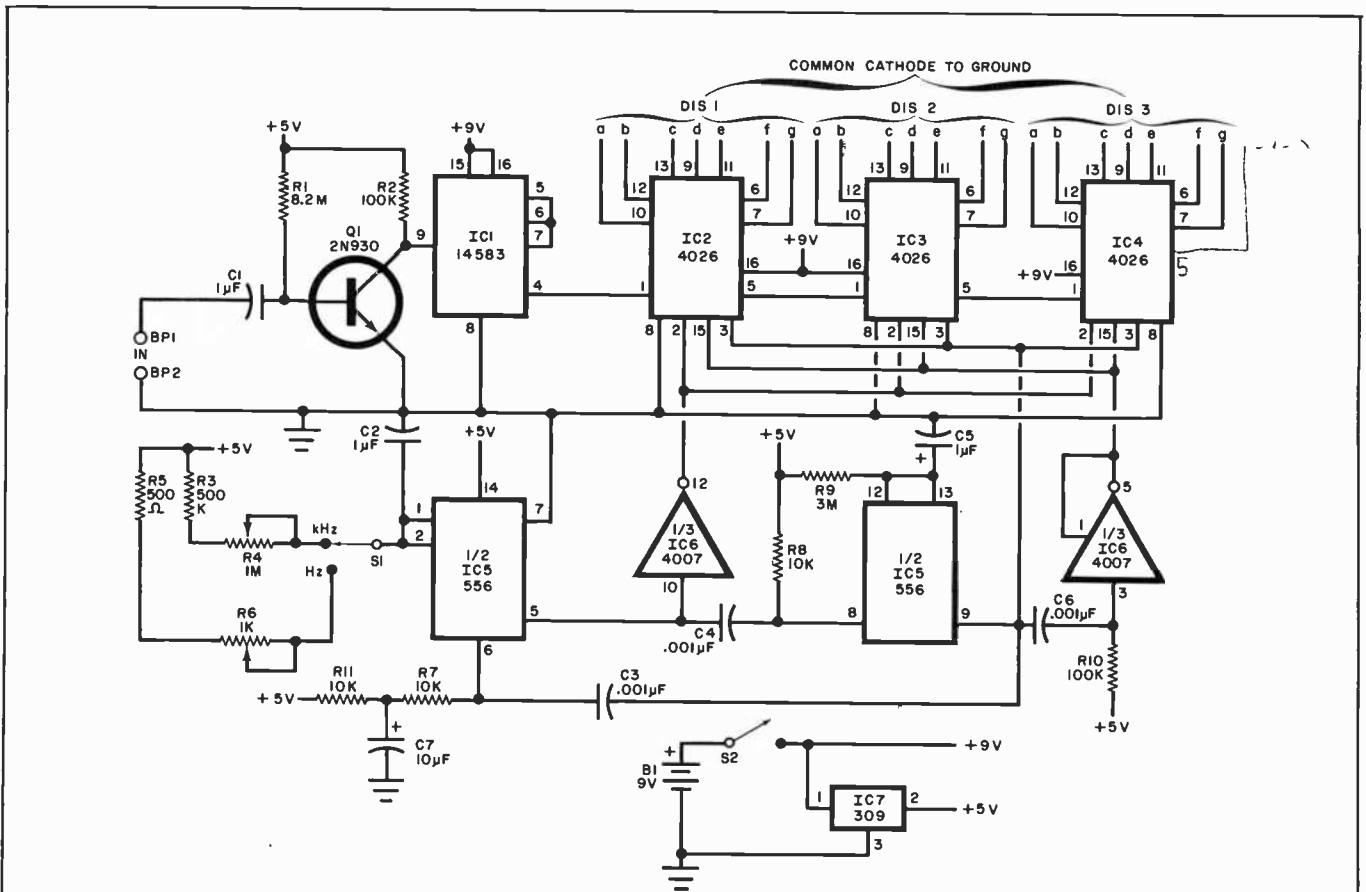

PARTS LIST

- B1—9-volt alkaline battery
- BP1, BP2—Binding post (one red, one black)
- C1, C2, C5—1- μ F ceramic, Mylar, or polystyrene capacitor
- C3, C4, C6—0.001- μ F disc capacitor
- C7—10- μ F, 16-V, electrolytic capacitor
- DIS1 through DIS3—Common-cathode 7-segment LED display (Motorola HEK-5 or similar)
- IC1—14583 Schmitt trigger IC
- IC2, IC3, IC4—4026 decade counter IC

- IC5—556 dual timer IC
- IC6—4007 dual complementary pair and inverter IC
- IC7—5-volt regulator IC (LM309 or similar)
- Q1—2N930 or similar transistor
- Following resistors are 1/4 watt:
- R1—8.2 megohms
- R2, R10—100,000 ohms
- R3—500,000 ohms
- R5—500 ohms
- R7, R8, R11—10,000 ohms

- R9—3 megohms
- R4—Subminiature 1-megohm potentiometer
- R6—Subminiature 1000-ohm potentiometer
- S1—Spdt switch
- S2—Spst switch
- Misc.—Perforated board; IC sockets (optional); battery holder; small Bakelite or plastic case; machine hardware; hookup wire; solder; etc.

terval, all events present at the input are counted and totaled. At the end of the count interval, the counts are stored and displayed. The counter is then inhibited from accumulating more counts until the display period ends. Then the frequency counter is reset and a new count cycle begins.

The complete circuit of the frequency counter is shown in the schematic. The input circuit can be modified according to the availability of components. Just keep in mind that the input should have a reasonably high impedance and that the input of the IC2 decade counter should have a clean positive-going leading edge.

Integrated circuit IC1 is a Schmitt trigger that conditions the input signal and converts it to logic levels suitable for the IC2 through IC4 counter chain. The tenth input count to IC2, at pin 1, generates a "carry" pulse at pin 5 to toggle IC3. At the instant the carry pulse is generated, IC2 causes DIS1 to display a 0, while IC3 causes DIS2 to display a 1. When a tenth input pulse is applied to the input of IC3, a carry pulse toggles IC4 and DIS2 displays a 0 and DIS3 a 1. In this circuit, the carry output of IC4 (pin 5) can be used to

turn on the decimal point of DIS1 to indicate an overrange condition.

The timing starts with half of the dual timer (IC5). Switch S1 enables either a 1-s or a 1-ms timing interval. During this interval, the second half of IC5 generates a 2- or 3-second display interval during which the counters are disconnected from the input and the display system is unblanked. At the end of the display, a reset pulse initiates the timing/counting interval.

Construction. Except for the input binding posts, switches, and displays, the entire circuit can be assembled on a piece of perforated board using point-to-point wiring. The only critical area of assembly is around Q1 and the input of IC1, where high-frequency signals will be present. Mount Q1 and IC1 at the end of the board nearest where the input jacks will be mounted on the case.

The displays, switches, and input binding posts should mount on the front of the enclosure. Mount the displays side by side in a slot just large enough to accommodate them and cement them in place. Then mount the binding posts and switches and com-

plete circuit wiring according to the schematic diagram.

Calibration. You can use any frequency counter of known accuracy and a signal generator to make all frequency adjustments. Simply set S1 to the Hz position, drive the counter with some fairly low-frequency signal, and adjust the setting of R6 for the correct indication. If you are using a highly accurate frequency counter to monitor the output of the signal generator, adjust R6 so that the displayed numbers on both counters are the same. Repeat the procedure with a high-frequency signal.

If you do not have access to a highly accurate frequency counter, you can calibrate the dial of any audio signal generator using a 60-Hz source and Lissajous pattern (on an oscilloscope). Then use the outputs as a reasonably accurate signal source to calibrate the frequency counter.

If you have an older signal generator whose dial has a high degree of inaccuracy, you can build the low-cost frequency counter into it. Then you will always know at exactly what frequency the generator is operating. ♦

Consumer Tested Remedy for Sick Car Performance Sparks New Life in Pre-1975 Cars.

Owners of pre-1975 cars get better performance with less maintenance when they install one of the Mark Ten C.D. Electronic Ignition Systems. In fact, thousands of users testify the Mark Ten has noticeably improved their automobile's performance. As a California doctor stated after using the Mark Ten for 95,000 miles. "... I can 'feel' the difference in performance between my conventional ignition and the Mark Ten..."

Mark Ten Systems* spark each plug with 50,000 to 60,000 volts in secondary output compared to a mere 25,000 volts in standard and most pointless systems. This means dramatic increases in acceleration and general engine performance, and substantial increases in gasoline mileage. Points will last the lifetime of the rubbing block. Spark plug life is extended three to ten times due to the hot spark generated by the Mark Tens, which eliminates fouling and cleans dirty plugs. And the Mark Ten Systems virtually eliminate at least 2 out of 3 tuneups! Look at what Delta Customer P.S. from New York wrote, "... I might add that I had another unit of yours that has been on three cars so far. Each of the cars was driven about 50,000 miles

before it was turned in. *Not one of the cars ever had a new set of points, new plugs or a tune-up.*

Now its on the fourth car with 20,000 miles on it and going strong." The result? BIG SAVINGS!

Send today for your copy of the new Delta brochure and learn how a Mark Ten System can spark your car into new life.

*Only Delta Products offers a full line of C.D. ignitions: The Mark Ten and Mark Ten B, available assembled or in kit form; and the Mark Ten C, assembled only.

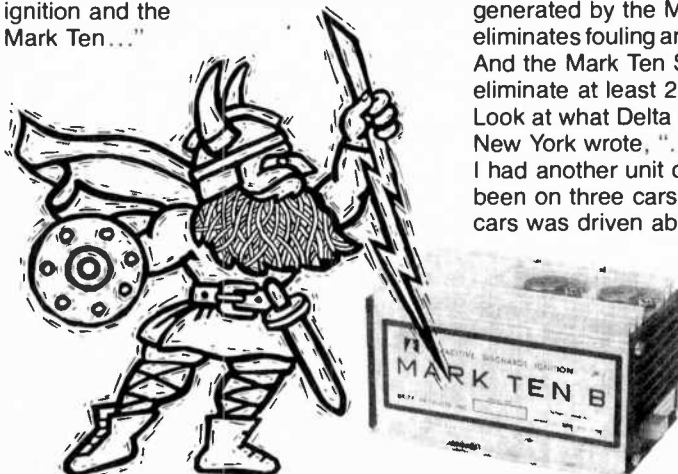

DELTA PRODUCTS, INC.
 P.O. Box 1147
 Grand Junction, Colo. 81501
 (303) 242-9000 Dept. PE

I want to know more about Mark Ten CDI's. Send me complete no-nonsense information on how they can improve the performance of my car.

Name _____

Address _____

City _____ State _____ Zip _____

FLOWER POWER

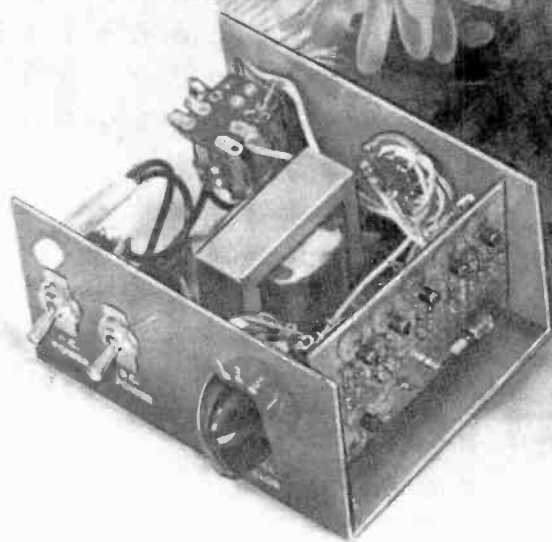

Photocell, transistor-diode ac power control system

BY JIM SQUIRES

HERE is an electronic system which can be used to control up to 350 watts of ac power simply by varying the amount of light applied to a set of three photocells (light dependent resistors or LDR's). The latter can be mounted in any convenient location—in the case of the prototype, they were concealed in an arrangement of artificial flowers. (Hence the

name, "Flower Power.") The system acts as a safety device to prevent the activation of a potentially hazardous appliance by young children. The illuminated flowers also provide a decorative control system which can function as a night light.

About the Circuit. In the project (see schematic diagram), pilot lamps

11 through 13 are attached to the bottoms of plastic flowers in line with light dependent resistors *LDR1* through *LDR3* mounted at the base of the arrangement. When an LDR is illuminated, its resistance is relatively low, on the order of a few hundred ohms. But when the LDR is placed in the dark or shade, its resistance goes up to a megohm or more. This in-

derive their power from a supply consisting of *T1*, and the full-wave rectifier/filter circuit made up of *D4*, *D5*, and *C1*. When only night light or TV light operation is desired, ac power switch *S3* should be closed and dc switch *S2* left open.

As mentioned earlier, three combinations are possible. Two LDR's, when momentarily shaded, turn the appliance on, while the remaining one cuts off *Q3* when its surface is shaded. This deenergizes *K1* and removes line voltage from *SO2*, turning the appliance off. The proper grouping for positions of FLOWER SELECTOR switch *S1* follow:

S1	FLOWER 1	FLOWER 2	FLOWER 3
1	ON	ON	OFF
2	ON	OFF	ON
3	OFF	ON	ON

That is, shading the LDR's below flowers 1 and 2 will turn the appliance on when *S1* is set to position 1. Shading the LDR below flower 3 will turn it off. The two other positions dictate similar patterns — but note that both on LDR's *must* be shaded simultaneously. Another safety feature is the protection given the appliance from power surges after a power failure.

If the project is supplying ac line current to an appliance when power fails, it keeps the load isolated from the line even after power has returned. In such a case it will be necessary to go through the correct shading procedure to restore power to the appliance.

Construction. Flower Power is composed of two units — the power board and the flower assembly. Most of the components are mounted on the power board. Only the switches, LDR's and lamps are off the board.

Since the circuit is relatively simple, it can be wired on a piece of perforated board. For safety purposes, the board should be mounted inside a metal utility box. The box can be concealed inside a clay flower pot for a more aesthetic appearance. Mount two sockets on the utility box. Octal socket *SO1* provides dc power for the LDR's and ac power for *I1*, *I2*, and *I3*. Socket *SO2* is a standard three-conductor power receptacle, into which the appliance should be plugged.

You will probably find that *Q3* and/or *Q6* get a bit hot in continuous operation. If desired, use press-on heat sinks. Allow clearance when mounting the board in a metal box for

the leads from *F1*, *T1*, and the neon bulb *I4*.

Form three support flanges from sheet aluminum about 10" (25.4 cm) long to begin the flower assembly. Drill a 1/4" (6.35 mm) hole at the straight end of each flange, and form a y-shaped base by securing the flanges with machine hardware. Also bolt three lengths of aluminum wire, such as used for clothesline to this point. Mount a cluster of plastic leaves on each flange and cement an LDR (avoid shorts) to the center of each cluster. Then remove the wire stem from each of three plastic flowers and slide the piece onto the aluminum wires to form a three-flower arrangement.

Solder a 36" (1-m) length of green stranded hookup wire to each contact of three #222 lensed lamps and LDR's. Then, with a small bead of silicone cement, mount a lamp at the *bottom* center of each flower. Wrap a layer of vinyl tape around the base of each lamp and LDR lead.

Next, route the wire pairs along the stems, wrapping them securely with florist's crepe stem tape (green) to the stems. Tie all wires into a neat bundle at the base of the arrangement. Cut the free ends of the wire bundle flush and prepare for soldering. Identify the leads using an ohmmeter across the LDR's and a 6-volt battery across the lamps and connect and solder the appropriate leads to an octal plug (*PL1*). Be sure to secure the bundle every few inches with florist's wire. Finally, bend the stems so the lamps are directly over and about 2" to 5" (5.1 to 12.7 cm) above the LDR's.

Testing. Double check all wiring and physical assembly. If everything looks OK, insert *PL1* into *SO1* and turn on ac power switch *S3*. All lamps including *I4* should glow. Follow this by closing dc power switch *S2*, and place FLOWER SELECTOR switch *S1* in position 1. Shade *LDR1* and *LDR2* — you should hear the relay click as it latches on. Then shade *LDR3* — you should hear another click as the relay deenergizes.

Now, plug a lamp into power receptacle *SO2*. Repeat the shading procedure. The lamp should turn on and off in step with the relay. Open *S2* and check each of the three combinations. As a rule, open *S2* before changing the combination or opening *S3* (when turning the system off) and close *S3* before *S2* when activating the system. And remember — *please* don't water the flowers! ♦

Sphere...

we started at
the top and worked
our way up!



And we're still working. We were first in the microprocessor computer field to offer a CPU in a complete system. A microprocessor with input, processing and meaningful output.

But we didn't stop there. We had the best product on the market, but we didn't have the best product possible. So our engineers went to work and added more memory and versatility in a rapid succession of advancements, all compatible with the basic product.

We're still on top in the microprocessor field...and through research and development we'll stay on top. At Sphere we're committed to engineering leadership, because in the microprocessor field, you're only on top as long as you're working your way up.

Write for complete information: P.O. 213
Bountiful, Utah 84010
Dept. 101



SPHERE
CORPORATION

DX PROGRAMS AND DX CLUBS ON SHORTWAVE

BY RICHARD E. WOOD

IF YOU'RE a shortwave listener, perhaps you're a member of a local, national or international DX club which sends you a magazine or club bulletin once a month or better. The volunteer clubs are fine sources of information, ideal places to exchange reception tips and get to know other SWL's.

There's another type of club, however, which is also a useful source of timely information on the fast-changing shortwave broadcast bands. This is the DX club organized by a shortwave broadcast station. Many other stations, though they don't have clubs, do broadcast regular DX programs. In fact, only a few stations beaming daily to North America don't have any kind of club or DX program. (Radios Peking and Tirana and RAE Buenos Aires are three of the latter.)

Why should a big international broadcaster organize a club, and even transmit news about other stations with whose ideology it may disagree? Probably in order to try to catch that elusive character, the DX station hunter, and turn him into a regular listener. One way to do this is by offering DX tips. Another way is by challenging him to hear and report the same station several different ways. Radio RSA, Johannesburg, for instance, offers prizes for reporting reception in every shortwave band it is using. The

BBC World Radio Club occasionally challenges members to hear all its SW transmitting sites—rather an easy task, in most parts of the U.S.

Let's look at the twenty best DX and club programs that you can hear in English, and what they have to offer. We'll take them in rough order of popularity and usefulness as seen from here, though tastes may differ. Remember that times are in GMT, but dates refer to *your* local date; the GMT date will be the next day, from 0000 to 0600. The times are approximate. Except for one airing from Radio Nederland Bonaire, and the show from Budapest, the DX program is never the first item in a transmission, but follows the news and/or other features. So tune in a few minutes early, and watch for reshuffles and possible changes of date and time. Frequencies are for summer 1976. For changes in September, consult the regular listings of English-Language Shortwave Broadcasts to North America in **POPULAR ELECTRONICS** for that month.

1. "DX Juke Box," Radio Nederland. Dick Speekman is the host for this lively Thursday show. Its varied contents and bright musical items give it its "Juke Box" format. In between the records you'll find both DX tips and technical info, with an average of five minutes of straight DX tips

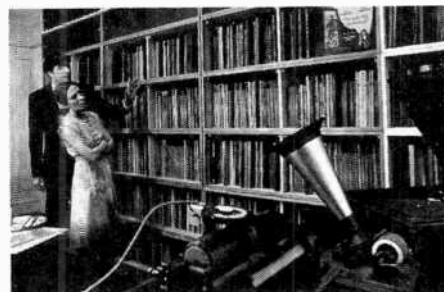

No matter how young or old the recording, the Institute of the American Musical, Inc. relies on Stanton for playback.

Speaking of problems, how would you like to be faced with the need to accurately reproduce the sound from Edison Diamond Discs, Pathés and Aeolian-Vocalions? That's just what the Institute is faced with — and that's precisely why they turned to Stanton cartridges.

The Institute collection consists of approximately 35,000 recordings, from just about every American theatre or film musical since the Berliners of the 1890's through to the latest stereo and quadraphonic recordings. They have original, historic machines to play the old recordings, but the arms are heavy and the old styli insensitive and somewhat worn. Furthermore, the acoustic playback does not permit them to filter the surface noise or tape these rare records.

Miles Kreuger, President of the Institute, discussed his problem with other famed and experienced archivists. They all agreed that the Stanton calibrated 681 Series was the answer. Naturally, it is the 681 Triple-E for critical listening and taping with more recent discs; the special 681 stylus for LP's; and, for some old 78's, a 681 cartridge, especially wired for vertical response (with a 1 mil stylus).

Today, scholars, authors and researchers, can get perfect to adequate reproduction of any of the material in the collection. The work of the Institute is important work . . . Stanton is proud to be an integral part of it.

Whether your usage involves archives, recording, broadcasting or home entertainment, your choice should be the choice of the professionals . . . the Stanton 681 Triple-E.

Write today for further information to:
Stanton Magnetics, Terminal Drive,
Plainview, N. Y. 11803.



CIRCLE NO. 48 ON FREE INFORMATION CARD

taped by experienced, competent DX'ers in four continents: North America (U.S.A.), Europe (Sweden), the Pacific (New Zealand) and Asia (Sri Lanka). The New Zealand contributor is the well-known blind DX'er Arthur Cushen, and the tips are the same as those on his "DX World" show heard a month earlier direct over Radio New Zealand. Much of the news from the four is taken from recent top loggings by active DX club members in their continent, and credited to them by name. Dictation-speed reading of frequencies makes it easy to make notes which can then lead to useful "catches." The DX Juke Box also commissions staff members and others to write and record valuable technical courses for study by listeners, with scripts or study guides often available free from Hilversum. Topics covered from season to season include propagation and the radio spectrum, transistor technology, DX'ing techniques and similar topics. The Juke Box is a pleasant, professional program with something for every listener.

THURSDAYS

Time, GMT	Freq., MHz
0645-0720	11.73 (via Bonaire)
0815-0850	9.715 (via Bonaire)
2015-2050	11.73 (via Talata)
2145-2220	9.715, 11.73
0215-0250	6.165 (via Bonaire)
0500-0535	6.165, 9.715 (via Bonaire)

2. "Sweden Calling DX-ers,"

Radio Sweden. Arne Skoog is the founder of this long-running show, whose 1361st issue was on the air as this was written. Arne himself compiles many of the programs; others are handled by experienced DX'er Bengt Dalhammar. Every two weeks, Radio Sweden generously airmails a transcript of the tips selected for broadcast. Single issues are sent to contributors of tips used, while DX editors, DX clubs and regular contributors receive bulletins by mail regularly. It is doubly useful to those who receive it because Radio Sweden's reception in North America at the convenient evening listening hours is often poor and the transcript contains tips not broadcast on the air in English, but only in other language editions such as Spanish or Russian. A word of caution: Arne believes in DX democracy, and often carries tips from beginners, those without accurate frequency calibration or those unable to distinguish Spanish from Portuguese. It's still a useful

show, 90 percent tips, the rest club news such as club-organized station popularity polls.

TUESDAYS

Time, GMT	Freq., MHz
1248-1258	15.305
1418-1428	15.305
2318-2328	6.035, 9.605, 11.705
	(subject to change)
0248-0258	9.695, 11.705

3. "World Radio Club," BBC. Here we come to the first DX program in our list which adopts the club format. The club issues membership cards, but there are no obligations or qualifications. The atmosphere is chatty, sociable and far from highbrow. As for the contents, let's quote from the BBC's magazine, *London Calling*: "Information for shortwave enthusiasts in language acceptable also for the non-technically minded. Membership is open to all who write to World Radio Club, BBC World Service, Bush House, London." Like *DX Juke Box*, but unlike *Sweden Calling*, the Club program has a mixed bag of contents, with a few DX tips (often meaty ones, mostly from the BBC Monitoring Service at Caversham Park), and technical questions answered in very elementary language mostly by the BBC's mellow-voiced chief engineer, Henry Hatch. He generally selects the type of question asked by beginners. A recent example: "Why do I hear the same BBC program on 15.07 and 15.26 MHz but with a few seconds' discrepancy in time of arrival of each, so that, if I switch quickly between the two frequencies, I hear the same words or musical notes over again?" Henry's answer to that one, by the way, was that, while 15.07 comes direct from England, 15.26 is the Ascension Island relay. Programs of music and other non-urgent material are shipped by air from the London studios to Ascension, to be played at pre-designated times, theoretically synchronized with the London studio. But human lapses and technical factors (different lengths of tape leader, for example) can cause less-than-perfect synchronization, hence the double broadcast effect.

WEDNESDAYS

Time, GMT	Freq., MHz
1330-1345	9.74, 11.75 (via Tebrau), 12.095, 15.07 15.40 (via Ascension), 17.79
2315-2330	5.975, 6.175 (via Sackville), 7.325, 9.41 9.51 (via

Sackville), 9.58 (via Ascension), 11.75, 11.78, 15.07, 15.26

FRIDAYS

2100-2115	9.41, 9.58 (via Ascension), 11.75, 12.095, 15.07, 15.26
-----------	---

SUNDAYS

0815-0830	9.60 (via Ascension), 9.64, 11.86 (via Ascension), 11.955, 15.07, 15.40 (via Ascension)
-----------	---

4. "Swiss Shortwave Merry-Go-Round," SBC.

"The Two Bobs," Bob Thomann and Bob Zanotti, are the hosts. They are amateurs, and this is the first show in our list with mostly ham tips: ARRL competitions, DX'peditions, and rare countries now active. They play a tape each time with a "mysterious signal," and identify it, helping all-band listeners identify telemetry, LORAN, jamming, SSB, numbers stations, and other transmission modes. They answer technical questions, but not being broadcast DX'ers they simply do not know the SWBC bands and therefore may give misleading or wrong answers to questions. For instance, they recently gave an inquiring listener the schedule and name information on the "ORTF," Paris, oblivious to the fact that the station and the broadcast which they cited no longer exist. Unlike some DX programs which tend to be bland, the Two Bobs are firm in their views and pull no punches in their comments on such practices as DX'ing for country totals rather than program content.

2nd & 4th SATURDAYS

Time, GMT	Freq., MHz
1322-1345	15.14
2107-2130	9.59, 11.72, 11.87, 15.305
0152-0215	5.965, 6.135, 9.725, 11.715
0437-0500	9.725, 11.715

5. "DX-ers Calling" and "Club Forum," Radio Australia.

The oldest DX program today dates from 1946. Like "DX Juke Box," it has alternating compilers of DX tips, from the west, south and east coasts of Australia. Like "Sweden Calling," it dictates DX tips clearly, giving the name and location of reporters. Some tips are fresh and original; others are taken from published sources, hence not so timely.

SATURDAYS

Time, GMT	Freq., MHz
2130-2140	11.84, 11.93, 15.16

SUNDAYS
 0900-0910 9.57, 15.27
 1200-1210 9.58
 1530-1540 9.77, 11.81
 0215-0225 15.32, 17.795

"Club Forum" is the program of the Radio Australia Listeners' Club. To qualify for membership, you must send in twelve numbered reception reports at a rate of two per month over a period of six months. Members get a kangaroo lapel badge and membership certificate. Send to Listeners' Club, Radio Australia, Melbourne 3000, Australia; or to 1270 Ave. of the Americas, Suite 2708, New York, NY 10020. The "Forum" discusses club activities, welcomes new members, discusses the writing of reception reports, and generally provides a social hour for the members scattered around the world.

SATURDAYS
Time, GMT Freq., MHz
 0830-0845 9.57, 15.27
 1200-1215 9.58
 1230-1245 5.995, 6.005, 9.77, 11.81
 1645-1700 9.77, 11.81
 0215-0230 15.32, 17.795

6. "DX Corner," Radio RSA. Gerry Wood of Capetown is the presenter of this recently expanded show, now with two different editions weekly. Unlike the other DX programs offered more than once a week, "DX Corner" is written and presented with two distinct audiences in mind. The Saturday show is for the advanced DX'er, and the Wednesday offering is for the beginner and general listener. It's a little like "DX Juke Box:" there are regular courses on basic topics like shortwave receiver selection. DX tips emphasize stations in Africa, and there are spotlights on particular African stations. Like BBC's "World Radio Club," Radio RSA often talks about its own transmitting facilities at the H.F. Verwoerd station, now under expansion.

WEDNESDAYS & SATURDAYS
Time, GMT Freq., MHz
 1635-1645 11.90, 15.175
 2135-2145 5.98, 7.27, 11.90
 2305-2315 5.98, 9.585, 9.695, 11.90

7. "DX Party Line," HCJB Quito. Clayton Howard, the host, is sometimes joined by his wife Helen for three different slow-paced, rather rambling half-hours. The "Party Line" is just the opposite of the rapid-fire tips programs from Sweden, Australia and Japan. Clayton takes his time, mander-

SOLID STATE...BREAKERLESS ELECTRONIC IGNITION.

The BEST...The ULTIMATE of All Ignition Systems

ALLISON 'OPTO-ELECTRIC'



★ No Breaker-Points or Condenser to EVER wear out or need any maintenance.



★ Once installed and properly timed your Distributor will give you **CONTINUOUS PEAK PERFORMANCE!**



● The Allison OPTO-ELECTRIC System ELIMINATES the Points and Condenser, replacing them with an OPTO-Electronic Trigger, using a Light-Emitting Diode and Phototransistor. This System operates on a BEAM OF LIGHT. There is NO "Breaker-Point Wiper-Arm" to wear down. Point bounce and erosion are completely eliminated thereby giving longer Timing ACCURACY than any System using "Mechanical" Breaker-Points. (and No Timing Fluctuation as with Magnetic Impulse Units). ACCURATE Timing gives the BEST in Engine EFFICIENCY...and that's the name of the Game for the BEST in GAS MILEAGE and ECONOMY.

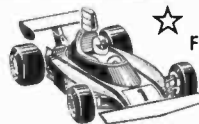

★ **PROVEN RELIABILITY**
 Factory Tested to 15,000 RPM
 Road and Race PROVEN
 (Opto-Electric Systems Won at INDY Two Years in a Row)

● The Allison's "Built-In" DWELL never needs adjustment, it is PRE-SET to supply the OPTIMUM Performance at BOTH High and Low speeds. The RPM capability of the "OPTO-ELECTRIC" unit exceeds that of any known automotive Internal combustion engine. Positive spark intensity and duration helps eliminate "misfire" and extends the Spark-Plug life.

● The Allison "OPTO-ELECTRIC" was engineered to OUT-LAST the LIFE OF YOUR CAR. Only the Highest Grade Solid-State Components are used...UNAFFECTED by Moisture or Vibration! Easier engine starting under ANY Weather Condition. Solid, DEPENDABLE PERFORMANCE.

★ Installed in your Distributor in same location as Points. **COMPLETE INSTRUCTIONS FURNISHED.**
 (Not Necessary to Dismantle your Distributor)



ALLISON

AUTOMOTIVE COMPANY 1267 - E8 East EDNA PL., COVINA, CAL. 91722

★ **ORDER with CONFIDENCE**...
FACTORY-BACKED 10-YEAR
 Free Repair or Replacement on ANY Defects in Materials or Workmanship.

★ **SAVE! ORDER FACTORY DIRECT**

● Send Check or M.O.
 State Make, Year, Engine Size, (4, 6, or 8-cylinder).

● You may use your **MASTER CHARGE** or **BANKAMERICARD**. Send us (1) Your Number, (2) Interbank No., (3) Exp. Date
MC or BA Card Holders, ORDER by TOLL FREE PHONE:
 (800) 423-6525, Ext. 2. (When in Continental U.S.A.)

★ Before Buying any other Type ignition system...
 ★ **Send Postcard for our FREE BROCHURE.**

★ If you have already installed a "Capacitive-Discharge" Ignition Modernize and Increase its Efficiency...
CONVERT YOUR "C-D" UNIT TO BREAKERLESS!
 Opto-Electric "TRIGGER UNIT"... Only \$34.95.

● America's Oldest and Largest Manufacturer of Opto-Electronic Ignition Systems.

Our BEST Salesmen are the USERS of our ALLISON System!

CIRCLE NO. 6 ON FREE INFORMATION CARD

If you don't need it for forever, don't build it for forever.

Here's an application for our ACE solderless breadboards you may not have thought of.

Next time you only need a circuit for a little while, build it up on an ACE. There's an ACE the right size for almost any circuit you have to build. And ACE is a more reliable solderless breadboard, so your circuit can stay functional for as long as you need it together. Then, when your need for the circuit disappears, just disassemble it and use everything over again. It's all good as new.

And what's true for ACE is also true for our versatile A P Super-Strips™, Terminal and Distribution Strips.

So if you have a special application circuit that you won't need around forever—a test jig, a set-up-and-calibrate hookup, you name it—put ACE to work for you. The time you save may be your own. ACE. The All Circuit Evaluator from A P Products.

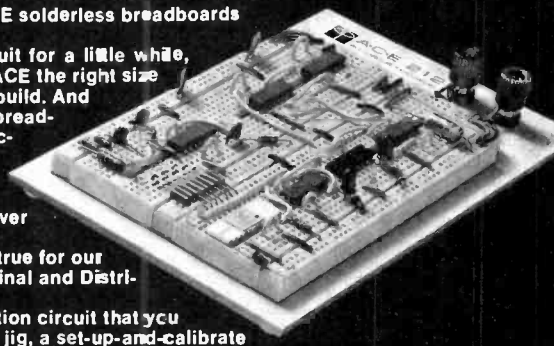

Order No.	ACE Model No.	Tie Points	DIP Capacity	No. Buses.	No. Posts	Board Size (inches)	Price Each	Qty.	Total
923333	200-K (kit)	728	8 (16's)	2	2	4-9/16x5-9/16	\$18.95		
923332	208 (assem.)	872	8 (16's)	8	2	4-9/16x5-9/16	28.95		
923334	201-K (kit)	1032	12 (14's)	2	2	4-9/16x7	24.95		
923331	212 (assem.)	1224	12 (14's)	8	2	4-9/16x7	34.95		
923326	218 (assem.)	1760	18 (14's)	10	2	6-1/2x7-1/8	46.95		
923325	227 (assem.)	2712	27 (14's)	28	4	8x9-1/4	59.95		
923324	236 (assem.)	3648	36 (14's)	36	4	10-1/4x9-1/4	79.95		

ACE solderless breadboards feature gold-anodized aluminum base/ground plating, non-corrosive nickel-silver terminals and four rubber feet.

Total for merchandise

Sales Tax (OH and CA)

Shipping (see table)

TOTAL ENCLOSED

- Check or M.O. enclosed
- Charge BAC
- Charge MC
- Send catalog

Shipping/Handling

Up to \$10.00 \$1.00
 10.01 to 25.00 1.50
 25.01 to 50.00 2.00
 50.01 to 100.00 2.50
 100.01 to 200.00 3.00

Orders subject to acceptance at factory.

Company PO's FOB Painesville
 No COD orders
DEALER INQUIRIES INVITED.



AP PRODUCTS INCORPORATED

Box 110-H Painesville, OH 44077 (216) 354-2101

CIRCLE NO. 1 ON FREE INFORMATION CARD

ing through tips, Andean folk music, letters from listeners, taped interval signals, complete articles read out from DX papers, and "Tips for Real Living," a series of evangelical spots intermingled with the DX. The American Short Wave Listeners' Club is the main source of the tips, but HCJB has its own DX club, ANDEX, similar to those described above. Write to ANDEX, c/o HCJB, Box 691, Quito Ecuador. The editor of another club bulletin, John Trautschold, tapes a weekly report. Despite the three weekly editions, the "Party Line" is not particularly timely in its reporting. Some listeners will like its folksy atmosphere, others may be turned off by its slow pace, lack of original material, or mixture of religion and music with the DX. Reception quality is great, though.

MONDAYS

Time, GMT	Freq., MHz
0930-1000	6.13, 9.745
1930-2000	15.30, 17.73, 17.855
0230-0300	6.095, 9.56, 11.915

WEDNESDAYS

0230-0300	6.095, 9.56, 11.915
-----------	---------------------

THURSDAYS

0930-1000	6.13, 9.745
1930-2000	15.30, 17.73, 17.855

SATURDAYS

0930-1000	6.13, 9.745
1930-2000	15.30, 17.73, 17.855
0230-0300	6.095, 9.56, 11.915

8. "Arthur Cushen's DX World," Radio New Zealand. Perhaps the world's best-known DX'er, blind-but-active Arthur, tapes his tips and station recordings at the Invercargill studios of the NZBC, near the tip of the South Island. This show is also for medium-wave DX'ers, especially those interested in Pacific and Southeast Asian stations. Radio New Zealand does not broadcast to North America, and its power is modest, but it is heard by nightowls even on the East Coast. You will hear Arthur's tips on other stations, however, especially Radio Nederland, Radio Australia and HCJB, a little later. This is the only monthly DX program.

1st WEDNESDAYS

Time, GMT	Freq., MHz
0745-0800	6.08 (alternate 6.105), 9.54
1030-1045	6.08, 9.52

(both one hour earlier Nov.-Apr.)

9. "World DX News," Adventist World Radio. Many U.S. SWL's may

never have heard this DX show, yet it is a good one, and audible in the U.S., except the West. Reason for its lack of fame here is that it is not broadcast to this continent, and that its schedule and single frequency are subject to change without notice. Like HCJB, Adventist World Radio, also known as the Voice of Hope, is a religious broadcaster. The show is prepared by British DX'ers, mostly from the World DX Club. All tips are original, not quoted from other programs or bulletins. It is transmitted over both stations from which AWR leases time in southern Europe. Better reception here is from the Malta transmitter, which is used later in the day for broadcasts to North America by Deutsche Welle.

SATURDAYS

Time, GMT	Freq., MHz
2020-2045	6.035 (subject to change, via Malta)

SUNDAYS

0935-1000	9.67 (via Sines, Portugal)
-----------	----------------------------

10. "Calling DX-ers & Radio Amateurs," Radio Budapest.

Another club program, this show carries reports from members of the Radio Budapest Shortwave Club (write simply to Radio Budapest, Hungary). As a so-called "liberal" communist country in its internal policies, Hungary does not shrink from broadcasting news of western stations, even from countries like Spain or South Africa, or from the Vatican Radio or HCJB. But the quality of hobbyist tips varies. Some are outdated, others seem dubious. At times there are letter sessions, and at others, amateur tips, as the title implies.

TUESDAYS & FRIDAYS

Time, GMT	Freq., MHz
0400-0415	6.00, 6.115, 9.585, 11.91, 15.22

11. "For the DX-ers" & "DX News," Voice of Turkey. Since Ankara extended its English transmission time last year it has had, like HCJB, a good deal of broadcast time to fill with, among other things, DX information. The idea of a daily DX program is a good one, but a challenge, of course, to obtain fresh timely material in sufficient quantity. Though Voice of Turkey tries, it does not really succeed in using the weekday five minutes valuably. Likewise, the longer Saturday show simply doesn't have the sources for good, original mate-

rial, and keeps on repeating the same information, on domestic stations in Turkey, VoT QSL cards and the like. Like HCJB and others, it uses the DX show as a mailbag, reading out letters and reception reports. Ankara's show is not specifically beamed to the U.S., but reception is often good here.

MONDAYS THRU FRIDAYS

Time, GMT	Freq., MHz
2230-2235	9.515, 11.88

SATURDAYS

2215-2235	9.515, 11.88
-----------	--------------

12. "Calling All Listeners," IBA.

Not a full-fledged DX program, but a mixture of listeners' mailbag and features on radio-related topics. Recent programs have covered such areas as IBA frequency selection and why the frequency of 11.645 MHz, received by a listener in Texas during the 2000 GMT English show in the summer, is not even used in winter; interviews with personnel from Galei Tshal, the Israel Defense Forces' station whose one-kilowatt transmitter on 2.442 MHz is an exceedingly difficult catch for North American SWL's; a talk about the Israeli manufacture of television receivers, and so on. Announcer Ben Dalfen is a professional who uses his five minutes to the full. It's interesting, but there are no DX tips.

SUNDAYS

Time, GMT	Freq., MHz
2250-2255	7.412, 9.82, 11.645, 12.025

13. "DX Program," Radio Moscow. Moscow prefers to concentrate on amateur tips and short technical talks. Of course, even a listing of timely tips for Soviet domestic shortwave transmitters would be welcomed by the many U.S. SWL's who have chosen the challenging area of Soviet Union DX'ing as their specialty. They would all love to have authoritative information from Moscow on the identity of the Soviet transmitter sites in use and how to get QSL's for each of them; but that, too, is the last thing to expect on the "DX Program." Don't even hold your breath waiting for Radio Moscow to list its frequencies for the North American Service without truncating the last digit, rendering 9.685 MHz as "9.68."

THURSDAYS

Time, GMT	Freq., MHz
2320-2330	5.905, 7.10, 7.11, 7.33, 9.635, 9.665, 9.685, 11.72, 11.75, 11.87, 12.00, 12.05,

15.21, 15.245, 17.72, 17.76, 17.90
 0320-0330 5.905, 7.33, 9.53, 9.665, 9.685, 9.70 (via Sofia)
 0350-0400 6.02, 9.635, 11.96, 12.05, 15.13, 15.18, 15.21, 15.245, 17.72
 0520-0530 6.02, 9.635, 9.71, 11.96, 12.05, 15.10, 15.13, 15.18, 15.21

14. "Finn DX," Radio Finland.

Presented by the Friendly DX Club, "Finn DX" is produced by several experienced DX'ers, including Jyrki K. Talvitie, translator of this writer's book *Short Wave Voices of the World*, into its Finnish version. It is a lively mixed bag of station news, features, talks on DX techniques and propagation, reports on DX'peditions to remote receiving locations and remote stations, and straight DX tips. Drawbacks are at times rather heavily accented English and reception is variable (often poor in winter). There is interesting material on European commercial pirate and "hobby pirate" stations and on trans-polar reception of North American domestic AM stations in northern Scandinavia.

TUESDAYS

Time, GMT	Freq., MHz
1413-1428	15.185 (alternate 15.11)
2313-2328	15.185

15. "DX Program," Radio Prague.

Like the other communist stations, except Budapest, listening to foreign stations today makes Prague jittery; so you'll hear mostly amateur material and features on the Czechoslovak Radio's domestic services.

THURSDAYS

Time, GMT	Freq., MHz
0140-0150	5.93, 7.345, 9.54, 9.74, 11.99
0340-0350	5.93, 7.345, 9.54, 9.74, 11.99

16. "DX Special," Trans-World Radio, Bonaire.

Al Stewart's TWR show resembles Clayton Howard's from HCJB in its mixture of DX and evangelism. Its items about DX clubs and tips are of varying degrees of difficulty. Best feature is the language identification quiz. Also broadcast from TWR Monaco.

WEDNESDAYS

Time, GMT	Freq., MHz
0045-0100	11.925

SATURDAYS

1207-1222	11.815
-----------	--------

17. "DX Program," Radio Bucharest. DX tips mostly from Rumanian listeners, and rather routine loggings. Combined with technical questions from listeners, it's rather dull listening. Reception tends to be poor in the West, especially in winter. Some frequencies in use are never readable, so only the better bets are listed.

WEDNESDAYS

Time, GMT	Freq., MHz
0215-0227	5.99, 6.19, 9.57, 11.94
0415-0427	5.99, 6.19, 9.57, 11.94

18. "DX Program," Radio Sofia.

Compiled by the national amateur radio club of Bulgaria, this show gives details of contests, rare DX amateurs active, etc. Dull presentation, little for the SWL.

FRIDAYS

Time, GMT	Freq., MHz
0015-0025	9.70
0415-0435	9.70

19. "DX-er Report," KDWN Las Vegas, NV.

This 50-kW clear-channel station, which is *not* shortwave, spreads the DX hobby in the West and Southwest through a one-and-a-half-minute to two-minute spot. It is presented as a public service and compiled by members of the International Radio Club of America, the well-known medium-wave-only club. It naturally presents tips mostly on stations on the AM band and is intended as an introduction to the hobby for the many clear-channel listeners who have never heard of DX'ing. So it mixes general medium-wave news with interesting tips, particularly on easy foreign MW catches from western listening locations. Don't look for KDWN in the East or Great Lakes area. It has to put a deep null in its signal in the direction of the senior station on 720, WGN Chicago.

WEDNESDAYS

Time, GMT	Freq., MHz
0445-0447	(during Daylight Savings)
0545-0547	(in winter)
	0.72

20. Other DX Programs. The following stations carry DX programs, but they are either not regularly audible in North America or do not contain much of interest: Deutsche Welle, Radio Japan, Radio Kiev, FEBA Seychelles, ÖRF Austria, Radio Korea, Seoul, Sri Lanka B.C., Swazi Music Radio, and Radio Tashkent. ◆

Focus on a fine memory

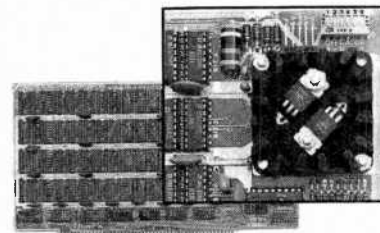

We'd like to show you all **76 IC sockets** on our **8KRA Static Memory Module**. But your imagination can do more, knowing what full **8192-word memory** will mean to your own 8080 system. So here are a few other extraordinary features of the 8KRA.

First, our **exclusive KSET™ address selection DIP switch** (upper portion of close-up), conveniently sets address boundaries in increments of 1K. You'll also see a **battery-standby power connector** on the card. Because our modules use low-power static RAM's, they'll retain data when powered by two "D" flashlight cells. So it's possible to protect your important data against sudden power loss.

Our low-power RAM's must meet military specifications (MIL STD-883C). However, our memories typically **require one third less power** than those used by our competitors. Each of our RAM's has its own IC socket, too, for easier assembly and repair (optional in the 4KRA version).

Kit Prices:

8KRA Static Memory Module \$295
 (8192-words; all sockets included)
4KRA Static Memory Module \$154
 (4096-words; all sockets included)
4KRA (without sockets) \$139



Write Us,
 about our other
 8080-compatible
 plug-in modules.

Processor Technology
 6200-Q Hollis Street
 Emeryville, CA 94608

LEARNING ELECTRONIC THEORY WITH HAND CALCULATORS

BY EDWARD M. NOLL

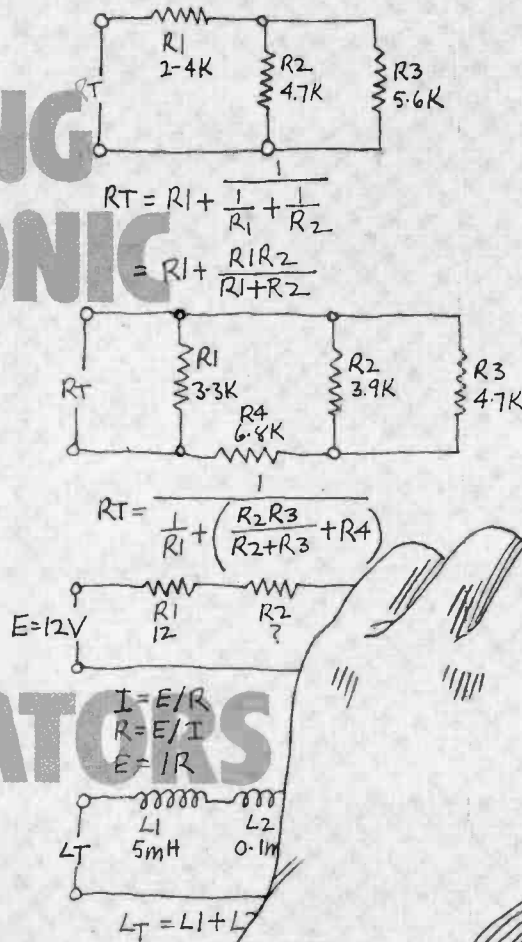

PART TWO: Reactance, Time Constants, and AC Calculations

IN THIS second installment on using the hand-held scientific calculator to learn electronics, we cover reactance, RC time-constants, and phasor calculations. As you will soon see, it is in the realm of ac mathematics that the scientific calculator is especially useful. Calculations involve finding squares and square roots of numbers. The numbers used in calculations are often very small, in the micro (10^{-6}) and pico (10^{-12}) ranges; while frequencies are in the megahertz (10^6) range. Right-triangle and phase calculations involve voltages, currents, and impedances in ac circuits.

Calculating Reactance. Simply defined, reactance (impedance) is the opposition an inductor (coil, transformer, etc.) or capacitor has to the flow of ac charges. It is expressed in ohms. Reactance is similar to the op-

position to the flow of current presented by a resistor in a dc circuit but is considerably more complex in nature.

Inductive reactance can be calculated from the equation $X_L = 2\pi fL$, where f is the frequency in hertz and L is the inductive value in henrys. Using this equation, what is the reactance of a 20-H choke at 60 Hz? Your keyboard entries for solving this problem would be:

$$2 \times \pi \times 60 \times 20 =$$

Display: 7539.82237

After rounding off, the answer would be approximately 7540 ohms.

Now, what is the inductive reactance of a 12- μ H coil at 4 MHz? The solution is:

$$2 \times \pi \times 4 \text{ EE } 6 \times 12 \text{ EE } +/-$$

6 = Display: 301.5928948

After rounding off, the answer would be 302 ohms.

To calculate capacitive reactance,

you use the formula $X_C = 1/(2\pi fC)$. Again, f is frequency in hertz, while C is capacitance in farads. Now, what is the reactance of an 8- μ F capacitor at 60 Hz?

$$2 \times \pi \times 60 \times 8 \text{ EE } +/- 6$$

= 1/x Display: 331.572798

The answer is roughly 332 ohms.

What is the reactance of a 100-pF capacitor at 4 MHz? The key sequence for solution of this problem is:

$$2 \times \pi \times 4 \text{ EE } 6 \times 100 \text{ EE } +/- 12 = 1/x$$

Display: 397.8873577

Rounded off, the answer is 398 ohms.

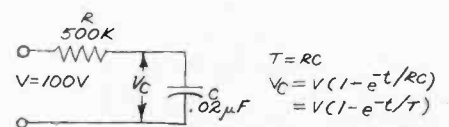

Fig. 1.

RC Time Constant. The time constant of a circuit is the product of resistance and capacitance and is expressed as $T = RC$, where T is in seconds, R is in ohms, and C is in farads. Therefore, if you wish to know the time constant for the component values shown in the Fig. 1, your keyboard entries would be:

5 EE 5 × .02 EE +/- 6 =

Display: 0.01 (second)

The answer can also be expressed as 10 ms (milliseconds).

The instantaneous voltage across a capacitor is an exponential related to the base e (2.718281828 obtained by operating the e^x key twice). The formula $V_c = V(1 - e^{-t/RC})$ is used for determining the voltage across a capacitor at any given time after power is initially applied to the circuit. Therefore to determine the voltage across the capacitor in Fig. 1 50 ms (0.05 second) after power is applied, the keyboard sequence would be:

100 × [1 - (+/- .05 ÷ 5
EE 5 ÷ .02 EE +/- 6) e^x]
= Display: 99.3262053

Note however that if you already know the time constant, you can simplify keyboard entry using the formula $V_c = V(1 - e^{-t/T})$:

100 × [1 - (+/- .05 ÷ .01
) e^x] = Display: 99.3262053

In both cases, you obtain the same answer—about 99.3 volts.

If time constant T and time period t for the Fig. 1 circuit were both 0.01 second, $-t/RC = -0.1/0.1 = -1$. Using -1 as the exponent of e , we get:

100 - (100 × +/- 1 e^x) =
Display: 63.2120559

This calculation verifies the rule that states that, in one time constant, a capacitor charges to 63.2% of the maximum voltage in the circuit.

Now, what is the voltage across the resistor when $-t/RC = -1$? Since $V = V_c + V_R$, $V_R = V - V_c$:

100 - 63.2120559 =
Display: 36.7879441

Hence, the voltage across the resistor at the end of one time period is approximately 36.8 volts.

Ac Time Constant. Time constant is important when sine waves are

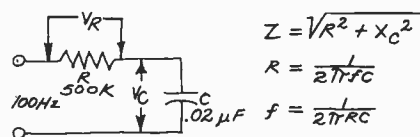

Fig. 2.

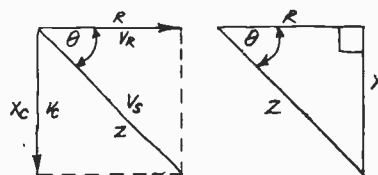

Fig. 3.

applied to resistor, capacitor, and inductor combinations. In the case of a sine wave, you cannot consider the voltage being applied as a constant as you do in dc circuits. Instead, the potential builds up gradually to peak amplitude. The reaction of the resistor-capacitor combination shown in Fig. 2 to the sine wave is a factor of frequency and the time constant of the network.

When the time constant is long compared to the period of the sine wave, the capacitor does not charge and discharge fully because the sine-wave variations are much faster than the time required to charge and discharge the capacitor by any appreciable amount. Consequently, the ac variations appear in their entirety across the resistor and not across the capacitor.

At low frequencies, where the sine-wave period is longer than the time constant, the capacitor does

same number system. Then continue to work the problem:

$$79.6 x^2 + 500 x^2 = \sqrt{x}$$

Display: 506.2965139

Hence, the circuit's impedance is roughly 506,300 ohms.

Now, at what frequency will $X_c = R$? The second equation in Fig. 2 allows us to derive the third equation, which is the one used for determining the frequency. Note that the denominator in the third equation contains the RC time-constant statement. Therefore:

$$2 \times \pi \times .01 = 1/x$$

Display: 15.9154943 (hertz)

If a 10-volt, 15.9-Hz signal is applied to the Fig. 2 circuit, how will the voltage divide? Inasmuch as reactance and resistance are basically the same, one might jump to the conclusion that 5 volts would appear across the resistor and 5 volts across the capacitor. This would be an incorrect assumption. Actually, 7.07 volts would appear across both elements. This does not

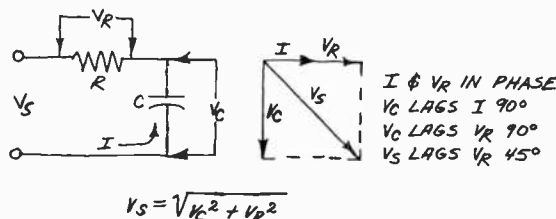

Fig. 4.

charge and discharge an appreciable amount. Therefore, there is likely to be a significant or even a great voltage variation across the capacitor, with a correspondingly lower variation across the resistor. To demonstrate this relationship, refer to Fig. 3. Note that capacitive reactance X_c lags resistance R by 90° . Therefore, the total impedance, Z , in the series RC circuit is a vector value somewhere between the resistive and reactive values. When you graph the values, a right triangle will result, with impedance Z becoming the hypotenuse.

To determine the impedance of the Fig. 2 circuit, use the first equation shown. Start by solving for X_c :

$$2 \times \pi \times 100 \times .02 \text{ EE } +/-$$

$$6 = 1/x \quad \text{Display: } 79577.47151$$

Round off and convert the result to 79.6 k so that R and C are both in the

mean that the applied voltage is 14.14 volts because a vector relationship exists.

The angular relationship can be better understood by examining Fig. 4. The same current flows through both components. The voltage across the resistor is in-phase with the current, but the voltage across the capacitor lags the current by 90° . Therefore, the capacitor voltage lags the resistor voltage by 90° , which means that the resultant must fall between the two. To determine the value of applied voltage V_s , use the formula given in Fig. 4. So, assuming $V_c = V_R = 7.07$ volts:

$$7.07 x^2 + 7.07 x^2 = \sqrt{x}$$

Display: 9.998489885

This proves that with a source potential of 10 volts, the voltages across the resistor and capacitor are both 7.07 volts when $X_c = R$.

Be the “New Professional” in electronics

**CREI trains you at home
for one of the most important
career levels in electronics—
plus offers you special
arrangements for engineering
degrees**

Most people think there are only two levels of careers in electronics: the technician level and that of the degree engineer.

There is, however, a third and very important level. It is that of the engineering technician or *practical* engineer. The growing importance of this career level has created what might well be called the “New Professional” in electronics.

If you look at the various levels of employment in electronics, you will understand why this “New Professional” is so important.

The average technician is a person who has had vocational training in electronics. He understands the basic principles of electronics so he can troubleshoot, repair and maintain equipment. He usually works under close supervision in performing his duties.

The engineer has college training in electronics. He usually supervises technician personnel and is responsible for planning and developing of electronic equipment and systems. Frequently, however, engineers are more heavily trained in the scientific principles of electronics and less in their practical application.

The engineering technician, by contrast, is a specialist in the practical application of electronics. His training usually consists of a two-year college program in electronic engineering technology. In many organizations, the engineering technician handles several of the responsibilities of the degree engineer. He often has the title of engineer.

CREI programs are designed to give you at home the same level and depth of training you receive in a two-year college program in electronic engineering technology. CREI programs are, in fact, more extensive than you will find in many colleges. And CREI gives you the opportunity to specialize in your choice of the major fields of electronics.

Unique Design Lab

CREI gives you both theory and practical experience in circuit design with its Electronic Design Laboratory Program. The professional equipment included in this program allows you to construct, test out and correct the circuits you design until you have an effective circuit.

This Lab Program helps you understand advanced electronics. It also gives you practical experience in many other important areas of electronics, as in pro-

Career Training at Home

totype construction, breadboarding, test and measurement procedures, circuit operation and behavior, characteristics of electronic components and how to apply integrated circuits.

Only CREI offers the unique Lab Program. It is a complete college Lab and, we believe better than you will find in most colleges. The "Lab" is one of the factors that makes CREI training interesting and effective. And the professional equipment in this program becomes yours to keep and use throughout your professional career after you complete the training.

Engineering Degree

CREI offers you special arrangements for earning credit for engineering degrees at certain colleges and universities as part of your home study training program. An important advantage in these arrangements is that you can continue your full time job while "going to college" with CREI. This also means you can apply your CREI training in your work and get practical experience to qualify for career advancement.

Wide Program Choice

CREI gives you a choice of specialization in 14 areas of electronics. You can select exactly the area of electronics best for your career field. You can specialize in such areas as computer electronics, communications engineering, microwave, CATV, television (broadcast) engineering and many other areas of modern electronics.

Free Book

In the brief space here, there isn't room to give you all of the facts about CREI college-level, home study programs in electronics. So we invite you to send for our free catalog (if you are qualified to take a CREI program). The catalog has over 80, fully illustrated pages describing your opportunities in advanced electronics and the details of CREI home study programs.

Qualifications

You may be eligible to take a CREI college-level program in electronics if you are a high school graduate (or the true equivalent) and have previous training or experience in electronics. Program arrangements are available depending upon whether you have extensive or minimum experience in electronics.

Send for this FREE Book describing your opportunities and CREI college-level programs in electronics



Mail card or write describing qualifications to

CREI CAPITOL
RADIO
ENGINEERING
INSTITUTE

McGraw-Hill Continuing Education Center
3939 Wisconsin Avenue Northwest
Washington, D.C. 20016

Accredited Member National Home Study Council

GI Bill

*CREI programs
are approved
for training of
veterans and
servicemen under
the G.I. Bill.*

The same phase relationships exist between resistance, impedance, and reactance as shown in Fig. 5. Again, the right triangle is the basis of the phasor. With this in mind, calculate the reactance of the capacitor in Fig. 2 when $f = 15.9$ Hz:

$$2 \times \pi \times 15.9 \times .02 \text{ EE } +/- 6 = 1/x \text{ Display: } 500487.2423$$

Note that the answer, after rounding off, is very close to the 500,000-ohm value of the resistor. Assuming $R = X_c = 500$ k, calculate Z :

$$500 x^2 + 500 x^2 = \sqrt{x} \text{ Display: } 707.1067811 \text{ (kilohms)}$$

Ac Trigonometry. The modern hand-held scientific calculator permits the student of electronics to dispense with trigonometry tables when calculating angles. We find extensive use of sin, cos, and tan functions in ac vector calculations, as well as their arc functions (\sin^{-1} , \cos^{-1} , \tan^{-1}). The important relationships for the impedance vector are: $\sin \theta = X/Z$; $\cos \theta = R/Z$; and $\tan \theta = X/R$.

Knowing that reactance X_c is equal to resistance R , both being 500 kilohms, for the Fig. 2 circuit, $\tan \theta = X/R = 500 \text{ k}/500 \text{ k} = 1$. From this, we can calculate the phase angle, $\theta = \tan^{-1} 1$:

$$1 \tan^{-1} \text{ Display: } 45 \text{ (degrees)}$$

Once you know angle θ and resistance R , you can find the impedance from the formula $Z = R/\cos \theta$:

$$5 \text{ EE } 5 \div 45 \cos = \text{ Display: } 707106.7813 \text{ (ohms)}$$

This proves that the impedance of the circuit is approximately 707,000 ohms and not the simple arithmetical summation of X and R .

The angle at which $X = R$ is 45° . For other frequencies and other reactance ratios, the same equations can be

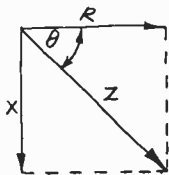

Fig. 5.

used. If any two quantities (X , R , Z) are known, angle θ can be calculated. The impedance can then be calculated. Likewise, when any two of the voltages are known, the third can be determined. A few examples will help to demonstrate these relationships in a series RC circuit.

First, in a series RC circuit that is to have an angle θ of 30° , X_c is 10,000

ohms. What resistor value is required? Using the formula $R = X_c/\tan \theta$, the calculator procedure would be:

$$10000 \div 30 \tan = \text{ Display: } 17320.50811 \text{ (ohms)}$$

The answer is approximately 17,320 ohms.

Next, calculate the impedance of a series RC circuit when X_c is 2000 ohms and R is 4000 ohms. Using the formula $\theta = \tan^{-1}(X/R)$, we get:

$$2000 \div 4000 = \tan^{-1} \text{ Display: } 26.5650511$$

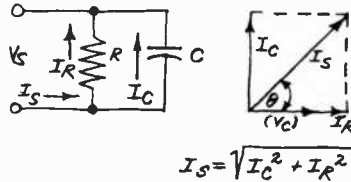

Fig. 6.

Then we find impedance using the formula $Z = R/\cos \theta$:

$$4000 \div 26.5650511 \cos = \text{ Display: } 4472.135954 \text{ (ohms)}$$

Now, prove that the above answer is correct by using the impedance formula:

$$2000 x^2 + 4000 x^2 = \sqrt{x} \text{ Display: } 4472.135954$$

As you can see, the answer checks out down to the last decimal place.

Finally, in a series RC circuit, R is 150 kilohms and f is 12,000 Hz. At what value of C will X_c be 500 kilohms? Start by solving for angle θ using the formula $\theta = \cos^{-1}(R/Z)$:

$$150 \div 500 = \cos^{-1} \text{ Display: } 72.5423969$$

The tangent equation can then be used to determine the required reactance to obtain a 72.54° angle:

$$150 \times 72.5423969 \tan = \text{ Display: } 476.969601$$

The final step is to determine the value of C that will produce a 476.97-kilohm reactance at 12,000 Hz. Use the formula $X_c = 1/(2\pi fC)$:

$$2 \times \pi \times 12 \text{ EE } 3 \times 476.96901 \text{ EE } 3 = 1/x$$

$$\text{ Display: } 2.780659563 - 11$$

Hence, after rounding off the result, we know that the capacitor must have a value of $0.0278 \mu\text{F}$ when used with a 150-kilohm resistor to provide the required impedance at 12,000 Hz.

Parallel RC Circuits. In a parallel resistor-capacitor circuit, the applied voltage appears across both elements. (In any parallel circuit, the same voltage appears across each

parallel leg.) The current, however, divides into separate components as a function of resistance and reactance. Likewise, the source current and the angle are related to the absolute and relative values of resistance and reactance.

In the resistive leg, the voltage and current are in-phase. Since source voltage V_s and capacitor voltage V_c are in parallel with resistor voltage V_R , they are in-phase with resistor current I_R as shown in Fig. 6. Capacitive current I_c must lead capacitor voltage V_c by 90° as shown. Therefore, in the parallel RC circuit, the source current must also lead resistor current.

The above relationship demonstrates that source current is not a simple summation of the resistor and capacitor currents. It is the vector sum:

$$I_s = \sqrt{I_R^2 + I_c^2}$$

Since the voltages across R and C are the same as the source, we can deal simply with impedances, so that

$$(1/Z)^2 = (1/R)^2 + (1/X_c)^2$$

or $Z = RX_c / \sqrt{R^2 + X_c^2}$. Impedance, therefore, is a product over sum relationship, much as is the case in which two resistors are connected in parallel. However, note that instead of a simple sum, a vector sum is required in the denominator.

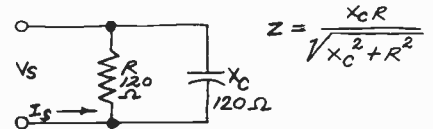

Fig. 7.

Calculate the impedance of the Fig. 7 circuit:

$$120 \text{ } 1/x \text{ } x^2 + 120 \text{ } 1/x \text{ } x^2 = \sqrt{x} \text{ } 1/x \text{ Display: } 84.85281381$$

or $120 \times 120 \div (120 x^2 + 120 x^2) \sqrt{x} = \text{ Display: } 84.85281378$

For all practical purposes, both answers are identical. Since R and X_c are equal, the calculations could have been simplified as follows:

$$120 \text{ } 1/x \text{ } x^2 \times 2 = \sqrt{x} \text{ } 1/x$$

or $120 x^2 \div (120 x^2 \times 2) \sqrt{x} =$

$$\text{ Answers in all cases will be within six-digit accuracy. What is the source current if the source potential is 24 volts in Fig. 7? From Ohm's Law, we know that } I_s = V_s/Z. \text{ Therefore}$$

$$24 \div 84.8528138 = \text{ Display: } 2.828427123 - 01$$

Translated, I_s is approximately equal to 283 mA.

A right triangle shows the vector relationship with angle θ between source current I_s and resistor current I_R , as in Fig. 6. The appropriate equations are: $\tan \theta = I_C/I_R = R/X_C$; $\cos \theta = I_R/I_s = Z/R$; and $\sin \theta = I_C/I_s = Z/X_C$. Now, using the $\tan \theta$ formula, determine angle θ for the Fig. 7 circuit:

$$120 \div 120 = \tan^{-1} \quad \text{Display: } 45^\circ$$

Again, as in the series RC circuit, $= 45^\circ$ when $X_C = R$.

Calculate I_C and I_R for the Fig. 7 circuit. Use the $\sin \theta$ and $\cos \theta$ formulas — $I_C = I_s \sin \theta$:

$$.282842712 \times 45 \sin =$$

$$\text{Display: } 1.999999993 -01$$

and $I_R = I_s \cos \theta$:

$$.282842712 \times 45 \cos =$$

$$\text{Display: } 1.999999996 -01$$

Now find the vector sum of I_C and I_R :

$$.199999999 x^2 + .199999999 x^2$$

$$= \sqrt{x} \quad \text{Display: } .282842711$$

When X_C and R are not equal, the current in the circuit divides in accordance with the ohmic values of the reactance and resistance. With this in mind, calculate Z and I_s for the Fig. 8 circuit:

$$100 x^2 1/x + 10 x^2 1/x =$$

$$\sqrt{x} 1/x \quad \text{Display: } 9.950371903$$

or $100 \times 10 \div (100 x^2 + 10$

$$x^2) \sqrt{x} =$$

$$\text{Display: } 9.950371903$$

Source current I_s can then be calculated:

$$100 \div 9.950371903 =$$

$$\text{Display: } 10.04987562$$

Phase angle θ becomes:

$$100 \div 10 = \tan^{-1}$$

$$\text{Display: } 84.2894069$$

From the answer obtained, it is obvious that this circuit is highly capacitive, since angle θ is much greater

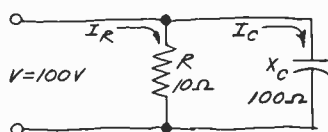

Fig. 8

than 45° . Reactive current I_C is 10 times greater than resistive current I_R and source current I_s leads source voltage V_s by a substantial amount.

Coming Up. This ends the second part of our series on using the handheld scientific calculator for learning electronics. In the third and final part of the series, we will be covering frequency response and resonance, RC coupling, basic amplifier calculations, and RLC circuits. ♦

The phono cartridge that doesn't compromise any modern record.

AT15Sa

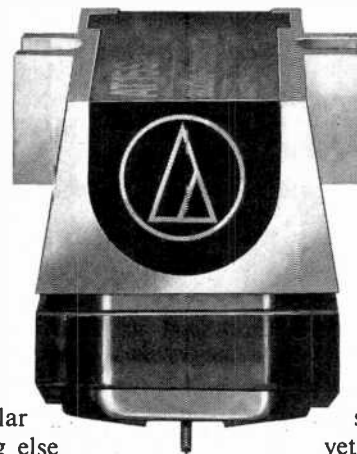

Choosing an AT15Sa can add more listening pleasure per dollar than almost anything else in your hi-fi system. First, because it is one of our UNIVERSAL phono cartridges. Ideally suited for every record of today: mono, stereo, matrix or discrete 4-channel. And look at what you get.

Uniform response from 5 to 45,000 Hz. Proof of audible performance is on an individually-run curve, packed with every cartridge.

Stereo separation is outstanding. Not only at 1 kHz (where everyone is pretty good) but also at 10 kHz and above (where others fail). It's a result of our exclusive Dual Magnet* design that uses an individual low-mass magnet for each side of the record groove. Logical, simple and very effective.

Now, add up the benefits of a genuine Shibata stylus. It's truly the stylus of the future, and a major improvement over any elliptical stylus. The AT15Sa can track the highest recorded frequencies with ease, works in

*TM. U.S. Patent Nos. 3,720,796 and 3,761,647.

any good tone arm or player at reasonable settings (1-2 grams), yet sharply reduces record wear. Even compared to ellipticals tracking at a fraction of a gram. Your records will last longer, sound better.



Stress analysis photos show concentrated high pressure with elliptical stylus (left), reduced pressure, less groove distortion with Shibata stylus (right).

The AT15Sa even helps improve the sound of old, worn records. Because the Shibata stylus uses parts of the groove wall probably untouched by other elliptical or spherical styli. And the AT15Sa Shibata stylus is mounted on a thin-wall tapered tube, using a nude square-shank mounting. The result is less mass and greater precision than with common round-shank styli. It all adds up to lower distortion and smoother response. Differences you can hear on every record you play.

Don't choose a cartridge by name or price alone. Listen. With all kinds of records. Then choose. The AT15Sa UNIVERSAL Audio-Technica cartridge. Anything less is a compromise.

audio-technica 

INNOVATION □ PRECISION □ INTEGRITY

AUDIO-TECHNICA U.S., INC., Dept. 86P, 33 Shiawasee Ave., Fairlawn, Ohio 44313



Product Test Reports

ABOUT THIS MONTH'S HI-FI REPORTS

In addition to being an outstanding performer, Onkyo's Model TX-4500 AM/stereo FM receiver features a novel and highly efficient aid called "Quartz Lock Tuning." Combining some of the characteristics of afc and synthesized tuning, though it is neither, the system makes it literally impossible to tune in any FM station incorrectly.

From Denmark comes Bang & Olufsen's Beogram Model 1900 record player that provides foolproof operation. A single control combines speed selection, record indexing, arm lift, and vernier speed adjustment functions. Technologically, the record player is notable for its extremely low-mass tonearm (the arm and pickup are integrated), which enhances the ability to play warped discs.

—Julian D. Hirsch

ONKYO MODEL TX-4500 AM/STEREO FM RECEIVER

Phase-locked loop reduces FM tuning error to zero.

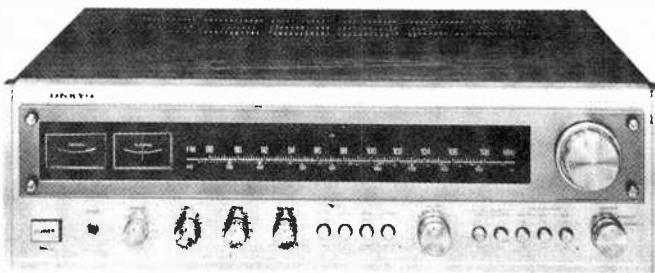

The Onkyo Model TX-4500 "Quartz Locked" stereo receiver features a novel and highly effective tuning aid that makes it virtually impossible to incorrectly tune in an FM station. Unlike conventional automatic frequency control (afc) that partially reduces tuning errors, the Quartz Lock is a phase-locked loop system that can reduce such errors to zero.

A 10.7-MHz crystal oscillator supplies the reference signal for the tuning system. The average i-f output from a received signal is compared to the reference signal, and any phase error produces a correcting voltage that "locks" the tuning to produce an i-f at exactly 10.7 MHz. The tuning knob is insulated from the panel and chassis. Touching it or even bringing a hand near it disables the PLL system

to permit conventional tuning. When a signal is within locking range, the legend LOCKED appears in red above the dial scales. (If the broadcast is in stereo, a STEREO legend also comes on in red.)

Releasing the tuning knob allows the PLL circuit to take over after about 0.7 second, solidly locking the receiver to the signal. When this happens, the TUNED legend appears in green over the dial scales.

The receiver measures a fairly large 21¼" W × 17" D × 6½" H (54 × 43.2 × 16.5 cm) and weighs about 36.5 lb (16.6 kg). Price is \$450.

General Description. A pushbutton switch on the front panel of the receiver can be used to disable the Quartz Lock tuning system and interstation muting to permit tuning in very weak signals. Other pushbutton switches are assigned to the Low and

HIGH audio filters and LOUDNESS compensation. There are terminals on the rear of the receiver for connecting an external FM Dolby unit. The Dolby unit is inserted into the audio signal path by operating another pushbutton, simultaneously changing the FM deemphasis from 70 μs to the 25 μs required for proper Dolby operation.

The input SELECTOR has positions for AM, FM AUTO, PHONO 1, and PHONO 2. Its settings are keyed to corresponding illuminated legends above the dial scale. Unlike most receivers, this one has no AUX input dedicated to an external high-level program source. Instead, there are three tape recorder circuits, each of which is controlled by its own MONITOR pushbutton. One or two of these circuits can be used for AUX sources, leaving facilities for one or two tape decks. By pressing the appropriate buttons, it is possible to dub from recorder 1 to recorder 2 or 3 or from recorder 2 to recorder 3.

At the lower left of the control panel are a large POWER pushbutton and a headphone jack. All remaining controls are operated by turning knobs. They include a SPEAKERS selector that controls up to three pairs of speaker systems. Any pair or two combinations of two pairs of speaker systems can be activated. Alternatively, all speaker systems can be silenced for private headphone listening. The BASS and TREBLE tone controls each have 21 click-stop positions. The BALANCE control is center detented, and the VOLUME control has 41 click-stop positions.

Most of the upper half of the front panel is given over to the tuning dial scales and signal-strength and FM center-channel tuning meters. The dial area blacks out when power is turned off. It is clearly lit in white when power is on. The linear FM dial scale is unusually long, spanning 9" (about 23 cm), and has markings at 0.2-MHz intervals. To the right of the dial area is the large tuning knob that drives a very smooth flywheel mechanism.

On the rear apron of the receiver are separate preamplifier output and main amplifier input jacks that are normally joined together with removable jumper links. There is also a 4CH FM output ahead of the deemphasis circuits (for use with a future discrete demodulator) and a three-position slide switch that permits adjustment of the sensitivity of the Quartz Lock disabling circuit activated by the tuning knob. The antenna inputs permit

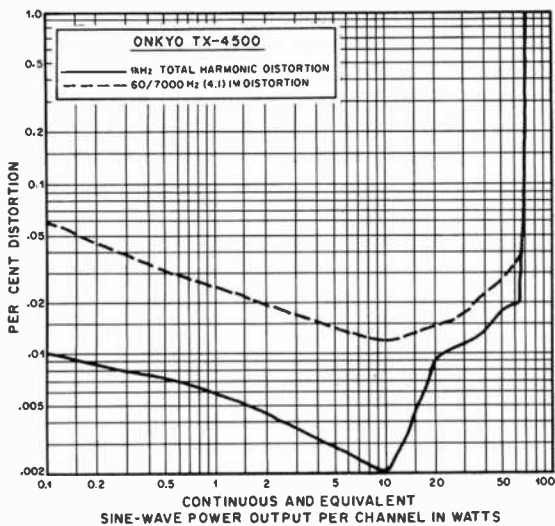

1 kHz total harmonic and 60/7000-Hz IM distortion (left). Harmonic distortion at 55 W, 1/2 power, and low power (right). Noise and sensitivity curves for FM section are given below.

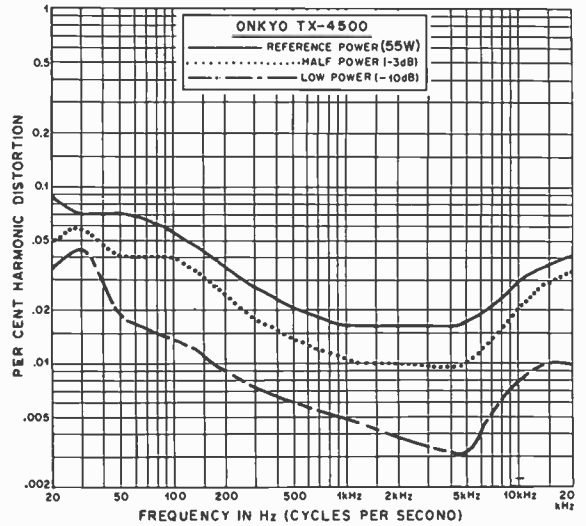

the use of either a 75- or a 300-ohm FM antenna and a separate wire-type AM antenna. There is also a hinged, but not pivoted, ferrite-rod AM antenna. The speaker terminals are insulated spring clips, and one of the three available accessory ac outlets is switched.

Laboratory Measurements. Following the standard FTC preconditioning period, the amplifiers delivered slightly greater than 70 watts/channel into 8 ohms at 1000 Hz before clipping occurred. Into 4 and 16 ohms, the measured power was 87.4 and 42.3 watts, respectively. At 1000 Hz, the THD was less than 0.01% between 0.1 and 30 watts and measured as low as 0.002% (the residual of our generator) at a 10-watt output. It increased gradually to about 0.11% at 70 watts, just before clipping. The IM distortion was between 0.01% and 0.02% at most power levels between 1 and 40 watts. It was only 0.43% at 70 watts. At very low power outputs, the IM rose slightly, to 0.4% at 2 mW.

At the rated 55 watts output into 8-ohm loads, the THD was less than

0.02% at middle audio frequencies. It rose to a mere 0.09% at 20 Hz and was 0.04% at 20,000 Hz, well within Onkyo's ratings. At lower power levels, the distortion was even less, typically between 0.002% and 0.01% at 5.5 watts output.

A phono input of 1.0 mV or a high-level input of 61 mV was required to drive the amplifier to a reference 10-watt output power level. Through either input, the unweighted noise level was 76 dB below 10 watts. Phono overload occurred at a high 225 mV.

The tone controls had a moderate, but adequate, range of about +7 to -10 dB, with a sliding bass turnover frequency and a treble response hinged at about 3000 Hz. The filters had 6-dB/octave slopes, with -3-dB response frequencies of 45 and 9000 Hz. The loudness compensation boosted both low and high frequencies. Phono equalization was accurate to within ± 0.25 dB from 40 to 20,000 Hz and was virtually unaffected by cartridge inductance — less than 0.5 dB response change at any frequency when measured through high-inductance cartridge coils.

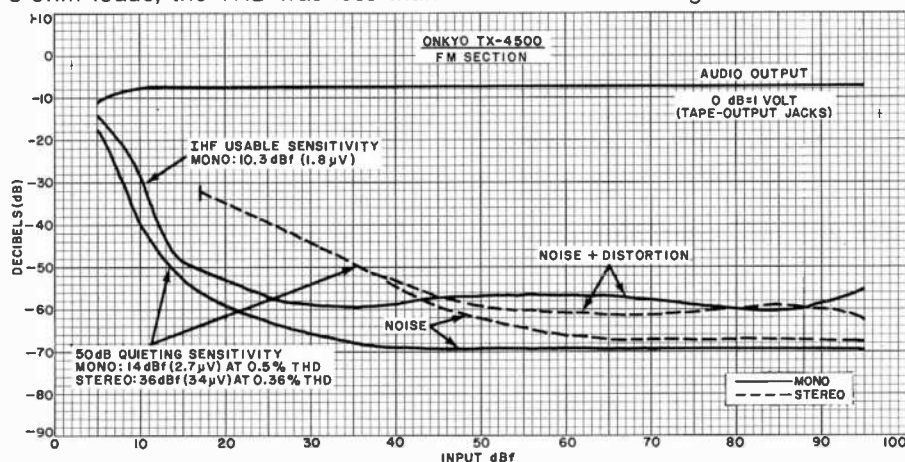

The performance of the FM tuner was equally impressive. The IHF usable sensitivity was as rated: 10.3 dBf (1.8 μ V) in mono. The stereo sensitivity was set by the automatic switching threshold of 3 to 4 μ V (about 16 dBf), which was also the muting threshold. For 50 dB of noise quieting in mono, a signal input of 14 dBf (2.7 μ V) was required, yielding a THD of 0.56%. In stereo, the 50-dB quieting sensitivity was 36 dBf (34 μ V), with 0.36% THD.

The ultimate S/N ratio at 65 dBf (1000 μ V) input was 69 dB in mono and 67 dB in stereo, with respective distortions of 0.15% and 0.09%. (A lower distortion in stereo than in mono, although not usual, does occur occasionally.) We also measured the stereo distortion at the three frequencies called for in the IHF tuner standards. At 100 Hz, it was 0.44%, at 1000 Hz, 0.05%, and at 6000 Hz, 0.14% (all measured with L - R modulation at 100%).

The FM tuner section had a frequency response flat within ± 1 dB from 30 to 14,500 Hz, with most of the deviation occurring between 2000 and 10,000 Hz. The channel separation was equally good, measuring better than 45 dB from 50 to 500 Hz and still an excellent 33.5 dB at 15,000 Hz. The capture ratio was about 1.8 dB, AM rejection was 58 dB, and image rejection was 74 dB. Alternate-channel selectivity was asymmetrical, measuring 65 dB above the signal frequency and 82 dB below it, for an average of 73.5 dB. Adjacent-channel selectivity was 6.4 dB on the average.

It should be noted that the selectivity measurements, as with all other measurements, were made with the Quartz Lock system disabled. With it in use, the effective selectivity is greatly increased, since the phase

locking prevents a stronger signal from breaking through or from "capturing" the receiver. Using the Quartz Lock system, the effective rejection of either adjacent or alternate channel signals was in excess of 80 dB. The 19-kHz pilot carrier leakage was 66 dB below full modulation.

The only measurement we performed on the AM tuner section was frequency response, which was typical of most AM tuners we have tested. The AM response was 6 dB down at 65 and 3000 Hz.

User Comment. The test data clearly reveals that the Model TX-4500 is a very good receiver in every respect. Although a few high-priced FM tuners may surpass it in some selectivity and distortion characteristics, the differences are trivial. There can be no doubt that the sound quality in FM reception with this receiver will be determined only by the quality of the broadcast program. As for the audio amplifiers, harmonic and intermodulation distortion measurements are in a class with highly regarded audio amplifiers.

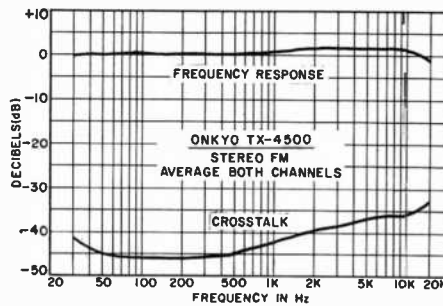

Frequency response and crosstalk averaged for both channels in stereo FM of Onkyo TX-4500.

Although the Quartz Lock system might appear to be merely a super afc, it is actually much more than that. We verified that the tuning system invariably resulted in the lowest possible distortion and noise and the best stereo separation of which the receiver is capable. The automatic disabling system works so unobtrusively that one soon forgets it is there. Muting action is perfect, with total silence until the red LOCKED light comes on and the program is heard. Regardless of the reading of the tuning meter, which can be appreciably off center at the lock point, releasing the knob

brings it to dead center as the green TUNED light comes on. The "pull-in" range of the Quartz Lock system appears to be about ± 50 kHz. The dial is very accurately calibrated so that when the meter is centered, there is no doubt as to the channel to which the tuner is set.

We noted that when playing records the sound had a definition and clarity that were unmistakable. To some extent, this might have been due to the maintenance of a true high-frequency response, instead of the couple of decibels of roll-off that often occurs above 10,000 Hz due to cartridge inductance interaction with the phono equalization. It has also been claimed that the exceptional dynamic range afforded by the receiver's high overload capability contributes to this result.

We did check the phono section with preequalized square waves, using a spectrum analyzer to detect any increase in the even harmonics in the output. We found no change in the spectral content of the square waves after they had passed through the phono preamplifier circuits.

CIRCLE NO. 80 ON FREE INFORMATION CARD

BANG & OLUFSEN BEOGRAM MODEL 1900 RECORD PLAYER

Integrated semiautomatic player handles beautifully.

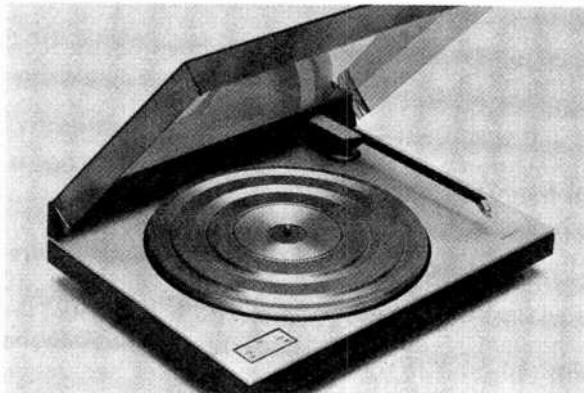

The new Beogram Model 1900 record player, consists of a 33 1/3- and 45-rpm

automatic single-play turntable and integrated tonearm/phono cartridge system. Beyond this, it has few similarities to its competitors. The conventionally pivoted tonearm has a rectangular, slim, magnesium alloy tube designed for high rigidity and low mass. The only phono cartridge it will accept is the B&O Model MMC4000, which is only a fraction of the size and

weight of most conventional cartridges (to maintain a very low arm/cartridge mass characteristic).

There is only one operating control, a flat plate that measures about $2\frac{1}{4} \times 1$ " (57.2×25.4 mm). It is mounted flush with the surface of the motorboard and provides all of the operational functions.

The record player comes mounted in a handsome rosewood veneered wood base. A tinted plastic dust cover that hinges open at any angle up to a full 90° is standard equipment. The system measures $17\frac{3}{8}$ " W \times 13" D \times

$3\frac{3}{8}$ " H ($44.1 \times 33 \times 8.6$ cm) and weighs about 14 lb (6.4 kg). System price is \$325.

General Description. The tonearm's counterweight is located over the pivots, with the arm tube fastened to its side. A plastic slider that moves along a calibrated scale on the arm is used for setting the tracking force over a range of 0 to 2.5 grams, the recommended force being 1 gram. The arm is balanced at the factory, but a screwdriver adjustment is available should it ever be necessary to reset it. The antiskating compensation system is built into the pivot design and is factory set to provide the proper compensation at the rated tracking force of the pickup.

The B&O cartridge does not have a user-replaceable stylus. If the stylus must be changed, the entire cartridge must be unplugged from the tonearm and returned to the company or one of its authorized service agencies. As with other B&O cartridges, the Model MMC4000 employs a moving-iron design with a "micro-cross" armature that varies the distribution of magnetic flux between its four pole pieces and is inherently symmetrical for all directions of stylus movement.

The 1.5-lb (0.68-kg) aluminum turntable platter is driven through a belt by an asynchronous induction motor, the speed of which can be adjusted over a nominal range of $\pm 3\%$ by an eddy-current brake. Speed selection is obtained by means of an idler wheel that moves to contact either of two different diameters of the motor shaft. A pulley on the idler shaft drives a larger central pulley, on which the platter rests, through a soft belt.

The platter has concentric rings to support the record and a ring of stroboscope markings in its label area. The turntable and tonearm support are rigidly linked by a subchassis, which is floated on compliant mounts from the motorboard to isolate the playing system from external vibration and shock and from motor vibration.

The single operating control is labeled 33 and STOP on the left side and 45 and PAUSE on the right. At the rear center of the control plate is the legend TURN, with + and - markings. The edge of a knurled wheel can be seen in the small gap between the control plate and brushed aluminum motorboard when the TURN section of the control plate is pressed.

To play an LP disc, 33 is pressed. The platter begins to rotate at 33 1/3 rpm, the tonearm swiftly indexes to the lead-in groove of a 12" (30.5-cm) disc, and after a couple of seconds lowers gently to the record surface. The audio outputs are muted whenever the pickup is not on the record. At the end of play, the arm lifts and returns to its rest position and the motor shuts off automatically. At any time during play, pressing the PAUSE side of the control lifts the pickup and in a few seconds shuts off the motor. Another touch of the 33 side of the control restarts the motor and lowers the pickup to resume play at the point from which it was lifted. Alternatively, if the tonearm is moved to another position, pressing the 33 portion of the control will cause the system to resume play at the selected point.

To play a single 45-rpm disc, a similar procedure is followed. (A large center hole adapter is provided.) The turntable is activated by pressing the 45 section of the control, where indexing is for 7" (17.8 cm).

Special disc combinations, such as 7" 33 1/3-rpm and 12" 45-rpm, cannot be played automatically, since the arm's indexing mechanism is internally coupled to the speed selected. Clearly, B&O did not intend for the sys-

tem to be played manually, since the tonearm has no finger lift and is not easily cued when in its position.

When the TURN portion of the control plate is pressed and held down, the platter rotates but the tonearm does not leave its rest position. This function can be used for cleaning a disc before playing or for adjusting the rotational speed of the platter with the knurled vernier control that becomes accessible when the plate is depressed.

The stroboscope markings on the platter are for 33 1/3 rpm only. The 45-rpm speed is adjusted automatically once the slower speed has been accurately set.

Laboratory Measurements. When we set the stylus force to 1 gram on the tonearm's scale, the measured force was exactly 1 gram. The cartridge did not lose contact with the heavily modulated low-frequency grooves of our Cook "60" test record, although it was on the verge of doing so.

The 10,000-Hz, 30-cm/s tones of the Fairchild "101" test record were reproduced with symmetrical peak clipping, revealing that this very high velocity was beyond the linear operating range of the cartridge. The 300-Hz test tones of the German Hi-Fi Institute test record could be played up to the 70-micron level without serious mistracking, but some distortion was encountered in the right channel on the 50-micron band. This indicates that the antiskating compensation was insufficient for equally effective tracking of both channels.

When playing the Shure "Audio Obstacle Course—Era III" test record, the cartridge handled the highest levels of the musical bell and violin sections without audible mistracking. On the very difficult sibilant section, a trace of "sandpaper" quality could be heard

on level 4 and definite mistracking on the maximum level 5. The maximum bass drum level also revealed a slight "crackle" that indicated incipient mistracking. These characteristics were not significantly improved by increasing the tracking force to 1.5 grams.

The frequency response of the cartridge, using the CBS STR100 record, was very smooth, with a gentle downward slope as the frequency increased from 500 to 15,000 Hz and a slight rise between 15,000 and 20,000 Hz. The overall frequency response was within ± 2 dB over the full audio range. Channel separation was typically 20 to 25 dB and was down to about 10 dB at 20,000 Hz. The advantages of the very low mass of the tonearm were evident in the low-frequency resonance, which occurred at about 12 Hz, with a 5-dB amplitude.

IM distortion measurements with the Shure TTR-102 record revealed a low 1% to 2% distortion at velocities up to about 14 cm/s, a very high recorded level for most commercial recordings, and a smooth rise to 10% at 22.6 cm/s. The maximum level of this record (27.1 cm/s) could not be tracked by the cartridge. The distortion was somewhat less at a 1.5-gram tracking force, but not enough to justify its use. The high-frequency tracking distortion, playing the shaped 10,800-Hz tone bursts of the Shure TTR-103 record, was typical of most of the better cartridges we have checked. It increased smoothly from 0.8% to 2% as the velocity increased from 15 to 30 cm/s.

The output of the cartridge was 3.9 mV at a 3.54-cm/s velocity, with the channel levels matched within 0.5 dB. The vertical stylus tracking angle was 24°. The tracking error of the tonearm was less than 0.4°/in. for radii between 2 1/2" and 6" (6.35 and 15.24 cm).

We were able to adjust turntable

Cartridge response for L & R are the same. Crosstalk curves are shown below.

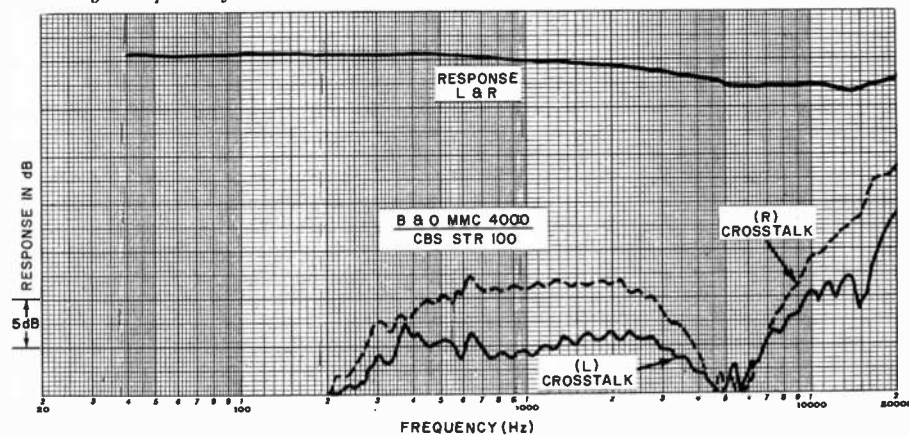

speed over a range of from +3.8% to -3.2%. When we set the 33 1/3-rpm speed exactly, the 45-rpm speed was 0.8% high. Increasing the line voltage from 117 to 135 volts ac increased the speed by only 0.3%. Decreasing the line to 95 volts lowered the speed by 4.4%, most of the change occurring as the potential fell below 100 volts.

Wow and flutter measured 0.04% and 0.035% (unweighted rms), respectively. The unweighted rumble was 32-dB down (-36 dB with vertical components cancelled), and with RRL weighting, it was 54-dB down. The isolation from vibration transmitted through the base was somewhat better than we have measured with most record players.

User Comment. The 1900's basic playing characteristics are those of a competent product. Judging from our lab tests, the cartridge itself couldn't be called "state-of-the-art" in its tracking ability. But this is not truly a limitation since we're only talking about

very extreme velocities not found on commercial music recordings.

The downward sloping frequency response gives the cartridge a very neutral, uncolored sound, especially when it is compared to cartridges with peaked, or rising high ends (which gives a somewhat "sparkly" sound). Obviously, personal taste is an important factor in assessing these sonic differences. When played through speaker systems with a strong but smooth top-end response, the B&O cartridge leaves nothing to be desired with respect to clarity and musical quality.

The Model 1900 is undeniably one of the finest handling record players on the market. The operation of the control plate is so simple and effortless that playing discs becomes more automatic than on a record changer. Simply put a disc on the platter, touch the control plate, and lower the cover. Everything thereafter is automatic.

The absence of a finger lift or a lever to manually cue the pickup seems

strange at first, but most manual cueing operations can be performed successfully with the arm in its raised position.

Of special import to us is the outstanding ability of the low-mass arm/pickup system to play the most severely warped records without a sign of distress. Our collection of warped discs is completely unplayable by any other pivoted tonearm we have used. (Only a low-mass radial arm, such as the one in the B&O Model 4002 record player, had been able to cope with them in the past.) Considering the prevalence of warpage in most discs, the importance of this feature cannot be overestimated.

In our view, the Model 1900 is an ideal choice for anyone who wants to listen to his records without aggravation and does not care to play the "battle of specifications" game. Additionally, it is an especially handsome unit, and its integrated construction eliminates the matching and assembly hassle usually faced.

CIRCLE NO. 81 ON FREE INFORMATION CARD

REALISTIC MODEL TRC-57 NAVAHO CB TRANSCEIVER

AM/SSB base station features PLL and digital clock.



THE REALISTIC Model TRC-57 Navaho from Radio Shack is a 23-channel AM/SSB CB transceiver with a number of features to recommend it. Foremost among these features is a phase-locked frequency synthesizer that eliminates the need for channel crystals. Adding to the rig's sophistication is an electronic digital clock with LED display.

Private listening is conveniently available via a phone jack on the transceiver's front panel. Separate S/r-f and SWR meters make it possible to monitor SWR while observing relative output power. A noise blanker or a conventional noise limiter can be individually switched in and out. Additional facilities include r-f gain, a-f gain, variable squelch, and clarifier

controls; LED's that indicate the mode of operation selected (AM/USB/LSB); PA service; external speaker jacks; detachable dynamic microphone; and front-facing speaker.

A built-in electronically regulated power supply permits the transceiver to be operated from conventional 117-volt 60 Hz ac power lines. Alternatively, a nominal 13.8-volt dc, positive-or-negative-ground, power source can also be used, while providing full regulation. Hence mobile operation is possible with this essentially base-station transceiver. (Mobile mounting hardware is supplied.) The transceiver measures 13.75" W x 11.2" D x 5.8" H (35 x 28.5 x 14.7 cm). Price is \$399.95.

Receiver Section. The receiver

employs single conversion to a 7.8-MHz i-f, where selectivity and sideband selection are obtained with a crystal lattice filter. The front end consists of a diode-protected r-f stage and mixer. The i-f strip contains two stages. These are followed by the AM detector and an, SSB product detector with bfo, amplified agc and squelch stages, audio amplifier, and an IC output stage that is also used as the AM transmitter modulator.

The noise blanker has two r-f stages, voltage-doubling pulse detector, and three-stage pulse amplifier with gating pulses applied to the collector circuit of the mixer. The r-f stages are tuned to 23 MHz, rather than to 27 MHz, to avoid triggering by CB signals.

A voltage-controlled oscillator (vco) furnishes the heterodyning signals for the receiver's mixer. It is set to the required frequency for each channel by means of the phase-locked loop (PLL) system. In the PLL system, a 10,000-Hz signal derived from the vco through a programmable dividing setup is compared at a phase discriminator with a 10,000-Hz standard signal derived from a crystal-controlled oscillator operating at 1 MHz. If the vco is not at the correct frequency, its derived comparison

signal will be other than 10,000 Hz (according to the dividing factor set up by the channel selector). An error voltage then appears at the discriminator to shift the vco until the exact 10,000-Hz signal is produced. The two 10,000-Hz signals are then locked in phase with each other, holding the vco at the proper frequency.

Our measurements on the receiver indicated a sensitivity of 0.5 μV on AM for 10 dB (S + N)/N at 30% modulation using a 1000-Hz signal. On SSB, sensitivity measured 0.15 μV at 500 Hz and 0.2 μV at 1000 Hz. Overall response was 300 to 2900 Hz on AM and 200 to 4400 Hz on SSB. Adjacent-channel rejection and desensitization were a minimum of 60 dB, while unwanted-sideband suppression was 50 dB at 1000 Hz.

Better-than-usual overload characteristics were exhibited by the receiver, which maintained good signal-handling capabilities with signals up to 10,000 μV in strength. Spurious unwanted-signal rejection was better than 60 dB, except at about 30.8 MHz, where it was 50 dB. I-f signal and image rejection were better than 80 dB.

The squelch was adjustable for thresholds between 0.5 and 1500 μV on AM and between 0.2 and 1500 μV on SSB. Excellent agc characteristics held the audio output to within 10 dB with an input signal change of 80 dB (at 1 to 10,000 μV), 6 dB of which change occurred at 1 to 10 μV . With very strong SSB signals, the release time was a bit fast, resulting in slight "pumping." However, this can be minimized by reducing the r-f gain. A 50- μV signal registered S9 on the meter.

Maximum sine-wave audio output power in both the receive and PA modes was 3 watts at 4% distortion into 8 ohms using a 1000-Hz test signal. We noted exceptionally good noise blanking. Using our impulse noise generator, the noise blanker attenuated noise peaks of 1000 μV or more (+60 dB above 1 μV) down to inaudibility in the presence of a 0.5- μV signal. The anl functions only on AM; its performance was highly effective.

Transmitter Section. The output of the receiver's bfo is combined with the vco signal by a balanced transmitter mixer to produce the on-channel carrier for AM transmissions. The SSB signal is generated by combining the bfo and microphone signals in an IC

balanced modulator and filtering out the unwanted sideband with a crystal filter. The signal is then amplified and combined with the vco signal in the transmitter's mixer.

The r-f section of the transmitter consists of a predriver stage, driver and power amplifier stages, and a multi-Pi output network. The output amplifier works with the driver stage to function as a collector-modulated setup on AM and as a linear amplifier on SSB.

Speech compression, or amc, is obtained with a "bootstrap" setup around the microphone amplifier that, in effect, acts as an audio-frequency agc. On SSB, r-f output limiting (or automatic level control) is incorporated by using a rectified sample of the output to control the gain of the 7.8-MHz SSB amplifier.

The carrier output power on AM measured 3.8 watts. Using a 1000-Hz test tone and greater than 40 dB of amc compression, the modulation held to 90% and the sine-wave signal exhibited only 3% THD. Under dynamic (voice operation) conditions, due to a slightly slow amc attack time, the modulation tended to go to 100%, with a bit of overshoot on the negative peaks. Nevertheless, the adjacent-channel splatter held to at least 55 dB down.

On SSB, using a two-tone test signal, the output power measured slightly greater than 12 watts pep. Third-order distortion products were an excellent 24 dB below the test tones (30 dB below pep), which is about the best performance we have ever obtained from a solid-state transmitter. However, with our voice test and using 40 dB of compression, the pep output initially tended to go to about 15 watts pep, with some flat-topping and deterioration of third-order distortion to 24 dB below pep. This was due to a slow alc attack time. Splatter was still way down, carrier suppression was 45 dB, and unwanted-sideband suppression was 50 dB at 1000 Hz.

The overall response on AM was 200 to 3500 Hz at the 6-dB points and was 300 to 3200 Hz on SSB. As might be expected from the PLL synthesizer system, the transmitter's frequency tolerance was the same on all channels, measuring nominally about minus 200 hertz.

User Comment. The transceiver is well styled and is easy to operate. Con-

Flexible alternative

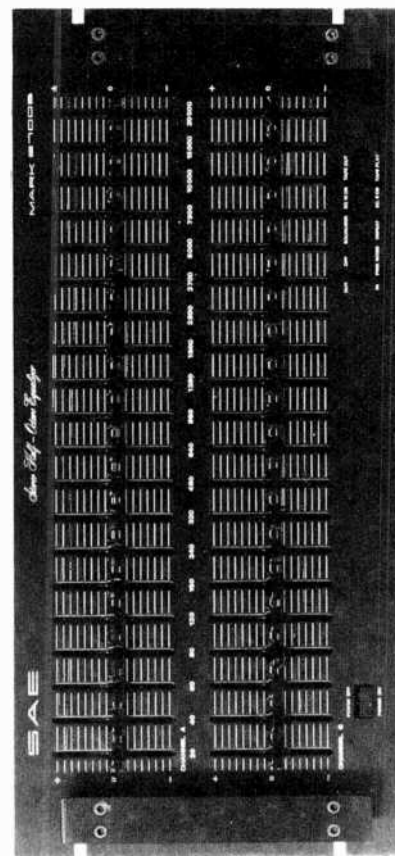

The SAE 2700B Half-Octave Stereo Equalizer

The 2700B can bring to your system the clarity & definition you have been looking for. Wayward sounds (booming bass, missing highs, blaring horns, or stifled solos) are all put in their place with the SAE 2700B Half-Octave Equalizer. The flexibility of 20 controls per channel only begins to tell the story. Some facts:

- * 0.02% THD & IM
 - * -100dB S/N Ratio
 - * Can drive any system
 - * FREE 5 YEAR Service Contract PLUS, long-throw oil-damped slide pots for better accuracy, precision wound toroid inductors for low distortion & a pink noise generator for system balance. Built with SAE quality, the 2700B is value packed with the capability and performance you need to control your system.
- PRICE: \$550.00 (suggested list)**

SAE
Scientific Audio Electronics, Inc.

P.O. Box 60271, Terminal Annex
Los Angeles, Calif. 90060

Please send me more information on the
SAE 2700B Half-Octave Equalizer.

NAME _____

ADDRESS _____

CITY _____ STATE _____ ZIP _____

trol knobs are large and easy to grip. The meters are large in size and illuminated for easy readability.

The digital clock can be set up to display time in either 12- or 24-hour format. The clock does not function when the transceiver is powered from

a dc source. The setting time may be quickly or slowly advanced or held to allow the actual time to catch up with the display.

From the results of our tests and description of the various operating facilities, it should be evident that this

transceiver is capable of superb performance. If you are looking for a full-feature AM/SSB transceiver that can do double duty as a base station and a mobile rig, this one is certainly worth serious consideration.

CIRCLE NO. 82 ON FREE INFORMATION CARD

SENCORE MODEL DVM32 PORTABLE DMM

Rugged, autopolarity, 3½-digit multimeter with large LED readout.



A FEW YEARS AGO, the typical digital multimeter was a relatively expensive, bulky piece of test gear. It required a lot of power, which tied it to the ac line and made it into a bench instrument. By contrast, the modern DMM has all the versatility, portability, compact design; and light weight of the traditional VOM. Prices have also come down considerably since the first DMM's were introduced.

Typical of the latest DMM's is the Sencore Model DVM32, which is priced at only \$198. This battery-powered portable instrument measures only 7" W x 5" H x 4" D (17.8 x 12.7 x 10.2 cm) and weighs 2¼ lb (1 kg). The instrument is housed in an impact-resistant Cicolac® case, the front edge of which forms an overlap surround to protect the controls and display from damage. The DMM's carrying handle doubles as a tilt stand.

The Model DVM32 is an autopolarity instrument. It is designed to measure both ac and dc voltage and current and high- and low-power ohms. The function and range are selected by separate rotary switches.

Technical Details. The numeric display consists of 3½ digits of 0.3" (7.62-mm) seven-segment red LED numerals, plus a LED +/– indicator. Plus is displayed, not implied. Current drain from the four C cells, which can be ordinary carbon zinc or rechargeable types, is only 15 mA to ensure long battery life. (An optional No. 39G90 ac power adaptor is available

for \$9.95 to permit the DMM to be line powered for bench use.)

There are four dc voltage ranges that provide a maximum indication of ±1999 volts. Accuracy is 0.5% of full scale. Input resistance in the dc voltage function is 15 megohms. All ranges are protected to 2000 volts dc plus peak. Ac rejection is specified at 40 dB between 50 and 60 Hz.

Ac potentials up to 1000 volts rms can be measured in four ranges with an accuracy of 1.5% at 60 Hz and 3% for the three digits. The frequency range on the ac voltage function is from 40 to 3000 Hz ±1 dB. Input impedance is 1.8 megohms shunted by 18 pF. The input is protected to 1000 volts rms plus dc on all of the voltage ranges.

There are two resistance-measuring functions, one for low-power ohms with 80 mV at the test probes and the other for high-power (conventional) ohms with 800 mV at the probe. The low-power mode has five ranges that go up to 1.999 megohms and provide a measuring accuracy of 1% of full scale. The high-power ohms mode also has five ranges, this time to 19.99 megohms, with an accuracy of 1% on all ranges except the highest, where the accuracy is stated as being 5%. In both resistance-measuring modes, the circuit is protected for inputs of up to 1000 volts dc plus peak on all ranges.

Both ac and dc current measurements can be performed on four ranges, with a maximum measuring capability of 1999 mA (1.9 amperes). Accuracy on both ac and dc is stated at 1%. The input is protected by a diode and a fuse.

The instrument has an interesting AUTO mode. With the front panel switch set to this mode, the power-consuming display comes on only when an actual measurement is being made (thus the reason for the long bat-

tery life). On standby, the internal circuits are operating, but the display is extinguished. Of course, if desired, the AUTO feature can be switched out, in which case, the display remains constantly on.

A 200,000-ohm isolation probe comes with the DMM. If potentials up to 50 kV must be measured, an optional No. 39691 high-voltage probe is also available.

User Comment. We performed our usual battery of accuracy tests on the DMM, using high-precision voltage sources and resistors. In all cases, the multimeter easily met or bettered its published specifications. Our use test of the DMM included a week at a busy workbench and an extended stint in the field. Our conclusion is that this instrument is as easy and automatic to use in either environment as any DMM we have tested in the recent past.

The large, bright display is easy to read under just about every ambient lighting condition and over a wide range of viewing angles. The controls operated with positive action and were large enough for a comfortable grasp. On several occasions when the DMM was used on battery power over a period of several hours, we came to really appreciate the battery-saving AUTO mode. We also found that replacing depleted batteries was a simple procedure. Simply remove one screw and the upper rear plate of the housing to remove the old and then replace with fresh cells.

We would not hesitate to recommend the Sencore Model DVM32 to anyone — service technician or hobbyist/experimenter — as an all-in-one test and measurements instrument for bench and field use. It is a practical size for lugging along on field jobs. It is ruggedly built to bear up under rough handling.

CIRCLE NO. 83 ON FREE INFORMATION CARD

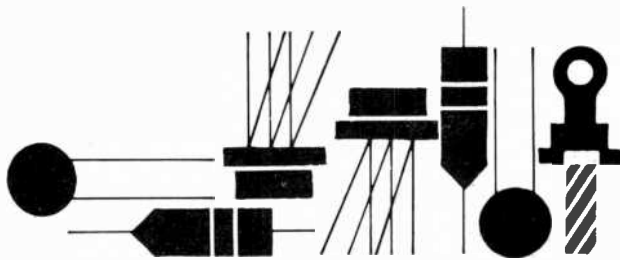

Solid State

By Lou Garner

SIMPLE STOPWATCH SPLITS SECONDS!

ALTHOUGH electronics may be one of your major hobbies, if you're a typical reader, chances are you're interested in a number of other things as well . . . track, perhaps, or wrestling, boxing, swimming, skiing, sailing, horse racing, skating, skeet, target shooting, rally driving, archery, chess, photography or chemistry. In many of these activities, it may be desirable to time an event or series of events with reasonable accuracy and, for this, a stopwatch is a virtual necessity. Fortunately, there's a wide choice of commercial instruments available for nearly all timing applications, from chemical reactions to photographic exposures, from sports matches to the single lap of a race, and from a chess move to the driving (or sailing) coverage of a measured distance. You can choose a conventional mechanical hand-wound type or a sophisticated digital electronic unit at prices ranging from less than fifty to more than two hundred dollars, depending on the accuracy and operational features needed for your application. On the other hand, if you prefer to "roll your own," you can assemble a versatile multi-function digital stopwatch at modest cost and with minimum effort by using an IC introduced late last year by *Intersil, Inc.* (10900 N. Tantau Ave., Cupertino, CA 95014). The resulting instrument features a timing range of up to 59 minutes 59.99 seconds in one-hundredth of a second increments, a low-battery indicator, crystal control, and two operating modes, yet requires, in addition to the IC, only a six-digit LED display, four spst

switches, a quartz crystal, a small trimmer capacitor, and three penlight cells, plus a case and customary hardware.

Designated type ICM 7205, Intersil's stopwatch IC is a single chip CMOS device designed to interface directly with a six-digit/seven-segment common-cathode LED readout, and is capable of furnishing a multiplexed drive current of up to 13-mA per segment with a nominal 3.8-volt dc source. It is suitable, however, for use on 2-to 5-volt dc supplies and is fully protected internally against damage from static charges, thus eliminating the need for special handling and wiring precautions. The unit has a maximum power dissipation rating of 0.75 watts and a specified operating temperature range of from -20°C to $+70^{\circ}\text{C}$. The device contains an integral oscillator, high- and low-frequency dividers, a multiplex generator, control logic, counters, a decoder, digit and segment drivers, and a low-battery sensor/indicator driver. In operation, the circuit divides the 3.2768-MHz signal generated by the crystal controlled oscillator by 2^{15} to obtain 100 Hz, which is then fed to the fractional seconds, seconds and minute counters. An intermediate frequency is used to develop a one-sixth duty cycle 1.07-MHz signal for multiplexing the display drivers. The blanking logic provides leading zero blanking for seconds and minutes independently of the clock.

Described in Intersil's 6-page technical bulletin for the ICM 7205, the stopwatch schematic shown in Fig. 1 is

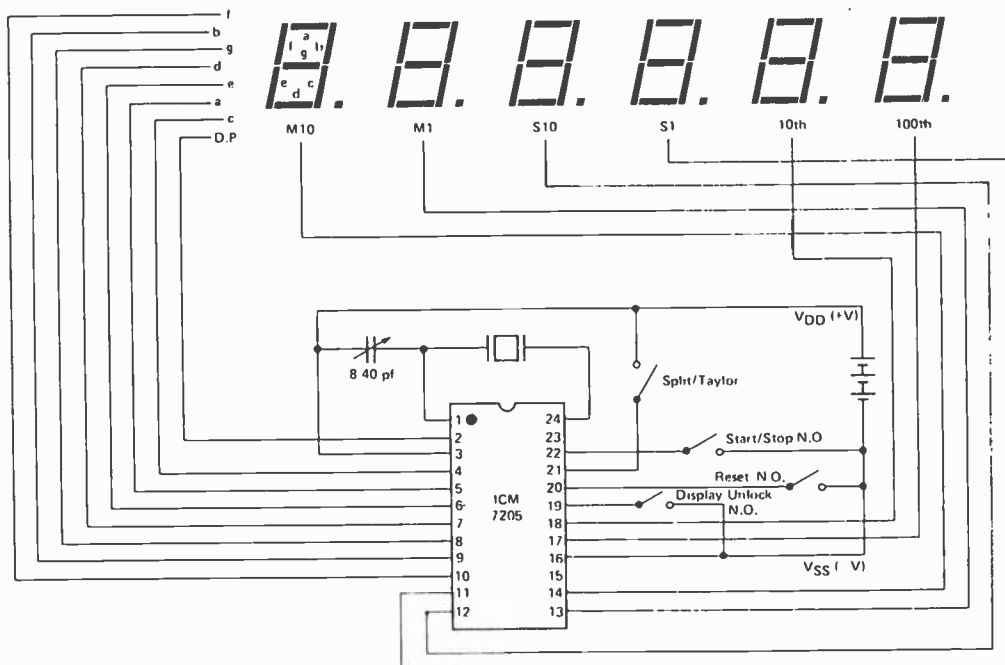

Fig. 1. Circuit for stopwatch using the 7205 chip.

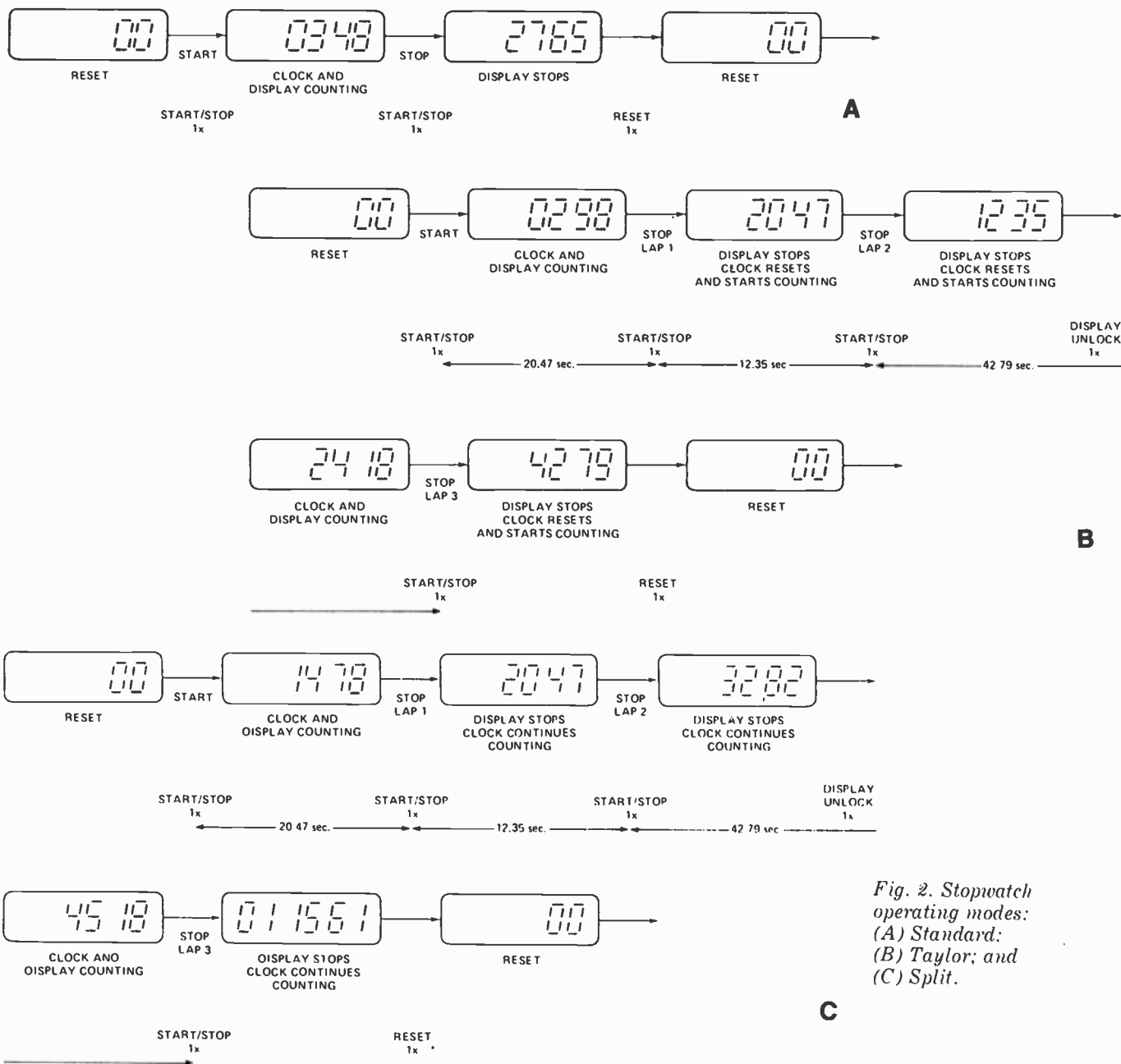

Fig. 2. Stopwatch operating modes: (A) Standard; (B) Taylor; and (C) Split.

complete except for an optional "on-off" power switch. If used, this may be a spst unit connected in series with either power supply lead. The power source consists of three series-connected AA cells or equivalent rechargeable NiCd units. Since standard components are specified, most of these should be readily available through local dealers. However, depending on the individual's location, it may be necessary to order the IC and crystal through one of the larger mail-order distributors. The manufacturer specifies that the quartz crystal used to control the oscillator's frequency should be a 3.2768-MHz unit with an R_s of 50 ohms and a load capacitance of 15 pF. If a different crystal is used, it may be necessary to change the trimmer capacitor's value (shown as 8 to 40 pF) to achieve optimum performance.

With neither parts layout nor lead dress critical, the individual builder may use either PC or perf board construction techniques when duplicating the circuit, as preferred. Good wiring practice should be followed, of course. For best performance, the spst START/STOP switch should be a high-quality, normally open pushbutton type with low

"bounce" (less than 15 ms) characteristics. After assembly and checkout, the oscillator trimmer should be adjusted for precise operation, checking the unit against an accurate standard, if available.

In practice, switching the stopwatch "on" will reset the circuits and display "00" in the fractional seconds position, with all other digits blanked. This display always indicates that the stopwatch is ready for operation. The instrument may be used in either of two modes in addition to that of a standard stopwatch. All three operational modes are illustrated graphically in Fig. 2. For timing a single event, the START/STOP and RESET switches are used. As shown in Fig. 2(A), depressing the START/STOP switch starts the clock and display counting. At the end of the timed event, depressing the START/STOP switch stops the display, permitting a readout of the time interval. Initially, only fractions of seconds are displayed, with seconds shown after one second and, finally, minutes after the first minute, providing a full display. Since the maximum range is 59 minutes 59.99 seconds, the user must remember the number of hours if the timed event exceeds an hour. Lead-

Fig. 3. Ted Reiter's frequency-to-voltage converter circuit.

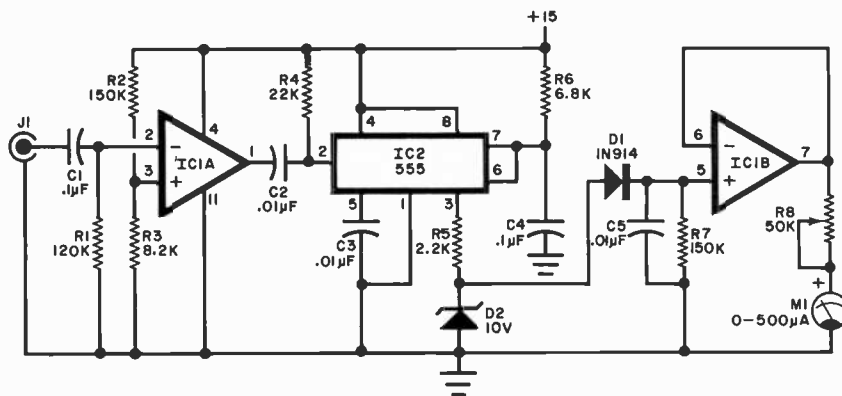

ing zeros are not blanked after the first hour. Once the event is timed, the instrument can be reset for another measurement by operating the RESET switch. The TAYLOR (or sequential) mode is used when timing a series of rapidly occurring events where the individual time for each event is of immediate interest, rather than the total time. Here, the SPLIT/TAYLOR switch (Fig. 1) is left open and the instrument is controlled using the START/STOP, DISPLAY UNLOCK, and RESET switches. As depicted in Fig. 2(B), depressing the START/STOP switch initially starts both the clock and display counting. At the end of the first event, depressing the START/STOP switch stops the display and resets the clock, which starts counting again. The display remains stationary after the first interval, showing the last previous time, until the START/STOP switch is actuated, which causes the display to show the next interval. Operating the DISPLAY UNLOCK switch will permit the display to show the running clock at any time. Upon completion of the timing tests, the stopwatch is reset by actuating the RESET switch. Finally, for those events where the user is interested in the cumulative time intervals for a series of events, the stopwatch can be operated in the SPLIT mode. Here, the SPLIT/TAYLOR switch is closed. Afterwards, depressing the START/STOP switch starts the clock and display counting, as shown in Fig. 2(C). At the end of the first event, the START/STOP switch stops the display but permits the clock to keep counting. Thereafter, the cumulative time can be read after each succeeding event by operating the START/STOP switch. Whenever desired, the DISPLAY UNLOCK switch may be used to let the display "catch up" with the running clock. At the end of the series of events, the RESET switch reestablishes initial starting conditions but, of course, this control can be used at any time.

The optional on-chip low battery indicator (LBI) is intended for use with a separate LED or with the decimal points of the digital readout. Its output (pin 2) is a p-channel transistor of approximately half the size of one of the segment drivers. The circuit is designed to maintain a voltage difference between the LBI trigger level and the minimum operating voltage. Thus, the lower the LBI trigger voltage, the lower the minimum operating voltage. In practice, this means that the stopwatch will provide at least 15 minutes of accurate timekeeping after the LBI turns on, assuming that the power pack consists of three size AA cells.

Readers' Circuits. A previous contributor to these pages, Ted Reiter (1442 Brook Drive, Titusville, FL 32780), suggests the circuit illustrated in Fig. 3 as an alternative frequency-to-voltage converter for experimenters who may not have access to Raytheon's new 4151, described in the April column. Ted developed his circuit for use in con-

junction with a project involving the measurement of solar intensity levels translated into varying audio tones. Requiring a 3-volt rms input signal, the circuit drives a standard 500- μ A meter and is designed for optimum performance between 100 and 500 Hz.

In operation, the input signal is applied through coupling capacitor $C1$ to op amp $IC1A$, biased by voltage-divider $R2-R3$ for operation as a modified Schmitt trigger. The amplified output signal is applied through a differentiation network, $C2-R4$, to a one-shot, $IC2$, which delivers fixed width output pulses to a peak limiting circuit, $R5-D2$. The pulses are then coupled through detector diode $D1$ to a pulse integrator, $C5-R7$. Since the pulses applied to the integrator are of constant width and amplitude, the instantaneous voltage developed across $C5$ will be directly proportional to the pulse repetition rate and hence to the frequency of the original signal. This voltage is amplified by a second op amp, $IC1B$, and used to drive the output meter, $M1$. Potentiometer $R5$ is used to set the meter's full scale reading at the highest frequency measured (500 Hz).

Ted has specified standard, readily available components in his design. Op amps $IC1A$ and $IC1B$ are two sections of a type 324 quad op amp (the other two sections are available for other circuit applications), while $IC2$ is a familiar 555 timer. Zener diode $D2$ is a 10-volt, 400 mW type. All resistors, except for calibration potentiometer $R8$, are $1/4$ - or $1/2$ -watt types, and the capacitors are small ceramic, plastic film or paper units. Operating power, nominally 15 volts, is actually furnished by a pair of series-connected 9-volt transistor batteries. Neither component layout nor wiring dress should be overly critical and the builder, therefore, may follow his own inclinations regarding construction methods when duplicating the circuit.

Peter Lefferts (1640 Decker Ave., San Martin, CA 95046), one of our more prolific west coast contributors, has submitted another interesting design . . . a wide range voltage probe. Pete's circuit, given in Fig. 4, requires but three basic components: a 6-watt, 120-volt incandescent lamp, $I1$, and a pair of type NSL 5023 or NSL 5024 light emitting diodes, $LED1$ and $LED2$. Despite its simplicity, the probe can indicate the presence of any voltage from 1.5 to 150 volts ac or dc, with either the lamp ($I1$) or one (or both) of the LEDs illuminated. The circuit depends, for its operation, on the unique characteristics of the incandescent lamp's filament. At lower voltages, only the LEDs are activated, with their currents limited by the incandescent lamp

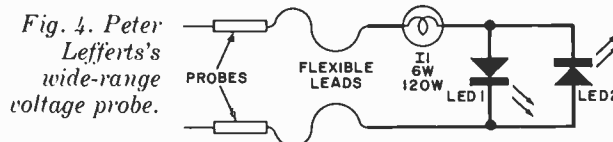

Fig. 4. Peter Lefferts' wide-range voltage probe.

serving here as a simple series resistor. At higher voltages, the rapidly increasing resistance of the lamp's filament limits the LEDs' currents to about 50 mA at full line voltage, or about 25 mA average for an ac input. If desired, one of the probes can be "polarized" for dc checks, with the corresponding LED illuminated at correct polarity. For example, if the upper probe (Fig. 4) is considered *positive*, LED1 is illuminated when correct polarity is applied, with LED2 indicating reversed polarity. The circuit can be assembled in a small metal chassis box with test jacks, in a plastic case with flexible test leads, or self-contained within a cylindrical tube, at the builder's option.

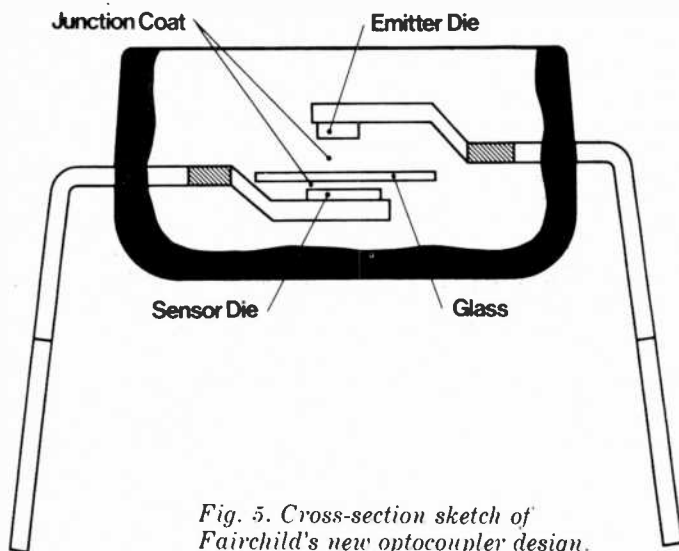

Fig. 5. Cross-section sketch of Fairchild's new optocoupler design.

Data Up-Date. The *National Semiconductor Corporation* (2900 Semiconductor Drive, Santa Clara, CA 95051) has released a number of new handbooks which should be of major interest to serious hobbyists and experimenters. The handbooks, listed below, may be purchased through the firm's franchised distributors or ordered directly from the manufacturer's Marketing Services Department (California residents should add 6% sales tax to the indicated prices):

The *PACE Technical Description* is a 96-page handbook describing the firm's "PACE" single-chip, 16-bit microprocessor. The volume describes both the full-feature CPU and the entire complement of hardware and software items that comprise the "PACE" (Processing And Control Element) system, showing in detail the family of support chips, application cards, software support (including program examples), and microprocessor development systems. Applications as well as operations are described, along with product and instruction summaries. The PACE manual is priced at \$3.00/copy.

Interface Integrated Circuits is the title of a 464-page data handbook which gives specifications on the firm's complete line of interface products, including peripheral/power drivers, level translator/buffers, line drivers and receivers, memory and clock drivers, sense amplifiers, display drivers, and optocouplers. The text is supported by graphs, charts and diagrams. Also included is a 72-page section of application notes covering such topics as transmission lines, data transmission in high-noise environments, and driving gas discharge and LED displays, together with product selection guides listing specifications for LED drivers, peripheral drivers and transmission

drivers, and two cross reference guides comparing product type numbers of other manufacturers. The interface handbook carries a price tag of \$4.00/copy.

The *TTL Data Handbook* describes National's complete line of bipolar logic devices, giving full specifications and electrical performance characteristics on standard 54/74 TTL, low-power 54L/74L, high-speed 54H/74H, ultrahigh-speed Schottky 54S/74S, low power Schottky 71LS/81LS, Series 9000 TTL, Series 10,000 ECL, and Series 930 DTL. It covers gates, buffers, drivers, flip-flops, latches, registers, counters, selector/multiplexers, multipliers, comparators, decoders, parity generators, and related devices. A Tri-State selection guide, an industry cross reference guide and a functional index also are included, as well as package outlines. The *TTL Data Handbook* may be obtained for \$4.00/copy.

The *Memory Data Book* is a 544-page volume covering the manufacturer's memory and memory-related products, including bipolar, MOS, CMOS RAMs, field and mask programmable ROMs (bipolar and MOS), MOS shift registers and PLAs. In addition, the book describes interface/support circuits for memory operation and includes pertinent application notes, cross reference guides and a production status guide on National memories as well as complete specifications, characteristics, diagrams and special features of the products. The price is \$3.00/copy.

Finally, the *SC/MP Technical Description* is a 65-page handbook which describes the firm's single-chip 8-bit "SC/MP" (Simple-to-use, Cost-effective, MicroProcessor), a CPU requiring only one memory chip to form a complete, fully-programmable system. Starting with a general introduction to "SC/MP" for non-technical users and following up with complete details for preparation of a preliminary design of "SC/MP"-based applications, the book includes 6 tables and 35 illustrations. The software described includes cross assemblers, loader/debug utilities, and input/output routines. Also outlined is a description of three application modules. The volume is \$3.00/copy.

Device/Product News. Both *Fairchild's* Linear Integrated Circuits Division (464 Ellis St., Mountain View, CA 94042) and Optoelectronics Division (4001 Miranda Ave., Palo Alto, CA 94304) have introduced new devices of potential interest to experimenters and hobbyists, including a line driver and receiver, a series of Darlington arrays, a family of high-voltage opto-couplers, and what is claimed to be the largest single digit LED display available in the industry. The 9636 and 9637 are monolithic circuits intended for applications in data communication and data terminal equipment. Of these, the 9636 is a dual single-ended line driver that provides TTL and CMOS compatible inputs and features an output slew rate that can be controlled with a single external resistor as well as short-circuit protection for all outputs. The 9637 is a Schottky dual differential line receiver providing a TTL compatible output and offering an input threshold accuracy of ± 200 mV over a ± 7 -volt common-mode range. Both the 9636 and 9637 are supplied in 8-pin miniDIPs, making it possible to insert two devices in a single 16-pin DIP socket for use as a quad-input assembly. The new series of Darlington arrays comprises six high-voltage, high-current units intended for interfacing TTL and MOS logic circuits with such devices as solenoids, relays, lamps, small motors and LED displays. The basic devices, types 9665, 9666 and 9667, are rated at 50 volts, with 80-volt units available and identified

by an "A" suffix (i.e., 9665A, etc.). All six devices feature seven high-gain Darlington transistor pairs per package, each capable of furnishing output currents of up to 350 mA, with suppression diodes provided for use with inductive loads. Outputs may be paralleled to increase load capabilities. The 9665 is a general purpose array which can be used with DTL, TTL, PMOS or CMOS logic and features input current limiting set by means of external resistors. The 9666 eliminates the need for external resistors and is specifically designed for direct interfacing with PMOS logic to solenoids and relays; it operates at supply voltages from 14 to 25 volts. The 9667 has a series base resistor connected to each Darlington pair for direct operation with TTL or CMOS logic powered by 5-volt sources. The Darlington arrays are available in either plastic or ceramic DIPs. Fairchild's new family of phototransistor couplers offers a minimum isolation voltage of 5,000 volts for all device types. This high rating, more than twice that of standard couplers, is achieved by using glass as an internal insulating spacer between the light source and phototransistor, as shown in Fig. 5. Finally, the firm's Optoelectronic Division is offering a group of 0.8-inch high LED display digits readable at distances of up to 30 feet. The new displays are available in common cathode or common anode versions with either a left or right-hand decimal point. Common-cathode types are the FND800, right-hand decimal, and the FND850, left-hand decimal. Common-anode types are the FND807, right-hand decimal, and the FND847, left-hand decimal. With an average intensity per segment of 0.15 millicandela, the displays require a 1.7-volt source and an average drive current of 5-mA per segment.

If your plans include projects involving telephone dial tone control, you'll want to investigate a new pair of ICs announced recently by the *MOSTEK Corporation* (1215 W. Crosby Road, Carrollton, TX 75006). The new devices, designated types MK 5085 and MK 5086, combine CMOS logic, D to A converters, an operational amplifier, and bipolar transistors on a single chip, and are designed to use an inexpensive 3.58-MHz crystal reference to produce eight distinct audio sinusoidal frequencies, which are mixed together on chip to provide high accuracy tones suitable for dual tone dialing. Both circuits are identical except for keyboard configuration. The MK5085 utilizes a self-scanning technique to interface directly to a class-A or 2-of-8 keyboard, while the MK5086 interfaces to either a 2-of-8 keyboard or other electronic systems. Common key functions such as switching out the transmitter and switching in muting resistance are accomplished electronically. The MK 5085 was designed using CMOS primarily for integration into telephone systems where it is possible to derive the necessary power directly from telephone lines; non-telephone hobbyist applications may use a fixed dc supply such as four AA cells or a single 9-volt battery. In operation, distinct audio frequencies are obtained when keyboard entries select the proper digital dividers to divide the 3.58-MHz crystal signal. These signals are processed by a conventional ladder network, and current-to-voltage transformation is made by an on-chip amplifier. This conventional D/A converter yields sine waves of sufficient purity that they require little or no filtering. The same amplifier accomplishes summing of the low and high group tones to obtain the required dual tone signal. ♦

THE COMPLETE DVM

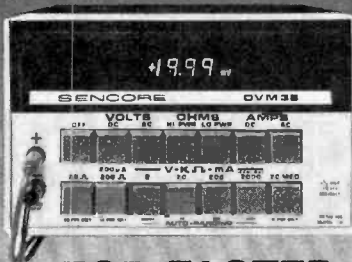

\$348

FOR FASTER, MORE RELIABLE MEASUREMENTS

A NEW STANDARD IS BORN
High accuracy you can trust
Versatile measuring capabilities
An efficient, easy to operate meter
All at an affordable price
That's the DVM38 . . . The complete DVM that sets new performance standards in 4 key areas.

A NEW ACCURACY STANDARD
The 3½ digit, .1% accuracy is backed by a 15 meg Ω input impedance, compared to 10 meg Ω input of conventional DVM's, which guarantees up to 50% greater accuracy with 1/3 less circuit loading on every measurement for high accuracy you can trust.

A STANDARD IN CAPABILITIES
The DVM38 is more accurate in MORE circuits with these versatile ranges: 100 μ V to 2000V DC, 1KV AC; .01 Ω to 20 meg Ω ; 0.1 μ A to 2A . . . Plus

Hi and LO ohms and a 50KV DC range with accessory Hv probe.

A NEW STANDARD IN SPEED AND EASE OF OPERATION
Large pushbuttons and callouts — no need to hunt and peck. Large .4" L.E.D.'s with direct readout, down to V and mV indicators. SINGLE STEP AUTO-RANGING for maximum resolution and efficiency. 2KV DC protection minimizes downtime.

THE AFFORDABLE STANDARD
There are few .1% DVM's less expensive—there are none as complete in this price range, plus backed by a LIFETIME guarantee against factory workmanship errors.

THE DVM38 . . . A NEW STANDARD IN DVM'S FOR SPEED, VERSATILITY AND ACCURACY.

DVM38 BACKED BY SENCORE'S 100% MADE RIGHT LIFETIME GUARANTEE
SENCORE 3200 Sencore Drive, Sioux Falls, S.D. 57107
Phone: 1-605-339-0100 TWX: 910-660-0300

THE COMPLETE PORTABLE DVM



\$198

IT'S PORTABLE

Industry preferred L.E.D.'s offer, dependable, durable and bright displays. But brightness means high current drain. Well, we've licked the "high current drain-short battery life" problem with our patent pending "auto-off" circuit that blanks the display between measurements. Your benefit? A long useable battery life and a bright easy to read display. And it's tough enough to be a portable. Cyclac case and recessed controls withstand that field use. It's protected electrically, too, up to 2000V DC, for minimum downtime — maximum uptime.

IT'S COMPLETE

Most portable DVM's sacrifice on features, functions, or accuracy. But not the DVM32. It's accurate with full 3½ digit readout, .5% of reading accuracy and 15 megohm input impedance. Complete functions and ranges from: 1mV to 1999V DC, 1mV to 1000V AC rms, 1 ohm to 19.99 megohm and 1 μ A to 1.999A, AC and DC, plus Hi and Lo power ohms. It's Fast with 2½ updates a second, plus auto-polarity, decimal and overrange indication.

The DVM32 . . . true portability with complete measuring capabilities.

DVM32 backed by SENCORE'S 100% MADE RIGHT LIFETIME GUARANTEE
SENCORE 3200 Sencore Drive, Sioux Falls, S.D. 57107
Phone: 1-605-339-0100 TWX: 910-660-0300

CIRCLE NO. 56 ON FREE INFORMATION CARD

CIRCLE NO. 57 ON FREE INFORMATION CARD



FCC Form 74-A
March 1975

The United States of America

MEMBER
P1-24-14355

FEDERAL COMMUNICATIONS COMMISSION

RADIO/TELEPHONE OPERATOR LICENSE

FIRST CLASS
(General Radiotelephone Certificate)

This certifies that JOHN R. DOE

SEX	HEIGHT	WEIGHT	COLOR EYES	COLOR HAIR	DATE OF BIRTH
M	6' 1"	185	BLUE	BROWN	MARCH 22, 1948

IS A LICENSED RADIO OPERATOR, AUTHORIZED, SUBJECT TO ANY SPECIAL ENDORSEMENT PLACED HEREON, TO OPERATE THE CLASSES OF LICENSED RADIO STATIONS FOR WHICH THIS CLASS OF LICENSE IS VALID UNDER THE ORDERS, RULES AND REGULATIONS OF THE FEDERAL COMMUNICATIONS COMMISSION, ANY STATUTE OF THE UNITED STATES AND ANY TREATY TO WHICH THE UNITED STATES IS A PARTY.

THIS LICENSE IS GRANTED UNDER THE AUTHORITY OF THE COMMUNICATIONS ACT OF 1934, AS AMENDED AND THE TERMS AND CONDITIONS THEREOF AND OF ALL LEGISLATIVE ACTS, EXECUTIVE ORDERS, AND TREATIES TO WHICH THE UNITED STATES IS SIGNATORY, AND ALL ORDERS, RULES AND REGULATIONS OF THE FEDERAL COMMUNICATIONS COMMISSION WHICH ARE SIGNIFICANT UPON RADIO OPERATORS, ARE MADE A PART HEREOF AS THOUGH SPECIFICALLY SET OUT IN FULL HEREIN.

NEITHER THIS LICENSE NOR THE RIGHTS CERTIFIED TO HEREIN SHALL BE ASSIGNED OR OTHERWISE TRANSFERRED TO ANY OTHER PERSON.

PLACE AND DATE OF ISSUANCE: WASHINGTON, D.C. MARCH 31, 1975

DATE AND TIME OF EXPIRATION: MARCH 31, 1980 AT THREE O'CLOCK A. M. EASTERN STANDARD TIME

SPECIAL ENDORSEMENT

SHIP RADAR ENDORSEMENT WASHINGTON, D.C. MARCH 31, 1975

Paul J. Harris
FEDERAL COMMISSIONER

John R. Doe
LICENSEE

SPECIMEN

NOT VALID UNTIL SIGNED

CIE's Warranty says a lot to you!

A lot about CIE's FCC License training programs...and a lot more about our school.

Our FCC License Warranty means just what it says. If you enroll in any CIE career course that includes FCC License preparation and successfully complete your training . . . you'll pass the Government FCC exam. We warrant that you'll succeed.

CIE can make this no-nonsense warranty because we're confident of our in-depth career training programs. You see, we have *specialized exclusively* in Electronics education-by-mail for more than 40 years. Just Electronics. And, the courses we offer today are the result of these years of teaching experience and proven methods of training.

Our courses of study are written in easy-to-understand language, so you can progress at your own learning pace, at home, in your spare time. And, there are never any classrooms to attend.

CIE courses challenge your thinking . . . help you develop your understanding of important electronics theories and applications . . . enable you to learn new skills and knowledge. Our courses are thorough. They have to be.

You see, we're training you for a career in Electronics. And, if an FCC "ticket" is part of your goal, you'll have to pass a tough licensing exam administered by the Federal Communications Commission (an agency of the U.S. Government). And you'll be prepared.

CIE is willing to warrant that you will pass! The reason is . . . we have every reason to expect that *you will* do exactly that. Based on a series of continuing surveys, *close to 9 out of 10 CIE grads pass* their FCC exams!

What's a license worth?

An FCC License can be worth a lot if you're interested in any area of Electronics involving communications. In some fields, federal law requires that you must have one. And, even in careers where a license is not required, it is

Government certification of certain electronics knowledge and skills.

What about other CIE courses?

In every CIE career course, you'll find the same time-tested instructional techniques that have made CIE's FCC License preparation programs so successful.

Each CIE career course is built on the principle that the best way for you to *learn* and *retain* what you've learned is to *explain*; then to *check* your understanding; then to *reinforce* your comprehension with practical applications. In some courses, you will perform experiments and tests with your CIE Experimental Electronics Laboratory using authentic electronic components and gear. And, if you select a course that includes Color TV technology, you will not only build and keep a 25" diagonal Color TV which features digital circuitry . . . you'll also learn how to troubleshoot your TV.

The CIE course you select (beginner, intermediate, or advanced college-level), will be a complete educational program, designed by *experts* to give you the best in Electronics home-study education.

Send for FREE school catalog

Discover more about the career opportunities open to people with electronics training. *Learn* how CIE career courses can help you build new skills and knowledge and prepare you for a meaningful, rewarding career. Whether you are just starting out in Electronics or are a college-trained engineer in need of updating, (or anywhere in between), CIE has a course designed for *you*. And, more than half of CIE's career courses include FCC License preparation.

Send today for our FREE school catalog and booklet on FCC License information. For your convenience, we will try to have a representative call to assist in course selection. Mail reply card or coupon to CIE . . . or write: Cleveland Institute of Electronics, Inc., 1776 East 17th Street, Cleveland, Ohio 44114. Do it TODAY.

G.I. Bill benefits

All CIE *career* courses are approved for educational benefits under the G.I. Bill. If you are a Veteran or in service now, check box for G.I. Bill information.

CIE's FCC LICENSE WARRANTY OF SUCCESS

CIE warrants that when you enroll in any CIE course which includes FCC License preparation, you will, upon successful completion of the course and the FCC License material, pass the Government FCC Examination for the License for which your course prepared you. If you do not pass the appropriate FCC Examination, you will be entitled to a full refund of an amount equal to the cash price for CIE's "First Class FCC License Course," No. 3. This warranty will remain in effect from the date of your enrollment to 90 days after the expiration of the completion time allowed for your course.

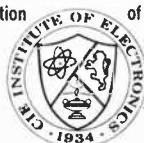

Dr. G. O. Allen
Dr. G. O. Allen President

CIE Cleveland Institute of Electronics, Inc.
1776 East 17th Street, Cleveland, Ohio 44114
Accredited Member National Home Study Council

Yes, I want your FREE school catalog and career information package today.

I am especially interested in:

PE-10

- | | |
|--|--|
| <input type="checkbox"/> Electronics Technology | <input type="checkbox"/> Industrial Electronics |
| <input type="checkbox"/> FCC License Preparation | <input type="checkbox"/> Electronics Engineering |
| <input type="checkbox"/> Color TV Maintenance | <input type="checkbox"/> Other _____ |
| <input type="checkbox"/> Mobile Communications | _____ |

Print Name _____

Address _____

Apt. _____

City _____

State _____

Zip _____

Age _____

Check box for G.I. Bill information: Veteran On Active Duty

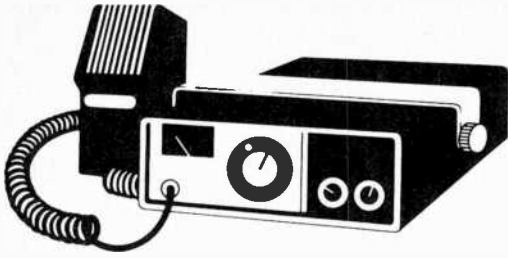

CB Scene

By Ray Newhall, KWI6010

IS CLASS E DEAD?

MY FEBRUARY column touched briefly on "Class E," a proposed new division of the Citizens Radio Service, first suggested in 1968 by the Electronic Industries Association. My mail bag tells me that I touched a tender nerve with at least a few of PE's "Ham" readers. Some letters have been in polite disagreement, but others contained emotional outbursts claiming that undisciplined CB'ers will soon blanket the entire radio spectrum with illegal linears. All responses were from radio amateurs who oppose any further expansion of the Citizens Band because CB'ers have abused Class D and have not "earned the right to use two-way radio."

I believe that the vast majority of the licensed CB'ers today are decent, law-abiding citizens who should not be spoken about in such a manner. Most use CB to conduct their personal communications, and, when needed, to help others. There are many more CB mobiles cooperating with law enforcement officers than those who try to harass them.

What is Class E? As originally proposed by the EIA, Class E would consist of FM communication in the vhf region (specifically, on the lower 2 MHz of the 220-to-225-MHz band currently assigned to Amateur Radio). There would be a total of 80 channels, most designated for specific uses (mobile, in-plant, road condition information, etc.). The Class E band would be very similar to the new vhf-FM Marine band, but personal communications could be conducted on it between your vehicle and home or office. That type of communication is not permitted on Marine frequencies.

Unlike Class D, it would be nearly devoid of skip, heterodynes, and ignition and other types of noise. Above 100 MHz, nearly all radio propagation is "line of sight." That is, once the radio wave reaches the horizon, it

merely flies off into space rather than bouncing off the ionosphere and returning to the earth as skip. Hence, more output power could be authorized for reliable communications without disturbing distant stations.

Another advantage is the FM "capture effect." An FM receiver will track the most powerful signal it receives, and suppress weaker ones on the same channel. In practice, you could either make solid contact or none at all. Between calls, the speaker is fully squelched and silent. FM lends itself to both tone-encoded squelch systems and phone patches, as Amateur practice on the 2-Meter band has demonstrated.

The original intent of the Citizens Radio Service was to provide short-range personal or business communication to any citizen. It was expected that most would use it between their cars or boats and homes or offices. (In keeping with that idea, only members of the licensee's immediate family or his direct employees can operate under the authority of his license.) Most important, CB was intended for those people who have no specialized technical knowledge or experience. Finally, the original CB concept excluded "hobby" operations (use of a CB radio for rag chewing, skip chasing, etc.)

Unfortunately, the inherent characteristics of AM signals and the 11-Meter band defeated these intentions as soon as the Service was established. It simply wasn't suitable for short-range, personal use, and many operators were hobbyists who got their "kicks" trying to pick out signals between the heterodynes, diathermy, and skip transmissions! Is it any wonder that manufacturers soon made linears available to anyone with the money to pay for them, and that Class D became the bandit band? How could anyone ask his wife or secretary to listen to that pandemonium all day while waiting for a call?

Would Class E Be Disciplined? I don't believe Class E would be abused as Class D has been, primarily because it would not attract the hobbyist who wants to DX half way across the country. Linears would not be any major advantage because enough power would be authorized (10 to 25 W) to put out a solid signal to the radio horizon. Also, a large increase in power (bootlegging it) would not boost effective range.

As it became popular, I believe the vhf band would be used by motorists just as they use the Class D band now. Safety and motorist assistance is a legitimate personal use, but in the Class E proposals to date, highway use would be restricted to relatively few channels. All transmitters should be of high quality and be rigidly controlled through type acceptance and mandatory periodic inspections. Automatic transmitter identification would enhance both regulatory powers and respect for FCC Regulations. It would also make the organized larceny of equipment far more difficult.

We must consider the radio spectrum as much a resource as air, water, coal, or petroleum. It must be conserved, but it must also be shared. The right to use it by the ordinary citizen cannot be refused because a minority has abused it. Do we close the beaches to the public because some thoughtless persons throw trash about? Do we refuse to issue new driver's licenses because some persons already licensed drive rather recklessly at times?

It is true that Class D privileges have been badly abused by a minority of users, but the overwhelming majority of licensed CB'ers try to operate their rigs legally. (I don't consider the unlicensed ones CB'ers — they would even drive their cars without a license if they thought they could get away with it!) Many legitimate operators have equipped their mobiles with CB just for the added safety it offers. I have noted that it is usually the newcomers on the band who show their exuberance by transmitting "Smokey" reports. But the band is maturing. Now, many truckers use their rigs more to assist law-enforcement agents than to try to "spot" them.

Where Do We Stand Today? For the moment, Class E is seemingly at an impasse. While the FCC recognizes

the justification for this new vhf-FM service, authorization has been temporarily blocked by Canada and Mexico by virtue of international treaties to which the U.S. is a party. Since our government cannot guarantee that the use of Class E transmitters by our citizens in border areas will not disrupt *their* use of these frequencies, those governments have refused to permit changes in the existing treaties which currently do not allow a Citizens Radio Service in this band.

There is also concern in this country that Class E would interfere with government radio-location services which share the 220-MHz band. And understandably, radio amateurs are cool to the ideal of Class E if it means losing 2 MHz of their spectrum allocations.

However, there are alternative courses of action the FCC could take. For example, it could allocate Class E a portion of the spectrum in which it would not conflict with the international treaties. Or it could try to negotiate a change of our neighbors' attitudes. It's not surprising that the Canadians are apprehensive, since they have experienced difficulties in controlling their own CB service.

Are The Objections To CB Valid?

If CB is judged by traditional values, the radio amateurs who wrote to me are justified in their criticism of CB. But I feel that many of the traditional "ham" values may no longer be valid. Although some hams are experimenters and make contributions to the technical advancement of radio, they cannot compete with government and industry financed R & D. Most hams no longer build their own equipment, and are mainly interested in communicating. Of course, their outstanding efforts in times of natural and man-made disaster are well documented.

Admittedly, their frequency allocations have been eroded, and the 11-Meter band was taken from them to set up the Class D band. But amateurs still hold 46.5 MHz of the entire spectrum below 450 MHz. We CB'ers do not begrudge them their 10.3% of the hf, vhf, and low uhf portion of the spectrum, but we do feel that it is a bit unfair when some of 285,000 amateurs complain so bitterly about the greater than four million licensed CB'ers who are crowded into less than 0.5 MHz of spectrum, and who want just a bit more!

Revolutionary New Wiring "Pencil" Makes Interconnections in 1/3 the Time!

- Create Finished Wired Circuits in Hours, Not Days
- For Breadboarding, Prototypes and Production
- Interconnects Circuit Elements in Digital and Analog Circuits

Easy for anyone — just hook up your components using the insulated "solder thru" wire (your choice of blue, red, green or clear). Wire feeds off a replaceable spool thru the P173 tool body and out of a steel tip so fine it easily routes wire around even the smallest I.C. lead. A touch of the iron, with solder, completes the joint.

Available accessory items include P179WS Wire Spacers for neat routing, tenth-tenth Micro-Vectorboards™, circuit Padboards and frames, like the 3677-6 and 51X-1. Order a P173 Now! Supplied with two 200' spools of AWG solder thru wire (1 red, 1 green), complete instructions. **\$9.50**

At your Vector distributor
Mail orders, add \$2 shipping and handling charge.
California residents add 6% sales tax.

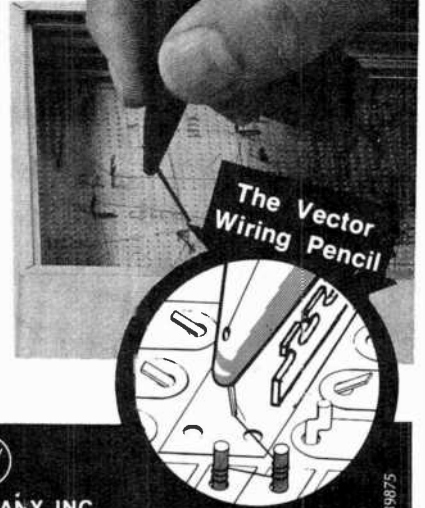

The Vector Wiring Pencil

Vector W P DIVISION
ELECTRONIC COMPANY, INC.
12460 Gladstone Ave. • Sylmar, CA 91342 • (213) 365-9661

CIRCLE NO. 65 ON FREE INFORMATION CARD

If you want a microcomputer with all of these standard features...

- 8080 MPU (The one with growing software support)
- 1024 Byte ROM (With maximum capacity of 4K Bytes)
- 1024 Byte RAM (With maximum capacity of 2K Bytes)
- TTY Serial I/O
- EIA Serial I/O
- 3 parallel I/O's
- ASCII/Baudot terminal compatibility with TTY machines or video units
- Monitor having load, dump, display, insert and go functions

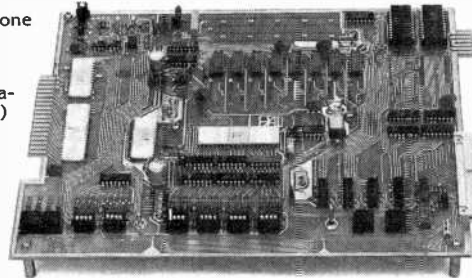

- Complete with card connectors
- Comprehensive User's Manual, plus Intel 8080 User's Manual
- Completely factory assembled and tested — not a kit
- Optional accessories: Keyboard/video display, audio cassette modem interface, power supply, ROM programmer and attractive cabinetry... plus more options to follow. **The HAL MCEM-8080. \$375**

...then let us send you our card.

HAL Communications Corp. has been a leader in digital communications for over half a decade. The MCEM-8080 microcomputer shows just how far this leadership has taken us... and how far it can take you in your applications. That's why we'd like to send you our card — one PC board that we feel is the best-valued, most complete



microcomputer you can buy. For details on the MCEM-8080, write today. We'll also include comprehensive information on the HAL DS-3000 KSR microprocessor-based terminal, the terminal that gives you multi-code compatibility, flexibility for future changes, editing, and a convenient, large video display format.

HAL Communications Corp.
Box 365, 807 E. Green Street, Urbana, Illinois 61801
Telephone (217) 367-7373

FREE EICO CATALOG

358 Ways To Save On Instruments, Citizens Band, Burglar Alarms, Automotive & Hobby Electronics!

The more you know about electronics, the more you'll appreciate EICO. We have a wide range of products for you to choose from, each designed to provide you with the most pleasure and quality performance for your money. The fact that more than 3 million EICO products are in use attests to their quality and performance.

"Build-it-Yourself" and save up to 50% with our famous electronic kits.

For latest EICO Catalog and name of nearest EICO Distributor, check reader service card or send 50¢ for fast first class mail service.

**EICO—283 Malta Street,
Brooklyn, N.Y. 11207**

*Leadership in creative electronics
since 1945.*



However, there is one important thing to keep in mind — CB and Amateur Radio are compatible! Although there have been strained relations in the past, more and more amateurs and CB'ers are getting to meet each other. They often find that the prejudices on both sides are not reflected in reality. Today the CB'er is not a "frustrated ham," but the guy down the block who uses radio for personal communications, not hobby operating. Evidence of this change of heart on the part of radio amateurs lies in the editorials of *QST* and *ham radio* for April, 1976.

Local amateur and CB clubs can work together to set up emergency communication systems, operator training sessions, etc. It is in the best interest of both services that there be mutual understanding and appreciation for the potentials of each group. So let's put aside any hard feelings and work together for our common goal — the efficient and proper use of frequencies allocated for individual use by private citizens, be they radio amateurs, CB'ers, or both!

To this CB'er, the facts are plain. One of every 30 Americans uses CB today. We represent a fair share of our country's total population. Collectively, the people are the ultimate authority under our Constitutional system. I believe that the Federal government should not deny us orderly and proper access to any of our nation's natural resources, including radio communications. I believe that the FCC *must* place a high priority on finding and allocating a suitable portion of the radio spectrum below 450 MHz for the personal use of the public.

Things to Come: The FCC is now considering a Citizens allocation in the vicinity of 910 MHz, twice the frequency that I consider the upper limit for practical use by citizens who have little or no technical competence in radio communication. I believe that that choice of frequencies would be as ill-advised as the original allocation of 27 MHz for Class D. The experience with the uhf Class B service only confirms my opinion. It was never accepted by the public as a viable frequency allocation and was eventually withdrawn. Equipment suited to operate at 910 MHz would be very expensive. Furthermore, I think it is ludicrous to consider an allocation which requires installation and maintenance support facilities that are beyond the

means of most two-way radio service establishments now in existence. All in all, that frequency region is totally unsuitable for allocation to the Citizens Radio Service.

The intent of this article is to lay Class E right on the line. I, for one, am acutely aware of the need of many thousands of citizens who have a need for high-quality, personal two-way radio, but who are *not* radio hobbyists. These people are not yet on the CB rolls and cannot be counted. They have not yet been offered a service which meets their needs.

We should all write and urge the FCC to continue its search for an adequate frequency allocation for a service such as it had in mind when Citizens Band was first authorized. Our citizens deserve no less than a first-class service with all the facilities that modern technology can provide. That includes private call facilities (tone-encoded squelch), phone-patch facilities, direct public service and correspondence channels, and possibly repeaters. However, along with these added privileges should come a strictly enforced system of equipment standardization, including a periodic inspection program such as most states have for motor vehicles.

I recommend the annual licensing of all transmitters, with the requirement of annual inspection before renewal. I support automatic (on-the-air) transmitter identification. There is no reason why the legitimate operator should fear it, and ATI will enhance enforcement of channel usage restrictions and reduce equipment theft (by making it more difficult to "fence" stolen CB equipment). I also believe that the FCC charter should be extended by the Congress to include new minimum receiver standards. This new aspect of the law would protect CB users as consumers, and would protect the public as a whole against TV and other receivers with insufficient off-channel rejection characteristics.

Class E would be a different service than Class D, and would draw a different group of licensees. In no way do I suggest any reduction in the Class D service, which has its own separate and useful function.

As usual, I invite comments, but I cannot personally answer all letters. I particularly would appreciate comments from the CB community, or those who would use Class E if it were authorized as I propose. ♦



B&K-PRECISION
Model 520B Transistor Tester
\$160.00

NOW WITH
HI/LO DRIVE

ACCURATE
TESTING
IN OR OUT
OF CIRCUIT

- All bipolar transistors, including hard-to-check Darlington's.
- FET's, SCR's, Diodes

In-circuit semiconductor testing and lead identification – automatically

New! The HI/LO power drive circuitry of the B&K-PRECISION Model 520B provides two important benefits.

You now can test accurately even more transistors and semiconductors in-circuit—and with shunt resistances as low as 10 ohms and shunt capacitances up to 15 μ F. You won't waste time resoldering leads because of faulty in-circuit testing.

Second, in LO drive you get positive, automatic identification of all three transistor leads.

The new Model 520B transistor tester is fast, too. A complete test can take less than nine seconds! With the tester in LO drive, just connect any test clip to any lead of the device to be tested. Move the test switch through its six positions until you hear a pulsating audio tone, which indicates a good semiconductor, plus lead identification. If you don't get a tone, switch to HI drive and operate the switch again. Now a tone indicates a good semiconductor and identifies the base.

With the Dynapeak[™] transistor testing method, you can be confident of a valid in-circuit and out-of-circuit test. A window indicates the leads to

which each probe is connected. Two LED's automatically tell you whether the device is PNP or NPN.

Out-of-circuit tests are equally easy and fast with the convenient mini-lock probes or the plug-in test socket. Leakage tests can be made without referring to charts. The meter panel is marked for both germanium and silicon devices, which are automatically identified by LED indicator lamps.

Ask for a demonstration of the 520B at your local distributor. Or write for our full color brochure explaining how the B&K-PRECISION Model 520B Transistor Tester will end time-wasting diagnostic errors and speed your solid state testing and service.

B&K PRECISION
PRODUCTS OF DYNASCAN

6460 West Cortland Avenue
Chicago, Illinois 60635 • 312/889-9087
In Canada: Atlas Electronics, Toronto

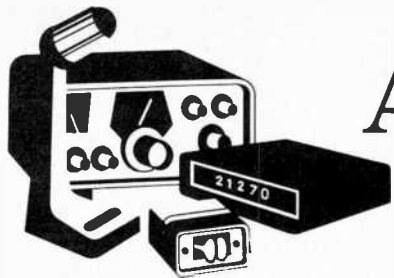

Amateur Radio

By Herbert S. Brier

LIGHTNING AND THE RADIO AMATEUR

MOST OF US are familiar with the indirect effects that lightning produces on amateur communications—tremendous static crashes can make 80 Meters (and above) almost unusable on some summer nights. But every so often, we hear of the direct consequences of a lightning strike at an amateur's station. Among the reported effects are vaporized antenna elements, burned-out rotator motors, melted insulation in control and coaxial cables, and fused conductors.

Inside the shack, a number of things can happen. The antenna coils in the receiver can melt, or the contacts on the band switch weld together. Tubes and transistors can be destroyed. Diodes and capacitors, especially in the power supply, can blow. From the outside, the rotor control box might look fine, but it can be a shambles of burned out and shorted components on the inside. Half the lights in the house might be blown, and the rest will glow whether they are switched on or off. Electrical receptacles can be blown half out of their wall boxes. If a fire ensues, the firemen can do as much damage ripping out equipment and cutting cable as the original lightning strike caused.

This type of damage that has been experienced by amateurs whose antennas were struck by lightning does *not* mean that an outside antenna invites disaster in an electrical storm. On the contrary, a properly installed antenna is said to create a "cone of protection" whose diameter is approximately equal to the height of the antenna itself. Many amateurs have operated for years and years with antennas that are the highest objects in the vicinity of their homes without lightning damage (Fig. 1).

The secret of protecting antennas and the equipment connected to them is to provide a direct path from the antenna to the earth so that the elec-

trical charges picked up from the atmosphere will be discharged harmlessly into the earth, rather than blasting a path to the earth through the equipment to which the antenna is connected. The most familiar static discharge units (popularly called "lightning arrestors") are inserted in the feedlines of TV and radio receiving antennas and are grounded at the point where they enter the building. The units are usually miniature spark gaps. The weak received signals flow past the gap without difficulty, but high-voltage static charges jump the gap and are diverted to the earth. Coaxial units with trade names such as "Blitz Bugs" can be connected in series with a coaxial cable. They are usable in transmitting applications when the SWR on the line is not too high. However, they are not really necessary when a properly-installed coaxial line is used with a dc-grounded antenna. A typical

homemade arrestor for open-wire line is shown in Fig. 2.

If coaxial cable is used to feed an antenna, the National Electrical Code's provisions for lightning protection are met by connecting its shield directly to ground where the cable enters the building. One method of doing the job is to mount a type 83-1F or UG-363/U coaxial "bulk adapter" on a corrosion-resistant metal bracket just outside or inside the opening through which the cable comes into the radio room. Connect the coaxial cable from the antenna to one end of the 83-1F adapter using a PL-259 connector on the cable, and the cable from the transmitter to the other end. Clamp the bracket to a ground electrode through a heavy conductor running in as straight a line as practical.

Ground Conductors. The N.E.C. specifies that a ground conductor must have a minimum cross-sectional area at least as large as *all* conductors being grounded through it. In any event, it should not be smaller than No. 10 and should be composed of copper, bronze, copper-clad steel, or equivalent. The conductor may be bare or insulated and should be protected from mechanical injury. It should go to the ground electrode in the shortest practical path with no sharp bends. Otherwise, the heavy current flowing through it during a lightning strike may ionize the air at

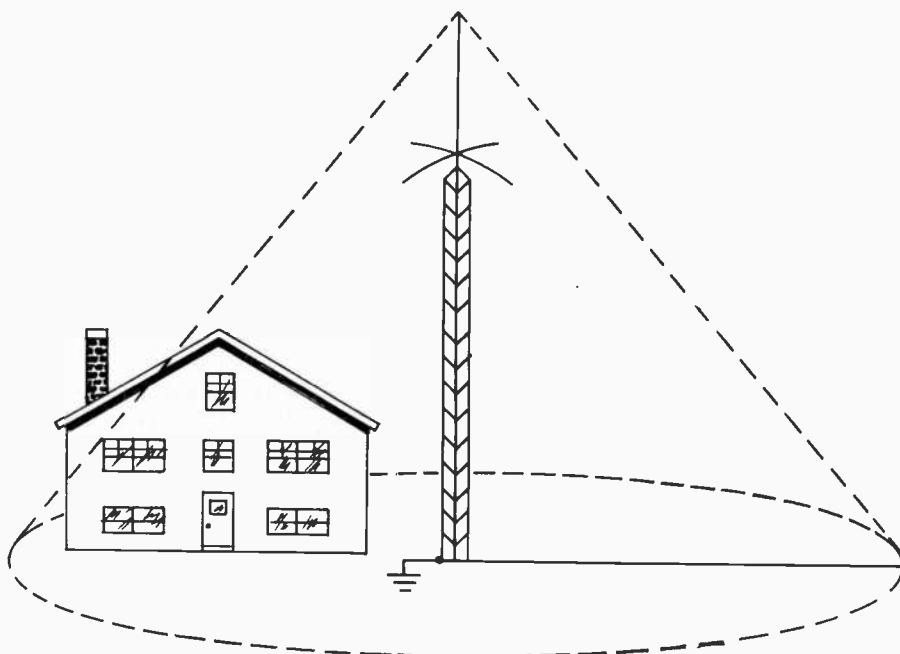

Fig. 1. Grounded antenna and tower create "cone of protection" for nearby structures.

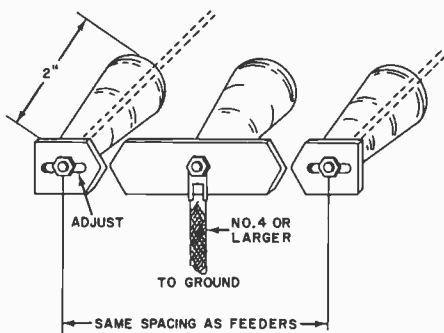

Fig. 2. Spark-gap lightning arrester for feedline.

the bend and leave the conductor at that point to find its own path to ground, doing much damage in the process.

When available, a metal underground water pipe should always be used as the ground electrode, regardless of its length; however, if its underground section is (or is likely to be) less than 10 feet in length, it should be supplemented by an additional grounding electrode. This electrode can be a heavily galvanized iron or steel pipe a minimum of 1.25 inches, outside diameter, a 1/2-inch copper rod or other approved ground electrode driven into the ground a minimum of eight feet. Such a driven electrode can replace the buried, water-pipe ground, if the latter is unavailable. If the soil is dry and sandy, two or more driven electrodes spaced a minimum of six feet apart and bonded together can be used to achieve a lower ground resistance. In fact, all available ground electrodes should be bonded together to lower the ground resistance as much as possible.

It's interesting to note the differences in ground systems for lightning protection and a buried radial system for a vertical antenna's ground plane. The former uses electrodes driven or buried deep in the earth; the latter is burned only a few inches. There is no objection to connecting the ends and centers of the radials for additional lightning protection, however.

Ground all supporting structures, including those mounted on roofs of buildings. Metal towers are usually adequately grounded, but run a heavy conductor to the hardware at the top of a wooden structure supporting a horizontal antenna to the ground electrode. If the mast supports only a wire antenna, extend a metal rod a foot or so above its top as a lightning rod. Any elevated "ground plane" radial wires and the shield of the coaxial feed line

AUGUST 1976

should be grounded before adjusting the antenna to the desired operating frequency. When the feed point of the vertical radiator is isolated from the radial system, a coaxial static discharge unit ("Blitz Bug") may be inserted between the PL-259 connector and the feed line to help drain static charges off of the vertical radiator of the antenna.

Unfortunately, grounding a multi-band "trap" antenna at the feed point does not protect its traps from high-intensity static currents in the event of a strike. The obvious solution to the problem is a spark gap across each trap, adjusted to the minimum spacing that does not arc under normal operation. However, many amateurs would merely repair or replace the trap if it is damaged by lightning.

Inside The Shack. For maximum safety, bond all metal cabinets, microphones, keys, and control boxes to a common ground bus. Homes built in the past few years or so often contain 3-terminal wall outlets with the third (round) terminal connected to the grounded neutral point of the power line. By using appropriate power cords with the third conductors connected to all chassis, they will be automatically grounded as the power plug is inserted in the receptacle.

I wish I could say that these suggestions guarantee that lightning will never damage any of your equipment. The sad truth is that a lightning strike or near miss creates such a high-energy field in the vicinity that induced voltage spikes up to several thousand volts have been measured on local power lines during severe electrical storms. Occasionally, these surges find their way to ground through equipment plugged into the lines, popping components in the process. Cautious operators pull the power plugs and disconnect their antennas whenever a bad storm is brewing, or when they leave their equipment unattended. If you decide to follow their lead, don't just disconnect the antenna lead-in and leave it lying on the floor. Whether connected or disconnected, the only safe conductor in a storm is a grounded conductor. If your antenna selector switch grounds all positions except the one in service, turn the switch to an unused position whenever you leave the room. Finally, don't forget to unplug the rotor control cable and plug it into a socket with all terminals connected to the main ground electrode.

Put Professional Knowledge and a COLLEGE DEGREE in your Electronics Career through HOME STUDY

Earn Your DEGREE

by correspondence, while continuing your present job. No commuting to class. Study at your own pace. Learn from complete and explicit lesson materials, with additional assistance from our home study instructors. Advance as fast as you wish, but take all the time you need to master each topic. Profit from, and enjoy, the advantages of independent study.

The Grantham electronics degree program begins with basics, leads first to the A.S.E.T. degree, and then continues through the B.S.E.E. degree level. Our free bulletin gives complete details of the program itself, the degrees awarded, the requirements for each degree, and how to enroll. Write or phone (no collect calls please) and ask for BULLETIN E-76.

Grantham School of Engineering
2000 Stoner Ave., Los Angeles, CA 90025

• Telephone (213) 477-1901 •

Worldwide Career Training thru Home Study

CIRCLE NO. 34 ON FREE INFORMATION CARD



**save on gas!
save on tune-ups!
save on maintenance!**

Electronic Ignition is "IN"! So says Detroit.

Update your car with either a TIGER CD or a TIGER I breakerless system.

Enjoy the benefits of better gas mileage, quicker starting, elimination of tune-ups, 50,000 miles on points and plugs, and reduced maintenance expenses.

TIGER MAX CD	\$69.95
TIGER 500 CD	59.95
TIGER SST CD	42.95
SIMPLIKIT CD	31.95
TIGER I	45.95

Postpaid U.S.A. only.

Tri-Star Corporation

Dept. ZZ, P.O. Box 1727
Grand Junction, Colorado 81501

CIRCLE NO. 64 ON FREE INFORMATION CARD

87

URF	.126
NOISE FIGURE UHF	2.2db

AUGUST 1976

CIRCLE NO. 67 ON FREE INFORMATION CARD

89

AUGUST 1976

CIRCLE NO. 66 ON FREE INFORMATION CARD

91



IMSAI

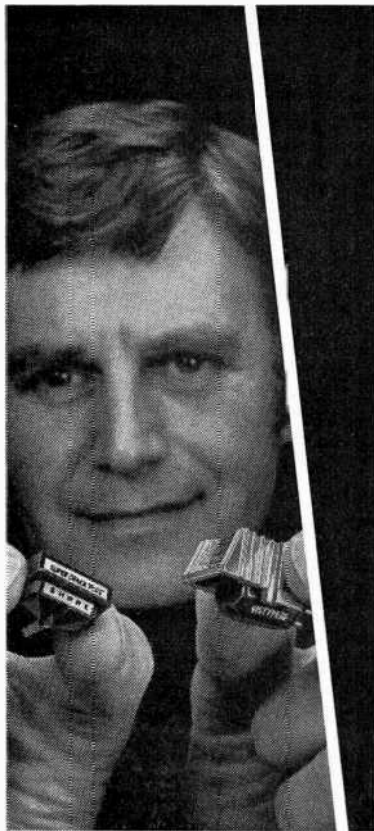

Tune-up Time.

Your intricate stereo stylus assembly is like a high-performance sports car — it needs a little routine care to keep it in top operating condition. Your Shure dealer will professionally inspect your stylus and clean it. Then, if your stylus tip is worn, he will select the correct genuine Shure replacement stylus to restore your cartridge to its original specifications. For more information, see your dealer or (next best), write for our booklet, "Visit to the Small World of a Stylus."

Shure Brothers Inc.
222 Hartrey Ave., Evanston, IL 60204
In Canada: A. C. Simmonds & Sons Limited

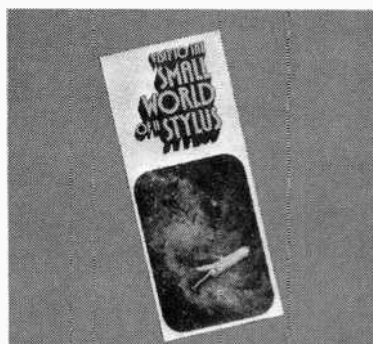

Manufacturers of high fidelity components, microphones, sound systems and related circuitry.

CIRCLE NO. 58 ON FREE INFORMATION CARD

familiar ac electric clock and newer battery-operated clocks. A comparison of various time bases and brief explanations of tuning-fork and quartz-crystal oscil-

projects—one- and six-digit clocks—are described, with full-size pc templates. Published by Howard W. Sams & Co., 4300 W. 62nd St., Indianapolis, IN 46206. 208

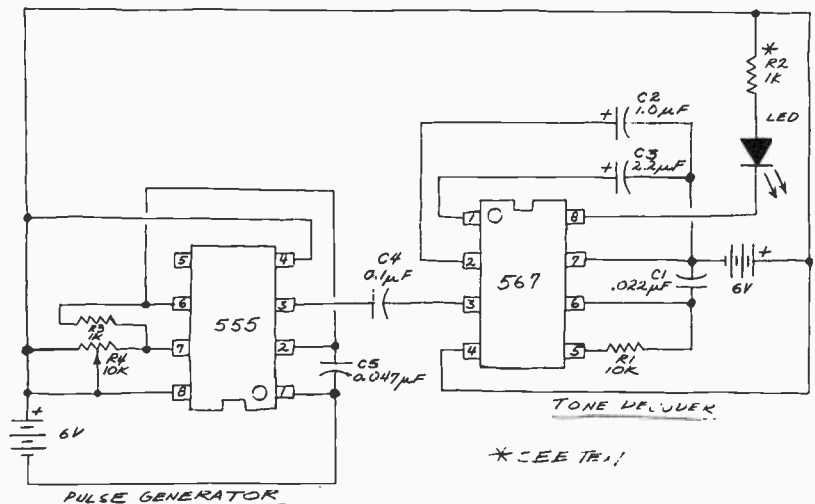

Fig. 2. Tone decoder demonstration circuit.

values speeds up the repetition rate. With the component values given in Fig. 2, f_i should be 5000 Hz ($1.1/10,000 \times 0.022 \times 10^{-6}$). The test circuit, however, gave an f_i of 4480 Hz. I measured $R1$ with a digital multimeter and found its actual resistance to be 10,320 ohms. This new value gave an f_i of 4845 Hz, which is within 3% of the predicted frequency, and any error is traceable to the tolerance of $C1$.

After you put the circuit together, experiment with the adjustment of $R4$ while watching the LED. The LED should turn rapidly on and off as you rotate $R4$'s shaft past the point where the 555 oscillates at the f_i of the 567. If you dim the room lights, you may notice the LED flickering just before and after it turns full on and off. Resistor $R2$ limits LED current to about 3.5 mA. If your workbench is brightly illuminated or your LED inefficient, you can reduce the value of $R2$ (say, to 500 ohms) to get more current through the LED. In any event, be sure to use a regulated dc supply or fresh batteries.

Frequency Response. A graph

showing the response of the circuit in Fig. 2 in the acceptance bandwidth region is shown in Fig. 3. The graph shows the input frequency from the 555 versus the output current through the LED. Note that the bandwidth is fairly wide when the input frequency goes high to low and vice versa.

After you've tried changing the frequency of the input tone, replace $R1$ of the tone decoder with a 2000-ohm fixed resistor in series with a 20,000- or 25,000-ohm potentiometer and readjust $R4$ to provide an unknown input tone. You should easily be able to lock onto the unknown input frequency by adjusting the potentiometer. You can arrive at a rough estimate of the frequency of the unknown tone *without* using a scope or counter by measuring the total resistance of the potentiometer and its 2000-ohm series resistor and using the center-frequency formula.

At this point, the 567 would appear to work just fine, since it triggers an LED in response to any desired tone. But if you actually build the test circuit, you'll soon discover that the 567

UNSCRAMBLERS!

FOR PUBLIC SERVICE BAND SCANNERS
FAR EXCEEDS ANY ON THE MARKET

★ SATISFACTION GUARANTEED ★

ORDER FROM:

**TNT
ELECTRONICS**

2404 SCOTSWOOD
GARLAND, TEXAS 75041

✓ **UNSCRAMBLER** — FOR ALL SCANNERS ■ **\$24⁹⁵**
TUNES EASILY TO UNSCRAMBLE ALL SCRAMBLE
FREQUENCIES ■ FULL INSTRUCTIONS INCLUDED
■ CONNECTS QUICKLY ■ 3½x3½x1½ INCHES ■

✓ **POCKET UNSCRAMBLER** — FOR POCKET **\$34⁹⁵**
SCANNERS ■ ONLY UNIT OF ITS KIND KNOWN ■
CONNECTS QUICKLY ■ ¾x1¼x2¼ INCHES ■
INSTANT TUNING ■ FULL INSTRUCTIONS ■

POSTPAID — TEXAS RESIDENTS ADD 5% SALES TAX — NO C.O.D.'S PLEASE.
■ DEALERS INQUIRES INVITED ■

CIRCLE NO. 61 ON FREE INFORMATION CARD

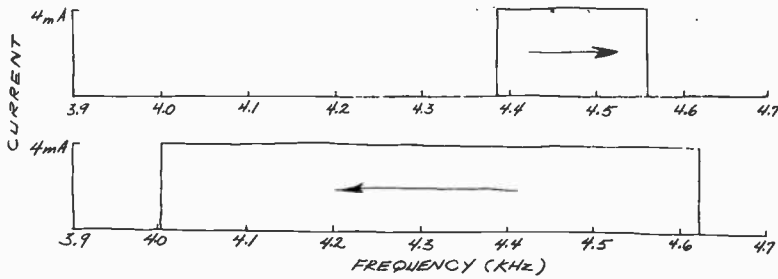

Fig. 3. Frequency response of circuit in Fig. 2. Arrows indicate positive and negative frequency changes.

has a tendency to trigger on what appear to be harmonics of the center frequency. The 567 will, in fact, lock onto frequencies corresponding to input signals near $f_c (4n + 1)$ (where $n = 0, 1, 2, 3, \dots$). Also, the square pulses from the 555 will cause an output for $f_c/2$.

Fortunately, the response of the 567 to tones other than f_c is usually of no consequence. And if false triggering to undesired tones becomes a problem, you can either change the center frequency of the 567 or attenuate the offending tone with a notch filter.

Other Applications. After you have experimented with the 567 using the basic circuit in Fig. 2, you will probably think of lots of interesting applications. One fascinating possibility is a secret photoelectric lock activated by a tone-modulated LED. A phototransistor connected to the input of the 567 can be used to receive the signal from the LED, as shown in Fig. 4. This circuit has an optical range of a few centimeters without external lenses at either the LED or phototransistor. This is all the distance you need for most lock applications, but for more range

you can add an amplifier between the phototransistor and the 567 and use a lens at each end.

Whether checking out a potential application or just for fun, don't hesitate to experiment with the basic 567 circuit in Fig. 2. For best results, Signetics recommends that the resistance of R1 be between 200 and 20,000 ohms. Capacitor C2, the loop low-pass filter, should be selected from the Bandwidth versus Input Signal Amplitude graph given in both the National and Signetics data sheets on the 567.

At very low input frequencies, the time required for the 567 to lock onto the input tone can become relatively long. For example, I found that an input tone of 500 Hz required a full second for lock to occur. These and other eccentricities of the 567 are covered in detail in the manufacturer's (Signetics) data sheet, and I urge you to obtain this well-prepared document to assist you while experimenting with the 567. Another excellent source of information on the 567 is found in the Signetics Digital/Linear/MOS Applications book (Section 6, "Phase Locked Loop Applications").

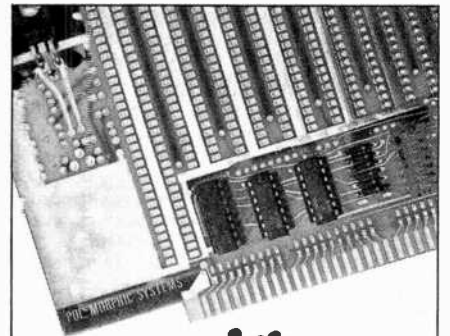

Altair, Imsai or Poly 88

We have boards for all three.

Video Terminal Interface: This is one almost every owner of an Altair-compatible computer needs. There have been problems getting parts for this one (the people with the other Video board have had the same problem, since they use the same hard-to-get chip), but deliveries are improving. By the way, our video board has GRAPHICS as well as an 8 bit parallel key board input port, so compare before you buy. \$185.00 - \$210.00 kit depending on whether 32 or 64 characters per line.

Poly I/O: With this one you will save a lot of time in making prototype circuits. I/O port address is selectable with dip switch and fully buffered inputs and outputs. \$55 kit.

Analog Interface: Good for interfacing your computer to an analog world. Ten bits of resolution in and out. \$145.00 for one channel and \$195.00 for two channels (kit).

Ask about how to get a free POLY I/O or ANALOG Board.

Watch for our new products. Next time they will be on the shelf before we advertise.

Have you heard about the POLY-88? We don't have the space here to describe all the features. See it at your local computer store (except for MITS dealers, though some do carry our other products). This might be the system you're looking for.

Support your local computer store.

All prices and specifications subject to change without notice. Prices are U.S.A. only. Calif. residents add 6% sales tax. Add 5% shipping, handling, and insurance. Bank Americard and Mastercharge accepted.

PolyMorphic Systems

737 S. Kellogg, Goleta, Calif. 93017
(805) 967-2351

CIRCLE NO. 50 ON FREE INFORMATION CARD

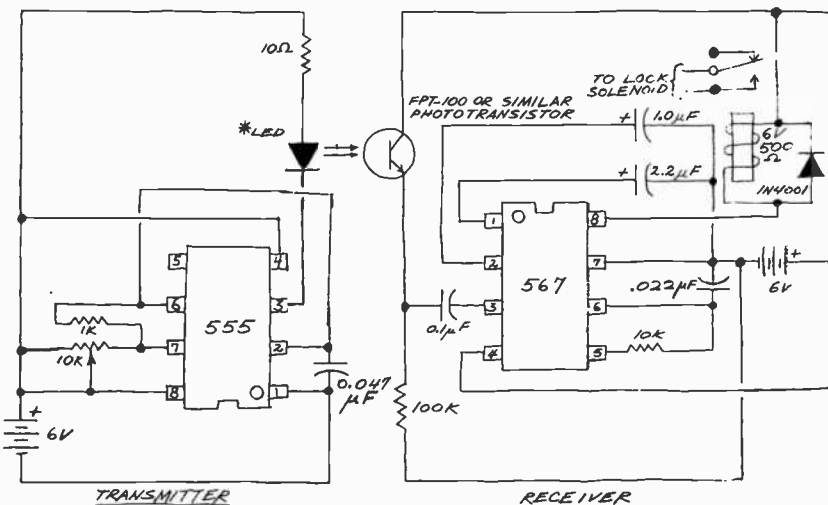

*USE HIGH EFFICIENCY INFRARED EMITTER SUCH AS SSL-55C, TIL 31, ETC. 555 APPLIES 45µS WIDE PULSES WITH PEAK CURRENT OF 120mA TO LED

Fig. 4. Infrared-activated secret lock.

ELECTRONICS MARKET PLACE

NON-DISPLAY CLASSIFIED: COMMERCIAL RATE: For firms or individuals offering commercial products or services, \$2.00 per word (including name and address). Minimum order \$30.00. Payment must accompany copy except when ads are placed by accredited advertising agencies. Frequency discount; 5% for 6 months; 10% for 12 months paid in advance. **READER RATE:** For individuals with a personal item to buy or sell, \$1.20 per word (including name and address.) No minimum! Payment must accompany copy. **DISPLAY CLASSIFIED:** 1" by 1 column (2-1/4" wide), \$230.00. 2" by 1 column, \$460.00. 3" by 1 column, \$690.00. Advertiser to supply film positives. For frequency rates, please inquire.

GENERAL INFORMATION: First word in all ads set in caps at no extra charge. All copy subject to publisher's approval. All advertisers using Post Office Boxes in their addresses **MUST** supply publisher with permanent address and telephone number before ad can be run. Advertisements will not be published which advertise or promote the use of devices for the surreptitious interception of communications. Ads are not acknowledged. They will appear in first issue to go to press after closing date. Closing Date: 1st of the 2nd month preceding cover date (for example, March issue closes January 1st. Send order and remittance to **POPULAR ELECTRONICS**, One Park Avenue, New York, New York 10016, Attention: Hal Cymes.

FOR SALE

FREE! Bargain Catalog—I.C.'s, LED's, readouts, fiber optics, calculators parts & kits, semiconductors, parts. Poly Paks, Box 942PE, Lynnfield, Mass. 01940.

GOVERNMENT Surplus Receivers, Transmitters, Snooperscopes, Radios, Parts, Picture Catalog 25 cents. Meshna, Nahant, Mass. 01908.

LOWEST Prices Electronic Parts. Confidential Catalog Free. KNAPP, 3174 8th Ave. S.W., Largo, Fla. 33540.

ELECTRONIC PARTS, semiconductors, kits. FREE FLYER. Large catalog \$1.00 deposit. BIGELOW ELECTRONICS, Bluffton, Ohio 45817.

RADIO—T.V. Tubes—36 cents each. Send for free catalog. Cornell, 4213 University, San Diego, Calif. 92105.

AMATEUR SCIENTISTS, Electronics Experimenters, Science Fair Students... Construction plans—Complete, including drawings, schematics, parts list with prices and sources... Robot Man — Psychedelic shows — Lasers — Emotion/Lie Detector — Touch Tone Dial — Quadraphonic Adapter — Transistorized Ignition — Burglar Alarm — Sound Meter... over 60 items. Send 50 cents coin (no stamps) for complete catalog. Technical Writers Group, Box 5994, University Station, Raleigh, N.C. 27607.

METERS—Surplus, new, used, panel or portable. Send for list. Hanchett, Box 5577, Riverside, CA 92507.

MECHANICAL, ELECTRONIC devices catalog 10 cents. Greatest Values — Lowest Prices. Fertik's, 5249 "D", Philadelphia, Pa. 19120.

SOUND SYNTHESIZER KITS—Surf \$12.95, Wind \$12.95, Wind Chimes \$17.95, Electronic Songbird \$6.95, Musical Accessories, many more. Catalog free. PAIA Electronics, Box J14359, Oklahoma City, OK 73114.

BUGGED??? New locator finds them fast. Write, Clifton, 11500-L N.W. 7th Avenue, Miami, Florida 33168.

DISCOUNT PRICES

B&K, SENCORE, LEADER, RCA
EICO, FLUKE, HICKOK, SIMPSON
Test Equipment

ICC/ServiceMaster, RCA and Raytheon Tubes
Complete line of electronic supplies

Free Catalog

FORDHAM RADIO SUPPLY CO., INC.

855R Conklin St., Farmingdale, N.Y. 11735 (516) 752-0050

YOU WILL SAVE BIG MONEY! Surplus, Clearouts, Bankruptcy, Inventory, Deals. Catalog \$1 (redeemable). ETCOA Electronics, Box 741, Montreal, H3C 2V2. U.S. Inquiries.

HEAR POLICE/FIRE Dispatchers! Catalog shows exclusive directories of "confidential" channels, scanners, Send postage stamp. Communications, Box 56-PE, Commack, N.Y. 11725.

CD IGNITIONS, VHF/UHF monitors, crystals, CB radios, Southland, Box 3591-B, Baytown, Texas 77520.

SURPRISE! Build inexpensively, the most Unusual Test Instruments, Futuristic Gadgets using Numerical Readouts! Catalogue Free! GBS, Box 100A, Green Bank, West Virginia 24944.

TELEPHONES UNLIMITED, equipment, supplies. Catalog 50 cents. Box 1654E, Costa Mesa, Calif. 92626.

UNSCRAMBLERS: Fits any scanner or monitor, easily adjusts to all scrambled frequencies. Only 4" square \$29.95, fully guaranteed. Dealer inquiries welcomed. PDQ Electronics, Box 841, North Little Rock, Arkansas 72115.

SURPRISE! SURPRISE! Digital Piano Tuning Device tunes musical instruments Accurately! Perfectly! Inexpensively! Construction-Instruction-Plans Complete \$12.95 Airmailed Postpaid! Moonlighting quickly repays \$40 electronics investment! GBS, Box 100P, Green Bank, West Virginia 24944.

RECONDITIONED Test Equipment. \$0.50 for catalog. Walter's Test Equipment, 2697 Nickel, San Pablo, CA 34806.

POLICE, Fire monitors, scanners, crystals, CB Transceivers, New Crystal-less scanners. Discount priced. Box 19224, Denver, CO 80219.

TELETYPE EQUIPMENT for sale for beginners and experienced computer enthusiast. Teletype machines, parts, supplies. Catalogue \$1.00 to: ATLANTIC SALES, 3730 Nautilus Ave., Brooklyn, NY 11224. Tel: (212) 372-0349.

JAPANESE TRANSISTORS, all transistors original factory made. Free catalog. West Pacific Electronics, P.O. Box 3879, Torrance, CA 90510.

BUILD YOUR OWN TV CAMERA!
— Ideal for home & business —

THE ECONOMICAL ANSWER TO HOME MONITORING OF NURSERIES, ENTRANCES, DRIVEWAYS, BUSINESS AND INDUSTRIAL SURVEILLANCE... AMATEUR TV PLUS HUNDREDS OF OTHER APPLICATIONS. MODEL AT-1A, SERIES D - KIT FORM \$185; ASSEMBLED \$275. SOLID-STATE. WORKS ON ANY TV SET. OPTIONAL SOUND KIT \$28.95. PHONE or WRITE for catalog. Dial 402-961-3711

1301 BROADWAY **ATV Research** DAKOTA CITY, NE. 68731

CB RADIO, Scanners, Antennas. The best for less. Free List. Capitol Sound, Box 3523, Des Moines, Iowa 50322.

YOU WANT TO BUILD IT: WE WANT TO HELP. WE SELL CONSTRUCTION PLANS with an Engineering Service. TELEPHONE: Answering Machines, Speakerphones, Car-phones, Phonevision, Touch Button Dialers. TELEVISION: VTR, 1" Color TV Set, PONG, \$25.00 Camera, COLOR PROJECTION TV. HOBBYIST: Electron Microscope, \$75 software programmable computer. BROADCAST: Special Effects Generator, Chroma Key, Audio Board, DA's. COURSES: Telephone Engineering \$52.00, Detective Electronics \$29.50, IC Engineering \$65.00, PLUS MUCH MORE. NEW Super Hobby Catalog PLUS year's subscription to Electronic News Letter AIR MAILED \$1.00. Don Britton Enterprises, 6200 Wilshire Blvd., Los Angeles, Calif. 90048.

SEMICONDUCTOR AND PARTS Catalogue, \$1.00 refundable, from the semiconductor specialists. J & J Electronics, Box 1437P, Winnipeg, Manitoba, Canada. U.S. Inquiries.

ELECTRONIC Ignition: Pointless, Transistor, Capacitor. Vapor inductors, Auburn Sparkplugs. Information 10 cents. Anderson Engineering, Epsom, N.H. 03234.

TV PING PONG game. Plays through your set's antenna terminals: Plans \$3.25. ARS SYSTEMS, Box 1922, Sunnyvale, CA 94088.

6 MHZ CRYSTALS including schematic and info to generate 60 Hz-12VAC to make your digital clock run on batteries. \$1.50 pp in US. Eastern Sales, Box 510, Raleigh, N.C. 27602.

DESCRAMBLERS: Several Professional Models that work with all Scanners. Tone Encoders/Decoders, Scanmate, AAPP, Radar Detectors, Big Ears, Alarms, Books, Kits, parts. Catalog 25 cents: KRYSTAL KITS, Box 445, Bentonville, Ark. 72712.

CARBON FILM RESISTORS. Brand new as low as 1.7 cents. Discounts of 20%. Prompt delivery. FREE samples/specifications. COMPONENTS CENTER, Box 134P, N.Y., N.Y. 10038.

WHOLESALE C.B., Scanners, Antennas, Catalog 25 cents. Crystals: Special cut, \$4.95, Monitor \$3.95. Send make, model, frequency. G. Enterprises, Box 461P, Clearfield, UT 84015.



WORLD'S SMALLEST RECHARGEABLE CALCULATOR...\$19.95!

Does Everything Big Ones Do

Small but mighty! 8-digit, 4-function electronic calculator even has automatic % key... for only \$19.95. Take it anywhere. Carry it in your pocket or purse — it's 2/3 the size of a pack of cigarettes. This 3 1/2-ounce dynamo features floating decimal, constant key, lead zero depression, clear entry, more! At Edmund's low price, the unit comes with a Ni-Cad rechargeable battery pack that can plug into any AC outlet. No need for special recharging adapters. Calculator overall is just 2 x 3 1/2 x 3/4" with plenty of room for most fingers. Another Edmund first with advanced technology. **\$19.95** ppd.

STOCK NO. 1945AV..... Only

GIANT FREE CATALOG!

NEW 172 Pages Over 4,500 Unusual Bargains for Hobbyists, Schools, Industry





JUST CHECK COUPON!

EDMUND SCIENTIFIC CO.
300 EDSCORP BUILDING
Barrington, N. J. 08007
(609) 547-3488

America's Greatest Science • Optics • Hobby Mart

COMPLETE AND MAIL COUPON NOW

EDMUND SCIENTIFIC CO. 300 Edscorp Bldg., Barrington, N. J. 08007

SEND FREE   Send me: _____
172 PAGE CATALOG 'AV' _____
 Charge my BankAmericard _____
 Charge my Master Charge _____
Service and handling charge \$ _____ \$1.00
Interbank No. _____
Card No. _____
Expiration Date _____
Enclosed is _____
 check, m.o. in amount of \$ _____
Signature _____
Name _____ Please print
Address _____
City _____ State _____ Zip _____

HELPING TO DEVELOP AMERICA'S TECHNOLOGY FOR OVER 30 YEARS.

CIRCLE NO. 23 ON FREE INFORMATION CARD

IC BONANZA

*Data Sheet included on these items

*2102	1K Static RAM	\$ 1.49
*5203Q	Erasable PROM 2K	10.95
*MMS330	National DVM Chip	9.95
*50310	Slide Rule Calculator Chip	3.95
*50250	Alarm Clock Chip	4.45
304H	Negative Regulator	.95
309K	5 Volt Regulator	.95
LM320K	5 Volt Neg Regulator	.84
LM340K	24 Volt Pos Regulator	.89
741	Op Amp - Minidip	.29
MAN 7	(HP-7730) 7 Seg. Display	1.15
MAN 3	7 Segment Display	5/1.00
MCA 8	Monsanto Slotted Opto Switch	.75
LED	2" Red	6/1.00
LED	2" Yellow	5/1.00
LED	2" Green	5/1.00
LED	2" Red-Right Angle	5/1.00
LED	12" Red	7/1.00
LED	12" Yellow	6/1.00
LED	12" Green	6/1.00

SEND FOR FREE CATALOG

Minimum order \$5.00, data sheets 25 cents each. Include 5% of order for postage and handling. Texas residents include 5% state sales tax.

BONANZA ELECTRONICS

P. O. Box 24767 Dallas, Texas 75224

COMPUTER HOBBYISTS! Bargain hunt and sell via ON_LINE. 18 issues/year — \$3.75. Free Sample. ON_LINE, 24695 Santa Cruz Hwy., Los Gatos, CA 95030.

N-RAMS	PREMIUM COMPONENTS	PROMS
2102-1.50	INTRODUCTORY OFFER	8223/G123-1.95
TTL	SCHOTTKY	CMOS
7400 .14 74123 .50 74502 .25 74LS153 .95 4001 .16 4030 .35	74S153 .95 4001 .16 4030 .35	7402 .14 74150 .60 74537 .40 74LS163 1.50 4002 .16 4040 .95
7404 .16 74151 .60 74585 .20 74LS164 1.50 4006 .90 4042 .60	74LS164 1.50 4006 .90 4042 .60	7410 .14 74157 .60 745140 .50 74LS174 1.50 4007 .16 4044 .70
7420 .14 74160 .75 745172 3.50 74LS175 1.50 4011 .16 4049 .38	74LS175 1.50 4011 .16 4049 .38	7427 .25 74161 .75 745175 1.50 74LS193 1.50 4012 .16 4050 .38
7438 .25 74163 .75 745181 3.50 74LS251 1.50 4013 .35 4066 .65	74LS251 1.50 4013 .35 4066 .65	7440 .14 74165 .80 745197 1.50 74LS253 1.50 4021 .95 4068 .35
7445 .45 74174 .75 745257 1.50 74LS257 1.50 4023 .16 4071 .16	74LS257 1.50 4023 .16 4071 .16	7450 .14 74175 .75 74LS258 1.50 4024 .75 4073 .16
7451 .14 74177 .70	Low Power 4025 20 4075 .16	7452 .14 74178 .70
7423 .22 74180 .80	Schottky 4027 40 4516 .95	7474 .23 74181 1.50 74LS00 .25
7493 .50 74191 1.00 74LS02 .25	ELTRON—P.O. Box 2542	7495 .49 74192 .70 74LS10 .25
74116 1.00 74193 .70 74LS73 .40	SUNNYVALE, CA 94087	74198 1.00 74LS75 .50
	Min. Order \$10.00-Add \$1.00	74LS151 .85
	P & H. Calif. Res. add 6% Tax.	

FREE Catalog. Ultrasonic Devices, LEDS, Transistors, IC's, Strobe Lights, UARTS, Memories, Digital Thermometers, Unique Components. Chaney's, Box 27038, Denver, Colo. 80227.

TV TECHNICIANS, SERVICEMEN, HOBBYISTS—Vista Model 740 Digital Crosshatch Generator. Compact crystal divider for lowest-priced ultra-stable 5x7 crosshatch or 56 dot patterns. AC powered. \$31.95 complete kit; \$41.95 assembled. Postpaid in USA, Canada. Information available free. Photolum Corporation, Dept. PE-86, 118 East 28th Street, New York, New York 10016.

PLANS—Video Pong . \$2.00. Laser . \$2.00. Projection TV . \$2.00. Catalog 50 cents. Technologc, Box 5262, Orchard Lake, Michigan 48033.

POLICE CODE UNSCRAMBLERS. Fits all scanners. Satisfaction Guaranteed. Jim's Two-Way, Box 275, Hot Springs, Ark. 71901.

ALTAIR 8800 & IMSAI 8080 Plug-ins . . . 8K Static Memory, . . . exceptionally low power . . . fast no wait states or refresh . . . Prototyping Board . . . Extender Card . . . Hex/Octal Encoder . . . IC Sockets . . . Microprocessor Coding Pads . . . low prices. ELECTRONIC CONTROL TECHNOLOGY, Box 6, Union, N.J. 07083.

NEW ADJUSTABLE THREE OUTPUT REGULATED POWER SUPPLY, plus 900 parts worth \$400.00 list. Solid state CARTRIVISION television recorder electronic unit. Schematics, parts cross reference. HEATHKIT television transistor substitutions. Power CB radios, MICRO-PROCESSORS. \$17.95 plus \$3.50 S&H, USA. Free Brochure, Master Charge, BankAmericard. MADISON ELECTRONICS COMPANY, INCORPORATED, Box 369, D55, Madison, Alabama 35758.

CIRCOLEX PRECISION PROCESS NEGATIVES. To 8x10 from artwork to 16x20 \$15. Specify circuit dimensions. Additional copies \$7. Postpaid. CIRCOLEX, Box 198, Marcy, N.Y. 13403.

ANALYZE Resistor Capacitor Inductor circuits with pictures. Electronic Circuit Analysis without mathematics \$2.25 postpaid. New York residents add 14 cents tax. Jamboree Acres, Box 415B, Jamestown, New York 14701.

TV GAME kit, boards. Plays tennis, gravity, handball, basketball. Has slam buttons, cybernetic mode, sound and score. Featured April '76 PE. Free brochure. Cal-Kit, Inc., Box 877P, Sebastopol, CA 95472.



Send for your information packet today—

which also includes circuit functions, component line-up, and accessories. Information Packet \$1.00 (refundable with order).

visulex P. O. Box 4204P Mountain View, CA 94040

GRAPHIC ARTIST visual synthesizer kit, boards. Creates thousands of complex moving patterns on standard oscilloscope. Featured Nov. '75 PE. Free brochure, sample patterns. Cal-Kit, Inc., Box 877P, Sebastopol, CA 95472.

PHOTORESIST — Negative Type. 4 oz. covers many square feet. Instructions included. \$3.95. Belco, 5431 Neosho, Shawnee Mission, KS 66205.

FREQUENCY counter-audio 10-100khz, 4 digit. Use to tune musical instruments, etc. Assembled less case, power cord. \$54.95. Belco, 5431 Neosho, Shawnee Mission, KS 66205.

ORGAN/SYNTHESIZER keyboards, pedalboards, amplifiers, consoles, etc. Free brochures. DANIELSON, 555 Richmond Road, West Chester, PA 19380.

ELECTRONICS DESIGN NEWSLETTER

★ Logic Design Techniques

★ Digital & Linear Design Theory & Procedures

★ Construction Projects

Subscription \$6 Sample Copy \$1

VALLEY WEST Box 2119-V Sunnyvale, CA 94087

LOW cost digital/analog test equipment. Exceptional values. Free catalog. Salen Electronics, Box 82, Skokie, Illinois 60076.

SUBMINIATURE FM TRANSMITTERS. Plans for 5 different circuits \$5.00 (no COD). J. Jobe, 2313 Bishop Estates, Jacksonville, Florida 32217.

SAMS PHOTOFACETS. Numbers 1-1075 with file cabinets. \$1100 or best offer. Buyer pays shipping. John McKeever, 640-D North Garland, Fayetteville, Arkansas 72701.

TELEPHONE SUPPLIES. Your retail source of wide selection of phones, cords, plugs, jacks, and parts. Flemco, 20272 37th Ave., N. E., Seattle, WA 98155.

PDP-11, \$675? LSI-11 single board 16-bit processor. For details, write: N.E.C.A., 834 Lawler St., Phila., PA 19116.

EDLIE'S BARGAIN BONANZA

ONLY HIGHEST QUALITY PRODUCTS



- (EP017) COPPER CLAD BOARDS! Copper on one side, 1/16" thick. Excellent quality for either production or experimental work.
- 6 1/2" x 17 1/2" \$1.19 ea. 3/\$2.99 Copper on both sides. 1/16" thick. Size 12" x 18".
- (EP018) \$1.99 ea. 3/\$4.99
- (EP134) 8 ROTARY SWITCHES Some multiple gang. \$1.00
- (EP128) 13 MINIATURE ELECTROLYTIC CAPACITORS \$1.00 Axial & upright, popular values.
- (EP144) TRANSISTOR REPAIR KIT \$1.19 Various parts used to repair transistorized devices.
- (EP336) TO-3 TRANSISTOR SOCKETS 12 for \$1.00

9 V. BUZZER FOR ALARMS 99c ea. 6 for \$5



- (EP164) 4 ROLLS OF WIRE \$1.00 Approx 25 ft. per roll, 20-28ga.
- (EP140) TAPE RECORDER SPARE PARTS KIT \$2.95 Parts for repairing most tape recorders: capacitors, meter, pilot lamp, jacks, and MUCH MORE.
- (EP167) 10' MINIATURE POTENTIOMETERS \$1.00
- (EP182) 2 MISC. METERS \$1.00 Miniature.
- (EP156) 60 DISC CAPACITORS \$1.00 Asst. from .0001 to .1, most 600v, 25u, NPO, N750, etc.

SURPLUS TUBES

All guaranteed for 1 full year.

ANY 3 FOR \$1.49

Acquired from U.S. Defense depots or removed from equipment (new and used). These are laboratory tested and guaranteed for one full year. Most are of such standard makes as RCA, GE, etc.

3A3	6A07	6CM7	6X4
3AF4	6AT6	6DE4	10EW7
3BN6	6AU6	6DR7	12AE7
3DG4	6AV6	6DW4	12AL5
3KT6	6AX4	6EB8	12AU7
3Q4	6AX5	6EM7	12AV6
4BC5	6AY3	6GF7	12BE6
4BN6	6BA6	6GH8	12BH7
4BU8	6BG6	6K6	18FW6
4BZ7	6BJ8	6K11	25L6
5V6	6BQ6	6L6B	35EH5
6AF4	6BZ6	6SN7	36AM3
6AG5	6CB6	6T8	50A5
6AG7	6CG7	6W4	50L6
6AL5			

- (EP147) 4 lb. GRAB BAG SPECIAL \$1.00 Full of exotic and exciting electronics parts
- (EP155) TUBE BONANZA! \$1.00 20 asst. popular tubes, untested.
- (EP142) 50 PRECISION RESISTORS \$1.00 All 1%, 1/2w and 1w. low and high ohmages.
- (EP150) POWER TRANSFORMER Primary 117 volts. Sec. 1-11.1 volts; Sec.2 17.7 volts; Sec.3 15.3 volts; Sec.4 27.7 volts. Each winding approx. 750 mils. Size 2 1/4" H x 2" D x 3 3/8" mounting centers. \$1.95
- (EP175) 70 1/2w CARBON RESISTORS \$1.00 Asst. values. Some 5%.
- (EP154) 150 CUT LEAD RESISTORS \$1.00 Carbon, all leads long enough for soldering.
- (EP149) 20 POLYSTYRENE TOP GRADE CAPACITORS \$1.00
- (EP132) 20 DUAL POTS \$1.00

24V. C.T. FILAMENT TRANSFORMER 1/2A. WITH 150V. TAP.



(EP202) 99c ea 6 for \$4.99

MONEY BACK GUARANTEE
Terms: Minimum order \$4.00. Include postage. Either full payment with order or 20% deposit, balance C.O.D.

BONUS FREE CAPACITOR KIT With Every \$5 Purchase

WRITE FOR FREE 1976 VALUE PACKED CATALOG Listing thousands of components, tubes, transistors, IC's, kits, test equipment.

THIS MONTH'S SPECIALS!

TTL	7400	16c	7446	80c
	7401	18c	7447	80c
	7402	22c	7448	80c
	7403	23c	7473	49c
	7404	23c	7474	49c
	7405	23c	7475	85c
	7406	23c	7476	53c
	7410	23c	7490	79c
	7411	27c	7492	79c
	7413	40c	7493	69c
	7420	23c	7495	79c
	7430	23c	74121	57c
	7440	30c	74122	57c
	7442	\$1.12	74123	67c

- LINEARS**
- LM309K 5v 1a. reg. \$1.15
 - 555 Timer 75c
 - 556 Dual 555 \$1.00
 - 566 Function gen. \$1.75
 - 567 Tone decoder \$1.95
 - 741 comp. op amp 39c
 - 2513 Char. gen. \$5.95
 - 8038 volt cont osc \$4.25

CLOCK CHIPS WITH DATA

- (MM5314) 6 dig clock \$4.95
- CT7001 Alarm & Date \$5.95

- LED'S**
- (EP223) 10 Asst LEDs \$1.00
 - (EP242) 5 Jumbo Green LEDs \$1.00
 - (EP242) 5 Med Yellow LEDs \$1.00
 - (EP001) 5 Jumbo Red LEDs \$1.00
 - (EP011) 5 Med Red LEDs \$1.00
 - (EP012) 5 Mini Red LEDs \$1.00
 - (EP293) DL707 (equiv.) 7 seg red LED, .3" char., comm anode \$1.00
 - (EP006) DL 704 (equiv.) same as DL707 except comm cath \$1.35
 - (EP007) DL747 7 seg red LED, .6" char., comm anode \$1.95
 - (EP013) MAN 5 (equiv.) 7 seg green LED, .27 char. comm. anode \$1.49

- IC BREADBOARDS & TERMINALS**
- Boards have .042 holes. Made of 1/16" polyester glass.
- (BB663) 3" x 4" 94c
 - (BB664) 3" x 6" \$1.29
 - (BB665) 4" x 6" \$1.65
 - (BB666) 4" x 8" \$2.12
- Push-in terminals
- (EP601-20) pkg 20/90c
 - (MP601-100) pkg 100/\$2.98
- Push-in flanged pins
- (BB660-20) pkg 20/90c
 - (BB660-100) pkg 100/\$2.98
- Push-in flea clips
- (BB663-20) pkg 20/90c
 - (BB663-100) pkg 100/\$2.98
 - (B008) 14 pin DIP sockets 3 for \$1
 - (EP1104) IC REMOVAL AND INSERTION TOOL \$4.95 "Pul-n-tertic" extracts and inserts ICs without damage.

REED RELAYS

(EP203) SPST, 12V, 1000 ohms coil. Price 79c



EDLIE ELECTRONICS, INC. 2700-EP HEMPSTEAD TPKE., LEVITTOWN, N.Y. 11756

The SC/MP Microprocessor Kit.
By National Semiconductors

Includes everything you need to build a functional microprocessor system, for every application. Includes 512 bytes (8-bit/byte) Read-only-Memory, 256 bytes of static read/write memory, teletype interface and much more. Comes with application literature

\$99.00

4510 Mathematics \$19.88
By National Semiconductors

8-digit LED display slide rule with arithmetic, trigonometric and logarithmic functions. RPN logic with 3-level stack, floating decimal, fully accumulating memory with M+, M- and M x X2; degrees/radians conversions, Pi, square root, reciprocal, exchange and sign keys, low battery indicator (includes 9V battery.)



Regular Price \$24.88

Memories

MM2102 - 1	static RAM 1024 x 1	\$ 2.00
MM1702A	prog. mem. 7048	\$12.99
5314 Digital Clock chip	LED/incremental trisp. 6 digits	\$ 4.25

Switches

10 position rotary switch by oak manuf. \$ 1.00 per 4



8 position, 1 off switch in TO5 can \$.89 ea \$ 3.00 per 4

Rocker Switch

SPST normally open contact rating 6A 250VAC solder terminals \$.50 ea \$ 2.50 per 6



Keyboard

Teletype keyboard 62 keys, undecoded



\$19.95

I.C.'s

DM 7092 180921	Dual 5-input N and Gate \$ 1.00 per 3
DM 7094 474261	Tri State Quad Buffer \$ 1.00 per 3
Mismarked I.C.S. (marked 64xx instead of 74xx)	
7408	\$ 1.00 per 10
74192	1.00 per 2

I.C. Socket

14 pin vert wrap \$ 1.70 per 5 or \$ 3.00 per 10

Bridges

1A	500V	\$ 1.00 ea	\$ 7.50 per 10
12A	50V	\$ 1.40 ea	\$ 12.00 per 10
25A	50V	\$ 1.60 ea	\$ 14.40 per 10

*were tested to 50V. Many may be good for 600-800V

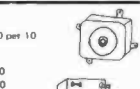

Silicon Rectifiers

6A	700V	\$.80 ea
12A	100V	.75 ea \$ 4.00 per 6



Displays

9 mm digits on P.C. board
Overall dimensions: 1.625" X .44"
Clear bubble magnifying lens.
Optical 9 digits calculator display.
1 1/8" character height.
Red lens on P.C. board.



Your choice: \$2.95

7 Segment Displays

7 segment, right hand decimal.
Man 84 - yellow Com. Cathode
Man 81 - yellow Com. Anode
Man 3610 - Orange Com. Anode



\$1.20 each
3" or 6/\$7.00

Discrete Led Lamps

FND 500	- Red	Com. Cathode	5"	\$1.50
FND 507	- Red	Com. Anode	5"	or 7/\$10.00

20" DIA.

5053 Red	5/51.00
5053 Green	4/51.00
5053 Yellow	4/51.00
5053 Orange	4/51.00



MINIMUM ORDER \$7.50
Shipping & Handling:
SC/MP - \$3.00 + \$5.00 Insurance
all others - \$1.00
California residents add 6% sales tax.

ELECTRONICS WAREHOUSE Inc.
1603 AVIATION BLVD.
REDONDO BEACH, CA. 90278
Tel. (213) 376-8005
WRITE FOR FREE CATALOG

CIRCLE NO. 27 ON FREE INFORMATION CARD

For faster service USE ZIP CODE on all mail

COLOR 'TV' CHASSIS AND PARTS

We have just purchased a large quantity of table color 'TV' chassis and parts which were derailed enroute to the final assembly plant. Chassis are intact and bulk-packed. A tough break for the manufacturer and a big break for our customers. Chassis and parts are for 17" and 19" sets, all 1976 models. We haven't sorted through the entire lot as of press time and can not offer an entire package, but it looks like an entire Color 'TV' can be put together for around \$100.00. Parts to be added to build a complete set include: picture tube, yoke, purity magnets, antenna, controls, tuners and case. All chassis supplied with shop tech manual and all data we have available. 17" or 19" TV Chassis only \$29.50 each.*

19" TV Chassis 6Z60172 -or- 17" TV Chassis 6Z60173	.. \$29.50
UHF Tuner	.. 5MI00418 .. \$2.50
Telescope Antenna	.. 5MI00419 .. \$1.50
Binding Post Ass'y	.. 5MI00422 .. \$1.50
TV's Tech Manual	.. \$4.50
17" Quintri-In-Line Matrix Picture Tube 6Z60176	.. \$49.50



MUSE - MUSIC COMPUTER COMPOSER * * * * *
This compact digital computer uses the latest electronic technology to compose and create your own synthesized electronic music . . . It's ahead of it's time! Complete new packaged system with its own instruction booklet. List price was \$347.50, yours for only \$125.00. QTY. LTD. An outstanding, unique experience for the buyer. A Close-Out Bargain.
Sh. Wt. 15 Lbs. MUSE \$125.00

TOUCH TONE DATA PHONE * * * * *
Surplus computer touch-tone phones both new and used, sold as complete units or in parts. Buy now at a fraction of cost. Complete phone and touch-tone pad, head set, micro-circuit boards, logic and op amp power supply (+5V +12V), power cord and phone cord etc. Complete unit priced at \$25.00
Sh. Wt. 7 Lbs. 6MI60179 \$25.00
Phone Case with head set, touch-tone pad, base unit for your circuitry, build your own super terminal or whatever...
Sh. Wt. 5 Lbs. 6MI60180 \$17.50

B & F ENTERPRISES CHARGES WELCOME!
119 Foster Street Super-Large 120 page catalog of Peabody, Mass. 01960 fantastic bargains FREE with an order.
(617) 531-5774/532-2323 *All material F.O.B. Peabody, Ma.

CIRCLE NO. 12 ON FREE INFORMATION CARD

INTRODUCING

NEW **OZ IS . . .**

. . . A POLYTONIC (CHORDS) PITCH SOURCE, INTERFACE TO ANY SYNTHESIZER INCLUDING THE GNOME MICRO-SYNTHESIZER. . . ALONE IT'S A BATTERY POWERED MINI-ORGAN.

COMPLETE KIT \$84.95 Plus Shipping 12 lbs.

FREE CATALOG

P&H ELECTRONICS DEPT. 8-P
1020 WEST WILSHIRE BLVD.
OKLAHOMA CITY, OK 73116

33 ALTAIR 8800 Programs/Projects \$5.95 J. ROTH .543
16th Ave. San Fran, CA 94118 CA add 6.5% tax.

COLOR VIDEO RECORDER—\$325.00

Cartrivision Recorder all aligned and in top condition.
Parts, Service, Tape, Programs, Accessories, New Circuitry.
5 years experience with Cartrivision.
Update your Recorder with our New Products—Write:
Media Associates, 1470A N 4th St-Dept P.
San Jose, Ca. 95112 (408) 294-5450

LOOK! NE555V-\$0.39, 100/\$35; SN7447N-\$0.69; SN7475N-\$0.45; SN7490N-\$0.45; FND-503-\$1.29; MM5316N-\$2.69; 10 Jumbo red LEDS-\$0.99; Complete Clock Kit Specials: 4-Digit 1/2" Alarm-\$10.99; 6-Digit 1/2" Alarm Calendar-\$23.99. 5% P&H S.A.S.E. Brings Catalogue. Jeff, 3015 Eaton, Cleveland, OH 44122.

NEW LOGIC PROBE

Direct readout for logic families: TTL, RTL, DTL. Displays: Pulse, High, Low and Open. Complete kit: Housing, IC's, 7 seg. LED, Xtors and PC board.
P-22 PROBE \$19.95
Add \$1.25 for postage and handling
Calif. res. add 6 percent sales tax
J&F ELECTRONICS
8110 Colegio Dr., Los Angeles, CA 90045

PLANNING TO MOVE?

Let us know 8 weeks in advance so that you won't miss a single issue of **POPULAR ELECTRONICS**.

Attach old label where indicated and print new address in space provided. Also include your mailing label whenever you write concerning your subscription. It helps us serve you promptly.

Write to: P.O. Box 2774, Boulder, CO 80302, giving the following information:

Change address only Extend my subscription

ENTER NEW SUBSCRIPTION

1 year \$9.98 Payment enclosed (1 extra BONUS Issue) (1 extra BONUS Issue)
Allow 30-60 days for delivery. Bill me later

NEW ADDRESS HERE 0187

Name _____ please print
Address _____
City _____
State _____ Zip _____

Additional postage per year: For Canada add \$2. For countries outside U.S. and Canada, add \$3--cash in U.S. currency only.

AFFIX OLD LABEL

If you have no label handy, print OLD address here.

Name _____ please print
Address _____
City _____
State _____ Zip _____

Poly Pak's EXCLUSIVE Avg. Ship. \$1.98 Wt. 6 ozs.



YOUR CHOICE OF ANY KIT

100'S OF BARRELS PURCHASED! TEST 'EM YOURSELF 'N SAVE!

For the first time anywhere, Poly Pak merchandisers introduce a new way in buying the economical way. Raw stock from the "barrel". Remember the "good ole days"? They're back again. The same way merchandisers

throughout the United States buy from various factories... their overruns in barrels. Poly Pak has done the same. Therefore you are getting the same type of material as the RE-TESTERS DO!

Every kit carries a money back guarantee!

BARREL KIT #1 SN7400 DIP IC'S 75 for \$1.98 Marked 14 and/or with 16 pin dips, may include gates, registers, flip flops, counters. Who knew! GUARANTEED SATISFACTION! Cat.No. 8E 2415 Untested.	BARREL KIT #2 LINER OP AMPS, DIPS 75 for \$1.98 Untested May include 709's, 711's, 703's, 660 series, 555 includes marked and unmarked. Cat.No. 8E 2416	BARREL KIT #3 1N4148/914 SWITCHING DIODES 100 for \$1.98 You never saw this before. Imagine famous switching diodes at these prices! Cat.No. 8E 2418 Untested.	BARREL KIT #4 "4000" RECTIFIERS 100 for \$1.98 Untested. These are the famous micro miniature rectifiers of the 1N4000 series. May include 28, 10, 100, 20A, 400, 600, 800 and 1000 volters. Cat.No. 8E 2417	BARREL KIT #5 SCRS, TRIACS, QUADRACS 40 for \$1.98 All the famous plastic power tube type. Raw factory stock! All the 10 amp types. Cat.No. 8E 2419 Untested.	BARREL KIT #145 MINI TRANSFORMER 15 for \$1.98 Miniature transformer back again. Asst. outputs, inter. shielded audio. Only 1 sq. in. sq. Wt. 2 lbs. 8E 3294	BARREL KIT #147 OVER-FLC FLUORESCENT NIXIES 5 for \$1.98 Used originally in table top calculators. Brand new. No recharge type, color. Blue. Cat.No. 8E 3268
BARREL KIT #7 VOLUME CONTROL BONANZAI 40 for \$1.98 100% good Singles, duals, variety of values, styles, big ones, small ones. Cat.No. 8E 2421	BARREL KIT #8 SUBMINIATURE IF TRANSFORMERS 100 for \$1.98 Amazing, includes 455kcs, osc. antenna, who knows? From transistor radio manufacturers. Cat.No. 8E 2422	BARREL KIT #10 ROMS-REGISTERS 50 for \$1.98 Untested 2R to 40 pin devices, marked internal factory numbers, 10 Cat.No. 8E 2424	BARREL KIT #12 POWER TAB TRANSISTORS 40 for \$1.98 PNP, plastic 10220 type, assorted 2N numbers. Cat.No. 8E 2426 Untested.	BARREL KIT #13 RESISTOR NETWORKS 60 for \$1.98 Untested. By Corning Glass, in 14-pin dip packs. Cat.No. 8E 2427	BARREL KIT #154 CLOCK CHIPS 10 for \$1.98 We gathered an assortment of clock chip, alarm, calendar, beepers, who knows, all mixed. At these prices? Cat.No. 8E 3308	BARREL KIT #152 VOLUME CONTROLS 15 for \$1.98 Control maker discontinues line; dumps controls with switches at ridiculous prices. Cat.No. 8E 3306
BARREL KIT #14 PRECISION RESISTORS 200 for \$1.98 Marked and unmarked 1/2, 2 watts. No. 8E 2428	BARREL KIT #15 MOSFET TRANSISTORS 60 for \$1.98 All 4 lenders TO-18 case, includes UHF transistors too! Cat.No. 8E 2429	BARREL KIT #17 LINEAR & 7400 DIPS 100 for \$1.98 Untested Marked and unmarked, internal numbers of raw factory stock. Cat.No. 8E 2431	BARREL KIT #19 DIPPED MYLARS 60 for \$1.98 Finest capacitors made, shiny finish, imagine factory dumping 'em in barrels. Cat.No. 8E 2597 100% good.	BARREL KIT #20 LONG LEAD DISCS 150 for \$1.98 Factory distributor stock Prime, marked only. Long leads. Cat.No. 8E 2598 100% good	BARREL KIT #155 MOLDED CAPACITORS 75 for \$1.98 Assst. size voltages, red, green, yellow, blue plastic types, max. leads. No. 8E 3311	BARREL KIT #157 MOLEX CONNECTORS 75 for \$1.98 Nylon, white cable connectors, asst. factory over-run. NO PICKEE! Mixed in barrels. Cat.No. 8E 3324
BARREL KIT #30 PREFORMED RESISTORS 250 for \$1.98 We got barrels of 1/4 and 1/2 watt resistors for use. You'll get even amount, 100% 1/4, 100% 1/2 watters. Cat.No. 8E 2608 100% good	BARREL KIT #31 METALLIC RESISTORS 100 for \$1.98 Made mostly by Corning, the finest resistor made. Mostly 1/2 watters, 1% to 5% tol, & a barrel of values. Cat.No. 8E 2609	BARREL KIT #32 TRANSISTORS WITH A HOLE IN IT 50 for \$1.98 Cat.No. 8E 2610 Untested. Can't name factory but we bought barrels of 25 watters with mtg. hole in middle. PNP's and NPN's.	BARREL KIT #35 NEON LAMPS 40 for \$1.98 100% good. Famous NE-2's. All prime, but factory made millions and barrel'd 'em. Your advantage. Cat.No. 8E 2613	BARREL KIT #36 GERMANIUM DIODES 200 for \$1.98 Untested Famous maker, popular item. Never grows old. But this is the way the RE-TESTERS buy 'em from the factories. Cat.No. 8E 2614	BARREL KIT #158 MAGNIFIED MAN-3's 15 for \$1.98 Cosmetic rejects Famous style MAN-3, 7-seg readout, with built-on magnifier. Factory discontinued line. 100% material. Cat.No. 8E 3325	BARREL KIT #159 MODULAR SWITCHES 25 for \$1.98 Cosmetic rejects Centralab "push-ON" switches, TV-makers exclusive. Dpt., opt., etc. Brand new. Cat.No. 8E 3325
BARREL KIT #40 PNP HIGH-POWER TRANSISTORS 20 for \$1.98 Popular germanium TO-3 case units, now available at "good ole barrel" prices. Cat.No. 8E 2618 100% good.	BARREL KIT #46 G.E. 3.5 WATT AMPLIFIERS 25 for \$1.98 Untested. Hobby type, factory fallouts, we purchased them in barrels. These are unknowns. Cat.No. 8E 2624	BARREL KIT #50 SIGNAL SILICON DIODES 200 for \$1.98 Includes many, many types of switching, signal silicon types, all axial leads. Some may be zeners. Cat.No. 8E 2628 Untested.	BARREL KIT #53 JUMBO RESISTOR PAK 100-pc. \$1.98 Cat.No. 8E 2721 Assortment film, precision, carbons, metal oxide powders, from 1/2 watt to 7 watts, 1/2, 1, 2, 5, 10, 20, 50, 100, 200, 500, 1000 ohms, 100% good. Worth \$10.	BARREL KIT #58 SLIDE SWITCHES 30 for \$1.98 All shapes, sizes, spot, dptd, momentaries, etc. Tremendous dump, purchased from a prester, have millions of 100% good. Cat.No. 8E 2727	BARREL KIT #154 MAGNIFIED MAN-3's 15 for \$1.98 Cosmetic rejects Famous style MAN-3, 7-seg readout, with built-on magnifier. Factory discontinued line. 100% material. Cat.No. 8E 3325	BARREL KIT #159 MODULAR SWITCHES 25 for \$1.98 Cosmetic rejects Centralab "push-ON" switches, TV-makers exclusive. Dpt., opt., etc. Brand new. Cat.No. 8E 3325
BARREL KIT #61 POLYSTYRENE CAPS 100 for \$1.98 Finest caps made. As a gamble we bought 10 barrels from factory, mixed values; all good. Cat.No. 8E 2729	BARREL KIT #65 MIXED READOUTS 15 for \$1.98 Factory returns — such numbers as MAN-4's, MAN-7's, MAN-9's, 11 barrels & no time to separate. Cat.No. 8E 2733 Untested.	BARREL KIT #68 2 WATTERS 100 for \$1.98 100% good. Nobody seems to want 'em! So many suppliers don't count, but throw 'em in the barrel. It's a hit! gold mine. All marked. Cat.No. 8E 2735	BARREL KIT #71 CAPACITOR SPECIAL 100 pcs. \$1.98 Emptied stockpiles into barrels of mylars, poly's, mica, mullides, plastics, ceramic, discs, etc. Nifty. 100% good. Cat.No. 8E 2738	BARREL KIT #73 TRANSISTOR ELECTROS 50 for \$1.98 It "bugs" us why the factories dump 'em in barrels. We don't wish to separate wide ass't voltages & values up to 300 mf. Cat. 8E 2747	BARREL KIT #59 PNP TRANSISTORS 40 for \$1.98 15 watt Bendix B-5000 pellet transistors, npn, all 250, 300, 350, 400, 450, 500, 600, 700, 800, 900, 1000, 1500, 2000, 3000, 4000, 5000, 6000, 7000, 8000, 9000, 10000, 15000, 20000, 30000, 40000, 50000, 60000, 70000, 80000, 90000, 100000, 150000, 200000, 300000, 400000, 500000, 600000, 700000, 800000, 900000, 1000000, 1500000, 2000000, 3000000, 4000000, 5000000, 6000000, 7000000, 8000000, 9000000, 10000000, 15000000, 20000000, 30000000, 40000000, 50000000, 60000000, 70000000, 80000000, 90000000, 100000000, 150000000, 200000000, 300000000, 400000000, 500000000, 600000000, 700000000, 800000000, 900000000, 1000000000, 1500000000, 2000000000, 3000000000, 4000000000, 5000000000, 6000000000, 7000000000, 8000000000, 9000000000, 10000000000, 15000000000, 20000000000, 30000000000, 40000000000, 50000000000, 60000000000, 70000000000, 80000000000, 90000000000, 100000000000, 150000000000, 200000000000, 300000000000, 400000000000, 500000000000, 600000000000, 700000000000, 800000000000, 900000000000, 1000000000000, 1500000000000, 2000000000000, 3000000000000, 4000000000000, 5000000000000, 6000000000000, 7000000000000, 8000000000000, 9000000000000, 10000000000000, 15000000000000, 20000000000000, 30000000000000, 40000000000000, 50000000000000, 60000000000000, 70000000000000, 80000000000000, 90000000000000, 100000000000000, 150000000000000, 200000000000000, 300000000000000, 400000000000000, 500000000000000, 600000000000000, 700000000000000, 800000000000000, 900000000000000, 1000000000000000, 1500000000000000, 2000000000000000, 3000000000000000, 4000000000000000, 5000000000000000, 6000000000000000, 7000000000000000, 8000000000000000, 9000000000000000, 10000000000000000, 15000000000000000, 20000000000000000, 30000000000000000, 40000000000000000, 50000000000000000, 60000000000000000, 70000000000000000, 80000000000000000, 90000000000000000, 100000000000000000, 150000000000000000, 200000000000000000, 300000000000000000, 400000000000000000, 500000000000000000, 600000000000000000, 700000000000000000, 800000000000000000, 900000000000000000, 1000000000000000000, 1500000000000000000, 2000000000000000000, 3000000000000000000, 4000000000000000000, 5000000000000000000, 6000000000000000000, 7000000000000000000, 8000000000000000000, 9000000000000000000, 10000000000000000000, 15000000000000000000, 20000000000000000000, 30000000000000000000, 40000000000000000000, 50000000000000000000, 60000000000000000000, 70000000000000000000, 80000000000000000000, 90000000000000000000, 100000000000000000000, 150000000000000000000, 200000000000000000000, 300000000000000000000, 400000000000000000000, 500000000000000000000, 600000000000000000000, 700000000000000000000, 800000000000000000000, 900000000000000000000, 1000000000000000000000, 1500000000000000000000, 2000000000000000000000, 3000000000000000000000, 4000000000000000000000, 5000000000000000000000, 6000000000000000000000, 7000000000000000000000, 8000000000000000000000, 9000000000000000000000, 10000000000000000000000, 15000000000000000000000, 20000000000000000000000, 30000000000000000000000, 40000000000000000000000, 50000000000000000000000, 60000000000000000000000, 70000000000000000000000, 80000000000000000000000, 90000000000000000000000, 100000000000000000000000, 150000000000000000000000, 200000000000000000000000, 300000000000000000000000, 400000000000000000000000, 500000000000000000000000, 600000000000000000000000, 700000000000000000000000, 800000000000000000000000, 900000000000000000000000, 1000000000000000000000000, 1500000000000000000000000, 2000000000000000000000000, 3000000000000000000000000, 4000000000000000000000000, 5000000000000000000000000, 6000000000000000000000000, 7000000000000000000000000, 8000000000000000000000000, 9000000000000000000000000, 10000000000000000000000000, 15000000000000000000000000, 20000000000000000000000000, 30000000000000000000000000, 40000000000000000000000000, 50000000000000000000000000, 60000000000000000000000000, 70000000000000000000000000, 80000000000000000000000000, 90000000000000000000000000, 100000000000000000000000000, 150000000000000000000000000, 200000000000000000000000000, 300000000000000000000000000, 400000000000000000000000000, 500000000000000000000000000, 600000000000000000000000000, 700000000000000000000000000, 800000000000000000000000000, 900000000000000000000000000, 1000000000000000000000000000, 1500000000000000000000000000, 2000000000000000000000000000, 3000000000000000000000000000, 4000000000000000000000000000, 5000000000000000000000000000, 6000000000000000000000000000, 7000000000000000000000000000, 8000000000000000000000000000, 9000000000000000000000000000, 10000000000000000000000000000, 15000000000000000000000000000, 20000000000000000000000000000, 30000000000000000000000000000, 40000000000000000000000000000, 50000000000000000000000000000, 60000000000000000000000000000, 70000000000000000000000000000, 80000000000000000000000000000, 90000000000000000000000000000, 100000000000000000000000000000, 150000000000000000000000000000, 200000000000000000000000000000, 300000000000000000000000000000, 400000000000000000000000000000, 500000000000000000000000000000, 600000000000000000000000000000, 700000000000000000000000000000, 800000000000000000000000000000, 900000000000000000000000000000, 1000000000000000000000000000000, 1500000000000000000000000000000, 2000000000000000000000000000000, 3000000000000000000000000000000, 4000000000000000000000000000000, 5000000000000000000000000000000, 6000000000000000000000000000000, 7000000000000000000000000000000, 8000000000000000000000000000000, 9000000000000000000000000000000, 10000000000000000000000000000000, 15000000000000000000000000000000, 20000000000000000000000000000000, 30000000000000000000000000000000, 40000000000000000000000000000000, 50000000000000000000000000000000, 60000000000000000000000000000000, 70000000000000000000000000000000, 80000000000000000000000000000000, 90000000000000000000000000000000, 100000000000000000000000000000000, 150000000000000000000000000000000, 200000000000000000000000000000000, 300000000000000000000000000000000, 400000000000000000000000000000000, 500000000000000000000000000000000, 600000000000000000000000000000000, 700000000000000000000000000000000, 800000000000000000000000000000000, 900000000000000000000000000000000, 1000000000000000000000000000000000, 1500000000000000000000000000000000, 2000000000000000000000000000000000, 3000000000000000000000000000000000, 4000000000000000000000000000000000, 5000000000000000000000000000000000, 6000000000000000000000000000000000, 7000000000000000000000000000000000, 8000000000000000000000000000000000, 9000000000000000000000000000000000, 10000000000000000000000000000000000, 15000000000000000000000000000000000, 20000000000000000000000000000000000, 30000000000000000000000000000000000, 40000000000000000000000000000000000, 50000000000000000000000000000000000, 60000000000000000000000000000000000, 70000000000000000000000000000000000, 80000000000000000000000000000000000, 90000000000000000000000000000000000, 100000000000000000000000000000000000, 150000000000000000000000000000000000, 200000000000000000000000000000000000, 300000000000000000000000000000000000, 400000000000000000000000000000000000, 500000000000000000000000000000000000, 600000000000000000000000000000000000, 700000000000000000000000000000000000, 800000000000000000000000000000000000, 900000000000000000000000000000000000, 1000000000000000000000000000000000000, 1500000000000000000000000000000000000, 2000000000000000000000000000000000000, 3000000000000000000000000000000000000, 4000000000000000000000000000000000000, 5000000000000000000000000000000000000, 6000000000000000000000000000000000000, 7000000000000000000000000000000000000, 8000000000000000000000000000000000000, 9000000000000000000000000000000000000, 10000000000000000000000000000000000000, 15000000000000000000000000000000000000, 20000000000000000000000000000000000000, 3000000000	

SEND FOR OUR FLYER

Godbout

Bill Godbout Electronics
Box 2355, Oakland Airport, CA 94614

Specials for Musicians

Headset \$9.95

Computer \$49.95

SEND FOR OUR FLYER

Circle No. 32 on Free Information Card

NEW

Wafers are meant to be inserted in a .063" maximum thickness board and have .043" diameter pins on .156" centers.

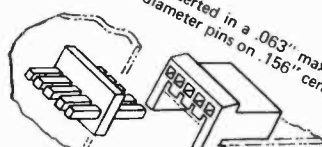

CATALOG NUMBER	DESCRIPTION	1-10	11-99
13-0001	12 pos. rt. angle connector	60	.50
13-0002	12 position wafer	60	.50
13-0003	9 pos. rt. angle connector	60	.50

QUALITY ELECTRONIC COMPONENTS

NEW DISCOUNT SCHEDULE SAVES YOU EVEN MORE!

AMD 8080A \$34.95 2102-1 \$1.99

MICROPROCESSOR 1024 Bit Random Access Memory
0-70°C 480 ns Clock Period 500 ns Max Access Time

INTEGRATED CIRCUITS - TTL, CMOS, LINEAR & MOS

7400	.21	7473	.30	4174	.98	4001	.23	4073	.23
7401	.21	7474	.30	74175	.93	4002	.23	4075	.23
7402	.21	7475	.49	74176	.79	4003	.23	4081	.23
7403	.21	7476	.32	74177	.79	4007	.23	4082	.23
7404	.21	7480	.70	74180	.70	4008	.79	4008	.79
7405	.21	7482	.70	74181	2.15	4009	.44	4510	1.14
7406	.25	7483	.70	74182	.79	4010	.44	4511	1.05
7407	.25	7485	.89	74184	2.19	4011	.23		
7408	.21	7486	.28	74185	2.19	4012	.23		
7409	.21	7489	2.19	74186	.79	4013	.40	4516	1.23
7410	.21	7490	.44	74189	3.50	4014	.26	4518	1.14
7411	.21	7491	.70	74190	1.23	4015	.96	4520	1.14
7412	.21	7492	.44	74191	1.23	4016	.40		
7413	.25	7493	.44	74192	.88	4017	1.05	4528	.88
7414	.89	7494	.70	74193	.88	4018	1.05		
7416	.25	7495	.70	74194	.88	4019	.23	LM309K	1.80
7417	.25	7496	.70	74195	.88	4020	1.14	LM324N	1.28
7418	.25	7497	.70	74196	.88	4021	1.14	LM340T-5	.85
7421	.25	74107	.30	74197	.88	4022	.96	LM340T-6	1.25
7423	.35	74109	.33	74198	.49	4023	.23	LM340T-8	1.25
7425	.35	74121	.33	74199	1.49	4024	.84	LM340T-12	1.25
7426	.35	74122	.33	74201	.25	4025	.23	LM340T-12	1.25
7427	.35	74123	.61	74279	.58	4026	1.68	LM340T-18	1.25
7428	.28	74125	.40	74365	.67	4027	.40	LM340T-24	1.25
7430	.21	74126	.40	74366	.67	4028	.89	LM3900N	.38
7432	.25	74132	.70	74367	.67	4029	1.14	NE567	3.24
7433	.30	74141	.88	74368	.67	4030	.23	NE540L	2.04
7437	.25	74145	.70	75150	1.31	4033	1.51	NE555V	.48
7438	.25	74147	1.63	75450	.88	4034	3.30	NE556A	.88
7440	.21	74148	1.30	75451	.61	4035	1.14	NE560B	3.83
7442	.53	74150	1.16	75452	.61	4040	1.14	NE561B	3.83
7443	.63	74151	.70	75453	.61	4041	.79	NE562V	1.28
7444	.70	74152	.70	75454	.61	4042	.79	NE566V	1.28
7447	.70	74157	.70	75492	.84	4043	.70	NE567V	1.36
7448	.70	74160	.88	75493	1.09	4044	.70	uA709CV	.44
7450	.21	74161	.88	75494	1.19	4049	.40	uA710CA	.44
7452	.21	74162	.88	8093	.40	4050	.40	uA711CA	.53
7454	.21	74163	.88	8095	.67	4052	1.28	uA722CA	.60
7460	.21	74164	.96	8096	.67	4053	.72	uA747CA	.70
7473	.30	74166	1.26	8097	.67	4057	.79	uA748CV	.49
7474	.30	74167	1.63	8098	.67	4058	.79	HC1458	3.13
7475	.30	74168	1.63	82525	2.19	4071	.23	2102-1	1.99
7476	.30	74173	1.42	4000	.23	4072	.23	8080A	34.95

AP SUPER STRIP II—Universal Breadboarding

Element with 840 Solderless Plug-in Tie-Points

\$17.00

IC TEST CLIPS

14 pin TC-14 \$4.50
16 pin TC-16 \$4.75
24 pin TC-24 \$13.85

photo ACE 201K

CMOS DATABOOK \$1.50

Specifications and pin-outs for 80 different 4000 series parts

SPECIAL! 1000 Molex IC terminals for \$7.50 2000 for \$13.50

SPECIAL! Motorola 741 Mini Dip 35¢—10 for \$3.00

LINEAR

ELECTROLYTIC CAPACITORS

PLEASE ORDER IN MULTIPLES OF 5 PER ITEM

WVDC	WORKING (uF)	VOLTS DC	\$
10	16, 35, 50	16	
20	16, 35, 50	16	
30	16	16	
50	16, 35	22	
100	16, 35, 50	25	
200	16	25	
500	16	34	
1000	16	52	
2200	16	80	

Specify ONE

NE501A 2.80
NE555A .50
A710CA .60
A741V .40
A747CA 1.10
A748CV .74
A723CA 1.00
MC1468L 3.90

Red Led & Mtg. Hardware
T-1-3/4
1-10 11-100
35 .29

MINIATURE FILM CAPACITORS

VALUE (uF)	1-14	15-50	51-100
.001	.10	.10	.08
.0047	.10	.10	.08
.01	.10	.10	.08
.05	.19	.17	.15
1	.20	.18	.16
.22	.25	.23	.21

These units are made by International Components Corp. All units 100% V.

FIXED POWER SUPPLY KITS

Specifications:	F0510	F3120	F5150
Input Voltage (50 500Hz)	105 125v	105 125v	110 125v
Output Voltage	5v ± 5%	12v ± 5%	15v ± 5%
Output Current (T _a = 25°C)	1.5A Max.	1.5A Max.	1.1A Max.

PRICE \$14.00 \$14.50 \$14.50

INCLUDES SHORT CIRCUIT PROTECTION. Price includes Pre-fitted G-10 Board, All Parts and Transformer.

DISPLAY BEZELS

CATALOG NUMBER	FILTER COLOR	PRICE 1-24	DIMENSION C
805-80	Red	\$2.75	1.37
810-80	Red	2.80	2.00
815-80	Red	3.00	3.00
920-80	Red	2.90	4.00
920-70	Amber	2.95	4.00

These bezels are heat resistant plastic with a black matte finish. Filters are circular polarized type.

BISHOP GRAPHICS Printed Circuit Drafting

Aids are now available from Digi-Key

DATA BOOKS

TTL IC's - 592 pages . . . \$4.00
INTERFACE IC's - 464 pages \$4.00
LINEAR IC's - 704 pages . . . \$4.00
VOLTAGE REGULATORS - 128 pages . . . \$3.00
CMOS IC's - 256 pages . . . \$3.00
LINEAR APPLICATIONS - 432 pages . . . \$4.00
TRANSISTORS - 288 pages . . . \$3.00
MEMORY IC's - 592 pages . . . \$3.00

REED RELAYS

1.5 Amp SPST N.O. Contacts

4.8v Coil	\$1.70	\$125/C
6.0v Coil	\$1.70	\$125/C
12v Coil	\$1.70	\$125/C
24v Coil	\$1.70	\$125/C

1/4 WATT 5% CARBON FILM RESISTORS

See each in multiples of 5 per value
\$1.70/100 of same value. 10 ohm to 1.0 meg

SILICON TRANSISTORS

MPS918, MPS930, MPS2222A, MPS2369A, MPS2712, MPS2907A, MPS3392, MPS3393, MPS3394, MPS3395, MPS3396, MPS3397, MPS3398, MPS3399, MPS3400, MPS3401, MPS3402, MPS3403, MPS3404, MPS3405, MPS3406, MPS3407, MPS3408, MPS3409, MPS3410, MPS3411, MPS3412, MPS3413, MPS3414, MPS3415, MPS3416, MPS3417, MPS3418, MPS3419, MPS3420, MPS3421, MPS3422, MPS3423, MPS3424, MPS3425, MPS3426, MPS3427, MPS3428, MPS3429, MPS3430, MPS3431, MPS3432, MPS3433, MPS3434, MPS3435, MPS3436, MPS3437, MPS3438, MPS3439, MPS3440, MPS3441, MPS3442, MPS3443, MPS3444, MPS3445, MPS3446, MPS3447, MPS3448, MPS3449, MPS3450, MPS3451, MPS3452, MPS3453, MPS3454, MPS3455, MPS3456, MPS3457, MPS3458, MPS3459, MPS3460, MPS3461, MPS3462, MPS3463, MPS3464, MPS3465, MPS3466, MPS3467, MPS3468, MPS3469, MPS3470, MPS3471, MPS3472, MPS3473, MPS3474, MPS3475, MPS3476, MPS3477, MPS3478, MPS3479, MPS3480, MPS3481, MPS3482, MPS3483, MPS3484, MPS3485, MPS3486, MPS3487, MPS3488, MPS3489, MPS3490, MPS3491, MPS3492, MPS3493, MPS3494, MPS3495, MPS3496, MPS3497, MPS3498, MPS3499, MPS3500, MPS3501, MPS3502, MPS3503, MPS3504, MPS3505, MPS3506, MPS3507, MPS3508, MPS3509, MPS3510, MPS3511, MPS3512, MPS3513, MPS3514, MPS3515, MPS3516, MPS3517, MPS3518, MPS3519, MPS3520, MPS3521, MPS3522, MPS3523, MPS3524, MPS3525, MPS3526, MPS3527, MPS3528, MPS3529, MPS3530, MPS3531, MPS3532, MPS3533, MPS3534, MPS3535, MPS3536, MPS3537, MPS3538, MPS3539, MPS3540, MPS3541, MPS3542, MPS3543, MPS3544, MPS3545, MPS3546, MPS3547, MPS3548, MPS3549, MPS3550, MPS3551, MPS3552, MPS3553, MPS3554, MPS3555, MPS3556, MPS3557, MPS3558, MPS3559, MPS3560, MPS3561, MPS3562, MPS3563, MPS3564, MPS3565, MPS3566, MPS3567, MPS3568, MPS3569, MPS3570, MPS3571, MPS3572, MPS3573, MPS3574, MPS3575, MPS3576, MPS3577, MPS3578, MPS3579, MPS3580, MPS3581, MPS3582, MPS3583, MPS3584, MPS3585, MPS3586, MPS3587, MPS3588, MPS3589, MPS3590, MPS3591, MPS3592, MPS3593, MPS3594, MPS3595, MPS3596, MPS3597, MPS3598, MPS3599, MPS3600, MPS3601, MPS3602, MPS3603, MPS3604, MPS3605, MPS3606, MPS3607, MPS3608, MPS3609, MPS3610, MPS3611, MPS3612, MPS3613, MPS3614, MPS3615, MPS3616, MPS3617, MPS3618, MPS3619, MPS3620, MPS3621, MPS3622, MPS3623, MPS3624, MPS3625, MPS3626, MPS3627, MPS3628, MPS3629, MPS3630, MPS3631, MPS3632, MPS3633, MPS3634, MPS3635, MPS3636, MPS3637, MPS3638, MPS3639, MPS3640, MPS3641, MPS3642, MPS3643, MPS3644, MPS3645, MPS3646, MPS3647, MPS3648, MPS3649, MPS3650, MPS3651, MPS3652, MPS3653, MPS3654, MPS3655, MPS3656, MPS3657, MPS3658, MPS3659, MPS3660, MPS3661, MPS3662, MPS3663, MPS3664, MPS3665, MPS3666, MPS3667, MPS3668, MPS3669, MPS3670, MPS3671, MPS3672, MPS3673, MPS3674, MPS3675, MPS3676, MPS3677, MPS3678, MPS3679, MPS3680, MPS3681, MPS3682, MPS3683, MPS3684, MPS3685, MPS3686, MPS3687, MPS3688, MPS3689, MPS3690, MPS3691, MPS3692, MPS3693, MPS3694, MPS3695, MPS3696, MPS3697, MPS3698, MPS3699, MPS3700, MPS3701, MPS3702, MPS3703, MPS3704, MPS3705, MPS3706, MPS3707, MPS3708, MPS3709, MPS3710, MPS3711, MPS3712, MPS3713, MPS3714, MPS3715, MPS3716, MPS3717, MPS3718, MPS3719, MPS3720, MPS3721, MPS3722, MPS3723, MPS3724, MPS3725, MPS3726, MPS3727, MPS3728, MPS3729, MPS3730, MPS3731, MPS3732, MPS3733, MPS3734, MPS3735, MPS3736, MPS3737, MPS3738, MPS3739, MPS3740, MPS3741, MPS3742, MPS3743, MPS3744, MPS3745, MPS3746, MPS3747, MPS3748, MPS3749, MPS3750, MPS3751, MPS3752, MPS3753, MPS3754, MPS3755, MPS3756, MPS3757, MPS3758, MPS3759, MPS3760, MPS3761, MPS3762, MPS3763, MPS3764, MPS3765, MPS3766, MPS3767, MPS3768, MPS3769, MPS3770, MPS3771, MPS3772, MPS3773, MPS3774, MPS3775, MPS3776, MPS3777, MPS3778, MPS3779, MPS3780, MPS3781, MPS3782, MPS3783, MPS3784, MPS3785, MPS3786, MPS3787, MPS3788, MPS3789, MPS3790, MPS3791, MPS3792, MPS3793, MPS3794, MPS3795, MPS3796, MPS3797, MPS3798, MPS3799, MPS3800, MPS3801, MPS3802, MPS3803, MPS3804, MPS3805, MPS3806, MPS3807, MPS3808, MPS3809, MPS3810, MPS3811, MPS3812, MPS3813, MPS3814, MPS3815, MPS3816, MPS3817, MPS3818, MPS3819, MPS3820, MPS3821, MPS3822, MPS3823, MPS3824, MPS3825, MPS3826, MPS3827, MPS3828, MPS3829, MPS3830, MPS3831, MPS3832, MPS3833, MPS3834, MPS3835, MPS3836, MPS3837, MPS3838, MPS3839, MPS3840, MPS3841, MPS3842, MPS3843, MPS3844, MPS3845, MPS3846, MPS3847, MPS3848, MPS3849, MPS3850, MPS3851, MPS3852, MPS3853, MPS3854, MPS3855, MPS3856, MPS3857, MPS3858, MPS3859, MPS3860, MPS3861, MPS3862, MPS3863, MPS3864, MPS3865, MPS3866, MPS3867, MPS3868, MPS3869, MPS3870, MPS3871, MPS3872, MPS3873, MPS3874, MPS3875, MPS3876, MPS3877, MPS3878, MPS3879, MPS3880, MPS3881, MPS3882, MPS3883, MPS3884, MPS3885, MPS3886, MPS3887, MPS3888, MPS3889, MPS3890, MPS3891, MPS3892, MPS3893, MPS3894, MPS3895, MPS3896, MPS3897, MPS3898, MPS3899, MPS3900, MPS3901, MPS3902, MPS3903, MPS3904, MPS3905, MPS3906, MPS3907, MPS3908, MPS3909, MPS3910, MPS3911, MPS3912, MPS3913, MPS3914, MPS3915, MPS3916, MPS3917, MPS3918, MPS3919, MPS3920, MPS3921, MPS3922, MPS3923, MPS3924, MPS3925, MPS3926, MPS3927, MPS3928, MPS3929, MPS3930, MPS3931, MPS3932, MPS3933, MPS3934, MPS3935, MPS3936, MPS3937, MPS3938, MPS3939, MPS3940, MPS3941, MPS3942, MPS3943, MPS3944, MPS3945, MPS3946, MPS3947, MPS3948, MPS3949, MPS3950, MPS3951, MPS3952, MPS3953, MPS3954, MPS3955, MPS3956, MPS3957, MPS3958, MPS3959, MPS3960, MPS3961, MPS3962, MPS3963, MPS3964, MPS3965, MPS3966, MPS3967, MPS3968, MPS3969, MPS3970, MPS3971, MPS3972, MPS3973, MPS3974, MPS3975, MPS3976, MPS3977, MPS3978, MPS3979, MPS3980, MPS3981, MPS3982, MPS3983, MPS3984, MPS3985, MPS3986, MPS3987, MPS3988, MPS3989, MPS3990, MPS3991, MPS3992, MPS3993, MPS3994, MPS3995, MPS3996, MPS3997, MPS3998, MPS3999, MPS4000, MPS4001, MPS4002, MPS4003, MPS4004, MPS4005, MPS4006, MPS4007, MPS4008, MPS4009, MPS4010, MPS4011, MPS4012, MPS4013, MPS4014, MPS4015, MPS4016, MPS4017, MPS4018, MPS4019, MPS4020, MPS4021, MPS4022, MPS4023, MPS4024, MPS4025, MPS4026, MPS4027, MPS4028, MPS4029, MPS4030, MPS4031, MPS4032, MPS4033, MPS4034, MPS4035, MPS4036, MPS4037, MPS4038, MPS4039, MPS4040, MPS4041, MPS4042, MPS4043, MPS4044, MPS4045, MPS4046, MPS4047, MPS4048, MPS4049, MPS4050, MPS4051, MPS4052, MPS4053, MPS4054, MPS4055, MPS4056, MPS4057, MPS4058, MPS4059, MPS4060, MPS4061, MPS4062, MPS4063, MPS4064, MPS4065, MPS4066, MPS4067, MPS4068, MPS4069, MPS4070, MPS4071, MPS4072, MPS4073, MPS4074, MPS4075, MPS4076, MPS4077, MPS4078, MPS4079, MPS4080, MPS4081, MPS4082, MPS4083, MPS4084, MPS4085, MPS4086, MPS4087, MPS4088, MPS4089, MPS4090, MPS4091, MPS4092, MPS4093, MPS4094, MPS4095, MPS4096, MPS4097, MPS4098, MPS4099, MPS4100, MPS4101, MPS4102, MPS4103, MPS4104, MPS4105, MPS4106, MPS4107, MPS4108, MPS4109, MPS4110, MPS4111, MPS4112, MPS4113, MPS4114, MPS4115, MPS4116, MPS4117, MPS4118, MPS4119, MPS4120, MPS4121, MPS4122, MPS4123, MPS4124, MPS4125, MPS4126, MPS4127, MPS4128, MPS4129, MPS4130, MPS4131, MPS4132, MPS4133, MPS4134, MPS4135, MPS4136, MPS4137, MPS4138, MPS4139, MPS4140, MPS4141, MPS4142, MPS4143, MPS4144, MPS4145, MPS4146, MPS4147, MPS4148, MPS4149, MPS4150, MPS4151, MPS4152, MPS4153, MPS4154, MPS4155, MPS4156, MPS4157, MPS4158, MPS4159, MPS4160, MPS4161, MPS4162, MPS4163, MPS4164, MPS4165, MPS4166, MPS4167, MPS4168, MPS4169, MPS4170, MPS4171, MPS4172, MPS4173, MPS4174, MPS4175, MPS4176, MPS4177, MPS4178, MPS4179, MPS4180, MPS4181, MPS4182, MPS4183, MPS4184, MPS4185, MPS4186, MPS4187, MPS4188, MPS4189, MPS4190, MPS4191, MPS4192, MPS4193, MPS4194, MPS4195, MPS4196, MPS4197, MPS4198, MPS4199, MPS4200, MPS4201, MPS4202, MPS4203, MPS4204, MPS4205, MPS4206, MPS4207, MPS4208, MPS4209, MPS4210, MPS4211, MPS4212, MPS4213, MPS4214, MPS4215, MPS4216, MPS4217, MPS4218, MPS4219, MPS4220, MPS4221, MPS4222, MPS4223, MPS4224, MPS4225, MPS4226, MPS4227, MPS4228, MPS4229, MPS4230, MPS4231, MPS4232, MPS4233, MPS4234, MPS4235, MPS4236, MPS4237, MPS4238, MPS4239, MPS4240, MPS4241, MPS

S. D. SALES CO.

P. O. BOX 28810 DALLAS, TEXAS 75228

ALARM CLOCK KIT SIX DIGIT LED

Thousands of hobbyists have bought and built our original clock kit and were completely satisfied. But we have received many requests for an alarm clock kit with the same value and quality that you have come to expect from S.D. So, here it is!

THE KIT INCLUDES:

- 1 Mostek 50252 Alarm Clock Chip
- 6 Hewlett Packard .30 in. common cathode readouts.
- 15 NPN Driver Transistors
- 2 Switches for time set
- 2 Slide Switches for alarm set and enable
- 1 Filter Cap
- 4 IN4002 Rectifiers
- 1 IN914 Diode
- 1 .01 Disc Cap
- 15 Resistors
- 1 Speaker for alarm
- 1 LED lamp for PM indicator.

\$9.95

PCB - 3.00

XFMR - 1.50

60 Hz. Crystal Time Base

FOR DIGITAL CLOCKS **\$5.95**
S. D. SALES EXCLUSIVE!

KIT FEATURES:

- A. 60 Hz output with accuracy comparable to a digital watch.
- B. Directly interfaces with all MOS clock chips.
- C. Super low power consumption (1.5 Ma typ.)
- D. Uses latest MOS 17 stage divider IC.
- E. Eliminates forever the problem of AC line glitches.
- F. Perfect for cars, boats, campers, or even for portable clocks at ham field days.
- G. Small size, can be used in existing enclosures.

BUY TWO FOR \$10.00

Kit includes crystal, divider IC, P.C. Board plus all other necessary parts and specs.

MOS 4 DIGIT COUNTER IC

All in one 28 PIN DIP. 4 Decade counters, latches, MUX circuits, display decoders, etc. Features: 5VDC operation, 25 MW power consumption, BOTH 7 segment and BCD outputs. Perfect for DVM's, frequency meters, tach's, etc. Can be cascaded for more digits. #5002 - \$8.95.

8008-1 MICRO PROCESSOR

New Units. High speed 8008. Almost twice as fast as units sold by others. Still a very versatile and widely used MPU. No data book, only pinout data included at this price. \$12.50 LIMITED QTY.

1101 A RAM IC

256 X 1 BITS. Perfect for 8008 or small systems such as telephone dials that do not require a lot of memory. Special 59c. 8 FOR \$4.

C & K MINI TOGGLE SWITCH

#7103 SUB MINI SPDT Center OFF. Special - 99c.

TTL INTEGRATED CIRCUITS

7400 - 19c	7430 - 19c	7476 - 35c	74153 - 75c
7402 - 19c	7432 - 34c	7480 - 49c	74154 - 1.00
74L04 - 29c	7437 - 39c	7483 - 95c	74157 - 75c
74S04 - 44c	7438 - 39c	7485 - 95c	74161 - 95c
7404 - 19c	7440 - 19c	7486 - 45c	74164 - 1.10
7406 - 29c	7447 - 85c	7490 - 65c	74165 - 1.10
7408 - 19c	7448 - 85c	7492 - 75c	74174 - 95c
7410 - 19c	7451 - 19c	7495 - 75c	74181 - 2.50
7411 - 29c	7453 - 19c	7496 - 89c	74191 - 1.25
7413 - 50c	7473 - 39c	74121 - 38c	74192 - 1.25
7420 - 19c	7474 - 35c	74123 - 65c	74193 - 1.00
	7475 - 69c	74141 - 75c	74195 - 69c

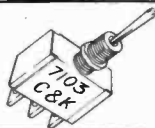

MOTOROLA POWER DARLINGTON - \$1.99

BACK IN STOCK!
Like MJ30C1. NPN 80 V., 10A., HFE 6000 TYP. TO-3 case. We include a free 723C volt. reg. with schematic for a power supply. SPECIAL - \$1.99

MOTOROLA RTL IC'S

Brand new, factory prime. Hard to find, but still used in a variety of projects. (See the RTL Cookbook by Howard W. Sams.)

MC724P-59c	MC780P-89c	MC791P-69c
MC725P-59c	MC785P-49c	MC792P-59c
MC764P-49c	MC787P-89c	MC799P-59c
MC767P-69c	MC788P-49c	MC9704P-89c
MC771P-49c	MC789P-59c	MC9709P-69c
MC775P-89c	MC790P-89c	MC9760P-69c

MV-50 TYPE LED'S

by LITRONIX
10 for \$1
Factory Prime!

3 DIGIT LED ARRAY - 75c

by LITRONIX
DL33MMB. 3 MAN-3 Size Readouts in one package. These are factory prime, not retested rejects as sold by others. compare this price! 75c 3 for \$2.



SALE ON CUT LEAD SEMICONDUCTORS

Leads were cut for PCB insertion. Still very useable.

1N914/1N4148	100/\$2
1N4002 1 Amp 100 PIV	40/\$1
1N4745A 16V 1W Zener	20/\$1
EN2222 NPN Transistor	25/\$1
EN2907 PNP Transistor	25/\$1
2N3904 NPN Driver Xstr.	25/\$1
2N3392 GE Pre-amp Xstr.	25/\$1
C103Y SCR. 800MA. 60V.	10/\$1

ALL NEW.
UNUSED.
SOME ARE
HOUSE #

SLIDE SWITCH ASSORTMENT

Our best seller. Includes miniature and standard sizes, single and multi-position units. All new, first quality, name brand switches. Try one package and you'll reorder more. Special - 12 for \$1 (Assortment)



DISC CAP ASSORTMENT

PC leads. At least 10 different values: Includes .001, .01, .05, plus other standard values.
60 FOR \$1



UPRIGHT ELECTROLYTIC CAPS

47 mfd 35 V-10/\$1 68 mfd 25V-8/\$1
Brand new by Sprague. PC leads.

RESISTOR ASSORTMENT

1/4 W 5% and 10%. PC leads.
A good mix of values. 200/\$2



1000 MFD FILTER CAPS

Rated 35 WVDC. Upright style with P.C. leads. Most popular value for hobbyists. Compare at up to \$1.19 each from franchise type electronic parts stores. S.D. Special 4 for \$1



FAIRCHILD BIG LED READOUTS

A big .50 Inch easy to read character. Now available in either common anode or common cathode. Take your pick. Super low current drain, only 5 MA per segment typical.

FND - 510	Common Anode	YOUR CHOICE \$1.50 ea. 6 for \$7.50
FND - 503	Common Cathode	

DUAL 741C (5558) OP AMPS

Mini dip. New house numbered units by RAYTHEON.
4 FOR \$1

FET'S BY TEXAS INSTRUMENTS - SPECIAL 5 for \$1

#TIS-75 but with an internal house number. TO-92 plastic case. N. Channel, Junction type FET.

We do not sell junk. Money back guarantee on every item. No C.O.D. Texas Res. add 5% tax. Postage rates went up 40%! Please add 5% of your total order to help cover shipping.

S. D. SALES CO.

P.O. BOX 28810
DALLAS, TEXAS 75228

ORDERS UNDER \$10
ADD 75c HANDLING.

T - - K - - -
- - - - -

ORDERS OVER \$15 CHOOSE \$1 FREE MERCHANDISE

FOREIGN ORDERS MUST BE PAID IN U.S. FUNDS

Spring-Pac super SALE! Each pac only \$1.98

All pacs are first quality (no fallout), tested and guaranteed.

Memory pac 4 MM5016 MOS TO-5 512 BIT shift registers from NATIONAL - with data \$1.98	Flip-Flop pac 10 assorted Flip-Flops, Dual JK's, 6ST's, and Low power FF's, with data \$1.98	Comparator pac 5 assorted DIP's-- LM311, 710, 711, with data \$1.98	TTL 7400 \$.20 74H00 .25 7401 .14 74H01 .25 7402 .25 7404 .25 74H04 .30 7405 .30 7406 .40 7408 .30 7410 .12 7413 .75 7417 .40 7420 .12 74L20 .25 74H20 .18 7430 .10 74H30 .30 74L30 .30 7440 .10 74H40 .22 7442 1.00 7447 1.50 7450 .10 74H50 .30 7451 .10 74H51 .25 7453 .10 74L54 .25 74L55 .25 7460 .15 74L71 .20 7472 .40 74L72 .60 7473 .35 74L73 .75 7474 .45 74H74 .75 7475 .80 7476 .35 74L78 .70 7480 .50 7483 .70 7485 2.00 7490 .70 7492 .35 7493 1.00 7495 .65 74L95 1.00 74L97 .25 74L123 .75 74L145 1.25 74L155 .90 74L174 1.00 74L180 1.00 74L192 1.00 74L193 1.00 75492 1.00
TTL Gates 15 assorted DIP's 7400 series-7420, 7430, 7440, etc... All prime, marked parts, with data \$1.98	LED pac 10 assorted discrete LED's-green, red, and infra-red, with data. \$1.98	Transistor pac 40 assorted TO-92 plastic transistors-- PNP's and NPN's, mostly Fairchild house marked. \$1.98	
Regulators 4 LM723 DIP variable regulators, 2-6V, with data \$1.98	100 Diodes 100 Germanium computer signal diodes with leads trimmed for PCB mounting. \$1.98	100 Resistors 1/4 watt 5% resistors of any single standard value from 2.7 ohm to 1M ohm \$1.98	
Linear pac 8 assorted linears in mini-DIP or TO-5/741 op amp, LM307 op amp, LM 703 RF-IF amp, with data and circuits \$1.98	DIP RC Network 50 assorted 14 and 16 pin IC packages containing precision resistors and capacitors-no data available \$1.98	Switches 8 SPST momentary contact push button N.O. Red button fits in approx. 1/4" panel, with lock washer and mounting nut. \$1.98	
LED Display pac 2 DL33 - 3 digits each, approximately .1" magnified digits in a 12 pin DIP, with data \$1.98	Buy 5 pacs for \$9.90 and pic-a-pac for 10c	The above are special offerings from Babylon Electronics, and will be shipped third class. See bottom of ad for ordering instructions.	
3 Amp Power Silicon Rectifiers MARKED AXIAL PACKAGE PKV EACH PRV EACH 50 \$.08 600 \$.24 100 .13 700 .27 200 .15 800 .30 300 .18 900 .40 400 .20 1000 .50 500 .22 1200 .60 1400 \$.70	POTTER BRUMFIELD Type KHP Relay 4 PDT 3A Contacts 24V DC . \$1.50 (650 coil) 120V AC . \$1.75 (10.5 MA coil)	Memories 93410-256x1 RAM, fully decoded, high speed (40 ns) open collector output. 16 pin DIP with data. \$1.75 each 10 for \$14.95	
Capacitors PCB vertical mount electrolytic capacitors, 2" long, 3/4" dia. 59c ea. 10 for \$5.00	Mail orders to: P.O. Box 41778 Sacramento, CA 95841 Phone (916) 334-2161 TWX # 910-367-3521	BABYLON ELECTRONICS All IC's are new and fully tested. Leads are plated with gold or solder. Due to increased costs, orders under \$7.00 add \$1.00 postage and handling. Residents of California add sales tax. Orders shipped promptly. \$10 minimum order on C.O.D.'s.	



DELTA ELECTRONICS CO.

P.O. BOX 2, AMESBURY, MASS. 01913

PC BOARDS

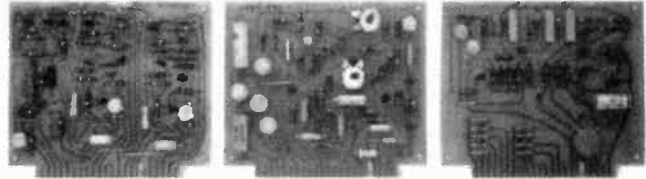

This set of boards has a wealth of small parts useful for many projects. The boards have 32 transistors, including 6 complimentary pairs and a UJT, 6 zener diodes (5.6v, 2 6.8v, 8.2v, 12v, 15v), and 33 rectifier diodes, 100v to 600v, 1 amp to 3 amp ratings. Also 3 trimpots, a Varistor, and many resistors and various caps, 2 SCRs.

STOCK NO. P5398 2 lbs. 3 board set \$3.00, 3 sets/\$8.00

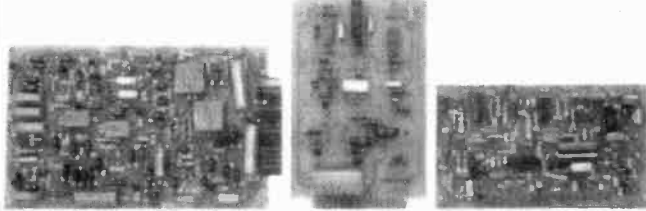

Another board set with many good linear parts. Has (5) 741 and (1) 709 op-amps in DIP packages, 19 transistors including 6 complimentary pairs, 31 diodes (rectifier, switching, & zeners), 5 multi-turn trimmers, and many good electrolytics, precision resistors, 1/4 & 1/2W resistors, etc.

STOCK NO. P5399 2 lbs. 3 board set \$4.00, 3 sets/\$11.00

Send for our free catalog. Phone orders welcome. MASTERCHARGE & BANKAMERICARD accepted. ALL numbers must be included to process order. Minimum order \$5. Include sufficient postage; excess will be refunded.

Phone (617) 388-4705

CIRCLE NO. 18 ON FREE INFORMATION CARD

MSI

Wise move

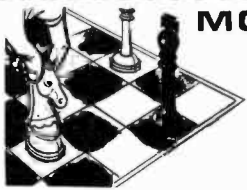

MODULAR SCIENTIFIC INSTRUMENTATION

Now you can build some of the most advanced digital electronic instruments with our new series of low-cost modular scientific kits. These kits will expand the range of your electronic applications enormously-and all at a surprisingly low cost.

The heart of the system is our 4-digit Decade Counter (Kit 012) which features a full 4-digit LED readout (you choose the size best suited to your application). Combine this with a 5-volt regulated power supply (Kit 030) and you have the basis of a wide range of sophisticated electronic instruments, including:

- A Digital Voltmeter (DVM) .. Kit 012 + Kit 030 + Kit 017
- Frequency Counter..... Kit 012 + Kit 030 + Kit 016 +Time Base
- RPM Counter..... Kit 012 + Kit 030 + Kit 020 + Kit 018

TIME BASES

1 Mhz crystal chain time base divider. Outputs: 1Mhz-100Khz-10Khz-1Khz-100Hz-10Hz-1Hz-0.1Hz. Accuracy better than .005% with proper adjustment.

Kit 013 complete CMOS with PC board \$15.75
Buffer Circuit for TTL Interfacing

Kit 014 Same as Kit 013, but with TTL..... \$13.75

Kit 015 50Hz or 60Hz chain time base using line frequency as reference. Accuracy 0.1-0.05%. Outputs 10Hz-1Hz-0.1Hz. Complete with CMOS shaping circuit and PC Board..... \$9.75

Kit 019 Same as Kit 015, but with TTL and 60Hz only..... \$7.75

Kit 018 60Hz chain time base using line frequency for Kit 020 RPM counter.

- *Outputs: 6 sec. = 100th of RPM
- 6 sec. = 10th of RPM
- 60 sec. = full revolution

\$9.75

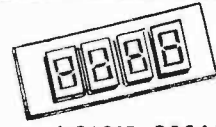

4-DIGIT DECADE COUNTER KIT
\$19.95 KIT 012

One chip 4 digit decade counter kit, with both 7 segment and BCD output.

1. Chip features internal oscillator for scanning speed.
2. Overflow and count extent outputs.
3. Transfer, reset, count, blanking and true complement control inputs.
4. PC Boards can be cascaded to 8-12-16, etc. digits.
5. Kit includes counter chip, drive circuit for 4 cathode type displays and PC Board. (For readout board see (FND70-FND503))

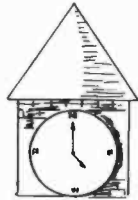

MORE TO COME

Watch this space in future issues for additional kits, including Multimeter, Timer, Capacitance Meter, Thermometer and many more. With our kits and your imagination, you'll find dozens of new and exciting applications.

KIT 016 FREQ. COUNTER

Features FET input front end with trigger circuit for measuring complex waveforms. Measures from 0.1Hz to 10MHz when used with Kit 015 or 019. Measures from 0.1Hz to 35MHz when used with Kit 013 and 014.
\$24.50

KIT 017 DVM

1.999V as basic, with polarity indication. 1 M ohm input impedance and accuracy to 1% if properly adjusted
\$13.50

KIT 020 RPM COUNTER

Counts from 1 to 100,000 RPM. RPM counter kit contains components and PC board.
\$8.95

KIT 030 POWER SUPPLY

*Input voltage: 25V max. *Output current: 1 amp max.
*Load regulation: 50mV. *Output voltage: 5V. *Line regulation: .01%. (requires 8-20V transformer)
\$4.55
(Contains all parts except transformer)

ALTAJ ELECTRONICS
P.O. BOX 38544 Dallas, Texas 75238
TERMS: Check or money order. No COD.
Telephone (214) 278-3561
Texas Residents Add 5%

MSI CLUB

Send for your membership card to the Modular Scientific Instrumentation Club and receive a big 10% off on future purchases of M.S.I. kits. Send \$3.00 with your name and address. We will promptly send your very own registered membership card. Don't miss out on the savings. Write now.

Memberships valid for one year from date of registration.

NEW MANAGEMENT!

- * Free Postage
- * No Minimum Order
- * 48 Hour Service
- * 24 Hour Phone Service



WE ARE EAGER TO SERVE YOU!

HP7730
 .33 in. high red very bright 25mA per seg. Common anode. **\$1.20**

FND807 ANODE
FND800 CATHODE
 One of our best readouts .5 in. high, 20mA per segment. Common anode. **\$3.75**

FND503
 .8 in. High. The Best on the market. Ideal for large readout application. **\$4.95**

LEDS
 Mini red .12
 Jumbo red .15
 Jumbo green .20
 Jumbo yellow .25

TI
 Fully multiplexed common cathode. Goldplated. Idea for mini 6 digit clock. **\$1.30**

BURROUGHS 12 DIGIT
 .25 in high orange digit. 160v dc. Free socket. **\$2.50**

DL33
 If you like an array of displays, we have it. Common cathode. **\$1.45**

4 & 6 DIGIT PC BOARDS

PC Board for 4 digit display FND 800 or 807	\$2.75
PC Board for 6 digit display FND 800 or 807	\$3.50
PC Board for 4 digit display MAN series or DL707	\$1.75
PC Board for 6 digit display MAN series or DL707	\$2.25
PC Board for 4 digit display FND503	\$2.00
PC Board for 6 digit display FND503	\$3.00
PC Board for 4 digit display DL747	\$2.50
PC Board for 6 digit display DL747	\$3.00
PC Board for 4 digit display DL727	\$2.25
PC Board for 6 digit display DL727	\$3.00
PC Board for 4 digit display FND70	\$1.75

All PC display boards are multiplexed for adding additional digits.

\$\$\$ SAVE! 4-DIGIT ALARM CLOCK
KIT NO. 1 \$13.95 (with PC Board)

FEATURES:
 Direct drive display outputs, * Current control regulation on chip, * Low power brightness control on chip, * RFI eliminating slowup circuitry, * Sleep Radio feature, * 24 hr. snooze alarm, * Independent digit setting, * Non multiplexed output circuitry. 12VAC CT 1/2 amp transformer for Kit No. 1 **\$2.00**

KIT NO. 2
 Complete kit with components, PC Board, Transformer, wood grain case and filter for display window. Includes .25 in. readouts. **\$21.50**

KIT NO. 3
 Complete kit with components, PC Board, Transformer, wood grain case, and filter for display window. Includes 5 inch readouts. **\$22.50**

* Components for Kit No. 2 or Kit No. 3 sleep radio feature, add \$95

LSI INTEGRATION

MM5316	4-6 digit alarm clock 40 pin dip w/spec.	\$ 4.25
7002	4 digit counter/latch decoder; 7 segment and BCD outputs. 28 pin dip w/spec.	\$12.50
7005	4 digit counter/latch decoder; 7 segment output only. 24 pin dip w/spec.	\$ 9.50
7007	4 digit counter/latch decoder with BCD output only. 16 pin dip w/spec.	\$ 7.00
70250	4-6 digit alarm clock 28 pin dip w/spec.	\$ 5.50
PC Board for 70250		\$ 4.25
70380	4 digit non-multiplexed radio alarm clock featuring direct drive display output 40 pin dip w/spec.	\$3.50
PC Board for 70380		\$ 3.75
8008	8 bit parallel CPU.	\$19.50
2102	1K static RAM for 8008.	\$ 2.25
MM5203	2K UV erasable PROM.	\$12.25
75491	segment driver.	\$ 0.35
75492	digit driver.	\$ 0.45
7020	6 function calculator chip with direct segment drive. 8 digit.	\$ 2.25

GE TRANSISTOR ASSORTMENT
 T098 cased Darling., SCRs, NPN, PNP, ect.
 50 for \$0.95
 100 for \$1.75
 300 for \$5.00

TTL BOARDS
 MEMOREX computer boards with TTL's Diodes and Transistors, etc.
 5 Boards containing 150-250 IC's **\$3.95**

GOT A CASE? HERE'S THE CURE!
 Ideal for Frequency counter case function generator, etc. Overall height 4", length 12", width 7 1/2".
 (Includes top, bottom, and hardware.)

\$5.95

MASTER II

LIGHTS
MUSIC 60 WATT COLOR ORGAN
 Completely self contained unit with 120 volt power cord included. **\$1.50**

THE KING OF ALTAJ
6-DIGIT ALARM CLOCK
 THE KING FEATURES:
 1) 6 digit, 12 hr. 60 cycle or 24 hr. 50 cycle alarm clock.
 2) Time sharing capability for display of additional information
 3) Single 12v. supply and a minimum of interface components.
 4) AM-PM and automatic power fail indications.
 5) 10 minute snooze
 6) Intensity control of LEDs.

\$23.50

Kit No. 70250-1R (Red readouts)
 Kit No. 70250-1G (Green readouts)
 Kit No. 70250-1Y (Yellow readouts)
 Kit No. 70250-2R (DL727 readouts)..... **\$28.50**
 Kit No. 70250-3R (FND807 readouts)..... **\$29.50**

All kits include components, PC Boards, Transformer, case, and construction manual.

THE KING'S HAREM
FATIMA 4-DIGIT TEMP. KIT
\$19.95

Features 4-digit temperature display; Fahrenheit or centigrade; complete C-Mos application; uses 7002 4-digit counter.

Kit includes all components, PC Board and instructions for interfacing with THE KING 6-digit alarm clock. Addition Number 1

DELILA APPLIANCE STARTER \$9.95
 (Example) Set your alarm for 7: a.m., set timer for 15 min. At exactly 7: a.m., the appliance will start; at 7:15 your clock alarm will wake you.

Kit includes all components, PC Board and instructions for interfacing with THE KING 6-digit alarm clock. Addition Number Z

TANYA 60HZ CRYSTAL TIME BASE
 ADDITIONAL FEATURES:
 1.) Low Power Consumption
 2.) Directly Interfaces with King MOS Clock Chip.
 3.) 60 Hz output with crystal time base accuracy
 4.) Ideal for Cars, Boats, & Campers.

\$5.95

Kit includes all components, PC Board and instructions for interfacing with THE KING 6-Digit Alarm Clock. Addition No. 3

TTL			CMOS		
7400	-.21	7447	-.94	74151	-.80
7402	-.21	7448	-.94	74153	-.94
7404	-.21	7453	-.21	74154	-1.00
7406	-.29	7473	-.42	74161	-1.04
7408	-.21	7474	-.42	74163	-1.24
7410	-.21	7475	-.70	74164	-1.94
7413	-.54	7476	-.44	74165	-1.54
7420	-.21	7483	-.90	74174	-1.34
7427	-.29	7490	-.74	74175	-1.44
7430	-.21	7492	-.80	74181	-2.80
7437	-.44	7493	-.80	74192	-1.30
7438	-.39	7495	-.80	74193	-1.30
7440	-.21	7496	-.80	74195	-.84
7442	-.74	74121	-.43	74197	-.84
		74123	-.80		
4000	-.24	4018	-1.49	4035	-1.39
4001	-.24	4019	-.59	4037	4.50
4002	-.24	4020	-1.59	4040	-1.59
4006	-1.49	4021	-1.49	4041	-.89
4007	-.24	4022	-1.19	4042	-.79
4008	-1.15	4023	-.24	4043	-.80
4009	-.59	4024	-.99	4044	-.59
4010	-.55	4025	-.24	4047	-.59
4011	-.24	4026	-1.49	4049	-.59
4012	-.24	4027	-.59	4050	-.59
4013	-.59	4028	-.99	4066	-.99
4014	-1.49	4029	-1.39	4077	-.39
4015	-1.19	4030	-.49	74C02	-.29
4016	-.59	4032	-.24	74C04	-.29
4017	-1.29	4033	-1.49	74C107	-1.29
		4034	-3.25		

CONTINENTAL SPECIALTIES
 THE ONE SOURCE FOR EVERYTHING NEW IN BREAD BOARDING

\$19.95 (Complete Kit)

CSC 100

NEW Proto Board

CSC 101

Write for our FREE Brochure

TRANSISTORS-DIODES

LINEARS		
555 Timer Mini dig	0.65	
8038 Functional generator	4.25	
RCA 3043 FM If, Aud Preamp.	1.20	
565 Phase Lock Loop	1.95	
567V Tone Decoder	1.50	
LM723 Pos. Volt. Reg.	0.55	
LM308 5v. Lamp Reg	1.10	
LM380 2w. Audio Amp. 8 pin dip	1.00	
LM741 Operational Amp.	0.25	
RCA200V 115W T05 NPN	1.25	
GE D40C1 NPN Darl.	0.25	
2N4443SCR 400v8A T0220	0.65	
2N2222 NPN Gen Ampl.	0.20	
2N3904 NPN Driver	0.15	
2N3906 PNP Compl. 2N3904	0.15	
2N4400 NPN Low level noise	0.20	
2N5401 PNP Nixie driver	0.25	
1N4004 400PIV	15 for 1.00	
1N4007 4000PIV	10 for 1.00	
1N746 3.3 Zen.	4 for 1.00	
1N4148 Switch	20 for 1.00	

LOOK!
 From Altaj to you, a special offer.
 Power Supply Kit: 5 Volt 1 Amp. Req.
 Line regulation .005%
 Load regulation 50mV

Kit includes Components, PC Board, Transf., Fuse, Pilot Light **\$5.50**
 Nothing else to buy:

P.O. Box 4430C Santa Clara, CA 95054

TERMS: \$5.00 min. order U.S. funds
Calif. residents add 6% tax.

FREE: Send for your copy of
our 1976 QUEST CATALOG.

Same day shipment
First line parts only. Factory
tested. Guaranteed money
back. Quality IC's and other
components at factory prices.

INTEGRATED CIRCUITS

7400 TTL	17	SN74251N	1.60
SN7400N	17	SN74258N	1.65
SN7401N	17	74LS00 TTL	
SN7402N	17	SN74LS00N	.34
SN7403N	17	SN74LS02N	.34
SN7404N	19	SN74LS04N	.39
SN7405N	23	SN74LS05N	.39
SN7410N	17	SN74LS10N	.39
SN7414N	63	SN74LS14N	.34
SN7416N	34	SN74LS28N	.41
SN7417N	39	SN74LS28N	.39
SN7420N	37	SN74LS30N	.34
SN7421N	37	SN74LS30N	.34
SN7423N	37	SN74LS75N	.75
SN7428N	25	SN74LS93N	1.10
SN7438N	25	SN74LS93N	1.10
SN7439N	25	SN74LS93N	1.10
SN7440N	17	SN74LS107N	1.89
SN7447N	60	SN74LS107N	.52
SN7448N	78	SN74LS132N	1.50
SN7450N	37	SN74LS132N	1.50
SN7473N	36	SN74LS151N	1.28
SN7474N	49	SN74LS151N	1.80
SN7475N	44	SN74LS157N	1.80
SN7476N	49	SN74LS157N	1.80
SN7483N	70	SN74LS163N	2.05
SN7489N	41	SN74LS170N	2.85
SN7490N	45	SN74LS192N	2.60
SN7492N	65	SN74LS194N	2.00
SN7493N	65	SN74LS197N	2.00
SN7496N	75	SN74LS259N	2.00
SN74100N	1.10	SN74LS290N	2.00
SN74107N	39	SN74LS290N	2.00
SN74121N	59	SN74LS290N	2.00
SN74123N	39	SN74LS290N	2.00
SN74129N	59	SN74LS290N	2.00
SN74145N	89	SN74LS290N	2.00
SN74150N	95	SN74LS290N	2.00
SN74151N	1.10	SN74LS290N	2.00
SN74154N	1.10	SN74LS290N	2.00
SN74155N	95	SN74LS290N	2.00
SN74157N	95	SN74LS290N	2.00
SN74161N	95	SN74LS290N	2.00
SN74169N	1.35	SN74LS290N	2.00
SN74170N	1.95	SN74LS290N	2.00
SN74174N	1.95	SN74LS290N	2.00
SN74175N	90	SN74LS290N	2.00
SN74181N	2.40	SN74LS290N	2.00
SN74190N	1.15	SN74LS290N	2.00
SN74191N	1.25	SN74LS290N	2.00
SN74193N	85	SN74LS290N	2.00
SN74198N	1.65	SN74LS290N	2.00

ELECTRONICS

LM741N	35	N81728	2.75
LM1303N	82	N81978	3.25
LM211N	1.95		
LM3000N	55		
LM3090N	70		
MC1455V	58		
NE550N	66		
NE553B	2.35		
NE555V	43		
NE565A	1.00		
NE565A	1.15		
NE565V	1.85		
NE567V	1.45		
SN75451CN	39		
SN75452CN	38		
CM05	42		
CD4001	25		
CD4002	25		
CD4011	25		
CD4012	25		
CD4013	40		
CD4016	50		
CD4017	1.00		
CD4020	1.35		
CD4024	1.20		
CD4027	55		
CD4030	55		
CD4049	62		
CD4050	62		
CD4071	40		
CD4072	40		
CD4082	45		
CD4511	2.20		
CD4511	3.80		
CD4512	2.00		
74C160	2.40		
74C192	2.40		
74C221	2.75		
8080	24.50		
8080A	33.00		

Include
.13¢
stamp.

ECL 10,000 SERIES

10101	39
10123	1.10
10124	1.10
10125	1.10

DISPLAY LEADS

MAN1	CA	270	2.90
MAN3	CC	125	39
MAN4	CC	187	1.95
MAN7	CA	300	1.50
MAN72	CA	300	1.50
MAN74	CA	300	1.50
DL727	CA	500	2.55
DL747	CA	800	2.25
FN503	CC	500	1.35
FN510	CA	500	1.35
FN500	CC	800	2.75
FN507	CA	800	2.75
MV502		69	
MV502		89	
5082-7414		1.40	

MOS/MEMORY

RAM	40	2102	1.80
		2102.1	1.80
		2102.2	1.80
		2102	1.80
		2107	1.80
		2107	1.80
		2112-2	7.90

CLOCKS

MM5311	3.60
MM5312	4.80
MM5313	3.60
MM5314	3.30
MM5315	4.00
MM5316	6.35
CT7001	5.80

IC SOCKETS

PN 1 UP	13.00
PN 15 UP	24.36
PN 18 UP	28.43
PN 20 UP	36.58
PN 24 UP	40.61
PN 28 UP	44.61
PN 32 UP	48.61
PN 36 UP	52.61
PN 40 UP	56.61
PN 44 UP	60.61
PN 48 UP	64.61
PN 52 UP	68.61
PN 56 UP	72.61
PN 60 UP	76.61
PN 64 UP	80.61
PN 68 UP	84.61
PN 72 UP	88.61
PN 76 UP	92.61
PN 80 UP	96.61
PN 84 UP	100.61
PN 88 UP	104.61
PN 92 UP	108.61
PN 96 UP	112.61
PN 100 UP	116.61

World's Lowest IC Prices

TTL	14	74151	.60	74LS00	.25	74LS164	1.50
7402	14	74157	.60	74LS02	.25	74LS174	1.50
7404	14	74160	.75	74LS10	.25	74LS175	1.50
7410	14	74161	.75	74LS13	.40	74LS193	1.50
7420	14	74163	.75	74LS15	.50	74LS251	1.50
7427	.25	74165	.80	74LS151	.85	74LS253	1.50
7438	.25	74173	1.25	74LS153	.95	74LS257	1.50
7440	14	74174	.75	74LS157	1.50	74LS258	1.50
7445	.45	74175	.75	74LS163	1.50		
7447	.65	74177	.70	CMOS			
7450	14	74180	.80	4001	.16	4027	.40
7451	14	74181	1.50	4002	.16	4028	.60
7473	.22	74191	1.00	4006	.90	4030	.35
7474	.23	74192	.70	4007	.16	4040	.95
7493	.50	74193	.70	4008	.70	4042	.60
7495	49	74198	1.00	4011	.16	4043	.75
74107	.29	9602	.50	4012	.16	4044	.70
74116	1.00	9300	.75	4013	.35	4049	.38
74123	.50	9312	.70	4015	.80	4050	.38
74150	.60			4016	.35	4066	.65
				4019	.70	4068	.35
SCHOTTKY				4020	.90	4069	.16
74502	.25	74S172	3.50	4021	.95	4071	.16
74537	4.00	74S175	1.50	4023	.16	4073	.16
74585	2.00	74S181	3.50	4025	.75	4075	.16
74S139	1.58	74S197	1.50	4025	.20	4516	.85
74S140	.58	74S257	1.50	4025	.75	4585	.85
74S153	2.58						
HIGH SPEED				LINEARS		RAMS	
74H00	.20	74H51	.20	NE555V	.43	2102	1.50
74H01	.20	74H52	.20	NE556A	.30	PROMS	
74H04	.20	74H74	.40	1458V	1.25	82S23/S123	1.95
74H10	.20	74H103	.50	566V	1.25		
74H11	.20	74H106	.50	567V	1.52		
74H11	.20			540L	2.00		

Order Minimum \$10.00. Add \$1.00 shipping and handling charge per order. California residents add 6% sales tax. All orders shipped promptly.

Order the famous lasis 6 volume Programmed Learning Course "Microcomputer Design is a Snap" for \$95.50 and receive a special \$10.00 credit on any group of IC's.

Satisfaction 100% guaranteed.

C.O.D. Orders:
Phone (day or night) 408/354-1448
ELTRON
PO Box 2542 A
Sunnyvale, CA 94087

Not a Cheap Clock Kit \$17.45
Includes everything except case
2-PC boards, 6-.50 LED Displays, 5314 clock chip transformer, all components and full instructions.

IC UPDATE MASTER MANUAL
Complete IC data from all Manufacturers, 14,000 cross references \$30.00 complete with quarterly update service. For Domestic Postage, add \$2.00, Foreign, \$6.00.

Miles Per Gallon Circuit
As described Jan. 1976 EDN mag.
Digital Flow sensor \$29.50
Speed transducer \$8.00
CMOS rate multipliers \$19.95
2-50 in. displays \$2.50

CIRCLE NO. 51 ON FREE INFORMATION CARD

CIRCLE NO. 28 ON FREE INFORMATION CARD

SUPER POWER FOR ANY AM RADIO

New Antenna Assist Turns A Tiny Transistor Into A Tiger!

This amazing antenna assist has pulled in stations up to 1000 miles away! Just set it beside your radio (no wires, clips, grounding) and fine-tune Select-A-Tenna's dial to the same frequency—"gangbusters"! Terrific for sportsmen, vacationers, shut-ins, radio & electronics buffs, Service men & women—who want to "get" home to a favorite station. Great for clearing weak signals in radio depressed areas, off-coast islands, stations in crowded frequencies, hard-to-tune stations way up on the dial. Solid state—no tubes to replace. Uses no electricity or batteries—works almost forever! Tough, break-resistant plastic case blends with any decor. **\$15.95**
STOCK NO 72,095AV JUST \$15.95 Ppd.

ULTRA SELECT-A-TENNA (TUNES OVER 1000 MILES AWAY)

Currently in use on Alaska's north slope where radio reception is very difficult. Has jack input & jack to which you attach 50 ft. of antenna wire (not included). **\$22.95**
STOCK NO. 72,147N ONLY \$22.95 Ppd.

GIANT FREE CATALOG!
NEW. 172 Pages. Over 4,500 Unusual Bargains for Hobbyists, Schools, Industry.

EDMUND SCIENTIFIC CO.
300 EDCORP BUILDING
Barrington, N. J. 08007
(609) 547-3488

America's Greatest Science - Optics - Hobby Mart

COMPLETE AND MAIL COUPON NOW

EDMUND SCIENTIFIC CO. 300 Edscorp Bldg., Barrington, N. J. 08007

Send SEND FREE 172 PAGE CATALOG "AV"
 Charge my BankAmericard
 Charge my Master Charge

Interbank No. _____
Card No. _____
Expiration Date _____

30-DAY MONEY-BACK GUARANTEE. You must be satisfied or return any purchase in 30 days for full refund.

Select-A-Tenna(s) No.72,095AV@ \$15.95 ea. \$ _____
Ultra Select-A-Tenna(s) No.72,147AV@ \$22.95 ea. \$ _____

Service and handling charge \$ _____ 1.00
Enclosed \$ _____ check,
_____ M.O. in amount of _____ \$ _____
Signature _____
Name _____ Please Print
Address _____
City, State, Zip _____

HELPING TO DEVELOP AMERICA'S TECHNOLOGY FOR OVER 30 YEARS.

6 TV GAMES ON ONE CHIP
MOS/LSI Design/Supply Limited
Chip \$39.95 Kit \$69.95
Send \$1.00 for kit info & data sheet
Advanced Microcomputer Products
P. O. Box 17329, Irvine, CA 92713

BRAIN MONITOR — Professional, dependable \$50.00. Check or M.O. L't'd Q'ty. DASZEWSKI Z.J. LAB., 361 Garretson Ave., Perth Amboy, N.J. 08861.

HP-45 Owners — OEM Crystal with comprehensive instructions for activating your timer, Daniel Sternberg, 54 Eldon Avenue, Lansdowne, PA 19050.

MINIATURE digital car clock, only 1-1/2" x 3" x 2-1/2". Accurate time base, simple to build. For plans send \$1.50 to: Kin's Electronics, 328 Stonemill, Dayton, Ohio 45409.

ELECTRONIC TICTACTOE. Play against internal computer or another player. Complete plans \$7.00. Danshi Products, Box 415, Fairfield, CT 06430.

FLOPPY Diskettes \$7.00, Digital Cassettes, \$9.00. Quantity Discounts. Ronlin, Box 6162, San Jose, CA 95150.

DIGITAL CLOCK KIT

This clock is housed in a satin gold aluminum case and features 12 or 24 hour readout format. Its size is 4 x 2 x 2 inches. The kit includes all parts, including 6 large .33 inch led readouts, line cord transformer and complete detailed instructions. Makes a great gift.

\$22.95
Ramsey Electronics P.O. Box 4072 Rochester, NY 14610 (716) 271-6487

CB ELECTRICAL Quick Disconnect available from Wald & Assoc., Inc., 206 North West Street, Angola, Indiana 46703. \$1.00 each postage included.

NYLON SCREWS, NUTS, WASHERS. Noncorrosive, non-conductive. Introductory Offer. 300 Assorted Pieces \$8.95. 3rd class, postage prepaid, Ill. Res. add 5%. Free detailed price list. Randex Products, P.O. Box 5927, Chicago, Ill. 60680.

DON'T LET VOLTAGE TRANSIENTS ZAP YOUR HI-FI. Solid state equipment protector plugs into outlet protects any transistorized equipment. \$6.95. Kopp Electronics, 1650 William St., Buffalo, N.Y. 14206. Free Brochure.

THE PEOPLE'S MAIL ORDER



Aladdin has been established for you, the Customer. Too many mail order companies guess as to your needs, Aladdin listens to your requests and suggestions. Simply write in and tell us how to make Aladdin a success by furnishing the items you need. We are also interested in any ideas you have for future kits kits.

FAIR-CHILD

We at Aladdin will do our best to find and offer to you, at reasonable prices, the parts you want in future ads.

FND 70
RED, .25 In. Char.
15mA per segment.
Common Cathode.
\$1.25

FND
807 ANODE
800 CATHODE

FND 503
RED, .5 In. Char.
10mA per segment.
Common Cathode.
\$1.60

.8 IN. CHAR.
The Best on the Market.
Ideal for large readout
application..... \$4.95

LINEARS

555

Timer **.65**

LM 380

2W. Audio Amp. **1.00**

LM 741

Operational Amp **.25**

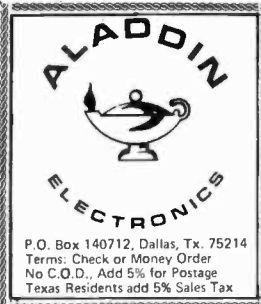

P.O. Box 140712, Dallas, Tx. 75214
Terms: Check or Money Order
No C.O.D., Add 5% for Postage
Texas Residents add 5% Sales Tax

'THE TRAVELER'
4 DIGIT AUTOMOBILE CLOCK

FEATURES:

- 1) Direct drive Outputs
- 2) Current Control Regulation
- 3) Low Power Brightness
- 4) RF Eliminating Slowup Circuitry
- 5) Non-Multiplexed Output Circuitry
- 6) Independent Digit Setting
- 7) Readout Visible Through Ignition Switch
- 8) .5 Inch Displays

A REAL BARGAIN!!

\$11.95 4 DIGIT ALARM CLOCK

FEATURES:

- 1) Independent Digit Setting
- 2) Non-Multiplexed Output Circuitry
- 3) 24 Hour Snooze Alarm
- 4) Direct Drive Display Output
- 5) RFI Eliminating Circuitry
- 6) .25 Inch Readouts

KIT INCLUDES:

COMPONENTS, PC BOARD,
TRANSFORMER, and
CONSTRUCTION MANUAL

KIT INCLUDES:

COMPONENTS, PC BOARD,
TRANSFORMER, and
CONSTRUCTION MANUAL.

SPEAKER

1" Dia. 40 Ohms

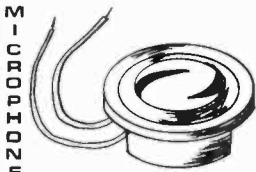

1.50

16V LAMP

PC TYPE



4/1.00

\$26.95



IDEAL FOR CAR, BOAT, CAMPER, ETC.

CIRCLE NO. 4 ON FREE INFORMATION CARD

CB SPECIALS-R.F. DRIVERS-R.F. POWER OUTPUTS-FETS

2SC481	1.85	2SC7671	1.75	2SC866	5.85	2SC1449-1	1.60	40081	1.50
2SC482	1.75	2SC773	.85	2SC013	1.50	2SC475	1.50	40082	3.00
2SC495	1.10	2SC774	1.75	2SC1014	1.50	2SC1678	5.50	2SC608	4.85
2SC502	3.75	2SC775	2.75	2SC1017	1.50	2SC1679	4.75	SK3046	2.15
2SC517	4.75	2SC776	3.00	2SC1018	1.50	2SC1728	2.15	SK3047	3.75
2SC514	3.80	2SC777	4.75	2SC1173	1.25	2SC1760	2.15	SJ2095	3.50
2SC615	3.90	2SC778	3.25	2SC1226A	1.25	2SC1816	5.50	SK3048	3.25
2SC616	4.15	2SC797	2.50	2SC1237	4.50	2SC1908	.70	SK3054	1.25
2SC617	4.25	2SC798	3.10	2SC1239	3.50	2SC1957	1.50		
2SC699	4.75	2SC781	3.00	2SC1243	1.50	2SF8	3.00	2SK19	1.75
2SC710	.70	2SC789	1.00	2SC1306	4.75	HEP-S3001	3.25	2SK30	1.00
2SC711	.70	2SC796	3.15	2SC1306-1	4.90	2SD235	1.00	2SK33	1.20
2SC735	.70	2SC799	4.25	2SC1307	5.75	MRF8004	3.00		
2SC756	3.00	2SC802	3.75	2SC1307-1	6.00	4004	3.00	3SK40	2.75
2SC765	9.50	2SC803	4.00	2SC1377	5.50	4005	3.00	3SK45	2.75
2SC766	10.15	2SC839	.85	2SC1449	1.30	40080	1.25	3SK49	2.75

JAPANESE TRANSISTORS

2SA52	.60	2SB187	.60	2SC458	.70	2SC815	.75	2SC1569	1.25
2SA316	.75	2SB235	1.75	2SC460	.70	2SC828	.75	2SC1756	1.25
2SA473	.75	2SB303	1.00	2SC478	.80	2SC829	.75		
2SA483	1.95	2SB324	6.00	2SC491	2.50	2SC830	1.60	2SD30	.95
2SA489	.80	2SB337	2.10	2SC497	1.60	2SC839	.85	2SD45	2.00
2SA490	.70	2SB367	1.60	2SC515	.80	2SC945	.65	2SD65	.75
2SA505	.70	2SB370	.65	2SC535	.75	2SC1010	.80	2SD68	.90
2SA564	.50	2SB405	.85	2SC536	.65	2SC1012	.80	2SD72	1.00
2SA628	.65	2SB407	1.65	2SC537	.70	2SC1051	2.50	2SD88	1.50
2SA643	.85	2SB415	.85	2SC563	2.50	2SC1061	1.65	2SD151	2.25
2SA647	2.75	2SB461	1.25	2SC605	1.00	2SC1079	3.75	2SD170	2.00
2SA673	.85	2SB463	1.65	2SC620	.80	2SC1096	1.20	2SD180	2.75
2SA679	3.75	2SB471	1.75	2SC627	1.75	2SC1098	1.15	2SD201	1.95
2SA682	.85	2SB474	1.50	2SC642	3.50	2SC1115	2.75	2SD218	4.75
2SA699	1.30	2SB476	1.25	2SC643	3.75	2SC1166	.70	2SD300	2.50
2SA699A	1.75	2SB481	2.10	2SC644	.70	2SC1170	4.00	2SD313	1.10
2SA705	.55	2SB492	1.25	2SC681	2.50	2SC1172B	4.25	2SD315	.75
2SA815	.85	2SB495	.95	2SC684	2.10	2SC1209	.55	2SD318	.95
2SA816	.85	2SB507	.90	2SC687	2.50	2SC1213	.75	2SD341	.95
		2SB511	.70	2SC696	2.35	2SC1226	1.25	2SD350	3.25
				2SC712	.70	2SC1243	1.50	2SD352	.80
2SB22	.65			2SC713	.70	2SC1293	.85	2SD380	5.70
2SB54	.70	2SC206	1.00	2SC732	.70	2SC1308	4.75	2SD389	.90
2SB56	.70	2SC240	1.10	2SC733	.70	2SC1347	.80	2SD-390	.75
2SB77	.70	2SC261	.65	2SC739	.70	2SC1383	.75	2SD437	5.50
2SB128	2.25	2SC291	.65	2SC715	1.75	2SC1409	1.25		
2SB135	.95	2SC320	2.00	2SC762	1.90	2SC1410	1.25	C106B1	.50
2SB152	4.50	2SC352	.75	2SC783	1.00	2SC1447	1.25		
2SB173	.55	2SC353	.75	2SC784	.70	2SC1448	1.25	MPS-U31	4.00
2SB175	.55	2SC371	.70	2SC785	1.00	2SC1507	1.25	MPS-80001.25	
2SB178	1.00	2SC372	.70	2SC793	2.50	2SC1509	1.25		
2SB186	.60	2SC394	.70						

POWER-TRANSISTORS HIGH-VOLT. TV. TYPE

BU204	1300V	3.90	BU207	1300V	5.40	2SC1172B	1100V	4.25
BU205	1500V	4.70	BU208	1500V	6.25	2SC308	1100V	4.95
BU206	1700V	5.90	2SC1170	1100V	4.00	2SC1325	1100V	4.95

CIRCLE NO. 44 ON FREE INFORMATION CARD

OEM SPECIALS

1N270	.10	2N960	.55	2N2219A	.30	2N2913	.75	2N3740	1.00	2N4401	.20
1N914	.10	2N962	.40	2N2221	.25	2N2914	1.20	2N3771	1.75	2N4402	.20
		2N967	.50	2N2221A	.30	2N2916A	3.65	2N3732	1.90	2N4403	.20
2N173	1.75	2N1136	1.35	2N2222	.25	2N3019	.50	2N3773	3.00	2N4409	.20
2N178	.90	2N1142	2.25	2N2222A	.30	2N3053	.30	2N3819	.32	2N4410	.25
2N327A	1.15	2N1302	.25	2N2270	.40	2N3054	.70	2N3823	.70	2N4416	.75
2N334	1.20	2N1305	.30	2N2322	1.00	2N3055	.75	2N3856	.20	2N4441	.85
2N336	.90	2N1377	.75	2N2323	1.00	2N3227	1.00	2N3866	.85	2N4442	.90
2N338A	1.05	2N1420	.20	2N2324	1.35	2N3247	3.40	2N3903	.20	2N4443	1.20
2N398B	.90	2N1483	.95	2N2325	2.00	2N3250	.50	2N3904	.20	2N4852	.55
2N404	.30	2N1540	.90	2N2326	2.85	2N3375	6.50	2N3905	.20	2N5061	.30
2N443	1.75	2N1543	2.70	2N2327	3.80	2N3393	.20	2N3906	.25	2N5064	.50
2N456	1.10	2N1544	.80	2N2328	4.20	2N3394	.17	2N3925	3.75	2N5130	.20
2N501A	3.00	2N1549	1.25	2N2329	4.75	2N3414	.17	2N3954	3.50	2N5133	.15
2N508A	.45	2N1551	2.50	2N2368	.25	2N3415	.18	2N3954A	3.75	2N5138	.15
2N555	.45	2N1552	3.25	2N2369	.25	2N3416	.19	2N3955	2.45	2N5198	3.75
2N652A	.85	2N1554	1.25	2N2484	.32	2N3417	.20	2N3957	1.25	2N5294	.50
2N677C	6.00	2N557	.15	2N2712	.18	2N3442	1.85	2N3958	1.20	2N5296	.50
2N706	.25	2N1560	2.80	2N2894	.40	2N3553	1.50	2N4037	.60	2N5306	.20
2N706B	.40	2N1605	.35	2N2903	3.30	2N3563	.20	2N4093	.85	2N5354	.20
2N711	.50	2N1613	.30	2N2904	.25	2N3565	.20	2N4124	.20	2N5369	.20
2N711B	.60	2N1711	.30	2N2904A	.30	2N3638	.20	2N4126	.20	2N5400	.40
2N718	.25	2N1907	4.10	2N2905	.25	2N3642	.20	2N4141	.20	2N5401	.50
2N718A	.30	2N2060	1.85	2N2905A	.30	2N3643	.15	2N4142	.20	2N5457	.35
2N720A	.50	2N2102	.40	2N2906	.25	2N3645	.15	2N4143	.20	C103Y	.25
2N918	.35	2N2128	.25	2N2906A	.30	2N3646	.14	2N4220A	.45	C103D	.40
2N930	.25	2N2218A	.30	2N2907	.25	2N3730	1.50	2N4234	.95	C106B1	.50
2N956	.30	2N2219	.25	2N2907A	.30	2N3731	2.75	2N4400	.20	C106D1	.75

SILICON UNIJUNCTIONS

2N2646	.50	2N2160	.65
2N2647	.60	2N4870	.50
2N6027	.55	2N4871	.50
2N6028	.70	2N4891	.50
D5E37	.25	2N4892	.50
		2N4893	.50
		2N4894	.50
		MU10	.40

INTEGRATED CIRC.

UA703C	.40
709C OP. AMP.	.25
741C OP. AMP.	.25
7400	.15
TA 7061P	3.50
TA 7205P	10.00
UPC 1001h2	6.00
NE 555	1.25

RECTIFIERS

	10	100
IN4001	.60	5.00
IN4002	.70	6.00
IN4003	.80	7.00
IN4004	.90	8.00
IN4005	1.00	9.00
IN4006	1.10	10.00
IN4007	1.20	11.00



New-Tone Electronics
P.O. Box 1738 A
Bloomfield, N.J. 07003
Phone: (201) 748-6171, 2, 3

ALL PARTS GUARANTEED AND TESTED ON PREMISES.

N.J. residents add 5% sales tax. Minimum order \$5.00. All orders add \$1.00 postage. Dealers write or phone for discount prices.

7400N TTL

SN7400N	16	SN7403N	27	SN74150N	100
SN7401N	16	SN7404N	25	SN74151N	79
SN7402N	21	SN7405N	22	SN74152N	85
SN7403N	16	SN7406N	22	SN74153N	1.25
SN7404N	18	SN7407N	35	SN74154N	1.25
SN7405N	24	SN7408N	37	SN74155N	95
SN7406N	20	SN7409N	39	SN74156N	99
SN7407N	29	SN7410N	32	SN74157N	99
SN7408N	25	SN7411N	32	SN74158N	1.25
SN7409N	25	SN7412N	32	SN74159N	1.25
SN7410N	18	SN7413N	32	SN74160N	1.25
SN7411N	36	SN7414N	32	SN74161N	1.10
SN7412N	32	SN7415N	32	SN74162N	1.10
SN7413N	45	SN7416N	32	SN74163N	1.10
SN7414N	70	SN7417N	32	SN74164N	1.10
SN7415N	35	SN7418N	32	SN74165N	1.10
SN7416N	35	SN7419N	32	SN74166N	1.25
SN7417N	45	SN7420N	32	SN74167N	1.25
SN7418N	70	SN7421N	32	SN74168N	1.25
SN7419N	35	SN7422N	32	SN74169N	1.25
SN7420N	21	SN7423N	32	SN74170N	1.25
SN7421N	33	SN7424N	32	SN74171N	1.25
SN7422N	49	SN7425N	32	SN74172N	1.25
SN7423N	37	SN7426N	32	SN74173N	1.25
SN7424N	79	SN7427N	32	SN74174N	1.25
SN7425N	79	SN7428N	32	SN74175N	1.25
SN7426N	79	SN7429N	32	SN74176N	1.25
SN7427N	37	SN7430N	32	SN74177N	1.25
SN7428N	47	SN7431N	32	SN74178N	1.25
SN7429N	26	SN7432N	32	SN74179N	1.25
SN7430N	31	SN7433N	32	SN74180N	1.25
SN7431N	27	SN7434N	32	SN74181N	1.25
SN7432N	15	SN7435N	32	SN74182N	1.25
SN7433N	27	SN7436N	32	SN74183N	1.25
SN7434N	15	SN7437N	32	SN74184N	1.25
SN7435N	25	SN7438N	32	SN74185N	1.25
SN7436N	89	SN7439N	32	SN74186N	1.25
SN7437N	59	SN7440N	32	SN74187N	1.25
SN7438N	75	SN7441N	32	SN74188N	1.25
SN7439N	75	SN7442N	32	SN74189N	1.25
SN7440N	75	SN7443N	32	SN74190N	1.25
SN7441N	61	SN7444N	32	SN74191N	1.25
SN7442N	69	SN7445N	32	SN74192N	1.25
SN7443N	79	SN7446N	32	SN74193N	1.25
SN7444N	76	SN7447N	32	SN74194N	1.25
SN7445N	77	SN7448N	32	SN74195N	1.25
SN7446N	77	SN7449N	32	SN74196N	1.25
SN7447N	77	SN7450N	32	SN74197N	1.25
SN7448N	77	SN7451N	32	SN74198N	1.25
SN7449N	77	SN7452N	32	SN74199N	1.25
SN7450N	77	SN7453N	32	SN74200N	1.25

CONSUMER ELECTRONICS

exelar



DIGITAL WATCH
This watch is manufactured by National Semiconductor. It provides 5 functions: hours, minutes, seconds, date, A.M. indicator dot. Accuracy is assured to 30 seconds per month by precision quartz crystal. If something should go wrong with the watch, repair is guaranteed within 48 hours after it is received. Complete with steel black leather band.

ES4-YS
3 MICRON GOLD PLATE BEZEL
\$29.95
NOT A KIT

Novus



DIGITAL ALARM CLOCK
This 4 digit Novus Alarm Clock is a very reliable and smartly styled unit. It provides such features as an alarm settable to any minute of the day, a 7 minutes snooze alarm, a power failure indicator, and even an A.M. P.M. indicator.

\$19.95
NOT A KIT

74LS00 TTL

74LS00	39	74LS55	39	74LS151	1.55
74LS02	39	74LS73	65	74LS153	1.89
74LS03	39	74LS74	65	74LS152	1.55
74LS04	45	74LS75	65	74LS154	2.25
74LS05	45	74LS76	65	74LS155	2.25
74LS08	39	74LS83	2.19	74LS156	2.25
74LS10	39	74LS86	65	74LS181	3.69
74LS13	79	74LS90	1.25	74LS190	2.25
74LS14	2.19	74LS92	1.25	74LS191	2.85
74LS20	39	74LS93	1.25	74LS192	2.85
74LS26	49	74LS95	2.19	74LS193	2.25
74LS27	49	74LS96	1.89	74LS194	2.25
74LS28	45	74LS107	65	74LS195	2.25
74LS32	39	74LS112	65	74LS257	1.89
74LS30	45	74LS132	1.55	74LS260	55
74LS42	49	74LS136	65	74LS279	.79
74LS51	39	74LS138	1.69	74LS280	5.95

OPTO ELECTRONICS

DISCRETE LEDS

R - RED
G - GREEN
Y - YELLOW
O - ORANGE

XC209R	5/51	XC256R	5/51	XC111R	5/51
XC209G	4/51	XC256G	4/51	XC111G	4/51
XC209Y	4/51	XC256Y	4/51	XC111Y	4/51
XC209O	4/51	XC256O	4/51	XC111O	4/51

125" dia. 185" dia. 190" dia.

200" dia. 200" dia. .085" dia.

MINIATURE TOGGLE

OPRY	ON	OFF	ON	OFF	ON	OFF	ON	OFF	ON	OFF	ON	OFF
1	ON	OFF	ON	OFF	ON	OFF	ON	OFF	ON	OFF	ON	OFF
2	ON	OFF	ON	OFF	ON	OFF	ON	OFF	ON	OFF	ON	OFF
3	ON	OFF	ON	OFF	ON	OFF	ON	OFF	ON	OFF	ON	OFF
4	ON	OFF	ON	OFF	ON	OFF	ON	OFF	ON	OFF	ON	OFF

PUSH BUTTON

Model 1 Quantity net prices
Part No. Price
PB-123 \$2.35 \$1.95 \$1.47 \$1.30

CMOS

CD4000	24	74C40A	75
CD4001	25	74C10A	65
CD4002	25	74C20A	65
CD4003	25	74C03A	65
CD4004	25	74C02A	2.15
CD4009	59	74C04A	1.50
CD4010	59	74C05A	1.50
CD4011	25	74C07A	1.15
CD4012	25	74C09A	2.00
CD4013	47	74C10A	1.25
CD4014	56	74C15A	2.90
CD4017	135	74C15A	3.00
CD4019	55	74C06A	3.25
CD4020	149	74C06A	3.25
CD4022	125	74C06A	3.25
CD4023	25	74C07A	3.00
CD4024	1.59	74C07A	3.25
CD4025	21	74C08A	2.60
CD4027	69	74C11A	2.75
CD4028	1.65	74C15A	2.75
CD4029	2.90	74C15A	4.50
CD4030	65	74C03A	55

DISPLAY LEDS

TYPE	POLARITY	HT	PRICE	TYPE	POLARITY	HT	PRICE
MAN 1	COMMON ANODE	20	\$3.25	MAN 7A	COMMON CATHODE	300	\$1.50
MAN 2	5 x 7 DOT MATRIX	40	4.95	DL707	COMMON ANODE	300	\$1.50
MAN 3	COMMON CATHODE	125	39	DL747	COMMON ANODE	600	2.25
MAN 4	COMMON CATHODE	187	1.95	DL750	COMMON CATHODE	600	2.49
MAN 7	COMMON ANODE	300	1.50	DL338	COMMON CATHODE	110	1.25
MAN 7G	COMMON ANODE-GREEN	300	1.95	FN070	COMMON CATHODE	290	.50
MAN 7Y	COMMON ANODE-YELLOW	300	1.95	FN053	COMMON CATHODE	500	1.75
MAN 7Z	COMMON ANODE	300	1.50	FN050	COMMON ANODE	500	1.75

THUMBWHEEL SWITCHES

Part No.	Description	Price	Part No.	Description	Price
SR EP	End Plate (Pair)	5.50	SR EP	End Plates (pair)	5.50
SR DP	Blank Body (each)	40	SR BR	Blank Body (each)	40
SR SB	Half Body (each)	40	SR HR	Blank Body (each)	40

8 POSITION ROTARY SWITCH

These switches are a 7 position, one position open, rotary switch enclosed in a TO-5 can. They have a standard 5 pin configuration and will mount perfectly on printed circuit board.

\$1.00

LINEAR

LM300H	80	LM135 LM	1.65
LM301H	35	LM1418 LM	65
LM302H	25	LM1496 LM	65
LM303H	100	LM155V LM	1.85
LM304H	100	LM155V LM	1.85
LM305H	95	LM155V LM	1.85
LM306H	100	LM155V LM	1.85
LM307H	100	LM155V LM	1.85
LM308H	100	LM155V LM	1.85
LM309H	100	LM155V LM	1.85
LM310H	100	LM155V LM	1.85
LM311H	100	LM155V LM	1.85
LM312H	100	LM155V LM	1.85
LM313H	100	LM155V LM	1.85
LM314H	100	LM155V LM	1.85
LM315H	100	LM155V LM	1.85
LM316H	100	LM155V LM	1.85
LM317H	100	LM155V LM	1.85
LM318H	100	LM155V LM	1.85
LM319H	100	LM155V LM	1.85
LM320H	100	LM155V LM	1.85
LM321H	100	LM155V LM	1.85
LM322H	100	LM155V LM	1.85
LM323H	100	LM155V LM	1.85
LM324H	100	LM155V LM	1.85
LM325H	100	LM155V LM	1.85
LM326H	100	LM155V LM	1.85
LM327H	100	LM155V LM	1.85
LM328H	100	LM155V LM	1.85
LM329H	100	LM155V LM	1.85
LM330H	100	LM155V LM	1.85
LM331H	100	LM155V LM	1.85
LM332H	100	LM155V LM	1.85
LM333H	100	LM155V LM	1.85
LM334H	100	LM155V LM	1.85
LM335H	100	LM155V LM	1.85
LM336H	100	LM155V LM	1.85
LM337H	100	LM155V LM	1.85
LM338H	100	LM155V LM	1.85
LM339H	100	LM155V LM	1.85
LM340H	100	LM155V LM	1.85
LM341H	100	LM155V LM	1.85
LM342H	100	LM155V LM	1.85
LM343H	100	LM155V LM	1.85
LM344H	100	LM155V LM	1.85
LM345H	100	LM155V LM	1.85
LM346H	100	LM155V LM	1.85
LM347H	100	LM155V LM	1.85
LM348H	100	LM155V LM	1.85
LM349H	100	LM155V LM	1.85
LM350H	100	LM155V LM	1.85
LM351H	100	LM155V LM	1.85
LM352H	100	LM155V LM	1.85
LM353H	100	LM155V LM	1.85
LM354H	100	LM155V LM	1.85
LM355H	100	LM155V LM	1.85
LM356H	100	LM155V LM	1.85
LM357H	100	LM155V LM	1.85
LM358H	100	LM155V LM	1.85
LM359H	100	LM155V LM	1.85
LM360H	100	LM155V LM	1.85

IC SOLEORTAL — LOW PROFILE (TIN) SOCKETS

8 pin	1-24	25-49	50-100	1-24	25-49	50-100
\$1.17	16	15	24	\$3.38	37	36
\$1.17	20	19	28	\$4.44	44	43
\$1.17	22	21	30	\$5.50	51	50
\$1.17	24	23	32	\$6.56	58	57

SOLEORTAL STANDARD (TIN)

14 pin	5-27	25	24	28 pin	5-99	90	81
\$1.17	30	27	25	36 pin	1.59	1.26	1.15
\$1.17	32	29	27	40 pin	1.59	1.45	1.30

SOLEORTAL STANDARD (GOLD)

8 pin	5-30	27	24	28 pin	5-70	63	57
\$1.17	35	32	29	36 pin	1.10	1.00	90
\$1.17	38	35	32	40 pin	1.75	1.50	1.45
\$1.17	42	39	36	48 pin	1.75	1.59	1.25

WIRE WRAP SOCKETS (GOLD) LEVEL #3

10 pin	5-45	41	37	24 pin	5-105	95	85
\$1.17	48	45	42	28 pin	1.40	1.25	1.10
\$1.17	52	49	46	36 pin	1.59	1.45	1.30
\$1.17	56	53	50	40 pin	1.75	1.55	1.40

ZENERS — DIODES — RECTIFIERS

TYPE	VOLTS	W	PRICE	TYPE	VOLTS	PRICE
1N4748	3.3	400m	41.00	1N4005*	50V	1.00
1N4751	5.1	400m	41.00	80V	1.00	1.00
1N4752	6.2	400m	41.00	100V	1.00	1.00
1N4753	8.2	400m	41.00	150V	1.00	1.00
1N4754	10	400m	41.00	200V	1.00	1.00
1N4755	15	400m	41.00	250V	1.00	1.00
1N4756	20	400m	41.00	300V	1.00	1.00
1N4757	25	400m	41.00	350V	1.00	1.00
1N4758	30	400m	41.00	400V	1.00	1.00
1N4759	35	400m	41.00	450V	1.00	1.00
1N4760	40	400m	41.00	500V	1.00	1.00
1N4761	45	400m	41.00	550V	1.00	1.00

CRYSTALS

THESE FREQUENCIES ONLY

Part #	Frequency	Case/Style	Price
CY1A	1.000 MHz	HC33/U	\$4.95
CY2A	2.000 MHz	HC33/U	\$4.95
CY3A	4.000 MHz	HC18/U	\$4.95
CY7A	5.000 MHz	HC18/U	\$4.95
CY12A	10.000 MHz	HC18/U	\$4.95
CY14A	14.31818 MHz	HC18/U	\$4.95
CY19A	19.000 MHz	HC18/U	\$4.95
CY22A	20.000 MHz	HC18/U	\$4.95
CY30B	32.000 MHz	HC18/U	\$4.95

CLOCK CHIPS — CALCULATOR CHIPS

MMS309	6 Digit, BCD Outputs, Reset PIN.	\$5.95
MMS311	6 Digit, BCD Outputs, 12 or 24 Hour	4.95
MMS312	4 Digit, BCD Outputs, 1 PPS Output	4.95
MMS313	8 Digit, BCD Outputs, 1 PPS Output	4.95
MMS314	6 Digit, 12 or 24 Hour, 50 or 60 Hz	4.95
MMS316	4 Digit, Alarm, 1 PPS Output	6.95
MMS318	Video Clock Chip. For Use With MMS641	9.95
CT7001	6 Digit, Calendar, Alarm, 12 or 24 Hour	6.95

CALCULATOR CHIPS

MMS725	6 Digit, Four Function, Less Decimal	\$2.95
MMS738	8 Digit, 5 Function, π , \ln , X , $\frac{1}{X}$, $\%$	2.95
MMS739	8 Digit, 4 Function, Floating Decimal	2.95
CT5001	12 Digit, 4 Function	3.95
CT5005	12 Digit, 4 Function with Memory	5.95
CT5030	12 Digit, 4 Function and $\%$	7.95

MISC. MOS

MMS520	TV Camera Sync. Generator	\$19.95
MMS530	4 1/2 Digit DVM Chip	9.95
MMS569	60 Hz Timebase Circuit From 3.58 MHz	5.00
MMS581	Video Generator For MMS516	18.00
MC1408-17	7 Bit Digital to Analog Converter	9.95
MKS507	4 Decade Counter with Latches	10.95
LD10/LD111	3 1/2 Digit DVM Chip Set	25.00
95490	100 kHz \pm 10 Counter For Prescalars	13.95

FILAMENT TRANSFORMERS

Part #	Secondary Voltage	Primary Voltage	Power	Price
F-7X	150	115	1.5	\$1.10
F-13X	150	115	3.0	\$1.10
F-14X	150	115	4.5	\$1.80
F-16X	150	115	6.0	\$3.35
F-18X	150	115	7.5	\$3.25
F-40X	150	115	40.0	\$7.00
F-45X	150	115	45.0	\$7.50
F-54X	150	115	54.0	\$8.50

VECTOR WIRING PENCIL



Vector Wiring Pencil P173 consists of a hand held featherweight (under one ounce) tool which is used to guide and wrap insulated wire, lead off a self-contained replaceable bobbin, into component leads or terminals installed on pre-punched "P" Pattern Vectorboard. Connections between the wrapped wire and component leads, pads or terminals are made by soldering. Complete with 250 FT. of red wire. **\$9.50**

REPLACEMENT WIRE — BOBBINS FOR WIRING PENCIL

W36-A-Pkg.	3	250 ft. 36 AWG GREEN	\$2.40
W36-B-Pkg.	3	250 ft. 36 AWG RED	\$2.40
W36-C-Pkg.	3	250 ft. 36 AWG CLEAR	\$2.40
W36-D-Pkg.	3	250 ft. 36 AWG BLUE	\$2.40

1/16 VECTOR BOARD

Part No.	Material	Price
PHENOLIC	64P44 062XXXP	4.50
	169P44 02XKXK	4.50
EPONDY GLASS	64P44 062	4.50
	169P44 062	4.50
EPONDY GLASS COPPER CLAD	169P44 062C1	4.50

VECTOR TERMINALS

Series	Part No.	Finish	Post Size	Gold	Tin	Price
144	144-1	144	025 .54	1.50 lot	1.00 lot	1.75 lot
146	146-1	146	028 .54	1.75 lot	1.25 lot	2.25 lot
149	149A	149	025 .54	1.75 lot	1.25 lot	2.25 lot
T42-1	PKG. 100	Terminals	\$3.00 C	\$13.00M		

DIP SWITCH

These switches feature seven SPST slide switches in a molded dip. They are ideally suited for microprocessor applications. **\$1.95**

SCR ANO FW BRIDGE RECTIFIERS

C360	15A @ 400V	SCR	\$1.95
C38M	35A @ 200V	SCR	1.35
2N2328	1.6A @ 200V	SCR	1.95
MDA 980-1	15A @ 50V	PW BRIDGE REC.	1.95
MDA 980-3	25A @ 200V	PW BRIDGE REC.	1.95

64 KEY KEYBOARD

This keyboard features 64 unenclosed SPST keys, unattached to any kind of P.C.B. A very solid molded plastic 13" x 4 1/2" base suits most applications. **\$19.95**

JOYSTICK



These joysticks feature four 100K potentiometers, that vary resistance proportional to the angle of the stick. Sturdy metal construction with plastic components only at the movable joint. Perfect for electronic games and instrumentation. **\$9.95 ea.**

MICROPROCESSOR COMPONENTS

8080 SUPPORT DEVICES

8080A	8212	8 BIT INPUT/OUTPUT PORT FOR 8080	\$ 5.95	8080	5.00
\$37.95	8224	CLOCK GENERATOR AND DRIVER FOR 8080	12.95	\$24.95	
	8228	SYSTEM CONTROLLER AND BUS DRIVER FOR 8080	12.95		

Part #	Description	Price
8008	8 BIT CPU	\$19.95
8080	Super 8008	24.95
8080A	Super 8080	37.95
2504	1024 Dynamic SR S	5.00
2518	Hex 32 BIT	7.00
2519	Hex 40 BIT	4.00
2524	512 Dynamic	2.95
2525	1024 Dynamic	6.00
2527	Dual 256 BIT	3.55
2529	Dual 512 BIT	4.80
2532	1024 80 BIT	3.15
2533	1024 Static	7.85
3341	16 x 4 Reg. File	6.15
74LS870	16 x 4 Reg. File	3.15
AY-5-1013	30K Base	5.65
2513	Char. Gen.	511.00
2516	Char. Gen.	13.00
74S387	1024-Bit Programmable	1.35

2K RAM SPECIAL

MMS262 Fully Decoded 2Kx1 Dynamic RAM. All inputs except clocks are TTL compatible. Provides a 635 ns minimum access time, and requires: $V_{CC} = +5V$, $V_{EE} = 0V$, and $-15V$ power supply. Low power, provides non-volatile memory using battery back-up. **\$0.99 ea. (0.05 cents per bit)**

Special Requested Items

RC4184	Dual Track V Reg	\$ 5.95	80797	\$ 2.00	MKS070	\$10.95	MC4044	\$ 4.50
RC4195	15V Track Reg	3.25	4024P	2.25	8063	5.95	LM3095	1.25
FD365	Decoder	3.95	DM8190	3.25	8267	2.75	MMS320	19.25
LD110/111	DVM Chip Set	25.00	9322	1.30	8288	1.15	4072AE	.45
CA3130	Super CMOS Op Amp	1.49	MC140176	.55	8285	3.00	7422	1.50
MC1408L7	D/A	9.95	2525	6.00	8880	2.50	7497	4.00
F3341	P/F0	6.95	2527	3.55	511AE	2.50	74156	5.00
MMS481	Character Gen.	18.00	CD4518	2.50	804136	2.00	74279	.90
AVS-9100	Push Button Dialer	17.50	MMS309	5.95	4565AE	3.00	82590	4.00

Continental Specialties



Proto Board 100 **\$75**
Proto Board 100 is a 100-pin breadboard with 100 pins. It is designed for prototyping ICs and other components. **\$75**



Proto Board 100 **\$19.95**
Proto Board 100 is a 100-pin breadboard with 100 pins. It is designed for prototyping ICs and other components. **\$19.95**



Proto Board 100 **\$29.95**
Proto Board 100 is a 100-pin breadboard with 100 pins. It is designed for prototyping ICs and other components. **\$29.95**



Proto Board 100 **\$39.95**
Proto Board 100 is a 100-pin breadboard with 100 pins. It is designed for prototyping ICs and other components. **\$39.95**



Proto Board 100 **\$49.95**
Proto Board 100 is a 100-pin breadboard with 100 pins. It is designed for prototyping ICs and other components. **\$49.95**



Proto Board 100 **\$59.95**
Proto Board 100 is a 100-pin breadboard with 100 pins. It is designed for prototyping ICs and other components. **\$59.95**



Proto Board 100 **\$69.95**
Proto Board 100 is a 100-pin breadboard with 100 pins. It is designed for prototyping ICs and other components. **\$69.95**

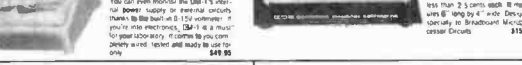

Proto Board 100 **\$79.95**
Proto Board 100 is a 100-pin breadboard with 100 pins. It is designed for prototyping ICs and other components. **\$79.95**

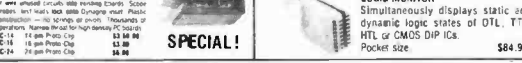

Proto Board 100 **\$89.95**
Proto Board 100 is a 100-pin breadboard with 100 pins. It is designed for prototyping ICs and other components. **\$89.95**

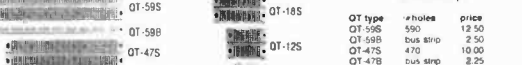

Proto Board 100 **\$99.95**
Proto Board 100 is a 100-pin breadboard with 100 pins. It is designed for prototyping ICs and other components. **\$99.95**

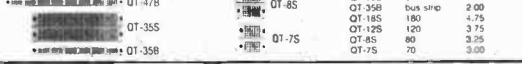

Proto Board 100 **\$109.95**
Proto Board 100 is a 100-pin breadboard with 100 pins. It is designed for prototyping ICs and other components. **\$109.95**



Proto Board 100 **\$119.95**
Proto Board 100 is a 100-pin breadboard with 100 pins. It is designed for prototyping ICs and other components. **\$119.95**

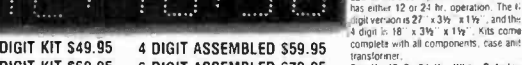

Proto Board 100 **\$129.95**
Proto Board 100 is a 100-pin breadboard with 100 pins. It is designed for prototyping ICs and other components. **\$129.95**

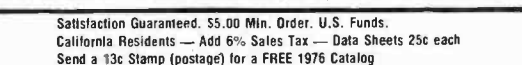

Proto Board 100 **\$139.95**
Proto Board 100 is a 100-pin breadboard with 100 pins. It is designed for prototyping ICs and other components. **\$139.95**



Proto Board 100 **\$149.95**
Proto Board 100 is a 100-pin breadboard with 100 pins. It is designed for prototyping ICs and other components. **\$149.95**

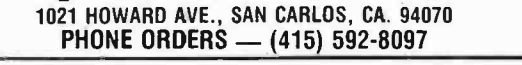

Proto Board 100 **\$159.95**
Proto Board 100 is a 100-pin breadboard with 100 pins. It is designed for prototyping ICs and other components. **\$159.95**

AUTOTEL

WARNING LIGHTS ARE NOT ENOUGH



AN AUDIBLE ALARM INDICATING POTENTIAL ENGINE DAMAGE

AUTOTEL is an efficient (15 ma current standby) device by which every owner of an automobile, truck or vehicle equipped with indicator lights for temperature and oil pressure can be assured of a reliable warning before an impending failure. AUTOTEL, by means of an audible signal (70 db pulsing) immediately forewarns the vehicle operator of a malfunction or failure, allowing time to correct and prevent major engine failures. It is programmed so there is no sound during normal operating conditions. AUTOTEL features CMOS circuitry, packaged in a 2 1/2" sq. x 1/2" case. The kit comes complete with all components, hardware and case to hook directly into your car's warning light system. **\$14.95 Assembled \$9.95 Per Kit**

IMS 3 1/2 DIGIT DVM KIT

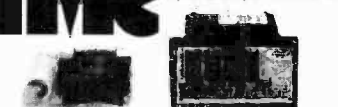

This D-2 VDC .05 per cent digital voltmeter features the Motorola 3 1/2 digit DVM chip set. It has a 4' LED display and operates from a single +5V power supply. The unit is provided complete with an injection molded black plastic case complete with Bezel. An optional power supply is available which fits into the same case as the D-2 VDC allowing 117 VAC operation. **A. 0-2V DVM with Case \$49.95**
B. 5V Power Supply \$14.95

JE700 CLOCK

The JE700 is a low cost digital clock, but is a very high quality unit. The unit features a simulated wallcut case with dimensions of 6" x 2 1/2" x 1". It utilizes a MAN72 high brightness red/white, and the MMS314 clock chip. **\$17.95**

Liquid Crystal Temperature Display

This clock makes an attractive addition to any desk. It has an extruded, black anodized aluminum case. It displays hours, minutes, and seconds with 11 inch displays, and comes complete with a liquid crystal thermometer. It operates off 115 VAC at 50 or 60 Hz. **\$24.95**

JE803 PROBE

The Logic Probe is a unit which is for the most part indistinguishable in probe shooting logic families TTL, DTL, RTL, CMOS. It derives the power it needs to operate directly off of the circuit under test, drawing a scant 10 mA max. It uses a MAN3 readout to indicate any of the following states by these symbols: (H) = 1 (LOW) = 0 (PULSE) = P. The Probe can detect high frequency pulses to 45 MHz. It can be used at MOS levels or circuit damage will result. **\$9.95 Per Kit**

T²L 5V 1A Supply

This is a standard TTL power supply using the well known LM309K regulator IC to provide a 500 mA current at 5 volts. We try to make things easy for you by providing everything you need in one package, including the hardware for only: **\$9.95 Per Kit**

NIBBLING TOOL

This nibbling tool is perfect for cutting through PCB material. It is designed to cut through 18 gauge material. **\$6.95**

DIAGONAL CUTTER

This diagonal cutter is perfect for cutting through PCB material. It is designed to cut through 18 gauge material. **\$6.95**

THIS MONTH ONLY!!!

C & K Rocker Switch SPDT	2/51.00
6PDT Push Button Switch	2/51.00
MAN 7G Common Anode-Green 3" DISPLAY LED	\$1.25
6" Black 3 Conductor Power Supply Cords	.99
LM309K	.99
2N2222 NPN to 18 Package	8/51.00
JE100 1 1/2" x 1 1/2" PC Mount XFMR.	.79
Primary: 120 VAC @ 50 Hz-60 Hz. Secondary: 10 VAC @ 50 MA and 50 VAC @ 30 MA	
Metallic Aluminum Electrolytic Axial Caps	
47 μ F/25V	8/51.00
100 μ F/25V	7/51.00
220 μ F/16V	7/51.00
470 μ F/15V	5/51.00
470 μ F/50V	2/51.00
10,000 μ F/10V	2/51.00

IMSAI & ALTAIR OWNERS!
IMSAI 8080 Computer
All Boards Completely Plug-
Compatible With Altair 8800

Basic computer includes front panel control board, LED's and switches, 28 amp power supply, expander board and cabinet. . . \$599 Kit, \$931 Assembled. Interchangeable MPU, Memory and I/O Boards. Full IMSAI 8080/Altair 8800 Compatibility. No Hardware Modifications Required. Just Plug In!

Part #	Description	Kit	Assembled
MPU-A	8080 microprocessor board	\$190	\$350
PROM 4-4	4K bytes EPROM board	399	579
EXT	Extender board	39	49
PIC-8	Priority interrupt/interval clock board	125	238
P10 4-1	One-port parallel I/O board	93	140
P10 4-4	Four-port parallel I/O board	156	299
S10 2-1	One-port serial I/O board	125	235
S10 2-2	Two-port serial I/O board	156	299
UCRI-1	Cassette recorder I/O interface board	59	99

NEW UNIQUE 4K RAM BOARD

4K bytes of static RAM, software memory protect, circuits for battery backup, LED's status indicators . . . \$139 Kit, \$179 Assembled.

COMPLETE DOCUMENTATION

Introduction to Microcomputers, 460 pp	\$10
INTEL 8080 Microcomputer Systems User's Manual, 157 pp	7
The T.I. TTL Handbook, 640 pp	10
Pinout Handbook, 54/7400 Series	5
IMSAI 8080 User's Manual	50
BASIC-PLUS Language Manual	17

SEND \$1 FOR NEW IMSAI 8080

ILLUSTRATED 16-PAGE CATALOG TODAY!
TERMS: Check, money order, BankAmericard, Master Charge (include all embossed data on card). 25% non-refundable deposit on C.O.D. 25% cancellation charge on all orders. California residents add 6% sales tax. Prices, terms and specifications subject to change without notice.

IMSAI

IMS Associates, Inc.
 14860 Wicks Blvd., San Leandro, CA 94577
 Phone: (415) 483-2093

PROFESSIONAL quality audio mixer. 6 channel, reverb. PA and recording use. Save 50 percent and more. Easy to build. \$179.50. Free brochure. Neptune Electronics, 934 N.E. 25th, Portland, Oregon 97232.

FREE diodes and catalog! Also Photo Pin Detector Diodes HP5082-4203, \$1.99. BDJ Electronics, 33 Howard, Orangeburg, New York 10962.

B&K TEST EQUIPMENT. 15% discount. Free shipping. Free Catalog. Spacetron, Box 84G, Broadview, IL 60153.

RECEIVERS, Transmitters, Components, Test Equipment. Catalog 25 cents. E. French, P.O. Box 249, Aurora, Ill. 60507.

250 PIECE assortment of hard to find nuts used in the electronics industry. Over 45 different sizes in brass, steel, aluminum. \$4.75 postpaid. Fastening Products, Box 151A, Cheltenham, PA 19012.

HIGH FIDELITY

DIAMOND NEEDLES and Stereo Cartridges at Discount prices for Shure, Pickering, Stanton, Empire, Grado and ADC. Send for free catalog. LYLE CARTRIDGES, Dept. P, Box 69, Kensington Station, Brooklyn, New York 11218.

WANTED

GOLD, Silver, Platinum, Mercury wanted. Highest prices paid by refinery. Ores assayed. Free circular. Mercury Terminal, Norwood, MA 02062.

TAPE AND RECORDERS

RENT 4-Track open reel tapes—free brochure. Stereo-Parli, P.O. Box 7, Fulton, CA 95401.

1930-1962 Radio Programs. Reels, \$1.00 Hour! Cassettes, \$1.00 Show! . . . Mammoth Catalog, \$1.25. AM Treasures, Box 192PE, Babylon, N.Y. 11702.

COLOR VIDEO TAPE RECORDER: \$250; TV Camera: \$150; VideoTapes: \$5; Cartrivision tools, manuals, parts. Trimble, 5835 Herma, San Jose, CA 95123.

RECORDS—TAPES! Discounts to 73%; all labels; no purchase obligations; newsletter; discount dividend certificates; 100% guarantees. Free details. Discount Music Club, 650 Main St., Dept 5-86, New Rochelle, New York, N.Y. 10801.



LOGIC PROBE KIT—Use with CMOS, TTL, DTL, RTL, HTL, HiNHL and most MOS IC's. Built-in protection against polarity reversal and overvoltage. Draws only a few mA from circuit under test. Dual LED readout. Complete kit includes case and clip leads. \$8.95

VARIABLE REGULATED POWER SUPPLY KIT—Continuously variable from 3 to over 150 Volts. Short-circuit proof with electronic current limiting at 300 mA. Compact size and typical regulation of 0.1% make this a great bench or lab power supply. \$11.95

FIXED REGULATED POWER SUPPLY KITS—Short circuit proof with thermal current limiting. Compact size and typical regulation of 0.5% make these ideal for most electronic projects. Available for 5V @ 500mA, 6V @ 500mA, 9V @ 500mA, 12V @ 400mA, 15V @ 300mA. Specify voltage when ordering. \$8.95 ea.

These easy-to-assemble kits include all components, complete detailed instructions and plated fiberglass PC boards. Power supply kits do not include case or meters. Add \$1.25 per kit for postage and handling.

TRANSISTORS (NPN)

2N918 TYPE RF Amp & Oscillator to 1 GHz	3/\$1.00
2N3563 TYPE RF Amp & Osc to 1 GHz (pl. 2N918)	6/\$1.00
2N3565 TYPE Gen. Purpose Gain (TO-92/106)	6/\$1.00
2N3866 TYPE RF Power Amp 1.5 W @ 450 MHz	50.75
2N3904 TYPE GP Amp & Sw to 100 mA hFE 100	6/\$1.00
Assort. NPN GP TYPES, e.g. 2N3694, 2N3903, etc. (15)	\$2.00
2N3638 TYPE (PNP) GP Amp & Sw to 300 mA	6/\$1.00
2N3906 TYPE (PNP) GP Amp & Sw to 30 MHz	6/\$1.00

FET's:

N-CHANNEL (LOW-NOISE)	
2N4091 TYPE RF Amp & Switch (TO-18/106)	3/\$1.00
2N4418 TYPE RF Amplifier to 450 MHz (TO-18)	2/\$1.00
2N5163 TYPE Gen. Purpose Amp & Sw (TO-106)	3/\$1.00
2N5486 TYPE RF Amp to 450 MHz (plastic 2N4416)	2/\$1.00
E100 TYPE Low-Cost Audio Amplifier	4/\$1.00
ITE4888 TYPE Ultra-Low Noise Audio Amp	2/\$1.00
TIS74 TYPE High-Speed Switch 401	3/\$1.00
Assort. RF & GP FET's, e.g. 2N5163, MPF102, etc. (8)	\$2.00
P-CHANNEL	
2N4360 TYPE Gen. Purpose Amp & Sw (TO-106)	3/\$1.00
E175 TYPE High-Speed Switch 125C (TO-106)	3/\$1.00

SUPER SPECIALS:

2N2222 NPN TRANSISTOR GP Amp & Switch	6/\$1.00
2N2905 PNP TRANSISTOR GP Amp & Switch	6/\$1.00
2N3553 RF Power Amp 5 W @ 150 MHz, 7 W @ 50 MHz	\$1.50
MPF102 N-CHANNEL FET RF Amp-200 MHz	3/\$1.00
556 ULCO 555 TIMER 1-use to 1 hour (DIP)	\$0.90
723 VOLT. REGULATOR 3.30 V @ 1200 mA (DIP/TO-5)	3/\$1.00
2740 FET Op Amp, Like NE536 and μ A740 (TO-5)	\$1.95
μ A7805 VOLTAGE REGULATOR 5 V @ 1 A (TO-220)	\$1.25
8038 WAVEFORM GENERATOR Wave/wkts	\$4.50
1N4154 DIODE 30 V/10mA-1N914 except 30 V	25/\$1.00
BR1 BRIDGE RECTIFIER 50 V PIV, 500 mA (DIP)	4/\$1.00
MM5531A DIGITAL CLOCK CHIP-With Specs/Schematics	\$4.95

LINEAR IC's:

308 Micro-Power Op Amp (TO-5/MINI-DIP)	\$1.00
309K Voltage Regulator 5 V @ 1 A (TO-3)	\$1.25
324 Quad 741 Op Amp, Compensated (DIP)	\$1.50
340T Volt. Reg.-1 Amp-Specify 5, 6, 12, 15 or 24 V-w/ckts	\$1.75
380 2-5 Watt Audio Amplifier 34 dB (DIP)	\$1.29
555 Timer 1 μ s to 1 hr. NE555, LM555, etc. (MINI-DIP)	2/\$1.00
709 Popular Op Amp (DIP/TO-5)	\$0.29
739 Dual Low-Noise Audio Preamp/Op Amp (DIP)	\$1.00
1458 Dual 741 Op Amp (MINI-DIP)	2/\$1.00
741 Freq. Comp. Op Amp (DIP/TO-5/MINI-DIP)	4/\$1.00

DIODES:

ZENERS—Specify Voltage 3.3, 3.9, 4.3, 5.1, 6.8, 8.2	400mW 4/\$1.00
9.1, 10, 12, 15, 16, 18, 20, 22, 24, 27, or 33V (\pm 10%)	1 Watt 3/\$1.00
1N914 or 1N4148 TYPE General Purpose 100V/10mA	15/\$1.00
1N3893 TYPE RECTIFIER Stud Mount 400 V/12 A	2/\$1.00
D5 VARACTOR 5-50 W Output @ 30-250 MHz, 7-70 pF	\$5.00
F7 VARACTOR 1-3 W Output @ 100-500 MHz, 5-30 pF	\$1.00

*MAIL NOW! FREE DATA SHEETS supplied with every item from this ad FREE ON REQUEST—741 Op Amp with every order of \$5 or more 749 Dual Op Amp or two E100 FET's with every order of \$10 or more, postmarked prior to 8/31/76. One free item per order.

ORDER TODAY!—All items subject to prior sale and prices subject to change without notice. All items are new surplus parts—100% functionally tested. WRITE FOR FREE CATALOG #7510 offering over 350 semiconductors carried in stock. Send 13¢ stamp
TERMS: Send check or money order (U.S. funds) with order. We pay 1st class postage to U.S., Canada and Mexico (except on kits) \$1.00 handling charge on orders under \$10. Calif. residents add 6% sales tax. Foreign orders add postage COD orders—add \$1.00 service charge.

ADVA ELECTRONICS
 BOX 4181 BY, WOODSIDE, CA 94062
 Tel. (415) 851-0455
 CIRCLE NO. 3 ON FREE INFORMATION CARD

BURGLAR ALARMS

BURGLAR-FIRE alarm supplies and information. Free catalog. Protecto Alarm Sales, Box 357-G, Birch Run, Michigan 48415.

DIALING Unit automatically calls police. Immediate delivery \$29.95. Free literature. S&S Systems, 5619-C St. John, Kansas City, MO 64123. (816) 483-4612.

NOW Available! Discount, Professional, Burglar-Fire Alarm Equipment for the Do-it-Yourselfer. Catalog 50 cents. Emel Electronics, PE8, Box 146, Sheffield, Mass. 01257.

TUBES

RADIO & T.V. Tubes—36 cents each. Send for free Catalog. Cornell, 4213 University, San Diego, Calif. 92105.

TUBES receiving, factory boxed, low prices, free price list. Transletronic, Inc., 1365 39th Street, Brooklyn, N.Y. 11218A, Telephone: 212-633-2800.

TUBES: "Oldies", Latest. Supplies, components, schematics. Catalog Free (stamp appreciated). Steinmetz, 7519-PE Maplewood, Hammond, Ind. 46324.

SAVE 50%! REG. \$30.00 VALUE SPY SCOPE
8x20 MONOCULAR
NOW \$14.95 ppd.

Fantastic bargain in a fine sighting instrument. Top quality 8 X 20mm Spy Scope, a \$30 value, is now offered at \$14.95! Our special purchase saves you 50% . . . and you get fully coated optics; 393-foot field of view. Weighs just two ounces—stores in pocket, purse, glove compartment. Fits in your palm, so you can peer into hard-to-see places without letting your subject know you're spying. Great for bird-watchers and racing fans. Includes neck strap, leatherette 3 1/2 x 1 1/2 x 2" case. Beautiful brushed metal finish. At this special low price, buy two—one for you, one for a gift!

STOCK NO. 1568AV..... JUST \$14.95 ppd.

GIANT FREE CATALOG!

NEW. 172 Pages. Over 4,500 Un-usual Bargains for Hobbyists, Schools, Industry.



EDMUND SCIENTIFIC CO.
 300 EDSCORP BUILDING
 Barrington, N. J. 08007
 (609) 547-3488

America's Greatest
 Science • Optics • Hobby Mart

COMPLETE AND MAIL COUPON NOW

EDMUND SCIENTIFIC CO. 300 Edscorp Bldg., Barrington, N. J. 08007

Send me:

SEND FREE 172 PAGE CATALOG "AV"
 Charge my BankAmericard
 Charge my Master Charge

Interbank No. _____
 Card No. _____
 Expiration Date _____
 30-DAY MONEY-BACK GUARANTEE. You must be satisfied or return any purchase in 30 days for full refund.
 City _____ State _____ Zip _____

Signature _____
 Name _____ Please print
 Address _____

HELPING TO DEVELOP AMERICA'S TECHNOLOGY FOR OVER 30 YEARS.

CIRCLE NO. 25 ON FREE INFORMATION CARD

ARIES brought you the first calculator kit, and the first digital clock kit... and now brings you three of the most innovative electronic kits ever made. The System 300 Electronic Music Synthesizer kit is the most advanced in the world today, regardless of price. The AR-781 is a space-age beauty for any decor. And the wholly solid state AR-830 does the work of a \$400.00 tape memory unit.



WARNING... if you're interested in a music synthesizer, don't make a move until you see our catalog first. It's more like a handbook than a catalog, with hundreds of in-depth photographs and descriptions to explain electronic music principles, and to show equipment to do the job. ARIES now offers a complete complement of modules, keyboards, and cases, matched to the most rigorous professional standards. Starter systems priced as low as \$395.00.

A clear, ruby-red cylinder shows off all six digits of this modern calendar clock. Easy-to-read numbers show the hours, minutes, and seconds, as well as the month and day every ten seconds.



Red LED 7-segment numerals are 0.33" high, in a sturdy cylinder 2-1/2" in diameter and 4-3/4" long, with finished hardwood ends. Time and calendar are controlled by 60 Hz line frequency, with a 12-month movement. Separate time and calendar adjustments. Includes all the components, PC boards, housing, and instructions. Shipping weight 2 lbs. AR-781 Clock Kit \$34.50

Add finger-touch operation to your old-fashioned dial telephone with an ARIES AR-830 Automatic Digital Telephone Dialer. This has the same layout and convenience as Ma Bell, plus other features she doesn't offer yet. For instance... AR-830 always remembers the last number you dialed, in case the line was busy and you want to try again later. Not only that, but the Dialer's memory can store as many as ten of your favorite numbers for one-touch dialing. AR-830 uses standard dialing and muting contacts; consult local tariffs before connecting. Sh. wt. 2 lbs. AR-830 Dialer Kit \$69.50



ARIES INC.
119 Foster Street
Peabody, Mass., 01960
(617) 532-0450

CIRCLE NO. 10 ON FREE INFORMATION CARD

GOVERNMENT SURPLUS

MANUALS for Govt Surplus radios, test sets, scopes. List 50 cents (coin). Books, 7218 Roanne Drive, Washington, D.C. 20021.

JEEPS, TRUCKS, Typically From \$52.40... Automobiles, Boats, Motorcycles, Airplanes, Periscopes, Tools, Clothing, Sports, Camping, Photographic, Electronics Equipment... 200,000 Bid Bargains Nationwide Direct From Government... Low as 2 cents on Dollar! Surplus Catalog and Sales Directory \$1.00 (refundable first order). National Surplus Center, 240 Eastcass-PEL, Joliet, IL 60432.

GOVERNMENT SURPLUS. Buy in your area. How, Where. Send \$2.00. Surplus, 30177-PE Headquarters Building, Washington, D.C. 20014.

EMPLOYMENT OPPORTUNITIES

ELECTRONICS/AVIONICS EMPLOYMENT OPPORTUNITIES. Report on jobs now open. Details FREE. Aviation Employment Information Service, Box 240E, Northport, New York 11768.

LINEAR

301	mDIP	.53	381	DIP	1.7
304	TO-5	.92	383	DIP	1.75
305	TO-5	.82	350	DIP	1.02
307	mDIP TO-5	.30	555	mDIP	.69
308	mDIP TO-5	1.02	556A	DIP	1.71
309K	TO-3	1.35	710	DIP	.69
310	mDIP	1.23	711	DIP	.30
311	mDIP TO-5	1.09	723	DIP	.71
320T	TO-220	733	TO-5	1.02	
5, 12, 15V	1.60	739	DIP	1.23	
320K	TO-3	741	mDIP	.37	
5, 12	1.60	747	DIP TO-5	.82	
324	DIP	1.75	748	mDIP	.40
339	DIP	1.69	1456	mDIP	1.83
340T	TO-220	1458	mDIP	.71	
5, 6, 8, 12	1.71	1800	DIP	2.85	
15, 18, 24V		3900	DIP	.49	
340K	TO-220	8038	DIP	4.89	
5, 6, 8, 12	1.94	75491	DIP	.82	
15, 18, 24V		75492	DIP	.92	
380	DIP	1.30			

ALARM CLOCK CHIP
MMS375AA 4-6 digit, 12 hour, 60Hz snooze alarm, brightness control capability, alarm tone output 24 pin DIP \$4.95

CMOS

4000A	.30	4018A	1.39	4066A	1.02
4001A	.29	4020A	1.49	4068A	.51
4002A	.29	4021A	1.39	4069A	.50
4006A	1.55	4022A	1.10	4071A	-.80
4007A	.30	4023A	.29	4072A	.40
4008A	1.79	4024A	1.02	4073A	.45
4009A	.66	4025A	.29	4075A	.45
4010A	.62	4027A	.68	4078A	.45
4011A	.33	4028A	1.13	4082A	.40
4012A	.29	4030A	.51	4518A	1.89
4013A	.52	4035A	1.46	4528A	1.84
4014A	1.49	4040A	1.39	4585A	2.10
4015A	1.49	4042A	1.49	4901A	.45
4016A	.56	4049A	.68		
4017A	1.19	4050A	.68		

74C00	.25	74C74	1.20	74C162	2.93
74C02	.30	74C76	1.54	74C163	3.06
74C04	.51	74C107	1.30	74C164	3.06
74C08	.78	74C153	3.00	74C173	2.61
74C10	.40	74C154	3.62	74C195	2.66
74C20	.40	74C157	2.02	80C95	1.35
74C42	1.55	74C160	2.85	80C97	1.35
74C73	1.20	74C161	2.93		

CALCULATOR CHIPS

CT5002	12 digit, 4 function fixed decimal - battery operation 40 pin	2.79
CT5005	12 digit, 4 function plus memory, fixed decimal 28 pin	2.99
MMS5725	8 digit, 4 function, floating decimal 28 pin	1.98
MMS5736	6 digit, 4 function, 9V battery operation 18 pin	3.95
MMS5738	8 digit, 5 function plus memory and constant floating decimal, 9V battery operation 24 pin	4.50
MMS5739	9 digit, 4 function, 9V battery operation 22 pin	5.35

MEMORIES

1101	1.50	5262	2.25
1101A	1.95	82523	3.69
1702A	14.95	F93410	1.95
2102	2.95	7489	2.48
5303	10.95	74187	5.95
5260	1.95	74200	5.90
5261	2.19		

CLOCK CHIPS

MMS311	\$4.35	MMS314	4.45
MMS312	3.95	MMS316	5.39
		CT7001	7.95

POCKET CALCULATOR
5 function plus constant - addressable memory with individual recall - 8 digit display plus overflow - battery saver - uses standard or rechargeable batteries - all necessary parts (needs to assemble form instructions included)
Calc. Kit, kit only \$10.95
Batteries (alkaline, disp.) 2.00
Adapter 60Hz 3.95
Kit, Batteries & Adapter 15.95

QUANTITY DISCOUNT NOT APPLICABLE ON THIS ITEM

TANALUM CAPACITORS SOLID-DIPDIP -20%

1 mil	35V	.25 ea.	6.8 mil	50V	30 ea.
.33 mil	35V	.25 ea.	6.8 mil	60V	40 ea.
1 mil	35V	.25 ea.	10 mil	25V	40 ea.
2.2 mil	20V	.25 ea.	15 mil	10V	40 ea.
2.2 mil	35V	.30 ea.	33 mil	10V	40 ea.
4.7 mil	16V	.30 ea.	47 mil	6V	40 ea.

IC SOCKETS
Solder Tail - low profile

8 pin	\$.19	24 pin	.45
14 pin	.22	28 pin	.59
16 pin	.24	40 pin	.69
18 pin	.35		

UNIVERSAL BREADBOARD
Silver plated copper circuit board 1.1" x 5.1" x .16" 2 rows of 25 holes for DIP IC's, space for 100 transistors, resistors & capacitors. Versatile and simple for breadboarding IC circuits. \$1.50 ea.

AUGUST SPECIALS

NSN71L	Red common anode .27"	10/\$ 9.25	100/\$ 82
NSN74	Red common cathode .27"	10/ 9.25	100/ 82
MAN 8	Yellow common anode .27"	10/ 19.00	100/ 165
Discrete	LED Jumbo red	10/ .85	100/ 8
F9340	RAM 256 bit Bi-polar	10/ 15.00	100/ 135
LM301	Op Amp mDIP	10/ 2.38	100/ 21
LM311	Volt Comparator DIP, TO-5	10/ 8.08	100/ 71
LM340T	5V Regulator TO-220	10/ 13.50	100/ 119
75491	Quad Segment Driver DIP	10/ 6.37	100/ 56
7430	8 input gate DIP	10/ 1.78	100/ 16
74121	One Shot DIP	10/ 3.40	100/ 30
7474	Dual D flip-flop DIP	10/ 2.47	100/ 21
723	Precision voltage DIP	10/ 4.25	100/ 37

RESISTOR KIT
Metal film: 1% RN60
Temp. COEF.: 50ppm/C
1/4 watt color banded 400 resistor, 40 values supplied in a 15 drawer, 60 compartment storage cabinet - table or wall mount. Ready to use
11251 \$54.95 ea.
*\$2.00 SHIPPING & HANDLING
SHIPPING VIA UPS OR PARCEL POST

19 6	105	887	8 25K	89 8K
22 5	147	115K	9 31K	84 5A
30 9	232	1 50K	11 8K	80 9K
45 1	309	2 40K	15 0K	103 8A
51 1	499	3 57K	21 5K	147K
71 5	504	4 75K	28 0K	215K
84 5	715	5 48K	40 2K	324K
90 9	805	6 04K	54 9K	454K

DIODE GRAB BAG
400 MW - SIGNAL DIODES, ZENER DIODES, SWITCHING DIODES & RECTIFIERS
30x 1.00
125x 1.00
350x 10.00

PACKAGE OF 10 - DEDUCT 15%
PACKAGE OF 100 - DEDUCT 25%

6 DIGIT LED CLOCK KIT
INCLUDES:
MM314 clock circuit
6 FN070 LED displays (.250" red 7 segment)
All necessary transistors, resistors & capacitors
1 double sided PC board accommodates LED's & clock circuitry
Schematic & instructions
Does not include 12V-300 ma transformer, switches & case \$12.95
QUANTITY DISCOUNT NOT APPLICABLE ON THIS ITEM

FTL

7400	-16	7451	20	74153	1.14
7401	-18	7453	20	74154	1.29
7402	-17	7454	20	74155	1.23
7403	-18	7460	20	74156	1.23
7404	-22	7464	40	74157	1.14
7405	-22	7465	40	74158	2.06
7406	-40	7470	35	74160	1.60
7407	-40	7472	35	74161	1.44
7408	-21	7473	40	74162	1.71
7409	-22	7474	40	74163	1.60
7410	-18	7475	66	74164	1.83
7411	-29	7476	45	74165	1.83
7413	-63	7483	91	74166	1.71
7414	-81	7485	127	74170	2.65
7416	-40	7486	46	74173	1.71
7417	-40	7489	248	74174	1.86
7420	-18	7490	59	74175	1.60
7422	-30	7491	112	74176	1.02
7423	-33	7492	82	74171	.97
7425	-31	7493	69	74180	1.04
7426	-30	7494	108	74181	3.43
7427	-33	7495	91	74182	.91
7430	-33	7496	91	74184	2.29
7432	-26	74100	150	74185	2.29
7437	-40	74105	51	74187	4.50
7438	-40	74107	46	74190	1.35
7440	-20	74121	48	74191	1.35
7441	1.13	74122	52	74192	1.25
7442	89	74123	69	74193	1.19
7443	100	74125	62	74194	1.25
7444	1.00	74126	72	74195	1.02
7445	1.10	74132	102	74916	1.44
7446	1.07	74141	120	74197	1.02
7447	1.02	74145	120	74198	2.06
7448	1.20	74150	112	74199	2.06
7450	-20	74151	91	74200	5.90
				74279	1.08

METAL FILM RESISTORS
-1% WATT

QTY	PRICE	PRICE	PRICE
	EACH	MINIMUM 10	MINIMUM 100
		PER VALUE	PER VALUE
10 - 10	5.20		
10 - 100	.20	5.15	
1000 - 1000		.10	5.04
		.10	.08

RESISTANCE (OHMS)

22.6	71.5	182	887	11.8K	40.2K
23.7	28.7	187	1.15K	13.0K	45.3K
25.5	84.5	191	1.5 K	15.0K	48.7K
30.9	105	205	2.49K	18.2K	54.9K
44.8	110	232	3.57K	19.1K	60.4K
40.2	115	243	4.75K	19.6K	64.9K
45.3	137	499	5.49K	22.6K	69.8K
51.1	147	604	6.04K	24.9K	84.5K
61.9	158	715	7.15K	28.0K	
64.9	178	806	8.25K	37.4K	

Zener Diodes, Diodes & Rectifiers

IN-486B	Diode	250V	\$.25 ea.
IN-715A	Zener	11V	.25
IN-747A	Zener	3.6V	.25
IN-754A	Zener	6.8V	.25
IN-756A	Zener	8.2V	.25
IN-904	Sw. Diode	30V	.10
IN-914	Sw. Diode	100V	.10
IN-4858	Zener	120V	.25
IN-5230A	Zener	4.7V	.25
IN-5242B	Zener	12V	.25

DISPLAYS

MAN1	\$1.95
MAN2	1.95
MAN3A	.19
MAN5	2.95
MAN6	1.95
MAN7	1.49
MAN8	2.95
MAN66	2.95
DL10A	2.19

DISCRETE LED'S

ME4	\$.29
MV50	.15
NSL100	.15
NSL101	.15
NSL102	.15
NSL103	.18
NSL104	.18
NSL105	.18
NSL106	.18
NSL107	.18
NSL108	.18
NSL109	.18
NSL110	.18
NSL111	.18
NSL112	.18
NSL113	.18
NSL114	.18
NSL115	.18
NSL116	.18
NSL117	.18
NSL118	.18
NSL119	.18
NSL120	.18

MISC DEVICES

ULN-2208	14 pin block 14dB mDIP	1.39
ULN-2209	14 pin block 48dB mDIP	1.59
2513	64 x 8 x 5 character generator	11.00
CA 3046	Transistor array 14 pin DIP	.86

5% OFF ON ORDERS OVER \$50.00
10% OFF ON ORDERS OVER \$100.00
15% OFF ON ORDERS OVER \$500.00

LOW POWER

74100	.29	74151	.33	74194	1.71
74102	.29	74155	.38	74191	1.67
74103	.29	74171	.29	74193	1.94
74104	.29	74172	.45	74195	1.94
74106	.29	74173			

PLANS AND KITS

FREE CATALOGUE KITS, COMPONENTS. Audio equipment, Sinclair Kits, radio parts. Gladstone Electronics, 1736 Avenue RD., Toronto, Canada, M5M 3Y7. U.S. Inquiries.

AMAZING ELECTRONIC PRODUCTS

LASERS SUPER POWERED, RIFLE, PISTOL, POKER. SEE IN DARK. PYRO-TECHNICAL, DE-BUGGING, UNCRAMBLERS, GIANT TESLA, STUNWAND, TV DISRUPTER, ENERGY PRODUCING, SCIENTIFIC DETECTION, ELECTRIFYING, CHEMICAL, ULTRASONIC, CB, AERO, AUTO AND MECH. DEVICES, HUNDREDS MORE - ALL NEW PLUS INFO UNLTD PARTS SERVICE.

INFORMATION unlimited

Box 626 Lord Jeffrey PZ. • Amherst, N.H. 03031

CATALOG \$1

ELECTRONICS kits for home or school project. Select from over 50 kits. Many under \$5.00. Send \$1.00 for catalog. Refundable with first order. Graymark, 1751 McGaw Ave., Irvine, CA 92714.

FREE KIT Catalog contains Test and Experimenters' Equipment. Dage Scientific Instruments, Box 1054P, Livermore, CA 94550.

PROFESSIONAL ELECTRONIC MUSIC PRODUCTS Available in kit or assembled form. Plans and parts lists. Catalogue \$2.00. ELECTRONIC PIANO, honkytonk, clavichord, piano / organ switch, two octave synthesizer. Plans \$10.00, Kit \$300.00, Assembled \$450.00. COMBO ORGAN-61 Note, percussion, echo, sustain, bass, piano, glide, rotator, etc. Plans \$10.00, Kit \$500.00, Assembled \$750.00. RHYTHM UNIT-40 pin LSI, 10 patterns, 8 drums, manual drum keyboard, digital beatcounter, LED display, 4 measure patterns. Plans \$8.00, Kit \$150.00, Assembled \$200.00. SKS SYSTEMS KIT, 205 East 17 Street, New York, New York 10003.

SPEAKER LAMP PLANS! Convert lamps to speakers. Send \$3.00 to: B.J. Feeney, 15-10 Skytop Gardens, Parlin, N.J. 08859.

EDUCATIONAL KITS. Introduction to digital IC's. Electronic games. Send stamp. NBL-E, Box 1115, Richardson, Texas 75080.

PROJECTION TELEVISION: Ingenious idea enables you to project a six foot wide picture from your own television. Detailed diagrams with quality optic system only \$15.95. Kelly, Dept. W, Box 8, Levittown, Penna. 19059.

TESLA COIL — 40" SPARKS! Plans \$7.50. Information 75 cents. Huntington Electronics, Box 2009-P, Huntington, Conn. 06484.

BUILD 'CB SAV-R'. Protects CB against theft. Complete plans \$2.00. CB SAV-R, Box 5303, Irving, TX 75062.

INVENTIONS WANTED

INVENTORS: Manufacturers Need New Products. Free "Recommended Procedure," by a creative fee-based invention service company. Washington Inventors Service, 422-T Washington Building, Washington, D. C. 20005.

INVENTORS

RECOGNITION...FINANCIAL REWARD...OR CREDIT FOR "INVENTING IT FIRST" MAY BE YOURS!

If you have an idea for a new product, or a way to make an old product better, contact us, "the idea people" We'll develop your idea, introduce it to industry, negotiate for cash sale or royalty licensing. Write now without cost or obligation for free information. Fees are charged only for contracted services. So send for your FREE "Inventor's Kit." It has important Marketing Information, a special "Invention Record Form" and a Directory of 500 Corporations Seeking New Products.

RAYMOND LEE ORGANIZATION
230 Park Avenue North, New York, NY 10017

At no cost or obligation, please rush my FREE "Inventor's Kit No. A-112"

Name Please Print

Address

City State Zip

FREE PAMPHLET: "Tips on Marketing Your Invention," from an experienced fee-based invention service company. Write United States Inventors Service Company, Dept. T, 1435 G Street NW, Washington, D. C. 20005.

BUSINESS OPPORTUNITIES

I MADE \$40,000.00 Year by Mailorder! Helped others make money! Free Proof. Torrey, Box 318-NN, Ypsilanti, Michigan 48197.

FREE CATALOGS. Repair air conditioning, refrigeration. Tools, supplies, full instructions. Doolin, 2016 Canton, Dallas, Texas 75201.

MAILORDER MILLIONAIRE helps beginners make \$500 weekly. Free report reveals secret plan! Executive (1K8), 333 North Michigan, Chicago 60601.

PIANO TUNING LEARNED QUICKLY AT HOME! Musical knowledge unnecessary. Free information. Empire School, Box 450327, Miami 33145.

GET RICH with Secret Law that smashes debts and brings you \$500 to \$5 Million cash. Free report! Credit 4K8, 333 North Michigan, Chicago 60601.

HIGHLY PROFITABLE ONE-MAN ELECTRONIC FACTORY

Investment unnecessary, knowledge not required, sales handled by professionals. Postcard brings facts about this unusual opportunity. Write today! Barta-DH, Box 248, Walnut Creek, CA 94597.

FREE SECRET BOOK "2042 UNIQUE, Proven Enterprises" Fabulous "Little Knowns". Work home! Haylins-B. Carlsbad, Calif. 92008.

\$178 WEEKLY, Work one hour daily. Completely Guaranteed. Free. FAS, Box 13703-R, San Antonio, Texas 78213.

HOW TO MAKE \$2,000 WEEKLY at home using other people's money. Guaranteed. Free details. Richlieu, Box 25277, Dept. F7, Houston, Texas 77005.

FREE DETAILS on how to borrow \$300-\$3,000 entirely by mail. Write Postal Finance, Dept 613-07, 6018 Maple, Omaha, Nebraska 68104.

REAL ESTATE

ANNOUNCING! FREE NEW FALL 1976 Catalog! Describes over 2,600 properties from coast to coast! UNITED FARM AGENCY, 612-EP, West 47th St., Kansas City, MO 64112.

INTEL 8080 CPU	\$29.50
2518-HEX 32 BIT SR	\$6.00
2102-1 1024 BIT RAM	\$2.60
5202A UV PROM	\$12.50
MM5203 UV PROM	\$12.50
1702A UV PROM	\$12.50
5204-K PROM	\$24.95
MINIATURE MULTI-TURN TRIM POTS 100, 500, 5K, 10K, 25K, 50K, 100K, 200K, \$.75 each, 3/52, 00	
MULTI-TURN TRIM POTS Similar to Bouras 3010 style 3/16" x 5/8" x 1-1/4", 50, 100, 1K, 10K, 50K ohms	
SI-50 ea.	3/\$4.00
LIGHT ACTIVATED SCR's	
TO-18, 200V 1A.	\$ 1.75
TRANSISTOR SPECIALS	
2N3985 NPN Si TO-66	\$.95
2N3772 NPN Si TO-3	\$ 1.60
2N4908 PNP Si TO-3	\$ 1.00
2N6055 NPN Si TO-3 Darlington	\$ 1.30
2N5086 PNP Si TO-92	4/\$ 1.00
2N4898 PNP TO-66	\$.60
2N404 PNP GE TO-5	5/\$ 1.00
2N3919 NPN Si TO-3 RF	\$ 1.50
MPSA 13 NPN Si TO-92	3/\$ 1.00
2N3767 NPN Si TO-66	\$.70
2N2222 NPN Si TO-18	5/\$ 1.00
2N3055 NPN Si TO-3	\$.80
2N3904 NPN Si TO-92	5/\$ 1.00
2N3906 PNP Si TO-92	5/\$ 1.00
2N5296 NPN Si TO-20	\$.50
2N6109 PNP Si TO-20	\$.55
2N3886 NPN Si TO-5 RF	\$.75
2N3638 PNP Si TO-5	5/\$ 1.00
2N6517 NPN TO-92 Si	3/\$ 1.00
CIMOS (DIODE CLAMPED)	
74C02 - 25 4016 - 40 4035 - 1.18	
74C10 - 25 4017 - 1.10 4042 - .68	
4001 - 19 4018 - 1.20 4046 - 2.20	
4002 - 19 4019 - .45 4047 - 2.20	
4006 - 1.20 4022 - 1.00 4049 - .43	
4007 - 19 4023 - 19 4050 - .43	
4009 - .47 4024 - .85 4055 - 1.45	
4010 - .47 4025 - 19 4066 - .70	
4011 - 19 4027 - .48 4071 - .25	
4012 - 19 4028 - .85 4077 - .25	
4013 - .35 4029 - .95 4081 - .25	
4015 - 1.10 4030 - .95 4076 - 1.20	
LED READOUTS	
FND 500-.5" C.C.	\$1.75
HP 7740-.3" C.C.	\$1.40
MAN-4-.25" C.C.	\$1.20
MAN-7-.3" C.C.	\$1.25
NS 39-3 dig. array	\$1.35

PRINTED CIRCUIT BOARD	
4-1/2" x 6-1/2" SINGLE SIDED EPOXY BOARD 1/16" thick, unetched	\$5.50 ea.
VECTOR BOARD 1" SPACING 4.5" x 6" SHEET	\$1.50
4 WATT IR LASER DIODE \$7.95	
2N 5460 P FET	\$.45
2N 5457 N FET	\$.45
2N 4891 UJT.	\$.45
TIS 43 UJT	\$.35
ER 900 TRIGGER DIODES	4/\$1.00
2N 6028 PROG. UJT	\$.65
VERIPAX PC BOARD	
This board is a 1/16" single sided paper epoxy board, 4 1/2" x 6 1/2" DRILLED and ETCHED which will hold up to 21 single 14 pin IC's or 8, 16, or LSI DIP IC's with busses for power supply connector. \$4.00	
MV 5691 YELLOW-GREEN	
BIPOLAR LED	\$1.25
MT-2 PHOTO TRANS	\$.60
RED, YELLOW, GREEN OR	
AMBER LARGE LED's	ea. \$.20
14 PIN DIP SOCKETS	\$.35
16 PIN DIP SOCKETS	\$.35
MOLEX PINS	1000/\$1.00
8 PIN MINI DIP SOCKETS	\$3.00
10 WATT ZENERS 3.9, 4.7, 18 OR 22V	ea. \$.60
1 WATT ZENERS 4.7, 5.6, 10, 12, 15, 18 OR 22V	ea. \$.25
Silicon Power Rectifiers	
PRV 1A 3A 12A 50A 125A	
100 06 14 .30 .80 3.70	
200 07 20 .35 1.15 4.25	
400 09 25 .50 1.40 6.50	
600 11 30 .70 1.80 8.50	
800 15 35 .90 2.30 10.50	
1000 20 45 1.10 2.75 12.50	

SILICON SOLAR CELLS	
2 1/4" diameter	
.5V at 500 ma. . . . \$5.00 ea., 6/\$27.50	

REGULATED MODULAR POWER SUPPLIES	
+ 15 VDC AT 100ma	
115VAC INPUT	\$27.95
5VDC AT 1A, 115VAC INPUT	\$24.95
12 VDC AT 5A	\$24.95
IN 4148 (IN914)	15/\$1.00

TANTULUM CAPACITORS	
22UF 35V 5/161.00	6.8UF 35V 3/161.00
47UF 35V 5/161.00	33UF 25V \$.40
68UF 35V 5/161.00	30UF 6V 5/161.00
1UF 35V 5/161.00	150UF 20V \$.50
4.7UF 35V 4/161.00	
CT7001 ALARM CLOCK CHIP	\$5.75
NATIONAL MOS DEVICES	
MM1402-3.20	MM5057-4.00
MM1403-3.20	MM5058-4.95
MM1404-2.50	MM5060-4.95
MM5013-7.75	MM5061-4.30
MM5016-3.75	MM5555-6.25
MM5017-4.75	MM5556-6.25
MM5055-4.00	MM5210-1.95
MM5056-4.00	MM5260-2.95

TTL IC SERIES		
74L00 - 25	7442 - 50	74126 - 48
7400 - 15	7445 - 79	74150 - 1.00
7401 - 15	7446 - 79	74151 - 64
7402 - 15	7447 - 79	74153 - 69
7403 - 18	7448 - 75	74154 - 1.05
7404 - 18	7472 - 28	74155 - 79
7405 - 18	7473 - 32	74157 - 65
7406 - 35	7474 - 32	74161 - 99
7407 - 35	7475 - 50	74164 - 85
7408 - 18	7476 - 35	74165 - 1.05
7409 - 18	7480 - 42	74173 - 1.30
7410 - 15	7483 - 71	74174 - 1.00
7411 - 25	7485 - 95	74175 - 90
7412 - 30	7486 - 33	74177 - 79
7413 - 45	7488 - 33	74180 - 72
7414 - 80	7489 - 2.00	74181 - 2.10
7416 - 27	7490 - 47	74190 - 1.15
7417 - 33	7491 - 69	74191 - 1.10
7420 - 15	7493 - 47	74192 - 1.00
7425 - 24	7494 - 76	74193 - 1.00
7427 - 28	7495 - 70	74194 - 95
7430 - 15	7496 - 73	74195 - 72
7432 - 24	7497 - 30	74196 - 94
7437 - 25	74121 - 37	74283 - 1.50
7438 - 25	74123 - 65	75324 - 1.75
7440 - 15	74125 - 49	75491 - 60
7441 - 82	74125 - 49	75492 - 60

MINIATURE DIP SWITCHES	
CTS-206-4 Four SPST switches in one minidip package.	\$1.50
CTS-206-8 Eight SPST switches in a 16 pin DIP package.	\$2.55
AY-5-1013-A30K ser./par., par./ser., universal UART. \$8.50	

ALCO MINIATURE TOGGLE SWITCHES	
MTA 106 SPDT	\$1.20
MTA 206 DPDT	\$1.70

Full Wave Bridges			
SANKEN AUDIO POWER AMPS			
SI 1010 G 10 WATTS	\$ 6.90		
SI 1020 G 20 WATTS	\$13.95		
SI 1050 G 50 WATTS	\$24.95		
PRV	2A	6A	25A
200	.95	1.25	2.00
400	1.15	1.50	3.00
600	1.35	1.75	4.00
CD 110 LINEAR 256 X1 BIT SELF SCANNING CHARGED COUPLED DEVICE	\$99.00		

LINEAR CIRCUITS	
LM 309K 5V 1A REGULATOR	\$1.00
723 - 40 + 40V REGULATOR	\$.50
301748 Hi Per. Op. Amp.	\$.28
320T 5, 12, 15, OR 24V NEGATIVE REG.	\$1.35
741A OR 741C OP AMP.	\$.28
710 COMPARATOR	\$.32
307 OP AMP	\$.25
CA 3047 Hi Per. Op. Amp.	\$.95
340T 5, 6, 8, 12, 15, 18, 24V POS REG. TO-220	\$1.20
101 OPER. AMP. HI PERFORM.	\$.75
LM 308 Oper. Amp., Low Power	\$1.05
747 - DUAL 741	\$.65
556 - DUAL TIMER	\$.95
537 - PRECISION OP. AMP.	\$1.70
540-70W POWER DRIVE	\$2.75
LM 3900 - QUAD OP. AMP	\$.49
LM 324 - QUAD 741	\$1.05
560 - PHASE LOCK LOOP	\$2.00
561 - PHASE LOCK LOOP	\$2.00
565 - PHASE LOCK LOOP	\$1.50
566 FUNCTION GEN.	\$1.65
567 - TONE DECODER	\$1.75
LM 1310N FM STEREO DEMOD.	\$2.75
8038 IC VOLTAGE CONT. OSC.	\$3.90
LM 370 - AGC SQUELCH AMP.	\$1.15
555 - 2w - 2 HR. TIMER.	\$.47
553 QUAD TIMER	\$2.50
FCD 810 OPTO-ISOLATOR	\$.80
1458 DUAL OP AMP.	\$.55
LM 380 - 2W AUDIO AMP	\$.95
LM 377 - 2W Stereo Audio Amp.	\$2.50
LM 381 - STEREO PREAMP.	\$1.25
LM 382 - DUAL AUDIO PREAMP	\$1.25
LM 311 - HI PER. COMPARATOR	\$.95
LM 319 - Dual Hi Speed Comp.	\$1.10
LM 339 - QUAD COMPARATOR	\$1.15

TRIACS		SCR'S	
PRV	1A	10A	25A
100	.40	.70	1.30
200	.70	1.10	1.75
400	1.10	1.60	2.60
600	1.70	2.30	3.60
		1.5A	6A
		35A	35A

SOLID STATE SALES

P.O. BOX 74A
SOMERVILLE, MASS. 02143 TEL. (617) 547-4005

AEC ELECTRONIC IGNITION

- IMPROVES ENGINE PERFORMANCE
- INCREASES GAS MILEAGE
- CUTS MAINTENANCE COSTS

90 DAY GUARANTEE on Material/Workmanship
ORDER MODEL 12 \$39.95
 If car equipped with Tach, specify make and model of auto or Model No. of Tach.

MICROHOOK by E-Z HOOK

XMS Micro Hook (1.75" long) Permits hookups to delicate wires where weight and leverage may damage component. Available in 10 Retma colors: red, black, blue, green, gray, orange, yellow, white violet or brown. 10 for \$7.95

PLESSEY SAMPLER

300 METALLIZED CAPACITORS
 18 DIFFERENT STD. VALUES
\$15.00

L-15 PULSE/SWEEP FUNCTION GENERATOR

FEATURES: 1 Hz to 100 KHz In 5 ranges, at constant amplitude • Sine and triangle adjustable to 20Vp-p into 600 ohms • Sine distortion is .5% typical • Voltage controlled sweep of sine and triangle waves • TTL square wave has a fully adjustable pulse and drive into 600 ohms • Frequencies of lower than 1 Hz and greater than 100 KHz are obtainable • Small, only 3" H x 6 1/2" W x 4" D. State-of-the-art design! . . . \$55.00

7400N TTL 1.9 10up	1.9 10up	1.9 10up	1.9 10up
7400N .14 .13	7451N .14 .13	74151N .102 .92	
7401N .18 .16	7453N .14 .13	74153N .85 .75	
7402N .18 .16	7454N .14 .13	74154N .108 .94	
7403N .18 .16	7460N .14 .13	74155N .102 .92	
7404N .21 .19	7470N .40 .30	74156N .102 .92	
7405N .20 .19	7472N .40 .30	74157N .90 .80	
7406N .36 .28	7473N .42 .38	74158N .150 1.30	
7407N .36 .28	7474N .44 .40	74160N .102 .92	
7408N .40 .36	7475N .44 .40	74161N .102 .92	
7409N .28 .21	7476N .44 .40	74162N .100 .90	
7410N .22 .19	7483N .82 .76	74163N .100 .90	
7411N .26 .20	7484N .180 1.70	74164N .116 1.05	
7412N .34 .32	7485N .120 1.08	74165N .120 1.10	
7413N .34 .32	7486N .120 1.08	74166N .120 1.10	
7414N .98 .95	7489N .220 2.10	74170N .200 1.80	
74161N .35 .32	7490N .56 .51	74173N .166 1.50	
74171N .35 .32	7492N .56 .50	74174N .100 .90	
74180N .21 .19	7493N .56 .50	74175N .100 .90	
7421N .30 .26	7494N .88 .80	74176N .108 1.00	
7422N .50 .45	7495N .80 .72	74177N .108 1.00	
7423N .37 .36	7496N .76 .68	74179N .180 1.70	
7425N .30 .23	7497N .50 .45	74180N .112 1.02	
7426N .28 .26	74100N .10 1.00	74181N .120 1.10	
7427N .28 .25	74107N .40 .36	74182N .100 .90	
7430N .26 .20	74109N .40 .36	74184N .280 2.50	
7432N .32 .30	74111N .100 .90	74186N .300 2.70	
7433N .29 .20	74116N .200 1.80	74188N .500 4.80	
7438N .29 .27	74121N .60 .54	74190N .100 .90	
7439N .44 .40	74122N .48 .43	74191N .120 1.10	
7440N .17 .16	74123N .68 .62	74192N .98 .90	
7441N .85 .83	74125N .50 .45	74193N .92 .88	
7442N .40 .40	74126N .50 .45	74194N .120 1.10	
7445N .90 .81	74128N .50 .45	74195N .76 .70	
7446N .90 .81	74129N .92 .85	74196N .140 1.30	
7447N .98 .90	74141N .170 1.50	74197N .140 1.30	
7448N .98 .90	74145N .170 1.50	74198N .140 1.30	
7450N .14 .13	74147N .100 1.10	74199N .140 1.30	
	74148N .150 1.35	74221N .136 1.25	
	74150N .152 1.40	74279N .66 .60	

HIGH SPEED TTL

74H00N .33	74H08N .40	74H73N .80	74H106N .95
74H04N .33	74H10N .33	74H74N .80	

SCHOTTKY TTL

74S00 .36	74LS32N .45	74LS112N .68	74LS174N2.20
74S01 .36	74LS51N .39	74LS114N .92	74LS175N2.00
74S02 .44	74LS120N .70	74LS123N .65	74LS192N2.85
74S05 .45	74LS73N .56	74LS139N2.00	74LS192N2.85
74S08 .38	74LS74N .56	74LS151N1.68	74LS192N2.85
74S10N .36	74LS76N .65	74LS153N1.80	74LS192N2.85
74S12N .44	74LS20N .59	74LS160N3.00	74LS260A2.50
74S13N .39	74LS100N .92	74LS161N3.00	

LINEAR IC's

74S00 .44	74S11 .85	74S64 .80	74S114 .120
74S02 .60	74S20 .65	74S74 .90	74S133 .80
74S04 .65	74S30 .80	74S76 .115	74S138 .220
74S08 .80	74S40 .80	74S112 .40	74S151 .40
74S10 .56	74S40 .85	74S113 .150	74S160 .390
		74S257 .240	

H-T0-5

N-OIP	M-MINI-DIP	O-CER OIP	K-T0-5
LM108H 3.00	LM311H 1.20	LM340-8K2.60	LM725CH 1.50
LM301AH 8.00	LM318H 2.90	LM340-18K2.60	LM725CH 1.50
LM301AM 8.00	LM318H 1.75	LM340-15K2.60	LM733CH 1.40
LM301AN 1.10	LM312H 1.75	LM340-18K2.60	LM733CH 1.50
LM304H 1.20	LM318H 1.50	LM340-24K2.60	LM733CH 1.30
LM305H 85	LM318H 2.40	LM340-18K2.60	LM741CH 1.25
LM305AH 1.05	LM324N 1.90	LM556CN 1.30	LM741CH 1.25
LM305N 1.00	LM331N 1.25	LM567CM 1.70	LM741CM .39
LM306N .95	LM339N 2.20	LM709CH .75	LM7417CH .75
LM306H .85	LM320-5K2.90	LM709CN .75	LM747CN .90
LM308AH 5.00	LM320-5T 2.50	LM710CN .90	LM748CN .55
LM308N 1.00	LM320-12K2.90	LM710CN .90	LM3046CN .95
LM309H 1.75	LM320-12T2.50	LM715CH 3.50	LM3054CN1.50
LM309N 1.50	LM340-5K2.60	LM723CH .60	SG4501T 2.40
LM310H 1.50	LM340-5K2.60	LM723CN .60	SG4501N 2.40
LM310M 1.80		CMOS	

1.9 10up	1.9 10up	1.9 10up	1.9 10up
4000AE .15 .14	4030AE .48 .40	4073AE .40 .39	
4001AE .24 .20	4030AE 2.00 1.90	4075AE .40 .39	
4002AE .24 .15	4035AE 2.00 1.10	4076AE 1.24 1.22	
4006AE 1.30 1.20	4040AE 1.20 1.10	4077AE .40 .39	
4007AE .24 .23	4041AE 1.25 1.00	4078AE .40 .39	
4008AE 1.15 1.14	4042AE 1.00 .85	4081BE .40 .39	
4009AE .50 .45	4043AE .95 .90	4082AE .39 .38	
4010AE .50 .45	4044AE .95 .90	4093AE 1.65 1.64	
4011AE .24 .23	4046AE 3.10 3.05	4095BE 1.95 1.94	
4012AE .24 .22	4047AE 2.00 1.90	4098AE 1.30 1.29	
4013AE .30 .28	4048AE 1.43 1.40	4099AE 2.90 2.89	
4014AE 1.05 1.00	4089AE .58 .53	4502AE 1.50 1.49	
4015AE 1.15 1.10	4090AE .62 .57	4507AE 1.20 .95	
4016AE .55 .49	4051AE 1.49 1.48	4508BE 2.20 2.19	
4017AE 1.05 1.00	4052AE 1.40 1.39	4510AE 1.40 1.39	
4018AE 1.24 1.23	4053AE 1.40 1.39	4511BE 2.00 1.99	
4019AE .54 .49	4054AE 1.40 1.39	4512BE 1.00 1.29	
4020AE 1.45 1.35	4056AE 1.99 1.98	4514AE 1.40 1.39	
4021AE 1.30 1.20	4060AE 1.70 1.68	4515AE 5.00 4.99	
4022AE 1.05 1.00	4063AE 2.50 2.49	4516AE 1.75 1.74	
4023AE .24 .22	4066AE .90 .89	4518AE 1.28 .98	
4024AE .30 .27	4068AE 1.44 .43	4520AE 1.28 .98	
4025AE .24 .20	4069AE .44 .43	4528AE 2.20 2.19	
4026AE 1.50 1.49	4070BE .60 .59	4585AE 2.05 1.95	
4027AE .85 .90	4071AE .45 .44	4901AE .32 .31	
4028AE .85 .90	4072AE .34 .33	4911AE .32 .31	
4029AE 1.20 1.10			

Prices effective through August 31, 1976
 Minimum order \$10.00. Add \$1.00 to cover postage and handling.
 California residents add 6% sales tax.

SEND CHECK OR MONEY ORDER TO

AKRONIA CORP.

Mail order: P.O. Box 2208P, Culver City, CA 90230
 Phone order: (213) 641-4064
 Prices may vary at over-the-counter locations.

WIRING PEN -

The wiring pen with self-contained spool of polyurethane lacquer insulated copper wire is used to route and wrap onto component leads, terminal pin, etc. Connections are completed by soldering which melts insulation & at the same time makes permanent solder joint.

Wiring pen with unique integral spring wire clamp for wire retraction advancement & retraction. With spool. \$7.99 each.

ADDITIONAL WIRE SPOOLS - Package of 2 spools (120 meters) of 34 AWG wire. \$2.68

LEDs

.125" dia.	.160" dia.	.200" dia.
209 RED .25	216 RED .25	220 RED .25
209 YELLOW .35	216 YELLOW .30	220 YELLOW .30
209 GREEN .35	216 GREEN .30	220 GREEN .30

LOW PROFILE .200" dia.	200" dia.	MV50 RED .30
226 RED .25	5053 RED .35	
226 YELLOW .30	5053 YELLOW .40	
226 GREEN .30	5053 GREEN .40	
226 ORANGE .30	5053 ORANGE .40	

MATSUO DIPPED TANTALUM CAPACITORS

MFO WDC 1.9 10up	50up	MFO WDC 1.9 10up	50up
.15	.35	4.7	.35
.22	.35	6.8	.35
.33	.35	10.0	.35
.47	.35	10.0	.36
.68	.35	20.0	.36
1.0	.35	20.0	.36
1.5	.35	22.0	.36
2.2	.35	33.0	.36
2.2	.35	22.0	.36
3.3	.35	68.0	.36

CARBON FILM RESISTORS . . . % WATT 5%
 139 STANDARD VALUES . . . \$1.69 per 100
 10 ohm to 10 megohms . . . Only in multiples of 100 per value

DISPLAYS

LARGE 1"
 EP1000 RED 5.60
 3 pcs EP1000 15.00
 5 pcs EP1000 22.50
 Data sheet-EP1000 .25

SGS-ATES

RHYTHM GENERATORS
 Designed specifically for electronic organs and other musical instrument designs. Detailed applications book, only . . . \$1.95.

M252B1AA 16 PIN OIP \$15.00
 M253B1AA 24 PIN OIP \$19.50

12 programmable rhythms which cannot be superimposed

INDUSTRIAL QUALITY COMPONENTS

What is more important? QUALITY or PRICE?
 We have decided to offer only the highest quality components. When quality counts, you can count on Ancrona.

FIRST QUALITY ONLY

ZENER DIODES

500 mW - 5%
 V Price

IN5246B 16 .22	SL16100C RF voltage amplifier . . . \$2.03
IN5247B 17 .22	SL1611C RF voltage amplifier . . . 2.03
IN5248B 18 .22	SL1612C IF voltage amplifier . . . 2.03
IN5249B 19 .22	SL1613C RF limiting amplifier/detector . 2.58
IN5250B 20 .22	SL1620C Voice operated gain adjusting device . . . 2.45
IN5251B 22 .22	SL1621C AGC generator . . . 2.58
IN5252B 24 .22	SL1622C AF amplifier & voga . . . 3.01
IN5253B 25 .22	SL1623C AM detector, AGC amplifier, & SSB demodulator . . . 3.01
IN5254B 27 .22	SL1624C Multimode detector . . . 2.91
IN5255B 28 .22	SL1630C Microphone/headphone . . . 2.10
IN5256B 30 .22	SL1640C Double-balanced modulator . . . 2.03
IN5257B 33 .22	SL1641C Double-balanced modulator . . . 2.03
IN5258B 39 .22	
IN5259B 43 .22	
IN5260B 47 .22	
IN5261B 51 .22	
IN5262B 55 .22	
IN5263B 62 .22	
IN5264B 66 .22	
IN5265B 68 .22	
IN5266B 75 .22	
IN5267B 77 .22	
IN5268B 82 .22	
IN5269B 88 .22	
IN5270B 92 .22	
IN5271B 95 .22	
IN5272B 98 .22	
IN5273B 102 .22	
IN5274B 105 .22	
IN5275B 108 .22	
IN5276B 112 .22	
IN5277B 115 .22	
IN5278B 118 .22	
IN5279B 122 .22	
IN5280B 125 .22	
IN5281B 128 .22	
IN5282B 132 .22	
IN5283B 135 .22	
IN5284B 138 .22	
IN5285B 142 .22	
IN5286B 145 .22	

WAVEFORM GENERATOR KIT

EXAR XR205K \$25.00

Here's a highly versatile lab instrument at a fraction of the cost of conventional unit. Kit includes 2 XR205 IC's, data & applications, PC board (etched and drilled, ready for assembly) and detailed instructions.

SPDT MINIATURE TOGGLE SWITCH

105D . . 115V . . . 5A Rating . . \$95

PLEASE VISIT OUR ELECTRONIC STORES

ARIZONA 4518 E. Broadway Tucson, AZ 85711

CANADA 5656 Fraser Street Vancouver, BC V5W 2Z4

CALIFORNIA 11080 Jefferson Blvd. Culver City, CA 90230

1300 E. Edinger Avenue Santa Ana, CA 92705

GEORGIA 3330 Piedmont Rd., N.E. Atlanta, GA 30305

OREGON 1125 N.E. 82nd Avenue Portland, OR 97220

CONTINENTAL SPECIALTIES

PROTO BOARDS

Build & test circuits as fast as you think!

PB-6	6 IC cap breadboard kit	\$15.95
PB100	10 IC cap breadboard kit	19.95
PB101	10 14-DIP cap, 5-way post, 940 solderless tie points, 5 x 4.5"	29.95
PB102	12 14-DIP cap., like PB101 with 1,240 tie points, 7.0 x 4.5"	39.95
PB103	24 14-DIP cap., 4.5 way posts, 2,250 tie points, 6.0 x 9.0"	59.95
PB104	32 14-DIP cap., 3,060 solderless tie point, 8.0 x 9.76"	79.95

LOGIC MONITOR 1

Simultaneously displays static and dynamic logic states of DTL, TTL, HTL or CMOS DIP ICs. Pocket size. \$84.95

LOGIC MONITOR 2

Automatically and accurately displays static and dynamic states of digital ICs. Selectable threshold control. . . \$124.95

LOGIC PROBE LP-1

Compact, circuit-powered multifunction logic probe. Multi-family compatibility. DTL/TTL/HTL/CMOS. Traces logic levels and pulses through digital circuitry. . . \$44.95

PROTO-CLIP

For power-on/hands off signal tracing. Bring IC leads up from PC board surface for fast trouble-shooting.

PC14	14-pin	\$4.50
PC16	16-pin	4.75
PC24	24-pin	8.50

SOCKETS & BUS STRIPS

Plug-in, wire, test, modify or expand without patch cords or solder. Snap together to form breadboard needed.

PN/Description	L. Hole-to-Hole	Term's	Price
QT598 Socket	6.5"	6.2"	118 \$12.50
QT598 Bus	6.5"	6.2"	20 2.50
QT475 Socket	5.3"	5.0"	94 10.00
QT475 Bus	5.3"	5.0"	16 2.25
QT358 Socket	4.1"	3.8"	70 8.50
QT358 Bus	4.1"	3.8"	12 2.00
QT185 Socket	2.4"	2.1"	36 4.75
QT129 Socket	1.8"	1.5"	24 3.75
QT85 Socket	1.4"	1.1"	16 3.25
QT75 Socket	1.3"	1.1"	14 3.00

PROTO BOARDS

With built-in regulated short-proof power supplies

PB203	5V, 1 amp regulated power supply	\$ 75.00
PB203A	5V, 1 amp and ±15V, 5 amp regulated power supply	120.00

DESIGN MATES

DESIGN MATE 1 CIRCUIT DESIGNER
 With built-in, regulated, metered power supply to design unusual circuits fast. \$49.95

DESIGN MATE 2 FUNCTION GENERATOR
 Complements Design Mate 1. Produces clean, accurate wave forms with variable amplitude and frequency controls. \$64.95

DESIGN MATE 3 R/C BRIDGE
 Saves design time by measuring and selecting capacitors and resistors to better than 5% instantly! \$54.95

DESIGN MATE 4 MULT

DO-IT-YOURSELF

TV PROBLEMS? Send symptoms / copy schematic / self addressed-stamped envelope with \$3.00. Troubleshooter, Box 4553-PE, Downey, Calif. 90241.

MODULAR TELEPHONES now available. Sets and components, compatible with Western Electric concept. Catalog 50 cents. Box 1654W, Costa Mesa, California 92626.

TREASURE FINDERS

TREASURE FINDER locates buried gold, silver, coins, treasures. 6 powerful models. Instant financing available. Write or call for free catalog. Phone (713) 682-2728 day or night. Dealer inquiries invited. Relco, Dept. AA20, Box 10839, Houston, Texas 77018.

DISCOVER true treasure hunting with world-famous deep-detecting mineral/metal detectors from White's! Locate gold, silver, rings, coins, artifacts and more! Sold, serviced, warehoused world wide. Priced from \$79.50. Free Catalog! White's Electronics, Dept. PD6V, 1011 Pleasant Valley Rd., Sweet Home, OR 97386.

MUSICAL INSTRUMENTS

UP TO 60% DISCOUNT. Name brand instruments catalog. Freepost Music, 114 N. Mahan St., W. Babylon, N.Y. 11704.

WHOLESALE! Professional Guitars, PA Systems, Altec Speakers, 240W RMS Amplifiers. Free Catalog, Carvin, Escondido, Calif. 92028.

HYPNOTISM

SLEEP learning. Hypnotic method. 92% effective. Details free. ASR Foundation, Box 23429EG, Fort Lauderdale, Florida 33307.

FREE Hypnotism. Self-Hypnosis. Sleep Learning Catalog! Drawer H400, Ruidoso, New Mexico 88345.







AMAZING self-hypnosis record releases fantastic mental power. Instant results! Free trial. Write: Forum (AA8), 333 North Michigan, Chicago 60601.

BOOKS AND MAGAZINES

FREE book prophet Elijah coming before Christ. Wonderful bible evidence. Megiddo Mission, Dept. 64, 481 Thurston Rd., Rochester, N.Y. 14619.

ACE OF THE MONTH SPECIALS

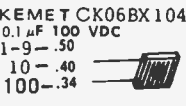
All new **ENGINEERING APPRAISAL ASSORTMENTS** first quality

 SLIDE SWITCH ASSORTMENT standard and miniature 40 for \$5.00	200 ELECTROLYTIC ASSORTMENT \$9.95 MINIATURE ALUMINUM Anhyd Lead FROM 1uf/50v to 470uf/25v
KEYBOARD ASSORTMENT 5 for \$9.95 CALCULATOR & COMPUTER	1% PRECISION RESISTORS 200 for \$4.95 Assortment contains a balanced inventory
 DISC CAP ASSORTMENT includes 22 pf 220 pf 0047uf 01uf Prime these 47 pf 470 pf 01uf 01uf values 100 pf 001uf 027uf 200 PCS FOR \$3.85	AC adapter ASSORTMENT 4 DIFFERENT models for \$9.95
POWER CORD ASSORTMENT 6 for \$2.95 2 and 3 conductor 6-8-ft. U.L. Listed	 DIPPED POLYESTER FILM CAPACITORS 100 for \$4.95
 SWITCHCRAFT Micro-Jax 10 — \$ 2.95 100 — 25.00 TR-2A 1000 — 199.50 10M — 1250.00	 SPEEDY BEND by PRODUCTION DEVICES NE-2 NEON 100 — 9.95 1000 — 49.95 10M — \$350.00
 KEMET CK06BX104 0.1 uF 100 VDC 1-9 — .50 10 — .40 100 — .34	 MOLEX I.C. PINS 1000 for \$6.95

SN74S201 13 ns 256 Bit RAM Three-State Output Plug In Replacement **\$ 2.95** for SN74200 10 for \$24.95

TMS 4030 JL, 4096-BIT DYNAMIC RAM Low Power 400 mW **\$9.95** with data and 22-Pin SOCKET removed from sockets **8 FOR \$64.95** Tested and guaranteed

TMS 5000 ASCII keyboard encoder with data \$14.95 ASR33 Teletype Code



ACOUSTIC COUPLER

This coupler was manufactured by Novation, Inc. Tarzana, California for use in Texas Instrument's model 725 Electronic Data Terminal. It is compatible with Bell 103 and 113 data sets or equivalent. The coupler operates asynchronously to a maximum speed of 450 baud in the full-or-half-duplex mode coupled to a standard telephone handset. Transmit freq. is 1270Hz for mark and 1070Hz for space. Receive frequency is 2225Hz for mark and 2025Hz for space. Unit required ± 12 VOLTS and ± 5 VOLTS for operation. Complete with schematic & all pertinent information, fully reconditioned, calibrated, and guaranteed **\$47.50**



ASCII COMPUTER KEYBOARDS

These keyboards were manufactured for use on Texas Instrument's line of Silent 700 series data terminals. They are fully encoded with TTL large scale integrated circuits (T.I. TMS-5000 in 28 pin socket). Additional IC's provide a parallel 7 bit, without parity, code plus a strobe signal indicating "valid" data and six other independent outputs for those special keys which are not encoded. The keys are with a format similar to typewriter. Internal circuitry provides for two key rollover and de-bounce. Output is on standard 10 pin double readout connector for data and power input. And 8 pin double readout connector for six special switch functions.

KB-6: Clara/Pender 720627-1 New: tested \$39.95
T.I. Part number 959327-1 Used: tested \$29.95
A 58 key ASCII encoded alphanumeric keyboard with six extra switch closures to ground marked HERE IS, PAPER ADV., BREAK, REPEAT, TAPE \rightarrow TAPE \leftarrow

KB-7: Clara/Pender 720731-1
T.I. Part number 959328-1 Used: tested \$39.95
This is a 64 key full ASCII encoded keyboard.



PITTMAN 12VDC MOTOR runs on as low as 2 volts rated 12 volts 250 ma, 2.8 inch of torque at 5000 RPM. Size 1 1/4" DIA X 2" long with 0.118 inch shaft. New Guaranteed. **\$1.95 each. 10 for \$15.00**

Kynar solid silver-plated wire wrap wire

30 AWG Blue	1000 FT. SPOOL	9.95
26 AWG Red or Black	1000 FT. SPOOL	10.95

DISCRETE LEDS

MV50 RED	100 for \$17.60
.200" dia.	17.60
RED	
.125" dia.	15.00

BISMUTH ALLOY. Melts in boiling water 4 oz. ingot **\$3.95**

PRINTED CIRCUIT BOARD G-10 1/16" thick, unetched copper clad 1 oz. 2 sides

Size	1	10	100
3x6"	.50	2.50	19.95
4x12"	1.00	5.00	39.95
8x8"	1.50	9.95	59.75

BURROUGHS PANAPLEX II 12 DIGIT 25 in. high. BR 16254 160V DC Ionization voltage **\$2.95 ea. 10 for \$25.00** With DATA

SEMICONDUCTOR	10	100	1000	10,000
MP53704	2.00	12.50	99.95	750.00
IN4448	IN914B	5.80	48.00	394.45
SZ13709	IN749A	1.95	14.95	99.95
2N930		2.50	19.95	150.00
2N5449		2.00	12.50	99.95
IN752A		2.40	19.00	150.00

CLOCK OF OUTPUT 1 OUTPUT 2

CALCULATOR	VAC	DCM	VAC	DCM
20CT	50	80	20	20

Weight, 5 1/2 oz. **10 for \$15.00**
100 for \$69.95
1000 for \$59.95

P.C. Mount



ELECTRONIC PARTS
5400 Mitchelldale, B-8
Houston, Texas 77092
Phone (713) 688-8114

TERMS: We pay postage, unless otherwise specified. Include check or money order, no COD. Texas residents add 5% sales tax. Canada and Mexico add \$2.50. Overseas countries add \$5.00. TWX 910-881-2411

ABOUT YOUR SUBSCRIPTION

Your subscription to POPULAR ELECTRONICS is maintained on one of the world's most modern, efficient computer systems, and if you're like 99% of our subscribers, you'll never have any reason to complain about your subscription service.

We have found that when complaints do arise, the majority of them occur because people have written their names or addresses differently at different times. For example, if your subscription were listed under "William Jones, Cedar Lane, Middletown, Arizona," and you were to renew it as "Bill Jones, Cedar Lane, Middletown, Arizona," our computer would think that two separate subscriptions were involved, and it would start sending you two copies of POPULAR ELECTRONICS each month. Other examples of combinations of names that would confuse the computer would include: John Henry Smith and Henry Smith; and Mrs. Joseph Jones and Mary Jones. Minor differences in addresses can also lead to difficulties. For example, to the computer, 100 Second St. is not the same as 100 2nd St.

So, please, when you write us about your subscription, be sure to enclose the mailing label from the cover of the magazine—or else copy your name and address exactly as they appear on the mailing label. This will greatly reduce any chance of error, and we will be able to service your request much more quickly.

FREE CATALOG. Aviation and Space Books. Aero Publishers, 329PE West Aviation, Fallbrook, California 92028.

THE AUDIO AMATEUR—A quarterly publication for the serious audio constructor. Free prospectus. The Audio Amateur, Box 1762, Peterborough, N.H. 03458.

CB SLANG DICTIONARY—Most complete CB Dictionary Handbook available. Hundreds of slang terms plus part 95 mandatory FCC rules. Great gift. Order NOW. Send \$5.00 to: Communication Books, Inc., Dept. PE, Box 10198, Milwaukee, WI 53210.

AVOID Speeding Tickets. Comprehensive booklet on defensive driving tactics showing countermeasures. Covers Radar and Vascor. Don't fall prey to the speed trap. \$2.25 plus 30 cents shipping. Booklet, 6728 Harvest Glen, Dallas, Texas 75248.

CRIMEFIGHTERS! SHOPLIFTING! LOCKPICKING! DE-BUGGING! All 3 books for only \$5.00. Don-Q, 548-PE, Seattle, Washington 98111.

UFO CHARTS: Newsletter; Daily Flight Pattern, Propulsion Theory; "Antigravity"; Wave Prediction; Transistor Optical Detector; DFM/Counter; Microcircuit Detectors; Sighting Recorder; Computerized Recorder 15+ Channels. Each \$2.10, 80 cents Airmail. R. E. Publications, (1969) Highlands, Needham-Market, Suffolk, England.

OLD POPULAR ELECTRONICS Jan. '59 — Mar. '75, 230 issues. \$95.00. Complete set ELECTRONICS ILLUSTRATED 1958-1972, 90 issues \$45.00. Digital Micro-lab (PE Apr. '70) \$20.00; Psych-Tone Music Composer (PE Feb. '71) \$30.00; HeathKit IT-18 Transistor Testor \$15.00. Ken Rubin, 33 College Place, Bklyn., N.Y. 11201. (212) 852-2920.

RECORDS

RECORD RATERS WANTED! Anyone qualifies. We ship you nationally released LP's to rate. We pay postage and handling. You pay nothing for LP's. All you pay is small membership fee. Applicants accepted "first come basis." Write: E.A.R.S., Inc., Dept PE, Box 10245, 5521 W. Center Street, Milwaukee, Wisconsin 53210.

RUBBER STAMPS

RUBBER ADDRESS STAMPS. Free Catalog. 45 type styles. Jackson's, Dept. K, Brownsville Rd., Mt. Vernon, Ill. 62864.

NEW Pocket Case Address STAMPER. \$11.95 100,000 Impressions without Re-inking! 25 Yr. Unconditional Guaranty, NO INK PADI LEE GARLAND, Box 17056, San Diego, CA 92117.

READER SERVICE NO.	ADVERTISER	PAGE NUMBER
1	A P Products Incorporated	55
2	Ace Electronics Parts	112
3	Acoustic Fiber Sound Systems, Inc.	2
4	Adva Electronics	108
4	Aladdin Electronics	105
6	Allison Automotive Company	55
68	Alpha Electronics	6
7	Altaj Electronics	102
8	Altaj Electronics	103
9	Ancona Corp.	111
10	Aries Inc.	109
12	Audio Technica, U.S., Inc.	65
12	B&F Enterprises	96
13	B & K Precision Products of Dynascan	85
15	Babylon Electronics	102
15	Bennies Warehouse	31
31	C&S Marketing	88
	CREI Capitol Radio Engineering Institute	60, 61, 62, 63
	Cleveland Institute of Electronics	78, 79, 80, 81
14	Cobra Product of Dynascan	SECOND COVER
16	Continental Specialties Corporation	THIRD COVER
17	Continental Specialties Corporation	22
18	Delta Electronics Co.	102
19	Delta Products, Inc.	49
20	Digi-Key Corporation	100
21	EICO	84
22	Edlie Electronics, Inc.	95
23	Edmund Scientific Co.	94
24	Edmund Scientific Co.	104
25	Edmund Scientific Co.	108
26	Edmund Scientific Co.	114
27	Electronic Warehouse	96
28	Electronics Technical Institute	11
29	Eltron	104
30	Empire Scientific Corp.	23
32	Godbout Electronics, Bill	100
34	Grantham School of Engineering	87
35	Graymark	90
36	Hal Communications	83
37	Handic USA Inc.	12
5	Health Company	21
	IMS Associates Inc.	7, 90, 108
39	Illinois Audio	90
40	International Electronics Unlimited	109
41	J&S National Sales Group	13
42	James	106, 107
33	Johnson Co., E.F.	FOURTH COVER
43	McIntosh Laboratory Inc.	6
	MITS	1
	NRI Schools	16, 17, 18, 19
	National Technical Schools	26, 27, 28, 29
44	New-Tone	105
45	Olson Electronics	113
46	Pathcom Inc.	8
47	Phase Linear Corporation	10
49	Poly Paks	99
50	Polymorphic Systems	93
	Processor Technology	57
51	Quest Electronics	104
52	Radio Shack	32
53	SAE, Inc.	71
54	SBE, Inc.	5
55	S.D. Sales Co.	101
56	Sencore	77
57	Sencore	77
58	Shure Brothers Inc.	92
59	Solid State Sales	110
60	Southwest Technical Products Corporation	25
	Sphere Corporation	52
48	Stanton Magnetics	53
61	TNT	92
62	Tenna Corporation	15
63	Tracy Design Corp.	100
64	Tri-Star Corporation	87
65	Vector Electronics Company, Inc.	83
66	Weller-Xcelite Electronics Division	91
67	Winegard Company	89
	CLASSIFIED ADVERTISING	94, 95, 96, 104, 108, 109, 110, 112, 113

PRO SPORTS ACTION FILMS

WATCH THE OLYMPICS (1970, that is) IN YOUR OWN HOME. See the Gymnasts (Olga Korbut), the Aquatics (Mark Spitz), Track and Field Stars, Competitive Sports (Basketball, Volleyball, etc.) and compare to the Montreal Games on TV. 4 films, each a 200' reel. Special, \$18.95 each PPD (Save A Dollar), Super 8 & Standard 8 in color; \$7.95 ea PPD (Save A Dollar) in B&W. Order 1 or the whole set of 4. (Postpaid means you save another 75 cents per film.) All light catalog, 25 cents; 40 cents each for Columbia, Castle or Sportline catalogs (coins, stamps, no checks, pls). SPORTLITE, Elect-8, 20 N. Wacker Dr., Chicago, IL 60606.

INSTRUCTION

LEARN ELECTRONIC ORGAN SERVICING at home all makes including transistor. Experimental kit—trouble-shooting. Accredited NHSC, Free Booklet. NILES BRYANT SCHOOL, 3631 Stockton, Dept. A, Sacramento, Calif. 95820.

EARN ELECTRONICS DEGREE by correspondence. Free information bulletin. Grantham, 2000 Stoner Avenue, Los Angeles, California 90025.

F.C.C. EXAM MANUAL

PASS FCC EXAMS! Memorize, study — "Test Answers" for FCC 1st and 2nd class Radio-Tele phone licenses. Newly revised multiple-choice questions and diagrams cover all areas tested in FCC exams plus "Self-Study Ability Test." \$9.95 postpaid. Moneyback Guarantee.

COMMAND PRODUCTIONS P.O. BOX 26348-P
AUDIO ENGINEERING DIVISION SAN FRANCISCO, CALIF. 94126

SCORE high on F.C.C. Exams... Over 300 questions and answers. Covers 3rd, 2nd, 1st and even Radar. Third and Second Test, \$14.50; First Class Test, \$15.00. All tests, \$26.50. R.E.I., Inc., Box 806, Sarasota, Fla. 33577.

UNIVERSITY DEGREES BY MAIL! Bachelors, Masters, Ph.D's. Free revealing details. Counseling, Box 317-PEB, Tustin, California 92680.

SELF-STUDY CB RADIO REPAIR COURSE. THERE'S MONEY TO BE MADE REPAIRING CB RADIOS. This easy-to-learn course can prepare you for a career in electronics enabling you to earn as much as \$16.00 an hour in your spare time. For more information write: CB RADIO REPAIR COURSE, Dept. PE086, 531 N. Ann Arbor, Oklahoma City, Okla. 73127.

LEARN Basic Digital Troubleshooting by correspondence. Information Free. Educational Technologies, Box 224, Reynoldsburg, Ohio 43068.

LEARN WHILE ASLEEP! HYPNOTIZE! Astonishing details, strange catalog free! Autosuggestion, Box 24-ZD, Olympia, Washington 98507.

BURGLAR/FIRE ALARM EXPERTS NEEDED for cars, homes, industry. Learn high profit systems installation at home spare time. Simple, quick, complete. Free information by mail. No salesmen. Security Systems Management School (homestudy), Dept. 7373-086, Little Falls, N.J. 07424.

FCC LICENSE STUDY GUIDE — 377 pages, 1465 questions with answers/discussions — covering third, second, first radiotelephone examinations. \$9.95 postpaid. GSE, 2000 Stoner, Los Angeles, California 90025.

ACHIEVEMENT in Electronics-Mathematics can be yours through independent study with individualized instruction. For your trial lesson, send \$2.00 to: Vinther Institute, Box 9447P, Berkeley, CA 94709.

ELECTRONICS (including FCC), Computer Science, Mathematics, Accounting. Earn more by learning more through ITI's effective correspondence courses. Free information. Intermountain Technical Institute, Box 258, Jerome, Idaho 83338.

ELECTRONIC COURSES. FCC License Preparation. Compare our prices. Free home study school catalog. Genn Tech, 5540 Hollywood Blvd., Los Angeles, CA 90028.

HIGHLY EFFECTIVE Degree Program in Electronics Engineering. Advance rapidly! Our 31st Year. Free literature. Cook's Institute, Box 20345, Jackson, Miss. 39209.

PASS FCC EXAMINATIONS! 532 First-Third license questions-answers. Guaranteed, \$7.00. "Exams", Box 5516-AH, Walnut Creek, CA 94596.

FM BROADCAST STATION. Start your own, home, school. Free booklet. "Radio!", Box 5516-AH, Walnut Creek, CA 94596.

INTENSIVE 5 week course for Broadcast Engineers. FCC First Class license. Student rooms at the school. Radio Engineering Inc., 61 N. Pineapple Ave., Sarasota, FL 33577 and 2402 Tidewater Trail, Fredericksburg, VA 22401.

Olson

Electronics Parts and Accessories



- TL-477. Soldering Iron 2.99
- VC-274. 12-Pc. Volume Control Kit 49c
- XM-501. 40-Pc. Terminal Strip 79c
- XM-370. 7 Seg. L.E.D. Display 1.29
- TR-446. 25-Pc. Ass't'd. SCR 1.49
- SW-555. 90-120 V AC Relay 59c
- SW-156. Ctr.-Off Toggle Switch DPDT. Pkg. 2 2.49
- SW-460. 3 Button Push Switch 24c
- SW-636. Thermostatic Switch 50-600 NO 39c
- SW-752. Unimax 15A Switch SPST 49c
- SW-156. 5A Toggle SPST NO 39c
- SW-431. Phone Type Lever Switch 4 SPST 62c
- SW-632. Reed Switch W/Magnet SPST. Pkg. 10 1.29
- MO-359. 1/30 RPM Timing Motor 120V AC 49c
- TT-026. 2500 OHM Output Transformer 64c
- TF-047. 6 V 1/2 A. Filament Transformer 44c
- TF-050. 12V .2A Filament Transformer 47c
- KN-030. 25-Pcs. Assorted Knobs 49c
- ME-182. 0-1 Ma Panel Meter 1 3/8" Mtg. Hole 89c
- ME-205. 0-200 UA. Panel Meter 1 5/16 x 5/8" 74c
- ME-204. 0-150 UA. Panel Meter 1 x 1 x 7/8" 74c
- ME-203. 100-0-100 UA. 1'x1'x7/8" Meter 74c

When ordering allow for postage. COD 20% Deposit. Residents of the following states please add Sales Tax: Ca. 5%, Fl. 4%, GA. 3%, Il. 4%, Ky. 5%, Ma. 5%, Mi. 4%, Mo. 3%, N.Y. 4%, Oh. 4%, Pa. 6%, Tx. 4%.

FREE

7 Olson Catalogs

NEXT 7 ISSUES SENT TO YOU FREE

FREE

Olson CB Catalog

WITH DEALERS PRICE LIST

Olson Electronics, 260 S. Forge St., Dept. 10, Akron, Ohio 44327
Please send me Olson catalog CB catalog Both Please Print

NAME _____

ADDRESS _____

CITY _____

STATE _____ ZIP _____

CIRCLE NO. 45 ON FREE INFORMATION CARD

FREE Educational Electronics Catalog. Home study courses. Write to: Edukits Workshop, Department 715D, Hewlett, N.Y. 11557.

PERSONALS

MAKE FRIENDS WORLDWIDE through international correspondence. Illustrated brochure free. Hermes, Berlin 11, Box 110660ZD, Germany.

Ph.D'S, MASTER'S, BACHELOR'S — official nonresident College Degrees easily acquired through mailorder Universities Complete Revealing Directory — \$2. Counseling Connection, 5495 Claremont, No. BPE, Oakland, CA 94618.

MISCELLANEOUS

WINEMAKERS: Free illustrated catalog yeasts, equipment. Semplex, Box 12276P, Minneapolis, Minn. 55412.

CORVAIR PARTS — 1800 different Corvair parts stocked. Big Catalog — \$1.50. Clark's Corvair Parts, Shelburne Falls, MA 01370.

THE SOLDERING IRON VS. THE PROTO-BOARD.[®] (IT'S NO CONTEST.)



The Soldering Iron

If you're still designing and testing breadboard circuits the conventional way, you're doing a lot of extra work, and getting a lot of grief in return. You've got to think as much about manual labor as you do about the circuit. Maybe even more.

Every time you add a component, there are 2 or more connections to make...over a dozen with most IC's, while watching out for overheating components and cold solder joints. And that's only half the problem.

The other half is when you want to change components or connections. Even with good desoldering equipment, you can still have a hassle on your hands. (Ever try to desolder a temperature-sensitive 14-pin DIP on a component-filled board?)

Solder. Desolder. Resolder.
Desolder: Now there's a better way...

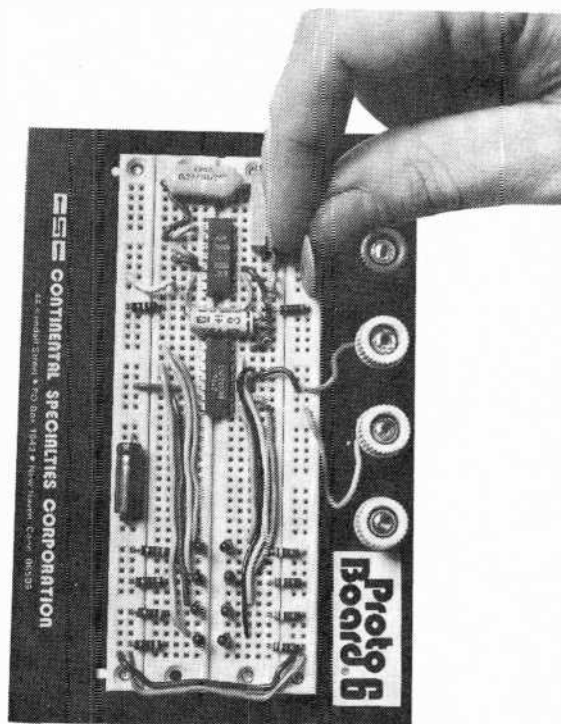

The Proto-Board

With the CSC Proto-Board breadboarding system, connecting components is as simple as pushing a lead into a hole. Rugged 5-point contacts insure low-resistance connections, and where jumpers are needed, components are interconnected with standard #22 AWG solid wire.

That's all there is to it.

You can choose Proto-Boards with anywhere from 630 to 3060 solderless tie-points. Proto-Boards with or without regulated power supplies. Even assemble your own, with the same solderless QT sockets and Bus Strips* for smaller (or larger) capacity. However you do it, you'll save time...money...aggravation...on every circuit.

CONTINENTAL SPECIALTIES CORPORATION



For more information, see your CSC dealer or distributor...or contact us for our catalog and distributor list.

Continental Specialties Corp., 44 Kendall Street, Box 1942, New Haven, CT. 06509 • 203-624-3103 TWX: 710-465-1227
West Coast Office: Box 7809, San Francisco, CA. 94119 • 415-421-8872 TWX: 910-372-7992
Canada: Len Finkler Ltd., 25 Toro Rd., Downsview, Ontario • 416-630-9103



state-of-the-art in receiver design...

**engineer's
triumph...
operator's
dream.**

Improving what is already the best is the ultimate challenge for the engineer. And the ultimate reward for the discerning CB operator. In the new Messenger 323A you can experience the incredible interference rejection of the only *dual cascaded crystal filtering system* available in any CB radio. Plus the exceptional noise rejection of both an efficient RF-type noise blander and a new fully-automatic noise limiter system that adjusts itself for the cleanest, clearest reception possible. Equally important are the features we *didn't* change — the large, easy-to-read meter, easy-to-handle control knobs, built-in electronic speech compression, P.A. function, and rugged steel cabinetry. It's the dream rig you can own for \$249.95.



JOHNSON

E. F. Johnson Company, Waseca, Minn. 56093

In Canada: A. C. Simmonds & Sons, Ltd.

CIRCLE NO. 33 ON FREE INFORMATION CARD