

ICD 08559

MODERN ELECTRONICS™

APRIL 1988 \$2.50
CANADA \$3.50

THE MAGAZINE FOR ELECTRONICS & COMPUTER ENTHUSIASTS

Record and Play Messages Without Magnetic Tape!

Compact solid-state project uses special LSI chip

Newest Flat-Panel Displays

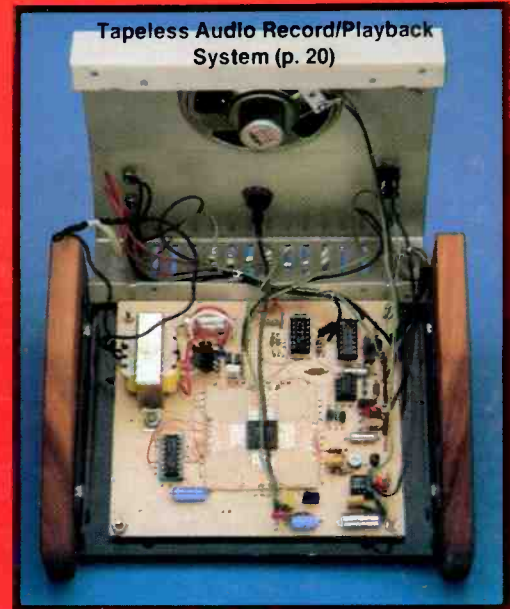

Tapeless Audio Record/Playback System (p. 20)

Full Construction Plans:

■ Semiconductor In-Circuit Tester
Device/Circuit Condition

■ Automatic Audio Panner
■ Infrared Remote-Control Relay

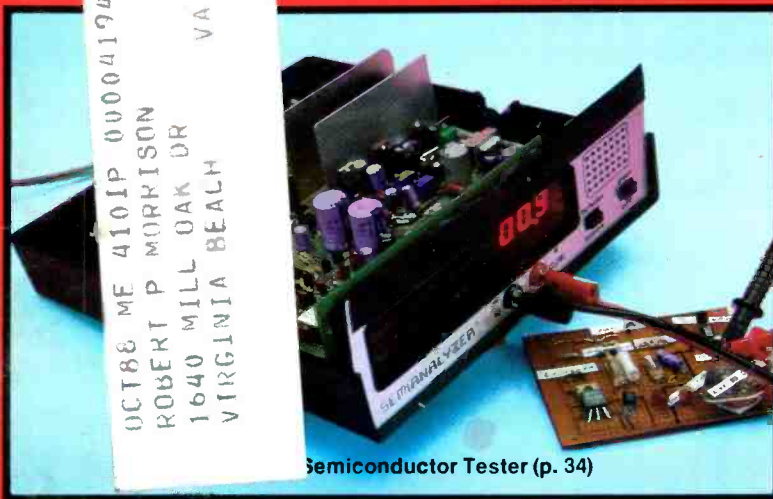

Semiconductor Tester (p. 34)

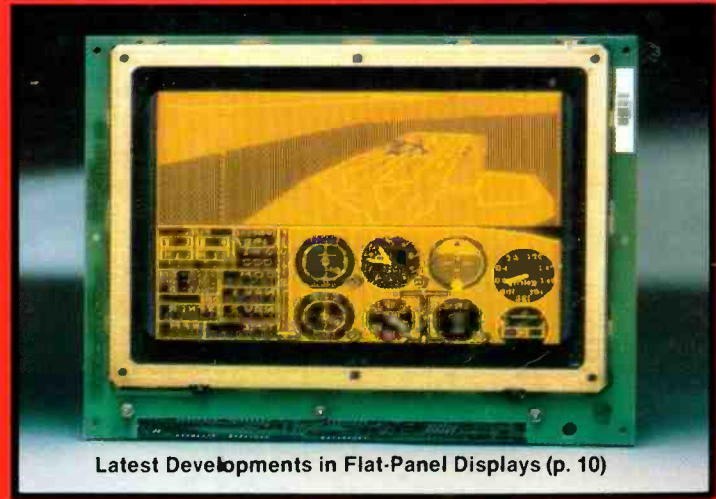

Latest Developments in Flat-Panel Displays (p. 10)

Bulk Rate
Permit No. 79
U.S. Postage Paid
Gordonsville, VA 22942

Also: Upgrading Clone Computers • Getting Started in Shortwave Listening
• Forrest Mims on Experimenting With Liquid Helium • Digitally Controlled
Potentiometers • Evaluating Heath's Computer Voice Card • Latest Books
& Literature • Electronic & Computer News . . . more.

OPTOelectronics inc

**NEW
POCKET SIZE**

**SIZE: 4" H x 3.5" W x 1" D
MADE IN USA**

FREQUENCY COUNTERS TO 1.3 GHZ

\$99⁹⁵ - \$150⁰⁰

**8 LED DIGITS • 2 GATE TIMES
ANODIZED ALUMINUM CABINET
INTERNAL NI-CAD BATTERIES INCLUDED
AC ADAPTER/CHARGER INCLUDED**

**EXCELLENT SENSITIVITY
& ACCURACY**

**AC-DC • PORTABLE
OPERATION**



#1200H 1.2 GHZ

#AC-1200
AC ADAPTER
CHARGER

Small enough to fit into a shirt pocket, our new 1.2 GHz and 1.3 GHz, 8 digit frequency counters are not toys! They can actually out perform units many times their size and price! Included are rechargeable Ni-Cad batteries installed inside the unit for hours of portable, cordless operation. The batteries are easily recharged using the AC adapter/charger supplied with the unit.

The excellent sensitivity of the 1200H makes it ideal for use with the telescoping RF pick-up antenna; accurately and easily measure transmit frequencies from handheld, fixed, or mobile radios such as: Police, firefighters, Ham, taxi, car telephone, aircraft, marine, etc. May be used for counter surveillance, locating hidden "bug" transmitters. Use with grid dip oscillator when designing and tuning antennas. May be used with a probe for measuring clock frequencies in computers, various digital circuitry or oscillators. Can be built into transmitters, signal generators and other devices to accurately monitor frequency.

The size, price and performance of these new instruments make them indispensable for technicians, engineers, schools, Hams, CBers, electronic hobbyists, short wave listeners, law enforcement personnel and many others.

STOCK NO:

- #1200HKC Model 1200H in kit form, 1-1200 MHz counter complete including all parts, cabinet, Ni-Cad batteries, AC adapter-battery charger and instructions \$ 99.95
- #1200HC Model 1200H factory assembled 1-1200 MHz counter, tested and calibrated, complete including Ni-Cad batteries and AC adapter/battery charger \$137.50
- #1300HC Model 1300H factory assembled 1-1300 MHz counter, tested and calibrated, complete including Ni-Cad batteries and AC adapter/battery charger \$150.00

ACCESSORIES:

- #TA-1005 Telescoping RF pick-up antenna with BNC connector \$12.00
- #P-100 Probe, direct connection 50 ohm, BNC connector \$18.00
- #CC-70 Carrying case, black vinyl with zipper opening. Will hold a counter and accessories \$10.00



1.3 GHZ
#1300H

FLA (305) 771-2050

**ORDER FACTORY DIRECT
1-800-327-5912**



AVAILABLE NOW!



OPTOelectronics inc
5821 N.E. 14th Avenue
Ft. Lauderdale, Florida 33334

Orders to US and Canada add 5% of total (\$2 min., \$10 max)
Florida residents add 5% sales tax. COD fee \$2.

CIRCLE 8 ON READER SERVICE CARD

www.americanradiohistory.com

CABLE EQUIPMENT PRICES SLASHED WHILE YOU WAIT!



Call Aunt Matilda at **Pacific Cable Co., Inc.**, and get a pleasant surprise: Instant price cuts even on our own cut-to-the-bone prices!

Here's how: Just supply her (or one of our other operators) with anybody else's published prices (even wholesale, if you're a dealer) for the unit you want; and if their price beats our published price, we'll match it—or even beat it! Simple as that.

Of course, you'll have to look far and wide to beat our prices (see below) and we're betting that Aunt Matilda will seldom need her "little hatchet" and can partake of her cherished afternoon nap. Which is fine with us—she makes us nervous with that thing! (Not to mention our competition!)

Check our prices on Scientific Atlanta Units!

ITEM	1 UNIT	10 OR MORE	ITEM	1 UNIT	10 OR MORE
RCA 36 Channel Converter (Ch.3 output only)	29.00	18.00	*Minicode (N-12)	89.00	58.00
Panasonic Wireless Converter (our best buy)	88.00	69.00	*Minicode (N-12) with Vari Sync	99.00	62.00
400 or 450 Converter (manual fine tune)	88.00	69.00	*Minicode VariSync with Auto On-Off	145.00	105.00
*Jerrold 400 Combo	169.00	119.00	Econocode (minicode substitute)	69.00	42.00
Jerrold 400 Hand Remote Control	29.00	18.00	Econocode with VariSync	79.00	46.00
*Jerrold 450 Combo	199.00	139.00	*MLD-1200-3 (Ch.3 output)	99.00	58.00
*Jerrold 450 Hand Remote Control	29.00	18.00	*MLD-1200-2 (Ch.2 output)	99.00	58.00
Jerrold SB-Add-On	89.00	58.00	*Zenith SSAVI Cable Ready	175.00	125.00
*Jerrold SB-Add-On with Trimode	99.00	70.00	Interference Filters (Ch.3 only)	24.00	14.00
*M-35 B Combo unit (Ch.3 output only)	99.00	70.00	*Eagle PD-3 Descrambler (Ch.3 output only)	119.00	65.00
*M-35 B Combo unit with VariSync	109.00	75.00	*Scientific Atlanta Add-on Replacement Descrambler	119.00	75.00

CHECK US OUT—WE'LL MEET OR BEAT THE OTHER'S ADVERTISED WHOLESALE OR RETAIL PRICES!



Pacific Cable Co., Inc.

7325½ Reseda Blvd., Dept. 1-20
Reseda, CA 91335
(818) 716-5914 • (818) 716-5140

• NO COLLECT CALLS! •

IMPORTANT • When ordering, please have the make and model number of the equipment used in your area—Thank you!

*Call for availability

Prices subject to change without notice

Jerrold is a registered trademark of General Instruments Corp.

Quantity	Item	Output Channel	Price Each	TOTAL PRICE
			SUBTOTAL	
			Shipping Add \$3.00 per unit	
			COD & Credit Cards—Add 5%	
			TOTAL	

California Penal Code #593-D forbids us from shipping any cable descrambling unit to anyone residing in the state of California.

Prices subject to change without notice

PLEASE PRINT

Name _____

Address _____ City _____

State _____ Zip _____ Phone Number () _____

Cashier's Check

Money Order

C.O.D.

Visa

Mastercard

Acct. # _____

Exp. Date _____

Signature _____

YOU MUST SIGN AND RETURN FOR OUR RECORDS:

DECLARATION OF AUTHORIZED USE — I, the undersigned, do hereby declare under penalty of perjury that all products purchased, now and in the future, will only be used on cable TV systems with proper authorization from local officials or cable company officials in accordance with all applicable federal and state laws. **FEDERAL AND VARIOUS STATE LAWS PROVIDE FOR SUBSTANTIAL CRIMINAL AND CIVIL PENALTIES FOR UNAUTHORIZED USE.**

Dated: _____ Signed: _____

© Copyright 1987 PACIFIC CABLE CO., INC.

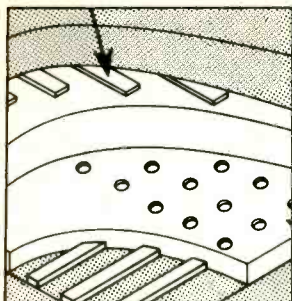

10

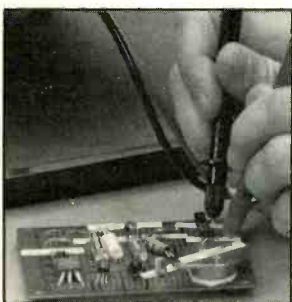

34

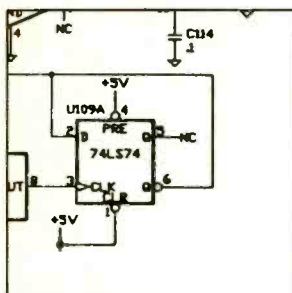

61

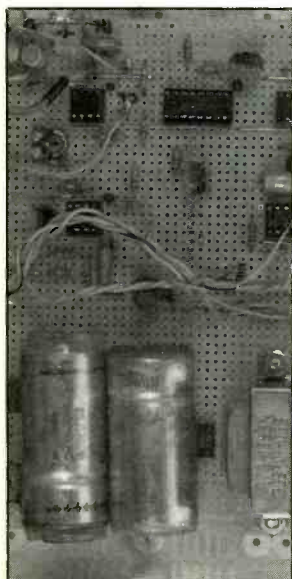

50

FEATURES

- 10 What's New in Flat-Panel Displays**
The latest crop is slimmer, lighter and easier to use.
By Bill Siuru, Ph.D.
- 20 Record/Playback Messages Without Magnetic Tape!**
Compact, all-solid-state design provides up to 16 seconds of automatic voice message.
By Anthony J. Caristi
- 34 The Semianalyzer (Part 1)**
Tests semiconductors for type, condition and number of junctions, circuitry around the devices and other components. *By David T. Miga, CET*
- 50 Automatic Audio Panner**
Special-audio-effects device automatically creates dynamic stereo sound from mono audio sources such as electric musical instruments. *By C.R. Fischer*
- 56 An Infrared Remote Control Relay**
\$10 project provides wireless VCR control to remote TV sets. *By Joseph O'Connell*

PRODUCT EVALUATIONS

- 61 Kit Report: Heath Computer Voice Card**
By Art Salsberg

COLUMNS

- 62 Electronics Notebook**
Experimenting With Liquid Nitrogen.
By Forrest M. Mims III
- 70 Solid-State Devices**
Digitally controlled potentiometers; Sematech finds a home in Texas. *By Harry Helms*
- 75 Electronics Omnibus**
Shortwave Listening. *By Curt Phillips*
- 78 PC Capers**
Clone Upgrading. *By Ted Needleman*

DEPARTMENTS

- 4 Editorial**
By Art Salsberg
- 5 Letters**
- 6 Modern Electronics News**
- 8 New Products**
- 82 Books & Literature**
- 96 Advertisers Index**

EDITORIAL STAFF

- Art Salsberg**
Editor-in-Chief
- Alexander W. Burawa**
Managing Editor
- Dorothy Kehrwieler**
Production Manager
- Elizabeth Ryan**
Art Director
- Barbara Scully**
Artist
- Pat Le Blanc**
Florence V. Martin
Phototypographers
- Hal Keith**
Illustrator
- Bruce Morgan**
Photographer
- Leonard Feldman, Harry Helms, Forrest Mims III, Ted Needleman, Curt Phillips**
Contributing Editors

BUSINESS STAFF

- Richard A. Ross**
Publisher
- Art Salsberg**
Associate Publisher
- Dorothy Kehrwieler**
General Manager
- Frank V. Fuzia**
Controller
- Arlene Caggiano**
Accounting
- Catherine Ross**
Circulation Director

SALES OFFICES

- Modern Electronics**
76 North Broadway
Hicksville, NY 11801
(516) 681-2922
- Advertising Manager
Peter Conn
Sales Assistant
Kathleen O'Lenahan
76 North Broadway
Hicksville, NY 11801
(516) 681-2922

Offices: 76 North Broadway, Hicksville, NY 11801. Telephone: (516) 681-2922. Modern Electronics (ISSN 0748-9889) is published monthly by Modern Electronics, Inc. Application to mail at second class rates pending at Hicksville, NY and other points. Subscription prices (payable in US Dollars only): Domestic—one year \$17.97, two years \$33.00, three years \$48.00; Canada/Mexico—one year \$20.00, two years \$37.00, three years \$54.00; Foreign—one year \$22.00, two years \$41.00, three years \$60.00. Foreign Air Mail—one year \$75.00, two years \$147.00, three years \$219.00.

Entire contents copyright 1988 by Modern Electronics, Inc. Modern Electronics or Modern Electronics, Inc. assumes no responsibility for unsolicited manuscripts. Allow six weeks for delivery of first issue and for change of address. Printed in the United States of America. Postmaster: Please send change of address notice to Modern Electronics, Inc., 76 North Broadway, Hicksville, NY 11801.

Radio Shack Parts Place™

THE BUILDER'S STORE! OVER 1000 COMPONENTS IN STOCK

Our Finest Benchtop LCD Multimeter

99⁹⁵

Low As \$15
Per Month*

- Manual or Autoranging
- Min/Max Values Can Be Stored

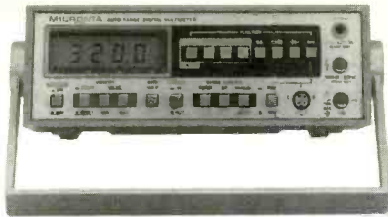

A champion performer for lab or home shop. The 31-segment analog bar graph display makes input peaks and trends easier to follow. Transistor checker measures β_{FE} (gain) and tests semiconductor junctions. Buzzer continuity checker. Measures to 1000 VDC, 750 VAC, AC/DC current to 10 amps, resistance to 30 megohms. Fused, overload protected. #22-195

Data-Connector Headquarters

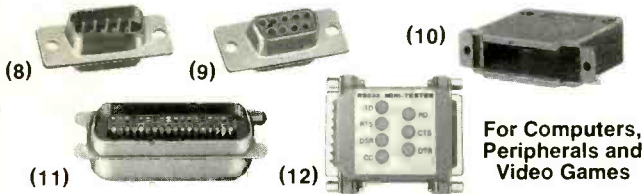

For Computers, Peripherals and Video Games

Fig.	Type	Positions	Cat. No.	Each
8	Male	9	276-1537	1.49
9	Female	9	276-1538	2.49
10	Hood	9	276-1539	1.99
—	Male	25	276-1547	1.99
—	Female	25	276-1548	2.99
—	Hood	25	276-1549	1.99

- (11) **Printer Connector.** Solder type, 36-position. For parallel printers. #276-1534 4.99
- (12) **RS-232 Inline Tester.** Diagnose interface problems without repair calls. #276-1401 14.95

Sight'n Sound

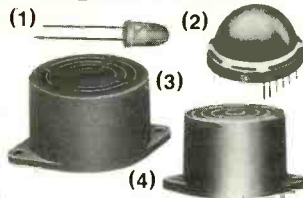

- (1) **Ruby Red LED.** #276-066 1.19
- (2) **Jumbo Red LED.** #276-064 3.49
- (3) **Tri-Sound Siren.** #273-072 5.95
- (4) **IC Chime.** #273-071 7.95

Builder Bargains

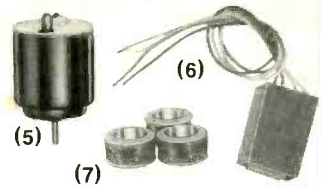

- (5) **1.5-3 VDC Motor.** #273-223 79¢
- (6) **1:1 Audio Transformer.** For phone interconnects. #273-1374 3.49
- (7) **Magnet Wire.** Three-spool set—22, 26, 30 gauge. #278-1345 4.49

Coax Cable Tools

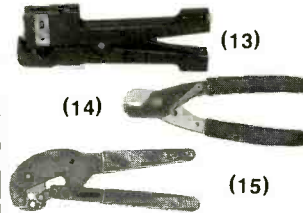

- (13) **Cable Stripper.** For all popular sizes. #278-240 11.95
- (14) **Coax Cable Cutter.** Preserves cable impedance. #278-244 4.95
- (15) **Professional Crimp Tool.** For all coax connectors. #278-243 12.95

The Right Stuff

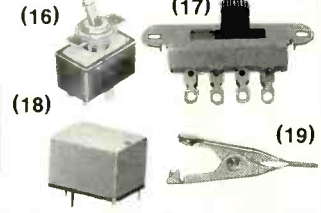

- (16) **Toggle Switch Set.** One DPDT, two SPST. #275-322 Set of 3/2.59
- (17) **Slide Switch Kit.** Assorted one or two poles/throws. #275-327 Set of 6/1.89
- (18) **Micromini Relay.** #275-248 2.79
- (19) **Micro Clips.** #270-373 10/1.59

Exciting New ICs For Hobbyists

TDA7000 FM Receiver on a Chip. Combines RF mixer, IF and demodulator stages in one IC. Just what you need to build a small, inexpensive FM band receiver, repeater monitor or public service band monitor. Mute circuit reduces spurious reception. Includes application notes. #276-1304 5.95

TDA1520A 20-Watt High-Power, High-Fidelity Audio Power Amp. Build your own quality audio amplifier! Nine-pin single inline package. Very low distortion. 20 to 20,000 Hz response. Requires 15 to 50 VDC. With data. #276-1305 5.99

Add Speech to Your Computer

SP0256-AL2 Speech Synthesizer IC. Cut 23%. Uses a stored program to produce natural sounding speech. Easy to interface with most computers. Requires 3.12 MHz crystal (special order), 28-pin DIP. Includes data. Reg. \$12.95. #276-1784 Sale 9.95

CTS256-AL2 Text-to-Speech IC. 30% Off. Preprogrammed 8-bit processor translates ASCII characters into control data for #276-1784 above. With data and schematics. Requires 10 MHz crystal (special order), 40-pin DIP. Reg. \$16.95. #276-1786 Sale 11.88

Finishing Touches

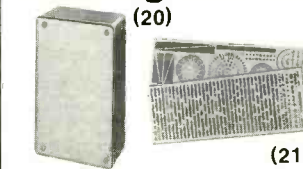

- (20) **Experimenters' Boxes.** Plastic with aluminum covers. Includes screws. 6 1/4 x 3 3/4 x 2". #270-627 2.39
- 3 1/4 x 2 1/8 x 1 1/8". #270-230 1.59
- 4 x 2 1/8 x 1 1/8". #270-231 1.69
- 7 3/4 x 4 3/8 x 2 3/8". #270-232 2.99
- 5 1/16 x 2 5/8 x 1 1/8". #270-233 1.99
- (21) **Dry-Label Transfers.** Letters, symbols, numbers. 4 sheets. #270-201 2.79

Hard-to-Find Caps

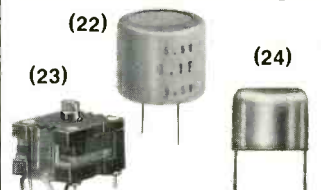

- (22) **CPU/RAM Backup.** Backs up CMOS microprocessors for brief AC failure. 0.1 farad, 5.5 VDC. #272-1440 2.95
- (23) **Dual-Ganged 335 pF Variable.** PC mount. With knob. #272-1337 4.95
- (24) **6-50 pF Trimmers.** PC/perboard-mount. #272-1340 Set of 2/1.59

Dynamic RAM

4164-64K. Warranted RAM chips are as close as your neighborhood Radio Shack. 150 ns access. Uses single 5 VDC supply. #276-2506 3.95

TMS 4256-256K. 150 ns access. Low-power design (230mV typical). Uses single 5 VDC supply. 16-pin DIP. #276-1252 6.95

Line Driver ICs For Data-Transfer

MC1488 RS-232 Quad Line Driver. Hook up terminals and remote peripherals with a simple "twisted pair" cable. 14-pin DIP with data. #276-2520 1.29

MC1489 RS-232 Quad Line Receiver. For use with above line driver. #276-2521 1.29

Operational Amps

741. General-purpose, single channel. Frequency-compensated, 8-pin DIP. #276-007 79¢

1458 Dual Op Amp. Internally compensated. Low power consumption. Two independent op amps in an 8-pin DIP. Split supply 5 to 16 VDC. #276-038 99¢

LM324 Quad Op Amp. Operates on 3 to 30 VDC or split 1.5 to 15 VDC supply. 14-pin DIP. #276-1711 1.29

TL082 Dual High-Performance Op Amp. Low-noise, high-Z biFET inputs. Low distortion. Split 4 to 18 VDC supply. 8-pin DIP. #276-1715 1.89

LM339 Quad Comparator. Four independent voltage comparators in a 14-pin DIP. Single 2 to 32 VDC. #276-1712 99¢

LM567 Tone Detector. Touch-Tone, RC and FSK decoding. Requires 4.75 to 9 VDC. 8-pin DIP. #276-1721 1.99

Musical Chips

UMC 3482 12-Tune Melody Synthesizer IC. 33% Off. Just the thing for musical doorbells, clocks, games and phone music-on-hold. Has an on-chip audio preamp. Tunes include Happy Birthday, Row-Row-Row Your Boat and other all-time "camp" favorites. Operates on 1.5 VDC, 16-pin DIP. With data and circuit examples. Reg. \$2.99. #276-1797 Sale 1.99

AY-3-8910A Programmable Sound Generator. Cut 21%. Use with a computer to provide an astonishing variety and range of sounds! Three independent outputs. Single 5 VDC supply. 40-pin DIP. With data. Reg. \$9.95. #276-1787 Sale 7.88

CMOS and TTL ICs

All are 100% prime and include pin-out and specs.

Description	Type	Cat. No.	Each
Quad 2-Input NOR Gate	4001	276-2401	99
Quad 2-Input NAND Gate	4011	276-2411	99
Dual Type-D Flip Flop	4013	276-2413	1.19
Decade Counter/Divider	4017	276-2417	1.49
Inverting Hex Buffer	4049	276-2449	1.19
Quad Bilateral Switch	4066	276-2466	1.19

Description	Type	Cat. No.	Each
Quad 2-Input NAND Gate	7400	276-1801	89
Hex Inverter	7404	276-1802	99
Quad 2-Input AND Gate	7408	276-1822	1.29
BCD to 7-Seg. Driver	7447	276-1805	1.69
Div. by 2/5 BCD Counter	7490	276-1808	1.19

Over 1000 items in stock: Binding Posts, Books, Breadboards, Buzzers, Capacitors, Chokes, Clips, Coax, Connectors, Fuses, Hardware, ICs, Jacks, Knobs, Lamps, Multitesters, PC Boards, Plugs, Rectifiers, Resistors, Switches, Tools, Transformers, Wire, Zeners, More!

*Revolving credit from Radio Shack. Actual payment may vary depending on purchases.

Prices apply at participating Radio Shack stores and dealers

Radio Shack®
The Technology Store™

A DIVISION OF TANDY CORPORATION

CIRCLE 36 ON FREE INFORMATION CARD

HAM RADIO IS FUN!

It's even more fun for beginners now that they can operate voice and link computers just as soon as they obtain their Novice class license. You can talk to hams all over the world when conditions permit, then switch to a repeater for local coverage, perhaps using a transceiver in your car or handheld unit.



Your passport to ham radio adventure is TUNE-IN THE WORLD WITH HAM RADIO. The book tells what you need to know in order to pass your Novice exam. Two cassettes teach the code quickly and easily.

Enclosed is my check or money order for \$15.00 or charge my

() VISA () Mastercard () Am. Express

Signature _____

Acct. No. _____

Good from _____ Expires _____

Name _____

Address _____

City _____ State _____ Zip _____

THE AMERICAN RADIO RELAY LEAGUE
225 MAIN ST.
NEWINGTON, CT 06111

CIRCLE NO. 137 ON FREE INFORMATION CARD

4 / MODERN ELECTRONICS / April 1988

EDITORIAL

The Electronic Chariot

When I got my driver's license, the only electronics in an automobile was in its AM radio. Today, automotive electronics is an integral part of any car model, even the least expensive ones. In a few years, however, it will virtually permeate an automobile that might rightly be called an electronic chariot.

In the car entertainment area today, AM/FM radios and cassette tape players can be considered standard equipment. A host of options expand the electronics card: CD players, power-boost amplifiers, active speaker crossover networks and graphics controllers, with digital audio tape players expected to emerge soon. Scanners, radar detectors and cellular telephones are electronic choices that are widely available, too, as are all manner of electronic anti-theft devices.

Many dashboards dazzle a driver's eyes with their digital electronic readouts, both numeric and graphic. There's even an interactive dashboard control center on one car, introduced in a 1986 Buick Riviera. It features a CRT touch-sensitive screen whose inputs are controlled by up to 10 microprocessors. With it, the driver can employ the touch of a fingertip to set the radio, climate, and trip monitor, among other actions. Readings from a variety of gauges can be activated, too.

More than anything, though, are the electronics/computers buried in a car that you never see. Chrysler introduced electronic cruise control that provides steady automatic speed with greater accuracy, system turn-off if there's rapid acceleration that might be caused by, say, wheels slipping on ice, etc. Ford and Chrysler provide lockup control of automatic transmissions in some models. Electronic antilock braking was introduced on some prestigious imported cars and is now available on some U.S. models. Electronic ignition systems are old hat now, as are engine computer control modules that automatically handle a bevy of functions.

Synthesized voice alerts and active suspension control systems are also among the newly available electronic/computer options on some car models.

Coming up are refinements of the same, plus newly anticipated developments such as satellite communications links from an automobile that might be used for navigation, inter-car communications bolstered by automatic voice warnings if proximity detectors indicate impending problems (a car moving too close to another one, theft deterrence by being able to sense a car's location, etc.). Diagnosing of repairs will soon be improved as dealers' service departments get new on-line computerized test instruments, one of which has a plug-in data recorder for checking a car for an intermittent problem while it is being driven.

All these developments are very impressive, especially since virtually everyone can see or feel the changes themselves. We also share the frustrations faced by automobile service people, who have to invest in computer terminal test equipment and continual upgrading to check new computer modules in the latest automobiles.

We suffer with them by paying higher and higher labor charges to compensate for their added test equipment expense and training time. And we help out car manufacturers who squeeze a 1/2-million transistors into a single chip by paying a small fortune for a whole module instead of small change for a little part.

Clearly, there's a price to be paid for greater fuel economy, smoother rides and safer braking, all made possible by advances in electronics. But, then, when did we ever get something for nothing?

Art Salsberg

Say You Saw It In Modern Electronics

Eavesdropping

• On "Laser Eavesdropping" (November 1987 issue) and laws governing illegality concerning eavesdropping, I also agree with Forrest Mims' moral position. It's like that of [the late] John Frye in *Electronics World*, LXXX (December 1968), pages 54 and 55, and also Harry Houdini, *A Magician Among the Spirits*, chapter 13, and *Discover* (November 1987), pages 50 through 56.

Hans L. Lembke
Milwaukee, WI

Hot Buyers

• Your article "Floppy Disk Drive Testing," *Modern Electronics*, October 1987, is of great advantage. Something was missing, however. For instance, a list of manufacturers' floppy drives that will not work or be put in proper operation by use of "Memory Minder" and to what address I respond to purchase the software.

Christopher Haenel
Pittsburgh, PA

We didn't find any diskette drives that couldn't be checked out. J&M Systems' city and state were given in the review. The full address is J&M Systems, Ltd., 15100-A Central SE, Albuquerque, NM 87123 (Tel.: 505-292-4182).—Ed.

• I thoroughly enjoyed the October 1987 issue of *Modern Electronics*, particularly the "Proportional Temperature Controller," which is an ideal project for my darkroom. However, I am having difficulty locating the Signetics TDA1023 time proportional triac trigger.

William R. Warren
Lacota, MI

This component is available from Digi-Key Corp., P.O. Box 677, Thief River Falls, MN 56701, among others.—Ed.

Project Updates

• There is no continuity in the text between page 35 and page 36 of "A General-Purpose Speech Synthesizer" (October 1987). Is there something important missing here?

Jim O'Keefe
New York, NY

Nothing is missing! During page layout two blocks of copy were accidentally transposed. The first seven lines in the first column on page 36 should follow the remaining lines in that column.—Ed.

• Most gremlins were chased out of the "General-Purpose Speech Synthesizer" (October 1987) with the fix given in the January 1988 Letters column. But there are a couple more. In Fig. 2, the rightmost data line to IC11 and IC12 should be moved up one line, as indicated in Figs. 4 and 5. The Q7 pin in Fig. 4 is actually number 19—not 9. Finally, C4 thru C7 and others on that line are 0.01- μ F

and C8, C9, C11 and C12 are 22-pF capacitors.

Incidentally, anyone who is having difficulty finding a 3.12-MHz crystal for this project can use a common 3.58-MHz "colorburst" crystal instead. I've used these successfully in the past with the SPO256A-AL2.

Terrence Vaughn
W. Covina, CA

ME

John J. Meshna Jr., Inc. SURPLUS ELECTRONICS

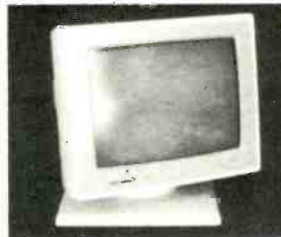

IBM® Compatible Flat Screen Monitor

We just bought a bunch of classy looking IBM® compatible TTL monitors. They were made by Samsung (Sm12SFA7). The monitors utilize a flat, 12" amber high contrast, non-glare CRT. Some of the nice features of this item are: high resolution 80 x 25 character display, they are fully enclosed and come with a tilt & swivel base. The TTL level signals are input thru a sub-D type connector. The monitors run on standard US house current. 95% of them are in their original factory cartons. They are tagged as having minor defects. We have looked over a few of them and have found them to be completely intact. We guarantee the CRT's are unbroken and will not have burn marks on them. The original selling price of this very handsome unit was over \$125.00 each including the tilt/swivel base. We offer it for only \$50.00 with the CRT guaranteed OK, as mentioned above. We will also provide a schematic. "AS IS" with Schematic. Shpg. Wt. 20 lbs...MOT-17...\$50.00

Universal

Battery Charger

Rechargeable nickel cadmium batteries are becoming more popular everyday. This has created a need for an inexpensive, reliable charger for them. The charger we offer is very universal because it will charge AAA, AA, C, D & 9V batteries. There are 2 charging sections with corresponding LED indicators. Any pair or same size batteries may be charged in a single section. 2 or 4 batteries can be charged at the same time. Each charger comes new in the box with instructions. Shpg. wt. 3 lbs...SPL-39A-49...\$10.00

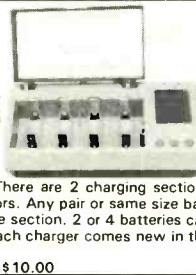

6V, 9A BATTERIES

As originally used, 2 of these 6V, 9A sealed lead acid batteries were put in series which gave them 12V to power a child's ride around car or jeep. The batteries we offer are from a discontinued model and are all unused. We have also found batteries of this type used in many fire alarms. Since they are sealed, they can be operated in any position without fear of spillage. We also have some of the dual 25A, fused wiring harnesses with the special connector available that they used for connecting the batteries in series. In addition, we have in stock the 12VDC, 800MA charge module with the mating connector for the wiring harness. All of these goodies are unused and are guaranteed OK. Current list price for these batteries is approximately \$22.00.

UNUSED BATTERY
Shpg. Wt. 6 Lbs...SP-170-48...\$13.00 each
WIRING HARNESS
Shpg. wt. 4 oz...SP-171-48...\$2.00 each
CHARGER MODULE
Shpg. wt. 2 Lbs...SP-172-48...\$5.00 each



PRC-6

US Military hand held walkie talkie chassis which covers the range of 47-55.4 MHz. Covers distance of approximately 1 mile. Amateur license required to operate this set. Requires batteries 1.5V & 45 (we don't have). We have a bunch of these now available that we are selling as parts value. Some of the parts that can be salvaged are the following: peanut tubes (3) Jan 5676; (6) Jan 5678; (1) Jan 2021; 1 384, output x former, components, connectors, springs, hardware. The kind of stuff found in older transceivers. Some are complete and some are not. Maybe you can make 1 from 2 units, we don't know. We offer them as a parts value or a collectors item. No more once these are gone. Sold "AS IS". Shpg. wt. 6 Lbs...PRC-6...\$7.00

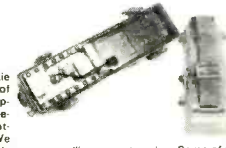

Rechargeable sub "D" Cell BATTERY PACK

We were fortunate to have purchased a Ltd. Qty. of these very high quality nicad sub "D" cells, but only 1-3/8"H. Great for radio controlled devices, battery back-up systems & many other uses. 6" color coded leads. This pack probably sold for over \$60.00 each. NEW. Shpg. wt. 2 Lbs...SP-84-47...\$25.00
Battery Charger module for above:
Shpg. wt. 1/2 Lb...SPL-128-38...\$3.00

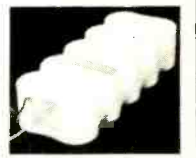

QUAD SUPPLY BARGAIN

Because our customers are always looking for inexpensive power supply parts, we look extra hard for the same thing and these should fulfill many a customer's wish. This power supply is made by ASTEC. (No. AA12690) for Wang Labs. The outputs are as follows: +5VDC; +0A(reg); +12VDC 2.5A(reg); +12VDC, 5A(Unreg); -12VDC, 25A(reg). We bought them cheap in "AS IS" condition and offer them the same way. The supplies are whole and intact. They are not cannibalize or trashed. The input is fused and switched. Turning on the supply automatically turns on the enclosed spire type fan. There are many salvageable parts should you wish to stock your parts bin. The fan, when new, sells for over \$20.00. We are trying to obtain a schematic for it and should we get one, we will provide it for free. The input is switchable for 110/220 Volts. A great deal whether you want to repair them or strip it for the many valuable parts. Shpg. wt. 8 Lbs...SP-31A-49...\$12.00 as is" Line Cord With appropriate connectors for above...cord 6...\$1.75 each



Rotron® Feather Fans

We just uncovered a small batch of these very popular high performance fans. They are rated to deliver 245CFM very quietly via Rotron's patented feathered edged blades. They measure 7" in diameter x 2.47" deep. We had these before and sold out very quickly. The current price on these babies is \$62.00 each! We have seen these fans used in many different applications including cooling down computer racks. They are very reliable. Unused surplus. Shpg. wt. 3 Lbs...SPL-17A-49...\$18.00 each

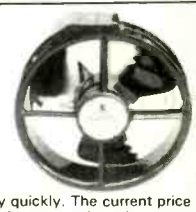

John J. Meshna Jr., Inc. SURPLUS ELECTRONICS

19 Alerton Street P.O. Box 8062 E. Lynn, MA 01904 Tel:(617)595-2275
Phone Orders accepted on MC, VISA or American Express. \$20.00 minimum order.
Spring Catalog now available 64 Pages of good stuff!

CIRCLE 81 ON READER SERVICE CARD

SONY HEDGES VCR BET. Sony Corp. announced it will be making the marketing VHS videocassette recorders after carrying the Beta-format VCR banner all these years. It isn't giving up on Beta types, however, though its share of the market is small and getting smaller. Although the company may be whistling in the dark concerning its continuance with Beta, as the sole maker of this format it still accounts for a lot of machines world-wide.

HOME EQUIPMENT CONTROL BUS. It's not a new idea, but NEC's Home Electronics Group has introduced a home control system that uses the ac power line. It's called the Spectrum AC and, unlike other systems, uses spread-spectrum technology instead of single frequencies and operates at 9600 baud. According to NEC, this design avoids the effects of line noise that could mar effective control. It's supposed to be available for use in commercial buildings at the end of '88.

CHALLENGING IBM. The Big One will have to fend off ever-increasing competition, it seems. Now Apple Computer, in its efforts to gain a greater foothold in corporations, has embarked on a joint development effort with Digital Equipment Corp. The intention is to integrate Macintosh personal computers and Appletalk networks with DEC's VAX systems and DECnet/OSI networks.... The cloners are marching against IBM, too, with claims that IBM's PS/2 hardware/software systems have been cracked. Everyone's wondering if there'll be a lawsuit for patent infringement, licensing deals, or what? On the other hand, many people wonder if there's a solid enough market for PS/2 clones at this moment since the AT-bus machines and supporting software and peripherals are still doing so well in the marketplace.

IN-STORE MUSIC SAMPLING. In the golden days of 78-rpm records, a prospective buyer could take a record into a little booth and listen to it via headphones before buying (or not buying) it. As 33-rpm long-play records took over, this music-sampling opportunity disappeared. This action was strange in a way since the LP's were less prone to damage by customers handling them and selling prices rose very substantially. Heat-shrink wrapping by manufacturers did the trick. Now, Interac Corp. (Los Angeles, CA), collaborating with major music-label companies, developed a music sampler supported by a video-related slide show called, of all things, "The Music Sampler." It consists of Interac's digitized image technology combined with the company's digital audio system, and has reportedly been installed in selected Tower Records stores in the greater Los Angeles area. With audio from new releases, supplemented by video slides provided by major record labels, shoppers can choose among new releases to hear (excepts, that is) and view. Hopefully, such browsing possibilities will grow.

EE ENROLLMENT DROPS. Electrical engineering undergraduate enrollment dipped slightly for the first time in a decade, while other engineering enrollments dropped steeply. This leveling off is reported to be due to the low birth rate in the 1960's. However, the number of part-time EE undergraduates, and master's and Ph.D. candidates increased.

With Instant Access, GE/RCA brings to the screen a world of replacement parts.

Now appearing at participating GE/RCA Distributors across the country is a new, highly efficient computerized replacement parts service called **Instant Access**.

With direct access to our main computer, a distributor can now learn the availability, pricing, and cross-referencing of whatever part you need, quickly and accurately.

Our massive inventory provides you with instant access to consumer parts, SK and MRO devices, broadcast parts, picture tubes, receiving tubes, electro-optics and devices, video accessories and video tape.

A precise cross-reference index automatically converts all leading industry

numbers for solid state devices (including MRO), and electro-optics and devices, into corresponding RCA part numbers. As well as converting RCA drawing

numbers into RCA stock numbers for Consumer Electronics replacement parts.

Next time you need a replacement part in a hurry, look into

Instant Access.

You can even specify delivery—in less than twenty-four hours if necessary. To find the participating **Instant Access** distributor nearest you, write: Sales Promotion Services, Distributor and Special Products, 2000 Clements Bridge Road, Deptford, NJ 08096-2088.



CIRCLE 29 ON FREE INFORMATION CARD



NEW PRODUCTS

For more information on products described, please circle the appropriate number on the Free Information Card bound into this issue or write to the manufacturer.

Portable Computer With Bundled Software

Amstrad, Inc. (Irving, TX) has introduced the Model PPC 512, a portable IBM PC-compatible computer that comes with MS-DOS 3.3 and the user's choice of bundled software. The computer is built around an 8086 microprocessor running at 8 MHz. The 11-pound computer features an 80 × 25-character (640 × 200-pixel) supertwist LCD display screen, single or dual 3.5-inch disk drives, a full-size 101-key AT-style keyboard, and 512K of user RAM.

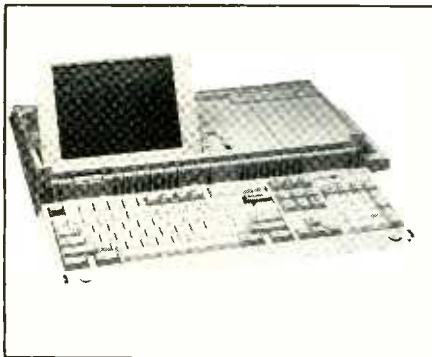

A unique feature of this new portable computer is that it is designed to operate on ac line power, a vehicle 12-volt dc electrical system, an Amstrad PC 1640 power supply and regular C cells. It also plugs into any standard 9-pin DIN socket for use with any PC-compatible video display monitor.

"Discover Kit" is one bundled software option, designed for the first-time or casual computer user. It consists of easy-to-use word-processor, database and spreadsheet software. Called DiscoverWrite, DiscoverFile and DiscoverPlan, the software enables the user to immediately write letters, make and file notes, use the computer as a calculator and play games without having to use manuals or DOS.

Option No. 2 is Migent's "Abili-

ty" integrated software that offers more experienced users sophisticated word processor, spreadsheet, business graphics, database management, communications and audio/visual presentation capabilities. \$949 with single drive; \$1,049 with dual drive.

CIRCLE 37 ON FREE INFORMATION CARD

VCR Torque Gauge

A universal dial-type torque gauge from Tentel (Campbell, CA) indicates both clockwise (+) and counterclockwise (-) torque on VHS and Beta videocassette recorders to a full 600 gram/centimeters. The Model TQ-600 has an extra-long reach that provides easy access to spindles in any VCR transport. The gauge is machined from aircraft-quality aluminum, making it rugged enough to be used in the field as well as on a workbench.

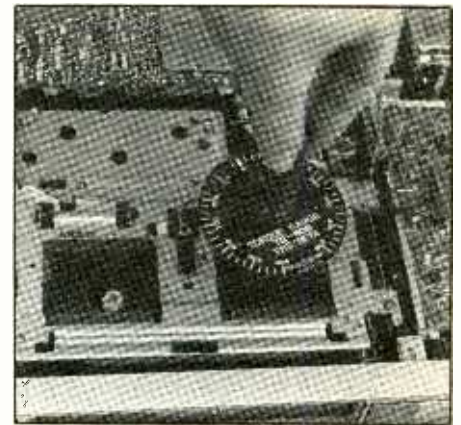

Accompanying the gauge is an accessory VHS T.E.A.C.H. (Tentel Easy Access Cassette Housing) cassette. This cassette eliminates the need for blocking optical sensors and shorting of switches, permitting fast torque readings. Also included is an instruction manual with a reference chart that outlines 11 critical torques for common VHS transports. \$139.

CIRCLE 38 ON FREE INFORMATION CARD

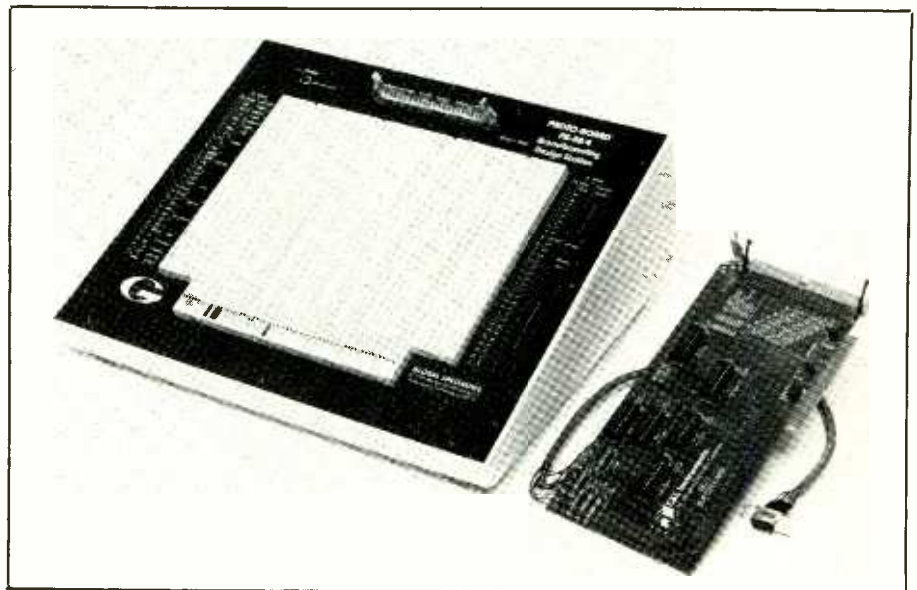

PC Prototyping Breadboard

Global Specialties' new Model PB-88/4 breadboarding system for IBM PCs and compatibles offers a convenient way to prototype or experiment with interfaces. A buffered plug-in card and 60-conductor cable that connects directly to any PC or compatible allows the PB-88/4 to bring all computer bus sig-

nals to labeled solderless sockets. More than 3,300 contact points are provided on the breadboarding area.

Power for the breadboarding system is provided by the host computer with which it is used and is switchable from the PB-88/4's front-panel "on" LED. The solderless breadboard measures 13"W × 11.5"D × 6"H.

CIRCLE 39 ON FREE INFORMATION CARD

LD/CD/CDV Player

The new Model CLD-1030 LD/CD/CDV player from Pioneer Electronics (USA) Inc. uses a single tray to play 5" CD and CDV, 8" and 12" LaserVision and the new 3" CD disks. The machine automatically senses type of disk. Picture quality is enhanced by a 420-line horizontal resolution and 46-dB luminance S/N. Audio enhancement is the result of digital filters and includes 96-dB S/N and 95-dB dynamic range on CDs and LaserDiscs with digital sound tracks.

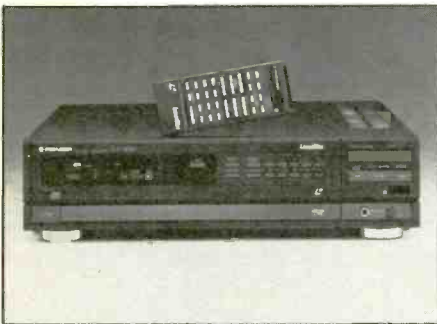

Front-panel improvements include a large fluorescent display with calendar and six new control keys. The display enables the user to read working mode, chapter/track number and time/frame number directly from the front panel, providing an alternative to on-screen display of this information.

Ten keys allow the user to control the most frequently used functions directly at the player's panel as well as through the supplied wireless remote-control transmitter. Keys are included for program editing, open/close, play/pause, forward/reverse scan, chapter skip/track search and random play.

This new player has on-board memory capable of playing back a sequence of up to 20 tracks or chapters (twice as many as in the earlier Model CLD-1010). An improved disc loading mechanism includes a tray that extends fully when opened, making it easier to insert discs. Dimensions are 17 1/4" D x 16 1/16" W x 4 1/16" H. \$900.

CIRCLE 40 ON FREE INFORMATION CARD

50-MHz Analog/Digital Storage Oscilloscope

The Philips Model PM 3350 from John Fluke Mfg. Co., is a 2-channel digital storage oscilloscope that offers real-time capability and ease-of-use. It has a maximum sampling frequency of 100 Msamples/second, maintained on both channels simultaneously for high-resolution signal display and storage.

In digital mode with triggering up to 100 MHz, cursor facilities take a wide range of measurements from the on-screen traces. Backup or reference memories are available for comparison purposes, and the cursors also operate in this mode.

One-button "autoset" is available in both analog and digital modes for automatic channel selection and set-

(Continued on page 86)

Joseph Electronics' 40th Anniversary Specials!

Model 2120 Oscilloscope

Model 3014 Function Generator

<p>Model 2120 Oscilloscope DC to 20 MHz, Dual Trace, 6" CRT-1mv Sensitivity Reg. \$479 \$379.40 40TH ANNIVERSARY PRICE Model 2125 Oscilloscope Same great features as 2120, except with delayed sweep Reg. \$570 \$469.40 40TH ANNIVERSARY PRICE Model 1541A Oscilloscope DC to 40 MHz, Dual Trace, 6" CRT 1mv Sensitivity Reg. \$845 \$739.40 40TH ANNIVERSARY PRICE Model 2520 Digital Storage 20MHz, Dual Trace, 2mv Sens. Reg. \$-990 \$1795.40 40TH ANNIVERSARY PRICE Model 2521 Digital Storage 20MHz, Dual Trace CRT Read-out, Cursors, RS232 Interface Reg. \$3050 \$2745.40 40TH ANNIVERSARY PRICE</p>	<p>Model 1249 NTSC RGB Color Bar Generator, Composite Video Output, RF Output Reg. \$475 \$399.40 40TH ANNIVERSARY PRICE Model 2009 MTS TV Stereo Generator ideal for Stereo TV, Receivers, VCR's and Stereo Adapter Service Reg. \$495 \$419.40 40TH ANNIVERSARY PRICE Model 2830 3-1/2 DIGIT LED BENCH Multimeter .5 DCV Accuracy, ALL 33 Ranges and Functions are Push Button Selectable Reg. \$233 \$199.40 40TH ANNIVERSARY PRICE Model 1045 Telephone Product Tester Provides Basic Operation Tests for Corded and Cordless Telephones, Answering Machines and Automatic Dialers Reg. \$471 \$399.40 40TH ANNIVERSARY PRICE</p>	<p>Model 1803 Frequency Counter 100 MHz, 8 digit display, zero blanking AC Reg. \$186 \$159.40 40TH ANNIVERSARY PRICE Model 2005 RF Signal Generator 100 KHz to 150 MHz, 16 fundamental bands and 450 MHz in harmonics Reg. \$195 \$169.40 40TH ANNIVERSARY PRICE</p>	<p>Model 3014 Function Generator 2 MHz, 4 digit display, TTL & CMOS pulse outputs Reg. \$225 \$189.40 40TH ANNIVERSARY PRICE Model 1630 DC Power Supply 0-30V, 0-3A high-low current range, Low ripple Reg. \$233 \$199.40 40TH ANNIVERSARY PRICE Model 1601 DC Power Supply isolated 0-50V, 0-2A in ranges, fully automatic shutdown, Adj. current limit Reg. \$440 \$369.40 40TH ANNIVERSARY PRICE Model 1650 Triple Output Power Supply two 0-25 VDC @ .5A and 5VDC @ 5A, fully automatic shutdown Reg. \$455 \$379.40 40TH ANNIVERSARY PRICE Model 1653 AC Power Supply variable isolated 0-150 VAC @ 2A, built-in isolation transformer Reg. \$190 \$169.40 40TH ANNIVERSARY PRICE</p>
--	---	---	--

We are celebrating our 40th Anniversary by offering you huge savings on B&K Test Equipment.

Send for FREE 480 page "Industrial Products Catalog". Understand it is FREE with any order or if requested on company letterhead. (Otherwise, \$4.95 to cover catalog and shipping costs.)

ORDER TOLL FREE
1-800-323-5925
IN ILLINOIS
312-297-4200
FAX: 312-297-6923
Our 40th Year

Joseph Electronics

JOSEPH ELECTRONICS, INC. Dept. M
8830 N. Milwaukee Ave., Niles, IL 60648

Rush merchandise per attached order. I understand rated accounts are shipped open account; otherwise send per credit card.

Include \$5.00 per item for shipping and handling.

Visa Master Card Discover
 Check Money Order Rush Catalog

Card No. _____ Exp. Date _____

Name _____
Company _____
Street Address _____
City _____ State _____ Zip _____

IL. Pcs. 7% Tax

CIRCLE 41 ON FREE INFORMATION CARD

What's New in Flat-Panel Displays



Laptop computers with easy-to-read flat-panel screens are possible with electroluminescent displays.

(Courtesy Lohja Electronics)

***The latest crop is slimmer, lighter and easier to use,
enhancing your viewing task to the point of comfort***

By Bill Siuru, Ph.D., PE

If your last experience with flat-panel displays was with the difficult-to-view liquid-crystal (LCD) types of a few years ago, you are in for a pleasant surprise with the displays now being used. Flat-panel display technology has taken great leaps forward. Advances have not

been confined to just basic displays, either; they have also been made in touch-screen input technology. The result of this development activity is display devices that each year become easier to read and use and the paving of the way of a new generation of visual equipment.

With the enormous (and lucrative) potential of flat-panel displays,

many companies are now investing heavily in development to produce flat-panel displays that rival or surpass the visible performance of CRT displays, at prices that are competitive with CRT displays. For example, a thin, lightweight display is imperative for laptop and transportable computers. There are obvious military applications for flat-panel displays, too, ranging from display panels in advanced fighter aircraft to wall-size "war-room" situation displays for keeping track of troop, materiel and weapons deployment, as well as for tracking space satellites.

On The Cover:

Flat-panel displays like this thin-film electroluminescent (TFEL) model take up less space than a CRT in the cockpit of an aircraft. *(Courtesy Planar Systems, Inc.)*



Supertwisted LCDs represent a major breakthrough in the viewability of flat-panel liquid-crystal displays. (Courtesy Tektronix, Inc.)

The aircraft industry's special interest is in development of flat-panel displays that reduce instrument depth and, thus, reduce the size of the cockpit. Potentially the most lucrative applications area for flat-panel displays is in motor vehicles, where millions of these devices annually will eventually replace analog meters and other indicators.

Meeting the Challenges

Many challenges must be overcome in developing usable flat-panel displays, foremost of which is viewability, which includes viewing angle, contrast ratio and resolution. Poor viewing angles plagued earlier LCD panels, which might have looked okay when viewed head-on but virtually washed out (became illegible) when viewed at only slight angles off-axis. Contrast ratio is the ratio of the brightness of displayed information to that of the screen's background. Resolution can be measured by the number of "lines" that can be distinguished per millimeter. The better the resolution, the clearer will be the picture on the screen and the more faithfully information will be

reproduced, whether that information is graphics or text.

Since many flat-panel displays will be used in battery-powered computers and other portable devices, low-power requirements are a critical fea-

ture of this technology. Where flat-panel displays must compete with traditional CRT displays, full color is often desirable.

Because displays must be driven by other electronics, interfaces are also a very important consideration. Flat displays must be reliable and have life expectancies comparable to CRTs. Finally, they must be relatively easy to manufacture in quantity, easy to integrate into a system and, of course, be competitively priced.

Display Types

The three basic types of flat-panel displays of greatest interest today include the familiar liquid-crystal display (LCD), electroluminescent (EL) panel and the plasma display. Touch-screen displays represent an alternative means of feeding data into a system as well.

Most LCDs use liquid-crystal molecules sandwiched between two sets of polarizers and transparent electrodes. The LCD depends on the po-

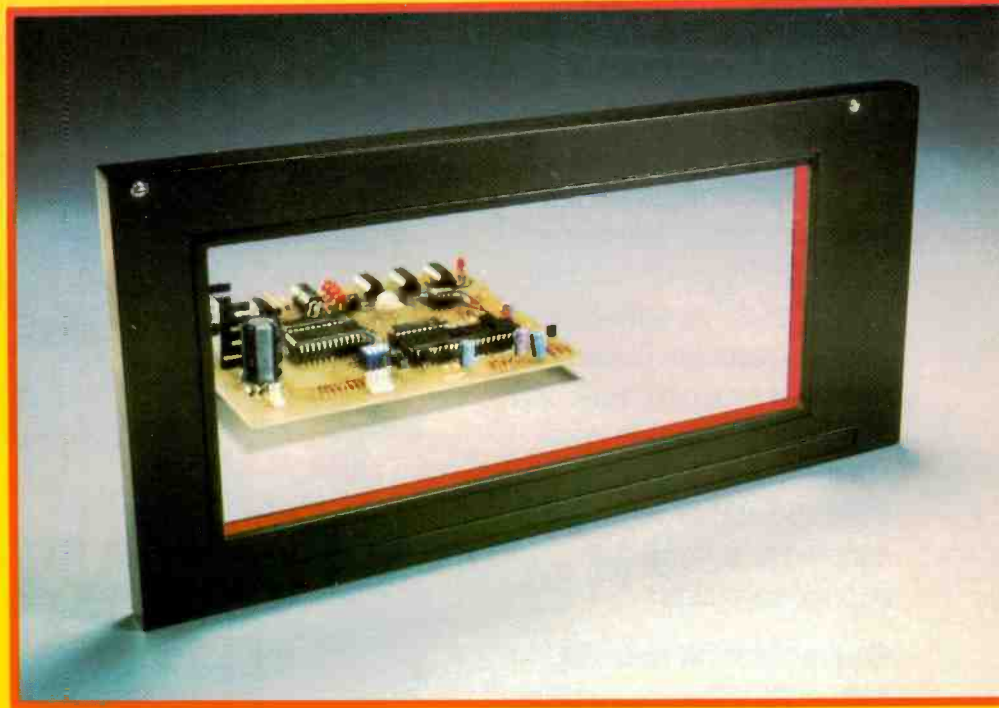

A Cyclops ES Touch Screen with the electronics package that makes it work in the background. (Courtesy Wells-Gardner Electronics Corp.)

Train with NRI for a servicing

NEW!

**20 Meg
Hard Disk
Included!**

Get started now by building this fully IBM PC- compatible computer

Now you get it all . . . training for one of America's fastest-growing career opportunities . . . training to service all computers . . . training on a total computer system, the Sanyo 880. Only NRI can give you the well-rounded training you need, because only NRI gives you a complete computer system . . . computer, monitor, floppy disk drive, hard disk drive, software, even test instruments like a DMM and logic probe to work with and keep. It all adds up to training that builds the knowledge and ability you need to succeed as a computer service specialist.

Get inside the newest, fully IBM PC-compatible Sanyo Microcomputer

As an NRI student, you'll get total hands-on training



as you actually build your own latest model Sanyo 880 Series computer from the keyboard up. It's fully IBM PC-compatible and, best of all, it runs programs almost twice as fast as an IBM PC. As you assemble the Sanyo 880, you'll perform

demonstrations and experiments that will give you a total mastery of computer operation and servicing techniques. You'll do programming in BASIC language—even run and interpret essential diagnostic software.

high paying career computers

HARD DISK—20 megabyte hard disk drive you install internally for dramatic improvement in data storage capacity and data access speed.

MONITOR—High-resolution, green screen displays, crisp text and graphics.

TECHNICAL MANUALS—with complete specs on Sanyo computer and professional programs.

DISCOVERY LAB—Using it, you construct and test circuits like those used with computers.

DIGITAL LOGIC PROBE—Simplifies analyzing digital circuit operation.

at your own convenience, backed at all times by your own NRI instructor and the entire NRI staff of educators and student service support people. They're always ready to give you guidance, follow your progress, and help you over the rough spots to keep you moving toward your goal.

Free 100-page catalog tells more . . . send today

Send the postage-paid reply card today for NRI's 100-page catalog that gives all the facts about computer training, plus career training in robotics, data communications, TV/audio/video servicing, and many other fields. If the card is missing, write to NRI at the address below.

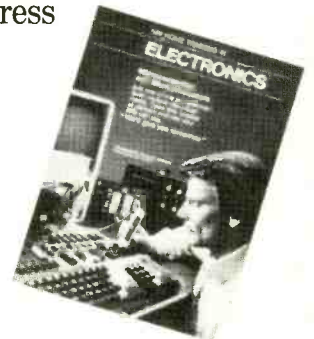

Understanding you get only through experience

You need no previous knowledge to succeed with NRI. You start with the basics, rapidly building on the fundamentals of electronics with bite-size lessons. You perform hands-on experiments

with your NRI Discovery Lab and then move on to master advanced concepts like digital logic, microprocessors, and computer memories.

Learn at home in your spare time

You train in your own home

NRI SCHOOLS

McGraw-Hill Continuing Education Center
3939 Wisconsin Avenue
Washington, DC 20016

We'll give you tomorrow.



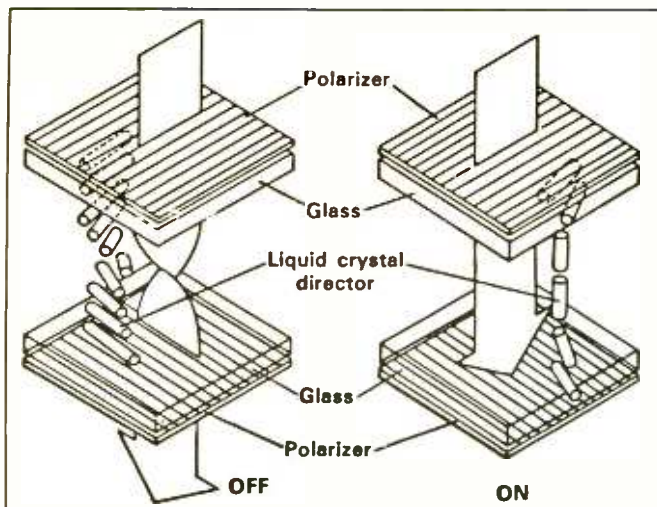

Schematic of a liquid-crystal display panel arrangement that uses the "twisted-molecule" principle. In the "off" state, the polarizing light ray is twisted by a liquid-crystal director so that it passes through the lower polarizer and is reflected back to provide a light screen background. In the "on" state, the light is untwisted and does not pass through the polarizer, thus presenting an on-screen dot.

(Courtesy Tektronix, Inc.)

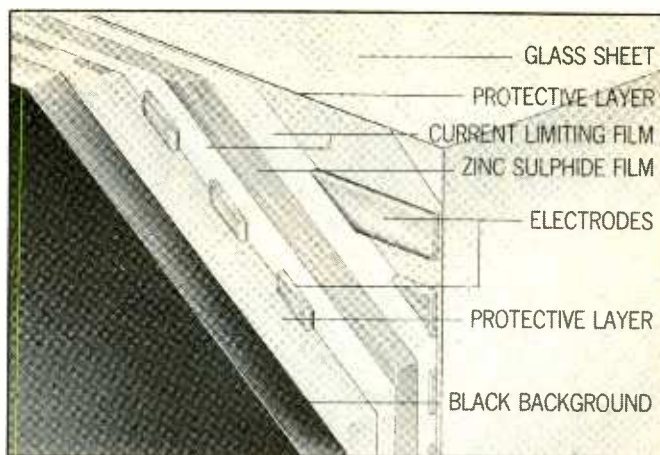

Schematic of an electroluminescent display. The display is composed of a thin-film structure that is grown directly on a sheet of glass so thin that together they measure only 0.001 mm in thickness. Display information is fed to the substrate through electrodes that have been integrated into the thin-film structure. (Courtesy Lohja Electronics)

larizing characteristics of light to provide a displayed image. On the top surface of the sandwich is a transparent glass surface, and a reflector is on the lowest-most surface. When the crystal is in the "off" state, the liquid crystals are twisted so that the light is turned to pass through the polarizer and is returned by the bottom reflector. This particular LCD cell then provides the background of the screen.

When an electric field is applied to the LCD through the electrodes, the crystal molecules line up so that light is absorbed by the lower polarizer and is not reflected. This cell then is dark and provides the individual dot image that is formed into the lines of the dot matrix (a matrix is a regular arrangement of columns and rows) on the screen.

In some applications, such as in automotive instrument panels, the lower polarizer is rotated 90 degrees so that the "on" condition occurs when light is reflected and the dark LCD occurs in the "off" condition.

This arrangement gives a bright line on a dark background.

LCDs are relatively inexpensive to produce and, thus, are already found in a multitude of consumer products. The technology behind them is well-developed and has been exploited much further than the EL and plasma display technologies.

Chief drawbacks of LCDs come in the area of viewability and are the reason why flat-screen displays of the past have been difficult to view. Viewing angles are typically quite narrow, and contrast ratios are less than half those of better EL and plasma devices. Also, unless some type of backlighting is used, the LCD can be used only under relatively strong ambient light.

Electroluminescent screens operate on the principle that certain materials will glow when excited by a high voltage. However, unlike fluorescent lighting that also works on the electroluminescent principle using a glowing gas such as neon, EL displays use exotic materials like euro-

pium, manganese or terbium contained in a "host" material like calcium, sulfide or zinc.

Very thin films of the EL materials are sandwiched between twin insulators, giving these display devices the name "TFEL," which stands for Thin-Film ElectroLuminescent. ELs do not glow until either the driving ac or dc voltage exceeds the required breakdown potential.

Typical EL displays have contrast ratios of 20:1 and, unlike LCDs, glow so that they can be read even under very-low light conditions. EL brightness depends on such factors as temperature and the amplitude or frequency of the driving voltage. EL displays can be viewed over angles as wide as 140 degrees, and resolutions are within the range of three lines per millimeter.

Plasma displays usually have neon or argon gas between two electrodes in much the same setup as in neon panel lamps. The gas is the medium used to produce an image on (actually, in) the screen. When the voltage

applied across the electrodes exceeds a threshold level, the gas starts to glow. Once the gas begins to glow, the voltage applied to the electrodes can be decreased to a lower sustaining level and the gas will continue to glow. This is important because it greatly reduces the display's memory requirements; that is, the sustained glowing eliminates the need to continually refresh the memory.

Plasma displays have already gained fairly wide acceptance because of proven reliability and high-level viewability. Current plasma displays have lifetimes on the order of 20,000 hours. Typical plasma displays have a viewing angle of about 120 degrees and contrast ratios of 20:1 or better. Resolution and brightness are excellent.

One of the main disadvantages is that plasma displays are relatively inefficient and require rather high operating voltages. While laptop computers that use plasma displays are noted for their easy-to-read screens, they can operate on batteries (if at all) for only a very short period of time. Also, plasma displays are monochrome devices; a technique for making color plasma displays still eludes the researchers.

Tackling the Problems

The key problems being tackled in LCD development today are concerned with improving readability. That is, the push is on to providing better contrast and viewing angles and making LCDs that can be used under poor lighting conditions.

One of the most promising means to increase viewability, mainly the contrast ratio, is by "supertwisting" the liquid-crystal molecule's angles up to 270 degrees, compared to the normal 90 degrees when driving voltage is applied. Supertwisting is accomplished by doping the liquid crystal material with another optically active molecule that has special properties that twists the entire molecular structure of the liquid crystal.

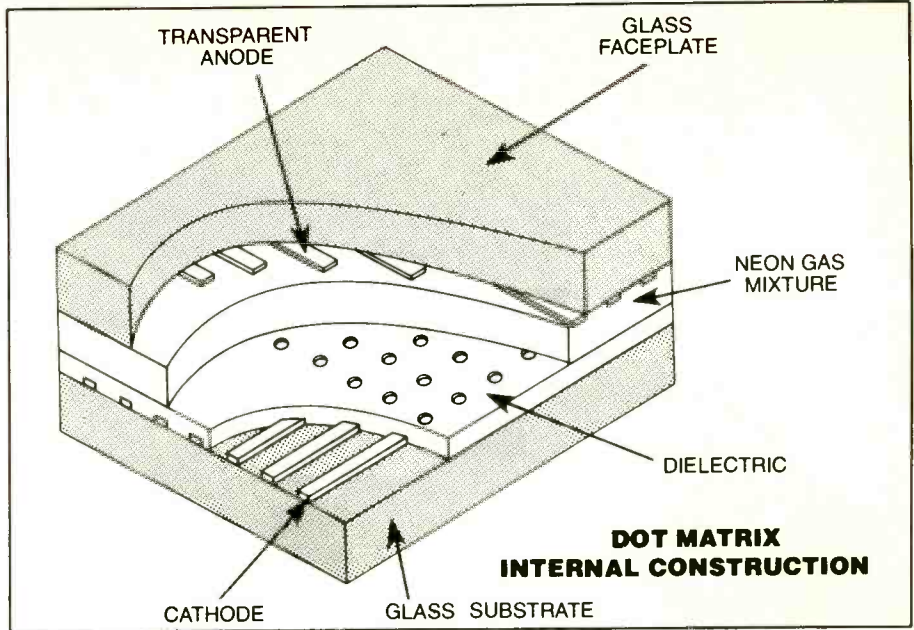

Schematic of a plasma display. (Courtesy Dale Electronics, Inc.)

Supertwisting goes by the rather technical title "super-twisted birefringence effect," or SBE. Tektronix, Inc.'s recently announced Hyper-twist LCD has a twist of 270 degrees,

giving a much greater viewability angle, plus a contrast ratio of greater than 12:1.

One factor that reduces the viewing angle of an LCD is the multiplex-

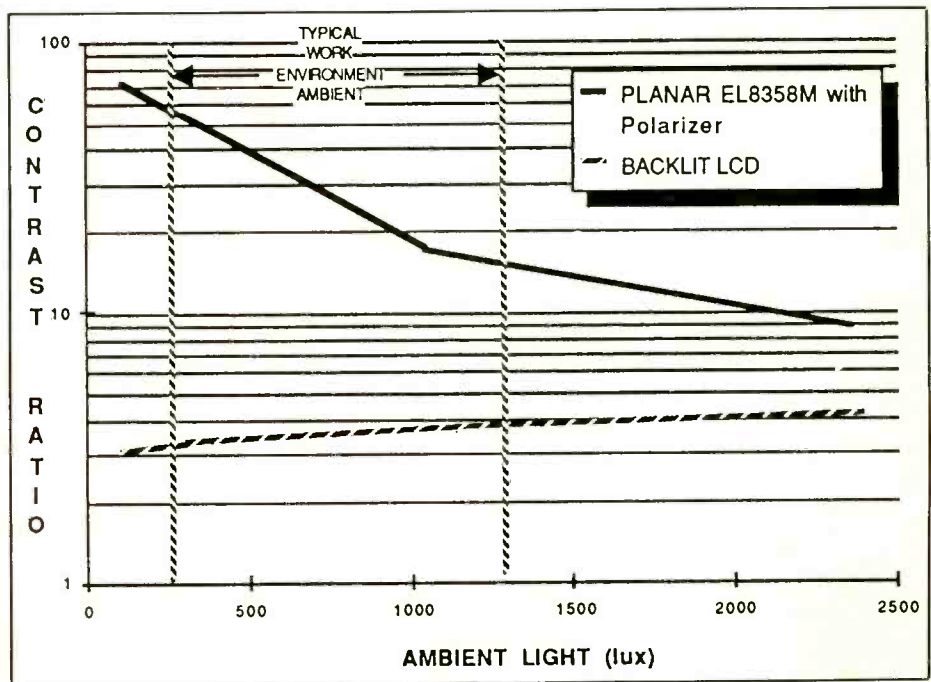

Comparison of contrast ratios between backlit liquid-crystal display (LCD) and electroluminescent (EL) display. Contrast ratio is the "on" brightness of the display divided by the "off" brightness. The larger the value, the easier it is to read the displayed image. (Courtesy Planar Systems, Inc.)

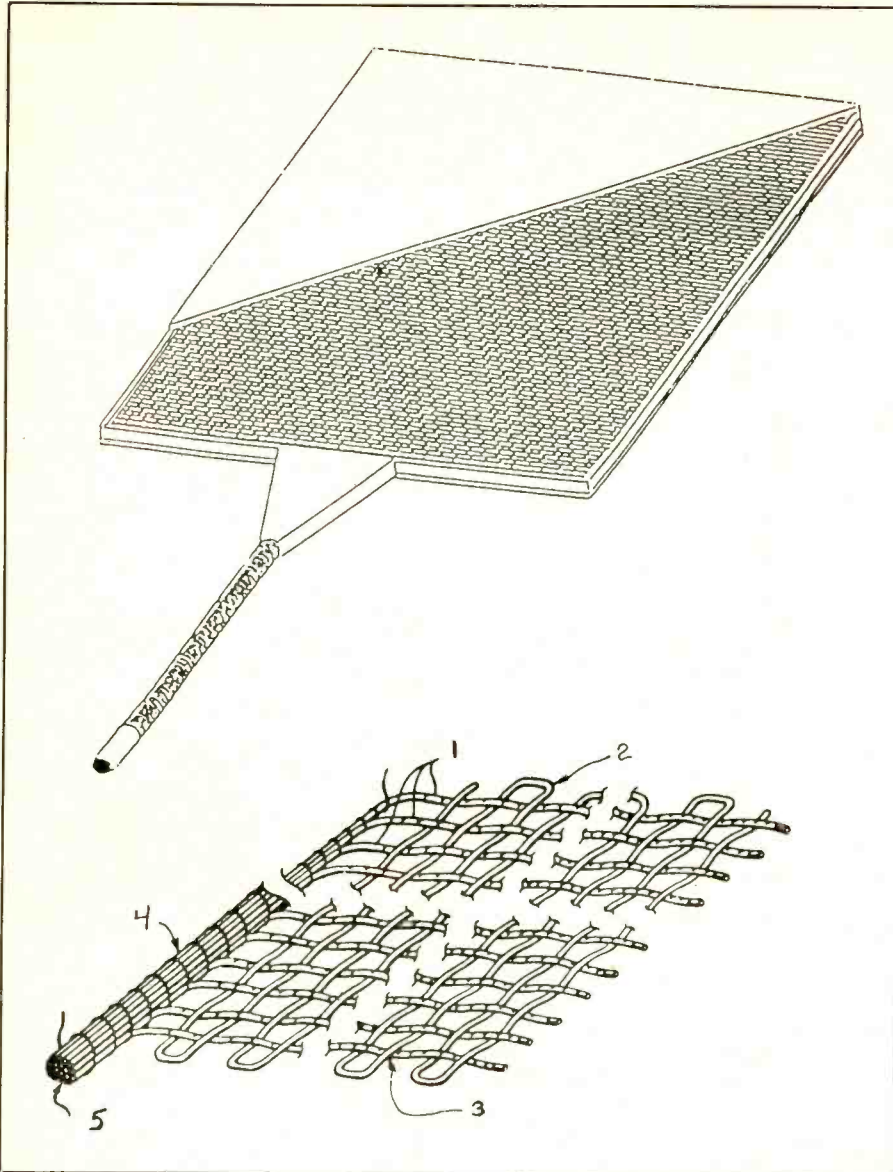

The Lumitex™ Panel-Lite uses woven optical fibers to provide backlighting for LCD screens so that they can be read under low ambient light conditions. Fiber-optic strands (1) are woven with conventional threads (2) to create a wave pattern in the fiber-optic material (3). Loose ends are gathered into a cable (4). The ends are then cut and polished into a converter (5). (Courtesy Lumitex, Inc.)

ing required to address the individual information pixels that “write” the image on the screen. As the number of lines that must be addressed increases, the activation voltage available to twist individual crystals drastically decreases. This results in greatly reduced viewing angles.

One of the simplest ways to handle this problem is to divide the total display area into two or more smaller

displays (areas). For example, a 640×400 -pixel screen could be divided into four 320×200 -pixel displays. But as the displays are divided, the electronics to drive and address cells grows in complexity and cost.

Another approach is to increase the slope of the brightness curve by increasing the tilt of the crystal when the driving voltage is applied.

The solutions to the lighting prob-

lem is to supply some kind of backlighting, but this dramatically drives up the cost of LCD devices that are usually aimed at applications where competitive pricing becomes a very important factor.

Some LCDs use an electroluminescent panel for backlighting, but Lumitex Inc. has developed a unique technique that uses fiber optics to provide backlighting. Optical fibers do not normally emit light, except at their ends, unless damaged. However, light will leave the fiber if it is bent to a fairly precise angle. By weaving the optical fibers with weft fiber, a lattice-like light-emitting panel can be formed. The result is a very uniform intensity, low manufacturing cost, and a very thin light source that can be used for backlighting an LCD panel.

Future Developments

Color displays are one of the goals on the horizon for EL displays. While full-color displays are not yet on the market, they are in the works. So commercial color panels should be available in the next few years.

Color for EL displays is accomplished by doping the EL layers so that they emit red, blue or green colors. By stacking three layers (one of each color), multiple colors can be obtained.

Thick-film EL panels have been developed by Cherry Electrical Products Corp. The advantage of thick films over TFELs is that they are easier to manufacture and are more reliable. Unlike TFELs, which are driven by an ac source, thick-film EL panels are dc driven.

Cherry claims it has overcome the problems of moisture, contamination and excessive heat that resulted in excessive voltages being required so that they exceed current capacities. Vacuum baking of the cells and current-limited drives have overcome this problem.

To obtain color from plasma screens, gases other than neon,

Portable Touch-Screen Terminal

Kiel Corporation (Amherst, NH) recently introduced a novel handheld computer terminal that makes use of a custom super-twist liquid-crystal display with an overlay touch-sensitive keyboard/screen to form a powerful field tool for easy use by people without computer operating experience. Using touch-screen technology that detects 8 × 6 positions of data input, the Videopad-2 data entry and retrieval model uses standard telephone lines and features a large 12-line × 25-character screen (a matrix of 120 × 96 pixels). It's powered by a 9-V alkaline battery.

Measuring about 6"H × 3¼"W × less than 1"D, Videopad-2 has an optional built-in modem and RS-232 port, and accommodates up to 32K of static RAM and 64K of CMOS EPROM. Its operating system uses up 10K of EPROM and 2K of RAM memory.

Operations are menu-driven, so the user doesn't have to learn a set of commands or codes. Input on the LCD "keyboard" uses one's own phrase and touch icons. The user-friendly key-

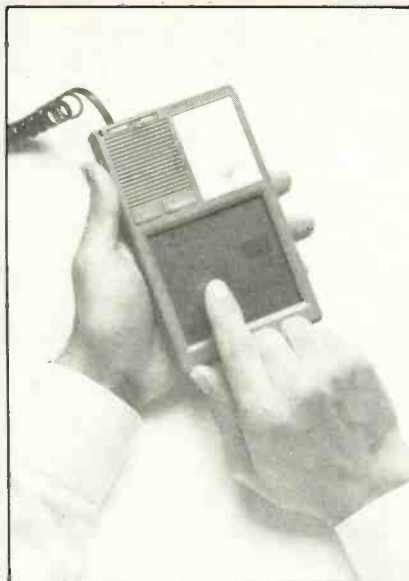

board is also programmable and allows one to manipulate keyboard space and display space. A software package called "Micropascal" is also available for versatile programming needs.

An Intel 80C31 8-bit CMOS micro-

controller that runs at 11 MHz is at the heart of the computer terminal. It detects the position of the user's finger when he or she depresses the upper screen glass and thereby shorts two touch elements.

Battery life is estimated to be about 30 hours and RAM contents are maintained until voltage level drops below 2.5 volts. LOW BATT and VERY LOW BAT indications are issued when voltage drops below 6.5 V and 5.5 V, respectively. RAM contents are maintained even without a battery for 10 minutes by the unit's discharging capacitors, providing enough safe time to install a fresh 9-V battery.

The pad has two controls: an ON switch and a CONTRAST control. The unit shuts itself off automatically after five minutes of inactivity.

Recommended peripherals that can be connected through the RS-232 port are the Diconix Model 150 ink jet printer, Star Micronix DP8340 dot-matrix 40-column printer, and Hewlett-Packard's HBCR-8300 bar-code reader.

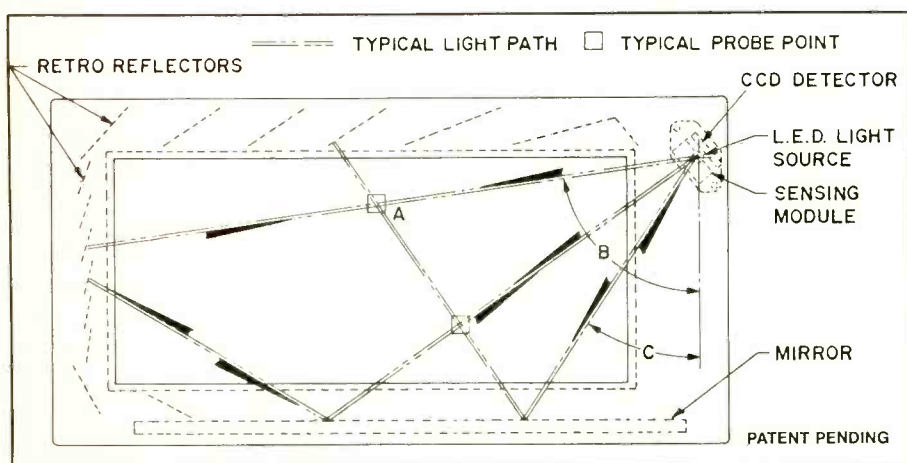

In the Cyclops® ES Touch Screen, light rays from a LED are emitted across the screen area and are reflected back on themselves by highly directional retroreflectors on one side and top of the screen's frame. The reflected rays are focused on a linear CCD detector. A mirror at the bottom of the screen allows the CCD to "see" two views of the light ray. Photodiodes measure the light level of the reflected rays and compares them with an average value. A reduced light level indicates that a light ray has been interrupted by a touch on the screen. A microprocessor determines the exact location of the touch point using triangulation. (Courtesy Wells-Gardner Electronics Corp.)

which gives off the current reddish-orange glow, would have to be used. Neon is currently being used because of its relatively low striking/holding voltage requirements. Other gases, such as xenon, require higher voltages and have shorter lifetimes than neon. This is the technological problem researchers are now working on; so color plasma displays are likely to be seen in the future.

Plasma displays are especially attractive for very-large "video" displays. Unlike projection CRTs, which are noted for their loss of definition and contrast near the edges of the screen. Even with screens 4 feet square, plasma displays can have constant contrast and resolution across the entire screen, and the screen could be a mere 6 inches deep.

Due to their "user-friendliness,"

(Continued on page 88)

Now You Can Record/Playback Messages Without Magnetic Tape!

New compact solid-state design provides up to 16 seconds of an automatic voice message without using magnetic tape or moving parts

By Anthony J. Caristi

All of you are familiar with recording and playing back voice announcements on a telephone answering machine. Now you can do the same with an exciting new solid-state design built around a special LSI (large-scale-integration) chip. No audio tape cassette; no moving parts whatsoever. More-

over, your digitized voice will be faithfully reproduced. All for about \$100 or less.

The advantages of an all-solid-state system such as this are clear. Firstly, there are no moving parts to wear out. Then, eliminating a tape machine makes it possible to package the system in a much more compact form. Finally, you can change messages in only a few seconds, as

compared to the more lengthy and confusing procedure required when doing the same with a tape machine.

The "AnswerMate" project presented here can be used productively in a variety of ways. For example, it can serve to give a message to someone who activates it by pressing your front door bell. This might be a friend you were supposed to meet, but you had to dash out for five minutes and couldn't greet him or her personally. The AnswerMate voice message from you, made easily in seconds, might say, "I had to run out for a few minutes, Dick. Please wait for me. I'll be there shortly."

You might want to use AnswerMate as a fun gimmick, perhaps causing it to activate some vocal comments when someone sits on a chair. Or maybe you'd want it to issue an automatic spiel when a box is opened. The opportunities for using AnswerMate seem to be limited only by your imagination.

Finally, the project presented here is designed to be a "poor man's" telephone answering machine. It will automatically issue your message (up to either 8 or 16 seconds in duration) to a phone caller if you don't answer the call. This is especially handy when you want to provide callers with a quick message that you can be reached at another number or will re-

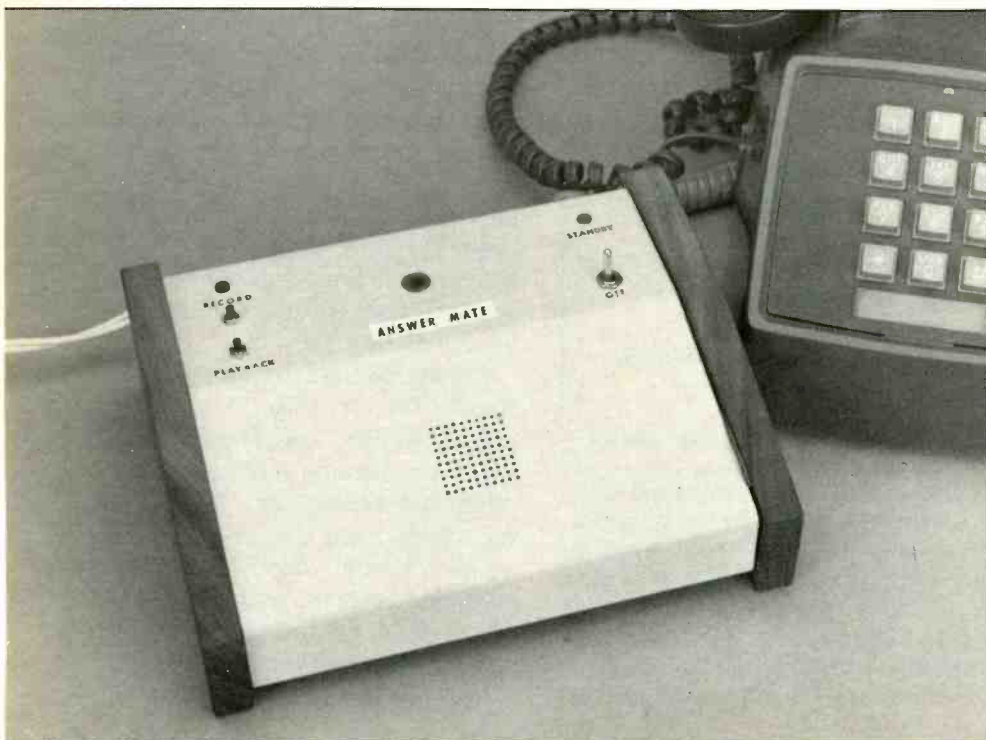

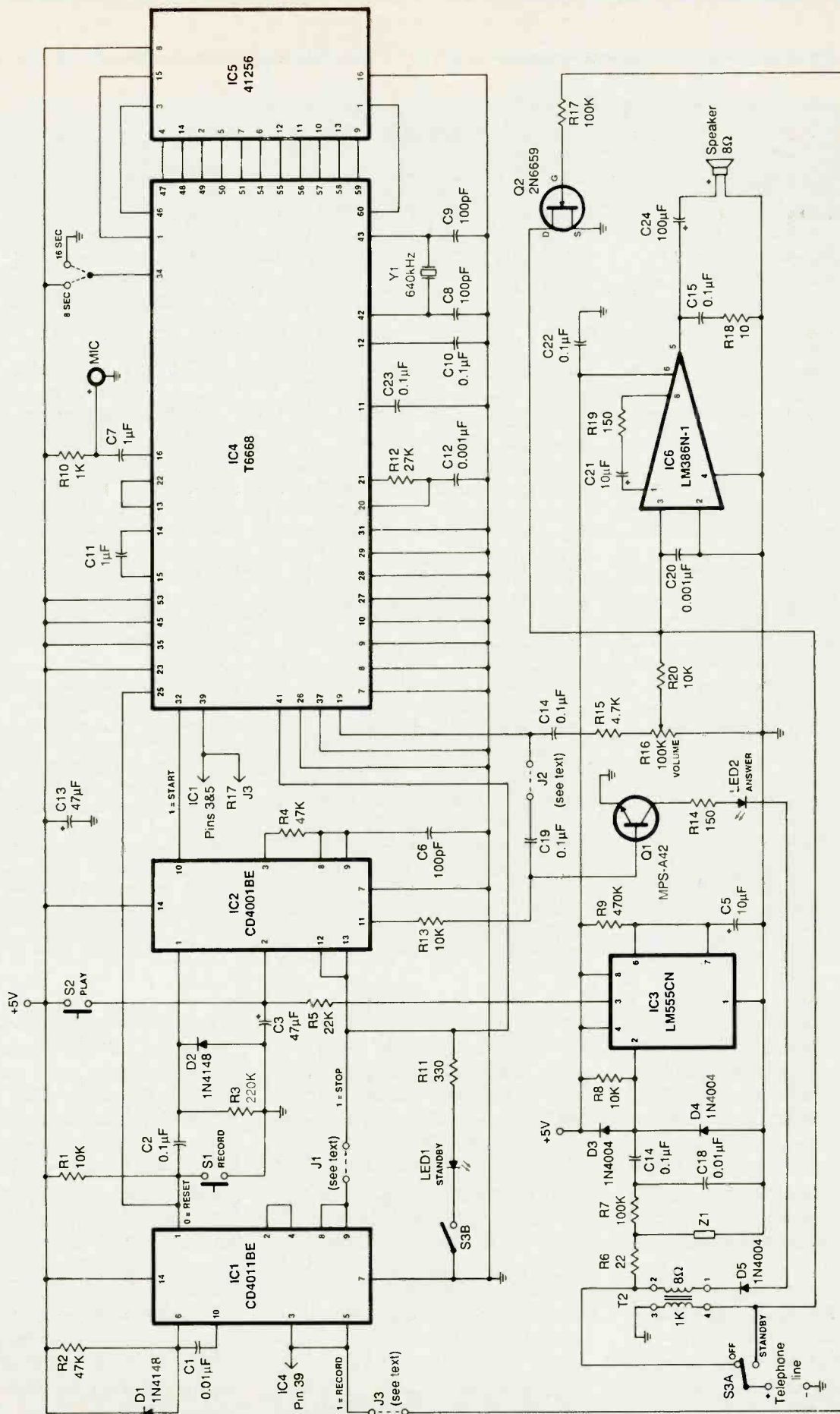

Fig. 1. Schematic diagram of project minus its power supply.

PARTS LIST

Semiconductors

D1, D2—1N4148 or equivalent silicon switching diode
 D3 thru D7—1N4004 or equivalent silicon rectifier diode
 D8—1N4735A or equivalent 6.2-volt zener diode
 LED1—Green light-emitting diode
 LED2—Red light-emitting diode
 IC1—CD4011BE quad 2-input NAND gate
 IC2—CD4001BE quad 2-input NOR gate
 IC3—LM555CN timer
 IC4—T6668 integrated circuit (Toshiba)
 IC5—TMM 41256 256K × 1 dynamic RAM (Toshiba)
 IC6—LM386N-1 audio power amplifier (National Semiconductor)
 IC7—LM340T-5 voltage regulator (National Semiconductor)
 Q1—MPS A42 or similar 300-volt npn silicon transistor (Motorola)
 Q2—2N6659 or similar n-channel enhancement-mode field-effect transistor
Capacitors (50 or more WV)
 C1, C18—0.01- μ F ceramic
 C2, C4, C10, C14, C15, C17, C19, C22, C23—0.1- μ F ceramic
 C3, C13—47- μ F, 10-volt electrolytic
 C5, C21—10- μ F, 10-volt electrolytic
 C6, C8, C9—100-pF ceramic

C7, C11—1- μ F ceramic
 C12, C20—0.001- μ F ceramic
 C16—1,000- μ F, 16-volt electrolytic
 C24—100- μ F, 10-volt electrolytic
Resistors (1/4-watt, 10% tolerance)
 R1, R8, R13, R20—10,000 ohms
 R2, R4—47,000 ohms
 R3—220,000 ohms
 R5—22,000 ohms
 R6—22 ohms
 R7, R17—100,000 ohms
 R9—470,000 ohms
 R10—1,000 ohms
 R11—330 ohms
 R12—27,000 ohms
 R14—150 ohms
 R15—4,700 ohms
 R18—10 ohms
 R19—150 ohms
 R16—100,000-ohm audio-taper p-type trimmer or panel-mount potentiometer (see text)

Miscellaneous

F1—0.5-ampere slow-blow fuse
 MIC—Electret microphone element (Radio Shack Cat. No. 270-090 or similar)
 S1, S2—Normally-open, momentary-action spst pushbutton switch
 S3—Dpst toggle slide or toggle switch
 SPKR—Miniature 4- or 8-ohm loudspeaker
 T1—12.6-volt, center-tapped power

transformer (Radio Shack Cat. No. 273-1365 or similar)
 T2—1k-to-8-ohm audio coupling transformer (Radio Shack Cat. No. 273-1380 or equivalent)
 Y1—640-kHz ceramic resonator
 Z1—Metal-oxide varistor (Radio Shack Cat. No. 276-570 or equivalent)
 Printed-circuit boards (see text); sockets for ICs; suitable enclosure (see text); bayonet or block-type holder for F1; ac line cord with plug; telephone cord with modular connector at one end; control knob for R16 (see text); dpst slide or toggle switch for message-length selection (optional—see text); No. 30 magnet wire; rubber grommets (2); Krazy glue or fast-set clear epoxy cement; silicone adhesive; lettering kit; clear spray acrylic; small-diameter heat-shrinkable or insulating plastic tubing; machine hardware; hookup wire; etc.

Note: The following items are available from A. Caristi, 69 White Pond Rd., Waldwick, NJ 07463: Large pc board, \$15.95; small pc board, \$4.00; CD4011BE and CD4001BE, \$1.75 each; LM555CN, \$1.50; T6668, \$14.00; TMM 41256, \$11.95; LM386N-1, \$2.95; LM340T-5, \$2.50; 640-kHz ceramic resonator, \$4.95; MPS A42 and 2N6695, \$2.95 each; 1k-to-8-ohm audio coupling transformer, \$4.95. Add \$1.50 P&H per order. New Jersey residents, please add state sales tax.

turn at a certain time to accept their call (thereby throwing the ball back to the caller's corner and saving you the expense of a telephone call). Minor circuit modifications allow you to include incoming call monitoring. (In its present form, AnswerMate does not record incoming messages from callers, which would complicate the design and add considerably to its cost.)

A single 256K-bit dynamic RAM chip and the LSI IC digitize and store your voice for playback. During record and playback, separate LEDs provide visual indication that the project is operational and ready to

perform its assigned task. When you are available to answer calls, you simply flip a switch to defeat the automatic transmit function so that callers will not be greeted by the recorded message. Here are complete plans for the phone-answering system. For non-phone use, one IC section (a ring-detector chip) could be eliminated to save a few bucks.

About the Circuit

As shown in Fig. 1, all recording and playback functions are controlled by IC4, a large-scale integration (LSI) chip dedicated to these two tasks. This Toshiba IC can be used in sever-

al different configurations, depending on the amount of memory and the desired speed or bit rate. In this project, the single 256K dynamic RAM chip identified as IC5 was chosen to keep component cost as low as possible but to allow a usable message time. The bit rate, which you select with a jumper (or an optional switch) to either the V+ or ground bus, can be 16K or 32K, respectively. A timing circuit built into IC4 is clocked at a 640-kHz rate, as determined by ceramic resonator Y1.

To provide control of the recording and playback functions, two additional chips are needed. These are

EXPAND YOUR CAREER HORIZONS...



The CIE Microprocessor Trainer helps you to learn how circuits with microprocessors function in computers.

START WITH CIE.

Microprocessor Technology. Satellite Communications. Robotics. Wherever you want to go in electronics... start first with CIE.

Why CIE? Because we're the leader in teaching electronics through independent study. Consider this. We teach over 25,000 students from all over the United States and in over 70 foreign countries. And we've been doing it for over 50 years, helping thousands of men and women get started in electronics careers.

We offer flexible training to meet your needs. You can start at the beginner level or, if you already know something about electronics, you may want to start at a higher level. But wherever you start, you can go as far as you like. You can even earn your Associate in Applied Science Degree in Electronics.

Let us get you started today. Just call toll-free 1-800-321-2155 (in Ohio, 1-800-362-2105) or mail in

CIRCLE 98 ON FREE INFORMATION CARD

the handy reply coupon or card below to:
Cleveland Institute of Electronics,
1776 East 17th Street, Cleveland, Ohio 44114.

CIE World Headquarters

Cleveland Institute of Electronics, Inc.
1776 East 17th Street • Cleveland, Ohio 44114

AMO-102

Please send your independent study catalog.
For your convenience, CIE will try to have a representative contact you — there is no obligation.

Print Name _____

Address _____ Apt. _____

City _____ State _____ Zip _____

Age _____ Area Code/Phone No. _____

Check box for G.I. Bill bulletin on Educational Benefits

Veteran Active Duty **MAIL TODAY!**

Just call toll-free 1-800-321-2155 (in Ohio, 1-800-362-2105)

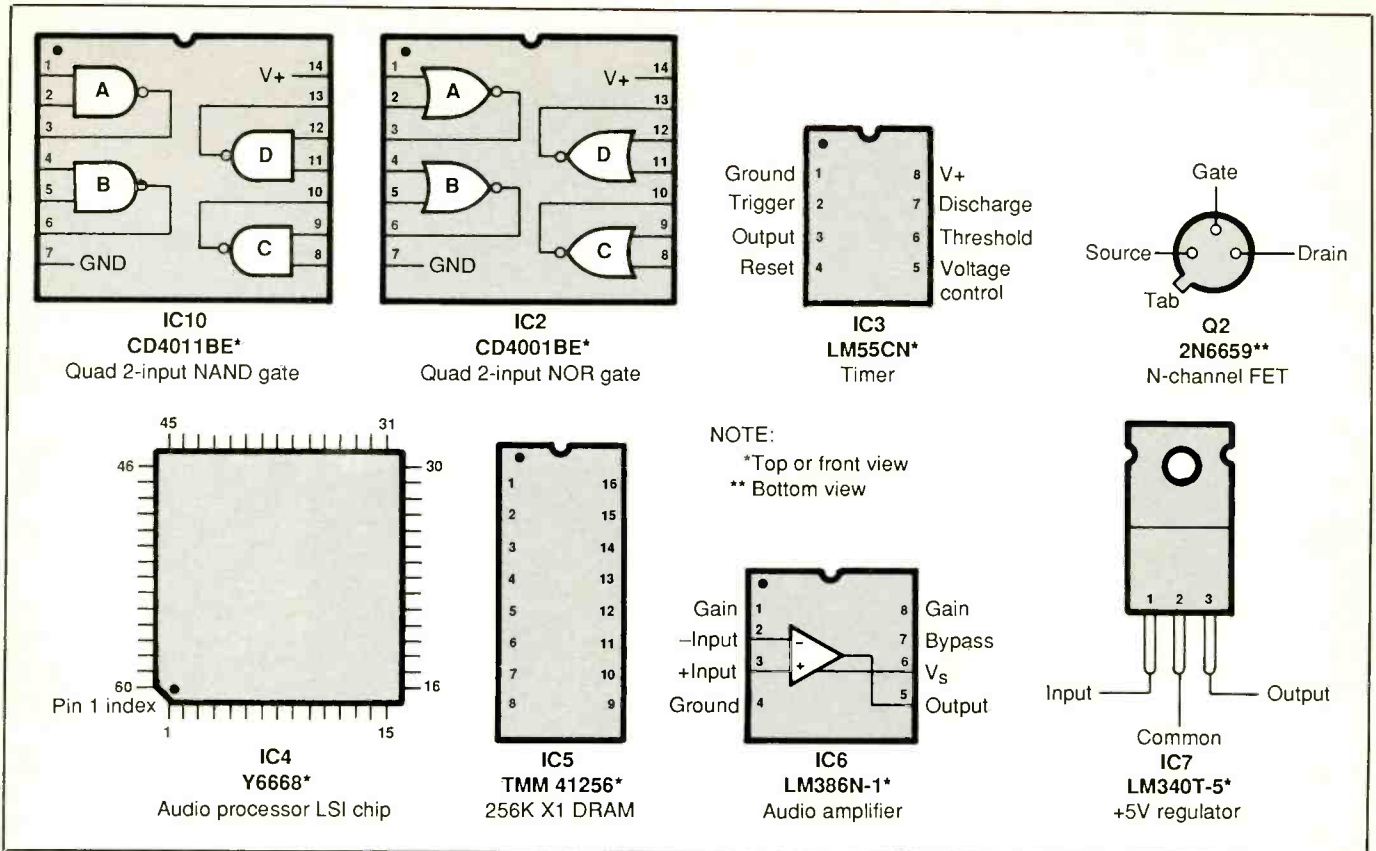

Fig. 2. Pinouts and some internal details of selected solid-state devices used in this project.

IC1 and IC2, which set the proper logic levels to the control inputs of IC4. NAND gates IC1A and IC1B (see Fig. 2 for gate identification for IC1 and IC2) are connected as a flip-flop to control record/playback mode selection at pin 39 of IC4.

When RECORD pushbutton switch S1 is pressed, a 0 logic level is applied to pin 1 of IC1. This causes the output of NAND gate IC1A at pin 3 to go to a logic 1 condition and remain there until a stop pulse is received at input pins 8 and 9 of IC1C.

The logic-0 level from S1 is also applied to pin 25 of IC4. This directs IC4 to reset in preparation for a new recording sequence. When S1 is released, a positive-going pulse is fed to pin 1 of IC2 and ultimately appears at pin 32 of IC2 to allow you to start recording.

When recording begins, pin 41 of IC4 goes to a logic-0 level. This extin-

guishes STANDBY light-emitting diode LED1 and clocks memory chip IC5 through 256K bits. This takes 8 or 16 seconds, depending on the bus to which the jumper at pin 34 of IC4 is connected. The sequence then stops and LED1 turns on again.

During recording, sounds that reach the microphone are amplified by IC4 and broken down into digital form. RAM chip IC5 stores this digital information as a representation of the audio signal reaching the microphone in the pin 16 circuit of IC4.

At the end of the recording, the circuit automatically stops and sets pin 41 of IC4 back to logic 1. The rising waveform at pin 41 returns the IC1A/IC1B bistable latch to its playback state. During the recording process, the positive output of IC1A at pin 3 also mutes audio amplifier IC6 so that no feedback occurs between speaker and microphone.

The digital recording data is stored inside IC5, and remains there as long as power is applied to the circuit or a new recording is initiated by pressing RECORD switch S1. At any time, it is possible to hear the stored recording by pressing PLAY pushbutton switch S2. This generates a positive pulse at start input pin 32 of IC4. The circuit then clocks through all addresses in IC6 at a 16K- or 32K-bit rate (according to the setting of the jumper at pin 34) to extract the stored digital information. The digital data is then filtered and amplified by IC4 to reconstruct the original recorded audio. The output at pin 19 of IC4 is fed to audio power amplifier IC6 through VOLUME control R16 to drive loudspeaker SPKR.

Bear in mind that the reconstructed audio consists of 256K bits of digital information, clocked at a rate of 16 or 32 kHz to accommodate a 16-

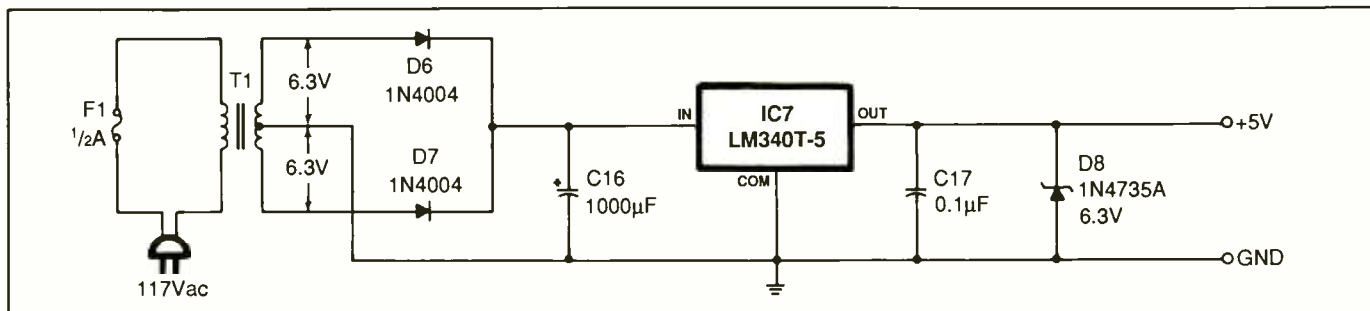

Fig. 3. Schematic diagram of project's 117-volt ac-operated dc power supply.

or 8-second message. Though either rate will give good to excellent audio fidelity, the faster 32-kHz rate for an 8-second message is superior.

When the circuit is in standby (rest), *STANDBY LED1* will be on and *IC4* will be in its playback mode. Timer chip *IC3*, wired as a monostable multivibrator, serves as a ring-signal detector for the telephone line. When the 90-volt, 20-Hz ring signal appears across the telephone line, pin 2 of *IC3* goes to a logic-1 level and remains there for about 5 seconds, determined by the time constant of the RC network composed of *R9* and *C5*.

The logic 1 at pin 2 of *IC3* is fed to input pin 2 of NOR gate *IC2A*. This generates a start pulse that is fed through *IC2C* whose pin 10 output is fed to the pin 32 input of *IC4* in a manner similar to that obtained by pressing *S2*. When this occurs, *IC4* clocks out the digital encoded audio data stored in *IC5* and feeds it to the *IC6* audio power amplifier. As the outgoing message is delivered to the telephone line, it can also be heard through the project's built-in speaker.

When *IC4* is in its active state, pin 41 goes to logic 0, extinguishing *LED1*. At the same time, *Q1* is forward biased through the inverting action of *IC2D*, causing the transistor to draw current from the telephone line and answering the call. ANSWER light-emitting diode *LED2* is turned on by the loop current from the telephone line, and the audio signal that appears at pin 19 of *IC4* is

impressed on the base of *Q1* to transmit the recorded message to the calling party.

When the full 256K bits of digital information have been processed by *IC4*, the circuit returns to its standby state. At this time, *Q1* cuts off to "hang up" the phone. The project is then ready for the next incoming call.

STANDBY/OFF switch *S3* allows you to break the connection to the telephone line so that you can easily disable the answering function when it isn't needed. A second pole on *S3* also cuts off *STANDBY LED1* to give you visual indication that the project has been disabled.

Transformer *T2* provides the means by which a call-screening function is incorporated into the project. Call screening allows you to hear the calling party's voice without having to pick up your telephone's handset. It gives you the option of answering the call or not.

Power for the project is provided from the 117-volt ac line with the dc power supply shown schematically in Fig. 3. Transformer *T1* steps down the incoming 117 volts ac to 12 volts ac. This center-tapped voltage is fed to *D6* and *D7* for full-wave rectification. The pulsating dc from *D6* and *D7* is then filtered to pure dc by *C16*, after which it is regulated to +5 volts dc by regulator *IC7*.

Total power required by the project is very low. Hence, no heat sinking is required for *IC7*. With very-low power drain, the project can be left continuously plugged into the ac

line and add very little to the cost of your electricity usage.

Construction

Owing to the relative complexity of this project, printed-circuit construction is a virtual necessity. Though you can mount and wire almost all of the circuitry on perforated board that has holes on 0.1-inch centers, using suitable soldering or Wire Wrap hardware, you *must* use a pc "carrier" board for LSI chip *IC4*. This chip is packaged in a flat pack that must be surface mounted and requires its own separate pc board. It doesn't come in a plug-in package configuration.

You need two single-sided pc boards. You can fabricate your own boards using the actual-size artwork shown in Figs. 4 (main board) and 5 (*IC4* board), or you can purchase ready-to-wire boards from the source given in the Note at the end of the Parts List. Whichever way you go, be sure to use sockets for all ICs except *IC4* and *IC7*.

Figure 6 shows the locations and orientations of the components that mount on the main board and connection points for all off-the-board components and hookups. Wire this board exactly as shown, beginning with installation of the IC sockets (do *not* install the ICs in the sockets at this time) and follow with the resistors (note that *R20* mounts upright—not flat on the board) and nonpolarized capacitors. Then in-

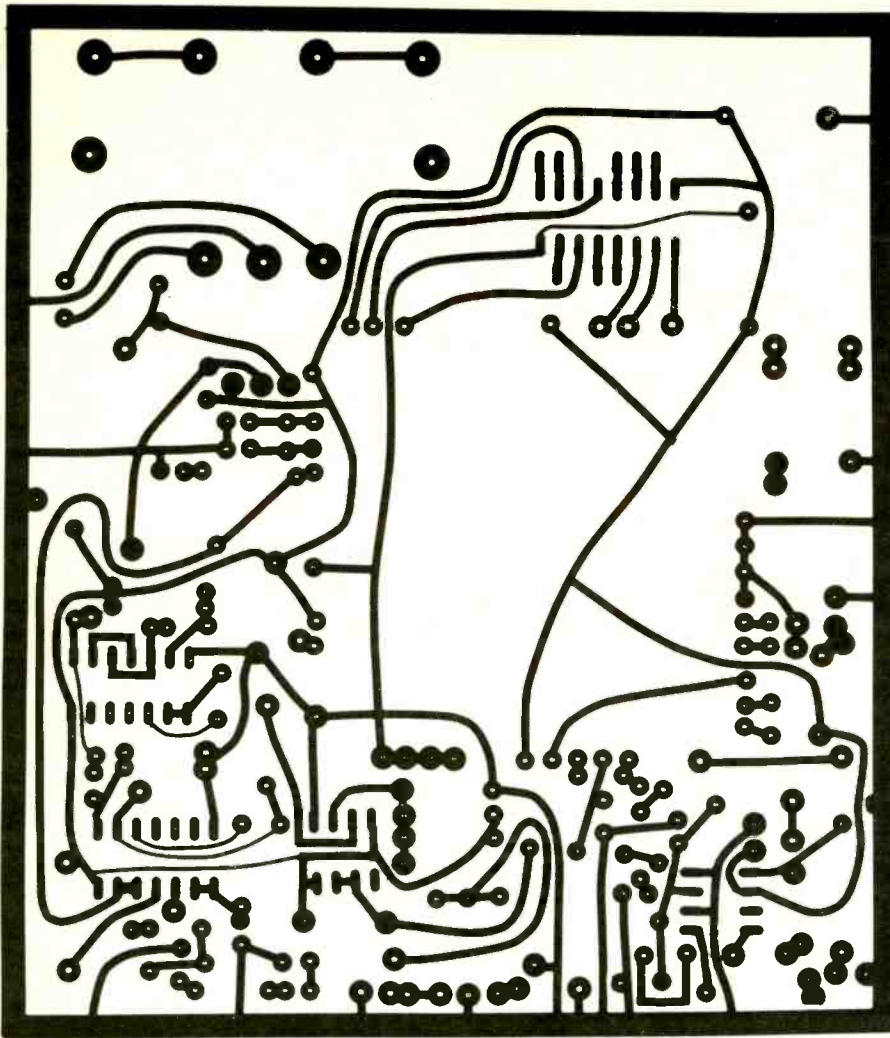

Fig. 4. Actual-size etching-and-drilling guide for main printed-circuit board.

stall and solder into place ceramic resonator *Y1*.

You can use either a miniature pc-type trimmer potentiometer for VOLUME control *R16*, installing it as shown, or a panel-mount control that can be conveniently readjusted without having to disassemble the project. If you decide on the panel-mount pot, use insulated hookup wires between it and the appropriate holes in the pc board.

Next, install the electrolytic capacitors, diodes, transistors and voltage regulator *IC7*. Make absolutely certain that these components are properly polarized or based before

soldering their leads or pins to the pads on the bottom of the board. Just one of these components installed incorrectly will render the circuit inoperative and may cause very expensive damage.

Identify the primary and secondary leads of power transformer *T1*. Mount the transformer in the upper-left of the board as shown. Plug its leads into their respective holes in the board and solder them to the pads on the bottom of the board.

Decide now what message length you want. If you want an 8-second message, connect a jumper wire from the pad above the one labeled

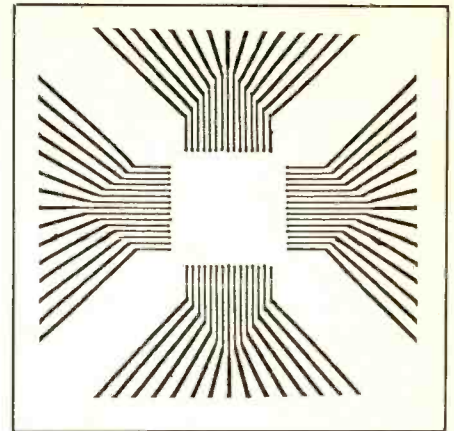

Fig. 5. Actual-size etching guide for "carrier" pc board for IC4 LSI chip. This board requires no holes to be drilled for making connections to IC or main circuit board.

34 to the pad labeled *v+*. If you want a 16-second message, install the jumper between the pad above the one labeled 34 and the pad labeled GND just above it. Alternatively, if you wish to have a choice between the two message lengths at different times, you can wire the jumper between the pad above the one labeled 34 and the center lug of a dpst slide or toggle switch and wire the lugs of the switch's alternate positions to the *v+* and GND pads. Then, whenever you want to increase or decrease the message length, you simply set the switch to the position that gives you what you want. Regardless of which message length you choose, the telephone company gives you a grace period of about 10 seconds to pick up the call after the project has "hung up."

Now decide whether or not you want to include in your project a call-screening function, which allows you to hear the calling party's voice without having to pick up your telephone's handset. To add call screening, simply add transformer *T2* to the circuit as shown at the bottom of the board layout drawing. Make sure you wire the low-impedance (8-ohm) side of *T2* in series with the telephone line. Note in Fig. 1 that when this op-

tion isn't used, the positive (+) side of the telephone line through S3A goes directly to R6 instead of to T2.

Four insulated jumper wires must be installed. These are identified in Fig. 1 as J1 through J4. The same numbering scheme is used in Fig. 6. J1 is shown continuous here. To make the J2, J3 and J4 jumper connections, simply install a jumper wire between like J numbers. If you omit call answering, you can also omit the J4 jumper. You can install these jumper wires either on top or the bottom of the board, whichever is more convenient. Use light-gauge (No. 24) insulated wire jumpers.

Strip 1/4 inch of insulation from both ends of 14 6-inch lengths of insulated hookup wire (make the wire count 20 if you've decided to use a panel-mount potentiometer for R16 and a switch for selecting recording-time length). Plug one end of these wires into the holes labeled S1, S2, S3A OFF, S3A STBY, LED1 ANODE, LED2 ANODE, MIC+, MIC-, SPKR+ and SPKR-. The other ends of these wires will be connected later.

When the main board is completely wired, turn it over and carefully inspect all soldered points for poor soldering and particularly for solder bridging between closely spaced pads and conductors. Reflow the solder on any questionable connection, and carefully remove any solder bridges. Flip over the board and double check all components for values and orientations. When you're satisfied that all is okay, set the circuit-board assembly aside.

Place the smaller pc board in front of you copper-pattern side up. You needn't concern yourself with orientation because all four sides of this board are identical to each other. Now examine the IC4 LSI chip. You'll note that one corner of the package is sheared off diagonally. This corner is the "index" that lets you readily identify pin 1.

To mount the LSI chip on its separate pc board, you need a low-power

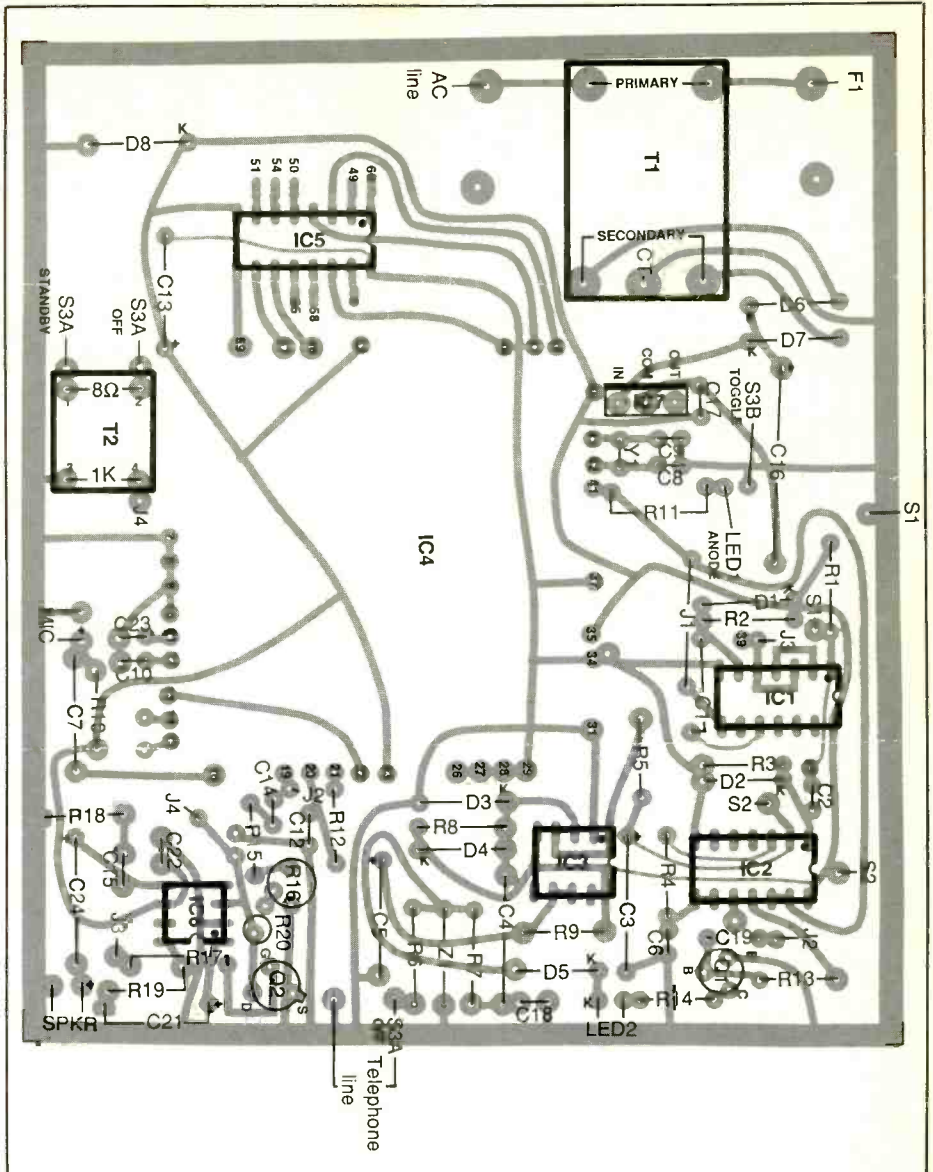

Fig. 6. Wiring diagram for main board.

soldering iron with a fine pointed tip. After allowing the tip to come up to soldering heat, carefully clean it. Place the LSI chip in the center of the pc board so that its leads directly line up with the traces on the latter.

Solder just one pin at each corner of the IC to the copper traces. Carefully examine the assembly to make certain that all other chip pins perfectly line up with their respective copper traces and that none straddles two traces. If you note misalignment that cannot easily be corrected by

straightening possibly bent pins, you can easily desolder the chip from the board to reposition it as needed.

Once you're satisfied that all pins are properly aligned with the copper-trace pattern on the board, solder the remaining pins to the traces. The best way to do this is to apply soldering heat at the point where the end of each pin touches the board trace and the trace itself and flow just enough solder to assure a good electrical connection. To avoid heat damage to the chip, solder one pin on the side near-

est you to the copper trace on one side of the board, rotate the board 90 degrees and solder one pin to the copper trace on the side now nearest you. Continue rotating the board and soldering just one pin until all pins have been soldered into place.

It's extremely important that you avoid creating solder bridges between the very closely spaced pin/trace connections. Clean your soldering tip frequently to remove excess solder build-up and oxidation, and use only enough solder to make good electrical connections. If you should accidentally create a solder bridge, use solder wick or a solder sucker to rectify the situation.

When you're finished soldering the pins to the copper traces, carefully examine all connections, preferably under a magnifying glass and good lighting, to make sure all connections are properly soldered.

Identify and mark the traces for pins 1, 7 through 16, 19 through 23, 25 through 29, 31, 32, 34, 35, 37, 41, 42, 43, 45 through 51, and 54 through 60. Carefully "wet" the ends of each of these traces with a thin film of solder (make sure you don't create any solder bridges).

Retrieve the main circuit-board assembly and place it in front of you oriented as shown in Fig. 6. Place the IC4 circuit-board in the center of the main board, orienting it so that the pin 1 index is toward the lower-left. This is the orientation the smaller board must have when mounted on the larger board.

Use a very small amount of fast-setting epoxy or other adhesive to mount the IC4 carrier board on the main circuit-board assembly in the proper orientation. Make sure that the smaller board doesn't cover any of the larger board's holes that will be used to electrically interconnect the two.

House your project in any type of enclosure that easily accommodates the circuit-board assembly and the off-the board components. An en-

closure that has a sloping panel, like that shown in the lead photo, will give the project a professional appearance.

Machine the the front or top panel of the enclosure for mounting the two LEDs, the three switches and the microphone element. Then drill separate holes to provide entry for the ac line cord and telephone line through the rear panel. The fuse holder for *F1* can be either an inexpensive block type that mounts via a single machine screw, lockwasher and nut or a more expensive bayonet type. Drill the size hole for whichever type of holder you choose through the rear panel. If the enclosure you choose has no holes punched in it to allow the sound from the speaker to escape, drill 25 or more small holes in the area over which the speaker will be mounted for this purpose.

If you've decided to use a panel-mount potentiometer for *R16* and/or a switch for selecting 8 or 16 seconds of recording, you need holes for either or both of these options, preferably through the rear wall of the enclosure so that these items won't be out in plain sight.

After drilling all holes, deburr them to remove sharp and rough edges. Then place a rubber grommet in the ac line cord and telephone line holes. Tightly twist together the fine wires at the end of the ac line cord and lightly tin with solder. If your telephone cable has modular connectors on both ends, cut off and discard the connector at one end. (Note: FCC Regulations *require* a quick-disconnect modular connector at the line end of the telephone cord.) Trim about 4 inches of the outer plastic jacket from the cut end and ¼ inch of insulation from the black- and red-insulated conductors.

Pass the free ends of the ac line cord and telephone cable through their respective grommets and tie a knot in each about 6 inches from the free ends inside the enclosure to serve as strain reliefs. Run a thin bead of

silicone adhesive around the perimeter of the loudspeaker and press it into place so that the hole pattern is centered in it.

Use a dry-transfer lettering kit to label the switch, LED and microphone holes with appropriate legends (see lead photo). If you're using them, also label the panel-mount VOLUME control and 8/16 second switch. When all labeling is done, apply two or three *light* coats of clear spray acrylic over them to protect them from abrasion.

When the acrylic spray has completely dried, mount the fuse holder, LEDs, switches, microphone element and VOLUME control in their respective locations. Use a drop or two of cyano-acrylate (Krazy) glue or fast-set clear epoxy cement to hold the LEDs and microphone element in place.

It's mandatory that the polarity of the connections for the telephone line to the project be correct, as indicated in Figs. 1 and 6. In most telephone installations, the green-insulated wire is positive (+) and the red-insulated wire is negative (-); The black- and yellow-insulated wires aren't used in modern installations. However, to be on the safe side, check the polarity of your telephone line. To do this, connect the "hot" and common probes of a dc voltmeter to the green- and red-insulated wires, respectively.

Plug the modular connector at the other end of the telephone cord into the telephone line and note the polarity indicated on the meter. If the indication is positive, label the green wire "+" and the red wire "-." On the other hand, if you get a negative indication, reverse the labeling. Disconnect the cord from the telephone line.

Plug the wire labeled "+" into the hole in the circuit-board assembly labeled TELEPHONE LINE + and the wire labeled "-" into the board hole labeled TELEPHONE LINE - and solder both into place. Then, connect and solder one conductor of the

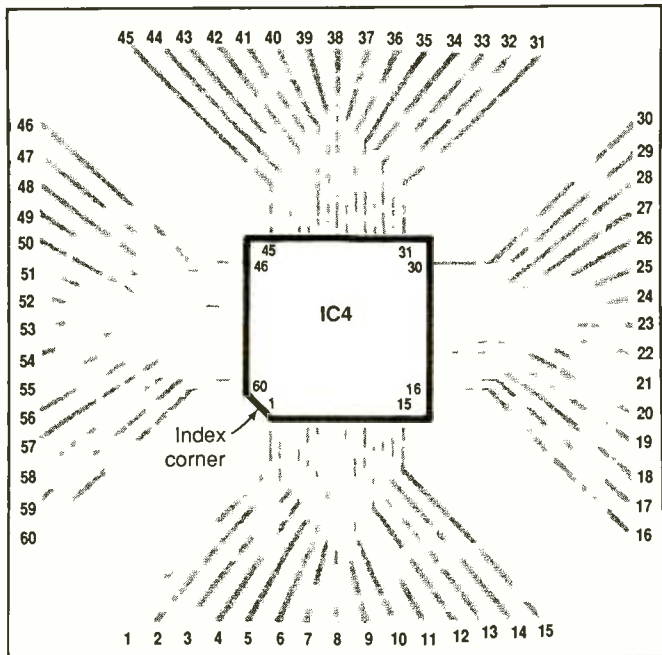
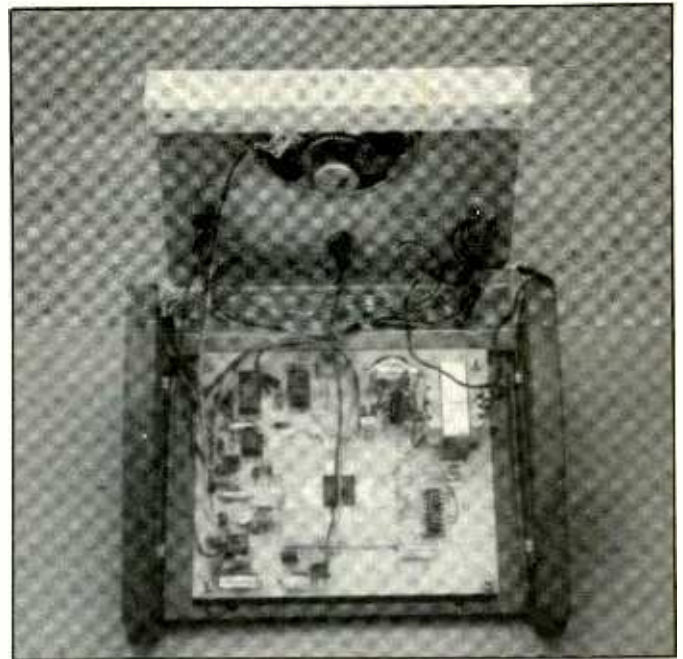

Fig. 7. Installation and pin/trace number details for LSI carrier board.



Interior view of finished project. Note how IC4 carrier board mounts on main board and is interconnected via small-gauge enameled magnet wire.

line cord to one lug of the fuse holder and plug the other line cord conductor into one of the holes labeled AC LINE CORD on the circuit-board assembly and solder into place. Trim ¼ inch of insulation from a long enough hookup wire to bridge between the other fuse block lug and the board hole labeled F1. Connect and solder this wire into place.

Locate the free ends of the switch wires and connect and solder them to the lugs of the appropriate switch lugs. If you're using a panel-mounted VOLUME control, do the same for its wires. Then, observing proper polarity, connect and solder the free ends of the MIC and SPKR wires to the microphone element and speaker lugs, respectively.

Slide a 1-inch length of small-diameter heat-shrinkable tubing or insulating plastic tubing over the free ends of the LED1 and LED2 anode wires. Cut the anode leads of both LEDs to ½ inch long and solder them to their respective board wires.

Slide the tubing up the wires until it's flush against the bottoms of the molded LED cases and shrink into place. Trim the cathode lead of LED2 to ½ inch and crimp and solder the appropriate wire from the board to it. Finally, connect and solder the cathode lead of LED1 to the appropriate lug on S3B; if necessary; use a length of hookup wire to make this connection.

Checkout & Use

With only IC7 installed in the circuit, plug the project's line cord into a 117-volt ac outlet and use a dc voltmeter (or a multimeter set to measure dc volts) set to read at least 5.5 volts to measure the output from the regulator. Take your reading across D8. If the dc power supply is functioning properly, you should obtain a reading between 4.5 and 5.5 volts dc. If not, unplug the line cord and troubleshoot the circuit. Don't proceed until you've rectified the problem.

When you're certain the power

supply is functioning as it should, proceed to final assembly.

The best way to interconnect the two boards together is to use light-gauge—say, No. 30—enameled wire. If possible, obtain a small quantity of the type of wire that can be directly soldered without having to scrape away the enamel insulation.

Tin about ⅜ inch of the end of the enameled wire and carefully tack-solder it to the end of the IC4 pin trace. Route this wire over to the hole numbered 1 near IC5, trim it to length, insert it in the hole and solder it into place. Do the same with the remaining identified traces and the same-numbered holes in the main circuit-board assembly.

Now install the ICs in their respective sockets. Handle the CMOS devices with the same precautions you would use when working with any other type of MOS device.

As you install each IC, make sure it's the proper device number and

(Continued on page 89)

The Semianalyzer

(Part 1)

This versatile instrument tests semiconductors for type, condition and number of junctions, the circuitry around the devices, and other components

By David T. Miga, CET

If you troubleshoot electronic equipment, you are probably using a DMM or an inexpensive transistor tester to check transistors and diodes, with only marginal success. What you need is an instrument that can probe a semiconductor device while it is still in a circuit and read out in printed legends the type, condition and number of junctions of the device and give circuit conditions *around* the component under test. The instrument could beep different tones for important circuit conditions like a shorted or leaky component and might even check LEDs, capacitors, neon lamps and semiconductors for proper voltage breakdown. It might even let you listen to the breakdown so that you can identify noisy components.

You might think the instrument just described is pure fancy, but it does exist. We call it the "Semianalyzer." If you were to buy a commercial equivalent of this instrument, it would cost you more than \$400. However, by building it yourself, you pay less than half that price.

This is a sophisticated piece of test gear that, with some patience, is not overly difficult to build. It requires both a double-sided printed-circuit board on which most of the components mount in a dense array and a smaller single-sided pc board for a legend/numeric display section. Believe me, it is worth the extra effort to build as compared to a simple project because it will pay off hand-

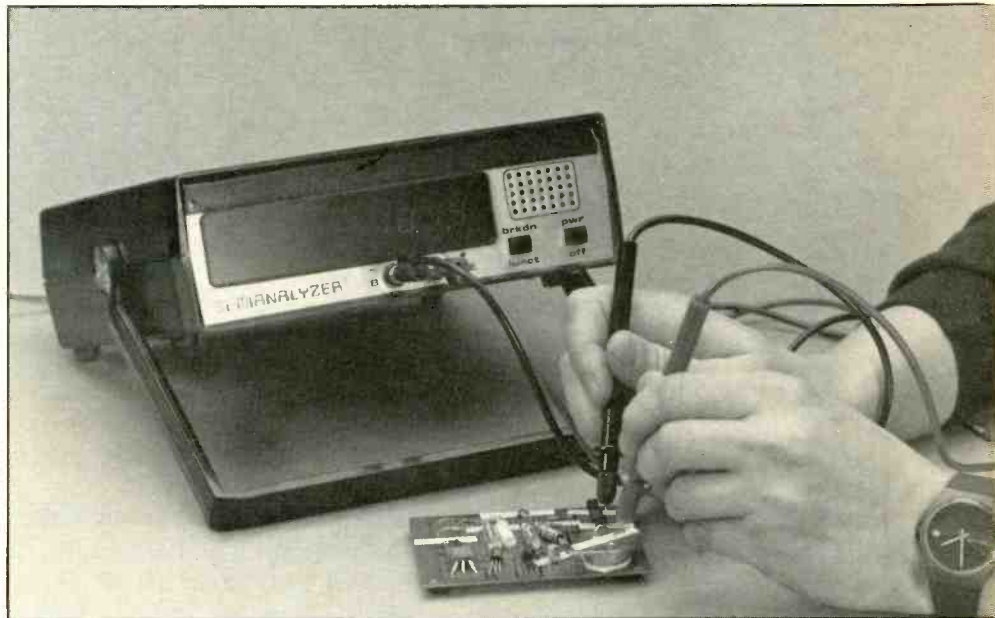

somely by saving so much troubleshooting time.

About the Circuit

Before examining the complex schematic diagram of the Semianalyzer, it is easier to visualize basic operation by examining the block diagram shown in Fig. 1. This diagram reveals that the Semianalyzer actually consists of two pieces of test equipment. The junction portion at the left contains a 6-volt ac signal that is sent through the test leads to the component under test. The component and its support circuitry will distort the signal in a certain manner. This signal is converted by the 8-bit comparator, which serves as an A/D (analog-to-digital) converter to form an

8-bit word. This word is level-shifted to the proper 0- to 5-volt signals that are then presented to the 2716 EPROM.

The EPROM must be programmed to recognize almost any circuit condition. It turns on the proper LEDs, through the LED driver circuitry, to illuminate the correct combination of legends in the LED display matrix. The EPROM also has five outputs that drive a tone oscillator at different frequencies that audibly alert the instrument user to shorted, leaky and multiple-junction devices.

The voltage-breakdown portion at the right in Fig. 1 generates a safe, isolated source of 150 volts dc. This voltage is applied to the component under test through a high-value resistor that limits test current to a maxi-

imum of 15 milliamperes. As the component breaks down at a certain threshold voltage, the potential is displayed on a DVM (digital voltmeter) IC and appears in the seven-segment numeric LED display shown at the upper-right.

Breakdown noise is monitored by the audio amplifier IC through the filter-protector circuit.

Now turn to the schematic of the junction circuit shown in Fig. 2. Red jack *J1* at the bottom of this circuit is connected to the *R19/R20* junction, which safely limits the inputs to quad comparators *IC8* and *IC9*. Also common to the junction point is insertion of a current-limited 6-volt ac signal that is derived from one of the secondaries of power transformer *T1* (see Fig. 4). Therefore, the signal sent through the red and black test leads connected to the Semianalyzer via *J1* and *J2* will have a peak-to-peak level of approximately 17 volts (6 volts ac rms \times 1.414 = 8.8 volts peak, and 8.8 volts peak \times 2 = 17.6 volts peak-to-peak).

You can think of the 17-volt p-p signal as being an alternating +8.5-volt and -8.5-volt signal. Since the semiconductor under test will pass much more current in one direction than it can in the other, the signal will be distorted into a clipped (lopsided) version of the original signal. This signal is fed into quad comparators *IC8* and *IC9* through resistors *R19* and *R20*, respectively.

The positive (+) reference string of resistors (*R26* through *R30*) and negative string of resistors (*R21* through *R25*) are biased at voltages that represent one, two, three and more than three semiconductor junctions of either polarity. (All reference resistors have 1-percent value tolerances.) Therefore, if the circuit under test is open, all four comparator outputs of *IC8* and all four *IC9* outputs will be brought low to the -9-volt dc rail. On the other hand, if the Semianalyzer detects a short circuit, all outputs will rise.

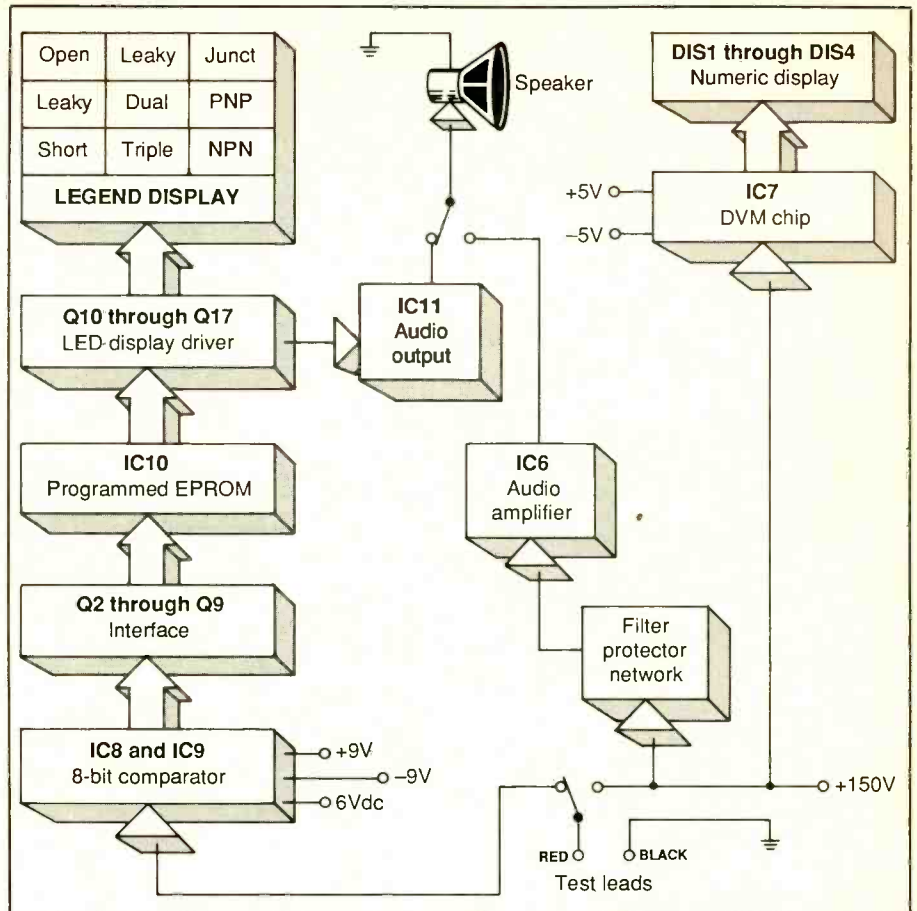

Fig. 1. Block diagram shows how Semianalyzer actually consists of two instruments that share the same chassis and power supply: junction test portion at left and voltage-breakdown portion at right.

Open-collector comparator outputs are used. These are biased by *R39* through *R62* so that the outputs will alternate between -9 and +5 volts to drive transistors *Q2* through *Q9*. These transistors serve as level shifters to provide the 0- to +5-volt signals required by EPROM *IC10*. Resistors *R55* through *R70* and capacitors *C40* through *C47* serve as integrators that smooth the pulsating voltages caused by the original 60-Hz ac signal into clean dc voltages for *IC10*'s inputs.

EPROM *IC10* is programmed to recognize 25 different circuit conditions, as shown in the Table. Its outputs drive *Q10* through *Q17*, which serve as open-collector drivers for *LED1* through *LED27*, via limiting

resistors *R92* through *R99*. (Note in Fig. 2 that the same arrangement shown for *D4*, *C40* and *R63* for the *Q2* circuit is repeated for the *Q3* through *Q8* circuits, with different component designations, of course.)

Shown in Fig. 3 is the schematic diagram of the Semianalyzer's display system. Note that three LEDs for each legend are wired in series with each other to reduce power consumption. All three LEDs in each case will glow at the same intensity because current flow through each LED in the string will be identical.

Returning to Fig. 2, *IC10* also drives *Q18* through *Q22*. These transistors provide the current needed to activate tone generator *IC11*. Values of *R84* through *R88* are selected to

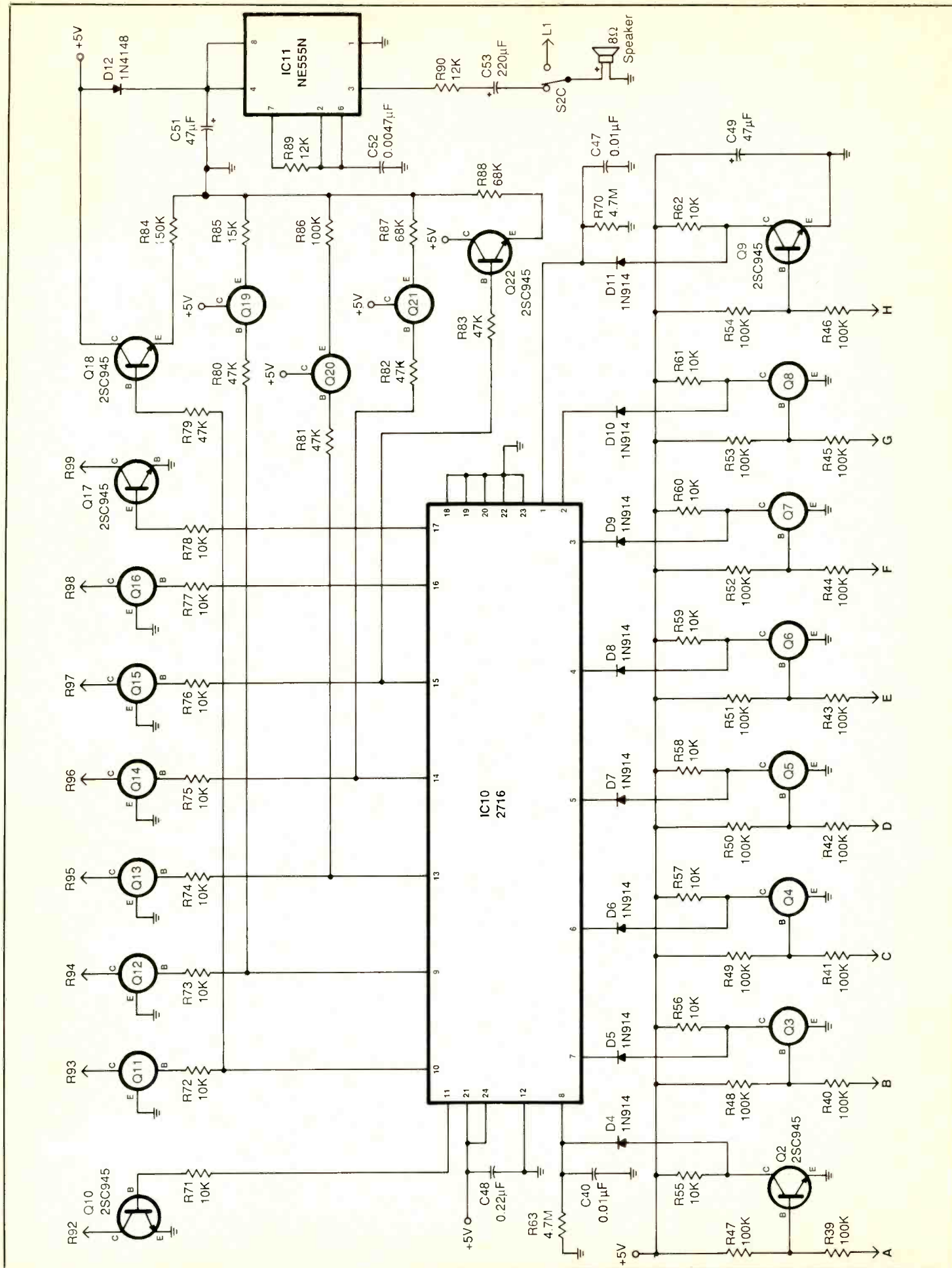
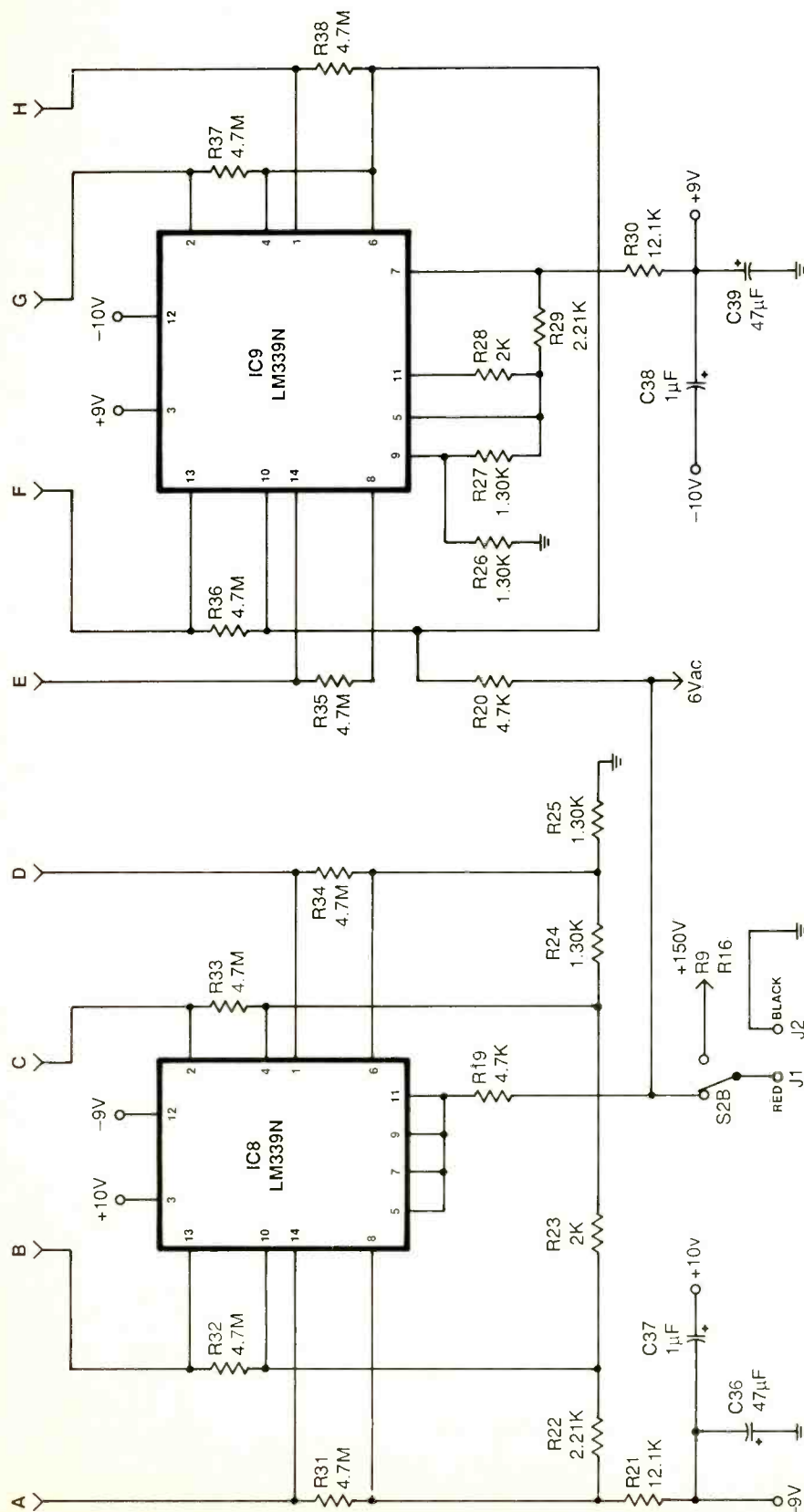

Fig. 2. Schematic diagram of junction-test circuit.



cause *IC11* to generate different tones. The output from *IC11* is dc isolated by *C53*, limited by *R90* and sent through *S2C* to loudspeaker *SPKR*.

The ac-operated dc power supply for the project is shown schematically in Fig. 5. Power transformer *T1* feeds full-wave bridge rectifier *D1*, whose pulsating dc output is filtered to pure dc by *C1*, *C2*, *C4*, *C10* and *C12*. After filtering, the dc is regulated to +9 volts by *IC1*, +5 volts by *IC3* and +12 volts by *IC4*.

To drive the Fig. 2 precision-resistor strings, precise sources of +9 and -9 volts dc are needed. To obtain the latter, a line is taken from the negative (-) side of *C1*, filtered by *C3* and regulated to -9 volts by *IC2*. The direct output of *IC2* is -9 volts dc. From this -9-volt rail, *R3*, *D2* and *C9* develop a -5-volt dc output as well.

Note that *IC1* and *IC2* are standard 8-volt dc regulators. By installing trimmer resistors *VR1* and *VR2* in the common-lead circuits of these regulators, the *IC1* and *IC2* outputs can be adjusted to provide exactly +9 and -9 volts dc, respectively.

As you can see, the +150-volt dc source needed for making voltage-breakdown tests, is derived from the +12-volt dc output from *IC4*. The +12 volts goes to the *IC5/Q1/T2* voltage-converter arrangement. After *IC5*'s ac output is current-amplified by *Q1*, and stepped up by *T1* it is half-wave rectified by *D3* and smoothed to dc by *C20*. The resulting +150-volts dc is then sent to the main circuitry through *R8* so that it is never more than 15 milliamperes. This +150 volts is switched through the component under test through *S2B* in Fig. 2.

In the Fig. 3 circuit, the +150 volts is digitized by DVM chip *IC7* and its value is displayed via LED numeric indicators *DIS1* through *DIS4*. It is also filtered by the high-pass filter made up of *C21*, *C22* and *R100*; low-pass filter *C23*; and clip-

per/protector *D13* to amplifier *IC6*.

Gain of *IC6* is set by feedback resistor *R11* to produce an audio level that will let you hear minute changes of the breakdown voltage or noise. The problem here is that if a very-noisy component is causing a very large signal to be emitted by *IC6*, it would quickly destroy the small loudspeaker. Therefore, a form of alc (automatic level control) is needed. This is why indicator lamp *L1* is included in the circuit. In small-signal situations, *L1* acts as an ordinary 12-ohm resistor and passes most of the audio signal. If a large-exursion signal is encountered, the lamp quickly heats up to 150 ohms to protect the speaker and, lighting up, serves as a visual indicator of a noisy breakdown.

Construction

Because of the relative complexity of this circuit, in terms of both functionality and component count, printed-circuit construction is highly recommended. You can etch and drill your own pc boards, using the actual-size artwork shown in Figs. 5 (main board) and 6 (display board).

Notice that the main board requires a double-sided etch pattern and should have plated-through holes. If you fabricate this board at home, you will not be able to plate-through the holes. You can still etch and drill the double-sided pattern and use the board if you make certain adjustments in the assembly procedure and make some component changes. (The board in the kit from the source given in the Note at the end of the Parts List comes with plated-through holes.) The single-sided display board can be etched and drilled in the usual manner.

• *The Main Board.* Etch and drill the main pc board, using the artwork in Fig. 5. The notches at opposite ends of the board fit around the molded plastic posts in the enclosure used for the prototype. If you use a different

Program Listing For Data to be Burnt Into EPROM

Circuit Condition (Voltages)	Hex Address	Data Out	Display Legends
-0.00 to +0.00	00	01	SHORTED/JUNCT
-0.00 to +0.60	10	02	LEAKY/JUNCT
-0.00 to +1.20	30	02	LEAKY/JUNCT
-0.00 to +2.20	70	02	LEAKY/JUNCT
-0.00 to +3.20	F0	02	LEAKY/JUNCT
-0.60 to +0.00	08	02	LEAKY/JUNCT
-0.60 to +0.60	18	C2	LEAKY/NPN/PNP/JUNCT
-0.60 to +1.20	38	8A	LEAKY/SINGLE/NPN/JUNCT
-0.60 to +2.20	78	8A	LEAKY/SINGLE/NPN/JUNCT
-0.60 to +3.20	F8	88	SINGLE/NPN/JUNCT
-1.20 to +0.00	0C	02	LEAKY/JUNCT
-1.20 to +0.60	1C	4A	LEAKY/SINGLE/PNP/JUNCT
-1.20 to +1.20	3C	02	LEAKY/JUNCT
-1.20 to +2.20	7C	92	LEAKY/DUAL/NPN/JUNCT
-1.20 to +3.20	FC	90	DUAL/NPN/JUNCT
-2.20 to +0.00	0E	02	LEAKY/JUNCT
-2.20 to +0.60	1E	4A	LEAKY/SINGLE/PNP/JUNCT
-2.20 to +1.20	3E	52	LEAKY/DUAL/PNP/JUNCT
-2.20 to +2.20	7E	02	LEAKY/JUNCT
-2.20 to +3.20	FE	A0	TRIPLE/NPN/JUNCT
-3.20 to +0.00	0F	02	LEAKY/JUNCT
-3.20 to +0.60	1F	48	SINGLE/PNP/JUNCT
-3.20 to +1.20	3F	50	DUAL/PNP/JUNCT
-3.20 to +2.20	7F	60	TRIPLE/PNP/JUNCT
-3.20 to +3.20	FF	04	OPEN/JUNCT

enclosure that does not have these posts, drill mounting holes instead of these notches.

Use a very-fine drill bit—say a No. 60 or 61—to very carefully drill a hole through the board at the end of each trace on the edge of the board to the right of *IC7* with the bottom guide oriented as shown. There are 34 holes to be drilled here. Make sure these holes are centered in each trace. Do the same for the nine holes near the edge of the board to the right of *Q10* through *Q17*. There are nine holes here, including the rectangular one at the corner of the board.

Assuming you are using a home-made pc board, when you begin installing components, keep in mind that all component leads and pins that go into holes that have copper traces leaving them on both sides of the board *must* be soldered to the pads on both sides. In fact, make it a habit to solder *all* leads and pins to

the pads on both sides of the board; this way, you will not inadvertently miss any as you go along. If you are using a board with plated-through holes, you need solder leads and pins to the bottom-of-the-board pads only.

There are a great many closely spaced pads and conductors on this board. If you are not careful, you can easily create solder bridges. Therefore, start with a low-power soldering iron equipped with a fine tip. When the tip comes up to soldering heat, thoroughly clean it. When soldering a connection, use only enough solder to make a good electrical and mechanical joint. Do not use excessive solder. Also, clean the tip of your iron frequently.

Start stuffing the main board by plugging the leads of the resistors into the appropriate holes and soldering them into place. Double check resistor values before soldering any leads to the copper pads. Once the re-

TAKE ANY ONE OF THESE HANDBOOKS FOR ONLY \$14.95 VALUES UP TO \$110.00

— when you join the **ELECTRONICS AND CONTROL ENGINEERS' BOOK CLUB®**

- your one source for engineering books from over 100 different publishers
- the latest and best information in your field
- discounts of up to 40% off publishers' list prices



STANDARD HANDBOOK FOR ELECTRICAL ENGINEERS, Twelfth Edition

Edited by D.G. Fink and H.W. Beaty
• 2,248 pages, 1,863 illustrations and tables
Publisher's Price \$86.50

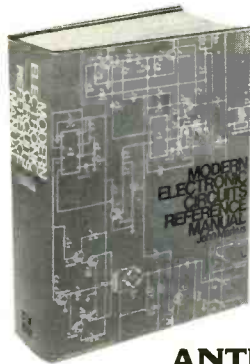
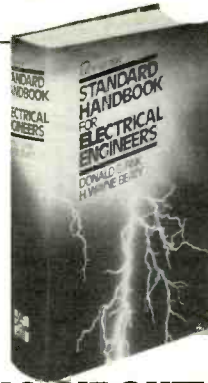

MODERN ELECTRONIC CIRCUITS REFERENCE MANUAL

By J. T. Markus
• 1,264 pages, 3,666 circuit diagrams
Publisher's Price \$82.50

ANTENNA ENGINEERING HANDBOOK, Second Edition

Edited by R. C. Johnson and H. Jasik
• 1,408 pages, 946 illustrations
Publisher's Price \$110.00



4 reasons to join today!

- 1. Best and newest books from ALL publishers!** Books are selected from a wide range of publishers by expert editors and consultants to give you continuing access to the best and latest books in your field.
- 2. Big savings!** Build your library and save money, too! Savings range up to 40% off publishers' list prices.
- 3. Bonus books!** You will immediately begin to participate in our Bonus Book Plan that allows you savings up to 70% off the publishers' prices of many professional and general interest books!
- 4. Convenience!** 14-16 times a year (about once every 3-4 weeks) you receive the Club Bulletin FREE. It fully describes the Main Selection and alternate selections. A dated Reply Card is included. If you want the Main Selection, you simply do nothing — it will be shipped automatically. If you want an alternate selection — or no book at all — you simply indicate it on the Reply Card and return it by the date specified. You will have at least 10 days to decide. If, because of late delivery of the Bulletin you receive a Main Selection you do not want, you may return it for credit at the Club's expense.

As a Club member you agree only to the purchase of three additional books during your first year of membership. Membership may be discontinued by either you or the Club at any time after you have purchased the three additional books.

FOR FASTER SERVICE IN ENROLLING CALL TOLL FREE
1-800-2-MCGRAW

McGraw-Hill Book Clubs
Electronics and Control Engineers' Book Club®
P.O. Box 582
Hightstown, NJ 08520-9959

Please enroll me as a member of the Electronics and Control Engineers' Book Club® and send me the book I have chosen for only \$14.95, plus local tax, postage, and handling. I agree to purchase a minimum of three additional books during my first year as outlined under the Club plan described in this ad. Membership in the club is cancellable by me or McGraw-Hill any time after the three book purchase requirement has been fulfilled. A shipping and handling charge is added to all shipments.

I wish to order the following book:

- STANDARD HANDBOOK FOR ELECTRICAL ENGINEERS (209/758)
 MODERN ELECTRONIC CIRCUITS REFERENCE MANUAL (404/461)
 ANTENNA ENGINEERING HANDBOOK (322/910)

Signature _____

Name _____

Address/Apt. # _____

City/State/Zip _____

This order subject to acceptance by McGraw-Hill. Offer good only to new members. Foreign member acceptance subject to special conditions.

E33933

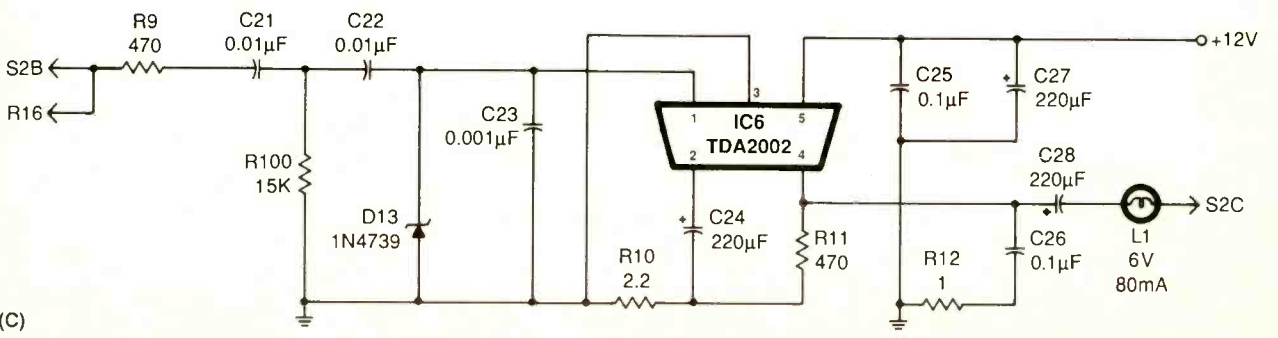
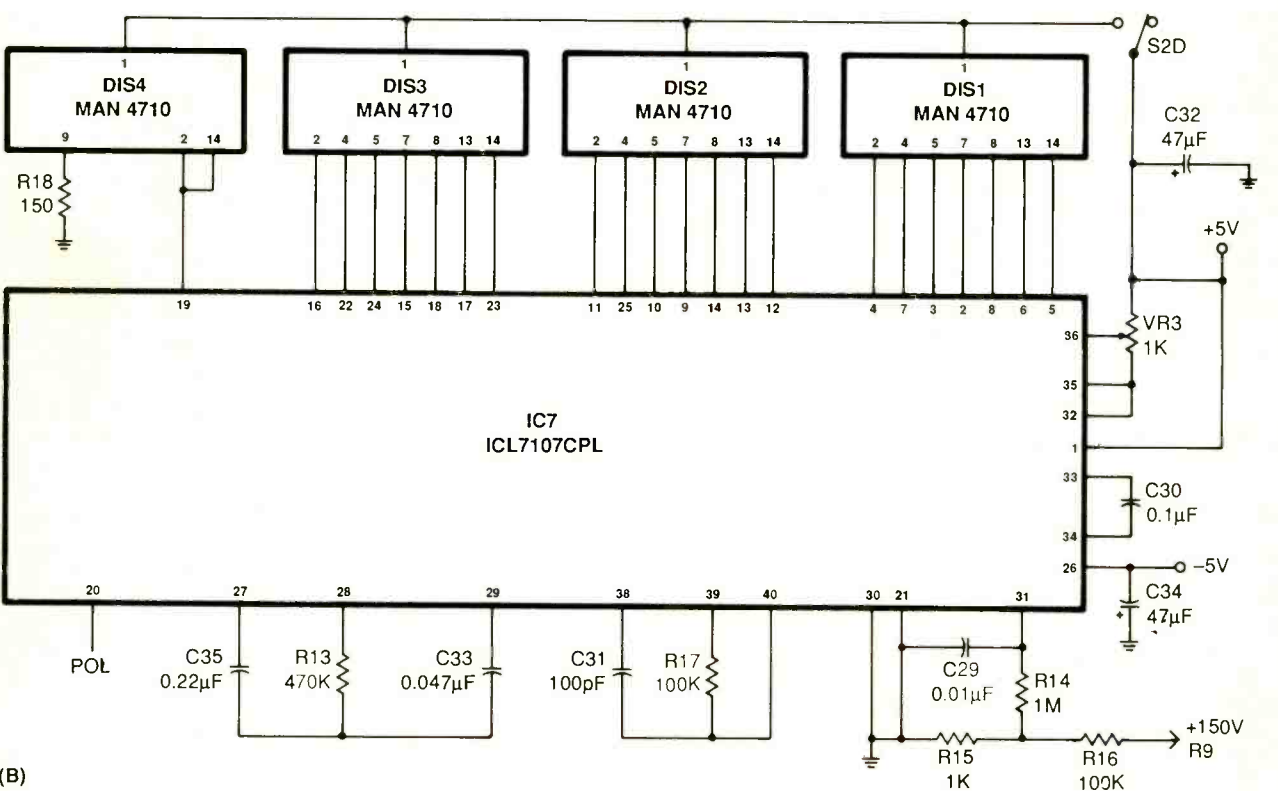
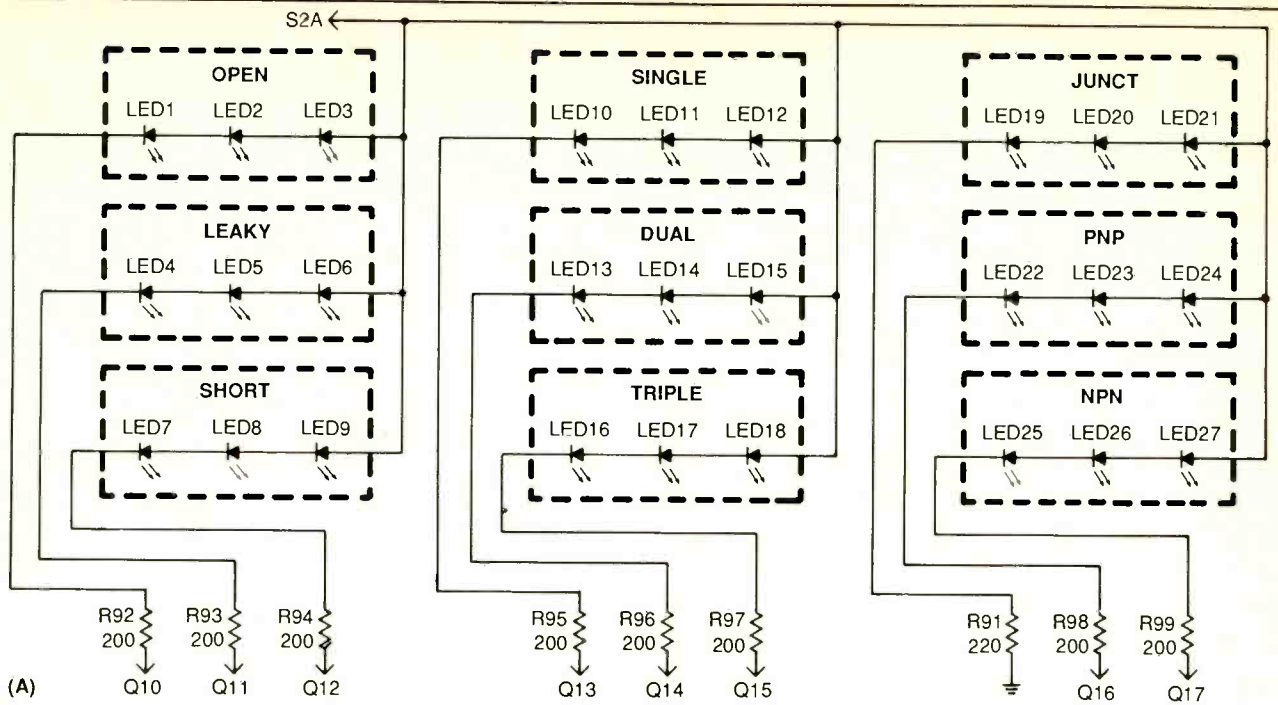

Fig. 3. Schematic diagram of project's legend and numeric display systems.

PARTS LIST

Semiconductors

D1—ECG 5304 or similar 1.5-ampere, 200-PIV round bridge rectifier
 D2—1N4733 or equivalent 5.0-volt, 1-watt, 10% tolerance zener diode
 D4 thru D12—1N4148 or 1N914 silicon switching diode
 D13—1N4737 or similar 9.0-volt, 1-watt, 10% tolerance zener diode
 DIS1 thru DIS4—MAN 4710 or equivalent 0.4" red common-anode 7-segment numeric display
 IC1—7808 or similar +8-volt, 1-ampere regulator in TO-220 case
 IC2—7908 or similar -8-volt, 1-ampere regulator in TO-220 case
 IC3—7805 or similar +5-volt, 1-ampere regulator in TO-220 case
 IC4—7812 or similar +12-volt, 1-ampere regulator in TO-220 case
 IC5, IC11—NE555N timer
 IC6—TDA2002 or equivalent 8-watt audio amplifier in TO-220 case
 IC7—ICL7107CPL or equivalent 3.5-digit DVM/LED driver (Intersil)
 IC8, IC9—LM339N quad comparator
 IC10—2716 or similar 450-ns EPROM
 LED1 thru LED27—T-1 ¼ 20-mA amber light-emitting diode
 Q1—2SB633, 2SB595 or similar 100-volt, 5-ampere (40-watt) npn power transistor in TO-220 case
 Q2 thru Q22—2SC945, 2SC1364, 2SC1000 or similar 50-volt, 100-mA (200-mW) npn power transistor in TO-92 case

Capacitors

Radial-Lead Aluminum Electrolytic:
 C1, C2—1,000 μ F (25-volt)
 C3, C4, C11, C13—4.7 μ F (50-volt)
 C5 thru C8, C37, C38—1 μ F (50-volt tantalum)
 C9, C16, C32, C34, C36, C39, C49 thru C51—47 μ F (16-volt)
 C10, C12, C15—100- μ F (25-volt)
 C14, C24, C27, C28, C53—220 μ F (16-volt)

Radial-Lead Film:

C17, C52—0.0047 μ F (50-volt Mylar)
 C18, C33—0.047 μ F (50-volt Mylar)
 C19, C21, C22—0.01 μ F (250-volt Mylar)
 C20—10 μ F (250-volt)
 C23—0.001 μ F (50-volt Mylar)
 C25, C26, C30—0.1 μ F (50-volt, 5% stacked metalized film)
 C29, C40 thru C47—0.01 μ F (50-volt Mylar)
 C31—100 pF (50-volt, 5% polystyrene)
 C35, C48—0.22 μ F (50-volt, 5% stacked metalized film)

Resistors (¼-watt, 5% tolerance)

R3—390 ohms
 R5, R18—150 ohms
 R6—5,600 ohms
 R7—4,300 ohms
 R9, R11—470 ohms
 R10—2.2 ohms
 R12—1 ohm
 R13—470,000 ohms
 R14—1 megohm
 R15—1,000 ohms
 R16, R17, R39 thru R54, R86—100,000 ohms
 R19, R20—4,700 ohms
 R31 thru R38, R63 thru R70—4.7 megohms
 R55 thru R62, R71 thru R78—10,000 ohms
 R79 thru R83—47,000 ohms
 R84—150,000 ohms
 R85, R100—15,000 ohms
 R87, R88—68,000 ohms
 R89, R90—12,000 ohms
 R91—220 ohms
 R92 thru R99—200 ohms
 R21, R30—12,100 ohms (¼-watt, 1% precision metal-film)
 R22, R29—2,210 ohms (¼-watt, 1% precision metal-film)
 R23, R28—2,000 ohms (¼-watt, 1% precision metal-film)
 R24 thru R27—1,300 ohms (¼-watt, 1% precision metal-film)
 R1, R2—22 ohms (1 watt)
 R4—12 ohms (1-watt)

R8—10,000 ohms (1-watt)

VR1, VR2, VR3—1,000-ohm top-adjust multi-turn cermet pc-type trimmer resistor

Miscellaneous

F1—500-mA pigtail fuse
 J1, J2—Red and black banana jack
 L1—6-volt, 80-mA pigtail incandescent lamp (GTE 5ES or similar)
 S1—Spst switch
 S2—4-pole pc-type push switch (Electronic Components Group No. TA4UEE or equivalent)
 SPKR—8-ohm, 0.1-watt 1.5" speaker (Panasonic No. 2P15SA or equivalent)
 T1—6-volt ac, 300-mA/30-volt ac with center tap, 1-ampere power transformer (Airline Mechanical No. EI: 57-28 or similar)
 Printed-circuit boards (see text); sockets for DIP ICs (and optionally for numeric displays); ac line cord with plug; 3-lug (none grounded) terminal strip; materials for making IC heat sink, legend display shield and display mask (see text); line cord with plug; rubber grommet; button caps for S1 and S2; suitable enclosure (see text); red and black banana plugs, test probes and test-lead wire for test cables (see text); lettering kit; clear acrylic spray; machine hardware; hookup wire; solder; etc.

Note: The following items are available from Electronic Design Specialists, Inc., 951 SW 82 Ave., N. Lauderdale, FL 33068: Complete kit of all parts, including enclosure but not including sockets for displays, \$139 + \$7.50 P&H; double-sided main pc board with plated-through holes, and single-sided display board, \$25.00; programmed EPROM, \$20.00; molded-plastic matrix display shield, \$5.00; cabinet kit, including hardware, \$29.00. Prices for other available components can be obtained by writing to the kit supplier. Add \$2.00 P&H for individual parts orders. Florida residents, please add state sales tax.

sistors have been installed, mount and solder into place all nonpolarized capacitors.

Next, install the sockets for the ICs in their respective locations. If you are using a board that has plat-

ed-through holes, simply drop the sockets into the holes at the indicated locations and solder into place from the bottom of the board. If you are using a board whose holes are not plated-through, you cannot use stan-

dard IC sockets because they do not provide top-of-the-board soldering access. In this case, use Molex Soldercon® socket strips that do. Break the Soldercon strips into as many strips as needed: four strips of 4 pins

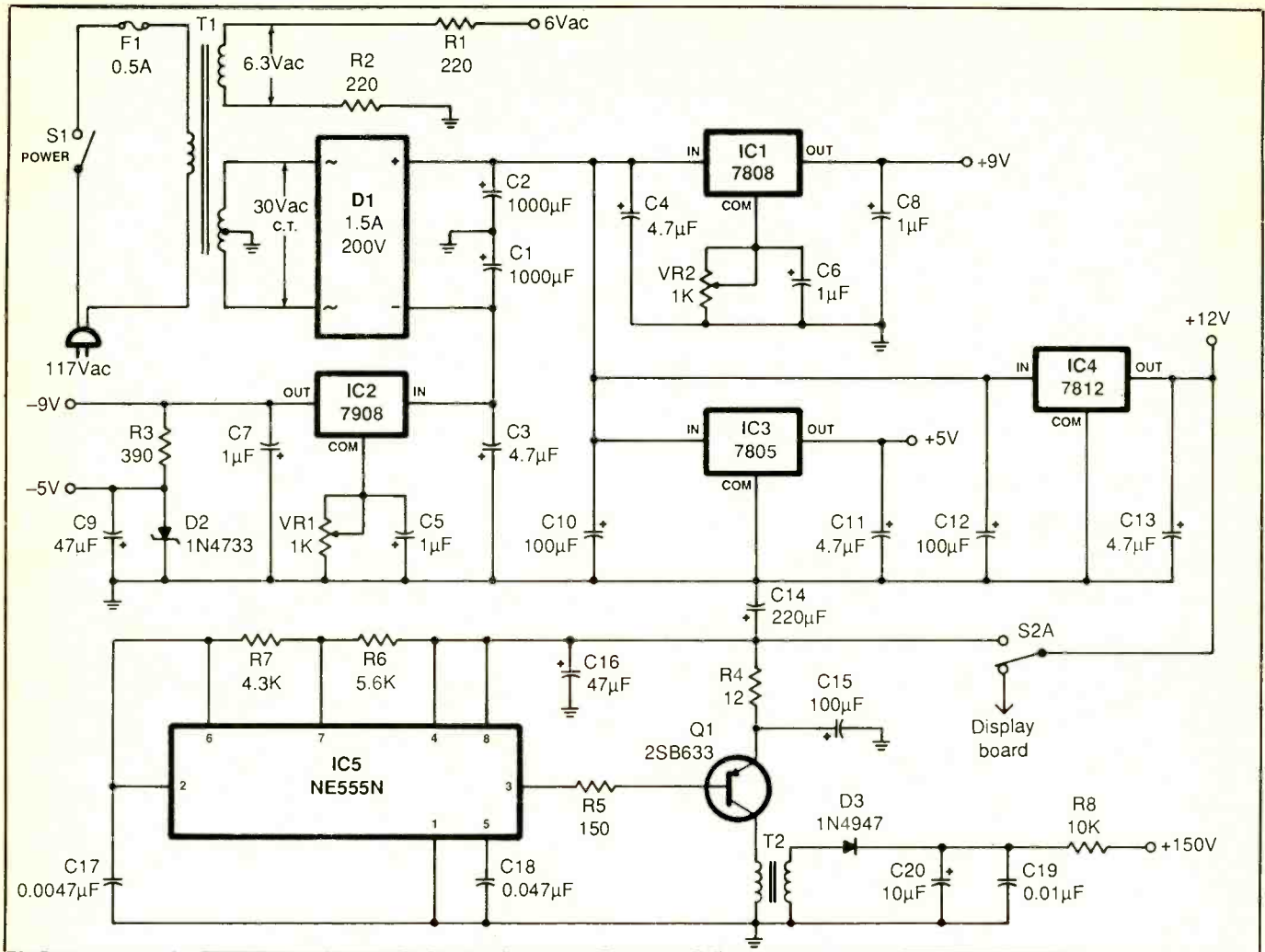

Fig. 4. Schematic diagram of ac-operated multiple-dc-output power supply.

for IC5 and IC11, four strips of 8 pins for IC8 and IC9, two strips of 12 pins for IC10 and two strips of 20 pins for IC7. Do not remove the metal bridging pieces at the tops of the strips until after each strip is soldered in its respective location.

Plug a 20-pin Soldercon strip into one line of holes for IC7 and solder the first and last protruding strip to the copper pads on the bottom of the board. Turn over the board and check that the strip is vertical to the surface of the board on the component side. If not, reflow the solder on both pins and hold it vertical until the solder sets. Then carefully solder all remaining pins to the pads on the bottom of the board.

Flip over the board and sparingly solder the Soldercons to the pads on the top of the board. Use only enough solder to make good electrical connections, and make sure that none of the solder clogs any of the pin sockets. Then repeat the entire procedure for all remaining strips and DIP IC locations. Gently flex the bridging metal strips from the tops of all Soldercon strips. Do not install any of the ICs in the indicated locations until after initial checkout has been performed.

Now install and solder into place the bridge rectifier and all diodes. Make absolutely certain that these components are properly oriented before soldering their leads to the

copper pads. This done, install and solder into place trimmer potentiometers VR1, VR2 and VR3 in their respective locations.

You may have difficulty installing 4-pole pushbutton switch S2 if you are using a board that does not have plated-through holes. To gain soldering access for the pin that must be soldered to the pad on the top of the board, the solution is to loop a length of No. 30 enameled wire (preferably the type that can be soldered-through and does not require the enamel to be scraped away to be made solderable) around and solder it to that pin. The free end of this wire should stick out from the rear end of the switch. Clip it to a length

Uniden® CB Radios & Scanners

Communications Electronics,™
the world's largest distributor of radio
scanners, introduces new models of
CB, radar detectors and scanners.

NEW! Bearcat® 760XLT-SA

List price \$499.95/CE price \$294.95
12-Band, 100 Channel • Crystalless • AC/DC
Frequency range: 29-54, 118-174, 406-512, 806-956 MHz.
Excludes 823.9875-849.0125 and 868.9875-894.0125 MHz.
The Bearcat 760XLT has 100 programmable channels organized as five channel banks for easy use, and 12 bands of coverage including the 800 MHz. band. You also get automatic scanning of pre-programmed aircraft, police, marine, and emergency services. It also includes Weather Search, Priority, Squelch, Lockout and Delay. It has automatic and manual band search to find new active frequencies in other areas of the radio spectrum. The Bearcat 760XLT mounts neatly under the dash and connects directly to fuse block or battery. The unit also has an AC adaptor, flip down stand and telescopic antenna for desk top use. 6-5/16" W x 1 1/4" H x 7 3/4" D. Model BC 580XLT-SA is a similar version without the 800 MHz. band for only \$219.95.

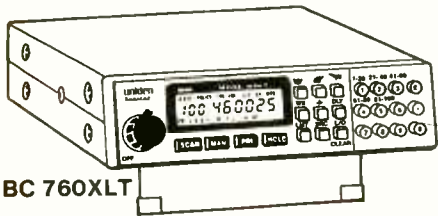

BC 760XLT

Regency® TS2-SA

List price \$499.95/CE price \$309.95/SPECIAL
12-Band, 75 Channel • Crystalless • AC/DC
Frequency range: 29-54, 118-175, 406-512, 806-950 MHz.
The Regency TS2 scanner lets you monitor Military, Space Satellites, Government, Railroad, Justice Department, State Department, Fish & Game, Immigration, Marine, Police and Fire Departments, Aeronautical AM band, Paramedics, Amateur Radio, plus thousands of other radio frequencies most scanners can't pick up. The Regency TS2 features new 40 channel per second Turbo Scan™ so you won't miss any of the action. Model TS1-RA is a 35 channel version of this radio without the 800 MHz. band and costs only \$239.95.

Regency® RH256B-SA

List price \$799.95/CE price \$329.95/SPECIAL
16 Channel • 25 Watt Transceiver • Priority
The Regency RH256B is a sixteen-channel VHF land mobile transceiver designed to cover any frequency between 150 to 162 MHz. Since this radio is synthesized, no expensive crystals are needed to store up to 16 frequencies without battery backup. All radios come with CTCSS tone and scanning capabilities. A monitor and night/day switch is also standard. This transceiver even has a priority function. The RH256 makes an ideal radio for any police or fire department volunteer because of its low cost and high performance. A 60 Watt VHF 150-162 MHz. version called the RH606B-SA is available for \$429.95. A UHF 15 watt, 10 channel version of this radio called the RU150B-SA is also available and covers 450-482 MHz. but the cost is \$419.95.

SALE Bearcat® 100XL-SA

List price \$349.95/CE price \$159.95/CLOSEOUT
9-Band, 16 Channel • Priority • Scan Delay Search • Limit • Hold • Lockout • AC/DC
Frequency range: 30-50, 118-174, 406-512 MHz.
Uniden has authorized CEI to closeout the famous Bearcat 100XL to make room for new models. This scanner has a full 16 channels with frequency coverage that includes all public service bands. Wow... what a scanner! Included in our low CE price is a sturdy carrying case, earphone, battery charger/AC adaptor, six AA Ni-cad batteries and flexible antenna. Since this is a special closeout price on our last 200 pieces, you must order your Bearcat today to take advantage of this excellent scanner opportunity.

★★★ Uniden CB Radios ★★★

The Uniden line of Citizens Band Radio transceivers is styled to compliment other mobile audio equipment. Uniden CB radios are so reliable that they have a two year limited warranty. From the feature packed PRO 540e to the 310e handheld, there is no better Citizens Band radio of the market today.

PRO310E-SA Uniden 40 Ch. Portable/Mobile CB... \$85.95
PRO330E-SA Uniden 40 Ch. Remote mount CB... \$109.95
NINJA-SA PRO310E with rechargeable battery pack \$99.95
B-10-SA 1.2V AA Ni-cad batt. for Ninja (set of 10).... \$20.95
KARATE-SA Uniden 40 channel rescue radio.... \$69.95
PRO520E-SA Uniden 40 channel CB Mobile.... \$59.95
PRO540E-SA Uniden 40 channel CB Mobile.... \$119.95
PRO640E-SA Uniden 40 channel SSB CB mobile.... \$159.95
PRO710E-SA Uniden 40 channel CB Base.... \$119.95
PRO810E-SA Uniden 40 channel SSB CB Base.... \$179.95

★★★ Uniden Radar Detectors ★★★

Buy the finest Uniden radar detectors from CEI today.
RD7-SA Uniden visor mount radar detector.... \$109.95
RD9-SA Uniden "Passport" size radar detector.... \$129.95
RD9XL-SA Uniden "micro" size radar detector.... \$159.95
RD25-SA Uniden visor mount radar detector.... \$59.95
RD500-SA Uniden visor mount radar detector.... \$79.95

NEW! Bearcat® 200XLT-SA

New Product... Available May, 1988
List price \$509.95/CE price \$299.95
12-Band, 200 Channel • 800 MHz. Handheld Search • Limit • Hold • Priority • Lockout
Frequency range: 29-54, 118-174, 406-512, 806-956 MHz.
Excludes 823.9875-849.0125 and 868.9875-894.0125 MHz.
The Bearcat 200XLT sets a new standard for handheld scanners in performance and dependability. This full featured unit has 200 programmable channels with 20 scanning banks and 12 band coverage. If you want a very similar model without the 800 MHz. band and 100 channels, order the BC 100XLT-SA for only \$219.95. Includes antenna, carrying case with belt loop, Ni-cad battery pack, AC adaptor and earphone. Order your scanner now.

Bearcat® 800XL-SA

List price \$499.95/CE price \$259.95/SPECIAL
12-Band, 40 Channel • No-crystal scanner Priority control • Search/Scan • AC/DC
Bands: 29-54, 118-174, 406-512, 806-912 MHz.
The Uniden 800XL receives 40 channels in two banks. Scans 15 channels per second. Size 9 1/4" x 4 1/2" x 1 1/2".
If you do not need the 800 MHz. band, a similar model called the BC 210XLT-SA is available for \$196.95.

Bearcat® 145XL-SA

List price \$189.95/CE price \$98.95/SPECIAL
10-Band, 16 Channel • No-crystal scanner Priority control • Weather search • AC/DC
Bands: 29-54, 136-174, 406-512 MHz.
The Bearcat 145XL is a 16 channel, programmable scanner covering ten frequency bands. The unit features a built-in delay function that adds a three second delay on all channels to prevent missed transmissions.

Bearcat® 175XL-SA

List price \$279.95/CE price \$156.95/SPECIAL
11-Band, 16 Channel • Weather Search Priority control • Search/Scan • AC/DC
Bands: 29-54, 118-174, 406-512 MHz.
The Bearcat 175XL has an automatic search feature to locate new frequencies. Priority, lock out, delay and scan speed are all included.

Regency® Informant™ Scanners

Frequency coverage: 35-54, 136-174 406-512 MHz.
The new Regency Informant scanners cover virtually all the standard police, fire, emergency and weather frequencies. These special scanners are preprogrammed by state in the units memory. Just pick a state and a category. The Informant does the rest. All Informant radios have a feature called Turbo Scan™ to scan up to 40 channels per second. The INF1-SA is ideal for truckers and is only \$199.95. The new INF2-SA is a deluxe model and has ham radio, a weather alert and other exciting features built in for only \$239.95. For base station use, the INF5-SA is only \$149.95 and for those who can afford the best, the INF3-SA at \$209.95, is a state-of-the-art, receiver that spells out what service you're listening to such as Military, Airphone, Police, State Police, Coast Guard or Press.

Regency® HX1500-SA

List price \$369.95/CE price \$179.95/SPECIAL
11-Band, 55 Channel • Handheld/Portable Search • Lockout • Priority • Bank Select Sidelit liquid crystal display • EAROM Memory Direct Channel Access Feature • Scan delay
Bands: 29-54, 118-136, 144-174, 406-420, 440-512 MHz.
The new handheld Regency HX1500 scanner is fully keyboard programmable for the ultimate in versatility. You can scan up to 55 channels at the same time including the AM aircraft band. The LCD display is even sidelit for night use. Includes belt clip, flexible antenna and earphone. Operates on 8 1.2 Volt rechargeable Ni-cad batteries (not included). Be sure to order batteries and battery charger from the accessory list in this ad.

★★★ Uniden Cordless Phones ★★★

A major consumer magazine did a comparison study on cordless phones. The check points included clarity, efficiency and price. Uniden was rated best buy.

XE300-SA Uniden Cordless Phone..... \$69.95
XE500-SA Uniden Cordless Phone with paging.... \$84.95
XE700-SA Uniden Cordless Phone with speaker... \$114.95

★★★ Extended Warranty Program ★★★

If you purchase a scanner, CB, radar detector or cordless phone from any store in the U.S. or Canada within the last 30 days, you can get up to three years of extended warranty service from Warrantech. This service extension plan begins after the manufacturer's warranty expires. Warrantech will perform all necessary labor and will not charge for return shipping. Extended warranties are non-refundable and apply only to the original purchaser. A two year extended warranty on a mobile or base scanner is \$29.99 and three years is \$39.99. For handheld scanners, 2 years is \$59.95 and 3 years is \$79.95. For radar detectors, two years is \$29.95. For CB radios, 2 years is \$39.99. For cordless phones, 3 years is \$34.99. Order your warranty for your merchandise today.

OTHER RADIOS AND ACCESSORIES

NEW! BC 55XL-SA Bearcat 10 channel scanner.... \$114.95
BC 70XL-SA Bearcat 20 channel scanner.... \$169.95
R1090-SA Regency 45 ch. scanner... CLOSEOUT \$119.95
Z60-SA Regency 60 ch. scanner... CLOSEOUT \$129.95
UC102-SA Regency VHF 2 ch. 1 Watt transceiver... \$117.95
BP55-SA Regency 16 amp reg. power supply.... \$169.95
MA549-SA Drop-in charger for HX1200 & HX1500.... \$84.95
MA518-SA Wall charger for HX1500 scanner.... \$14.95
MA553-SA Carrying case for HX1500 scanner.... \$19.95
MA257-SA Cigarette lighter cord for HX12/1500.... \$19.95
MA917-SA Ni-Cad battery pack for HX1000/1200.... \$34.95
BP205 Ni-Cad battery pack for BC200/BC100XLT.... \$49.95
B-8-SA 1.2 V AA Ni-Cad batteries (set of eight).... \$17.95
FB-E-SA Frequency Directory for Eastern U.S.A.... \$14.95
FB-W-SA Frequency Directory for Western U.S.A.... \$14.95
ASD-SA Air Scan Directory.... \$14.95
SRF-SA Survival Radio Frequency Directory.... \$14.95
TSG-SA "Top Secret" Registry of U.S. Govt. Freq.... \$14.95
TIC-SA Techniques for Intercepting Comm.... \$14.95
RRF-SA Railroad frequency directory.... \$14.95
EEC-SA Embassy & Espionage Communications.... \$14.95
CIE-SA Covert Intelligence, Elect. Eavesdropping.... \$14.95
MFF-SA Midwest Federal Frequency directory.... \$14.95
A60-SA Magnet mount mobile scanner antenna.... \$35.95
A70-SA Base station scanner antenna.... \$35.95
USAMM-SA Mag mount VHF ant. w/ 12' cable.... \$39.95
USAK-SA 3/4" hole mount VHF ant. w/ 17' cable.... \$35.95
USAK450-SA 3/4" hole mount UHF ant. w/ 17' cable.... \$35.95
Add \$3.00 shipping for all accessories ordered at the same time.
Add \$7.00 shipping per radio and \$3.00 per antenna.

BUY WITH CONFIDENCE

To get the fastest delivery from CE of any scanner, send or phone your order directly to our Scanner Distribution Center™. Michigan residents please add 4% sales tax or supply your tax I.D. number. Written purchase orders are accepted from approved government agencies and most well rated firms at a 10% surcharge for net 10 billing. All sales are subject to availability, acceptance and verification. All sales on accessories are final. Prices, terms and specifications are subject to change without notice. All prices are in U.S. dollars. Out of stock items will be placed on backorder automatically unless CE is instructed differently. A \$5.00 additional handling fee will be charged for all orders with a merchandise total under \$50.00. Shipments are F.O.B. Ann Arbor, Michigan. No COD's. Most products that we sell have a manufacturer's warranty. Free copies of warranties on these products are available prior to purchase by writing to CE. Non-certified checks require bank clearance. Not responsible for typographical errors.

Mail orders to: Communications Electronics,™ Box 1045, Ann Arbor, Michigan 48106 U.S.A. Add \$7.00 per scanner for R.P.S./U.P.S. ground shipping and handling in the continental U.S.A. For Canada, Puerto Rico, Hawaii, Alaska, or APO/FPO delivery, shipping charges are three times continental U.S. rates. If you have a Discover, Visa or Master Card, you may call and place a credit card order. Order toll-free in the U.S. Dial 800-USA-SCAN. In Canada, order toll-free by calling 800-221-3475. FAX anytime, dial 313-971-6000. If you are outside the U.S. or in Michigan dial 313-973-8888. Order today.

Scanner Distribution Center™ and CEI logos are trademarks of Communications Electronics Inc.

† Bearcat is a registered trademark of Uniden Corporation.
‡ Regency and Turbo Scan are registered trademarks of Regency Electronics Inc. AD #020288-SA

Copyright © 1988 Communications Electronics Inc.

For credit card orders call
1-800-USA-SCAN

**COMMUNICATIONS
ELECTRONICS INC.**

Consumer Products Division

P.O. Box 1045 □ Ann Arbor, Michigan 48106-1045 U.S.A.
For orders call 313-973-8888 or FAX 313-971-6000

of 1 inch and, if necessary, scrape about 1/4 inch of enamel insulation from its free end and tin with solder.

Plug the switch into the board holes where indicated, plunger shaft pointing away from the board, and press it as close to the surface of the board as you can as you solder one pin in each row to the copper pads on the bottom of the board. Flip over the board and carefully tack solder the wire tail to the appropriate trace. Make sure that neither the wire nor the solder comes in contact with any other trace on the board. Use an ohmmeter to check for continuity between the top and bottom traces for this switch pin. If you do not obtain continuity, desolder the switch from the board and repeat the process until you do. Once you obtain continuity, solder the remaining pins of the switch to the pads on the bottom of the board.

Now install the transistors on the board. Start with the circuit-board assembly oriented as shown. As you install each transistor, set it in place so that you have soldering access to all leads on both sides of the board. Install the transistors with the emitter (E), base (B) and collector (C) leads plugged into the appropriate holes. The E, B and C designators are shown independently for *Q1* and collectively for *Q2* through *Q9* near where *Q2* mounts, for *Q10* through *Q17* near where *Q10* mounts, and for *Q18* through *Q22* near where *Q18* mounts. The only transistor that is different from the others is *Q1*; so make sure you separate this one out and install it in the *Q1* location first.

Taking care to properly orient them, install the electrolytic capacitors in their respective locations and solder their leads to the copper pads. Then mount audio coupling transformer *T2* on the board in the indicated locations. Make sure *T2*'s 8-ohm and 1-kilohm pins are plugged into the proper holes before soldering them or the metal mounting tabs to the board's pads.

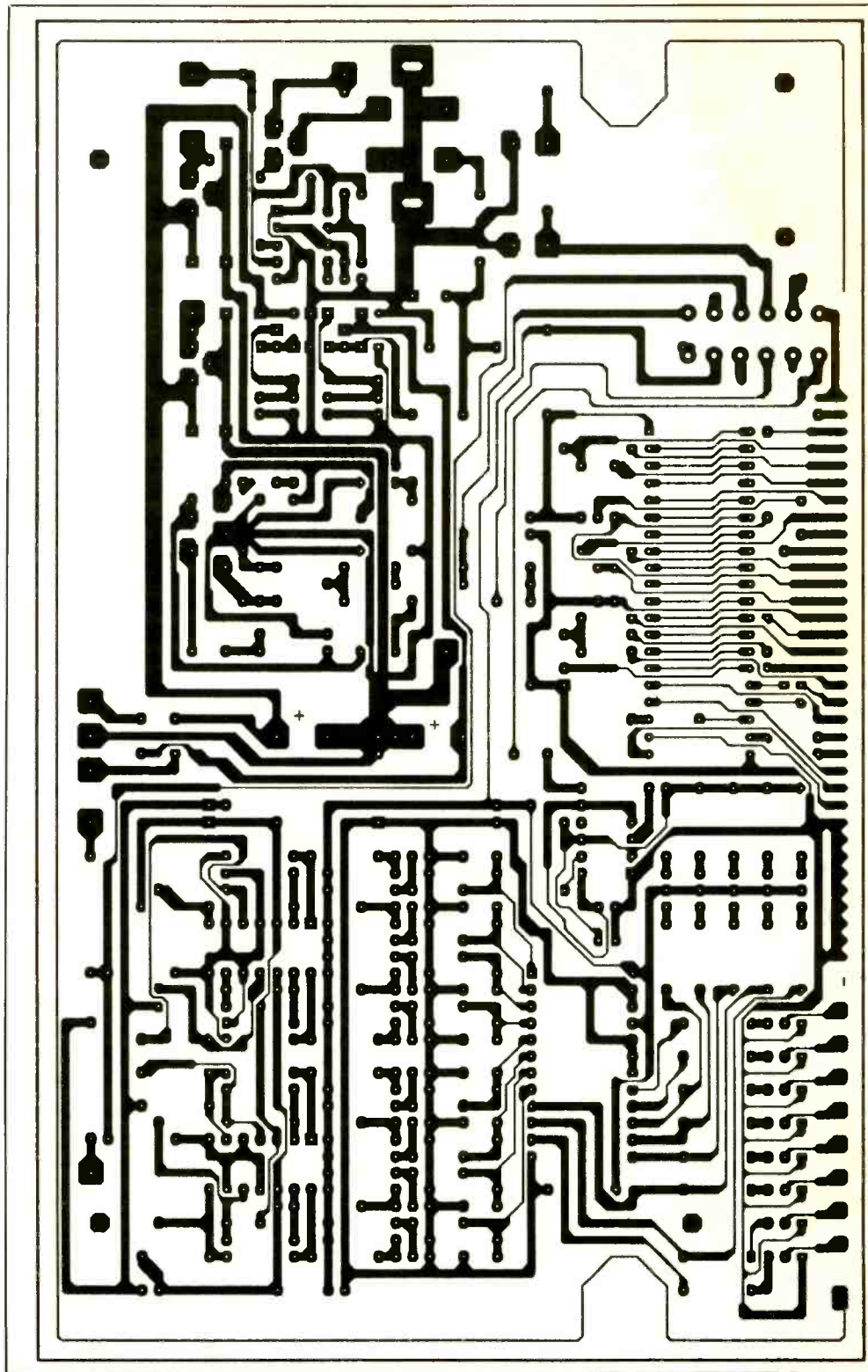

Strip 1/4 inch of insulation from both ends of an 8-inch length of stranded hookup wire. Tightly twist together the fine conductors at both

ends and sparingly tin with solder. Plug one end of the wire into the hole labeled GND and solder into place.

Now, disregarding the holes la-

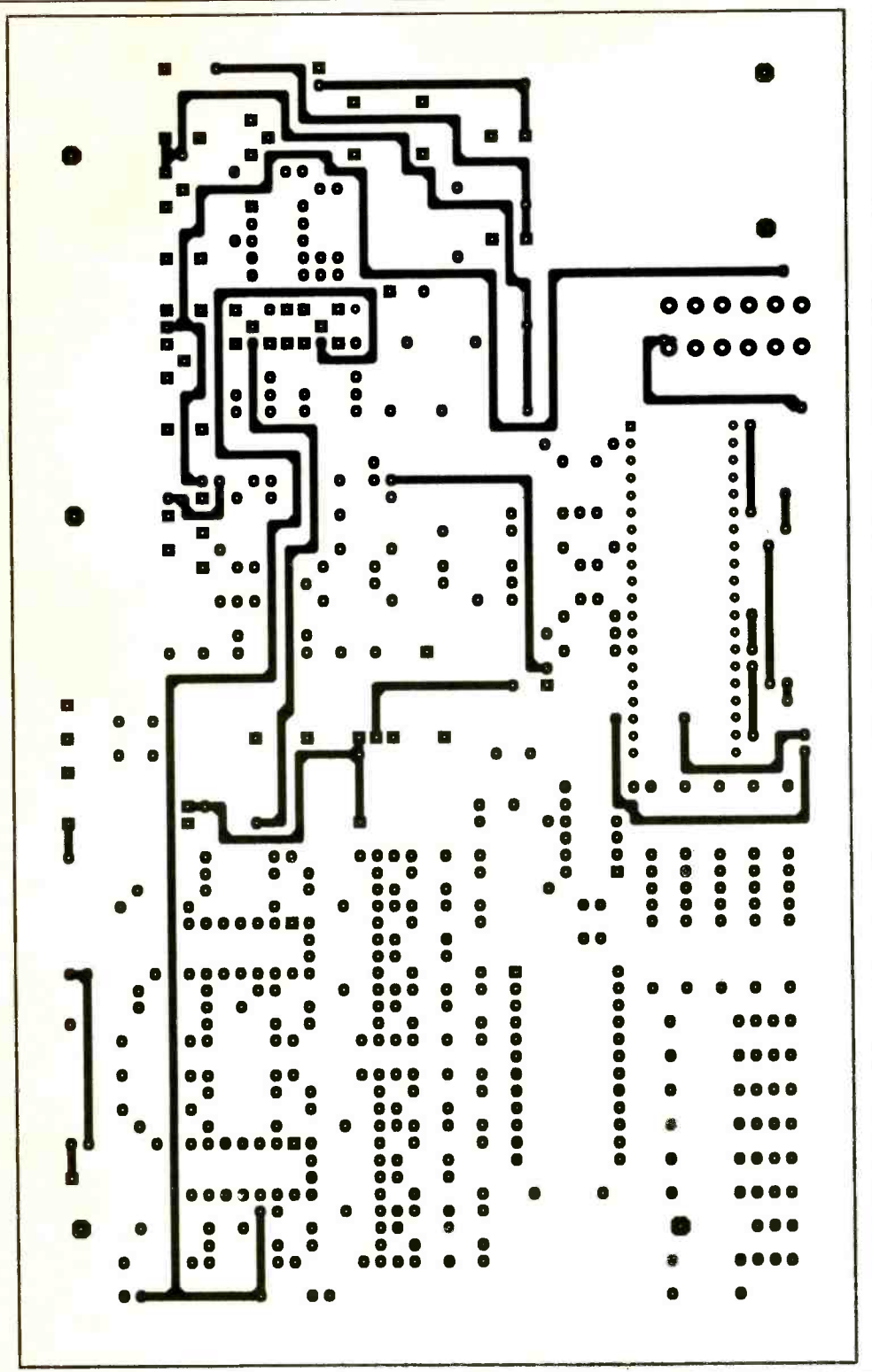

Fig. 5. Actual-size etching-and-drilling guides for double-sided main printed-circuit board.

beled 30VAC, CT and 6VAC, check the board for any unoccupied holes. As you locate these, check them against Fig. 7 to make sure you have not left

out components in those locations. When you are certain that an unoccupied hole should not have a component lead or pin in it, plug the end

of a bare hookup wire into it and solder it to the pad on the top of the board, flip over the board and solder it to the pad on the bottom and, finally, clip the wire close to the connection. Do this for all unoccupied holes where a jumper wire is needed to bridge traces that alternate between top and bottom of the board. If you have a board that has plated-through holes, disregard the instructions in this paragraph.

Prepare a heat sink from 1/8-inch-thick or so aluminum stock as follows. First, cut the aluminum to 5 inches by 3 1/4 inches. Fold this sheet to form a U channel so that it has 2-inch legs and is 1 inch across the bottom, squaring up the corners. From the outside of the U channel, measure 3/4 inch up one leg and strike a line here across the leg parallel with the bottom. Then strike lines 1/2, 1 1/2 and 2 1/2 inches across the first line, starting from the left end of the heat sink. The last line should be 3/4 inch from the right end of the sink. The points where the lines cross identify the locations in which holes must be drilled for IC3, IC4 and IC6.

Invert the heat sink and strike a line down the length of the channel. Measure 5/8 inch in from the edge of the channel where you drilled the hole on the leg 1/2 inch in and strike a cross line. Add another 2 1/8 inch and strike a second line. These last two points are where holes are to be drilled for mounting the heat-sink assembly on the main circuit board. Drill a 3/16-inch hole through the heat sink in all five indicated locations.

Liberally coat the rear (metal surface) of the 7805 regulator (IC3) with heat-sink compound. Push the neck of a shoulder fiber washer into the hole in the metal mounting tab of the IC and follow with 4-40 x 1/4-

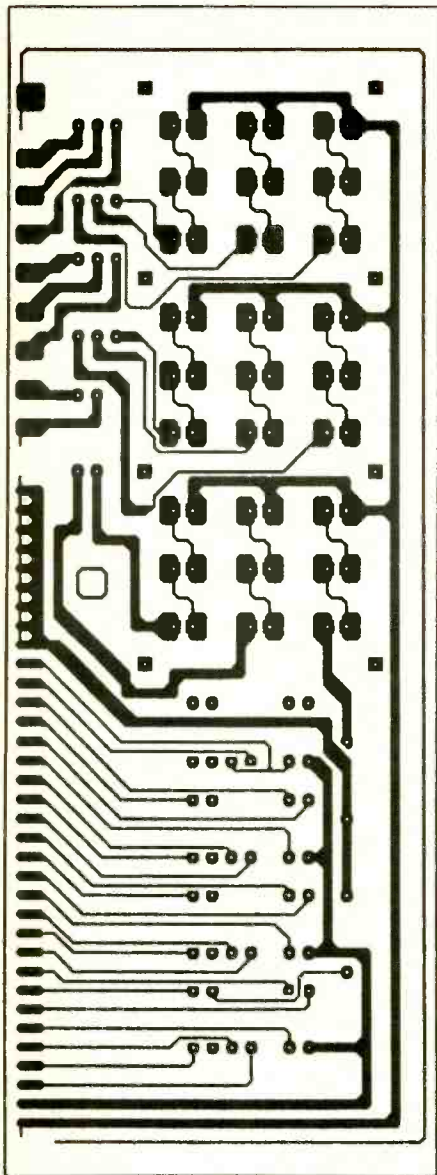
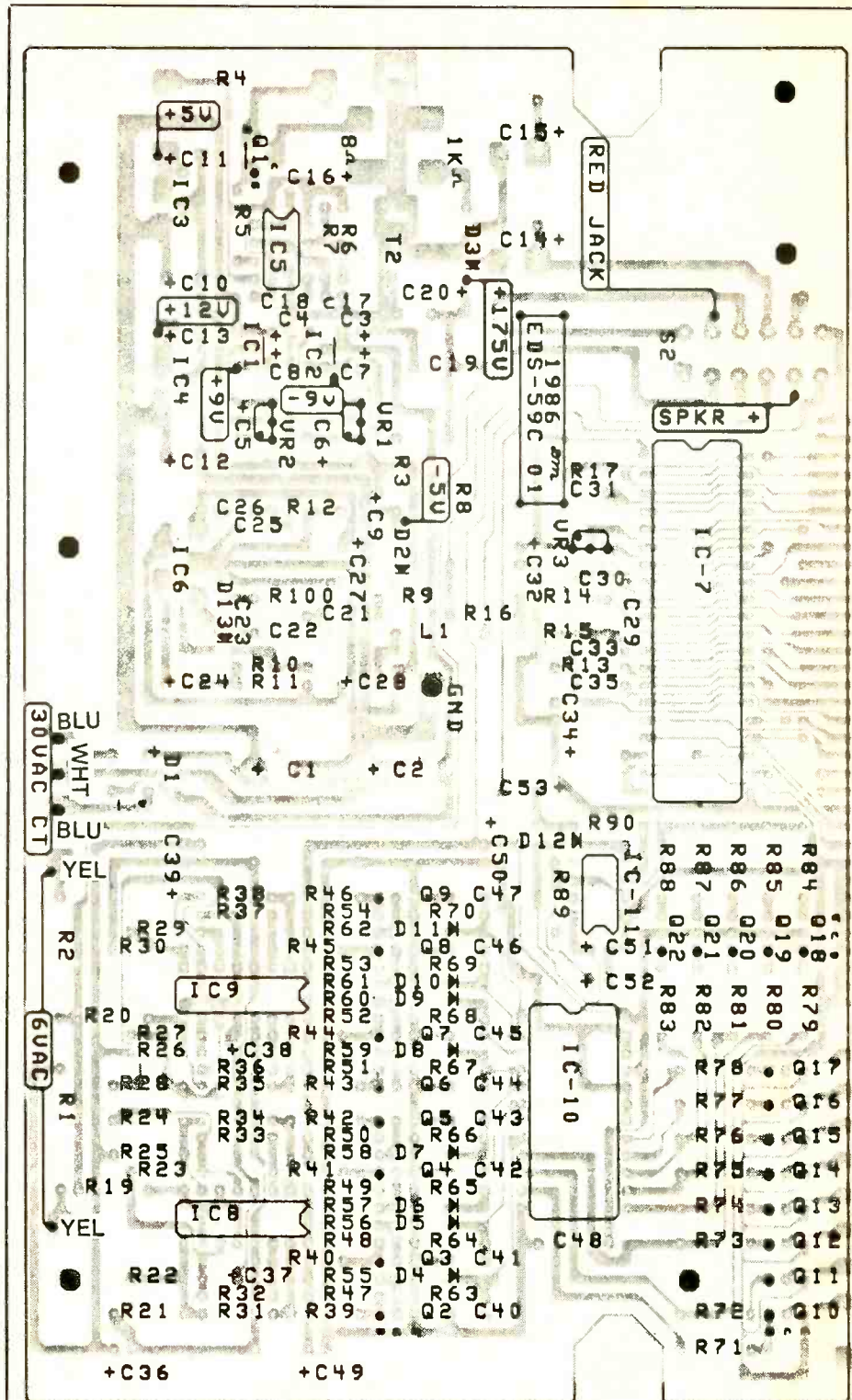

Fig. 6. Actual-size etching-and-drilling guide for single-sided display printed-circuit board.

inch machine screw. Mount the 7805 on the heat sink via the 1¼-inch-spaced hole at the right, using heat-sink compound, a mica insulator and No. 4 machine nut and lockwasher. Repeat with the 7812 IC4 regulator, mounting it in the center hole.

Bend the center and two outer pins of the TDA2002 audio amplifier (IC6) 90 degrees toward the front of the IC ¼ inch from the bottom of the case and then downward at 90 de-



Insulation color coding is for power transformer specified in Parts List. If you use a different transformer, make appropriate changes in insulation color coding.

Fig. 7. Wiring guide for main pc board.

grees 1/4 inch from the first bend. Spread the two outer pins a bit and plug this IC's pins into the IC6 holes in the board to make them fit the hole pattern. Remove the IC from the board and bolt it directly to the left-most hole in the heat sink, using a 4-40 x 1/4-inch machine screw, lockwasher and nut. Do *not* use heat-sink compound or a mica insulator with this IC.

With the IC mounting hardware only finger tight, plug the heat-sink assembly into the circuit board via the IC pin holes and position it so that the two interior mounting holes align with the holes in the board. Use 4-40 machine hardware to loosely mount the heat sink in place. Then tighten the hardware on the ICs.

It is imperative that IC3 and IC4 be completely insulated from the heat sink. To make sure of this, measure the resistance between each IC's metal tab and the heat sink. In both cases, the reading should be infinity. Any other reading indicates a short or partial short circuit and must be rectified before you solder any IC pins to the board's pads. Since the metal tab of IC6 mounts directly to the heat sink, an ohmmeter reading here will be 0 ohms.

Solder all pins of these ICs to the circuit-board pads. If you are using a board that does not have plated-through holes, solder the pins to the pads on both sides of the board.

The above method of mounting the IC/heat-sink assembly should be followed exactly as described. It will eliminate ground loops and thermal stresses when the project is put into operation.

Coming Next Month

Next month, in the conclusion of this article, we will finalize assembly instructions with wiring of the display board and chassis construction. We will also discuss checkout and calibration of the completed project and tips on using the Semianalyzer. **ME**

They're Here!

MODERN ELECTRONICS

FUN PROJECT BOOKS

You'll want these two exciting project books, packed with complete plans for building a wide variety of useful electronic devices. The *First and Second Books of Modern Electronics Fun Projects*, both Howard W. Sams publications, are now available.

You'll find all the how-it-works information, schematics, photos, drawings, printed-circuit guides and parts sources to make it a snap to build almost 50 useful, unique electronic devices at modest cost.

Discover how these circuits and modern electronic devices perform their magic. Learn practical electronic technology the painless way and have fun doing it!

All projects are based on material published in *Modern Electronics*, with updates and revisions. They've been built and tested by the original authors. Chapters are divided into Intro To Electronic Projects, Home Electronics, Audio/Video Electronics, Security Electronics, Computers, Test Equipment, and Electronic Designing. There's something for everyone!

Look at what you can build & take pride in:

- *Digital voltmeter accessories—high-frequency ac probe, true-rms adapter, temperature probe
- *Car projects—anti-theft alarms, engine tachometer
- *Life-saving detectors—gases & microwave leaks



- *Computer system power controller
- *Dual-pulse generator
- *Surround-sound audio enhancer
- *Security—telephoned status reporter, alarm control center
- *Home convenience—selectable phone ringer musical tunes, touch-sensitive light controller.
- ... and so much more.

The Fun Projects are capped by introductory information on building projects and kits (tools needed, parts sources, etc.) and advanced design techniques that illustrate how a designer thinks and plans when putting together a practical end product.

From beginning to end, MODERN ELECTRONICS FUN PROJECT BOOKS are for you! Order them today for a fast start in the world of electronics.

MODERN ELECTRONICS
76 N. Broadway, Hicksville, NY 11801

Order Date: _____

Name _____
 Address _____
 City _____
 State _____ Zip _____
 () Check () MasterCard () VISA
 Card No. _____
 Expires _____
 Signature _____

QTY	Title	Price	Total
	First Book of Modern Electronics Fun Projects	\$12.95 ea.	
	Second Book of Modern Electronics Fun Projects	\$12.95 ea.	
		Total	
		*Shipping	
		Grand Total	

(Signature required on all charge orders)

*Shipping charges \$2 per order. Orders processed day received, but please allow 30 days for delivery.

Automatic Audio Panner

Special-audio-effects device automatically creates dynamic stereo sound from monophonic audio signals such as produced by electric guitars

By C.R. Fischer

Special-effects devices have always been popular among modern-day musicians and tape recordists, whether professional or amateur. Among the creative sound effects they make possible is "panning," which is controlling a signal so that it is positioned at some perceived location between left and right speakers. Placing the sound somewhere within a stereo panorama (hence the name "panning") is often done manually with a mixer control called a "panpot." In home stereo systems, such a control is commonly called a balance control.

Making the audio move between two speakers *automatically* opens new, dramatic sound opportunities, especially when combined with signal level, depth and rate controls, as the subject of this project does. Devices that produce such special effects are called autopanners. Commercial ones are usually quite costly. The one presented here, which we call "Autopanner," is not. Yet it can inexpensively allow any mono electric musical instrument or other audio source to produce innovative sounds that spell the difference between amateur and pro.

About the Circuit

As shown in Fig. 1, the Autopanner is composed of six sections: an input buffer, a pair of voltage-controlled amplifiers (vca's), a low-frequency oscillator (lfo), a control-voltage



processor and a power supply. These sections are designed to work together with a minimum of noise and distortion.

Figure 2, shown in two parts, is the complete schematic diagram (sans power supply) of the Autopanner's circuitry. The portion shown in Fig. 2(A) is an input buffer and preamplifier built around dual low-noise operational amplifier *IC1*. The buffer has a reasonably high input impedance to minimize loading down signal sources like electric-guitar pickups, which can result in a loss in high frequencies and overall volume when the signal is reproduced through the stereo system's speakers.

LEVEL control *R2* provides a means for adjusting the gain of the preamp from 0 to 5 so that the Autopanner can be used with a variety of

input signal levels. The other half of the op amp is wired as a comparator that lights CLIP LED1 whenever an excessively high input signal level is applied to the project's input via AUDIO INPUT phone jack *J1*. Therefore, *R2* should normally be set so that LED1 never quite turns on.

The dual vca's are the center of action in the Autopanner. A voltage-controlled amplifier has variable gain that is controlled by an input voltage. (For more vca circuit designs, see "Using The Transconductance Amplifier" *Modern Electronics*, September 1986.)

Because building a high-quality vca is not an easy task, a quad vca chip (*IC2*) designed for music synthesizers was used in the Autopanner. This SSM 2024 IC features low noise, low distortion and wide band-

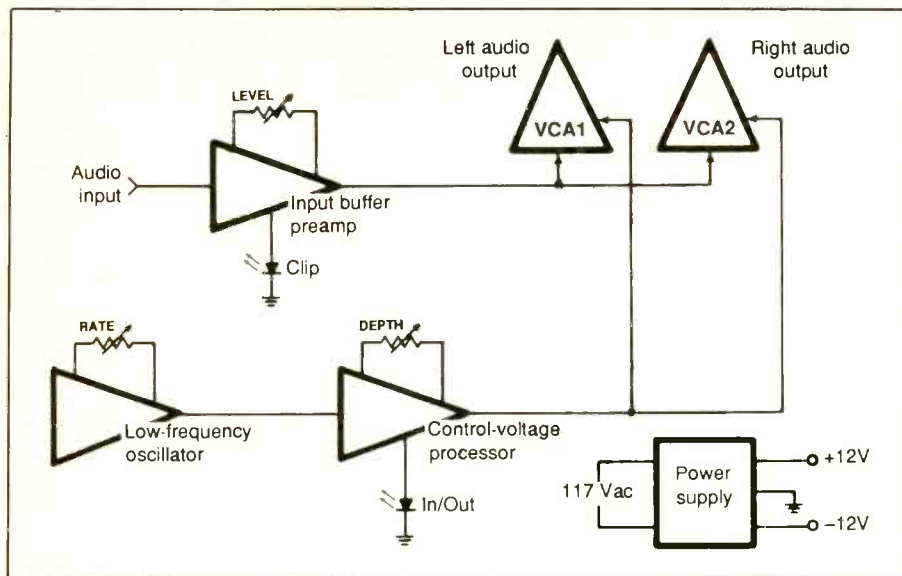

Fig. 1. Autopanner is composed of six circuit "blocks," including power supply, that work together with minimum noise and distortion.

width, and is reasonably priced. Although less-expensive alternatives to the SSM 2024 are available, their use would have resulted in unacceptable noise and distortion levels.

Since the two vca's are identical

(except for the different control-voltage sources), we will examine only one in detail. Attenuator R6/R7 prevents overloading the low-level vca input. Trimmer potentiometer R9 allows you to null out any voltage

offset that appears at the input. (Offsets tend to cause "thumps" in the output whenever the control voltage is changing rapidly. With proper calibration of R9, this thumping can be made inaudible.)

The SSM 2024 has low-level, high-impedance current outputs that require amplification so that they can be boosted to usable signal levels. Dual op amp IC3 provides that amplification, with R14 setting the output level and C3 contributing to amplifier stability.

DEPTH potentiometer R21 controls the amount of triangle-wave signal applied to both vca's. Lower-level settings result in a subtle "shimmering" effect, while higher-level settings cause the signal to alternate between the speakers.

Almost all effects devices require some sort of input/output switching to allow the musician or audio engineer to turn them on and off as desired. It is a good idea to use a control signal to switch in and out the effect to avoid running the audio signal

PARTS LIST

Semiconductors

- D1—1N914 or similar silicon switching diode
- IC1, IC3, IC4, IC5—TL 072 dual bi-FET operational amplifier (or 1458 or 4458 op amp for IC4 and IC5)
- IC2—SSM 2024 quad voltage-controlled amplifier
- LED1, LED2—T-1 3/4 red light-emitting diode
- IC6—7812 + 12-volt regulator
- IC7—7912 - 12-volt regulator
- Q1—General-purpose n-channel field-effect transistor
- RECT1—50-PIV, 1-ampere bridge rectifier

Capacitors (25 WV or greater)

- C1, C6 thru C9—0.1 μ F ceramic or polyester
- C2, C3—100 pF mica
- C4, C5, C13, C14—4.7 μ F tantalum
- C10—2 μ F nonpolarized aluminum
- C11, C12—2,200 μ F electrolytic

Resistors (1/4-watt, 10% tolerance)

- (Note: metal-film resistors are preferred—see text)
 - R1, R25—220,000
 - R3, R22, R26 thru R29—100,000 ohms
 - R5, R23—1,000 ohms
 - R6, R10—4,700 ohms
 - R7, R11—220 ohms
 - R8, R12—1.5 megohms
 - R14, R15, R30, R31—10,000 ohms
 - R17—820 ohms
 - R18, R20—33,000 ohms
 - R19—12,000 ohms
 - R24—22,000 ohms
 - R2—1-megohm, linear-taper potentiometer
 - R4—50,000-ohm multi-turn pc-type trimmer potentiometer
 - R9, R13—100,000-ohm multi-turn pc-type trimmer potentiometer
 - R16, R21—100,000-ohm, linear taper potentiometer
- #### Miscellaneous
- F1—0.25-ampere slow-blow fuse

- J1—Closed-circuit phone jack
 - J2 thru J4—Phone jack
 - S1, S2—Spst slide or toggle switch
 - T1—12.6-volt ac, 100-mA power transformer (see text)
 - Perforated board with holes on 0.1" centers, DIP IC sockets and soldering or Wire Wrap hardware for circuit board; holder for F1 (see text); ac line cord with plug; suitable enclosure; 2-lug terminal strip with neither lug connected to mounting tab; rubber grommet for line cord; knobs for panel-mount potentiometers; jack for plug-in power transformer (optional—see text); spst footswitch with phone plug (optional—see text); lettering kit; machine hardware; hookup wire; solder; etc.
- Note: The SSM 2024 quad voltage-controlled amplifier chip is available for \$6.25 PPD. (California residents, please add 6.5% state sales tax) from Mescal Music, P.O. Box 5372, Hercules, CA 94547.

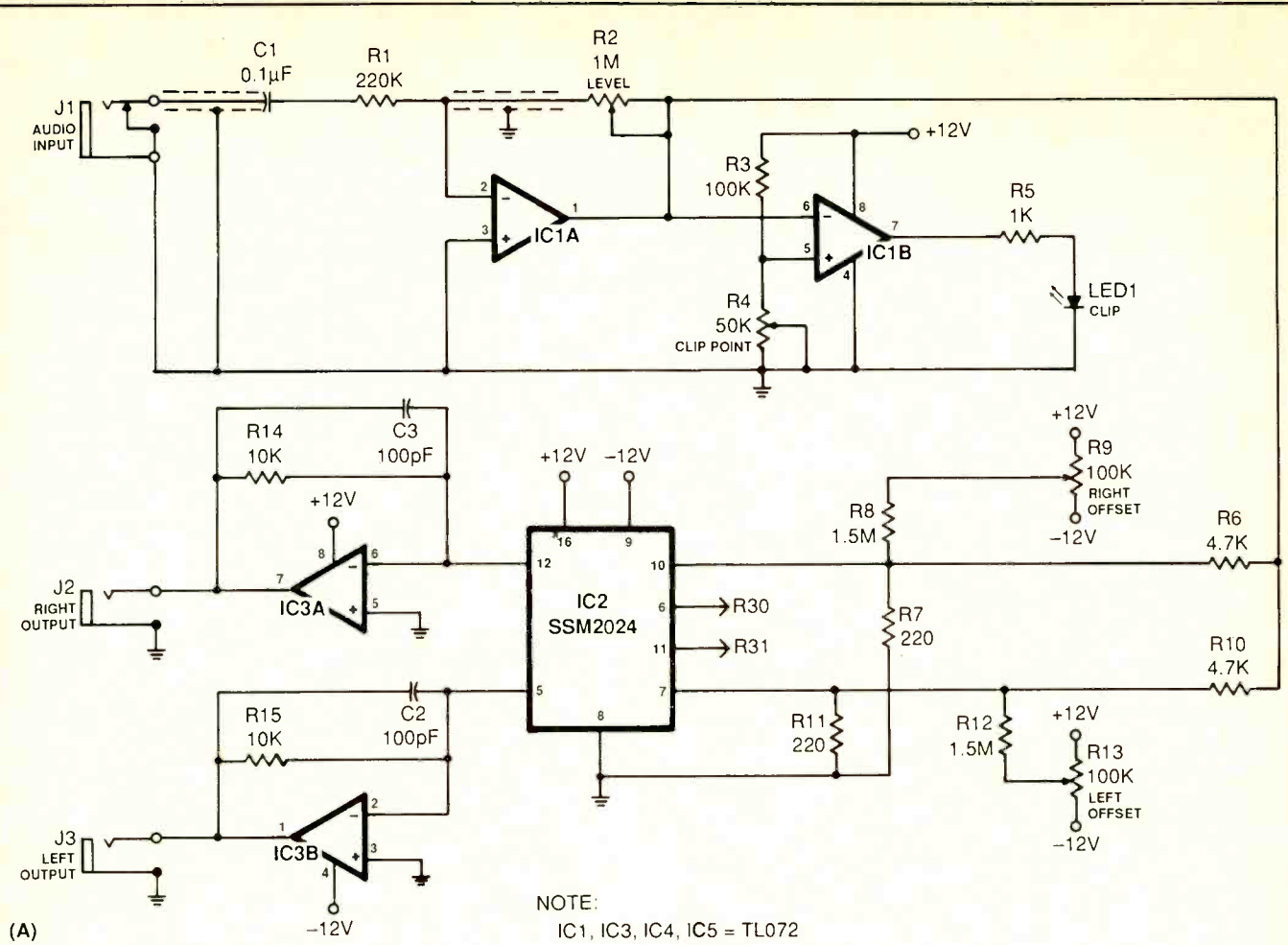

NOTE:
IC1, IC3, IC4, IC5 = TL072

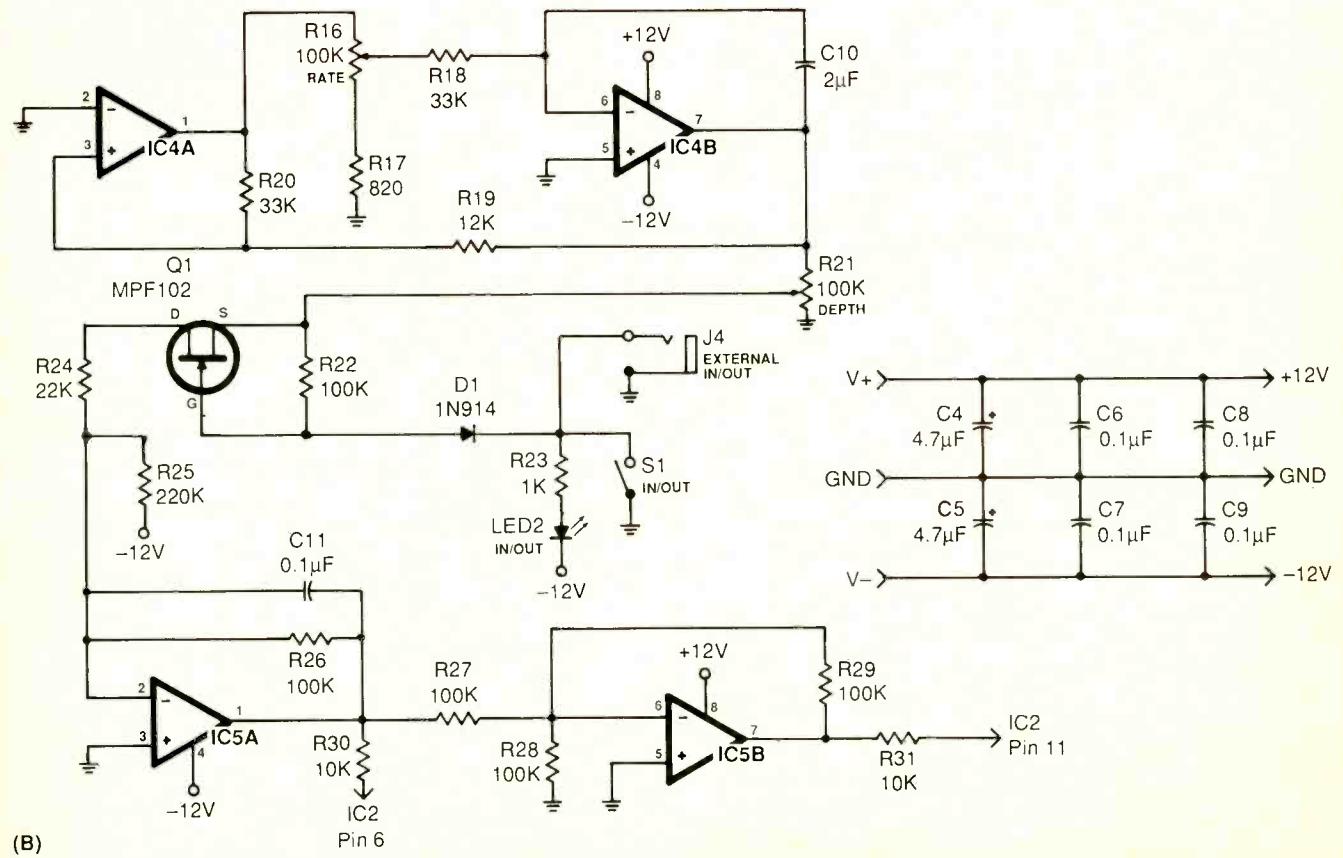

Fig. 2. Schematic diagram of audio (A) and control (B) sections.

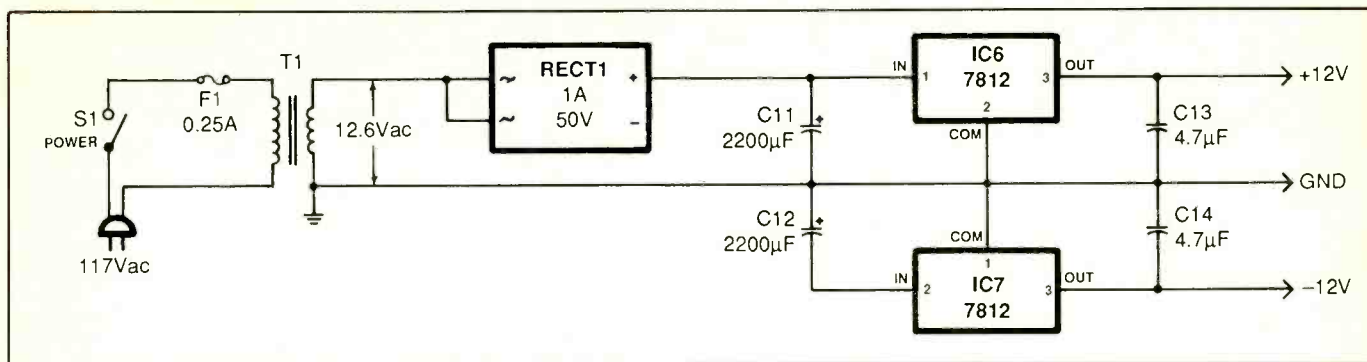

Fig. 3. Schematic diagram of a suitable ac-operated ± 12 -volt dc power supply.

itself through long wires to and from a footswitch. To accomplish this, the lfo's triangle wave is applied to field-effect transistor *Q1*.

With INPUT/OUTPUT switch *S1* open, *Q1* is held in cutoff by the negative voltage across *D1/R23* and IN/OUT *LED2*, preventing the lfo waveform from reaching the vca's.

Closing *S1* grounds the I/O point. This causes *LED2* to light, reverse-biases *D1*, and allows the triangle wave to control the vca's.

Since the I/O circuit is a simple logic design that is either grounded or floating, an spst footswitch can be connected to the circuit via EXTERNAL IN/OUT jack *J4*. A cable as long as needed can be used without causing signal degradation. You can then use the footswitch instead of *S1* to switch in and out the Autopan's effect. IN/OUT *LED2* will glow slightly when off due to leakage current from *Q1*. However, the difference between the "on" and "off" settings is large enough to avoid confusion. With the effect off, the Autopan sends the input signal to both outputs.

Dual op amps in *IC3* serve as inverting amplifiers that drive the vca. Amplifier *IC3A* sets the proper gain range with *R24*, *R25* and *R26*, and *C11* acts as a crude filter to eliminate any small glitches that might be generated whenever one vca is at full gain and the other is off. Current

limiting to the vca control-voltage inputs is provided by *R30* and *R31*.

A bipolar power supply that has outputs between +9 and +15 volts is needed to power the Autopan. The schematic diagram for a suitable +12-volt power supply is shown in Fig. 3. Instead of using the center-tapped power transformer usually found in bipolar power supplies, this one uses a transformer with an untapped secondary winding. This gives you the option of using a plug-in ac transformer if you wish, allowing the Autopan to be built into a smaller enclosure than would otherwise be needed and preventing any ac field from showing up in the project's outputs.

Construction

For best results, use perforated board that has holes on 0.1-inch centers on which to mount the components that make up the project's circuitry. Use sockets for the ICs and appropriate soldering or Wire Wrap hardware for component-lead connections. Keep all component leads as short as possible, and make sure to include bypass capacitors *C6* through *C9* in Fig. 2. (As you wire the board, install only the IC sockets—not the ICs themselves—and save IC installation until after initial voltage checks have been performed.) With a little care in laying out the

components and routing the wiring, you should be able to obtain professional-quality operating results.

If you demand the very highest in operating quality, several improvements can be made for a slight increase in the cost of the project. For example, you can use metal-film resistors and high-quality mica and polystyrene capacitors in the audio circuitry around *IC1*, *IC2* and *IC3*. Because resistor noise is proportional to resistance, it is an especially good idea to use a metal-film resistor for input resistor *R1*.

After wiring your circuit-board assembly, you can mount it inside a metal or plastic enclosure, an example of the latter illustrated in the lead photo. If you are using an internal power supply, mount it in a location at the rear of the enclosure where it and the incoming ac line cord will be as far away from the input and output jacks on the rear panel and the input audio circuitry on the board. Use a two-lug terminal strip (neither lug grounded) to make the line-cord to transformer primary connections. If you use an external plug-in supply, mount on the rear panel a suitable jack to accommodate the connector at the end of its cord.

All controls and the light-emitting diodes mount on the front panel and all input/output jacks mount on the rear panel of the enclosure. After drilling the required holes, deburr

them if the enclosure is of metal construction. Then label the controls, LEDs and jacks with appropriate legends (see lead photo).

Fuse *F1* can be mounted inside the enclosure using an inexpensive chassis-mount fuse block. Alternatively, you can mount the fuse in a bayonet-type holder mounted on the rear wall of the enclosure. POWER switch *S2* can be a slide or toggle type and can be mounted either on the front or rear (preferred location) of the enclosure or can be eliminated altogether if you prefer.

Keep in mind that the cables between INPUT jack *J1* and the circuit board and between LEVEL control *R2* and the junction between *R1* and pin 1 of *IC1* must be shielded. Ground the shields of these two cables at only one end to avoid feedback.

When you wire the various panel-mounted and trimmer controls into the circuit, make sure that the wiring is done so that their effect *increases* when they are adjusted clockwise!

Figure 4 is a photo of the interior of the author's completed Autopan-ner prototype. Note the neat layout of the components on the circuit-board assembly and off the board. Try to emulate this layout as much as possible to avoid interference effects when the project is put into service.

Test & Calibration

With the ICs still not installed in their sockets, plug the Autopan-ner's line cord into an ac outlet. Set a multimeter to the dc volts function and its range switch to a setting that will allow you to measure up to 20 volts or so. Connect the meter's common probe to any circuit ground point and leave it there as you make your preliminary voltage checks.

Touch the meter's "hot" probe to the positive (+) lead of *C1* and then the negative (-) lead of *C2*, noting the readings obtained in both cases. Your meter readings should be +12 volts on the positive lead of *C1* and -12 volts on the negative lead of *C2*,

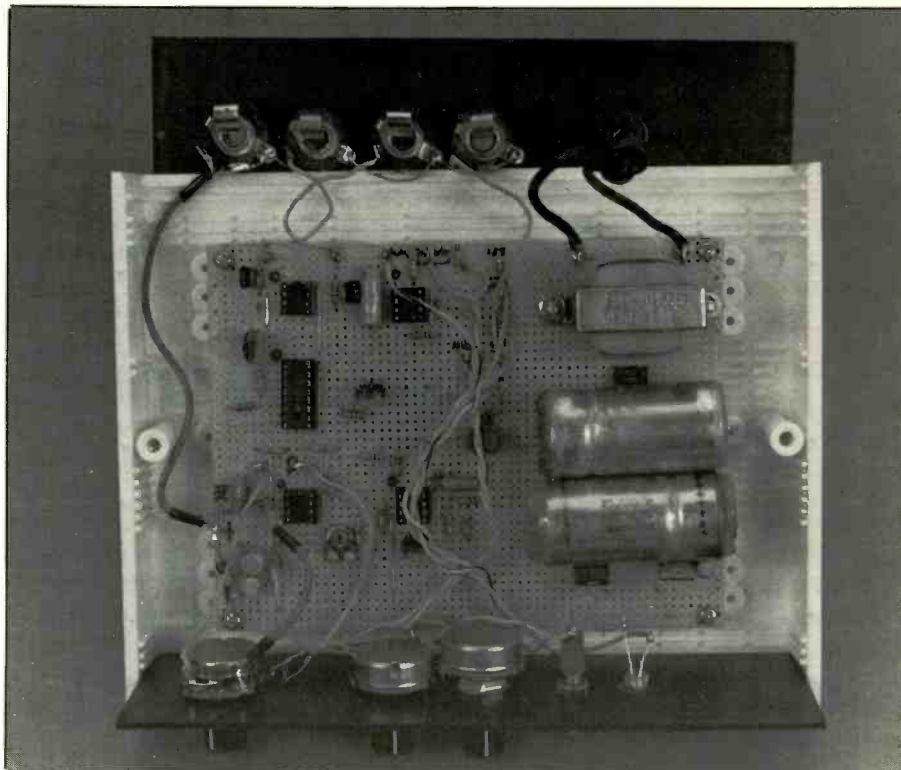

Fig. 4. Interior view of assembled prototype. Note clean layout of components both on and off the board.

assuming you are using the Fig. 3 power supply. If you are using an external plug-in power transformer that has a different voltage on its secondary, the readings should be between +9 and +15 volts on the positive lead of *C1* and between -9 and -15 volts on the negative lead of *C2*.

Touching the meter's hot probe to the pin 8 socket terminals for *IC1*, *IC3*, *IC4* and *IC5* should yield the same positive voltage reading obtained on the positive lead of *C1*. The same applies when taking a reading at the pin 16 socket receptacle for *IC2*. Similarly, you should obtain the same negative voltage reading as measured on the negative lead of *C2* when you touch the meter's hot probe to the pin 4 socket receptacles for *IC1*, *IC2*, *IC4* and *IC5* and the pin 9 socket receptacle for *IC2*.

If you do not obtain the proper reading at any or all of the IC socket pin receptacles, power down the circuit and carefully recheck your wir-

ing against Figs. 2 and 3. Also, check particularly for proper electrolytic capacitor orientations.

When you are certain that your wiring and component installation are correct, power down the project and allow the charges to bleed off the electrolytic capacitors. Then install the ICs in their respective sockets. Make sure you properly orient each IC as you install it and that no pins overhang the sockets or fold under between ICs and sockets.

If you have a sine-wave generator, turn its level control completely down and plug its line cord into an ac outlet and its output cable into the Autopan-ner's AUDIO INPUT jack. If you do not have a sine-wave generator, use a musical instrument instead.

Turn the volume control of your stereo amplifier all the way down and connect the Autopan-ner to the inputs of the amplifier. Turn on the generator, amplifier and Autopan-ner. Turn up the Autopan-ner's LEV-

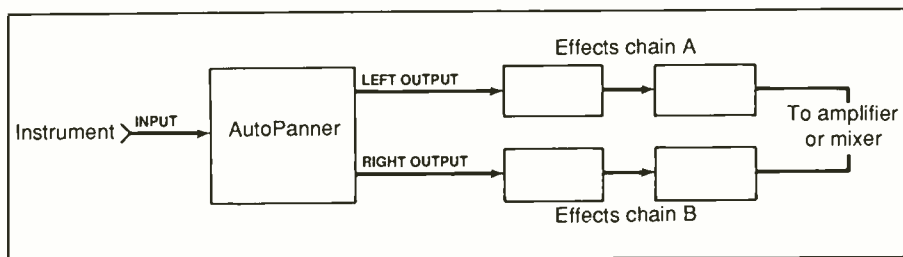

Fig. 5. In addition to stereo panning, Autopanner can be used to fade between groups of special-effects devices.

EL control to about mid-position and set its RATE and DEPTH controls fully clockwise. Set the project's IN/OUT switch to "on" (or step on the foot-switch, if you are using it, to close its contacts). Slowly raise the setting of the amplifier's volume control. Then adjust the generator's level control until you hear its signal coming from the speakers.

If everything is working as it should, you should now hear the input signal rapidly alternate between the two speaker systems in your stereo setup. If you hear any distortion at this time, lower the Autopanner's LEVEL control setting until it disappears (ignore the CLIP LED for now; it has not yet been calibrated).

As you adjust the Autopanner's controls the effects should increase. If it is just the opposite, power down the project, disconnect it from the signal generator and stereo amplifier, and transpose the connections going to the two outer lugs of the offending control. Then reconnect the project to the generator and amplifier, repower the system and continue with calibration.

Now adjust both vca's for minimal offset voltages as follows. Lower the setting of the project's LEVEL control to minimum and set your stereo amplifier so that only the right channel can be heard. Adjust the amplifier's volume control upward until you hear a clicking sound and adjust RIGHT OFFSET control R9 for minimum audible noise. Then set the amplifier so that only the left channel is

audible and repeat the procedure with LEFT OFFSET control R13.

Final trim involves adjusting the reference voltage at comparator IC1B so that the CLIP LED turns on just before the onset of distortion. Turn up the project's LEVEL control setting once again until distortion returns and adjust CLIP POINT control R4 so that the CLIP LED turns on. It is a good idea to set R4 so that the CLIP LED comes on just before the onset of distortion to obtain optimum signal-to-noise ratio.

In the event the Autopanner is not operating properly, troubleshooting should be performed in a logical manner. First determine if the input signal is reaching OUTPUT jacks J2 and J3. If there is no output with the LEVEL control turned fully clockwise, immediately power down the project, remove the ICs from their sockets, and recheck the power-supply rails to each IC socket.

Once you have an output signal, troubleshooting the circuit becomes a lot easier to do. You should then determine if the lfo is oscillating and if Q1 is biased so that the lfo's triangle wave cannot reach the vcas. If there is no "movement" between the outputs, the problem probably lies around IC3 and/or IC4 or the input/output circuit.

Using the Autopanner

The most obvious use for the Autopanner is to create a "ping-pong" effect from a mono input. Electric guitars, pianos, organs and synthesizers

can all benefit from the animation that dynamic panning provides. While high DEPTH settings may immediately attract the attention of listeners, lower settings can add subtle enhancement that will more readily benefit the music being played. Different rates can be selected, depending on the tempo or "mood" of the music being played.

A more unusual use for the Autopanner's automatic effects is illustrated in Fig. 5. The Autopanner's outputs can be connected to any number of other special-effects boxes, such as phasers, fuzz boxes, echo units, chorus units, etc. As the Autopanner sweeps between outputs, two different sets of effects will be heard with an arrangement like this. This is an interesting way of getting some new sounds.

As with any special effect, that of the Autopanner requires a little practice and experimentation to obtain best results. ME

ATTENTION!
ELECTRONICS
TECHNICIANS

EARN YOUR
B.S.E.E.
DEGREE

THROUGH HOME STUDY

Our New and Highly Effective Advanced-Placement Program for experienced Electronic Technicians grants credit for previous Schooling and Professional Experience, and can greatly reduce the time required to complete Program and reach graduation. No residence schooling required for qualified Electronic Technicians. Through this Special Program you can pull all of the loose ends of your electronics background together and earn your B.S.E.E. Degree. Upgrade your status and pay to the Engineering Level. Advance Rapidly! Many finish in 12 months or less. Students and graduates in all 50 States and throughout the World. Established Over 40 Years! Write for free Descriptive Literature



COOK'S INSTITUTE
OF ELECTRONICS ENGINEERING

4251 CYPRESS DRIVE
JACKSON, MISSISSIPPI 39212

An Infrared Remote Control Relay

\$10 project provides wireless VCR control to remote TV sets

By Joseph O'Connell

The Infrared Remote Control Relay is a simple project that can be built for under 10 dollars. It will send the command signals of a hand-held infrared remote-control unit from one room to another. Therefore, if you have a VCR and TV receiver in one room and a second TV set installed in another room, as in Fig. 1, this project will save you the time of running back and forth between the second TV set and the VCR machine that is controlling it. Without it, you'd have to leave the room just to change channels or operate the VCR.

This device isn't only limited to video systems. Stereo systems with infrared controls can also use the relay to send commands from another room. Even some computer keyboards, electronic scales, and household appliances transmit information over an infrared beam. With the RC Relay, one of those devices could be used in another room or the components could be kept farther apart than otherwise.

It would cost you about 50 dollars to buy a commercial device that does the same thing. But for one-fifth of that cost, you can make this device,

Adapted from *Twenty Innovative Projects Electronic Projects for Your Home* by Joseph O'Connell, to be published July 1988 by Tab Books, Blue Ridge Summit, PA 17214.



which has somewhat less range, but is more versatile.

Although the relay box can be many rooms away from the VCR, the hand-held remote must be held within a foot or two of the relay for the control signal to be received properly. The relay box is small, though, and can be moved around easily, so this shouldn't pose much of a problem.

The restriction on range can't be avoided if the project is going to be simple because infrared intensity from a hand-held remote control di-

minishes greatly with distance. A range of more than a few feet would require a very sensitive receiver. Commercial remote-control devices have a shielded assembly containing a photodiode and sensitive high-gain circuitry that wouldn't be practical to build yourself. If long range is imperative, therefore, you'd be better off buying the required circuitry than making it yourself. But if the limited range of this project is tolerable, which it will be for most applications, a \$10 alternative and some fun building it is attractive.

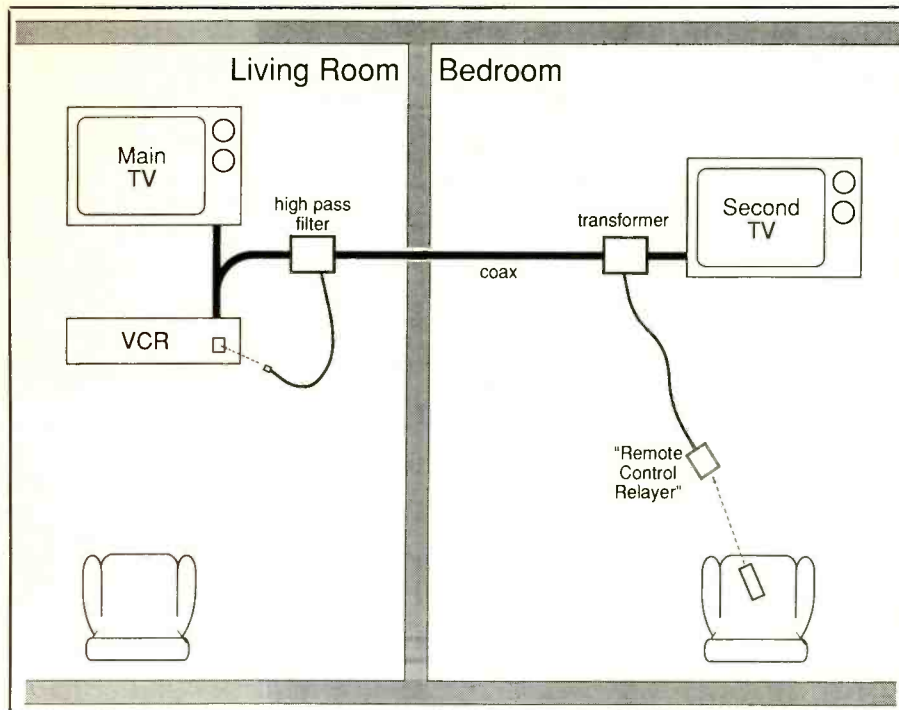

Fig. 1. The remote-control relay will send control signals from one room to another using the same wire that carries the video signals.

How It Works

Like its commercial competition, this project sends its control signals over the same coaxial cable that carries the video signal to the extension TV. (See Figs. 1 and 2.) This allows you to use the cable wire that's already installed, which is much easier than installing a new one. And just as the commercial models do, this device allows normal use of the remote control with the VCR or other video source at all times.

The circuit is quite simple. Figure 2 is the complete schematic. When power switch *S* is on, phototransistor *Q* modulates the current that flows through the infrared *LED* from the battery. Every pulse of infrared radiation received at *Q* is duplicated by the infrared *LED*'s output.

The phototransistor is shielded from ambient light by a small piece of infrared filter plastic. This material looks dark red to the eye and is nearly opaque to visible light. It is

sold at low cost by some surplus dealers. If you can't obtain the correct filter material, a thin piece of translucent red plastic can be used instead.

The purpose of shielding is to ensure that the infrared phototransistor doesn't draw excessive current from the battery in response to visible light. Although the circuit is quite sparing of power when shielded this way, the switch extends the battery's life additionally if it is turned off when the relay is not in use.

The purpose of the transformer and the high-pass filter shown in the schematic is to block control signals from entering the video equipment. This is necessary so that the relay's control signals can travel over the same wiring as the video signal. There are two ways to split the control signal from the video signals. Either can be used at both ends, although the best way is to use a transformer at the TV end and a high-pass filter at the VCR end, as follows:

1. A Radio Shack high-pass filter

designed to eliminate amateur-radio interference from video signals can be slightly modified.

2. An ordinary 75-ohm to 300-ohm video matching transformer to block infrared signals to the TV set in addition to its usual function. Transformers are cheap, readily available, and often necessary anyway to match the 75-ohm output of modern video equipment to older TV sets.

Construction

Any small case can house the relay circuitry as long as it will block visible light falling on the phototransistor. The prototype shown in Fig. 1 used an enclosure sold by Radio Shack. It comes with a pre-drilled perfboard insert to which components can be mounted.

Using this enclosure or another suitable one, install the power switch so it can be reached from the front of the enclosure. Cut out a piece of the infrared filter material to glue behind a 1/2-inch hole in the front. Mount the phototransistor directly behind the filter. Be sure to observe polarity when connecting the components or the phototransistor may be damaged.

Run a piece of thin, two-conductor wire from the relay box to the high-pass circuit. Directions follow for hooking up the other end of that wire to each of the alternative high-pass filters, and for connecting the *LED* to the other filter.

Connections

Some video matching transformers provide two screw terminals as an FM output. These are the best transformers to use because the screw terminals are a convenient place to attach the wire connecting the relay to the coaxial cable.

To modify one of these transformers, open it up by removing the metal ring around the F-connector input. Cut away the thin transformer wires that go to the FM terminals. Now

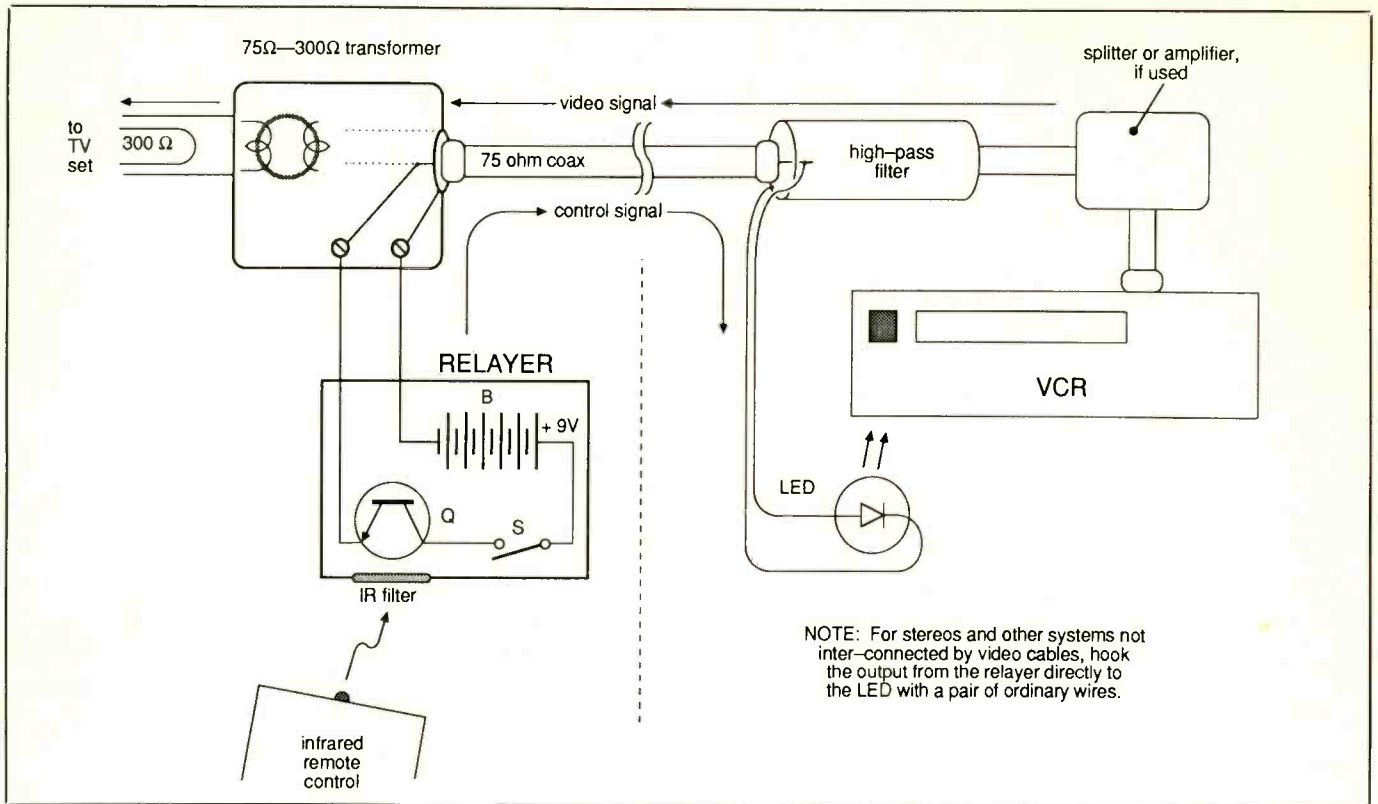

Fig. 2. The complete remote-control relay has a very low parts count.

PARTS LIST

B1—9-volt battery
 Q/LED—Infrared emitter/detector pair [Radio Shack Cat. No. 276-142. (For additional phototransistors, use TIL-414, Radio Shack Cat. No. 276-145 or equivalent)]
 S—Miniature spst toggle switch
 T—75-to-300-ohm video matching transformer (Radio Shack Cat. No. 15-1139 or similar)
 Misc.—High-pass filter (Radio Shack Cat. No. 15-579 or equivalent); suitable enclosure; snap connector and battery clip for B1; thin 2-conductor cable; hookup wire; solder; etc.

wire the F-connector directly to those terminals. Close up the case, leaving the rest of the internal circuitry untouched.

Connect the modified transformer between the VCR and the TV set on the end with the TV. The screw-type

FM-output terminals should be connected to the wire from the remote-control relayer box.

To use a Radio Shack #15-579 or similar high-pass filter to split the infrared and video signals, you must open its case and connect a wire. First remove the outer plastic jacket that encloses the filter. Then use a knife to remove the rubber grommet from around the short length of coaxial cable protruding from one of the ends. This should reveal a metal washer fitted into the aluminum body of the splitter. Remove the washer with needle-nosed pliers, setting it aside. With a few taps on the F-connector at the other end, slide the inner circuitry out of the aluminum sleeve.

Observe that the circuitry is encased in some kind of potting compound and wrapped in plastic. Cut the plastic wrap off and chip away just enough potting compound

around the F-connector to make its terminal accessible. Solder a few feet of thin two conductor wire to the connector. This wire will later be connected to the infrared LED (or to the remote relayer box if you are using a second of these splitters instead of the transformer described above). Using hot-melt glue or epoxy cement, re-pot the filter and place it back in its aluminum sleeve.

The wire you added should exit the case alongside the piece of coaxial cable. It should pass through the washer that previously held the grommet. Figure 4 shows this type of splitter modified and connected to an infrared LED.

Installation

Placement of the infrared LED depends on the VCR (or other equipment) it will be used with. It should be mounted a short distance from the sensing window on the equipment,

(Continued on page 90)

Heath Computer Voice Card

Heath's new HV-2000 computer-voice kit is an \$89.95 half-size plug-in card for use with any IBM or compatible PC, XT or AT model. It comes with a small external speaker and housing, and includes software, a 69-page construction and operation manual, and 10 pages of kit-building pictorial information, plus appropriate parts and pc board.

The Heath Voice can add human-sounding male voice, music and sound-effect capabilities to your computer. Assembly is easy, requiring only 1 hour and 10 minutes to complete, doing so without a hitch. Plugging in the card, closing up the computer case, then plugging in the external speaker to an RCA-type jack (there are two in the event one wishes to use an output for a hi-fi system), we were ready to install the software.

Following instructions, which included adding a `DEVICE = VOICE.SYS 300` driver to our `CONFIG.SYS` file, `SPEAK SPEAKME.TXT` was typed at the DOS prompt, upon which the instructions indicated that the computer should "congratulate you." What we heard, however, was a computerized voice speaking gobbledygook!

What went wrong? Were the pc board's address ports selected incorrectly? Was there a defective component? A different way to generate speech from the computer was the next step, which directed the typing of `SPEAK` followed by a string enclosed in quotes. So I typed `SPEAK "Hello"` and pressed the RETURN key. Sure enough, the computer voice said "Hello." In fact, using any options available, the voice always worked properly except in rare single-word instances. I can only conclude that Heath has a foul-up in its demonstration file, which I haven't found time to rewrite.

There are a number of ways to use the Heath Voice. Typing `SPEAK` and a "string" is one cited earlier; `SPEAK [filename]` is another mentioned (the .txt demo file that didn't work properly). With this command you can have a file, say, a WordStar one, read to you. Path names can be used, but wild cards cannot. The `SPEAK` command can also generate voice when text is received from a serial port (COM1 or COM2) with baud rates from 150 to 38,400. Thus, you can listen to data being received through your modem. You can also listen to matter that you're transmitting. Use of function

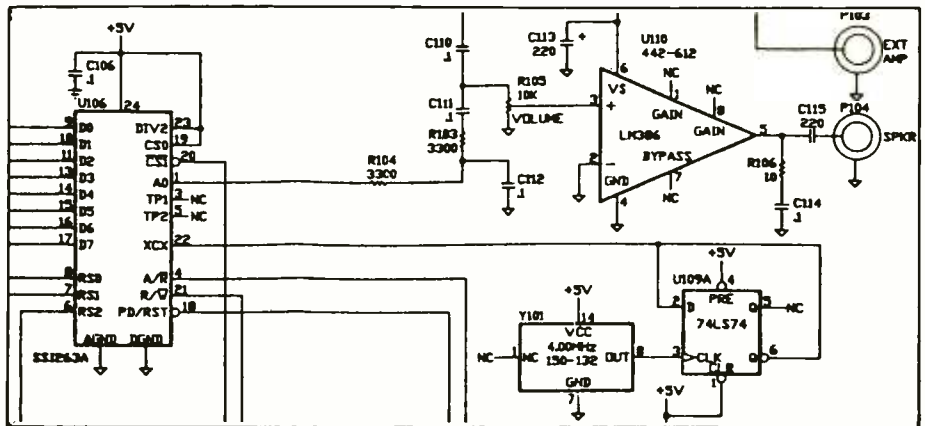

Heart of the Heathkit Voice is an SSI-263 IC, U106, which contains five write-only registers to select phonemes and attributes. It makes use of a 4-MHz clock whose output is divided in two by a 74LS74 chip, U109A. The synthesizer's audio output is filtered and fed to two RCA-type jacks. One is a direct line output to drive an external amplifier, while the other is fed, through a volume control, to an LM386 audio amplifier for output to the external 8-ohm speaker supplied with the kit.

keys F1-F10 simplifies operations. A 60K buffer is provided in the event that communications "handshaking" is not established.

Alternatively, you can use the DOS `COPY` command to speak a file or the DOS `TYPE` command to do the same. Moreover, voice can be added to a BASIC program. Additionally, you can write your own voice programs, inserting pauses, inflections, articulation, etc.

A few options can be included in the `CONFIG.SYS` file established in the root directory by appending a slash (/) that's followed by one or more "switch" characters. The letter `w` inserts a pause between words; an `I` sets automatic inflection; a `P` causes the Voice to speak punctuation marks; a `D` makes numbers to be spoken digit by digit; and an `L` locks in the chosen actions so that you can't modify them by preceding a string with special characters.

A very few words aren't spoken properly by the Voice. An example that is given for this in the Heath manual is the word "read." This word might be used as the sound, "reed" or as the sound, "red." The Voice selects the most commonly used one. Such words can be placed in a special file called `WORDS.EXE`. When such a word is listed, you are given an opportunity to edit the mnemonics to make changes so that it sounds right to you before it's listed as an exception to

the Voice pronouncing rules. The maximum number of words that can be stored is one hundred.

Writing text is done in mnemonic form to represent sounds. A listing in the manual is provided for this purpose. The mnemonic "er," for example, represents the "i" in the word "bird." Thus, it would be written as "berd" instead of "bird." Mnemonic strings must be enclosed in opening and closing braces ({and }) on the same line, and the letters must be in lower case. A variety of other sound-creation rules are included in the manual, including combination sounds, voice attributes such as amplitude, duration, and others.

The Heathkit Voice kit is a welcome, low-cost enhancement device for MS-DOS computers. The "voice" sounds fine, though it's a bit crude as far as modern computerized voices go. It's also a very versatile package, allowing the user to produce spoken material in a variety of ways. The manual's guide to writing mnemonically can be improved, though. This information is not as clearly presented as it should be. Nevertheless, the Voice makes a worthwhile addition to one's computer system for only \$90 and about an hour of work. Then it'll certainly keep you occupied and entertained.

—Art Salsberg

CIRCLE 93 ON FREE INFORMATION CARD

Experimenting With Liquid Nitrogen

By Forrest M. Mims III

You are probably wondering what an article about liquid nitrogen is doing in an electronics magazine. As you will soon see, there are some very important reasons for its appearance in these pages. After reading the following, you may even want to obtain some liquid nitrogen to duplicate the experiments I'm about to describe or try some of your own.

If you read last month's "Electronics Notebook" on experimenting with a superconductor, you already know that I had to obtain liquid nitrogen to perform the experiments I described. The dewar the supplier lent to me held 30 liters of liquid, considerably more than needed to experiment with a superconductor. That was fine with me since there were a number of other tests and experiments I've long wanted to try.

Those experiments will be described below. First, however, let us consider the importance of liquid nitrogen to everyday electronics. Some of the solid-state components we take for granted today could once be operated only when cooled by liquid nitrogen.

Liquid Nitrogen and Solid-State Components

Perhaps the best example of a component whose development was impacted by liquid nitrogen is the semiconductor laser. Prior to 1970, laser diodes could operate continuously only when cooled to the temperature of liquid nitrogen. The fact that these lasers could be operated continuously when cooled was an important hint that room-temperature operation might someday be achievable. Laser diodes that operate at room temperature and above, *without* cooling, are the key component of today's desktop laser printers, compact-disk players, optical disk memories and long-haul optical fiber communications links.

The light-emitting diode is another component whose development was influenced by liquid nitrogen. In the early 1960s, LEDs operated at room tempera-

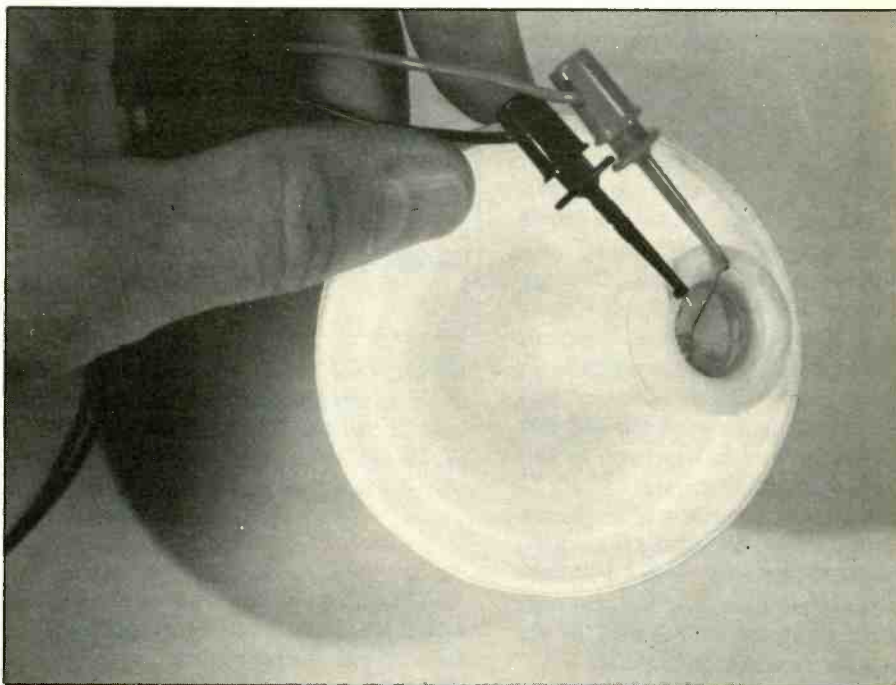

Fig. 1. Immersing an LED in liquid nitrogen.

ture were very inefficient. However, their efficiency increased by as much as ten times when they were cooled by liquid nitrogen. As we'll soon see, today's room-temperature LEDs match and even exceed the efficiency of yesterday's LEDs cooled with liquid nitrogen.

Photodetectors provide still another example of how improved performance at liquid nitrogen's temperature was an indication of what would eventually happen at room temperature. Random noise is an important limiting factor in the operation of all kinds of photodetectors. Cooling can greatly reduce this noise level. Though today's photodetectors are still plagued by noise, better processing technologies have reduced the noise levels to far below those of early devices.

Recent developments of ceramic superconductors is the latest example of the vital role played by liquid nitrogen in the development of solid-state technology. Prior to 1987, the only superconducting materials available had to be cooled to or near the temperature of liquid helium or liquid hydrogen. The present availability

of superconductors that exhibit zero resistance at the temperature of liquid nitrogen holds great promise for highly efficient electromagnets, electric motors and lossless power transmission lines. As in the case of the laser diode and LED, however, the triumph of achieving superconductivity at the temperature of liquid nitrogen has only whetted the appetites of researchers. Their ultimate goal is room-temperature superconductors.

These are only some of the examples in which liquid nitrogen has played a key role. Besides its ongoing role in ceramic superconductor research and development, liquid nitrogen has many other applications in electronics today. One of the most important is its role as a coolant for ultra-sensitive radiation detectors and infrared sensors used in some astronomical telescopes.

Cooling LEDs With Liquid Nitrogen

Figure 1 shows an LED being immersed in liquid nitrogen in a miniature evacu-

ated dewar flask placed inside a foam-plastic cup on my workbench. This miniature dewar is used to store liquid nitrogen for high-altitude balloon payloads. While it holds the liquid far longer than a foam-plastic cup alone, a cup is perfectly satisfactory for the experiments that follow.

The wavelength of the radiation emitted by an LED is directly related to the temperature of the diode's junction. In most cases, the wavelength is directly proportional to temperature. That is, wavelength of the LED decreases as temperature decreases.

This phenomenon is best illustrated by immersing an AlGaAs near-infrared emitter in liquid nitrogen. The most common commercially available AlGaAs devices emit radiation having a wavelength of 880 nanometers at room temperature. This wavelength is generally considered to be beyond the range of human vision. However, most, but not all, people can see a dim red glow by viewing an AlGaAs device straight-on in a darkened room. When the diode is immersed in liquid nitrogen, the wavelength shifts *downward* and the red glow becomes brighter.

The temperature coefficient of a typi-

cal AlGaAs LED is about 0.22 nm per degree Celsius. The difference between the temperature of liquid nitrogen (-196 degrees C) and room temperature (22 degrees C) is 21 degrees C. Therefore, the wavelength of a typical AlGaAs LED shifts downward some 48 nm when the diode is cooled with liquid nitrogen. This means that a diode that emits radiation having a peak wavelength of 880 nm at room temperature emits at a peak wavelength of 832 nm when cooled to -196 degrees C with liquid nitrogen.

Radiation emitted by GaAs LEDs and diode lasers experiences a slightly greater downward shift when these devices are cooled with liquid nitrogen. For example, the room-temperature wavelength of a GaAs laser diode is 905 nm, but its liquid-nitrogen wavelength is 845 nm.

More dramatic than the downward wavelength shift of cooled LEDs is the significant increase in the efficiency with which these devices transform an electrical current into photons. I performed two kinds of experiments to illustrate this phenomenon.

Simpler of the two—a demonstration, actually—was to apply a small forward

current to an inexpensive GaAsP red LED and visually compare its brightness before and after immersing the diode into liquid nitrogen. Even though I have worked with LEDs for more than 20 years, it was an astounding experience to observe the amazing increase in brightness that occurred after the LED was cooled in liquid nitrogen.

I tried this demonstration with several LEDs. First, I poured liquid nitrogen into a foam-plastic cup. Then I connected clip leads to an LED and applied a forward current of 5 to 10 milliamperes. I then extinguished the room lights and dipped the LED into the liquid nitrogen. For several seconds, the brightness emitted by the LED appeared to remain unchanged as the liquid nitrogen boiled violently in response to the "hot" (by liquid-nitrogen standards) LED.

As the bubbling slowed down when the junction of the LED began to cool, the soft red glow from the LED became as bright as the beam from a two-cell flashlight. When the LED was first immersed in the liquid nitrogen, its dim glow could barely be seen through the wall of the cup. After it reached peak power, the en-

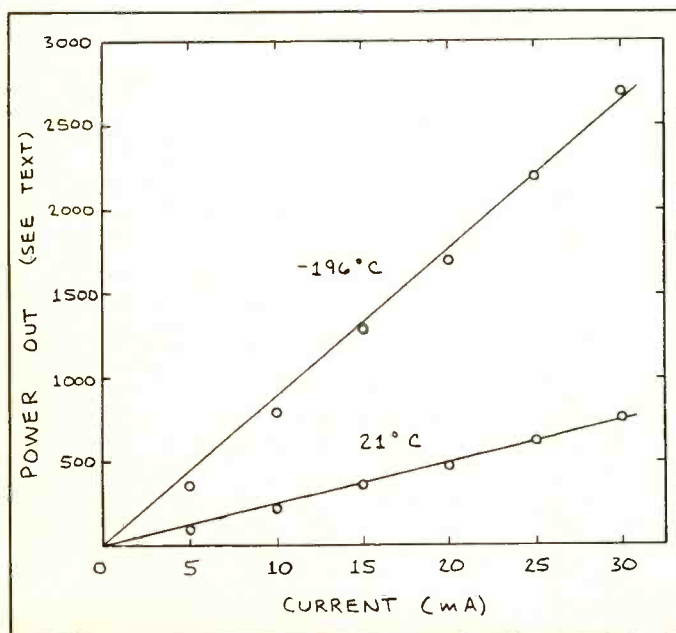

◀ Fig. 2. Output of GaAsP red LED at 21 and -196 degrees C.

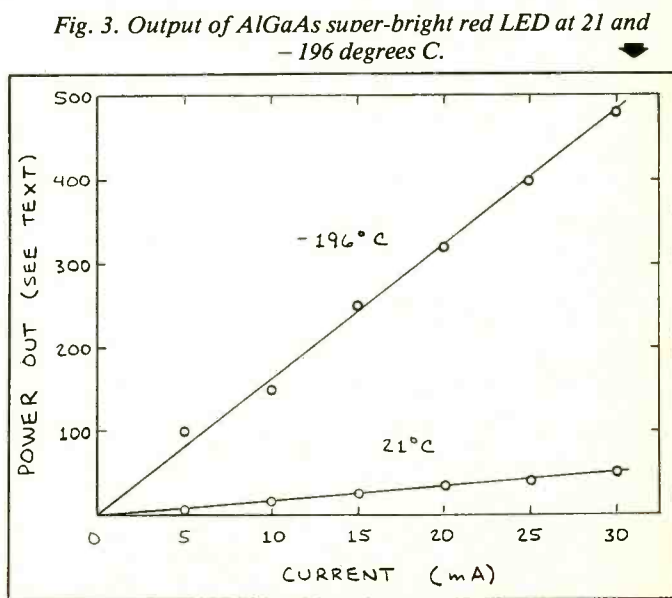
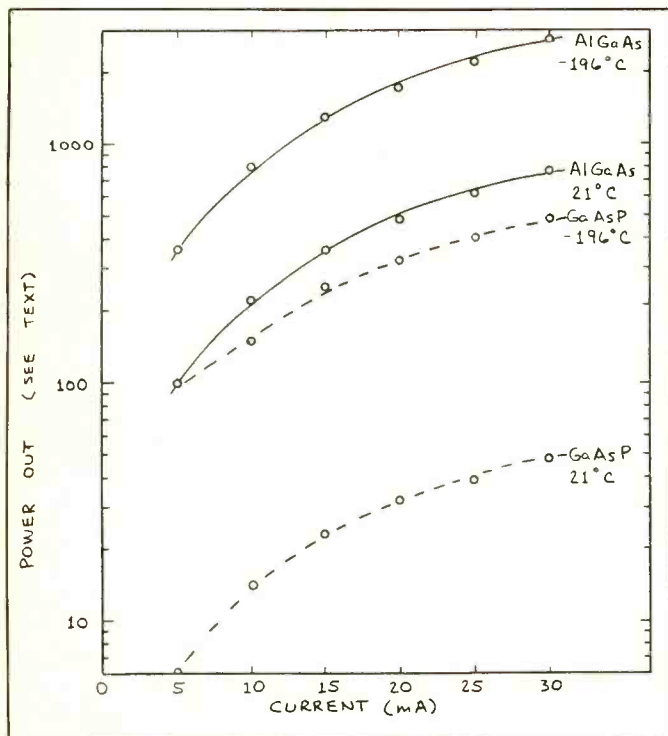
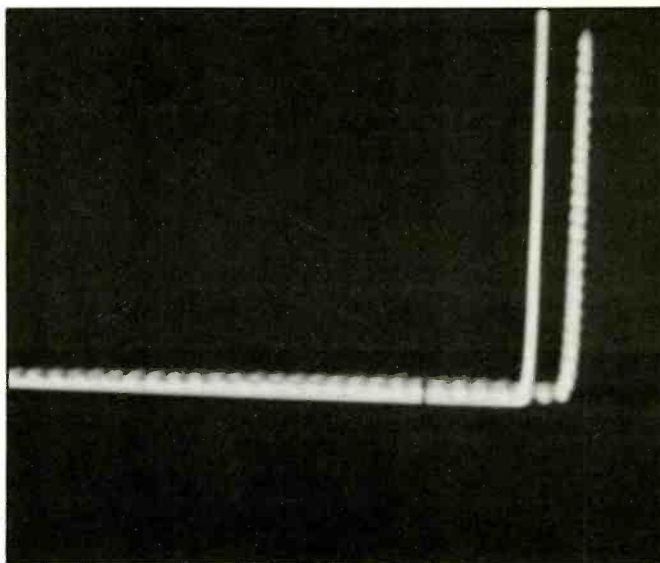

Fig. 3. Output of AlGaAs super-bright red LED at 21 and -196 degrees C. ▶



◆ Fig. 4. Comparison of AlGaAs and GaAsP LEDs at 21 and -196 degrees C.

Fig. 5. Current (vertical axis) versus voltage curves of two 1N914 silicon switching diodes at room temperature (22 degrees C). ◆



tire cup glowed like a Japanese lantern. The nonlinear response of the human eye notwithstanding, I estimated a factor of 10 brightness increase.

The second experiment is to measure the output power from LEDs at both room temperature and the temperature of liquid nitrogen and to compare the results. For quantitative results, a calibrated, large-area silicon photodiode or solar cell should be used. However, since their response to incident radiation is linear over several orders of magnitude, an ordinary silicon solar cell can also be used. All that's necessary is to connect the output from the solar cell to a milliammeter.

Incidentally, keep in mind that the spectral response of a silicon solar cell will affect your results if you measure LEDs that emit at different wavelengths. Peak response of most silicon solar cells is near 900 nm.

For consistent results, it's important to make all power measurements under the same physical conditions. You can do this simply by touching the end of the

LED to the same spot on the detector when making each measurement. Since the cooled LED will continue to operate at its increased power level for several seconds after you remove it from the liquid nitrogen, you can measure its output simply by removing it from the liquid nitrogen and quickly placing it against the monitoring solar cell.

Figure 2 is a graph that compares the output power of a cheap GaAsP red LED for a range of forward currents at both 21 and -196 degrees C. The vertical power-output axis is labeled in uncalibrated or arbitrary units. In this illustration, the units represent output current of the monitoring solar cell in microamperes.

It's interesting to observe that this graph verifies my "factor of 10 increase" guess based on simply observing the increase in the light level emitted by the cooled LED. Indeed, when the forward current was 30 milliamperes, the diode emitted 10.2 times more power when cooled than when it was at room temperature. The following tabulation summar-

izes the increase in power for each of several forward currents (room temperature output in each case is normalized as 1.00):

Current (in mA)	Power Increase (at -196° C)
5	16.67 times
10	10.71 times
15	10.87 times
20	10.32 times
25	10.26 times
30	10.21 times

The substantial increase in radiant power from cooled LEDs inspired early scientists to develop more efficient room-temperature devices. Their latest success is AlGaAs super-bright LEDs that emit 20 times or more the power of conventional GaAsP LEDs.

Shown in Fig. 3 is a graph that compares the output power of an AlGaAs super-bright LED for a range of forward currents at both 21 and -196 degrees C. As in Fig. 2, the vertical scale is labeled in

arbitrary units (output current in microamperes from the monitoring solar cell).

Though this LED does exhibit an increase in output power when cooled, the increase is not nearly as great as for the GaAsP LED used for Fig. 2. The following summarizes the increase in power for each of several forward current levels (again, room temperature output is normalized as 1.00):

Current (in mA)	Power Increase (at -196° C)
5	3.61 times
10	3.64 times
15	3.61 times
20	3.54 times
25	3.55 times
30	3.55 times

Figure 4 compares the performance of the GaAsP and AlGaAs LEDs on the same graph. Since the power emitted by the two diodes differs by as much as two decades, it was necessary for the scale of the power-output axis of the graph to be logarithmic. This graph clearly shows that the room-temperature performance of a modern super-bright LED slightly exceeds that of older GaAsP LEDs.

The results plotted in Fig. 4 have not been corrected for the spectral response of the solar cell. The response of a typical solar cell at the 670-nm wavelength emitted by a GaAsP LED is about 77 percent of the cell's response at its peak sensitivity point near 900 nm. The response at the 880-nm wavelength emitted by an AlGaAs LED is about 98 percent of the response at the peak-sensitivity point. Therefore, the performance of the GaAsP LED is actually somewhat better than that plotted in Fig. 4.

Incidentally, most LEDs are not rated for operation or storage at -196 degrees C. Of the dozen or so epoxy-encapsulated LEDs I immersed into liquid nitrogen, four developed a single crack completely across the epoxy in the plane formed by the two wire leads. Though the cracked LEDs continued to function, their performance may eventually degrade if moisture enters the crack and reaches the LED chip. As an aside, the

soft plastic used to insulate alligator clips also cracks when immersed in liquid nitrogen. Often, a popping sound is heard when LEDs and plastic immersed in liquid nitrogen develop fractures.

Diodes & Transistors at -196 Degrees C

The noise level of diodes and transistors is reduced when these devices are cooled. However, there is a tradeoff. In the case of transistors, at least the ones I tried, the tradeoff was reduced gain. Here is the H_{fe} for two 2N2222 transistors before, during and after immersion in liquid nitrogen (temperature is in degrees C):

2N2222 Transistor	H_{fe} Temperature at:		
	21°	-196°	21°
A	23	2	20
B	140	4	138

I intentionally selected these transistors due to their significant difference in H_{fe} . At 21 degrees C, transistor B has an H_{fe} that is six times that of transistor A. But at -196 degrees C, the advantage falls to a factor of two.

I also measured the forward voltage of several 1N914 silicon switching diodes at 21 and -196 degrees C. The diodes exhibited a slight increase in forward voltage when cooled. The Fig. 5 photo is of the screen of a Heath Model 2232 Component Tracer showing the current (vertical axis) versus voltage curves of two 1N914 diodes at room temperature. Figure 6 shows the curves for the same two diodes when the one represented by the right trace has been immersed in liquid nitrogen.

If you carefully compare the curves in Figs. 5 and 6, you will see that the forward voltage of the cooled diode has been slightly increased. You may also note that the diode has a sharper "knee" when cooled to -196 degrees C than when it is at room temperature.

Unlike silicon pn-junction diodes, germanium point-contact diodes don't appreciate being cooled to -196 degrees C. If you have an oscilloscope, connect an ac signal to a germanium diode and mon-

itor the amplitude of the rectified signal when the diode is at room temperature. Then immerse the diode in liquid nitrogen and observe the difference. The amplitude of the signal will be substantially reduced when the diode is cooled.

If you don't have access to an oscilloscope, connect a high-impedance crystal earphone across a germanium diode and connect one lead to an antenna to make a simple all-wave radio receiver. When you're listening to a station, immerse the diode in liquid nitrogen. The amplitude of the received signal will fall substantially. If you try this experiment with a silicon diode. The volume of the signal will decrease only slightly.

The results of the experiments with germanium diodes certainly run counter to those with silicon diodes. Perhaps it was the point contact of the germanium diodes I tested and not the semiconductor crystal that caused the degraded performance of the diodes I tested.

Radioactivity

Earlier, I noted that cooled semiconductors exhibit less noise than do uncooled semiconductors. Do radioactive materials become less radioactive at -196 degrees C?

The final experiment I performed was to compare the radioactivity of a substance at 21 and -196 degrees C. The radioactive source I used was a thorium-impregnated lantern mantle. First, I placed a radiation monitor on my desk and measured a background count of 11 counts per minute. I then placed a lamp mantle in a foam-plastic cup next to the radiation monitor, which then indicated 100 counts per minute. Next, I poured liquid nitrogen into the cup. After waiting a minute or so to allow the mantle to cool completely to -196 degrees C, the monitor indicated 46 counts per minute.

Finally, I removed the cup containing the mantle and again measured a background count of 11 counts per minute. Subtracting the background count from the two readings gave 89 counts per minute when the sample was at room temperature and only 35 counts per minute

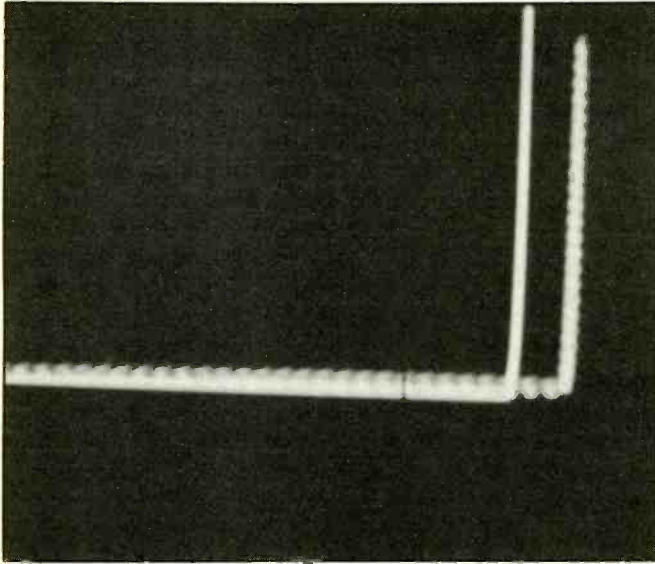

Fig. 6. Current versus voltage curves for the two diodes in Fig. 5 when the one represented by right trace has been immersed in liquid nitrogen.

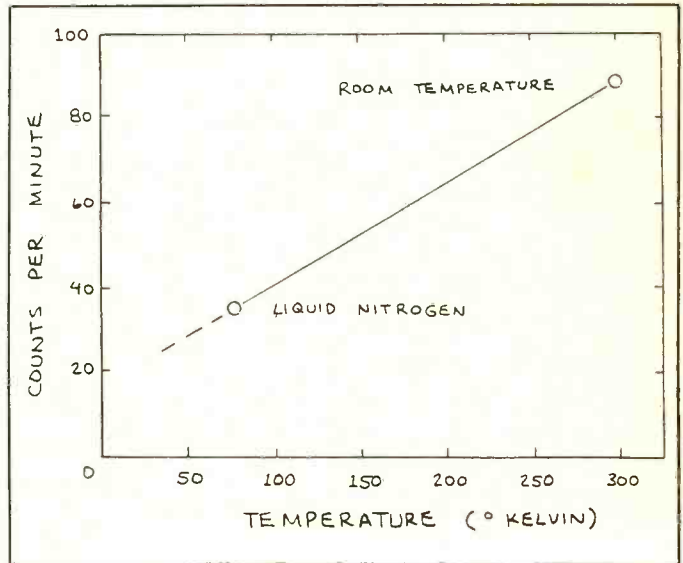

Fig. 7. Radioactivity of a thorium lamp mantle at 21 and -196 degrees C.

when the sample was cooled to -196 degrees C. Therefore, the radioactivity of the cooled thorium lamp mantle was reduced to 39 percent of its radioactivity at room temperature.

Figure 7 is a graph of these results. I've included this graph with some trepidations, since ordinarily it's not good practice to plot a trend from only two data points. However, in this case it's quite interesting to note that when the line between the two measured points is extended downward, it almost intersects the origin of the graph. In other words, at absolute zero, the thorium lamp mantle would cease to be radioactive.

Where to Acquire Liquid Nitrogen

Liquid nitrogen's commercial applications include freeze drying of food, refrigeration of produce during transport, cryosurgery, production of ultra-high vacuums and storage of various kinds of biological materials. This wide range of applications means that liquid nitrogen is widely available, especially in large metropolitan areas.

You can conduct all the experiments described here with only a liter or so of liquid nitrogen. Some welding shops will sell small quantities of liquid nitrogen for a dollar or two per liter. You might also be able to obtain liquid nitrogen from some doctors (particularly podiatrists), hospitals, research laboratories and the physics department of a university. If none of these sources is willing to sell you some liquid nitrogen, ask for the name of their supplier. As I explained in last month's column, I purchased liquid nitrogen and rented a large dewar from a man whose business is artificial insemination of cattle. I paid \$30 for 30 liters of liquid nitrogen and \$20 to rent the dewar for three days.

A dewar is a cryogenic flask having an evacuated double-wall construction. Often, the flask is lined with an insulating blanket of foamed plastic. An ordinary thermos bottle is a dewar. The dewar I rented is called a liquid-nitrogen refrigerator. It will store a full load for as long as 150 days. Some dewars will store liquid nitrogen for as long as six months.

Unless you are able to borrow or rent a dewar or liquid-nitrogen refrigerator,

you will not be able to transport or store liquid nitrogen. One possibility is to have the supplier fill a 1-quart thermos bottle with the liquid nitrogen and perform your experiments nearby. Perhaps the supplier will be interested in watching what you do.

Caution: Under *no* circumstances should you place a stopper in the mouth of a thermos bottle containing liquid nitrogen! If you do, the pressure of the evaporating nitrogen gas will become exceedingly high, and the bottle will *explode!* You can place cotton loosely in the mouth of the bottle and/or invert a foam-plastic cup over the mouth of the bottle to reduce evaporation of the liquid nitrogen.

An ordinary 1-quart or 1-liter evacuated glass thermos bottle that costs from \$5 to \$10 will easily store liquid nitrogen for a day or two when the mouth is covered by an inverted foam-plastic cup—*not* a stopper. Several gallons of liquid nitrogen will last half a day or more inside a foam-plastic ice bucket. Don't use a plastic-lined ice chest; the extreme cold temperature will weaken and probably crack the lining.

If you plan to use liquid nitrogen on a regular basis, it's best to purchase your own suitable storage container. Various kinds of plastic, glass and metal liquid-nitrogen storage containers and dewar flasks are available from scientific supply companies like Fisher Scientific (711 Forbes Ave., Pittsburgh, PA 15219) and Cole-Parmer Instrument Co. (7425 N. Oak Park Ave., Chicago, IL 60648).

Safety Precautions for Liquid Nitrogen

Liquid nitrogen can quickly freeze exposed flesh, and its vapor can quickly develop extremely high pressure inside a closed container. For these reasons, in last month's column I included a list of safety precautions to follow when transporting and using liquid nitrogen. They are as follows:

- (1.) *Never* place liquid nitrogen in a tightly closed container. If you do, the container will certainly explode!
- (2.) Do not transport an open container of liquid nitrogen in a vehicle.
- (3.) Wear eye protection when pouring liquid nitrogen and when immersing objects into liquid nitrogen.
- (4.) Liquid nitrogen boils violently when it is poured into a container that is at room temperature. So stand clear to avoid being splashed.
- (5.) If liquid nitrogen splashes onto your clothing, quickly grasp a *dry* section of the fabric and pull the wet area away from your skin. The liquid will soon evaporate from your clothing.
- (6.) It is so important that I feel obliged to repeat the first admonition: *Never* attempt to store liquid nitrogen in a tightly sealed container!

Incidentally, the sale, use and transport of liquid nitrogen may be regulated by law or local statutes in some areas. Be sure to inquire about any local regulations that might apply.

Going Further

You can perform many other experiments with liquid nitrogen besides those described above. For example, you can

transform the 905-nm radiation emitted by GaAs single-heterostructure laser diodes into visible red light that has a wavelength of 845 nm.

You can also perform many non-electronic experiments and demonstrations. Second in fascination only to a demonstration of the Meissner effect (a magnet floating above a superconductor) is what happens to an inflated balloon slowly immersed into liquid nitrogen. As the air inside the balloon contracts and itself liquefies, the balloon contracts and becomes completely deflated. Then, when you hold it in your hand, the balloon will reinflate. Be sure to obtain several kinds of balloons, since some types will simply explode when they reinflate. My daughter and I had good results with balloons designed to be twisted into animals and other shapes.

If you live in an area inhabited by fire

ants, you'll find that a cupful of liquid nitrogen will instantly kill thousands of these dangerous pests. Just disturb the ant mound with a stick, wait for the ants to swarm out and then pour the liquid nitrogen onto them. Since air is 80 percent nitrogen, liquid nitrogen has no effect, ill or otherwise, on the environment. Too, its cost is comparable to that of the dangerous chemicals ordinarily used to eradicate fire ants.

You'll also find that normally soft objects, like bananas, flowers, leaves and wieners (hot dogs), become rock solid at -196 degrees C. My daughter skewered a wiener on a steel rod, dipped it in liquid nitrogen and used it to hammer a nail into wood!

In parting, let me remind you to always be sure to follow the safety precautions outlined above when working with liquid nitrogen. **ME**

CB Thoroughbreds with winning credentials.



the **AS** **Black Stallions**™

Sleek and spirited, the new A/S Black Stallion™ CB antennas have an unfair advantage over all other brands—the long, proud heritage of the most respected name in professional communication antennas. With the finest 17-7PH stainless steel whips, high-tech protective black DURA-COAT™ finish, and contemporary styling, these exceptional antennas have no peers for strength and beauty.

Now's the time to catch a Black Stallion for yourself. Send for your free 16-page "CB/Monitor Antennas" booklet today.

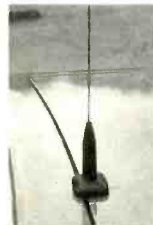

Model 900
Trunk Mount



Model 902
Trunk Mount



Model 904
Magnet Mount



Model 906
On-Glass®

the antenna specialists co.

A member of The Allen Group Inc.

30500 Bruce Industrial Parkway • Cleveland, OH 44139-3996 • 216/349-8400

© 1987 by The Antenna Specialists Co.



® "Stripes of Quality"

CIRCLE 84 ON FREE INFORMATION CARD

April 1988 / MODERN ELECTRONICS / 69

Digitally controlled potentiometers/ Sematech finds a home in Texas and more

By Harry Helms

The past three decades have seen remarkable changes in the components of electronic circuits. The vacuum tube, a mainstay of electronic design back in 1958, today is virtually unknown except in a few high-power r-f applications. The transistor was once the cutting edge of technology, yet it is rapidly approaching the status of a specialty item. Even standard ICs are threatened by the growth of custom and semicustom IC products. Yet one device has remained remarkably constant over the years—the potentiometer. In fact, potentiometers have remained essentially the same for over 50 years.

They must be controlled by humans, using ears and/or eyes as feedback circuits. Thus, precise setting or resetting of a "pot" is often a hit-or-miss affair. Several approaches have been tried to "automate" control of potentiometers, with the most popular being the use of stepper motors to set detented or "stepped" potentiometers. Such efforts have not proven satisfactory since each solution creates more problems (power consumption, voltage transients, excessive space and heating, etc.) than they solve.

However, Xicor, Inc. has recently introduced three devices that allow digital selection of different levels of resistance. These devices—the X9103, X9104 and

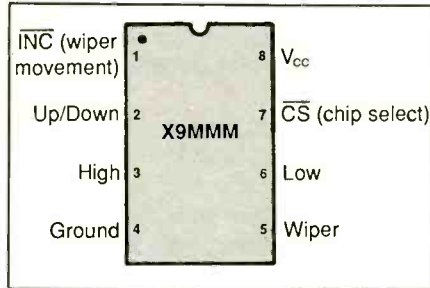

Fig. 1. Pinout details for X9MMM series of digitally controlled potentiometers.

X9503—are called *digitally controlled potentiometers* by Xicor. Each device contains 99 resistive elements, with 100 power tap points selected by a digital control signal. The last setting of the wiper can be stored in an internal nonvolatile memory and will automatically be recalled when the device is again powered up. The supply voltage of each of the three devices is +5 volts, and each is capable of handling from -5 to +5 volts. Each device is packaged in an 8-pin DIP, and Fig. 1 shows the package outline and pin identification of all three devices.

The high, low and wiper pins correspond to the three terminals on a conventional potentiometer. Movement of the wiper is controlled by the INC input at pin 1 and the UP/DOWN CONTROL INPUT at pin 2. Direction of the wiper's movement

along the resistive array is determined by the signal at pin 2. If this signal is high, the wiper will move "up" the resistive array, but it will move "down" the array if the signal is low. Since the resistive array is not one continuous resistive element (as in a conventional potentiometer), resistance increases and decreases in a series of discrete steps. The X9103 can be varied from 40 ohms to 10 kilohms in 101-ohm steps, the X9104 from 40 ohms to 100 kilohms in 1,010-ohm steps, and the X9503 from 40 ohms to 50 kilohms in 505-ohm steps.

The pin 1 INC INPUT controls the rate at which the resistance is increased or decreased. The INC signal is a negative-edge trigger (the edge of a signal going from a high to a low logic state) and can be up to 100 kHz in frequency for normal operation. However, once the device reaches either the upper or the lower end of its resistance range, it will ignore any further INC inputs until the pin 2 UP/DOWN CONTROL INPUT is reset to allow "travel" in the opposite direction.

Once a desired setting of resistance has been found, it can be stored in an internal nonvolatile memory by making the pin 7 CHIP SELECT INPUT low and then returning it to high while the INC INPUT is also high. (This occurs because the CHIP SELECT INPUT is positive-edge triggered.) To change the setting, the CHIP SELECT

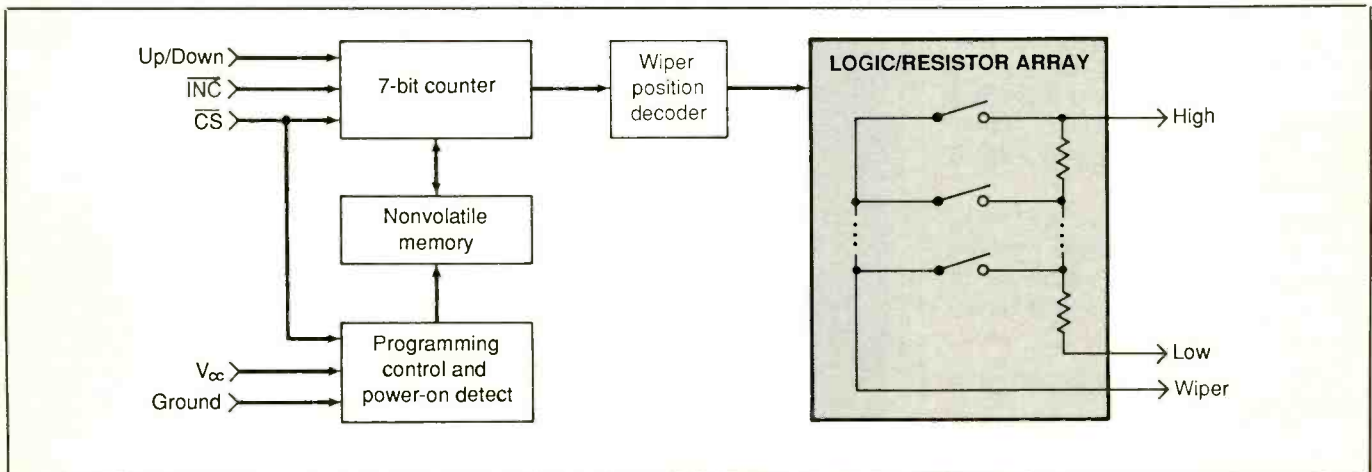

Fig. 2. Block diagram of circuitry contained within X9MMM series digitally controlled pots.

X9103/X9104/X9503 Specifications

Supply voltage: 5 volts
Terminal voltages: -5 to +5 volts
Supply current: 25 milliamperes
Wiper current ± 1 milliamperes
Wiper resistance: 40 ohms typical
Power rating: 10 milliwatts.

INPUT must be kept low. If the device's supply voltage is removed or interrupted while the CHIP SELECT INPUT is low, contents of the nonvolatile memory may be lost. Xicor claims that contents can be retained more than 100 years!

Figure 2 is a block diagram of the internal circuit in each device. The Up/Down and INC control signals are applied to a 7-bit counter, while the Chip Select signal is applied both to the counter and to a programming control and power-on detection circuit. The Chip Select signal enables the counter and also signals the memory through the programming control and power-on detection stage to save the current memory contents. The supply voltage and ground point for the circuit "enter" through the programming control/power-on detection section.

The counter stage can read or write to the memory, while the programming control and power-on detection stage can only write to memory. Output of the counter goes to a wiper position decoder, which produces a 1-of-100 output signal. This signal selects one of the 100 possible wiper tap points. Each of the 99 resistive elements has equal value, or 1/99th the resistance of the total array.

These digitally controlled potentiometers can be used in virtually any applications where mechanical pots are used, up to the voltage and current limitations stated in the specifications sheets that accompany the devices. Digital noise introduced by these devices is typically 65 dB below a 1-volt signal, which is satisfactory for most audio applications. For the experimenter and hobbyist, these devices can open up new vistas in microprocessor control of analog circuits. For example,

circuits could be adjusted or calibrated from remote locations by radio or modem, or a stereo system could be controlled from a microcomputer's keyboard. They also have several advantages even if microprocessor control is not a major consideration since they can be precisely reset to a desired value and their value cannot be altered by vibration or jarring. Moreover, they can be directly mounted on circuit boards in the same manner as other DIP ICs, which is a much simpler task than mounting mechanical potentiometers. (For an exercise in frustration, try using a conventional pot with a solderless breadboard!)

Production samples of these devices are available from Xicor sales representatives and are beginning to appear on the "surplus" devices market. Hints on using the X9103, X9104 and X9503 can be found in Application Note #AN-106, titled "E2POT Digitally Controlled Potentiometer Brings Microprocessor Control to Audio Systems—Adds Features," available from Xicor sales offices or directly from Xicor, Inc., 851 Buckeye Court, Milpitas, CA 95035.

Other New Devices

GE/RCA Solid State announced a 5-volt low-power dual-tone multi-frequency (DTMF) receiver IC that requires only a bias resistor and 3.58-MHz color-burst crystal as external components. The CD22202E detects either 12 or 16 standard DTMF digits and can provide output in 4-bit hexadecimal code or in binary coded 2-of-8 formats. The data sheet for the CD22202E gives a schematic diagram for a DTMF receiver with guard-time circuit. (GE/RCA Solid State, Rte. 202, Sommerville, NJ 08876.) . . . Teledyne Semiconductor has announced the TSC170/171, a switch-mode power-supply controller based on CMOS technology. It can operate on a supply potential from +8 to +16 volts, with a quiescent-mode supply current of only 3.8 milliamperes, which is exceptionally low for this category of device. The device's outputs can directly drive MOSFETs, and

HITACHI SCOPES

15-25% Discount



V1060
100MHz
\$1375

V660 60MHz Dual Trace \$990
V422 40MHz Dual Trace \$699
V212 20MHz Dual Trace \$475

ELENCO PRODUCTS AT DISCOUNT PRICES!



\$498
MO-1252

Scopes

MO-1253 40MHz Dual Trace \$550
Delayed Sweep 12KV HV, More
MO-1252 35MHz Dual Trace \$498
MO-1251 20MHz Dual Trace \$349
w/ Two 1x, 10x 100MHz probes, manual
S-3000 10MHz fully calibrated \$239

GF-8016 Function Generator with Freq. Counter



\$239.95

Sine, Square, Triangle
Pulse, Ramp, .2 to 2MHz
Frequency .1 thru 10MHz

GF-8015 without Freq. Meter \$179

Digital Triple Power Supply

Model XP-765 \$239.95



0-20V @ 1A
0-20V @ 1A
5V @ 5A

Fully Regulated, Short Circuit Protected
with 2 Limit Cont. 3 Separate Supplies
XP-660 w/ Analog Meters \$169.95

Multi-Function Counters F-1000



1.2GHz
\$259.95
F-100
120MHz
\$179.95

Frequency, Period, Totalize, Self Check with High-Stabilized Crystal Oven Oscillator, 8 Digit LED Dis

Digital LCR Meter

\$138.00
Model
LC-1800
Measures
Inductors,
Capacitors,
Resistors



Multimeter with Cap. and Trans. Tester

\$59.95
Model
CM-1500A
8 Functions
with Case



C&S Sales Inc., 1245 Rosewood
Deerfield, IL 60015 (312) 459-9040
800-292-7711 ASK FOR CATALOG

15 Day Money Back Guarantee
2 Year Limited Guarantee
Add 5% for Postage (\$10 max)
IL Res., 7% Tax



SOLID-STATE DEVICES...

the TSC170/171 is pin-compatible with the popular UC3846/3847 from Uni-trode. (Teledyne Semiconductor, 1300 Terra Bella, Ave., Mountain View, CA 94039-7267.)

Literature

Available from GE/RCA Solid State at the address given above is Application Note SS-8766, "Transient Voltage Suppression in Automotive Vehicles." While the orientation is obviously toward automotive electronics, much of the information in the Ap Note can be applied to other situations where voltage transients are a problem . . . Why did this take so

long? Motorola recently became the first company to make some of its data sheets and applications notes available on-line to anyone who has a modem. The name of the bulletin board is "Dr. DuB," and it is operated by Motorola's Austin, TX facility. Its subject matter is digital signal processing (DSP), and it includes current data sheets and applications notes and a question-and-answer forum on DSP. To access Dr. DuB, you need a 1,200-baud Bell 212A or V.22 modem. If your modem is Bell 212A, dial 512-440-DSP1; if your modem is V.22, call 512-440-DSP2. The log-on code is simply *quest*, and Motorola makes the bulletin board available without charge. Hope-

fully, other companies will follow Motorola's lead!

Sematech Goes to Austin

In addition to Dr. DuB, Austin, TX will also be the home of the Sematech consortium. Sematech is a cooperative effort of such companies as IBM, National Semiconductor, Motorola, Advanced Micro Devices, and Texas Instruments to pool their resources (both financial and human) in order to develop what they hope will be the finest IC manufacturing capabilities in the world by 1993. The Sematech consortium arose out of concerns by member companies and the Department of State that foreign prowess in semiconductor manufacturing, particularly in Japan, would place the U.S. industry at such a competitive disadvantage in the next decade that national security could be threatened. The major goals of Sematech are to improve IC yield and quality as well as to perfect "sub-micron" technologies necessary to manufacture the billion-transistor ICs of the next decade. The fruits of Sematech's work will be equally shared by all members of the consortium.

Congress has allocated \$100-million to fund Sematech for this year and will be asked to maintain approximately that level of funding over the next decade. Twelve states competed to be Sematech's site, with the various states putting together funding and incentive packages to supplement congressional funding. Austin is believed to have beat out such strong contenders as Massachusetts and California because several Sematech members already have facilities in the area, its central location, reasonable living costs, and the presence of the University of Texas. Another factor may well have been Rep. Jim Wright of Ft. Worth, who as Speaker of the House helped secure Sematech's congressional funding and will be in a key position to maintain the funding.

Regardless of how it came to be, many semiconductor industry observers are convinced that the continued health of the U.S. industry is linked to Sematech's success. We wish them well. **ME**

Over 75,000 active amateurs in over 125 countries throughout the world read and enjoy a different kind of ham magazine every month. They read CQ.



The Radio Amateur's Journal
76 N. Broadway, Hicksville, NY 11801

Please send me CQ for Life 3 Years 2 Years 1 Year
 New Renewal Start with _____ Issue

Name _____ Call _____

Street _____

City _____ State _____ Zip _____

Charge My Order To: Payment Enclosed \$ _____

- 1 year - 12 Issues \$18.00
(Save \$12.00)
- 2 years - 24 Issues \$35.00
(Save \$25.00)
- 3 years - 36 Issues \$52.00
(Save \$38.00)



MasterCard My account number is

VISA _____

Shortwave Listening

By Curt Phillips

The worldwide dissemination of information is taken for granted nowadays. When you turn on a television receiver, you are likely to see such things as snow skiing live from the Alps, news footage from the Middle East and a stock-market report from Japan.

This easy access to the world can lead to a casual attitude about worldwide communications. But all these sources of information are filtered through an intermediary, often based in New York City. Shortwave broadcasts, in contrast, give you direct access to the news-making areas of the world and often provide a level of intimacy and immediacy that more closely approaches Marshall McLuhan's concept of the planet as a "global village."

Shortwave listening has been a popular hobby since the early days of radio, but semiconductor technology has brought the price of a good receiver within the means of even someone interested in casual listening. The shortwave frequencies are generally considered to be those from 3 to 30 MHz (listening to the vhf and uhf frequencies above 30 MHz with scanners is a specialized activity usually differentiated from shortwave listening). Many *Modern Electronics* readers are already shortwave listeners (SWLs), and they are served by the periodic English broadcast frequency listings published. For those of you not already involved in this area of electronics, here are some basics on this special-interest field.

What You Can Hear

The international broadcasters are the best-known and easiest-to-find stations on the shortwave bands. They are often sponsored by governments, who are willing to spend substantial sums to spread their viewpoints around the world. Their booming signals, often running in the half-megawatt range, provide music, news (sometimes tainted with propaganda), educational and other entertainment programming. Their signals are usually strong and reasonably clear, and their

transmissions are generally confined to identifiable frequency ranges (Table I).

These bands are based upon agreements drawn up under the auspices of the International Telecommunications Union (ITU). The various frequency ranges are traditionally referred to by using the wavelength in meters of one of the component frequencies; that is, 49 meters is the wavelength of 6,122 kHz, and the 49-meter band extends from 5,950 to 6,200 kHz.

One of the stations you are sure to hear if you listen much is the BBC. The British Broadcast Corporation's worldwide network of shortwave transmitters was established to serve the "empire" back in the days when the sun never set on it and remains the standard by which all shortwave broadcasting operations are often measured. The thrill of hearing Big Ben's toll is one of the initiation rites of shortwave listening.

Among the other powerhouses of the airways are the Voice of America, Radio Moscow, Radio Netherlands and HCJB in Ecuador. Many of these stations offer music programming, but be aware that the fidelity is at best barely equivalent to the AM broadcast band and the signals are subject to fading due to the long distance they are traveling to reach you. The diversity of music and programming available is far greater than that available on the local broadcast bands and that easily outweighs these factors. Listen to viewpoints from Cairo and Jerusalem on

the latest mid-east events, Rome's and the Vatican's contrasting attitudes, etc.

Many other types of signals are also accessible on the shortwave frequencies. You can tune in ham-radio operators (Table II) engaged in such diverse activities as emergency message handling and technical discussions.

Military and government operations can often be found on the shortwave frequencies, including Air Force One, which I have heard on several occasions. The National Bureau of Standards station, WWV, broadcasts minutely timed announcements that allow you to set your watch with absolute precision (well, absolute if you adjust for the radio waves traveling at the speed of light).

Many unusual and mysterious signals appear on occasion, including some reputed spy and drug-smuggling operations. Some SWLs were able to find the correct frequencies and listen to transmissions from *Voyager's* historic non-stop flight around the world. "Pirate" radio stations broadcasting without licenses in defiance of radio law can be heard operating intermittently on the shortwave bands.

Shortwave listeners with computers can get equipment to interface their computers with a shortwave receiver and receive radioteletype transmissions from AP, UPI and others, as well as automatically copy and print out Morse-Code transmissions, weather-satellite transmissions and news-service photographs transmitted via facsimile.

Receivers & Antennas

In the old days (about 15 years ago), shortwave receiver performance was measured by "Three S's": sensitivity, selectivity and stability. In modern receivers, excellence in sensitivity (the ability to read weak signals) and stability (the ability to hold steady on the frequency tuned) is common; so selectivity is the parameter to be most alert for.

Big circular dials or long ruler-type dials characterized the shortwave receivers of yore, but the digital LED readouts of most modern receivers are much more

TABLE I. International Shortwave Broadcast Bands

Frequency range (in kiloHertz)	Meter Band
3,200-3,400	90
4,750-5,060	60
5,950-6,200	49
9,500-9,775	31
11,700-11,975	25
15,100-15,450	19
17,700-17,900	16
21,450-21,750	13
25,600-26,100	11

LISTEN UP!

Here's what you've been looking for — an all new hard-hitting monthly magazine which gives a unique insider's view of what's really going on in the world of communications. POP'COMM is your primary source of information — bigger and better than any communications magazine, with exciting coverage of scanners, shortwave broadcast & utility stations, spy stations, pirate and clandestine broadcasters, RTTY monitoring, survivalist communications systems, FCC news, wiretapping and bugging, scrambling/unscrambling, surveillance/undercover communications, satellite & cable TV, sophisticated telephones, & more. What you've been looking for all along! Take advantage of substantial savings over the newsstand price by subscribing now. Don't miss out on even one single issue of POPULAR COMMUNICATIONS — order your subscription now.

Twelve Issues
\$16

POPULAR COMMUNICATIONS 76 N. Broadway, Hicksville, NY 11801

Yes! The NEW POPULAR COMMUNICATIONS is just the magazine I've been looking for. Start sending it to me now! I understand that I may cancel at any time for any reason, and receive a full refund on my unused subscription.

My account number is: _____

Payed by: Check Money Order MasterCard Visa

1 year - 12 issues \$16.00 (Save \$14.00)

2 years - 24 issues \$31.00 (Save \$29.00)

3 years - 36 issues \$46.00 (Save \$44.00)

Name _____

Street _____

City _____ State _____ Zip _____

Canada and Mexico one year \$20.00 US two years \$39.00 US three years \$58.00 US Foreign one year \$22.00 US two years \$43.00 US three years \$64.00 US

ELECTRONICS OMNIBUS . . .

accurate and easy to tune. When you see a frequency listing, you can merely spin the dial until the numbers match and feel confident that you have tuned it correctly. The old style analog dials required interpolation of frequency and bandspread dials, and you still might not be tuned where you thought you were.

Shortwave receivers priced below \$100 will probably not give satisfactory performance. There are several receivers priced in the \$100 to \$200 range, however, that can provide excellent performance and have many features to enhance reception. In the more rarefied air above \$500, you can buy receivers with computerized control and specifications that exceed those of military and communications receivers of not too many years ago.

You are fortunate if you have a local store that sells high-quality shortwave receivers. If you do not live in such an area, you can get catalogs from a number of mail-order suppliers, such as the Electronic Equipment Bank (516 Mill St., Vienna, VA 22180). Many other good sources for shortwave receivers can be found in *Popular Communications* magazine (76 N. Broadway, Hicksville, NY 11801).

Good receivers can be found on the used market, too, especially at hamfests. Be aware, though, that the older receivers often do not have the sensitivity or stability of recent models and may have been manufactured by a company that has long since gone out of business. Nonetheless, these old tube-powered monsters (some weighing over 50 pounds) have an undeniable appeal and are sometimes full of extra features such as a notch filter, variable agc control, S-meters, etc. A '50's vintage Hammarlund HQ-180C has a spot on my (sturdy) operating desk. *Shortwave Requiem Past and Present*, a nice 8½" × 11" soft-cover book recently published contains fine coverage on used SW receivers, including new and used-model values. It sells for \$5.95 plus \$1 postage from Universal Shortwave, 1280 Aida Dr., Reynoldsburg, OH 43068.

What kind of an antenna do you need? The answer to that question is to put up

TABLE II: Amateur Radio Bands

Frequency range (in kilohertz)	Meter Band
3,500-4,000	80
7,000-7,300	40
14,000-14,350	20
21,000-21,450	15
28,000-29,700	10

as much wire as you can, as high as possible. Practically, any convenient length of wire between 30 and 100 feet long and placed approximately 20 feet high or more will yield good results. If you are using a portable receiver with a telescoping "whip" antenna, ignore that antenna if you can. If the radio does not provide a connection for an external antenna, use an alligator clip to connect a wire to the "whip" antenna.

The antenna wire can be strung between any two convenient supports. A long straight run of wire will be best, but if bending it around a support will allow you to put more wire in the air, do so. Trees work well as supports, as long as they do not sway enough to break the wire. Often, one end of the antenna can be anchored to the eaves of a house, at a location chosen to make the lead-in wire as short as possible. Do *not* place the antenna over or under electric power lines, of course. Not only can power lines cause interference to shortwave reception, but a mishap during installation can be fatal to you. Also, a falling or swaying wire can damage your antenna or destroy your receiver (and you).

The wire should be insulated from the supports (ceramic insulators are a cheap way to do this) and from touching any object that will short it to ground. It does not matter whether you use insulated wire or not for the antenna, but using insulated lead-in wire makes it easier to avoid shorting out the antenna on window sills and the like. An antenna wire of sufficient diameter to withstand the rigors of the weather will forestall antenna repairs; No. 12 or 14 hard-drawn copper wire is a good choice. Any connections or splices, such as where the lead-in is con-

nected to the antenna, should be soldered to provide good electrical connection.

If you live in an apartment or condominium, all this talk about eaves and trees may seem alien to you. Indoor antennas can work acceptably well, though; so do not be discouraged. A length of wire strung around the room, preferably on an outside wall and near a window, will yield plenty of received signal. If you can drop an insulated wire out a window, that can work even better.

Listening Notes

A final piece of equipment that is helpful is a set of headphones. If you already have stereo headphones, you can use them for this purpose, although if you become a serious listener you will probably want to get a specialized set for communications. These are monophonic and have the narrower bandwidth that is desirable. Even with headphones, it is useful to locate the receiver in an area that is away from the distractions of the TV, kids, etc. if possible. In searching for weak signals, the ability to concentrate that headphones afford is a powerful ally.

When you see a listing of shortwave broadcasting times and frequencies, the time will most often be listed in UTC, expressed using the 24-hour clock. Here, 3 AM is 0300, 1 PM is 1300, 5 PM is 1700, etc. UTC stands for Universal Coordinated Time (the initials come from the French) and is the modern-day equivalent of Greenwich Mean Time (GMT). Using this time-keeping system allows people all over the world to easily determine when a station will be on the air. To convert UTC to U.S. local time, subtract 5 hours from UTC to get EST (Eastern Standard Time), 6 hours to get CST (Central Standard Time), 7 hours to get MST (Mountain Standard Time) and 8 hours to get PST (Pacific Standard Time). Daylight savings time requires that you subtract one hour less in each time zone; that is, 4 for EST, 5 for CST, etc.

Although much of shortwave broadcasting is aimed at a non-English speaking audience, plenty of English-language

programming can be found. For the adventuresome, many of the foreign stations offer broadcasts to aid in the learning of their native tongues. Otherwise, high-school level language mastery is probably not enough to decipher foreign-language broadcasts, since they assume more-than-conversational fluency.

Finally, listeners can receive a variety of reception acknowledgment cards, some very colorfully illustrated, by writing to the broadcaster with some information about the program heard, including reception quality.

Shortwave listening is a fascinating and enjoyable facet of hobby electronics. I hope this column has encouraged you to get started.

Your comments and ideas for this column are welcome. Contact me at P.O. Box 678, Garner, NC 27529, or by computer on Delphi (CURTPHIL) or The Source (BDK887).

ME

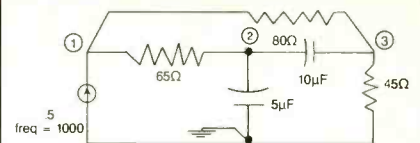

ELECTRONICS AC DC CIRCUIT ANALYSIS PROGRAMS \$29.95

Commodore 64, C-128 (64 mode), IBM PC (IBM version requires MS DOS PC DOS 2.0 or higher)

... you type ...

I 0 1 5 current source from 0 to 1
R 1 2 65 65Ω resistor from 1 to 2
C 0 2 5E-06 5μF capacitor from 0 to 2
C 2 3 10E-6
R 1 3 80 etc.
R 0 3 45
FQ 1000 set frequency to 1000
SV solve circuit

... computer displays ...

#1 NV MG = 27.2856457 A = -19.4722821
#2 NV MG = 11.163452 A = -55.1874268
#3 NV MG = 13.1239761 A = -43.3549603

Program calculates and displays general numerical solution to up to 40 node electronic circuits of resistors, capacitors, inductors, voltage or current sources, or 4 types of controlled sources, VCCS, CCCS, VCVS or CCVS. Computer displays node voltages, branch voltages branch powers and power factors (AC). Menu commands make it possible to change parameters and recalculate the solution. Programs also allow log or linear stepping of frequency or branch parameters with solution graphically displayed. Programs are menu controlled, user friendly and very easy to use.

Computer Heroes ORDERS ONLY
P.O. Box 79M 1-800-622-4070
Farmington, CT 06034

CIRCLE 69 ON FREE INFORMATION CARD

Order Back Issues of

MODERN ELECTRONICS

THE MAGAZINE FOR ELECTRONICS & COMPUTER ENTHUSIASTS



BACK ISSUE ORDER FORM

Please send me the following issues @ \$2.50 each:

Month(s) & Year(s): _____

Number ordered @ \$2.50 each: _____

Total Payment Enclosed: _____
(Check or M.O. only)

NAME: _____

COMPANY (Optional): _____

STREET ADDRESS: _____

CITY: _____ STATE: _____ ZIP: _____

Clone Upgrading

By Ted Needleman

On re-reading last month's column, I find that I left out an important consideration when buying a compatible or clone computer. Actually, it was a fortuitous omission, as it bears directly upon this month's main subject, a third-party Apple Macintosh memory upgrade.

This consideration has to do with being left in the lurch when the company that produced or marketed your computer system goes under or decides they'd rather produce dishwashers than computers. The "orphan" computers are something I have, unfortunately, too much experience with. My Apple ///, for example, now resides in a good home with someone who gets a kick out of playing with Visicalc 3 and doesn't much care that there will never be any new software that can run on the system.

Today's clones, in contrast, generally give you good insurance against the orphan syndrome. This is true even if they're made by the "Three Guys and a Goat Computer Company" because just about any clone you buy today is a *generic* PC. Therefore, no matter where the parts come from, they can most likely be replaced by an equivalent one made by someone else.

Even if the clone you purchased uses a proprietary BIOS that fails to give you the degree of compatibility you expected, it too can be replaced with a BIOS from one of the major suppliers. Accordingly, with clone assemblers largely following IBM's designs on its earlier pc models, no longer made by IBM, you get a good amount of peace of mind.

Chances are you'll be able to keep the new clones going almost forever. And you'll also be able to enhance their performance as you go along (until you reach the economic point of no return). As you want more performance, you can even swap out an 8088 motherboard for an 80286 one. By the end of this year, it's expected that 80386 motherboards will be down in the realm of affordability. And all the other components of your system, from the case and power supply

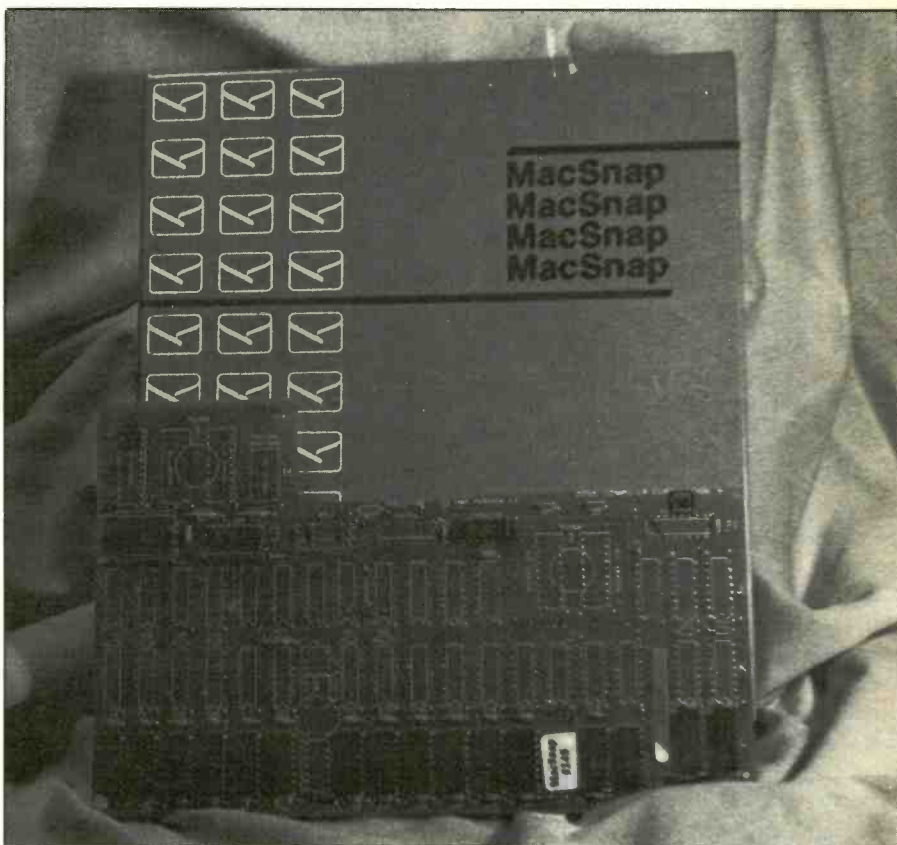

to the floppy-disk controller card, are still usable.

Big Red

This brings me to this month's product focus. While PCs (Big Blue's and other's) are designed to be upgradable throughout their usable life, many of the models from Big Red (Apple Computer) are not. Until recently, for example, Apple Macintosh models were all closed-architecture types.

Apple Computer's past Apple /// and Lisa fared even worse. The Three was just abandoned. And the plan Apple came up with for trading in a Lisa, originally costing \$10,000, on a Macintosh, was an insult to the owner's intelligence (in the vein of "if you were foolish enough to buy the machine in the first place, maybe you'll be foolish enough to go for this upgrade!").

Looking back over the past, where does that leave those of us with 512K Macintoshes? When Apple introduced the Macintosh, I had no intention of ever buying one. After all, I still remembered how I got stuck with the Apple ///. Then I started getting requests to review Macintosh software, but held off purchasing a system until they brought out the 512K Mac (also known as the "Fat Mac"). In the two years I've had the system, I've spent about \$400 upgrading it—adding enhanced ROMs, an 800K internal drive, and buying a Mac-Plus keyboard.

Today's Macs, though, come with a minimum of 1 meg of RAM, and a completely different interface—SCSI (Small Computer Systems Interface)—for hard disk drives. And much of the great software coming out lately, such as Hypercard and Multifinder, run poorly, if at all, in less than a meg. It looked like an expensive motherboard swap was my an-

swer until I received a MacSnap to review from Dove Computer.

MacSnap

MacSnap, available in several different models for 128K, 512K, and Mac Pluses from third-party developer, Dove Computer, is a memory-upgrade board. Also available from Dove are ROM upgrade boards and an SCSI interface board. The Model 524S kit they sent me contained a memory board to upgrade my 512K enhanced system to a Meg of RAM, and a small board to add an SCSI interface to the system. Since I don't have an SCSI hard disk to test out this interface, I installed only the memory upgrade.

The MacSnap installation guide is well illustrated and comprehensive. It also has some glitches and needs upgrading, though no error is serious enough to damage your system. The guide also mentions several tools, including a No. 15 Torx screwdriver, case opening tool, and a grounding strap. These are contained in an *optional* tool kit, not included with the review unit. If you buy the Dove kit, be sure to also purchase the tool kit. You'll need it! Installing the board is about an hour's work. Most readers of *Modern Electronics* should be more than competent to do it.

The first step is to read through the entire manual at least once, then open up the Mac's case. There are five Torx screws holding it closed; the two located in the recessed carrying handle require a screwdriver with a long shaft. I was able to cobble something together for this purpose, but the screwdriver included in the optional tool kit would have saved some time. Next you must gently pry open the case. Again, the optional kit's special tool makes this easy. Lacking it, and necessity being the mother of invention, I used a butter knife. With the back of the case removed, you must disconnect two cable sets from the motherboard at the bottom of the system. Then slide the motherboard back and out.

A confusing instruction section followed. The manual has installation instructions that include additional instructions, italicized for emphasis, for

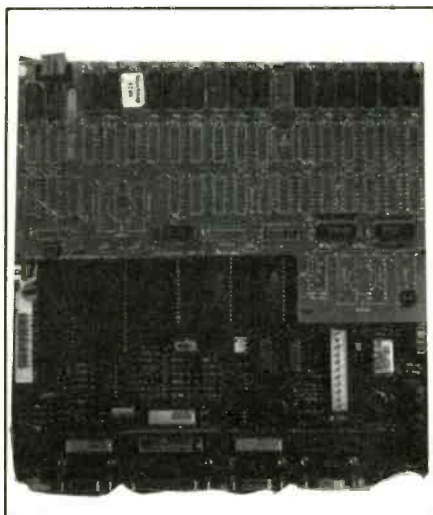

MacSnap mounted in place on Apple Macintosh motherboard.

owners who have a HyperDrive hard disk installed (which I don't). However, the hardware illustrated to attach the Dove card to the Mac's motherboard bore no relation to what was included with MacSnap upgrade kit.

The manual showed several different sizes of standoffs, some of which were supposed to be used as nuts, and both flat and lockwashers. My hardware kit had two standoffs, four nylon screws, and six flat nylon washers. In reality, the screws screw into the standoffs, which are placed on the bottom of the MacSnap toward the front. It's really the only place for them, but it did give me a few minutes pause. Not as much, though, as the next step. The MacSnap has six special sockets on the bottom which snap over and onto six ICs on the Mac's motherboard. The installation addendum states that if you have NEC DRAMs on your motherboard you need to *cut* away the plastic separators between the contacts on two of these sockets. Of course, my Mac had the NEC DRAMs!

I'm not all that happy about cutting things even when I've bought the adapter. When it's a review unit, I'm even less inclined to do so. After some thought, I figured, "what the heck," and went looking for a "cutting tool" as specified in the instructions. I finally decided that

Be an FCC LICENSED ELECTRONIC TECHNICIAN!



No costly school. No commuting to class. The Original Home-Study course prepares you for the "FCC Commercial Radio-telephone License". This valuable license is your "ticket" to thousands of exciting jobs in Communications, Radio-TV, Microwave, Computers, Radar, Avionics and more! You don't need a college degree to qualify, but you do need an FCC License.

No Need to Quit Your Job or Go To School
This proven course is easy, fast and low cost! **GUARANTEED PASS** - You get your FCC License or money refunded. **Send for FREE facts now. MAIL COUPON TODAY!**

COMMAND PRODUCTIONS

FCC LICENSE TRAINING, Dept 220
P.O. Box 2223, San Francisco, CA 94126

Please rush **FREE** details immediately!

NAME _____
ADDRESS _____
CITY _____ STATE _____ ZIP _____

AMAZING SCIENTIFIC & ELECTRONIC PRODUCTS

PLANS—Build Yourself—All Parts Available In Stock

- LC7—BURNING CUTTING CO₂ LASER \$ 20.00
- RUB4—PORTABLE LASER RAY PISTOL 20.00
- TCC1—3 SEPARATE TESLA COIL PLANS TO 1.5 MEV 20.00
- IOG1—ION RAY GUN 10.00
- GRA1—GRAVITY GENERATOR 10.00
- EML1—ELECTRO MAGNET COIL GUN/LAUNCHER 5.00

KITS

- MFT1K—FM VOICE TRANSMITTER 3 MI RANGE 49.50
- VWPMSK—TELEPHONE TRANSMITTER 3 MI RANGE 39.50
- BTC3K—250,00 VOLT 10-14" SPARK TESLA COIL 199.50
- LHC2K—SIMULATED MULTICOLOR LASER 39.50
- BL51K—100,000 WATT BLASTER DEFENSE DEVICE 69.50
- ITM1—100,000 VOLT 20" EFFECTIVE RANGE INTIMIDATOR 69.50
- PSP4K—TIME VARIANT SHOCK WAVE PISTOL 59.50
- PTG1K—SPECTACULAR PLASMA TORNADO GENERATOR 139.50
- MVP1K SEE IN DARK KIT 169.50

ASSEMBLED

- PG70H—MULTICOLOR VARIABLE MODE PLASMA GLOBE "7" 425.00
- BTC10—50,000 VOLT—WORLD'S SMALLEST TESLA COIL 44.50
- LGU40—1MW HeNe VISIBLE RED LASER GUN 299.50
- TAT20 AUTO TELEPHONE RECORDING DEVICE 24.50
- GPV10—SEE IN TOTAL DARKNESS IR VIEWER 299.50
- LIST10—SNOOPER PHONE INFINITY TRANSMITTER 169.50
- IPG70—INVISIBLE PAIN FIELD GENERATOR—MULTI MODE 69.50

• CATALOG CONTAINING DESCRIPTIONS OF ABOVE PLUS HUNDREDS MORE AVAILABLE FOR \$1.00 OR INCLUDED FREE WITH ALL ABOVE ORDERS.

PLEASE INCLUDE \$3.00 PH ON ALL KITS AND PRODUCTS PLANS ARE POSTAGE PAID. SEND CHECK, MO, VISA, MC IN US FUNDS.

INFORMATION UNLIMITED
P.O. BOX 716, DEPT. ME, AMHERST, NH 03031

CIRCLE 97 ON FREE INFORMATION CARD

PC CAPERS...

a razor knife qualifies as one and hacked away with it for a few minutes to prepare for installing the adapter.

Installation consists of positioning the adapter over the motherboard and pressing down hard with your thumbs on places marked (there are three spots noted) on the MacSnap. With 200-plus pounds concentrated onto two thumbs, I quickly felt three satisfying "snaps" as the board clicked into place. Putting in two more nylon screws to finish the mounting process, I was ready to reinstall the motherboard.

Here, again, the instructions were wrong. The installation guide states that the standoffs don't allow the MacSnap/motherboard combination to slide into the system. You are supposed to position the board into one set of guides, then pry the other set into place. Maybe I have a rogue Mac, but the motherboard combination slides back in as easily as it came

out. I reconnected the two cables, put the case back together, and was ready to power up and see if I had done irreparable damage to my Mac.

Powering up with the RamSnap disk included with the board, I was thankful to see the smiling Mac face come up on the screen. RamSnap, by the way, is a handy RAM disk and disk-cache utility that Dove includes with all of its Snap upgrades. Launching the program, I was gratified to see almost 900K available for a RAM disk (Apple's operating system for the Mac Finder is a real memory hog).

The only thing left to worry about now are the scattered reports of Macintosh power supplies going up in smoke when memory upgrades (including Apple's own) are added. Dove states that its upgrade uses less power than Apple's, and Apple denies that smoked power supplies are much of a problem, so maybe I'll be lucky on this score.

Is Dove's MacSnap a good deal? I believe it is. Fortifying this view, my friendly Apple dealer quotes \$599 for an upgrade of a 512K motherboard to a 1-meg Mac-Plus motherboard. Dove's Model 524S gives you the same thing (including the SCSI interface) for \$339 or almost 40 percent less. Thus, MacSnap represents a substantial savings.

Moreover, if someone like myself, who has yet to get an assembled Heathkit, terrific instructions and all, working on the first try, can do a faultless installation, chances are good that you won't have any difficulty with MacSnap. For more information on MacSnap, contact Dove Computer Corp., 1200 N. 23 St., Wilmington, NC 28405 (phone: 919-763-7918) or circle the number indicated below on the postpaid Free Information Card included in this issue. **ME**

CIRCLE 83 ON FREE INFORMATION CARD

Organize and Protect Your Copies of



THE MAGAZINE FOR ELECTRONICS & COMPUTER ENTHUSIASTS

Now there's an easy way to organize and keep copies of your favorite magazine readily available for future reference.

Designed exclusively for **ME** by Jesse Jones Industries, these custom-made titled cases and binders provide the luxury look that makes them attractive additions to your bookshelf, desk or any location in your home or office.

Whether you choose cases or binders, you'll have a storage system that's durable and well organized to help protect your valuable copies from damage.

- Cases and binders designed to hold a year's issues (may vary with issue sizes).
- Constructed of heavy reinforced board, covered with durable leather-like material.
- Title hot-stamped in gold.
- Free personalization foil for indexing year.
- Cases V-notched for easy access.
- Binders have special spring mechanism to hold individual rods which easily snap in. This allows magazines to be fully opened for easy readability.

MODERN ELECTRONICS
Jesse Jones Industries, Dept. Mod-E
499 East Erie Avenue, Philadelphia, PA 19134

Please send _____ cases; _____ binders
for Modern Electronics Magazine.

- Enclosed is \$ _____
- Charge my: (Minimum \$15)
 American Express Visa
 MasterCard Diners Club

Quantity	Cases	Binders
One	\$ 7.95	\$ 9.95
Three	\$21.95	\$27.95
Six	\$39.95	\$52.95

Add \$1 per case/binder postage and handling. Outside USA \$2.50 per case/binder. (U.S. funds only.)

Card # _____ Exp. Date _____

Signature _____

Change Orders: Call TOLL FREE 7 days, 24 hours 1-800-972-5858

Print Name _____

Address _____

City/State/Zip _____

PA residents add 6% sales tax

No P.O. Box Numbers Please

SATISFACTION GUARANTEED

COMPUTER PARTS GALORE

IBM COMPATIBLE WIRED CARDS

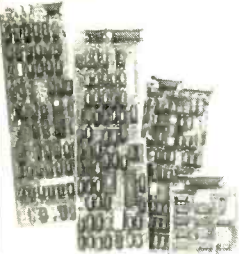

- MULTIFUNCTION \$79.95
- NEW MOND/PRINTER \$49.95
- NEW COLOR/PRINTER \$49.95
- MULTI I/O \$79.95
- PRINTER (PAR) \$24.95
- GAME \$24.95
- RS232 \$34.95
- CLOCK/CAL \$44.95
- 576K RAM \$59.95
- I/O +2 \$58.95
- 1.2/360 DRIVE \$59.95
- DRIVE 2 PORT \$24.95
- DRIVE 4 PORT \$29.95

Most wired boards can be bought in bare PCB form with parts list and placement diagram for \$9.95 (small) to \$19.95 ASK!

MEMORY MAGIC RAM CARD \$139.95

This clever little card has copied the Lotus/Intel RAM format for expanded memory specs (EMS) and is far, far cheaper, but just as good. Comes ready to stuff with 64K DRAMS, and will accept 2MB of 256K or 512K of 64K DRAM. Comes with driver disk for RAM disk or spooler.

EPROM PROGRAMMER

A clever card that plugs into your IBM and lets you program any EPROM up to 512K under software control. Full screen edit/add/delete features, will program all types 5v, 12v, 21v, 24v, a really full feature unit for the price. Comes in two styles: the EW901 does 1 at a time, the EW904 does 4 EPROMS at a time. EW901...\$119.95 EW904...\$199.95

640K 2 OR 4 LAYER XT MOTHERBOARD

4 LAYER 10 MHZ TURBO This is a champion of a board, made with the latest of 4 layer PCB fabrication techniques. It is rock-solid and has perfect hard-switch (a toggle switch chooses speed) modes to choose from. It will also use two BIOSes, DIP switch selectable for when you want to select certain BIOSes for particular applications. A high quality board at a realistic price. \$159.95

4 Layer 8 Mhz TURBO as above but single BIOS. Hard-soft Sw. \$149.95

2 Layer 8 Mhz TURBO \$129.95

ASTEC 200W POWER SUPPLY FOR AT \$129.95

We sell the ASTEC power supplies because they are very good. Less than 0.1% fail in service and the overvoltage protection is so good that they never fry boards. Just try some of the real cheaps, ask a friend who had a system fry at 18V on the 5V line, hard drives and all. They are FCC/CSA and UL approved. They put out a true 200W with -5V at 21A, -12V at 8A, -5V-12V at 0.3A. And they will last forever, being ASTEC. \$179.95

"HOW TO BUILD YOUR OWN P.C. COMPATIBLE"

FROM COMPREHENSIVE GUIDES \$12.95

BIG BLUE SEED

The BIG BLUE seed now has over 100 IBM mother boards and cards listed in it. All the part values and placements make it useful for service and repair and the same old price of \$179.95

NEW ATAK 286-1A \$395.00 8 MHZ

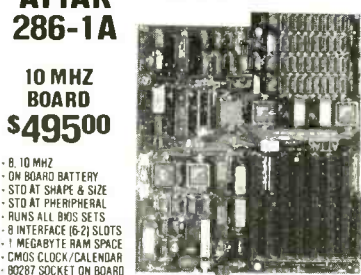

10 MHZ BOARD \$495.00

- (B) 8, 10 MHZ ON BOARD BATTERY
- (S) STD AT SHAPE & SIZE
- (T) STD AT PERIPHERAL
- (R) RUNS ALL BIOS SETS
- (I) 8 INTERFACE (6-2) SLOTS
- (M) 1 MEGABYTE RAM SPACE
- (C) CMOS CLOCK/CALENDAR
- (S) 80287 SOCKET ON BOARD

At last the new model 1A of the ATAK-286 board is in stock. It uses the LSI chip set from CHIPS & TECHNOLOGY that you have heard tell about. It is of 4 layer construction for noise free high speed operation and is exhaustively pretested on a GENERAL RADIO bed of nails computerized matrix tester. It is the same size as the real AT and has space for up to 1 Meg of RAM. Wired boards are equipped with the latest PHOENIX BIOS. We sell the boards in these formats:

- (B) Bare tested PCB with parts list & placement \$39.95
- (C) Detailed manual, with CHIPS & TECH data, schematics and many useful hints and kinks \$29.95
- (D) PHOENIX BIOS, for bare PCB buyers, latest version \$59.95
- (E) Keyboard BIOS from PHOENIX for bare PCB \$29.95
- (I) CHIPS & TECHNOLOGY 5 Chip set, 8 Mhz \$39.95
- (K) 80286 CPU, 8 Mhz \$89.95

We have many other parts in stock, ask

FREE PAD WITH EVERY MOUSE



- C7 MOUSE \$84.95
- BUS MOUSE \$94.95
- LOGIMOUSE \$94.95

POWER SUPPLIES

UNINTERRUPTIBLE POWER SUPPLY SENDON



AS LOW AS \$259.95 UPS 250

1 year warranty - EMI/RFI filters - Surge protection circuits - High efficiency - Internal GEL CELL - Audible power loss warning - Fast transfer time - Multiple output sockets

UPS 400 \$379.95

HOLD TIME	MODEL	XT	AT	OUTLETS
UPS 250	45 min	42 min	2	
UPS 400	53 min	50 min	4	

NCR BURROUGHS NORTHERN TELECOM

The ever famous NCR switching power supply for their defunct IBM clone 5V at 7A, 12V at 5A, 5, 12 at 1A. Another very nice unit. It will run a clone and is a very high quality unit. \$34.95

The NORTHERN TELECOM power supply is running out at last. We have only 300 of these great beauties left (out of the 3000 we had). It gives 5V at 4A, 12, 5, -12V at 1A each. \$19.95

A real deal at only \$24.99

POWER BAR



- Surge suppressor
 - EMI/RFI filter
 - 6 outlets
 - Circuit breaker
- ONLY \$13.95 While quantities last

Easy to Build • All Wired • Pre-Tested Kit

AT SYSTEM KIT \$999.95 1 YEAR WARRANTY

All Wired and Pretested Complete Kit

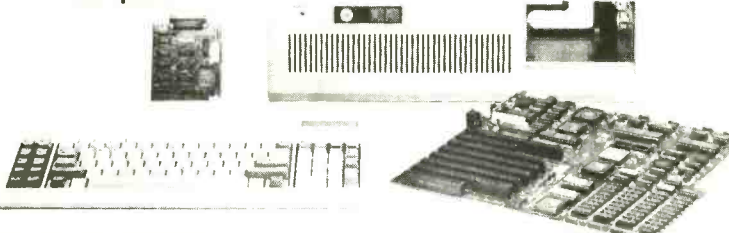

BOARD INCLUDED (8MHZ)

ALL YOU NEED TO BUILD up a really nice AT clone system with our FLIP-TOP case, 200W power supply, and ATAK-286 with 512K RAM on it. Floppy/Hard drive controller, 1.2M DS4D drive - RT-101 Keyboard - PHOENIX BIOS - PHOENIX Keyboard

BIOS - All the small bits and pieces to quickly allow you to make your own AT clone in 1 hour or less. This kit uses all first quality reliable components for long life.

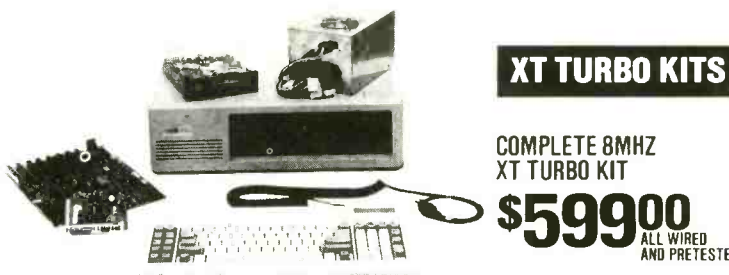

Yes we make up the kits from stocks of wired and tested boards so you know all will be well when it is assembled. We insist on the best quality of pre-tested boards, stuffed with good new IC's and then thoroughly tested and burned in. This kit consists of the following parts: Flip-top case, heavy gauge steel • 150 Watt power supply, true 150W • 5160 AT/XT autoswitch keyboard • 8 Mhz Turbo with 640K DRAM • Drive card & cable • 2 DSDD drives - Video card, color/mono (your choice) • Clock/cal/ser/par ports • 10 free diskettes with firmware • Assembly manual • speaker

XT-AT KEYBOARD

KEYTRONICS RT-101 100% REAL ONLY \$99.95 1 YEAR WARRANTY

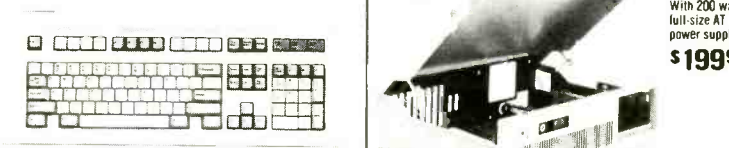

We were able to get a few more RT-101 from an OEM who was overstocked with them, but only a few so act fast. The final shipment will arrive about one week after you see this ad so act fast to get in the queue.

BEST QUALITY IBM COMPATIBLE KEYBOARDS AS LOW AS \$54.95



As you know the keyboard is one of the two mechanical items in your system, all else is solid state and runs forever. We have looked high and low for good Taiwan keyboards, and found them! BTC, one of the world's finest keyboard makers, has them. We tested them thoroughly first, and then we bought. We found them to be of excellent quality, 100% IBM/Keytronics compatible and only a little more costly than the real cheapies.

5150 The std. 84 key type for XT, with large return key \$54.95

5180 The new XT/AT autoswitch type that knows what it is plugged into. Has LED status panel, large return key, and a very nice feel! \$64.95

5161 The enhanced AT/XT autoswitch with 12 function keys, LED status panel, numeric pad, large return key \$88.95

XT, AT FLIP TOP CASES

REGULAR AT \$129.95 1 YEAR WARRANTY

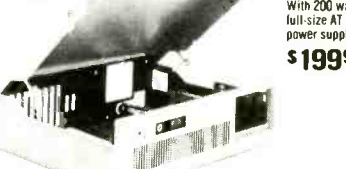

With 200 watt full-size AT power supply \$199.95

With 200 watt full-size AT power supply \$127.95



With 200 watt full-size AT power supply \$197.95

XT FLIP-TOP CASES \$59.95

NEW ITEMS BOCA RAM/AT TOPHAT SAMSUMG MONITORS AMAZING THING MODEMS IDEA MODEMS SEA GATE HARD DRIVES 20, 30 and 40 MEG CALL FOR CURRENT PRICES

For tight quarters, drawer allows you to stow away the keyboard. RECS...\$49.95 N/KS...\$35.00

COMPUTER PARTS GALORE INC.
56 HARVESTER AVE.
BATAVIA, NY 14020 USA
TEL: 716-343-6133
FAX: 716-343-9912

CALL TOLL FREE
1-800-431-9008



Terms and Conditions: Minimum order \$10.00. For orders less than \$60.00, please add \$5.00 for packing and freight. Over \$60.00, please add 5% for packing and freight. Heavy items may need extra freight. All orders sent by UPS ground unless another way is requested. In that case any extra fee we must pay is charged. UPS red, blue are available. C.O.D. by US mail or UPS. Please add \$3.50 C.O.D. fee to the above. We accept Visa, MasterCard, American Express, certified check, money order, school, college, university, or state and federal institution purchase orders. Personal checks need 14 days to clear. All goods shipped as soon as possible. All items subject to prior sale. Prices are subject to change without notice.

CIRCLE 30 ON FREE INFORMATION CARD

www.americanradiohistory.com

Mastering Digital Control by William G. Houghton. (Sybex. Soft cover. 374 pages. \$24.95.)

This book is directed to engineers or technicians who need to design microcontroller-based systems, as well as to the hobbyist who is interested in this area. It focuses on single-chip microcontrollers and practical design problems and solutions.

At the outset, the author lays the groundwork with an introduction to microcontroller concepts, defining the differences between microprocessors and microcontrollers and introducing two families of Intel devices and one family of Motorola devices. Devices discussed in this chapter are the foundation upon which later chapters are built.

Each chapter is devoted to a specific topic: external program memory expansion, external data memory expansion, expanding I/O, use of interrupts, single-bit operations, external clock sources, adding an RS-232 port, etc. By the ninth chapter, more sophisticated subjects are introduced: interfacing a microcontroller as a peripheral device in multi-processor systems, scanning keypads, interfacing to display devices and the like. There are also chapters devoted to table translation, ac control and zero-crossing detectors and analog measurements and interfacing procedures.

Chapter 15, which concludes the main text material, offers an application example that covers the programming needs of EPROMs, required interfaces, an EPROM programmer circuit and software drivers.

Two appendices are also included. The first is an assembly-language source code listing of the software drivers for the EPROM programmer previously described. It not only gives the listing, it describes it in detail. Listed in the second appendix are the names, addresses and telephone numbers of microcontroller/peripheral device manufacturers from whom readers can obtain additional information needed to build microcontroller-based digital control systems.

This well-written book clarifies the skeleton information provided by data sheets and application notes, and is appropriately supported with logic and block diagrams, tables and subroutines listings. Thus, it should serve exceptionally well as a hands-on guide to microcontrollers and designing digital device

controllers, assuming the reader has a working knowledge of basic digital logic elements. Therefore, if you really want to learn how to create digital control circuits, this is the book for you.

Complete Guide to Stereo Television (MTS/MCS) Troubleshooting and Repair by John D. Lenk. (Prentice-Hall. Hard cover. 174 pages. \$29.95.)

More and more TV sets with stereo sound and second audio programs (SAP) are finding their way into U.S. homes. Generally called MTS (multichannel TV sound) systems, service technicians should know how to troubleshoot these circuits, which is this book's subject. Beginning with a brief history of stereo TV, the book quickly gets down to cases discussing the methods used to create and demodulate two-channel audio in a TV broadcast, a noise-reduction system, the troubleshooting approach and basic troubleshooting functions.

Since it is the basic troubleshooting tool used in servicing stereo TV, the MTS TV stereo generator is given its own chapter. The focus here is on the B&K Precision Model 2009 generator. This chapter not only tells you what an MTS generator is, it also tells you, in step-by-step detail, how to use it for performing various tests. For the newcomer to MTS TV servicing, this may very well be the most valuable part in the book.

Later chapters deal with the specifics of Mitsubishi's MTS TV and hi-fi/stereo VCR circuits, Sony's MTS adapter and TV stereo and General Electric's multi-channel sound decoder. Each of these chapters contains sections that deal with circuit descriptions, typical test/adjustment procedures, the troubleshooting approach and, where applicable, additional circuits.

The author, who has a long-time background in the electronics servicing area, provides lucid, easy-to-follow text and excellent supportive illustrations (photos, block diagrams and schematics). This is a hands-on *user's* guide, as well as a good theoretical overview of MTS.

Though this book's coverage might at first appear to be too product specific, the reader can relate details for any given product to any other not covered that operates on the same principles. Consequently, this book can serve as a general guide to the test and reception equipment

encountered in the MTS stereo TV consumer product category. An understanding of basic TV principles is assumed by the author.

NEW LITERATURE

SMD Resistor & Capacitor Kits. Communications Specialists offers a data sheet that describes the company's new CC-1 Chip Capacitor and CR-1 Chip Resistor kits for prototyping and repair work that require surface-mount devices. Tables on both sides of the card-stock sheet list specs of each device type included in a kit (10 each of 154 types of resistors, plus 10-chip bonus; 5 each of 73 types of capacitors, plus 5-chip bonus). For a free copy, write to: Communications Specialists, Inc., 426 W. Taft Ave., Dept. ME, Orange, CA 92665-4296.

Electronic Parts & Equipment Catalog. All Electronics' 52-page Winter 1988 catalog lists and fully describes, including prices, a wide range of electronic components, tools, chemicals, project cases, books, intruder alarms and more. In addition to the usual line-up of resistors, capacitors, chokes and transformers, diodes, transistors and ICs, the catalog contains listings for relays, switches, microphones, speakers and tone transducers, crystals, fans, batteries, circuit-prototyping and -building items, and wires and cables. Individual products listed include multimeters, black-light assembly, light-activated motion sensor, keyboards, telephones and accessories. An extensive line-up of circuit-board and ribbon-cable connectors and assemblies are also listed. For a free copy, write to: All Electronics Corp., P.O. Box 567ME, Van Nuys, CA 91408.

Test & Instrumentation Product Guide. United States Instrument Rental's 400-page 1988/1989 Product Guide provides information on more than 5,000 different models from well over 100 major manufacturers of electronic test and measuring instruments, data-processing equipment and telecommunications test devices available for rent, lease and sale. The Guide contains full specifications, descriptions, photos and technical data on a broad variety of product categories.

(continued on page 96)

MASTER THE NEW ELECTRONICS WITH MCGRAW-HILL'S

Contemporary Electronics Series

The fast, easy and low cost way to meet the challenges of today's electronic innovations. A unique learning series that's as innovative as the circuitry it explains, as fascinating as the experiments you build and explore.

From digital logic to the latest 32-bit microprocessor, the McGraw-Hill Contemporary Electronics Series puts you into the electronic picture one easy step at a time. Fifteen unique Concept Modules, sent to you one every 4-6 weeks, give you a handle on subjects like optoelectronics, robotics, integrated circuits, lasers, fiber optics and more.

Each Concept Module goes right to the heart of the matter. You waste no time on extraneous material or outdated history. It's a fast, efficient, and lively learning experience... a non-traditional approach to the most modern of subject matter.

Unique Interactive Instruction

With each module, you receive a McGraw-Hill Action Audio Cassette. Each tape is a dynamic discussion that drives home the key facts about the subject. Your learning

With your first module, you get this solderless breadboarding system. You'll use it throughout the series to build electronic circuits and bring concepts to life.

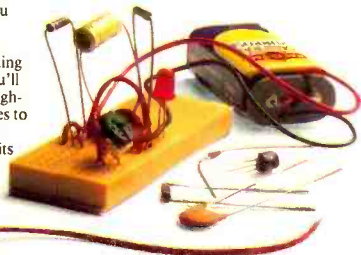

experience is reinforced through interaction with vividly illustrated text, audio cassettes, and actual electronic experiments. Indexed binders preserve backup material, notes, and tapes for convenient referral.

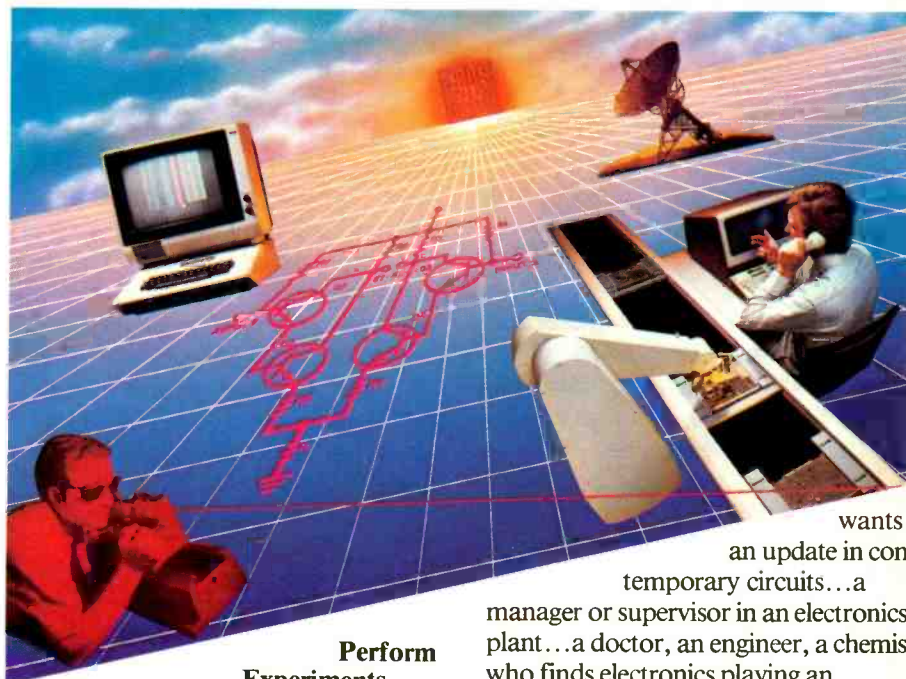

Perform Experiments in Contemporary Electronics

Throughout your series, laboratory experiments reinforce every significant point. This essential experience... dynamic, hands-on demonstrations of theory in practice... will help you master principles that apply all the way up to tomorrow's latest VLSI (Very Large Scale Integrated) circuitry.

In your very first module, you'll use integrated circuits to build a digital oscillator, verifying its operation with a light emitting diode (LED). You'll learn to identify passive and active components, understand concepts common to all electronic circuits.

For Anyone Interested in Electronics

The Contemporary Electronics Series is designed for anyone from hobbyist to professional. It's for you if you're looking for new fields of interest... if you're a teacher who

wants an update in contemporary circuits... a manager or supervisor in an electronics plant... a doctor, an engineer, a chemist who finds electronics playing an increasingly important role in your work. It's even for electronics engineers or technicians who feel their training needs freshening up. It's the quickest, most convenient, probably least expensive way to do it. And the only one that gives you hands-on experience.



15-Day No-Risk Trial

To order your first module without risk, send the card today. Examine it for 15 days under the terms of the order form and see how the Contemporary Electronics Series gets you into today's electronics. If card has been used, write us for ordering information.



McGraw-Hill
Continuing Education Center
3939 Wisconsin Ave.
Washington, D.C. 20016

ting of amplitude, timebase and triggering parameters for any signal applied to the scope's input(s).

Cursor measurements include peak-to-peak, frequency and period, rise-time, and dV and dt between any defined points. Cursor positioning is defined by softkeys, and all associated control functions and measuring options are displayed on-screen. A

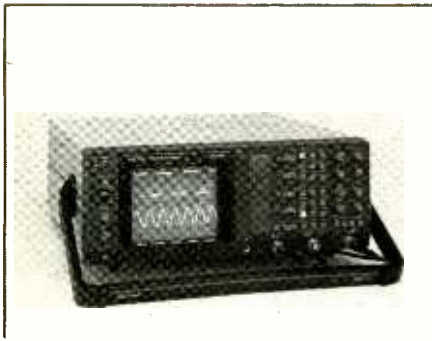

zoom function automatically calculates delay and timebase settings and allows for capture of signal details out of complex waveforms.

Both channels are clocked simultaneously, with real-time resolution of up to 10 ns to permit accurate time measurements between channels. Record lengths can be up to 4K.

Rocker switches enter ranges and settings, and a back-lit LCD panel displays instrument status and current parameter settings. Remote operation is via an optional IEEE-488 or RS-232 interface, the latter supporting a plotter or printer. \$3,990.

CIRCLE 42 ON FREE INFORMATION CARD

PLCC Test Clips

Convenient testing of 28- and 44-pin PLCC (plastic leaded chip carrier) devices has been added to the 3M line of AP Products test clips. These new clips have a wedge design that permits all four sides to open simultaneously. Heavy-duty compression springs provide firm contact pressure. An insulating contact comb prevents accidental shorts, while a patented wiping action ensures contact integrity. Narrow body design permits testing of ICs with as little as 0.200" row-to-row spacing between devices.

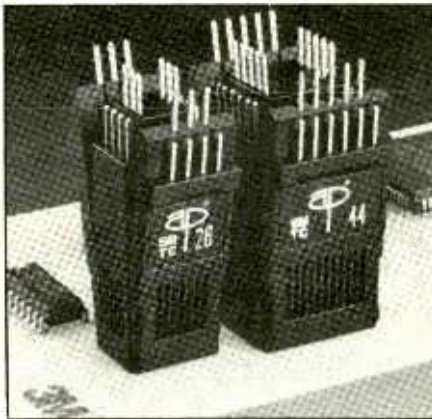

Visible probe access points permit fast, safe testing of individual leads. Staggered contact rows are on 0.1" centers for easy probe attachment. Industry-standard 0.024" square contact pins accept single row female socket connectors and Wire Wrap connections for interfacing with test equipment.

The test clips are available with alloy 764 or gold-plated leads. \$23.89 and up for 28-pin, \$30.95 and up for 44-pin versions.

CIRCLE 43 ON FREE INFORMATION CARD

PC Drawing Tablet

Easyl PC from Inforite Corp. (San Mateo, CA) is a new pressure-sensitive tablet designed for desktop publishing, presentation systems, art, animation, CAD and other touch-control applications. Its 8.5 x 12.875-inch active surface contains a matrix of 1,024 x 1,024 switches to allow the user to draw or trace directly into a computer with an ordinary pen or pencil on paper. The system is designed to run in any IBM



PC/XT/AT or compatible computer using popular graphics software, including PC Paintbrush and Dr. Halo, in CGA or EGA mode. Easyl PC operates under the GEM or Windows environment.

Easyl PC can emulate other digitizing tablets. It is supplied with emulation drivers for Summagraphics's Model MM961 and Bit Pad One. The tablet has everything implemented in software. Hence, there are no DIP switches to set to select certain features.

Secondary pointing device support is also provided. Easyl PC comes with support for the Microsoft Mouse, Logitech Mouse, PC Systems Mouse and ITAC Trackball, which plug directly into the product's board. Other secondary pointing devices can be supported as well.

Supplied with a standard RS-232 serial port, Easyl PC's hardware comes on a printed-circuit card that simply plugs into the computer's expansion bus. Extra hardware support enables the Easyl PC tablet to work in conjunction with a serial mouse or any other serial pointing device. The serial connector can be used for any standard serial device and can be configured as either COM1: or COM2: . Two-button mouse emulation is provided on the tablet, making it possible to perform any mouse action directly from the tablet.

Registration pegs that are locatable on the tablet frame are designed to accommodate ordinary punched paper to keep the paper surface in place while drawing or tracing.

CIRCLE 44 ON FREE INFORMATION CARD

Hand-Held CB Radio

Fanon Courier's Model CWT-40 hand-held 40-channel CB transceiver features better than 70 dB adjacent-channel rejection, an automatic noise limiter, and adjustable squelch. A selectable r-f-power level/battery-saver switch allows switching from full output to 0.4 watt of power.

Convenience features include a bright LED channel-number display with battery-saver on/off switch, LED meter to indicate relative signal strength, transmit, receive power and modulation percentage. Other features include an automatic Chan-



nel 9 switch, transmit/battery "low" indicators, separate condenser microphone and speaker, and jacks for earphone, external antenna and external 12-volt dc power supply.

The transceiver operates on 12 volts dc, which can be from either 10 1.2-volt rechargeable Ni-Cd rechargeable cells or eight standard 1.5-volt alkaline cells (not included). \$109.95, including carrying case and auto-lighter adapter.

CIRCLE 45 ON FREE INFORMATION CARD

Cordless Soldering Gun

A new rechargeable soldering gun has been introduced by Ungar. The Ungar 1200 Rechargeable gun is suited to all types of quick soldering tasks and for use wherever ac line



power is not available. It features a general-purpose tip that heats up rapidly and provides up to 250 solder joints on a single charge of its nickel-cadmium battery.

Supplied with the soldering gun is a UL-listed recharger that refreshes the battery overnight. A safety lock prevents accidental turn-on, and a trigger-activated light illuminates the connection being soldered. A bail on

the handle permits the gun to hang on a wall during recharging.

Optional accessories include a fine tip for electronics applications and a 60-watt heavy-duty tip for heavy electrical work and metal repair.

The 1200 is also available in a seven-piece kit (No. 2200) that includes accessory tip, flux brush/pick, 60/40 rosin-core solder and carrying case.

CIRCLE 46 ON FREE INFORMATION CARD

Hang in there — until you receive your new MCM ELECTRONICS Catalog!

It's FREE...and its 168 pages contain nearly 10,000 in-stock items that can be shipped quickly under extremely flexible payment terms.

Quality is controlled by multiple preshipment inspections under our stringent standards.

Competitive prices let you enjoy increased profit margins on every job.

Quick, TOLL-FREE ordering helps you get the items you need...when you need them.

Get your copy TODAY!



For your **FREE** copy, call **TOLL-FREE!**
1-800-543-4330

In Ohio, call
1-800-762-4315
In Alaska or Hawaii,
call **1-800-858-1849**



MCM ELECTRONICS
858 E. CONGRESS PARK DR.
CENTERVILLE, OH 45459
A PREMIER Company

SOURCE NO. ME-34

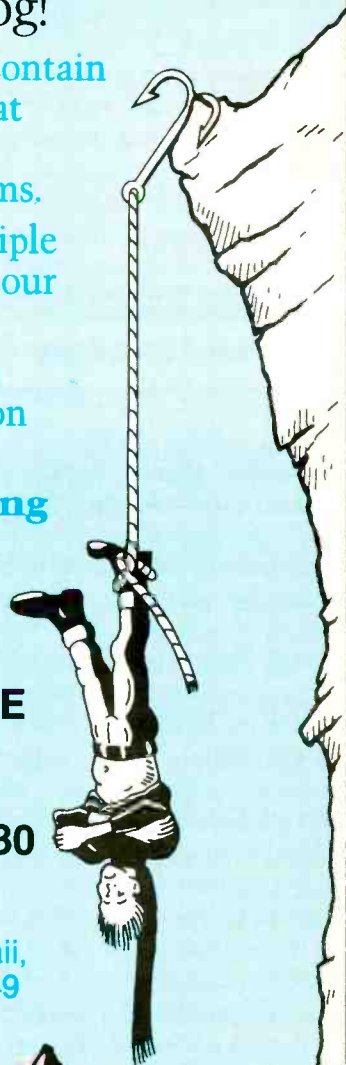

NEW PRODUCTS...

Feature-Laden Color TV

An S-video input jack provides Super-VHS (S-VHS) compatibility on Panasonic's 155-channel, cable-ready Model CTK-2063S 20" color TV receiver. The 4-pin S-video jack



enables users to connect an S-VHS VCR directly to the receiver's luminance and chrominance circuits to reduce mixing of color and luminance information and prevent cross-color interference. S-VHS capability gives this TV set the capability of re-

producing more than 400 lines of horizontal resolution, depending on program source.

A flat-faced picture tube with hyperbolic curvature places the center and outer edges of the viewing surface in approximately the same plane to reduce color imperfections. The built-in decoder allows the CTK-2063S to receive broadcast stereo and SAP (separate audio programs), and features dbx noise-reduction circuitry. A stereo amplifier features separate bass, treble and balance controls.

Additional features include: audio and video input jacks, variable audio output jacks, 12/24/48-hour parental lockout, sleep timer, Color Pilot, sharpness control, and comb, SAW and notch filters. An on-screen function displays volume level, channel selection, time of day and sleep timer, sound mute and stereo, mono or secondary audio source.

CIRCLE 47 ON FREE INFORMATION CARD

CB Receive Preamp

Electron Processing, Inc.'s (Medford, NY) RFTR Signal Intensifier wideband receiver preamplifier is designed to improve reception of CB transceivers. It installs in the antenna lead of any AM or SSB CB transceiver and connects to the unit's 12-volt dc power supply. In use, received sig-



nals are amplified a minimum of 13 dB. On transmit, an internal relay automatically bypasses the preamp. Insertion loss and VSWR are said to be negligible, and power drain is rated at 80 mA at 10 to 15 volts dc. \$49.95.

CIRCLE 48 ON FREE INFORMATION CARD

Flat-Panel Displays (from page 19)

and the fact that the input and output are in the same location, touch-screen displays are ideal in situations where users are completely untrained in the use of computers and keyboards. Touch screens are currently gaining popularity as display/input devices for controlling a wide variety of high-technology equipment in industry. They're also very useful where a computer must interface with a complete cross-section of the public, such as in automatic bank-teller machines and computerized library-card catalogs. "Hardening" of these displays to the effects of moisture, dust and dirt is a necessity to assure long life and reliable operation under a wide variety of environmental conditions.

Touch screens usually have pairs of emitter/detector transducers arranged around their perimeter so that the X and Y location of the

touch point can be accurately determined. In optically-based screens, the location is pinpointed when X and Y light beams are interrupted. Other detection schemes are based on capacitive, resistive and ultrasonic transducers.

With the capacitive technique, for example, a transparent coating layered over the screen acts as one capacitor plate, the screen itself serving as the other plate. Touching the screen causes a current drain at the touch point. This current is sensed by X-Y electrodes located around the periphery of the screen. With a resistive device, two conductors, separated by a dielectric, form a "sandwich" that covers the entire screen. Touching the screen closes a circuit that identifies the touch point.

Wells-Gardner Electronics Corp.'s recently introduced touch screen is aimed at driving down the typically

high cost of touch-screen devices. Its Cyclops system uses a CCD (charge-coupled detector) device that is an adaptation of the photodiodes commonly used in 35-mm cameras. Light from a single source (a light-emitting diode) is focused across the touch screen. When the light strikes the retroreflective material placed on two sides of the screen, it is reflected back to the CCD. The CCD then measures the angle of the returning light of each diode and compares it to an average value with a microprocessor that is part of the system. A diode output that is significantly different from the average value indicates a break in the beam and, thus, the touch point's location.

As you can see, some exciting advances are being made in flat-panel and touch-screen displays. Expect to see more of them used for specialized applications. **ME**

Without Magnetic Tape (from page 33)

that it's correctly oriented. Gently but firmly, push each IC home in its socket, taking care to prevent any pins from overhanging the socket or folding under.

To perform final checkout of the project, plug the line cord into an ac receptacle and the telephone cord into the ac line via its modular connector. Set *S3* to STANDBY; green ANSWER LED2 should now be extinguished but red STANDBY LED1 should be on.

Set VOLUME control *R16* to about mid-rotation and press and release RECORD switch *S1*. The STANDBY LED should now be off and the ANSWER LED should be on, confirming that a connection to the telephone line has been made. If your project has call-screening capability, you should also now hear a dial tone.

Speak in a normal-level voice into the microphone element until the STANDBY LED comes on again. Now, to hear the recording you just made, press PLAY switch *S2*, at which time you should hear your voice coming from the project's loudspeaker. If you incorporated the call-screening function, you'll also hear the dial tone in the recording. This won't occur during recording of your outgoing message since *S3* will be OFF during recording.

If your project doesn't function as described, check the logic circuits that feed *IC4* to determine if they're operating properly. The best way to do this is with an oscilloscope, but a high-impedance (1-megohm or more) dc voltmeter can be used to measure logic levels. A logic-0 condition is indicated by an approximately 0-volt reading, while a logic-1 condition is indicated by an approximately +5-volt reading.

Check pin 34 of *IC4* to determine if the start pulse occurs when the RECORD pushbutton is released. This is a positive-going pulse of about 25 milliseconds in duration. Also check that pin 32 of *IC4* goes to logic 1 when PLAYBACK is pressed.

If you don't obtain the proper logic levels, check the wiring of the pushbutton switches and the components associated with *IC1* and *IC2*. If possible, try new ICs. Also, make sure that you haven't inadvertently interchanged the two ICs.

The ring-detector circuit can be checked by momentarily shorting pin 2 of *IC3* to circuit ground while measuring the logic level at pin 3. The voltage at pin 3 should go to logic 1, remain at this level for about 5 seconds and then return to logic 0. If *IC3* doesn't operate as described, check the components associated with the chip to verify that they're correct in value and properly oriented on the circuit-board assembly. Also, try a new chip.

The final test is to make a recording and check operation of the project when a call comes in. If your project has call-screening, remember to set *S3* to OFF before pressing the RECORD button. Record a message and then play it back to verify that what you said was indeed recorded. Then call a friend and have him or her call you back. When the telephone rings, the call will be answered in about one second. You'll hear the recording from the project's speaker, and the ANSWER LED will light. After 8 or 16 seconds (depending on the message-length selection made), the project should revert to its standby mode. You now have up to 10 seconds to pick up your telephone's handset before the telephone system disconnects your caller.

To preserve any recording you've made, always keep the project's line cord plugged into an ac receptacle. You can use the STANDBY/OFF switch to allow the project to answer or not answer your incoming calls as you require.

When you want to make a new recording, press the RECORD button and speak directly into the microphone at a conversational level. Set *S3* to STANDBY, and the project is ready to answer your calls. **ME**



FREE CATALOG TEST INSTRUMENTS & HARD-TO-FIND TOOLS

Packed with over 5,000 quality products for testing, repairing, and assembling electronic equipment. A full selection of test instruments, power protection equipment, precision hand tools, tool kits, soldering supplies, and much more. Products are shown in full color with detailed descriptions and pricing. All products come with a 100% satisfaction guarantee. SAME-DAY shipment program.

In a hurry to receive your catalog?

Call (800)-225-5370

In Massachusetts call (617)-682-2000

Contact East, Inc., Dept. R413

P.O. Box 786, No. Andover, Ma 01845

CIRCLE 28 ON FREE INFORMATION CARD

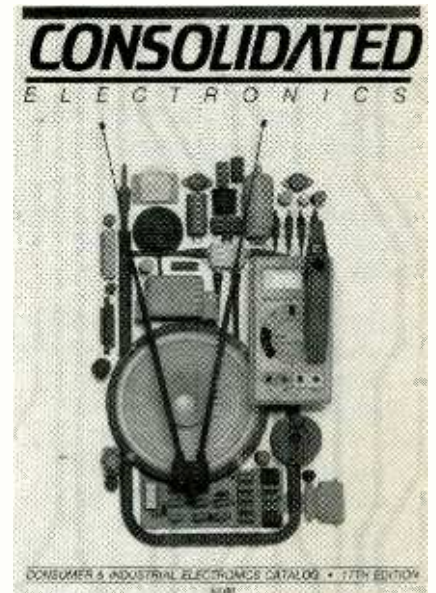

GET THE ULTIMATE ELECTRONICS CATALOG.

Order your 260 page catalogue packed with over 10,000 money saving electronic parts and equipment. Send \$3.00 check or money order, or call 1-800-543-3568 today and use your Mastercard or Visa.
Consolidated Electronics, Incorporated
705 Watervliet Ave., Dayton, Ohio 45420-2599

NAME _____
ADDRESS _____
CITY _____
STATE _____ ZIP _____

CIRCLE 60 ON FREE INFORMATION CARD

A Career Start in 21st Century Electronics

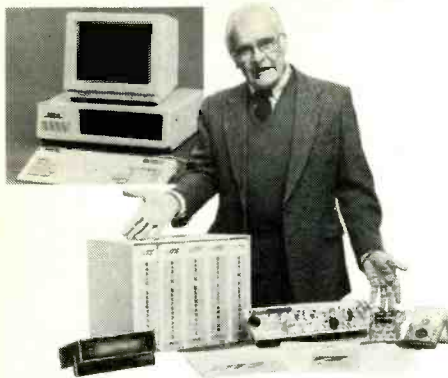

Since 1905, National Technical Schools has helped over 300,000 people just like you learn at their own pace and build successful careers. Enter the boom in electronics through home study courses in Microcomputer Technology & Servicing, TV & Radio Servicing, Video Technology, Industrial Controls (Micro-processing), Robotics or Basic Electronics.

To begin a new career or to sharpen your current skills, call 1-800-B-BETTER or write us today for complete details: NTS, Dept. ME-410, 456 West M.L. King Jr. Blvd., Los Angeles CA 90037.

Accredited by National Home Study Council

CIRCLE 73 ON FREE INFORMATION CARD

ELECTRONIC KITS

Do It Yourself, HOBBY,
EDUCATIONAL, PROFESSIONAL
100 KITS to Choose From

Don't miss out on the ultimate in hobby,
educational, and professional high
quality, functional kits.

- | | |
|----------------------|-------------------------|
| *Light Dimmers | EPROM Programmers |
| Universal Timers | Audio Input Selectors |
| Power Amplifiers | Alarms |
| Pre-Amplifiers | Thermostates |
| Power Supplies | Thermometers |
| *Light Computers | AC Motor Controls |
| Electronic Ignitions | Geiger Counters |
| Infra-red Receivers | Extension Boards |
| *Stereo-Decoders | Interface Cards |
| AM/FM Tuners | Relay Cards |
| Door Bells | OPTO Input Cards |
| Power/Switch Dimmer | *Quad Triac Switch Card |

Send For Free Catalog

H O B B Y
E L E C T R O N I C

P.O. Box 44247
Denver, Colorado 80201-4427
303-298-5544

CIRCLE 68 ON FREE INFORMATION CARD

Infrared Remote Control Relay (from page 60)

but should be kept as unobtrusive as possible. It should not block the window totally since you will probably want to use the remote control directly. One possibility is mounting the LED in a flat piece of clear plastic, and taping or gluing the plastic to the side of the VCR. If the VCR is kept in a cabinet, the sides of the cabinet can make a good mounting surface for the LED.

Be sure to connect it the right way. The correct polarity can be determined by retracing the wiring back to the relay box or by trial and error using a visible-light LED as an indicator and having someone press the buttons on the remote controller in the remote location.

Due to its short range, the remote relay should be kept as close to one's favorite viewing position as possible. Its small size should make this easy to do. Leave the transformer mounted on the back of the TV set

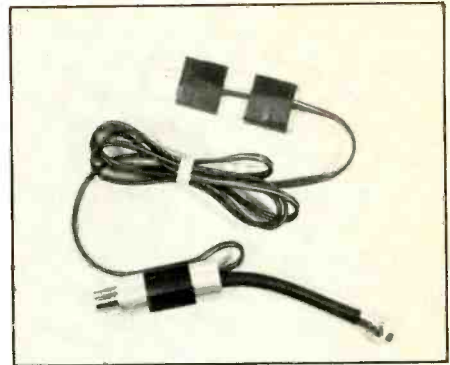

Fig. 3. Here is the Radio Shack Cat. No. 15-579 filter modified for use with the prototype.

to keep the video signal path as short as possible. The extra distance should be made up by the wire from the relay. If this wire is too long, it will get in the way. However, a long wire will allow the relay box to be moved to different locations within the room to overcome the range limitation.

If you have video signal splitters or a distribution amplifier connected to the output of your VCR, be sure to connect the infrared splitter after all that. The coax cable that runs between the high-pass filter at the VCR and the transformer at the TV end should have no interruptions.

Conclusion

More and more home electronic devices are being sold with infrared remote controls. This project can relay their control signals from room to room. The coax cable and the splitters aren't absolutely necessary, but in their place you will need a two-conductor wire to connect the relay to the LED. Correct polarity is still essential.

If you have more than one remote TV set playing off the same VCR, more than one remote control relay can be used with a single infrared LED. The signal splitters and relay boxes will have to be duplicated at each TV, of course, but only one LED is needed at the VCR end. **ME**

ATTACH LABEL HERE

PLEASE PRINT

NEW ADDRESS HERE

NAME _____

ADDRESS _____

CITY _____ STATE _____ ZIP _____

DATE _____

DATE _____

DATE _____

SUBSCRIBER SERVICE

CHANGE OF ADDRESS

Planning to move? Please let us know six weeks in advance so you won't miss a single issue of **MODERN ELECTRONICS**. Attach old label and print new address in space provided. Also include your mailing label whenever you write concerning your subscription to insure prompt service on your inquiry.

Modern Electronics
76 N. Broadway,
Hicksville, NY 11801

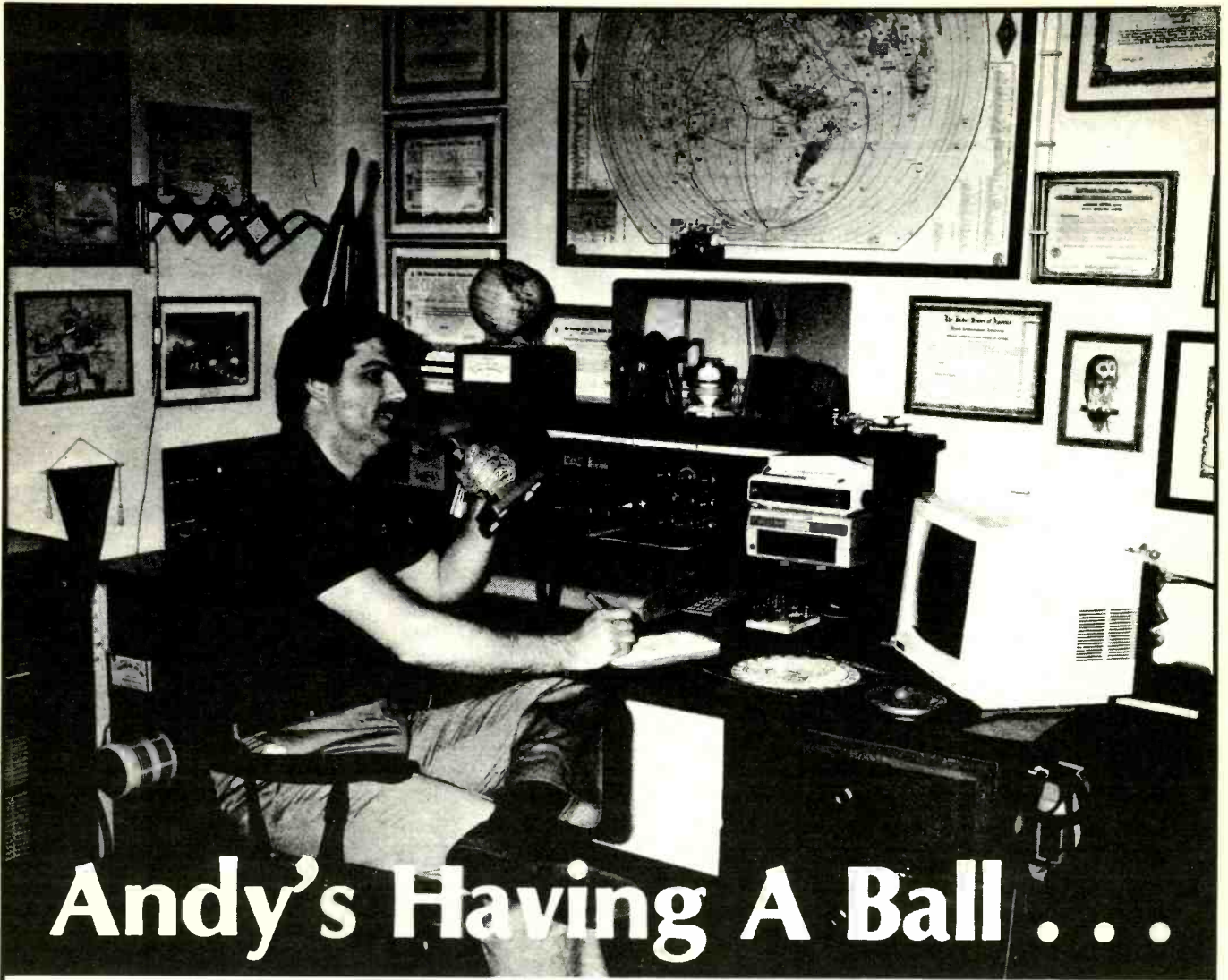

Andy's Having A Ball . . .

and you can too!

Andy is a Ham Radio operator and he's having the time of his life talking to new and old friends in this country and around the world.

You can do it too! Join Andy as he communicates with the world. Enjoy the many unique and exclusive amateur bands . . . the millions of frequencies that Hams are allowed to use. Choose the frequency and time of day that are just right to talk to anywhere you wish. Only Amateur Radio operators get this kind of freedom of choice. And if it's friends you're looking to meet and talk

with, Amateur Radio is the hobby for you. The world is waiting for you.

If you'd like to be part of the fun . . . if you'd like to feel the excitement . . . we can help you. We've got all the information you'll need to get your Ham license. Let us help you join more than a million other Hams around the world and here at home. Who are we? We're the American Radio Relay League, a non-profit representative organization of Amateur Radio operators.

For information on becoming a Ham operator
circle number 110 on the reader service card or write to:

AMERICAN RADIO RELAY LEAGUE

Dept CQ, 225 Main Street
Newington, Conn. 06111.

This space donated by this publication in cooperation with the American Radio Relay League.

MODERN ELECTRONICS MART

Classified Commercial Rates: \$1 per word, 15-word minimum (\$15.00) prepaid. (Word count includes name and address; ZIP code and abbreviation each count as one word; P.O. Box number and telephone number count as two words each.) Indicate free category heading (Computers, Communications, Electronics, Video or Miscellaneous). A special heading is available for a \$6 surcharge. First word only is set boldface caps at no charge. Add 20% for additional boldface words.

Non-Commerical Rates: FREE to subscribers, as space permits; maximum 15 words. A recent *Modern Electronics* mailing label must accompany ad.

Mart Display Rates: 1" x 1 col., \$120; 2" x 1 col., \$230. Prepayment discount 5% for 6 issues; 10% for 12 issues prepaid at once.

(All advertisers with P.O. Box addresses must supply permanent address and telephone number. Copy is subject to publisher approval.)

Mailing Information: Copy must be received by the publisher by the 25th of the third month preceding the cover date. Send Advertising material with check or money order to: Modern Electronics, Classified Department, 76 N. Broadway, Hicksville, NY 11801.

VIDEO

PROJECTION TV . . . Convert your TV to project 7 Foot picture . . . Results comparable to \$2,500 projectors . . . Total cost less than \$30.00 . . . **PLANS AND 8" LENS \$21.95 . . .** Illustrated information **FREE.** Macrocoma-MG, Washington Crossing, Pennsylvania 18977. Credit card orders 24 HRS. (215) 736-3979.

CABLE TV Secrets - the outlaw publication the Cable Companies tried to Ban. HBO, Movie Channel, Showtime, Descramblers, Converters, etc. Suppliers list included. \$8.95. Cable Facts, Box 711-ME, Pataskala, OH 43062.

STEREO-VISION Convert your old TV into a laser light show. Watch your favorite albums, FM, or guitar on the screen, Easy and inexpensive. Send \$5.00 for plans to ACG, PO Box 1972, Alexandria, VA 22313.

COPYGUARD CORRECTOR RESTORES RENTAL MOVIES. Connects between VCRs. Satisfaction Guaranteed. \$59.95 plus \$4 handling. 1-800-338-8751.

CABLE TV CONVERTERS. Scientific Atlanta, Jerrold, Oak, Zenith, Hamlin. Many others. "New" **VIDEO HOPPER "The Copy Killer"**. Visa, M/C & AMEX. 1-800-826-7623. B&B Inc., 10517 Upton Circle, Bloomington, MN 55431.

UNIQUE Video/film supplies! **FREE** catalog. Superior Pix, 323f S. Franklin Bldg., Suite 473, Chicago, IL 60606.

CABLE TV We carry a full line including units for Tocom and Pioneer. Tocom turn-ons, technically correct, recordable, auto sensing. Units for Video Tape Copyguard from \$59.95. Deluxe Electronics, 1432 Heim, Orange, CA 92665 (714) 998-6866.

ELECTRONICS

TESLA COILS - Kirlian Electrophotography - Plasma Bulbs. FREE 1988 Science Plan Catalog! SCIENTIFIC, Box 1054HMD, Duvall, WA 98019.

TRANSISTOR DEVICES that grab attention. Spinning tops, swinging figures. Plans \$6.00. Motion Products, Box 32631, San Jose, CA 95152.

AMPLIFIER 12V, 16WRMS, mono. Kit \$11.95, Assembled \$16.95. SASE for information. ERDA, 1016 Woodland Rd, Kohler, WI 53044.

CANADIANS send for free price list. DG ELECTRONICS, PO Box 312, NDG, PQ H4A 3P6.

VOICE DISGUIISERS! FM Bugs! Telephone Transmitters! Phone Snoops! More! Catalog \$1.00 (Refundable): XANDI ELECTRONICS, Box 25647, "U", Tempe, AZ 85282.

BUILD a 4 to 20 volt 1 or 2 + amp power supply. Detailed plans and diagrams \$3.75. Plans with PC board \$6.75. Thiele Electronics Co., 801 Rinzetta Dr., St. Louis, MO 63129.

SEND FOR
1988 CATALOG...
52 PAGES!

ALL ELECTRONICS CORP.

Compact well regulated switching power supply designed to power Texas instruments computer equipment INPUT 14.25 Vdc @ 350 ma -5 Vdc @ 1.2 amp -5 Vdc @ 200 ma
SIZE 4 3/4" square
CAT# PS-30 \$35.00 each

Complete functioning assembly includes ballast, on-off switch, power cord, sockets and F4T5-BL blacklight Mounted on a 7 1/8" X 3 1/8" metal plate Use for special effects lighting or erasing EPROMS
CAT# BLTA \$10.00 each

S.P.S.T momentary Push to make CAT# MPB-1
35c each - 10 for \$3.25

Will charge most nickel-cad batteries even button & N
CAT# UNCC-N \$15.00 each

Sleek high tech lamp assembly Could be used as a third auto tail light, emergency warning light, or special effects lamp. Red reflective lens is 2 3/4" X 5 1/2" is mounted on a 4" high pedestal with up down swivel adjustment. Includes 12 V re placeable bulb
CAT# TLB \$3.95 each

26 IC's including 6520A and 6560 Not guaranteed but great for replacement parts or experimentation
CAT# VIC-20 \$15.00 each

AAA SIZE 1 25180mAh \$2.25
AA SIZE1 25V 500mAh \$2.00
AA with solder tabs \$2.20
C SIZE1 2 V 1200mAh \$4.25
SUB-C with solder tabs \$4.25
D SIZE 1 2V 1200mAh \$4.25

3/4" X 1/8" dia
CAT# FLT-1 2 for \$1.00

Jumbo T 1:3:4 (5mm)
RED CAT# LED-1 10 for \$1.50
GREEN CAT# LED-2 10 for \$2.00
YELLOW CAT# LED-3 10 for \$2.00
TWO PIECE HOLDERS FOR ABOVE LED'S
CAT# HLED 10 for 65c 100 for \$5.00

Control 3:32 Vdc Load 10 amps 120 Vac Size 2 1/2" X 3 4" X 7/8"
CAT# SSRLY-10A \$9.50 each - 10 for \$85.00

TELEX 5101010163 (ALL ELECTRONIC) CUSTOMERS OUTSIDE OF THE U.S.A SEND \$1.50 POSTAGE FOR CATALOG

INFO:(818)904-0524 FAX:(818)781-2653

QUANTITY LIMITED MINIMUM ORDER \$10.00 ALK. ADDABLE TAX U.S.A. \$3.00 SHIPPING NO COD

NEW

hp HEWLETT PACKARD

The HP-28S Advanced Scientific Calculator

The HP-27S for Science and Business

Brand New

\$84.95

NEW Calculators from Hewlett-Packard

New, easy to use



SEND FOR FREE CATALOG

If you like DISCOUNTS you'll want our 116p catalog!

(714)582-2637
8-5 pm Mon.-Fri.

EduCALC, 27953-M CABOT ROAD
LAGUNA NIGUEL, CA 92677 U.S.A.

NATIONAL SEMICONDUCTOR • PANASONIC MACHINE • EVC, INC. • INTERSIL • AD EAC, INC. • J. W. MILLER • AAVD ENGINEER E. F. JOHNSON • ATLANTIC SEMICONDUCTOR

256K (262,144 x 1) DRAM 150NS \$5.70/1; \$39.95/9 Factory Firsts

JODES • DIAMOND TOOL • UNGAR • E.S. • CW INDUSTRIES • AMDEX • G.E. • UNGAR YAGED • J. W. MILLER • LUXO SC CHEMICALS • ARIES • PLESSEY

Table with 4 columns: Part No., Description, Price, and Quantity. Section: INTEGRATED CIRCUITS.

Table with 4 columns: Part No., Description, Price, and Quantity. Section: INTEGRATED CIRCUITS.

Table with 4 columns: Part No., Description, Price, and Quantity. Section: I.C. SOCKETS.

SOLDER TAIL DIP SOCKETS. Single beam, Low profile, YOUR CHOICE, TIN OR GOLD. Includes diagrams and specifications.

5% Carbon Film Resistors. Available in 1/4 W, 1/2 W, 1 W. Includes diagrams and specifications.

Table with 4 columns: Part No., Description, Price, and Quantity. Section: DISC CAPACITORS.

Table with 4 columns: Part No., Description, Price, and Quantity. Section: TANTALUM CAPACITORS.

Table with 4 columns: Part No., Description, Price, and Quantity. Section: CMOS.

Table with 4 columns: Part No., Description, Price, and Quantity. Section: CMOS.

WIRE WRAP DIP SOCKETS. Standard profile, Universal mounting and packaging capabilities. Includes diagrams and specifications.

1/4 Watt Carbon Film Resistors. Available in 1/4 W, 1/2 W, 1 W. Includes diagrams and specifications.

Table with 4 columns: Part No., Description, Price, and Quantity. Section: DISC CAPACITORS.

Table with 4 columns: Part No., Description, Price, and Quantity. Section: TANTALUM CAPACITORS.

Table with 4 columns: Part No., Description, Price, and Quantity. Section: TANTALUM CAPACITORS.

Table with 4 columns: Part No., Description, Price, and Quantity. Section: 74500 TTL.

Table with 4 columns: Part No., Description, Price, and Quantity. Section: 74500 TTL.

TIN PLATED WIRE WRAP DIP SOCKETS. Available in 1/4 W, 1/2 W, 1 W. Includes diagrams and specifications.

1/4 Watt Metal Film Resistors. Available in 1/4 W, 1/2 W, 1 W. Includes diagrams and specifications.

Table with 4 columns: Part No., Description, Price, and Quantity. Section: DISC CAPACITORS.

Table with 4 columns: Part No., Description, Price, and Quantity. Section: TANTALUM CAPACITORS.

Table with 4 columns: Part No., Description, Price, and Quantity. Section: TANTALUM CAPACITORS.

Table with 4 columns: Part No., Description, Price, and Quantity. Section: 74LS00 TTL.

Table with 4 columns: Part No., Description, Price, and Quantity. Section: 74LS00 TTL.

SILICON TRANSISTORS. Diode Key, Part No., Description, Price, and Quantity.

5% Metal Film Resistors. Available in 1/4 W, 1/2 W, 1 W. Includes diagrams and specifications.

Table with 4 columns: Part No., Description, Price, and Quantity. Section: DISC CAPACITORS.

Table with 4 columns: Part No., Description, Price, and Quantity. Section: TANTALUM CAPACITORS.

Table with 4 columns: Part No., Description, Price, and Quantity. Section: TANTALUM CAPACITORS.

Table with 4 columns: Part No., Description, Price, and Quantity. Section: 74C00 CMOS.

Table with 4 columns: Part No., Description, Price, and Quantity. Section: 74C00 CMOS.

1 AMP SILICON RECTIFIERS. Available in 1/4 W, 1/2 W, 1 W. Includes diagrams and specifications.

5% Wirewound Res Resistors. Available in 1/4 W, 1/2 W, 1 W. Includes diagrams and specifications.

Table with 4 columns: Part No., Description, Price, and Quantity. Section: DISC CAPACITORS.

Table with 4 columns: Part No., Description, Price, and Quantity. Section: TANTALUM CAPACITORS.

Table with 4 columns: Part No., Description, Price, and Quantity. Section: TANTALUM CAPACITORS.

Table with 4 columns: Part No., Description, Price, and Quantity. Section: 74ALS00 TTL.

Table with 4 columns: Part No., Description, Price, and Quantity. Section: 74ALS00 TTL.

3 AMP SILICON RECTIFIERS. Available in 1/4 W, 1/2 W, 1 W. Includes diagrams and specifications.

5% Wirewound Res Resistors. Available in 1/4 W, 1/2 W, 1 W. Includes diagrams and specifications.

Table with 4 columns: Part No., Description, Price, and Quantity. Section: DISC CAPACITORS.

Table with 4 columns: Part No., Description, Price, and Quantity. Section: TANTALUM CAPACITORS.

Table with 4 columns: Part No., Description, Price, and Quantity. Section: TANTALUM CAPACITORS.

The Dig-Key volume discount and service charges are simple to apply. Most items sold by Dig-Key may be combined for a volume discount. Items that are not discountable are identified by the suffix 'HARG'. We pay all shipping and insurance to addresses in the U.S.A., Canada and Mexico when check or money order accompanies order. Dig-Key only ships orders within the continental U.S., Alaska, Hawaii, Canada and Mexico.

WHEN ORDERING BY PHONE CALL 1-800-344-4533 (AK 218-881-8674). BY MAIL SEND YOUR ORDER TO: DIGI KEY, P.O. Box 877, Thiel River Falls, MN 55701. You may pay by check, money order, MasterCard, VISA or C.O.D. DIGI KEY GUARANTEE: Any parts or products purchased from Dig-Key that prove to be defective will be replaced or refunded if returned within 90 days from receipt with a copy of your invoice. PRICES SUBJECT TO CHANGE WITHOUT NOTICE.

SERVICE CHARGES: \$0.00-\$9.99 Add \$2.00, \$10.00-\$49.99 Add \$4.00, \$50.00-\$99.99 Add \$6.00, \$100.00-\$499.99 Add \$8.00, \$500.00-\$999.99 Add \$12.00, \$1000 & Up Add \$25.00

VOLUME DISCOUNT: \$0.00-\$99.99 .NET, \$100.00-\$499.99 .Less 10%, \$500.00-\$999.99 .Less 15%, \$1000 & Up .Less 25%

CTM

The magazine for Computerist & Amateur Radio
Your #1 source of Packet info.

... received my moneys worth with just one issue ...

—J. Trenbick

... always stop to read CTM, even though most other magazines I receive (and write for) only get cursory examination ...

—Fred Blechman, K6UGT

U.S.A. \$18.00 for 1 year

Mexico, Canada \$32.00

Foreign \$43.00 (land) - \$68.00 (air)

(U.S. funds only)

Permanent (U.S. Subscription) \$150.00

Sample Copy \$3.50

CHET LAMBERT, W4WDR

1704 Sam Drive • Birmingham, AL 35235
(205) 854-0271

CIRCLE 33 ON FREE INFORMATION CARD

NO WAITING FOR COMPLETE, LOW PRICED, CHIP COMPONENT KITS

CC-1 Capacitor Kit contains 365 pieces, 5 ea. of every 10% value from 1pf to .33µf. CR-1 Resistor Kit contains 1540 pieces, 10 ea. of every 5% value from 10Ω to 10 megΩ. Sizes are 0805 and 1206. Each kit is ONLY \$49.95 and available for immediate One Day Delivery!

Order by toll-free phone, FAX, or mail. We accept VISA, MC, AMEX, COD orders, or company PO's with approved credit. Call for free detailed brochure.



COMMUNICATIONS SPECIALISTS, INC.

426 West Tarr Avenue • Orange, CA 92665-4296
Local (714) 998-3021 • FAX (714) 974-3420
Entire U.S.A. 1-800-854-0547

CIRCLE 34 ON FREE INFORMATION CARD



PICKS UP A WHISPER 50 FEET AWAY!

The model WAT-50 miniature FM transmitter uses a 4-stage circuit NOT to be confused with a simple wireless microphone. Simply snap the unit on top of a 9V battery and you can hear every sound in an entire house up to 1 mile away! Use with any FM radio. Tunes to any frequency from 70mhz - 130mhz. Easy to assemble kit includes all parts and instructions. Only 29.98 tax incl.



The **WIRELESS TELEPHONE TRANSMITTER** model WTT-20 is only about the size of a dime, yet transmits both sides of a telephone conversation to any FM radio with crystal clarity. Completely automatic. Uses power from the telephone line itself - never needs a battery! Up to ¼ mile range. Tunes from 70mhz - 130mhz. Easy to assemble kit includes all parts and instructions. Only \$29.98 tax incl.

Call or send MO, VISA, MC for immediate delivery. Single kit orders include \$1.50 S&H. FREE SHIPPING on orders of 2 or more. All orders shipped by U.S. Mail. COD add \$4.00. Personal checks allow 21 days.

DECO INDUSTRIES
BOX 607, BEDFORD HILLS, NY 10507
914-232-3878

CIRCLE 35 ON FREE INFORMATION CARD

WHO'S LISTENING? Telephone Tap Detector - red light, someone's listening - extension or tap; green light, talk safely. Telephone line power, no batteries, easy install. \$29.95 + \$3.50 S&H. THECO Logic, Box 25761, Portland, Oregon 97225-0761.

COMMUNICATIONS

TRANSISTORS-TUBES: MRF421 \$24.00, MRF454 \$14.50, MRF455-MRF477 \$11.75, MRF492 \$16.00, SRF2072 \$12.75, SRF3800 \$17.50, 2SC2290 \$16.75, 2SC2879 \$22.00, 6LF6, 6LQ6, 6JS6 8950, etc-call. New **RANGER AR3500** All Mode 10 Meter Transceiver \$319. Quantity Discounts! Best Prices on Hard-to-Find Parts, Antennas, Mics, Power Supplies, & Equipment! Catalog \$1.00 (refundable), or free with order. **RFPC**, Box 700, San Marcos, CA 92069. For information or Same Day Shipment—Call (619) 744-0728. VISA/MC/C.O.D.

POLICE, Fire Scanning Radios. Bearcat Regency Fanon. Harvey Park Radio, Box 19224ME, Denver, CO 80219.

DETECTIVES, Experimenters. Exciting New Plans. Hard to find **MICRO** and **RESTRICTED** Devices. Large Catalog \$5.00 Refundable on 1st Order. **WILSON**, P.O. BOX 5264, Augusta, Georgia 30906.

COMMUNICATIONS PLANS, BOOKS, KITS! AM/FM broadcasting (licensed/unlicensed), 1750 Meter transceivers, ham/CB amplifiers, surveillance bugs, more! **FREE** catalog, **PAN-COM**, Box 130-ME4, Paradise, CA 95967.

SECRET CB PUBLICATIONS (modifications, schematics, etc.). **KITS, FM, PARTS, ACCESSORIES, BOOKS.** Catalog \$1.00 (refundable). Selman Enterprises, P.O. Box 8189, Corpus Christi, Texas 78412. 512/853-2935.

COMPUTERS

COMMODORE CHIPS, Distributor, Factory Fresh. Low prices. For eg., 6510/6526-\$9.95, 6581-\$12.85, PLA/82S100-\$12.85, all 901 ROMS-\$10.95, New C128 Upgrade ROMS \$37.95 and many others . . . "THE **COMMODORE DIAGNOSTICIAN**", a new inexpensive way to diagnose faulty chips. This aid is a double sided laminated display diagnosing 88 variations and what chip to look for. Over 4,000 sold. \$6.95 plus \$1.00 shipping . . . **HD Power Supply** for C-64, \$27.95 plus postage . . . **COMMODORE COMPUTER REPAIR AVAILABLE** at low prices (eg. C64-\$39.95 parts/labor) . . . Send for complete catalog . . . **VISA/MC** . . . **Kasara Micro Inc.**, 31 Murray Hill Drive, Spring Valley, N.Y. 10977. 1-800-248-2983 (Nationwide) or 914-356-3131.

BASIC Computers, 10 lesson correspondence course, \$39.50. Certificate. Details free. **AMERICAN TECHNICAL INSTITUTE**, Box 201, Cedar Mountain, NC 28718.

FINAL Closeout of new, Surplus, MS-DOS Software, and Manuals!! 10% Off with this ad. Free Catalog. **GIL Electronics**, Dept. 2, P.O. Box 1628, Soquel, CA 95073.

Educational Engineering Software, CompDes Circuit Design, CompMath Math tutor, CompView Digital Signal Analysis. \$49 each, (614)491-0832, **Bsoft Software**, 444 Colton Road, Columbus, Ohio 43207.

ORGANIZER SOFTWARE. Now Apple II+, Iie, Iic owners can use their computer for organizing, all phone numbers, addresses, recipes, combinations, serial numbers, etc. Instructions and private access code included on disk! **TO ORDER;** send \$10 and S.A.S.E. to: S.A. Golin, P.O. Box 879, Antioch, IL 60002.

LINEAR PARTS—Transistors: MRF454 \$15, MRF455 \$12, MRF477 \$11, MRF492 \$16.75, MRF421 \$22.50, SRF2072 \$13, SRF3662 \$25, 3800 \$18.75, 2SC2290 \$19.75, 2SC2879 \$25. **Tubes:** 6KD6 \$10.50, 6LQ6 \$9.75, 6LF6 \$9.75, 8950 \$16.75. Best Prices on Palomar Road Noise Mics, Ranger AR3300. New 16 page Catalog listing radio/amplifier tricks—Channel Modification, PLL-Sliders, Peaking for Range, Hard-to-Find Linear Parts—Mail \$1.00 to: **RFPC**, Box 700, San Marcos, CA 92069. For Same Day Parts Shipment, Call (619) 744-0728.

TI-99/4A Software/Hardware bargains. Hard to find items. Huge selection. Fast Service. Free Catalog. **TYNAMIC**, Box 690, Hicksville, NY 11801.

INTERFACE, solid state, for 8-bit microprocessors. Control 8 devices (AC or DC) and detect status with microswitches, etc. Expansion capability to 32 devices. Innovative Engineering, Inc., P.O. Box 30252, Knoxville, TN 37923.

INVENTORS

INVENTOR SEEKS INVESTORS to supplement financing of marketing of new type of television receiver. Details free. \$500 minimum investment secured by ½% of royalties when awarded. **VIDEOVENTIONS**, P.O. Box 22725, Lyndon, KY 40222.

INVENTORS

INVENTORS! Can you profit from your idea? Call **AMERICAN INVENTORS CORPORATION** for free information. Over a decade of service, 1-800-338-5656. In Massachusetts or Canada call (413) 568-3753.

INVENTORS

INVENTORS! Have idea for product or invention, don't know what to do? Call **AIM** we present ideas to manufacturers - Toll Free 1-800-225-5800.

POLICE/FIRE SCANNER

"**WANTED**" Good, Used Shortwave Receivers, Ham Gear, Police Scanners, CBs, Etc., Highest Prices Paid!! We Buy/Sell/Trade!! One Stamp For Our Huge Used List! **NEW** Catalog \$1.00. **GALAXY**, Box 1202, Akron, OH 44309 (216) 376-2402.

UNIVERSITIES

VILLARREAL NATIONAL UNIVERSITY. Fully accredited state university, 45,000 students on campus. Offering non-residential Master's and Doctorate degrees. Inquire: International Program, c/o International Educational Consultants, 2175-B Highpoint Road, Suite 217-3, Snellville, GA 30278.

CB RADIO/10 METERS

WE specialize in technical information, parts, and services for CB radios. 10-Meter and FM Conversion kits, repair and modification books, plans, high-performance accessories. Over 12 years! Catalog \$2. CBCI, Box 31500ME, Phoenix, AZ 85046.

CABLE EQUIPMENT

CABLE TV DECODERS AND CONVERTERS get your free catalog or order toll free 1-800-624-1150. Information Call (402)-554-0417. M.D. Electronics Inc., 5078 So. 108th Ste#115, Omaha, Nebraska 68137

MISCELLANEOUS

MUSIC-ON-HOLD circuit. Easy to build, adds music or recorded announcements 'on-hold', to any phone! Complete plans \$7.00. Kits/plans catalog \$2.00. **LESTRONICS**, Box 2321-ME, St. Louis, MO 63114.

HI-TECH in your car. Complete plans: \$14.45; free details. Modern Labs, 2900a Ruisseau, St. Elizabeth, QC, J0K2J0, Canada.

"**BEARCAT, REGENCY**" Kenwood, Icom, Sony, NEW/USED, BUY/SELL/TRADE! MORE!! 1988 Catalog \$1.00, STAMP For Used List!! **GALAXY**, Box 1202, Akron, OH 44309. (216) 376-2402.

STRANGE STUFF COMPLETE ITEMS PLANS, KITS. LASER EAVESDROPPING, HIDDEN WEAPONS, BUGGING AND COUNTERMEASURE SOURCES, ADULT TOYS. INFORMATION PHOTO PACKAGE \$3.00 REFUNDABLE, DIRIJO CORPORATION, BOX 212-M, LOWELL, NC 28098. INFORMATION 704-868-3408.

ASIAN LADIES want correspondence for friendship, marriage, **SUNSHINE INTERNATIONAL, Dept. TW, Box 260, North Hollywood, CA 91603.**

APEX® Screwdriving Bits. Any size. Complimentary illustrated list. M. Shockey's, 5841 Longford, Dayton, Ohio 45424. (513) 236-2983.

101 Money Making Businesses... Make your home computer pay off!! Send \$2.00 Box 816265, Dallas, TX 75381.

INTRODUCING 101 New and Improved Screwdriving Bits! Free details. Write: Shockey's, Dept. 457, 5841 Longford, Dayton, OH 45424. (513) 236-2983.

SATELLITE and cable equipment schematics, service manuals, booklets, diagrams, information packages, construction material, covers, converters, receivers, decoders. Catalog \$3.00. Ponderosa Company, 3624 Citadel Drive North #289M, Colorado Springs, Colorado 80909.

Free Product Information

Readers can obtain free information on products advertised by certain companies, as well as for some editorially mentioned products. Simply circle the appropriate number printed below an advertisement onto the Modern Electronics "Free Information Service" card bound into this issue. After filling in your name and address, just mail the postpaid card. Your request will be forwarded directly to the advertiser with a mailing label prepared by our reader-service department to ensure speedy response.

CABLE T.V. CONVERTERS WHY PAY A HIGH MONTHLY FEE?

All Jerrold, Oak, Hamlin, Zenith, Scientific Atlanta, Magnavox and all specialized cable equipment available for shipment within 24 hours. For fast service MC/VISA or C.O.D. telephone orders accepted (312) 638-5320 60 Day Warranty (Quantity Discounts) 8 A.M. to 5 P.M. Monday through Friday Central Time. Stamp Envelope (60¢ postage) for FREE Catalog.

Midwest Electronics Inc.
5143 W. Diversey • Chicago, IL 60639
No Illinois Orders Accepted

REMOTE CONTROL KEYCHAIN



Complete w/mini-transmitter and +5 vdc RF receiver Fully assembled including plans to build your own auto alarm

\$19.95 Check, Visa or M/C 30 days return

VISITECT INC. (415) 872-0128
PO BOX 5442, SO. SAN FRAN., CA 94080

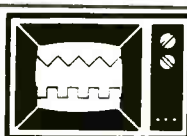

FINALLY!

An interesting and worthwhile project. This EASY-TO-BUILD circuit lets you use any regular TV set as a simple OSCILLOSCOPE. Build for less than \$10. NO MODIFICATIONS TO TV! Single or dual trace. Send for FREE CATALOG of other plans and kits.

DETAILED PLANS: \$4.95
TV-SCOPE
PENN RESEARCH, Box 3543
Williamsport, PA 17701

MICRO ART

508 Central Ave.
Westfield, N.J. 07090
(201) 654-6008

TTL SERIES		74LS154		4012		25	
7400	25	74396	85	74LS155	60	4013	25
7401	25	74393	100	74LS157	45	4015	30
7402	25	75324	20	74LS174	30	4016	25
7403	25	75452	55	74LS191	45	4019	30
7404	25	75454	55	74LS192	60	4022	60
7405	30	74LS194	60	4023	20		
7406	30	74LS195	60	4024	45		
7407	25	74LS201	55	4025	20		
7408	30	74LS202	60	4026	45		
7409	30	74LS203	60	4027	45		
7410	25	74LS204	60	4028	60		
7411	25	74LS205	60	4029	60		
7412	25	74LS206	60	4030	60		
7413	25	74LS207	60	4031	60		
7414	25	74LS208	60	4032	60		
7415	25	74LS209	60	4033	60		
7416	25	74LS210	60	4034	60		
7417	25	74LS211	60	4035	60		
7418	25	74LS212	60	4036	60		
7419	25	74LS213	60	4037	60		
7420	25	74LS214	60	4038	60		
7421	25	74LS215	60	4039	60		
7422	25	74LS216	60	4040	60		
7423	25	74LS217	60	4041	60		
7424	25	74LS218	60	4042	60		
7425	25	74LS219	60	4043	60		
7426	25	74LS220	60	4044	60		
7427	25	74LS221	60	4045	60		
7428	25	74LS222	60	4046	60		
7429	25	74LS223	60	4047	60		
7430	25	74LS224	60	4048	60		
7431	25	74LS225	60	4049	60		
7432	25	74LS226	60	4050	60		
7433	25	74LS227	60	4051	60		
7434	25	74LS228	60	4052	60		
7435	25	74LS229	60	4053	60		
7436	25	74LS230	60	4054	60		
7437	25	74LS231	60	4055	60		
7438	25	74LS232	60	4056	60		
7439	25	74LS233	60	4057	60		
7440	25	74LS234	60	4058	60		
7441	25	74LS235	60	4059	60		
7442	25	74LS236	60	4060	60		
7443	25	74LS237	60	4061	60		
7444	25	74LS238	60	4062	60		
7445	25	74LS239	60	4063	60		
7446	25	74LS240	60	4064	60		
7447	25	74LS241	60	4065	60		
7448	25	74LS242	60	4066	60		
7449	25	74LS243	60	4067	60		
7450	25	74LS244	60	4068	60		
7451	25	74LS245	60	4069	60		
7452	25	74LS246	60	4070	60		
7453	25	74LS247	60	4071	60		
7454	25	74LS248	60	4072	60		
7455	25	74LS249	60	4073	60		
7456	25	74LS250	60	4074	60		
7457	25	74LS251	60	4075	60		
7458	25	74LS252	60	4076	60		
7459	25	74LS253	60	4077	60		
7460	25	74LS254	60	4078	60		
7461	25	74LS255	60	4079	60		
7462	25	74LS256	60	4080	60		
7463	25	74LS257	60	4081	60		
7464	25	74LS258	60	4082	60		
7465	25	74LS259	60	4083	60		
7466	25	74LS260	60	4084	60		
7467	25	74LS261	60	4085	60		
7468	25	74LS262	60	4086	60		
7469	25	74LS263	60	4087	60		
7470	25	74LS264	60	4088	60		
7471	25	74LS265	60	4089	60		
7472	25	74LS266	60	4090	60		
7473	25	74LS267	60	4091	60		
7474	25	74LS268	60	4092	60		
7475	25	74LS269	60	4093	60		
7476	25	74LS270	60	4094	60		
7477	25	74LS271	60	4095	60		
7478	25	74LS272	60	4096	60		
7479	25	74LS273	60	4097	60		
7480	25	74LS274	60	4098	60		
7481	25	74LS275	60	4099	60		
7482	25	74LS276	60	4100	60		
7483	25	74LS277	60	4101	60		
7484	25	74LS278	60	4102	60		
7485	25	74LS279	60	4103	60		
7486	25	74LS280	60	4104	60		
7487	25	74LS281	60	4105	60		
7488	25	74LS282	60	4106	60		
7489	25	74LS283	60	4107	60		
7490	25	74LS284	60	4108	60		
7491	25	74LS285	60	4109	60		
7492	25	74LS286	60	4110	60		
7493	25	74LS287	60	4111	60		
7494	25	74LS288	60	4112	60		
7495	25	74LS289	60	4113	60		
7496	25	74LS290	60	4114	60		
7497	25	74LS291	60	4115	60		
7498	25	74LS292	60	4116	60		
7499	25	74LS293	60	4117	60		
7500	25	74LS294	60	4118	60		

LINEAR		N5556		TRANSISTORS & DIODES	
LM300K	50	UA741	25	MPF901	1 25
LM307H	40	UA798	50	2N2222A	101
LM338H	60	MC1350	85	2N2222A	41
LM339H	60	MC1356	40	PN9207A	101
LM311H	40	MC1398	60	2N2904A	51
LM311H	40	MC1458	25	2N3055	55
MC1317	75	UJN283	150	PN3643	101
LM318H	40	LM3903	50	PN4004	101
CA324	35	LM3904	50	PN3906	101
LM324	60	MC7805	45	2N5998	2 50
LM339	35	MC7806	45	2N5998	2 50
LM380N	40	MC7812	45	HOUSE#216	
LM386N	80	MC7824	45	U92 NPN 2911	
LM390B	45	MC7905	45	1N914A	401
N5555	25	MC7912	45	1N4148	401
				1N4001	301
				1N4002	251
				1N4007	151
				1N5218	51

DIP IC SOCKETS	
8 PIN/09, 14 PIN/13, 15 PIN/15, 18 PIN/17, 20 PIN/19, 22 PIN/21, 24 PIN/23, 28 PIN/26, 40 PIN/28	
Zero Insertion Test Socket 28 PIN	5.00

TOKO COILS FOR FEB 1984 TV PROJECT	
Toko #s BKAN-K552AXX2, #E520HN-3000023 (07UH) & L-2(12UH) Fixed. 1 Set of 4 pcs \$6.00, 3 Sets \$15.00, 10 Sets \$45.00.	
Opto Isolator H11AX (Transistor Type)	65
Opto Isolator MXXC (SCR Type)	85
Hewlett Packard Clock (10k Specs)	2.50
Line Cord 6 feet UL Listed SPT 2	
Scope Probe Set w/everything x1/x10	24.95
Wire Stand Offs	10/15
Zener Ass'1 - 65 pcs Total - Includes Minimum 3 Different TV Devices	\$1.95
Resistor Ass'1 - 1,000 pcs 3% Values Minimum. Popular Values (1K, 10K, 100K) Included. Mostly 1/4 & 1/2W. Some 1 & 2W. Lots of Precision. Carbon Film. Taped and Reeled for Easy Sorting	\$9.95
Jumper Plugs (Combined) - Male to Male for Breadboard & Connectors	10/15 25
9VDC Wall Transformer, 200ma	\$2.95
9VDC Wall Transformer, 500ma	\$3.95
12VDC Wall Transformer, 400ma	\$6.95
6.3V 1.2A Transformer	\$1.60
12.6 VCT 1A	\$3.50
7 (Seven) AMP Tapped Transformer - 7 1/2/25/50V or 0V/18VAC	\$9.95
Muffin/Split Style Fan #SU2C7 (EG & G Rotor)	\$5.95
3 1/2" Sq., 115V	\$5.95
Jumbo Red LED's	15\$/10, 100/\$50, 500/\$100
Jumbo Green LED's	10\$/10, 100/\$10, 500/\$50
Jumbo Yellow LED's	10\$/10, 100/\$10, 500/\$50
Jumbo Yellow Hi-Intensity with Rt Angle & Black Case Features	10\$/10, 100/\$10, 500/\$50
Jumbo Amber LED's	10\$/10, 100/\$10, 500/\$50
Mini Yellow Hi Intensity with Discret, Pale Blue Lens/Case Feature 10/1.20, 100/1.00 LED Clips/Rings for Jumbo	15\$/1, 100/\$5

MAN6910 - Double Digit 7 Segment Display, Hi Efficiency Red. 56" Comm Ann	1.25
MM5481 - 14 Segment Driver Chip	.75
Hewlett Packard 7 Seg. 4" Red Ann#7651	.95
7 Seg. 3" Bent Lead (Hobby Grade)	4/51
7 Seg. 6" Bent Lead (Hobby Grade)	3/51
1.5A 50V Bridge (TO-5)	.50
4A 50V Bridge (KBU05)	.75
6A 50V Bridge 5/8" Square	1.00
10A 50V Bridge 5/8" Square	1.15
25A 200 Bridge (Soldier Lug Type)	.60
12VDC SPST Reed Relay PC Mount	.60
SPST PB Switch (Keyboard Type)	3/51
Mini Toggle DPDT (Lock Latch Feature)	.75
DPDT "Snap In" Rocker with Bulb Socket	.45
Push-Lighted Switch (No Bulb) Off - Mom	.45
Pushbutton DPST Off - Mom PC Mount	3/51
DPDT Push Button 6A 125V	3/51
TPDT "Bat" Handle Toggle (On Off On)	1.65
DPDT R: Angle PC Toggle (On Off On)	.95
11 LED Bar Graph Display, 2-3/4", Rectangular LED's (Specify Red, Green, Amber)	2.69
Giant Alpha Numeric Display 1-1/2" x 2" 7 x 5 (35 Tot)	1.25
Red LED Matrix	4.95
22uf 35V Solid Tantalum (Kemet)	3/1.00
Radial Volts - 1uf 50V, 13.2uf 50V, 13.3uf 50V, 14, 4.7uf 40V, 12, 10uf 50V, 14 22uf 35V, 15, 33uf 35V, 15, 47uf 50V, 15, 100uf 35V, 20, 220uf 35V, 22, 330uf 35V, 33, 470uf 35V, 39, 1,000uf 16V, 45	
1,000uf 75V Altic	75
3,000uf 50V Twist Loco	65
3,300uf 50V Axial Litic	85
5,000uf 40V Computer Grade (Mallory)	1.50
Ceramic Monitors - All 50V or Higher: 470uf, .001uf, .001uf, .001uf, .002uf, .002uf, .003uf, .003uf (All 50V), .01uf - 20/51, .02uf 15/51, .1uf 10/51, .22uf 10/51	
Crystal Clock Oscillator 14.9760 MHZ.	.50
UCN4168 - OSC/Freq Div Clock IC	51/1.00
AM/FM	

Plan To Move? Let Us Know.

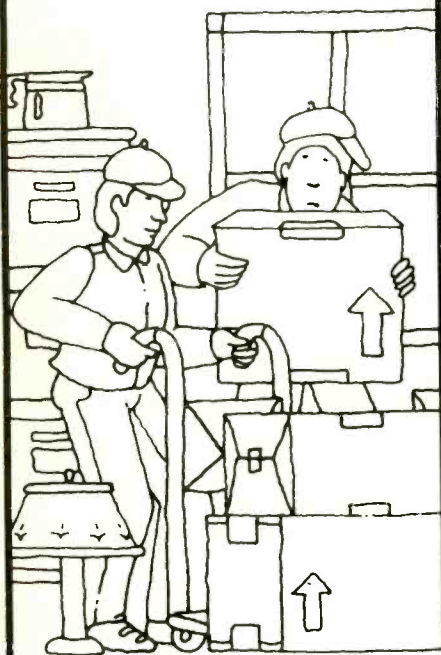

ATTACH LABEL HERE

PLEASE PRINT

NEW ADDRESS HERE

NAME _____

ADDRESS _____

CITY _____ STATE _____

DATE _____ ZIP _____

SUBSCRIBER SERVICE

CHANGE OF ADDRESS

Planning to move? Please let us know six weeks in advance so you won't miss a single issue of Modern Electronics

Attach old label and print new address in space provided. Also include your mailing label whenever you write concerning your subscription to insure prompt service on your inquiry

Modern Electronics
76 N. Broadway,
Hicksville, NY 11801

LITERATURE...

(from page 82)

Products listed include analyzers, CAE/CAD equipment, generators, meters, recorders, oscilloscopes, signal amplifiers, microcomputers and general telecommunications test equipment. For a free copy, write to: United States Instrument Rentals, 2988 Campus Dr., San Mateo, CA 94403.

Computer Accessories Catalog. Catalog #10 from B&B Electronics introduces eight new computer accessories products. Included are newly designed four- and eight-channel RS-232-to-RS-422 converters, receive-only RS-422-to-RS-232 converter, 10-mile short-haul modems, serial-to-parallel converter and two-position parallel and serial scanning switches. In addition to these items, the catalog lists and describes a wide range of stock and custom-designed electronic devices. For a copy, write to: B&B Electronics Mfg. Co., 1500P Boyce Memorial Dr., P.O. Box 1040, Ottawa, IL 61350.

Computer-Based Interfaces Catalog. MetraByte's Winter 87/88 handbook includes listings for a complete line of data-acquisition, industrial control and monitoring, signal conditioning and communications products for IBM PC/XT/AT, PS/2, Apple II and VME bus computers. Listings in this catalog are included for IBM's PS/2 Models 50, 60, 80 and other Micro-Channel computers. Other products listed include: data-acquisition boards for process control, laboratory and analytical data-collection applications; a variety of serial, parallel and IEEE-488 communications interfaces; the MetraBus industrial I/O product family; several families of intelligent modules for local and remote sensor conditioning; and a wide range of software support products. The 208-page color catalog provides complete technical and pricing information and includes helpful application and product configuration guides. For a copy, write to: Terry Persun, MetraByte Corp., 440 Miles Standish Blvd., Taunton, MA 02780.

IEEE-488 Bus Products Catalog. This new literature from ICS Electronics lists and fully describes a broad line of IEEE-488 bus enhancement products. Included in the listings are interfaces, analyzers, extenders and controllers. For a copy of the catalog, write to: ICS Electronics Corp., 2185 Old Oakland Rd., San Jose, CA 95131.

ADVERTISERS' INDEX

RS#		Page #
137	ARRL	4
21	All Electronics	92
84	Antenna Specialists	69
31	C&S Sales	71
33	CTM	94
98	Cleveland Institute of Elec	25
-	Command Productions	79
72	Communications Elec	45
34	Communications Specialists, Inc	94
69	Computer Hero	77
30	Computer Parts Galore	81
60	Consolidated Electronics	89
28	Contact East	89
32	Cook's Institute	55
35	Deco Industries	94
76	Digi-Key Corp	93
22	Edu-Calc	92
55	Electronic Equipment Bank	Cov. III
24	Fordham Radio Supply Co	Cov. IV
68	Hobby Electronics	90
97	Information Unlimited	79
41	Joseph Electronics	9
23	MCM Electronics	87
-	McGraw Contemporary	85
-	McGraw Hill Continuing Educ	41
81	Meshna, Inc., John J.	5
67	Micromart	95
-	Midwest Electronics	95
-	NRI Schools	12, 15
73	National Technical Schools	90
8	OptoElectronics	Cov. II
-	Pacific Cable Co., Inc	1
29	R.C.A.	7
36	Radio Shack	3
-	TV Scope	95
-	Visitect Inc	95

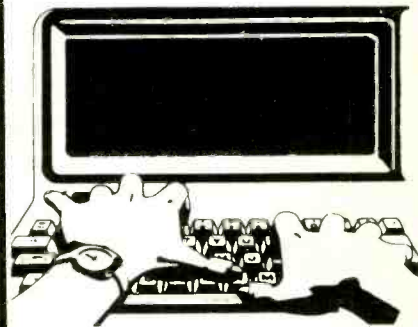

Free Product Information

Readers can obtain free information on products advertised by the above companies, as well as for some editorially mentioned products. Simply circle the appropriate number printed below an advertisement onto the Modern Electronics "Free Information Service" card bound into this issue. After filling in your name and address, just mail the postpaid card. Your request will be forwarded directly to the advertiser with a mailing label prepared by our reader-service department to ensure speedy response.

ORDER DESK HOURS (Eastern):
MONDAY-FRIDAY 10 A.M. to 5 P.M.
SATURDAY 10 A.M. to 4 P.M.
 Technical and VA orders call (703) 938-3350

Electronic Equipment Bank
 516 Mill Street N.E., Vienna, VA 22180
 Telephone (703) 938-3350

STORE HOURS (Eastern):
 Same as Order Desk Hours
 Closed Mondays
 Thursday 10 A.M. to 9 P.M.

Electronic Equipment Bank—Order Toll Free 800-368-3270

SMALL PORTABLES

DIPLOMAT 4950 \$69.95 + \$4. UPS



AM 550-1670
 FM 88-108
 11 Shortwave bands
 Stereo headset out.
 OPT. AC adapter
 SPA4.5 \$9.95

SONY ICF-4920 CALL

FM & AM
 7 Shortwave bands
 OPT. AC adapter
 Sony AC-39 \$19.95
 or ACW3...\$9.95



SANGEAN ATS-801 \$99.95 + \$4. UPS



25 Memories
 AM, FM, SW
 Digital readout
 Clock & timers
 OPT. AC adapter
 PA6P \$9.95

TOSHIBA RP-F11 CALL

All international
 & Tropical Bands
 'S' Meter
 Safety Lock
 OPT. AC adapter
 PA6P \$9.95



SONY ICF 2003 CALL



150 kHz - 30 MHz
 AM, FM
 Memories, Scanning
 24 hour clock
 OPT. AC adapter
 PA6N \$9.95

SONY ICF-7700 CALL

FM, LW, MW & 12 Shortwave bands, Clock,
 LCD readout, 15 memories. OPT AC Adapter
 PA6N \$9.95.

PANASONIC RF-B60 \$249.95

\$4. UPS

AM, FM & SW
 36 Memories, Scanning
 Keypad entry, Clock
 LCD Frequency display
 OPT. AC adapter
 PA6N \$9.95



PANASONIC RF-B10 \$89.95

FM, AM & 6 SHORTWAVE BANDS \$4. UPS
 Micro: 4 5/16 X 2 3/8 X 7/8"

WORLD RADIO TV HANDBOOK

NEW 1988 EDITION!



Listen to the world...hear the voices of people making history...eavesdrop on local programs from around the globe...gain a new perspective on international events. Guides to English broadcasts. Station information including frequencies, transmitter powers, operating times, languages, addresses, etc. Stations listed by frequency in order to help you identify them more easily. The other Shortwave Listener's Bible!

ORDER: WRTVH...\$19.95 POSTPAID!

LARGER PORTABLES

NEW! ATS 803A \$189.95 + \$6. UPS



Free Radio Stand

AM, FM, SSB & CW
 LED readout.
 Clock/Timers.
 9 Memories/Scanning.
 Stereo headset out.
 Wide/Narrow switch.
 AC Adapter included!

MAGNAVOX D2935 \$199.95 + \$6. UPS

AM, FM, SSB.
 13 Shortwave bands.
 LED readout.
 Signal meter.
 Many more extras.



Free Radio Stand

MAGNAVOX D2999 \$299.95 + \$8. UPS

AM, FM, SSB, CW/16 Memories.
 Continuous AM tuning 146 kHz-30 MHz.
 LCD readout/Quality 2 speaker sound!

SONY ICF-2010 CALL



AM, FM, SSB, CW & Air
 Band. 32 Memories.
 Scanning. LED readout.
 Clock/Timers.
 AC Adapter included.

GRUNDIG 400 \$399.95 + \$6. UPS



AM, FM, SSB, CW/24 Memories/Scanning.
 LED readout; 24 hr clock; timer.
 Many other features. Best portable audio!
 120/240V or Battery **Free Radio Stand**

ANTENNAS

'EAVESDROPPER'...SWL \$59.95 + \$4.

'DX SLOPER'...DXSWL \$69.95 + \$4. UPS

'DATONG ACTIVE ANTENNA' 

AD370...\$129.95 + \$4 UPS W/AC Adapter

SONY AN1...\$89.95 + \$4 UPS W/AC Adapter

'MFJ OUTDOOR ANTENNA'

AC Adapter

MFJ1024...\$119.95 + \$4 UPS PA1312...\$9.95

FREE EEB CATALOG!

36 Pages over 300 items for the SWLer!

NEW FOR 1988

Many items found only at EEB!

CALL OR WRITE TODAY!

GET ALL THE DETAILS!

DESK TOP RADIOS

NRD-525 CALL



90 kHz - 34 MHz. 200 Memories! Options for
 34-60, 114-174 & 423-456 MHz. 2 Clocks/Timer.
 AM, FM, CW, SSB, RTTY. Many more features.

KENWOOD R-5000 CALL



100 kHz - 30 MHz. 100 Memories! Optional 108
 -174 MHz converter. AM, FM, SSB, CW, FSK.
 Scanning. 2 Clocks/Timer. Many fine features.

KENWOOD R-2000 CALL

150 kHz - 30 MHz. 10 Memories. Optional 118
 - 174 MHz converter. AM, FM, SSB, CW. LCD
 readout. Scanning. 2 Clocks/Timer.

ICOM R-71A CALL



100 kHz - 30 MHz. 32 Memories! AM, FM (opt.),
 CW, SSB, RTTY. Scan Memory/Band. Many more
 fine features included! EEB HP Options: Call

ICOM R-7000 CALL

25-1000, 1025-2000 MHz! AM, FM & SSB. 99
 Memories. Full Scanning control. The best
 available under 15K\$! EEB HP Options: Call

YAESU FRG-8800 CALL



150 kHz - 29.999 MHz. 12 Memories. Optional
 118 - 174 MHz converter. AM, FM, SSB, CW.
 LCD readout. Scanning. 2 Clocks/Timer.

YAESU FRG-9600 CALL

60 - 905 MHz. 100 Memories. AM, FM & SSB.
 Scanning. 'Kuranishi' converters are
 available for 20 kHz - 60 MHz; 800 - 1300 MHz.

PASSPORT TO WORLDBAND RADIO

NEW 1988 EDITION!

The Shortwave Listener's Bible! 

At a glance: Data on every Broadcast station in the Shortwave spectrum! Names, Locations, Frequencies, Operating time, Language, Target area and Transmitter power. All displayed in a convenient easy to read frequency graph form. Buyers guide to more than 90 tabletop and portable receivers. Antenna recommendations. Cross index of major stations alphabetically by country.

ORDER: WBR...\$14.95 + \$1.95 UPS



- We ship world-wide
- Shipping charges not included
- Prices & specifications subject to change without notice

10 miles west of Washington, D.C.
 Sorry—No COD's
 10-5 Tues., Wed., Fri. 10-9 Thursday
 10-4 Saturday Closed Sunday and Monday



ELECTRONIC EQUIPMENT BANK
 516 Mill Street, N.E. Order Toll Free:
 Vienna, VA 22180

800-368-3270

Technical and VA Orders (703) 938-3350

Fordham measures up

Quality • Price • Delivery

Mini-Meters with Maxi-Specs



SCOPE 3½ Digit LCD Meter

• 0.5% Accuracy • DC Voltage • AC Voltage • DC Current • Resistance • Diode Test • Battery Life 300 Hrs. • Overload Protection: DC 500V, AC 350V, ohms 250V DC/AC.

Model DVM-630
Our Price **\$2995**

Zipped carrying case CC-30 \$4.50

NEW!

SCOPE 3½ Digit, LCD 8 Function with Transistor Tester

• 0.5% Accuracy • Audible continuity and diode test • 10 Amp measurement • Resistance • DC/AC Voltage.

Model DVM-632
Reg. \$60.00
Our Price **\$4495**

Zipped carrying case CC-30 \$4.50

SCOPE 3½ Digit LCD with Autoranging

• 0.5% Accuracy • Auto/Manual range selection • DC Voltage • AC Voltage • AC Current • DC Current • Resistance.

Model DVM-631
Our Price **\$4995**

Special

Deluxe carrying case CA-92 \$9.95

SCOPE Hand-Held Digital Multimeters

• Overload protection • Auto-decimal LCD readout • Polarity indication • 300 hr. 9V battery life • Low battery indicator.

• 8 Function, 37 ranges including Transistor and Capacitance measurements

Model DVM-636
Our Price **\$6750**



• 11 Function, 38 ranges including Logic Level Detector, Audible and Visual Continuity, Capacitance and Conductance measurements

Model DVM-638
Our Price **\$8750**



CA-92 Deluxe Padded Case for DVM meters. \$9.95
TL-216 Transistor and Capacitance Test Leads \$9.90

NEW!

SCOPE Frequency Counters

• 8-digit LED • Compact • lightweight • High performance • Automatic range and Hold function • High stability in reference oscillator.

Model FC-7011
100 MHz Our Price **\$16995**

Model FC-7051
550 MHz Our Price **\$24995**



FORDHAM Frequency Counter

• 10 Hz - 150 MHz Range • 7-digit LED display • VHF/HF selection • Gate time 1 sec., 5 sec. • ±1 count accuracy.

Model FC-150
Our Price **\$13990**



NEW

FORDHAM Function Generator

• 0.5 Hz - 500 KHz in 6 ranges • Sine, square & triangle wave forms • VCA and VCF inputs • Accuracy ±5% of full scale.

Model FG-202
Our Price **\$14990**



FORDHAM Signal Tracer / Injector

• Easy to operate • VU meter • Two LED mode indicators • 1 KHz test tone • 8 ohm speaker • Test leads.

Model SE-610
Our Price **\$11990**



FORDHAM LCR Bridge Meter

• Fully transistorized • 1 KHz signal generator • Measures resistance • Inductance • High mechanical and electrical stability • Battery operated.

Model LC-340
Our Price **\$14995**

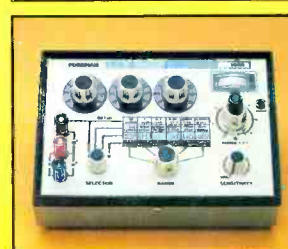

SCOPE Digital Capacitance Meter

• Digital LCD display • LSI-circuit • High accuracy: 100 ppm 0.5% • Broad test range • Fast sampling time • Capacitor discharge protection • Compact, lightweight design • One-hand operation.

Model DCM-602
Our Price **\$5995**

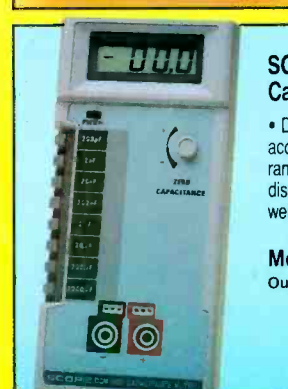

Telephone Orders Now!

EVERYDAY INCLUDING SATURDAY
Mon. - Fri. 8 a.m. - 8 p.m. EST. Sat. 9 a.m. - 3 p.m. EST

ASK FOR FREE CATALOG. Money orders, checks accepted. C.O.D.'s require 25% deposit



Fordham

260 Motor Parkway, Hauppauge, NY 11788

Toll Free **800-645-9518**

In NY State 800-832-1446

Service & Shipping Charge Schedule Continental U.S.A.

FOR ORDERS	ADD
\$25-100	\$4.50
\$101-250	\$6.00
\$251-500	\$8.00
\$501-750	\$10.50
\$751-1,000	\$12.50
\$1,001-1,500	\$16.50
\$1,501-2,000	\$20.00
\$2,001 and Up	\$25.00