

HOBBY
ELECTRONICS

From the Publishers of
Radio-Electronics

\$2.50 U.S.
SPRING 1985
\$2.95 CANADA

Hands-on Electronics

THE MAGAZINE FOR THE ELECTRONICS ACTIVIST!

48784

#4

SPACE TECHNICIANS SERVICE THE SATELLITES!

We tell you what
went on up there!

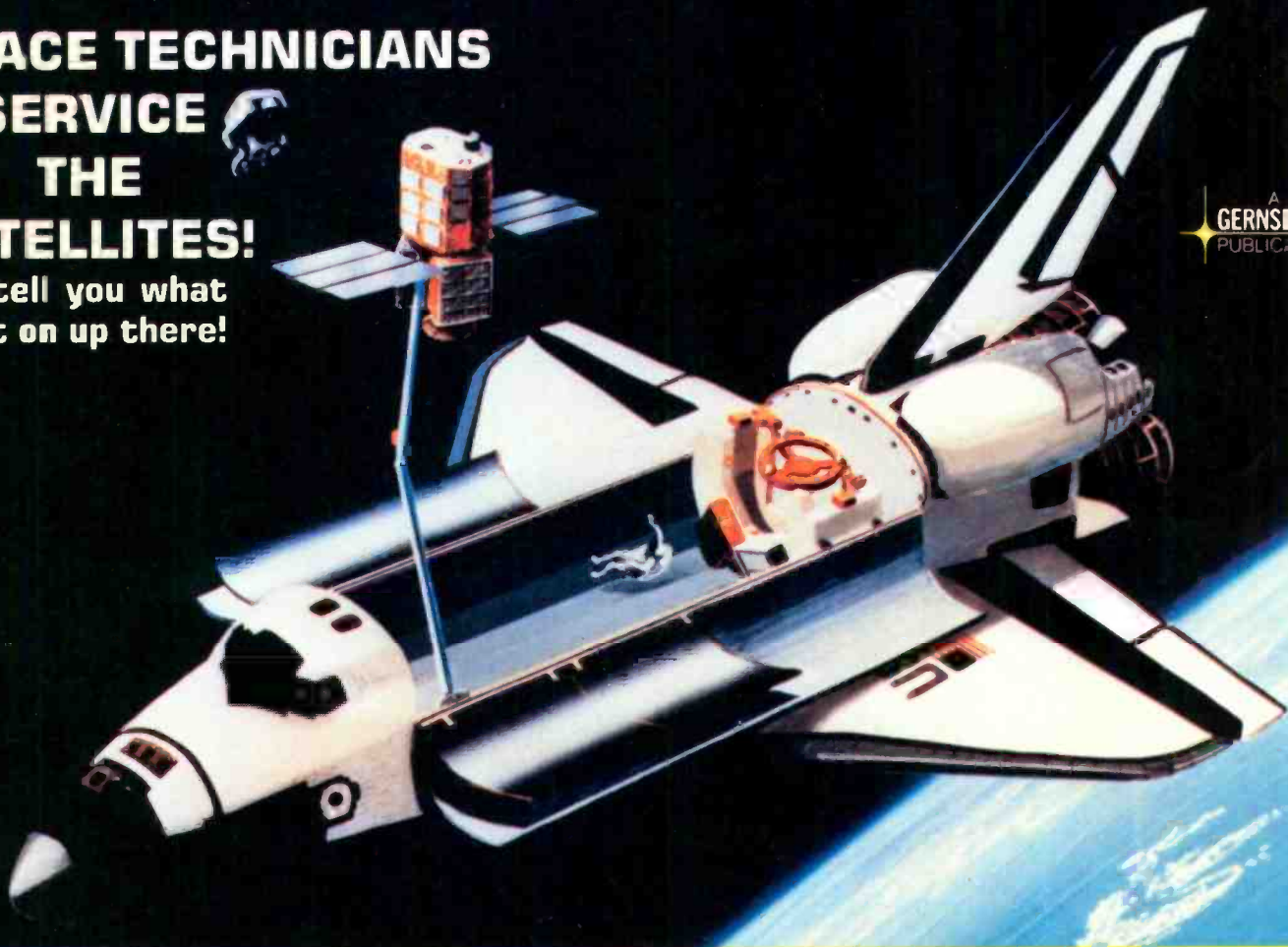

A
GERNSBACK
PUBLICATION

- Communications and Interface Port for the ZX81
- Build an Antique Shortwave Radio that works!
- Inside Digital Logic Circuits—a short course
- Battery/Alternator Monitor checks out your car

Plus— Budget C-to-V converter
Match your own 1% resistors
Test solar cells like the pros
Infrared remote/control transmitter



You can't judge a scope by its cover.

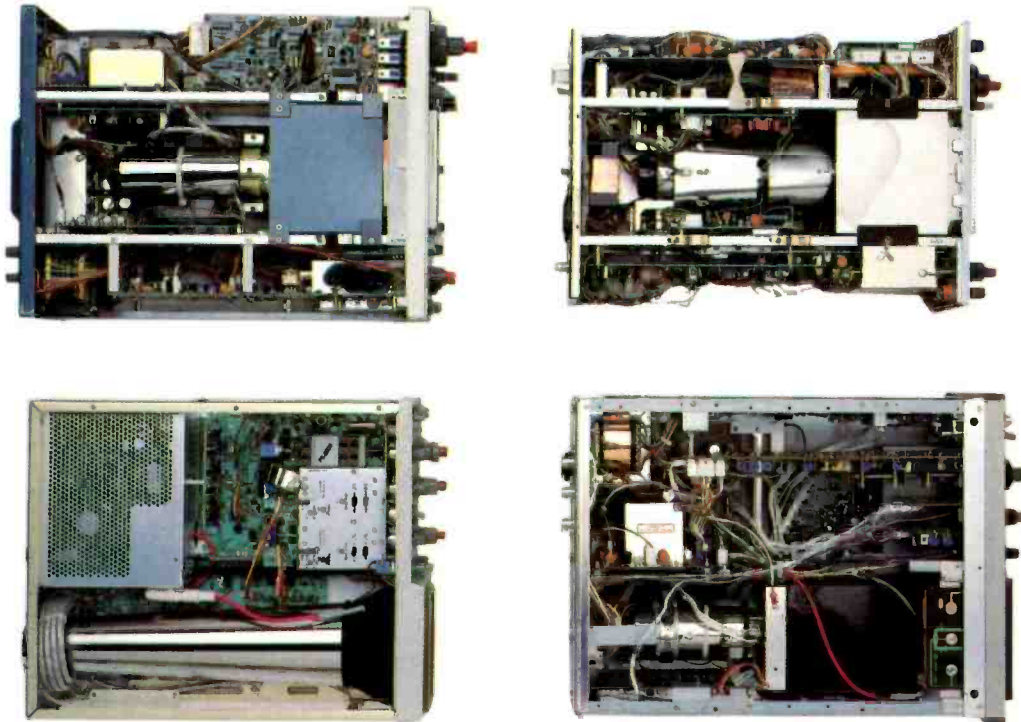

When you look at our simplified, practical internal design, you see why the Tek 2200 Series delivers unparalleled high performance and reliability in the field. You get quality that's unmistakably Tektronix in scopes so advanced, they cost you less to buy and own.

Through an innovative new concept in scope design we reduced the number of mechanical parts by 65%. Reduced cabling by 90%. Virtually eliminated board electrical connectors. And eliminated the need for a cooling fan.

The result: a scope with designed-in simplicity that increases reliability as it cuts downtime and repair costs. All of which means outstanding value in

a compact, lightweight package that your service technicians will appreciate.

Plus, you get a selection of performance to precisely match your needs. There are the 60 MHz single time base delay 2213A at \$1200* and the 60 MHz dual time base 2215A at \$1450*. And at 100 MHz, the dual time base 2235 at \$1650* and the 2236 with an integrated counter/timer/multimeter at \$2650*.

The industry's first three-year warranty† is testimony to 2200 Series dependability. Adding value to value are a variety of optional service plans that can economically extend this coverage to five years.

Consider what you're paying

now in downtime, in service, in back-up scopes. On the bottom line, a Tek 2200 Series scope will save you money, time and trouble now and in the years to come.

Contact your Tek Sales Engineer for a demo today. Or call 1-800-426-2200, Ext. 201.

In Oregon, call collect: (503) 627-9000, Ext. 201.



CIRCLE 413 ON FREE INFORMATION CARD

Tektronix
COMMITTED TO EXCELLENCE

*Prices F.O.B. Beaverton, Oregon
†3-year warranty includes CRT and applies to 2200 family oscilloscopes purchased after 1/1/83. Scopes are UL listed, CSA and VDE approved.

FEATURES

- 22 **Space Technicians Service the Satellites**—the details about the first service call in space
73 **Digital Fundamentals/Logic Circuits**—discover the operation of five digital logic-circuit elements
79 **BCB Antennas for Small Lots**—you get more wire for your space

PROJECTS YOU CAN BUILD

- 32 **C to V Converter**—measure capacitance with your digital voltmeter
40 **Solar-Cell Tester**—test for the characteristics that count
45 **Cross Match One**—match resistors to less than 1 percent
49 **Auto Battery/Alternator Monitor**—a sparkling idea for your car
53 **Infrared R/C Transmitter**—remote touch-tune your TV
59 **Build an Antique Shortwave Radio**—an old idea with new parts
82 **Shutter-Speed Tester**—your oscilloscope checks your camera

COMPUTER COVERAGE

- 65 **Add an RS-232 Port to Your ZX81**—a cheapie comes out of the closet
87 **Make Your Budget Printer Valuable**—easy retro-fits discussed
94 **Friedman on Computers**—saving on disk drives

MINI-PROJECTS

- 35 **Yelping Siren**—two oscillators against each other
36 **Low-Power Audio Amp**—plug in the Yelping Siren and stand back

SPECIAL COLUMNS

- 56 **Jensen on DX'ing**—tuning in the Pacific nations
58 **Testbench Tips**—your fresh ideas are worth money
93 **Saxon on Scanners**—pull-in the aero-action
95 **Calling All Hams**—go up instead of out with a vertical

DEPARTMENTS

- 2 **Editorial**—we talk about you this issue!
4 **Letters**—here are some interesting ones
8 **New Product Showcase**—look at all these goodies
14 **Bookshelf**—a roundup of what's new

We get letters!

I received a letter from a reader who claims that he knows our thinking on how we select construction articles for **Hands-on Electronics**. He went on, and on, and on—for six typewritten pages telling me my inner thoughts. So I devote this editorial to Charlie D. living somewhere in California.

Charlie, to be honest with you, most editors would have trouble walking across a room if they had to think about it! In the same manner, our selection process for articles is not as complex as you believe. You see, Charlie, we're hobbyists just like you. When we read a manuscript, we read it first for enjoyment. That's our prerogative, you see! And, if we enjoy the manuscript, we then begin to look deeper. We ask some basic questions like, "Will many of our readers want to build this project? Are the parts easy to obtain? Are the parts inexpensive? Is the circuit so critical that should I wire it in the morning, it will work, and when I wire it in the afternoon, it won't work?" But most important, when the project is finished will it impart practical experience on the builder that will improve his overall hobby activity? I'll stop here because I don't have the six pages that Charlie had.

I guess you know now the major criteria for inserting a particular project into **Hands-on Electronics**—the editor wants to build it himself! We are just like you, Charlie, with one big exception; we work at a job that is plain to us!

So start thumbing through this issue and start enjoying it as we did, many weeks ago, while preparing it for you.



Julian S. Martin, KA2GUN
Editor

P.S. Do all hobbyists have lumps of solder embedded in their pants as I do?

Cover photo by Walter Herstat
Composition and interior design by
Mates Graphics

STAFF

Hugo Gernsback (1884-1967) founder
M. Harvey Gernsback, editor-in-chief
Larry Steckler, CET, publisher
Art Kleiman, editorial director
Julian S. Martin, KA2GUN
editor

Carl Laron, associate editor
Brian C. Fenton, associate editor
Ruby M. Yee,
production manager
Robert A. W. Lowndes, production
associate
Karen S. Tucker, production assistant
Dianne Osias, production assistant
Jacqueline P. Weaver, circulation director
Arline R. Fishman,
advertising coordinator

BUSINESS AND EDITORIAL OFFICES

Gernsback Publications, Inc.
200 Park Ave. S., New York, NY 10003
President: M. Harvey Gernsback
Vice President: Larry Steckler



NATIONAL ADVERTISING SALES

Joe Shere
1507 Bonnie Doone Terrace
Corona Del Mar, CA 92625
714/760-8697



Hands-on Electronics, (ISSN 0743-2968) Published quarterly by Gernsback Publications, Inc., 200 Park Avenue South, New York, NY 10003. Second-Class postage pending at New York, NY and at additional mailing offices. One-year, four issue, subscription rate U.S.A. and possessions \$10.00, Canada \$13.00, all other countries \$17.00. Subscription orders payable in U.S. funds only, international postal money order or check drawn on a U.S.A. bank. U.S. single copy price \$2.50. © 1985 by Gernsback Publications, Inc. All rights reserved. Printed in U.S.A.

A stamped self-addressed envelope must accompany all submitted manuscripts and/or artwork or photographs if their return is desired should they be rejected. We disclaim any responsibility for the loss or damage of manuscripts and/or artwork or photographs while in our possession or otherwise.

As a service to readers, **Hands-on Electronics** publishes available plans or information relating to newsworthy products, techniques and scientific and technological developments. Because of possible variances in the quality and condition of materials and workmanship used by readers, **Hands-on Electronics** disclaims any responsibility for the safe and proper functioning of reader-built projects based upon or from plans or information published in this magazine.

NOW YOU CAN TRAIN FOR A GREAT CAREER IN ELECTRONICS RIGHT IN YOUR OWN HOME...

...Or Train For One Of 32 Other Money-Making Careers Below

Get In On The "Boom Years"! Electronics And Microcomputers Are The Big-Demand Fields Of The 80's!

HOME STUDY MAKES IT EASY TO START!

There's no need to quit your job or take time from your family or friends. As an ICS student, you learn at home, the hours you choose. You waste no time traveling to class or standing in registration lines. And you never miss a paycheck. But you are not alone. Although your lessons are especially written for home study, if you ever need a better understanding of something in your lessons, just phone or write to us and one of our instructors will get back to you with a detailed answer.

HANDS-ON TRAINING AND EQUIPMENT INCLUDED WITH COURSE

The great thing about your training is that it's so complete. We start you at the very beginning... explain everything step-by-step. Your lessons are clearly written and fully-illustrated with photos, charts, diagrams, examples... whatever it takes to give you a total understanding of each subject or experiment. Everything you need to complete your training—books, lessons, equipment, testers—is included with your course at no extra cost.

FIRST FOLD HERE

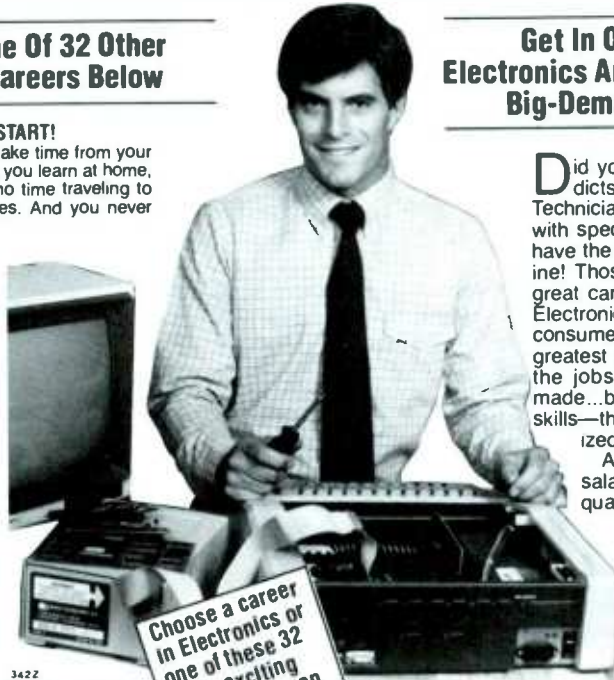

Did you know the Department of Labor predicts a 40% increase in jobs for Electronics Technicians over the next ten years! And those with specialized training in microcomputers will have the same kind of opportunities! Just imagine! Those who start now and get in on these great careers will witness the "boom years" of Electronics... the years of biggest demand for consumer and industrial products...the time of greatest opportunity for job advancement. Yes, the jobs are there and there's money to be made...but only for those with knowledge and skills—the kinds of skills gained through specialized training.

Already many employers are offering top salaries and bonuses to attract the most qualified people. And as electronics and microcomputers become more vital in every aspect of our lives—industry, business, even in the home—it's easy to see why the future of electronics has no place to go but UP!

3422

FIRST FOLD HERE

NO POSTAGE NECESSARY when you mail this ENTIRE Postage-Paid ad To Mail—Fold ad in following manner:

1. Remove entire page—tear out or cut on dotted line to left
2. Fold page in half on 1st fold lines
3. Fold page again, on 2nd fold lines
4. Tape or glue the 3 open sides and drop in the mailbox today.



RUSH me free facts and full information on how I can study at home for the career I have chosen. I understand I am under no obligation and no salesman will visit me. **CHECK ONE BOX ONLY.**

TWO-YEAR BUSINESS DEGREE PROGRAMS

- Business Management
- Accounting
- Marketing
- Finance

TWO-YEAR TECHNICAL DEGREE PROGRAMS

- Mechanical Engineering Technology
- Civil Engineering Technology
- Electrical Engineering Technology
- Electronics Technology

CAREER DIPLOMA PROGRAMS

- Microcomputer Repair
- Basic Electronics
- TV/VCR Repair
- Computer Programming
- High School
- Catering Gourmet Cooking
- Auto Mechanics
- Bookkeeping*
- Hotel/Restaurant Management
- Drafting*
- Veterinary Assistant*
- Travel Agent*
- Air Conditioning & Refrigeration
- Electrician
- Police Sciences*
- Art
- Small Business Management
- Wildlife/Forestry Conservation*
- Diesel Mechanics
- Gun Repair*
- Motorcycle Repair*
- Surveying & Mapping
- Small Engine Repair
- Fitness & Nutrition

*These courses are offered by North American Correspondence Schools. Both North American and International Correspondence Schools are Accredited Members of the National Home Study Council in Washington D.C.

Dept. WMS55

Name _____ Age _____

Address _____

City/State/Zip _____

Phone No. () _____

Choose a career in Electronics or one of these 32 other exciting careers you can train for at home in spare time.

NO POSTAGE NECESSARY IF MAILED IN THE UNITED STATES

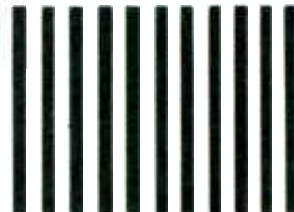

BUSINESS REPLY MAIL

First Class Permit No. 1000 Scranton, PA 18515

Postage will be paid by addressee

INTERNATIONAL CORRESPONDENCE SCHOOLS
NORTH AMERICAN CORRESPONDENCE SCHOOLS
Scranton, PA 18515

REMOVE AND MAIL ENTIRE PAGE

REMOVE AND MAIL ENTIRE PAGE

SECOND FOLD HERE

SECOND FOLD HERE

TOLL FREE ORDERS • 1-800-826-5432
(IN CALIFORNIA: 1-800-258-6666)
INFORMATION • (213) 380-8000

**L.E.D.'S
STANDARD JUMBO
DIFFUSED**
RED 10 FOR \$1.50
GREEN 10 FOR \$2.00
YELLOW 10 FOR \$2.00

**FLASHER LED
5 VOLT OPERATION
RED JUMBO SIZE
\$1.00 EACH**
**BI POLAR LED
2 FOR \$1.70**

**LED HOLDERS
TWO PIECE HOLDER
FOR JUMBO LED
10 FOR 65¢ 200 FOR \$10.00**

**CLEAR CLIPLITE
HOLDER
MAKE LED A FANCY
INDICATOR CLEAR
4 FOR \$1.00**

**EDGE
CONNECTORS**



**22/44 22/44 GOLD PLATED
CONTACTS
156 CONTACT SPACING
\$2.00 EACH 10 FOR \$18.00**

**28/56
28/56 GOLD PLATED CONTACTS
156 CONTACT SPACING
\$2.50 EACH 10 FOR \$22.00**

13 VDC RELAY
CONTACT SP N C
10 AMP @ 120 VAC
ENERGIZE COIL TO
OPEN CONTACT
COIL 13 VDC 650 OHMS
SPECIAL PRICE \$1.00 EACH

**KEY ASSEMBLY
5 KEY \$1.00
EACH**
CONTAINS 5 SINGLE-POLE
NORMALLY OPEN SWITCHES
MEASURES 3 3/4" LONG

**6 KEY \$1.25
EACH**
CONTAINS 6 SINGLE-POLE
NORMALLY OPEN SWITCHES
MEASURES 4 1/4" LONG

**SUB-MINIATURE
D TYPE
CONNECTOR**



**SOLDER TYPE SUB-MINIATURE
CONNECTORS USED FOR
COMPUTER HOOK UPS**

DB-15 PLUG \$2.75
DB-15 SOCKET \$4.00
DB-15 HOOD \$1.50
DB-25 PLUG \$2.75
DB-25 SOCKET \$3.50
DB-25 HOOD \$1.25

MULTI-SWITCHES
5 STATION INTERLOCKING
3 - 2PDT AND 2 - 6PDT SWITCHES ON FULLY
INTERLOCKING ASSEMBLY 3 1/2" BETWEEN
MOUNTING CENTERS \$2.50 EACH
5 STATION NON-INTERLOCKING
SAME AS ABOVE. EXCEPT EACH SWITCH
OPERATES INDEPENDENTLY \$2.50 EACH

SEND FOR NEW 1985 48 PAGE CATALOG

**COMPUTER
GRADE
CAPACITORS**

2,000 mfd. 200 VDC
1 3/4" DIA. • 5" HIGH \$2.00

3,600 mfd. 40 VDC
1 3/8" DIA. • 3 3/4" HIGH \$1.00

6,400 mfd. 60 VDC
1 3/8" DIA. • 4 1/4" HIGH \$2.50

31,000 mfd. 15 VDC
1 3/4" DIA. • 4" HIGH \$2.50

72,000 mfd. 15 VDC
2" DIA. • 4 3/8" HIGH \$3.50

185,000 mfd. 6 VDC
2 1/2" DIA. • 4 1/2" HIGH \$1.50

CLAMPS TO FIT CAPACITORS 800-00

**SOLDERING
IRON STAND**



ON WEIGHTED BASE
\$5.00 EACH

**WALL
TRANSFORMER**



ALL ARE 115 VAC
PLUG IN
4 VDC @ 70 MA \$2.00
9 VAC @ 1 AMP \$3.00
12.5 VAC @ 265 MA \$2.50
17 VAC @ 500 MA \$4.00
24 VAC @ 250 MA \$3.00

MINIATURE TOGGLE SWITCHES
ALL ARE RATED 5 AMPS @ 125 VAC

**S.P.D.T.
(on-on)**
P.C. STYLE
NON-THREADED
BUSHING
75¢ EACH
10 FOR \$7.00

**S.P.D.T.
(on-on)**
SOLDER LUG
TERMINALS
\$1.00 EACH
10 FOR \$9.00
100 FOR \$80.00

13.8 VOLT REGULATED POWER SUPPLY

THESE ARE SOLID STATE FULLY REGULATED
13.8 VDC POWER SUPPLIES. ALL FEATURE
100% SOLID STATE CONSTRUCTION. FUSE
PROTECTION, L.E.D. POWER INDICATOR
2 AMP CONSTANT, 4 AMP SURGE
UL LISTED \$18.00 EACH



ALL ELECTRONICS CORP.
ALL ELECTRONICS CORP.

905 S. VERMONT • P.O. BOX 20406 • LOS ANGELES, CA 90006
• QUANTITIES LIMITED • FOREIGN ORDERS
• MINIMUM ORDER \$10.00 • INCLUDE SUFFICIENT
• USA \$3.00 SHIPPING • SHIPPING
NO C.O.D. • CALIF. RES. ADD 8.25%

LETTERS

Let the Sun Shine In

I don't believe it! I was told that there is a solar-power piano, and I can't for the life of me believe that someone would buy a piano that can be played only in the sun or under a strong light. Please set the record straight in your letter column.
D.D., Boulder, WY

I don't dare, because once I do I will be proven wrong. First off, there is an electric car (circa 1909 or there about) that recharges its battery from sunlight. The solar cells were installed in the mid-sixties. So, somewhere (nowhere that we know of now), someone is playing an electronic piano by battery that is recharged by a solar panel. It's just got to be! Nevertheless, I think someone is toying with you because there is a toy on the market called the Solar Piano (S11-106) that is available from H & R Corporation, 401 East Erie Avenue, Philadelphia, PA 19134 for only \$29.50. It is a novelty item which demonstrates the use of solar energy. A pre-programmed microchip is used to generate two switch-selected tunes—Nocturne and Minuet. I was told that all it takes to power the circuit is light from a 75-watt bulb or direct sunlight.

Raise the Voltage

I am running a 7805 to provide +5-volts of regulated DC to a project that is a bit fussy about power requirements. I'm inputting the regulating circuit with a 6-volt lead-acid cell that has the oomph to power 100 such projects and still the regulation is a bit "noisy." I have replaced the 7805 twice and the circuit is identical to what I've seen in Hands-on Electronics many times over. What could be wrong? No—it's not the circuit because it runs well in the house.
B.B., Pensacola, FL

You are quite mysterious about what the project is that requires such "clean" regulated voltage. But, never mind! Your problem lies with the battery voltage. The input voltage to the 7805 should be about three volts greater than the output voltage to provide good regulation by the chip. The 6-volts DC is cutting it close. Try 8-volts DC. I'll bet it'll take care of the problem. The 3-volt boost for input voltage holds true for all 78XX and 79XX DC regulator IC's.

Two 8's and 9's

You blew it! In the Fall 1984 issue, the Musical Ringer story has errors in the

schematic diagram. Chip U1, the melody synthesizer IC, has two sets of 8 and 9 pinouts. Also, you have two S13's. Come on guys, the Musical Ringer is a great project. I've made two now and have an order for one more (my mother-in-law). J.P., Memphis, TN

Yep, we erred, etc., etc., etc. However, since everyone who purchased the chip received a pinout diagram with it, almost everyone figured out the goof. As for the two S13's, cross out the S13 in the upper left in the drawing and insert an S12 above the words "RINGER CONTROL" to the immediate left. That's it! Two readers

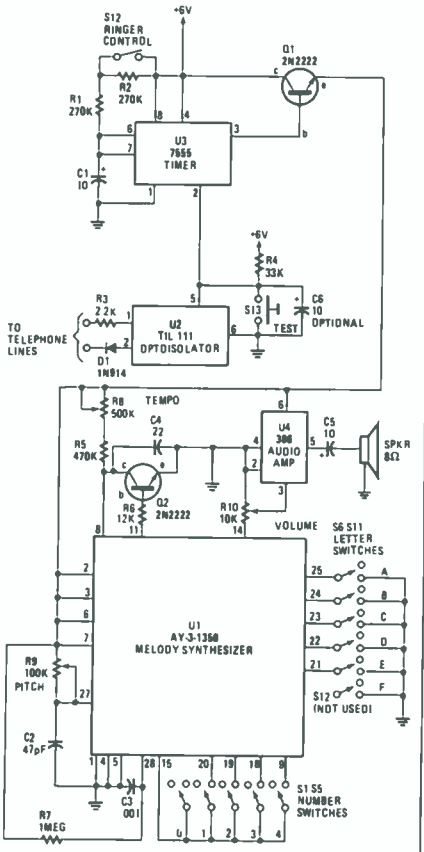

complained that the audio amp output was too low. Well, look at the size of the 386 audio chip and loudspeaker. Yes, the output would be too low in a noisy room or den where the hi-fi was blasting. You may want to add an audio amplifier chip with more zonk! The details of such an amplifier will be found in this issue.

Close the Gate

I'm using a multi-input AND gate and I tied the unused inputs to a hi (+5 V). I'm told that I should do that through a 1K resistor. Is that correct?
G.G., Detroit, MI

Yes it is! In fact, all the unused inputs (gates) on that chip can be connected together and connected to a hi through
(Continued on page 21)

What's New at AMERICAN DESIGN COMPONENTS?

"The Source" of the electro-mechanical components for the hobbyist.

We warehouse 60,000 items at American Design Components—expensive, often hard-to-find components for sale at a fraction of their original cost!

You'll find every part you need—either brand new, or removed from equipment (RFE) in excellent condition. But quantities are limited. Order from this ad, or visit our retail showroom and find exactly what you need from the thousands of items on display. Open Mon.–Sat., 9–5.

THERE'S NO RISK.

With our full 90-day warranty, any purchase can be returned for any reason for full credit or refund.

J APPLE 2c DISC DRIVE



Original equipment drive, compatible with Apple 2e, 2+ and 2c.

\$139.50 RFE

O 19" COLOR X-Y DISPLAY



Originally designed for use in Atari coin-operated games. Contains a 19V/22P 3-gun color tube, focus and brightness controls. Has electromagnetic deflection and solid state circuitry with three "Z" amp inputs (red, green, blue). Ideal for arcade replacement or, with the addition of external circuitry, for color graphics display. Manual included.

\$129.00 NEW

T 6 AMP VARIAC VARIABLE OUTPUT TRANSFORMER



Use wherever you have to vary the output voltage. Variable output 0–115V. Input 115V; 6 amp. Continuous duty.

\$29.95 NEW

A 115 CFM MUFFIN FAN



Metal frame with 5 high impact plastic blades. For cooling Hi Fi, electronic equipment, computers, etc. Mounts for intake or exhaust. 115 VAC, 60 Hz., Dim.: 4 1/8" x 1 1/2" D.

\$7.95 RFE

B SPEED CONTROL



0–100% adjustable; converts fans, blowers, hand tools to variable speed. Panel mount. Wire leads. 120V, 60 Hz., 1.6A. Dim.: 2" H x 1 1/2" W x 7/8" D. Mfr. Teccor MSC-21B

\$3.50 NEW

C 24 VDC MUFFIN FAN



115 CFM, 11 Watt. Metal frame with 5 high-impact plastic blades. For cooling Hi Fi, electronic & computer equipment. Mounts for intake or exhaust.

Mfr. — Centaur #CNDC24K4–601

\$14.95 RFE

D 35 CFM SPRITE FAN



Low noise level; intake or exhaust. Ideal for cooling electrical/electronic equipment. 115V, 50/60 Hz.; Dim.: 3.14" sq. x 1.645" deep. Mfr.: Rotron Model SU2E1

\$6.95 RFE

12V NICAD BATTERY BACK-UPS (RECHARGEABLE)



12V @ 450 Ma. Contains 10 AA cells. Recharge rate 45 MA, 16–18 hrs. Case with tab output connections. Dim: 2 1/4" H x 1 1/4" x 2 1/4" L. Mfr. GE #123233 or equiv.

\$5.95 RFE



13.2V @ 1.65 AH. Contains 11 C Cells. Portable computer battery back-up. Mfr. GE #41B035BB00101

\$15.95 RFE

COMPUTER DISC DRIVE SWITCHING POWER SUPPLY



INPUT: 115/230VAC, 50/60 Hz. OUTPUT: 12V @ .17A, +24V @ 2.2A, +5V @ 3A. Dim.: 7 1/2" x 6 1/2"

\$19.95 NEW



Power supply regulator board for microcomputers and games. INPUT: 18–24VAC; DC OUTPUT: +12V @ .05A, +5V @ .5A, –5V @ .04A. On/off switch. TRANSFORMER INCLUDED!

\$4.95 NEW

K 5 1/4" TANDON DISC DRIVE



1/2 Ht. 96 T.P.I. TM55–4 DS/Quad

\$99.00

L 48 KEY KEYBOARD

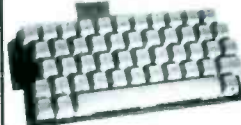

Replace the membrane keyboard on your Timex/Sinclair Z-81/1000 with this brand new "big computer" keyboard from Texas Instruments. Simple to install—complete instructions and schematic included.

\$5.95 NEW

M 12 VDC SERIES FIELD MOTOR



Coil: 115/120 VAC, 50/60 Hz. Contacts 4-pole N.O., 30 A, 240 VAC full load. Contacts: double break. Terminals: screw or quick connect. Base mtg. Dim.: 3 1/2" x 3" W x 3 1/4" H. Mfr.: Arrow Hart #51824

\$9.95 NEW

N PLUG-IN POWER SUPPLY



INPUT: 120 VAC/60 Hz., .25A OUTPUT: Pin 1 +5 VDC, .9A Pin 2 –5 VDC, .1A Pin 3 +12 VDC, .3A Pin 4 ground

Mfr.: Coleco Model 55416

\$6.95 NEW

PUMPS—COMPRESSORS—BLOWERS—MOTORS—POTENTIOMETERS—COUNTERS TIMERS—RELAYS—AUDIO & VIDEO MODULATORS—VOLTAGE REGULATORS—POWER SUPPLIES

P RELAYS

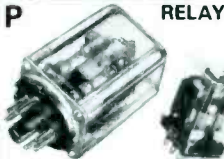

P-1 KHP Type. Voltage: 24VDC. 110VDC–115VAC. Contacts: 4 PDT 3–5 amps.

\$3.00 RFE

P-2 KAP/KRP Type. Voltage: 12/24/110VDC & 115VAC. Contacts: TPDT 5 amps. Mfr.: Potter Blumfield or equiv.

\$3.75 RFE

Q AUDIO & VIDEO MODULATOR



Made for Texas Instruments. Lets you use your TV set as a monitor for video and audio signals produced by home computers, surveillance cameras, video games, etc. Complete with 8', 5-pin din cord, hook-up diagram.

\$7.95 NEW

R 4-POLE CONTACTOR



Input: 12 VDC @ .7 amp (no load) Speed: 3400 RPM; 2300 RPM @ 25 in./lb. torque CCW rotation, facing shaft. Ideal for portable fans, blowers, etc. Dim.: 3" dia. x 2 1/2" deep.

\$4.95 NEW

S 115 VAC WALL ADAPTERS



S-1 9 VDC @ 100 ma Model #6040

\$1.95 NEW

S-2 21 VAC @ 2A TI Model #ac 9610

\$2.95 NEW

AMERICAN DESIGN COMPONENTS, 62 JOSEPH STREET, MOONACHIE, N.J. 07074

YES! Please send me the following items:

A, B, C, etc.	How Many?	Description	Price	Total

Total

Shipping & handling, we ship UPS unless otherwise specified. Add \$3 plus 10% total. Canadian: \$3 plus P.O. cost. Charge only.

Sales Tax (N.J. residents only, please add 6% of total)

ORDER TOTAL

FREE CATALOG of electro-mechanical devices sent with every order.

MINIMUM ORDER \$15. My check or money order is enclosed. Charge my credit card. Visa Master Card HO-55

Card No. _____
Exp. Date _____
Signature _____
Telephone: Area Code _____ Number _____
Name _____
Address _____
City _____
State _____ Zip _____

All inquiries and free catalog requests call 201-939-2710.

For all phone orders, call TOLL-FREE 800-524-0809. In New Jersey, 201-939-2710.



NATIONAL SEMICONDUCTOR • PANASONIC • QUALITY • Name brand products from nationally recognized manufacturers.
VISA • MICO • HEMWIK • ATLANTIC DIODES • N.
ARIES • PLESSY • MOLEX • UNGAR • GC CHEMICALS • A.
OK MACHINE • UNGAR • GC CHEMICALS • A.
NATIONAL SEMICONDUCTOR • PANASONIC • SAVINGS • Volume Discounts • OEM Quantity Pricing • Toll Free 800 NUMBER

CHEMICALS • ARIES • PLESSY • MOLEX • E.
MACHINE • DIAMOND TOOL • UNGAR • GC CH
AS INSTRUMENTS • D.K. • AP PRODUCTS • ARI
ING • GC CHEMICALS • ARIES •
CHEMICALS • ARIES • MOLEX • E.
MONTHLY CHARGE
CAT NO. P. UNIT PRICE

Table of integrated circuits including Linear, 4000 CMOS, and Standard Resistor Value tables with various part numbers and values.

TEXAS INSTRUMENTS I.C. SOCKETS. Includes description of sockets, solder tail dip sockets, and wire wrap dip sockets.

PANASONIC ELECTRONIC CHEMICALS 150 CAPACITORS. Includes descriptions of electrolytic capacitors and a price list.

DISC CAPACITORS table listing various capacitor types, values, and prices.

Table of 1% Metal Film Resistors and 5% Carbon Film Resistors with specifications.

WIRE WRAP DIP SOCKETS. Describes universal mounting and packaging capabilities.

Table of Panasonic LS Series miniature aluminum electrolytic capacitors.

Table of Panasonic NP type disc capacitors.

Table of 5% Carbon Film Resistor Values in Ohms and various resistor specifications.

TEXAS INSTRUMENTS GOLD EDGEBOARD CONNECTORS. Describes edgeboard connectors for PCBs.

Table of Panasonic V-SERIES Bushed Multilayer Film Capacitors.

Table of Panasonic TSW Series Large Aluminum Electrolytic Capacitors.

Table of Micro components and various electronic parts.

TEXAS INSTRUMENTS GOLD EDGEBOARD CONNECTORS (continued). Includes technical details and part numbers.

Table of Panasonic V-SERIES Bushed Multilayer Film Capacitors (continued).

Table of Panasonic TSW Series Large Aluminum Electrolytic Capacitors (continued).

Table of A/D & D/A converters and other integrated circuits.

TEXAS INSTRUMENTS GOLD EDGEBOARD CONNECTORS (continued). Includes pricing and availability information.

Table of Panasonic V-SERIES Bushed Multilayer Film Capacitors (continued).

Table of Panasonic TSW Series Large Aluminum Electrolytic Capacitors (continued).

Table of Silicon Transistors with various part numbers and specifications.

TEXAS INSTRUMENTS GOLD EDGEBOARD CONNECTORS (continued). Includes detailed technical specifications.

Table of Panasonic V-SERIES Bushed Multilayer Film Capacitors (continued).

Table of Panasonic TSW Series Large Aluminum Electrolytic Capacitors (continued).

Table of 415 200 nsec 16.341 Ohm Resistor and other components.

TEXAS INSTRUMENTS GOLD EDGEBOARD CONNECTORS (continued). Includes connector dimensions and part numbers.

Table of Panasonic V-SERIES Bushed Multilayer Film Capacitors (continued).

Table of Panasonic TSW Series Large Aluminum Electrolytic Capacitors (continued).

Table of AMP Silicon Rectifiers with various part numbers and specifications.

TEXAS INSTRUMENTS GOLD EDGEBOARD CONNECTORS (continued). Includes connector diagrams and part numbers.

Table of Panasonic V-SERIES Bushed Multilayer Film Capacitors (continued).

Table of Panasonic TSW Series Large Aluminum Electrolytic Capacitors (continued).

Table of AMP Chomp Connector with various part numbers and specifications.

TEXAS INSTRUMENTS GOLD EDGEBOARD CONNECTORS (continued). Includes connector dimensions and part numbers.

Table of Panasonic V-SERIES Bushed Multilayer Film Capacitors (continued).

Table of Panasonic TSW Series Large Aluminum Electrolytic Capacitors (continued).

SHIPPING AND ORDER INFORMATION. Includes shipping methods, order forms, and contact information.

CIRCLE 417 ON FREE INFORMATION CARD. Includes promotional text and a coupon.

QUALITY - Name brand products from nationally recognized manufacturers. SERVICE - Computerized order processing and inventory control. SAVINGS - Volume Discounts • OEM Quantity Pricing • Toll Free 800 Number

AMERICAN SEMICONDUCTOR • PANASONIC QUALITY • NAME BRAND PRODUCTS FROM NATIONALLY RECOGNIZED MANUFACTURERS. SERVICE - COMPUTERIZED ORDER PROCESSING AND INVENTORY CONTROL. SAVINGS - VOLUME DISCOUNTS • OEM QUANTITY PRICING • TOLL FREE 800 NUMBER

MATE-N-LOK CONNECTORS

AMP, AMP-ROBICON

Part No.	Description	Price
A1201	Pin, Free Hanging, 3 Circuits	27.20
A1202	Socket, Panel Mount, 3 Circuits	22.20
A1203	Pin, Panel Mount, 4 Circuits	24.21
A1204	Socket, Panel Mount, 4 Circuits	23.12
A1205	Pin, Panel Mount, 6 Circuits	25.21
A1206	Socket, Panel Mount, 6 Circuits	24.12

SOCKET CONNECTOR

AMP, AMP-ROBICON

Part No.	Description	Price
A1207	Pin, Free Hanging, Single Circuit	27.20
A1208	Socket, Free Hanging, Single Circuit	22.20
A1209	Pin, Free Hanging, 6 Circuits	25.21
A1210	Socket, Free Hanging, 6 Circuits	24.12

LED's - Red, Green, Amber

MA1026 Time-Temp. Clock Module

Part No.	Description	Price
MA1026	Time-Temp. Clock Module	15.95
MA1027	110 VAC Transducer for MA1026	6.95

National Semiconductor

MA1026 Time-Temp. Clock Module

Part No.	Description	Price
MA1026	Time-Temp. Clock Module	15.95

BARON WIRE

Monolog Wire, Standard PVC Insulated

Part No.	Description	Price
BA1001	1016, 600V, 50 to 100P, VW-1	1.18

ELECTRO-TAP SPLICES

AMP, AMP-ROBICON

Part No.	Description	Price
A1211	Pin, Free Hanging, Single Circuit	27.20
A1212	Socket, Free Hanging, Single Circuit	22.20

CARD EDGE CONNECTOR

AMP, AMP-ROBICON

Part No.	Description	Price
A1213	Pin, Free Hanging, Single Circuit	27.20
A1214	Socket, Free Hanging, Single Circuit	22.20

Panasonic LED Numeric Displays

Red, Green, Amber and Orange Colors - Chrom Drive

Part No.	Description	Price
P222	PA3, 3.3, 10 to 100	1.00
P223	PA4, 3.3, 10 to 100	1.00

National Semiconductor

MA1026 Time-Temp. Clock Module

Part No.	Description	Price
MA1026	Time-Temp. Clock Module	15.95

SAXTON WIRE

Manufacturers' 22 AWG JSD Stranded

Part No.	Description	Price
SA1001	AWM 2404, E-214, 150V, 20P to 80P	1.18

FLEXI-BLOCK

Internal Block System

Part No.	Description	Price
A1215	Block, 20 Pin, 14 AWG	31.00

AMP-ROBICON

Various connector parts

Part No.	Description	Price
A1216	Pin, Free Hanging, Single Circuit	27.20

Standard Assembly Styles

Various electronic components

Part No.	Description	Price
A1217	Pin, Free Hanging, Single Circuit	27.20

DIGI-CLOCK

110 VAC, 100 to 1000 Hz

Part No.	Description	Price
MA1026	DIGI-CLOCK	15.95

COAXIAL CABLE

Various types and lengths

Part No.	Description	Price
BA1001	1016, 600V, 50 to 100P, VW-1	1.18

D-SUB CONNECTORS

AMP, AMP-ROBICON

Part No.	Description	Price
A1218	Pin, Free Hanging, Single Circuit	27.20

PLUGS & RECEPTALS

AMP, AMP-ROBICON

Part No.	Description	Price
A1219	Plug, 2 Pin, 14 AWG	1.18

SILICON ZENER DIODES

Various voltages and powers

Part No.	Description	Price
A1220	Zener Diode, 5.1V, 1W	0.15

LITTLEFUSE FUSES

AG, AGC, AGU, AGV, AGW, AGX, AGY, AGZ

Part No.	Description	Price
MA1026	Fuse, 10A, 250V	0.15

COAXIAL CABLE

Various types and lengths

Part No.	Description	Price
BA1001	1016, 600V, 50 to 100P, VW-1	1.18

PLUGS & RECEPTALS

AMP, AMP-ROBICON

Part No.	Description	Price
A1221	Plug, 2 Pin, 14 AWG	1.18

BRIDGE RECTIFIERS

Various types and voltages

Part No.	Description	Price
A1222	Rectifier, 100V, 1A	0.15

BRIDGE RECTIFIERS

Various types and voltages

Part No.	Description	Price
A1223	Rectifier, 100V, 1A	0.15

BRIDGE RECTIFIERS

Various types and voltages

Part No.	Description	Price
A1224	Rectifier, 100V, 1A	0.15

BRIDGE RECTIFIERS

Various types and voltages

Part No.	Description	Price
A1225	Rectifier, 100V, 1A	0.15

PINS & SOCKETS

AMP, AMP-ROBICON

Part No.	Description	Price
A1226	Pin, Free Hanging, Single Circuit	27.20

PINS & SOCKETS

AMP, AMP-ROBICON

Part No.	Description	Price
A1227	Pin, Free Hanging, Single Circuit	27.20

BRIDGE RECTIFIERS

Various types and voltages

Part No.	Description	Price
A1228	Rectifier, 100V, 1A	0.15

BRIDGE RECTIFIERS

Various types and voltages

Part No.	Description	Price
A1229	Rectifier, 100V, 1A	0.15

BRIDGE RECTIFIERS

Various types and voltages

Part No.	Description	Price
A1230	Rectifier, 100V, 1A	0.15

PINS & SOCKETS

AMP, AMP-ROBICON

Part No.	Description	Price
A1231	Pin, Free Hanging, Single Circuit	27.20

PINS & SOCKETS

AMP, AMP-ROBICON

Part No.	Description	Price
A1232	Pin, Free Hanging, Single Circuit	27.20

BRIDGE RECTIFIERS

Various types and voltages

Part No.	Description	Price
A1233	Rectifier, 100V, 1A	0.15

BRIDGE RECTIFIERS

Various types and voltages

Part No.	Description	Price
A1234	Rectifier, 100V, 1A	0.15

BRIDGE RECTIFIERS

Various types and voltages

Part No.	Description	Price
A1235	Rectifier, 100V, 1A	0.15

Circle 417 on Free Information Card

When ordering by phone, call 1-800-344-4558 (AK, call 218-681-6674). By mail send your order to DIGI KEY, 701 Brooks Ave. South, Thief River Falls, MN 56701.

Service Charges: \$0.00-6.99, \$6.99-10.00, \$10.00-25.00, \$25.00-49.99, \$50.00-99.99, \$100.00-499.99, \$500.00-999.99, \$1000.00 & up. Volume Discount: 5%, 10%, 15%, 20%, 25%, 30%, 35%, 40%, 45%, 50%, 55%, 60%, 65%, 70%, 75%, 80%, 85%, 90%, 95%, 100%.

At Home Professional Quality Fine Line PCB's.

Introducing an easy, inexpensive, step by step method for the home production of professional quality printed circuit boards without a major equipment investment—KeproClad, by Kepro, makers of quality industrial equipment and supplies. KeproClad was designed for the home user who needs professional results with:

A Simple Circuit Board;

Use KeproClad unsensitized copperclads. These boards come in 2 popular sizes with 1 sided foil, a marking pen, all for a suggested retail price as low as \$3.50.

A Fine Line Detailed Board;

Use KeproClad photosensitized copperclads. Available in 2 sizes with 1 or 2 sided foil. These copperclads use the latest technology of negative acting dry-film photoresist. This material is rugged, yet holds extremely fine detail. It comes with a premeasured amount of developer and sells for as little as \$3.90 (suggested retail).

Other KeproClad products such as a photo reversal kit for making negative film, etch, tin plating solution and photoflood lamps are all available at your local distributor. (For the distributor nearest you, call or write:

KEPRO CIRCUIT SYSTEMS, INC.
630 Axminister Drive., Fenton, MO 63026-2992
In MO 314-343-1630 Toll Free 800-325-3878

CIRCLE 411 ON FREE INFORMATION CARD

ELECTRONIC COMPONENTS

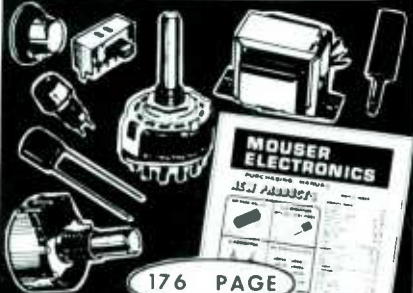

176 PAGE

FREE CATALOG

MANUFACTURERS OF QUALITY ELECTRONIC COMPONENTS

- BATTERY CLIPS & HOLDERS
- CABLE SETS • CONNECTORS • CAPACITORS
- DISPLAYS • LEDs • FUSES • JACKS & PLUGS
- KNOBS • LAMPS • POTENTIOMETERS
- RF COILS • RELAYS • RESISTORS
- SWITCHES • SEMICONDUCTORS • SPEAKERS
- TEST EQUIPMENT • TRANSFORMERS • TOOLS
- WIRE & CABLE

OVER 15,000 DIFFERENT ITEMS IN STOCK!

- Sales and Order Desk
Open from 8:00a.m. (PST)
- Phone and Mail
Orders Welcome
- TERMS C.O.D. Visa
MasterCharge
- Catalogs Mailed
Outside USA
Send \$2.00
- (Open Accounts Available)

MOUSER ELECTRONICS

11433 WOODSIDE AVE. SANTEE, CA 92071
PHONE: (619) 449-2222 TWX: 910-331-1175

CIRCLE 424 ON FREE INFORMATION CARD

NEW PRODUCTS SHOWCASE

BUILT A BETTER BREADBOARD

A P Products has added ACE 118 to its 100 series of All Circuit Evaluators. This new solderless breadboard is economical, carrying a suggested retail price of \$39.95, yet contains features that are unique for its size.

Highlighting ACE 118 are its four standard, five-way, binding posts, attached to the base plate. Those make convenient connections to power supplies, signal generators, or other external equipment.

Circuit creativity is made possible by the Ace 118's 1280-terminal tie points. Up to 18 14-pin DIP's or 16 16-pin DIP's can be used in this universal matrix of 1824 solderless plug-in tie points. Complementing that variety of configurations are a picture frame and center line design of 544 distribution tie points.



CIRCLE 451 ON FREE INFORMATION CARD

The buses can be linked to offer such functions as voltage and ground distribution, reset line, clock line, and shift command. In addition, ACE 118 accepts all DIP sizes as well as a wide variety of discreet components.

Coming fully assembled, the Ace 118 saves the user valuable time in circuit building and troubleshooting. Circuit elements are easily interconnected with ordinary #22 AWG solid wire. Or, pre-formed, pre-measured Jumper Wires from A P PRODUCTS can be used. Since the back plate area is of steel, the board has "heft-ability" and stays stationary when circuits are being built on it.

For more information or the name of the nearest A P Products stocking distributor call toll free: 800-321-9668. In Ohio, call collect: (216) 354-2101.

ACTIVE REFERENCE CHART

If you design or repair electronic circuits for fun or profit, you can now get a



CIRCLE 452 ON FREE INFORMATION CARD

handy plastic reference card that lets you get right to the basic workings of active electronics components. The chart covers everything from op-amps to programmable unijunction transistors without having to go through theory, fabrication methods, or advanced terminology. From Micro Logic, Micro Chart No. 10 entitled "Active Electronic Components" is a two-sided two-color 8-1/2- by 11-inch plastic card that is packed with information. Refer to this card while designing circuits, and you will end up with circuits that are simpler and less expensive to build. If you repair circuits, you will not have to stop and research unfamiliar parts.

Non-digital functions readily available in a single monolithic package are covered including 13 diode types, 6 types of transistors, 5 families of thyristors, 4 types of light emitters, 9 types of light receivers, plus the analogue switch, A/D and D/A, comparator, multiplier, one-shot, op-amp, opto-coupler, PLL, bridge rectifier, sample and hold, Schmitt trigger, tone decoder, varistor, VCO, voltage follower, voltage regulator, and more. Typical descriptions cover: names of part, signal names, detailed operation, and examples of key specification parameters.

Micro Chart No. 10 and other time-saving cards are available for \$5.95 each (plus \$1 postage) from Micro Logic, Dept HO4, P.O. Box 174, Hackensack, NJ 07602. Telephone: 201/342-6518.

NEW HEATH CATALOG

Over 400 electronic products in kit form, including the new Hero Jr. home robot, are showcased in the latest, colorful Heathkit Catalog. Hero Jr., is fully programmed with speech output, light



CIRCLE 453 ON FREE INFORMATION CARD

and sound sensors, an ultrasonic sonar, drive and steering motors, and an on-board computer system. He sings songs, plays games, recites nursery rhymes, and can act as a security device and wake up alarm.

The new GT-2218 Hotshot Dialer is a unique one-number telephone dialer that quickly dials any telephone number up to 31 digits. It permits the use of an alternate long distance service without lengthy 13-digit phone and billing numbers, and also allows an emergency number to be dialed

by simply picking up the phone. The Hotshot Dialer features an easy-to-program memory that doesn't require battery backup since it is manually programmed. It plugs into any standard modular phone jack or Y-adaptor.

Those are just two of the over 400 electronic products offered in the new Heathkit Catalog. To receive this colorful catalog free of charge write Heath Company, Dept. HO4, Benton Harbor, MI 49022. In Canada, write Heath Company, 1020 Islington Avenue, Dept. HO4, Toronto, Ontario M8Z 5Z3. Free catalogs are also available at Heathkit Electronic Centers and Heath/Zenith Computers and Electronics Centers in the U.S. and Canada. Consult the telephone directory white pages for the nearest store.

SURGE-PROOF YOUR OUTLET

The EMF-315 *PowerPure* voltage surge and noise suppressor provides an inexpensive means of protecting costly electronic equipment from both transient voltage surges and RF noise interference. The EMF-315 clamps voltages to a safe level below 500 volts without interfering with normal current flow, and attenuates RF noise up to 40 db from 200 kHz to 30



CIRCLE 454 ON FREE INFORMATION CARD

MHz. Thus, the *PowerPure* unit gives effective protection against short-duration, high-voltage spikes and prevents faulty equipment operation caused by RF noise on AC power lines. Further information can be obtained from authorized distributors of Philips ECG products. To locate the nearest distributor, consult "Electronics Parts Wholesalers" in the telephone directory yellow pages or call toll-free 800/225-8326; in Mass., 890-6107.

WIRE MARKER DOES THREE JOBS

An unusual wire marker lets you do three marking tasks without letting go of the applicator tab. Each marker is perforated. The first part is a terminal marker and the two remaining pieces will mark both ends of an attached wire. The complete marker will fully encompass a 0.350-inch OD cable.

The 3 perforation arrangement is

A QUALITY TRIPLE-REGULATED POWER SUPPLY AT A LOW, LOW PRICE!!

NOT A KIT!



MODEL PS101 FULLY ASSEMBLED & TESTED!

This DC triple regulated variable power supply has all the features you could ask for plus a full 1 year guarantee. Fully adjustable from 1½ VDC to 35 VDC! Three completely independent supplies that offer many advantages! They can be either a pos. supply or a neg. supply...they can also be stacked in series so that a 5V and two 15V supplies can total a 35 VDC supply or any combination of the three...(after one of the terminals is grounded to give it a reference)...for the first time you can now purchase this American made fully adjustable power supply at a price that is one-half of what you'd expect to pay!

\$ 119.88
FULL 1 YEAR REPLACEMENT WARRANTY
- Made In The United States -

SPECIFICATIONS

3 outputs:
Fixed 5 VDC ± 0.2V
2 variable ≤ 1½ V to ≥ 15 VDC
Polarity - floating; can be used as pos. or neg.
Ripple less than 10mV at full load,
Regulation ≤ 1% no load to full load,
Line Regulation < 0.2% 108 VAC to 135 VAC.
Current:
Fixed supply 1.0 amp max.
Variable supplies 0.5 amp max.

Protection built in, current limiting, with thermal shutdown.
Power: 108-135 VAC.
Dimensions: 8¼" x 3¼" x 7¼" (WxHxD)
Wood grain finished metal case.
Weight: 4 lbs., 9 ozs.
Lighted on/off power switch, easy-to-read Voltmeter and large binding posts.
Warranty: one year full replacement warranty from date of purchase.

DISTRIBUTOR AND REPRESENTATIVE INQUIRIES INVITED



VISA, MASTERCARD, AMEX TELEPHONE ORDERS ACCEPTED!
6 Herman Drive, E. Granby, CT 06026 □ 203/651-0285

CIRCLE 421 ON FREE INFORMATION CARD

MULTI-CHANNEL DUAL POLARITY

MICROWAVE TV SYSTEMS

Complete Systems From \$69.95

Full 800 MHz
Range

Antenna Tunes
1.9 to 2.7 GHz
Includes All
ITFS Channels

DEALERS WANTED

COD's and Credit Card
Orders Call TOLL FREE
1-800-247-1151



GALAXY
Electronics
5644 N. 53rd Avenue
Glendale, AZ 85301
1-602-247-1151



SILVER STAR



MICRO STAR



STAR II



CIRCLE 423 ON FREE INFORMATION CARD

SUPER LONG PLAY TAPE RECORDERS

10 Hour Model — \$95.00*
14 Hour Model — \$159.00*

Modified Panasonic Slimline
high quality AC DC
Recorders provide 5 or 7
continuous hours of quality
recording & playback on
each side of cassette for a
total of 10 or 14 hours
depending on model. Built-in
features include: • Voice
level control • Digital
counter, etc. TDK DC 180
Cassette Furnished



PHONE RECORDING ADAPTER

Records calls automatically. All Solid
state connects to your telephone
jack and tape recorder. Starts
recording when phone is lifted.
Stops when you hang up.

\$24.50*

FCC APPROVED

VOX VOICE ACTIVATED CONTROL SWITCH
Solid state self contained Adjust-
able sensitivity. Voices or other
sounds automatically activate and
control re-order. Uses either re-
corder or remote mike. \$24.95*

*Add for ship & hdg Phone Adapter & Vox \$1.50 ea
Recorders \$4.00 ea. Cal Res add tax. Mail order VISA
MIC COD's OK Money Back Guarantee City disc
avail. Dealer inquiries invited Free data
AMC SALES INC Dept A 9335Lubec
St. Box 928 Downey CA
90421 (213) 869-8519

CIRCLE 422 ON FREE INFORMATION CARD

NEW PRODUCTS

unique; each perforation line has a different strength so that the marker will always tear apart right at the wire or terminal. The balance is either used immediately or is replaced on the card for later jobs. The marker's adhesive is impervious to most oils and hydraulic fluids.



CIRCLE 455 ON FREE INFORMATION CARD

Adhesion to vinyl insulation is initially moderate to enable repositioning; bonding increases substantially after 4 to 6 hours in place.

Flexy-Markers are available in bound sets of 24 3/4- x 5 1/2-inch cards. Marker styles include letters, letter-number combinations, twelve NEMA-EIA colors, and single and consecutive numbers from 1 to 520. Marker quantities vary from 624 to over 1000 per set, depending on individual marker width. Price for any set is \$6.95 ea.

For more info, write to The Datak Corporation, 65 71st Street, Guttenberg, NJ 07093. Telephone: 201/869-2200.

FOAM-FILLED COMPUTER CASE

Jensen Tools introduces a new zipper-style case filled with high-density polyfoam for conveniently and safely transporting a personal computer and peripherals, or other sensitive electronics equipment. The two-inch layer of remova-



CIRCLE 456 ON FREE INFORMATION CARD

ble foam can be cut to match the exact shape of practically any personal computer. A foam pad affixed to the inside of lid offers additional protection.

Measuring 16- x 11- x 3 1/4-inch inside and covered with rugged cordura nylon, the case also features three roomy outside pockets for additional accessories and/or

documentation. The largest pocket (10- x 14- x 2 1/2-inch) will accommodate an operating manual. Two smaller pockets (10- x 7- x 2 1/2-inch each) provide ample room for a tape recorder, modem, power cords, lunch, etc.

For more information, or for a free catalog about other special kits and cases for computers, write to Jensen Tools, Dept. HO4, 7815 S. 46th Street, Phoenix, AZ 85040. Telephone: 602/968-6231.

GLUE-DOWN RUB-DOWN TRANSFERS

Once a curiosity, rub-down transfers (dry transfers) are now part of the project-builder's tool kit. The letters stick to all surfaces, but permanence is a problem: Unprotected transfers easily wear off if repeatedly handled. General purpose aerosol sprays aren't much help: they contain aggressive solvents that cause a dry transfer to dissolve, wrinkle, or even float out of position before repeat coats can build a protective film.



CIRCLE 457 ON FREE INFORMATION CARD

Datakoat acrylic spray has been available. It is excellent for overcoating transfers on metal, plastics, and paint, but it will not form a smooth film on porous materials like paper and tracing vellum. The Datakoat rests on top of the transfer, but sinks into the surrounding surface.

The porous-surface problem has now been solved with Hardcoat, a unique spray for rubdown transfers on paper and porous surfaces. A single coat softens and penetrates the transfer ink, then glues it to the surface. Abrasion resistance is superb. Additional coats are not needed unless severe weathering is expected.

Hardcoat is supplied in 12-ounce spray cans in either a gloss (Cat. #04170) or matt (Cat. #04171) formulation. Price for either is \$4.75 each. For more information, write to The Datak Corporation, 65

71st Street, Guttenberg, NJ 07093. Telephone: 201/869-2200.

TIN PLATE

Electroless tin plating has usually meant a dull gray-plate with marginal solderability, poor adhesion, and a four-month solution shelf-life. Most formulas also require the addition of a strong acid.

Datak solves those problems with Tinnit, a dry, chemical mix that can be stored for years without deterioration. When mixed in water it plates a shiny layer of



CIRCLE 458 ON FREE INFORMATION CARD

pure, solderable tin over copper, brass, and non-alloy steels. No acid is added, and there is almost no odor. Plating is done at 110 to 130° F. The metal should be reasonably clean, but cleaners in Tinnit prepare the metal for a perfect plate. A maximum plating thickness of 0.0004-inch is reached after 15 minutes in a fresh solution.

Tinnit was designed to plate bare-copper circuit boards, but it can also be used for general cosmetic plating. Although tin's resistivity is slightly higher than gold, Tinnit works successfully as a protective plate on edge-card connector fingers when gold is not available.

Tinnit (Catalog No. ER-18) is supplied in a 600-square-inch (1-pint) size for \$3.50. Large bulk quantities are available on an individual quote basis. For more information write to The Datak Corporation, 65 71st Street, Guttenberg, NJ 07093. Telephone: 201-869-2200.

VIEW 8 TRACES ON YOUR SINGLE OR DUAL TRACE SCOPE WITH THIS LOW COST DEVICE!!

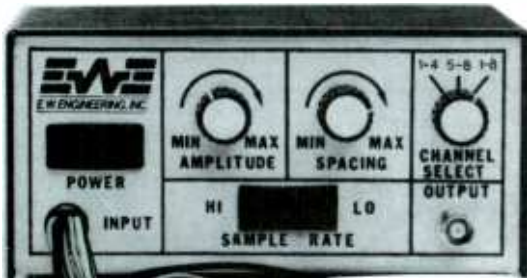

Now you no longer have to spend thousands on an expensive multi-trace oscilloscope - our single trace Hitachi scope combined with this module will allow you to view up to 8 simultaneously occurring analog or digital (or both) signals in their real time and amplitude relationship. The MPX 101 may be used on any oscilloscope, whether single, dual or multiple traces. Its low cost makes it a particular favorite for designers, testers, hobbyists and repairmen who want to compare and analyze displayed signals in a timing diagram format. The controls on the front panel of the metal case allow you to vary amplitude and spacing of the displayed signals.

MODEL MPX101 FULLY ASSEMBLED & TESTED!



NOT A KIT

\$99⁸⁸

FULL 1 YEAR REPLACEMENT WARRANTY

- Made In The United States -

SPECIFICATIONS

Inputs: 8 signals plus ground via 9 input leads terminated with alligator clips
 Bandwidth: ± 1dB to 5 MHz
 Impedance: 10.9 K
 Input Voltage: ± 5V peak (diode clamped to ± 5 Volt supplies)
 Output: Staircase waveform summed with input signals, 0-800 mV full scale
 Step Amplitude: Variable 0 to 150 mV/ step
 Signal Voltage: Variable 0 to

150 mV/step @ 5V Input
 Multiplex Rate: Switch selectable, 40 KHz or 4 KHz
 Impedance: 50 Ohms
 Power: 105-135 VAC @ 1 V a
 Dimensions: 6.25" x 3.25" x 4.75" (WxHxD)
 Operating Temperature: 0-40°C
 Weight: 1 lb. 10.5 oz.
 Warranty: one year full replacement warranty from date of purchase
 Lighted on/off power switch
 Wood grain finished metal case

DISTRIBUTOR AND REPRESENTATIVE INQUIRIES INVITED



VISA, MASTERCARD, AMEX TELEPHONE ORDERS ACCEPTED!
 6 Herman Drive, E. Granby, CT 06026 □ 203/651-0285

CIRCLE 420 ON FREE INFORMATION CARD

DIGITAL TV

The Toshiba America's CZ-2094 is a digital-TV model that boggles the mind with a variety of features and functions. The set will have a suggested retail price of \$1,199. The model has full compatibility for the audio-video range from home computers to the approaching direct-broadcast satellite, teletex, and videtex systems.

The set uses Toshiba's FST (flattest, squarest tube) with fine-pitch shadow mask for higher resolution. The quality of the picture is exceptionally high, due to the processing of ordinary TV signals digitally.

The CZ-2094 has a digitized chassis that converts analog signals and processes chrominance, video, and deflection, digitally. By using its digital circuitry, the set has picture-within-a picture capability when used with a second signal source. The viewer can freeze the inset picture by using the set's memory storage, or can enlarge the inset picture from 1/16th to 1/4th of the total screen size.

Other features include 138-channel cable compatible, both 8-pin and 21 pin
 (Continued on page 12)



Electronic Systems Newsletter

The magazine written especially for the electronics hobbyist/experimenter

- Fascinating Projects • New Ideas
- Sources • Tips & Techniques
- New Products

Each issue brings you exciting and unique articles and projects including information on

- Designing with Leds
- Control Systems
- Backlighted Visual Displays
- Electronics Directory
- Components & Circuitry
- Book Reviews
- Trouble-Shooting Tips
- Business Opportunities
- Construction Features
- Communications
- Robotics
- Lasers

... and much more

FREE DETAILS



AF PUBLISHING CO.
Dept M
P.O. Box 524
So. Hadley, Mass. 01075

CIRCLE 412 ON FREE INFORMATION CARD

A forest fire can take your breath away.



A Public Service of This Magazine
& The Advertising Council

NEW PRODUCTS

(Continued from page 11)

RGB inputs, three audio/video, input/output terminals, stereo-bilingual sound receiving capability, on-screen-control and function indicators, multi-function wireless remote-control, and a new 2-way, speaker system. Sold at major television retail outlets.

THE RUNNING PROGRAM

MECA (Micro Education Corporation of America) has found a way for runners to use their personal computers to help improve their running and overall fitness through a guide for all levels of ability. The Running Program, MECA's innovative new software, provides every run-

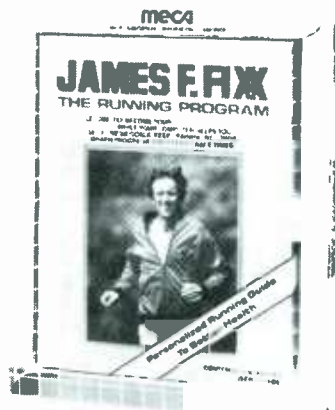

CIRCLE 459 ON FREE INFORMATION CARD

ning enthusiast, from the occasional jogger to the serious marathon competitor, with a personal running coach to help them set individualized goals for general fitness, weight loss, a "10K" race or a marathon. It's all contained in one easy-to-use package.

The Running Program begins by evaluating current fitness with six simple tests. With that information, the program develops realistic personalized day-by-day training schedules. The Running Program prints the runner's schedule and summaries of training, racing, and nutritional records. It then goes on to keep records and graph achievement statistics for the entire family—including records for swimming, cycling, and 30 other types of exercise.

In addition, The Running Program tracks and evaluates the runner's diet for weight control and shows the runner (through innovative graphics) six stretching exercises that will help to minimize the chance of injuries. The Running Program will ultimately predict the runner's probable race times and best competitive distance.

The Running Program is dedicated to James F. Fixx, the founder of modern run-

ning, who helped develop the program for MECA.

The Running Program is available for the IBM PC, XT, AT PCjr and COMPAQ. The suggested retail price is \$79.95. Available at most computer software outlets.

LOW-COST POCKET-SIZE MULTIMETER

Non-Linear Systems new AP-105 Digital Multimeter is so small that it will fit inside your pocket! The AP-105 is a low-cost, 3½-digit multimeter that can be used just about anywhere that electrical measurement is needed. Besides AC and DC voltage measurement, the AP-105 incorporates seven additional functions including: DC current, conductance, resistance, NPN and PNP transistor, diode, and battery test. A single, convenient, rotary switch selects on-off power, function, and 23 different ranges.

The AP-105 measures 4.8-long × 2.8-wide × 0.9-inch high, and it weighs only seven ounces. It also uses a large 0.5-inch LCD readout with high-contrast numbers—automatic polarity and overload in-



CIRCLE 460 ON FREE INFORMATION CARD

dication are included. The multimeter is powered by a 9-volt transistor-radio battery with a life of 300 hours. A low-power indicator is also provided.

NLS products and information are available at local electronics distributors throughout the USA.

CONTINUITY TESTER

Vaco recently introduced the new No. 70305 Continuity Tester, a handy tool which instantly detects shorts or broken circuits in all types of electrical devices. Used for testing circuits with power off, the 70305 is ideal for checking lamp cords and fuses, motors, electrical appliances, switches and receptacles, and many other devices. It features an 36-inch lead wire

(Continued on page 20)

Time- and Money-Saving Advice . . .
Practical Troubleshooting & Repair Tips . . .
State-of-the-art Technology . . . Hundreds
of Projects . . . Plus, Exceptional Savings

Take Any 4 Books for Only \$2⁹⁵

Values to \$90.80

Join Now, Get a Utility Apron FREE!

 1875 List \$21.95	 1583 List \$19.95	 1393 List \$14.50 (paper)	 1431 List \$17.95	 1108 List \$15.95	 1183 List \$16.95	 1765 List \$21.95	 1777 List \$21.95
 1492 List \$14.95	 1211 List \$12.95 (paper)	 1820 List \$16.95	 1616 List \$19.95	 1605 List \$19.95	 1932 List \$17.95	 1690 List \$19.95	 1604 List \$24.95
 1672 List \$18.95	 1218 List \$18.95	 1665 List \$15.95 (paper)	 1740 List \$18.95	 1650 List \$19.95	 1577 List \$19.95		

7 very good reasons to join the Electronics Book Club

- **Big Savings.** Save 20% to 75% on books sure to increase your electronics know-how
- **No-Risk Guarantee.** All books returnable within 10 days without obligation
- **Club News Bulletins.** All about current selections—mains, alternates, extras—plus bonus offers. Comes 13 times a year with hundreds of up-to-the-minute titles to pick from
- **Automatic Order.** Do nothing and the Main selection will be shipped automatically! But . . . if you want an Alternate selection—or no books at all—we'll follow the instructions you give on the reply form provided with every News Bulletin
- **Bonus Books.** Immediately get a Dividend Certificate with every book purchased and qualify for big discounts of 60% to 80%
- **Exceptional Quality.** All books are first-rate publisher's editions selected by our Editorial Board and filled with useful up-to-the-minute information



ELECTRONICS BOOK CLUB
P.O. Box 10, Blue Ridge Summit, PA 17214

Please accept my membership in the Electronics Book Club and send the 4 volumes circled below, plus, my FREE utility apron, billing me \$2.95 plus shipping and handling charges. If not satisfied, I may return the books within ten days without obligation and have my membership cancelled. I agree to purchase 4 or more books at reduced Club prices (plus shipping/handling) during the next 12 months, and may resign any time thereafter.

1108 1183 1211 1218 1393 1431 1492 1539 1542
1577 1583 1593 1599 1604 1605 1616 1650 1665 1670
1672 1690 1699 1740 1765 1777 1820 1875 1932

Name _____ Phone _____
Address _____
City _____
State _____ Zip _____

Valid for new members only. Foreign applications will receive ordering instructions. Canada must remit in U.S. currency. This order subject to acceptance by the Electronics Book Club.

RESP-585

FREE!

New Catalog of Hard-To-Find Precision Tools



Jensen's new catalog is jam-packed with more than 2,000 quality items. Your single source for hard-to-find precision tools used by electronic technicians, scientists, engineers, schools, instrument mechanics, laboratories and government agencies. This popular catalog also contains Jensen's world-famous line of more than 40 tool kits. Call or write for your free copy today!

JENSEN TOOLS INC. 7815 S. 46th Street
Phoenix, AZ 85040
(602) 968-6241

CIRCLE 425 ON FREE INFORMATION CARD

DON'T FORGET



USE
YOUR
READER
SERVICE
CARD

BOOKSHELF

Kahn on Codes—Secrets of the New Cryptology By David Kahn

Why didn't the National Security Agency, with an annual budget of \$1 billion, and with more computers under one roof than any other U.S. Institution, detect the increased Soviet activity on Grenada? Could the attack on the marines stationed in Beirut have been avoided if communications intelligence had penetrated the situation? Those confrontations have sparked

postwar growth in intelligence technology has affected individual rights. Governments, according to Kahn, no longer limit their intercepts to official communications; rather, they draw intelligence from the communications of private firms and individuals.

Many of the articles in collection were originally published in periodicals as diverse as *Playboy*, *Foreign Affairs*, and *The New York Times*. For the codebreaking buff, and the war historian, as well as the layperson concerned with government intelligence and his own liberties, here is a comprehensive look at the evolution of cryptology by America's foremost writer on the subject.

David Kahn, a Ph.D in Modern History from Oxford, has been an amateur cryptologist since the age of thirteen. He is an editor of the Long Island daily *Newsday*, and co-editor of *Cryptologia* magazine.

MacMillan Publishing Company, 866 Third Avenue, New York, NY 10022. Hardcover, 343 pages, 19.95.

Bit by Bit—an Illustrated History of Computers By Stan Augarten

Just forty years ago, there wasn't a single computer in the world. Today, there are millions, and they touch the lives of every one of us. Like most other revolutionary inventions, the computer was the culmination of a long chain of technological developments, beginning with the invention of the abacus five thousand years

(Turn to page 16)

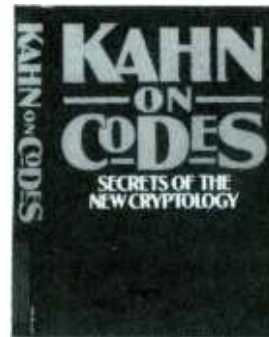

CIRCLE 490
ON FREE INFORMATION CARD

a flurry of questions about the effectiveness of our intelligence operations and the importance of cryptology to our national security.

David Kahn, noted cryptologist, historian, and author of the bestselling *The Codebreakers*, makes plain the complexity of modern-day surveillance (and its impact on the private citizen) in his latest book. Tapping computers, Soviet spy ciphers, and the search for an unbreakable code are some of the subjects covered in this collection of articles written over the past two decades. Kahn ranges from the allied codebreaking successes of World War II to how the

SPECIAL DEALS

Dble. 10 .156 Edge Connector Solder Tail	\$1.25 ea.
Dble. 22 .156 Edge Connector PC. MT.	\$.65 ea. 10/\$5.00
16 Pin Solder Socket (machined pin)	\$.50 ea. 100 for \$35.00
16 Pin Tin Wire Wrap Socket (2 level)	\$.25 ea.
20 Pin Tin Wire Wrap Socket (2 level)	\$.35 ea.
22 Pin Tin Wire Wrap Socket (2 level)	\$.40 ea.
24 Pin Tin Wire Wrap Socket (2 level)	\$.50 ea.
8 VAC 1 amp Plug In Xformer	\$1.25 ea. 10/\$9.39
4164 150 ns	9 for \$25.00
5 1/4" diskettes, 10 Sector	box of 10 \$9.95
Flourescent 10 Digit Display 16VDC	10/\$1.00
Flourescent 12 Digit Display 16VDC	10/\$1.00
Solid State Relay PC. MT. 240 VAC 1.5 amps	1.88 ea. 10/\$15.00

ASTEC VM1291-1 Video Modulator

Switch Selectable for CH 3 or 4
RCA output, comes with schematic



\$1.88 each

10 for
\$12.50

Game / TV Switchbox

Used with
most Video
Games



94¢ ea. 10 for \$7.50

VISA MASTERCARD AMERICAN EXPRESS

HALTED SPECIALTIES CO. INC.
827 E. EVELYN AVE. SUNNYVALE, CA., 94086

408-732-1573 WE SHIP C.O.D.

TERMS: Minimum Order \$10.00. California residents add 6 1/2% sales tax. Prepaid orders sent freight C.O.D. or call for charges, shipping will be added to credit card and C.O.D. orders. Prepaid orders over \$100.00, use money order or certified check. Please do not send cash. No refunds—exchange or store credit given within 10 days. Some items limited to stock on hand.

Radio Shack Parts Place[®]

Famous for Value! The Store for Builder's Since 1921

4000-Series CMOS ICs



With Pin-Out and Specs

Type	Cat. No.	Each
4001	276-2401	.99
4011	276-2411	.99
4013	276-2413	1.19
4017	276-2417	1.49
4049	276-2449	1.19
4066	276-2466	1.19

TTL Digital ICs

With Pin-Out and Specs

Type	Cat. No.	Each
7400	276-1801	.89
7404	276-1802	.99
7408	276-1822	1.29
7447	276-1805	1.59
7490	276-1808	1.09

Operational Amplifiers



Type	Cat. No.	Each
741 (Single)	276-007	.89
MC1458 (Dual)	276-038	.99
LM324 (Quad)	276-1711	1.29
TL082 (Dual)	276-1715	1.89
LM339 (Quad)	276-1712	1.49
TLC271 (Single)	276-1748	1.59
TLC272 (Dual)	276-1749	2.19
TLC274 (Quad)	276-1750	2.99

Monolithic Ceramic Capacitors on Sale

Up to

44% Off

- Epoxy Dipped
- 50 WVDC

Value	Temperature Coefficient	Cat. No.	Reg.	SALE
10 pF	NPO	272-151	.69	.44
100 pF	NPO	272-152	.69	.44
470 pF	NPO	272-153	.69	.44
1000 pF	Z5U	272-154	.69	.44
4700 pF	Z5U	272-155	.69	.44
.01 μF	Z5U	272-156	.69	.44
.047 μF	Z5U	272-157	.69	.44
.1 μF	Z5U	272-158	.79	.44

Power Transformers

120 VAC Primaries

Type	Volts	Current	Cat. No.	Each
Miniature	6.3	300 mA	273-1384	2.59
Miniature	12.6	300 mA	273-1385	2.79
Miniature	25.2	300 mA	273-1386	3.49
Miniature	12.6 CT	450 mA	273-1365	3.59
Miniature	25.2 CT	450 mA	273-1366	3.99
Standard	6.3	1.2 A	273-1351	3.99
Standard	12.6 CT	1.2 A	273-1352	4.99
Standard	25.2	1.2 A	273-1353	5.99
Heavy-Duty	12.6 CT	3.0 A	273-1511	5.99
Heavy-Duty	25.2 CT	2.0 A	273-1512	6.29
Heavy-Duty	18.0 CT	2.0 A	273-1515	6.99

CT = Center Tap

1/4-Watt, 5% Resistors

Pkg. of 5 **39¢**

Ohms	Cat. No.	Ohms	Cat. No.
10	271-1301	10k	271-1335
100	271-1311	15k	271-1337
150	271-1312	22k	271-1339
220	271-1313	27k	271-1340
270	271-1314	33k	271-1341
330	271-1315	47k	271-1342
470	271-1317	68k	271-1345
1k	271-1321	100k	271-1347
1.8k	271-1324	220k	271-1350
2.2k	271-1325	470k	271-1354
3.3k	271-1328	1 meg	271-1356
4.7k	271-1330	10 meg	271-1365
6.8k	271-1333		

Replacement Transistors



Type	Cat. No.	Each
2N1305	PNP	276-2007 1.19
MPS2222A	NPN	276-2009 .79
PN2484	NPN	276-2010 .89
MPS3904	NPN	276-2016 .69
TIP31	NPN	276-2017 .99
TIP3055	NPN	276-2020 1.59
MPS2907	PNP	276-2023 .79
MJE34	PNP	276-2027 1.49
2N3053	NPN	276-2030 .99
MPS3638	PNP	276-2032 .79
TIP120	NPN	276-2068 1.29
2N3055	NPN	276-2041 1.99
MJ2955	PNP	276-2043 2.19
2N4401	NPN	276-2058 .69
MPSA42	NPN	276-2061 .69
2N3819	N-FET	276-2035 .99
MPF102	N-FET	276-2062 .99
IRFS11	V-FET	276-2072 2.59
IRFD123	V-FET	276-2073 1.49
2SC1308	NPN	276-2055 7.95

Power Supply Diodes

Micromini 1-Amp Diodes. 30-Amp surge.

Type	PIV	Cat. No.	Pkg. of 2
1N4001	50	276-1101	.49
1N4003	200	276-1102	.59
1N4004	400	276-1103	.69
1N4005	600	276-1104	.79

3-Amp "Barrel" Diodes. 200-Amp surge.

Type	PIV	Cat. No.	Pkg. of 2
1N5400	50	276-1141	.79
1N5402	200	276-1143	.89
1N5404	400	276-1144	.99

Voltage Regulators



Type	Adjustable	Cat. No.	Each
LM723	0 to 40 VDC	276-1740	.99
LM317T	1.2 to 37 VDC	276-1778	2.79

Type	Fixed Output	Cat. No.	Each
7805	+ 5 VDC	276-1770	1.59
7812	+ 12 VDC	276-1771	1.59
7815	+ 15 VDC	276-1772	1.59

Electrolytic Capacitors

- 50 WVDC
- For Printed Circuit Boards



μF	Cat. No.	Each
470	272-1046	1.59
1000	272-1047	1.99
2200	272-1048	3.49

30-Amp Automotive Lighting Relay

4⁹⁹



- Heavy-Duty Design
- With Mounting Bracket

SPST contacts are rated 30 amps at 12 VDC. It's ideal for controlling high-power lighting and auto accessories, and for switching Ham radio power supplies. 12 VDC coil. 275-225 4.99

21-Range LCD Digital Multitester

59⁹⁵

Handy "Beep" Continuity and Range-Change Indicator



Digital precision at a great low price! Features convenient pushbutton zero-adjust and a diode/semiconductor test mode. Measures up to 1000 volts DC, 500 volts AC, AC and DC current to 200 milliamps, and resistance to 20 megohms in 6 ranges. With spare fuse, test leads and manual. Batteries extra. 22-191 59.95

Digital Logic Probe

19⁹⁵



Simultaneous Tone Output Frees Eyes for Fast Testing

Lets you "peek inside" TTL, LS and CMOS digital circuits. Color-coded LEDs and hi/lo tone indicate high, low or pulsed logic states. Overload and polarity protected. Really usefull! 22-302 19.95

Semiconductor Reference Guide

Only **3⁴⁹**

Over 200 Pages



Cross over 80,000 devices to their low-cost Radio Shack equivalents. Includes detailed data on Archer[®] ICs, SCRs, LEDs diodes and more. 276-4008 3.49

Getting Started in Electronics

Only **2⁴⁹**

Learn As You Build!

By Forrest Mims III



Learn basic electronics by building your own circuits from Radio Shack parts. Features easy-to-read text and large diagrams. 128 pages. 276-5003 2.49

Over 1000 items in stock: Binding posts, Books, Breadboards, Buzzers, Capacitors, Chokes, Clips, Connectors, Fuses, Hardware, ICs, Jacks, Knobs, Lamps, Multimeters, PC Boards, Plugs, Rectifiers, Relays, Resistors, Switches, Tools, Transformers, Transistors, Wire, Zener Diodes, and more!

Radio Shack
A DIVISION OF TANDY CORPORATION

Prices apply at participating Radio Shack stores and dealers

BOOKSHELF

(Continued from page 14) ago. Now, the author tells the whole computer story for the first time—from grooves in the dirt, and beads on a frame, to today's superfast computers.

But the book is much more than a story about machines; it is also about the brilliant, forward-looking, and often eccentric men and women who have shaped the computer's history—from Wilhelm Schickard, the obscure German professor who invented the first mechanical calculator in 1623; to Charles Babbage, the debonair 19-century genius whose Analytical Engine came within an inch of being a full-fledged computer; to Stephen Wozniak, the young electronics wizard who founded Silicon Valley's Apple Computer Company.

With magnificent photos culled from around the

world, and a superbly written text, *Bit by Bit* is both a guided tour of the world of the computer and an absorbing account of its evolution.

Stan Augarten is the author of *State of the Art—A Photographic History of the Integrated Circuit*. He has an M.A. in American history from Columbia

BIT BY BIT An Illustrated History of Computers STAN AUGARTEN



CIRCLE 491

ON FREE INFORMATION CARD

University. He has been a reporter for the Associated Press, and a news writer and producer for television

stations in Oakland and San Francisco.

Ticknor & Fields, A Houghton Mifflin Company, 52 Vanderbilt Avenue, New York, NY 10017. Paperback, 324 pages, \$17.95.

Electronic Prototype Construction By Stephen D. Kasten

While many books are being written in the wide-open field of electronics concerning the design of microcomputer and computer interfacing circuits, very little practical information is available about construction techniques for converting schematics and ideas into functional electronic prototype units.

This book was written to fill that gap. It can be divided into the following four major features: Wire-wrapping, printed-circuit boards, graphic techniques, and hardware packaging. If

you are an active project builder, look into *Electronic Prototype Construction*.

Blacksburg Continuing Educational Series. Howard

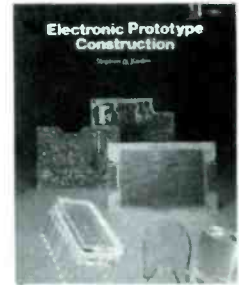

CIRCLE 492

ON FREE INFORMATION CARD

W. Sams and Co., Inc., 4300 West 62nd Street, Indianapolis, IN 46268. Paperback, 399-pages, \$17.95.

How to Design Electric Projects By R.A. Penfold

Information on standard circuit building blocks is available from manufacturers' catalogues.

(Continued on page 30)

DELTA X DUAL TRACE OSCILLOSCOPES

(TWO QUALITY 10-1 HOOK ON PROBES INCLUDED)

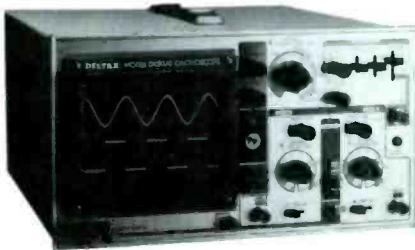

DX5020 20MHz \$379.95

SALIENT FEATURES:
BUILT-IN COMPONENT TESTER.
AUTOMATIC TRIGGERING.
TV VIDEO SYNC. FILTER.

BRIEF SPECIFICATIONS:
DEFLECTION FACTOR:
5MV to 20V/DIV.
RISE TIME: Less than 17ns.
TIME BASE: 0.2µs to 0.5 s/DIV.



DX5015S 15MHz \$510.00

SALIENT FEATURES:
PORTABLE. WORK ON AC/DC.
BUILT-IN BATTERY.
AUTOMATIC RECHARGE

BRIEF SPECIFICATIONS:
DEFLECTION FACTOR:
2MV to 10V/DIV.
RISE TIME: Less than 23ns.
TIME BASE: 0.5µs to 0.5 s/DIV.

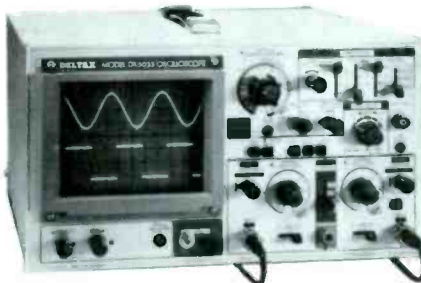

DX5035 35MHz \$527.00

SALIENT FEATURES:
SINGLE SWEEP.
DELAYED TRIGGERING SWEEP.
DELAY TIME BECOMES DIM.
SWEEP STARTS AT TIME DELAYED.
ALT. TRIGGER FOR TWO
NON-SYNCHRONIZED SIGNALS.

BRIEF SPECIFICATIONS:
DEFLECTION FACTOR:
5MV/DIV. — 10V/DIV.
1MV/DIV. (5X gain)
RISE TIME: Less than 10ns.
TIME BASE: 0.1µs — 0.5 s/DIV.

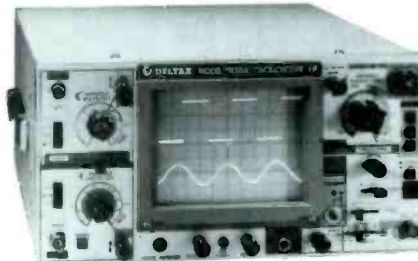

DX5045 45MHz \$789.95

SALIENT FEATURES:
DELAY LINE TO PERMIT
ANALYSIS OF RISE TIMES.
DELAYED TRIGGER SWEEP
FEATURE AS DX5035.
WIDE FREQUENCY BAND
WIDTH, SCALE ILLUMINATION.

BRIEF SPECIFICATIONS:
DEFLECTION FACTOR:
5MV/DIV. — 5V/DIV.
1MV/DIV. (5X gain)
RISE TIME: Less than 8ns.
TIME BASE: 0.2µs — 0.5 s/DIV.

TERMS: One year limited warranty on parts and labor.
Satisfaction guaranteed, or return unit in original form for refund within 10 days from date merchandise received.
California residents add 6½% sales tax.
Orders shipped UPS, add \$8.50 for shipping handling and insurance.

TO ORDER: CALL COLLECT (714) 594-7131
MONEY ORDER, VISA, MASTERCARD, C. O. D. (REQUIRED 25% DOWN)
DELTA X DELTA X DYNAMIC INC.
20955 LYCOMING ST., WALNUT,
CALIF. 91789, TELEX: 503749 DELTAX

With NRI training at home, you can...

Move up to a high paying career servicing computers



And you can start by actually building NRI's 16-bit IBM-compatible computer.

You can create your own bright, high paying future as an NRI trained computer service technician. The biggest growth in jobs between now and 1995, according to Department of Labor predictions, will occur in computer service and repair, where demand for trained technicians will double. There is still plenty of room for you to get in on the action—if you get the proper training now.

Total computer systems training, only from NRI

To learn how to work on computers, you have to get inside one. And only NRI takes you inside a computer, with total systems training that gives you hands-on experience with computers, peripherals, and software. As part of your training, you'll build a Sanyo MBC-550-2, which experts have hailed as the "most intriguing" of all the new IBM-compatibles. The Sanyo even surpasses the IBM PC in computing speed and graphics quality.

Even if you've never had any previous training in electronics, you can succeed with NRI training. You'll start with the basics, rapidly building on the fundamentals of electronics until you master advanced concepts like digital logic, microprocessor design and computer memory. You'll probe into electronic circuits, using the exclusive

NRI Discovery Lab® and professional Digital Multimeter, that you keep.

You'll assemble Sanyo's intelligent keyboard, install the power supply and disk drive, and attach the high resolution monitor—all the while performing hands-on experiments and demonstrations that reinforce your skills.

Learn to service today's computers

As you complete your Sanyo, you grasp the "secrets" that qualify you for a new career. You'll learn to program in BASIC and machine language. You'll use utility programs to check out the operation of the Sanyo's 8088 microprocessor (the same chip used in the IBM PC). And you also get over \$1,000 worth of software, including WordStar and CalcStar.

Most importantly, you'll understand the principles common to all computers. Only a person who fully understands all the fundamentals can hope to be able to tackle all computers. NRI makes sure that you'll gain the knowledge and skills to maintain, troubleshoot and service computers.

Learn at home in spare time

With NRI training, you'll learn at home on your own time. That means your preparation for a new career or part-time job doesn't have to interfere

with your current job. You'll learn at your own pace, in the comfort and convenience of your own home. No classroom pressures, no rigid night school schedules. You're always backed up by the NRI staff and your instructor, who will answer questions, give you guidance and be available for special help if you need it.

Let others worry about computers taking their jobs. With NRI training, you'll soon have computers making good paying jobs for you.

Send for Free NRI Catalog

Send the post-paid reply card today for NRI's 100-page catalog, with all the facts about computer training plus career training in Robotics, Data Communications, TV/Video Servicing and many other fields. If some other ambitious person beat you to the card, write to NRI at the address below.

NRI SCHOOLS

McGraw-Hill Continuing Education Center
3939 Wisconsin Avenue, NW
Washington, DC 20016

We'll Give You Tomorrow.



IBM is a Registered Trademark of International Business Machines Corporation.



YOUR ELECTRONIC COMPONENTS CENTER

TOLL FREE: 1-800-343-0874

SPRING '85 CATALOG

NAME ADDRESS CITY STATE ZIP CODE

MAIL COUPON TO:

USA: P.O. Box 9100 Westborough, Mass. 01581 CANADA: 5651 Ferner St. Montreal, Quebec H4P 1N1

NEW PRODUCTS

(Continued from page 12) with a fully insulated alligator clip, and a 3/4-inch pointed probe. The exclusive Comfordome handle has a nylon cap that



CIRCLE 461 ON FREE INFORMATION CARD

can be removed for battery and bulb replacement.

In use, the alligator clip is attached to the circuit being tested, and the probe is placed on any terminal or contact point. If the circuit is complete, the bulb in the handle lights up. If the bulb does not glow, there is a break in the circuit that requires correction.

For more information, write or call Vaco Products Company, 1510 Skokie Blvd., Northbrook, IL 60062. Telephone: 312/564-3300.

NEW CATALOG

MCM Electronics, a distributor of electronics parts and accessories, has introduced their new Catalog No. 9. The new MCM Catalog contains 128 pages of test equipment, computer accessories, telephone accessories, speakers, televi-



MCM ELECTRONICS

THE ONLY ELECTRONICS PARTS COMPANY YOU'LL EVER NEED CALL TOLL FREE 1-800-543-4330 IN OHIO 1-800-762-4315

CATALOG NUMBER 9

CIRCLE 462 ON FREE INFORMATION CARD

sion parts, flybacks, yokes, switches, fuses, lamps, capacitors, resistors, cartridges, styli, wire, CATV equipment, and the largest selection of Japanese semiconductors in the country. Over 4,500 items are contained in the new Catalog. For a free copy of the new MCM Catalog call 800/543-4330. In Ohio, 800/762-4315.

HEAD-WORN MICROPHONE

Designed for hands-free vocal delivery, the Telex PH20 Head-Worn Microphone utilizes a close-talking, wide response, electret microphone, with an excellent (Continued on page 96)

SERVICE - ORDERS PROCESSED IN 24 HOURS. QUALITY - CURRENT DATE CODES • LEADING MFR'S. SAVINGS - VOLUME DISCOUNTS • TOLL FREE NO. SELF SERVE - STORES ARE OPEN AT 8:00 AM

SEMICONDUCTORS • PASSIVE COMPONENTS • DATA BOOKS CRYSTALS • CHEMICALS • POWER SUPPLIES • HARDWARE TEST INSTRUMENTS • BREADBOARDING • SOCKETS • SOLDER SWITCHES • MICROCOMPUTERS • TOOLS • TRANSFORMERS • KITS WIRE & CABLE • HEAT SINKS • RELAYS • FANS • CAPACITORS

Table with columns for ACT #, Qty, Price, and parts numbers (7400, 74LS, 74F SERIES FAST).

Partial listing only • Call us for your complete requirements

ORDERING INFORMATION

Use only the 5 digit ACT # when ordering. Some packages contain multiples other than one. Please note that these multiples will not be broken. Pkg'd Quantity is one (1) unless otherwise indicated. Minimum Order \$10.00. Plus \$3.75 Postage & Handling.

MAIL ORDERS

U.S. P.O. Box 9100 Westborough, Mass 01581 (517) 366-0300 TOLL FREE 1-800-343-0874 CANADA 5651 Ferner St. Montreal, Quebec H4P 1N1 (514) 731-1441 TOLL FREE 1-800-361-5884

CONVENIENT SELF-SERVE ELECTRONIC STORES LOCATED AT:

U.S. WESTBOROUGH, Mass 131 Tupper St. Westborough, MA 01581 (517) 366-9884 BELLEVUE, Wash 13107 Northup Way (206) 861-8191

CANADA MONTREAL 3651 Ferner St. Montreal, QC H4P 1N1 (514) 731-1441 OTTAWA 1023 Merivale Rd. Ottawa, ON K1H 1S9 (613) 728-1900 TORONTO 14 Garden St. Toronto, ON M5H 2K2 (416) 597-7692

EDMONTON 5312 Capara Trail Edmonton, AB T6C 4S8 (403) 438-3888 VANCOUVER 3070 Kingsway Vancouver, BC V6J 1G2 (604) 681-5324 STORES OPEN FROM 8:00 AM

LETTERS

(Continued from page 4)

the same 1K resistor. Of course, connect to a hi only those inputs that you want hi. That goes for all chips. Better still, on an AND chip, connect the unused gates to used gates. You don't need a resistor to do that.

Wrong Plane

On page 91 of the Winter, 1985 issue, the aircraft pictured is not a C-130. It is, in fact, a C-141B "Starlifter" heavy jet transport. The C-130 "Hercules", by contrast,

is a smaller (half the size) turboprop transport. Both, incidently, are manufactured by Lockheed, and both are in wide use in the U.S. Air Force. The smaller C-130 is also used by all of the other U.S. armed forces and the Coast Guard, and is in wide use in its military and civil (Lockheed L-100) versions around the world.

G.P., Summerville, SC

Thanks! If the plane were all shiny aluminum, and not camouflaged, I would have thought it was a 747. The armed

forces should color-code aircraft rudder surfaces like resistors so that we novices may read the model numbers. Thanks for the extra details.

Longer Life

I once read that human life can be extended by placing ourselves in a magnetic field. Can you give me more facts? P.C., Maplewood, NJ

Oh, hum, it's hokum! Friedrich (Franz) Anton Mesmer promoted magnetism as an effective medicine. The cures he claimed were more psychological than real. So investigation in the last few decades indicate an effect on human and non-human tissues that promotes (and hinders) the intake of oxygen. There is some interaction between magnetic fields and life forms. However, don't look for doctor's prescriptions reading, "1--100,000-oersted permanent magnet," in the near future.

Hot Wire

How accurate were those old hot-wire ammeters?

M.S., Park, NY

They worked! A wire was stretched and hung from its center was a string and it was pulled by a spring. That string was wrapped around a shaft at its midpoint. Now, as current went through the wire, it heated up and stretched. The spring felt the slack and pulled on the string as it took up the slack. The string moved a small amount, and since it was wrapped around the shaft, the shaft rotated. Put a pointer on the shaft and you have a hot-wire ammeter. Why the need for a hot-wire ammeter?

Well, in the old days hams wanted to measure the output of their antennas, and no RF device was capable of doing it. The hot-wire ammeter was just another link in the antenna system that was sensitive to current changes at any frequency.

The hot wire is an averaging device and added almost no loss in the antenna line. It was a natural. Later, Detroit used meters of that type in automobiles to indicate charging current. It could handle large currents and was very rugged. You don't see too many meters of that type today. Thermocouples do a better job with RF and jeweled meters are rugged enough today for automotive and portable use. So, bye bye hot-wire ammeter. It's been so good to know you.

We enjoy receiving letters from our readers. Each letter is read carefully. Essential information is used to guide the editors in preparing the next issue. However, please forgive us should we not answer your letter—it is impossible to answer all of them. ■

This will be coming to you when you subscribe to **Radio-Electronics**

• HELPFUL CONSTRUCTION ARTICLES...

Test Equipment
Hi-Fi Accessories
Telephone Accessories
Music Synthesizers
Computer Equipment
Automotive Equipment
Intruder Alarms—Home & Car
Video Accessories

• NEWS ON NEW TECHNOLOGY

Computers
Microprocessors
Satellite TV
Teletext
Automotive Electronics
Speech Synthesizers
IC Applications

• FASCINATING "HOW TO DO IT" ARTICLES...

Build Your Own Projects
Make Your Own PC Boards
Wiring Techniques
Soldering and Desoldering
Design and Prototyping



Radio-Electronics covers all aspects of the fast moving electronics field...featuring
COMPUTERS • VIDEO • STEREO TECHNOLOGY • SERVICE COMMUNICATIONS • PROJECTS

Get it all!

Subscribe today to Radio-Electronics! Don't miss a single issue and...see subscription card in back of this issue for big savings.

When you select one of the subscription offers listed on the handy coupon—you'll be assured of having your copy reserved, even if it sells out on the newsstand. Make sure you get all the excitement in every issue of Radio-Electronics, every month, by filling in and mailing your subscription card today.

• HOW YOU AND THE COMPUTER CAN BE FRIENDS...

Getting Started
Programs, Circuit Design, Games
A/D-D/A Interfacing
Peripheral Equipment

• NEW AUDIO DIMENSIONS FOR YOUR PLEASURE...

Noise-Reduction Devices
How to Connect that Extra Add-On
Hi-Fi Accessories
New Technology

• TV WONDERS FOR YOUR FUTURE...

Latest Receivers and Circuits
The Home Entertainment Center
Projection TV
Satellite TV Receivers
Jack Darr's Monthly Service Clinic
Service Problems and Solutions

• REGULAR MONTHLY FEATURES

DESIGNERS NOTEBOOK
by Robert Grossblatt
HOBBY CORNER
by "Doc" Savage, K4SDS
STATE-OF-SOLID-STATE
by Bob Scott
WHAT'S NEWS new products, stereo news
VIDEOGAMES, new products, game reviews and NEW IDEAS, STEREO PRODUCTS, NEW COMPUTER PRODUCTS FOR HOME JOB and MUCH MORE!

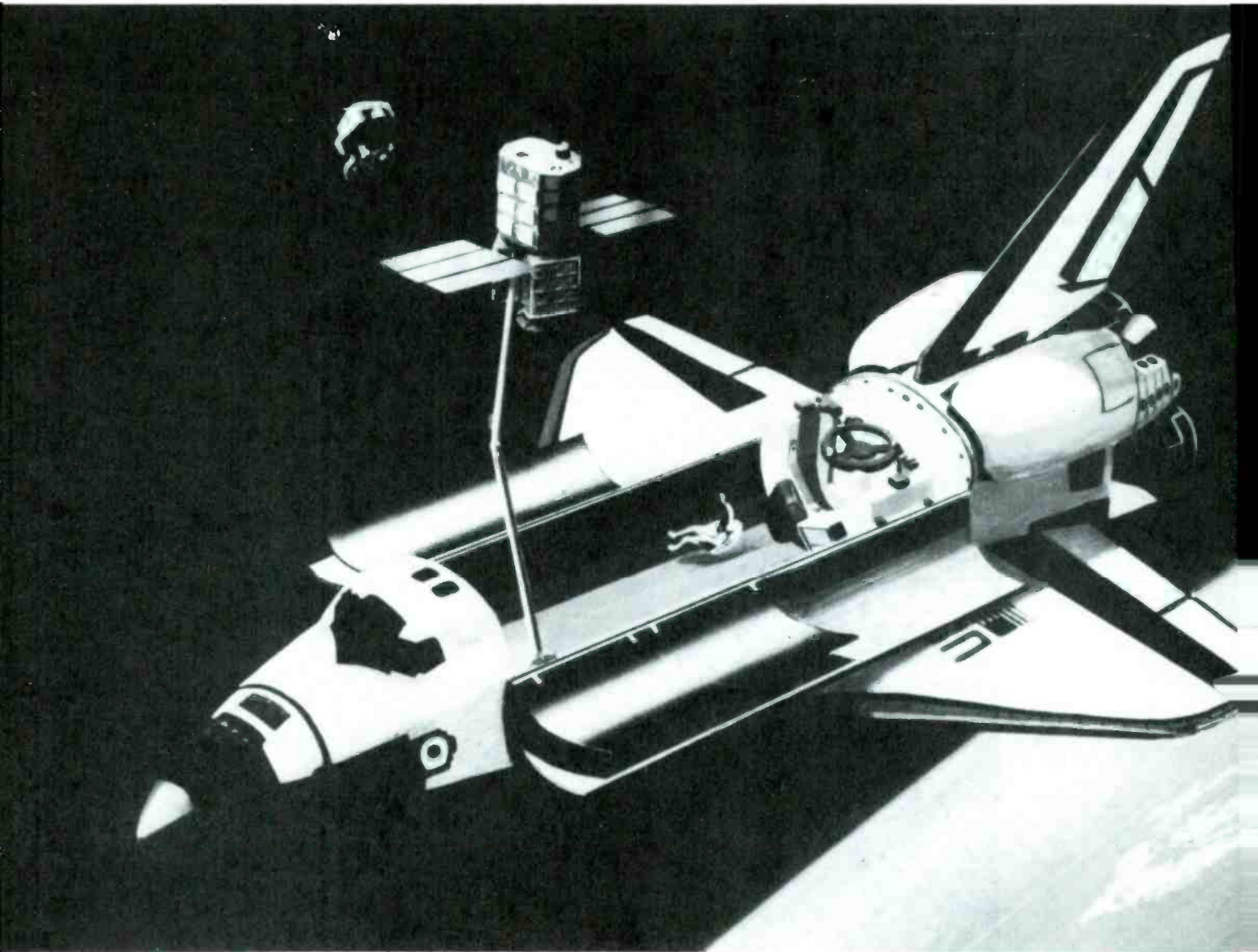

□FOR ALMOST AS LONG AS THERE'S BEEN ELECTRONIC equipment to break down, there have also been service technicians to come out and fix the wayward equipment. Now most service technicians probably have their own tales about a *way out* service call, but none will top the one that can be told by Drs. George D. Nelson and James D. van Hoften. After all, their *service call* took them nearly 270 miles, straight up.

The Solar Max

On February 14, 1980, the Solar Maximum observatory (or Solar Max, as it is commonly known) was launched. Its mission was to provide solar scientists with information about the sun that was impossible to obtain using earthbound instruments.

Among the subjects to be studied by using the satellite were solar flares. Radio amateurs are familiar with the effects caused by those massive solar storms. Within hours after the occurrence of a flare, earth-bound communications can be severely curtailed and brilliant auroras (northern lights) may be generated.

One of the things known about solar flares is that they appear to occur in cycles, with peaks in activity falling about

every 11 years. One such year of peak or solar maximum activity was 1980; thus, the Solar Max was launched in that year to learn more about the Sun in general, and solar flares in particular, during the active period.

Solar flares are complex phenomenon. In fact they are so complex that no single instrument can monitor all of their features. Because of that, Solar Max carried seven scientific instruments that all are simultaneously used to monitor a flare. Six of those instruments are used to measure the energy emitted in the electromagnetic spectrum, from visible light to ultra-violet, and from X-rays to gamma rays. The data gathered by those instruments is used to help us learn more about how flares start, how they release their energy, and how that energy effects the earth. The seventh instrument on board the satellite is used to measure the total radiation released by the Sun.

Trouble in Space

During its first nine months in space, the Solar Max mission was a smashing success. Then, suddenly, three fuses in the satellite's Attitude Control System blew, causing the satellite to lose its ability to point its onboard instruments accurately. That rendered all but three of the instruments

SPACE TECHNICIANS SERVICE THE SATELLITES

High above the clouds and atmosphere astronauts serviced Solar Max. It's the first in-space satellite service call!

useless. Later, a fifth instrument developed an electronic problem and failed.

Because the mission objectives established before the launch were met, the Solar Max project was declared a success. Nevertheless, since the lifetime of the satellite was reduced from an expected two years to just nine months, a great deal of useful data was lost to earthbound scientists.

But Solar Max was one of the first of a new breed of satellites: one that was, at least in part, designed to be repaired in space. The faulty Attitude Control System was one of three replaceable modules. Those modules, which are used for such things as power and positioning, are located in the bottom portion of the satellite (see Fig. 1 on the next page). They are standardized units, called the multimission modular system, and are designed to be used in a wide variety of satellites.

When the space shuttle program was first conceived, one of its primary benefits was intended to be the repair or retrieval of satellites. But until it was actually accomplished, no one could say for sure that such a feat was possible. Because of its design, and relative importance to earthbound solar scientists, Solar Max was chosen to be the first test of that capability.

A Service Call

The space shuttle *Challenger*, with a crew of five, was launched from the Kennedy Space Center in Florida on April 6, 1984. Among its prime mission objectives was the repair of the Solar Max. That repair was to consist of two parts.

One part was the replacement of the Attitude Control System. The second, and more difficult repair was the replacement of the main electronics "box" in the Coronagraph/Polarimeter, an instrument that was used to study the sun's outer atmosphere, or corona, by creating an artificial eclipse. That instrument was not intended for repair in space, and the faulty circuitry was located inside the insulated shell of the satellite; but the instrument was positioned in such a way that it was felt that a repair was feasible.

For any repair job the proper tools are needed, and the repair of a satellite in space is no exception. One of the most important tools used in the repair is the Flight Support System, a mounting platform for the satellite during repairs (see Fig. 2). The support system was designed to mate with the multimission modular base of the satellite.

The Flight Support System is U-shaped and fills the 15-foot width of the of the shuttle's cargo bay. It consists of three cradles, called A, B, and A prime, and a circular ring to

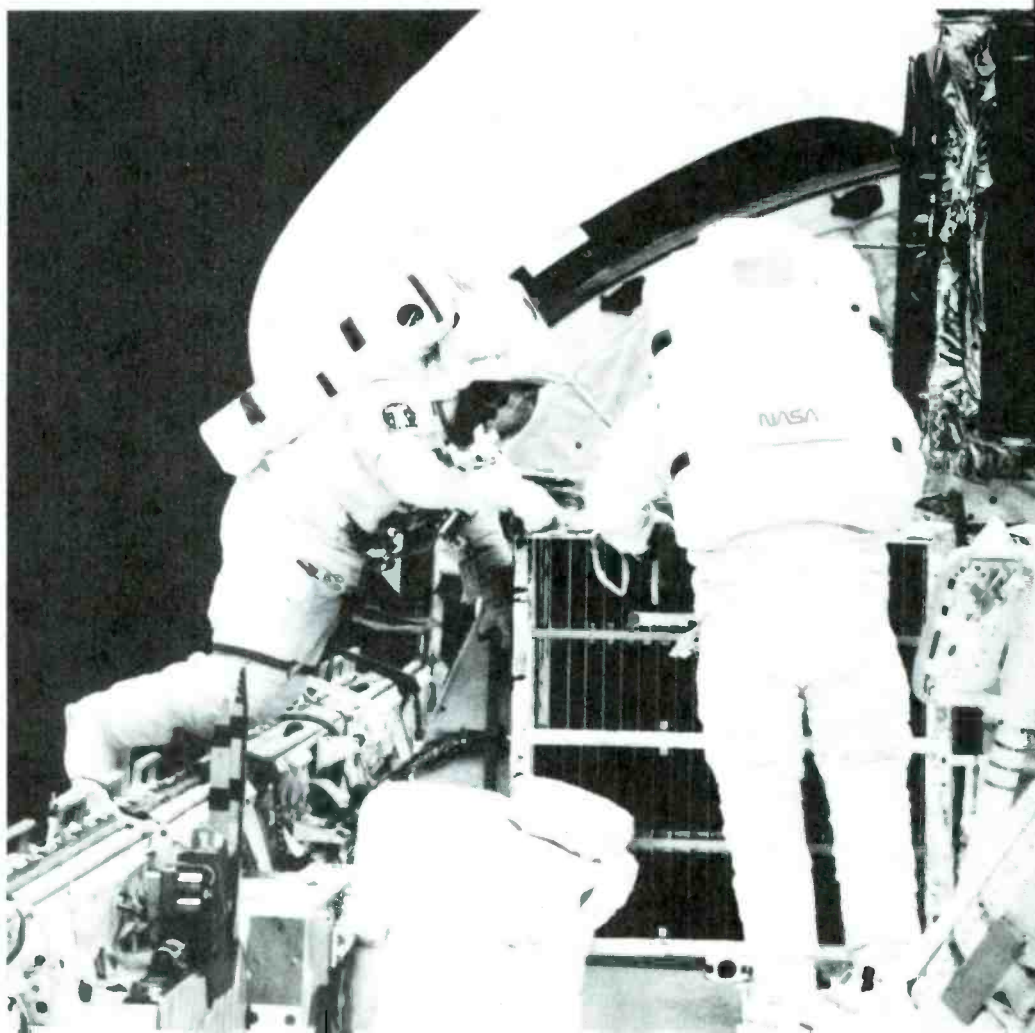
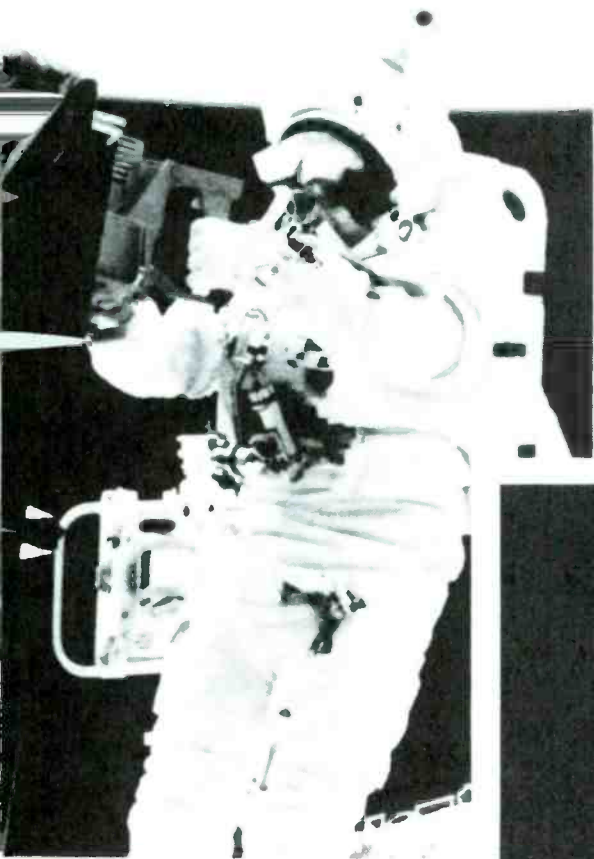
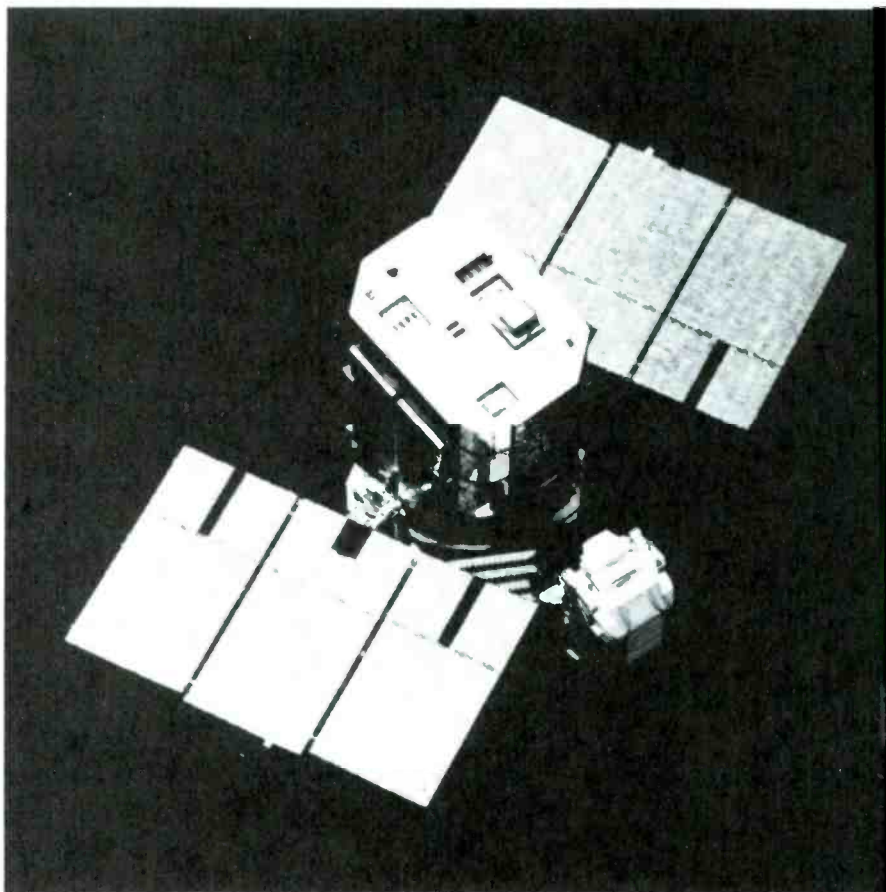
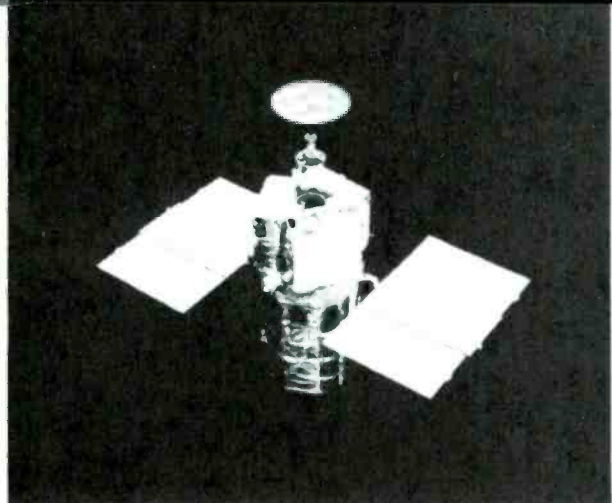

Solar Maximum Mission Satellite (SMMS) orbits through space, (upper left) providing no useful function due to the on-board malfunction. Astronaut George Nelson (upper right) space-walked to connect the trunion pin-attachment device. In the photo at right, Astronauts James van Hoften (right) and George Nelson (left) work cautiously on the faulty attitude-control module in the *Challenger's* open cargo bay. A special tool (immediately above) is used by George Nelson to disassemble the module.

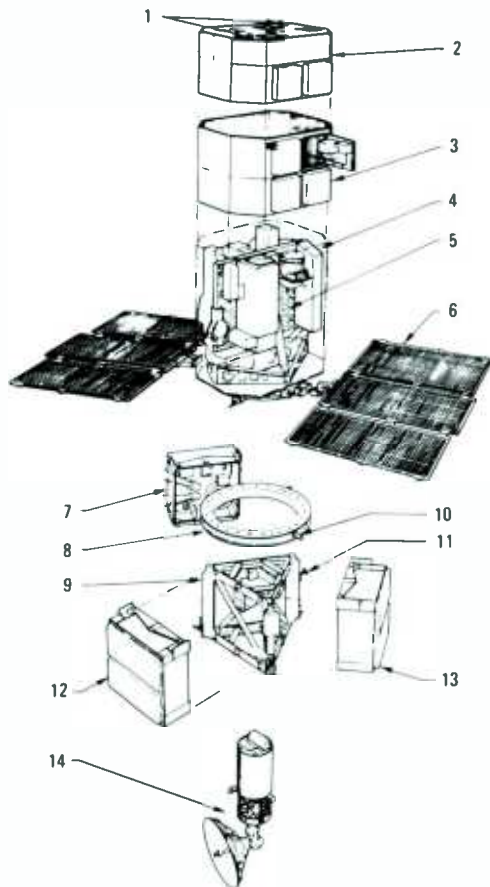

Fig. 1—An exploded view of the Solar Max satellite. The three modular units at the base of the satellite are intended for replacement while in space. One of those units, the Attitude Control System (ACS) was replaced in space by Drs. James D. van Hoften and George D. Nelson.

- | | |
|---|-------------------------------------|
| 1. Coarse Sun Sensors | 8. Transition Adaptor |
| 2. Thermal Enclosure | 9. Module Support Structure |
| 3. Electronic Enclosure | 10. Trunnion Pin |
| 4. Instruments | 11. Grapple Point |
| 5. Instrument Support Plate | 12. Power Module |
| 6. Solar Array System | 13. C and DH Modules |
| 7. Attitude Control System (ACS) Module | 14. High-Gain Antenna System (HGAS) |

weigh 500 pounds. Because of that, the astronauts doing the repair must work carefully and slowly. If one of the modules were set in motion by accident, it would be hard to control and could do considerable damage.

The Coronagraph/Polarimeter unit is not a module, and its repair is more difficult and time-consuming. But the "tool kit" used in its repair might be a bit more familiar to earth-bound technicians. It consisted of scissors, adhesive tape, and an electric screwdriver. To do the repair, the astronaut must first cut through the foil insulation and remove the screws that secure a protective thermal blanket over the instrument. After taping the insulation and blanket out of the way, a panel is unscrewed and opened, exposing the main electronics "box", which is about the size of a briefcase. To complete the repair, the faulty box is disconnected and removed; the new one installed and reconnected; the panel closed, and the protective insulation reattached.

which the satellite can be anchored during the repair.

The Flight Support System provides electrical and mechanical connections between the shuttle and the satellite under repair. A rotator on the support system can turn the satellite, and a pivotor is used to tilt the satellite at any angle from upright to horizontal. To secure the satellite, three berthing latches clamp onto pins near its bottom. Power and heat from the shuttle are provided to the satellite via umbilical connectors.

A module service tool, see Fig. 3, is used to remove the modular Attitude Control System. That module service tool, which has been specially designed for that task, is controlled by two handles and two switches. To remove the faulty module, two latches on the tool are inserted in matching holes in the module. The latches are used to hold the tool in place, as the socket wrench at the end of the device is used to loosen the two retention bolts that hold the module to the satellite. (If a regular socket wrench were used on those bolts, the astronaut would turn—but the bolts would not move!)

Once the bolts are removed, the service tool is used to hold the module and it is slipped off the satellite. The faulty module is then stowed in a temporary location; the new module is retrieved and mounted using the tool; and the faulty module moved to its permanent location for return to earth. On earth, the module will be examined to find the cause of the failure and may possibly be repaired for future use.

One of the problems of repair in space is that while objects are weightless, they are not massless. The modules are large units, measuring some 4 × 4 × 1.7 feet. On earth they would

Best Laid Plans

As any one who has ever serviced electronic equipment knows, rarely do things go as planned. And that service call was no exception.

When the satellite failed, ground controllers placed it in a slow, stable spin of about one degree per second. That kept the satellite's solar panels constantly pointed toward the sun, keeping the unit's batteries fully charged.

As you might imagine, grabbing a spinning satellite is no simple matter. That's because, even though it is weightless, the satellite retains its momentum.

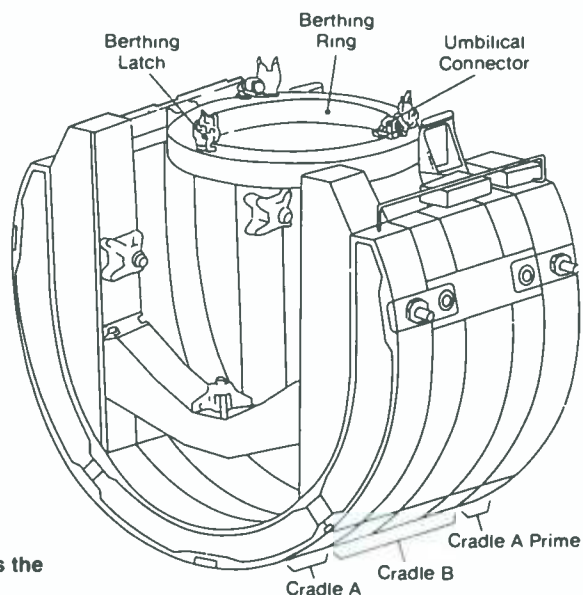

Fig. 2—During repairs, the satellite is mounted in the Flight Support System cradle. That U-shaped cradle fills the width of the shuttle's 15-foot cargo bay.

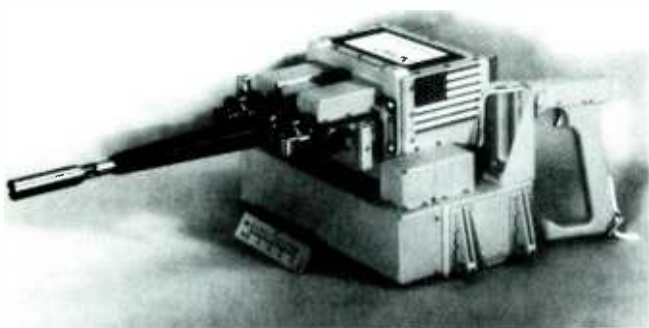

Fig. 3—The module service tool serves as a zero-torque socket wrench and as a handle-grip to move the defective and new modules about. The module weighs about 500 pounds on Earth.

The first task, then, was to stop that spin so that the shuttle's manipulator arm could pick up the satellite safely. To do that, an astronaut—in this case Nelson—was to fly over to the satellite using a jet-powered Manned Maneuvering Unit, or MMU (see Fig. 4). Once at the satellite, Nelson was to stop the spin by docking himself to a pin protruding from the Solar Max and using the maneuvering unit's 1.7 pound thrusters. To accomplish the docking, a special receptacle, called the Trunion Pin Acquisition Device, TPAD, was mounted on the arms of the MMU.

By the mission's third day, the *Challenger* had caught up with the wayward satellite, and astronaut Nelson set out for his short 10-minute trip to Solar Max on schedule. When he reached the satellite, he matched its spin by firing the MMU thrusters. So far, so good.

Then trouble hit. When he attempted the docking, the jaws within the TPAD failed to clamp onto the satellite's pin as they were supposed to. Nelson tried again, this time moving in a bit faster, but still could not dock.

By now, the docking attempts had begun to disrupt the satellite's orderly spin. As a final attempt, Nelson tried to steady the satellite by grabbing onto one of its solar panels. That, however, only made matters worse. Since the MMU's fuel supply was now running low, Nelson returned to the shuttle.

But damage had been done. Now, instead of spinning in an orderly manner, the satellite was spinning unpredictably about all three axis. After Nelson returned to the *Challenger*, four attempts were made to grab the satellite's pin using the shuttle's manipulator arm. All of those attempts also failed.

The failed docking attempts caused two problems. The first was the uncontrolled spin; the second was that the solar panels were no longer aimed toward the Sun. Because of the latter, the satellite's batteries would power the satellite for only an additional six hours.

Fortunately, using telemetry, ground controllers were able to stabilize it to the point where the satellite was holding almost perfectly still. And, more fortunately still, though the panels were still pointed away from the Sun, the satellite's orbit swung around and pointed those panels toward the sun just before time ran out on Solar Max's batteries.

By the next morning, the satellite's batteries had almost completely recharged, and it was time to try to retrieve the satellite once more. Because the satellite was turning much more slowly (at about half of its original rate), and because fuel levels aboard the shuttle were beginning to run low, it was decided try using the manipulator arm once again.

A Nice Catch

The fourth day of the mission was used to attend to other activities not related to the repair of Solar Max. But, early on the fifth day, the shuttle successfully grabbed the satellite and hauled it safely into the cargo bay.

To perform the maneuver, mission commander Robert L. Crippen carefully positioned the shuttle under the satellite so that astronaut Terry J. Hart could extend the manipulator arm upward and grab onto the satellite's pin. This time, they caught it on the first try!

The satellite was then brought into the cargo bay and secured to the Flight System Support cradle. Power was supplied to the satellite through the umbilical connectors, and the satellite was pivoted around so that Drs. Van Hoften and Nelson could get at the electronics more easily.

The fifth day of the mission was the day that repairs were performed. Though originally scheduled for two days, because of the problems the crew ran into while catching the satellite, all repairs now needed to be completed in one day.

(Continued on page 98)



MEET THE SPACE TECHNICANS

Dr. James D. van Hoften (left) is a hydraulic engineer and leader of the Astronaut Support Team responsible for Space Shuttle testing and flight preparations. He is a specialist in shuttle guidance, navigation, and flight control. Dr. George D. Nelson (right) is an astronomer with experience in astronomical research, development of the shuttle-era space suit, and mission support for the STS-3 and STS-4 space shuttle flights.



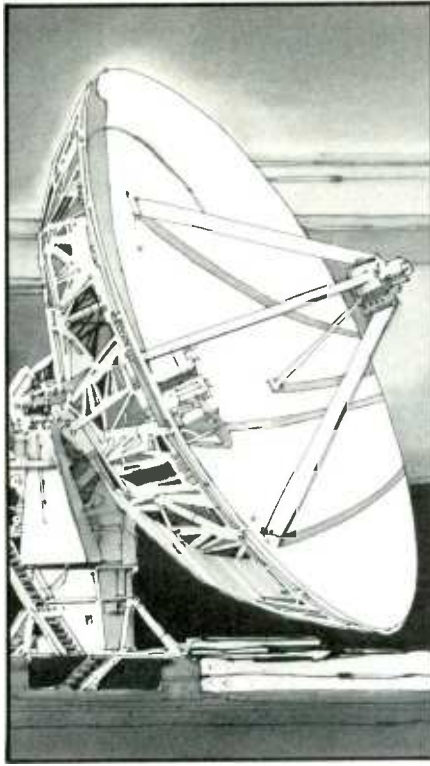

What can you do with electronics? Ask CIE.

Computer technology. Satellite communications. Cable television. Cellular radio. Digital electronics. Robotics. The hottest careers in electronics. And CIE can get you started. By teaching you the basic theory and principles of how they work.

Why CIE? Because we're the leader in specialized electronics education with over 25,000 students. With over 50 years of proven experience teaching electronics **without** classroom sessions. And with plenty of hands on, practical experience using our specialized training laboratories.

Whether it's learning new skills or upgrading old ones, CIE can start you where you want, take you as far as you want. From the basics to CIE's Associate in Applied Science Degree in Electronics. We've done it for thousands of students. We can do it for you.

Let us get you started today. Just call toll-free **1-800-362-2155** (in Ohio, 1-800-362-2105) or mail in the handy reply coupon below or card to Cleveland Institute of Electronics, 1776 East 17th Street, Cleveland, Ohio 44114.

CIE World Headquarters

Cleveland Institute of Electronics, Inc.
1776 East 17th Street • Cleveland, Ohio 44114

- Please send me your CIE Off-Campus Studies Catalog, including details about the Associate Degree program. I understand there is no cost for the catalog and a CIE representative may call, but there is no obligation.

Print Name _____

Address _____ Apt. No. _____

City _____ State _____ Zip _____

Age _____ Area Code/Phone No. _____ / _____

Check box for G.I. Bill bulletin on Educational Benefits

Veteran Active Duty

MAIL TODAY!

RP-29

Be an FCC LICENSED ELECTRONIC TECHNICIAN!



Earn up to \$600 a week and more!

Learn at home in spare time. No previous experience needed.

No costly School. No commuting to class. The Original Home-Study course that prepares you for the FCC Radiotelephone license exam in your spare time! An FCC Government license is your "ticket" to thousands of exciting jobs in Communications, Radio & TV, Mobile two-way, Microwave, Computers, Radar, Aerospace and more. You don't need a college degree to qualify, but you do need an FCC License. **No need to quit your job or go to school!** You learn how to pass the FCC License exam at home at your own pace with this easy-to-understand, proven course. It's easy, fast and low cost! **GUARANTEED PASS**—You get your FCC License or money refunded. Write for free details. Soon you could be on your way to being one of the highest workers in the electronics field. **Send for FREE facts now. MAIL COUPON TODAY!**

COMMAND PRODUCTIONS
 FCC LICENSE TRAINING, Dept. 200
 P.O. Box 2223, San Francisco, CA 94126

Rush FREE facts on how I can get my FCC License in spare time. No obligation. No salesman will call.

NAME _____
 ADDRESS _____
 CITY _____ STATE _____ ZIP _____

THE GOVERNMENT CAN DO EVERYTHING THE UNITED WAY DOES. ONLY THEY WRAP IT UP FOR YOU IN NICE RED RIBBON. MILES AND MILES OF IT.



One of the best things about United Way is not what it does, but what it doesn't do. For instance, because United Way is run almost entirely by volunteers, it is able to return an amazing 89% of every dollar to people who need it. That means less than 11% goes for administrative costs. So it doesn't waste your money. And because United Way is re-created each year with a combination of old and new volunteers, it doesn't become over-encumbered with huge staffs of people who might actually get in the way of progress. So it doesn't strangle you in red tape. All of which means that because of what United Way doesn't do, it can do a much better job at what it does do. Helping people.



Thanks to you it works for all of us.

BOOKSHELF

(Continued from page 16)

books, magazines, and other sources, but there is little information available to the electronics hobbyist on how to combine and integrate those various circuit parts into a complete working project. The aim of this book is to do just that, by helping the project builder put together home-brew gadgets from circuit building blocks with the minimum of trial and error. Hints on designing circuit blocks to meet the experimenter's own special requirements, where no stock designs are available, are also included.

The subject is tackled by taking a series of simple practical examples, analyzing exactly what each circuit must do, exploring possible methods of achieving each circuit action, and then working out practical designs including component values. Thus a number of useful circuits are provided as well as project design advice.

Electronic Technology Today, Inc., P.O. Box 240, M/S-HOE4, Massapequa, NY 11762-0240. Softcover, 101-pages, \$5.75 plus \$.75 for postage and handling.

THE CET EXAM BOOK

By Dick Glass and Ron Crow

Whether you're just starting out in the electronics service field or you're an experienced technician who has just never gotten around to getting your CET certification, this is the ideal sourcebook to prepare you for that exam. It is not a guarantee, but you may pass it the first time with flying colors!

Thoroughly practical and completely up-to-date, this guidebook will set aside any fears you might have had that the Certification Exam is based strictly on theory, rather than the everyday workbench knowledge you rely on in

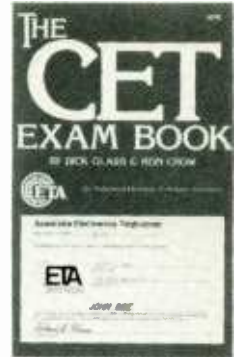

CIRCLE 493 ON FREE INFORMATION CARD

your job. It shows that what you need is a realistic balance of hands-on know-how and basic theory. And, with the confidence you'll gain using this book's sample questions and explanations, there's no reason why taking your exam won't be as simple as doing your everyday job.

Here, in easy-to-follow format, are samples of all the questions you'll encounter on the exam—plus the answers to the those questions and full explanations of all the principles involved. It covers the latest technical information, provides sample quizzes on each topic, shows you how to examine your test scores to tell where you need extra study, and helps you determine the achievement level needed to gain certification. Also included is an appendix listing the names and addresses of all Certification Administrators in the U.S. and Canada so that when you're ready to take the exam you'll be able to locate a qualified administrator!

TAB Books Inc., Blue Ridge Summit, Pa. 17214. Paperback, 215 pages, \$ 9.95.

Understanding Data Communications

By George E. Friend, John L. Fike, H. Charles Baker, and John C. Bellamy

Data Communications—the communication of information using digital signals—is the lifeblood of our economy. Everything

NEW FOR '85 DATA CABLE PRODUCTS

AUGAT PACKAGED PRODUCTS

Visit us at **EDS Booth Nos. A47, A49**

The Single Source for Sockets, Alcoswitches, Knobs, Ribbon Cable Products, RDI Terminal Blocks, D-Subs, Edge Cards, Telecon, RS-232 & Co-Axial Cables, Gender Changers, UHF & BNC, Flat Cable, Accessories

1985 Catalogs Available

1985 Catalog features Sockets, Switches, Knobs, Ribbon Cable Products
Data Cable Products Catalog features D-Subs, Edge Cards, Telecon, RS-232 Cables, UHF & BNC, Flat Cable, Accessories
1985 Supplement features RDI Terminal Blocks

GUARANTEED SALE **AUGAT PACKAGED PRODUCTS** **PREPAID* FREIGHT**

Call these TOLL FREE numbers for the name of the distributor or sales rep nearest you.
Nationwide (800) 336-3613 / In Mass. (800) 428-5700
 P.O. Box 659, 40 Perry Avenue, Attleboro, MA 02703
Service Is Our Business No Order Too Small

CIRCLE 418 ON FREE INFORMATION CARD

from facts and figures for corporations, telephone network control signals, banking and credit-card purchases, newspaper copy sent from a central location to outlying printing stations, and more, dramatizes the impact of this technology. An understanding of what data communications is and what it does may be as necessary in the future as knowing how to dial a telephone. It is something you need to know.

Basic concepts and fundamentals, transmissions and reception, asynchronous and synchronous, protocols, error control, and networking are covered in 10 chapters. You will cover such topics as: An overview of data communications, data terminals, messages and transmission channels, asynchronous modems and

Understanding Data Communications

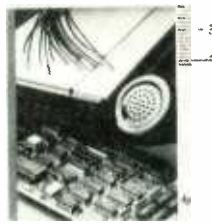

CIRCLE 494 ON FREE INFORMATION CARD

interfaces, synchronous modems and digital transmission, fiber optic and satellite communications, protocols and error control, alternatives in Local area networks, architectures and packet networks, and network design.

Understanding Series TM books from Texas Instruments form a library written for anyone who wants to learn easily and quickly more about today's electronic technology and the era of personal

computing, its impact on our world, and its application in our lives. Each book is written in bright, clear, down-to-earth language and focuses on one aspect of what's new in today's electronics.

Texas Instruments, P.O. Box 225012, MS-54, Dallas, TX 75265. Paperback, 272 pages. \$14.95.

Basic Integrated Circuit Theory and Projects By Charles K. Adams

Here's the ideal workbench guide for anyone who wants to learn how integrated circuits work and to begin using both analog and digital ICs in practical, working applications! No advanced math or science background is needed, because the author has broken down IC theory into easily digestible segments, complete with

applications data and projects that provide you with hands-on experience.

To provide you with the background you'll need to apply IC's to specific projects, there are complete specifications for representative IC's, including analog devices and both simple and advanced 7400 devices. Applications information further aids your understanding of this versatile electronics technology. You'll get a look at analog applications for the MCI4066B analog switch, the 555 timer, the LM340T-5 voltage regulator, the LM324 operational amplifier, and the MCI306P audio amplifier. Digital applications illustrated include flip-flops, a counter module, and a comparator.

With this background, you'll be able to immediately put your IC

knowledge to work using a series of 24 exciting and useful projects. Build a NAND gates, series NAND gates, and wired AND gate, a NOR gate or series NOR gates.

BASIC INTEGRATED CIRCUIT THEORY & PROJECTS



CIRCLE 495 ON FREE INFORMATION CARD

With the insight you'll gain from the easy-to-follow explanations and hands-on project instructions included in this exciting sourcebook, you'll have acquired the skills and know-how to begin using IC's in other circuits and applications.

Tab Books Inc., Blue Ridge Summit, PA 17214. Paperback, 258 pages. \$11.95.



"In Just A Few Days, I'll Show You How To Do

REAL MATH

On Your Calculator!

- Quick. •Guaranteed.
- Easy. •Fun, Too!

INTRIGUED BY CALCULATORS? Then you can step up your math skills fast! Use my new method in guidebook form. It's called **CALCULATOR CALCULUS**. This space-travel spinoff is sure-fire, so it has a simple guarantee — just return it for an immediate refund if you are not astounded at the problems you're solving with it!

But the point is - you won't want to send it back. For this is the *easiest, fastest shortcut* ever! The day you receive your copy in the mail you'll want to put it to work. It's that exciting and helpful.

My name is Dr. George McCarty. I teach math at the University of California. I wrote this guidebook to cut through the confusion. I guide you with examples you follow step-by-step on your calculator — you do simple exercises — then you solve practical problems with real precision!

POWER METHODS. Need to evaluate polynomials, areas, volumes — solve equations — use curves, trig, polar coordinates — find limits for sequences and series! It's all here!

If you're in the biological, social or physical sciences, you'll be doing Bessel functions, carbon dating, Comperitz growth curves, half-life, future value, marginal costs, motion, cooling, probability, pressure — and plenty more (even differential equations).

Important numerical techniques? Those algorithms are here, too: rational and Pade approximation, bracketing, continued fractions, Euler's method, Heun's method, iteration functions, Newton's method, predictor-corrector, successive substitutions, Simpson's method and synthetic division.

LOOK AT WHAT USERS SAY: Samuel C. McCluney, Jr., of Philadelphia writes:

"**CALCULATOR CALCULUS IS GREAT!** For ten years I have been trying to get the theory of calculus through my head, using home-study courses. It was not until I had your book that it became clear what the calculus was all about. With your book and a calculator the whole idea becomes clear in a moment, and is a **MOST REFRESHING EXPERIENCE.** I program some of the iterative problems you suggest and it always

GIVES ME A THRILL to see it start out with a wild guess and then approach the limit and stop."

Professor John A. Ball of Harvard College (author of the book *Algorithms for RPN Calculators*) writes: "I wish I had had as good a calculus course."

Professor H. I. Freedman of the U. of Alberta, writing in *Soc. Ind. Appl. Math Review*, states: "There can be no question as to the usefulness of this book...lots of exercises...very clearly written and makes for easy reading."

Tektronix Engineer Bill Templeton says "**CALCULATOR CALCULUS is the best, most clearly written book I have seen for improving your math skills.**"

I WANT YOU TO DO THIS. Get my complete kit, with a TI-35 calculator, plus its 200 p. Student Math Book, **AND** the guidebook, **ALL** for \$44.95 (for shipping to USA add \$2, or \$5 by AIR; Foreign \$5, or \$10 AIR; \$2.70 tax in CA). Order Stock No. 7A.

If you already have a scientific calculator, you can invest in "**CALCULATOR CALCULUS**" for only U.S. \$19.95 (to USA or foreign; add \$1 for shipping, or \$4 by AIR; \$1.20 tax in CA). Order Stock No. 6A.

As pennywise Ben Franklin said, "**An investment in knowledge pays the best dividends.**" **GET STARTED NOW** — Tax deductible for professionals.

MONEY-BACK GUARANTEE! Send for it today. Be sure to give me your complete mailing address with your check or money order. If you want to charge it (Visa or MC), tell me your card no. and exp. date.

Prompt shipment guaranteed. Thank you!

George W. McCarty

EduCALC Publications
27953 Cabot Road, Laguna Niguel, CA 92677
For fast service, phone MC or VISA orders
TOLL FREE to (800) 633-2252, Ext. 340.

T
E
A
R
O
U
T
A
N
D
M
A
I
L
T
O
D
A
Y

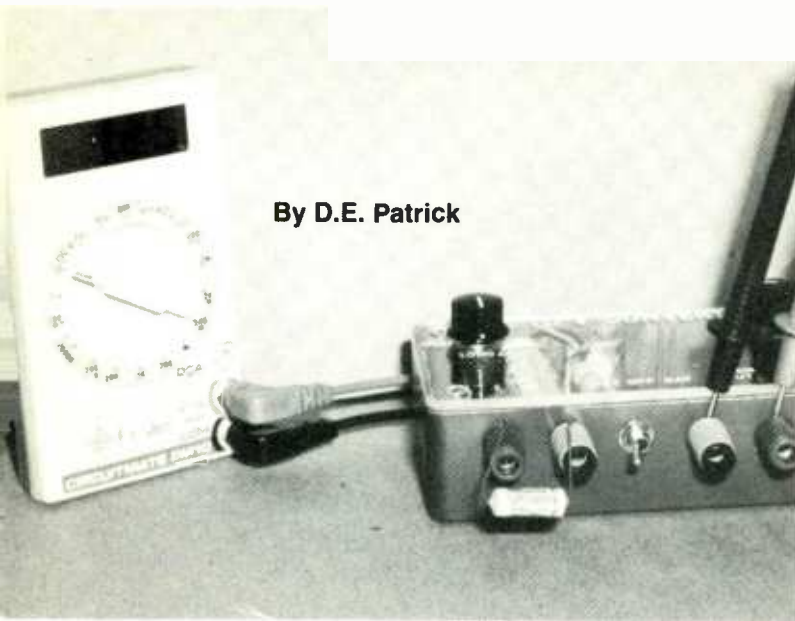

By D.E. Patrick

C to V CONVERTER

Beats the socks off any other capacitor meter published to date! Display and control electronics are eliminated! Designed for 1% accuracy! Only one calibration control. Cheap enough for Uncle Scrooge to build!

OVER THE LAST FEW YEARS THERE HAVE BEEN NUMEROUS, ridiculously complicated articles on how to build digital *cap rappers* (capacitance meters) using capacitance-to-frequency (C to F) conversion in a myriad of experimental magazines.

How many? Too many! And they are too complicated, and too expensive!

Well, if you yearned for cheap, accurate simplicity, you'd better believe you didn't get that from projects using 555/556-type converter circuits. But, in this article you will discover how to get .1% to 1% accuracy out of just four or five common *el cheepo* junkbox IC's. In most prior projects, most of your time, effort, and money would have gone into building display and control electronics. However, a DMM is used with this project for a display. The project uses capacitance-to-voltage (C-to-V) conversion, and it's just too simple to pass up. In fact, its name became obvious—C to V Converter.

Going Farther

Since most of us already own a DMM, using it to display capacitance eliminates the wasted time and effort needed to duplicate what we've already paid for! All we have to add to what we have is a capacitance-to-voltage (C to V) converter.

which can still be built out of *el cheepo* 555- or 7555-type timers, with expected accuracy in the 1% range or better. Also, using a precision timer like an LM322, we can get accuracies down to the .1% range or better, but let's leave that for another time.

Working with the 555- or 7555-type IC, a C to V converter can be built whose accuracy will be limited by the accuracy of the timers used in a monostable configuration, when triggered by a crystal stabilized clock pulse. However, to cut costs and simplify time-base design, you could use another 555 or 7555 as an astable clock source, and even that configuration could still yield accuracies in the 5% range.

So, that brings us to the circuit in Fig. 1 which will work with most DVM's, DMM's, or even high-impedance multi-meters for that matter. However, you can't expect the kind of resolution from a standard analog meter that you would get from a 3½-digit DMM.

The full-scale output is 1 volt with a 100% over-range. That is, where 1-volt is the full-scale output of a 1000-pF (102) capacitor on the 1000 pF range, you can actually go up to 1999 pF on a 3½-digit DMM having a full-scale range of 2 volts.

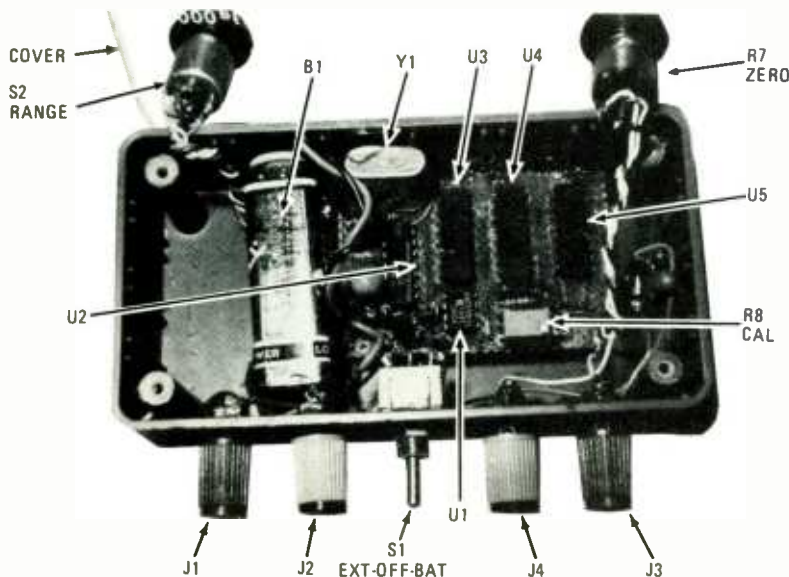

How the Circuit Works

In Fig. 1, U1, a 7555 CMOS version of a 555 is used as a low power C-to-V converter. U2, a 4069 CMOS inverter, Y1, a 1-MHz crystal, and associated circuitry, provide a crystal stabilized 1-MHz frequency. Three dual-decade 4518 CMOS counters, U3 through U5, divide the 1-MHz output. S1 selects the trigger input to U1 provided by U2 through U5 giving us the ranges 1000-pF, .01- μ F, .1- μ F, and 1.0- μ F, which may be changed as desired.

Looking down into the the *guts* of the C to V Converter. The author used a perf-board layout combining some wrapping and point-to-point wiring that suited his construction taste. He opted for an internally connected battery for a power supply, making the unit fully portable.

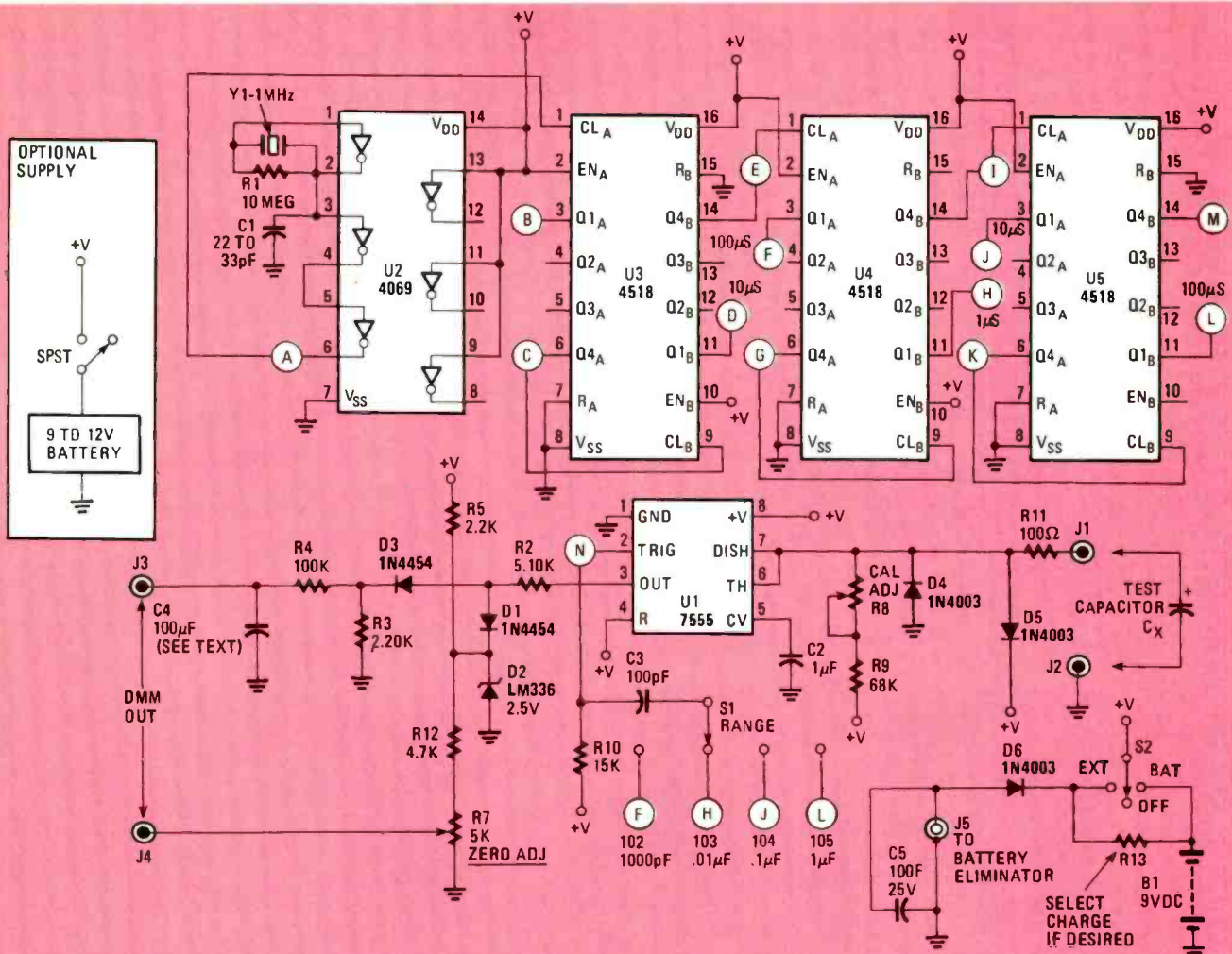

Fig. 1—Schematic diagram for the C to V Converter was simplified by eliminating many of the crossing wires. Interconnect all circled points identified by the same letter. To assist the wire-wrapping project builder, the drawing is as close as possible to a wiring diagram with the IC pin-outs in sequential order.

Chip U1 is configured as a monostable multivibrator with an output pulse width determined by the equation $T_p = 1.1R_1C_1$. Now, S1 selects the input trigger signal, which would be 10 milliseconds (ms) in the .1- μ F position. With R8 properly adjusted and $C_x = .1\text{-}\mu\text{F}$ across J1 and J2, there will be a 1 volt output across J3 and J4.

U1 provides a duty cycle of 4 parts in 10 or 40%, when R8 has been properly adjusted with a 10-ms trigger input. And, U1 will provide an output pulse width having a variable duty cycle, which is directly proportional to C_x 's value. The change in duty cycle is what we use to determine capacitance when U1's output is converted back into a proportional voltage. When U1 is triggered, its output voltage will swing toward the positive rail, and the reference voltage of D2 will appear across R3. That reference voltage across D2 is outputted to your DVM or DMM after filtering by C4. But, with a 40% duty cycle, the meter won't see the reference voltage of 2.5 volts. It will see only 40% of 2.5 volts, which is integrated by C4/R4 into a full-scale output of 1 volt.

As the duty cycle decreases for a given value of C_x less than .1 μ F in the example above, the voltage output looking back into J3 will decrease proportionately. As the duty cycle increases for larger values of C_x , the output voltage increases.

The longer the trigger and output pulse durations of U1, the

longer the integration time necessary out of the low-pass filter made up of R4 and C4. The value of C4 is not critical to accuracy, but will affect the stability of the readout. In the prototype, C4 is set at 100 μ F, which is generally higher than necessary; however, the readout on the 1 μ F range is rock solid, with no jitter. On the .1- μ F to 1000-pf ranges only 1- μ F is required for a stable readout. Therefore, if you want fast settling or the fastest possible settling time on all ranges, C_x 's value could be changed either by a separate switch labeled FILTERING, or it could be handled by a ganged deck on S1. Also, on some types of integrating voltmeters, almost no filtering is required. The bottom line here is that C4's value was set to handle the worst case one might find on any DMM on the market today; and to keep things simple, extra switching and two or three values of C4 were eliminated. However, they are mentioned here so that the reader can make changes, if desired.

Without zero compensation, there will be some stray capacitance such that when $C_x = 0$, the readout will not read 0000. That is, since you can't avoid the inherent 15 to 20 pF of stray capacitance, in order to zero the readout, we have to make our DMM think we've gotten rid of it. Potentiometer R7 provides the zeroing adjust to compensate for inherent stray capacitance by offsetting the voltage at J4. Now, we can

PARTS LIST FOR C TO V CONVERTER

SEMICONDUCTORS

D1, D3—1N4448, 1N4454, or 1N914 diode
D2—LM336, 2.5-volt Zener diode
D4-D6—1N4003 rectifying diode
U1—7555 or CMOS 555 timer integrated circuit
U2—4069 CMOS inverter integrated circuit
U3, U4, U5—4518 CMOS dual counter integrated circuit

RESISTORS

(All fixed resistors are 1/4-watt, 5% units except where specified.)

R1—10-Megohm
R2—5100-ohm, 1% (can be selected from 5.1 K 5% units with DMM)
R3—2200-ohm, 1% (can be selected from 2.2 K 5% units with DMM)
R4—100,000-ohm
R5—2200-ohm
R6—4700-ohm
R7—5000-ohm, linear-taper potentiometer
R8—50,000-ohm, linear-taper, 10- to 15-turn trimmer potentiometer
R9—68,000-ohm
R10—15,000-ohm

R11—100-ohms, 1/2-watt
R12—4,700-ohm
R13—Charge current limiting resistor—select value to match charging current (optional)

CAPACITORS

C1—22- to 33-pF ceramic
C2—.1- μ F ceramic
C3—100-pF ceramic
C4—100- μ F tantalum electrolytic (for max stability of all meters on highest range, can be reduced on most meters to reduced setting time. 1- μ F adequate on 1000-pF to .1- μ F ranges—see text.)
C5—100- μ F, 25-WVDC, tantalum electrolytic

ADDITIONAL PARTS AND MATERIALS

B1—9-volt DC NiCd battery
J1-J4—5-way binding posts or banana jacks, two red, two black
J5—Jack to match external plug-pack power supply
S1—Single pole, double pole, center-off toggle switch
S2—4-pole, single-throw rotary switch
Plastic case, knobs, hookup wire, plug-pack power supply, solder, decals, etc.

effectively negate stray capacitance picked up at J1 and J2, and fool the DMM.

The circuit is all CMOS and uses only a small amount of power; therefore, a standard 9-volt battery can be used. However, any unregulated, low-ripple supply from around 9-volts to 12-volts should work. Another alternative is to use a rechargeable NiCd or standard battery with external backup. Still another option is a rechargeable supply that allows for both battery and external power.

Construction Hints

Obviously, there is nothing critical about construction of the C to V Converter. The circuit shown can easily be breadboarded, wire-wrapped, or a circuit-board developed. Crystal Y1, C1, and R1 should be placed as close to U2 as possible. Unused inputs of U2 should be tied high. Keep hookup wires as short as possible, especially those to off-board controls such as zero and range, etc. Use good standard

construction practices, using the pictures provided as a construction guide.

Some Final Notes

Once you've gotten everything thrown together, you'll need to calibrate the C to V Converter by adjusting the CAL ADJ trimmer potentiometer, R8. The simplest way to proceed is to use a capacitor of known value covering as much of the full scale as possible. Only a single capacitor is required here (unlike the case with many other designs), because we opted for switched trigger-frequencies so as not have a maze of trimmer potentiometers. Thus, there's only one calibration adjustment. A precision capacitor substitution box might be borrowed and used for the same purpose, but it is not required. The latter method can be used to check accuracy at several points on a given range, providing not only an indication of absolute accuracy, usually taken close to full scale, but linearity, too!

Finally, calibrated accuracy will depend on the reference capacitor used more than anything else. For example, if a 5% tolerance reference capacitor is used for calibration, obviously final accuracy of the instrument would be severely impaired. At the very least, you should use a reference capacitor in the 1% range.

Another, and probably cheaper, approach is to go down to your local parts and test-equipment supplier, who always has those expensive *cap rappers* on display. Saunter on down and calibrate yours against the best one of theirs. But be careful. A lot of those so-called service-grade units have accuracy specifications worse than 1%. Don't forget that, although you might have built the C to V Converter out of junkbox parts, it can still have laboratory quality potential. ■

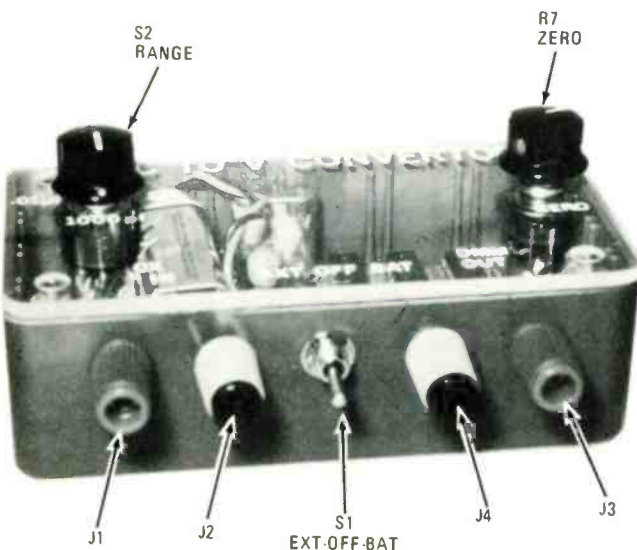

What's up front and top is all you need to operate the C to V Converter. Connect the capacitor to the binding posts on the left and the DMM to the binding posts at right. On the top surface are the range-selector switch S2 and ZERO adjust potentiometer R7.

YELPING SIREN

Take two oscillators, play one against the other, and hear them sound off!

By Robert F. Scott

THE YELPING SIREN IS SIMILAR IN CONCEPT TO THE BRITISH hee-haw police siren that many of us first heard on the "Man From U.N.C.L.E." TV series. Basically, two-tone pulsing and warbling sirens consist of two oscillators. One, the tone generator, operates at a fairly high audio frequency; the other is the control generator, operating at a much lower, sub-audio frequency. The control frequency modulates the tone generator or pulses it on and off, depending on the effect that you want.

Inside the Circuit

The circuit arrangement in Fig. 1 is a popular one, based on circuits in unijunction transistor application notes from Motorola and Texas Instruments. In the circuit, unijunction transistors Q1 and Q2 are both connected as relaxation-type, sawtooth oscillators. Transistor Q1 is the low-frequency control oscillator and Q2 is the tone generator. Sawtooth waveforms are produced at the emitter terminals. The frequency of each oscillator is determined by the values of the resistor and capacitor in its emitter circuit.

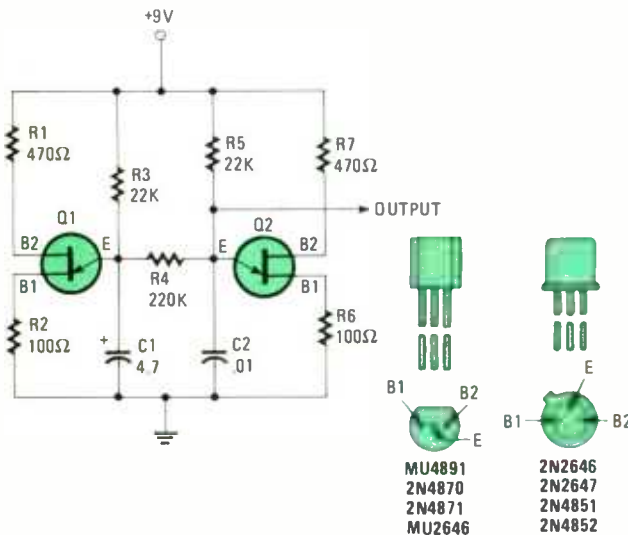

Fig. 1—The schematic diagram for the Yelping Siren is easy to understand when you omit resistor R4 and study each half of the diagram. Then insert R4 and see how the lower frequency affects the higher frequency.

PARTS LIST FOR YELPING SIREN

- C1—4.7- μ F, 50-WVDC electrolytic capacitor
- C2—.01- μ F, disc or metallized-polystyrene capacitor
- Q1, Q2—General purpose unijunction transistor, MU4891 (Radio Shack No. 276-2029), 2N4870, 2N2646, 2N2647, MU2646, etc.
- R1, R7—470-ohm, 1/4-watt, 10% resistor
- R2, R6—100-ohm, 1/4-watt, 10% resistor
- R3, R5—22,000-ohm, 1/4-watt, 10% resistor

Without R4 connecting the two emitters, each oscillator operates independently with its frequency determined mainly by the RC time constant. With the values shown, Q1 operates in the 1 to 1.5-Hz range (you can't hear that frequency) while Q2 is operating in the 400-500-Hz range. (With all the high-frequency components in the output, you not only hear it; it drives you nuts). When R4 is connected between the two emitters, it couples the low-frequency sawtooth from Q1 directly across capacitor C2. That causes the frequency of the tone generator to increase, along with the rise in sawtooth voltage from Q1. The tone generator's frequency drops to its lower design value when C1 discharges and produces the falling edge of the sawtooth.

With the time constants shown, Q1 operates at about 1 Hz and frequency-modulates the 500-Hz tone to produce the familiar *Whee-Oooo, Whee-Oooo...* about once each second. Speed up the control oscillator and set Q2 to around 800 Hz.

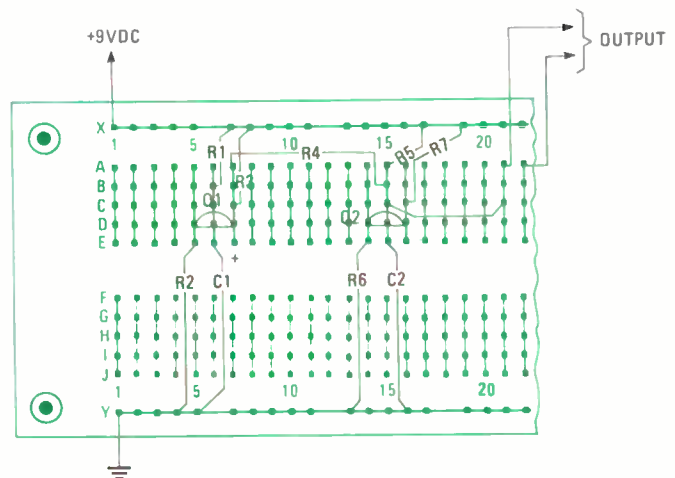

Fig. 2—Assemble the Yelping Siren circuit provided in Fig. 1 on a solderless breadboard the first time. You may want to add an audio amplifier. A printed-circuit board duplicating the connection terminations of the solderless board can be used later to hard-wire the unit.

and you hear the more demanding *Wheep-Wheep-Wheep*. Shunt a 10- μ F electrolytic across C1 and you get a *Whoop-Whoop-Whoop* that you can associate with a destroyer's siren as it charges a submarine in the movie *Victory at Sea*.

This siren produces a sawtooth output signal with a peak-to-peak voltage equal to approximately half the supply voltage. That is sufficient to drive a small output transistor or a low-power audio amplifier.

Boarding It

The layout of components for the Yelping Siren is shown in Fig. 2. The Yelping Siren shares a Global Specialties type 300 solderless board with a small audio amplifier. (The amplifier is described next).

With only 6 external components this amplifier delivers the sound you need!

By Robert F. Scott

□ YOU HAVE JUST BUILT THE *YELPING SIREN* AND WOULD LIKE some *zork* power into a loudspeaker. Here's a simple, little job that'll do the trick! We call it the Low-power Audio Amplifier! Designed around the Sprague ULN-3705M low-voltage, audio, power-amplifier chip, the unit is also suitable as a low-cost, compact alternative to an equivalent audio amplifier using two or three discrete transistors in other projects.

The Low-power Audio Amplifier operates from supplies ranging up to 12 volts, and operates (with reduced volume) from supply voltages as low as 1.8 volts without having distortion rise to unacceptable levels. (Its power requirements make it suitable for solar-cell application.)

Inside the Circuit

Components external to the integrated circuit, U1, consist of four capacitors and a potentiometer for volume control. See Fig. 1. Capacitor C3 is for decoupling, low-frequency roll-off, and power-supply ripple rejection. Capacitor C4 is an electrolytic type that couples the audio output to a 8- to 32-

ohm speaker that is efficient. The speaker's diameter ranges from 2 to 5 inches. Capacitor C4's value is selected for the desired low-frequency roll-off with a given speaker impedance. With an 8-ohm speaker in the circuit, the -10-dB cutoff points are at 20, 30, and 60 Hz; when C4 is 500 μ F, 250, and 100 μ F, respectively. The volume-control potentiometer, R1, or a selected fixed resistor, between input pin 8 and ground is ideally 100,000-ohms, or less. Values up to 200,000-ohms can be used.

You can use a speaker with impedances of 8-, 10-, 16-, or 32-ohms. The lowest impedance produces the highest power output for a given supply voltage. Higher impedances reduce harmonic distortion. With a 6-volt supply, power output is 450 milliwatts with an 8-ohm speaker, and 240 milliwatts into 16 ohms. With a 9-volt supply, the output is 600 milliwatts into 16 ohms, and 310 milliwatts into a 32-ohm speaker.

The input lead to potentiometer R1 is shown shielded in Fig. 1. That shield reduces noise, hum and feedback pickup. However, if the amplifier circuit is assembled on a breadboard with a siren (the one that precedes this article), then the shield lead is not necessary. Should the input circuit and potentiometer R1 be mounted off the board, shielding of all signal leads is necessary.

(Continued on page 96)

Fig. 1—There's nothing to it! The Low-Power Audio Amplifier consists of one chip and six other parts. Should the output level be set to a fixed value, the components may be encapsulated in epoxy and secured permanently to the speaker metal frame.

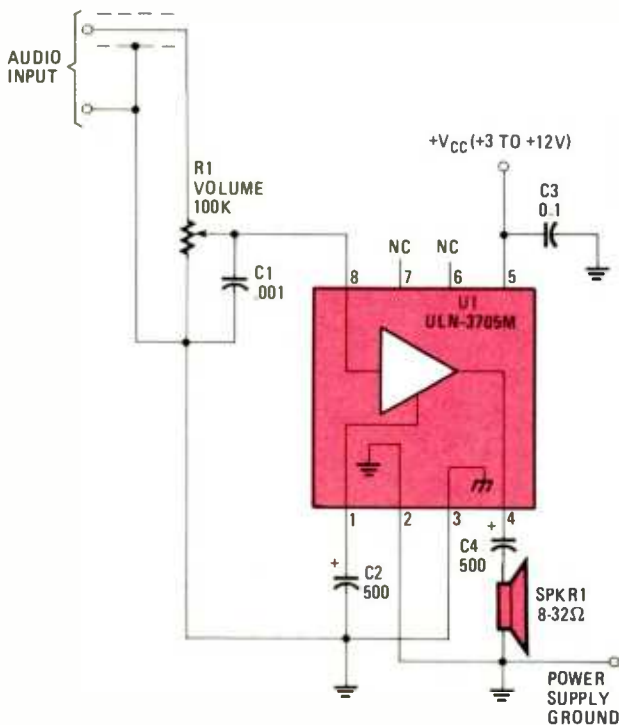

PARTS LIST FOR LOW-POWER AUDIO AMPLIFIER

- C1—0.001- μ F, ceramic disc capacitor
- C2, C4—500- μ F, 35-WVDC, electrolytic capacitor
- C3—0.1- μ F, ceramic disc capacitor
- R1—100,000-ohm, audio-taper potentiometer
- SPKR1—8- to 32-ohm speaker, 2- to 3.5-in. diameter
- U1—ULN-3705M audio amplifier IC (Sprague)

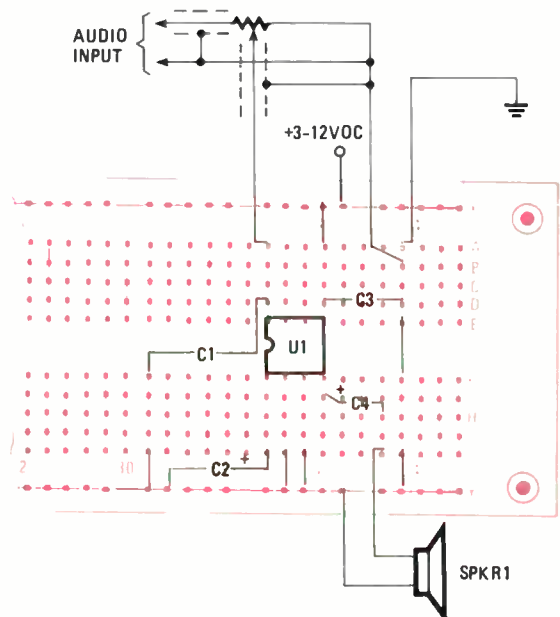

Fig. 2—Here's how the Low-Power Audio Amplifier looks wired on a solderless breadboard. The parts are so positioned that they can share a board with the *Yelping Siren*.

The IBM-compatible NTS/Heath HS-151 PC is included in three training programs.



IF YOU WANT TO GET INTO PC SERVICING YOU HAVE TO GET INTO A MICROCOMPUTER

Learn PC Servicing By Building Your Own NTS/HEATH HS-151 Desk-Top Computer

NTS Intronic home training gets you right down into the heart of computer circuitry. Learn how microprocessors function, how they operate and are used to solve problems. Your program includes a wide variety of tests and projects you perform as you build your own PC, circuit board by circuit board unit by unit.

The NTS/HEATH 16-Bit HS-151

This remarkable desk-top PC is the most powerful and versatile ever offered in any home study course. Advanced features include:

- 128 KB RAM user memory, expandable to 640 KB. This power translates into high speed operation,

- Two video outputs provide connections for either a color or monochrome video display monitor.
- 16-Bit 8088 microprocessor runs most IBM and MS-DOS software.
- 4 open slots provide for expansion, will accept most peripheral boards designed for IBM PC.

Your NTS training course will teach you how to program on this powerful PC using lessons, texts and diagrams showing you how to make full use of its remarkable capabilities.



NTS Offers Many Additional Courses in Electronics, and other fields:

Robotics: Build the NTS/Heath Hero 1 Robot as you learn robotic programming.

Video Technology: Build the NTS/Heath System 3 advanced Color TV as you learn circuit diagnostics.

TV and Radio Servicing: A specialized course featuring training in both analog and digital test equipment. Learn servicing of monochrome and color TV receivers.

NTS also offers courses in Auto Mechanics, Air Conditioning/Solar Heating, Home Appliances.

If card is missing, write direct to the address below and specify the course in which you are interested. A FREE color catalog will be sent to you by return mail.

NTS NATIONAL
TECHNICAL
SCHOOLS

TECHNICAL TRADE TRAINING SINCE 1905
Resident and Home-Study Schools

4000 So. Figueroa St., Los Angeles, CA 90037

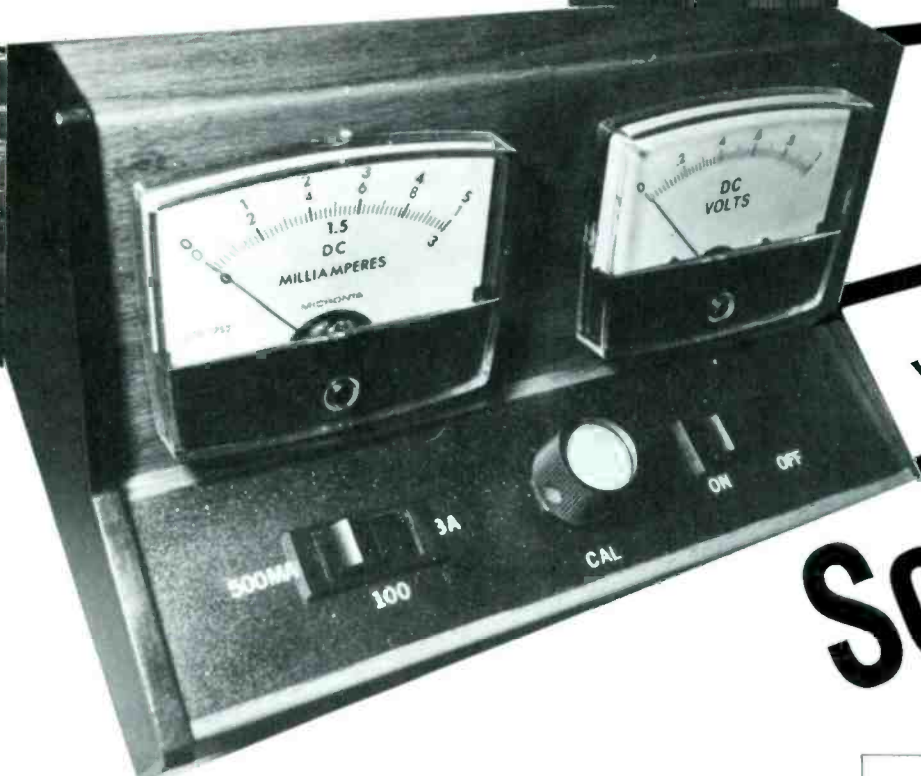

By T.J. Byers

Voltage doesn't mean a thing
if the current has no zing!

Solar-Cell

WORKING WITH SOLAR CELLS IS LIKE WORKING WITH ANY other power supply. Each kind is designed to deliver a certain amount of current at a given voltage. Unlike conventional power supplies, though, the output characteristics of the solar cell are dependent upon the amount of light falling on it. And, as everyone knows, sunlight is erratic at best. A passing cloud, for instance, can reduce power output by more than 50%.

To further complicate matters, not all cells generate equal amounts of current under the same lighting conditions—even when the cells are identical in size and construction. Variations in the manufacturing process can cause the cells from the same batch to vary widely in their output currents. When designing or building solar-powered projects, those factors must be taken into account.

Consequently, testing is important if we are to obtain the maximum performance from *photovoltaics*—the process of

Fig. 1—A family of curves showing the relative output characteristics of a solar cell under varying sunlight conditions.

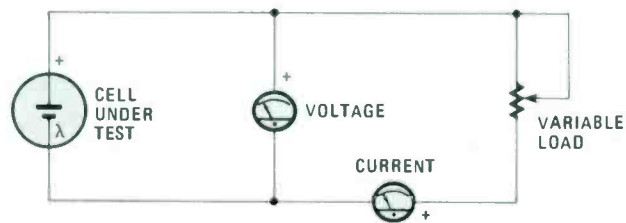
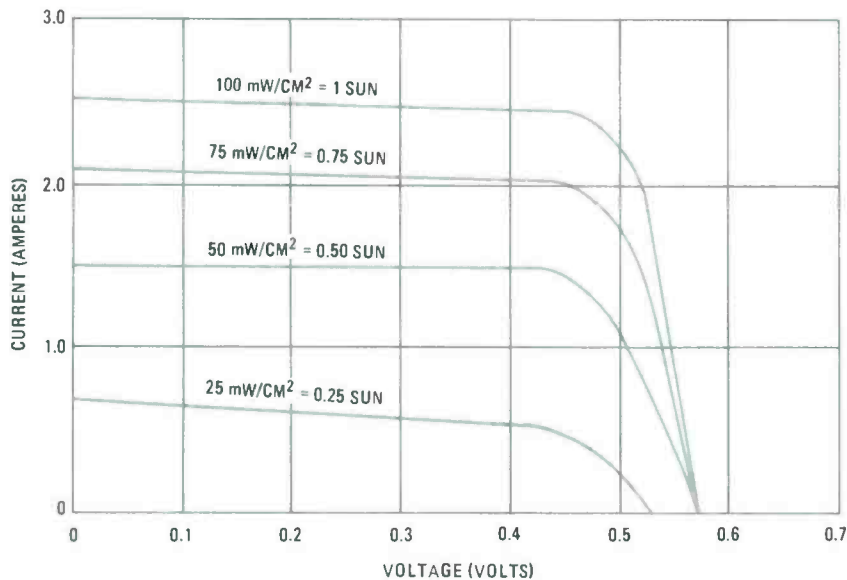

Fig. 2—Diagram of a simple solar cell tester.

making electricity from sunlight. To better understand the parameters involved, let's first take a look at the silicon photovoltaic cell's characteristics.

Photovoltaic Characteristics

Whenever using any power source, it is imperative that we understand how the voltage and current interact with each other and with the load. In most cases, Ohm's law establishes the relationship. Unfortunately, silicon solar cells are non-linear devices, and there is no simple formula expressing that relationship. Instead, we will use a family of easily understood curves (Fig. 1) to demonstrate the solar cell's characteristics. Also, by using the circuit in Fig. 2, we can explain the electrical behavior exhibited in Fig. 1 in more detail.

Looking at Fig. 2, you see that we are monitoring both the voltage and the current output of the solar cell as it passes through a variable resistance load. We will assume that the light intensity is stable for the duration of the test.

We begin by turning the potentiometer to its maximum resistance setting. In that mode, virtually no current is being drawn from the solar generator and the resulting voltage can be considered equal to the *open circuit voltage*—the voltage produced by a solar cell when no load is applied to it. It is approximately 0.6-volts, or 600-millivolts. Of course, that voltage may vary slightly from cell to cell, and manufacturer to manufacturer.

As we decrease the potentiometer setting,

Tester

the load across the cell increases. The heavier loading causes the output current to increase, much as it would do to a battery under the same conditions. At the same time, the cell's output voltage shows a slight decrease, as it should with an unregulated power source. So far there is nothing out of the ordinary.

Then something strange happens. A point is reached where decreasing the load resistance no longer causes an increase in the output current. No amount of loading will extract any more current from the cell once that point has been reached—right on down to an absolute short! In fact, that current value is known as the *short circuit current*, and rightfully so.

In essence, our solar generator has become a constant-current source. But what about the voltage, you ask? Well, the voltage begins a gradual decline that is proportional to the increasing load. Finally, the voltage drops to zero as the load resistance becomes zero. By the way, a short circuit across a photovoltaic generator does no damage to the cell.

The amount of current that the solar cell can produce is a function of the light intensity. For our first measurement we have taken the liberty of assuming that the highest radiation level was used, which was plotted as the top curve. Each successive curve was derived from the same cell at progressively reduced light intensities.

Power Curve

If we were to plot a graph of the voltage in relationship to the power output, it would look something like the one in Fig. 3. At one extreme, we have maximum current with no voltage. Of course, no power is produced at that point, because without voltage there can be no power. At the other extreme, we have maximum voltage but no current, resulting in the same no-power condition.

Between those two extremes the photovoltaic cells produce power. Only at one point, however, does the solar generator produce peak power: It is at that point where all factors come together to provide the most power from the cell. The power peak occurs at about 450-millivolts (0.45-volts), which incidentally, happens to coincide with the knee of the current curve seen in Fig. 1.

The fact that the entire family of current curves have the same shape means that we will always realize peak power at the same voltage, regardless of the solar illumination. Of course, the actual power will depend upon the solar radiation at the time, but it will not shift with respect to voltage.

Therefore, an accurate way of evaluating the performance of a silicon solar cell would be to load the cell under operating

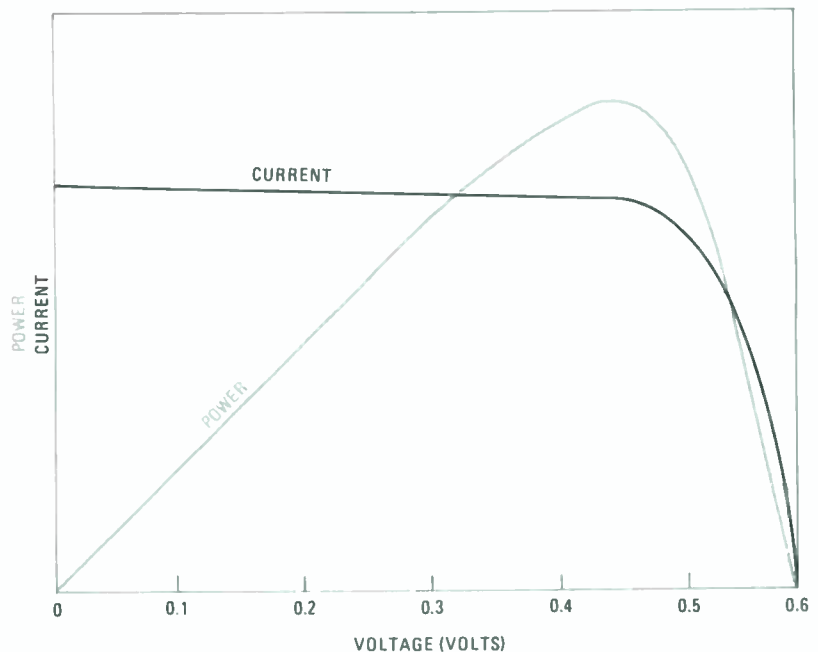

Fig. 3—The relationship of output power of a solar cell compared to the cell's voltage-current output.

conditions so that its output voltage equals 0.45-volts and take a power reading. Not only are all cells compared on an equal basis, using that method, but individual cell performance can be judged at the same time.

Designing a Tester

As we have already demonstrated, you can use the circuit shown in Fig. 2 to test your solar cells. As a matter of fact, that is a quick and easy to do it. Simply place the cell across the circuit, adjust the voltage with the potentiometer, and note your readings. Power is calculated by product of the output voltage (in volts) and the current (in amperes).

However, each cell is a little different. Therefore, the

The Need to Test Solar Cells

The need for matching solar cells becomes most apparent when assembling a solar module of many solar cells. Because the output voltage of an individual solar cell is a mere 0.5-volts, several cells must be wired in series to produce a workable voltage. For instance, it takes at least 30 cells to make a 12-volt photovoltaic module.

The problem arises when cells of different current-capabilities are wired in series. The cells are chained in a long string, with each cell adding its small voltage to the whole. Individual differences in the voltage output of any one solar cell is of little concern. All voltages will be tallied in the end. Should the module's total voltage be too low, or too high, the subtraction, or addition, of a solar cell or two will restore the voltage to within .25 volt of the desired level.

The current, on the other hand, flows through the entire string of cells equally. And the current seeks the level of the weakest solar cell in the chain. In other words, if we place a 2-ampere cell in series with a 1-ampere cell you can only obtain 1 ampere from the combination of those two cells.

Obviously you are losing potential power, due to the weakest cell. If, however, all the cells are matched with regard to their output current, each cell will be driven to its peak potential, and maximum power will be realized from the array. Current matching of solar cells should be within 5% and shouldn't exceed 20%.

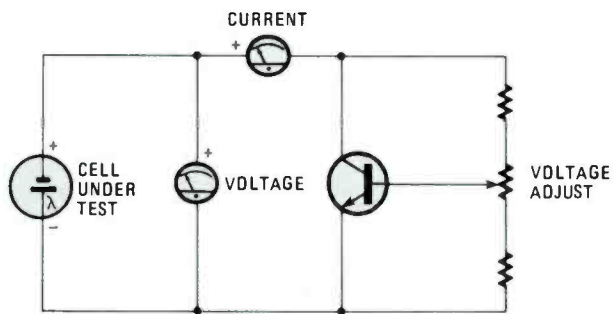

Fig. 4—A transistor is used to load the solar cell under test in place of a resistive load. Although this circuit eliminates the problem of a heating load resistor, current control is still a problem in the transistor's base circuit.

resistance required to stabilize the cell at its peak power point will vary. And accordingly, you must adjust the load resistance to re-establish the operating voltage. Furthermore, the power produced by the solar cell must be dissipated entirely by the potentiometer, with the resultant heating affecting resistance stability.

An effective way of reducing that problem is to isolate the load resistance from the adjustment. What could be better than a transistor? A transistor makes an excellent substitute. In that particular application, the transistor can be thought of

as a dynamic resistor.

A small current to the base of the transistor, as shown in the circuit of Fig. 4, produces a large current change at the collector. The base current effectively changes the resistance of the transistor, which in turn is used to load the solar cell.

Unfortunately, the transistor suffers from the same short-coming as the potentiometer. That is, we still have to fine tune the base current as we switch testing from one cell to the next. Now, suppose you have to test 30, or 40 solar cells, or more? It would quickly become a time-consuming task, indeed!

A better scheme would be to find a way to automatically adjust the base current without having to manually compensate for it each time. What we need is a shunt-voltage regulator.

A shunt-voltage regulator is a closed-loop controller that uses the input voltage to control the base current. Regardless of the voltage initially presented to the input, the shunt regulator will adjust its shunt resistance so that the output voltage holds the desired value.

How the Circuit Works

The finished product of our design appears in Fig. 5. You'll see that an operational amplifier (U1-a) has been put in charge of controlling the transistor's base current. A 220-ohm resistor (R5) limits the base current to Q1.

The regulator works by comparing the input voltage from

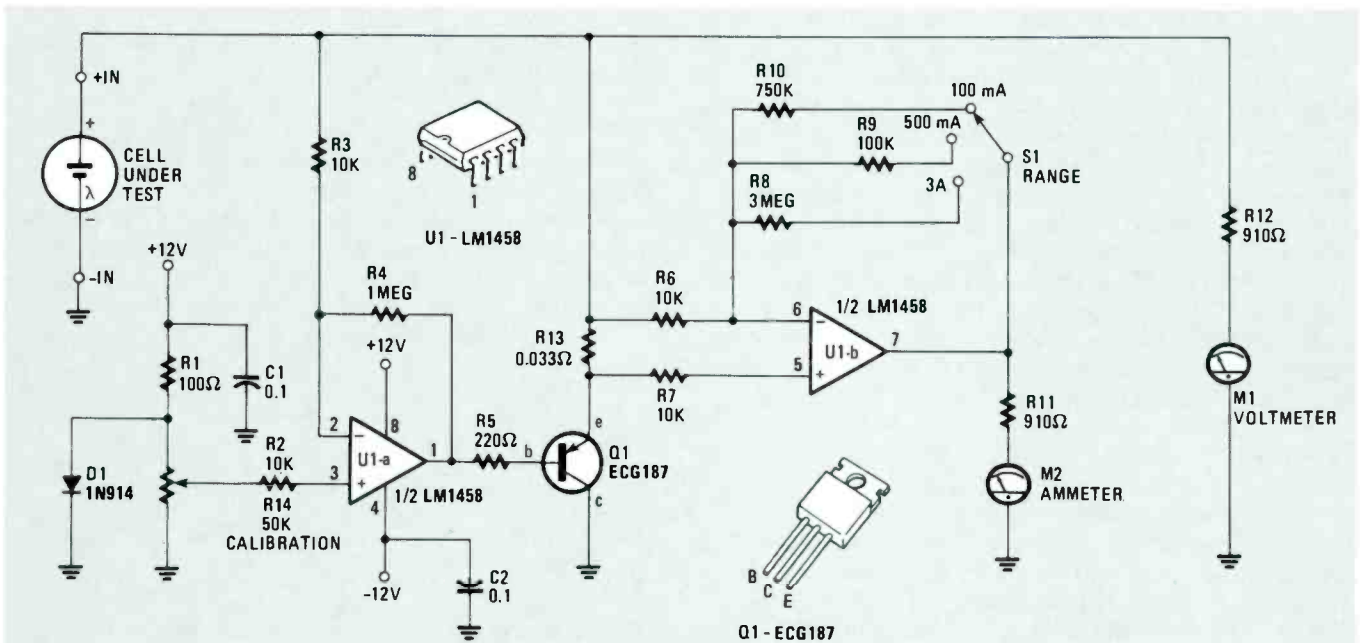

PARTS LIST FOR SOLAR-CELL TESTER

SEMICONDUCTORS

- U1—LM1458 or MC1458 dual op-amps
- Q1—ECG187 silicon, PNP, audio-power transistor
- D1—1N914 signal diode

RESISTORS

- (All fixed resistors are 5%, 1/4-watt units)
- R1—100-ohm
 - R2, R3—10,000-ohm
 - R4—1-Megohm
 - R5—220-ohm
 - R6, R7—10,000-ohm (see text)
 - R8—3-Megohm

- R9—100,000-ohm
- R10—750,000-ohm
- R11, R12—910-ohm
- R13—.033-ohm (see text)
- R14—50,000-ohm potentiometer

ADDITIONAL PARTS AND MATERIALS

- C1,2—0.1-μF, 50-WVDC
- M1, M2—0-1 mA panel meter
- S1—Single-pole, 3-position rotary switch
- Cabinet, Solar Cell Holder, printed-circuit materials, wire, solder, etc.

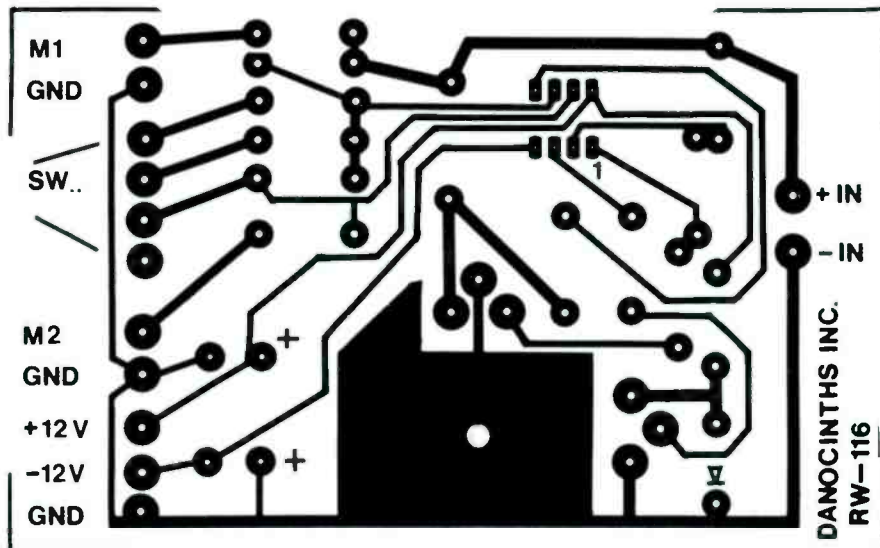

Fig. 6—Same-size foil pattern for the printed-circuit board that can be used to assemble the Solar-Cell Tester.

the cell under test to a reference voltage. Normally, the reference source is established by a Zener diode. In our circuit, that would require a Zener with an extremely low voltage, preferable under 1-volt. Unfortunately, Zeners in that voltage range are either very temperature-sensitive or expensive—usually both.

A forward-biased diode, on the other hand, makes an excellent low-voltage reference source. Our reference diode (D1), which is forward-biased by resistor R1, establishes the voltage range of the regulator by limiting the voltage across CALIBRATION potentiometer R14. The reference voltage is fed to the non-inverting input (pin 3 of U1-a) of the amplifier.

The inverting input senses the photovoltaic voltage through resistor R3. Resistor R4 sets the gain of the amplifier, which is 100.

By its very nature, our amplifier circuit attempts to maintain the inverting input voltage equal to the voltage at its non-inverting input. By forcing current through the shunt regulating transistor Q1 until its resistance drags down, the input

voltage will equal the voltage at the tap of R14. The tap voltage can be adjusted anywhere from zero volts up to +0.7-volts.

Actually, it is impossible for a transistor to achieve zero resistance. So a small residual voltage lingers—approximately 150-millivolts. That characteristic limits our regulating range between +0.15- and +0.7-volts.

Monitors

Voltmeter M1 monitors the voltage developed by the solar cell, while ammeter M2 measures the current flowing through the shunt transistor. Multiplying one reading by the other nets you the power in watts.

The voltmeter is pretty straightforward. It is a 1-milliamperere panel meter with a series-limiting resistor—R12—that indicates 1-volt at full scale.

Ammeter M2, on the other hand, uses an operational amplifier (U1-b) to measure current flow. The circuit is arranged so that the emitter current of Q1 must flow through resistor R13. The current passing through R13 reflects the current magnitude generated by the solar cell.

Current flowing through R13 produces a voltage drop across the resistor, albeit, a small one. Monitoring the voltage across R13 is a differential amplifier (U1-b). Resistors R6 and R7 feed the differential voltage to the inverting and non-inverting inputs, respectively.

The gain of the amplifier (U1-b) is controlled by resistors R8, R9, R10. Resistor R8 is a fixed value that is permanently connected across the output and inverting input. It is a 3-Megohm resistor that sets the gain of the amplifier (U1-b) at 300. With a gain of 300 an output voltage of 1-volt is developed at U1-b, pin 7 when 100 mA flows through R13.

The output voltage from the differential amplifier is measured with voltmeter M2, identical to M1. The voltmeter converts the voltage from the amplifier into a current reading where 1 volt equals 100 mA.

When R10 is placed across R8, the amplifier's (U1-b) gain is reduced to 60. That gain produces a 1-volt output from the amplifier when 500-mA flows through resistor R13. In effect, we have extended the limit of our current meter from 100-mA to 500-mA. Similarly, paralleling R9 across R8 gives us a 0-3 amplifier current meter.

Construction

Although the Solar-Cell Tester can be built using any conventional form of construction, the use of a printed-circuit board is strongly recommended. A foil pattern of the board is shown in Fig. 6.

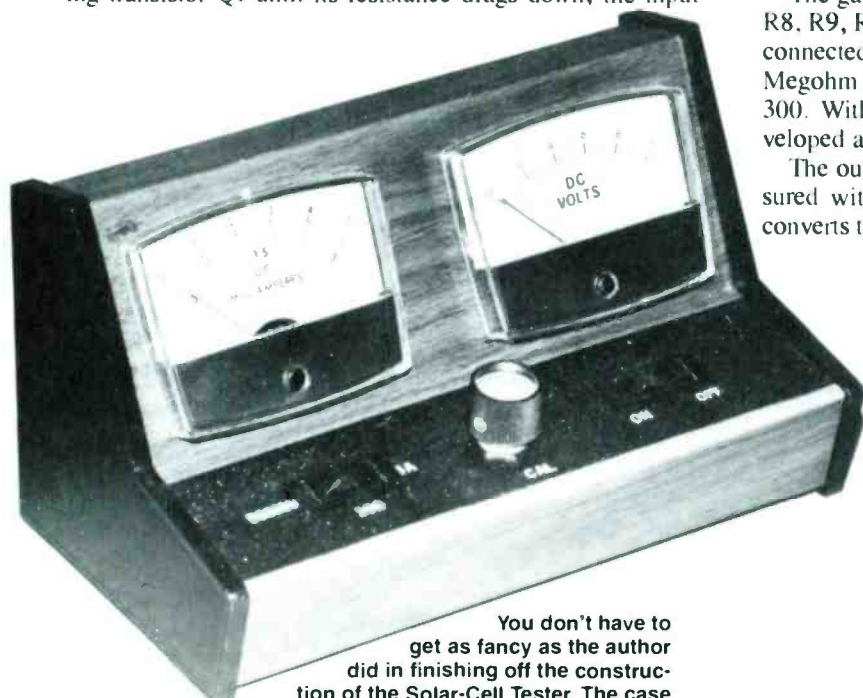

You don't have to get as fancy as the author did in finishing off the construction of the Solar-Cell Tester. The case formerly housed a CB SWR-antenna test device.

Fig. 7—X-ray view of the printed-circuit board showing the foil pattern underneath and the parts location on the top surface of the board. Connection to parts external to the board are detailed. The Solar-Cell Tester circuitry may be housed on a breadboard or in a chassis box.

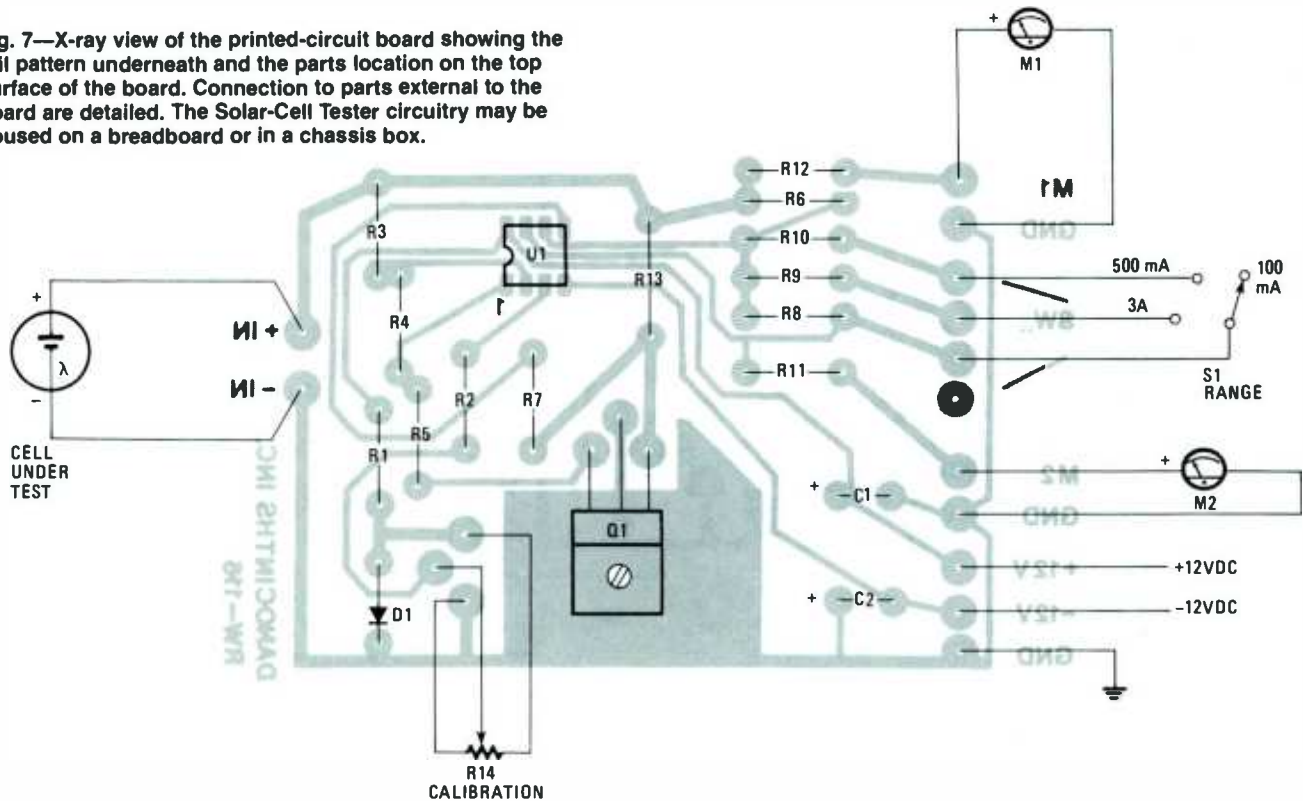

Insert the components according to the parts layout in Fig. 7 and solder them in place. Observe semiconductor polarity. Notice that the shunt regulating transistor Q1 mounts on the foil side of the board. Firmly bolt the transistor to the large copper pad which serves as the heat sink for Q1. No insulating washers are necessary.

Ideally, R6 and R7 should be a matched pair. Now I realize that precision resistors are both expensive and hard to come by; so I recommend getting a handful of 10,000-ohm resistors and measuring their value on a digital multimeter. It won't take you long to find two that match. Your castaways can be used for R2 and R3.

Another trick that you can use is to find four 20,000-ohm resistors that closely match and place pairs in parallel, resulting in an averaging effect to bring the respective resistive pairs closer together. (In this issue we have a project, Cross Match One, which may be of assistance to you.)

Resistor R13, on the other hand, is not a conventional resistor. I seriously doubt that you could find one in popular stock. But you can make R13 with a 4-inch length of #30 wire—the same wire popularly used for wire wrapping. Use a pencil as a form and coil the wire so that it fits comfortably on the board.

The exact value of R13 is quite critical in determining the accuracy of the current meter. You might want to start off with

a piece that is just slightly longer than four inches, and trim it back as you monitor the current indication on M2, thus increasing its accuracy.

The two meters (M1, M2), the CALIBRATION control (R14), and the RANGE switch are mounted in a suitable cabinet along with the printed-circuit board.

The instrument is powered by two power supplies: +12-volt positive and -12-volt negative. Their common junction represents ground. However, those supplies are not critical; neither is their voltage. You can power the tester with a pair of 9-volt transistor batteries, if you wish. A schematic of a suitable supply is shown in Fig. 8.

Probably the most difficult piece to obtain or fabricate for the tester is a solar-cell holder of some kind. Here you have to use your imagination. A flat aluminum plate slightly larger than the cell itself could provide a good back connection, while a test probe borrowed from a VOM makes a nice front contact. For more automated testing, you might want to consider buying or building a test jig.

Using the Tester

Using the solar-cell tester couldn't be easier. Basically, all you have to do is insert the cell to be tested into the tester and take a reading. The back contact of the cell is the positive output, and it goes to the positive input of the tester. The grid

(Continued on page 102)

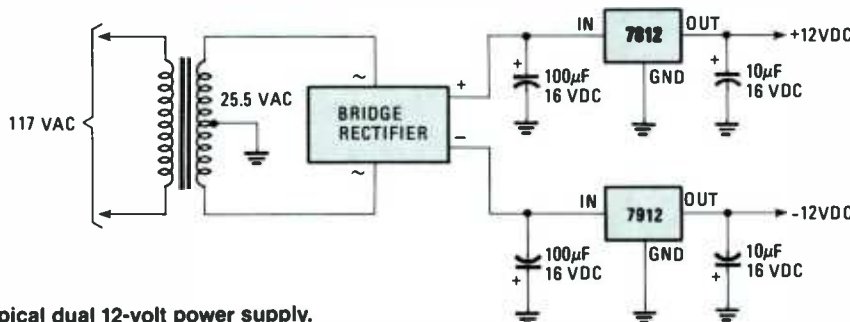

Fig. 8—Typical dual 12-volt power supply.

CROSS MATCH ONE

By D.E. Patrick



Match resistors to better than 1% accuracy—no meter needed!

One's three LED readouts indicates OVER, UNDER, and IN TOLERANCE. There's no analog meter to interpret; you don't have to make ten different settings on some expensive bridge, and there's no waiting around for some slow 5-digit readout to settle in. So, it's a better way to go even if you own the kind of premium stuff that few of us can afford.

□ WHEN FACED WITH BUILDING COOKBOOK INSTRUMENT amplifiers requiring 1% to .1% matched resistors and the like, the average project builder or electronics experimenter is generally out of luck. Few of us can afford to run out and buy *matched* resistors, even when we are lucky enough to find them locally. A cheaper solution would be to select them out of your junkbox. But even fewer of us own expensive laboratory-type equipment like Wheatstone, Kelvin, and impedance bridges. Further, even if you own an expensive bridge, 5-digit DMM, *et al*, cross-matching resistors will be a tedious task at best.

Another and better solution to the problem is the Cross Match One. That device works like an expensive production-line tester to select resistors, with simple, easy-to-interpret LED readouts that will allow you to select resistors at the rate of one a second or better. The project relies on the principle of selecting a sample resistor that is within some tolerance of another reference resistor, as opposed to measuring actual resistance.

That is, you set the tolerance desired at 10%, 5%, 1%, .1%, etc., plug in your reference resistor, and the Cross Match

How It Works

The circuit in Fig. 1 is basically a null-detecting bridge with LED readouts instead of a meter. Two legs of the bridge are formed by the selected *reference resistor* and chosen *sample resistor*. The other two legs of the bridge are formed by two other matched resistors, where if $R_{REF} = R_{SAMPLE}$ and $R1 = R2$, there will be a null output. In a standard Wheatstone bridge, one arm of the bridge might be a calibrated potentiometer or precision decade box for direct readout. However, in this application, we are using a balanced bridge that does not provide a direct readout in Ohms.

When the bridge is balanced, the differential input to U1 is at a null. The output of U1 will assume a mid-range value of the applied voltage and its output will be around 4.5 volts for a 9-volt battery input, which does not have to be regulated. Under those conditions both transistors Q1 and Q2 will be turned on and the IN TOLERANCE light-emitting diode LED1 will be lit. The extent to which the R_{REF} value approaches the R_{SAMPLE} 's value will determine where the OVER or UNDER light-emitting diodes LED2 and LED3, respectively, will be lit. Potentiometer R3 in the feedback loop of U1 will determine expected tolerance limits.

When Q1 and Q2 are conducting (see Fig. 1), the voltage drop across R8 and R9 cut off Zener diodes D1 and D2, so the

Fig. 1—The two input resistors, R1 and R2, for the Cross Match One should be matched, although the value, if above 2000-ohms, is not critical. A standard 9-volt transistor battery or chargeable battery should be used. Voltage regulation is not critical for proper circuit operation.

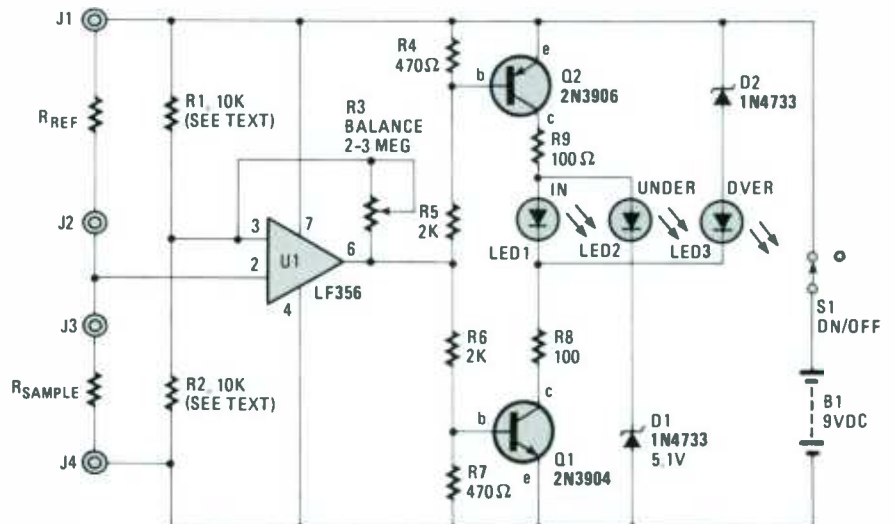
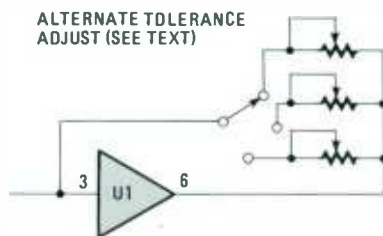

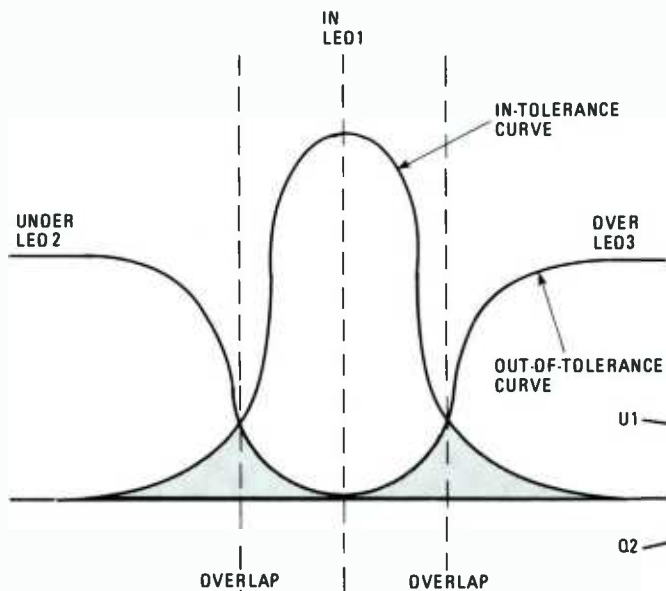

Without taking the cover off the Cross Match One, the parts can be identified. Since the project's interior can be seen, it would be a good idea to wire neatly.

Fig. 2—The response curve for light-emitting diode operation is detailed here. The degree of overlap depends on the gain of the op-amp. The diagram is not drawn to any scale.

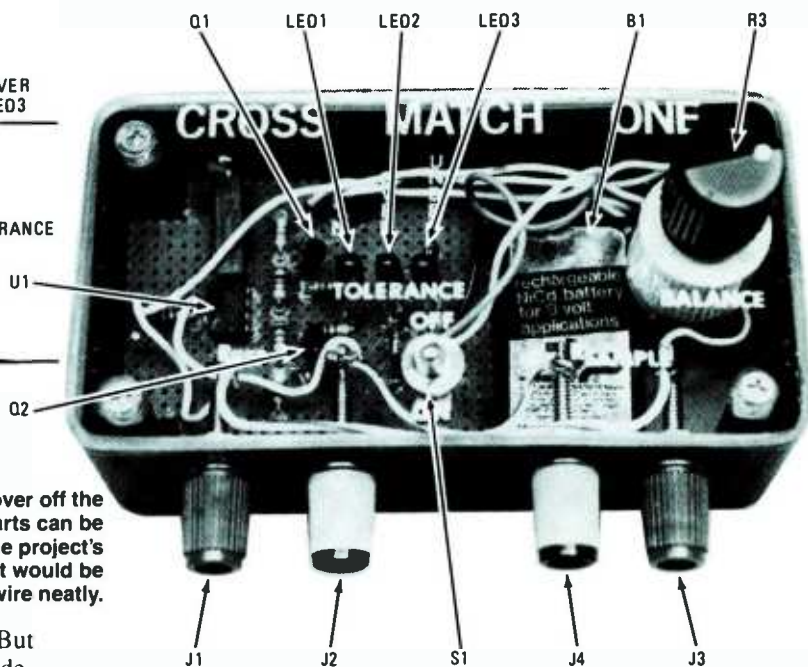

PARTS LIST FOR CROSS MATCH ONE

SEMICONDUCTORS

D1, D2—1N4733 Zener diodes, 5.1-volt, 1-W
 LED1-LED3—Light-emitting diode, 20-mA, red
 Q1—2N3904 NPN transistor
 Q2—2N3906 PNP transistor
 U1—LF356 op-amp

RESISTORS

R1, R2—Matched resistors, absolute value not critical.
 (10,000-ohm used in prototype—see text)
 R3—2- to 3-Megohm potentiometer for gain adjust.
 Fixed resistors and/or trimmers may be added along with range switch if desired. (see text)
 R4, R7—470-ohm
 R5, R6—2000-ohm
 R8, R9—100-ohm

ADDITIONAL PARTS AND MATERIALS

J1—J4—Banana jack
 S1—SPST toggle switch
 B1—9-volt, transistor-radio battery
 Plastic case, clear Plexiglas sheet, perfboard, hardware, hookup wire, solder, decals, RTV cement or epoxy, etc.

OVER and UNDER light-emitting diodes will be held off. But when the differential voltage at U1's input increases or decreases out of some specified tolerance, either Q1 or Q2 will turn off and the OVER or UNDER light-emitting diode will come on. The tolerance, or range of change, in R_{SAMPLE} above or below R_{REF} that must occur to light the respective light-emitting diode is set by R3 in U1's feedback loop.

The circuit will then have a response where UNDER, IN, or OVER light-emitting diode will be lit, as shown in Fig. 2. We can easily see that there is an overlap area under the INTOLERANCE curve such that OVER or UNDER light-emitting diode may also be lit when the IN light-emitting diode is lit. That condition aids in defining the skirts of the in-tolerance curve, where the width of the skirts and sharpness of the curve will obviously be dependent again on the setting of potentiometer R3. Thus, several distinct tolerance ranges can be chosen by adding a switch and several trimmers or fixed resistors in place of R3, or R3 could be a calibrated potentiometer. However, options such as a rotary selector switch and additional resistors are left up to the project builder who wants to customize the unit to suit his needs.

Construction Hints

There is nothing critical about construction of Cross Match One. No critical components are required, except resistors R1 and R2, which we'll get to in a moment. The unit can be built right out of most junkboxes at zero or nominal cost. And, as we can see in the photos provided, the simple one op-amp circuit is easily breadboarded.

The prototype shown was built out of my junkbox into a Keystone plastic box, the type you can get at any Radio Shack store. A piece of scrap Plexiglas clear sheet plastic was substituted for the standard cover, so that the light-emitting diodes can easily be seen without the necessity to drill front panel holes—but that's optional. The R_{REF} and R_{SAMPLE} banana jacks (J1-J4) were mounted on the side of the case with ON/OFF switch S1 and BALANCE (gain) shaft of R3 sticking out the top.

The only things that might give you a problem are resistors R1 and R2. Their actual absolute value is not important, only that they are closely matched. The better that match, the sharper the tolerance curve can be made. And the easiest way to lay your hands on some closely matched resistors is to rip them out of a junked Kelvin-Varley Bridge, differential voltmeter, old nixie tube DVM, *et al*. That kind of stuff abounds at any surplus store, especially if you know what you are looking for.

Old tube-type Fluke, Keithley, *et al* differential voltmeters,
 (Continued on page 96)

Auto BATTERY

ALTERNATOR MONITOR

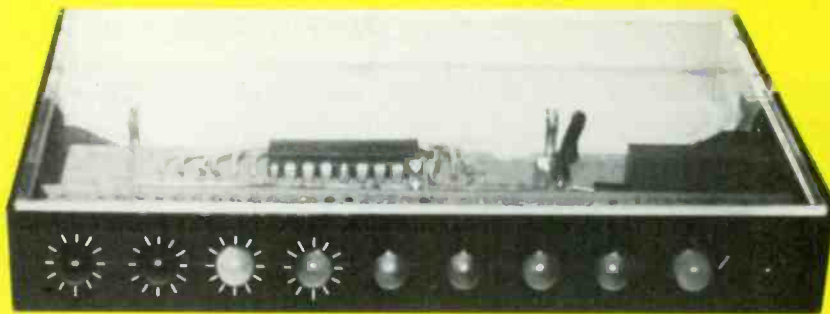

By Warren Baker

IF YOU ARE ONE OF THE MILLIONS OF AUTOMOBILE DRIVERS in the country who have experienced a dead battery in your car, then the Battery/Alternator Monitor project described here may be just the gadget you have been searching for. When installed in your vehicle, it will warn of a charging-circuit problem even when the idiot light system has failed, or sits there ready to blink on just as the battery dies. In addition, the monitor can forwarn the owner of impending battery failures at least six months in advance, by indicating abnormal behavior. In fact, the design and assembly of the first Battery/Alternator Monitor was *generated* by just such an occurrence—a defective alternator.

Most everyone in electronics will be aware that battery voltage in automobiles will vary considerably from the 12 volts usually considered to be normal, up to about 14.8 volts or so. In reality, a system that displays only 12 volts is already in trouble.

Over a period of time, most vehicles' electrical systems will average anywhere from about 13 volts to as much as 14.7 volts in the normal driving range. Voltages less than 13 volts will usually indicate a charging-system problem or a current drain on the system that the alternator is unable to overcome. If the car is idling at a stop light with the heater, headlights, and other high-current devices turned on, the battery voltage may drop below the 13 volts. The battery voltage should immediately return to a higher voltage when the engine is speeded up. The idiot light should tell you that, by coming on when the voltage is low. On the other hand, when charging voltages are in excess of 14.5 volts for long periods of time, damage to the battery may occur—and not become apparent until after the battery exhibits a failure. Such high-charging rates should be investigated before expensive replacement problems occur.

If the readers should monitor voltages for a length of time, there is another interesting event that takes place in most automotive electrical systems. It is well known that batteries require a higher charge rate in cold weather than they do in warm temperatures. It will be seen that in wintertime driving, the system's regulator automatically considers the temperature and will *kick* the voltage up to the higher charge rates. It will also be apparent that when the engine compartment (and alternator) become warm, the charging voltage will once more drop to about 13.8 to 14.2 volts and remain steady. Summertime temperatures will prevent automatic ad-

vance in charge rate, which is just the effect we desire, because batteries do not require as much charging voltage in the warm weather.

By noting what the voltage of your battery is at night when the car is put into the garage, and once again in the morning when you enter the vehicle, it is possible to determine the condition of your battery. For instance, if the voltage drops overnight to less than 12.5 volts or so, you can be wary of the battery's ability to see you through the winter weather if you reside in the colder climates. By all means, if the voltage is 12 volts or less, some corrective action should be taken before you stall on the road with a dead battery.

When the Lights Go On

The Battery/Alternator Monitor will provide an insight to all the above problems and perhaps more. A close examination of Table 1 will show that if either of the leftmost red lamps are lit, then battery potential will be less than 12 volts. Depending on the status of the engine (off or on), the chart will outline problems to be expected. If the battery has been unused overnight, as outlined above, then most likely the battery is bad. On the other hand, if the red lights are lit with the engine running, then it may indicate a possible alternator defect.

When the third lamp (yellow) is lit with the vehicle unused overnight, you should be confident that your battery is in relatively good condition. Once again, when it is illuminated while the engine is running, it may show a borderline charging rate, or, perhaps an extra heavy drain on the electrical system. Lamps numbered from 4 to 8 are green and will show the normal operating range of the system you should anticipate. In most cases a warm engine and a fully charged battery will show in the 14-volt range and lamp number 6 will be lit.

Whenever lamp number 9 lights, it should indicate that the system has approximately 15.1 volts being generated. That is a bit high and the owner should have some corrective action taken. The last lamp is again red, because if your system reaches that voltage level (15.6 volts) a diagnostic service should be performed as soon as possible and corrective action be taken.

Putting It Together

Circuit construction is very simple and inexpensive. The following discussion outlines a method to easily duplicate the

TABLE 1
INDICATIONS AND REMEDIES

Lamp	Color	Volts (+ DC)	Engine Status	Indication Meaning	Notes
1	Red	11.5	Off	Bad or discharged battery	Unused overnight slight battery drain
			On	Alternator problem	Find repair shop immediately
2	Red	12.0	Off	Weak or bad battery	Unused overnight
			On	Alternator problem	Service is required
3	Yel.	12.5	Off	Good battery	Unused overnight
			On	Borderline charging or heavy drain	Reduce electrical load—system should be checked
4	Grn.	13.0	On	Normal Operating Range	No problems
5	Grn.	13.4	On		Daytime operation No problems
6	Grn.	13.8	On		No problems
7	Grn.	14.3	On		No problems
8	Grn.	14.7	On		
9	Yel.	15.1	On	High charging voltage	System should be checked
10	Red	15.6	On	Very high charging rate	Find repair shop immediately

author's working model. Although you may elect to use any other method, the one to be described lends itself to a rather compact package, which can be placed at almost any convenient location on the dash panel of your auto. The prototype shown was designed to fit into a standard protective box used to store cassette tapes. By using Global Specialties Corporation (GSC) EXP-300-PC circuit board material, the entire chassis for the Battery/Alternator Monitor can be constructed. As shown in Fig. 1, the printed-circuit board is cut with a small saw into two pieces. The larger of the two will form the main board. The smaller piece (the LED board) is used to mount the ten light-emitting diodes (LED's).

Cutting the boards from a piece of Global Specialties EXP-300 PC printed-circuit board is recommended. The cuts can be made by a Dremel jigsaw. Otherwise, gouge a deep score line where the cuts are to be made, using a razor held in a handle designed for that purpose. Then, place a block of wood over the printed circuit board on a tabletop. Position the cut or break line of either end of the board, the edge of the wood block, and the table edge. Snap off the excess piece, leaving the used piece under the block. If you have trouble, the scored line is not deep enough.

Repeat the procedure until the two boards are obtained. Then, with a fine sandpaper resting rough-side up on the workbench, sand the rough edges of the boards to a smooth edge.

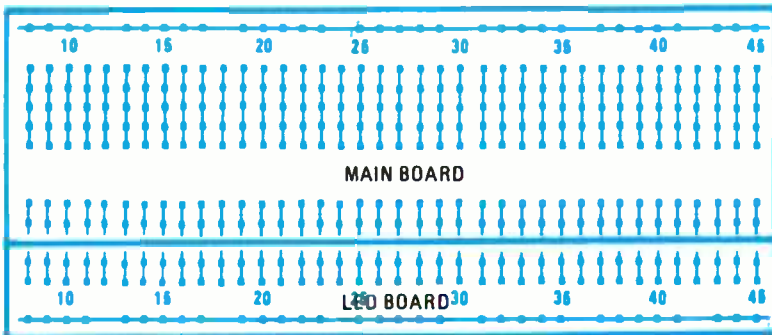
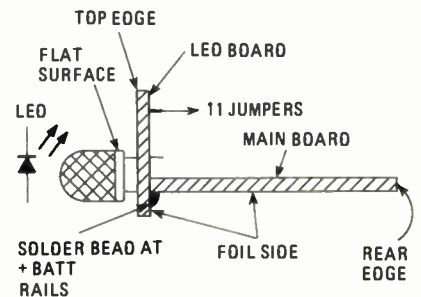

Fig. 1—Diagrammed details on how to cut the main and LED boards from a Global Specialties EXP-300 PC experimenter's circuit board. Refer to text for tips on cutting the board.

Next, the boards should be attached to each other as shown in Fig. 2. First, place the smaller one (LED board) flat on the workbench with the foil side facing upward. Now, take the main board and place it with the single row of holes against the LED board's edge, which also contains the single row of

Fig. 2—This cross-sectional drawing details how the two boards are attached to each other. Solder is used like a glue to fix the copper surfaces together so that the boards are secured. + Batt rails from both boards are soldered together so that they require no electrical interconnection.



holes. As shown in Fig. 2, the LED leads will pass through the holes and be directly under the foil side of the main board. By placing a few spots of solder on the foils of each board (where they meet each other), the two boards will be held in rigid positions.

It would be a good idea to jump ahead a bit and install the 10 LED's as shown in Fig. 3 first. Solder only the cathodes for each LED. The cathode for the LED is the lead closest to the flat surface on the body of the LED. Both + Rails on the

boards should be next to each other so that solder will bridge the boards and secure them together. You may want to add some epoxy to make the joint firmer, but it may not be necessary. That soldering action connects the two + Batt rails together so that a jumper is not needed.

It is now time to begin wiring the main board, which is accomplished as outlined in Fig. 3 and Fig 4. You may want to refer to the schematic diagram shown in Fig. 5.

The integrated circuit (U1) may be mounted in a socket if desired. It is

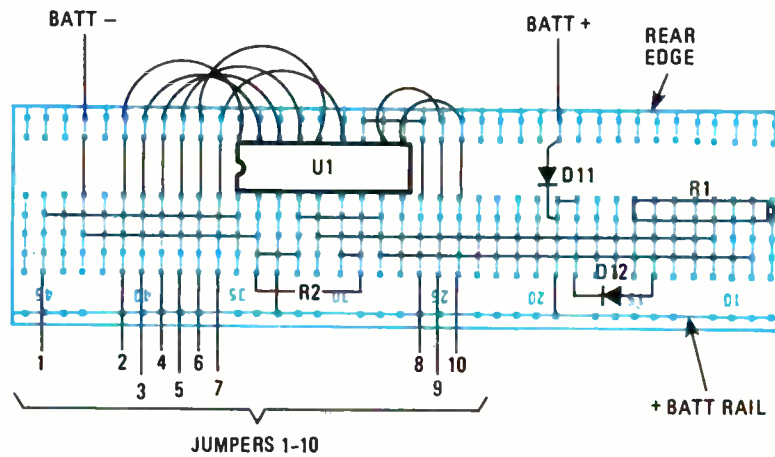

Fig. 3—Wiring diagram for the main board. Numbers at the bottom are for jumpers that connect to the LED circuit board. Numbers 1 through 10 correspond to LED1 through LED10.

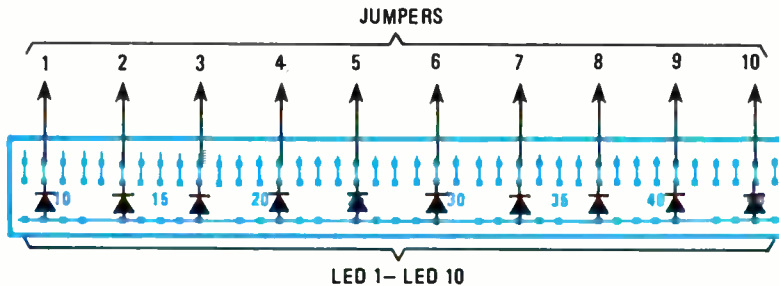

Fig. 4—The wiring diagram for the LED board is simple, but be careful when you connect the jumpers between the two boards. A mistake here will cause an LED to come on out of order.

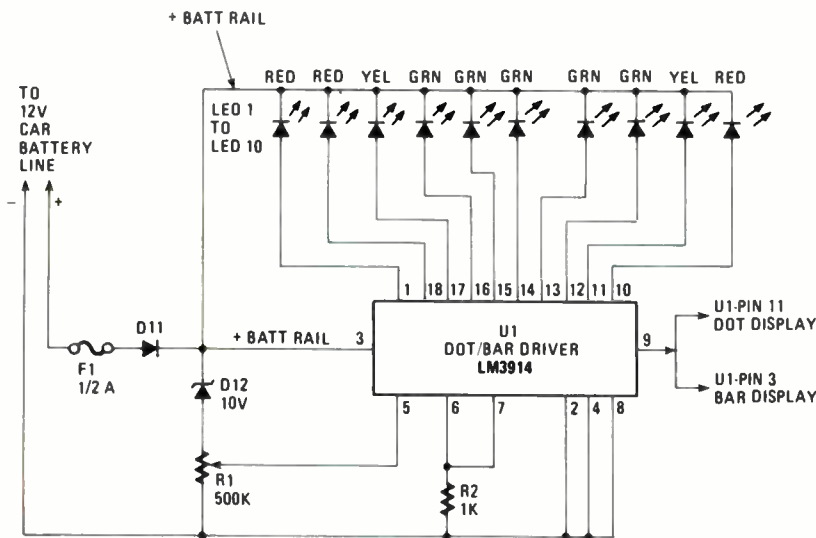

Fig. 5—The entire circuit for the Battery/Alternator Monitor appears to be one integrated-circuit chip and a bunch of light-emitting diodes which is actually the case. Be sure to include the protect fuse, F1, in the circuit. Short circuits in an automobile can draw currents up to 200 amperes that result in melted cables and the high probability of fire.

Those may be made by circuit pins or directly to the foil. Also, along the front edge of the board there are numbers (1 to 10) shown. Those are the connections that will be extended by insulated jumper wires to the respective numbered connection on the LED board. The latter is outlined in detail in Fig. 4. The numbers on that board refer to row A of the main board at the holes as shown. Otherwise, numbers 1 through 10 are from the left to right.

While not entirely required, the potentiometer chosen for R1 (see Fig. 5) is a ten-turn trimmer type and does assist in accurately adjusting the voltage steps to those shown in Table I. Once R1 was adjusted, it has remained untouched since the monitor was placed into regular service.

The diode designated D11 was added mainly for safety's sake to prevent damage should the unit be installed, or used, with a positive ground vehicle, or if the leads were connected in reverse. Of course, in either event, as long as the plus lead went to the positive side, the monitor will work because there are no external common-ground connections in the circuit.

Dot or Bar

The unit will illuminate one lamp (LED) for each voltage condition encountered in the charging system. That is called a *dot-graph* display. It is achieved by wiring pin 9 (mode control) to pin 11 on U1. It is possible to wire the monitor so that each lamp, from the leftmost red lamp to the present reading, will be illuminated up to the maximum voltage on the line at that moment. The latter is referred to as a *bar-graph* display. By connecting pin 9 to pin 3 on U1, the bar-graph mode will be enabled.

Since a red lamp showing on the instrument panel will signal *trouble* to most people, it seems that the single-lamp dot display is the most logical to use. When the operator sees only green (or an occasional yellow) light on the panel, he or she will realize everything is functioning normally. However, whenever a red LED lights, it will attract the driver's attention immediately. There is another side benefit of using only one lamp at a time—current drain is lowered and, therefore, the temperature rise of U1 is greatly reduced.

How It Works

A quick glance at the schematic diagram in Fig. 5 will be all that is neces-

suggested that a low-profile socket be used, especially if you are going to mount the Battery/Alternator Monitor in the cassette box as the author did.

Using Fig. 2 as a wiring diagram, install the jumpers and other parts in the locations as shown. The jumpers shown from pins 9, 10, and 13 through 18 of U1

are soldered into their respective holes and placed over the top of the board. Thin insulated wire may be used for that purpose. In fact, it is advisable to use the same insulated wire for all jumpers, especially those spanning more than two or three holes. Note the battery connections along the rear of the board.

sary to see the simplicity of the circuitry. Most of the circuitry is contained on board the LM3914 dot/bar-graph driver integrated-circuit chip. In addition to the comparator circuitry within the package, it also contains a stable reference supply and the drivers for the LED's. Another nice feature is that one resistor (R2) acts as the current limiter for all the LED's, which further eliminates several resistors. Resistor R2 may be varied for LED brightness. The lower value in the Parts List is for a bright readout; the higher value offers a dimmer light.

Adjustment

Once the circuitry has been completed, connect the leads to a source of variable DC voltage and set the voltage for about 13 volts. If no lights are on, adjust R1 until one or more of the lamps illuminate. For that adjustment, it may assist you to temporarily connect pin 9 to pin 11 of the U1 so that a dot-graph display is provided, illuminating one lamp at a time. When you have determined that the unit is working, adjust the variable supply to the voltages indicated on Table 1 and then check the display to be sure that the lamps light as shown. A digital voltmeter will assist you in the adjustment. If everything is right, the sixth (6th) lamp should be on when the DVM is indicating approximately 13.8 volts.

In the event the linearity is poor, try a different Zener diode (D12) as they do vary somewhat. The Zener diode specified in the Parts List was found to work well, as did several other 10-volt units checked.

When you are ready for packaging the monitor, you will find that the chassis you just constructed will fit quite nicely into the front portion of a standard audio cassette protective plastic box. Prepare the box by drilling ten small holes in the narrow edge of the box. The spacing is chosen to match that of the spacing of the LED's. The same for the diameter of the holes, because that will be governed by your choice of LED's. If you have been careful, the LED's will fit nicely through the holes and the chassis will remain in place with little or no other fastening devices.

Installation

Mounting the Battery/Alternator Monitor on the panel of your automobile is left to your imagination. However, some vehicles have a sort of hood over the instruments that shades them from sunlight. A couple of pieces of two-sided tape will hold the unit to the underside of the hood. That placement makes the unit visible whenever one glances at the instrument panel. Connection to the auto's electrical system may be made directly to the fuse block, other hot connection under the dash, or to a plug that can be inserted into the cigar lighter. However you do it, be sure to insert a 1/2-ampere fuse as close to the tie point as possible. Without the fuse, you are inviting disaster.

There is no need to provide a switch to turn the battery monitor on or off because the power consumed is so small that it will never be noticed. However, if you take long trips and leave your vehicle behind, you may want to disconnect the unit, or have someone start the car at least once a week.

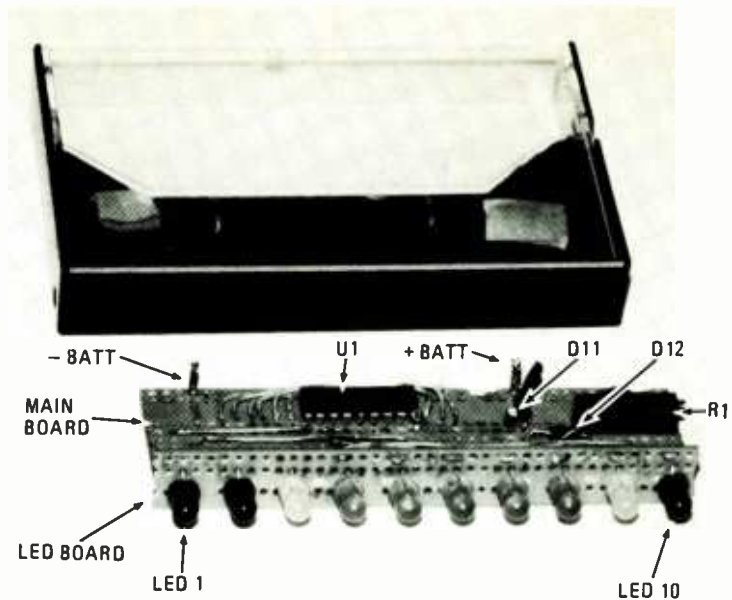

Here's a view of the Battery/Alternator Monitor just prior to assembly in its plastic cassette protective case. Since it would be difficult to see the holes in the black panel against a black background of the case's inside surface, we highlighted them for easy viewing.

PARTS LIST FOR BATTERY/ALTERNATOR MONITOR

- D1, D2, D10—Light-emitting diode, red
- D3, D9—Light-emitting diode, yellow
- D4-D8—Light-emitting diode, green
- D11—Silicon rectifying diode, 1-A, 50-VDC, or better
- D12—Zener diode, 10-volt, 1/4-watt (1N1744 or equivalent)
- F1—1/2-A fuse with in-line holder
- R1—500,000-ohm, 10-turn, linear-taper trimmer potentiometer
- R2—1000-2000-ohm, 1/2-watt, fixed resistor (see text)
- U1—LM3914 dot/bar driver integrated-circuit chip
- 1—Continental Specialties EXP-300 PC printed-circuit board
- 1—Plastic cassette protective case
- Plus: Wire, solder, glue or epoxy, etc.

The glow of the little lamp on the dashboard of your automobile may have a certain deterring effect upon a potential thief because he would have no way of knowing whether or not the lamp indicated an armed alarm system, or whatever.

Build this simple but useful piece of equipment now. Begin to understand your automobile's battery and charging system. The key thing to remember is that if you park your car at night, when you get into it in the morning it should still be indicating about 12.5 or 12.6 volts. If not, you may be expected to replace your battery within six months, especially if you live in one of the cold climates of the country. One more thing you will learn is just how a load affects the voltage on the line.

Look in the car window (in the AM) and the lamp shows yellow. Open the door and notice that the red lamp indicates that the voltage has dropped below the 12.6 volt level. Once you watch the activities for a couple of days, you will be in a better position to analyze the electrical system and to be able to predict future troubles before they leave you stalled far from home.



INFRARED R/C TRANSMITTER

Build your own Remote/Control device and save bucks on cable-TV converter rentals!

By Edward Asbell Payne

□INFRARED REMOTE CONTROLS (R/C'S) HAVE BEEN AVAILABLE on many home-entertainment devices for several years now. They are becoming almost standard equipment for most television sets, thanks to the ease of implementation and the low cost of today's MSI/LSI integrated circuits. The odds are that if you purchased a television receiver within the last several years you own a remote control. But what do you do when you subscribe to cable TV with a remote channel converter and your old remote control becomes next to useless? Do you lease a remote control, the way you use to lease your telephone, or are you lured into a more expensive package of channels just to receive a remote control? Maybe you just want a construction project that is fun and will receive lots of use. If you fall into any of those categories, this project might be for you.

There are several manufacturers of remote-control chip sets; among them are General Instruments, National Semiconductor, and Motorola. Each of those companies have their own data format and are not compatible with one another. This article centers on the Motorola MC14457 CMOS remote/control transmitter chip. Aside from being designed for use in many TV sets and home entertainment devices, it is used by one large supplier of cable-television channel converters with a slightly modified format.

TABLE 1—MOTOROLA FORMAT

	R1	R2	R3	R4	R5	R2 + R5	R3 + R5	R2 - R3 + R5
C1	0	2	4	6	8	10	12	14
C2	1	3	5	7	9	11	13	15
C3	SPARE	FINE TUNING	SPARE	VOL ◀	MUTE	SPARE	SPARE	SPARE
C4	SPARE	FINE TUNING	SPARE	VOL ▶	OFF	SPARE	SPARE	SPARE

TABLE 2 MODIFIED MOTOROLA/OAK FORMAT

	R1	R2	R3	R4	R5
C1	0	2	4	6	8
C2	1	3	5	7	9
C3	ENTER	NOT USED	NOT USED	NOT USED	RECALL
C4	NOT USED	NOT USED	NOT USED	NOT USED	ON/OFF

The circuit described in this article will transmit either Motorola or the modified Motorola/OAK format by simply moving a jumper on the printed-circuit board. Under the Motorola format, there are up to 32 commands such as on/off, volume, channel-step, etc. Under the modified Motorola/OAK format, 13 commands are implemented from the previous group. Those are 0 through 9, enter, recall, and on/off. Tables 1 and 2 are provided to aid the builder in selection of functions; however, some receiver manufacturers may mix the control lines at the receiver end, leading to departures from the tables. If that is the case, simply experiment with row and column closures until all commands have been identified; then wire your keypad accordingly.

You may also reduce the number of functions and save some cost on the quantity of switches you need to purchase. For example, I have found that the implementing only the on/off and recall functions on my home unit suffices me quite well. Feel free to customize the Infrared R/C Transmitter to your own liking.

How It Works

The MC14457 integrated circuit, U1, encodes a keypad matrix (see Fig. 1) consisting of switches S1 through S20. For each key (switch) closure, U1 generates a unique burst or train of frequency-modulated bi-phase data. Most closures generate a single burst of data for each key depression; however, several commands generate a continuous train of data for functions such as volume up, fine tune, etc.

In the circuit described in Fig. 1, a free-running ceramic resonator oscillator (CRI), operating at 455 kHz, is internally triggered by the MC14457 chip (U1) upon detection of any key closure. That oscillator's output is then divided by 13 or 12 to form frequencies of 35.0 kHz or 37.92 kHz, respectively. A transmitted *zero* consists of 256 pulses of 35.0 kHz followed by 256 pulses of 37.92 kHz. A transmitted *one* is the same process simply reversed in order.

Fig. 1—Schematic diagram for the Infrared R/C Transmitter includes the keypad matrix hookup. First-rate (not grab-bag variety) transistors have low DC leakage, so that the battery life is almost equal to battery shelf-life.

Each key closure is encoded into a 5-bit word preceded by a header of a zero and a one—in effect a 7-bit word. In addition, that 7-bit word is again preceded and ended by a low-frequency burst of 35.0 kHz. In the modified Motorola/OAK format, the low-frequency portions of the word are removed entirely. That makes the modified format unique and prevents interaction or use by other controls in consumer appliances which chose the Motorola chip for the foundation of their remote control design.

Components R1, R2, C1, C2 and CR1 (see Fig. 1) form a resonant network, meeting the requirements of U1's internal oscillator driver. Transistors Q1 through Q4 serve to eliminate the necessity of using double-pole switches by effectively grounding both row and column inputs on U1 with a single-pole switch. That lowers the unit's cost and makes the selection of available switches broader.

In the OAK jumper position (see Fig. 1), U2-a AND's in the modulation signal with the data stream to remove the low-frequency data for the modified format. With the

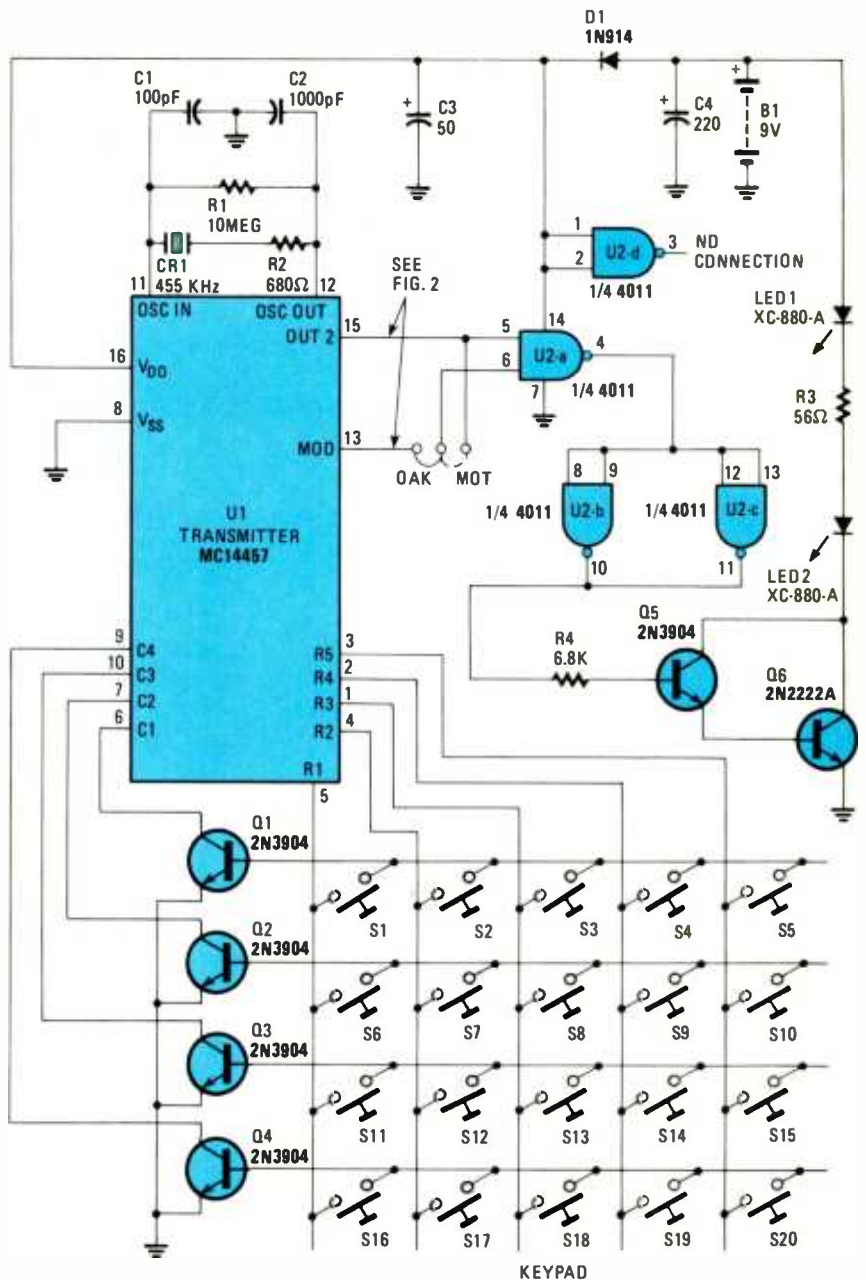
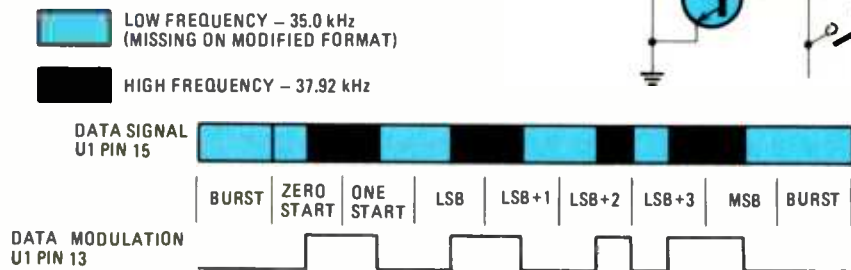

Fig. 2—The frequency bursts you can expect when transmitting the number 9. The Motorola system uses 35.0-kHz and 37.92-kHz bursts as seen from pin 15 of U1. The OAK system uses only 37.92-kHz bursts that are gated by a DC signal from pin 13 of U1. Refer to the schematic diagram in Fig. 1 for circuit action.



jumper in the MOT (Motorola) position, U2-a acts as a simple inverter, passing both high and low frequencies from U1's output on pin 15. See Fig. 2. That signal is then passed through two paralleled gates, U2-b and U2-c. Those are wired as inverters to restore the original polarity of the data and to provide more than adequate drive for the Darlington-arranged LED drivers, Q5 and Q6.

The remaining unused gate, U2-d, has its input hard-wired to a logic one (see Fig. 1), in effect shutting it down. Since CMOS only consumes power while switching, that prevents any noise from being coupled into U2-d and consuming battery power. Resistor R3 limits the current through D1 and D2, and is set for approximately 60 mA in this design. Diode

D3 prevents possible damage from accidental battery reversals, and is cheap insurance for a five-dollar integrated circuit.

Capacitors C3 and C4 serve to bypass noise in the battery power supply (see Fig. 1) when the LED'S are active. CMOS integrated circuits were used throughout, and all bipolar transistors are in their quiescent off state when no keys are depressed. That eliminates the need for a power switch and assumes essentially shelf life from the battery while the unit is not being operated.

Construction

The circuit's layout for the Infrared R/C Transmitter is not critical and almost any method of construction will suffice; however, for ease of construction and small size, a printed-circuit board is recommended. One may be copied from the

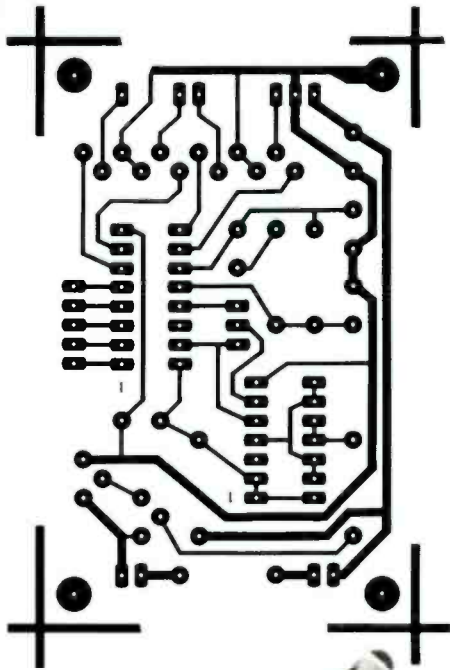

Fig. 3—Same-size foil layout for the printed-circuit board.

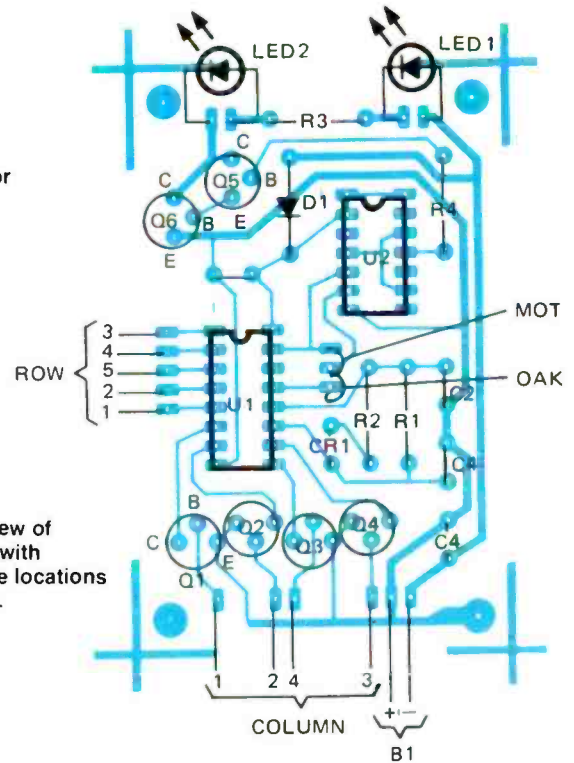
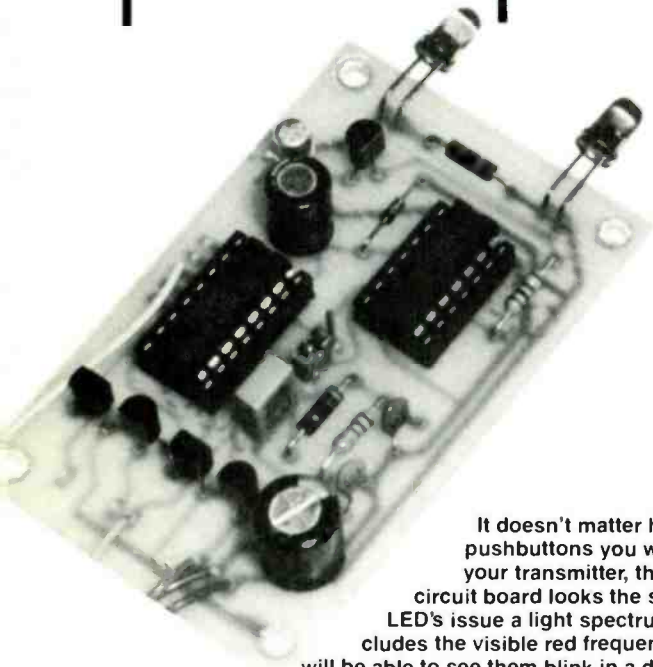

Fig. 4—Here's an x-ray view of the printed-circuit board with the foil side down and the locations of components indicated.



It doesn't matter how many pushbuttons you will use on your transmitter, the printed-circuit board looks the same. The LED's issue a light spectrum that includes the visible red frequencies. You will be able to see them blink in a dark room.

foil layout given in Fig. 3, or an etched and drilled circuit board may be ordered from the source given in the Parts List. Fig. 4 offers an x-ray view of the foil on the reverse side of the printed-circuit board with the components positioned in place.

The Infrared R/C Transmitter may be housed in any suitable enclosure, but a metal box is highly recommended in dry climates where static discharge could bridge through a switch and consequently into the CMOS circuitry. The infrared light-emitting diodes, LED1 and LED2, may be mounted with standard plastic grommets or may be housed behind a protective and decorative lens. Surprisingly, almost any tint of plexiglass or plastic will do. Most translucent colors have little attenuation at infrared wavelengths of light. Do avoid smoked plastics, which have suspended particles to achieve their effect. Those will attenuate light at any wavelength.

Parts were chosen with availability and cost in mind. Many substitutions are possible. Any infrared LED with energy centered near 880 nanometers will do; but also note that some

(Continued on page 99)

PARTS LIST FOR THE INFRARED R/C TRANSMITTER

SEMICONDUCTORS

- CR1—455-kHz ceramic resonator (Radio Shack 272-1303 or equivalent)
- D1—1N914 silicon diode
- LED1, LED2—XC-880-A infrared light-emitting diode (Radio Shack 276-143 or equivalent)
- Q1-Q5—2N3904 NPN silicon transistor
- Q6—2N2222 NPN silicon transistor
- U1—Motorola MC14457 integrated-circuit chip
- U2—CD4011 or MC14011 integrated-circuit chip (Radio Shack 276-2411 or equivalent)

CAPACITORS

- C1—100-pF, 50-WVDC ceramic disc capacitor
- C2—1000-pF, 50-WVDC ceramic disc capacitor

- C3—50-uF, 35-WVDC electrolytic capacitor
- C4—220-uF, 16-WVDC electrolytic capacitor

RESISTORS

- R1—1-Megohm, ¼-watt, 5% resistor
- R2—680-ohm, ¼-watt, 5% resistor
- R3—56-ohm, ¼-watt, 5% resistor
- R4—6800-ohm, ¼-watt, 5% resistor

ADDITIONAL PARTS AND MATERIALS

- B1—9-volt DC alkaline transistor radio battery
- S1-S20—Any SPST, normally-open, momentary-contact switch
- Battery connector clip, battery holder, IC sockets, enclosure, wire, solder, and hardware.



By Don Jensen

JENSEN ON DX'ING

Pulling in the nations that share the Pacific's warmth!

ON A WARM AND SCENTED BREEZE, from somewhere in the darkness beyond the flickering light of the torches, comes a pulse-pounding throb of drums. You are standing on the beach. Somewhere across the lagoon, you know the surf is rolling whitely over the coral reef. Though the tropical night envelopes you, overhead there are the twinkling points of the Southern Cross.

That is the Pacific—or at least my mental image of a South Sea paradise. Chances are that it's not too different from yours.

Because of those day-dream visions of the lands surrounding and dotting the Pacific, it is an area of great interest to SW listeners. There are few DX'ers who don't get a special thrill from tuning the SW broadcasters of that exotic part of the world.

In our last few columns, we've begun working our way around the globe by SW beginning with Europe and Asia. In the future, we'll continue the journey, continent by continent. But, this time finds our SW'ing survey all at sea, checking out the stations you can hear from the great expanse of the western ocean.

As has been the case with our previous continental looks at SW'ing, we'll find a mixed bag of DX targets. Some of those stations are easy to hear; others provide a bit more of a challenge to tune in; and still others are real toughies that take real tuning skill, reasonably good listening equipment and, yes, luck.

The old phrase, "half a day away," is literally true when you are talking about the lands of the Pacific. But that day may be today or tomorrow, since the International Date Line runs right down through the mid-Pacific. New Zealand is exactly a half-a-day away from UTC (Universal Time Coordinate, a term which is replacing the old standard, Greenwich Mean Time or GMT). In New Zealand, the local time is UTC + 12 hours; when it is 6 in the morning (0600) UTC, it is 6 P.M. (1800) for the *Zed'ers* Down Under.

When it is 1400 UTC (2 P.M.) on Monday afternoon, the corresponding local time on the Pacific island of New Caledonia (UTC + 11) is 0100 (1 A.M.) Tuesday. But on the other side of the International Date Line, just two time

zones to the east in the Cook Islands, at the very same moment, the local time is 0300 (3 A.M.) Monday!

And Australia, because of its large size, spans the distance from UTC + 8 to UTC + 10 hours.

On the lower SW frequencies, to receive a signal, a "path of darkness" between broadcaster and receiver must exist. Some of the major Pacific area broadcasters use frequencies above 10 MHz, where the path of darkness rule does not apply. But with most of the lower-powered, lower-SW frequency stations, the best times for reception in North America are around 0800 to 1500 UTC. That is depending on where in the U.S. or Canada you live, between post-midnight and dawn, local time. Be prepared to lose some sleep for some of the more difficult Pacific SW loggings.

Now let's take a closer look at those DX targets, beginning with the largest of the Pacific nations.

Australia—*Radio Australia* is one of the world's major international broadcasters, and surely one of the most important SW voices from the Pacific.

SWL's in North America will have no trouble tuning in that station at various times of the day. Here are a few times and frequencies to try: 5,995 kHz at 1130 UTC; 6,035 kHz at 2130 UTC; 9,580 kHz at 1400 UTC or 2100 UTC; 15,160 kHz at 0330 UTC; 15,395 kHz at about the same

time, and 21,720 kHz at 0500 UTC.

In addition to the broadcasts of Australia's overseas broadcasting operation, the Australian Broadcasting Corporation also airs domestic SW programs for the home folks who live in the more remote areas of the country. One of those home-service stations which can be received in North America is VLM4, broadcasting from Brisbane on 4,920 kHz. Give that one a try between about 0900 and 1300 UTC.

New Zealand—A few years ago, *Radio New Zealand* had a separate SW programming service, but then an economic crunch hit the station. Fortunately, *Radio New Zealand* was able to stay on SW, but the separate programming for overseas listeners was replaced with relays of domestic medium-wave programs. Many SWL's consider that to have been a plus, rather than a loss, and I agree! I much prefer to hear the same programming as New Zealanders do on their own AM radios, rather than something supposedly designed just for foreign listeners.

Look for *Radio New Zealand* on 9,620 kHz signing on at 0930 UTC with its bellbird interval signal and the start of National Service programming. Or, at a more reasonable hour in North America, try 17,705 kHz around 0030 UTC.

Philippines—Here there are several stations for SW listeners to tune.

(continued on page 102)

HANDS-ON ELECTRONICS

the voice of asian christianity

radio veritas

Manila

15 MHz

9-21 MHz

11 MHz

11 MHz

15 MHz

CHINA

INDIA

PHILIPPINES

INDONESIA

THAILAND

VIETNAM

BRUNDAI

SIAM

SRILANKA

AUSTRALIA

Radio Veritas offers a handsome multicolored QSL card.

KENWOOD

pacesetter in amateur radio

Scan the World. R-2000

Kenwood's R-2000 receiver has opened the doors to a new world in the 150-kHz to 30-MHz HF bands, with microprocessor controlled operating features and an UP conversion PLL circuit for maximum flexibility and to enhance the excitement of listening to stations from east to west, and from pole to pole. An optional VC-10 VHF converter, for 118 to 174-MHz, allows access to police, aviation, marine, commercial, and two meter Amateur frequencies. With dual digital VFO's, ten memories that store frequency, band and mode information, memory scan, programmable band scan, fluorescent tube digital display, and dual 24-hour clock with timer, this outstanding radio has the versatility needed to reach out and catch those distant and elusive stations in the most remote areas of the world.

The R-2000 receives in the USB, LSB, CW, AM, and FM modes, and its ten memories allow moving from band to band without concern for mode of operation. The programmable band scan feature permits scanning over operator selected

limits, reducing scan cycle time. Memory scan allows the operator to scan all, or only specific memories. Lithium battery memory backup (Estimated 5 year life) is built-in.

With the sensitive R-2000, only the best in selectivity will do. It has three built-in IF filters, with NARROW/WIDE selector switch, and an optional 500-Hz narrow CW filter is available. A noise blanker, and an all-mode squelch circuit further enhance the operators control of his listening environment. An AGC switch, and an RF attenuator switch allow selection of the best signal-to-noise ratio. It has a large, front mounted speaker, a tone control, an "S" meter, high and low impedance antenna terminals, and operates on 100/120/220/240 VAC, or on 13.8 VDC, with an optional DCK-1 DC cable kit. Other features include a record output jack, an audible "beeper," a carrying handle, a headphone jack, and an external speaker jack.

The R-2000 places the world at your finger tips.

R-2000 optional accessories:

VC-10 VHF converter • HS-4, HS-5, and HS-6 headphones • DCK-1 DC cable kit • YG-455C 500-Hz CW filter.



R-1000 High performance receiver
• 200 kHz - 30 MHz • digital display/clock/timer • 3 IF filters • PLL UP conversion • noise blanker • RF step attenuator • 120-240 VAC (Optional 13.8 VDC).



R-600 General coverage receiver
• 150 kHz - 30 MHz • digital display • 2 IF filters • PLL UP conversion • noise blanker • RF attenuator • front speaker • 100-240 VAC (Optional 13.8 VDC).

More information on these products is available from authorized dealers of Trio-Kenwood Communications, 1111 West Walnut Street, Compton, California 90220.

Specifications and prices are subject to change without notice or obligation.



TESTBENCH TIPS

Is There a Ground?

I often have to power-ground electronic equipment in older buildings having the old fashioned two-wire outlets. Because the outlets lack a ground pole I take the earth ground via an adapter from the screw that secures the outlet's cover plate:

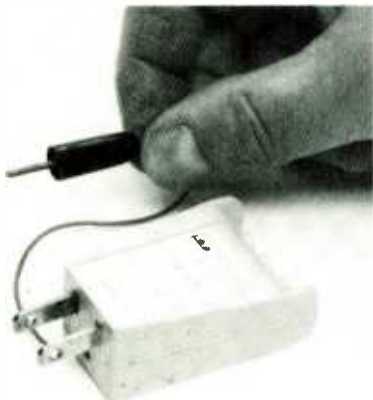

but it often turns out that the plate isn't grounded to earth. By modifying a standard outlet-tester so the earth ground is tested manually, I can now quickly check whether the plate is grounded. I replaced the tester's "ground pole" with a short wire tipped with test probe which I press against the plate. If the plate is grounded the tester's ground lamp turns on.

R.E.—Denver, CO

New Way for 5-Way

It used to be difficult for me to tighten the mounting nut of a 5-way binding post, because there's usually not enough room

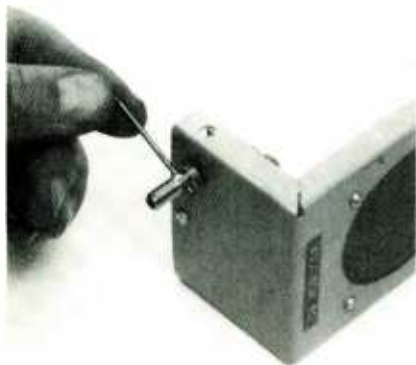

to fit a socket wrench inside the cabinets used for my home-brew projects. Now I tighten the assembly by using a finishing nail passed through the hole in the post. Turning the nail tightens the post rather than the mounting nut. I hold the nut with a small open-end wrench from and ignition tool set, or I sometimes use my long-nose pliers. Other times, the tip of my finger is all that is needed.

T.U., Schaumburg, IL

Novel Bug Holder

I use an ordinary "Yankee" film clip to hold an integrated circuit when I need to straighten bent terminals. The clip, which



is exactly the right size for 16- and 20-pin DIP's, applies more than enough pressure to keep the integrated circuit from flying out, but not enough to damage the device.

P.S., Miami, FL

He's All Thumbs

My large fingers can barely hold a miniature screwdriver, let alone a screw that's even too small for a "hold-e-zee" screw-



The very next time you come up with a simple, but clever, idea that helps you build a better project, or do a better job of installing, or testing, a project, let us know about it. Put your idea on paper (typewrite it), spelling out the details on one sheet. Take a black-and-white photo of the idea in action and send it to the Editor. (Color photos lose too much contrast.) If your tip is used in this column, you will receive a check for \$20. Sorry, we will be unable to return your tip or photo, and all entries become the property of **Hands-on Electronics**. Send all mail to **Hands-on Electronics Testbench Tips**, Room 1101, 200 Park Avenue South, New York, New York 10003.

driver. So, I temporarily secure the screw to the screwdriver with a drop of plumber's grease, which is so thick and clingy it can even hold a #10 screw to the screwdriver. Pick up the grease at a hardware store that specializes in plumbing supplies.

G.K., Waco, TX

Steel-Wool Cleans

I have boxes and boxes of components collected over a period of years. Time has oxidized the wires so that soldering is difficult. Instead of the time-consuming process of scraping the oxidation off a wire with a knife, I glue a small bit of coarse steel wool to a small scrap of



printed circuit board which I keep on the workbench. Passing a wire over the steel wool removes the oxidation and leaves the wire clean and ready for solder. If the oxidation is really stubborn, I push the wire into the steel wool with a fingertip.

R.Q., Woodbridge, NY

BUILD AN ANTIQUE SHORTWAVE RADIO

Tune the airwaves with this vintage shortwave receiver. Its 1930's triode vacuum-tubes and plug-in spiderweb coils. Bring back the excitement of the "good old days!"

By David Whitby

□ JUDGING BY THE RESPONSE OF OUR READERS TO THE article "How To Build a 1920's Style Wireless Receiver", in the Fall 1984 issue of *Hands-on Electronics*, there is a real interest in experimenting with early circuit designs and techniques. Many readers who built the Unidyne one-valve (vacuum tube) receiver also expressed interest in the possibility of an all-band receiver with plug-in coils, built to the same vintage standards as the Unidyne receiver. So by popular demand we present the Reinartz 2. The receiver described in this article is based on a kit prepared by an Australian supplier. However, within this article we have supplied sufficient information so that the hobbyist active in RF circuitry construction will have enough information to assemble his very own receiver. Again, the serious buff may prefer the kit so that he would achieve a receiver that is very nearly a replica

of what would have been assembled in the 1920's.

The receiver was designed around two medium-impedance triode vacuum tubes, type HL2K (RAF type VT50). Those vacuum tubes have 2-volt filaments and a 4-pin base; they perform well in this circuit at frequencies up to more than 20 MHz. Some American-vintage types that can be substituted are (number of pins in base and filament voltage given): 11 (4-pin, 1.1-volt), 26 (4-pin, 1.5-volt), 27 and 27S (5-pin, 2.5-volt), 30 (4-pin, 2.0-volts), 37 (5-pin, 6.3-volt), and 76 (5-pin, 6.3-volt).

Obviously, vacuum-tubes of that era (they are a 1920's design, and were made at the beginning of WWII) are now as scarce as hens' teeth, but sufficient stocks are available provided you can find them at flea markets and old radio-repair shops. The Parts List provides the address of an overseas supplier.

Main Features

The circuit is of the regenerative-detector type followed by one stage of audio amplification. The regeneration arrange-

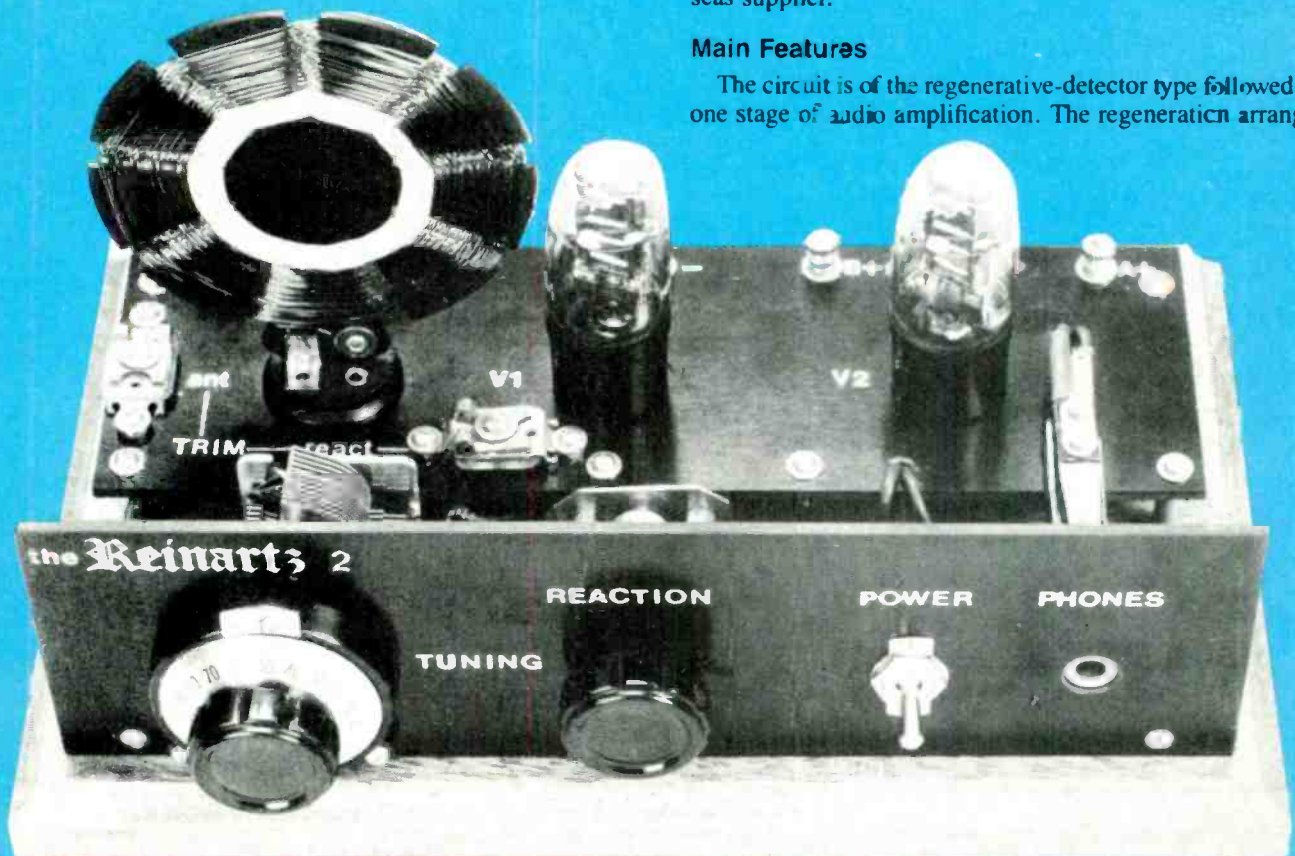

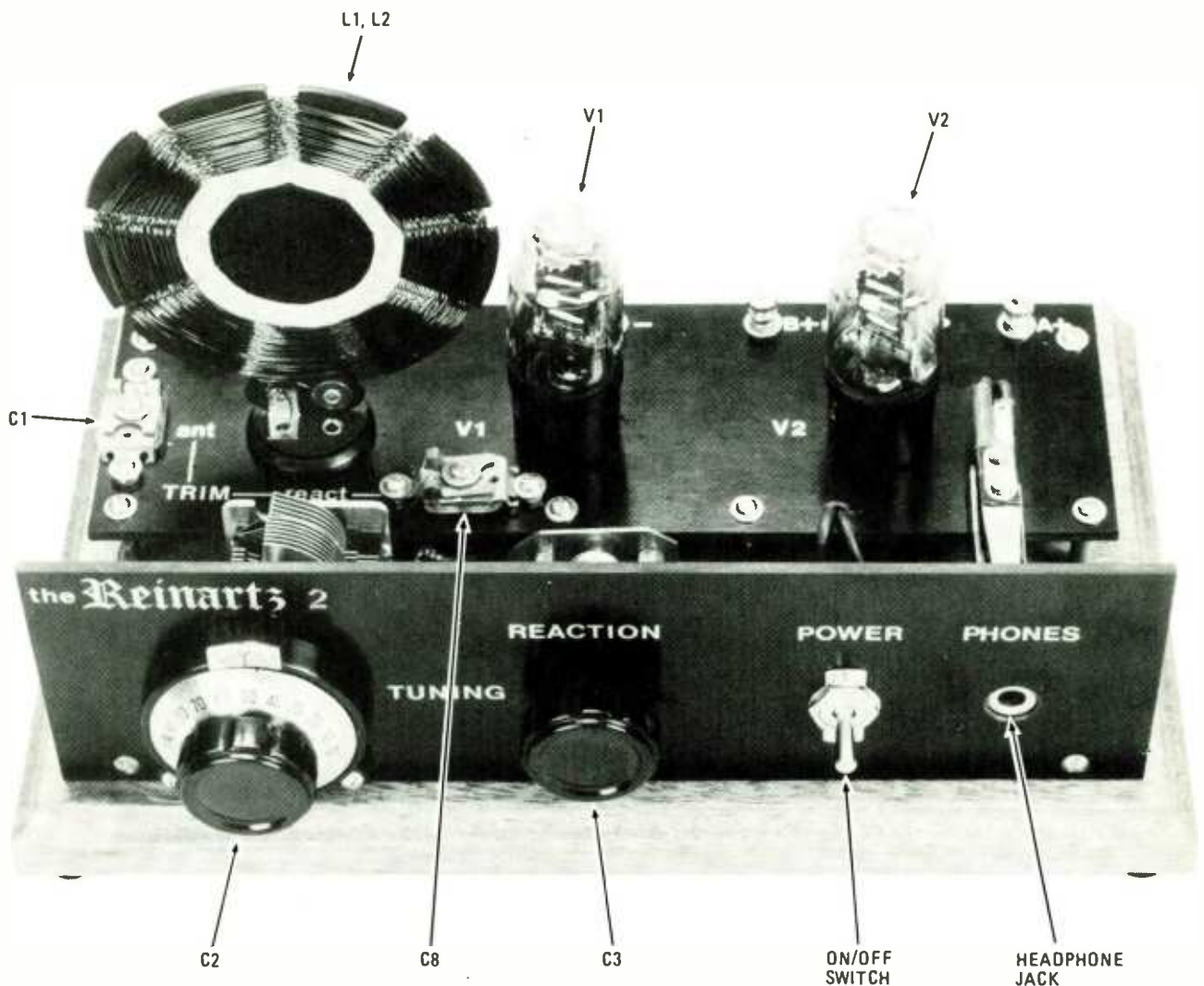

Since the Reinartz shortwave receiver is not in a cabinet, viewers of your project will be able to see your handiwork. Parts location is an indication of signal flow—from the antenna coil (left) through V1, V2, and out at the PHONES jack (right).

ment is the famous Reinartz circuit, about which more will be said later.

Plug-in *spiderweb* coils are used to cover the various bands (broadcast to approximately 20 MHz). The plug-in formers for those coils have been specially produced by the parts supplier (see Parts List) and allow for easy winding of coils that are very efficient, even though they were first designed around 70 years ago.

Tuning is carried out by an air-spaced variable capacitor, which is driven by a precision 6:1 vernier dial (used in kit). Both the capacitor and the dial are of relatively modern design but make for precise and stable tuning on the shortwave bands. As can be seen from the photographs, they do not detract noticeably from the vintage flavor of the radio.

The tuning capacitor has two sections of 200 pF and 90 pF. The 200-pF section is used for tuning the receiver; the other section is connected via a 30-pF trimmer capacitor (C8) to the reaction capacitor (see Fig. 3). Although not a feature of the original Reinartz circuit, that last step reduces the amount of travel required by the reaction capacitor over each tuning range.

The reaction capacitor has been built especially for the kit, and consists of a 25-pF, air-spaced, beehive capacitor fitted

with a shaft and mounted in a brass frame. That little capacitor has the advantage of requiring four turns of the shaft from minimum to maximum capacity which, in effect, gives a vernier action to the reaction control.

In terms of appearance, the receiver is built on a high-quality (Meranti) wooden baseboard, which has a *cove* routed edge to create a really attractive vintage appearance. The tuning and reaction controls, on/off switch and phone jack socket are mounted on a front panel of gold-lettered black bakelite, which is attached to the baseboard by means of three small right-angle brackets.

A rear sub-panel, also of black bakelite, holds most of the other components, including the coil and tube sockets, and the terminals for the antenna, ground, and power-supply connections.

The receiver is designed to operate medium- or high-impedance headphones. If you have built the Unidyne receiver and would like to use the low-impedance phones supplied with that kit, then a small vacuum-tube plate-circuit transformer (ratio not particularly critical) should be used for best results. There is room to fit the transformer on the baseboard behind the front panel. For those who require headphones, a suitable receiver of high-quality 3400-ohm

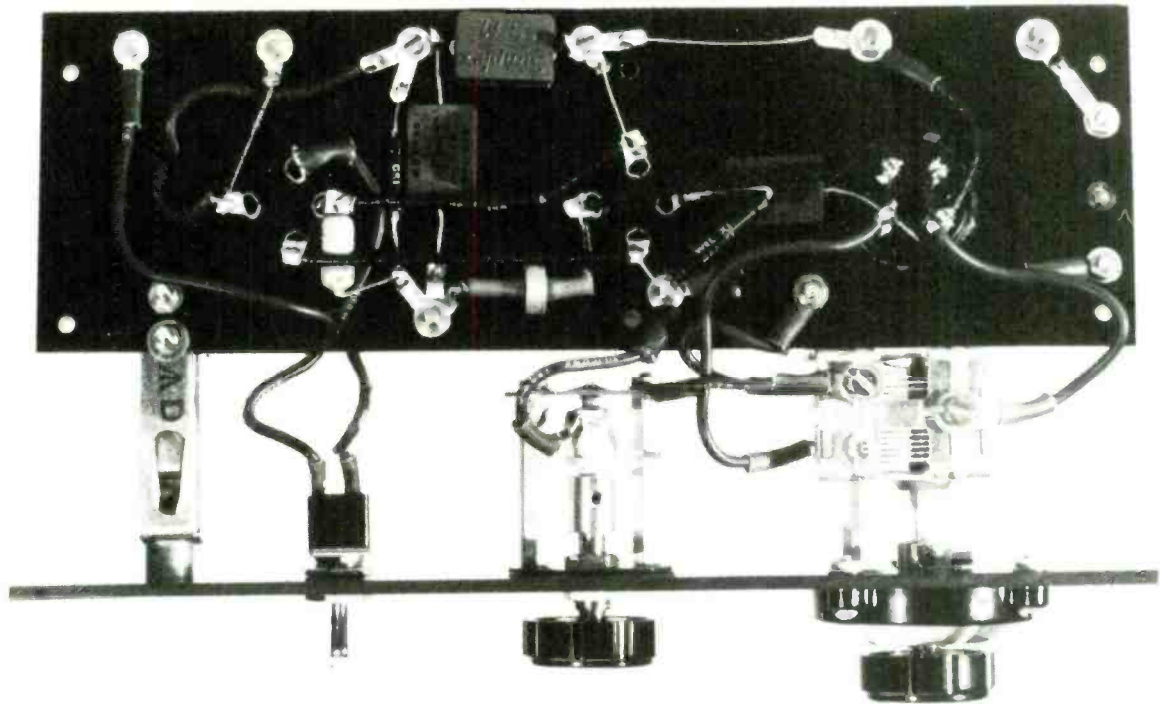

Parts location on the sub-panel and front panel.

STC phones is available (1940 vintage).

The receiver requires an A-battery voltage of 3.0-4.5-volts DC at around 100 mA, and a B-battery with a voltage of 90 volts DC, or thereabouts, at approximately 1.5 mA. Two heavy-duty alkaline D-cells will provide a suitable supply for the filaments, while a series string of ten transistor-radio-type 9-volt batteries will provide a long-lasting B battery.

A battery box to hold those could be easily made up and the battery snaps for the 9-volt batteries and holders for the D cells are cheap and easy to obtain. If you don't want to go to the trouble of making your own battery box, then a complete battery-holder system mounted on a wooden base to match the radio is available (see photograph and Parts List).

The Reinartz Circuit

Of all the receivers built by hobbyists over the years from the 1920's onward, the all-band type or two-tube receivers

with plug-in coils were probably the most popular. Of those the Reinartz circuit was undoubtedly the best known.

The basic circuit arrangement was devised by J. L. Reinartz and was published in the June 1921 and the March 1922 issues of *QST* magazine. That single vacuum-tube receiver was of the *grid-leak regenerative-detector* type. It used a spiderweb coil with switched taps to cover various bands and featured variable-capacitor control of the regeneration (or reaction).

It was that capacitive-reaction control which was the distinguishing feature of the Reinartz circuit, compared to previous regenerative-detector arrangements.

Previous methods of regeneration control included the *swinging reaction coil* (as in the Unidyne receiver), the tuned-anode Variometer circuit (due to Armstrong), and other methods which used a fixed-reaction coil coupled to the tuning coil and controlled the amount of reaction by varying the filament or anode voltages of the vacuum-tube

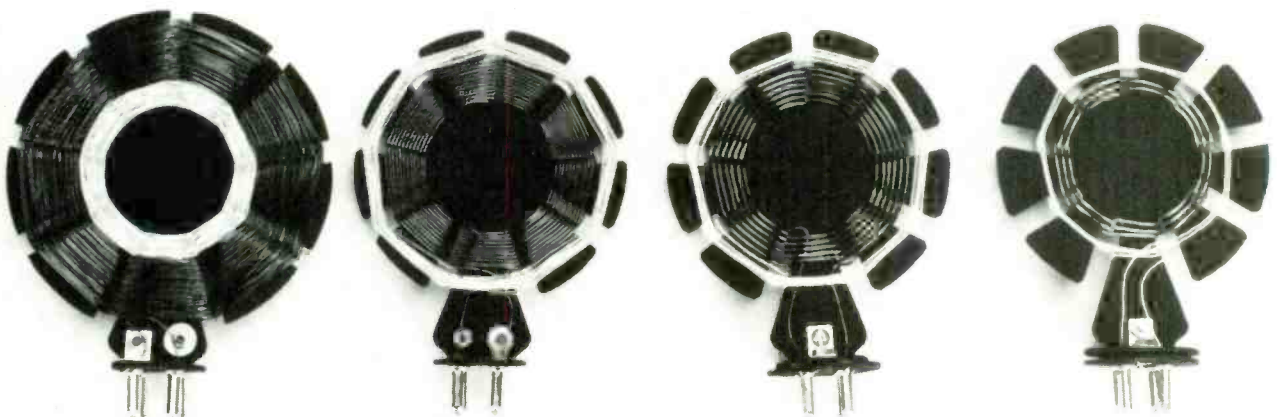

Examine the windings on the four spiderweb coils. The more windings per coil, the lower the frequency range each will tune in. The coils from left to right correspond to the data for coils 1 through 4, respectively, in Table 1.

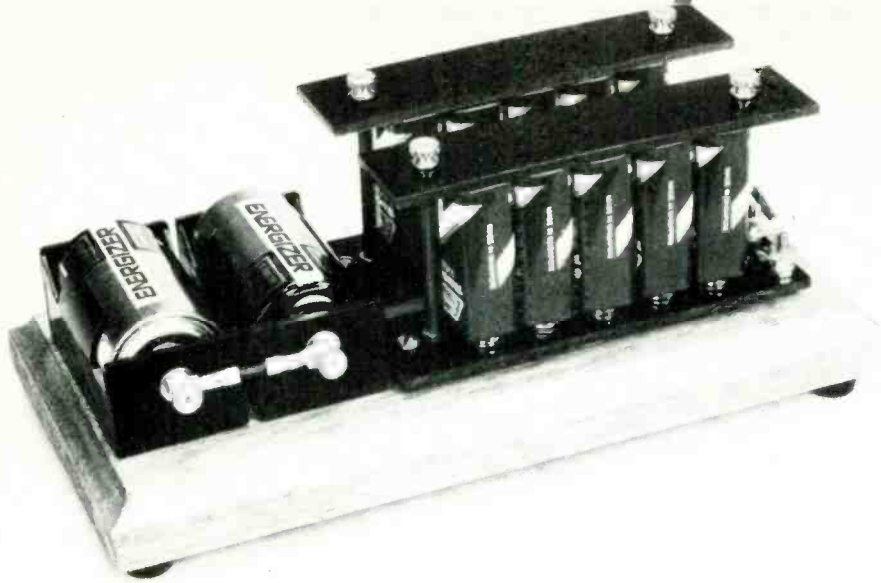

This vintage style A and B battery holder helps disguise the fact that modern batteries are used. If you wish, you can draw power from a hidden power supply and only the cable will be seen.

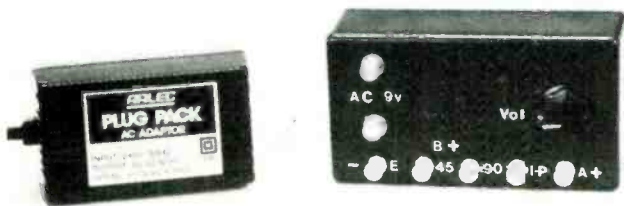

Optional AC power-supply/audio-amplifier unit.



A rarity these days, a working pair of hi-impedance headphones.

All of those methods were workable (some more so than others) on the long and medium wavelengths; but when it came to operation on the shorter bands, reaction control became very tricky. An unstable receiver was often the result. The Reinartz circuit quickly became popular, mainly due to the smooth reaction control made possible by the arrangement—especially on the shorter wavelengths.

Simply explained, the reaction capacitor is in series with the reaction coil and is thus able to control the RF current through that coil. Adjustment of the capacitor provides precise control over the amount of positive feedback (regeneration) in the circuit.

The basic circuit shown in Fig. 1 was soon modified to that

PARTS LIST FOR REINARTZ 2 SHORTWAVE RADIO

VACUUM TUBES

V1, V2—HL2K, VT50 (see text)

CAPACITORS

C1, C8—3-30-pF trimmer capacitor

C2—200- and 90-pF, two-section, variable, air capacitor (see text)

C3—(see text)

C4—100-pF mica capacitor

C5, C7—.001-pF mica capacitor

C6—.01 tubular paper capacitor

RESISTORS

R1—3-Megohm

R2—50,000-100,000-ohm

R3—.5-1.0-Megohm

ADDITIONAL PARTS AND MATERIALS

L3—2.-mH radio-frequency choke

3—UX4 4-prong coil socket

Base material, knobs, sockets and plugs, spiderweb coil forms, hardware, solder, phone jack, on/off switch, rubber-covered solid-copper wire (approximately #22 AWG), magnet wire for spiderweb coils (see Table 1), right-angle brackets, tapped spacers, decals, etc.

A full kit of parts for the Reinartz 2 is available from Technicraft, 338 Katoomba St, Katoomba, NSW 2780, Australia. Phone 011-61-047-82-3418. The prices for the kit and other parts are:

Basic kit (does not include headphones or power supply)—\$79.50

Vintage-style A and B Battery Holder—\$24.00

AC power-supply/audio-amplifier kit (requires 9-12-volt DC plug pack)—\$39.50

High-impedance headphones (STC, 3400, 1940 manufacture)—\$17.50

Spare tube—type HL2K (one per kit order)—\$10.00

Spare plug-in coil formers—(3/8-in. dia.) \$3.30 and (3/4-in. dia.) \$3.70.

Packing and postage to the United States via surface mail (2-4 months) is \$14.00; and via surface air-lifted (2-6 weeks), \$24.00. Payments should be made by way of International Money Order or bank draft in \$U.S.

Further information on Reinartz 2, and other vintage radio parts, may be obtained by sending 2 International Reply Coupons (available at your local post office) to *Technicraft Electronics* at the above address.

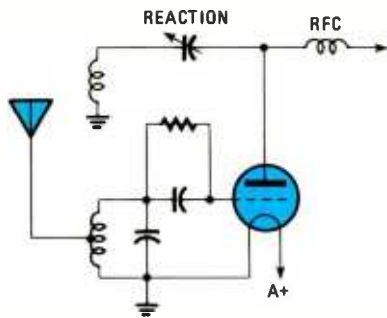

Fig. 1—The original Reinartz regenerative feedback circuit. The lower coil is tapped to match the antenna load. The circuit without the upper coil and reaction capacitor was suitable for receiving AM signals when the antenna was a few miles away from the transmitter in the early days!

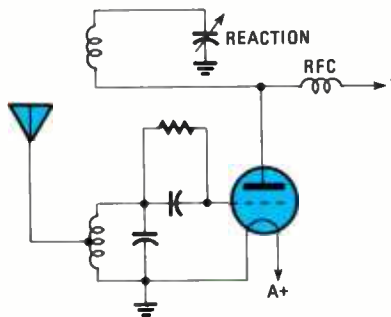

Fig. 2—The modified Reinartz circuit placed the capacitor at ground level. The stator plates of the air capacitor provided electrostatic shielding so that the human body would not load down the regenerative circuit during the tuning process. With 2-volts DC across the filament, the average potential difference between the grid to heater element was -1-volt DC, providing the DC grid biasing for the vacuum tube without need for a "C" battery.

shown in Fig. 2, the main improvement being a reduction in body-capacity effects by grounding the moving plates of the reaction capacitor.

It was in that form that the circuit became widely known and used. Many one- and two-tube Reinartz receivers were described in the pages of electronics magazines over the years (*Radio-Electronics* had its share). The Reinartz 2 receiver embodies many of the features of the earlier receivers, so let's take a closer look at the circuit.

Circuit Details

The full-circuit diagram is shown in Fig. 3. Signals from the antenna are coupled via C1 (trimmer capacitor rated at 3-30 pF) into the tuned circuit L1 and C2a. Those frequencies selected by the tuned circuit are detected by the grid of V1 which, together with C4 and R1, forms a grid-leak detector arrangement. (For a full explanation of that, refer to the Fall 1984 article.) To improve the sensitivity of the detector to weak signals, grid-leak resistor R1 is connected to the positive side of V1 filament.

Regeneration is accomplished by the L2 and C3 parallel combination, which feeds back some of the RF energy amplified by V1 into L1 in such a way as to aid the original signal and bring about a great increase in gain and selectivity. The setting of C3 controls the amount of regeneration, the op-

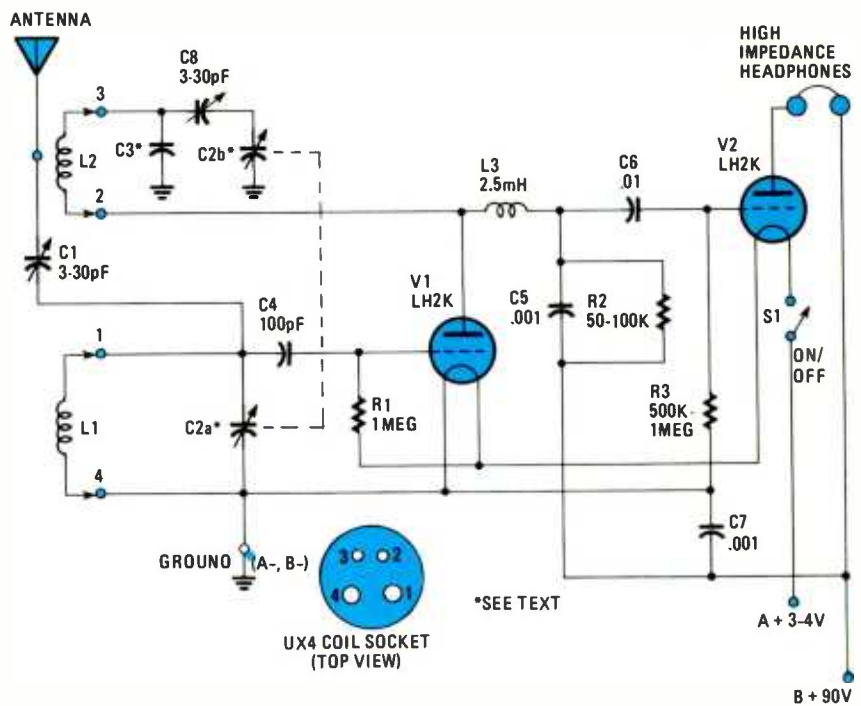

Fig. 3—Here is the schematic diagram of the Reinartz shortwave receiver you can build. The coils L1 and L2 are wound on a spiderweb form and mounted on polarized 4-prong plugs common in the 1920's era.

timum setting being just short of the point of oscillation (as evidenced by a high-pitch howl).

Coil L3 is an RF choke that prevents loading of the regeneration system by the following audio-amplification stage. L3 also operates in conjunction with bypass capacitor C5 to prevent RF currents from passing to the output stage. An RF choke in that position was always a feature of the Reinartz receivers.

Audio signals developed across V1 load resistor R2 are coupled via C6 into the grid of V2, which drives the headphones.

It will be noted that the vacuum-tube filaments are connected in series. That is done to provide an effective negative grid bias voltage for tube V2—obtained by virtue of the fact that both sides of V2's filament are positive with respect to the grid, which is at ground potential through R3.

Capacitor C7 is a RF-bypass capacitor across the B supply and S1 switches power to the receiver by making or breaking the filament supply.

Construction

The first thing to do is to finish the wooden base, should you obtain the kit. It comes routed and drilled, and requires only fine sanding and then two coats of satin polyurethane with a light sanding between coats. You could make your own wooden base by using pine wood, which is easy to work with. While the finish is drying, the tuning and reaction capacitors and the on/off switch can be fitted to the front panel. An 1/8-in. or 3/16-in. plywood panel died black can be used here for the do-it-yourselfer.

Put that aside and then fit all the major mechanical parts to the sub-panel as shown in Fig. 4. The various electronics components can then be soldered in position and the wiring run, using the black rubber-covered wire supplied with the kit. Check out decorative lamp stores for wire of that type.

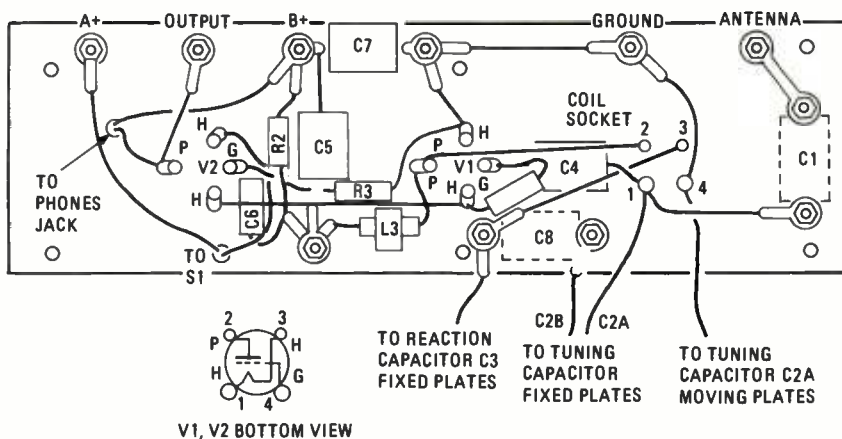

Fig. 4—Should you decide to make your Reinartz receiver from scratch, prepare the rear sub-panel to the approximate layout shown in the above diagram. Also, refer to the photos and try to duplicate the receiver's physical appearance as much as possible.

TABLE 1
TUNING COIL WINDING DETAILS

Coil	Frequency Range (MHz)	L1-Tuning	L2-Reaction	Comments
		Standard Wire Gauge (SWG)		
1	.560-1.5 (Broadcast)	60 turns #26 enamelled	40 turns #32 DCC*	Reaction coil wound first. Use 3 3/4-in. former.
2**	1.5-3.6	24 turns #26 enamelled	14 turns #36 DCC*	Tuning coil wound first. 1/8-in. space between coils. Use 3 1/2-in. former.
3	3.5-8.0	12 turns #20 enamelled	7 turns #26 DCC*	Winding space and former same as Coil 2.
4	7.7-19.0	5 turns #20 enamelled	4 turns #26 DCC*	Most international shortwave transmissions are in these bands.

*Double-cotton-covered. **Optional

When the baseboard is thoroughly dry, screw the four rubber feet into the four corner holes. That done, fit the three right-angle brackets, which hold the front panel in place, and mount the six 3/4-inch tapped brass spacers by means of the screws from underneath the baseboard.

Both panels may now be fitted to the baseboard with the screws supplied and the wiring from the back panel to the components on the front panel completed. Make sure that you don't transpose the connections to the fixed plates of the tuning capacitor (C2). Pin 1 of L1 goes to the 200-pF section while the lead from C8 goes to the 90-pF section.

Full winding instructions for the coils are supplied with the kit. Table I indicates the number of turns and wire gauges for each band.

Three plug-in coil formers (one large and two small) are supplied with the kit, along with a selection of wire of various gauges suitable for winding all the coils listed. The spiderweb forms can be made from black electrical fish paper (any stiff, pressed cardboard or plastic sheet may be used) cut to the proportions shown in the photographs. There are nine slots (odd number) so that the wire will not touch except at the slot crossovers.

The band covered by coil No. 2 listed in Table I is probably the least important, because there are very few worthwhile stations in that band. Winding details for that band are included to make the chart complete.

Spare coil formers and wire are available for those who would like to experiment with that band or other bands, such

as those below 550 kHz or above 20 MHz.

Antennas

For best results, an outdoor long-wire antenna of from 10-35 feet, mounted as high as possible, is desirable. However, quite respectable results can be achieved with a good indoor antenna in many locations (10-15 feet of wire around the room, etc). In most cases any ground will be found advantageous. A guide sheet to suitable antennas and grounds is supplied with each kit.

When you are trying the receiver on any band for the first time, start with the reaction capacitor plates fully out of mesh and vary the setting of the tuning capacitor. You will probably hear *some* stations, even if only weakly.

Tune capacitor C2 so that the station you want comes in as loudly as possible. Then gradually turn the reaction capacitor, C3, so that the plates come into mesh. The volume of the station will increase as you do that, and if you now check the setting of the tuning capacitor, C2, you will find that it has shifted slightly. After a little practice, you will be able to tune the receiver very accurately in a few seconds.

At higher frequencies, the setting of both controls becomes more critical and more skill is required to obtain the best results. You may find it easier to make

tuning a two-handed job. In any case, it is interesting to note that, with correctly adjusted regeneration, the receiver performs as well as much larger receivers do without regeneration.

An amazing number of stations can be received—especially at night—on all bands with a good antenna and ground, and careful tuning.

AC Power Supply/Audio Unit

A few words about the AC power supply, which has been designed for the receiver and also for the Unidyne receiver. The power supply utilizes a 9-volt AC plugpack and by means of a voltage multiplier provides approximately 45 volts (for the Unidyne receiver) and approximately 90 volts (for the Reinartz 2). A rectifier/filter and IC regulator is used to provide a filament supply of 3.6 volts, which is suitable for both receivers. An IC audio amplifier, together with a volume control and speaker, is also included, enabling loudspeaker output from both those vintage receivers.

Most of the components are mounted on a printed-circuit board and the whole circuit is housed in a black molded box with brass terminals for all inputs and outputs.

The unit is a worthwhile addition to both of those vintage receivers and, as well as eliminating battery costs, enables the listening experience to be shared with others.

We hope you will get as much pleasure from building and operating the Reinartz 2 as we have from hunting down the parts and re-creating that little item of radio history. ■

Add a RS232 PORT to your ZX81

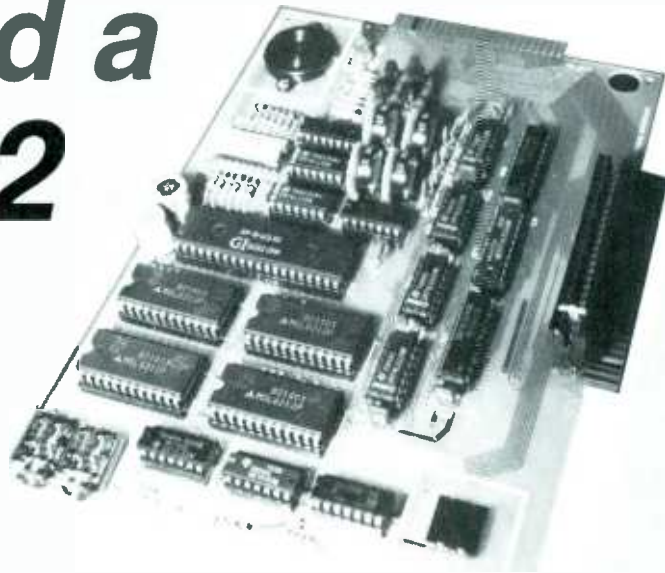

By Edward W. Loxterkamp

□ UNLESS YOU WERE HIDING IN A CLOSET THROUGHOUT THE entire microcomputer revolution, you should be at least somewhat familiar with the Sinclair ZX81 or Timex Sinclair 1000. (Hereafter we'll refer to it only as the ZX81). That was the first packaged computer that sold for less than \$100. Granted, by today's standards, the ZX81 can't do much. But a few years back, and at \$100, who cared?

Even today, the ZX81 is a great computer to learn from. And if you have the patience, you can really do a lot with it—you can even overcome one of its biggest disadvantages: the lack of a standard communications port.

We'll show you how to add a standard communications interface to the ZX81—an RS-232 serial communications port that will let you access standard printers, modems, other computers, and more! We'll give you all the details you need to build the interface and we'll even show you how to control external devices (such as LED's, relays and buzzers, etc.) with software. With the interface's input capability you'll be able to monitor outside functions (such as temperature, humidity, acidity, light intensity, etc.) via transducers.

Before we go any farther, we should mention that this interface can also be used with the ZX80—the forerunner of the ZX81. We'll give you the details later. We'll also show you how to use the interface along with the 8K battery-backed-up RAM board that was presented in our sister publication, *Radio-Electronics*, July and August 1983.

A Look at the Circuit

We'll start our look at the interface circuit at the output of the ZX81. All the signals necessary for the communications interface are taken from the computer's card edge. Its pinout is shown in Fig. 1.

Figure 2 is the schematic diagram for the interface, which is mapped into the last two addresses of the 8K-16K region of the ZX81—addresses 16382 and 16383. As you can see in Fig. 2, lines that are used by the port are buffered by U1-U3 (74LS244's). That eliminates the strain on the drivers in

ZX81 and is especially important if other circuitry (such as a 16K RAM pack) makes use of those lines.

Control signals and data flow are controlled by U10-U13, four 8212 PIO (Parallel Input/Output) devices. They allow for easy interfacing between the ZX81's data bus and the heart of the interface—an AY-3-1015D UART. The \overline{RD} and \overline{WR} lines from the ZX81, along with U8-a and U8-b, are used to control which of those four I/O ports are active.

The first two PIO's, which we'll call DI and DO, are used for data input and data output respectively. The other two, CI and CO, are used for control input and control output respectively. The control ports are used mainly to check and control the status of data being transmitted or received. For example, the CO port controls the UART and the state of two LED's and a buzzer. That allows for both audible and visual indicators which are excellent programmer's aids. We'll show you how to use them shortly.

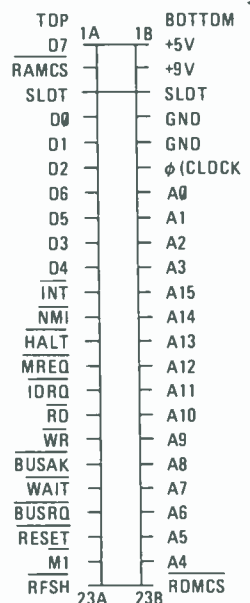

FIG. 1—The port of the ZX81 computer. All the lines of the Z80 microprocessor are available at the card edge. A standard connector can't be used to get at them. While special connectors are available, you can also make your own. Cut the ends off a standard 25/50 connector (with 0.1-inch spacing), add a polarizing key, and you're in business.

TABLE 1—DATA PORT ASSIGNMENTS

DI Port			DO Port		
U10 input pin	UART output pin	ZX81 data line (received data)	U11 output pin	UART input pin	ZX81 data line (transmitted data)
3	12	D0	4	26	D0
5	11	D1	6	27	D1
7	10	D2	8	28	D2
9	9	D3	10	29	D3
16	8	D4	15	30	D4
18	7	D5	17	31	D5
20	6	D6	19	32	D6
22	5	D7	21	33	D7

Perhaps the most important feature of control ports is that there are still three lines on the CO port and two lines on the CI port for your own applications and circuit expansions. Tables 1 and 2 summarize how the ports are configured.

Setting up the UART

The mainstay of the communications circuit is U14, an AY-3-1015D UART or *Universal Asynchronous Receiver/Transmitter*. The baud rate, word length, parity, and the number of stop bits are externally selectable—that helps make the interface compatible with other RS-232 serial communications ports.

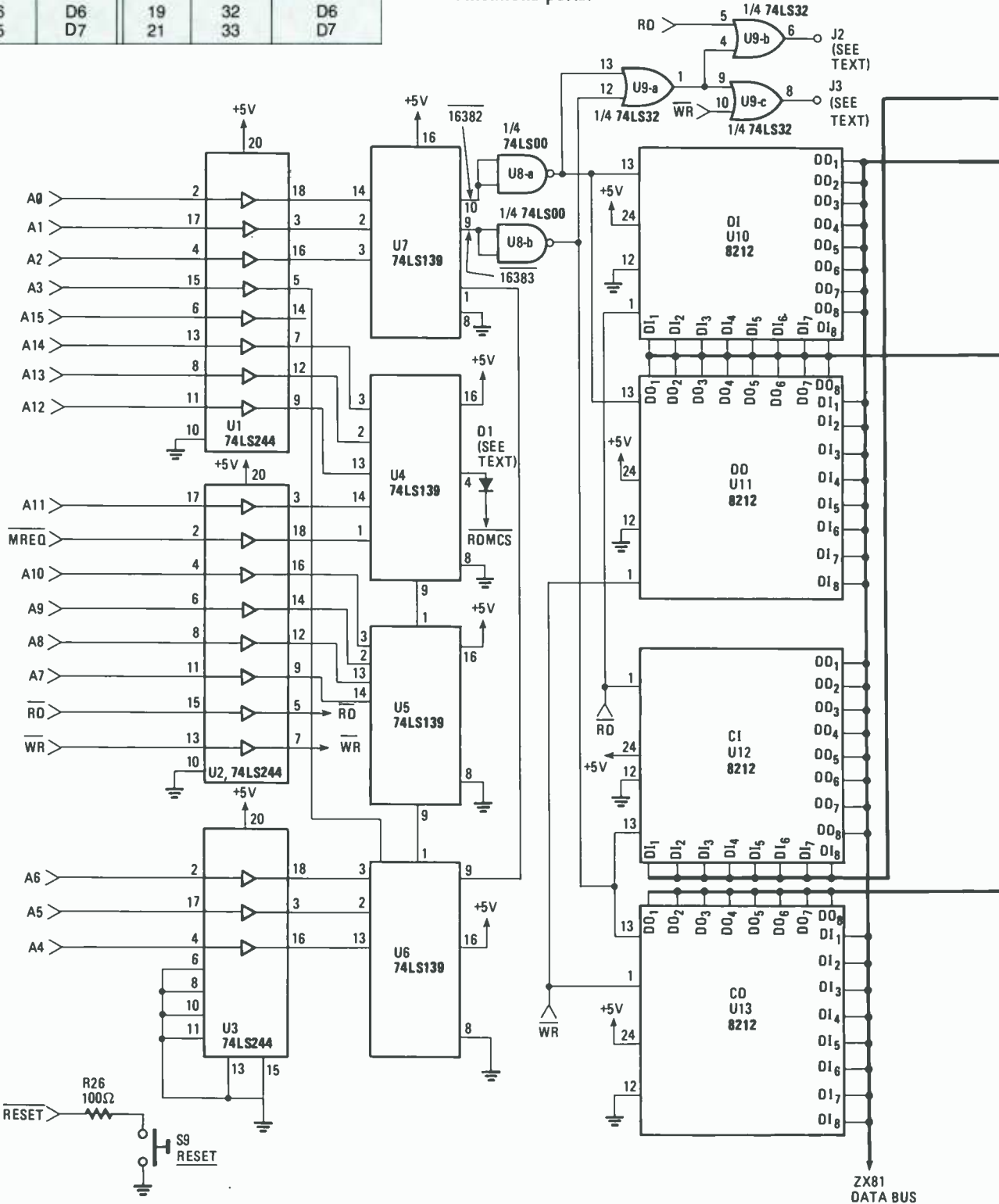
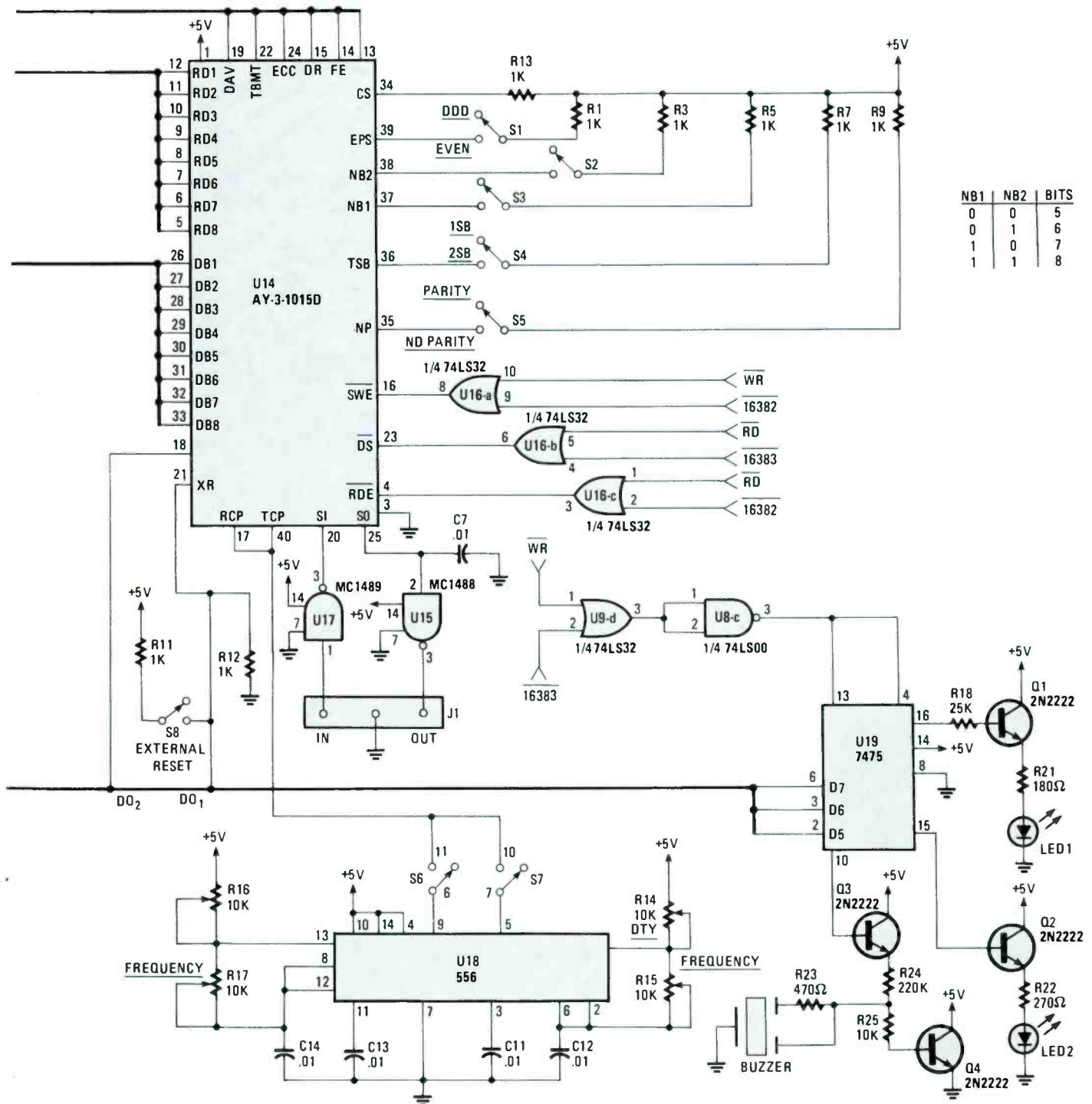

TABLE 2—CONTROL PORT ASSIGNMENTS

CI Port				CO Port			
U12 input pin	UART output pin	ZX81 data line	Data bus contents	U13 output pin	UART input pin	ZX81 data line	Data bus contents
3	—	D0	Open	4	21	D0	External reset
5	—	D1	Open	6	18	D1	Reset data available
7	13	D2	Parity error	8	—	D2	Open
9	14	D3	Framing error	10	—	D3	Open
16	15	D4	Overrun error	15	—	D4	Open
18	24	D5	End of character	17	—	D5	Red LED
20	22	D6	Transmitter buffer empty	19	—	D6	Green LED
22	19	D7	Data available	21	—	D7	Buzzer

FIG. 2—The schematic of the interface. Note the table at the top right: It tells you how to set up switches S2 and S3 for the proper number of bits per word. Bus lines are shown in bold.



Before data can be transmitted or received, the control bits for the UART must be set. That's done using switches S1-S5. Switch S1 determines whether the parity is odd (S1 open) or even (S1 closed). If you want no parity, close S5. Switches S2 and S3 determine the number of data bits per word as shown in the table on the schematic diagram. The number of stop bits is determined by S4: 1 stop bit if it's open, and 2 stop bits if it's closed.

Once the control bits for the UART are set, data can be loaded on the data-bit lines, DB1-DB8. Then the DATA STROBE (\overline{DS}) line must be pulsed. (That's done when a POKE to the DO port—address 16382—is issued.) The TRANSMITTER BUFFER EMPTY (TBMT) signal then changes to a logic zero, indicating that its data-bit holding register is full. It will return to a logic one, as you might guess, when the transmitter buffer is empty. That signals you (or the computer, to be more precise) that the UART may be loaded with another character that is to be sent. The TBMT signal is connected to the CI port (address 16383) to control the sending of the next character. That becomes an important line during high baud-rate transmissions.

The data that was loaded into the data-bit inputs is output at pin 25 of the UART as serial data with the proper bit spacing. That output is converted to RS-232C levels by U15, an MC1488 line driver. An END OF CHARACTER (EOC) signal (pin 24) is issued at the end of each character transmission and is read into the computer through the CI port. That line can be used to see if the last character in a series of characters has been sent.

The UART Receiver

Incoming serial input data is converted to binary levels by

U17 an RS-232C line receiver. It is then fed to pin 20, the SERIAL INPUT (SI) of the UART. For the computer to receive data, it must first check the CI port to see if data is available. The status word on the CI port is enabled by hardware (U16-b) each time the CI port is read. If data is available, a memory PEEK of the DI port is performed and the data is stored in memory.

Pin 4 of the UART, the RECEIVED DATA ENABLE RDE line

PARTS LIST FOR POWER SUPPLY

SEMICONDUCTORS

- BR1, BR2—Bridge rectifier, 1 A
- D2—1N4002 rectifying diode
- LED3, LED4—Light-emitting diode, red
- U20—LM317 three-terminal adjustable regulator
- U21—LM340T 12-volt positive regulator
- U22—7912 12-volt negative regulator

RESISTORS

- B25—270-ohm, 1/2-watt, 10%
- R26—5000-ohm linear-taper potentiometer
- R27—420-ohm, 1/4-watt, 5%
- R28—580-ohm, 1/4-watt, 5%

CAPACITORS

- C15—1000-3300- μ F, 50-WVDC, electrolytic
- C16—10- μ F, 10-WVDC, electrolytic
- C17—1- μ F, tantalum
- C18, C19—2200- μ F, 50-WVDC, electrolytic
- C20, C21—10-100- μ F, 25-WVDC, electrolytic

ADDITIONAL PARTS AND MATERIALS

- F1—1 A
- F2—1/4 A
- T1—Line step-down transformer, 25.2-VAC, 1.2-A
- T2—Line step-down transformer, 34-VAC, center-tapped, 300-mA
- Power switches, accessory outlet, cabinet, mounting hardware, wire, solder, hardware, etc.

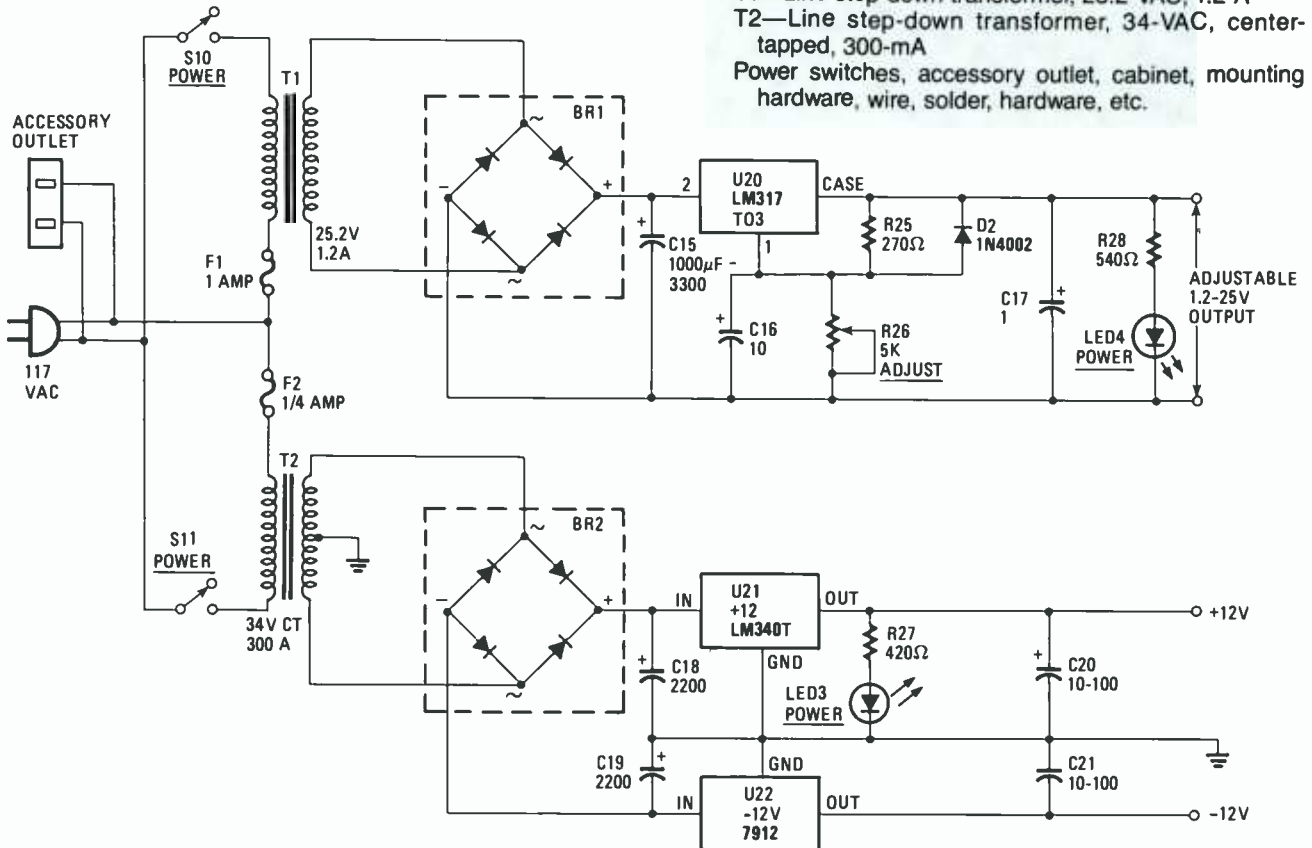

FIG. 3. This power supply was built specifically to be used with the communications port—it gives you the voltages you need for RS-232 compatibility. However, it makes a great bench-top supply, too! Note the accessory outlet—it's ideal for the ZX81 power pack.

(pin 4) is activated by hardware during a READ of location 16382. That enables data flow from the UART to the DI port. Once the data is read, the DATA-AVAILABLE or DAV line (pin 19) must be reset by POKE-ing the CO port with a "0".

If the CI port is read and errors are present, a reset must be issued: POKE 16383,1. To determine which error lines are active, simply convert the data on the CI port into binary and compare it to Table 2. Some conditions for error signals on the CI port are:

- Parity Error—received parity does not agree with the selected parity.

- Framing Error—Invalid stop bit.
- Overrun Error—Previous data not read before next character received.

Transmit/receive clock

The UART requires a transmit/receive or TX/RX clock rate that is 16 times that of the desired baud rate. (That's required for internal timing overhead of the UART.) The interface is designed for two baud rates—300 and 600 baud. You'll find that most computer networks that are accessible by the public use 300 baud.

FIG. 4—The component side of the interface printed circuit board.

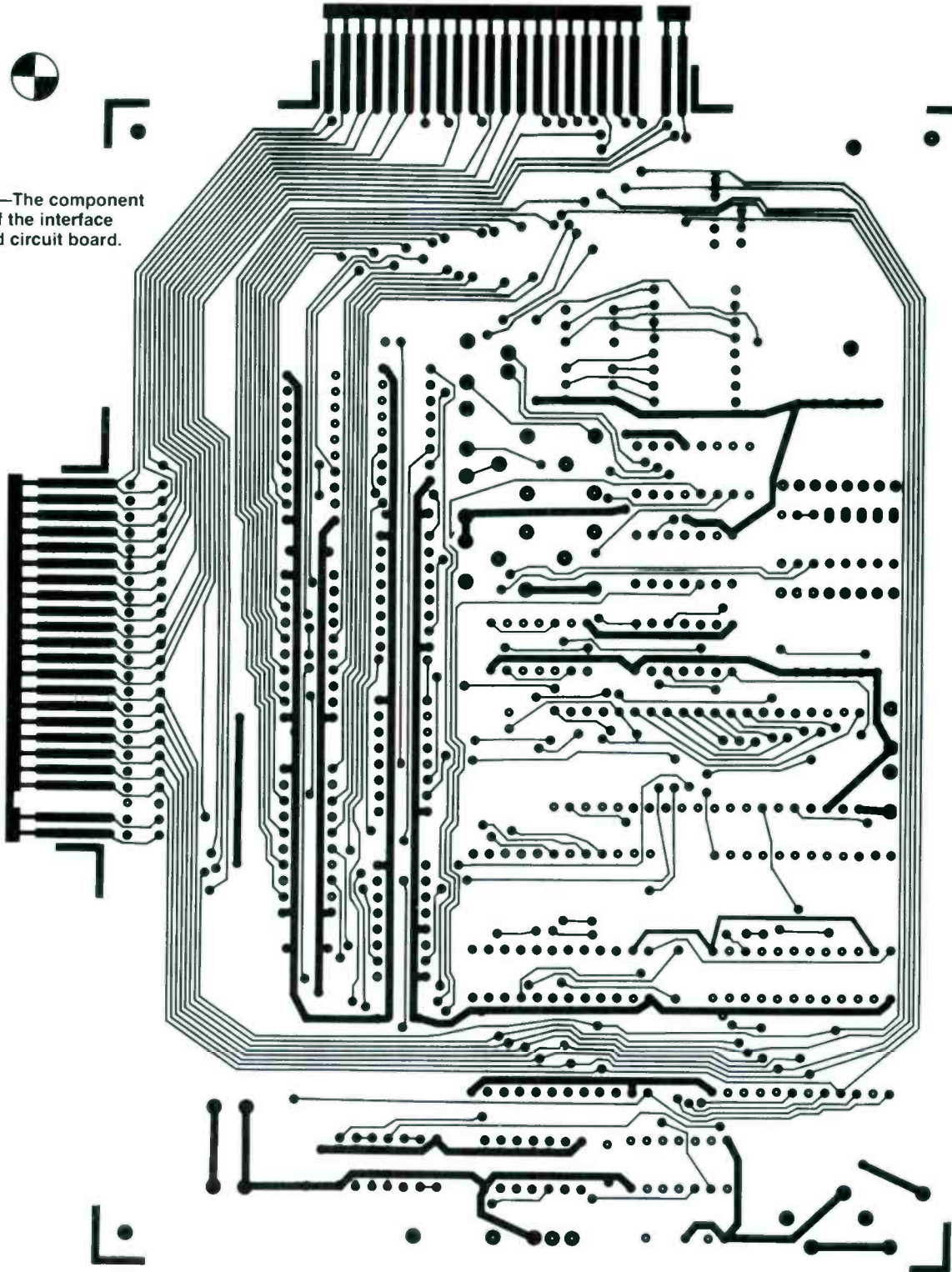

The two rates are easily produced by a 556 dual timer (U18). When selecting the interface baud rate, be sure not to select both rates simultaneously. Either S6 or S7 should be closed but not both. To make it impossible to close both switches at the same time, you may want to use a single, single-throw, double-throw switch instead of separate switches. (But DIP switches are not available in that configuration.)

If variable resistors are used for the timing resistors, any baud rate can be generated within the range of the timing capacitor. Keep in mind though, that the output frequency must be 16 times the desired baud rate. If the clock is not on the the proper baud

rate frequency, totally false transfers will occur—the data you receive will not be the data sent and vice versa. Therefore, while it's best to use variable resistors for timing resistors so that the proper rate can be adjusted until it is correct, it's also a good idea to use a dab of nail polish to hold the potentiometer in the proper position.

RS-232C

Since transmission lines are susceptible to noise, it is not unlikely for data on the lines to be altered by inherent noise on the lines. Parity-detection schemes are used to check for dif-

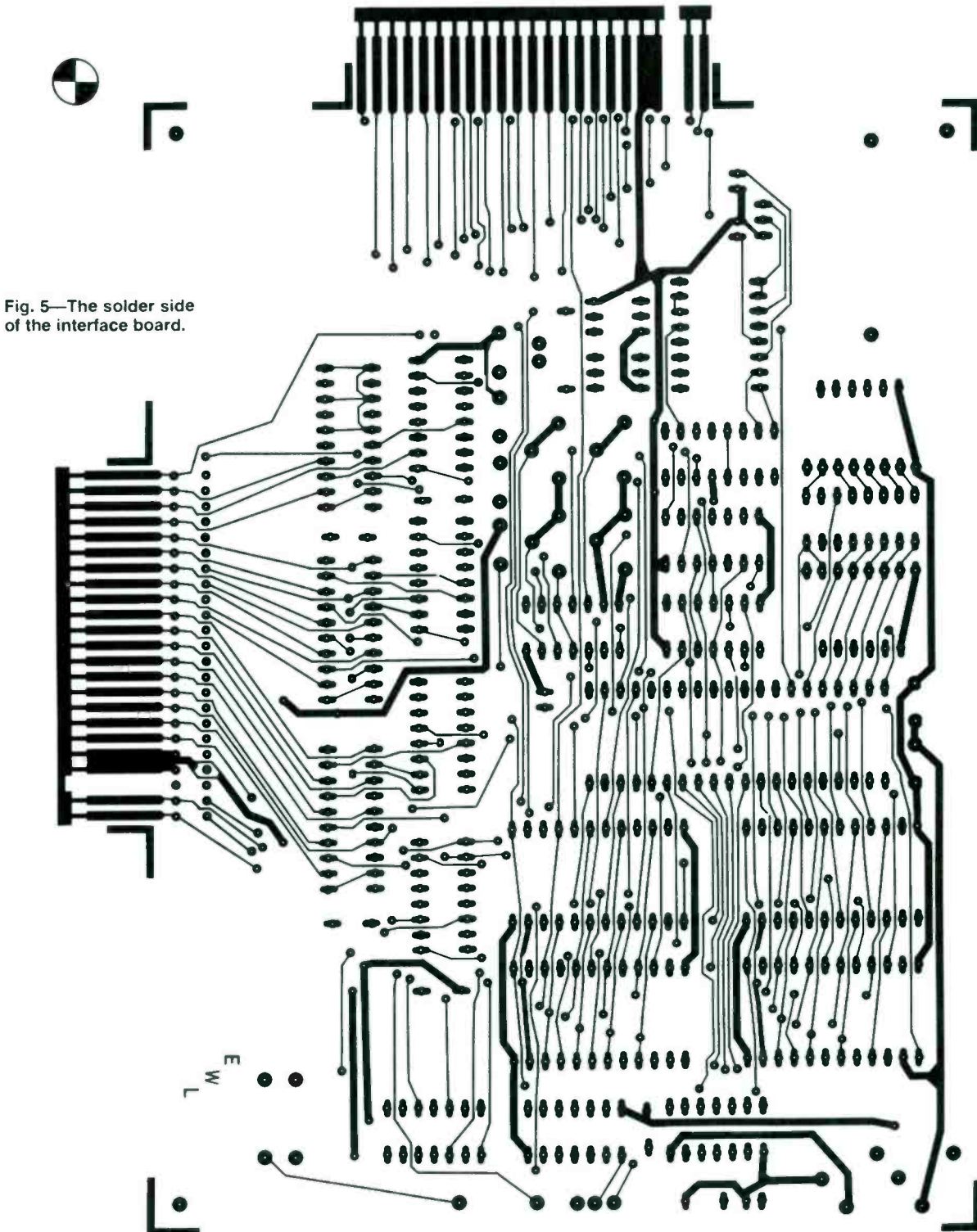

Fig. 5—The solder side of the interface board.

ferences between transmitted and received data. They do not, however, help to overcome the problem. That is the purpose of RS-232C.

In an idle state, the serial-output line of the UART will be a logic "1" which goes to U15, an MC1488 RS-232 line driver. The driver converts +3 to +5 volts into a -12 volts, and a -3 to -5 volts into a +12 volts for transmission over the transmission line. At the receiver end, an RS-232 line receiver, U17, converts -12 volts to a logic "1" and +12 volts to a logic "0". Jack J1 can be a commonly used 5 pin DIN connector for connecting GND, SO, and SI to other devices.

As stated earlier, various LED's, buzzers and relays can be controlled through the CO port. In the schematic (Fig. 2) , you can see that U19, a D-type flip-flop, is controlled by D5-D7 of the CO port. That flip-flop then controls transistor drivers Q1-Q3 which turn a buzzer and various LED's on and off. Those devices come in handy as indicators for transmitting or receiving data or as check-point indicators in programs.

Power supply

Because we're using the RS-232C convention, we need some type of differential 12-volt supply for the line driver. We could

PARTS LIST FOR RS-232 INTERFACE

SEMICONDUCTORS

- D1—N914 diode
- LED1—Light-emitting diode, red
- LED2—Light-emitting diode, green
- Q1-Q4—2N2222 NPN transistor
- U1-U3—74LS244 octal buffer integrated circuit
- U4-U7—74LS139 dual 2 to 4 demultiplexers integrated circuit
- U8—74LS00 NAND gate integrated circuit
- U9, U16—74LS32 OR gate integrated circuit
- U10-U13—M5L8212 PIO integrated circuit
- U14—AY-3-1015D UART integrated circuit
- U15—MC1488 RS-232C driver integrated circuit
- U17—MC1489 RS-232C receiver integrated circuit
- U18—555 dual timer integrated circuit
- U19—74LS75 D flip-flop (latch) integrated circuit

RESISTORS

- (All fixed resistors are 1/4-watt, 5% units)
- R1-R13—1000-ohm
- R14-R17—10,000-ohm, 1/4-watt, PC-mount potentiometer
- R18-R20—25,000-ohm

- R21, R22—270-ohm
- R23—470-ohm
- R24—220,000-ohm

CAPACITORS

- C1, C2—.01 μ F (not essential)
- C3, C4, C8-C10—.047- μ F
- C7, C11-C14—.01- μ F, ceramic disc
- C5, C6—47 μ F, 35-WVDC, electrolytic

ADDITIONAL PARTS AND MATERIALS

- J1—5-pin DIN jack (female)
- J2—3-conductor, 1/8-inch jack
- J3—3-conductor, 1/8-inch jack (only 2 conductors used—+5V and GND)
- S1-S8—SPST, 8-switch DIP package
- S9—RESET momentary switch, normally open
- Buzzer (Radio Shack 273-64 or equivalent 3-wire buzzer), printed-circuit board, solder, etc.

A printed-circuit board is available Edward W. Loxterkamp, 249 W Dayton-Yellow Springs #248, Fairborn, OH 45324 for \$25.95. Add \$1.95 for shipping and handling.

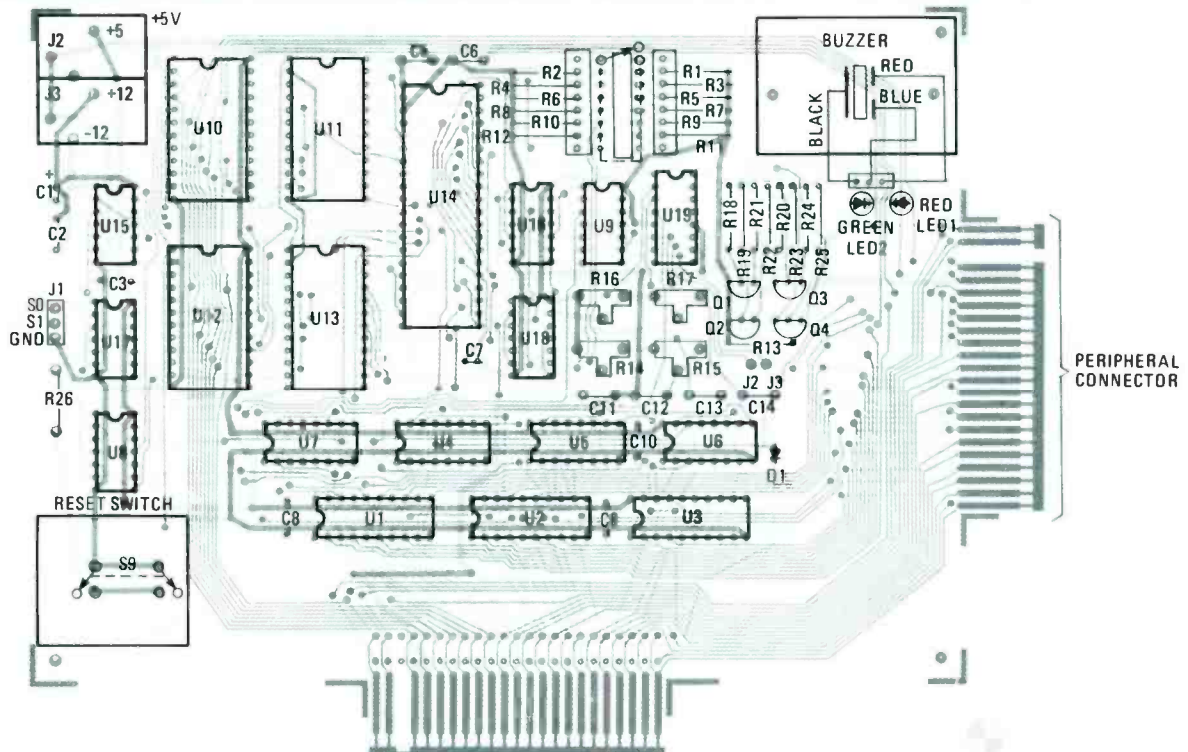
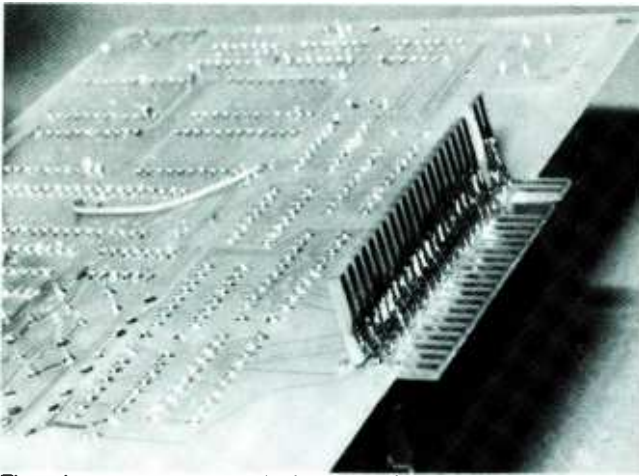

Fig. 6—While the parts-placement diagram shows discrete resistors, you may prefer to use resistor pack—you can even mount them in DIP sockets. Unless you want to mount the interface in a cabinet, use a DIP-switch for S1-S8, and a board-mounted switch for S9.



The edge connectors are designed to give you a number of options for connecting your computer and peripherals. For example, if you want to mount the interface separately, you can connect it to the ZX81 with a 50-conductor ribbon cable.

accomplish that with a DC-to-DC converter, but that wouldn't be cost effective. It is more convenient to build an additional power supply, such as the one shown in Fig. 3. That power supply has outputs of +12, -12, and +5 volts. Those outputs go to two jacks, J2 and J3, on the interface board. Even if you don't want to build the RS-232 interface, the power supply would be a welcome addition to any work bench. The variable regulator makes it extremely versatile.

Simple Control Software

Table 3 lists a simple program that will transmit or receive data. The software is set up to send and receive, at any one time, binary data. The software makes use of the LED's and buzzer during communications. This gives audible and visual indications of communication status.

Building the Circuit

The circuit can be easily built on a printed-circuit board. Foil patterns for that double-sided board are shown in Figs. 4 and 5. A parts-placement diagram follows in Fig. 6. The board is laid out so that it's easy to make external connections (such as power and ground). The pull-up and pull-down resistors associated with the 8-switch DIP housing (S1-S8) can be discrete, but resistor packs might be more convenient.

The most useful part of the board design is the edge connectors. If you'd like to house the interface separately, the edge-card connectors make it easy. The connector on the 7½-inch side can be connected to the computer with a double female ribbon cable while the other edge connector allows for other peripherals to be connected. If you prefer the usual wire-wrap type connection, the male card-edge pins can be cut off and a wire-wrap edge connector used. On the 5½-inch side of the board is another male edge card connector. That has all the ZX81 signals in the "normal" configuration, allowing for easy connection of additional hardware.

We mentioned previously the extra control lines that are available. The applications are limitless. By adding a temperature transducer to an input line, a constant home or room temperature can be maintained economically. An output control line can be used to control an air conditioning or heating unit.

Those control lines can also be used for sensors in a home security system. A software routine could be written to monitor the entire house and even call the police—assuming you have the appropriate dialing equipment. Controlling various appliances is only a simple task with SCR output optocouplers.

So you can see this circuit has many varied uses that range from printer interfacing to appliance control and from communicating with other computers to controlling a home security system. *(Continued on page 100)*

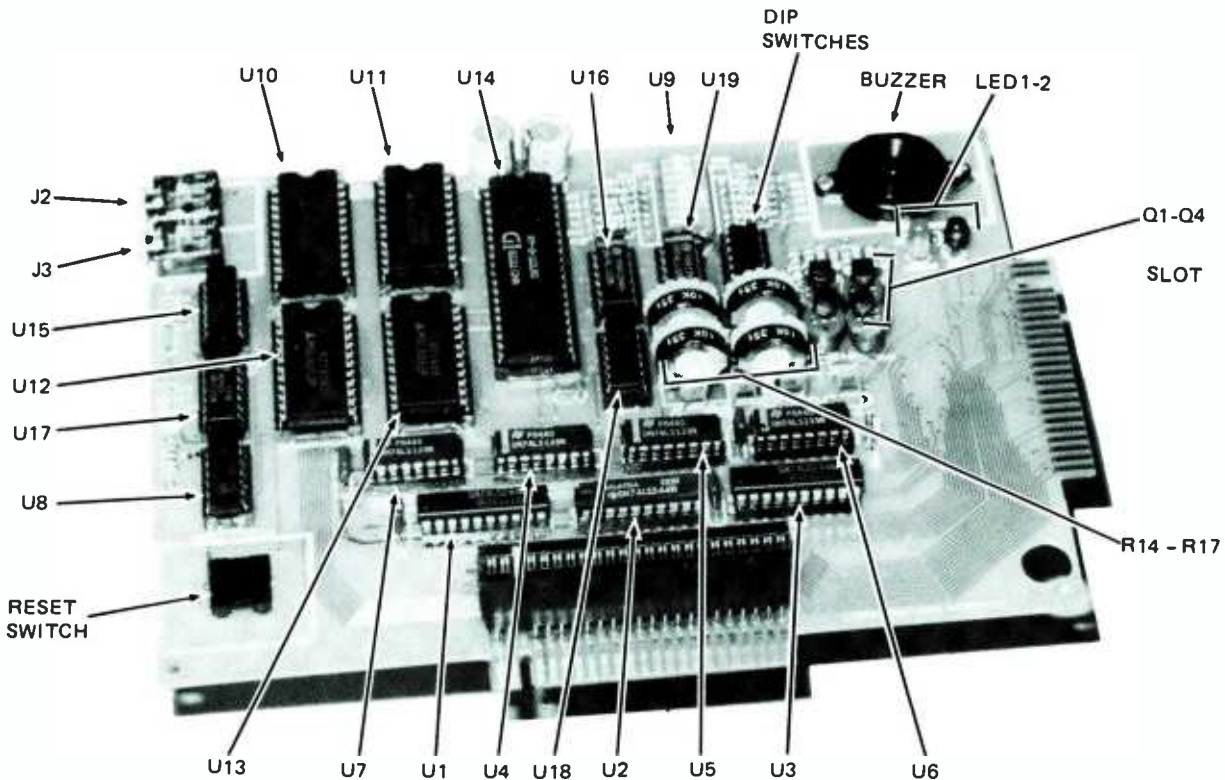

Here are the major part locations on the top of the printed-circuit board.

DIGITAL FUNDAMENTALS

Discover the operation of five basic digital-logic elements and how to use their truth tables. Understand simple Boolean algebra expressions that define the logic circuit. Also, learn about the element's rise and fall times and propagation delay.

LESSON 2: Digital-Logic Circuits

By L. E. Frenzel

□ ALL DIGITAL-ELECTRONICS EQUIPMENT IS MADE UP OF just a few basic building blocks known as digital-logic circuits. Those basic circuits are combined in a variety of ways to process the binary data used in **communications, computation, or control applications.**

Those digital-logic circuits typically accept two or more binary inputs and generate a single output. The output state is determined by the binary states of the input and the special processing characteristics of the digital-logic circuit. Figure 1 shows a typical digital logic circuit. Typically the electronic circuit itself is not shown, because it is basically irrelevant. Only the logical functioning of the circuit is of interest. Most digital-logic circuits are called **gates.**

The basic function of a digital-logic circuit is to make a **decision.** The logic circuit looks at the states of the input signals, then makes a decision and generates an output. Those digital-logic circuits are then combined in a variety of ways to form larger, more sophisticated circuits called **combinational-logic circuits.** It is the decision-making characteristics that gives logic circuits their functional capability.

There are five basic digital-logic circuits. They are the **AND gate,** the **OR gate,** the **inverter,** the **NAND gate,** and the **NOR gate.** The AND, OR, and inverter circuits are really the core elements while the NAND gate and NOR gate are special

Fig. 1—Generic, hypothetical digital logic circuit is usually referred to as a gate.

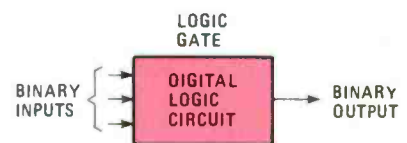

combinations of the basic three, as you will see later. All digital equipment is made up of those simple elements.

The Inverter

The simplest digital-logic circuit is the inverter. It has a single input and a single output. Its primary function is to invert a logic signal. It converts a binary 0 (low) into a binary 1 (high) and a binary 1 into a binary 0.

The logic symbol used to designate an inverter is shown in Fig. 2. The triangle typically represents the electronic circuitry while the circle, which can be shown at the output or input, represents the inversion process.

The output of an inverter is simply the opposite of its input. In digital terminology, we say that an inverter generates an output which is the complement of the input.

The operation of an inverter, or any other logic circuit for that matter, is usually expressed in one of three ways: a **truth**

table, a Boolean algebra expression, or waveform timing diagram. Let's look at all three for the inverter.

A truth table is nothing more than a chart that shows all the possible combinations of inputs and outputs of a logic circuit. A truth table (Table 1) for an inverter is shown below.

**TABLE 1
INVERTER TRUTH TABLE**

A (Input)	B (Output)
0	1
1	0

The input and output binary signals in Truth Table 1 are identified by letters of the alphabet as seen in Figs. 2 and 3.

In the truth table for the inverter (Table 1), the lefthand column represents all possible input combinations. With a single input line, only two states are possible. Naturally, only two output states are possible. Note that the output is the complement of the input.

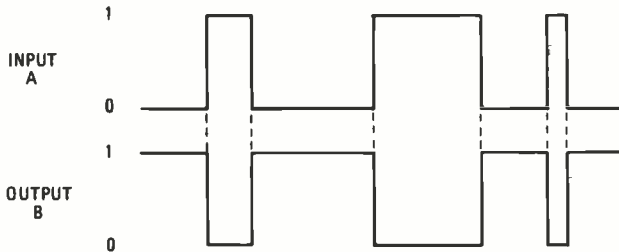

Fig. 2—Logic symbols for an inverter.

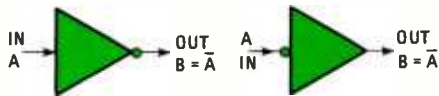

Fig. 3—Input and output waveforms of an inverter.

Another method of expressing the operation of a logic circuit is to use Boolean algebra. Boolean algebra was invented by mathematician George Boole and is a simple mathematical way to show what's going on in digital-logic circuits.

A Boolean expression is nothing more than a simple formula that expresses the output in terms of the input. The output and the input are given letter or letter/number designations. They are shown in Figs. 2 and 3. The Boolean expression for an inverter is:

$$B = \bar{A}$$

The way to read the above equation is: output B is equal to NOT A. The bar over the input designation A is called a **NOT bar** or **NOT symbol**. It is used to denote inversion. What that simple algebraic expression tells you is that if the input is A, then the output B is NOT A. In other words, if the input is 0 (low), then the output is NOT 0, it is 1 (high). An inverter is also referred to as a NOT circuit.

If the input to an inverter is X, the output Y will be X or NOT X NOT.

$$Y = \bar{\bar{X}} = X$$

The two NOT symbols cancel one another.

Instead of the NOT bar which is an unusual symbol and difficult to type or print, an asterisk or prime symbol is often used to show inversion as indicated below:

$$B = A^* \text{ or } B = A'$$

Timing Diagrams

Another way of showing the operation of a logic circuit is to use timing diagrams. Those diagrams show the actual input and output waveforms that occur. Those waveforms are what you would expect to see if you were monitoring the input and output signals on a multi-trace oscilloscope. Figure 3 shows the typical input and output waveforms of an inverter.

The waveforms typically shown in timing diagrams are usually shown in their ideal form. That means that the waveforms are perfectly square, with vertical sides and flat tops. In the real world, digital signals are not that perfect. Figure 4 shows what real logic signals would look like on an oscilloscope when the sweep period is very brief. The waveforms are those that you would see at the input and output of a typical inverter circuit.

First note that the sides of the waveform in Fig. 5 are not perfectly vertical. The waveform rises or falls linearly. That means that the transition between the binary 0 and 1 state (or binary 1 and 0 state) is not instantaneous. While digital-logic circuits switch rapidly, it does take a finite period of time for the logic state to change. The times involved in changing states are referred to as the **rise time** and **fall time**. The rise time is the amount of time it takes the logic signal to rise from 10% to 90% of its full amplitude value. The fall time is the time it takes for the logic signal to drop from 90% to 10% of its full amplitude value. Rise and fall times can be measured on an oscilloscope screen if the scope has a calibrated time base.

Another important real-world logic-circuit factor is **propagation delay**. That means that the output occurrence of a logic signal is somewhat delayed from its input. For example, in an inverter, when the input rises from 0 to 1, the output of the inverter does not simultaneously drop from 1 to 0. There is a time shift between the input and output. That time shift is known as propagation delay. It is measured between the 50% amplitude points on the corresponding input and output waveforms as detailed in Fig. 4. Propagation delay results from imperfections in the logic circuit itself.

All digital-logic circuits have propagation delay. Granted they are very short, less than 10 nanoseconds in most circuits. For many applications, that is such a small time period that the response is essentially considered to be *instantaneous*.

The AND Gate

The term **gate** is used to describe a digital-logic circuit with two or more inputs and a single output. The expression *gate* is metaphorical and tends to describe how a typical digital-circuit functions. For example, when the gate is open, a logic signal passes. If the gate is closed, a logic signal does not pass. In reality, the operation is more complex, but incredibly easy to understand.

The two basic kinds of logic gates are **AND** and **OR**. When those are combined with an inverter, they form the other two types of gates, **NAND** and **NOR**. We will consider the **AND** gate first.

The basic logic symbol used to represent the **AND** gate is shown in Fig. 5. Two, three, and four input **AND** gates with

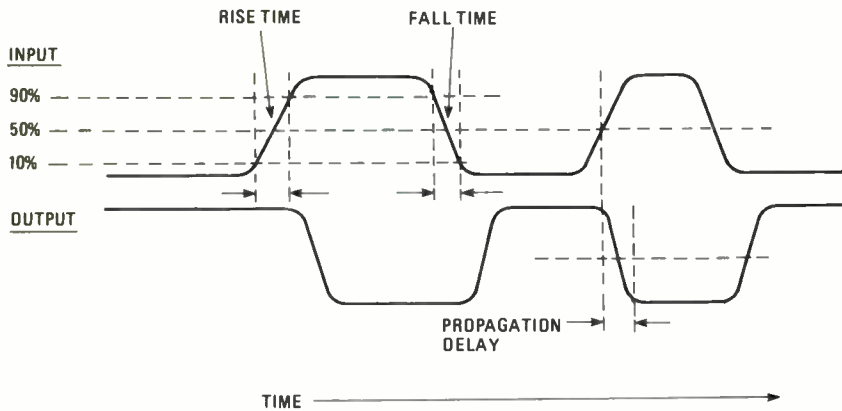

Fig. 4—Inverter input and output waveforms illustrating rise and fall times and propagation delay.

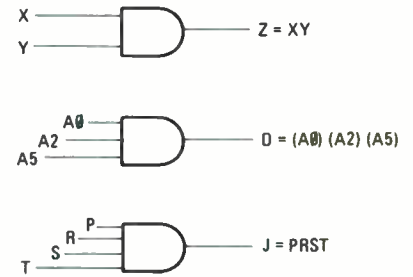

Fig. 5—Logic symbols for the AND gate.

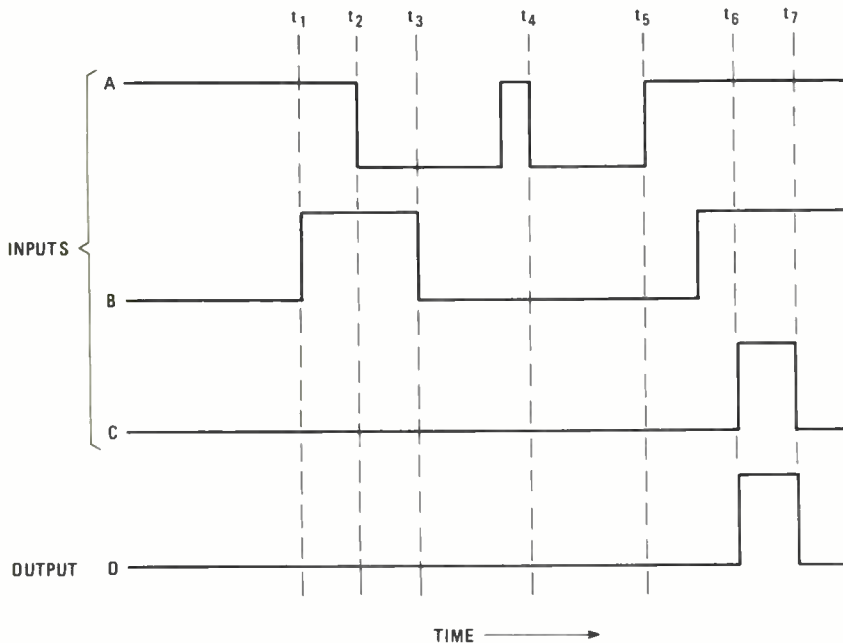

Fig. 6—Input and output waveforms for a 3-input AND gate.

TABLE 2
AND TRUTH TABLE
FOR TWO INPUTS

Inputs		Output Z
X	Y	
0	0	0
0	1	0
1	0	0
1	1	1

TABLE 3
AND TRUTH TABLE
FOR THREE INPUTS

Inputs			Output Z
W	X	Y	
0	0	0	0
0	0	1	0
0	1	0	0
0	1	1	0
1	0	0	0
1	0	1	0
1	1	0	0
1	1	1	1

their inputs and outputs labeled are shown.

In operation, an AND gate generates a binary 1 output if all of its inputs are binary 1's. If any one or more of its inputs is binary 0, the output is a binary 0. A truth table (Table 2) clearly shows the operation of an AND gate. Take a look at the truth table (Table 2) for a two input AND gate below shown in Fig 5.

Here there are two inputs, X and Y. With two inputs, there will be 2 to the second power (2^2) or 4 possible input conditions. There is an output Z that occurs for each different set of inputs. In that case, a binary 1 output appears only when both inputs are binary 1's.

Now take a look at the truth table for a three input AND gate (Table 3).

With three inputs, there can be a total of 2 to the third power (2^3) or 8 possible different input states. Again, the output is binary 1 only when all three inputs are binary 1.

The Boolean expression for an AND gate with inputs X and Y and output Z is simply:

$$Z = X \cdot Y = XY$$

To read the above algebraic expression, you say that Z equals X AND Y. The dot between the two inputs designates the AND function. But in most cases, the dot is omitted and the input terms are simply written adjacent to one another as they would be if the terms were to be multiplied as in a standard algebraic expression. Sometimes, parenthesis are used to separate the inputs when multiple letters or letter/number designations are used. For example:

$$F = (J2)(L7)$$

Figure 6 shows typical timing diagrams for a three-input AND gate. Carefully observe the states of each input and how they correspond to the output. As you can see, a binary 1 output pulse occurs only where the three inputs are simultaneously binary 1's. That characteristic has led to the AND gate being described as a coincidence circuit, since the output occurs only during the coincidence of the binary 1 states. At times t_1 through t_5 the three inputs are never at a high at the same time. However, beginning at time t_6 and ending at time t_7 the three inputs are high during the interval so that output D goes high.

One of the most common applications for an AND gate is gating input. Figure 7 illustrates the concept. Here a clock signal from an oscillator clock (CK) is applied to one input. A control signal (CTL) is applied to the other. The purpose of the control signal is to literally open or close the gate. When the CTL signal is binary 0, the gate is closed. Any time an input to an AND gate is binary 0, the output is correspondingly a binary 0.

When the CTL signal is binary 1, the gate is enabled and the clock signal applied to the other input passes through to the output. As long as the CTL signal is binary 1, the clock signal will pass through.

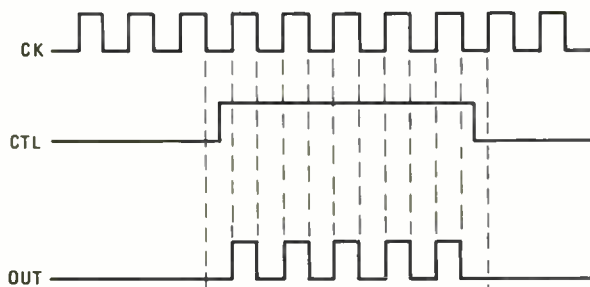
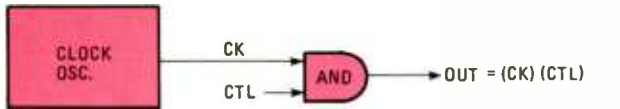

Fig. 7—"Gating" with an AND gate.

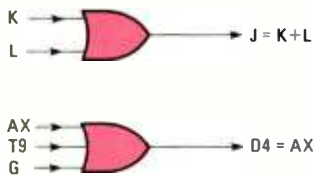

Fig. 8—Logic symbols and Boolean algebraic expressions for an OR gate.

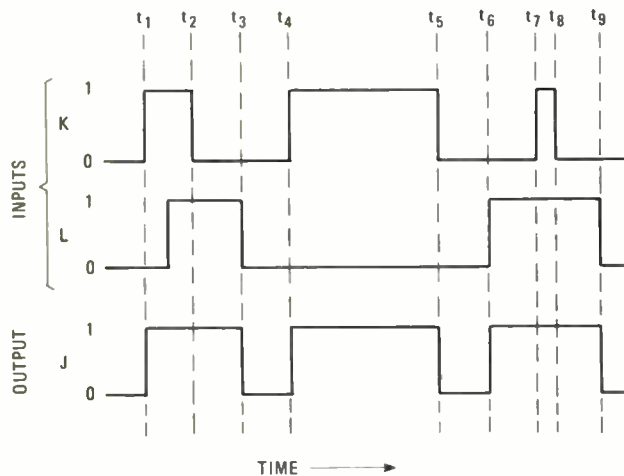

Fig. 9—Input and output waveforms for an OR gate.

The OR Gate

The other basic logic circuit is the OR gate. It can have two or more inputs and a single output. The symbol used to represent the OR gate is shown in Fig. 8.

As for its function, an OR gate generates a binary 1 output if any one or more inputs is binary 1. The output of the OR is

zero only when all of its inputs are zero. The truth table (Table 4) shows the basic operation of a two-input OR gate.

TABLE 4
OR TRUTH TABLE
FOR TWO INPUTS

Inputs		Output
K	L	J
0	0	0
0	1	1
1	0	1
1	1	1

Note that those three input combinations where binary 1's occur on either or both inputs generate a binary 1 output.

The Boolean expression for the OR function is shown below:

$$J = K + L$$

To read that equation we say that J equals K OR L. The plus sign indicates the OR function. The Boolean expression for the three-input OR gate in Fig. 8 is:

$$D4 = AX + T9 + G$$

Figure 9 shows the operation of an OR gate using two-input waveforms. The rise and fall times and propagation delays are not shown to simplify the illustration. Follow each input waveform and note the output condition for the binary 1 input condition. For example; input K goes high causing output J to go high at time t_1 . At time t_2 input K goes low, but input L is high; thus output J remains high until time t_3 when both inputs are low.

An OR gate is a useful logic function as it allows two or more individual signals to control a single output. A simple application is shown in Fig. 10. Here a cooling fan motor is controlled by the output of the OR gate. The fan motor may be turned off or on by two separate inputs to the OR gate. The first input is a temperature sensor. When the temperature rises (+V level) to the OR gate, the fan motor is turned on. The other input to the OR gate is a manually operated switch to be turned off and on to control the motor. When either input is a binary 1, the fan will turn on. The resistors at the inputs to the OR gate keep the input states at binary 0 until a switch closes, applying a binary 1. Since the logic OR chip is rated for small signals only, a driver is inserted into the circuit to provide the power switching required to control the motor.

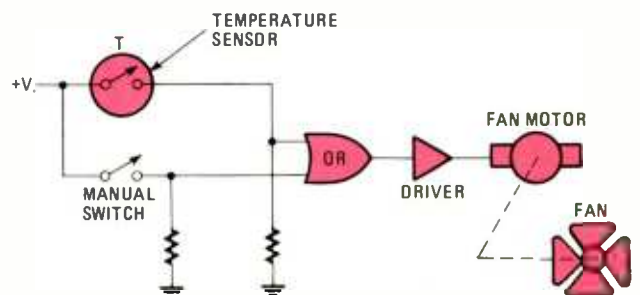
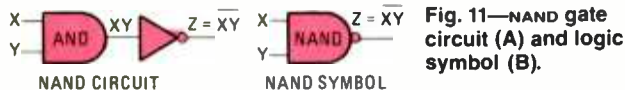

Fig. 10—Using an OR gate to select active input to control the operation of a fan motor.

NAND and NOR Gates

The use of an inverter immediately at the output of AND and OR gates combined within a package makes possible NAND and NOR gates. For example, Fig. 11 shows a NAND gate. It is made up with an AND circuit followed by an inverter. That circuit is usually represented by a single symbol which is the AND symbol with a circle at its output to indicate inversion.

The operation of a NAND gate is simple to deduce. It is the output result of an AND gate inverted. That is illustrated in the NAND truth table (Table 5).



For a two-input NAND gate, the output is binary 1 except where both inputs are binary 1 at which time the output is binary 0.

The Boolean expression for a NAND gate is also simple to understand. It is simply the AND expression with a NOT bar over all inputs as shown below:

$$D = \overline{EFG}$$

The operation of a NAND gate is illustrated by the waveforms in Fig. 12. Note that the only time the output is a binary 0 is when both inputs are simultaneously binary 1. The output pulses occur during time periods t_2 - t_3 , t_6 - t_7 , and t_{10} - t_{11} . Check the inputs diagrammed during those periods and you'll discover that they are high. At all other times, one or both inputs are low.

A NOR circuit is shown in Fig. 13. It is an OR gate followed by an inverter. The special symbol used to represent that circuit is the OR symbol with a circle at its output to indicate signal inversion.

The truth table (Table 6) shows the operation of the NOR gate. The output of the NOR gate is simply the inverted or

TABLE 5
OR/NOR TRUTH TABLE
FOR TWO INPUTS

Inputs		Outputs	
A	B	OR	NOR
0	0	0	1
0	1	1	0
1	0	1	0
1	1	1	0

TABLE 6
NAND TRUTH TABLE

Inputs		Outputs	
X	Y	AND	NAND
0	0	0	1
0	1	0	1
1	0	0	1
1	1	1	0

The waveforms in Fig. 14 illustrate the operation of the NOR gate. Here the output is a binary 0 when any one or more of the inputs are binary 1. Note that the NOR output occurs only during periods t_3 - t_4 and t_7 - t_8 . Verify that statement by using the NOR truth table (Table 6). In fact, now would be a good time to quickly review all the truth tables (Tables 1 through 6) to be sure you fully understand the operation of the AND, OR, NAND, and NOR circuits.

NAND and NOR Applications

All five basic logic circuits are available in integrated circuit form. Several 2-gate OR inverters are packaged together into a common dual in-line integrated-circuit package. A typical digital logic IC is the popular 4001 quad 2-input CMOS NOR shown in Fig. 15.

While any of the basic logic functions can be obtained in IC form, the most widely used are the NAND and NOR gates.

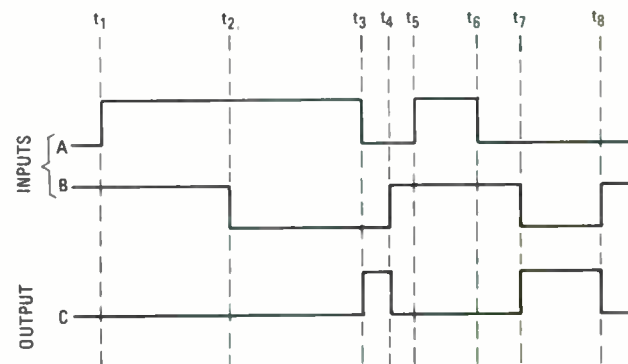

Fig. 14—Input and output waveforms for a 2-input nor.

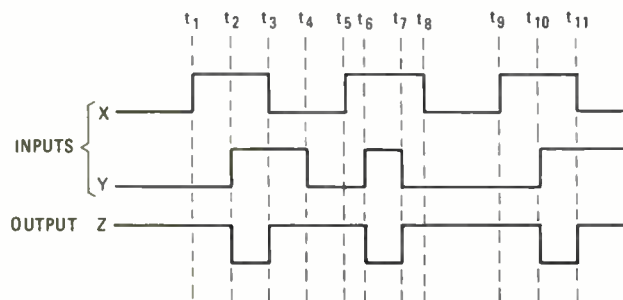

Fig. 12—Input and output waveforms for a 2-input NAND.

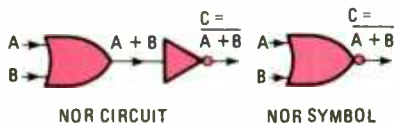

Fig. 13—NOR logic circuit and logic symbol.

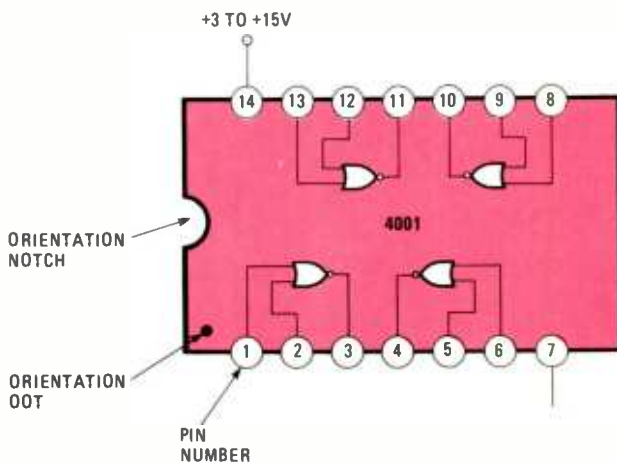

Fig. 15—Pictorial diagram for the 4001 CMOS quad 2-input NOR integrated circuit.

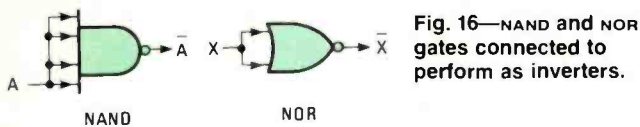

Fig. 16—NAND and NOR gates connected to perform as inverters.

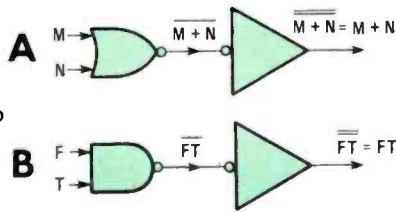

Fig. 17—NOR and NAND gates connected to perform as inverters.

They can be interconnected to perform basic AND, OR and inverting functions. For example: A NAND or a NOR gate can be used as an inverter as shown in Fig. 16. To do that, all of the inputs are connected together to form a single input. The resulting circuit operates just like any inverter.

A NOR gate can be used for the OR function by simply connecting an inverter at the output of it. The inverter complements the output back to the standard OR output. See Fig. 17A. The same is true of a NAND gate. The AND function can be illustrated in Fig. 17B.

Several other variations of making AND and OR gates from NANDS and NORs are shown in Fig. 18A. Here a NAND gate can be used as an OR circuit by connecting inverters ahead of the inputs. When used in that way, the NAND circuit is usually

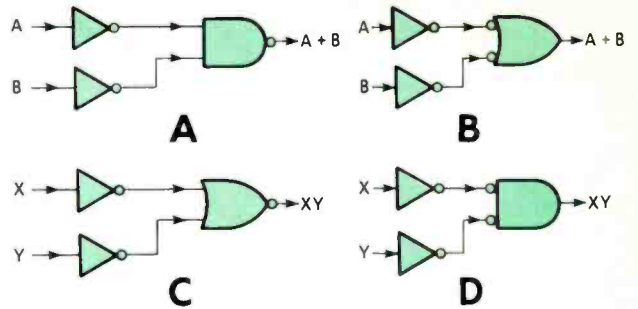

Fig. 18—Using NAND's and NOR's for AND and OR operations.

represented by the special symbol shown in Fig. 18B. That is an OR symbol with circles at the inputs to designate that special function.

You can also use a NOR gate as an AND. Again all you have to do is connect inverters to the two inputs as shown in Fig. 18C. When a NOR gate is used in that way, the special symbol shown in Fig. 18D is used. The symbol on a logic diagram should designate the actual logic function performed. That is an aid in understanding the operation of the circuit and in troubleshooting it.

The short quiz that follows will help you review the main facts presented in the above article. Answering those questions will help you apply what you have learned to reinforce your knowledge. ■

SHORT QUIZ ON DIGITAL LOGIC CIRCUITS

1. The output of the circuit shown below is:



- a. binary 0 b. binary 1

2. The output of an inverter is said to be the _____ of the input.

3. The circuit generating the output waveforms shown below is a(n):

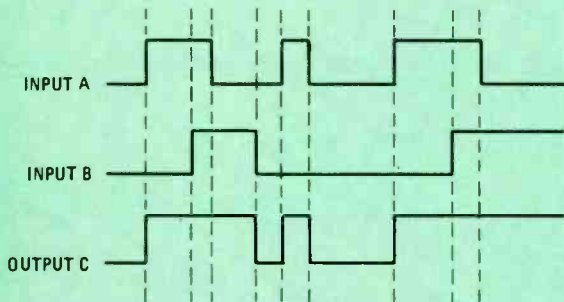

- a. inverter b. AND c. OR
d. NAND e. NOR

4. A coincidence circuit is a(n):

- a. AND b. NOR c. inverter

5. The Boolean expression for a NOR gate is:

- a. $C = A + B + C$
b. $C = ABC$
c. $C = \overline{1ABC}$ d. $C = A = B = C$

6. Which of the following is the truth table for a NOR gate?

a. 0 0 0	b. 0 0 1	c. 0 0 0	d. 0 0 1
0 1 1	0 1 1	0 1 0	0 1 0
1 0 1	1 0 1	1 0 0	1 0 0
1 1 1	1 1 0	1 1 1	1 1 0

7. Which circuits below perform the AND function?

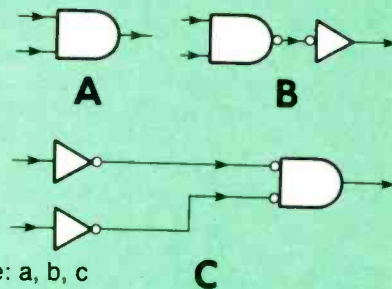

Circle one: a, b, c

8. The time shift between the output and input of a logic circuit is referred to as _____

9. A 4-input NAND gate will have how many possible input and output state?

- a. 4 b. 8 c. 16 d. 32

ANSWERS TO QUIZ

1. b. binary 1
2. complement
3. c. OR
4. a. AND
5. a. $C = A + B + C$
6. d. NOR
7. a, b, and c
8. propagation delay
9. c. $16 = 2^4 = 2 \times 2 \times 2 \times 2$
 $2 = 16$

BCB Antennas for Small Lots

By Ed Noll



IDENTIFICATION OF WEAK SIGNALS IS A MAJOR THRUST OF broadcast-band DX'ing. Not too long ago, increasing signal level with a longer antenna and/or increasing receiver sensitivity only provided limited benefits because strong locals would then spill over from adjacent channels and/or desensitize receivers. Today's better broadcast-band receivers with radio-frequency amplifiers and improved selectivity curves, as well as ability to handle a wide range of signal levels, make the long antennas more attractive.

A long antenna has two advantages. It is obvious that it picks up more signal. However, an often neglected benefit of a long antenna has to do with the better matching of the receiver input to provide maximum signal-current transfer. A random antenna wire that is one-quarter wavelength long provides a good match to the receiver input. The far end of a single-wire antenna has a high impedance. Exactly a quarter-wavelength away, where the wire connects to the receiver input, there is a low impedance and an attractive match that transfers signal current well.

The problem with such a long antenna is the actual length of the antenna wire necessary to obtain a quarter-wavelength. Table 1 shows the quarter-wavelength dimension in feet for broadcast-band frequencies from 540 to 1600 kHz. At the low end of the band a quarter-wavelength is greater than 400 feet, while at the upper-frequency end it is about 146 feet. How does one accommodate such a long antenna on a small lot?

If you can stretch out a quarter-wavelength antenna in a straight line, you will obtain maximum signal pickup. However, by bending and folding the antenna wire you can still obtain an improved pickup as compared to a short antenna, and also gain the added advantage of better signal-current transfer to your receiver input. If you are pinched, with only a 40-foot mounting site, you can certainly do better than using only a 40-foot antenna. Just make some appropriate folds and turns.

TABLE 1—QUARTER-WAVE DIMENSIONS ON BROADCAST BAND

kHz	Feet	kHz	Feet
540	433	1100	213
660	390	1200	195
700	334	1300	180
800	292	1400	167
900	255	1500	156
1000	234	1600	146

Some ideas for doing that are shown in Fig. 1. In example A, a little added length can be obtained, based on extending the antenna from ground level up 15 feet, across 40 feet, and down 15 feet. That very simple antenna does well and is easy to erect, using a non-metallic mast, such as PVC piping.

Example B of Fig. 1 offers further improvement. Note that the antenna wire is folded back upon itself in ladder-like fashion. Thus the name that is appropriate is "ladder antenna." Such an antenna can also be constructed very simply by

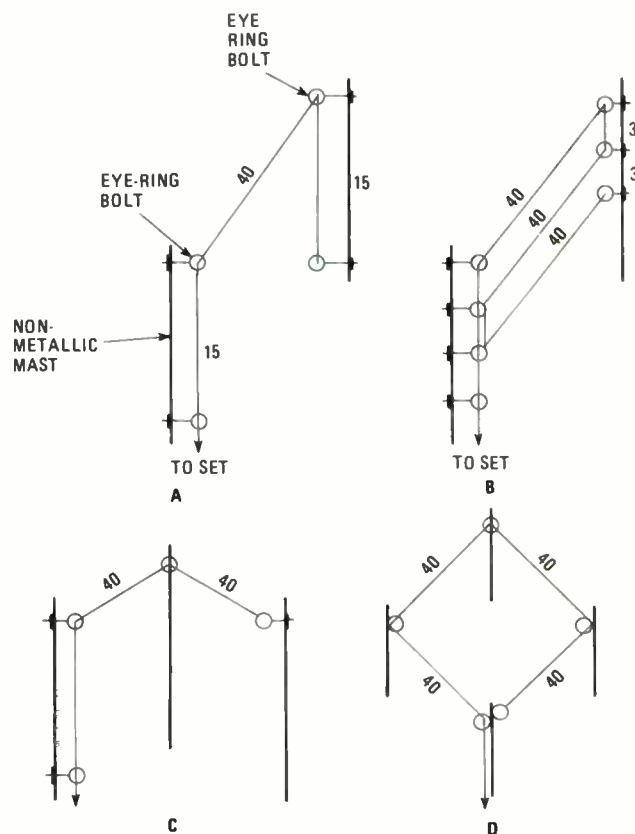

Fig. 1—four basic types of folded long-wire antennas. A—a simple folded long-wire antenna that takes advantage of its height to use the lead-in and a vertical leg at its end to obtain an addition 30 feet of antenna length. B—a ladder-type array folds the antenna wire back on itself to effectively increase its overall length. C—The antenna makes a "dog-leg" turn following the perimeter of the property line to gain added length. D—The long-wire antenna follows the perimeter of a 40- × 40-foot lot. If the construction allowed for two-ladder rungs, the overall length would be 320 feet.

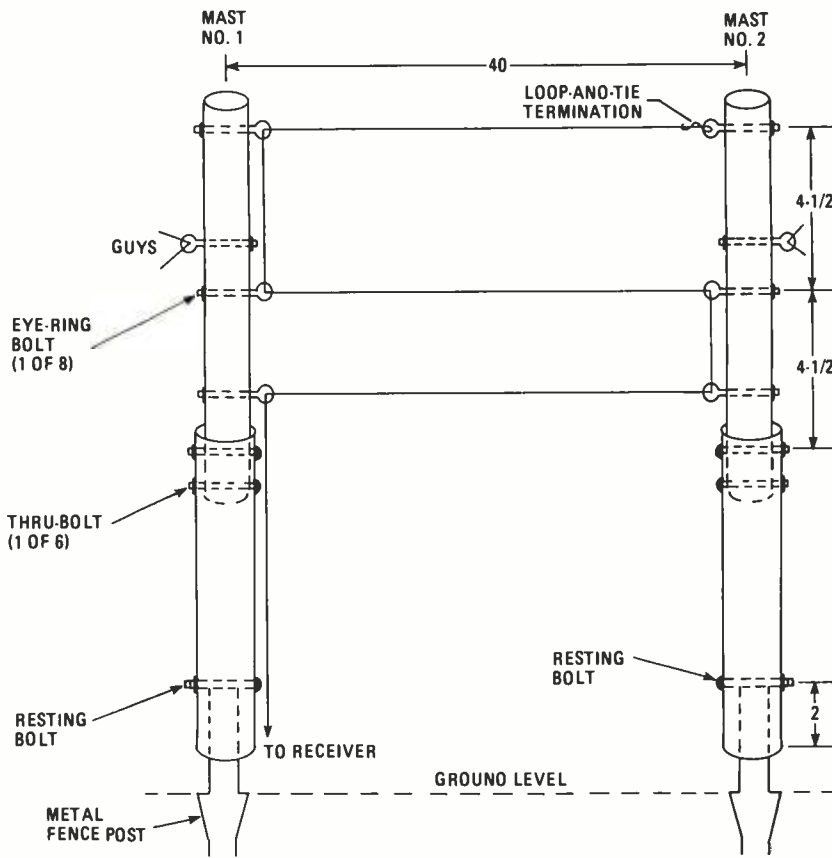

Fig. 2—This illustration details the construction of the PVC masts and the running of antenna wire to make a three-rung ladder-type antenna. Estimating a mast height of 15 feet, the total length of this antenna is 135 feet.

using PVC piping. Note that the overall length brings you very near to a quarter-wavelength on 1600 kHz. In fact, adding on to that figure the length of a single-wire feed line into the radio room, you will find you have a quarter-wavelength somewhere at the high-frequency end of the broadcast band, though you have only a 40-foot mounting length.

Example C of Fig. 1 shows what you can do when 40 foot *this way* and 40 feet *that way* is available. Your antenna wire is now longer than 80 feet (assuming a height of 15 feet). If you make a one ladder fold you will be over 160 feet. Add the lengths of the wire that run vertically on the masts, and the lead-in length to the radio room—you are well up into the lower frequency portion of the high-frequency segment of the broadcast band. Using a three-ladder configuration, you are up into the middle section of the band.

If you have a 40- by 40-foot square layout, you are already resonant down at the high-frequency end of the band. Refer to example D in Fig. 1. A two-ladder arrangement takes you into the low-frequency end of the band.

The arrangements of Fig. 1 show you that a long antenna is really not impossible on a small lot. Plan your antenna with respect to the space available. If you have more than 40 feet, that's fine; if less, work with that smaller real estate.

Build-it Details

The construction plan for a three-ladder antenna with a 40-foot separation between masts is shown in Fig. 2. Two ten-foot sections of PVC piping are telescoped together (the 1.5-in. OD pipe fits snugly inside the 2-in. OD pipe). When antenna wire is to be fed up and down the mast, or between masts, use eye-ring bolts. Secure the mast sections with through bolts and nuts. Use insulated wire for the antenna. Plastic-covered #16 AWG stranded wire is ideal. The mast is supported by a metal fence post driven into the ground.

The PVC piping is so light that it requires but one person to lift it up and set it over the fence post. A resting bolt through the mast holds the mast assembly above ground level to obtain a little additional height. As a result, it is possible to attain a mast that is 20 feet above ground level at its top and at the same time telescope two ten-foot sections together.

The path of the antenna wire (Fig. 2) is up mast I to the first eyebolt and then across to the first eyebolt of the second mast. From there it is run up the mast to the second eyebolt and then

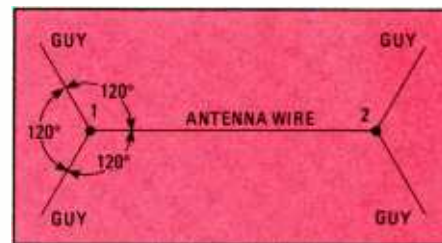

Fig. 3—Guys are required to keep the masts erect. They will bow inward due to the pull of the taut antenna wire and its weight. Use nylon rope set at the approximate angles shown.

across to the second eyebolt of the first mast. The final path is up the first mast through the top eyebolt and then across to a *loop-and-tie* termination the very top of the second mast. The overall length will be equal to a quarter-wavelength somewhere in the high-frequency end of the broadcast band.

Each mast is held straight up with a combination of the antenna wire and two rope guys as shown in Fig. 3. The two mast sections are perfectly self-supporting. However, the guys prevent the bend-over of the top sections that would occur were the antenna wire pulled tight without the presence of the pair of guys. The connection of the antenna wire at the base of the lower mast section (chest high) is shown in Fig. 4. An appropriate soldering ring is fastened to the end of the antenna wire. If you desire, you can then connect a single-

TABLE 2—GAIN OF 3-RUNG LADDER ANTENNA VS. LONG WIRE ANTENNA

Call	kHz	dB	Call	kHz	dB
CJSB	540	+1.5	WGY	1030	+2.5
WFIL	560	+1.0	KYW	1060	+2.0
WIP	610	+2.0	WBRW	1170	+4.0
WSM	560	+2.0	WWVA	1170	-1.0
WNBC	660	+1.5	WCAU	1210	+1.0
WLW	700	-1.5	WNEW	1430	+5.0
WOR	710	-1.5	WNPV	1440	+3.0
WABC	770	+1.0	WCHE	1520	+4.0
WWL	870	0.0	WKBW	1520	+2.0
WCBS	880	+4.0	WSNI	1540	+3.0
WLS	890	+0.5	WQXR	1560	+6.5
KDKA	1020	0.0	WBUX	1570	+8.0

wire feed line to that point and on into the radio shack.

When the noise-reduction characteristics of coaxial, lead-in line is desired, the inner conductor is connected to the antenna wire terminal, Fig.5. The braid of the coaxial line connects to second terminal. That connection is made to secure the heavy coaxial cable so the center solid-copper lead will not snap. No other wire is connected to the braid terminal. Better noise rejection is obtained if a good ground is connected to the receiver in the radio room. Remember to connect the coaxial braid to the ground of the the receiver.

Table 2 is a signal strength comparison between a 40-foot wire antenna wire and the three-rung ladder arrangement of Fig. 2. First the 40-foot antenna wire was used and compared to an attic-mounted reference antenna located in the crawl-space at the top of the house. Those figures were jotted down for an array of stations from the low to high-frequency ends of the broadcast band. The three-rung antenna was then erected at exactly the same site and between the same two 20-foot masts. The three-rung antenna was then compared with the reference and the resultant figures jotted down. To obtain a rather good comparison between the two antennas, it was only necessary to subtract the first set of comparison readings from the second set. Those are the figures given in the dB

column of Table 2. Note the very substantial gains obtained at the high-frequency end of the broadcast band—simply because the overall antenna wire length was approaching a quarter-wave resonance at the high-frequency end of the broadcast band.

There is some gain over the mid and low-frequency segments of the band as well. The station-to-station figures are not consistent, because angle of signal's arrival, as well as length of transmission line, also have an influence on the absolute value of the signal current delivered to the receiver input. Nevertheless, it does show quite realistically the improvement of gain that can be obtained by using a longer antenna wire mounted in the same space. Of course, if you can separate the two antenna masts a greater distance, the overall length of the antenna wire will increase and you can anticipate higher gain figures on the lower frequencies. Also the use of four or five rungs can also improve performance of the ladder antenna.

When you are receiving strong signals, the additional gain is not of much significance. However, if you are working with weak signals and stations difficult to identify, any boost in signal as delivered to the input of the receiver can be a definite advantage. ■

Fig. 4—One good idea is to terminate the antenna wire at a through-bolt terminal. A single lead-in wire will connect there. A good connection can be made with an alligator clip that is disconnected when not in use—a form of lightning protection.

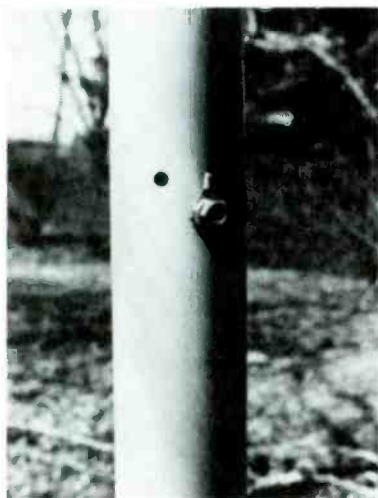

Fig. 5—Coax lead-in cable should have its shield connected to a dummy terminal that provides good mechanical support for the cable and keeps the weight off the solid inner conductor.

SHUTTER-SPEED TESTER

By Hugh Gordon



□ THE SHUTTER-SPEED TESTER IS ESSENTIAL FOR CHECKING camera shutters for time-interval accuracy. To obtain good quality, properly exposed photographs, particularly in color, the camera's shutter-open time should correspond accurately with the exposure setting indicator/control on the camera. If a shutter is not accurate, or more important, inconsistent, then poor exposures will result. The Shutter-Speed Tester can also detect faults that have developed. Those detected faults indicate the need for repair or an exposure-correction adjustment by a professional camera repairman.

Your oscilloscope can be used, with the addition of a few parts and an evening's work, as a Shutter-Speed Tester. The tester, when used with your oscilloscope, provides an accurate checking of shutter speeds, shutter consistency, opening and closing operation, and motion-picture camera and projector-framing speeds.

The screen of the oscilloscope displays the waveform of the shutter-operating interval, graphically indicating the opening and closing characteristics and the average shutter speed.

Fig. 1—The basic waveform seen on the oscilloscope when the time of one sweep-frequency cycle is a bit longer than the shutter's exposure time. The time from A to B is the interval required to open the shutter fully; B to C is the time the shutter is fully open; and C to D is the interval required to close the shutter. Points E and F at mid-point in the vertical presentation on the scope face indicates the effective shutter exposure time (or speed).

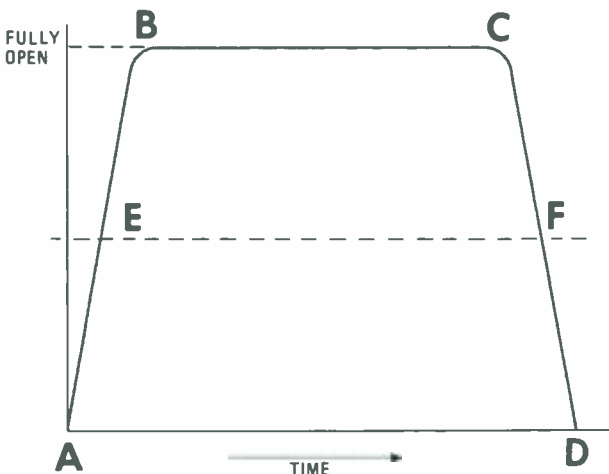

Interpreting the Display

Shutter speed is the measurement of the time light passes through the lens to the film while the shutter is open. The measurement includes both the opening and closing time periods, as well as the period the shutter remains fully open. Fig. 1 is a graph of shutter operation. The discussion to follow refers to shutter blades, as in a leaf shutter, but is similarly applicable to the focal-plane type.

The shutter blades begin opening at point A and are fully open at point B. That is the opening period. The blades remain open from B to C. Beginning with point C, the shutter blades begin to close and are completely closed at point D. That is the closing period.

The length of the dotted line passing through the center of the graph from points E to F illustrates the *average* time the shutter is open. That time should coincide with the shutter-speed indication on the camera dial. The horizontal time base of the oscilloscope is measured in time travelling from left to right. Thus, for a camera shutter-speed setting of "60," the time interval from E to F in Fig. 1 should be $1/60$ of a second, or 17 milliseconds (mSec).

Fig. 2—By adjusting the oscilloscope's sweep frequency, points E and F observed in Fig. 1 can be made to coincide so that the time of the sweep frequency is exactly equal to the effective shutter open time.

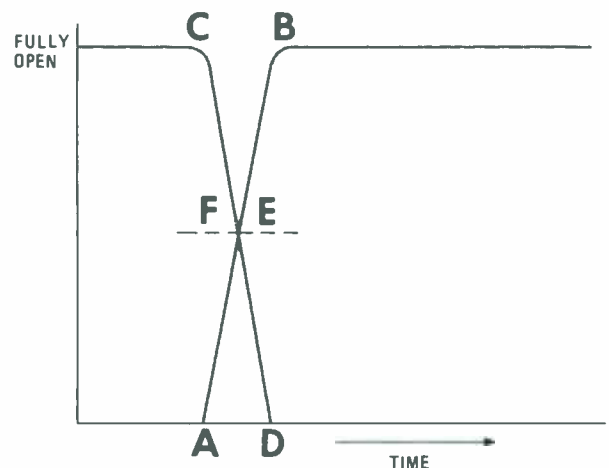

Your camera's shutter is a mechanical device that can get out-of-time as your car's engine does. Checking its accuracy will indicate whether repair is necessary or not.

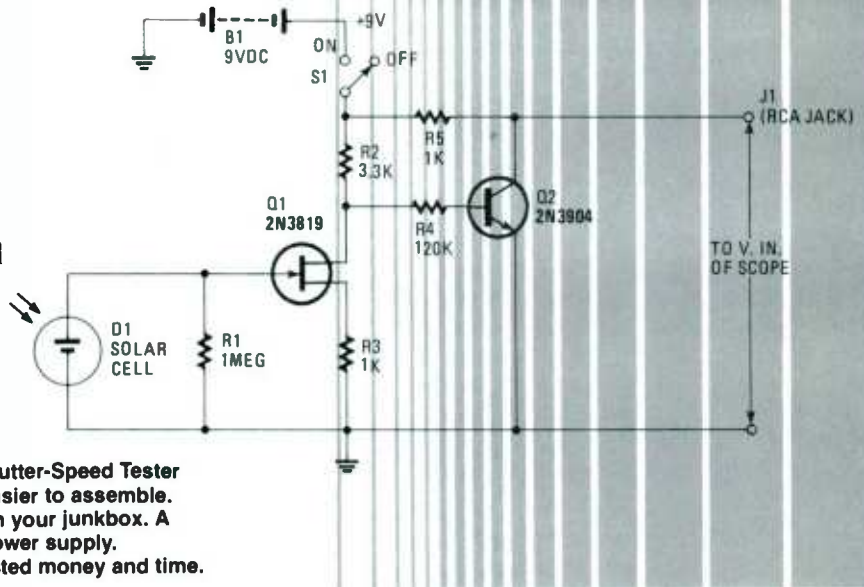
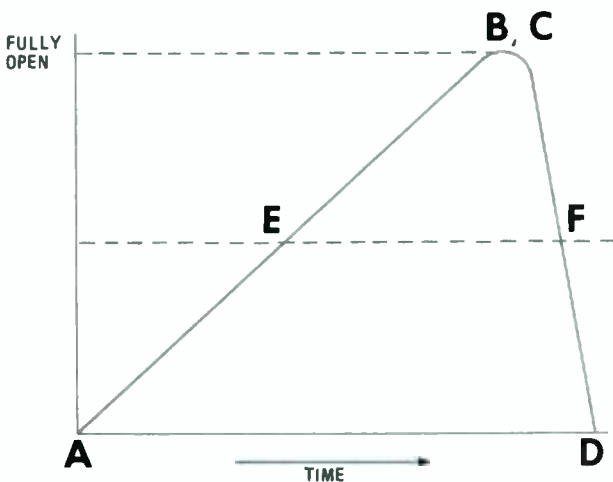

Fig. 4—The schematic diagram for the Shutter-Speed Tester is very simple to understand, and even easier to assemble. Most of the parts should be available from your junkbox. A fresh battery is all that is required for a power supply. Any thing more elaborate than that is wasted money and time.

When viewing that waveform on the oscilloscope, you want to interpret the average speed. With a standard oscilloscope, the sweep is recurring and cannot be triggered to begin at point A, as would be desired and which is accomplished on expensive testers. However, the average opening time can be determined by observing a trace as seen in Fig. 2, which shows the ideal waveform with the point of crossing halfway on the maximum amplitude. That point coincides with the dotted line across Fig. 1 such that reference points E and F coincide. You're actually looking at two parts of the total wave that is split partway along the time base. If the scope is adjusted to obtain that, then the average speed is read directly from a simply-made chart attached to the scope.

Some electronic shutters open and close at vastly different rates. In Fig. 3, the graph of one type is shown. Here, the shutter blades begin to open at point A, but are not fully open until point B. Then, at the time they are fully open, they immediately begin to close. The closing time is from B to C and is much shorter than the opening time, A to B. That shutter type can be tested in the same way and the scope will provide an accurate measurement when the trace lines cross at the halfway position.

Fig. 3—Some shutters exhibit different curves on the oscilloscope. In the above presentation the shutter opens slowly until it reaches a peak and then snaps shut quickly. The letters correspond to the letters seen in Fig. 1.



How it Works

The solar cell, as shown in the schematic diagram of Fig. 4, is connected across the input of the FET (field-effect transistor), Q1, so that it will produce a positive DC voltage to the gate when activated by light shining through the open shutter. That decreases the negative gate-source bias already established by the source resistor and causes an increase in drain current. The drain voltage goes more negative which causes a decrease in Q2's base current. Thus, Q2's collector current decreases, and its collector voltage becomes more positive. Thus, there is an amplified positive-going voltage output at the collector, and it's applied directly to the oscilloscope's vertical input. That produces a waveform that is displaced vertically whenever light strikes the cell.

Construction

All parts can be easily mounted in a small chassis or plastic box. The author used a small box he had on hand that measured 2½- wide, 2¾- high and 4½-inch long, but any convenient size and type of box may be used. Mount the solar cell first, using a method similar to that illustrated in Fig. 5. A ¼-inch hole is cut in the top of the box to permit light to shine through to the cell. A thin plastic sheet was first glued to the underside in order to protect the delicate cell from damage; it does not take much to fracture it.

If a metal box is used, the plastic sheet (Fig. 5) will insulate the cell from the box. The cell is held in place by a metal strap

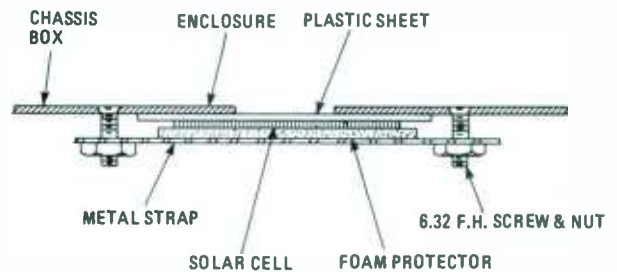
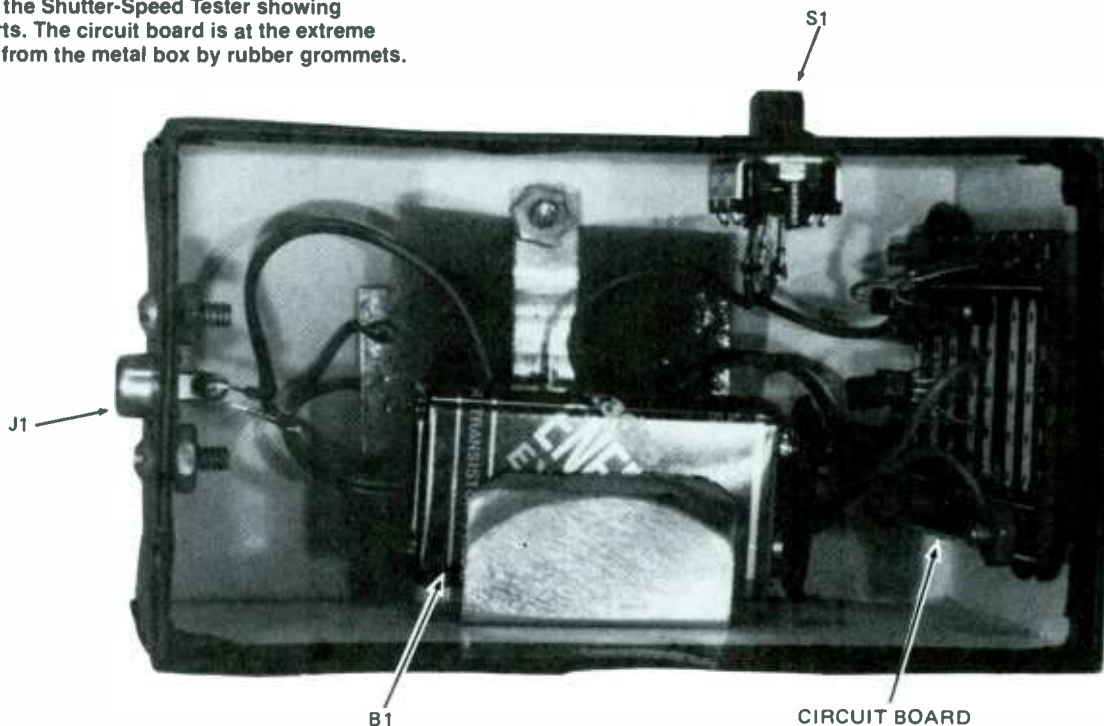

Fig. 5—This cross-sectional view illustrates how the solar cell may be mounted. However you do it, be very careful when handling the cell. It is very brittle and cannot take much tension, bending or warping—it'll crack.

Fig. 6—Interior view of the Shutter-Speed Tester showing the arrangement of parts. The circuit board is at the extreme right and is supported from the metal box by rubber grommets.



made by straightening a NMSC cable strap. The foam protector was packed with the cell when purchased. Glue a layer of black felt or cloth on top of the box to prevent scratching the camera when testing shutters.

The circuit can be constructed on a small board and will fit neatly at one end of the box, while the RCA jack will fit at the other end. The original was constructed on a type of Vector board, but perfboard or an etched printed-circuit board are both suitable. The arrangement of the parts is not critical. An internal view of the author's unit is shown in Fig. 6 and the completed tester is shown in Fig. 7.

A shielded phono-cable is used to connect the unit to the oscilloscope terminals. The cable requires a phono plug on

one end, and terminators to fit your oscilloscope's vertical-input terminals on the other.

For light, simply position a desk or bench lamp so it will shine directly through the lens onto the solar cell when the shutter is operated. A more permanent installation can be made, if desired. A 60-watt or 100-watt lamp is adequate. If using very small apertures, such as f8 or f11, position the lamp quite close to the lens in order to supply adequate light for good vertical deflection. Those lamps throw off a lot of heat, so be careful not to burn yourself and/or overheat the lens system under test.

Calibration

Before using the Shutter-Speed Tester, you must calibrate the time base of the oscilloscope to read shutter speeds directly. That is easy to do. A scale can then be drawn, as in Fig. 8, to indicate speeds in fractions of a second, or if you prefer, in milliseconds.

Since the alternating-current supply to the home is accurately controlled in frequency, it is a dependable standard to use. The following method was checked against a calibrated Hewlett-Packard laboratory generator and found to be within one or two cycles of accuracy, which equates to less than 3 milliseconds of error at 1/30 second, and less at higher speeds.

First, make a semi-circular paper dial, similar to the one in Fig. 8, that will fit over the horizontal vernier control knob on your scope, and tape it lightly to the face plate. Remember, you have to remove it later if you want to make a more permanent scale with inked figures. Then, rotate the control knob to each of its two extremes, marking on the paper. Those points are used later for repositioning the inked chart. Then, follow this procedure:

Fig. 7—Here's what the completed Shutter-Speed Tester looks like when assembly is complete. A dark felt is cemented to the top of the unit. The felt protects the camera housing from scratches and provides some what of a light seal when the lens housing is resting on it.

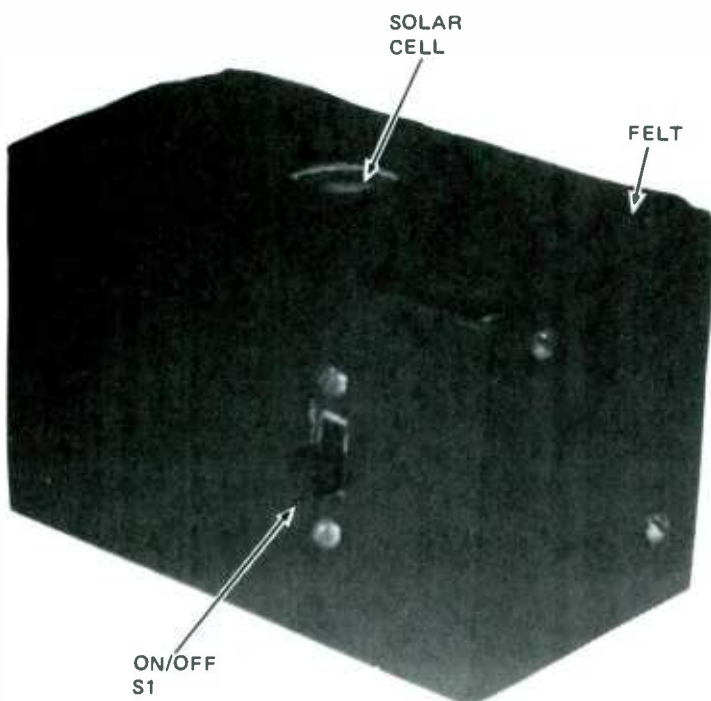

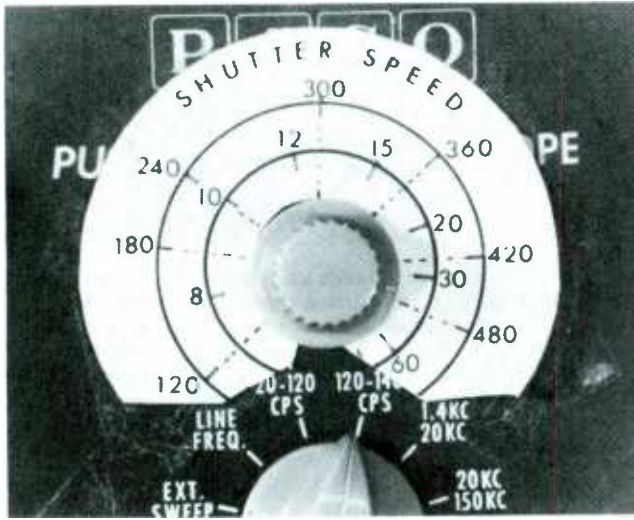

1. Set the coarse horizontal frequency control to its lowest setting. e.g. 20 to 120 Hz.

2. Switch on the calibration voltage, or connect a low-voltage, 60-Hz signal to the vertical input. Adjust the controls to provide a trace about 2-inches high and 3-inches wide, or 5-cm high and 8-cm wide.

3. Adjust the horizontal vernier control until exactly one cycle is displayed on the oscilloscope face with the retrace line, if visible, centered. See Fig. 9. Mark a line on the paper chart, opposite the knob's pointer line, and label that line as 60. That is the 60-Hz point, or as a shutter speed, 1/60 second.

4. Readjust for exactly two cycles and mark that point 30; then for 3 cycles, 4 cycles, etc., as far as your scope will go. If 6 complete cycles are observed, the sweep frequency is 10 Hz, and the point is then marked as 10, or 1/10 second.

5. Change the coarse frequency to the next highest range (e.g. 120 to 1200 Hz), and read just the Vernier control to obtain the figures shown in Fig. 10. Mark each in turn on your chart. Those will give you the 120 Hz to 480 Hz positions, or 1/120 to 1/480 second. On some oscilloscopes, those latter speeds might lie quite close together.

The time base is now calibrated. You can either leave that scale on the scope or remove it, and make a neatly printed copy. When repositioning it, use the extremity marks as your guide, and recheck at the 60-Hz position.

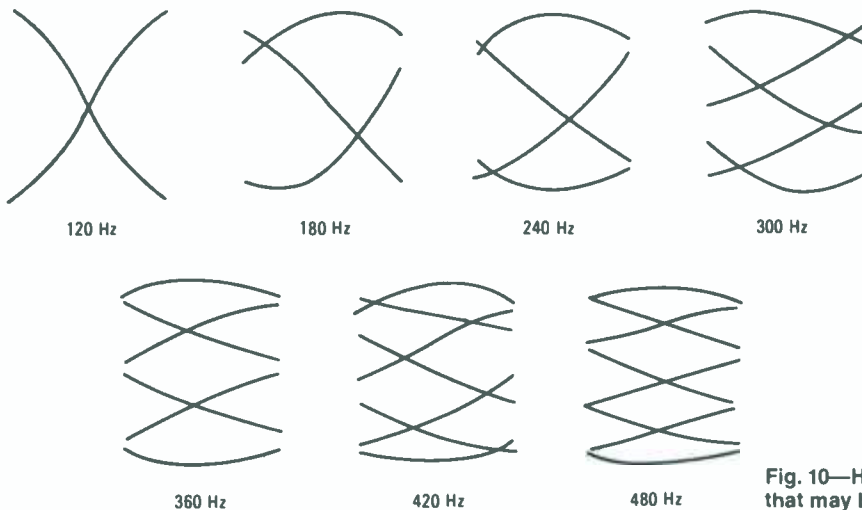

Fig. 8—You don't need an exotic oscilloscope with the Shutter-Speed Tester. The PACO scope shown here is probably older than most the readers of this magazine. Notice the LINE FREQ. setting on the coarse frequency control. That setting puts 60-cycles from the line directly into the horizontal-sweep, frequency-sync circuit. Also, note the KC markings as opposed to HZ markings on new oscilloscopes.

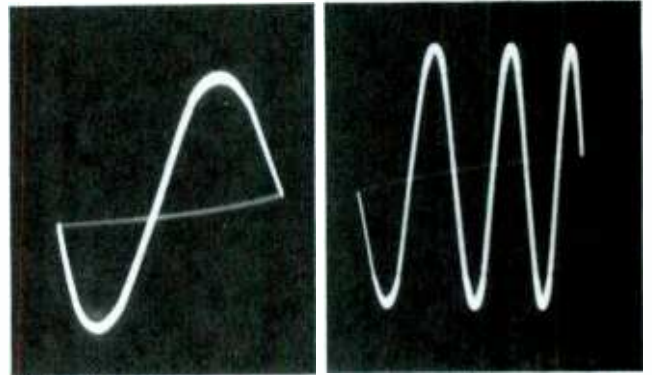

Fig. 9—These two waveforms indicate different sweep periods. At the left is a 60-Hz cycle indicating a 1/60th second sweep. At the right are three complete 60-Hz cycles within one scope sweep indicating a time sweep of 1/20 second.

Using the Tester

Connect the Shutter-Speed Tester to the oscilloscope's vertical-input terminals. The camera to be tested is placed on top of the enclosure with the back opened and the lens pointing upward. See Fig. 11. Be sure that the camera focal-plane opening is generally centered over the solar cell. Set the lens aperture to its largest opening. Position and aim the lamp so its light passes through the camera with the light, camera lens and solar cell opening in alignment. That is most important when measuring short shutter speeds.

Set the oscilloscope sweep speed to less than the shutter speed being tested. Set the shutter. Watching the screen, trip the shutter. You should see a waveform similar to Fig. 1, but with the horizontal time-base trace at the bottom as well. The waveform will be located somewhere along the time base. Now, adjust the control to a higher sweep speed and trip the shutter again. Continue until you have the lines crossing at the center as in Fig. 2. Then, the dial setting is the actual shutter speed. That procedure is actually very simple and in a few tries you'll find it surprisingly easy and fast.

Never expect a shutter to always deliver exactly the set speed. As long as it is within 20%, it is within the accepted standards. At high speeds, such as more than 1/100 second, the acceptability tolerance is plus or minus 30% for leaf shutters. For focal-plane shutters at over 1/400 second, it is plus or minus 35%.

The actual diaphragm opening is unimportant, except that it should be large enough to allow enough light to reach the cell to provide adequate vertical deflection of the trace.

(Turn page)

Fig. 10—Here are waveforms for ten different frequencies that may be used to calibrate the dial shown in Fig. 8.

PARTS LIST FOR SHUTTER-SPEED TESTER

SEMICONDUCTORS

- D1—Solarvoltaic cell (Radio Shack 276-124, or any suitably-sized photovoltaic cell)
- Q1—2N3819 field-effect transistor (FET)
- Q2—2N3904 NPN transistor

RESISTORS

- (All resistors are 1/2-watt, 10% units)
- R1—1-Megohm
- R2—3300-ohm
- R3, R5—1000-ohm
- R4—120,000-ohm

ADDITIONAL PARTS AND MATERIALS

- B1—9-volt transistor-radio battery
- J1—RCA phono jack
- S1—SPST slide switch
- Foam protector, sheet plastic, metal strap, shielded phono cord with proper terminators (see text), circuit board, case, wire, hardware, black cloth or felt, solder, etc.

Focal-plane shutters expose film by passing two curtains across the film plane, the curtains being separated by a space that is inversely proportional to the shutter speed. To accurately test those, it is necessary to reduce the size of the opening to the solar cell by making a small piece of paper, as in Fig. 12, with a slit of about 1/16-inch wide in it and taping that on top of the cell. Orient the slit perpendicular to the direction of curtain travel. Light entering the slit during shutter operation will indicate the average light reaching the film at the position where the slit is located on the focal plane.

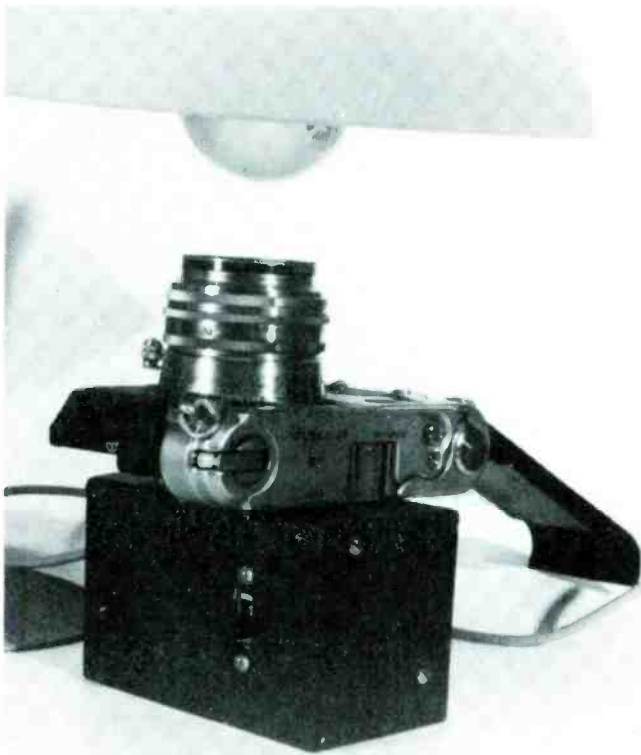

Fig. 11—Here's what the test setup looks like. The 100-watt bulb should be kept at least 3-inches away from the lens during the actual test. When not needed, it should be turned off so that the heat from the lamp will not damage the lens system. If you can remove the lens system where a focal-plane shutter is used, do so as a precautionary procedure.

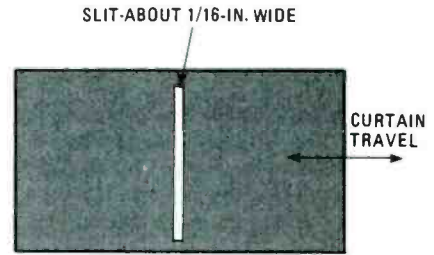

Fig. 12—You will need to make a opaque mask for cameras with a focal-plane shutter. Use ordinary black photographic paper (comes in every box of print paper) and cut a slit approximately 1/16-inch wide and about 1-inch long. Another technique is to use excess exposed film that is clear and use an opaquing paint to cover the film except for the slit area. The film can be loaded in the camera and the slit can be positioned behind the lens' center line.

To check exposure at each extremity of the focal-plane opening, simply check exposure with the slit at each side of the opening at the rear of the camera. In a properly operating camera those speeds should be the same. Should they differ, have an expert carry out more elaborate testing for faults.

Troubles You May Detect

No matter what trouble you may detect, consider that there are over one hundred parts in the average shutter and do not attempt a repair procedure unless you have the proper tools and training. If the shutter speeds are too slow or erratic, the shutter probably needs a disassembly and cleaning. If isn't erratic, then you can often compensate for the difference between the set and actual speed in your exposure. Some shutters will go slow as the camera ages but will otherwise operate properly.

One type of display you might see is shown in Fig. 13. That display occurs when the shutter blades or curtains bounce open again after they have closed. That can be due to a weak spring and will produce ghost images on the film with leaf shutters as well as an over-exposed section with focal-plane shutters. Have a technician repair it for you.

As mentioned previously, uneven exposure on each end of the picture frame may be detected with focal-plane shutters.

(Continued on page 98)

Fig. 13—The Shutter-Speed Tester is useful in discovering other interesting operational conditions, one of which is shown here to be a shutter fault. When the shutter, closes, it slams up against a stop, and bounces. That is evidenced by the small "bubble" at the bottom of the graph display. The bounce is due to a weak shutter spring and repair should be undertaken by a qualified camera technician.

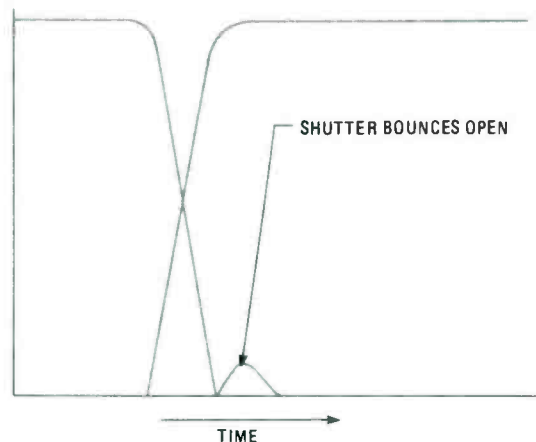

By Herb Friedman

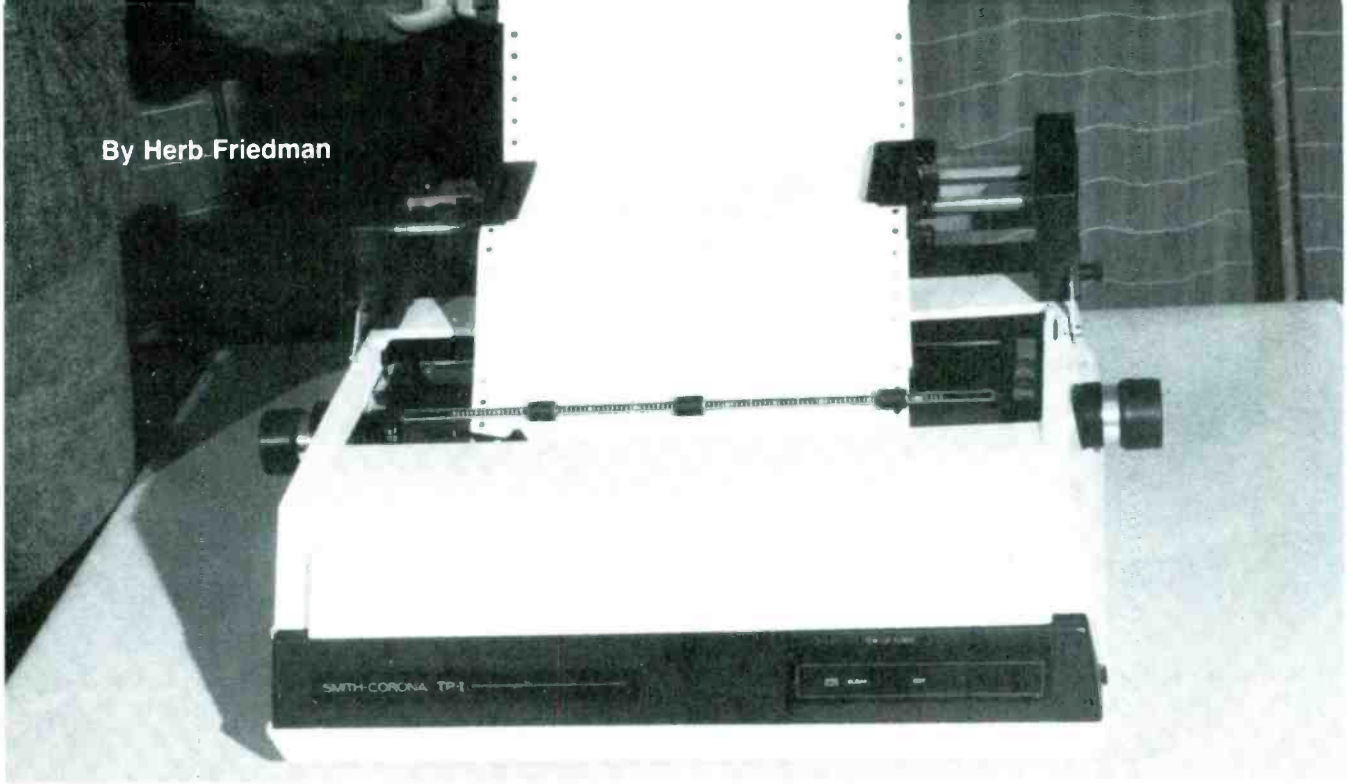

Make your Budget Printer VALUABLE

Add new features and greater flexibility with upgrade kits currently available

□ IF YOU HAVE BEEN INTO PERSONAL COMPUTING FROM ITS "hobbyist" days, or have built your system on a tight budget, it's odds-on that you have either an Epson *MX-80* matrix printer or Smith-Corona *TP-1*, *TP-2*, or *TP-2 PLUS* daisy printer. Whatever you have has probably given you years of trouble-free service, but lately you find that more and more software can't be used with your printer, or you want to upgrade the computer but find your printer can't quite hack it as an up-to-date printer with the new computer hardware. For example: The original *Epson MX-80* (without *Grafrax*) does not have IBM compatible dot-addressable graphics.

Essentially, what you have is still functional equipment that's been made obsolete by modern software, or by modern uses for a personal computer.

In the beginning

The Epson *MX-80* printer, which could be used with any computer having a Centronics-compatible parallel printer output, was intended primarily for the Radio Shack *TRS-80 Model 1*, the most popular computer of its day, hence the *MX-80* featured a Radio Shack graphics mode. Much of the modern software, however, is written for the graphics mode of the newer *MX-80* printers, which has the graphics capability for the present most popular 8-bit computers, the Apple *II* and *Ile*, and the IBM PC's. Even if the software is for other

than Apple computers the graphics will most likely be intended for the graphics capability of the most recent version of the *MX-80*.

The *MX-80* (and its clones such as the Texas Instruments and IBM printers) accommodates only tractor-feed paper. If you want to print on single sheets, such as letterhead, the only way to do it is to use a special plastic tractor/pin feed "carrier," some of which are prone to damage the printhead when pushed through the printer mechanism. While the original *MX-80* has a host of features such as compressed or enhanced printing it lacks a backspace, which precludes underscoring

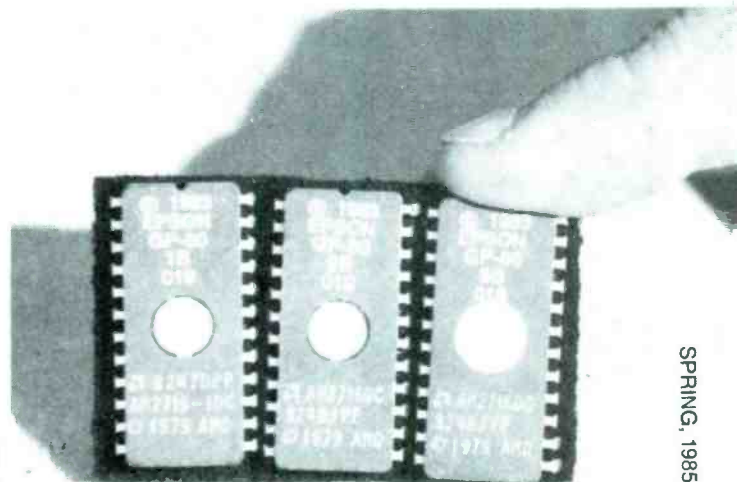

Epson's *Grafrax-Plus* printer upgrade consists of three ROM's secured to a conductive foam strip.

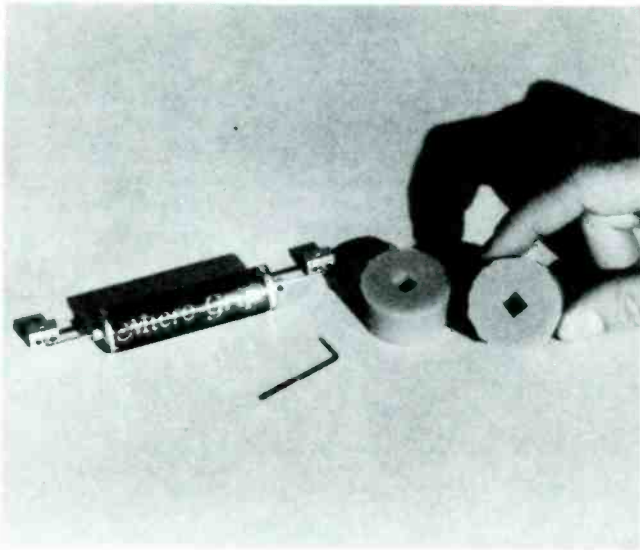

The Micro-Grip single-sheet upgrade kit does not interfere with the printer's standard tractor operation.

from some of the less expensive (but otherwise excellent) word processors that are available.

Then came the wheel

The "letter quality" Smith-Corona daisy printer TP family is the "buy of buys" when it comes to letter-quality printers for home-and-family and small businesses. The *TP-1* was the first under-\$1000 Daisy printer, which by 1985 was selling for as little as \$250. Thousands upon thousands of personal computer users who could not otherwise possibly afford a letter quality daisy printer struck gold in the *TP's*—the price might very well be the reason you decided to get a letter quality printer even though you already had a matrix printer. (If a type 251 ribbon is used—which was not mentioned in the early documentation—the *TP-1* can produce "camera ready" print quality the equal of machines costing well over \$1000 because it is essentially the printer end of a Smith-Corona electronic typewriter with an accessory interface for computer output.)

Don't follow the Epson instruction to work on the printer with the cover attached. It's safer to pull the plug.

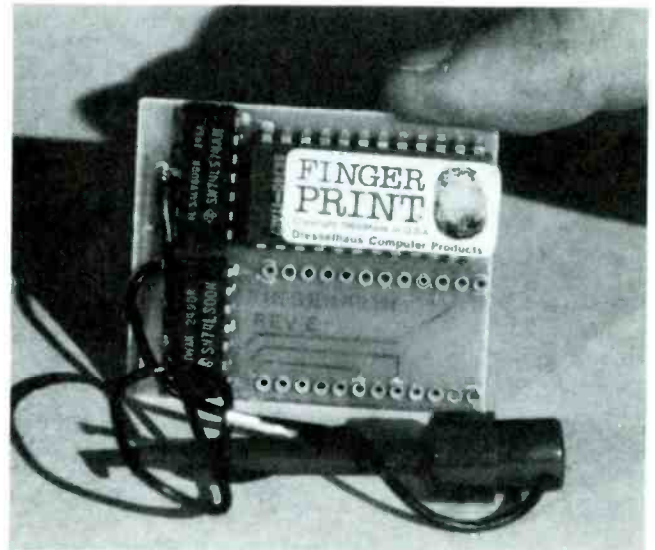
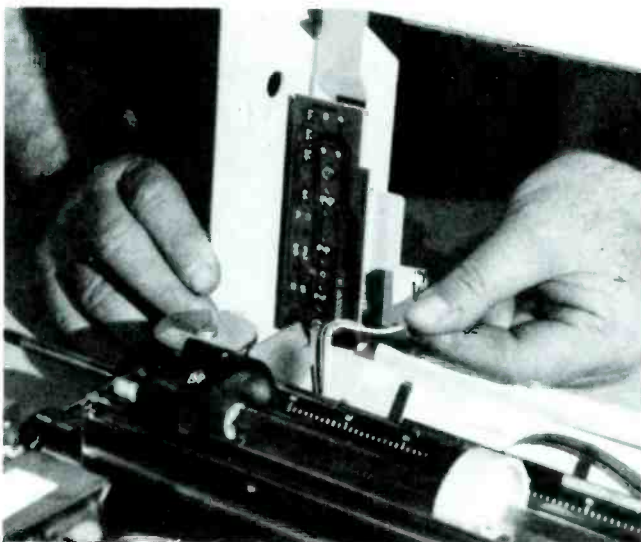

The FingerPrint module plugs into an Epson ROM socket. The existing ROM is stored on an empty socket on the board.

The problem with the *TP's* is that they were intended for single-sheet documents such as business letters, etc., which is logical because it is really the printer mechanism from a typewriter. But today, much modern software is intended for continuous forms printing, such as checks, labels, IRS schedules, even business stationary—which includes letterheads and envelopes. To insure precise alignment of the printing, continuous forms must be tractor or pin fed.

So what we have is a popular tractor-feed matrix printer that needs at least new graphics capability and the ability to feed single sheets, and a daisy printer that needs a tractor feed in order to accommodate continuous forms. Let's see what we can do to satisfy those important needs.

Retrofit kits

Regardless of why you purchased the *MX-80* or *TP-1* in the first place, user-installed retrofit kits are available that will upgrade either printer to accommodate modern needs. While some of the retrofits are better or more convenient than

If you have an original *MX-80* printer, you would see only two (not three) ROM's in this view of the base.

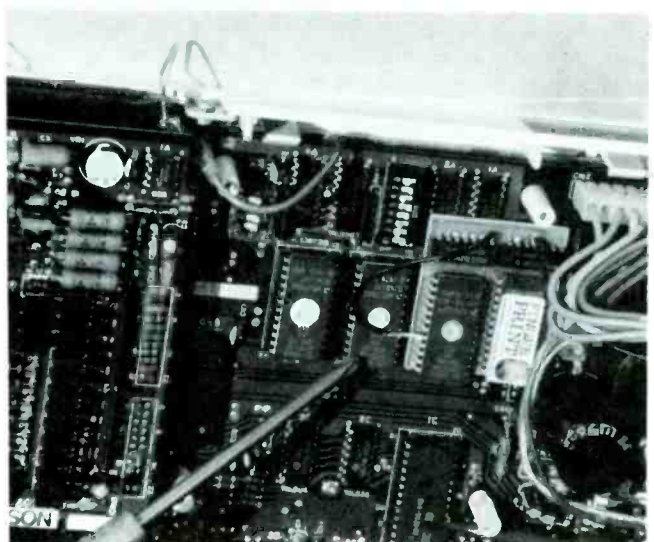

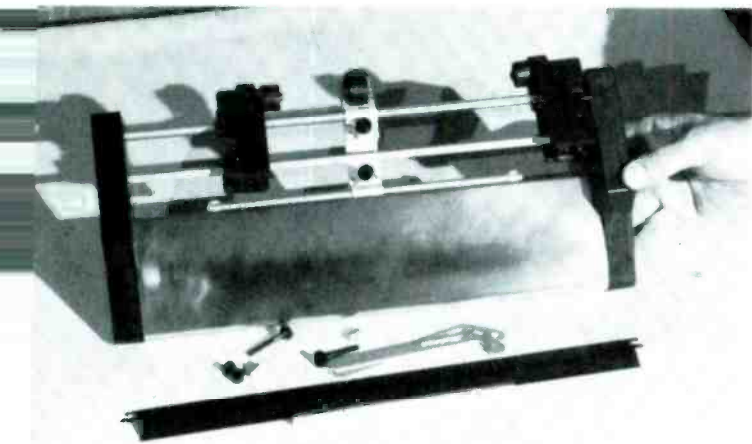

The passive tractor-feed upgrade kit for the Smith-Corona printers comes complete with the main section assembled.

others, we know those discussed here will really work exactly as promised because we actually tried them out.

The first of the user-installed *MX-80* retrofits was Epson's own *Grafrax*, which consisted of three ROM's, two of which plugged into empty sockets in the base of the printer while the third replaced an existing ROM. Among other things, the *Grafrax* upgrade provided for dot-addressable graphics, italics printing, and even more important, backspacing. It was terrible backspacing because the printhead returned to the extreme left and then advanced for each backspace, but it was adequate for general word processing: underscore, kerning, etc. Unfortunately, a graphic printout would cycle the head continuously until the drive motor could be heard slowing to a crawl.

The latest retrofit available from Epson dealers is *Grafrax-Plus*, which gives your old model *MX-80* the advanced features of the latest model. Among the *Grafrax-Plus* highlights are the Apple-compatible graphics (no more Radio Shack *Model 1* graphics); a true backspace that puts graphic

The removal of this collar from the *MX-80* begins the simple process of the Micro-Grip single-sheet feed modification.

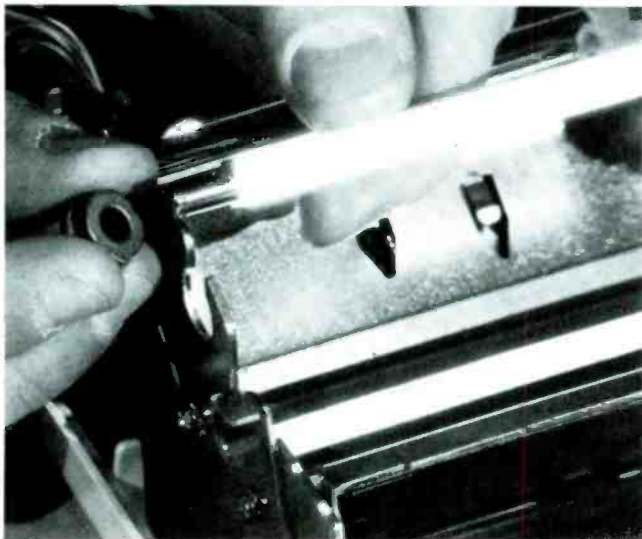

The adhesive Mylar label you fix to the front panel of your printer lists the new functions provided by the modification.

printouts in high gear and relieves the strain on the printer's printhead-drive motor; a "fine print" that can be used for superscripts and subscripts; automatic perforation skipover (no more program listings printing on the perforations); and a continuous underscore that can be turned on and off from within a program or word processor. (A continuous underscore is formed simultaneously with the character; the head does not backspace for the underscore.)

The *Grafrax-Plus* retrofit kit consists of three ROM's and the latest Epson-with-*Grafrax* printer manual—which explains all the "bells and whistles." The *Grafrax-Plus* retrofit has the same kind of installation as for the original *Grafrax* upgrade—just plug the ROM's into the correct sockets. One "caveat" however: The Epson instructions leave the top of the printer attached when you open the printer by separating the top and bottom; it has you delicately balancing the cover on its end. If you look closely you'll see the wires to the switches in the cover are attached through a connector. Mark the orientation of the connector with a pencil or pen and then

Here, the Micro-Grip modification is continued. Note the two rollers being added to the bar that held the paper rollers.

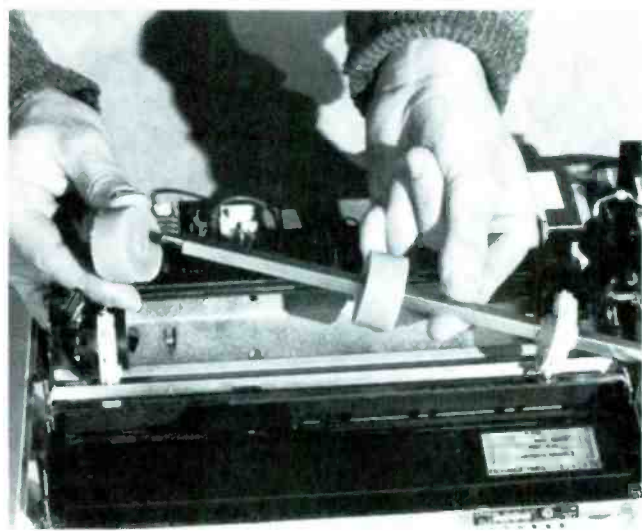

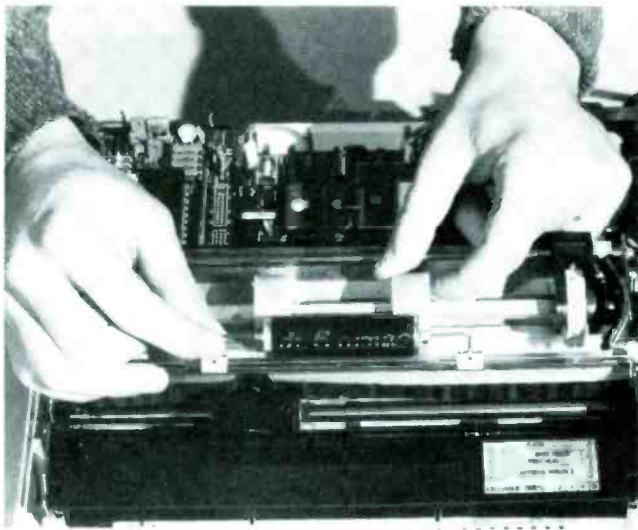

In this view the pressure roller is attached to the paper bail and single-sheet retrofit to the MX-80 is finished.

separate the connector and put the cover in a safe place until you're finished.

Fingerprint bonus

As long as you have the printer open consider a retrofit called *Fingerprint* (Dresselhaus Computer Products, 837 E. Alosta Ave., Glendora, CA 91740), which allows the three printer control pushbuttons to also program ten operating modes: compressed print; double-wide; emphasized; double-strike; perforation skipover; left margin indent; 8 lines/inch spacing; italics, and fine print. For example, just touch the printer's ON-LINE button twice and the printer shifts to compressed type without any commands from the computer.

Fingerprint is supplied on a small printed-circuit board that swaps for the ROM in a socket 1B, the one that's replaced in the *Graftrax* retrofit. Instead of substituting for the ROM in socket 1B, install the *Graftrax* ROM in the *Fingerprint* socket and then snap the *Fingerprint* assembly into socket 1B. You clip two attached *Fingerprint* leads where indicated and you now have both the *Graftrax* and the *Fingerprint*

Because the leads to the fan assembly are too short, you cannot detach the TP-1 casing top when making the modification.

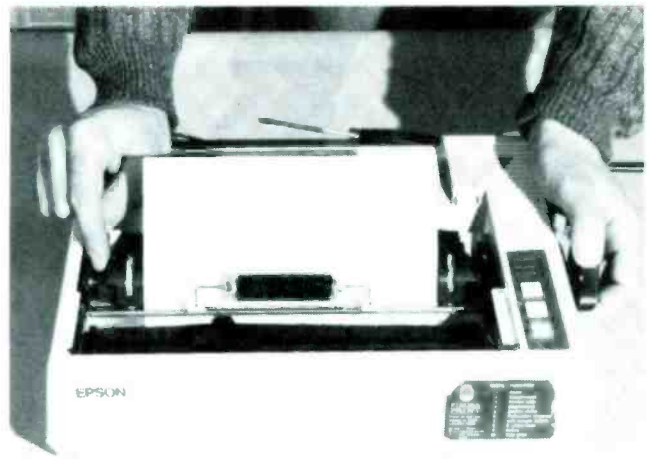
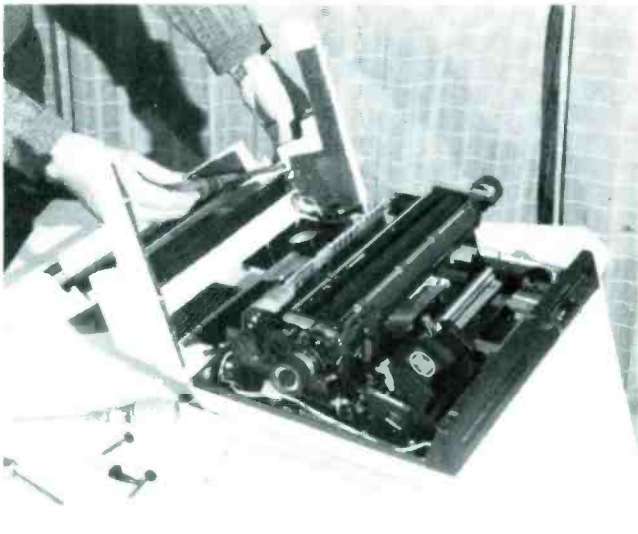

When the job is done, run the test. Note that the pin-feed mechanism is against the paper sides, and the feed is straight.

retrofits, and with virtually no extra effort required on your part. The *Fingerprint* also can be installed in an IBM Graphics printer because the IBM Graphics Printer is MX-80 *Graftrax* based (cloned)!

Sheet feed

If you quit now you'll have one heck of a matrix printer, but you can go one step farther and add a real single-sheet feed by installing a *Micro-Grip Friction Feed* (Bill Cole Enterprises, Box 609, Wollaston, MA 02170). The *Micro-Grip* retrofit does not interfere with the tractor operation, but it does permit single sheets to be fed directly through the printer without the need for a plastic carrier.

The *Micro-Grip* kit consists of three components: two rubber rollers that replace the existing Epson paper guide roller (which is sandwiched between the two tractor pin feed mechanisms), and a rubber-roller pressure assembly that clamps to printer's paper bail—the bar that holds the paper down for printing.

(Continued on page 102)

The mechanism for the TP-1 printer retrofit appears to be permanently installed; however, it can be removed in seconds.



ON SCANNERS



SAXON

By Mark Saxon

Pull in all that aero-action that's on the air!

□MANY MODERN SCANNERS COVER THE VHF aero band, which runs between 118 and 136 MHz. Unfortunately, all too often, that band is either overlooked or ignored in favor of the standard VHF and high/low UHF bands, which permit tuning in of police and fire communications. The fact is that the VHF aero band has plenty to say for itself. If you have the ability to scan those frequencies and aren't doing so, you're missing plenty!

For example: The airlines have certain frequencies in that band which they use for air/ground communications relating to equipment problems and various other complaints. Chances are that they are not especially interested in the public's listening in on those conversations, because they reveal a batch of rather hair-raising mechanical problems taking place, while passengers are relaxing with a cocktail and watch a film.

Write Ups

The pilots call those problems "write-ups," and those write-ups include various flashing red lights warning of malfunctions in hydraulic, electrical, or electronic systems. Sometimes, the pilot reports non-working toilets ("heads"), foul tasting drinking water, cracked windows, and broken doors which refuse to remain open or closed. A great many of the problems are noted as being *repeat items* which had been reported many times previously.

Those aero frequencies are also used for passenger complaints, like the poor soul who discovered that he had left his briefcase containing negotiable bonds in an airport rest room (no worse than the lady who did the same with her diamond ring)!

Frequencies used for write-ups all lie within the sub-band running between 128.8 and 132 MHz. While the specific frequency varies from airline company to company (they aren't the same in every area), you might try checking out 129.85 MHz. American Airlines uses that frequency in many areas. TWA problems have been noted on 131.05 MHz. Other frequencies that have produced similar communications include 129.475, 130.4, and 131.725 MHz. Pan American's prob-



Private aircraft pilots can often be heard chatting on 122.75, 122.85, and 122.9 MHz, much to the FCC's dismay. Best action occurs on sunny weekends.

lems go out on 130.25 MHz at times. Put your scanner in search mode and seek out more of those frequencies. But, be aware that there are all sorts of other airline company communications between 128.8 and 132 MHz which relate to gate assignments, food delivery, etc., and you'll have to select those which contain the pilot write-ups.

You'll also find it interesting to listen in on the frequencies selected by pilots to chit-chat with one another, although the FCC has issued a number of stern warnings against the practice. The FCC doesn't want the Aviation Radio Service to turn into yet another CB-like service; yet, airline pilots can often be heard chatting merrily away on 123.45 MHz, although the frequency is supposed to be used for other types of communication. Private pilots like to chat on 122.75, 122.85, and 122.9 MHz, although those conversations are also frowned upon by the FCC.

There's More!

Some of the off-beat and unusual aviation activities that take place are worthy of monitoring, such as air shows, races, fly-ins, gliders, sailplanes, ultralights, hang-gliders, hot-air balloons, parachutists, etc. Many of those activities can be monitored on 123.3 and 123.5 MHz, and

temporary control towers at air shows are usually established on 123.1 MHz.

Not all airports have FAA control towers. In fact, many small rural landing areas have no communications facilities at all. Many smaller airfields catering to private pilots do have a communications facility known as Unicom, which isn't exactly a control tower but can be used by the pilots to obtain information on wind direction, runway conditions, and advice on ground facilities (fuel, food, lodging, ground transportation) available.

The majority of Unicom's at small fields operate on 122.8 MHz, although some landing areas may (instead) use 122.7 or 123.0 MHz. At other airports, which have neither a control tower nor a Unicom, pilots of radio-equipped aircraft will normally transmit their intentions "in the blind" on 122.9 MHz.

Larger airports with a control tower also have a Unicom channel (usually 122.95 MHz) which private pilots use to order taxis, limos, rental cars, and even food.

Helicopters are most active on 123.05 MHz, although they can often also be heard on 123.025 and 123.075 MHz. Check out the Goodyear Blimp on 132.0 MHz.

There are also control towers, ground-

(Continued on page 98)

By Herb Friedman

ON COMPUTERS



FRIEDMAN

Inside facts on inexpensive disk drives

INSTANT ACCESS! RANDOM FILES! For almost pocket change, your computer's cassette data-storage system can be upgraded with a disk drive!

The way some advertisements tell it, everyone can now afford a disk drive. 5¼-in. drives which sold for \$300 as recently as two years ago are advertised for under \$100, while \$200 disk-drive cabinets—which include the power supply—can now be purchased for well under \$100.

As with all other things in life, nothing is ever as good as it first appears. While it is true that there are some outstanding values in disk drives, and some of you will undoubtedly come out way ahead of the game, much of the budget-priced disk hardware cannot be used with many commonly-used personal computers—in particular, the newer models. A goodly number of electronics hobbyists are going to end up with useless, expensive hardware unless they keep on reading.

There is a difference!

First things first: not all disk drives that

look alike *are* alike. Several computer manufacturers purchase the same basic mechanical mechanism that's used by other manufacturers and add their own electronics board, which is not compatible with other equipment. For example, most Radio Shack computers, IBM-clones and Heath/Zeniths can use the same 5¼-in. disk drives because the electrical connections are the same. Osborne and Kaypro drives, which at first glance appear similar to the ones used by Radio Shack, IBM, etc., have different electrical connections. A great buy in an IBM-compatible drive is worthless for, say, an Osborne computer.

Then there are a computer's internal functional differences that are rarely, if ever, spelled out in an advertisement. For example, the TRS-80 model 1 computer uses a 35 track drive with a 30 mSec. Track access—which is called *step rate*. The Shugart SA200 drive, which can now be purchased for under \$100, fits the specifications. The reason the SA-200 is so cheap is because it really shouldn't or

can't be used with the modern computers. Radio Shack's newer computers uses 40-track drives, the same as IBM and Zenith. Also, all commonly-used modern computers use a drive with much step rate, generally 6 msec. A computer designed for 40 tracks, or 6 msec. step rate, or both, *can* use an SA-200 drive or its equivalent. On the other hand, you can install a faster drive having more track capacity than required by the computer. For example, many users installed the Siemens model 100-5B, 40-track, 20-msec. drive in a TRS-80 Model 1. Those drives were kicking around the surplus marketplace at \$125 when Radio Shack's own drives were going for well over \$200.

Of all the characteristics, it is step-rate time that is the most limiting. Install an otherwise compatible disk drive in a computer and a relatively slow access time can make the drive *invisible* to the DOS (disk operating system): You attempt to read or write to the disk and the computer tells you that the drive doesn't exist.

But it is possible for the computer's DOS to allow the user to work around the disk drive's track capability and access time. For example, NEWDOS allows the use of any track density from 35 to 80 tracks per side, and any access time from 30 msec. to 6 msec.

Similarly, the Montezuma Micro CP/M 2.2 for the TRS-80 Model 4 computer can be configured to recognize any individual drive characteristic. Drive A: might be 40 tracks single-sided double-density with 6 msec. step rate, while drive B: is 40 tracks, double-sided, double-density, 20 msec.

At this point I am sure that some of readers have reached a state of high du-
(Continued on page 97)

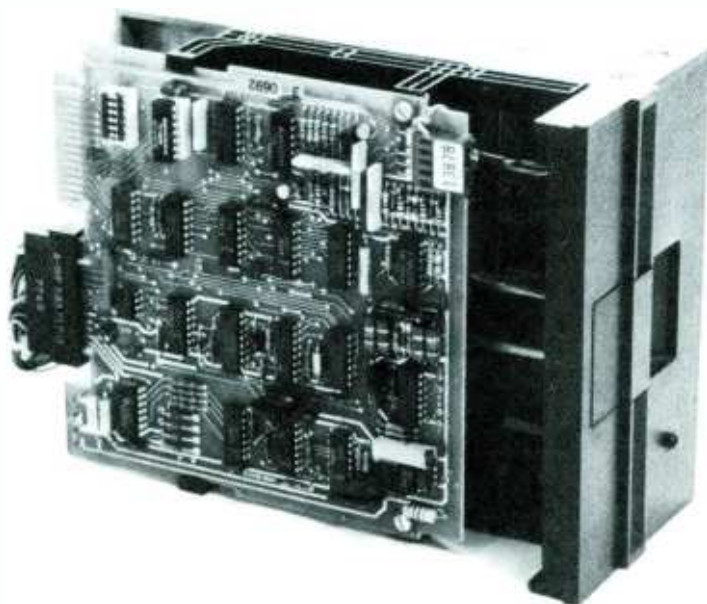

This Shugart SA-400 floppy-disc drive provided the standard for the disc drives used by most popular computers—IBM PC's, TRS-80's, and Heath/Zeniths. Although modern drives have faster track access, the SA-400 can still be used with many of the new and older computers provided the DOS accommodates 30 millisecond access.

CALLING ALL HAMS

□ A QUARTER-WAVE VERTICAL IS A NEAT package and adaptable for installation on a small lot. However, esthetics, cost, installation difficulties, and other drawbacks exist, because of the required height for operation on the lower-frequency bands—40-, 80- and 160-meters. Ironically, it is on those bands that the vertical performs at its best. A significant reduction in height is possible with a helical vertical. That may be the new wave in low-band antenna installations.

The basic helical vertical consists of a uniform spiral or helix of antenna wire wound on an appropriate mast (Fig. 1A). Two trying problems of the helical vertical are very low impedance and limited bandwidth. The W3FQJ 40-meter helical vertical (antenna) combines a number of ideas that result in an SWR no higher than a 1.4 ratio over the entire 40-meter band. No tuner is required. The antenna is 40-percent shorter than the usual 40-meter vertical.

One innovation is the wide-space, large-diameter spiral that is wound on a 1-1/2- and 2-inch ID telescoping PVC piping mast. (Note: Plumbers are concerned about inside diameters, and the pipes, therefore, those pipes are specified in that way by plumbing supply centers.) Spirals are not spaced uniformly but are crowded in the central region as per Fig. 1B. This technique is used to

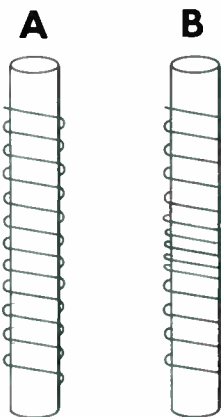
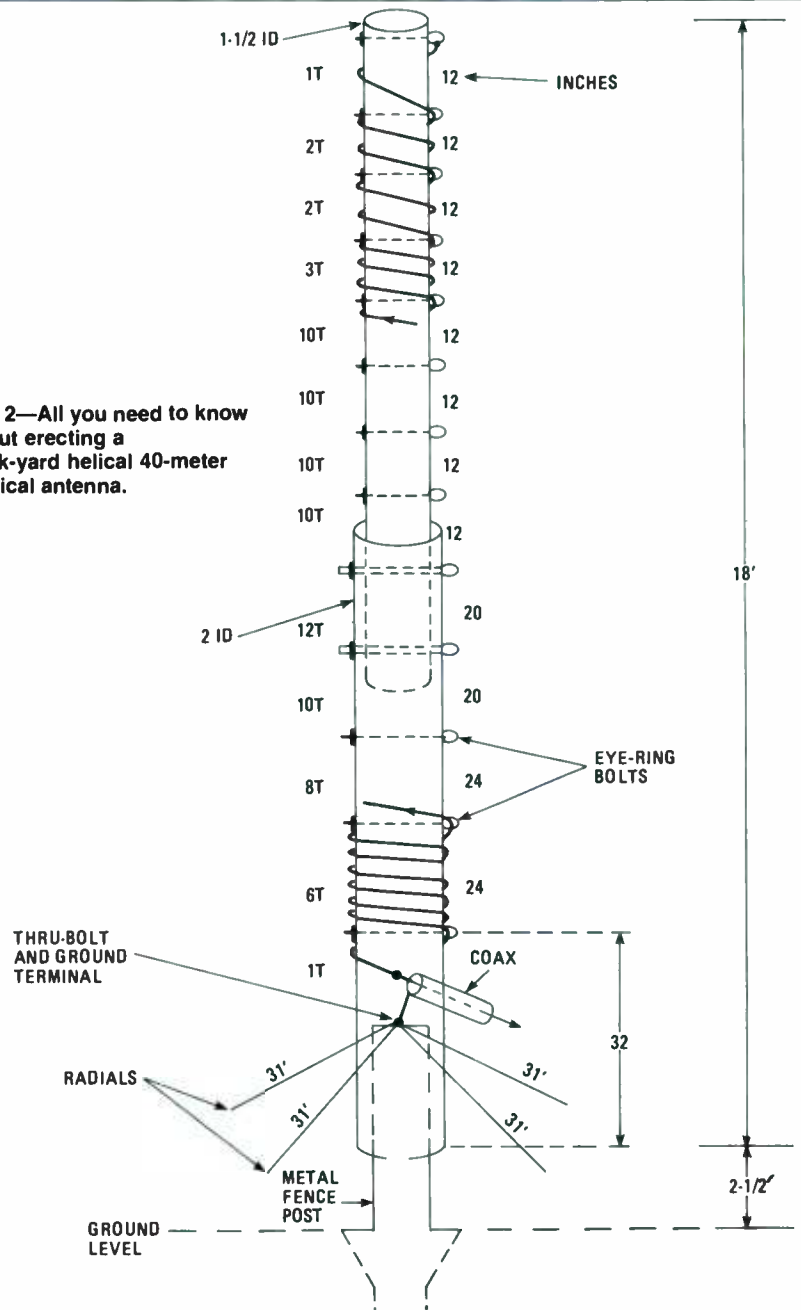

Fig. 1—The basic helical winding is shown in A. Note that spacings are equal between each turn. In B, the turns are closer together in the center, thus loading the coil.

Fig. 2—All you need to know about erecting a back-yard helical 40-meter vertical antenna.



improve operation as do the coil insertions in shortened, mono-band beams and in center-loaded, land-mobile verticals. Four resonant radials are helpful. Those can be laid upon the surface of the ground or buried about 1-inch beneath ground.

Wind the Wire

In winding a helix, theory tells us that approximately a half-wavelength of antenna wire is needed to construct quarter-wave helical. Dutifully, I started out with

(Continued on page 105)

CROSS MATCH ONE

(Continued from page 46)

which are virtually worthless pieces of junk, may have closely matched resistors with tolerances in the .01% range. Nixie tube voltmeters by HP, Fluke, Danna, and the like are another source of resistors. But, that's only the tip of the iceberg.

Generally, you can find close tolerance or well-matched resistors in all kinds of otherwise useless surplus. If all else fails, any resistors around 10,000-ohm or higher having .01% to .025% specs will get the job done, when matching resistors in the .1% range. However if you're just after selecting 1% units from 5% and 10% units, you can probably do with less accuracy and a less than ideal match.

In any case, use old wire-wound resistors for R1 and R2. They have the best temperature coefficients and less drift over both time and temperature.

Set Up and Application

The gain adjustment (BALANCE) potentiometer, R3, which determines tolerance limits, need only be set once for a given

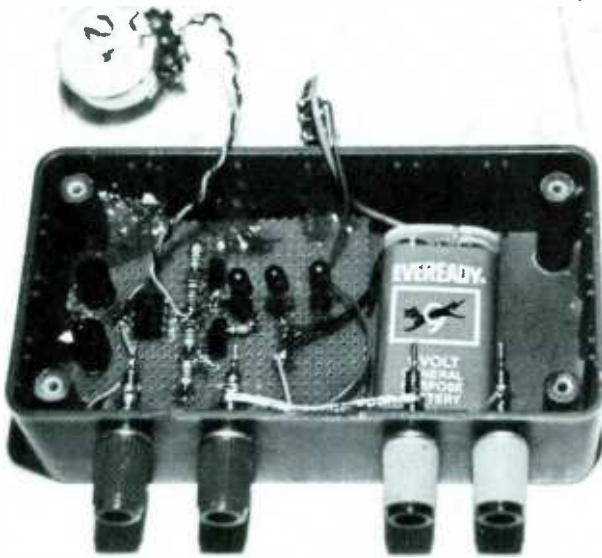

What looks like an exploded view is the Cross Match One just before assembly into its plastic case. You may want to glue the perf-board to the bottom of the case.

range, i.e., 1%, .5%, .1%, etc. That is most easily accomplished by the use of three known sample resistors and one reference resistor. One sample should be over accepted tolerance. One sample should be under accepted tolerance. And the third sample should be within accepted tolerance, relative to the reference used.

The absolute values of the above resistors are not as important as the ratios between them. All resistors should be connected directly to the fiveway binding posts to avoid lead-resistance errors, especially for small resistance values, under 2000-ohms. Very small resistance values cannot be measured, because of battery drain and/or destructive current drawn. However, that should present no problem for most applications, especially where resistors are being matched for instrumentation amplifiers, where values from 2000-ohms to 100,000-ohms are typical.

In any case, by adjusting gain of the op-amp, the respective light-emitting diode should light when each is placed in the R_{SAMPLE} position relative to the resistor placed in the R_{REF} position. That setup will both calibrate and check out the Cross Match One.

Another possibility is to use a Deca potentiometer or resistor substitution box for R_{SAMPLE} . That configuration will allow you to not only look at over, under, and in-tolerance conditions, but also where the skirts of in-over curves and in-under curves overlap (see Fig. 2). So, you can fine-tune gain as desired. Also, using a Deca potentiometer or resistance substitution box for R_{REF} will allow you to determine the R_{SAMPLE} 's value, where you simply dial up the resistance that lights the in tolerance light-emitting diode. That configuration will yield accuracies in the 5-digit area, if you have a precision substitution box that will handle it.

On the other hand, assuming you don't want to use the three-resistor test and don't have access to either a Deca potentiometer or resistance substitution box, there's still another option. That is, you can always resort to using a 10-turn potentiometer for R_{SAMPLE} and a precision resistor for R_{REF} when adjusting tolerance. In that configuration, you'd dial up the desired value you want to substitute across the R_{SAMPLE} terminals while measuring the potentiometer with a suitable multimeter. If the potentiometer isn't stable enough, try a fixed resistor and trimmer in series. However, that method should be used only as a last resort, and you need a good DMM around 4½ digits, or better. If you don't have a good DMM, use the one on display down at your local parts supplier. Any DMM with 5 times the accuracy you want to get out of your finished project, and which has sufficient resolution, will work nicely. ■

NEW PRODUCTS

(Continued from page 20)

frequency response curve for a variety of applications, including music, computer speech-recognition, auction, PA systems, and audio-visual applications.

The PH20 has a stable, split-piece headband that mounts securely on the head for a comfortable, dependable fit. Slip-proof foam temple cushions provide long-lasting comfort while averting fatigue. A reversible swivel-mount and 180° adjustable boom provide a custom fit for proper mouth-to-microphone distance and the option of wearing the mike on the right or the left side of the head.

For more detailed information, write to Telex Communications, Telex Professional Audio Department, 9600 Aldrich Avenue South, Minneapolis, MN 55420. Telephone: 612/884-4051. ■

LOW-POWER AUDIO AMP

(Continued from page 36)

The parts for the Low-Power Audio Amplifier are arranged on a solderless breadboard as shown in Fig. 2. The amplifier was so wired that it could share a Global Specialty's breadboard with the *Yelping Siren*. To insure good stability, keep the input and output signal lines separated. For best performance, connect the input-signal ground and the negative terminal of C2 together at pin 3—that is the input-signal ground terminal. Connect the speaker ground and the power-supply ground together at pin 2.

It would be a good idea to test the audio output with the speaker output muffled by pillows. Siren sounds do not promote good-neighbor feelings. ■

FRIEDMAN ON COMPUTERS

(Continued from page 94)

dgeon and can't wait to take pen in hand to protest that data disks from an IBM are not compatible with Radio Shack, etc. You are, or course, correct. But I am not talking about data or program disks: I am talking about the disk drive itself. Except for the 99.9 IBM-compatibles and clones, virtually every manufacturer has a proprietary method for recording the electrical signals on the disk. That is why you can't pop a Kaypro disk in an TRS-80 Model 4, or an Apple disk in an Atari, or any disk into any other computer unless you use some kind of software that interprets the electrical format of the disk to what's required by the host computer. Even then, some formats simply cannot be converted: You cannot convert Apple discs to a different computer unless the host computer actually contains an Apple emulator. The same is true for Atari and Commodore.

But I am not talking about data disks: only about the disk drive itself. That's where there is compatibility that translates into **BIG BUCKS** when you need an extra drive, or a replacement.

When no provision is made

So far we have only mentioned the *bare drive*, a drive that does not have its own power source. That is the kind of driver you would use to physically replace an existing drive, or one that will be installed in the *empty space* provided for a second drive. In either event, you will use the power connections already built into the computer. The problem of power comes in when you want to add a drive not originally provided. For example, the IBM PC can accommodate two additional external floppy drives through the signal connector on the back of the disk-controller card. Likewise, the TRS-80 Model 4 can accommodate two additional drives. In each instance, however, no power is available from the computer itself: a separate power supply must be provided for the extra drive(s).

If you look through advertisements for disk-drive hardware, you'll see that some power-supply prices are still back in the stone age of personal computing—somewhere around \$150 for a single-drive power supply and a cabinet. Neither the components nor the cabinet are worth that kind of money. About \$50 is what it's worth, and that's what you'll pay at one of the direct-mail, disk-drive suppliers such as Software Support, Inc. (One Edgell Road, Fraingham, MA 01701). Actually, Software support charges only \$45 for a standard-size cabinet and power supply.

But what if you want to add two disk drives? Do you need two power supplies with cabinets? Not any more. The *surplus* market is awash with half-height disk drives: the same kind or size used in the

latest computers. Two half-heights have the same space requirement as a conventional full-size disk drive. If you need two external drives you can go the half-height route, and for an extra \$15 (\$65 total cost), Software Support will sell you a standard cabinet with a dual power supply (for two half-height drives).

Presently, low cost 5¼-in. *bare* replacement or complete (with power supply and cabinet) disk drives are available for the most popular computers: IBM-compatibles and clones, Radio Shack TRS-80, Apple, and T199/4A. Often, the savings from *doing it yourself* is more than 50% of what the job would cost at an authorized shop or distributor. ■



Regardless who made the drive, the power connector is the same. However, the metric equivalents from Europe don't quite fit the American-made connectors. It's the "old metric-error problem," because there is not precise metric equivalent for inches!



Get every issue!

SUBSCRIBE TODAY!

Use the order form below.

■ YOU CAN HAVE THE NEXT FOUR ISSUES of *Hands-on Electronics* delivered directly to your home for only \$10.00. We pay the postage. If you want the next eight issues, you can even save a dollar off the newsstand price. Get eight issues for \$19.00

■ IF YOU'RE THE KIND OF READER that doesn't want to wait, you can order your next copy of *Hands-on Electronics* now. *Hands-on Electronics* is crammed full of electronic projects that you won't be able to wait to build for yourself. You can expect top-notch digital projects, fun-to-play electronic games, valuable add-on computer projects, BCB and shortwave receivers, photographic/darkroom gadgets, devices to improve your car's performance, test equipment ideas, and more in every issue of *Hands-on Electronics*.

■ TO HELP YOU TO BE SURE that you don't miss any future issues of *Hands-on Elec-*

tronics—SUBSCRIPTIONS ARE NOW AVAILABLE!

■ EVERY ISSUE OF *Hands-on Electronics* will continue to contain a variety of construction articles to suit every taste. In addition, feature articles on electronics fundamentals, test equipment and tools will round out each issue. Of course, *Hands-on Electronics* will continue to provide new product and literature listings to keep you up to date on the latest developments in electronic technology.

■ GET IN ON THE ACTION! Order your next issue of *Hands-on Electronics* today. Use the convenient order coupon below. Be sure to send check or money order—no cash!

Hands-on Electronics SUBSCRIPTION

I want to be sure I don't miss any issues. Send me the next four issues of *Hands-on Electronics* for \$10.00 starting with #5. Postage is free in U.S. For Canada add \$2.00. Foreign add \$7.00

I want to be sure I don't miss any issues and want to save \$1.00 too. Send me the next eight issues of *Hands-on Electronics* for \$19.00: starting with #5. Postage is free in U.S. For Canada add \$4.00. Foreign add \$14.00.

Send me _____ copies of *Hands-on Electronics* #4 at \$2.50 plus \$1.00 postage and handling for U.S., Canada and Mexico \$1.00 per copy. U.S. funds only.

Please print

Allow 6-8 weeks for the first issue to arrive.

(Name) _____

Detach and mail today to:
HANDS-ON ELECTRONICS
SUBSCRIPTION DEPT.
P.O. BOX 338
MOUNT MORRIS, IL 61054

(Street Address) _____

(City) _____

(State) _____

(Zip) _____

SPACE TECHNICIANS

(Continued from page 26)

After donning spacesuits, Nelson and Von Hoften made their way out of the ship and into the cargo bay, where they immediately went to work.

Their main task, replacing the faulty Attitude Control Module, took about 45 minutes and went smoothly. Replacing the Coronagraph/Polarimeter electronics was supposed to be a lengthy task. After all, the job entailed pulling back a panel covering the box, cutting and taping back a layer of insulation, removing some two dozen screws, and cutting a number of wires, all while wearing bulky spacesuit gloves. All went much smoother than expected, however, and Nelson completed the job, using clips instead of screws to reconnect the severed wires, in less than an hour; pre-flight estimates had pegged the repair time at three hours. The final step in the repair of the satellite was the installation of a baffle cover over an instrument called an X-ray Polychromator, used to measure the X-ray emission from solar flares, to vent its exhaust gas away from the rest of the satellite's instruments.

The Future

The success of the Solar Max repair mission signaled the

dawn of a new era in the repair of electronic instruments. Now, failed satellite-based systems can be successfully repaired, and satellites can be realistically returned to service.

Perhaps key to the future of space repair will be the concept of modular construction. New satellites will make increasing use of modular construction, such as that used in the multi-mission modular spacecraft base. That will make it possible to replace faulty satellite circuitry with relative ease. The failed circuitry can then be returned to earth, and troubleshooting using conventional techniques can be done on the unit. The unit can then be repaired and used on another satellite. For instance, the Attitude Control Module retrieved in the Solar Max mission can be repaired and used again.

When modular construction techniques, as well as the techniques used to repair satellite modules are perfected, expect more and more modular satellites. Eventually, interchangeable modules may be mass-produced and carried as part of an on-going inventory. When a circuit fails, the service technician of the future may be able to select an appropriate module out of inventory, swap the modules in space, and then repair the module in a more conventional environment.

The Solar Max mission was but a first, halting step. But most important, it was a successful step, and one that showed that such repair missions are both possible and practical. ■

SHUTTER SPEED TESTER

(Continued from page 86)

That may be caused by unequal spring tensions on the curtain rollers and should be adjusted by a technician.

Testing Motion Picture Equipment

To check a motion-picture camera, you will need an additional, small photovoltaic cell about a half-inch square, with leads soldered to it. To those leads, add a shielded lead to make a direct connection to the vertical input terminals of your oscilloscope. Amplification is not needed as the f-stop is usually quite large. Carefully insulate the cell so it will not ground on metal parts and place it behind the lens in the film gate. Set the lens for wide-open aperture and point it toward a bright light.

When the shutter is operated, the light passes through the

lens onto the photocell, providing sufficient voltage to deflect the trace on the oscilloscope. With the camera operating, adjust the oscilloscope's horizontal vernier control to obtain a one-cycle square wave on the screen. Then, read the framing speed directly from your chart. If the camera is equipped to run at more than one speed, use the same procedure for each. Should the framing speed of the camera be slow, pictures could be blurred or jerky and overexposed. If the camera speed is fast, the pictures may be fine, but possibly underexposed. With the latter, you would also use more film.

Projectors may be checked similarly. Merely hold the movable photocell, or the Shutter-Speed Tester's solar cell, in front of the projector's lens, with the lamp on, and measure the framing speed. Do that with and without film in the projector. If film in the projector causes the framing speed to vary, the projector should be serviced. ■

SAXON ON SCANNERS

(Continued from page 93)

control stations, approach and departure stations, weather, FAA Air Route Traffic Control Centers, FAA Flight Service Stations, and all sorts of other interesting stations to monitor. You might even hear the FAA's special "Flight Check" aircraft, which test the accuracy of the electronic navigation systems at major airports; those stations can often be overheard on 135.85 MHz (alternate 135.95 MHz).

A complete updated directory of all VHF aero frequencies and stations in the USA and Canada, including the airlines, is called *Air-Scan* (4th Edition). It's a large, 120-page directory which gives you thousands upon thousands of listings and is the most comprehensive directory of its kind ever assembled. It includes all military, private, and commercial airports, plus airports not open to the public. That

new book is \$10.95 (plus \$1 postage to addresses in USA/Canada/APO/FPO). Order it from CRB Research, P.O. BOX 56-GP, Commack NY 11725.

Mailbag

Will J. Gilmartin of Illinois writes to ask if we can supply him with information on the communications frequencies used by the Federal Emergency Management Agency. He says that he has seen their units in operation, but can't seem to get a handle on the frequencies they use. Listen in on 142.35, 142.425, 142.975, and 143.00 MHz, and you may well hear what you're seeking.

Charles Hallinger, who hails from California, passes along the information that 156.625 MHz is a frequency used for operations and general communications connected with offshore powerboat races. That frequency is used in all areas.

O.N. Creighton of Atlantic City, NJ, notes that the State of New Jersey has a

special task force that keeps tabs on all of the gambling casinos in Atlantic City. If you are going there for a visit, listen to that agency on 460.25, 460.475, and 460.50 MHz.

A reader in Dallas, TX, who asks that we not use his name here, reports hearing "unusual" communications on 167.05 MHz. Those stations were using coded identifications such as "Lima 65." He asks if we can figure out what that was. Normally it's almost impossible to pinpoint so-called "tactical" identifications; however, 167.05 MHz is dead giveaway. That is the FCC's frequency and "Lima 6" is the ID they use in Dallas. Each local office has a similar coded ID, for instance "Charlie 2" is Kansas City MO, "Foxtrot 7" is Norfolk VA, "Romeo 5" is New Orleans, "Whiskey 6" is New York, and so on.

Let's have more reader letters. And what about some photos of your monitoring stations? ■

INFRARED REMOTE CONTROL

(Continued from page 55)

LED's are more efficient than others and some collimate the light where a wide angle of dispersion would be desirable here. Even some visible-red LED's emit sufficient energy for testing purposes, but yield an extremely limited distance of operation for the transmitter.

The transistors used in this design are readily available and are conservatively rated for this application. If you do substitute here, make sure that the transistors have no leakage when no base current is applied. A leaky transistor will drain the battery or disable the key matrix. It is best to stay away from factory seconds and grab-bag specials.

Total component cost for the Infrared R/C Transmitter can be kept around twenty dollars, depending upon the number of switches the builder wants to use.

Integrated circuit U1, the MC14457, will be the most difficult part to locate. Not so much from an availability standpoint, but due to current slack demand by hobbyists, which generates little advertising by distributors. You might have to look in several catalogs or make a few phone calls. I found one in a mail-order catalog for under five dollars and received it in ten days. Most mail-order outfits have minimum-order dollar amounts, so it would be wise to find the chip first and then make up the difference, if possible, with the other components you might need, instead of buying the common parts first.

Testing

Once all parts are soldered into place and you have made sure that U1, U2, and all diodes and capacitors are properly installed, connect a 9-volt battery to the circuit. You should be able to start sending commands immediately with your Infrared R/C Transmitter to your television set or channel-converter box by making the appropriate switch closures.

If your unit doesn't work, first check the polarity of the LED1 and LED2 to make sure that they were installed properly. Also check pin 16 of U1 and pin 14 of U2 with a high-impedance input voltmeter. The meter should read approximately 8.3 volts if diode D1 is good.

The next step is to substitute a visible red LED for one of the infrared LED's.

All switch closures should generate either a short or continuous burst of light, depending upon the function selected. If that test passes, the odds are that there is either a malfunction in the receiver or a compatibility problem. If the LED produces no light, check each row and column input on U1 with a high-impedance input voltmeter. Each line should be at approximately 8 volts with no switch depressed. If a line is low, a shorted or leaky transistor is the probable cause.

If your unit still fails to work, use an oscilloscope to follow the data through U2, Q5, and Q6 to determine the problem. If no scope is available, substitution of U1, U2, Q5, and Q6 is in order.

One final note to the builder. Although the Infrared R/C Transmitter project described in this article requires no connection or modification to the cable channel converter box, and generates no interfering or detectable signals, it would still be courteous to check the cable company's policies before using that device. ■

Radio-Electronics

SPECIAL REPRINT
BUILD A BACKYARD SATELLITE TV RECEIVER



NEWLY EXPANDED 1985 EDITION
Includes Antenna Rotator and
RF Converter for Stereo
Build Your Own and Save Dollars

Don't miss out again!

Send away today for your 36-page booklet containing a complete reprint of all seven articles in the series on Backyard Satellite TV Receivers by Robert B. Cooper, Jr.

This all-inclusive report give syou all the data you need to build your own Backyard Satellite TV Receiver

- TELLS ALL ABOUT domestic satellite communications, with full details on how you can pull those elusive TV signals from space
- LEGAL REQUIREMENTS, technical

specifications, and how you, the home constructor, can meet them. Find out what mechanical and electronics skills you need

- RECEIVER CHARACTERISTICS, technical details and specifications, along with examples of actual receivers built at comparatively low cost
- ANTENNA DESIGN and exactly how you can build a spherical antenna, while keeping total earth-station cost for the complete system under \$1,000
- THE FRONT END is critical when you build your own system. We help you explore several different approaches to making one

that will work for you.

- RECEIVER-SYSTEM hardware, and how it goes together to bring you direct-from-satellite TV reception in your own home

To order your copy:

Complete coupon and enclose it with your check or money order for \$7.00, plus \$1.00 for postage and handling. We will ship your reprint within 6 weeks of receipt of your order. All others add \$4.00 for postage. New York State residents must add 5% sales tax.

March of Dimes SAVES BABIES
HELP FIGHT BIRTH DEFECTS

Radio-Electronics Satellite TV Reprints
45 East 17th Street
New York, N.Y. 10003

Please print
Name _____
(Street address) _____
(City) _____ (State) _____ (Zip) _____

I want _____ reprints @ \$7.00 each, plus \$1 for handling & First Class postage
I have enclosed \$ _____ N.Y. State residents must add sales tax (U.S. and Canada only)

A RS-232 PORT

(Continued from page 72)

The ZX80 and 8K RAM Addition

Another very useful addition to the ZX81 is an 8K battery-backed-up CMOS RAM board that was described in the July and August 1983 issues of *Radio-Electronics*. The interface is designed to work with or without the CMOS RAM addition. Back issues describing the circuit are available from: Radio-Electronics Reprint Department, 200 Park Ave. South, New York, NY 10003. Each back issue costs \$3.50, and you must include \$1 per item for postage and handling. Photocopies of the article are also available at 50¢ per page. (The article ran a total of 9 pages.)

If the 8K CMOS RAM is to be used, diode D1 is not necessary since the ROMCS signal is already provided. That means that the 8K CMOS RAM must be disabled when using addresses 16382 and 16383. That's easily done by simply connecting two disable lines to the 8K CMOS RAM board. One for \overline{RD} cycle and the other for \overline{WR} cycle. The \overline{RD} line between the edge connector and the RAM's on the 8K CMOS RAM board is the only trace that needs to be broken. Jumper J2 is connected to the RAM side of the broken line and jumper J3 is connected to the pin 21 pad of JU2 on the 8K CMOS RAM board. If HM6116p-3's are used, the jumper connected to that point (pin 21 pad of JU2) should be disconnected. Jumper J3 is unnecessary if 2716s or 2732s are used.

If the 8K CMOS RAM is to be used then D1 must be removed. (D1 allows the interface to disable the system ROM whenever addresses above 8K are addressed.) Of course if you are not using the RAM board, then jumpers J2 and J3 will not be necessary and should not be connected.

There are really so many possible applications for the port. If you haven't come up with a good, useful task to dedicate your computer, let me suggest a dumb terminal. The 8K battery-backed-up CMOS RAM can be used for Sinclair code to ASCII conversion along with the communication control software. The communications interface eliminates the need

TABLE 3
COMMUNICATION CONTROL SOFTWARE

```
10 PRINT "TRANSMIT -1 or RECEIVE -2"
20 INPUT A
30 IF A = 2 THEN GOTO 100
40 PRINT "TYPE DECIMAL EQUIVALENT TO ASCII CODE"
50 INPUT D
60 POKE 16383, 160 (Turn buzzer & RED LED on during XMIT &
  RDAV)
70 POKE 16382, D (Transmit Data)
80 POKE 16383, 64 (Turn green LED on and RDAV)
85 CLS
90 GOTO 10
100 LET RC1 = PEEK 16383 (Read control port)
110 IF RC1 <= 127 THEN GOTO 1500 (Is data available?)
1110 LET RD = PEEK 16382 (Read in received data)
1115 POKE 16383, 64 (Turn green LED on and RDAV)
1116 PRINT "DATA = ";RD, "BUT MUST BE CONVERTED FROM
  ASCII"
1118 PAUSE 100
1120 CLS
1400 GOTO 10
1500 CLS
1510 PRINT AT 11, 1; "ERROR OCCURRED DURING SERIAL IN-
  PUT"
1520 PAUSE 200
1530 POKE 16383, 65 (Turn green LED on and reset UART)
1535 CLS
1540 GOTO 10
```

to spend upwards of \$600.00 on a dumb terminal that does the same thing.

The ZX80 computer, which was the forerunner of the ZX81, can also be used with this communications port. The only difference is that the output port of the ZX80 has no connection in place of the ZX81's ROMCS line. But that can be easily fixed by running a jumper from the pin 23-b on the ZX80's edge connector to pin 20 of IC2 inside the Sinclair. That is the chip-select signal for the system 8K ROM. You'll also have to modify the circuit board of the ZX80. Break the trace that runs from pin 7 of U6 to pin 20 if the ROM inside the ZX80. Then bridge the break with a 680-ohm resistor. ■



\$350

NEW IDEAS

42 PROJECTS
COMPLETE PARTS LISTS
ONE-EVENING PROJECTS
EASY TO BUILD

■ NEW IDEAS is packed with 42 practical circuits for the Electronics Experimenter and Project Builder. In addition to the headlight alarm, the voltage freezer, and the remote telephone ringer, you get complete plans for a simple Tesla coil project that can generate 25,000-volts AC and draw one-inch sparks. Other interesting projects are: a sound-effects generator, a crystal tester, a stereo remote control, and much, much more! Each project was selected for its low cost of parts!

■ WANT TO EXPAND your knowledge of electronics? Build gadgets that only you can have on your block? Acquire a library of projects? NEW IDEAS is the gold mine of circuits you should own and read. You could start the first night building a project that will have others praising what it can do and admiring you for building it.

■ THERE ARE PROJECTS for everyone—automotive, household, test equipment, audio and hi-fi, and projects just for fun.

NEW IDEAS—Circuits for Experimenters and Project Builders!

Please send one copy of NEW IDEAS at \$3.50. First Class postage and handling \$1.00 (U.S. and Canada only). All other countries: \$2.00 for sea mail, \$3.00 for air mail

Please send _____ copies of New Ideas. Total cost is sum of copy price and First Class postage and handling cost multiplied by number of issues ordered.

Please print

Allow 6-8 weeks for the material to arrive.

Detach and mail today:
HANDS-ON ELECTRONICS
Reprint Department
200 Park Avenue South
New York, NY 10003

(Name) _____

(Street Address) _____

(City) _____

(State) _____

(Zip) _____

All Payment must be in U.S. Funds!

Radio-Electronics Software Store

New for our readers....A mailorder source of software for Atari 400, Atari 800, IBM P C, Commodore VIC-20, Apple II, and other personal computer systems.

IBM PC



FLIGHT SIMULATOR by Microsoft ... List \$49.95. Our price ... \$43.00. Highly accurate simulation of flight in a single-engine aircraft. Working instruments. Out the window graphics. Real-time flight conditions. (IBM P C, 64k, color graphics, disc)

EASYWRITER II by Information Unlimited ... List \$350.00. Our price ... \$300.00. Turns your computer into a word processor. You see everything on the screen. There are no imbedded commands. (IBM P C, disc)



DEADLINE by Infocom ... List \$49.95. Our price ... \$43.00. A locked door. A dead man. You have 12 hours to solve the mystery. One false move, and the killer strikes again. (IBM P C, 48k, disc)

ALGEBRA, Vol. 1 by Eduware ... List \$39.95. Our price ... \$34.00. A first year algebra tutorial covering definitions, number line operations, sets, etc. (IBM P C, 48k, color graphics, disc)



MICRO/TERMINAL by Microcom ... List \$94.95. Our price ... \$83.00. Allows access to remote mainframes and minis, information data banks, and other personal computers. (IBM P C, disc)

PC TUTOR by Comprehensive Software ... List \$79.95. Our price ... \$69.00. Interactive program teaches you how to use your IBM Personal Computer, including hardware and software. (IBM P C, 64k, disc)



APPLE



PRISONER2 by Interactive Fantasies ... List \$32.95. Our price ... \$28.00. Escape is hardly possible. The island keeps you under surveillance. Just try and get out! (Apple II, 48k, disc)

PRISONER2 by Interactive Fantasies ... List \$39.95. Our price ... \$34.00. (Atari disc)

THE MASK OF THE SUN by Ultrasoft Inc ... List \$39.95. Our price ... \$34.00. An animated adventure through a series of hi-res screens. An ultimate adventure challenge. (Apple II, 48k, disc)



MASTERTYPE by Lighting Software ... List \$39.95. Our price ... \$34.00. A typing instruction system in an exciting hi-res game format. Learn to type while battling waves of attacking enemy words. (Apple II, 48k/64k, disc)

THE GRAPHICS MAGICIAN by Penguin Software ... List \$59.95. Our price ... \$53.00. Make your own animated graphics. Handles up to 32 independent objects. Stores hundreds of color pictures. (Apple II, 48k, disc)



RENDEZVOUS by Eduware ... List \$39.95. Our price ... \$34.00. In four phases, simulates an actual space-shuttle flight from Earth Liftoff through Orbital Rendezvous and Approach to Alignment Docking with a space station. Hi-res graphics (Apple II, disc)

SAT WORD ATTACK SKILLS by Eduware ... List \$49.00. Our price ... \$43.00. A tutorial for mastering vocabulary, deciphering new or unfamiliar words, and taking tests. (Apple II, disc)



COMMODORE VIC-20



PIPES by Creative Software ... List \$39.95. Our price ... \$34.00. Connect a pipeline from the water supply tank to every house. Watch out for leaks. Use as little pipe as possible. 5 skill levels. (Commodore VIC-20 cartridge)

SHAMUS by Human Engineered Software ... List \$39.94. Our price ... \$34.00. Only you can stop the Shadow's mad reign of terror. Two levels with 20 rooms each. A joystick challenge. (Commodore VIC-20 cartridge)



HOUSEHOLD FINANCE by Creative Software ... List \$17.95. Our price ... \$15.00. Home utility program records and analyzes your monthly income, expenses and budget in 16 categories. (Commodore VIC-20 tape cassette)

HOME OFFICE by Creative Software ... List \$29.95. Our price ... \$25.00. Combines VICPRO, a flexible and efficient word processor with VICDATA a powerful and sophisticated information storage and retrieval system. (Commodore VIC-20, cassette tape, 8k additional memory required)



ATARI



SUBMARINE COMMANDER by Thorn EMI ... List \$49.95. Our price ... \$43.00. A submarine patrol simulator to hunt and destroy enemy ships. 9 skill levels. Plug-in cartridge. (Atari Cartridge 400/800)

APPLE

MINER 2049 by MicroLab ... List \$39.95. Our price ... \$34.00. Chase into a Uranium mine thru 10 levels of traps and capture Yukon Yohan. Scale ladders, jump from moving platforms, and win—if you can. (Apple II, 48k, disc)



Radio-Electronics Software Store

200 Park Avenue South
New York, NY 10003

Number of items ordered

Total Price of Software \$ _____

Sales Tax (NY State Residents Must Include) \$ _____

Shipping (\$2.00 per item) \$ _____

TOTAL ENCLOSED (Sorry, No COD's) \$ _____

Name _____

Address _____

City _____ State _____ ZIP _____

SORRY - NO CREDIT CARD OR COD ORDERS

BUDGET PRINTER MADE VALUABLE

(Continued from page 92)

To install the *Micro-Grip* retrofit it is necessary to very slightly dismantle the printer's feed mechanism so the rubber rollers can be fitted to the tractor-drive bar (instructions are

provided in the kit). It is, however, a minor disassembly, and the whole installation shouldn't take more than 10 or 15 minutes. Just be certain you don't push or bend anything while you are doing the work—do everything very, very gently.

When you see the *Micro-Grip* installed you won't believe it

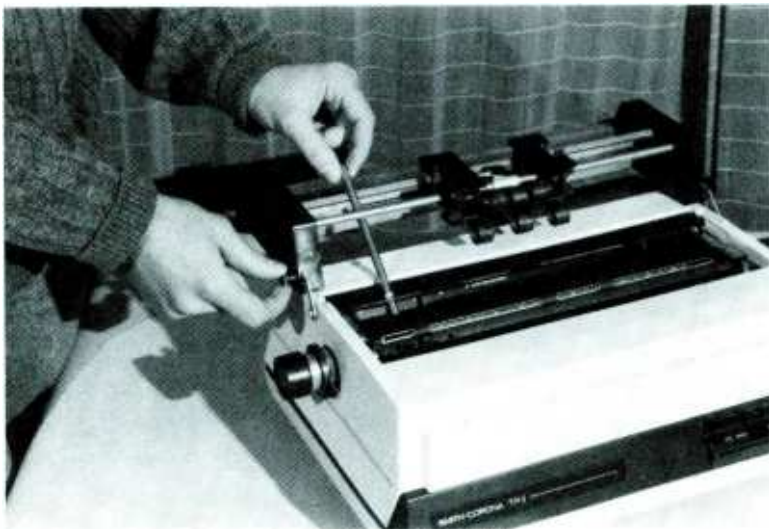

Slide the supplied gauge (a notched rod) on the drive bar, tighten two screws, and the tractor assembly is ready for use.

will work, but it does.

To use continuous form tractor paper you simply slide the two rubber rollers to the side and reset the tractors, or leave the rollers where they are and pull the paper bail (with its roller) away from the paper; the Epson will print on continuous tractor feed forms just as well without the bail.

Tractor feed

The tractor feed upgrade for the Smith-Corona *TP*'s isn't really a retrofit because it does not really become a permanent part of the printer, it can be easily removed in seconds. The tractor feed mechanism, which is available from some (not all) Smith-Corona dealers and the Smith-Corona service centers is a "passive" tractor feed, meaning it's really a guide that insures precise registration even though the paper is really driven by the normal platen mechanism—just like a single sheet.

The supplied documentation shows how to install and adjust the tractor mechanism itself, all of a 10 minute job at the very worst. A special gauge is provided in the kit for alignment of the tractor mechanism. The whole project looks much more difficult than it is. Actually, separating the back of the casing top from the base will be the most difficult part of the upgrade.

With the tractor-mechanism upgrade the *TP-1/TP-2* can accommodate either single sheets, tractor-fed sheets, or tractor-fed forms and labels. As with the Epson retrofits, you lose nothing; you only gain. ■

SOLAR CELL TESTER

(Continued from page 44)

lines on the face of the cell are negative and they go to ground.

You must make sure that a good electrical contact is made to the cell's terminals. We are dealing with a very small voltage here, and the least bit of resistance could make a significant difference in your readings. Use a fair amount of pressure on the contacts to ensure a good connection. However, care must be taken that excessive pressure isn't applied to the cell at any time, for they are very thin and fragile—and break easily! A well-designed cell holder comes in handy here.

The CALIBRATION control, R14, sets the test voltage, which is usually calibrated to 450-millivolts—a one-time setting should last forever. However, you may wish to alter the test voltage to satisfy a particular criterion.

There you have it! From here on in, don't guess—let the Solar-Cell Tester check it out! ■

JENSEN ON DXING

(continued from page 56)

First there is the *Voice of America's* powerful relay SW stations at Poro and Tinang. The *VOA* overseas relay broadcasts come from such places as West Germany, Great Britain, Morocco, Botswana and Liberia in Africa, Antigua in the West Indies, Greece, Sri Lanka, Brazil and the Philippines. The purpose, of course, is to be able to put better signals into the far-flung corners of the world.

A few times and frequencies: 1300 UTC on 6,030 kHz; 1700 UTC on 6,110 kHz; 1400 UTC on 9,725, 11,945 kHz.

There also are two active religious SW broadcasters in the Philippines: *Radio Veritas*, a Roman Catholic voice, 1430 UTC on 11,955 and 15,240 kHz; and the

Far East Broadcasting Co., a Protestant station, 0830 UTC on 11,890 kHz.

Guam—Another religious broadcaster, *Trans-World Radio*, which also operates from Europe, Africa, and the West Indies, has a powerful station on that mid-Pacific island. *KTWR* can be heard about 0000 UTC on 11,790 kHz, and 17,790 kHz.

Saipan—*KYOI* is in the business of bringing American pop music and commercials to Japan by SW, 24 hours a day. Programming is mostly in Japanese, naturally, but there are English identifications, too.

Hearing that one is largely a matter of finding the right frequency for prevailing propagation conditions, since it is on all the time. Some channels to try are 9,665,

11,900, 15,190 and 15,405 kHz.

Indonesia—That, along with Brazil, is one of the most active countries on SW. The government operates a foreign-service SW station called the *Voice of Indonesia*, which broadcasts in English at 0800 and 1500 UTC on 11,770 kHz.

In addition, however, there are home-service SW operated by the *Radio Republik Indonesia* network in more than 40 different cities from Irian Jaya, the western half of the island of New Guinea, to the tip of Sumatra.

Those RRI stations are favorite targets of DX'ers, and range in terms of reception from the relatively common to the very rare catch.

Some worth trying for between about 1000 and 1400 UTC include: RRI Jay-

apura, 9,611 kHz; RRI Jogjakarta, 5,046 kHz; RRI Jakarta, 6,045 kHz; RRI Ambon, 4,845 kHz; RRI Palu, 3,960 kHz; RRI Timor, 3,985 kHz; RRI Kendari, 4,000 kHz, and RRI Manado, 3,215 kHz.

Additionally, there are local governmental stations—in the U.S. the equivalent would be at the county level—which number in the hundreds. A few are heard occasionally in North America; most have never been logged here. Programming is all in Indonesian, of course.

Just as an example, one experienced listener, Ralph Perry, who currently lives

and DX's from Kuala Lumpur in Malaysia—just a stone's throw from Indonesia—reports that one of those stations, *Radio Pemerintah Daerah Kabupaten Karo* in the provincial town of Kabanjahe now operates on a frequency wandering around 4,191 to 4,196 kHz. That is a bit too exotic for most North Americans to even try.

Tahiti—The *Radio-TV Francaise d'Outre Mer (RFO)* station at Papeete may be just about everyone's favorite Pacific SW outlet. That one is an exotic catch that fires the imagination, par-

ticularly when it is programming that fantastic local music!

Tune for Tahiti on 15.170 kHz around 0300 UTC: or perhaps on 6.135, or just a bit off 9.750 and 11.825 kHz later in the evening, say 0600 to 0730 sign off.

Cook Islands—*Radio Cook Islands* is another bit of exotica and can be heard on 11.759 kHz in the Maori language from about 0700 UTC, with English news following at 0800 UTC.

Solomon Islands—The Solomon Islands Broadcasting Service at Honiara is another nice logging for those prowling the SW's for Pacific treasures. Tune 9.545 kHz around 0700 UTC, or 5.020 kHz between about 1000 and 1300 UTC.

Vanuatu—That used to be known as New Hebrides, but the local name has been substituted for the Scottish. The SW signals of *Radio Vila* can be heard on about 7.260 kHz from around 0700 to past 0800 UTC, and they're worth losing some sleep to hear.

New Caledonia—Another bit of France in the Pacific is New Caledonia. The RFO station here is located at Noumea and operates on both 3.355 and 7.170 kHz. Tune for that broadcaster around 0800 to 1200 UTC.

Sarawak and Sabah—Those two parts of the nation of Malaysia are physically separated from the mainland Asia portion, both being located on the island of Borneo. And they have their own SW stations.

Radio Malaysia Sarawak has broadcasting stations at Sibul 5,005 kHz and at Kuching on 5,030 kHz. Sabah's station is *Radio Malaysia Kota Kinabalu*. You can try for all three around 1300 UTC.

Papua New Guinea—That country includes the eastern half of the huge island of New Guinea, plus some off-shore archipelagos. Such a widespread nation, understandably, relies on SW radio to keep its people informed. PNG operates a network of stations which provide the DX'er with interesting listening targets.

Long the best bet for tuning that country has been the *National Broadcasting Commission* station at Port Moresby. That station transmits on 4,890 kHz during the morning hours in North America until 1400 UTC.

That's It

Now you have plenty of Pacific area listening targets for your SW tuning.

I'm always interested in knowing what you readers are hearing. Share your Pacific catches and other SW loggings with others through this column. And your questions, plus your photos of your listening post, are always welcome! I'll include as many as I can in future columns, so keep them coming to *Jensen on DX'ing*, **Hands-On Electronics**, Gernsback Publications, Inc., 200 Park Avenue South, New York, New York 10003.

Electronics Paperback Books

NEW Paperbacks You'll Want To Read

CHECK OFF THE ONES YOU WANT

AN INTRODUCTION TO PROGRAMMING THE ATARI 800/800XL...\$5.00. This book is designed to complement the information supplied by the manufacturer. Essential reading for all Atari owners.

20 PROGRAMS FOR THE ZX SPECTRUM & 16K ZX81...\$5.00. In-cluded with each program is a detailed flow chart for both games and practical applications in filing, statistics, and engineering.

BASIC PASCAL IN PARALLEL...\$3.75. Develops programs in both languages; amply illustrates programs illustrate structure.

30 SOLDERLESS BREADBOARD PROJECTS...\$5.75. 30 more new projects based on CMOS IC's that can be done in minutes on an electronic breadboard.

MICRO INTERFACING CIRCUITS—Book 1...\$5.75. In-depth coverage of how the ex-posed pins can interface add-on of all kinds to his home computer to trans-form it into a sophisticated piece of control equipment.

HOW TO GET YOUR ELECTRONIC PROJECTS WORKING...\$5.00. When you can't get that home-built equipment to work, this book may have the answers you need.

INTERNATIONAL CODE EQUIVALENTS GUIDE...\$5.75. Find substitutes when you need them for codes, traces, thyristors, OC's, photodiodes and display codes.

DESIGN & MAKE YOUR OWN PRINTED CIRCUIT BOARDS...\$5.75. Everything you ever needed to know about how to make printed circuit boards at home.

ART OF PROGRAMMING THE 16K ZX81...\$4.25. What happens when you add the RAM pack, Scrolling graphics and more.

MULTI-CIRCUIT BOARD PROJECTS...\$5.00. 21 simple projects that can all be built on one circuit card. Use the same components in several projects.

A PRACTICAL INTRODUCTION TO MICRO-PROCESSORS...\$5.00. The reader will construct his own simple micro-processor circuit and learn more about how microprocessors work.

25 SIMPLE AMATEUR BAND ANTENNAS...\$5.00. Includes designs for dipoles, beams, triangle and even a mini-omni-antenna. Includes a complete set of dimension tables.

INTERNATIONAL TRANSISTOR EQUIVALENTS GUIDE...\$7.50. Lists possible substitutes for a popular user-oriented selection of modern transistors. The products of more than 100 manufacturers are included.

PRACTICAL ELECTRONIC BUILDING BLOCKS, Book 1...\$5.75. Electronic circuits are all made up of individual building blocks. Make the blocks, then combine them to build the circuits you need.

EASY ADD-ON PROJECTS FOR SPECTRUM, ZX81...\$7.00. Plus di-rector, picture digitizer, 5-key pad, model controller, light pen and more.

INTERNATIONAL EQUIVALENTS GUIDE...\$7.50. Lists possible substitutes for a popular user-oriented selection of modern transistors. The products of more than 100 manufacturers are included.

PRACTICAL ELECTRONIC BUILDING BLOCKS, Book 2...\$5.75. Follow up to Volume 1 presents more building blocks for the experimenter.

ELECTRONIC SIMPLIFIED-CRYSTAL SET CONSTRUCTION...\$4.50. All of these receivers are designed around modern inexpensive components and hand-wound coils.

MODEL RAILWAY PROJECTS...\$5.00. Electronic projects that will make your model rail-road more realistic in both appearance and sound.

ELECTRONIC TECHNOLOGY TODAY INC. HOE # 4
P.O. Box 240, Massapequa Park, NY 11762

Number of books ordered

Total Price of Books _____

Sales Tax (NY State Residents only) _____

Shipping and Handling (75¢ 1 or 2 books 30¢ each add'l book) _____

TOTAL ENCLOSED _____

Name _____

Address _____

City _____

PRICES GOOD UNTIL June 30

HANDS-ON MARKETPLACE

PLANS AND KITS

PROJECTION TV...Convert your TV to project 7 foot picture...Results comparable to \$2,500.00 projectors...Total cost less than \$30.00...Plans and 8" lens \$19.95...Illustrated information free. **MACROCOMA-GH**, Washington Crossing, PA 18977. Creditcard orders 24 hours. (215) 736-3979.

CATALOG: Hobby, radio broadcasting, CB, lowfrets. Transmitters, linears, active antennas, converters, scramblers, bugging devices, more! **PANAXIS**, Box 130-F4, Paradise, CA 95969.

DIGITAL Klock Kit plays 1-of-12 melodies each quarter hour. Displays time, date, and other features. Send \$2.50 for assembly plans and pricing to **KERBER KLOCK KO**, 36117 Hillcrest, Eastlake, OH 44094.

SCANNERS

JOIN 30,000 other scanner owners in the nation's largest not-for-profit association of scanner owners. Bi-monthly publication with tech tips, fascinating true stories, news of new listening adventures. Plus member benefit package including car rental discounts, no-extra-cost insurance coverage, free classified ad service, and more. Send just \$9.75 for 10-month trial membership to: **SCANNER ASSOCIATION OF NORTH AMERICA**, 240-A Fencil Lane, Hillside, IL 60162.

CABLE TV "CYLINDERS"

SUPER powered notch filters. Equivalent of cable company "cylinders". Eliminate undesirable signals. Any channel 2 through 8; 14(A) through 22(I). (Please specify.) Send \$20.00 each. **Money back guarantee**. Quantity discounts. **CATV**, Box 17621, Plantation, FL 33318.

FOR SALE

CABLE-TV Secrets—the outlaw publication the cable companies tried to ban. HBO, Movie Channel, Showtime, descramblers, converters, etc. Suppliers list included. \$8.95. **CABLE FACTS**, Box 711-R, Pataskala, OH 43062.

RESISTORS 1/4W&1/2W5% 3 cents. 1% metal films, precision custom wirewounds, \$1.00 refundable to: **JR INDUSTRIES**, 5834-B Swancreek, Toledo, OH 43614.

FREE catalog featuring scanner accessories, carrier/subcarrier detectors, voice scramblers, unusual kits. **CAPRI ELECTRONICS**, Route 1R, Canon, GA 30520.

THE Intelligence Library—Restricted technical information & books on electronic surveillance, surveillance-device schematics, lock-picking, investigation, weapons, identification documents, covert sciences, etc. The best selection available. **Free brochures**. **MENTOR**, (Dept. Z), 135-53 No. Blvd., Flushing, NY 11354.

CABLE television, copy of Federal laws \$10.00. **ROBERTS**, PO Box 63 6025, Margate, FL 33063.

INDIVIDUAL photofact folders, No. 1 to no. 1400, \$3.00 postpaid. **LBT**, 414 Chestnut Lane, East Meadow, NY 11554.

WHOLESALE F-59 cable connector \$80.00/1000. **Free MATV catalog**. S.A.S.E. (212) 897-0509. **D&WR**, 68-12 110 Street, Flushing, NY 11375.

TI-99/4A software/hardware bargains. Hard-to-find items. Huge selection. Fast service. **Free catalog**. **DYNA**, Box 690, Hicksville, NY 11801.

FREE Automotive Security Catalog. Largest selection available. Do-it-yourself pagers, alarms, hood/locks, glass detectors. Allow 4 weeks for delivery, or for rush send \$1.00. **AUTOMOTIVE SECURITY EQUIPMENT COMPANY**, Dept. 1, PO Box 382, Plainview, NY 11803.

TUBES, new, unused. Send self-addressed, stamped envelope for list. **FALA ELECTRONICS**, Box 1376-2, Milwaukee, WI 53201.

SATELLITE TELEVISION

SATELLITE-TV receiver breakthrough! Build your own system and save! **Instruction manuals, schematics, circuit boards!** Send stamped envelope: **XANDI**, Box 25647, Dept. 21K, Tempe, AZ 85282.

PCB for Satellite Stereo Project in October article is now only \$15.00. **JIM RHODES, INC.**, 1025 Ransome Lane, Kingsport, TN 37660.

BUSINESS OPPORTUNITIES

US \$8.00 including disk thousand name brand programs for Apple IBM-PC details **RELIANT**, PO Box 33610, Sheungwan, Hong Kong.

MECHANICALLY inclined individuals desiring ownership of small electronics manufacturing business—without investment. Write: **BUSINESSES**, 92-R, Brighton 11th, Brooklyn, NY 11235.

CLASSIFIED AD ORDER FORM

To run your own classified ad, put one word on each of the lines below and send this form along with your check to:

Hands-on Electronics Classified Ads, 200 Park Avenue South, N.Y., N.Y. 10003

PLEASE INDICATE in which category of classified advertising you wish your ad to appear. For special headings, there is a surcharge of **\$10.00**.

() Plans/Kits () Business Opportunities () For Sale
() Education/Instruction () Wanted () Satellite Television
() _____

Special Category: \$10.00

PLEASE PRINT EACH WORD SEPARATELY, IN BLOCK LETTERS.

(No refunds or credits for typesetting errors can be made unless you clearly print or type your copy.) Rates indicated are for standard style classified ads only. See below for additional charges for special ads. **Minimum: 15 words.**

1	2	3	4	5
6	7	8	9	10
11	12	13	14	15 (\$18.75)
16 (\$20.00)	17 (\$21.25)	18 (\$22.50)	19 (\$23.75)	20 (\$25.00)
21 (\$26.25)	22 (\$27.50)	23 (\$28.75)	24 (\$30.00)	25 (\$31.25)
26 (\$32.50)	27 (\$33.75)	28 (\$35.00)	29 (\$36.25)	30 (\$37.50)
31 (\$38.75)	32 (\$44.00)	33 (\$41.25)	34 (\$42.50)	35 (\$43.75)

We accept MasterCard and Visa for payment of orders. If you wish to use your credit card to pay for your ad fill in the following additional information (Sorry, no telephone orders can be accepted.):

Card Number _____

Expiration Date _____

Signature _____

IF YOU USE A BOX NUMBER YOU MUST INCLUDE YOUR PERMANENT ADDRESS AND PHONE NUMBER FOR OUR FILES. ADS SUBMITTED WITHOUT THIS INFORMATION WILL NOT BE ACCEPTED.

CLASSIFIED COMMERCIAL RATE: (for firms or individuals offering commercial products or services) \$1.25 per word prepaid (no charge for zip code)...**MINIMUM 15 WORDS**. 5% discount for same ad in 6 issues; 10% discount for same ad in 12 issues within one year; if prepaid. **NON-COMMERCIAL RATE:** (for individuals who want to buy or sell a personal item) \$1.00 per word, prepaid...no minimum. **ONLY FIRST WORD AND NAME** set in bold caps at no extra charge. Additional bold face (not available as all caps) 25¢ per word additional (20% premium). Entire ad in boldface, add 20% premium to total price. **TINT SCREEN BEHIND ENTIRE AD:** add 25% premium to total price. **TINT SCREEN BEHIND ENTIRE AD PLUS ALL BOLD FACE AD:** add 45% premium to total price. **EXPANDED TYPE AD:** \$1.85 per word prepaid. All other items same as for STANDARD COMMERCIAL RATE. **TINT SCREEN BEHIND ENTIRE EXPANDED TYPE AD:** add 25% premium to total price. **TINT SCREEN BEHIND ENTIRE EXPANDED TYPE AD PLUS ALL BOLD FACE AD:** add 45% premium to total price. **DISPLAY ADS:** 1" x 2 1/4"—\$135.00; 2" x 2 1/4"—\$270.00; 3" x 2 1/4"—\$405.00. **General Information:** Frequency rates and prepayment discounts are available. **ALL COPY SUBJECT TO PUBLISHERS APPROVAL. ADVERTISEMENTS USING P.O. BOX ADDRESS WILL NOT BE ACCEPTED UNTIL ADVERTISER SUPPLIES PUBLISHER WITH PERMANENT ADDRESS AND PHONE NUMBER.** Copy to be in our hands on the 15th of the third month preceding the date of the issue. (i.e., August issue copy must be received by May 15th). When normal closing date falls on Saturday, Sunday or Holiday, issue closes on preceding working day.

CALLING ALL HAMS
(Continued from page 95)

65 feet in the first try. The helical wire is No. 16 with vinyl insulation. Final version obtained 40-meter resonance with approximately 54 feet. That is strictly a cut-and-try final procedure, but the length specified above will bring you near resonance should you use my construction data.

In the initial checks I must have lifted off the mast about fifteen times, and start-

ed the winding from scratch three times. You will be relieved of that initial drudgery. However, several lifts might be needed to resonate the helical on some preferred frequency. That is no big problem because of the wide helical bandwidth and the light weight of the PVC piping.

The final version of the W3FQJ PVC helical is shown in Figs. 2 and 3. Two ten-foot sections of PVC piping are telescoped together for a distance of 2 feet. They are held firmly by two eye-ring

through-bolts. A total of 13 such bolts are used, spaced as shown on the right side of the mast. Two through-bolts and associated nuts are used as the two terminals of the vertical. Bottom end of spiral wire is attached to one terminal and the four 31-foot resonant radials are connected to another. Inner conductor and braid of the coaxial line are attached to these two terminals as shown in Figs. 2 and 4. For a permanent job you may wish to use epoxy protection and/or VHF sealant tape.

In winding the helical, notice that the turns are wide-spaced at top and bottom.

(Continued on page 106)

Radio-Electronics REPRINT BOOKSTORE

- | | | | |
|--|---------|--|--------|
| <input type="checkbox"/> Build Your Own Satellite TV Receiver | \$7.00 | <input type="checkbox"/> Special Projects (Spring 1981) | \$4.50 |
| <input type="checkbox"/> 8-Ball Satellite TV Antenna | \$5.00 | <input type="checkbox"/> Special Projects #4 (Summer 1982) | \$4.50 |
| <input type="checkbox"/> Build Your Own Robot | \$12.00 | <input type="checkbox"/> Special Projects #5 (Winter 1983) | \$4.00 |
| <input type="checkbox"/> TV Descrambler (January, February 1981) | \$3.00 | <input type="checkbox"/> Special Projects #6 (Spring 1983) | \$4.00 |
| <input type="checkbox"/> Radio-Electronics back issues (1984) | \$3.00 | <input type="checkbox"/> Special Projects #7 (Summer 83) NOT AVAILABLE | |
| <input type="checkbox"/> Radio-Electronics back issues (1983) | \$3.50 | <input type="checkbox"/> Special Projects #8 (Fall 83) ... NOT AVAILABLE | |
| (January, February 1983 not available) | | <input type="checkbox"/> Special Projects #10 (Spring 84) | \$4.00 |
| Write in issues desired | | <input type="checkbox"/> Radio-Electronics Annual 1983 | \$3.50 |
| <input type="checkbox"/> Radio-Electronics back issues (1982) | \$3.50 | <input type="checkbox"/> Radio-Electronics Annual 1984 | \$2.50 |
| Write in issues desired | | <input type="checkbox"/> How to Make PC Boards | \$2.00 |
| <input type="checkbox"/> Radio-Electronics back issues (1981) | \$4.00 | <input type="checkbox"/> All About Kits | \$2.00 |
| (Jan., Feb., March, Dec. 1981 not available) | | <input type="checkbox"/> Modern Electrics (Vol. 1, #1 | \$2.25 |
| Write in issues desired | | April 1908) | |
| <input type="checkbox"/> Etch your own PC boards | \$3.00 | <input type="checkbox"/> Electro Importing Co. Catalog | \$4.95 |
| <input type="checkbox"/> Hands On Electronics #1 | \$3.00 | (1918) (176 pp) | |
| <input type="checkbox"/> RE Annual '85 | \$2.50 | <input type="checkbox"/> Low Frequency Receiving Techniques | \$6.00 |
| <input type="checkbox"/> VCR Repairs | \$3.00 | Building and using VLF Antennas | |
| <input type="checkbox"/> IBM Typewriter to | | <input type="checkbox"/> New ideas - 42 circuits for experimenters | \$3.50 |
| Computer Interface | \$3.00 | | |

To order any of the items indicated above, check off the ones you want. Complete the order form below, include your payment, check or money order (DO NOT SEND CASH), and mail to Radio-Electronics, Reprint Department, 200 Park Ave. South, New York, NY 10003. Please allow 4-6 weeks for delivery.

If you need a copy of an article that is in an issue we indicate is unavailable you can order it directly from us. We charge 50¢ per page. Indicate the issue (month & year), pages and article desired. Include payment in full, plus shipping and handling charge.

ARTICLE _____

PAGES _____ MONTH _____ YEAR _____

TOTAL PAGES _____ @ 50¢ each TOTAL PRICE _____

MAIL TO: Radio-Electronics
Reprint Department, 200 Park Ave. South, New York, NY 10003 **All payments must be in U.S. funds**

Total price of order

Sales Tax (New York State Residents only)

Shipping & Handling (U.S. & Canada only) (Includes FIRST CLASS POSTAGE) \$1.00 per item \$ _____

All other countries (\$2.00 per item, sea mail)

(\$4.00 per item, air mail)

Total Enclosed

Name _____

Address _____

City _____ State _____ Zip _____



Fig. 3—W3FQJ helical vertical is shown in the author's yard.

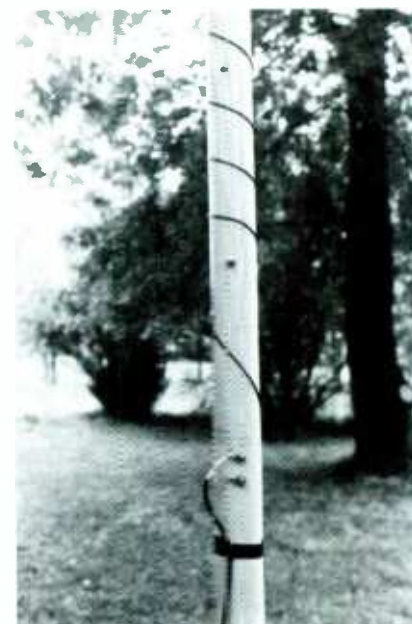

Fig. 4—The bottom of the helical antenna mast is shown here. Note the two terminals and the coaxial cable connected to them.

(Continued from page 105)

Close spacing is used over the central portion of the vertical as can be seen in Fig. 3. On the left side of Fig. 2, the number of winding turns between the sequence of eye-bolts is given. Follow that winding sequence to duplicate the W3FQJ performance as near as possible.

Mount Up

The PVC helical was slipped over a strong metal fence-post. Note in Fig. 2 that the overall length of the PVC piping was 18 feet. The metal fence post was driven into the ground and when the mast is set atop the fence post, the through-bolt of the ground terminal rests on the fence post top. As shown, that provided an addi-

tional 2-1/2 feet of antenna height. Thus, the very top of the helical was about 20 feet above ground. No guys are required. The usual metal 40-meter vertical is more than 30-feet high, and is much more difficult to erect, support and feed.

In our initial test of this antenna, a tuner was always used between transmitter output and antenna to protect the transmitter. Testing was done at low power. As mentioned previously, too many turns were used initially and it was possible to note the decline in SWR between the high end and low end of the 40-meter band. Then we began to clip away as the SWR kept falling until we removed approximately ten feet of wire. Each time, turns had to be shifted to occupy mast length. Once reso-

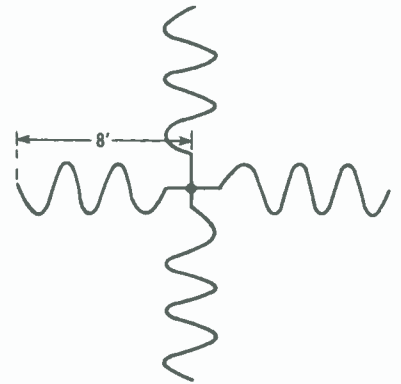

Fig. 5—The author placed the radials down in a lazy "S" fashioned in order to reduce the overall length to fit a space.

nance was obtained the SWR dropped to a level that required no tuner. Winding configurations were then shifted about to obtain the very lowest SWR.

Radials were 31-feet long. Stretch them out full length. However, we tried zig-zagging the radials out to 8 feet and, after adding several turns to base of helix, the same low SWR and bandwidth obtained. (See Fig. 5.) The bottom of helix is readily available for fine-tuning of turns after helical vertical is in position.

The low SWR and the wide bandwidth were not anticipated. The results were more startling. A 40-meter sloping dipole was used for comparison, its high end about 32 feet up. All reports were the same or little difference. VK contacts were made almost immediately. Ride the new wave (antenna) of the future.

Keep tuned in. ■

ADVERTISING INDEX

HANDS-ON ELECTRONICS magazine does not assume any responsibility for errors that may appear in the index below.

Free Information No.	Page
412	AF Publishing 12
422	AMC Sales 10
—	Active Electronics 20
426	All Electronics 4
428	American Design Components 5
418	Augat 30
—	C.I.E. 27-29
—	Command Productions 30
419	Deltex 16
417	Digi-Key 6-7
—	Educac 31
—	Electronic Book Club 13
—	ETT 103,106
420-421	Electronic Warehouse 9,11
415	Fluke C4
423	Galaxy 10
427	Halted 14
—	IC'S 3
410	Jameco C3
425	Jensen 14
411	Kepro 8
424	Mouser Electronics 8
—	N.R.I. 17-19
—	N.T.S. 37-39
414	Radio Shack 15
—	R-E Bookstore 10
413	Tektronix C2
416	Trio-Kenwood Communications 57

COMPUTER PAPERBACK BOOKS

Great Books For The Computer Hobbyist

CHECK OFF THE BOOKS YOU WANT

PROGRAMMING THE ZX SPECTRUM...\$7.50. Make this color computer do its stuff. With this book in hand it's easy.

AN INTRODUCTION TO PROGRAMMING THE ATARI 800...\$5.00. This text is designed to complement the information supplied by the manufacturer. Essential reading for all Atari owners.

DIGITAL IC PROJECTS...\$5.00. Simple & more advanced projects intended to help develop knowledge of digital circuits.

AN INTRODUCTION TO BASIC PROGRAMMING TECHNIQUES...\$5.00. Based on the author's own experience in learning Basic & helping others to learn to program & understand the language.

AN INTRODUCTION TO MICRO-PROCESSORS & COMPUTERS...\$4.50. An introduction to the basic theory and concepts of binary arithmetic, micro processor operation & machine language programming.

20 PROGRAMS FOR THE ZX SPECTRUM & 16K ZX81...\$5.00. Included with each program is a detail flow chart for both games and practical applications in timing statistics and engineering.

A MICRO-PROCESSOR PRIMER...\$4.50. We start by designing a small computer and look at how the microprocessor plays its role in making the job work effectively.

THE 6809 COMPANION...\$5.00. Discusses the features of the 6809 and a reference work for 6809 programmers.

MICRO INTERFACING CIRCUITS...Book 1...\$5.75. Coverage of how the expansion card interface Penmeter can interface add-on of all kinds to the home computer to transform it into a sophisticated piece of control equipment.

ART OF PROGRAMMING THE 16K ZX81...\$6.25. What happens when you add the RAM pack. Scrolling, PEEK, POKE, Page graphics and more.

EASY ADD-ON PROJECTS FOR SPECTRUM, ZX81, & ACE...\$6.50. Pulse detector, picture digitizer, 5 key pad, mouse, controls, light pen and more.

BASIC & PASCAL IN PARALLEL...\$4.25. Develops programs in both languages simultaneously. Sample programs illustrate structure.

AN INTRODUCTION TO PROGRAMMING THE ORIC-1...\$5.00. A new authoritative manual for owners of this new personal computer.

ELECTRONIC TECHNOLOGY TODAY INC. HOE # 4
P.O. Box 240, Massapequa Park, NY 11762-0240

Number of books ordered

Total Price of Books _____

Sales Tax (NY State Residents only) _____

Shipping and Handling (75¢ 1 or 2 books 30¢, each add'l book) _____

TOTAL ENCLOSED _____

Name _____

Address _____

City _____ State _____ Zip _____

PRICES GOOD UNTIL June 30, 1985

7400

74F00

74ALS00

DISK CONTROLLERS

Table with columns: Part No., Price, Part No., Price, Part No., Price. Lists various 7400 series components.

Table with columns: Part No., Price, Part No., Price, Part No., Price. Lists various 74F00 series components.

Table with columns: Part No., Price, Part No., Price, Part No., Price. Lists various 74ALS00 series components.

Table with columns: Part No., Price, Part No., Price. Lists disk controllers.

MICROPROCESSOR COMPONENTS

MICROPROCESSOR CHIPS

Table with columns: Part No., Price, Part No., Price, Part No., Price. Lists microprocessor chips.

Digitalker

DT1050 - Applications, teaching aids, digitalizers, clocks, autoconverters, language translators, etc. The DT1050 is a standard DIGITALER set enclosed with 137 modular...

DT1050 Digitalker Processor Chip \$34.95 ea. MMS4104 Processor Chip \$14.95 ea.

DT1057 - 4 pins on the DT1050 necessary from 137 to cut 740 series lead. 10 pins on spec. Part No. DT1057 \$24.95 ea.

INTERSIL

Table with columns: Part No., Price, Part No., Price. Lists Intersil components.

30009 1983 INTERSIL Data Book (1986) \$9.95

74HC High Speed CMOS

Table with columns: Part No., Price, Part No., Price. Lists 74HC High Speed CMOS components.

74C-C/MOS

Table with columns: Part No., Price, Part No., Price. Lists 74C-C/MOS components.

LINEAR

Table with columns: Part No., Price, Part No., Price. Lists linear components.

6500 6800/8080 SERIES

Table with columns: Part No., Price, Part No., Price. Lists 6500 6800/8080 series components.

8080/8085 SERIES

Table with columns: Part No., Price, Part No., Price. Lists 8080/8085 series components.

74S/PROMS*

Table with columns: Part No., Price, Part No., Price. Lists 74S/PROMS* components.

CA-LINEAR

Table with columns: Part No., Price, Part No., Price. Lists CA-LINEAR components.

CD-CMOS

Table with columns: Part No., Price, Part No., Price. Lists CD-CMOS components.

310 Minimum Order - U.S. Funds Only. CA Residents Add 6% Sales Tax. Shipping: Add plus \$1.50 Insurance. Send \$1 Postage for FREE 1983 Jameco Catalog. Prices Subject to Change. Send stamped, self-addressed envelope to receive a Monthly Sales Flyer - FREE!



1355 SHOREWAY ROAD, BELMONT, CA 94002. 508 PHONO ORDERS WELCOME - (415) 592-8029 - Telex: 176043

CIRCLE 410 ON FREE INFORMATION CARD



Take home a world champion.

\$85* gets you a technical knockout.
The Fluke 70 Series.
Winners of the digital vs. analog battle.

Since their debut, they've become the worldwide champions of the industry.

Never before have such tough, American-made meters offered so many professional features at such unbeatable prices.

Each comes with a 3-year warranty, 2,000+ hour battery life, and instant autoranging.

You also get the extra resolution of a 3200-count LCD display, plus a responsive analog bar graph for quick visual checks of continuity, peaking, nulling and trends.

Choose from the Fluke 73, the ultimate in simplicity. The feature-packed Fluke 75. Or the deluxe Fluke 77, with its own protective holster and unique "Touch Hold" function** that captures and holds readings, then beeps to alert you.

So don't settle for just a contender. Take home a world champion.

For your nearest distributor or a free brochure, call toll-free anytime
1-800-227-3800, Ext. 229. From outside the U.S., call 1-402-496-1350, Ext. 229.

**FROM THE WORLD LEADER
IN DIGITAL MULTIMETERS.**



FLUKE 73	FLUKE 75	FLUKE 77
\$85*	\$99*	\$129*
Analog/digital display	Analog/digital display	Analog/digital display
Volts, ohms, 10A, diode test	Volts, ohms, 10A, mA, diode test	Volts, ohms, 10A, mA, diode test
Autorange	Audible continuity	Audible continuity
0.7% basic dc accuracy	Autorange/range hold	"Touch Hold" function
2000+ hour battery life	0.5% basic dc accuracy	Autorange/range hold
3-year warranty	2000+ hour battery life	0.3% basic dc accuracy
	3-year warranty	2000+ hour battery life
		3-year warranty
		Multipurpose holster

* Suggested U.S. list price, effective July 1, 1984.
** Patent pending.

FOR TECHNICAL DATA CIRCLE 415

Copyright © 1984, John Fluke Mfg. Co., Inc. All rights reserved. Ad No. 4701-70

FLUKE®